

PRACTICAL WIRELESS

DECEMBER 1964

2¢

FREE inside!

**BLUEPRINT
TO BUILD
SHORT-WAVE
SUPERHET**

and
simple
**ALIGNMENT
OSCILLATOR**

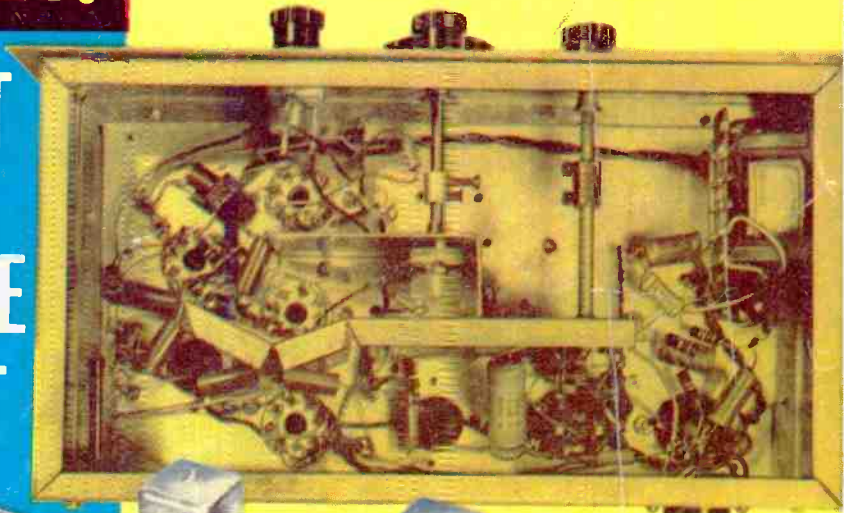

**A NEW RECEIVER
FOR THE S.W.L.**

3 Short Plus M.W. and L.W. Coverage

ADCOLA

ADCOLA PRODUCTS LTD.
(Incorporated in England)

SOLDERING INSTRUMENTS AND EQUIPMENT



DESIGNED FOR
THE AMATEUR'S
RADIO STATION

ILLUSTRATED
List No. 70 $\frac{1}{8}$ " BIT
IN
PROTECTIVE
SHIELD
List No. 68

for catalogue apply direct to:—

Sales and Service Dept.,

**ADCOLA PRODUCTS LTD.,
ADCOLA HOUSE,
GAUDEN ROAD, LONDON, S.W.4**

Telephones
MACaulay 4272 & 3101

Telegrams
SOLJOINT LONDON SW4

'SUPER SIX' LONG & MED. WAVE TRANSISTOR RADIO KIT NOW ONLY £4.17.6 (post 5/-)

Owing to a fortunate bulk component contract the price of this model is now reduced to £4.17.6. Purchasers who have already paid the previous higher price will have the difference refunded on application.



- All new parts.
- 6 transistors and diode.
- 350mW output.
- Superhet circuit, Ferrite rod aerial.
- Weymouth Radio printed circuit board.
- Component positions and references printed on back of board.
- Nicely styled wooden cabinet, 11 x 7½ x 3½ in.
- Vinyl covered in various colours.
- 6 x 4 in. speaker giving good bass and treble response.
- Full instruction booklet 2/-. Free with kit.
- I.F. frequency 470 kc/s.
- Lining up service if required.
- All parts supplied separately. Write for list. S.A.E. please.
- Set can be supplied fully built for £6.17.6 tax paid and carriage paid.
- 9v. battery required. VT9 or P.P.9 (3/9 with kit).

"MINOR" RECORD PLAYER WITH "MAJOR" PERFORMANCE fully built, rexine covered, 10 x 7 x 5 in. 4 transistor amplifier. Good Volume. 7in. records 45 and 33 r.p.m. £6.7.6. (Post 5/-). Battery 3/9.

TRANSISTORS

Packet of 3 coded RF transistors (equivalent of OC44/5) 7/6 post paid. Set of 6 transistors and diode with circuit diagram. Neatly packed in foam-lined box; useful for presentation. 15/- post paid.

TRADE SUPPLIED

ELECTRONICS (Camberley) Ltd.
15 Victoria Avenue, Camberley, Surrey.
(closed Saturdays)

JACKSON

the big name in **PRECISION** components



Precision built radio components are an important contribution to the radio and communications industry. Be sure of the best and buy Jackson Precision Built Components.

"00" Twin Condenser



Designed for use in miniature transistor receivers. The front (aerial) section is 208 pF to provide coverage for medium waves, and the rear section is 176 pF, which may be padded to match the oscillator—very robust yet lightweight. Front area 1½ in. x 1½ in. x 1½ in. deep.

In the "ten five" receiver used 3 gang type F price 18/6. 2 air tune pF 6/9. each caliband drive at 28/-.

JACKSON BROS. (LONDON) LTD.

(Dept. P.W.) KINGSWAY-WADDON,
CROYDON, SURREY

Phone: Croydon 2754-5. Grams: Walfilco, Souphone, London

SURBITON PARK RADIO LTD.

ALL ORDERS DESPATCHED SAME DAY ● WE PAY POSTAGE AND INSURANCE MONEY REFUND GUARANTEE

LEADING STOCKISTS OF MARTIN RECORDAKITS AND AUDIOKITS

MARTIN RECORDAKITS		Dep.	£	Mthly. pmt. of
HALF TRACK				
TAPE AMPLIFIER FOR STUDIO DECK with ready wired printed circuit control and input panels, muting and output transformers, knobs, pins, screws, etc. EP86, BCN4, EZ80, 6M85 and 2 EL84. 3 watt output. Magic eye, Radio and Mic. Inputs. Ex. speaker socket. Tone and Monitor controls (can be used as an amplifier)				
		47/-	8	25/6
COLLARO STUDIO DECK. Very latest model, 3 speeds, 3 motors and 4 tape spools				
		44/-	8	24/8
CASE for above with 8 x 6in. speaker, two-tone grey head				
				£5. 5.0
COMPLETE KIT with tape and microphone				
		120/-	12	44/-
QUARTER TRACK				
TAPE AMPLIFIER FOR STUDIO DECK as above				
		52/-	8	27/6
CASE as above with speaker, two-tone grey				
				£5. 5.0
COLLARO STUDIO DECK fitted Marriott "X" series head				
		58/-	12	20/6
COMPLETE KIT with tape and microphone				
		136/-	12	49/10
TAPE PRE-AMPLIFIERS				
HALF TRACK FOR STUDIO deck, 300 mV out				
		34/-	6	25/8
QUARTER TRACK as above				
		39/-	6	28/4
TAPE HEADS				
BRADAMATIC Half track Record/Playback and Erase-on plate				
				£118.6

MARTIN AUDIOKITS		Dep.	£	Mthly. pmt. of
The new MARTIN all-transistor TEN WATT AMPLIFIER kits represent excellent value for money. Each unit is complete, requiring only to be connected to the next. We show only the popular units here. Others are available. Leaflet upon request.				
UNIT 1. FIVE INPUT SELECTOR. Size 8 1/2 x 3in. Mag. P.U., Crystal P.U., Radio, Mic, Tape Head. 9-15 Volts. Must be used with Unit 4				
				£2. 7.6
UNIT 4. PRE-AMPLIFIER AND CONTROL. Size 6 1/2 x 2 1/2in. Volume on off, Bass and Treble control. 9-15 Volts. Must be used with Unit 1				
				£3. 2.6
UNIT 7. MAIN AMPLIFIER. 10 watts. 6-transistor Transformerless Push-pull output. Mounted on fit sink. 15 ohms output. 40 Volts supply				
				£3.12.6
UNIT 8. POWER SUPPLY. Gives 9 and 40 Volts. 6-15 Volts. Transformer, rectifier and smoothing				
				£2.15.0
CONTROL PANEL for Units band 4				
				10.0
ALL FOUR ABOVE UNITS WITH PANEL. 15 ohms output				
				£15. 8.0
UNIT 5. MAIN AMPLIFIER. As Unit 7 but 3 ohms output. 25 Volts				
		62/-	12	22/6
UNIT 6. POWER SUPPLY. As Unit 8, use with Unit 5				
				£2.12.6
ALL FOUR UNITS 1, 4, 5 & 6 WITH PANEL. 5 ohms output				
				£14. 5.0
STEREO VERSIONS NOW AVAILABLE. LEAFLET UPON REQUEST.				

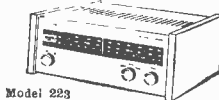
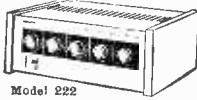

NEW ARMSTRONG TUNERS AND AMPLIFIERS

224 F.M. Tuner S/Powered	£22.10.0	90/-	12	33/-
225 A.M./F.M. Tuner S/Powered	£28.15.0	115/-	12	42/2
127 MONO Tuner/5 watt amp	£26.10.0	106/-	12	38/10
227 MONO Tuner/10 watt amp	£33.18.0	138/-	12	49/8
127 STEREO Tuner/5 - 5 watt amp	£37.10.0	150/-	12	55/-
227 STEREO Tuner/10 + 10 watt amp	£48.15.0	195/-	12	71/6
228 STEREO AS 227 plus Max. P.U.	£56. 0.0	214/-	12	82/1
228 STEREO 10 + 10 watt amp	£27.10.0	110/-	12	40/4
SHELF MOUNTING TEAK CASE £3.10.0 EXTRA				
ALL MODELS SEND FOR NEW LEAFLET GIVING FULL TECHNICAL DETAILS.				

MONO AMPLIFIERS

LINEAR L45/A 3 valve, 3 watt	£6. 8.0			
DULCI G60 Integrated, 5 watts, ECL76 valve	£13. 2.6	52/6	12	19/8
TRIPLETONE HI-FI MAJOR 10 watts output, 2 EL84	£15.18.9	64/9	12	23/3
LEAK TL12 10 watt MAIN AMPLIFIER ONLY	£29. 0.0	80/-	12	29/4
LEAK VARISLOPE Mono Pre-amplifier	£15.15.6	63/-	12	23/1
DULCI DPA15 15 watt with 12 valve pre-amp.	£26. 3.0	105/-	12	38/8

STEREO AMPLIFIERS

ROGERS CADET Mk. II with P.A. 4 ECL86 valve	£26.15.0	107/-	12	39/2
LEAK TRANSISTOR STEREO 30 P.A. and Main amp.	£49.10.0	198/-	12	72/7
LEAK STEREO 20 P.A. and main amplifier, complete	£55. 9.0	229/-	12	80/8

HI FI AND GUITAR LOUDSPEAKERS

GOODMANS AXIETTE 8 inch	£5. 7.6			
GOODMANS AXIOM 10 inch	£8. 5.1			
GOODMANS 5K/30/XL Tweeter and crossover 77. 7.0	£20. 0.0			
GOODMANS X05000. £2.0.11. X0950. £5.10.11	£10.17.6	43/8	8	24/3
GOODMANS 201 F.M. unit Full range, 20 watt	£15. 4.8	61/-	12	22/4
GOODMANS GUITAR SPEAKER Audium 81 15"	£25. 0.0	100/-	12	38/8
W.B.HF1012 10 inch unit, 3, 5 & 15 ohms	£4.12.0			
WHARFEDALE SUPER 3 Tweeter	£5.10.8			
WHARFEDALE SUPER 5 Tweeter	£5.19.7			
WHARFEDALE SUPER 8 RS/DD	£6.14.2			
WHARFEDALE SUPER 10 RS/DD. Full range	£10.18.0	44/-	8	24/3
WHARFEDALE RS12/DD 12in. unit, Full range	£11.10.0	46/-	8	25/6
WHARFEDALE SUPER 12 RSDD	£17.10.0	70/-	12	25/8
LEAFLETS BY WHARFEDALE AND GOODMANS AVAILABLE ON REQUEST				

F.M. TUNERS

TRIPLETONE F.M. TUNER, Less power	£13.19.6	45/-	12	20/8
TRIPLETONE F.M. TUNER, With power	£16.14.8	63/-	12	23/1
JASON JTV2 F.M. and T.V. sound, 6-switched, auto-powered	£22. 5.0	88/-	12	33/7

GRAMOPHONE UNITS

NEW BSR UA25	£6. 6.0			
B.S.R. DA14 with T.M. Mono cartridge	£25.10.0	238/-	6	22/-
GARRARD SRP10, Single player, Mono cart	£5.10.0			
GARRARD AUTOSLM, 4 speed changer, Mono	£8.12.6			
GARRARD AT6 AUTOSLM DE LUXE, Mono	£10.10.0	45/-	8	23/4
GARRARD AT6/5/P (toprvd Autolinn (Stereo))	£9. 0.0	36/-	6	27/4
GARRARD AT5/3000 LM as AT6 with slip arm (Stereo)	£11.12.0	46/6	8	25/9
GARRARD "DECADEK" Single Player with Decca Peram Cartridge	£15.15.0	65/-	12	23/1
GARRARD 4HP Transcription Unit, Mono	£17. 0.0	68/-	12	24/11
GARRARD LAB "A" Transcription changer	£19.14.9	78/-	12	29/11
GARRARD 301 STROBE Transcription unit	£22. 0.0	85/-	12	32/3
PHILIPS AG1016, Stereo cartridge, will change 7in. records with adaptor, 10% extra	£12.12.0	50/6	12	18/6
GOLDRING G158 with arm but less cartridge	£17. 1.0	69/-	12	24/11
GOLDRING G170 with arm but less cartridge	£27. 9.4	111/4	12	60/1
GOLDRING "88" Transcription, less arm	£18.15.5	75/5	12	27/8

GUITAR SPEAKERS

PANEL 12in. Heavy duty unit, 20 watt	£5. 5.0			
GOODMANS AUDIOM 51 12in. 15 watt BASS	£6. 2.9	26/8	6	27/8
WHARFEDALE W12/EG 12in. 15 watt LEAD	£10.10.0	42/-	8	23/6
WHARFEDALE W15/EG 15in. 15 watt BASS	£17.10.0	70/-	12	25/8
GOODMANS AUDIOM 81 15in. 50 watt BASS	£29.15.0	119/-	12	43/7
GOODMANS AUDIOM 81 12in. 20 watt LEAD or BASS	£12. 7.8	47/8	12	21/1
WRITE FOR GOODMANS LEAFLET "LOUD-SPEAKERS FOR ELECTRIC GUITARS."				

GUITAR AMPLIFIERS

LINEAR DIATONIC 12 watt, 2 inputs	£13. 2.8	52/6	12	19/3
LINEAR CONCORD 30 watt with COVER	£19. 4.6	77/-	12	28/2
LEAK TL25 with Pre-amp, 25 watt	£42. 5.0	159/-	12	61/11
LEAK TL50 with Pre-amp, 50 watt	£51. 6.0	205/-	12	75/3

MICROPHONES AND FLOOR STANDS

RESLO RBH/T Ribbon	£11. 2.6	44/8	8	24/9
RESLO RBH/TS Ribbon with on/off switch	£13.10.0	64/-	12	18/9
RESLO Heavy Duty Floor Stand	£7. 0.0			
PIEZO DM304 Dual impedance with switch	£4.10.0			
MIZCO BM3 Crystal with switch	£2.10.0			
JAP. FLOOR STAND	£6. 3.0			

EASILY REACHED BY FREQUENT TRAINS FROM WATERLOO TO SURBITON

SURBITON PARK RADIO LTD.

48, SURBITON ROAD, KINGSTON-UPON-THAMES, SURREY

Phone: KIN 5549

- Order for Cash. C.O.D. or Terms.
- Hours 9 a.m.-6 p.m. (1 p.m. Wed.)
- Open Lunch Time and all day Sat.

- all these and hundreds more

Mon.—Sat. 9 a.m.—5.45 p.m. Wednesday 1 p.m.
Lunch 1.30—2.30

Special 24 Hour Express Mail Order Service

AZ31 19/6	EDP89 7/6	EP89 8/-	EZ41 7/-	PL88 9/-	U20 10/-	UL84 8/-	5Y30/OT 8/6	6B6 6/6	6Y90 4/-	12B46 7/6
DAF91 4/6	ECSN1 4/-	EP91 4/-	EZ80 5/6	PL84 7/-	U26 10/6	UL41 7/6	6A7 8/6	6C100 9/6	6V6GT 7/6	12K68 7/6
DAF96 6/6	ECS89 6/6	EP92 4/-	EZ81 5/6	PL85 7/6	U191 18/6	U85 5/6	12/6	6C116 10/6	6X4 4/6	12K70T 5/6
DF91 3/-	ECS84 5/6	EP88 10/-	GZ82 10/6	PL86 10/-	H301 18/6	V4B 15/-	6A9 8/6	6C6 5/6	6X5G 5/-	12K8GT 10/-
DF96 6/6	ECS84 6/6	EP88 8/-	HL14(D) 11/6	PL80 11/6	U801 19/6	VR150/30 7/-	6A13 3/6	6F6 5/6	6X5GT 8/6	12Q7GT 6/-
DK91 5/6	ECS85 7/-	EP184 8/-		PL81 7/6	CAB380 8/6		6AM6 4/-	6H8 2/-	6Y30L2 12/6	12Q7 12/-
DK92 7/-	ECH35 12/6	EL33 12/6	KT66 17/6	PL82 7/6	U432 8/6	W81M 6/-	6A45 5/6	6F5GT 7/6	7H7 9/6	19A45 8/-
DK95 7/6	ECH44 8/6	EL41 9/-	KT81 10/6	PL83 7/6	UB41 8/-	X61M 13/6	6A79 4/6	5/6	7U5 10/6	20Z1 7/6
DL92 5/-	ECH81 7/-	EL42 9/-	RTW81 7/-	PL84 7/-	UBF90 7/6	X78 26/-	6B8G 2/6	6J70 5/-	7/6	85L9GT 8/6
DL94 7/-	ECH83 8/-	EL84 5/6	MU14 8/6	PY82/3 10/-	UBF89 7/6	X79 40/-	6BA6 5/6	6K7G 2/6	717 8/-	20V4 8/6
DL96 6/6	ECL80 6/6	EL95 9/6	N78 22/6	PY81 6/-	UCH42 8/6	1H5 5/6	6B66 5/6	6K7GT 2/6	787 18/-	35Z4 6/6
EABC80 5/6	EUL82 8/6	EM80 8/-	OZ4 6/-	PY82 8/6	UCH81 7/-	185 4/6	6B66 8/-	6K8G 4/-	774 2/-	30D5 6/6
EAP42 3/6	ECL86 8/6	EM81 8/-	PC84 6/-	PY89 7/6	UCL82 8/6	1T1 3/-	6B17 10/6	6K8GT 9/6	8D3 4/-	80 7/6
EB11 2/6	EP41 7/6	EM84 8/-	PC89 8/6	PY80 8/6	UC183 9/-	384 8/-	6BW6 9/-	6LGG 7/6	10F1 10/-	807 9/6
EB41 8/-	EP90 8/-	EY61 7/6	PCF80 7/6	PZ30 12/0	UF41 7/6	3V4 7/-	6BW7 9/-	6Q76 6/-	12AH9 12/-	
EBF80 7/6	EP85 5/-	EY86 7/6	PCF86 8/6	EP91 3/-	UF89 7/-	6U49 4/6	6C4 3/6	6Q7GT 10/-	12AU7 5/6	
EBF85 8/-	EP86 7/-	EZ40 7/-	POL82 7/6	U14 9/-	UL41 7/6	5V4G 9/-	6C80T 8/-	10U5G 7/6	19AX7 8/6	

COMPLETE VALVE LIST FREE WITH ORDER
OBSOLETE VALVES A SPECIALITY
SEND FOR QUOTATION

TERMS OF BUSINESS C.W.O. or C.O.D.
4/2 PACKING CHARGE ON ALL C.O.D. ORDERS.
POSTAGE 6d. per VALVE

BRAND NEW TRANSISTORS			
OC35 10/-	OC72 8/-	OC81D	5/-
OC42 6/-	OC74 8/-	OC81m/pr	12/6
OC44 5/-	OC75 8/-	OC82	8/-
OC45 5/-	OC77 8/-	OC82D	6/-
OC71 5/-	OC81 5/-	OC170	6/-
SILICON RECTIFIERS			
400 volts 350 mA			7/6 each

SETS OF VALVES			
IR5, IS5, IT4, 354, 3V4	Set of 4, 17/-
DAF91, DF91, DK91, DL92, DL94	Set of 4, 17/-
DAF96, DF96, DK96, DL96	Set of 4, 25/-

R.S.T. VALVE MAIL ORDER CO. Tel MITCHAM 6202 Open Daily to Callers 211a STREATHAM ROAD MITCHAM SURREY

FREE TO AMBITIOUS ENGINEERS

— THE LATEST EDITION OF ENGINEERING OPPORTUNITIES

Have you sent for your copy?
ENGINEERING OPPORTUNITIES is a highly informative 156-page guide to the best paid engineering posts. It tells you how you can quickly prepare at home for a recognised engineering qualification and outlines a wonderful range of modern Home Study Courses in all branches of Engineering. This unique book also gives full details of the Practical Radio & Electronics Courses, administered by our Specialist Electronics Training Division—the B.I.E.T. School of Electronics, explains the benefits of our Employment Dept. and shows you how to qualify for five years promotion in one year.

We definitely Guarantee "NO PASS — NO FEE"

Whatever your age or experience, you cannot afford to miss reading this famous book. If you are earning less than £25 a week, send for your copy of "ENGINEERING OPPORTUNITIES" today—FREE.

WHAT IS YOUR PET SUBJECT?

- Mechanical Eng.,
- Electrical Eng.,
- Civil Engineering,
- Radio Engineering,
- Automobile Eng.,
- Aeronautical Eng.,
- Production Eng.,
- Buildings, Plastics,
- Draughtsmanship,
- Television, etc.

GET SOME LETTERS AFTER YOUR NAME!

- A.M.I.Mech.E.
- A.M.I.C.E.
- A.M.I.Prod.E.
- A.M.I.M.I.
- A.I.O.B.
- A.F.R.Ac.S.
- B.Sc.
- A.M.Brit.I.R.E.
- City & Guilds
- Gen. Cert. of Education
- Etc., etc.

PRACTICAL EQUIPMENT

- Basic Practical and Theoretic Courses for beginners in Radio, T.V., Electronics, Etc., A.M.Brit.I.R.E. City & Guilds Radio Amateurs' Exam. R.T.E.B. Certificate P.H.G. Certificate
- Practical Radio
- Radio & Television Servicing
- Practical Electronics
- Electronics Engineering
- Automation

INCLUDING TOOLS!

The specialist Electronics Division of B.I.E.T. NOW offers you a real laboratory training at home with practical equipment. Ask for details.

B.I.E.T. SCHOOL OF ELECTRONICS



POST COUPON NOW!

Please send me your FREE 156-page "ENGINEERING OPPORTUNITIES"
 (Write if you prefer not to cut page)
 NAME _____
 ADDRESS _____

SUBJECT OR EXAM THAT INTERESTS ME _____ SE/21

THE B.I.E.T. IS THE LEADING ORGANISATION OF ITS KIND IN THE WORLD

R.S.C. BRADFORD, BRISTOL, BIRMINGHAM, DERBY, DARLINGTON, EDINBURGH, GLASGOW, HULL, LEICESTER, LEEDS, LIVERPOOL, LONDON, MANCHESTER, MIDDLESBROUGH, SHEFFIELD

PAGE 708 FOR ADDRESSES

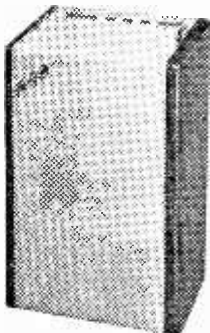

BASS-MAJOR 30 WATT GUITAR AMPLIFIER

A MULTI-PURPOSE HIGH FIDELITY, HIGH OUTPUT UNIT FOR VOCAL AND INSTRUMENTALIST GROUPS

Eminently suitable for bass, lead or rhythm guitar and all other musical instruments

- ★ Incorporating two 12in. heavy duty 25-watt high flux (17,000 lines) loudspeakers with 2in. diameter speech coils. Designed for efficient handling full output of amplifier at frequencies down to 25 c.p.s.
- ★ Dual Cone in second speaker reproduces frequencies up to 17,000 c.p.s.
- ★ Heavily made cabinet of conventional size 24 x 21 x 14in. has an exceptionally attractive covering in two contrasting tones of Vynair.
- ★ For 200-250 v. to 50 c.p.s. A.C. mains operation.
- ★ Four Jack socket inputs and two independent vol. controls for simultaneous connection of up to four instrument pick-ups or microphones.
- ★ Separate bass and treble controls providing more than adequate "Boost" or "Cut".
- ★ LEVEL frequency response throughout the audible range.
- ★ SUPERIOR TO UNITS AT TWICE THE COST.

39½ Gns.

Send S.A.E. for leaflet OR DEPOSIT of £4.3.0 and 12 monthly payments of £3.9.11. Carr. 17/6.

BASS-REGENT 50 WATT GUITAR AMPLIFIER

AN EXCEPTIONALLY POWERFUL HIGH QUALITY ALL-PURPOSE UNIT

For bass, lead or rhythm guitar and all other musical instruments

For vocalist, gram, radio, tape and general P.A.

- ★ UNUSUALLY POWERFUL LOUDSPEAKER COMBINATION consisting of a FANE HIGH FLUX 15 in. 30 watt unit and a FANE 12 in. 20 watt unit with extended frequency response.
- ★ 4 Jack Socket Inputs and two independent volume controls for simultaneous use of up to four instruments, pickups, or mikes.
- ★ Separate Cabinets fully covered with Rexine and Vynair in contrasting tones for Amplifier and Speakers.
- ★ Separate Bass and Treble controls for "Boost" and "Cut".

Send S.A.E. for leaflet. Or call at one of our many branches and compare the Bass-Regent with units at more than 3 times the cost.

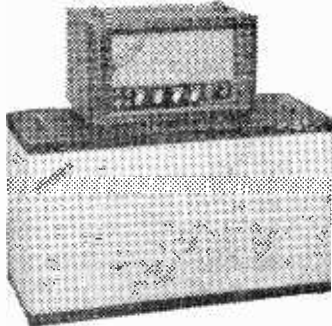

44 Cash Price GNS. Carr. 19/6

Or Deposit £4.18.6 and 12 monthly payments of £3.16.8

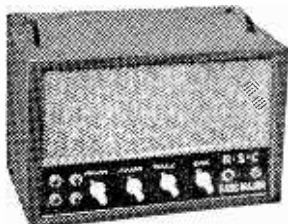

R.S.C. G15 15 WATT LEAD OR RHYTHM GUITAR AMPLIFIER

High-fidelity push-pull output. Separate bass and treble "cut" and "boost" controls. Twin separately controlled inputs so that two instruments or "mike" and pick-ups can be used at the same time. Loud-speaker is a heavy duty high flux 12in. 20 watt model with cast chassis. Cabinet is well made and finished as Junior Model. Size approx. 18 x 18 x 8in. Only **19 Gns.** Carr. 10/.

Send S.A.E. for leaflet. Or DEPOSIT 39/11 and twelve monthly payments of 33/4.

RSC G5 GUITAR AMPLIFIER

5-watt high quality output. Incorporating high flux 12in. 10 watt 12,000 line loud-speaker. Sensitivity 50 m.v. High Impedance Jack Input. Handsome strongly made cabinet (size 14 x 14 x 7in. approx.) finished in complimentary shades of Rexine/Vynair. 200-250 A.C. mains. **£9.19.6** Or DEPOSIT 22/3 and 9 monthly payments of 22/8. Carr. 7/6.



30W. HIGH QUALITY AMPLIFIER

A Four Input, two volume control, H-FI unit with separate Bass and Treble "Cut" and "Boost" controls. Designed for vocal or instrumental groups. For Bass, Lead or Rhythm Guitar. Six Mullard or Brimar latest type valves. Housed in strong Rexine covered-cabinet with twin chrome carrying handles. Attractive black and gold perspex fascia plate. For 200-250 v. A.C. mains. Output for 3 or 15 ohm speakers. Send S.A.E. for leaflet.

16½ Carr. 10/- or Deposit £2.1.6 and 12 monthly payments of £1.8.4

R.S.C. B20 BASS GUITAR AMPLIFIER

A highly efficient unit incorporating a massive 15in. high flux loud-speaker specially constructed to withstand heaviest load conditions. Rating 25 watts. Individual bass and treble controls give ample "boost" and "cut". Two high impedance Jack socket inputs are separately controlled. All controls are conveniently positioned in a recess on top of the cabinet. Cabinet is of substantial construction and attractively finished in two contrasting tones of Rexine and Vynair. Size approx. 24 x 21 x 13in. Operation from 200-250 v. 50 c.p.s. A.C. mains. Send S.A.E. for leaflet **29½** Gns. Or deposit £3.2.0 and 12 monthly payments of 51/8. Carr. 17/6.

LINEAR TREMOLO/PREAMP. UNIT Designed for introducing the Tremolo effect to any amplifier which is fitted with a reserve power supply point for smoothed H.T. and 6.3 v. A.C. L.T. The unit plugs into power supply point and any input socket of amplifier. Controls are Speed (frequency of interruptions). Depth (for



R.S.C. COLUMN SPEAKERS

Finished in polished veneered walnut. Ideal for vocalists and Public Address. Normally supplied for 15 ohm matching but can be supplied for 100 v. line for 35/- extra.

Type C57, 10-15 watts. Fitted five 6 x 4 elliptical speakers. Overall size approx. **9 Gns.** Carr. 26 x 9 x 4ins. 7/6.

Type C58, 15-20 watts. Fitted five 8in. high flux speakers. Overall size approx. **12 Gns.** Carr. 10 x 5ins. 10/-

Or Deposit 27/6 and 12 monthly payments 26/10.

HEAVY DUTY LOUDSPEAKERS IN SUBSTANTIAL REXINE COVERED CABINETS. Type BG1. Suitable for Bass Guitar. Speaker Unit 15in., High Flux, 15 ohms, 30 watts. Cabinet size approx. 24 x 21 x 13in. Only **19½** gns. Or Deposit 43/- and 12 monthly payments of 34/-. Type BG2. Suitable Bass and Lead Guitar. Two 12in. high flux 15 ohm 25 watt speakers, one with aluminium speech coil and dual cone to provide smooth frequency response from 25 to 17,000 c.p.s. Cabinet size approx. 30 x 21 x 14in. Covered in two contrasting tones of Grey Vynair and Rexine. Rating 50 watts. Only **29 gns.** Or Deposit **£3.7.6** and 12 monthly payments of 50/-.

heavy or light effect). Volume and Switch. Three sockets are for two inputs and Foot Switch. **ONLY 4 Gns.**

R.S.C. (Manchester) Ltd.

MAIL ORDERS TO:

54 WELLINGTON STREET, LEEDS 1

Terms: C.W.O. or C.O.D. No C.O.D. under £1. Postage 2/9 extra under £2. 4/6 extra under £5. Trade Supplied.

S.A.E. with all enquiries, please. Personal shoppers welcomed at any of the branches below. Open all day Saturday.

BRADFORD 54 Morley Street.
Nr. Alhambra Theatre
(Half-day Wednesday)

BRISTOL 14 Lower Castle Street
Half-day Wednesday

BIRMINGHAM 6 Gt. Western Arcade, opp.
(No half day) Snow Hill Station

DERBY 26 Osmaston Rd., The Spot
(Half-day Wednesday)

DARLINGTON 13 Post House Wynd
(Half-day Wednesday)

EDINBURGH 133 Leith Street
(Half-day Wed.)

GLASGOW 326 Argyle Street
(Half-day Tuesday)

HULL 51 Savile Street
(Half-day Thursday)

LEICESTER 32 High Street
(Half-day Thursday)

LEEDS 5-7 County (Maces) Arcade
(No half-day closing)

LIVERPOOL 73 Dale Street
(No half-day closing)

LONDON 238 Edgware Road
(Half-day Thursday)

MANCHESTER 8-10 Brown St.
(Market Street)
(No half-day)

Callers also welcome at our extensive new premises at 60A/60B Oldham St.

MIDDLESBROUGH 106 Newport Rd.
(Half-day Wednesday)

SHEFFIELD 13 Exchange Street.
Castle Market Bldgs.
(Half-day Thursday)

EX. GOV. 2 V. ACCUMULATORS.
16 A.II. Size 7 x 4 x 2in. Brand new,
4/9 each. Three for 12/6. Carr. 5/-.

JASON FMTI V.H.F./F.M. Radio Tuner design. Total cost of parts including valves, Tuning dial, Escutcheon, etc., **£8-10-6.**

LINEAR L-65 MINIATURE 4-5 WATT QUALITY AMPLIFIER. Suitable for any record playing unit and most microphones. Negative feedback 12dB. Separate Bass and Treble Controls. For mains 200-250 v. 50 c/s. Output for 2-3 ohm speaker. Mullard valves E290, ECC83, EL84 size only 7 x 5 x 5 1/2 in. high. Guaranteed 12 months. Only 6 gns. Send S.A.E. for leaflet. Terms: Deposit 24/9 and 5 monthly payments of 24/9.

R.S.C. BATTERY TO MAINS CONVERSION UNITS

R.S.C. BATTERY TO MAINS Type BM1. An all-dry battery eliminator. Size 5 1/2 x 4 1/2 x 2 in. approx. Completely replaces battery supplying 1.4 v. and 90 v. where A.C. mains 200-250 v. 50 c/s is available. Suitable for all battery portable receivers requiring 1.4 and 90 v. This includes low consumption types. Complete kit with diagrams, 39/9, or ready to use, 46/6.

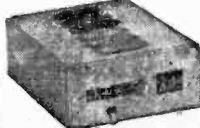

R.S.C. 30-WATT ULTRA LINEAR

HIGH FIDELITY AMPLIFIER A10
A highly sensitive Push-Pull high output unit with self-contained Pre-amp. Tone Control Stages. Certified performance figures compare equally with most expensive amplifiers available. Hum level 70 dB down. Frequency response ± 3 dB 300-20,000 c/s. A specially designed sectionally wound ultra linear output transformer is used with 807 output valves. All components are chosen for reliability. Six valves are used EF86, EF86, ECC83, 807, 807, GZ34. Separate Bass and Treble Controls are provided. Minimum input required for full output is only 12 millivolts so that ANY KIND OF MICROPHONE OR PICK-UP IS SUITABLE. The unit is designed for CLUBS, SCHOOLS, THEATRES, DANCE HALLS or OUTDOOR FUNCTIONS, etc. For use with Electronic ORGAN, GUITAR, STRING BASS, etc. For standard or long-playing records. **OUTPUT SOCKET PROVIDES L.T. and H.T. for RADIO FEEDER UNIT.** An extra input with associated vol. control is provided so that two separate inputs such as Gram and "Mike" can be mixed. Amplifier operates on 200-250 v. 50 c/s. A.C. Mains and has output for 3 and 15 ohm speakers. Complete Kit of parts with fully punched chassis and notes, diagrams and instructions. If required perforated cover with carrying handles can be supplied for 19/9. The amplifier can be supplied factory built with EL34 output valves and 12 months' guarantee, for 14 gns. Send S.A.E. for leaflet.

11 Gns.

Carr. 10/-.

Terms: Deposit 17/9 and 9 monthly payments of 17/9. Only 27-19-6. Carr. 8/6. For larger types see page 618.

FANE HEAVY DUTY HI-FI SPEAKERS

12in. 15 ohms. Cast chassis. Exceptionally robust. 2in. diam. Voice Coil Assemblies. £2-10-2watt, 5 gns. 122/10A 20watt, 8 gns. 122/12 20watt, 7 gns. 122/12A 20watt, 8 gns. 122/14 22watt, 9 gns. 122/14A 22watt, 10 gns. 122/17 25watt, £1-17-6 122/17A 25watt, £12-17-6 15in. 15 ohms. Cast chassis. Exceptionally robust. 2in. diam. Voice Coil Assemblies. 152/12 20watt, 12 gns. 152/12A 20watt, 13 gns. 152/14 27watt, 14 gns. 152/14A 27watt, 15 gns. 152/17 35watt, 16 gns. 152/17A 35watt, 17 gns. "A" Indicates dual cone type. 30-17,000 c.p.s. Send S.A.E. for leaflets. Terms available.

R.S.C. 4/5 WATT A5 HIGH-GAIN AMPLIFIER

A highly sensitive 4-valve quality amplifier for the home, small club, etc. Only 50 millivolts input is required for full output and so that it is suitable for use with the latest High-fidelity Pick-up heads in addition to all other types of pick-ups and practically all "mikes". Separate Bass and Treble Controls are provided. These give full long-playing record equalisation. Hum level is negligible being 71 dB down. 15 dB of Negative feedback is used. H.F. of 300 v. 25 mA and L.T. of 6 v. 1.5 A. is available for the supply of a Radio Feeder Unit, or Tape-Deck pre-amplifier. For A.C. mains input of 200-230-250 v. 50 c/s. Output for 2-3 ohms speaker. Chassis is not alive. Kit is complete in every detail and includes fully punched chassis (with baseplate) with Gold-Hammer finish and point-to-point wiring diagrams and instructions. Exceptional value at only 24-15-9, or assembled ready for use 25/- extra. Plus 3/6 carr., or deposit 22/6 and 5 monthly payments of 22/6 for assembled unit.

THE SKYFOUR T.R.F. RECEIVER. A design for a 3 valve long and medium wave 200-250 v. A.C. Mains receiver with selenium rectifier. High gain H.F. stage and low distortion detector. Valve line up 6K7, 6X4, 6V6. Selectivity and quality excellent. Simple to construct. Point-to-Point wiring diagrams, instructions and parts list 1/9, maximum building costs £4-12-6. Inc. attractive walnut veneered wood cabinet 12 x 6 1/2 x 5 1/2 in.

TWEETERS. R.A. 3 ohm 25/9; 15 ohm 25/9.

R.A. 12in. DUAL CONE 3 ohm 8 watt Speakers. Ideal for Stereos. Only 39/9 ea.

Type BM2. Size 8 x 5 1/2 x 2 1/2 in. Supplies 120 v. 90 v. and 50 v. 40 mA and 2 v. 0.4 A. to 1 amp. fully smoothed. Thereby completely replacing both H.T. batteries and L.T. 2 v. accumulators when connected to A.C. mains supply 200/250 v. 50 c/s. **SUITABLE FOR ALL BATTERY RECEIVERS** normally using accumulators. Complete kit with diagrams and instructions, 49/9, or ready for use, 59/6.

12in. 10 WATT

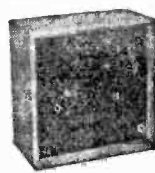

HIGH QUALITY LOUDSPEAKER.

In walnut veneered cabinet. Gauss 12,000 lines. Speech coil 3 ohms or 15 ohms. Only **£4-19-6.** Carr. 5/-. Terms: Deposit 11/3 and 9 monthly payments of 11/3. **12in. 10 WATT HI-FI LOUDSPEAKERS IN CABINETS.** Size 18 x 13 x 10in. Finish as above.

Terms: Deposit 17/9 and 9 monthly payments of 17/9. Only 27-19-6. Carr. 8/6. For larger types see page 618.

R.S.C. CORNER CONSOLE CABINETS

Polished walnut veneer finish. Pleasing design.

JUNIOR MODEL. Size 20 x 11 x 8in. for 8 x 5in. or 10 x 6in. speakers. **£2-9-9.**

STANDARD MODEL. Size 27 x 18 x 12in. for 8 or 10in. speakers. **£4-11-9.**

SENIOR MODEL. Size 30 x 20 x 15in. for 12in. Speaker. Suitable Speaker systems below. Only 7 gns.



AUDIOTRONE HI-FI SPEAKER SYSTEMS. Consisting of matched 12in. 12,000 line, 15 ohm high quality speaker; crossover unit (consisting of choke, condenser, etc.) and Tweeter. The smooth response and extended frequency range ensure surprisingly realistic reproduction. Standard 10 watt rating **£4-19-6.** Carr. 5/-. Or Senior 15 watt. **£6-19-6.** Carr. 7/6.

R.S.C. BASS REFLEX CABINETS. **JUNIOR MODEL** Specially designed for W.B. HF1012 Speaker, but suitable for any good quality 10in. speaker. Acoustically lined and ported. Polished walnut veneer finish. Size 18 x 12 x 10in. Handsome appearance. Ensures superb reproduction for only **£3-19-6.**

STANDARD MODEL. As above but for 12in. speakers. Size 18 x 15 x 13in. For vertical or horizontal use, **£5-19-6.** Set of legs with brass ferrules. 19/6.

P.M. SPEAKERS, 10in. W.B. "Stentorian"

3 or 15 ohms type HF1012 10 watts, hi-fidelity type. Recommended for use with our All Amplifier 24-12-6. 12in. R.A. 3 ohms 10 watts (12,000 lines), 59/9.

ARMSTRONG, DULCI, LINEAR, ROGERS, LEAK and JASON EQUIPMENT, GOODMAN'S, W.B. and FANE SPEAKERS, GARRARD and GOLDRING T/TABLES CASH or H.P.

SUPERHET FEEDER UNIT. Design of a high quality Radio Tuner (specially suitable for use with our Amplifiers). Delayed A.V./C. Controls are Tuning, W/Ch. and Vol. Only 250 v. 15 mA H.T. and L.T. of 6.3 v. 1 amp. required from amplifier. Size approx. 9 x 8 x 7in. high. Simple alignment procedure. Point-to-Point wiring diagrams, instructions and priced parts list with illustrations, 2/6. Total building cost **£55-0.** S.A.E. for leaflet.

MULTI-METER, CABY MI. Sensitivity 2,000 ohms per volt. A.C. and D.C. 54/-, A.10. Basic Meter sensitivity 155 microamps A.C. and D.C. ranges **£4-11-6.** B-40. Sensitivity up to 10,000 ohms per volt A.C. and D.C., **£8-2-6.** 30,000 ohms per volt, with overload buzzer. **£8-19-6.**

AUDIOTRINE HI-FI TAPE RECORDER KIT 25

REALISM AT INCREDIBLY LOW COST, CAN BE ASSEMBLED IN AN HOUR
 Incorporating the latest Collaro Studio Tape Transcriber. The Audiotrine High Quality Tape Amplifier with negative feedback equalisation for each of 3 speeds, High Flux P.M. Speaker, empty Tape Spool, a Reel of Best Quality Tape and a Handsome Portable Carrying Cabinet tastefully covered in two contrasting shades of Rexline and Vynair, size 14 1/2 x 15 x 8 1/2 in. high and circuit. Total cost if purchased individually approximately £40. Performance equal to units in the £60-£80 class. S.A.E. for leaflets. **TERMS.** Deposit £2.13.9 and 12 monthly payments of 44/-. Cash price if settled in 3 months.



ONLY 3 PAIRS OF SOLDERED JOINTS PLUS MAINS

HIGH FIDELITY 12-14 WATT AMPLIFIER TYPE A11

PUSH-PULL ULTRA LINEAR OUTPUT "BUILT-IN" TONE CONTROL PRE-AMP STAGES

Two input sockets with associated controls allow mixing of "mike" and gram., as in A10 High sensitivity. Includes 5 valves, ECC83, ECC83, EL84, EL84, EZ81. High Quality sectionally wound output transformer specially designed for Ultra Linear operation and reliable small condensers of current manufacture. **INDIVIDUAL CONTROLS FOR BASS AND TREBLE** "Lift" and "Cut". Frequency response - 3 dB 30-20,000 c/s. Six negative feedback loops. Hum level 60 dB down. **ONLY 23 millivolts INPUT required for FULL OUTPUT.** Suitable for use with all makes and types of pick-ups and microphones. Comparable with the very best designs for **STANDARD or LONG PLAYING RECORDS.** For **MUSICAL INSTRUMENTS** such as **STRING BASS, LEAD OR RHYTHM GUITARS, etc.**

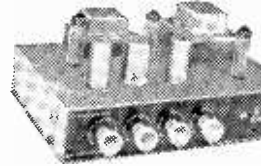

For supply of a **RADIO FEEDER UNIT.** Size approx. 12 x 9 x 7 in. For A.C. mains 200-250v. 50 c.p.s. Output for 3 and 15 ohms speaker. Kit is complete to last nut. Chassis is fully punched. Full instructions and point-to-point wiring diagrams supplied. **Only 8 Gns.** Carr. 10/-

If required louvred metal cover with 2 carrying handles can be supplied for 18/9. **TERMS ON ASSEMBLED UNITS.** DEPOSIT 24/9 and 9 monthly payments of 24/9. Send S.A.E. for illustrated leaflet detailing Cabinets, Speakers, Microphones, etc., with cash and credit terms.

LINEAR TAPE PRE-AMPLIFIER. Type LP/1. Switched Negative feedback Equalisation. Positions for Record film, 3 1/2 in., 7 in. and Playback. EM84 Recording Level Indicator. Designed primarily as the link between a Collaro Tape Transcriber and a high fidelity amplifier, but suitable for almost any Tape Deck. **Only 9 gns.** S.A.E. for leaflet.

R.S.C. STEREO/TEN HIGH QUALITY AMPLIFIER



A complete set of parts for the construction of a stereophonic amplifier giving 5 watts high quality output on each channel (total 10 watts). Sensitivity is 50 millivolts. Suitable for all crystal stereo heads. Ganged Bass and Treble Control give equal variation for "lift" and "cut". Provision is made for use as straight (monaural) 10-watt amplifier. Valve line-up ECC83, ECC83, EL84, EL84, EZ81. Outputs for 2-3 ohm speakers. Point-to-Point wiring diagrams and instructions supplied. Send S.A.E. for leaflet. **8 Gns.** Carr. 10/-

Kit can be supplied assembled and ready to use for 59/8 extra.

SENSATIONAL STEREO OFFER

A complete set of parts to construct of a good quality Stereo amplifier with an undistorted output total 6 watts. For A.C. mains input of 200-250 v. Sensitivity 130 mv. Ganged Vol. and Tone Controls. Preset balance control. Full instructions and wiring diagrams supplied. Stereo Pick-up Head 19/9 extra with above only. **4 Gns.**

HEAVY DUTY CHARGER KIT 6/2 v. 6 amps. variable output. Consisting of Mains Transformer 0-200-230-250 v.; F.W. (Bridge) Selenium Rectifier; Ammeter, Variable Charge Rate Selector Panels, Flugs, Fuses, Fuseholder and circuit. 59/8. Carr. 4/6.

R.S.C. MAINS TRANSFORMERS (GUARANTEED)

Interleaved and Impregnated. **Primaries 200-230-250 v. 50 c/s. Screened TOP SHROUDED DROP THROUGH**

250-0-250v. 70mA, 6.3v. 2a, 0.5-6.3v. 2a	17/9
350-0-350v. 80mA, 6.3v. 2a, 0.5-6.3v. 2a	19/9
250-0-250v. 100mA, 6.3v. 2a, 6.3v. 1a	21/9
250-0-250v. 100mA, 6.3v. 3.5a, C.T.	19/9
250-0-250v. 100mA, 6.3v. 4a, 0.5-6.3v. 3a	27/9
300-0-300v. 130mA, 6.3v. 4a, 6.3v. 1a, for Mullard 510 Amplifier	33/9
300-0-300v. 100mA, 6.3v. 4a, 0.5-6.3v. 3a	27/9
350-0-350v. 100mA, 6.3v. 4a, 0.5-6.3v. 2a	27/9
350-0-350v. 150mA, 6.3v. 4a, 0.5-6.3v. 3a	35/9

FULLY SHROUDED UPRIGHT

250-0-250v. 60mA, 6.3v. 2a, 0.5-6.3v. 2a	17/11
250-0-250v. 100mA, 6.3v. 4a, 0.5-6.3v. 3a	28/9
300-0-300v. 100mA, 6.3v. 4a, 5v. 2a	28/9
300-0-300v. 130mA, 6.3v. 4a, C.T. 6.3v. 1a, for Mullard Amplifier	35/9
350-0-350v. 100mA, 6.3v. 4a, 0.5-6.3v. 3a	28/9
350-0-350v. 150mA, 6.3v. 4a, 0.5-6.3v. 3a	37/9

R.S.C. BATTERY CHARGING EQUIPMENT

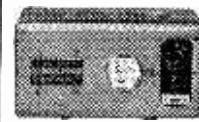

charging. Louvred steel case with stoved grey hammer finish. Fused and ready for use with mains and output leads and battery clips. Carr. 4/6. **59/9**

All for A.C. Mains 200-250v., 50c/s.

ASSEMBLED 4 amps 6/12 v. Fitted Ammeter and variable charge rate selector. Also selector plug for 6v. or 12 v. Fused, ready for use with mains and output leads. Carr. 3/9.	39/9
6/12v. 1 amp. 27/9 Less meter.	

CHARGER KIT, 12 v. 14 AMP or 24 v. 7 AMP Consisting of mains trans. 200-230-250 v. F.W. (Bridge) Selenium Rectifier, Ammeter, Fuses, Variable Resistor, Heavy Steel Stove enamelled case and Circuit. **Only £8.18.6.** Carr. 15/-. Please state if 12v. or 24v. kit required.

Guaranteed 12 months

BATTERY CHARGER KITS Consisting of Mains Transformer, F.W. Bridge, Metal Rectifier, well ventilated steel case, Fuses, Fuse-holders, Grammetts, panels, Heavy Duty Clips, circuit. Carr. 3/6 extra.

6v. or 12v. 1 amp.	22/9
As above with Ammeter.	23/9
6 v. or 12 v. 2 amps.	25/9
6 v. or 12 v. 2 amps. inclusive of Ammeter.	25/9
6 v. or 12 v. 4 amps. with Ammeter and variable charge rate selector.	32/9

CHARGER AMMETERS 0-1.5 a., 0-4 a., 0-7 a., 8/9 each

CHARGER KIT, 12v. 10 AMP with variable charge rate selector and ammeter. £4.18.8. Carr. 10/-.

MIDGET MAINS Primaries 200-250 v. 50 c/s. 250v. 60mA, 6.3v. 2a. .. 11/9
 250-0-250v. 80mA, 6.3v. 2a. 12/11
 Both above size 2 1/2 x 2 1/2 in.

FILAMENT TRANSFORMERS All with 200-250v. 50 c/s primaries 6.3v. 1.5a, 5/9; 6.3v. 2a, 7/8; 12v. 1a, 7/11; 6.3v. 3a, 8/11; 6.3v. 6a, 17/6; 12v. 1.5a, twice, 17/6.

SMOOTHING CHOKES 150mA, 7-10 H, 250 ohms .. 11/9
 100mA, 10 H, 200 ohms .. 5/9
 80mA, 10 H, 300 ohms .. 7/9
 60mA, 10 H, 400 ohms .. 4/11

CHARGER TRANSFORMERS All with 200-230-250v. 50 c/s Primaries; 0-9-15v. 1a. 12/9; 0-9-15v. 2a, 14/9; 0-9-15v. 3a, 18/9; 0-9-15v. 5a, 19/9; 0-9-15v. 8a, 23/9; 0-9-15v. 8a, 23/9.

AUTO (step up/Step down) TRANSFORMERS 0-110/120-230/250v. 50-30 watts, 13/6; 200 watts, 39/8; 150 watts, 27/8.
MICROPHONE TRANSFORMERS 120:1 high grade, clamped, 8/6.

HI-FI 10-WATT AMPLIFIER

Brand New Complete Units. **£7.19.6** Carr 5/6

Manufacturer's discontinued Model. Push-Pull output. Latest high efficiency valves. Dual separately controlled inputs for "Mike" and gram. Separate Bass and Treble Controls. High Sensitivity. Output for 3 or 15 ohm speaker. Guaranteed tested and in perfect working order.

SELENIUM RECTIFIERS

F.W. BRIDGE	24 v. 2 amp. ..	14/9
6/12 v. 1a. ..	3/11 24 v. 20 amp. ..	8/9/9
6/12 v. 2a. ..	6/11 H.T. TYPES H.W.	
6/12 v. 3a. ..	3/9 150 v. 40 mA. ..	3/9
6/12 v. 4a. ..	12/3 250 v. 50 mA. ..	3/11
6/12 v. 6a. ..	15/3 250 v. 60 mA. ..	4/11
6/12 v. 10a. ..	26/9 250 v. 80 mA. ..	5/11
6/12 v. 15a. ..	35/9 250 v. 250 mA. ..	11/9

CONTACT COOLED. 250 v. 75 mA. F.W. (Bridge). 10/11. 250 v. 50 mA. F.W. (Bridge). 8/11. H.W. 250 v. 60 mA. 5/11.

HE-40 De-Luxe 4 Band.

220/240 v. 50/60 c.p.s. A.C. mains operation. Frequencies covered 550 Kc/s to 30 Mc/s continuous. Incorporates 5in. speaker. Slide rule tuning dial. "S" meter. Internal ferrite aerial for medium wave. Telescopic whip aerial 59in. 10 section for short waves. Fitted sockets for optional outdoor aerial. Headphone, external speaker socket. Other features are electrical bandspread tuning, 0-100 logarithmic scale. Noise Limiter, A.V.C., B.F.O., stand by switch. Size approx. 14 x 8 x 3 1/2 in. Handsome grey crackle finished metal cabinet with chromium fittings. Brand new with full instructions manual. Usual guarantee.

TERMS: Deposit £3.15.0, and nine monthly payments of 5/2. Cash price if cleared Only **£24.15.0** Carr. in 3 months Free.

COMPLETE POWER PACK KIT, 19/11

Consisting of Mains Trans., Metal Rectifier, Double electrolytic, smoothing choke chassis and circuit. For 200-250 v. A.C. mains. Output 250 v. 60 mA. 6.3 v. 2 a.

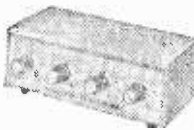
TRANSISTORISED MICROPHONE MIXER

Enables mixing of up to 4 instruments, i.e. mic., tape, gram, tuners, etc., into single output. Compact and completely self-contained, uses standard 9v. battery. Inputs and

outputs take standard plugs. **PRICE 49/6**

TRANSRECEIVERS.

Two-way Transmitter Receivers. 9 transistor S/H circuit. Crystal controlled range up to 5 miles according to conditions. Size of each unit 6 1/2 x 3 x 1 1/2 in. Complete with batteries. Telescopic aerials and leather cases. Brand new guaranteed **£25.0.0** Per Pair.

R.S.C. POWER PACK, 39/9. Louvred metal case only 8 x 5 1/2 x 2 1/2 in. Stove enamelled. For 200-250 v. A.C. mains. Output at 4 pin plug and socket 250 v. 60 mA. fully smoothed at 6.3 v. 2 a. Suitable for power requirements of almost any Pre-amp or Radio Tuner.

R.S.C. BABY ALARM or INTER-COMM. KIT. Complete set of parts with diagrams, etc. Housed in two polished walnut finished cabinets of pleasing design. High sensitivity. For 200-250 v. A.C. mains. Fully intercom. Controllable at both units. An intercomm. of this class would normally cost £20-£30. Only 89/6, carr. 5/- or assembled ready to use 6 gns.



TRANSISTOR SALE. Mullard OC71 3/9, OC3 4/11, OC4 4/11, OC72 4/8, OC31 4/11, OC11 8/9, Ediswan XA101 5/9, XB102 3/9, XA12 3/9, XB13 3/9, XB104 3/9, XC101A 3/9. Postage 6d. for up to 3 Transistors. **EX. GOVT. SMOOTHING CHOKEN.** 200 mA, 3-5 H, 50 ohms. Parmeko 8/9; 150 mA, 10 H, 50 ohms; 9/9; 120 mA, 12 H, 100 ohms; 8/9; 100 mA, 10 H, 100 ohms; 6/9; 60 mA, 5-10 H, 250 ohms, 2/11.

EX GOVT SELENIUM RECTIFIERS 12v 15 AMP (BRIDGE) F.W. ONLY 19/9

R.S.C. BRADFORD, BRISTOL, BIRMINGHAM, DERBY, DARLINGTON, EDINBURGH, GLASGOW, HULL, LEICESTER, LEEDS, LIVERPOOL, LONDON, MANCHESTER, MIDDLESBROUGH, SHEFFIELD

PAGE 708 FOR ADDRESSES

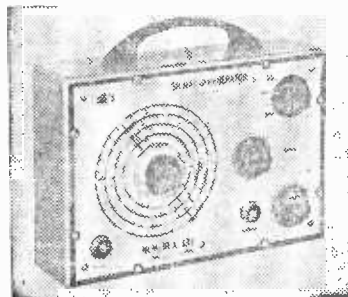

Wide-range Transistorised
SIGNAL GENERATOR—Model 27

Range 150 Kc/s to 350 Mc/s

- ★ Accuracy better than 2%
- ★ Directly calibrated
- ★ Battery operated
- ★ Compact and light

£9.12.3

with test lead and battery
Post and Packing 3/6 extra.

H.P. 48/- deposit and 27/- monthly.

Trade and Export Enquiries Invited

NOMBREX INSTRUMENTATION

Wide range Transistorised
AUDIO GENERATOR—Model 63

Range 10—100,000 c/s

- ★ Laboratory Standard Specifications
- ★ Size and Shape as above
- ★ Direct Frequency Calibration
- ★ Accuracy and Low Distortion
- ★ Calibrated Output Voltage
- ★ Battery Operated and Compact

£16.15.0 complete with test lead

Battery 2/3. Post and Packing 3/6.
H.P. 4 gns. deposit and 31/- monthly.

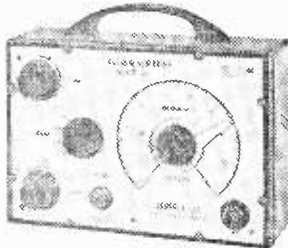

Wide-range Transistorised
C.R. BRIDGE—Model 62

6 Ranges: 1Ω to 100M
1pF to 100μF

- ★ Visual null indicator
- ★ Power factor check
- ★ Electrolytic leakage test
- ★ Battery operated

£8.7.3

including battery.
Post and Packing 3/6 extra.
H.P. 40/- deposit and 24/- monthly.

S.A.E. for full technical leaflets

NOMBREX LTD.

Instruments
Division

ESTUARY HOUSE, CAMPERDOWN TERRACE
EXMOUTH, DEVON. Phone: 3515

HOUSING HI-FI?

The three Nordyk Units illustrated comprises Speaker Enclosure (left) for 8" hi-fi speakers 7 gns., Record Cabinet (centre) takes 150 records £5.17.6, and Equipment Cabinet (right) for turntables and amplifiers 7 gns. Available in teak, walnut or mahogany. Send for illustrated catalogue of 20 different models.



RECORD HOUSING

(Dept. P.W.12), Brook Road, London N22
Telephone: BOWes Park 7487/8

VALVES SAME DAY SERVICE NEW! TESTED! GUARANTEED!

SETS			
1R5, 1R5, 1T4, 3R4, 3V4, DAF91, DF91, DK91, DL92, DL94: Set of 4 for 15/-, DAF96, DF96, DK96, DL96: 4 for 23/8			
1A7GT	7/8 6063	16/- DF33	8/- EF41
1D5	6/8 787	3/- DF91	2/6 EF42
1HS6T	8/3 705	7/8 DF96	6/- EF50
1NS6T	3/- 736	7/8 DH76	3/6 EF56
1R5	4/9 787	5/9 DH77	3/6 EF66
1R5	3/9 787	19/8 DH81	12/6 EF89
1T4	2/6 7Y4	5/- DK92	8/- EF91
3A5	6/9 12A7E	4/3 DK91	4/9 EF92
3Q4	4/10 12A7T	3/9 DK92	6/9 EF95
3R4	4/9 12A6E	5/- DK96	6/6 EL35
3V4	5/6 12A17	4/9 DL33	7/3 EL41
5Y40	4/8 12AN7	4/9 DL35	6/9 EL54
6Y30T	5/- 12K70T	4/3 DL92	4/9 EM34
6Z40	7/- 12K80T	8/9 DL94	5/6 EM80
6AL5	2/- 12Q7GT	4/3 DL96	6/- EMS1
6AQ5	6/- 19B666	6/9 EABC90	6/6 EM84
6AT9	3/6 20P4	13/8 EAF42	8/- EM87
6BA5	6/- 20P5	14/9 EBF41	6/- EY51
6BB5	5/3 25L66T	4/9 EBY1	2/- EY86
6BB6G	12/6 25L66T	6/6 EBC33	5/- EZ40
6BH6	5/- 20L15	9/8 EBF41	7/3 EZ41
6B46	5/6 30PL1	8/- EBF80	6/- EZ80
6F13	3/- 30PL13	9/- EBF89	6/- EZ81
6FL4	9/- 30PL14	12/3 EBY40	6/9 FW4500
6J74	4/6 35A5	14/- EBY81	3/9 EY37
6K7D	1/6 35L66T	6/3 EBY82	4/9 EY32
6K7GT	4/- 35Z4GT	4/11 EBY83	7/- EY96
6K96	4/3 32K13	13/8 EBY84	6/3 EY76
6K84T	7/9 55K U	6/6 EBY85	6/3 EY84
6P28	9/6 ACV22	6/6 ECP80	6/3 M114
6Q7G	4/9	12/6 ECP82	6/3 MVS/PEN B
6Q7GT	7/9 A231	9/6 ECP86	10/9
6R7GT	9/8 B35	4/6 ECP85	6/- N18
6SL2GT	5/6 C133	9/6 ECH42	8/- N108
6SN7GT	3/9 CV1	12/6 ECH81	6/- P365
6V6G	3/9 DAC32	8/3 ECL89	6/3 P387
6V6GT	6/8 DAF91	3/8 ECL82	7/- P384
6X4	3/9 DAF96	6/- ECL85	9/- P385
6X5GT	6/8 DC90	6/9 EFX9	3/9 PCC88
			9/9 U50
			5/- Y63
			4/8
			3/9
			8/6
			5/9
			12/91
			9/-
			15/9
			5/9
			5/8
			8/-
			8/-
			7/3
			6/-
			6/9
			5/6
			8/-
			8/8
			15/-
			8/-
			6/6
			7/8
			8/8
			15/8
			7/8
			5/6
			5/6
			5/6
			5/9
			4/9
			7/9
			8/8
			8/8
			6/3
			6/3
			7/9
			15/-
			4/9
			7/3
			8/8
			8/8
			12/3
			5/6
			5/9
			7/9
			5/9
			7/3
			5/6
			12/3
			4/10
			16/6
			5/9
			4/9
			2/8
			3/8
			16/8
			19/8
			4/8

READERS RADIO

24 COLBERG PLACE, STAMFORD HILL, LONDON N.16
STA. 4587

Post 6d. per valve extra. Any Parcel Insured against Damage in Transit 6d. Extra. Any C.O.D. Parcel 4/3 extra.

TECHNICAL TRAINING

in radio television and electronics

Whether you are a newcomer to radio and electronics, or are engaged in the industry and wish to prepare for a recognized examination, ICS can further your technical knowledge and provide the specialized training so essential to success. ICS have helped thousands of ambitious men to move up into higher paid jobs—they can help you too! Why not fill in the coupon below and find out how?

Many diploma and examination courses available, including expert coaching for:

- Institution of Electronics & Radio Engineers [Brit.I.R.E.]
- C. & G. Telecommunication Techns' Certs.
- C. & G. Supplementary Studies
- R.T.E.B. Radio/T.V. Servicing Certificate
- Radio Amateurs' Examination
- P.M.G. Certs in Radiotelegraphy
- General Certificate of Education, etc.

Examination Students Coached until Successful

NEW SELF-BUILD RADIO COURSES

Learn as you build. You can learn both the theory and practice of valve and transistor circuits, and servicing work while building your own 5-valve receiver, transistor portable, signal generator and multi-test meter—all under expert tuition. Three courses to choose from.

POST THIS COUPON TODAY

for full details of ICS courses in Radio, T.V. and Electronics.

INTERNATIONAL CORRESPONDENCE SCHOOLS

Dept. 171, Intertext House, Parkgate Road, London S.W.11

Please send me the ICS prospectus free and without obligation.

(state Subject or Exam.) _____

NAME _____

ADDRESS _____

12.64

INTERNATIONAL CORRESPONDENCE SCHOOLS

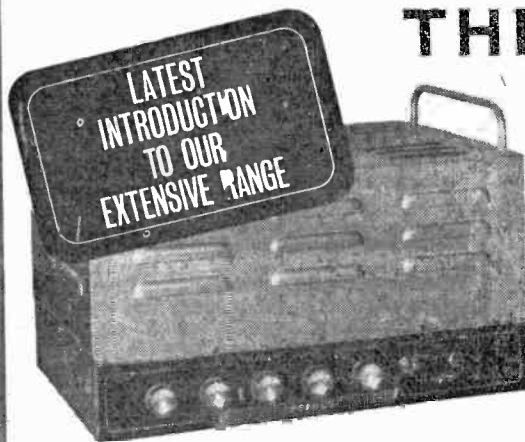

THE PEAK 60

60 WATT GUITAR AMPLIFIER

A multi-purpose high output power amplifier for MICROPHONE and INSTRUMENTAL applications or for providing high quality sound for Auditoriums, Halls, Dance Bands and outside Public Address functions.

As the amplifier is capable of delivering 60 watts over a wide frequency range it is equally suitable for Bass Guitar, Lead Guitar, or Voice Reproduction. In addition it will meet the most discriminating requirements in domestic sound installations where peak power is not of prime importance.

The use of the two Inputs with their associated volume controls, together with the Master volume control gives an effective mixing facility. Silver bammer finish. Black perspex front panel. Overall size 14 x 9 x 7 1/2 in. high including cover (plus 1 1/2 in. high handles).

- BASS AND TREBLE CONTROLS
- MASTER VOLUME CONTROL
- MIXING FACILITIES
- BUILT IN PRE-AMPLIFIER AND CONTROL UNIT
- 60 WATT UNDISTORTED OUTPUT
- SWITCHED OUTPUT FOR 3 or 15 ohms loudspeakers
- TWO INPUTS high gain and low gain with individual volume controls.

FULL DETAILS ON REQUEST

COMPLETE KIT OF PARTS..... £18.18.0

ASSEMBLED AND TESTED £25.4.0

(Ventilated Cover with chrome plated handles as illustrated
35/- extra.)

STERN

GREAT BRITAIN'S GREATEST

STERN CLYNE

SOUND
REPRODUCING
AND

HI-FI

EQUIPMENT

READY BUILT
AND TESTED OR
KITS OF PARTS FOR
HOME CONSTRUCTION

MAKE YOUR CHOICE FROM THE FOLLOWING

	Complete Kit of parts	Ready built and tested	Car- and Ina.	Instruction book available separately
Stern Mono-Gram Amplifier 3 watts	£4 10 0	£8 0 0	3/8	2/8
Mullard 2 valve Audio Pre-amplifier	£8 6 0	£9 10 0	5/-	2/-
Mullard 3 valve Audio Pre-amplifier	£10 0 0	£13 13 0	5/-	3/8
Stern JLI0 Double Feature Pre-amplifier for Audio and Tape	£13 13 0	£19 19 0	5/-	5/-
Mullard "3-3" Amplifier with Passive Control Unit Model 33/RG 3 watts	£8 8 0	£11 10 0	6/6	2/-
Mullard "5-10" Main Amplifier Model 510/M. 10 watts	£10 0 0	£13 10 0	6/6	2/-
Mullard "5-10" Amplifier with Passive Control Unit. 10 watts	£12 0 0	£16 0 0	7/8	2/-
Stern JLI0 Main Amplifier Mono. 10 watts	£10 0 0	£13 13 0	8/8	3/-
Stern Twin Three Stereo Amplifier. 3 watts per Channel)	—	£9 0 0	5/-	—
Stern Twin Three Stereo Amplifier in Portable Case with Two Speakers and Leads	—	£16 10 0	10/-	—
Mullard "10 + 10" Stereo Amplifier. 10 watts per Channel	£16 0 0	£20 0 0	8/8	3/-
Mullard "10 + 10" Stereo Amplifier with Passive Control Unit. 10 watts per Channel	£20 0 0	£24 0 0	10/-	3/-
Mullard 4-channel Electronic Mixer Unit Model 2H for 2 Mics, Radio and Gram.	£8 8 0	—	5/-	2/8
Mullard 4 channel Electronic Mixer Unit Model IL	£10 5 0	—	5/-	2/8
HF/TRS Tape Amplifier with Power Unit	£13 13 0	£19 0 0	7/8	3/-
Type "C" Tape Pre-amplifier with Power Unit.	£14 0 0	£19 10 0	7/8	3/8
STP-1 Tape Pre-amplifier with Power Unit. Mono and Stereo ..	£22 0 0	£28 0 0	8/8	5/-
CR3/8 Tape Recorder with Studio Deck	£33 8 0	—	15/-	3/-

INDIVIDUAL DESCRIPTIVE LEAFLETS GIVING TECHNICAL SPECIFICATIONS, DIMENSIONS,
PRICES, TERMS ETC., FREE ON REQUEST

TUNER UNITS



STERN FIDELITY MK. II VHF/FM TUNER (as illustrated). Including Mullard Tuning Heart it has been specially designed to operate with Stern Mullard Amplifiers. Kit of Parts £10.10.0. Built and Tested £14.5.0. Carr. and Ins. 5/-.

ARMSTRONG AM/FM Tuner Model 223 £28.15.0. FM Tuner Model 224 £22.10.0. Carr. and Ins. 7/6.

JASON FMT1 FM Tuner. Kit of Parts £6.15.0. **FMT2 FM Tuner.** Kit of Parts £10.12.6. Kit of Parts £12.5.0.

FMT3 FM Tuner for Fringe Areas. Kit of Parts £12.5.0.

FMT4 Tuner £20.0.4.

JTV2/EM/TV Sound. Kit of Parts £15.15.0. Carr. and Ins. on above 5/- each.

LEAK Tough Line III FM Tuner £29.7.6. Carr. and Ins. 7/6.

QUAD AM2 Tuner. L. M. S. Waves £29.10.0.

FM Tuner £24.18.9. Carr. and Ins. 5/- each.

Descriptive leaflets free on request. Please state model required.

RECORD PLAYERS



Garrard SRP10 Single Player £5.9.1. Carr. and Ins. 4/6. **BSR UA14 Autochanger** £5.19.6. **BSR UA15 Autochanger** £5.19.6. **Garrard Autosim Autochanger** £8.10.0. **Magnator "Studio" 080 Autochanger** £6.19.6. **Garrard AT6 Autochanger** £10.19.6. **BSR Super Slim Autochanger** £9.19.6. **Garrard AT5 LM Autochanger (3000LM)** £11.11.1. **Philips AG1016 Stereo/Mono Record Player** £12.12.0. Carriage and Ins. 5/- on above.

Garrard 4HF Single Player £16.17.6. **Goldring Lenco Model 88 Transcription Turntable** £18.18.5. **Garrard Laboratory Type "A" Autochanger** £18.15.0. **Garrard Model 301 Transcription Turntable** £20.12.0. **Goldring Lenco GL52** with 580 Cartridge £21.19.0. **Goldring Lenco GL70** less Pickup Head £27.9.4.

Carr. and Ins. 7/6 on above. Descriptive leaflet including prices with alternative cartridges, dimensions, terms etc., free on request.

LOUDSPEAKERS



We supply a complete range of Goccmans, Wharfedale, Stentorian, TSL Speaker Units and complete systems. A comprehensive leaflet is available on request, this covers technical specifications and prices of nearly 50 types including:—

Celestial Model CX1512 (as illustrated) £11.10.0. **Celestial Model CX2012** £16.10.0. **Stentorian HFS12** 5 watts £3.16.0. **Stentorian HF1012** 10 watts £4.12.0. **Goodmans Axiote** 8 6 watts £2.5.7. **Goodmans Axom** 10 10 watts £6.5.11. **Goodmans Aviom** 201 15 watts £10.17.4. **Wharfedale Super 6, RS/12/DD** 6 watts £6.14.2. **Wharfedale Go den RS, DD** 8 watts £7.17.5. **Wharfedale ES/12/DD** 15 watts £11.10.0.

Guitar Speakers include:—
Wharfedale W15EG 15 watts £10.10.0. **Wharfedale W15EG** 20 watts £17.10.0. **Goodmans Audiom** 51B 15 watts £9.2.8. **Goodmans Axiom** 61B 20 watts £14.7.8.

Carr. and Ins. extra

STERN-CLYNE

ELECTRONIC HOBBIES ORGANISATION

TAPE EQUIPMENT AND ACCESSORIES

Lafayette Stereo Tape Deck with Built-in Pre-amplifier (as illustrated) 42gns. C. and I. 15/-.

Collaro Studio Tape Deck 1/2 track Heads £10.10.0.

Collaro Studio Tape Deck 1/2 track Heads £13.19.6.

Truvor D82 Tape Deck with 1/2 track Heads £28.5.0.

Truvor D84 Tape Deck with 1/2 track Heads £29.8.0.

Brenell Mk. 5 Series 2 Tape Deck with 1/2 track Heads 31gns.

Brenell Mk. 5 Series 2 Tape Deck with 1/2 track Heads 41gns.

Wearite Model 5A Tape Deck with 1/2 track Heads £42.0.0.

Wearite Model 5S Tape Deck with Micro Heads £49.7.0. C. and I. on above 10/- each.



LAFAYETTE ACETATE TAPE

5in.	600ft.	Standard	8/6
5in.	900ft.	Long Play	10/-
5 1/2in.	1,200ft.	Long Play	12/6
7in.	1,800ft.	Long Play	15/-

BEL-CLEER ACETATE TAPE

5in.	600ft.	Standard	12/6
5in.	900ft.	Long Play	15/-
5 1/2in.	1,200ft.	Long Play	18/6
7in.	1,800ft.	Standard	18/6
7in.	1,800ft.	Long Play	25/-

LAFAYETTE MYLAR TAPE

3 1/2in.	600ft.	Double Play	11/6
7in.	1,200ft.	Standard Play	12/6
5in.	1,200ft.	Double Play	15/-
7in.	1,800ft.	Long Play	20/-
5 1/2in.	1,800ft.	Double Play	22/6
7in.	2,400ft.	Double Play	25/-

Postage and Packing 1/- per Reel extra, 4 or more Reels POST FREE.

We also stock the complete range of Scotch Boy, BAMP, Tapes, Accessories etc. Price List free on request.

FULLY AUTOMATIC TAPE SPLICER 14/6. P. & P. 1/6.

PLASTIC TAPE SPOOLS 2 1/2in. 1/-; 3 1/2in. 3/-; 4in. 2/-; 5in. 2/-; 5 1/2in. 2/3; 7in. 2/6.

PLASTIC SPOOL CONTAINERS. For spool sizes 5in. 1/6; 5 1/2in. 2/-; 7in. 2/3.

Any single item plus 6d. P. & P. Orders over £1 post free.

WE CARRY FULLY COMPREHENSIVE STOCKS OF TAPE RECORDERS, DECKS AND ACCESSORIES AT ALL BRANCHES OR ORDER WITH CONFIDENCE BY MAIL.

MICROPHONES

Acos Crystal Model MIC 45/1 19/6. **Acos "Stick" Microphone.** Crystal MIC 39/1 32/6. **DM.303 Dynamic High Impedance Leak Microphone** complete with Stanc. Metallic Green Finish 5gns. **BM.3 Quality Crystal Microphone** with Hubing Switch. Complete with Lead, Neck Cushion and Removable Stand Adapter 39/6. **Matching Table Stand** 12/6 extra. **DX.29 Dynamic High Impedance.** Black Crackle Finish with Isok Stand 59/6. **DM.301 Dynamic High Impedance** with On/Off Switch. Omnidirectional. Carcine plated diecast frame 99/6. **DM.304 Dynamic Dual High or Low** with On/Off Switch. Satin chrome finish 69/6. **DM.197 Dynamic High Imp.** with switch. Chrome and black enamel finish 69/6. **MICROPHONE STANDS**
MS.4 3 section floor stand 59/6.
MS.3 2 section floor stand 100/-.
MS.2 2 section desk stand 22/6. P. & P. 2/6 extra on all above.



The P.W. AUTOCRAT CAR RADIO

As featured in
"PRACTICAL WIRELESS" BLUEPRINT

and described on pages 624, 625, 626
with NOVEMBER ISSUE.

ALL REQUIRED COMPONENTS
CAN BE PURCHASED AT ALL
STERN-CLYNE BRANCHES.

The total cost of parts specified
amounts to approx. £12, but we can
supply the complete set of parts to
build this

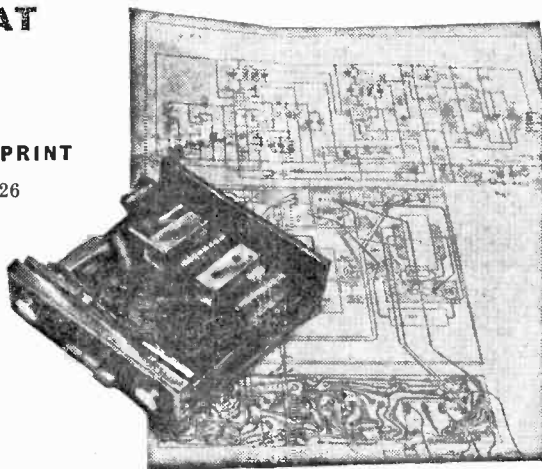

LOW COST CAR RADIO

For ONLY **£7.19.6** P. & P. 5/-

STERN-CLYNE

GREAT BRITAIN'S GREATEST ELECTRONIC HOBBIES ORGANISATION

**NOW
OPEN!!**

**OUR NEWEST
ELECTRONICS CENTRE**

AT

**125 THE MOOR
SHEFFIELD**
(CORNER OF CUMBERLAND STREET)

All items available as advertised, together with the finest selection of Hi-Fi, Audio and Tape Recording equipment by all leading manufacturers and a comprehensive range of electronic components for the build it yourself enthusiast. A warm welcome awaits you at Sheffield's latest and most up to date electronics centre.

**VISIT YOUR NEAREST
STERN-CLYNE ELECTRONICS CENTRE**

LONDON

18 Tottenham Court Road, W.1. MUSEUM 5929/0095. Half Day Saturday.
23 Tottenham Court Road, W.1. MUSEUM 3461/2. Half Day Thursday.
309 Edgware Road, W.2. PADDDINGTON 5963. Half Day Thursday.
109 Fleet Street, E.C.4. FLEET STREET 6812/3. Half Day Saturday.
162 Holloway Road, N.7. NORTH 7941. Half Day Thursday.
9 Camberwell Church Street, S.E.6. RODNEY 2875. Half Day Thursday.

CROYDON

12 Suffolk House, George Street. MUNICIPAL 3260. Half Day Wednesday.

BRISTOL

26 Merchant Street, Bristol 1, Bristol 20261. Open 6 days a week.

SHEFFIELD

125 The Moor Sheffield, Sheffield 29998.

LIVERPOOL

52 Lord Street, Royal 7450.

MANCHESTER

20/22 Withy Grove Manchester 4. BLACKFRIARS 5379. Open 6 days a week.

MAIL ORDERS AND ENQUIRE TO

Dept. P.W. 3/6 Eden Grove Holway, London N.7. NORTH 8161/6.

BENTLEY ACOUSTIC CORPORATION LTD.

Suppliers to H.M. Government. 38 CHALCOT ROAD, LONDON, N.W.1 Telephone: PRIMROSE 9090

NEAREST UNDERGROUND IS CHALK FARM. ALL GOODS ARE NEW, BEST QUALITY BRANDS ONLY, AND SUBJECT TO MAKERS' FULL GUARANTEE. PLEASE NOTE THAT WE DO NOT SELL ITEMS FROM FAULTY EQUIPMENT NOR MANUFACTURERS' SECONDS & REJECTS, WHICH ARE OFTEN DESCRIBED AS "NEW AND TESTED" BUT HAVE A SHORT AND UNRELIABLE LIFE

0A2	4/6	8B87	25/-	7A7	12/6	35U40GT18/2	AC2pen 11/6	F180F	19/0	EL83	6/0	KTW91	4/9	QP35	5/-	U47	8/0	AF124	11/-	
0B2	7/6	8BW0	6/0	7B9	12/6	28Y	AC2PEN 11/6	F119	1/9	EL34	1/9	KTW92	4/9	Q87520	10/0	U90	4/9	AF123	10/8	
0ZAGT	4/3	8BW7	5/-	7B7	7/6	27Y5G	DD 13/6	FA50	1/6	EL35	10/-	KTW93	5/6	Q8150/159/6	10/0	U80	4/9	AF126	10/0	
1A3	2/6	8BX6	8/9	7C5	7/8	28Z40	AC5PEN/	EA76	6/9	EL38	8/9	KT471	5/6	R10	15/-	U76	4/9	AF127	9/6	
1A4	12/6	8C4	2/3	7C8	6/9	28Z5	DD 23/8	EAB00	5/6	EL37	12/3	L63	3/-	R13	5/6	U78	3/8	BY123	11/8	
1A5	5/-	8C8	4/-	7C7	5/-	28Z6GT	AC8PEN 4/9	EAC91	3/3	EL41	7/3	LN162	6/9	R16	25/-	U84	10/0	GD3	5/6	
1A7GT	7/9	8C8	3/-	7D3	15/-	28U	AC2PEN 11/6	EAF42	7/0	EL42	7/0	LN309	7/9	R17	17/0	U85	10/0	GD6	5/6	
1C1	4/-	8C8	3/-	7D5	14/6	28U	DD 17/6	EBA4	1/9	EL43	6/9	LN319	8/6	R18	5/6	U107	17/0	GD14	10/-	
1C2	3/9	8C9	10/9	7D8	14/6	30C1	AC2PEN/	EBA1	4/9	EL83	6/5	LP2	9/1	R19	6/6	U191	6/6	GET103	7/-	
1C3	6/3	8C10	7/6	7D5	15/6	30C15	(7) 17/-	EBR1	2/8	EL84	4/9	LZ319	5/6	R52	9/-	U251	9/-	GET104/10	7/-	
1C3	5/-	8C12	8/-	7H7	5/9	30C18	AC8G 22/8	EBR3	20/6	EL85	7/8	LZ329	6/9	RG1/240A	U281	9/6	GET106/17/8	7/-		
1C4	10/6	8C16G	18/6	7H7	10/6	30C18	AC8G/VG	EBR33	8/9	EL86	7/8	ME41	13/-	U283	12/3	U301	11/3	GET113	6/9	
1D3	6/6	8C16S	8/9	7Y7	5/6	30FL1	AC2PEN 11/6	EBR4	6/9	EL91	2/8	MD1	3/6	U301	11/3	U301	11/3	GET113	6/9	
1D5	9/6	8C0W4	24/-	7Y4	5/6	30FL1	AC2PEN 11/6	EBR4	6/9	EL96	5/8	MH4	3/6	U329	9/6	U329	9/6	GET114	6/6	
1PD1	5/9	8D1	1/6	8D2	8/6	30L15	AC/TP 18/-	EBR30	9/9	EL360	27/-	MHD4	7/6	U339	9/6	U339	9/6	GET872/10	7/-	
1PD9	3/8	8D3	9/6	8BW6	9/6	30P4	AC/VP112/-	EBR91	5/6	EL830	16/4	MHL612/6	SP13C	U408	9/9	U408	9/9	GET873	9/8	
1Q6	5/6	8E3	5/-	8D3	8/6	30P12	AC/TP2 20/6	EBF96	5/6	EL822	16/8	MIL6	5/9	U404	6/9	U404	6/9	GET874	9/8	
1H8GT	7/9	8E6	9/6	8D7	7/6	30P16	AC/TP4 2/3	EBF98	7/9	EL900	20/6	M84B	20/6	U501	16/3	U501	16/3	GET875	9/8	
1L4	2/3	8F1	9/6	10C1	8/9	30P19	AC/TP4 2/3	EBF99	6/3	EM4	17/9	M8P4	12/-	U4020	6/6	U4020	6/6	GET876	9/8	
1L4A	17/6	8F6G	9/9	10C2	12/3	30P18	AC/TP4 2/3	EBF99	10/6	EM34	11/8	MU12/14/4	SP65	27/2	VMP5G11/9	U4020	6/6	GET877	9/8	
1L4A	16/10	8F6GT	7/6	10D1	7/6	30P13	AC/TP4 2/3	EBF99	4/3	EM35	12/-	MX40	8/9	T41	9/-	VMP5G11/9	U4020	6/6	GET878	9/8
1L5	4/6	8F7G	5/-	10D4	11/8	30P14	AC/TP4 2/3	EBF99	13/6	EM71	13/6	NX7	23/3	T42	12/3	VMP5G11/9	U4020	6/6	GET879	9/8
1N5GT	3/6	8F11	17/9	10F9	9/9	38S1	12/3	EBI3	10/6	EM70	4/9	ENR1	7/9	TP25	5/6	U4020	6/6	GET880	9/8	
1P1	5/9	8F12	3/-	10P18	9/9	38	12/6	EC90	2/3	EM84	6/9	ENR3	15/6	TP25	5/6	U4020	6/6	GET881	9/8	
1P13	4/6	8F13	3/9	10D13	6/3	38A5	14/6	EC91	3/9	EM85	8/9	ENR3	15/6	TP25	5/6	U4020	6/6	GET882	9/8	
1P11	5/3	8F14	23/8	10D11	9/6	38AGT	8/6	EC92	6/8	EM87	7/6	ENR3	15/6	TP25	5/6	U4020	6/6	GET883	9/8	
1P14	4/6	8F15	6/6	10D12	9/6	38AGT	8/6	EC93	7/8	EM84	10/6	ENR3	15/6	TP25	5/6	U4020	6/6	GET884	9/8	
1P4	5/6	8F17	12/6	10P14	11/6	38Z3	14/6	EC93	4/9	ENR1	5/6	PC84	10/8	TP25	5/6	U4020	6/6	GET885	9/8	
1P5	8/6	8F18	15/6	11D3	17/6	38Z4GT	4/6	EC93	4/9	ENR1	5/6	PC84	10/8	TP25	5/6	U4020	6/6	GET886	9/8	
1P2	20/-	8F23	6/3	11D5	17/6	38Z5GT	5/6	EC93	4/9	ENR1	5/6	PC84	10/8	TP25	5/6	U4020	6/6	GET887	9/8	
1T4	2/3	8F24	3/8	11E1	15/6	38Z6GT	5/6	EC93	4/9	ENR1	5/6	PC84	10/8	TP25	5/6	U4020	6/6	GET888	9/8	
1U4	5/6	8F25	8/6	12A	12/6	38Z7	12/6	EC93	4/9	ENR1	5/6	PC84	10/8	TP25	5/6	U4020	6/6	GET889	9/8	
1U5	5/3	8F23	8/6	12A6	2/6	41MTL	8/6	EC93	4/9	ENR1	5/6	PC84	10/8	TP25	5/6	U4020	6/6	GET890	9/8	
2A7	12/6	8G3	2/6	12A5	18/6	41MTL	15/-	EC93	4/9	ENR1	5/6	PC84	10/8	TP25	5/6	U4020	6/6	GET891	9/8	
2C26	2/9	8H6	1/6	12A5C	8/6	42	5/-	EC93	4/9	ENR1	5/6	PC84	10/8	TP25	5/6	U4020	6/6	GET892	9/8	
2D13G	7/6	8J5G	3/6	12A6	8/6	43	10/-	EC93	4/9	ENR1	5/6	PC84	10/8	TP25	5/6	U4020	6/6	GET893	9/8	
2D21	5/6	8J6GT	5/6	12A7	8/6	43	10/-	EC93	4/9	ENR1	5/6	PC84	10/8	TP25	5/6	U4020	6/6	GET894	9/8	
2P	23/8	8J8	3/-	12AH7	5/6	45Z5	15/6	EC93	4/9	ENR1	5/6	PC84	10/8	TP25	5/6	U4020	6/6	GET895	9/8	
2X2	3/-	8J7G	4/6	12AH8	10/9	45Z6	11/10	EC93	4/9	ENR1	5/6	PC84	10/8	TP25	5/6	U4020	6/6	GET896	9/8	
3A4	8/9	8J7GT	7/6	12A7S	4/6	50B5	8/6	EC93	4/9	ENR1	5/6	PC84	10/8	TP25	5/6	U4020	6/6	GET897	9/8	
3A5	9/9	8J8	12/6	12A7T	2/6	50C6	8/6	EC93	4/9	ENR1	5/6	PC84	10/8	TP25	5/6	U4020	6/6	GET898	9/8	
3B7	5/6	8K6GT	5/6	12A8	8/6	50C6GT	8/6	EC93	4/9	ENR1	5/6	PC84	10/8	TP25	5/6	U4020	6/6	GET899	9/8	
3D4	8/6	8K7G	3/6	12A7U	6/6	50C6GT	8/6	EC93	4/9	ENR1	5/6	PC84	10/8	TP25	5/6	U4020	6/6	GET900	9/8	
3Q4	5/3	8K7GT	4/6	12A7E	6/6	50C6GT	8/6	EC93	4/9	ENR1	5/6	PC84	10/8	TP25	5/6	U4020	6/6	GET901	9/8	
3Q8GT	7/6	8K8G	3/3	12A7X	4/6	52KU	14/6	EC93	4/9	ENR1	5/6	PC84	10/8	TP25	5/6	U4020	6/6	GET902	9/8	
384	4/6	8K8GT	7/9	12A7Y	9/9	72	4/6	EC93	4/9	ENR1	5/6	PC84	10/8	TP25	5/6	U4020	6/6	GET903	9/8	
3V4	5/3	8K26	5/6	12B6	8/6	73	4/6	EC93	4/9	ENR1	5/6	PC84	10/8	TP25	5/6	U4020	6/6	GET904	9/8	
4D1	3/9	8L1	10/6	12B6E	6/9	77	5/6	EC93	4/9	ENR1	5/6	PC84	10/8	TP25	5/6	U4020	6/6	GET905	9/8	
5R4G	7/6	8L6G	12/6	12B7	6/9	80	5/3	EC93	4/9	ENR1	5/6	PC84	10/8	TP25	5/6	U4020	6/6	GET906	9/8	
5T4	7/6	8L6G	6/6	12E1	16/9	83	22/6	EC93	4/9	ENR1	5/6	PC84	10/8	TP25	5/6	U4020	6/6	GET907	9/8	
5U4G	4/6	8L7GT	4/6	12E6GT	8/6	83V	8/6	EC93	4/9	ENR1	5/6	PC84	10/8	TP25	5/6	U4020	6/6	GET908	9/8	
5V4G	7/6	8L18	10/6	12E6	2/6	85A2	8/6	EC93	4/9	ENR1	5/6	PC84	10/8	TP25	5/6	U4020	6/6	GET909	9/8	
5Y3GT	4/9	8L19	10/6	12J7GT	7/3	90A3	8/6	EC93	4/9	ENR1	5/6	PC84	10/8	TP25	5/6	U4020	6/6	GET910	9/8	
5Y4	9/6	8L13	6/6	12K5	10/6	90AV	6/6	EC93	4/9	ENR1	5/6	PC84	10/8	TP25	5/6	U4020	6/6	GET911	9/8	
5Z3	7/6	8L13	7/6	12K7GT	9/6	90C9	42/-	EC93	4/9	ENR1	5/6	PC84	10/8	TP25	5/6	U4020	6/6	GET912	9/8	
630L2	8/3	8L20	5/6	12K8GT	9/6	90CV	42/-	EC93	4/9	ENR1	5/6	PC84	10/8	TP25	5/6	U4020	6/6	GET913	9/8	
6A8G	3/9	8M7GT	5/6	12Q7GT	3/6	90C9	16/-	EC93	4/9	ENR1	5/6	PC84	10/8	TP25	5/6	U4020	6/6	GET914	9/8	
6A8G	3/9	8M7GT	5/6	12Q7GT	3/6	90C9	16/-	EC93	4/9	ENR1	5/6	PC84	10/8	TP25	5/6	U4020	6/6	GET915	9/8	
6B7	4/6	8P36	9/6	12S7	4/6	100C3	4/6	EC93	4/9	ENR1	5/6	PC84	10/8	TP25	5/6	U4020	6/6	GET916	9/8	
6A07	3/6	8P23	11/6	12S7	3/6	181ST	34/11	EC93	4/9	ENR1	5/6	PC84	10/8	TP25	5/6	U4020	6/6	GET917	9/8	
6A05	2/6	8Q7G	4/6	12S7	5/6	2158G	8/6	EC93	4/9	ENR1	5/6	PC84	10/8	TP25	5/6	U4020	6/6	GET918	9/8	
6A07	7/6	8Q7GT	7/9	12S7	3/6	229B	10/6	EC93	4/9	ENR1	5/6	PC84	10/8	TP25	5/6	U4020	6/6	GET919	9/8	
6A05	4/9	8R7G	5/3	12S7	8/6	301	30/0	EC93	4/9	ENR1	5/6	PC84	10/8	TP25	5/6	U4020	6/6	GET920	9/8	
6A05	4/9	8R7GT	11/6	12S7	5/6	302	10/6	EC93	4/9	ENR1	5/6	PC84	10/8	TP25	5/6	U4020	6/6	GET921	9/8	
6A05	4/9	8S7	11/6	12U5G	7/3	303	15/6	EC93	4/9	ENR1	5/6	PC84	10/8	TP25	5/6	U4020	6/6	GET922	9/8	
6A05	4/9	8S7	4/9	13D1	5/6	304	15/6	EC93	4/9	ENR1	5/6	PC84	10/8	TP25	5/6	U4020	6/6	GET923	9/8	
6A15	2/3	8T7	4/9	13D3	5/6	305	13/6	EC93	4/9	ENR1	5/6	PC84	10/8	TP25	5/6	U4020	6/6	GET924	9/8	
6A05	2/6	8H7	3/6	1486	20/9	308	13/6	EC93	4/9	ENR1	5									

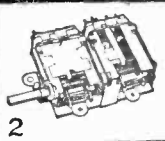

3 to 4 watt Amplifier Kit comprising chassis $8\frac{1}{2} \times 2\frac{1}{2} \times 1\frac{1}{2}$ in. Double wound mains transformer, output transformer, volume and tone controls, resistors, condensers etc. Valves 6V6, ECC81 and metal rectifier. Circuit 1/6 free with kit. 29/6 plus 4/- P. & P.

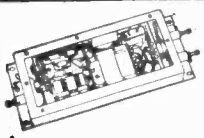

3



5

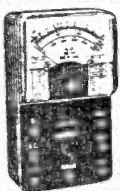
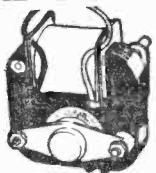

8

7

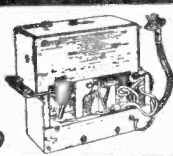

10

9



12

11

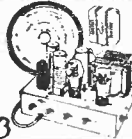

14

13

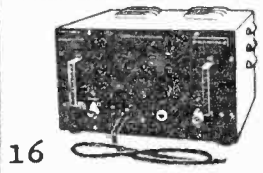
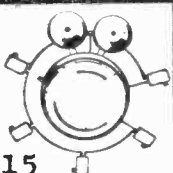

16

15

L 6 VALVE 15 WATT PUSH-PULL AMPLIFIER, $15 \times 7 \times 1\frac{1}{2}$ in. A.C. Mains 200-250 volts. 4 inputs with controls for same and bass and treble lift controls. Tapped for 3 and 15 ohm speakers. Extra H.T. and L.T. for F.M. Tuner supplies etc. Built and tested. 7 gns. P. & P. 12/6.

2. CYLON A.M. F.M. PERMEABILITY TUNER FOR ALL TRANSISTOR OPERATION. Size $2\frac{1}{2} \times 2\frac{1}{2}$ in. approx. By famous manufacturer. A.M. 1.7-470 Kc/s. F.M.-11 P. 10.7 Mc/s. A.M. coverage from 1620 Kc/s-225 Kc/s. F.M. coverage 108 Mc/s-88 Mc/s. Circuit diagrams 2/6. FREE with Tuner. 1st. 2nd. 3rd A.M. I.F.s. 1st. 2nd. 3rd and 4th F.M. I.F.s. V.H.F. Osc. choke. A.M. I.F. trap. A.F. 114 and A.F. 115. All the above are the R.F. end of an A.M./F.M. receiver car radio etc. The above sizes items, £2.10.0.

3. AMPLIFIER KIT.

4. TRANSISTOR INVERTOR. 50 v. D.C. Input. Output 240 v. A.C. 40 watts incorporating transformers, choke, condensers and 2 6et573. In solid 18 gauge aluminium case size $10 \times 6 \times 2\frac{1}{2}$ in., by famous manufacturer. 19/6. plus 6/- P. & P.

5. FLUORESCENT LIGHT FITTING. Twin 40 watt 200/250 v. less tubes 59/6. P. & P. 6/-.

6. SIGNAL GENERATORS. Cash £7.5.0. P. & P. 6/6. Coverage 100 Kc/s to 100 Mc/s on fundamentals and 100 Mc/s to 200 Mc/s on harmonics. Case $10 \times 6\frac{1}{2} \times 3\frac{1}{2}$ in. Three miniature valves and Metal Rectifier. A.C. mains 200/250 v. Internal modulation of 400 c.p.s. to a depth of 30 per cent. Modulated or unmodulated R.F. output continuously variable 100 multivolts. C.W. and mod. switch, variable A.F. output. Magic eye as output indicator. Accuracy 2 per cent.

7. A.C. MAINS MOTOR. Can be used for a variety of purposes, silent running, satisfactory in every way. 230/250 v. A.C. 9/6. P. & P. 2/-.

8. POCKET MULTI-METER. Size $3\frac{1}{2} \times 2\frac{1}{2} \times 1\frac{1}{2}$ in. Meter size $2\frac{1}{2} \times 1\frac{1}{2}$ in. Sensitivity 1,000 O.P.V. on both A.C. and D.C. A.C. and D.C. volts. 0-15, 0-150, 0-1000. D.C. current 0-150 mA. Resistance 0-100K Ω . Complete with test prods, battery and full instructions. 35/-. P. & P. 2/6. FREE GIFT for limited period only. 30 watt Electric Soldering Iron value 15/- to every purchaser of the Pocket Multi-Meter.

9. CHANNELE TUNER I.F. 16-19 Mc/s. Continuously tunable from 174-216 Mc/s. Valves required—PCF80 and PCC84 (in series). Cover BBC and ITA ranges. Also Police, Fire and Taxis, etc. Brand new by famous maker, 10/-. P. & P. 3/-.

10. THE MOTORISTS' REV. COUNTER. Kit of parts comprising 270 degree 3in. moving coil movement. Manufacturer's present price of the movement would be at least £7. Complete with full instructions and circuit diagram. Scale calibrated up to 8,000 r.p.m. Can be used with any 4 or 6 cylinder car. 49/6, plus 3/6 P. & P.

11. B.S.R. MONARCH UA14 WITH FULL FI HEAD. 4-speed, plays 10 records. 12in., 10in. or 7in. at 16, 33, 45 or 75 r.p.m. Intermixes 7in., 10in. and 12in. records of the same speed. Has manual play position: colour brown. Dimensions: $12\frac{1}{2} \times 10\frac{1}{2}$ in. Space required above baseboard $4\frac{1}{2}$ in. below baseboard $2\frac{1}{2}$ in. Fitted with Full FI turnover crystal head. £5.19.6. P. & P. 6/6.

12. 50 MICRO-AMP METER movement by world famous manufacturer. Size $3 \times 2\frac{1}{2}$ in. 25/-, plus 1/6 P. & P.

13. 9-watt PUSH-PULL 5 VALVE AMPLIFIER plus METAL RECTIFIER. A.C. mains 200-250V. Size $10\frac{1}{2} \times 6\frac{1}{2} \times 2\frac{1}{2}$ in. 3 valves. For use with all makes and types of pick-up and mike. Negative feed back. Two input, mike and gram, and controls for same. Separate controls for Bass and Treble lift. Response flat from 40 cycles to 15 kc/s. Note level 40 dB down at 100 Hz. Output 8 watts at 5 percent total distortion. Note level 40 dB down at 100 Hz. Output transformer tapped for 3 and 15 ohms speech coils. For use with std. or L.P. records, musical instruments such as guitars, etc. Suitable for small halls. £3.19.6. P. & P. 7/-. Crystal mike to suit, 15/-. P. & P. 2/-. 5in. P.M. Speaker to suit, 12/6. P. & P. 2/-.

14. FLUORESCENT LIGHT KIT. Twin 20 choke instant start, complete with 4 bi-pin 200/250 v. holders, 11/6. P. & P. 4/-. Twin 40 choke instant start with 4 bi-pin 200/250 v. holders, 17/6. P. & P. 4/-.

15. RINGO BURGLAR ALARM SYSTEM. A.C. mains. 200/240 volt. Fire salvage slightly tarnished. List price 7 gns. Our price, complete with double gong bell five micro switches and full instructions, 49/6. P. & P. 4/-.

16. FIXED FREQUENCY SIGNAL GENERATOR. Crystal control in metal case size $10 \times 6 \times 3$ in. Incorporating two FC13 valves, mains transformer, metal rectifier, choke, indicator lamp, crystal and numerous components. Modulated and unmodulated output socket. Originally used for I.T.V. frequencies. Brand new. 39/6, plus 6/- P. & P. A.C. mains 200-250 volts.

SILICON RECTIFIERS. 250 v. P.I.V. 750 mA. 81x for 7/6 post paid.

RADIO & T.V. COMPONENTS (ACTON) LTD.

21b High Street, Acton, London, W.3.

All enquiries S.A.E. Goods not despatched outside U.K.
Shop Hours 9 a.m.—6 p.m. Early closing Wednesday.

SPECIAL OFFER! FROM R. & T.V. LTD.



COMBINED PORTABLE & CAR RADIO

The Radio with the STAR features
4in. SPEAKER

- ★ 7-transistor superhet. Output 350mW.
- ★ Two-tone grey wooden cabinet, fitted handle with silver coloured fittings. Size 12½ x 8½ x 3½ in.
- ★ Horizontal tuning scale, size 11½ x 2½ in. in silver with black lettering.
- ★ All stations clearly marked.
- ★ Ferrite-rod internal aerial.
- ★ I.F. 470 Kcs.
- ★ Operated from PP9 battery.
- ★ Full comprehensive instructions and point-to-point wiring diagrams.
- ★ Printed circuit board, back printed with all component values.
- ★ Fully tunable over medium and long waveband.
- ★ Car aerial socket.
- ★ Full after-sale service.

ONLY
£4.19.6

Plus 5/6 P. & P. Parts list & circuit diagram 2/6. FREE with parts.

SPECIAL OFFER—POWER SUPPLY KIT to purchasers of "Elegant Seven" parts, incorporating mains transformer etc. A.C. mains 200-250v. Output 9v, 100mA, 7/6.

Goods not despatched outside U.K. All enquiries S.A.E. Terms C.W.O.

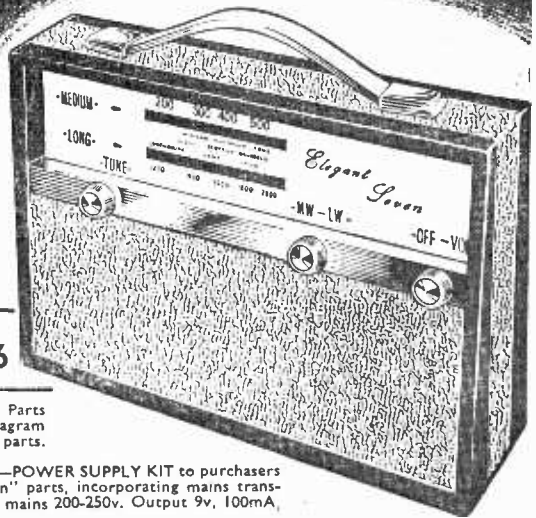

RADIO & TV COMPONENTS (ACTON) LTD 21C High St., Acton, London W3

Open 9 a.m.—6 p.m. including Sats. Early closing Wed.

pitman

AN ELECTRONIC ORGAN FOR THE HOME CONSTRUCTOR

Alan Douglas, Sen. Mem. I.E.E.E.

A very popular "how to make it" book. Shows exactly what is involved in work and materials (a list of sources of supply is included) in constructing an inexpensive instrument for use in the home. For this new edition, an alternative arrangement of continuous tuning has been added to a revised and up-to-date text.

Second edition 20s. net.

from all booksellers

Pitman Parker St. London WC2

BARGAINS FROM BROADWAY ELECTRONICS

- 12in. ALTHAM SPEAKER with built-in tweeter, 3 ohm or 15 ohm 7,000 Gauss Magnet. Only 29/6, postage 3/6.
- L.S.H.75 ELECTROSTATIC TWEETER—2/6 with diagram.
- HAYDON CABINET (17 x 15 x 8in.) designed to take a 12in. Heavy Duty Speaker, 50/-. Postage 7/6.
- ATTRACTIVE TWO-TONED CABINET, 11 x 6 x 5in.. room for small amplifier, fitted with ex T.V. 5in. speaker. Only 19/6, post 2/6.
- The Famous B.M.3XTAL MICROPHONE with neck lanyard, 39/6 table stand for above, 9/6 extra. Xtal Insert, 7/3.
- GUITAR PICK-UP, complete with clip and screened lead, 15/-.
- 3-WAY PUSH-BUTTON UNITS. Each button operates a 4-pole, 2-way switch, 4/6.
- BARGAINS IN TRANSISTORS. Mullard RF Packs, OC44, two OC45, 12/6; AF Packs, OC81D, two OC81, 12/6; OC44, 3/6; OC45, 3/-; OC71, 2/6; OC72, 3/-; OA81 diode, 2/3; AF115, 6/6; AF117, 6/6; ORP12 Light Cell, 7/6; OC29, 12/6; OC35, 12/6.
- TRANSISTOR ELECTROLYTICS, 1, 2, 4, 5, 8, 10, 16, 32, 50 100mPd —all at 15 volts, 1/3 each.
- MICHAEL TELESCOPIC TV AERIAL, 23in. extends to 45in. Fitted with co-ax plug will suit any set. Only 7/6.
- CARTRIDGES. Acos 67-1G Low Output, 87-2G Medium Output GP59-5 High Output, Garrard GC2 or GC8, all with mounting brackets, 15/-. Ronette Stereo with mounting bracket, 25/-. EARPHONES with cord and 3.5 mm. plug. 8 ohm magnetic, 3/-; 250 ohm, 4/-; 180 ohm magnetic with clip, 6/6; Xtal, 4/-; 3.5 mm. plugs with nice long shank, complete with jack, 3/-; 3.5 mm. plugs with nice long shank, complete with jack, screened 4/-.
- TOGGLE SWITCHES. Single pole with on-off plate, 2/6.
- NEON PANEL LIGHTS. 240c A.C. Arcolastic, 2/6.

TERMS: C.W.O. OR C.O.D.

BROADWAY ELECTRONICS 92 MITCHAM ROAD, TOOTING, S.W.17

Phone: BALham 3984

(four minutes from Tooting Broadway Underground Station)

LASKY'S RADIO

Offer the Finest Value and HOME CONSTRUCTORS

We consider our construction parcels to be the finest value on the home constructor market. If on receipt you feel not competent to build the set, you may return it as received within 7 days when the sum paid will be refunded less postage.

THE SKYROVER & SKYROVER De Luxe

★ LONG WAVEBAND COVERAGE IS NOW AVAILABLE FOR THESE WELL-KNOWN SETS

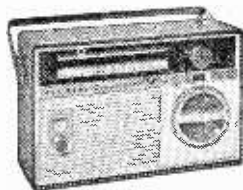

THE SKYROVER

Controls: Waveband Selector, Volume Control with on/off Switch, Tuning Control. In plastic cabinet, size 10 x 6 1/2 x 3 1/2 in. with metal trim and carrying handle. Can now be built for **£8.19.6** P. & P. built for **£8.19.6** P. & P. H.P. Terms: 20/- deposit and 11 months at 16/6.

THE SKYROVER DE LUXE

Tone Control Circuit is incorporated with separate Tone Control in addition to Volume Control, Tuning Control and Waveband Selector. In a wood cabinet size 11 1/2 x 6 1/2 x 3 in. covered with a washable material with plastic trim and carrying handle. Also car aerial socket fitted. **£10.19.6** Can now be built for P. & P. 5/-. H.P. Terms: 25/- deposit and 11 months at 20/-. Data for each receiver 2/6 extra. Refunded if you purchase the parcel. Four U2 batteries 3/4 extra. All Components Available Separately.

A simple additional circuit provides coverage of the 1100/1950 M. band (including 1500 M. Light programme). This is in addition to all existing Medium and Short wavebands. All necessary components with construction data **Only 10/- extra** Post Free. This conversion is suitable for both models that have already been constructed.

GENERAL SPECIFICATION
7 transistor Plus 2 diode superhet, 6 waveband portable receiver. Operating from four 1.5 v. torch batteries. The SKYROVER and SKYROVER DE LUXE cover the full Medium Waveband and Short Waveband 31-94 M. and also 4 separate switched band-spread ranges, 13M, 16M, 19M and 25M, with Band Spread Tuning for accurate Station Selection. The coil pack and tuning heart is completely factory assembled, wired and tested. The remaining assembly can be completed in under three hours from our easy to follow stage by stage instructions.

SPECIFICATION:
Superhet 470 Kc/s. All Mullard Transistors and Diode. Uses 4-U2 batteries. 5in. Ceramic Magnet P.M. Speaker. Easy to read Dial Scale. Band Spread Tuning. 500 MW Output. Telescopic Aerial & Ferrite Rod Aerial. **WAVEBAND COVERAGE:** 180-576M; 31-94M and Band Spread on 13, 16, 19 and 25 metre Bands.



The "Sixteen" Multirange METER KIT

This outstanding meter was featured by *Practical Wireless* in the Jan. '64 issue. Lasky's are now able to offer the complete kit of parts as specified by the designer.
RANGE SPECIFICATION: D.C. volts: 0-2.5-25-50-250-500 at 20,000 Ω/V. A.C. volts: 0-25-50-250-500 at 1,000 Ω/V. D.C. current: 0-50μA. 0-2.5-50-250 mA. Resistance: 0-2,000 Ω. 0-200k Ω. 0-20M Ω. Basic movement: 40μA f.s.d. moving coil. With universal shunt full scale deflection current is 50μA. Size/finish: Black plastic case, 3 1/2 x 5 1/2 x 1 1/2 in. Controls: 12 position range switch; separate slide switch for A.C. volts—D.C. ohms; zero adjustment pot. meter; meter zero. External connections: Two 4mm. sockets for test lead plugs. Power requirements: One 15V. and one 1.5V. batteries. Complete with all parts and full construction details.
Data and circuit available separately 2/6 refunded if all parts bought. Pair of Batteries. 2/5 extra.

LASKY'S PRICE £5.19.6

P. & P. 5/- H.P. Terms: 21/- deposit and 5 months at 21/-



NEW SINCLAIR SUPER MINIATURES

THE MICRO-6 Self-contained pocket radio. Size only 1 1/2 x 1 1/2 x 1/2 in. A marvel of modern miniaturisation—truly amazing performance. Without a doubt the most advanced transistor circuit ever offered to home constructors—yet may be built in an evening. Complete with earphone and detailed construction data. **59/6** Mercury cell 1/11 extra (2 required). Can be built for only **59/6** All parts sold separately.

THE SLIMLINE The new 2-transistor pocket radio. Size only 2 1/2 x 1 1/2 x 1 1/2 in. Micro alloy transistorised and printed circuit. All components available separately. **Easy to assemble. CAN BE BUILT FOR 49/6**

THE X10 10 watt power amplifier fitted with integrated pre-amplifier. Requires only 1 mV. for an output of 10 watts undistorted. Frequency response is flat 4 dB from 5 c/s. to 20 kc/s. Size only 6 x 3 x 1 1/2 in. Weight 5 oz. Built on printed circuit. Operates from 12 v. D.C. at 75 mA. quiescent. **£5.19.6** Post Free. 7 M.A.T.s and 4 R.P. power transistors. **AVAILABLE READY BUILT, TESTED AND GUARANTEED, £6.19.6** Post Free. 3 pots. for volume, Bass and Treble, 7/6 the 3 extra. Mains power pack, if required. **54/-**

E.M.I. 4-SPEED RECORD PLAYER New, unused and individually boxed fitted with lightweight pick-up with ACOS G.P. 73/2 stereo cartridge. Cabinet space required 13 1/2 x 12 1/2 x 4 1/2 in. A 9in. metal turntable is fitted. For use on 200/250 volt A.C. Mains, with Auto-Stop. The stereo cartridge will play all types of Mono Records, 78's, L.P.'s etc. but if desired a G.P. 67 LP/78 Mono cartridge will be supplied **LASKY'S PRICE 79/6** P. & P. 3/6 in lieu of the G.P. 73 at no difference in cost. extra

The "REALISTIC" Seven

★ 7-transistor Superhet. ★ 350 milliwatt output into 4in. high flux speaker. ★ All components mounted on a single printed circuit board. ★ Full medium and long wave cover. ★ Plastic cabinet with carrying handle, size 7 x 10 x 3 1/2 in. Blue/Grey or all Grey. ★ Easy to read dial. ★ External socket for car aerial. ★ I.P. frequency 470 Kc/s. ★ Ferrite rod internal aerial. Operates from PP9 or similar battery. ★ Full comprehensive data supplied with each receiver. All coils and I.P.'s etc. fully wound ready for immediate assembly. An Outstanding Receiver. **LASKY'S PRICE** for the complete parcel including Transistors, Cabinet, Speaker, etc. and Full Construction Data. Can be built for **£5.19.6** P. & P. 4/6

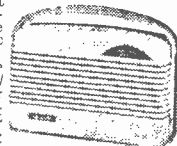

PP9 Batt. 3/9. Data and instructions separately 2/6. Refunded if you purchase the parcel.

REALISTIC Seven DE LUXE

With the same specification as standard model—PLUS a superior wood cabinet in contemporary styling. ALSO a full vision circular dial. **FOR ONLY £1 EXTRA** P. & P. as std. model.

RECORD PLAYERS

45 r.p.m. 6 volt Batt. operated. Complete with pick-up fitted crystal cartridge. Size only 7 1/2 in. x 6 in. Fitted auto. stop and start. New and perfect.

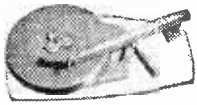

45 r.p.m. Model **49/6** P. & P. 2/6
2 speed model for 33 and 45 r.p.m. (as illustrated) **69/6** P. & P. 2/6

DEAC RECHARGEABLE NICKEL CADMIUM CELLS

Rating 1.22 v. 3.5 AH at 10 hour rate. 1001 uses for model makers, miniature equipment, portable radios, transistor radios, TV's, tape recs., trans receivers, photo flash etc. Hermetically sealed. Size 3 1/2 x 1 1/2 x 1 1/2 in. Listed at 35/- each. **LASKY'S PRICE 15/-** Post Free. Bank of 9 79/6.



TRANSISTORISED TELEPHONE AMPLIFIER

Powerfully amplifies the incoming call. The pick-up is suction fixed to phone. Battery-operated at negligible cost. Fitted with on/off switch and Vol. control. Size: 4 1/2 x 3 x 1 1/2 in. Complete with PP9 battery. **LASKY'S PRICE 69/6**. P. & P. 2/6.

GUITAR PICK-UPS

CGM35. Crystal-high imp. Size only 1 1/2 x 1 1/2 x 1 1/2 in. Clips to finger board—no screws. Complete with cable. **LASKY'S PRICE 15/11**. P. & P. 1/6.

CGM35. Fully adjustable pick-up position carrier. Simply fixed. Separate tone and volume control. Heavy chrome finish. Pick-up size 3 1/2 x 1 1/2 in. control size 2 1/2 x 1 1/2 in. Complete with long lead and jack plug. **LASKY'S PRICE 59/6** P. & P. 1/6

LASKY'S FOR D.I.Y. CONSTRUCTION BARGAINS

Service in Great Britain to both & HI-FI ENTHUSIASTS

TAPE RECORDERS · RECORD PLAYERS · AMPLIFIERS ETC. COMPLETE MONO/STEREO SYSTEMS TO YOUR SPEC.



TRANSISTORISED



MICROPHONE MIXER

The Harrow will mix 4 high impedance channels: mikes, tape rec's, tuners, grams, etc. 9 v. battery operated. Neatly styled, size only 6 x 2 1/2 x 2 1/2 in. standard jack sockets. Complete with P.F.3 batt. full circuit diagram and operating instructions.

Model TM4 Mono **59/6** P. & P. 2/6

Model SM5 Stereo **72/6** P. & P. 2/6

SPEAKERS SPECIAL OFFER

12in. FANE HEAVY DUTY DUAL CONE HI-FI SPEAKER



Type 192/17A—listed at 12 gns. Power handling 25 watts—15 ohms imp. Flux density 17,000 gauss. Special Anisotropic magnet. Limited stock.

LASKY'S PRICE £6.19.6
P. & P. 5/-.

TYPE 8CX1 8in. HI-FI SPEAKER—(IMPORTED) Power handling 10 watts—15 ohms impedance.

LASKY'S PRICE 6 Gns. P. & P. 5/-

THE HARROW CV1 VARIABLE CROSSOVER

Gives variable volume control of Woofer and Tweeter. Strong metal construction. Size 4 x 2 1/2 x 1 1/2 in. Screw tag connections.

LASKY'S PRICE 22/6 P. & P. 1/6

NOW IN STOCK THE NEW STUDIO RANGE OF CELESTION HI-FI SPEAKERS

"HARROW" POWER PACK

Battery eliminator—converts your battery portable to A.C. mains. Replaces 6 v. 41 v. or 9 v. batteries. State voltage required when ordering. Size only 3 x 2 x 2 1/2 in.

LASKY'S PRICE 29/6 P. & P. 1/6

LAFAYETTE TAPE

Famous American Brand—Fully Guaranteed

8in. Double play, 1,200ft., Mylar base	15	0
8in. Long play, 900ft., Acetate base	10	0
8in. Standard play, 900ft., P.V.C. base	8	6
8 1/2in. Long play, 1,200ft., Mylar base	15	0
8 1/2in. Double play, 1,800ft., Mylar base	22	6
8 1/2in. Long play, 1,200ft., Acetate base	12	6
7in. Standard play, 850ft., P.V.C. base	11	6
7in. Long play, 1,800ft., Mylar base	12	6
7in. Double play, 2,400ft., Mylar base	25	0
7in. Long play, 1,800ft., Acetate base	15	0
3in. Message tape, 150ft.	3	6
3in. Message tape, 225ft.	4	11
3in. Message tape, 900ft.	7	6
8in. Triple play, 2,400ft., Mylar base	12	6
4in. Triple play, 900ft., Mylar base	22	6
8in. Triple play, 1,800ft., My ar base	42	6
8 1/2in. Triple play, 2,400ft., Mylar base	55	0
7in. Triple play, 3,500ft., Mylar base	75	0

P. & P. 1/- extra per reel; 4 reels and over Post Free

THE NEW "KUBA" CONTINENTAL AM/FM

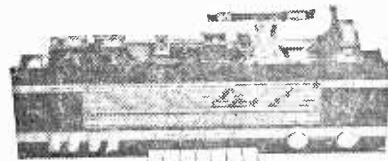

STEREO RADIOGRAM CHASSIS

Long, medium and short waveband coverage plus VHF/FM. Piano key wave-change. Separate 8-wheel tuning on AM and FM. Bass, treble and balance controls.

Magic-eye tuning indicator. Ferrite rod aerial. The very latest printed circuitry. Provision for multiple adaptor. 5 valves—line-up: 6XN5, 6XHS1, EC083, ELL50, EAF801. Full vision tuning scale size 2 1/2 x 6in. Overall dimensions: 21 x 6 1/2 x 8in. Made to the very highest standards.

LASKY'S PRICE 29 1/2 GNS.

Carriage & Insurance 12/6 extra.



THE BH-14 AMPLIFIER

High quality 14 watt power amplifier with base and treble controls and separate volume controls on each input. Output 3 or 15 ohms. Valve line-up: 2 x 6L4, 1 x 6X5, EC083 and EZ81. Frequency res. 15 c/s—20 Kc/s. Ideal for the hi-fi enthusiast or for guitar amplifier. Gold hammer finish with Perspex front panel. Complete kit of parts with detailed construction data. Instruction book avail. sep. 1/6.

VIKING "SOUND 30"

High quality guitar and P.A. amplifier. A.C. Mains operated—30 watt output, 8 inputs. Fitted with 4 separate volume controls for mixing, also Bass and Treble controls. 15 ohms out. British made—highest quality components used throughout—fully guaranteed. In strong portable case, size approx. 20 x 9 x 6in. Carr. & Pack 7/6 extra.

LASKY'S PRICE 35 GNS.

LASKY'S KIT PRICE 9 GNS.

Post and Packing 7/6.

AVAILABLE READY BUILT AND TESTED. **LASKY'S PRICE 11 GNS.** P. & P. 7/6.

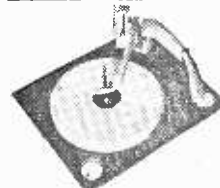

AUTOCHANGER SCOOP!!!

LASKY'S CAN NOW OFFER B.S.R. AUTOCHANGERS AT LOWEST EVER PRICES

All brand new and fully guaranteed—complete with cartridge and stylus.

UA14 4 speed, mains	£3.19.6
UA16 4 speed, mains	£4.19.6
UA14 4 speed, 9 v. battery operated	£5.19.6
UA20 4 speed, mains	£5.19.6

Add 5/- carriage and packing, each.

THE TRANSISTOGRAM

A portable battery operated fully transistorised Record Player. Made by famous British manufacturer, fully guaranteed. Size 6 1/2 x 12 x 10 1/2 in., weight 10lb. Operates on 6 U2 batt. 4 speeds—16 2/3, 33 1/3, 45 and 78 r.p.m. Goldring Cygnet player unit with lightweight pick-up fitted with GM-50 turnover ceramic cartridge. Output 500 mV to 5mV, ceramic magnet speaker, fitted into lid. Cabinet constructed of wood, covered in two tone (gate blue-grey, leathercloth). High quality amplifier with tone and volume controls. Plays 7, 10 and 12in. records. New, boxed and guaranteed—ex. batts. Today's value 12 Gns.

Carriage and insurance 7/6.

LASKY'S PRICE £6.19.6



CRYSTAL PICK-UP CARTRIDGES LOWEST EVER PRICES!

All complete with Stylus L.P. and Standard (and Stereo where shown) fully guaranteed. Standard Fitting will fit most P.U. Arms and Heads. Postage 1/- each extra.

STEREO	MONO	
Acostereo 731 2 sapphires	25	0
Acostereo 732 Diamond LP/Stereo and sapphire Std.	29	6
Ronette Stereo 0.V. Turnover, 2 sapphires	25	0
Ronette Stereo type 102 and 108, 2 sapphires	25	0
Ronette Stereo type 105 and 106 Diamond LP/Stereo and sapphire Std.	35	0

AND EVEN LOWER PRICES!

Mono C.T.1.	4	11
Collaro Type C, stereo, 2 sapphires	15	0
Coliel S.C.L. Diamond LP/Stereo	17	6
Garrard Magnetic T.O.M.2.	15	0
Acos GP.59	14	0
Acos GP.65/3	15	0
Acos GP.65/1	17	0
Acos GP.67/1	14	0
Bonitone 8T stereo, 2 sapphires	19	11
Bonitone 2TA, mono, 2 sapphires	15	0

Postage 1/- each extra.

207 EDGWARE ROAD, LONDON, W.2.
Near Praed St. PADDINGTON 3271/2
BOTH OPEN ALL DAY SAT. Early Closing Thurs. Mail Orders to Dept. A.W., Edgware Rd.

33 TOTTENHAM COURT ROAD, W.1
Nearest Stn. Gooch St. MUSEUM 2605

152/3 FLEET STREET, LONDON, E.C.4
Telephone: Fleet Street 2833
Open all day Thursdays. Early closing Sat.

LASKY'S FOR SPEEDY MAIL ORDER SERVICE

Brand new individually checked and guaranteed VALVES

Table listing various vacuum tube types and their specifications, organized in columns. Includes models like AC7H, AL60, ARS, ARP, etc., with their respective codes and quantities.

MANY OTHERS IN STOCK include Cathode Ray Tubes and Special Valves. All U.K. orders below £1, P. & P. 1/-; over £1, 2/-; over £3, P. & P. free C.O.D. 2/6 extra. Overseas Postage extra at cost.

MARCONI COMMUNICATION RECEIVERS CR.150. Frequency coverage 2-60 Mc/s in 5 bands. Two Ifs 1st 1,600 kc/s, 2nd 463 kc/s. Image signal protecting over 40 dB up to 30 Mc/s and 20-40 dB from 30-60 Mc/s. Self-checking calibration (built in calibrator). Stabilisation of supply and temperature compensation. Electrical and mechanical bandspread. Metering and visual tuning indicator. Bandpass from 100's to 10 kc/s in 5 stages. Acoustic filter associated with 100 c/s. Bandpass position for CW reception. Facilities for diversity reception. Excellent checked condition. £49. Mains P.S.U. by P.C. Radio, £4.10.0. Carriage 30/-.

CARBON INSET MICROPHONE G.P.O. type 2/6. P. & P. 1/6. WELL PROVEN RELIABLE COMMUNICATION RECEIVER P.C.R.2 (Made by Pye). 120 kc/s-350 kc/s. 525 kc/s-1600 kc/s. 6 Mc/s-22 Mc/s. Overall sensitivity 1.2 uV. S/Noise ratio 10 dB at 6 uV. Circuit incorporates an RF stage, two I.F. stages, tone control, A.V.C. antenna trimmer, 6V6 output. Set in fully working condition together with headphones and speaker plug. £7.12.6. Carriage 15/-.

SIGNAL GENERATOR MARCONI TF 995A-1. Range 1.5-220 mc/s in 5 bands. Output voltage variable in 1 dB steps from 1 uV to 100 mV. Carrier may be unmodulated, frequency modulated, amplitude modulated, or simultaneously frequency and amplitude modulated. Frequency deviation is variable from 25-600 kc/s for FM and modulation (internal or external) up to 50 x for A.M. Crystal calibrator for checking frequencies incorporated. Incremental frequency control. Fully checked and guaranteed. Price £88.15.0. Carriage in U.K. 30/-.

CONNECTORS FOR TCS RECEIVER, TRANSMITTER AND REMOTE CONTROL, with original plugs on both ends. New £1.7/6 each. P. & P. 2/6.

EVERSHED MEGERG CIRCUIT TESTER. 2 ranges 0 to 1000Ω, 100Ω to 200,000Ω. With test leads, leather carrying case. Tested £4.19.6. P. & P. 3/6. 32/44ft. AERIALS each consisting of ten 3ft. 7in. dia. tubular screw-in sections. 14ft. (7 section) whip aerial with adaptor to fit the 7in. rod, insulated base, stay plate and stay assemblies, pegs, reamer, hammers etc. Absolutely brand new and complete, ready to erect, in canvas bag. £2.19.6. P. & P. 10/6.

ARBED RECEIVERS. Fully reconditioned. £55; rebuilt models, £85; brand new, £95. Carriage paid U.K. CHR HIGH RESISTANCE HEADPHONES. New, 16/-, P. & P. 1/6.

PANEL METERS (round) table listing meter types and their prices. Includes models like 0-50 microamps, 0-100 microamps, etc., with prices ranging from 40/- to 63/-.

P. C. RADIO LTD 170 GOLDHAWK ROAD, W.12. Shepherd's Bush 9496. Open 9-5.30 p.m. Thursday 9-1 p.m.

**"Weston", as usually used in H.R.C. as "G" meter. **Projection type.

L. K. ELECTRONICS

The Cheapest — The Best
The Quickest Service

● Famous Autochanger or Single Player Units supplied with brand new, two-tone, de-luxe portable cabinets, 17 x 15 x 8 1/2 in. Strong carrying handle, gilt finish clips and hinges are used by famous make for 22 gn. model. Ready cut out motor board, 14 x 13 in. Front baffle 7 x 4 in. High flux loudspeaker and 3 watt amplifier. Amplifier ready built on metal chassis with output transformer, volume and tone controls. All items fit together perfectly. Assembly in 30 minutes. Only 5 wires to join. 12 months' written guarantee. Available separately or package deals as below.

Our NEW MK II Superb Kits are now being dispatched.

L K PRICES FOR COMPLETE KITS:

Autochanger Kits as above
B.S.R. U.A. 14, T.C. 8 Mono £10.17.6 P.P. 5/6
Garrard Autoslim. Mono £11.7.6 P.P. 5/6

Single Player Kits as above
Garrard S.R.P. 10, Mono £10.12.6 P.P. 5/6
E.M.I. Autostop, Mono £10.17.6 P.P. 5/6

Individual Prices for those who wish to purchase separately.
Record Player Cabinet with Cut-out Board ... £2.15.0 P.P. 3/6
Amplifier with 7 x 4 in. speaker £3.10.0 P.P. 2/6

● SCOOP! B.S.R. U.A. 25 Autochangers. T.C. 8 Mono P.U. Brand new and boxed. Wired for stereo. Note OUR price £5.7.6. P.P. 5/-. The very, very latest model.

● SCOOP! B.S.R. U.A. 14 Autochangers. T.C. 8 Mono P.U. Brand new and boxed. Wired for stereo. Note OUR price £5.7.6. P.P. 5/-. Latest model.

● SCOOP! Garrard Autoslim. Mono P.U. Brand new and boxed. Wired for stereo. Latest model. Note OUR price £6.0.0 only. P.P. 5/-.

● SCOOP! Garrard A.T.5. Wired for stereo, inclusive of head and mono cartridge (A.T.5 is an auto transcriber). The finest changer of them all. OUR price, brand new and boxed, £7.10.0 only. P.P. 5/-.

AUTOCHANGERS

Single Players
E.M.I. Autostop, Mono £5.7.6 P.P. 4/6
Garrard S.R.P. 10, Mono £5.5.0 P.P. 4/6
E.M.I. Separate Pick-up £3.0.0 P.P. 3/6
Transcription Units Stereo Head Mono
Garrard 4 H.F. Stereo £14.10.0 P.P. 5/-
Philips A.G. 10/16, Stereo £12.0.0 P.P. 5/-
Garrard A.T.6, Stereo £9.19.6 P.P. 5/-
Garrard 301 £16.10.0 P.P. 5/-

● SCOOP! Record Player Cabinets. Two-tone, de-luxe finish with cut-out board. These are brand new and product of very famous national manufacturer. OUR price £2.15.0 only. P.P. 3/6.

● SCOOP! 3-watt Gramophone Amplifier. Complete with 5 in. Speaker. 49/6. P.P. 5/-.
The amplifier is complete, on a fabric-covered baffle board. Output transformer included. Tone and volume controls and on/off switch. Ready to switch on and play. Terrific volume. Size 12 1/2 x 6 x 3 1/2 in. back to front. For 200-250v. A.C. Output 3 watts.

● SCOOP! Diodes—over 1,000,000 in stock—ideal substitute O.A.81 vision detector.
Note OUR price £1.0.0 per 500. P.P. 2/- (In 500 lots only).

● SCOOP! Transistor Tape Recorder. The best obtainable by very famous manufacturer. Brand new, boxed, guaranteed. Reduced from 12 gns. OUR price £7.10.0. P.P. 3/6. Complete with microphone, tape, batteries and operational booklet. Features push-pull amplifier, two motors, single switch operation, pause, speed, wind, rewind, record, play back. Can be used in any position, indoor or outdoor

● SCOOP! Hi-Fidelity Speakers 15-watt. Very famous national manufacturer—we cannot mention name. 45-13,000 c.p.s., 3 or 15 ohm voice coils, response 45-13,000 c.p.s. Magnet 15,000 lines. In carton—unopened and unused. OUR price £4.4.0 only.

● SCOOP! A Stereophonic Amplifier with the following features. A twin gauged tone control in a special negative feedback circuit, giving a wide range of tone correction. A balance control enabling the amplifiers to be equalized in output to compensate for pick-up, lead, speakers, recording differences. A speaker switch, M1 single amplifier. M2 dual amplifiers for increased Monaural output. 53, two speakers at 1/2 watts per channel. Twin gauged volume controls and all four controls placed equidistant along the front of the chassis. Designed, made and guaranteed by Brittamer Ltd. Brand new and at a fraction of original cost. OUR price £7.10.0 only.

● SCOOP! Monaural 15 watt Amplifiers. A limited number only. A.C. only. Dual inputs. To clear at half price. Brand new and boxed. Guaranteed. While stocks last, £13.0.0 only

● SCOOP! 1964 Radiogram Chassis. Stereo 3-wave bands, long, medium, short. 5 watts per channel. 6 valves. Latest Mullard A.C. 200/250v. Ferrite aerial. Glass dial. Horizontal winding. Size 13 x 4 in. Aligned and calibrated. Concentric controls. Isolated chassis. Size 13 1/2 x 9 in. high x 5 in. deep. Product of famous national manufacturer. Brand new and boxed. Maker's guarantee.

OUR price £13.10.0. List price £19.8.0. P.P. 5/6. Our Chassis List quotes prices—the keenest in the Trade. We are Main Agents for the complete range of Brittamer Chassis and Amplifiers. "Brittamer"—makers of Radiogram Chassis to the Top Names in Radio.

● SCOOP! For £25.0.0 only. A fabulous offer. Garrard A.T.5 Transcriber plus 2 12 in. 15 watt Hi-Fidelity speakers, plus the very latest Continental push-button chassis by Brittamer. Stereo 3-wave band, 6 valves, 5 watts per channel. The finest chassis of its type in the world. You will be amazed at performance and quality. We unhesitatingly recommend this chassis.

● SCOOP! Limited number only. Miniature Superhet 4-valve Portable Radios. Ferrite rod aerial. Hide leather case. Complete with valves, speaker and circuit. To clear OUR price 50/- only. Cannot be repeated.
Speakers ex Equipment. 5in. 5/-. 7in. x 4in. 6/-. 6in. 6/6. 8in. 7/- P.P. 1/6 each.

● SCOOP! Microphones. Complete Lead Coax, Plug, Brand New. OUR price 5/- only. P.P. 1/6.

TRANSISTOR SECTION

● SCOOP! A first-class 2 wave-band 3 transistor superhet chassis by world famous manufacturer. Fully built, aligned, tested, guaranteed. Full coverage long and medium waves. Note OUR price £5.4.0 only. Suitable speaker 10/6. A few cabinets can be supplied at 22/6 each. OUR price for the package deal £6.10.0 only. Ideal for Caroline.

● SCOOP! A Limited Number Only. Tape Decks by B.S.R. Latest model. A.C./200/240v. Brand new and boxed. OUR price £6.10.0 only. P.P. 4/6.

● SCOOP! Tape Recorder Amplifiers. Suitable for B.S.R. or Collaro Decks. Price: £6.10.0 for B.S.R. Deck; £6.12.0 for Collaro Deck. P.P. 6/-

Mk. III. Fully built, high gain, low noise, printed circuit. The amplifier is supplied complete with the switch wafer fully wired for B.S.R. deck. For Collaro deck, a completely wired separate switch with spindle is supplied. Magic Eye.

S.A.E. enquiries please. Our Complete Lists 1/- only—credited against your order.

● IF NOT ADVERTISED IT IS STILL IN STOCK

L.K. ELECTRONICS (Victoria) LTD.

★ 17 GILLINGHAM ROW, WILTON ROAD, LONDON, S.W.1. ★

Lewis have the Cabinet for you

We can supply any cabinet to your own specification These are only two examples of —THE LARGEST RANGE OF CABINETS IN THE COUNTRY

Equipment is also our speciality.



The Grosvenor
Price 18 gns.



The Lowboy
Price 27 gns.



100(P124) Chase Side, Southgate
London, N.14. Tel 3733/9666

FREE CATALOGUE

Send today for the new Lewis Catalogue

Designed to assist your choice of cabinet.
Sent absolutely free. The new Lewis Radio Cabinet Catalogue—the most comprehensive ever prepared. Choose from 49 different Models.
Please send your new free 24 page colour cabinet catalogue.

Name _____
Address _____

BLOCK CAPITALS PLEASE

FAMOUS FOR THIRTY YEARS for SHORT-WAVE EQUIPMENT OF QUALITY

H.A.C. SHORT-WAVE KITS

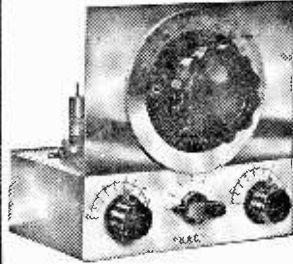

H.A.C. were the original suppliers of Short-Wave Receiver Kits for the amateur constructor. Over 10,000 satisfied customers—including Technical Colleges, Hospitals, Public Schools, R.A.F., Army, Hams, etc.

IMPROVED 1964 RANGE

1-Valve model "CX", complete kit. Price 34/6

Customers say: "Definitely the best one-valve S.W. kit available at any price. This kit contains all genuine Short-Wave components, a drilled chassis, accessories and full instructions. Ready to assemble and, of course, as all our products, fully guaranteed. FULL RANGE of other kits still available including the famous model 'K', price 77/-"

Before ordering call and inspect a demonstration receiver or send for a descriptive catalogue and order form to:—

"H.A.C." SHORT-WAVE PRODUCTS
(Dept. T.H.), 44 Old Bond St., London W.1

NEW VALVES!

Guaranteed Set Tested
24-HOUR SERVICE

1R5, 1S5, 1T4, 3S4, 3V4, DAF91, DF91, DK91, DM2, DL34, SPT OF 4, 14/-
DAF96, DF96, DK96, DL96, SET OF 4, 22/-

0A2	3/9	DL33	6/9	PCL83	7/9
1D5	4/9	DL35	6/6	PCI84	7/-
1R5	4/3	DL92	4/3	PL36	7/9
1R55	3/3	DL94	5/-	PL81	6/6
1T4	2/3	DL36	5/6	PL82	5/-
3S4	4/3	RBC41	6/3	PL83	5/-
3V4	5/-	EBF80	4/6	PL84	5/-
5Y3GT	5/-	ECC40	6/9	PY32	8/6
5Z4G	6/9	ECC81	3/-	PY33	8/6
6K7G	1/3	ECC82	4/-	PY80	4/9
6K9G	3/9	ECC83	4/6	PY81	5/-
6Q7G	4/3	ECC84	6/3	PY82	4/11
6U7G	6/6	ECC85	6/-	PY83	5/6
6V6G	3/6	ECP80	5/9	U23	3/-
6X5GT	6/3	ECP82	5/9	U26	7/9
12K7G	3/3	ECH42	7/3	U91	5/3
12K8GT	8/6	CH81	5/3	U801	15/-
12Q7GT	3/3	ECL80	5/9	UABC80	5/-
20P4	13/3	ECL82	6/3	UAF12	6/9
25L6G	4/9	EP41	5/9	UBC41	6/-
3FL1	7/9	EP80	3/9	UCB80	5/6
35L6GT	6/-	EP82	4/6	UCB84	7/11
35Z4GT	4/6	EP86	5/9	UCB85	6/6
85A2	5/9	EP89	4/3	UCB80	8/3
CL33	8/6	EL41	7/-	UCH42	6/9
DAC32	7/9	EL84	4/6	UCH81	5/9
DH7T	7/9	EY31	5/6	UCB82	7/3
DAF96	5/6	EY86	5/-	ULC83	7/9
DF33	7/6	EZ40	5/-	UF41	6/3
DF91	2/3	EZ80	3/9	UF89	5/9
DF96	5/6	EZ81	3/9	UL41	6/6
DH7T	3/6	PCB94	5/3	UL54	5/9
DK32	7/6	PCF89	5/6	UR1G	5/-
DK91	4/3	PCF90	6/9	UY21	7/3
DK92	6/9	PCF82	6/-	UY41	3/11
DK96	6/-	PCL82	6/3	UY85	4/9

Postage 6d. per valve extra. Any Parcel Insured against Damage in Transit 6d. extra. ANY C.O.D. Parcel 1/3 extra. Office address, no callers.

GERALD BERNARD
83 OSBALDESTON ROAD,
STOKE NEWINGTON
LONDON, N16

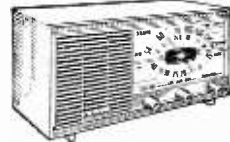

BRAND
NEW
A.C. MAINS
5 VALVE
SUPERHET
RADIO
RECEIVERS

Housed in beautifully styled cabinets offering terrific performance and very high quality reproduction. Built-in ferrite rod aerial for reception of all your favourite programmes. Fully guaranteed. MODEL 55 (as illus.) Covers Medium Long and Short Waves. Size 8 1/2 in. w. x 3 1/2 in. d. x 4 1/2 in. h. PRICE ONLY £7.17.6. P. & P. 5/6. ALSO FEW ONLY similar spec. to above but M. wave only. £4.14.6. P. & P. 5/6.

SPECIAL OFFER

HIGH GRADE 2-STAGE GRAM AMPLIFIERS Made by very well-known manufacturer

Using a double-wound mains transformer (fully isolated chassis) with tapped primary, full wave contact cooled rectifier, and Mullard ECL83 triode-pentode valve. 3 watt output. Separate tone and volume controls. Overall size 6 1/2 in. wide x 3 in. deep x 4 1/2 in. high. Each amplifier Brand New and tested and supplied complete with valve, 3 ohm output transformer and knobs.

PRICE 49/6 P. & P. 4/-

(ideal as an add-on self-contained Audio unit for our MK1 or MK2 FM Tuner).

BRAND NEW 3 OHM LOUDSPEAKERS

2 1/2 in., 12/6; 5 in., 12/6; 6 1/2 in., 15/-; 8 in., 21/-; 10 in., 25/-; 12 in., 27/6; (12 in. 15 ohm 30/-); 16 in. x 6 in.
Latest type E.M.I. 13 1/2 x 8 in. with high flux ceramic magnet, 11,000 gauss. Aluminium centre cone. 10 watts. 50 c/s to 10 Kc/s. 42/-
P. & P. only. 11/6; over 6 in. 2/6 per speaker.

SPECIAL OFFER !!

BRAND NEW HEAVY DUTY 12in. SPEAKERS Response 45 c/s-13 Kc/s. 1 1/2 in. voice coil. Available in 3 or 15 ohm. Guaranteed full 15 watt British rating. Heavy cast aluminium frame. These are current production by world famous maker and as they are offered well below list price we are not permitted to disclose the name. LIMITED NUMBER ONLY. UNREPEATABLE AT 89/6. P. & P. 5/-

SPEAKER AND CABINET FABRIC Oatmeal or Red and Gold Vynair for speaker and cabinet covering. All 5 1/2 in. wide and usually sold at 35/- yard.

OUR PRICE 13/6 per yard length.

Plus P. & P. 1/9 (Minimum order 1 yard). Send S.A.E. for samples.

BARGAIN OFFER CORNER

ROLA CELESTION. Approx. 9 in. x 6 in. 3 ohm Middle register speaker. 10/6. P. & P. 2/6.

MAINS TRANSFORMER

Drop thru type. Tapped primary 110v., 200v., 230v., 240v., 320-0-320v. at 50ma. and 5.5 amp. at 3 amps. Generous core. Stack size 3 1/2 x 2 1/2 in. Weight 4 lbs. ONLY 15/-, P. & P. 3/6.
ACOS CRYSTAL MIKES. High imp. For desk or hand use. High sensitivity, 18/8. P. & P. 4/6.
TSL CRYSTAL STICK MIKE. Listed at 45/-. Our price 18/8. P. & P. 1/6.

T.C.C. SUPPRESSOR CONDENSERS. 250v. A.C. .005 + .003 x .1. In tubular can 1 1/2 in. long x 3/4 in. dia. 2 for 3/-. Post free.
plus 4 suitable Transistors giving approx. 1 watt. output. 25/-, P. & P. 2/6
CONDENSERS. 5,000 mF. 12 v. wkg. Size 3 x 1 in. dia. 2/- each. P. & P. 6d. each.
T.V. or AMPLIFIER. EDGE CONTROL PANELS. T-500k 1 1/2 in. pots: one 500k Low; one D/F mains switch. Brand New 3/6 per panel. P. & P. 1/-
3-PUSH BUTTON SWITCH UNIT. 4 single pole changeover on each push-button. Approx. 3 x 1 1/2 x 1 in. An absolute Bargain at 4/6 each P. & P. 1/6 each.

MATCHED PAIR OF 2 1/2 WATT TRANSISTOR DRIVER AND OUTPUT TRANSFORMERS. Stack size 1 1/2 x 1 1/2 in. Output trans. tapped for 3 ohm and 15 ohm output. 10/- pair, plus 2/- P. & P. Worth double.
MARCONI QUARTZ CRYSTALS TYPE ZHB (Glass encapsulated, 2 wire lead out. Size 1 1/2 in. high x 1/2 in. dia. Following frequencies (Kc/s only available).
13583, 13646, 13708, 13771, 13833, 13896
13938, 14021, 14083, 14146, 14208, 14271
14333, 14396, 14459.
6/- each. P. & P. 1/- per crystal. 3 or more, Post Free.

Harverson Surplus Co. Ltd. ▶

3-VALVE AUDIO AMPLIFIER MODEL HA34



Designed for Hi-Fi reproduction of records A.C. Mains operation. Ready built on plated heavy gauge metal chassis, size 7 1/2" x 4 in. d. x 4 1/2 in. h. Incorporates ECC83, EL84, E280 valves, heavy duty double-output transformer and matched for 3 ohm speaker, separate Bass, Treble and volume controls. Negative feedback line. Output 4 1/2 watts. Front panel can be detached and leads extended for remote mounting of controls.

The HA34 has been specially designed for us and our quantity order enables us to offer them complete with knobs, valves, P. & P. etc. wired and tested for only **£4.50**

TAPE DECKS

OLLARO STUDIO DECK. 3 motors, 3 speeds, push button control. Up to 7 in. spools. **£10.10 P. & P. 5/6.**
B.R. MONARDECK. Single speed, 3 1/2 in. per sec., simple control uses 5 1/2 in. spools. **£6.15.0 plus 5/6 carr. and ins.** (Tapes extra on both).

STEREO AMPLIFIERS

Incorporating 2 ECC83s and 1 E280 heavy duty double-wound mains transformer. Output 4 watts per channel. Full tone and volume controls. Absolutely complete.

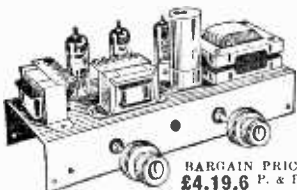

BARGAIN PRICE £4.19.6 P. & P. 5/-

6 TRANSISTOR AND DIODE SUPERHET

A first-class 2 wavebands transistor superhet • Printed circuit panel (size 8 1/2 x 2 1/2 in.). • 3 pre-aligned I.F. transformers. • High-grade Ferrite rod aerial. • All first-grade transistors. • Car aerial winding. • push-pull output. • All parts supplied with simple instructions. All parts sold separately. Set of parts if purchased at one time.

ONLY £4.5.0 P. & P. 2/6.
 Circuit diagram 1/6 (free with set of parts).

35 OHM SPEAKERS

Suitable for use with above. 2in. 3ohmms. Ideal replacement for most pocket portables, 8/6. 3 1/2 in., 12/6. 5 in., 17/6. 7 x 4 in., 21/-. P. & P. 1/6 per speaker.

Portable CABINET

Size approx. 9 1/2 x 3 1/2 in. Suitable for above using 3 in. speaker, 25/-. P. & P. 3/6.

COIL AND TRANSFORMER SET FOR TRANSISTOR SUPERHET

3 I.F. transformers, one oscillator coil, one driver transformer and wound Ferrite aerial (med., long and car aerial coupling). 32/8 complete, post 1/6. 6 transistor printed circuit board to match, 8/6 Post 9d. Circuit diagram 1/6 extra.

SPECIAL TRANSISTOR BARGAINS

ALL BRAND NEW
 GRT 15 (Matched Pair) 15/-
 OC71 5/-; OC78 6/-; AF117 7/6; Set of Mullard 6 transistors, OC44, 2-OC45, OC81D matched pair, OC81, 25/-

EDISWAN MAZDA

FXA101 8/6; XA103 6/6
 R.F.1 Pack: 1-PA102 Mixer: 2-PA101 I.F. Amp.; (Equip. OC44 and OC45) 10/6
 R.F. 2 Pack: 2-PA101 I.F.; -PA102 Osc.: 1-PA102 Mixer 12/6
 L.F.6 Pack: Containing FXA113 Driver, Matched pair FXA71 mounted complete with testshika (Equip. OC81D and OC81) 12/6
ALL TRANSISTORS POST FREE.

QUALITY RECORD PLAYER AMPLIFIER

A top-quality record player amplifier. Size 7 in. w. x 2 1/2 in. d. x 5 1/2 in. h. This amplifier (which is used in a 28 kn. record player) employs heavy duty double wound mains transformer, ECC83, EL84, E280 valves. Separate bass, treble and volume controls. Complete with output transformer matched for 3 ohm speaker. Ready built and tested.

PRICE 6/9.6 P. & P. 3/6
ALSO AVAILABLE. Mounted on board with output transformer and 6 in. speaker, ready to fit into cabinet below. **PRICE 8/8.6 P. & P. 4/6.**

QUALITY PORTABLE R/PLAYER CABINET

Uncut motor board. Will take above amplifier and B.S.R. or GARRARD Autochanger or single. Record Player Unit, size 18 x 14 x 8 1/2 in.

PRICE £3.9.6 Carr. 5/-.

EMBRASSY PORTABLE RECORD PLAYER CABINET

Will accommodate amplifier, up to 7 x 4 in. speaker and B.S.R. or GARRARD auto-changer or single player unit. Attractive rexine covered finish. Overall size 17 x 15 x 8 1/2 in. Supplied with uncut motor board. **PRICE 6/9.6 Carr. 5/-.**

4-SPEED PLAYER UNIT BARGAINS

All Brand New in Makers' Original Packing

SINGLE PLAYERS
 B.S.R. TU/12..... £10.00 Carr. 3/6
 B.S.R. GU7 with unit mounted pick-up arm £4.18.8. Carr. 4/-

AUTO CHANGERS
 B.S.R. UA14, £5.19.6; B.S.R. UA15, £6.19.6
 Latest B.S.R. UA15 Super Slim..... £5.2.0
 Standard Garrard Autoslim..... £5.10.0
 Garrard AT6 Mono..... £10.10.0
 Carr. 5/- on each

NEW CARTRIDGE BARGAINS!

B.S.R. TC85. High output compatible Stereo Cartridge. Brand new. Complete with Stereo/LP/78 sapphire stylus and universal mounting bracket. Original price 44/11. **OUR PRICE 2/6 P. & P. 1/6.**
RONETTE STEREO 105 CARTRIDGE. Stereo/LP/78. Complete with two sapphires. Original list price 67/9. **OUR PRICE 24/- P. & P. 1/-.**
OLLARO HI-FI STEREO T/O CARTRIDGE. Type "C". Complete with universal bracket and stylus for stereo, L and R. Original list price 59/8. **OUR PRICE 25/- P. & P. 1/-.**

E.M.I. 4-speed Player and P.U.

FURTHER BUGE PURCHASE enables us to offer these at **67/6 P. & P. 4/6.**
 Heavy 8 1/2 in. metal turntable, low friction, low torque performance 200/250 v. shaded motor with tap at 45v. for amplifier valve filament if required. Turnover LP/78 head.

THE NEW HARVERSON KIT FOR THE HOME CONSTRUCTOR

A really excellent all purpose A.C. mains 200/240v. **AMPLIFIER KIT TYPE HSL 'FOUR' 3 VALVE, 4 WATT USING EC939, EL84, E280 VALVES** Special features include:

- Heavy duty double-wound mains transformer with electrostatic screen. • Separate Bass, Treble and Volume controls, giving fully variable boost and cut with minimum insertion loss. • Heavy negative feedback loop over 2 stages ensures high output at excellent quality with very low distortion factor. • Suitable for use with guitar, microphone or record player. • Provision for remote mounting of controls or direct on chassis. • All this builds onto a chassis size only 7 1/2 in. wide x 4 in. deep. Overall height 4 1/2 in. • All components and valves are brand new. • Very clear and concise instructions enable even the inexperienced amateur to construct with 100% success. • Supplied complete with valves, output transformer (3 ohms only), screened lead, wire, nuts, bolts, solder etc (No extras to buy) **79/6 P. & P. 5/-**

Comprehensive circuit diagram, practical layout and parts list 2/6. (Free with kit).



10/14 WATT HI-FI AMPLIFIER KIT

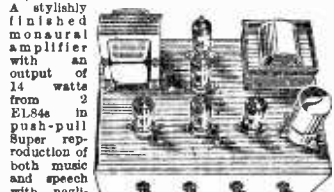

A stylishly finished Hi-Fi amplifier with an output of 14 watts from 2 EL84s in push-pull Super reproduction of both music and speech with negligible hum. Separate inputs for mike and gram. allow records and announcements to follow each other. Fully shielded speaker wound output transformer to match 8-15 ohm and independent volume controls and separate bass and treble controls are provided giving good lift and cut. Valve line-up 2 EL84s, EC939, EF86 and E280 rectifier. Simple instruction booklet 1/6. (Free with kit).

All parts sold separately. **ONLY £6.19.6 P. & P. 5/6**

Also available ready built and tested complete with standard input jack sockets. **£8.15.6 P. & P. 6/6.** Carrying Case for above **23/6 P. & P. 4/-**

HIGH GAIN 4-TRANSISTOR PRINTED CIRCUIT AMPLIFIER KIT

Type TA1

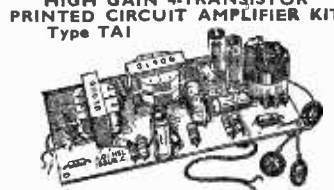

• Peak output in excess of 1 1/2 watts. • All standard British components. • Built on printed circuit panel size 6 x 3 in. • Generous size Driver and Output Transformers. • Output transformer tapped for 3 ohm and 10 ohm speakers. • Transistors (GET 114) or 81 Mullard OC81D and matched pair of OC81 o/p) • 9 volt operation. • Everything supplied, wire, battery clips, solder, etc. • Comprehensive, easy to follow instructions and circuit diagram 1/6 (Free with kit). All parts sold separately. **SPECIAL PRICE 45/- P. & P. 2/6** Also ready built and tested, **£6/6 P. & P. 2/6.** A pair of TA1's are ideal for stereo.

HARVERSON'S F.M. TUNER Mk. I

• F.M. tuning head by famous maker. • Guaranteed non-drift tuning. • Frequency coverage 83-100 Mc/s. • OAB1-balanced diode output. • Two I.F. stages and discriminator. • Attractive maroon and gold dial (7 x 3 in. glass). • Self powered, using a good quality mains transformer and valve rectifier. • Valves used ECC83, two EF80's and E280 (rectifier). • Fully drilled chassis. • Size of complete set of parts if purchased at one time **£6.19.6 plus 8/6 P. & ins.** Circuit diagram and instructions 1/6 post free. Mark II Version as above, but complete with magic eyes, front panel metal brackets, **£6.12.6 P. & P. 3/6**

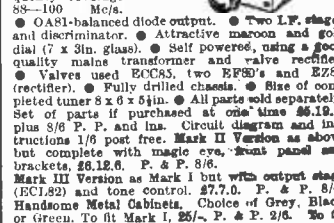

Mark III Version as Mark I but with output stage (ECC82) and tone control. **£7.7.0 P. & P. 8/6** Harverson Metal Cabinets. Choice of Grey, Black or Green. To fit Mark I, 25/- P. & P. 2/6. To fit Mark II, 17/6. P. & P. 2/6.

SPECIAL PURCHASE! TURRET TUNERS

By famous maker. Brand new and unused. Complete with PC884 and PCF80 valves, 28-38 Mc/s I.F. Biscuits for Channels 1 to 6 and 10 to 14. Circuit diagram supplied. **ONLY 44/- each. P. & P. 2/6.**
BRAND NEW CYLONDR F.M. TUNER HEAD Performance tuned. 83-100 Mc/s. Etched circuit. A completely screened unit ready for direct mounting in chassis. 10.7 Mc/s. I.F. O.P. Supplied complete with ECC85 valve and full circuit diagram. Aerial input circuit suitable for either 75 ohm unbalanced or 300 ohm balanced. Size only 3 in. w. x 2 1/2 in. d. x 1 1/2 in. h. (2 1/2 in. high with valve). Limited number only at **27/6 P. & P. 1/6.** Also available 10.7 Mc/s. I.F. traps and disc. trans. **11/8 pair. P. & P. 1/6.**

GOLFER F.M. TUNER HEAD

65-100 Mc/s. 10.7 Mc/s. I.F. 18/- P. & P. 2/6 (ECC85 valve, 8/6 extra).

SEE LEFT PAGE FOR MORE ITEMS

HARVERSON SURPLUS CO. LTD.

170 HIGH ST., MERTON, S.W.19 Cherrywood 3985
 Open all day Saturday Early closing Wed. 1 p.m.

A few minutes from South Wimbledon Tube Station (Please write clearly)
 PLEASE NOTE: P. & P. CHARGES QUOTED APPLY TO U.K. ONLY. P. & P. ON OVERSEAS ORDERS CHARGED EXTRA.
 SEND STAMPED ADDRESSED ENVELOPE WITH ALL ENQUIRIES

The Goldenair GROUP-MASTER 30 WATT GUITAR AMPLIFIER

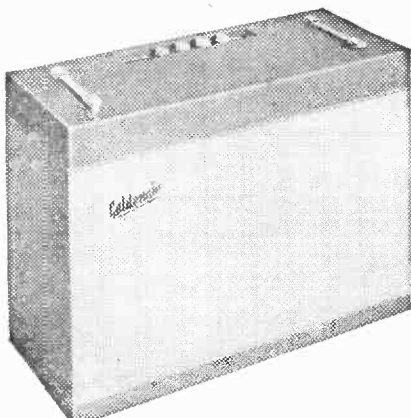

A VERSATILE UNIT FOR INSTRUMENTALISTS AND VOCAL GROUPS

being suitable for clubs and public address

- Ideal for bass, lead or rhythm guitar, and all other musical instruments.
- ★ The two 12 inch 25 watt heavy duty loudspeakers are specially designed for this type of amplifier, and give outstanding reproduction.
- ★ Robust attractive two-tone finished cabinet of compact size, 28"x 20"x 10 1/2" fitted with carrying handles.
- ★ For standard AC mains 50 c/s operation.
- ★ Four inputs provided can be used simultaneously with instrument pickups or mikes.
- ★ Separate Bass and Treble controls are incorporated.

Full 12 months guarantee

Go Goldenair

TWICE THE QUALITY AT HALF THE PRICE

Customers are invited to see and hear this amplifier at our shop premises in Lambert's Arcade. Send S.A.E. for leaflet.



or deposit of £4.12.0 and twelve monthly payments of £3.12.5.

Carriage and insurance 25/- to be sent with deposit.

The Goldenair "THIRTY" HI-FI AMPLIFIER

A high quality 30 watt amplifier developed for use in large halls and clubs etc. Ideal for bass lead or rhythm guitars, schools, dance halls, theatres and public address. Suitable for any type of mike or pickup.

Valve line-up: two EF86; one ECC83; one GZ34; two EL34.

Four separate inputs are provided with two volume controls. Bass and Treble controls are incorporated. Amplifier operates on standard 50 c/s mains. 3 ohm and 15 ohm speakers may be used.

Perforated cover with carrying handles can be provided if required. price

21/-

Full 12 months guarantee

Customers are invited to see and hear this amplifier at our shop premises in Lambert's Arcade.

Send S.A.E. for leaflet.

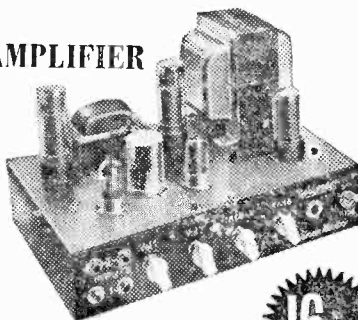

or deposit of £1.16.0 and twelve monthly payments of £1.9.2.

Carriage 15/- to be sent with deposit.

Go Goldenair

TWICE THE QUALITY
HALF THE PRICE

GOLDENAIR 5 WATT AMPLIFIER

IDEAL FOR HOME USE

Suitable for guitars, record decks and microphones. Cabinet size approx. 13 x 18 x 7 in. The cabinet is well made and attractively finished. Volume bass and treble controls incorporated. Price 6gns. post paid. Send S.A.E. for leaflet.



THE GOLDENAIR GRAMETTE

A compact 3-4 watt gram. amplifier that can be used with all types of record players. Fitted with volume and tone controls. Incorporating mains isolating transformer, thus making the unit completely safe. A triode pentode valve and modern silicon rectifier are utilized. Price 3gns. P. & P. 5/-. Ready built and tested £3.10.6. P. & P. 5/-.

THE GOLDENAIR THREE

A uniquely designed 2 valve 3 watt gram. amplifier, fully enclosed in a compact well ventilated metal case, size 7 x 5 1/2 x 2 1/2 in. Three controls provided, Volume, Treble and Bass. A completely safe unit incorporating mains isolating transformer. Price 4gns. P. & P. 5/-.



CRYSTAL SET

A wonderful educational kit for all children. Provides hours of amusement while following the easy step by step instructions. It is powered entirely by wireless waves, eliminating the expense of batteries. No soldering required. Receives all main stations. Price 25/- P. & P. 2/6. An ideal Christmas Present for the children



LOUDSPEAKERS

TYPE 1. Model G.G.25. A heavy duty loudspeaker by famous manufacturer. Diameter 12in. Frequency response 80-5,000 c.p.s. Power handling 25 watts. Impedance 15 ohms. Ideally suitable for Bass instruments used with high power amplifiers. Price £9.10.6. P. & P. 5/-. Send S.A.E. for leaflet.

TYPE 2. A 12in. Heavy Duty Loudspeaker unit. 12 watts power handling. Frequency response 30-14,000 c.p.s. Pure aluminium cast frame. British made by famous manufacturer. Price 5gns. P. & P. 5/-. Send S.A.E. for leaflet.

SONA STREAMLINE MICROPHONE



Omnidirectional response 60-10,000 c/s. Output level 52 dB. Built in on/off switch. Provision for conversion to hand-held, cord suspended or stand mike. Attractive satin chrome finish.

Microphone 37/6 P. & P. 2/6.
Desk Stand 10/- P. & P. 2/6.
Floor Stands Available

SONA

MORE BARGAINS OPPOSITE

TRANS/RECEIVER NO. 46

Compactly built to be carried by one man. This has a range of approx. 10 miles, and being crystal controlled, tuning is avoided, and operation is as accurate as a telephone. Frequency 3.6-9.1 mc/s. Complete stations comprising receiver, transmitter, and aerial. One set of headphones carrying bag, crystal coil unit available by authorized use only. Price 35/- per set. Post Free. Brand new in maker's sealed cartons. Price per station **£4.10.0** P. & P. 10/- each. Two stations for **£9.10.0** Post free.



HANDY POWER PACK

Housed in compact metal case, 200/250 v. A.C. mains. Output 250 v. 50 mA fully smoothed, 6.3 at 2 amps. Can be used for powering almost any pre-amp. or radio tuner. Price 59/6. P. & P. 2/6.

LEAD ACID ACCUMULATORS (Unspillable)

2 volts at 16 A.H. Brand New. Size 4 x 7 x 2 1/2. 4/11 each. 5 for 12/0. P. & P. 3/- per cell.



TRANS. RADIO TUBULAR SPEAKER

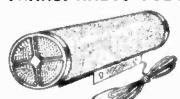

Booster Speaker. Plugs into ear-piece socket of most radios and tape recorders. Gives double the volume and a high stereo effect that will amaze you, size Approx 9 x 2 1/2 in. PRICE **25/-** P. & P. 2/6.

VALVE SALE

All valves 2/6 each. P. & P. 9d. 2 for 4/6. P. & P. 6d. 6K7C, EF50, 6H6, DF92, 6K8C, EB34, 1L4.

H.R.O. INSTRUCTION HANDBOOK

3/6 each P. & P. 6d.

No. 19 SET INSTRUCTION HANDBOOK

3/6 each P. & P. 6d.

1155 INSTRUCTION HANDBOOK

3/6 each P. & P. 6d.

FREQUENCY METER HANDBOOK

BCC 221 3/6 each P. & P. 6d.

VERNIER DIALS



Precision vernier dials with approx. 8 to 1 ratio. Surmount mounting. Accurately centred metal insert for pin-shaft. Reas counter clockwise 0-100 in 150. Model T.503 3in. dia. **16/-**

TYPE 19 SHORT WAVE RECEIVING SET



Works straight off the mains. An excellent short wave receiver, requires only phones for immediate operation. Price **£5.19.6**.

P. & P. 2/6. Suitable phones 15/- per pair. P. & P. 2/6. During an evening's testing on this excellent receiver, we obtained clear reception from scores of stations many of them thousands of miles distant including ship stations. Government Transmissions and time broadcasts and also the short wave radio Luxembourg broadcasts.

IMPEDANCE MATCHING UNIT

An impedance matching device enabling both high and low resistance phones to be used from any seven piece of equipment. Incorporates a matching transformer. Enclosed in a metal case with pivoting terminal board. Four standard jack sockets enabling four pairs of phones to be used simultaneously—two HiR and two LLR. Price 19/11. P. & P. 2/6.

4 CHANNEL TRANSISTORISED SOUND MIXER

Add musical highlights plus additional sound effects to your tape-recorder. This instrument permits mixing of 4 signals such as microphone, record player, radio tuner etc., into single output. Fully transistorised and self contained in handsome cabinet. Price 55/-. P. & P. 2/6. Standard plug packs to fit same, 2/6 each. P. & P. 2/6. 2 for 4/6. P. & P. 9d. Chrome shielded 3/6 each. P. & P. 6d. 2 for 6/6. Post free.

RF FIELD INDICATORS

Designed for checking the radiation from a transmitting antenna. The sensitivity can be controlled by a limit of the panel control, the antenna length, or by increasing distance from the radiator. Frequency range 1-250 Mc/s. 200mA D.C. Complete with instruction book. Post free. **67/6**

LIGHTWEIGHT GRAMOPHONE PICK-UP ARM

Complete with Acos hi-fi turnover cartridge. Price 27/6. P. & P. 1/-.

TRANSFORMERS

TYPE 1. Filament Transformer. 200/250 primary 50 c/s. Secondary 9.3 volts at 2 amps. Price 5/11. P. & P. 2/6.
TYPE 2. Mains Transformer. 200/250 primary 50 c/s. Secondary 250, 0/250 volts at 80 mA, 6.3 v. at 4 amps, 5 v. at 2 amps. Price 19/9. P. & P. 3/6.
TYPE 3. Primary 200/250 50 c/s. Secondary tapped as follows: 5 v., 11 v. and 17 v. all at 4 amps. Price 29/6. P. & P. 3/6.
TYPE 4. Primary 200/250 50 c/s. Secondary tapped as follows: 3 v., 4 v., 5 v., 6 v., 8 v., 9 v., 10 v., 12 v., 15 v., 18 v., 20 v., 24 v. and 30 v. all at 4 amps. Price 39/6. P. & P. 3/6.
TYPE 5. Primary 200/250 v. 50 c/s. Secondary 350, 0/350, at 80 ma. 6.3 v. at 4 amps, 5 v. at 2 amps. Price 25/-. P. & P. 3/6.
TYPE 6. Primary 200/250 v. 50 c/s. Secondary 450, 0/450 v. 250 ma. 6.3 v. at 4 amps, 5 v. at 3 amps. Price 65/-. P. & P. 5/-.
 Complete with instruction book. Post free.

SPECIAL XMAS OFFER!

Six-transistor radios at 59/6 each. Fully guaranteed. Will receive Home, Light, Luxembourg etc. Hi-Fi toned speaker. Few only. P. & P. 3/6. Battery 2/6 extra. Earpiece 3/6 extra. Hurry while they last.

MICRO ALLOY TRANSISTORS

Mat 100 7/9
 Mat 101 8/8
 Mat 120 7/9
 Mat 121 8/8
 VHF Transistor ADT140 15/-
 Above MAT's postage paid.
 Ferrite Slab Aerials suitable for transistor sets 3/-, P. & P. 4d.

TRANSISTOR SALE

Mullard OC71 (P. & P. 3d) 2/11
 Mullard OA50 (P. & P. 3d) 1/11
 Ediswan X1922 Germanium diodes (P. & P. 3d) 1/11
 Mullard OA79 (P. & P. 3d) 1/11
 Transistor holder 3-pin (P. & P. 3d) 11d each

POWER UNIT & LF AMPLIFIER

For the 88 set. In good condition employing modern valves and built-in vibrator pack. Excellent smoothing facilities. 12v. operation. Many applications, including 39/6 P. & P. use with car radios.

MORSE KEYS

Morse key assembly. Key with base, cover and terminals. Complete with lead. 6/11. P. & P. 2/-, 2 Morse Keys for 12/6 post-free.



HIGH IMPEDANCE HEADPHONES

Lightweight. Suitable for all applications. 11/- per pair. P. & P. 1/6. 2 pairs for 22/6, post free.

R.A.F. SHORT WAVE RECEIVER

35 to 40 Mc/s. Power supplies 12 volts and 250 volts D.C., in excellent condition with exceptionally fine slow-motion tuning and clean component layout. Price £2.19.8. P. & P. 6/-.

SONA STREAMLINE BM3 MICROPHONE CRYSTAL INSERTS

Price 7/6. P. & P. 9d.

BATTERY CHARGE ADJUSTERS

● Charge Rate Adjuster. ● Government manufacture. ● Easily fitted to charging circuit. 3/6 each; 2 for 6/8. P. & P. 2/6.

BM3 SONA STREAMLINE MICROPHONE STANDS

TYPE 1 Heavy metal base. Black gloss finish, 7/6. P. & P. 2/6.
TYPE 2 Chrome finish. Telescopic desk stand extending to 12in. height, heavy black gloss base. 25/-. P. & P. 3/6.
TYPE 3 Floor stand, 3 sections. Chrome finish. Heavy base. 55/-. P. & P. 7/6.

TX/RX No. 19 POWER UNITS

12 v. D.C. input. Output 275 volts at 110 ma. and 500 volts at 50 ma. The equipment is of American or Canadian manufacture. Price 21. Carriage 10/-.

DOUBLE THROAT MIKES

Double throat mikes. Can be adapted for use with musical instruments. 5/11. P. & P. 9d.

TRANSISTOR BATTERIES

Save pounds this winter. P13 type replacement, 6 for 10/-, P. & P. 1/9. 12 for 18/6. P. & P. 3/6. Limited stocks.

NEW WALK-ROUND STORE OPEN IN LAMBERT'S ARCADE, LOWER BRIDGE, LEEDS 1. NEXT TO HALFORD'S CLOTH SHOP. OPEN ALL DAY SATURDAY. 48-HOUR DESPATCH SERVICE. ALL MAIL ORDERS TO OUR BRIGGATE HOUSE ADDRESS.

Postage rates apply to U.K. only.



SONA ELECTRONIC CO. (Dept. PW12) BRIGGATE HSE, 13 ALBION PL, LEEDS

TERMS:
 CASH WITH ORDER
 5/- EXTRA ON C.O.D. ORDERS
 No C.O.D. under 30/-

TRADE SUPPLIED
 ORDERS FROM
 ABROAD WELCOMED
 Telephone: 34798

THE TRIPLE TONE HI-FI MAJOR

PRICE ONLY £15.18.9 COMPLETE

Guaranteed 12 Months

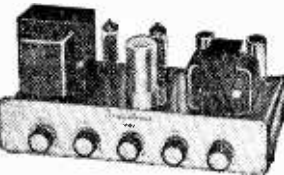

A 12 watt quality amplifier incorporating negative feedback, with a pre-amp for mic. and provision for mic./gram mixing. Frequency response ± 1 dB 15-20,000 c/s. Distortion only 0.15%, with noise and hum -80 dB. Separate Bass, Middle and Treble lift controls. Valve line-up 12AX7, 12AX7, EL84, EL84 and EZ81. Push-pull output with matching to 3 or 15 Ω . Fully isolated power supply from 200/250v. A.C. input, with take-off for tuner etc. Size 12 x 5 $\frac{1}{2}$ x 6in. high.

De. Luxe Case 14in. x 9in. x 7 $\frac{1}{2}$ in. 30/- extra.

New R.C.S. VALVES 90-day Guarantee

1R5	6/-	6Q70	8/-	ECB41	8/-	PCL84	5/-
1R5	6/-	88N7	5/-	EB081	5/-	PL11	10/-
1T4	3/-	6V6G	5/-	EBF80	5/-	PL83	8/-
384	7/-	6X4	5/-	ECB42	9/-	PY80	7/-
3V4	7/-	6X5	6/-	ECB19	9/-	PY81	8/-
5U4	6/-	12AT7	6/-	ECB150	8/-	PY82	7/-
5Y3	8/-	12AV7	7/-	EB228	10/-	392	7/-
5Z4	9/-	12AX7	7/-	EF183	7/-	4P81	8/-
6AM6	4/-	12K7	5/-	EF184	7/-	4P22	7/-
6AT6	6/-	12K8	14/-	EP86	10/-	4UBC41	8/-
6BA6	7/-	12Q7	7/-	EP89	9/-	4UBF8	9/-
6BE6	5/-	12S V6G	6/-	EL84	7/-	4UHB1	9/-
6G6	5/-	35Z4	5/-	EY51	5/-	4UL82	10/-
6J5	5/-	854	2/-	EZ40	5/-	4PFR8	5/-
6J8	5/-	DAP90	3/-	EZ80	7/-	EL41	5/-
6J7G	6/-	DP90	8/-	EZ81	7/-	UY41	5/-
6K6	5/-	DK96	8/-	MU14	7/-	UY85	7/-
6K70	5/-	DL96	8/-	PC97	7/-	UC9	7/-
6KNG	5/-	EAB080	6/-	PC984	8/-	VR150	7/-
6NT7	5/-	EB91	4/-	PCF80	5/-	WR11	6/-

I.F. TRANSFORMERS 7/8 pair
405 K/s Sing Tuning Miniature Oct. 3 x 1/4in. dia.
High Q and good bandwidth. Data Sheets.

NEW ELECTROLYTICS

TUBULAR	TUBULAR	CAN TYPES
1/350V 2/-	150/350V	5/8 8/600V 9/-
2/350V 2/8	100/25V	2/- 16/450V 5/-
4/350V 2/3	250/25V	3/- 16/800V 12/-
8/450V 2/8	500/12V	3/- 16+10/500V 7/8
16 450V 3/-	1,000/12V	3/- 50/450V 6/-
32/450V 3/9	5,000/60V	5/- 32+32/350V 5/8
55/25V 1/8	8+8/450V	5/8 32+32/450V 6/-
23/50V 2/-	8+16/430V	3/8 50+30/850V 7/-
50/25V 2/-	16+16/450V	4/8 64+120/350V 11/8
50/50V 2/-	32+32/350V	4/8 100+200/275V 12/8

TELESCOPIC CHROME AERIALS. 12 to 33in. 6/8.
TRIPLEXERS Bands I, II, III. 12/8. **COAX PLUGS.** 1/-.
LEAD SOCKETS. 2/-. **PANEL SOCKETS.** 1/-.
OUTLET BOXES (Surface or flush). 4/- each.
BALANCED TWIN FEEDER yds. 6d., 30 or 300 ohms.
TWIN SCREENED per yd. 1/-. 80 ohms only.
Wirewound Ext. Speaker Control 10 Ω 3/-, 25 Ω 6/8.
WIRE-WOUND POTS. 8 WATT. Pre-set Min. TV Types. All values up to 10 ohms to 25K. 3/- ea. 30K. 4/-, Carbon 30K to 2 meg. 3/-.
WIRE-WOUND 4 WATT Pres. Long spindle. Value, 50 ohms to 50K. 6/8; 100K. 7/8.
PHILIPS TRIMMERS. 0-10 pF., 3-30 pF., 1/- TRIMMERS. Ceramic. 30, 50, 70 pF., 9d., 100pF. 130pF., 1/8; 250pF., 1/8; 500pF., 750pF., 1/8.
TV etc. TRIMMER. 1,000pF., with knob, 2/-.
RESISTORS, Preferred values. 10 ohms to 10 meg. $\frac{1}{2}$ w., $\frac{1}{4}$ w., 1 w., 2 w., 5 w., 10 w., 25 w., 50 w., 100 w., 1/8; 250pF., 1/8; 500pF., 1/8.
High Stability. $\frac{1}{2}$ w., 1%, 2/-. Preferred values 10 Ω to 10 meg. Ditto 5% 10 Ω to 22 meg. 9d.
BRIMMISTORS CRT. 3/8; C22. 2/8; C23. 1/8.
5 watt } WIRE-WOUND RESISTORS } 1/8
10 watt } 10 ohms-10,000 ohms } 2/8
15 watt } 2/-
12.5K to 25K 10 w. 2/8
Toggle Switches s.d. 2/- d.p., 3/8,
d.p.d.t., 4/-. Min. Size d.p.d.t., 3/8.

Volume Controls 80 ohm CABLE COAX Semi-air spaced 4in. 40 yds. 17/8 60 yds. 25/- 6d. yd. Ideal 825 lines. U.H.F. Low loss 5dB 100ft. 500 Mc/s 1/6yd.

MAINS TRANSFORMER 200/250 v. A.C.
Postage 2/- each transformer
STANDARD 250-0-250, 80mA, 6.3 v. 3.5 a. tapped 4 v. 4 a. Rectifier 6.3 v. 1 a. 5 v. 2 a. or 1 v. 2 a. 22/6, ditto, 350-0-350 29/6
MINIATURE 200 v. 20 mA. 6.3 v. 1 a. 10/8
MIDGET 230 v. 45 mA. 6.3 v. 2 a. 15/8
SMALL 250-0-250, 45 mA. 6.3 v. 2 a. 17/8
STD. 250-0-250, 65 mA. 6.3 v. 3.5 a. 17/8
HEATER TRANS. 6.3 v. 1 1/2 a. 7/8
Ditto, tapped 1.4, 2, 3, 4, 5, 6.3 v. 10/8
Ditto, sec. 6.3 v. 4 amp. 10/8
GENERAL PURPOSE LOW VOLTAGE, 2 amp. 3, 4, 5, 6, 8, 9, 10, 12, 15, 18, 24, 30 v. 22/6
AUTO TRANSFORMERS. 150 w. 22/6
0.115, 200, 230, 250 v. 500 w. 82/6
MULLARD "510" Mains Transformer 33/6
MAINS POWER PACKS. Ready built with Transistors, Rectifiers, Condensers, providing H.T. and L.T. outputs.
200 v. 20 mA. D.C. 6.3 v. 1 a. A.C. 25/6
220 v. 50 mA. D.C. 6.3 v. 2 a. A.C. 35/6
250 v. 80 mA. D.C. 6.3 v. 3.5 a. tapped 4v. and 6.3 v. 1 a. tapped 5 v., 1 v. 2 a. 45/6

INTERVALT TRANSFORMERS. 311 or 511, 9/-
O.P. TRANSFORMERS. Heavy Duty 3/6, 5/6, 5/10 ratio, 7/8. Multiple to heavy duty push-pull, 10 w. 15/6. Battery 4/8. Sub. min. DL96, 3/4, etc. 5/10 w. O.P. matching trans. 3, 7, 15 Ω , 12/6.
L.F. CHOKES. 15/10H, 60/35 mA. 5/-; 1011, 85 mA. 10/6; 10H, 150 mA. 14/-.

C.R.T. BOOSTER TRANSFORMERS for heater cathode short circuit or tubes with failing emission. Full instructions supplied, mains input. Type A optional 25% and 30% boost 2v. or 4v. or 6.3v. or 10.5v. or 13.6v. State Voltage required. PRICE 10/6.

TINNED COPPER WIRE 16 to 22 swg., 11s. 3/6.
ENAMEL COPPER WIRE 16-22, 22/6; 24-30, 3/6; 32-40, 4/8; D.C.C. 28, 34, 36 swg., 2oz. 3/8.
FULL WAVE BRIDGE SELENIUM RECTIFIERS: 2, 6 or 12 v., 1 1/2 amp. 8/8; 2 a., 11/3; 4 a., 17/8.
CHARGER TRANSFORMERS. Tapped input 200, 250 v. for charging at 2, 5 or 12 v., 1 1/2 amps. 15/6; 2 amps., 17/8; 4 amps., 22/6. Circuit included.
4 AMP CAR BATTERY CHARGER with ammeter, Leads, Fuse, etc. for 6v. or 12v., 69/6.

BOOKS list S.A.E.
Boys' Book of Crystal Sets. 2/8
"W.W." Radio Valve Data. 7/8
High Fidelity Speaker Enclosure 5/-
Valve and TV Tube Equivalents. 9/8
TV Fault Finding 5/-
Standard Amplifier Manual. 8/8
Radio Valve Guide, Books 1, 2, 3, 4 or 5. 5/- each
Practical Radio Inside Out. 3/8
Master Colour Code Chart. 1/8
Transistor & Controlled Models. 7/8
International Radio Stations. 2/8

4 TRANSISTOR PUSH-PULL AUDIO AMPLIFIER
3 x 1 1/2 x 4 in.
A ready built miniature push-pull amplifier with driver and output transformers, 4 transistors. Ideal for use with record players, intercoms, baby ALARMS, etc. Complete with full instructions and circuit.
Price 47/6. In. Batt. 2/8. 2 1/2 in. Speaker 15/-

1964 RADIOGRAM CHASSIS

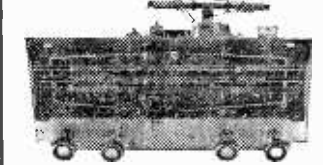

THREE WAVEBANDS FIVE VALVES
T.W. 16in - 50in. LATENT MULLAID, etc. M.W. 20in. - 55in. EC81H, EP89, EB081, L.W. 800m - 2,000m. EL84, E290 12-month Guarantee A.C. 200/250 v. Short-Medium Long/Gram. Ferrite Aerial A.C.V. 3 ohm output 5 watts. Tube Sockets. Glass, metal, horizontal wording size 13 x 7 in. Aligned and calibrated, isolated Chassis size 13 1/2 in. x 7 in. high x 5 1/2 in. deep. £9.15/6 Carr. & Ins. 4/6.

Post 1/- (unless otherwise stated)
C.O.D. 2/- extra. Full list 1/-.
All enquiries answered by experts.

BAKERS

"Selhurst" LOUSPEAKERS



THE CONNOISSEUR'S CHOICE
BAKERS
8in. JUNIOR SPECIAL
8w. 17,000 lines, 5 gns.
Foam Suspension 40-20,000 c.p.s.

BAKERS
12in. GUITAR HEAVY DUTY 25w. 5 gns. 15 ohm voice coils. Unlimited Applications. Response 20 to 10,000 cps. Magnet 12,000 lines. Genuine Musical Instrument Loudspeaker.

BAKERS 12in. STANDARD 20w. 7 gns.
More powerful magnet 14,000 lines special suspension. 40-14,500 cps. Recommended wherever a high standard of reproduction is desired.

BAKERS 12in. BASS 25w. 12 gns.
New 1964 high power model. Aluminium coil former with magnetic damping 25-15,000 cps. Ideas for all electric guitars.

BAKERS 15in. AUDITORIUM 35w. 18 gns.
Improved magnet alexomax with heavy plated assembly, weight 18lbs., 17,000 lines. 20-12,000 cps. Heat proofed coil former. Full repair service. Specials made to order. Older types up-dated.

LOUDSPEAKERS P.M. 3 OHM. 21, 3, 4, 5in. 7 x 4in. 15/8; 6in. Rola, 16/8; 8in. Plessey, 17/8; 9 x 6in. 8 x 5in. 21/-; 10 x 6in. 22/8; 10in. Rola 30/-; 12in. R.A. 30/-; EMI, Double Cone Ceramic magnet 10 w. 13 x 8in., 45/-; 10in. Tweeter 25/8; STEREOA HP1015 7in. 3 to 15 khz 10 w. 22/-; 8in. HFN12 70/-; Crossover CX3000 83/-
EXTENSION SPEAKER CABINET. 5in., 15/8; 6 1/2in., 18/8; 8in., 19/8; 10in., 29/8; 12in., 60/-

TWIN GANG TUNING CONDENSERS. 365 pF., 1in. x 1 1/2in. x 1 1/2in., 10/-; 500 pF. Standard with trimmers, 9/-; midget, 7/8; with trimmers, 9/-; 500 pF. slow motion tuning standard, 9/-; Transistor gang 200+178 pF. with trimmers, 10/8. SMALL 3 gang 500 pF. 17/-, SINGLE 365 pF. 7/8, SINGLE 10 pF. 25 pF. 50 pF. 75 pF. 100 pF. 150 pF. 5/8. Solid dielectric 100, 300, 500 pF. 3/8.

CONDENSERS. 0.001, 7 kv. T.C.C., 5/8; 20 kv. 9/8; 0.1, 7 kv. 9/8; Tubular 500 v. 0.001 to 0.05, 9d.; 0.1, 1/-; 0.25, 1/8; 0.5/300v., 1/8; 0.1, 3/8. CERAMIC COND. 500 v. 1 pF. to 0.01 mfd. 9d.

SILVER MICA CONDENSERS. 10% 5 pF. to 500 pF. 9d.; 600 pF. to 3,000 pF. 1/-. Close tolerance (+1 pF. 2.2pF. to 47pF. 1/-. Ditto 1% to 50pF. to 815pF. 1/-. 1,000pF. to 5,000pF. 1/8.

FERGUSON QUALITY AMPLIFIER 4 watts.
6 1/2 x 6 x 4 in. Mullard Valves. Mains Transf. 200/250V. Volume and tone controls. Sensitivity 200 mv. Response 25 to 20,000 cps. Price 49/6 ea. or 2 units matched for Stereo. 89/6.

WAVECHANGE SWITCHES
3 p. 4-way 2 water long spindle. 8/8
2 p. 3-way or 2 p. 6-way long spindle. 3/8
4 p. 2-way or 4 p. 3-way long spindle. 3/8
3 p. 4-way or 1 p. 12-way long spindle. 3/8
Wavechange "MAKITS". Wafers available:
4 p. 1 p. 12 way, 2 p. 6 way, 3 p. 4 way, 4 p. 3 way, 6 p. 3 way, 1 water, 1 water, 8/8;
2 water, 12/8; 3 water switch, 9/8;
additional wafers up to 12. 3/8 each extra.
Valveholders. EA50, 6d. B12A, CRT, 1/3. Engl. and Amer. 4, 5 and 7 pin, 1/-. Mazda and Int. oct. 6d.; B7C, B6A, B6B, B6A, 9d.; Ceramic EF50, B7G, B9A, Int. oct., 1/-. B7G, B9A can 1/- each. Valve plugs B7C, B9A, Int. oct., 2/8.

HIGH GAIN TV PRE-AMPLIFIERS
I.B.C. Channel 1 to 5 Gain 18dB. ECC84 valve. Kit price 29/8 or 49/8 with power pack. Details 6d. (PCC84 valve if preferred). Coils only 9/6.
BAND II I.T.A.-Same prices.
Tunable channels 7 to 13. Gain 17dB. Circuit and coils only. 9/6. Chassis 4/8.

THE ORIGINAL COMPONENT
OPEN ALL DAY (Wed. 1 p.m.)

THE "INSTANT" BULK TAP
ERASER AND RECORDING HEAD
DEMAGNETISER 200/250 v. A.C.

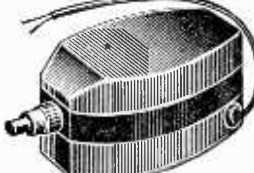

35/-

Leaflet
S.A.E.

PLASTIC RECORDING TAPE

Double Play	7in. reel, 2,400ft.	42/-	Spare
	5in. reel, 1,200ft.	25/-	Plastic Reels
Long Play	7in. reel, 1,800ft.	22/6	3in. 1/6
	5in. reel, 1,200ft.	17/6	4in. 2/-
	5in. reel, 900ft.	13/6	5in. 2/-
Standard	7in. reel, 1,200ft.	17/6	5 1/2in. 2/-
	5in. reel, 900ft.	11/6	7in. 2/6

"EASISPLICE" Tape Splicer 5/-
Leader tape 4/6; Splicing tape 3/-.

CRYSTAL SET BOOKLET 1/-.
CRYSTAL DIODE 6.E.C. 2/-, GEX34 3/-, OA81 3/-.
HIGH RES. PHONE. 3,000 ohms 15/-, 2,000 ohms 12/6.
MOVING COIL PHONE. 100 ohms, 10/-.
SWITCH CLEANER. Fluid squirt, 4/6 tin.

"6 + 1" TRANSISTOR RADIO
First class components to make a 6 transistor 2 waveband superhet chassis. Ideal for portable or table radio. All parts including BVA transistors, ferrite aerial, with car aerial coil, printed circuit, 8in. x 2 1/2in., but EXCLUDING Speaker and cabinet.
Speakers, 35 ohms, 8 x 4in., 2/-, £4.50
5in., 17/6; 3 1/2in., 15/6.

BULGIN PLUGS AND SOCKETS. Non-reversible P74, 2-pin, 4/3; P75, 4-pin, 4/6; P76, 6-pin, 6/6 JACKS. English open circuits, 2/6. Closed circuit, 4/3. Grundig type, 3-pin, 1/3. Grundig lead jack, 3/6. JACK PLUGS. English. Type screened, 3/6. Grundig 3-pin, 3/6; Phono Plugs, 1/-; Sockets, 6d. ALADDIN FORMERS and cores, 1in., 8d.; 1/2in., 10d. 0.3in. Formers, 0.837 or 2 pins TVI or 2, 2in. sq. x 2 1/2in., or 4in. sq. x 1 1/2in., 2/- with cores. SLOW MOTION DRIVES. 6.1, 4/3; 36.1, 10/6. SOLON IRON, 25W, 24/-; 65W, 29/-.
ANTX SUB-MIN IRON, 15W, 200 or 250 v., 32/6. BENCH STAND for above, 12/6. Spares in stock. Pacolin Panels, 10 x 8 x 1/2 in., 2/-. Miniature Contact Cooled Rectifiers, 250V, 60mA, 7/6; 250V, 65mA, 9/6. Selenium Rectifier, 300V, 84mA, 5/-, K325, 600V, 5mA, 5/-, RM4, 2.5M, 15A, 100, 10/- each. PCB, 20/-, TV etc. Silicon Sub-Min. Rectifiers, 250V 450mA, 10/-; 250V, 150mA, 5/6.

465 k/c/s. SIGNAL GENERATORS
Price 10/6, ready made with valve I55. POCKET SIZE 2 1/2x4 1/2in. One resistor to change. Full instructions supplied. Battery 8/6 extra. Details Free.

Coils Wearite "P" Type, 4/- each. Osamor Midget "Q" type, a/c. dust core, from 4/- each. All ranges. List S.A.E. Repanco DRR2. L. and Med. T.R.F. with reaction, 4/6. Med. wave D.R., 3/6. Ferrite Aerial, M., 6/9; M. and L., 12/6. Osamor Ferrite Rod Aerials, L. and M. for transistor circuits, 10/- each. Ferrite Rods, 8 x 1in., 6 x 1in., 6 x 1/2 in., 3/-, H.F. Chokes, 2/6, Osamor UC1, 6/9. T.R.F. Coils, 4/HF 7/- pair; HAX, 3/6. Screwdrivers, 5in., 6in. Test Prods, 2/9 ea. Neoside Trimming Tool, 1/3. Neon Mains Tester Screwdriver, 5/-. Multicore Solder, 4d. yd. Dispenser, 2/6.

Blank Aluminium Chassis, 18 s.w.g. 4 sides, riveted corners, lattice fixing holes, 2 1/2in. sides, 7 x 4in., 4/9; 9 x 7in., 5/9; 11 x 7in., 6/9; 13 x 9in., 8/6; 14 x 11in., 10/6; 15 x 14in., 12/6. Aluminium Panels, 18 s.w.g., 12 x 12in., 4/6; 14 x 9in., 4/-; 12 x 8in., 3/-; 10 x 7in., 2/3; 8 x 6in., 2/-; 6 x 4in., 1/6.

MARTIN TAPE PRE-AMPLIFIERS (PLAY-BACK THROUGH YOUR OWN AMPLIFIER)
For Coliario 2 Track Decks 8 gns. COMPLETE RECORDING & PLAY-BACK AMPLIFIERS
For 2 Track Coliario £11.11.0
TAPE DECKS
Coliario Studio 2 Track £10.15.0
BSR T12 2 Track Tape Deck £7.5.0
Coliario Record/Erase Heads, 2-track Upper or lower 35/- pr., 4-track £5.10.0

MAINS DROPPERS. Midzest adjustable slide 0.3A, 1,000 ohms, 6/-; 0.2A, 1,200 ohms, 6/-; 0.15A, 1,500 ohms, 6/-; 0.1A, 2,000 ohms, 6/-.
LINE CORD. 3-way 100 ohms L., 1/- ft.
MIKE TRANSFORMERS. 30-1, 3/9.
P.V.C. Covered Wire, single or stranded, 2d. yd. Sleeving, 1 or 2 mm., 2d.; 4 mm., 3d.; 6 mm., 5d. yd.

B.T.H. TAPE MOTORS, 115 v. A.C., 28w, pair for 230 v. (in series), 12/6. Post free.

SPEAKER-FRET. Gold Maroon or Green (cloth 17 x 25in, 5/-; 25 x 33in, 10/-, Tygan, various colours 25in. wide from 10/- ft., 25in. wide from 5/- ft. Samples 1/-, Expanded Metal, Gold, 12 x 12in., 8/- Panel mounting tape holder, 2/-. Fuses 1 1/2in. 60mA, 5A, 6d. Insulated side cutters, 3/6. Bib Strippers, 3/6

RADIO AND TELEVISION SPARES
All leading makes, volume controls, etc., fine output transformers, etc.
B. V. A. valves (current and obsolete types). Send S.A.E. for quotation.

WEYRAD P50

COILS AND TRANSFORMERS FOR 2-WAVE TRANSISTOR SUPERHET
Long and Medium aerial—RA2W 5in. rod 208 pf tuning, with car aerial coil 12/6
Osc. Coil P50/LAC 176 pf tuning 5/4
1st and 2nd I.F. P50/CC 470 kc/s 5/7 each
3rd I.F. P50/3CC 6/-, Spare Cores, 6d.
Driver Transformer—LFD74 9/6
Wavechange Slide switch d.p.d.t. 3/6
Printed Circuit—PCA1, Size 2 1/2 x 3in.
Ready drilled and printed
Volume Control, 5K-DP 4/6
25 ohm Speakers, 3 1/2in., 15/6; 5in., 17/6; 6 x 4in., 21/-.
J.B. Tuning Gang with trimmers 10/6
Constructor's Booklet 2/-
3 ohm O.P. Trans. O.P.T.1 10/6

NEV MULLARD TRANSISTORS
OC71 6/-, OC72 7/6, OC81D 7/6, OC81 7/6, OC44 8/-, OC45 8/-, OC71 10/6, AF117 9/6.
Sub Miniature Condensers, 0.1 mFd. 30V, 1/3-1, 2, 4, 5, 8, 16, 25, 30, 50, 100 mFd. 15V, 2/6 ea. Transistor Holders, 1/3.

SINCLAIR "SLIMLINE" RADIO
Earphone, ferrite aerial, 3 x 1 1/2 in. Kit 49/6. No aerial required.
SINCLAIR MICRO-6, Kit, 59/6.
Transistor 4 Channel Mixer with 4 separate input-output controls 59/6.

"THE POWER MITE" 45/- 200/250V.
PM5 Mains Unit 9 volt for Transistor Radios. Same size as P.P.9.
Miniature PP3 model, 19/6.

ADASTRA 3-3 AMPLIFIER 3 WATTS

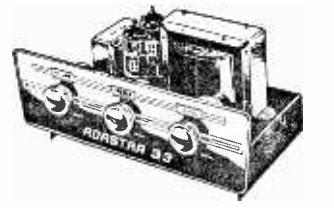

A.E.C. 200-250V. Valves ECL86 and E280. 3 ohms output. Controls: Bass, Treble and Volume. Separate front panel with de luxe finish. Quality mains transformer. Enamelled chassis 6in. x 5in. x 3in. Price £5.9.6. Details S.A.E.
"Performs agreeably well!" (The Gramophone)

BUILD YOUR OWN
RECORD PLAYER
FROM £9.19.6

AND
SAVE
POUNDS!!



4 Speed Autochanger or Single Player units with Brand New 2-tone de luxe cabinets 17 x 13 x 8 1/2in. Strong handle, 4ft finish clips and handles. Used by Famous Make for 20 cns. models. Ready cut out motor board 14 x 13in. Front baffle with 7 x 4in. high flux loudspeaker and 3 watt 2 valve UCL5 UCL5 amplifier built on metal chassis 12 x 3 x 2 1/2in. Quality 3 ohm output transformer, low hum level circuit Volume and Tone controls. 3-core safety mains lead. All items fit together perfectly. Special instructions enable assembly in 30 minutes, only 5 wires to join! 12-month written guarantee. Available separately or package deals as below.

AUTOCHANGE KITS COMPLETE (as above)
B.S.R. Mousch . . . £11.10.9 P.P. 5/6
Garrard Autolium . . . £12.13.6 P.P. 5/6
SINGLE PLAYER KITS. Complete (as above)
B.S.R. Junior . . . £9.19.6 P.P. 5/6
Garrard SRP10 . . . £11.5.0 P.P. 5/6
OR SEPARATELY
Cabinet with board 14 x 13in. cut out for your choice . . . £3.9.6 P.P. 3/6
Amplifier with 7 x 4in. speaker £3.17.3 P.P. 2/6
AUTOCHANGERS
B.S.R. UA14 . . . £5.19.6 P.P. 4/6
B.S.R. UA15 Slimline . . . £6.17.6 P.P. 4/6
Garrard Autolium . . . £6.17.6 P.P. 4/6
SINGLE PLAYERS
Garrard SRP10 . . . £5.5.6 P.P. 4/6
E.M.I. auto stop/start . . . £5.5.0 P.P. 4/6
B.S.R. Junior . . . £3.7.6 P.P. 3/6

TRANSCRIPTION UNITS
Garrard 4HF . . . £15.15.0 P.P. 5/-
Philips AG1016 . . . £12.0.0 P.P. 5/-
Garrard AT8 . . . £10.10.0 P.P. 5/-

BARGAIN XTAL PICK-UP ARM
Complete with ACOS LP-78 Turnover Head, 20/-
Replacement sapphire styl 5/-, diamond 15/-, Mono ACOS Xtals 15/-; Stereo Ronsette 30/-.

BARGAIN SINGLE PLAYER KIT 200/250 v. A.C. £5.15.0 (less cabinet) Post 5/-
With 2-stage Amplifier; 3 watt; 2 valves, UCL52, UY35. High-dx 5in. speaker; 4-ganged B.S.R. Turntable, 16, 33, 45, 78 r.p.m.; Crystal Pick-up for LP/STD. Records, 7in. 10in., 12in.; Cut out Mounting Boards 12 1/2 x 9 1/2in.

ARDENTE TRANSISTOR TRANSFORMERS
D8055, 7.3 CT-1 Push-pull to 3 ohms output 11/-
D8054 1.5:1, C.T. Push-pull Driver 11/-
D8058, 11.5:1 Output to 3 ohms, etc. 11/-
D828, 4.5:1 Driver, 7in. x 7in. x 7in. 11/6
D240, 8.5:1 Driver, 7in. x 7in. x 7in. 11/6
ARDENTE TRANSISTOR VOLUME CONTROLS
VC1548, 5K with switch dia. 9in. 9/3
SUB-MIN. EARPIECE Xtal or Magneta 7/6
SUB-MIN. JACK AND PLUG 2.5 or 3.5 mm. 3/6 pair

MINIATURE PANEL METERS
Size 1 1/2in. sq. Precision jewelled bearings, 2% accuracy, silvered dials, black numerals and fine pointers; zero adjustment screw on front of meter.

1 mA . . . 27/6	50µA . . . 39/6
5 mA . . . 27/6	500µA . . . 32/6
300V . . . 27/6	"S" Meter 35/-

MOVING COIL MULTIMETER TK 20a
0-1000 v. A.C./D.C., ohms 0-100k, etc., 49/6.
0-150 mA pocket size with 2in. scale

CRYSTAL MIKE INSERTS, 6/6
High output. Size 1 1/2in. dia. x 1in.
ACOS MIC. insert 1 1/2in. dia. x 1in. 8/6
ACOS 38-1 DELUXE MIKE 35/-
EMI QUALITY MIKE 25/-
TELEPHONE TAP MIKE . . . 10/6
GUITAR CONTACT MIKE . . . 15/6
MOVING COIL MIKE, high or low impedance, 90/-
FLOOR STAND, 57/-
TANNOY Carbon Hand Mike . . . 3/6.

COMPONENT SHOP 337 WHITEHORSE ROAD
SPECIALISTS WEST CROYDON
Telephone: THO 1665
Export envelope. Send remittance, and extra postage, no C.O.D.

Buses 133 or 68 pass door. S.R. Station, Selhurst

RADIO-AMATEUR GEAR
EDUCATIONAL KITS



TEST INSTRUMENTS
HI-FI EQUIPMENT

World-famous kit-sets anyone can build

The clearly written instruction manuals, issued with each kit, show you how
A KIT FOR EVERY INTEREST . . . FOR HOME, WORKSHOP, LABORATORIES

HI-FI F.M. TUNER. Tuning range 88-108 Mc/s. Tuning unit (FMT-4U) with 10.7 Mc/s I.F. output (£215.0 inc. P.T.) I.F. Amp. (FMA-4U) complete with cabinet and valves. (£13.3.0). Total kit £15.18.0 Assembly can be arranged.



AMATEUR BANDS RECEIVER. Model RA-1. Covers all Amateur Bands from 160 to 10m. Special features incl. half lattice crystal filter, 8 valves, signal strength "S" tuning meter, tuned R.F. amplifier stage. Kit £39.6.6 Assembled £52.10.0



5W HI-FI MONO AMPLIFIER. Model MA-5. A low-priced well designed amplifier. Printed circuit construction makes it easy to build. Kit £10.19.6. Assembled £15.10.0
"COTSWOLD" HI-FI SPEAKER SYSTEMS. MFS or Standard. Range 30-20,000 c/s. Kit £23.4.0. Assembled £30.15.0
MONO CONTROL UNIT. Model UMC-1. Ideal for use with MA-12 or similar amplifier. Kit £8.12.6. Assembled £13.12.6
HI-FI EQUIPMENT CABINETS. Large range, in kit form or assembled and finished, incl. record housing range, available to meet various needs. Details on request. from £7.7.0 to £37.16.0

6W DE LUXE AMPLIFIER. Model S-33H. An inexpensive Stereo-Mono amplifier, with high sensitivity. Suitable for Decca Demam Cartridge. Kit £15.17.6. Assembled £21.7.6
6 TRANSISTOR PORTABLE. Model UXR-1. Prealigned I.F. transformers. Printed circuit, 7 x 4in. high flux speaker. Real hide case. Very easy to build. Kit £12.11.0
SHORTWAVE TRANSISTOR PORTABLE. Model RSW-1. Two short bands, trawler and medium wave. Kit £19.17.6
HI-FI A.M. F.M. TUNER. Covers F.M. 88-108 Mc/s. A.M. 16-50, 200-550, 900-2,000m. Tuning heart (£4.13.6 inc. P.T.) and I.F. Amp. £21.16.6. Printed circuit board. Total Kit £26.10.0

SEND FOR FREE BRITISH HEATHKIT CATALOGUE — MANY MODELS TO CHOOSE FROM

Assembled models also available: prices on request—Deferred terms available over £10. Free delivery U.K.

5in. OSCILLOSCOPE. Model 10-12U. Wide band amplifiers essential for T.V. servicing, F.M. alignment etc. T/B covers 10 c/s-500 kc/s in 5 ranges. Kit £32.12.6. Assembled £41.10.0. The ideal low-priced 'scope.



"OXFORD" DE-LUXE TWO WAYBAND TRANSISTOR PORTABLE. Model UXR-2. The ideal domestic, car, or personal portable receiver. 10 Semi-conductors. Send for full details. £14.18.0 Kit (inc. P.T.). Assembly can be arranged.



PA AMPLIFIER. Model PA-1. 50W output. For vocal and instrumental groups, guitars, etc. 4 inputs, 2 speakers, Tremolo. Send for full details. Kit £54.15.0 Legs optional extra 17/6 set. Assembled £74.0.0.
50W POWER AMPLIFIER. Model MA-50. Ideal for PA work etc. Kit £19.18.0. Assembled £27.18.0.

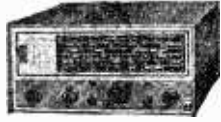

RG-1

COMMUNICATIONS TYPE RECEIVER
Model RG-1. An excellent low cost receiver Freq. cov.: 600 kc/s-1.5 Mc/s. 1.7 Mc/s-32 Mc/s. A two speed tuning drive. R.F. "front end" supplied assembled, aligned and tested. Send for details Kit £39.16.0. Assembled £53.0.0.

2 1/2in. PORTABLE SERVICE OSCILLOSCOPE. Model OS-1. An ideal light, compact 'scope for servicing and general work. Printed circuit construction. Kit £22.18.0. Assembled £30.8.0
"MOHICAN" TRANSISTOR GEN-COVERAGE RECEIVER. Model GC-1U. An excellent portable for the short wave listener. Kit £37.17.6. Assembled £45.17.6
VALVE VOLTMEETER. Model V-7A. Measures up to 1,500 v (D.C. and r.m.s.) and 4,000 pk-to-pk. Res. 0.1Ω to 1,000 MΩ. Kit £13.18.6. Assembled £19.18.6

LATEST AMERICAN SINGLE-SIDE-BAND AMATEUR EQUIPMENT. Now available from Gloucester Please send for details.
MULTIMETER. Model MM-1U. Ranges: 0-1.5 v. to 1,500 v. A.C. and D.C. 0-150μA—15A D.C. 0.2Ω to 20MΩ 4 1/2 in. 50μA meter. Kit £12.18.0. Assembled £18.11.6
R.F. SIGNAL GENERATOR. Model RF-1U. Up to 100 Mc/s fundamental, 200 Mc/s on harmonics. Up to 100 mV output all bands. Kit £13.8.0. Assembled £19.18.0

TELEVISION ALIGNMENT GENERATOR. Model HFV-1. Accurate alignment of TV receivers achieved in minimum time at low cost. Covers 3.6 to 220 Mc/s fundamentals. £34.18.0 Kit. £44.10.0 Assembled

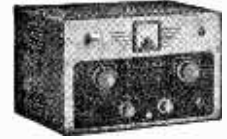

40 w. to aerial Prov. for VFO Kit £33.19.0. Assembled £45.8.0.

AMATEUR TRANSMITTER
Model DX-40U. Self-contained. 80-10 m. Power input 75 w. CVW., 60 w. peak C.C. phone. Output

AMATEUR TRANSMITTER.
Model DX-100U. Covers all amateur bands. 160-10 m. 150 w. D.C. input, self contained with power supply. Modulator, VFO Kit £79.10.0. Assembled £104.15.0



DX-100U

DAYSTROM LTD.

Dept. P.W.12, GLOUCESTER, ENGLAND
 A subsidiary of Weston Instruments Group, manufacturers of the
WORLD'S LARGEST-SELLING ELECTRONIC KITS

Send me **FREE BRITISH CATALOGUE** (Yes/No)
 Full details of model(s) _____
 NAME _____
 ADDRESS _____

Practical Wireless

Vol. XL No. 694 DECEMBER, 1964

Editorial and Advertisement
Offices:

PRACTICAL WIRELESS

George Newnes Ltd., Tower House
Southampton Street, W.C.2.

© George Newnes Ltd., 1964

Phone: Temple Bar 4363

Telegrams: Newnes, Rand, London.

SUBSCRIPTION RATES

including postage for one year

To any part of the world £1.9.0

Contents

Editorial	729
Round the World of Wireless	730
Short-Wave Superhet	732
Inverted V Aerial	736
Preparing for the R.A.E.	740
A Model Control Transmitter	745
Monitoring A Big Receiver	747
Practically Wireless	751
An Experimenter's Galvano- meter	752
Photoconductors	753
Sand-loaded Loudspeaker Baffles	756
Improvements to Transistor Portables	759
On the Short Waves	762
TV & Radio Show	766
Understanding Semiconduc- tors	770
Books Reviewed	777
A Band II Pre-amplifier	781
Trade News	785
Light-operated Switch... ..	789
Club News	790
Letters to the Editor	793

The Editor will be pleased to consider articles of a practical nature. Such articles should be written on one side of the paper only and should contain the name and address of the sender, whilst the Editor does not hold himself responsible for manuscripts every effort will be made to return them if a stamped and addressed envelope is enclosed. All correspondence intended for the Editor should be addressed: The Editor, PRACTICAL WIRELESS, George Newnes, Ltd., Tower House, Southampton Street, London, W.C.2. Owing to the rapid progress in the designs of wireless apparatus and to our efforts to keep readers in touch with the latest developments, we give no warranty that apparatus described in our columns is not the subject of letters patent. Copyright in all drawings, photographs and articles published in PRACTICAL WIRELESS is specifically reserved throughout the countries signatory to the Berne Convention and the U.S.A. Reproductions or imitations of any of these are therefore expressly forbidden. PRACTICAL WIRELESS incorporates "Amateur Wireless."

Pirate Saboteurs

PRE-WAR amateurs were obliged to call "Test" on each transmission; today they call "CQ" like amateurs in other countries. This neatly illustrates a changing of attitude. Before the war, the amateur was encouraged as an experimenter and a potential radio operator in times of National emergency; today he is operating on sufferance. He is grudgingly tolerated, but is liable to be pushed around, his scope restricted.

Our national radio society, the RSGB, has fought long and tough battles to resist encroachments into amateur territory. It has struggled to retain frequencies, to get more. With other national societies it has done what it can to resist strong pressures for chunks of amateur bands from broadcasting, commercial and military services. The RSGB has done yeoman service in keeping so much for the amateur, but even so we have lost valuable (and irreplaceable) air space since the war.

It is manifestly obvious that in the incessant fight to retain the privileges of the radio amateur (for they *are* privileges and *not* rights, as many fail to grasp) it is incumbent on each individual amateur operator to conduct himself on the air in a manner, if not exemplary, at least not provocative.

It hardly needs stating that the continual efforts of national societies and responsible operators can be placed in jeopardy by the irresponsible behaviour of a few. Pirates notably sabotage and mar not only the good name of amateur radio but proffer, on a plate, strong arguments to those who wish to reduce even further the still reasonable freedom of licensed amateurs.

Dealers can help clean up the current situation by refusing to sell transmitting equipment to all-comers. The fact that a licence is necessary (or that certain equipment is not operable on licensed frequencies) is never pointed out to customers. And it must be patently obvious to store assistants that they frequently sell such equipment to unsuspecting youngsters who thereafter run the risk of fines and confiscation, not to mention possible disruption of existing radio services.

Ideally, of course, it should be illegal for anyone to purchase transmitting equipment except on the production of a transmitting licence—as it should be for any shop to *sell* such equipment to non-licensed customers.

From the would-be operator's point of view the remedy is simple. The Radio Amateur Examination requires only a basic knowledge unlikely to strain the abilities of the genuine enthusiast. It covers only subjects which any active amateur must know to operate his station.

The cold fact is that anyone incapable of passing the RAE cannot really expect the privilege of putting a transmitter on the air. It has never stopped the real enthusiast.

A good deal of literature, including sample papers from previous examinations, is readily available. Our own new series on the RAE, too, we hope, will be of help to those aspiring to a "ticket".

Taking it all round, it seems that there is no real justification, or excuse, for amateur radio piracy.

Our next issue dated January will be published on December 4th

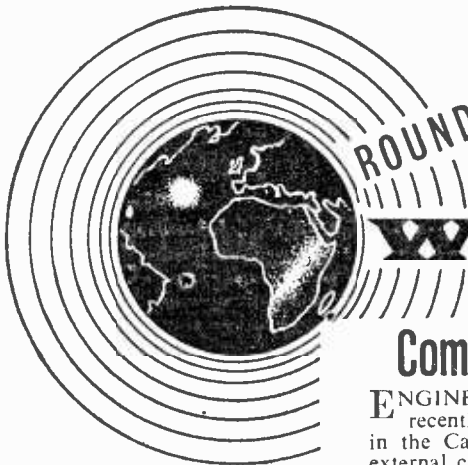

ROUND THE WORLD

of WIRELESS

NEWS AT HOME
AND ABROAD

Communications in the Caribbean

ENGINEERS of Cable and Wireless (West Indies) Ltd., have recently carried out an extensive survey of the Cayman Islands in the Caribbean, preparatory to the installation of internal and external communications equipment in these Islands. Precise details of the equipment and circuits to be operated has not yet become available. However, a fully automatic telephone exchange is planned for Georgetown, the

principal town, which will initially provide for 400 lines. A new wireless station is also planned which will link Grand Cayman with Jamaica by an h.f. circuit.

The Georgetown telephone exchange will also serve West Bay, Boddentown, North Side and East End.

The Cayman-Jamaica link will provide the islands' external communications by carrying composite teleprinter and radio telephone circuits. The latter facility will be made capable of being linked over the Jamaica-Florida cable into the international telephone system.

The two islands Grand Cayman and Cayman Brac will be connected by another radio telephone link, which will give the latter access to the international services as well.

These plans were announced after the Islands had accepted Cable and Wireless' offer to install, maintain and operate all their internal and external communications.

Miniaturisation in Hearing Aids

FOR many years Mullard developments have contributed to the gradual improvement and miniaturisation of hearing aid devices, and at the recent London convention of the Society of Hearing Aid Audiologists, the company demonstrated circuits which may soon be introduced to continue the trend toward smaller aids.

With devices such as those shown at the Convention, hearing aid manufacturers are advancing from the "behind-the-ear" instruments, once considered tiny, to "in-the-ear" types. The kind of device which is making the transition possible is the integrated circuit module on show by Mullard, measuring only 2mm x 2.5mm x 1mm. This plastic encapsulation contains what is effectively, a three-stage d.c. coupled amplifier made from a single slice of silicon.

Other components exhibited,

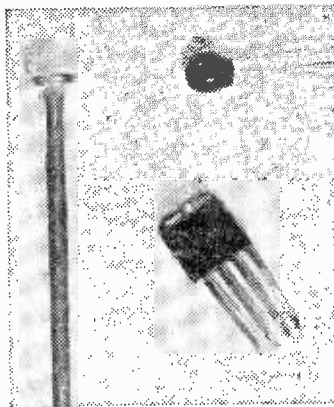

Here a Mullard integrated d.c. coupled amplifier (lower right) and an epitaxial transistor are compared to a pin.

were silicon planar epitaxial transistors measuring only 1.5mm round by 1.8mm long, and pinhead resistors only 1.7mm in diameter.

Photo-electric Equipment will Detect Fog

MODULATED photo-electric equipment supplied by Lancashire Dynamo Electronic Products Limited (part of the M.I. Group), is to be installed at the Haulbowline Lighthouse in the Irish Republic, to detect fog and mist.

The equipment in the lighthouse,

which is situated at the entrance to Carlingford Lough, will span the 1,300 yards to the north bank of the estuary with a light beam. Once this beam is broken by poor visibility, i.e. fog, mist, snow, rain, an integral relay system automatically brings into operation a large Swedish-made fog

horn which ceases operation when visibility clears.

The equipment consists of a light projector unit and a light receiver unit, each fitted with a 6in. lens, precision optical viewing sights, and a sensitivity control on the receiver unit for adjustment of the operating level.

BBC RESEARCH SCHOLARSHIPS

THE Engineering Division of the BBC provides a number of research scholarships at United Kingdom Universities, intended to provide selected honours graduates with the opportunity to work for a higher degree, the subject chosen for post-graduate study being within those fields of physics or engineering that have an application to sound or television broadcasting. Scholarships this year have been awarded to G. Brown of Durham University, R. W. Smith of Trinity College, Cambridge, and B. J. Vieri of Birmingham University.

Mr. Brown's research will be on the microwave spectroscopy of maser materials, while Mr. Smith will be concerned with photo-electronic image delay and storage tubes.

Mr. Vieri will, under his scholarship, continue and complete the research he has been conducting for the past three years on the automatic bandwidth reduction of television and facsimile channels by statistical encoding.

RADAR SIMULATOR FOR EIRE

EQUIPMENT that can simulate a surveillance radar has been ordered for the training of air traffic control personnel at the Shannon International Airport, County Clare, Eire. The transistorised radar simulator will be supplied by a division of Solartron Electronic Group Ltd.

New Cable Factory in Scotland

THE demand for high voltage oil filled cables has increased so rapidly, that Scottish Cables Limited are to build a new factory at Renfrew for their manufacture.

This was announced recently by Sir William McFadzean, Chairman of the BICC Group, whose research organisation has been at the disposal of Scottish Cables during the planning of a £3 million expansion programme, of which the new factory is part.

The factory, with a floor area of approximately 160,000 sq. ft., will be equipped with a highly specialised plant for the manufacture and testing of single core and 3-core oil filled cables for voltages up to 130,000.

NEW RECEIVERS ARE AUTOMATICALLY TUNED

A RADIO receiving system in which the receiver performs all tuning operations entirely automatically, has recently been introduced by the Marconi Company Limited.

The system has been designed to cut both capital and running costs for high-grade h.f. communications by taking advantage of new techniques and methods of construction. These include transistorisation throughout and the use of printed circuit techniques and modular construction.

The result has been more reliable, more stable and smaller equipment (the overall size has been reduced to a third of that of previous designs) automatic operation as far as possible, and very rapid frequency changing. The valve and the telegraph relay have been eliminated completely.

A Marconi Self-Tuning (MST) h.f. communications system enables one man, at a central point, to control every receiver. Simply by setting decade dials on a frequency synthesizer unit to the required frequency, and pressing a button, he initiates the self tuning action of the equipment and within 24 seconds all stages of the receiver are accurately tuned to the new frequency.

The MST communications system includes three separate

receivers; a dual-diversity telegraph receiver, suitable for diversity reception of f.s.k. or four frequency duplex signals; a dual-diversity i.s.b./s.s.b. receiver, and a single path i.s.b./s.s.b. receiver.

The associated units making up the complete system include the frequency synthesizer, a display and control unit, and a master frequency source.

The fully transistorised synthesizer provides the high-stability first oscillator input to any of the MST receivers and a 100kc/s signal used for carrier reinsertion and for generating the second

oscillator signal where a.f.c. is not used. Its coverage is from 3-0000 to 30-9999Mc/s, in steps of 100c/s, permitting any one of 250,000 frequencies to be selected.

This synthesizer requires a 1Mc/s master frequency signal of a high accuracy and stability and this can be provided by the master frequency source.

In creating this new communications system, Marconi's have achieved reductions in size and cost of equipment; staff and cost of both operation and maintenance.

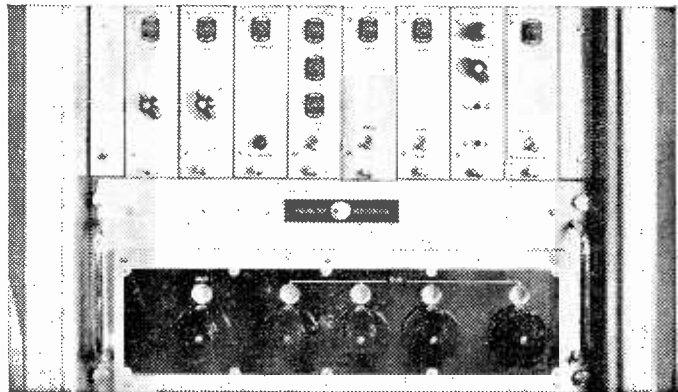

The control panel of a Marconi Self-Tuning receiver.

PRESENTED FREE
WITH
"PRACTICAL WIRELESS"
DECEMBER 1964

Practical Wireless
BEGINNER'S S.W. SUPERHERO

PRICE
5/-

AND ALIGNMENT
OSCILLATOR

PUBLISHED BY GEO. NEWNES LTD., TOWER HOUSE, SOUTHAMPTON STREET, LONDON W.C.2.

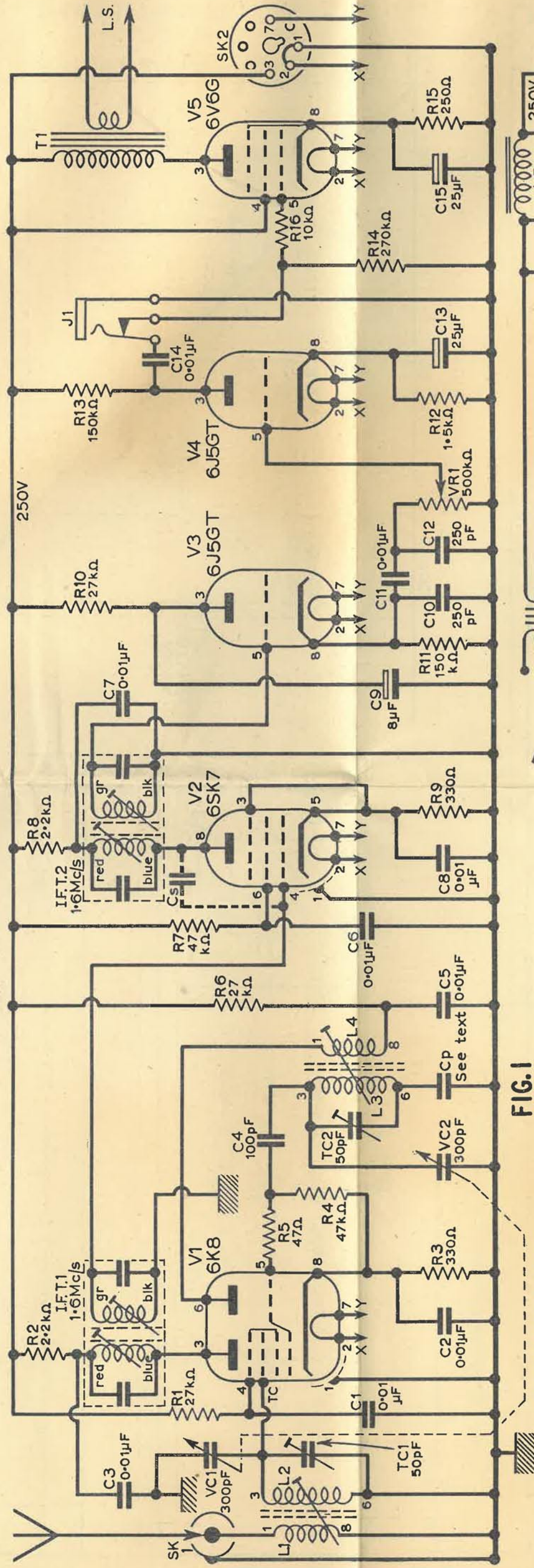

FIG. 1

Hole A..... $1\frac{3}{16}$ " dia. hole
Hole B..... $\frac{3}{4}$ " dia hole
Hole C..... $\frac{3}{8}$ " dia hole
Hole D..... $\frac{1}{4}$ " dia hole
All other fixing holes
are 4BA clearance

Overall chassis dimension
 $13\frac{1}{2} \times 7\frac{1}{2} \times 3$ "

Volume

Tuning

Osc. trim.

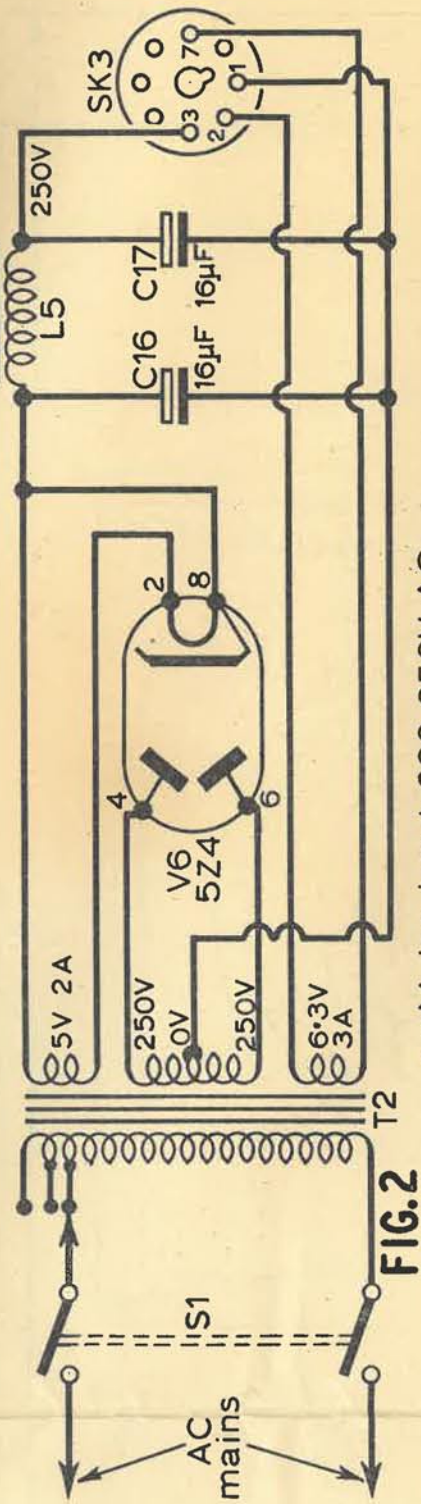

FIG. 2

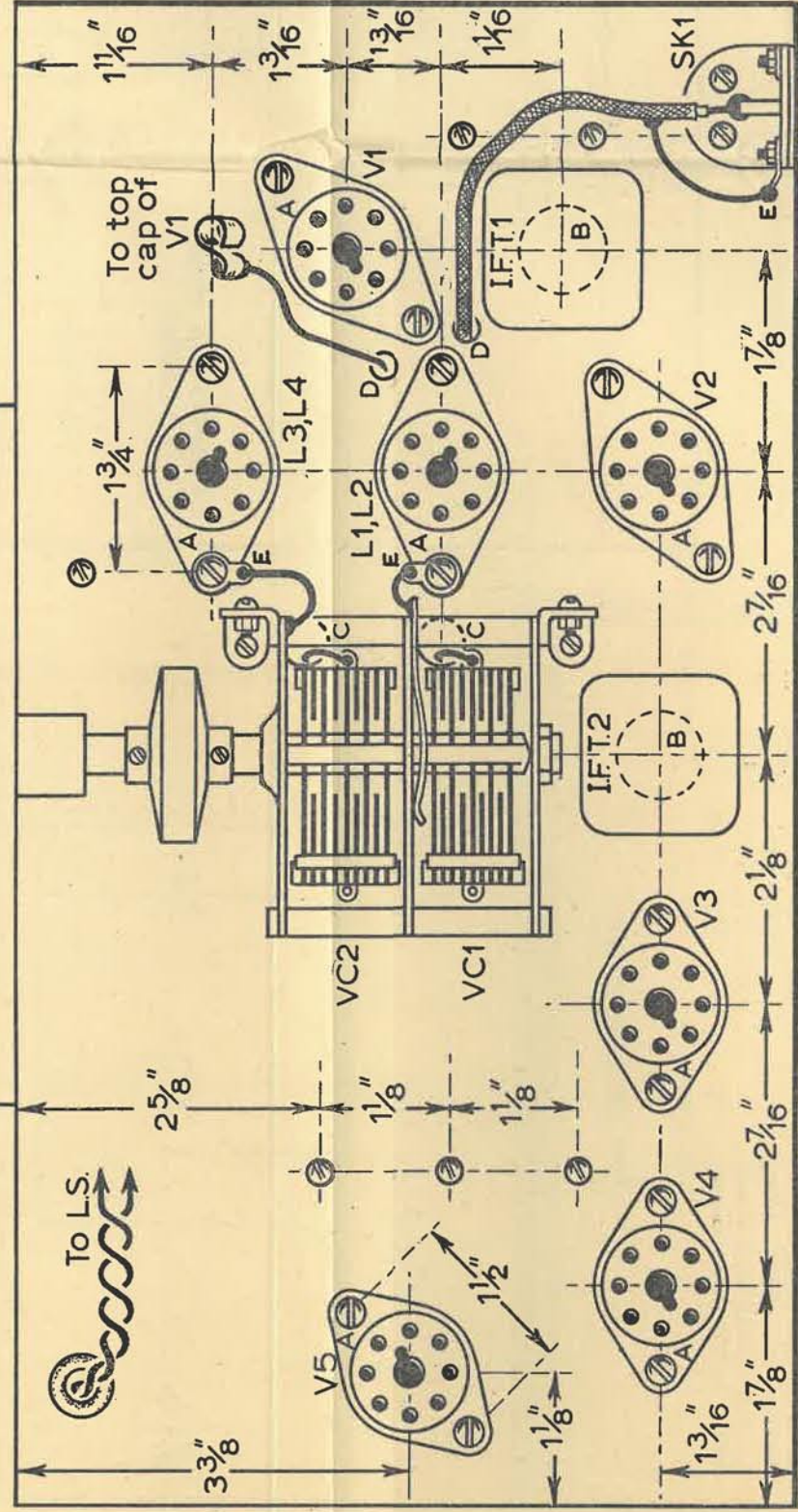

FIG. 3

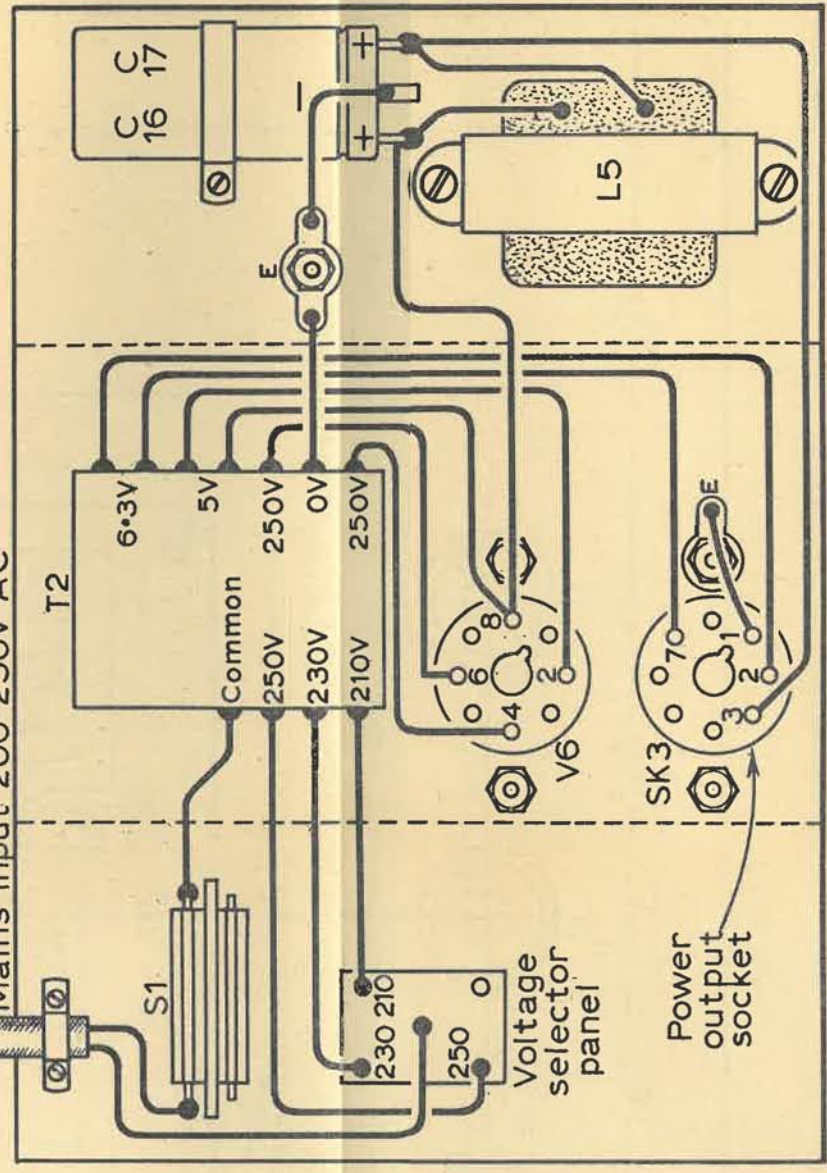

FIG. 5

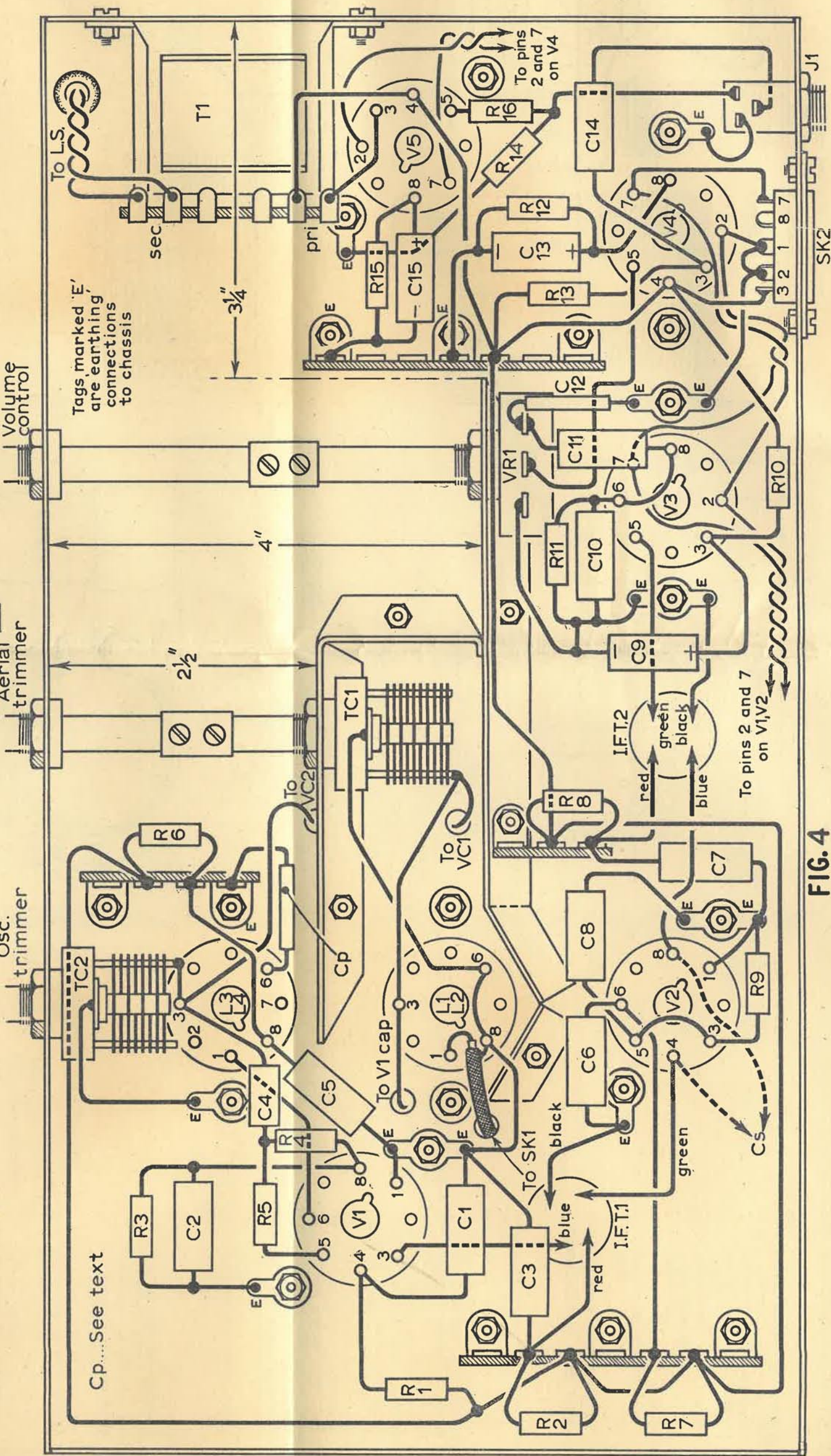

FIG. 4

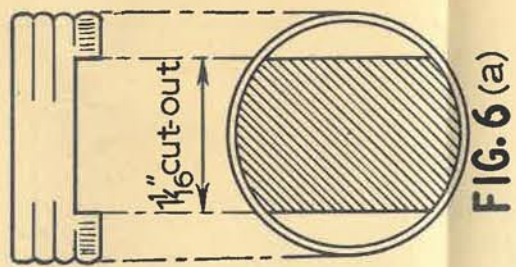

FIG. 6 (a)

Lid clamped between holder and chassis

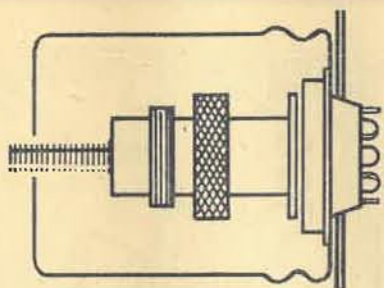

FIG. 6 (b)

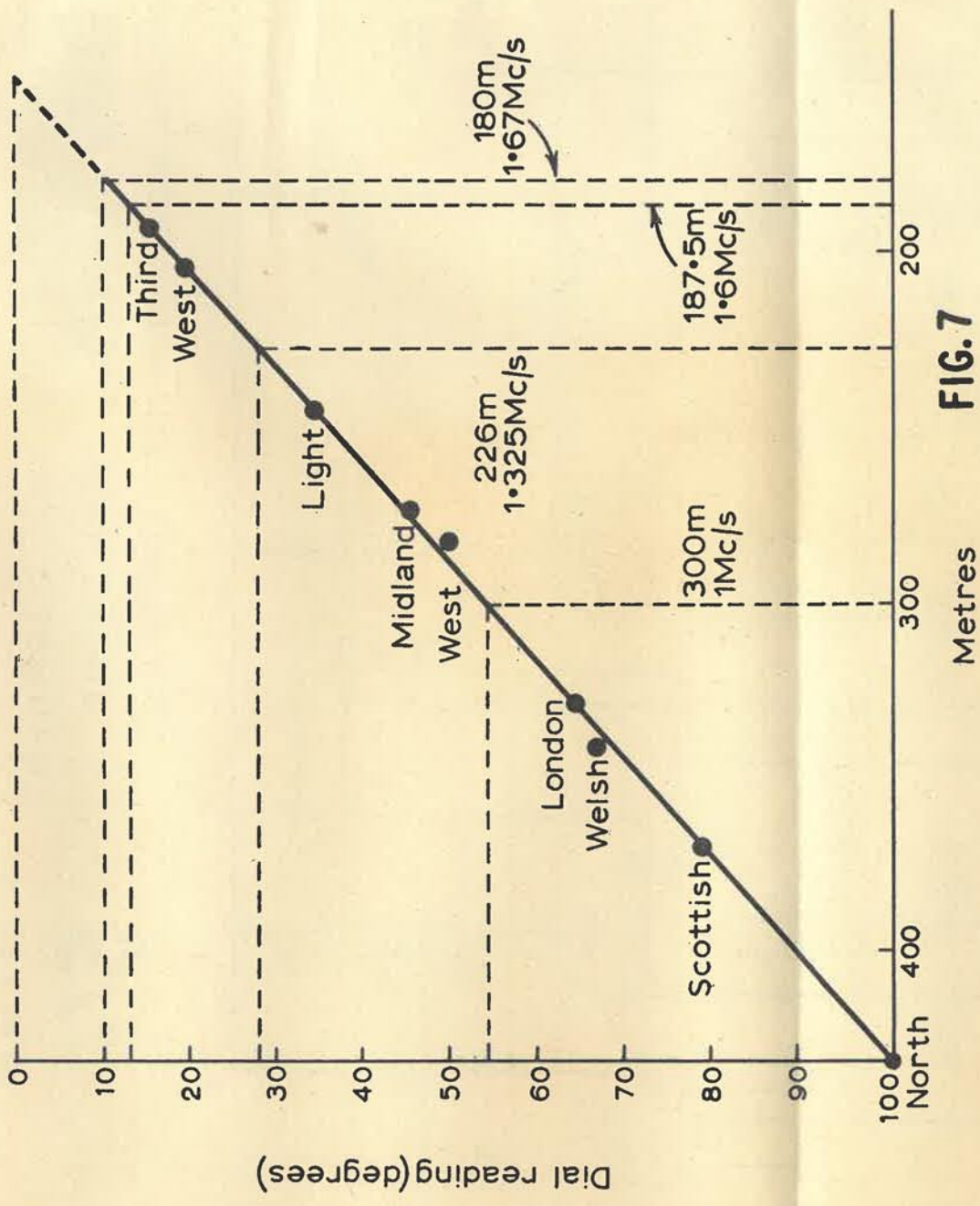

FIG. 7

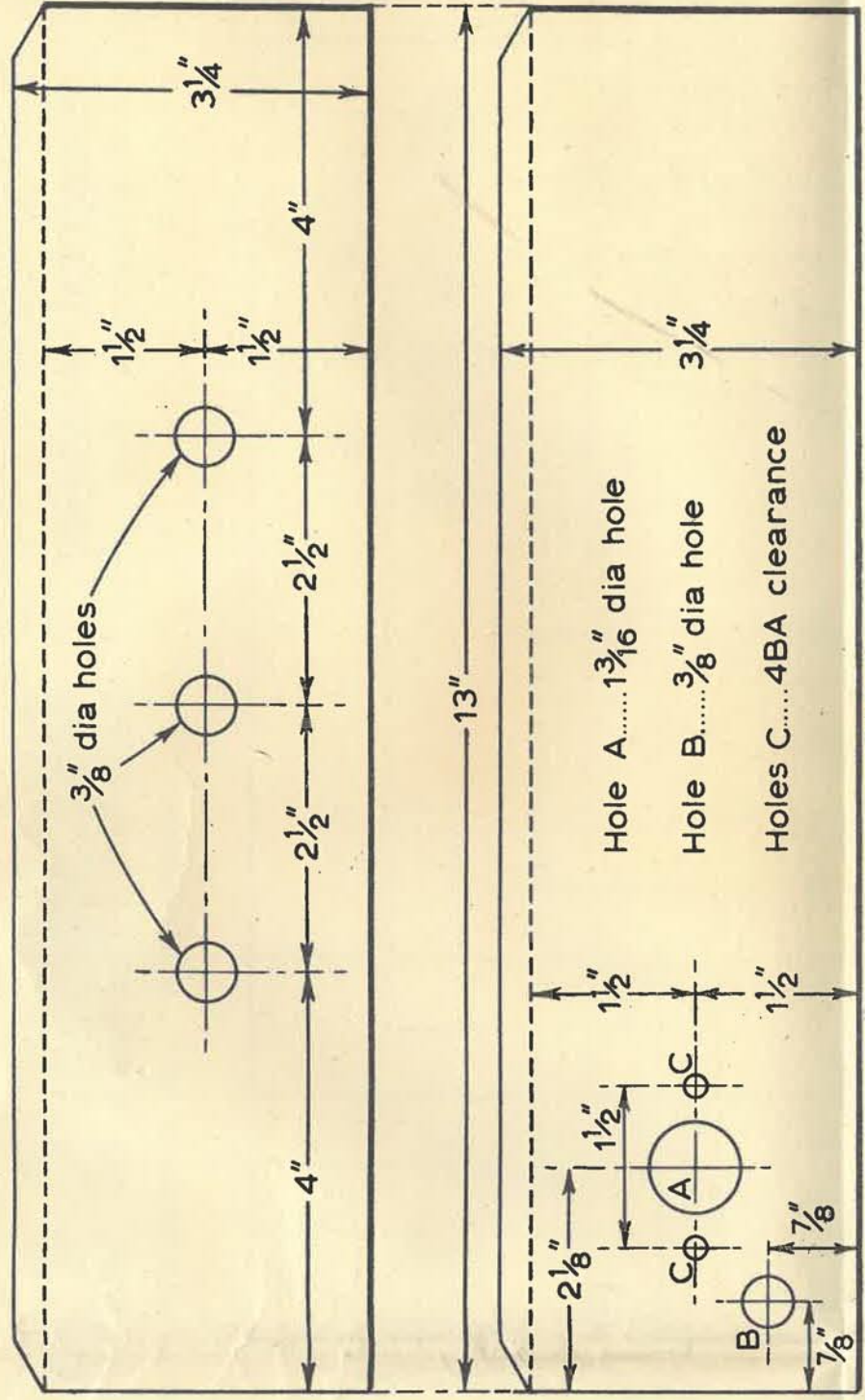

FIG. 8

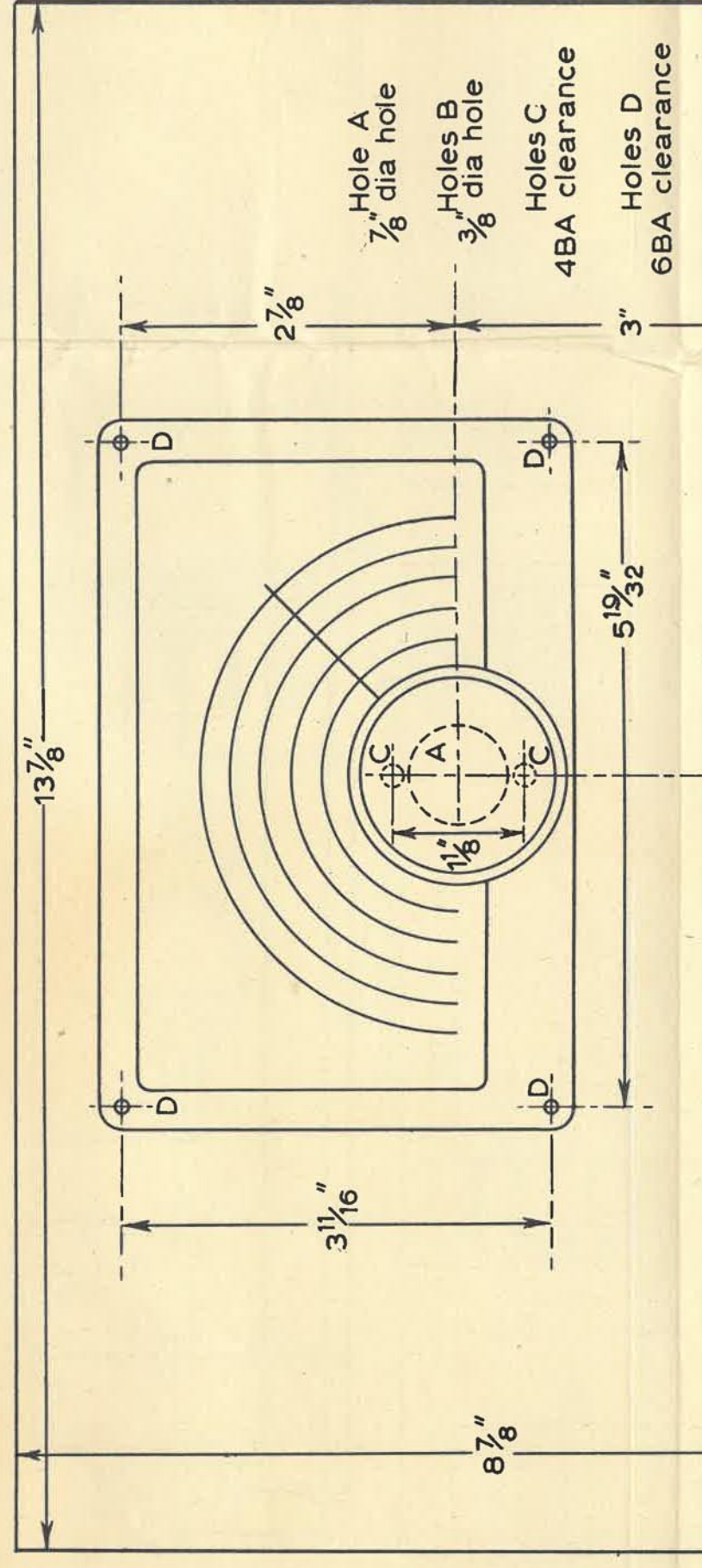
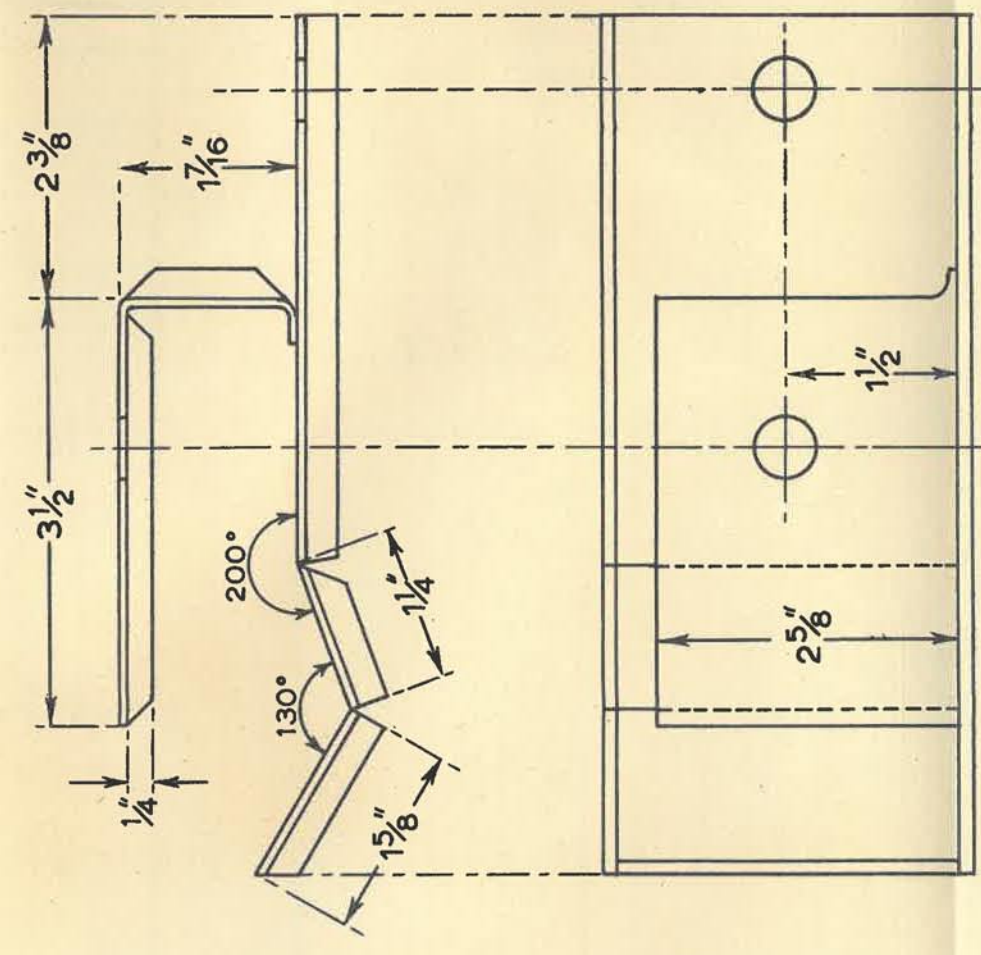

FIG. 9

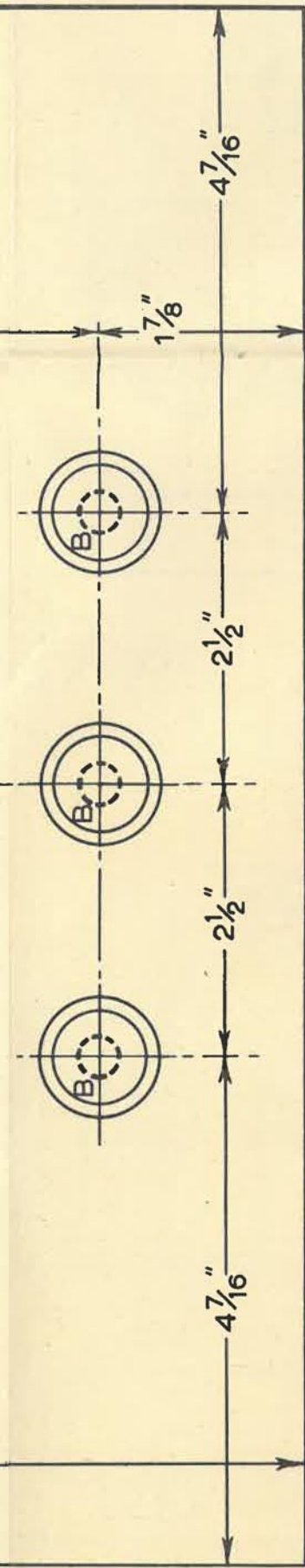

FIG. 10

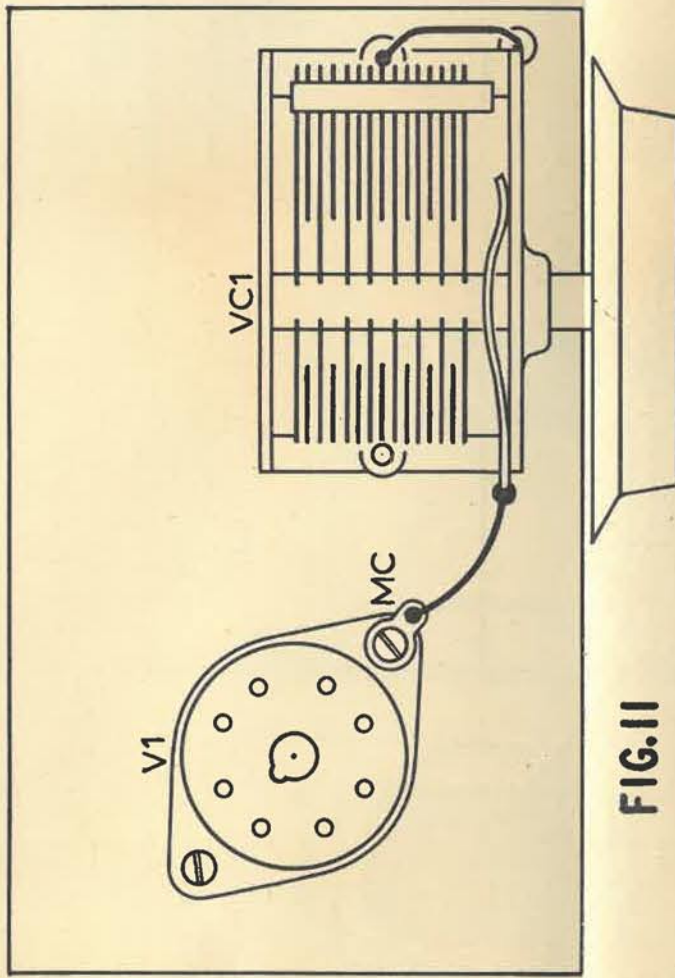

FIG. 11

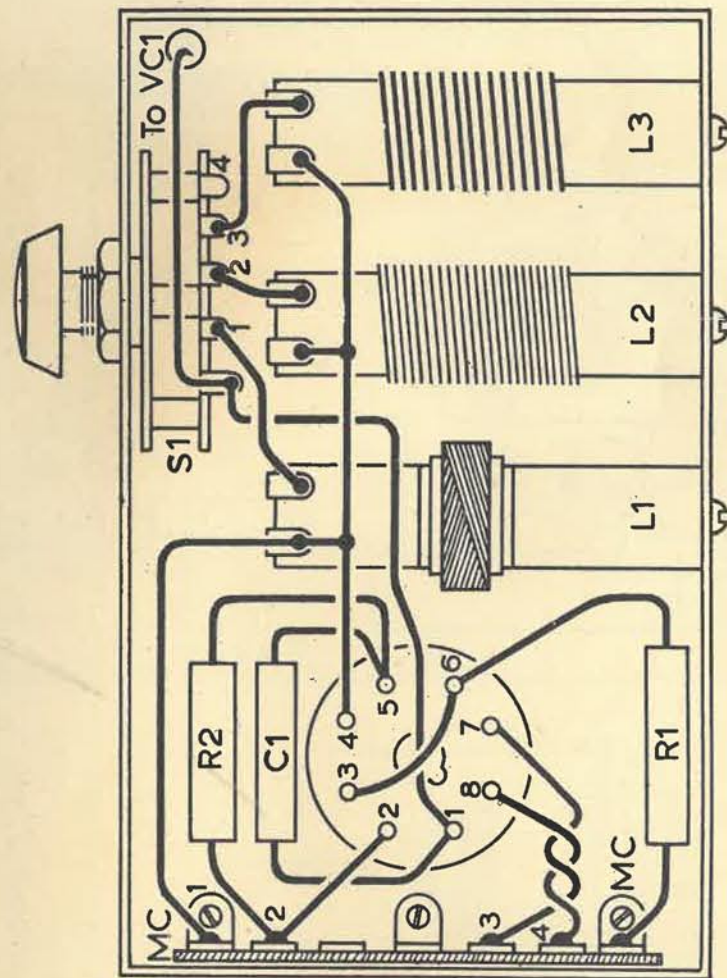

FIG. 13

FIG. 12

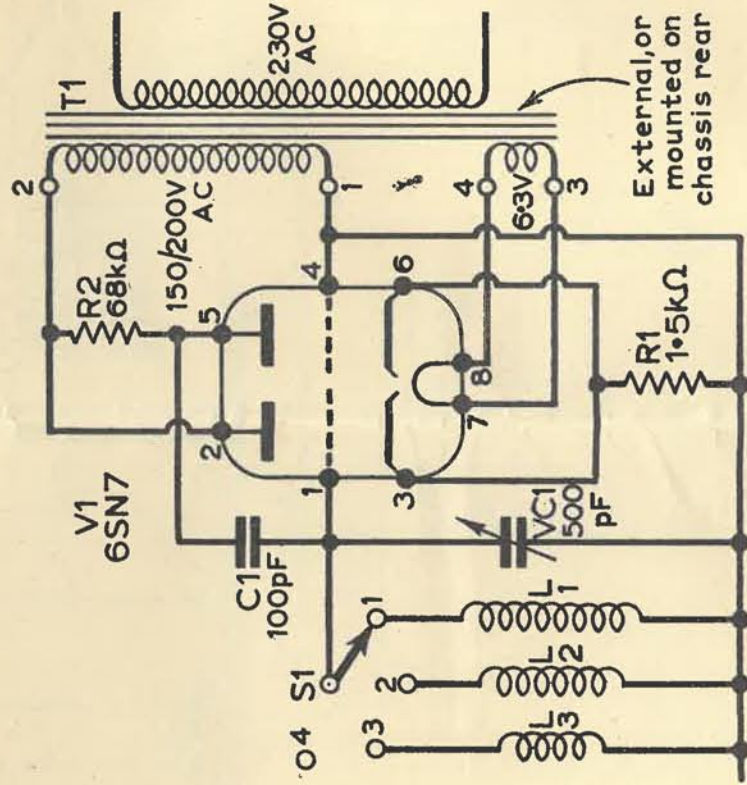
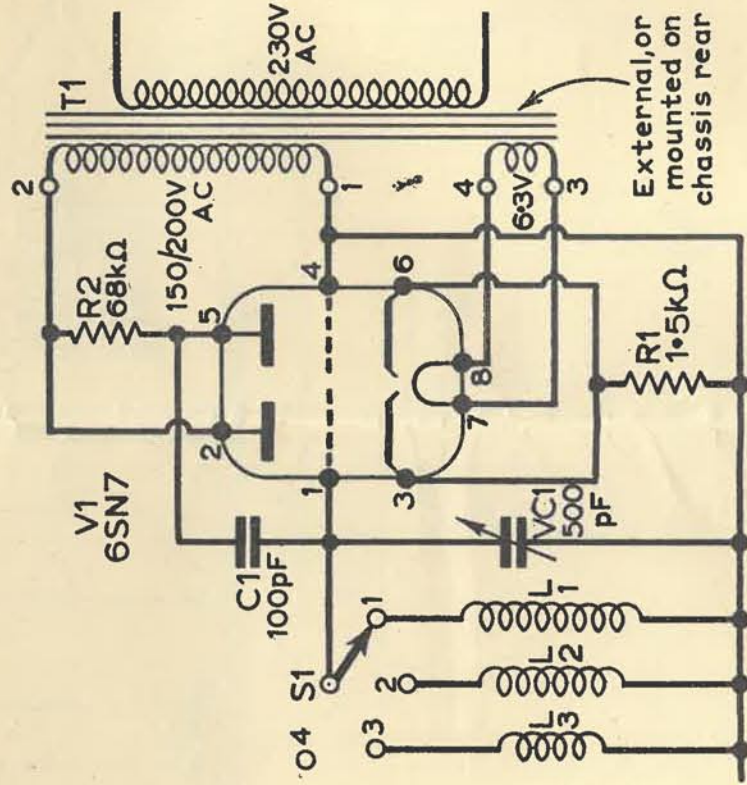

FIG. 14



COMPONENTS LIST

Resistors:

- R1 27kΩ 1W R9 330Ω
- R2 2.2kΩ R10 27kΩ 1W
- R3 330Ω R11 150kΩ
- R4 47kΩ R12 1.5kΩ 1W
- R5 47Ω R13 150kΩ 1W
- R6 27kΩ R14 270kΩ
- R7 47kΩ R15 250Ω 3W w.w.
- R8 2.2kΩ R16 10kΩ
- All ±10% 1/4W carbon unless otherwise stated.
- VR1 500kΩ log. potentiometer.

Inductors:

- T1 Pentode-type output transformer (Wharfedale OP3)
- T2 Mains transformer. Secondaries: 250-0-250V 100mA, 6.3V 3A, 5V 2A.
- IFT1 1-6 Mc/s i.f. transformer (Denco IFT6A)
- IFT2 1-6 Mc/s i.f. transformer (Denco IFT6A)
- L1 Aerial coil (Denco Maxi-Q blue coil, ranges 3, 4, 5—plug-in octal type)
- L2 Oscillator coil (Denco Maxi-Q white coil, ranges 3, 4, 5—plug-in octal type)
- L3 10H 1.f. choke 80—100mA

Capacitors:

- C1 0.01μF 500V
- C2 0.01μF 500V
- C3 0.01μF 500V
- C4 100pF silver mica
- C5 0.01μF 500V
- C6 0.01μF 500V
- C7 0.01μF 500V
- C8 0.01μF 500V
- C9 8μF electrolytic 500V
- C10 250pF silver mica
- C11 0.01μF 500V
- C12 250pF silver mica
- C13 25μF electrolytic 50V
- C14 0.01μF 500V
- C15 25μF electrolytic 50V
- C16, 17 16+16μF elec. 500V
- TC1 50pF trimmer (Jackson C804)
- TC2 50pF trimmer (Jackson C804)
- VC1, VC2 300pF twin-gang variable (Jackson E2)

Miscellaneous:

- S1 D.P. on/off toggle switch, 250V 1A
- Four international octal valveholders—ceramic type. Four international octal valveholders—standard type.
- Universal chassis parts, 7in. x 13in. x 3in. (Home Radio). Top plate (panel) 8in. x 14in. (Home Radio). Side plate (screen) 3in. x 10in. (Home Radio). Full vision dial (Stratton). Flexible coupler (Stratton). Two 1/4in. brass couplings. Two 1/4in. spindle bushes. Four 7-way tag strips—3 ways earthed (Home Radio). Three 1/4in. knobs. Two chrome handles. One jack plug (Bulgin P38). One I.O. top-grid cap. Two octal plugs. Loudspeaker. Three 1/4in. rubber grommets. 4 B.A. nuts, bolts, solder tags, wire, etc.

Sockets:

- SK1 Coaxial socket
- SK2 International octal valveholder (standard type)
- SK3 International octal valveholder (standard type)
- J1 Closed-circuit jack socket (Bulgin J12)

Valves:

- V1 6K8
- V2 6SK7
- V3 6J5GT
- V4 6J5GT
- V5 6V6G
- V6 5Z4

COMPONENTS LIST FOR ALIGNMENT OSCILLATOR

- V1 6SN7
- R1 1.5kΩ 1W R2 68kΩ 1W
- VC1 500pF variable capacitor (Jackson E1)
- C1 100pF silver mica
- S1 Single-pole, 4-way rotary switch
- T1 Mains transformer. Secondaries: 200V 20mA, 6.3V 1A.
- L1 2, 3 See text
- One I.O. valveholder. Knobs, dial, etc.

A NEW RECEIVER FOR THE S.W.L.

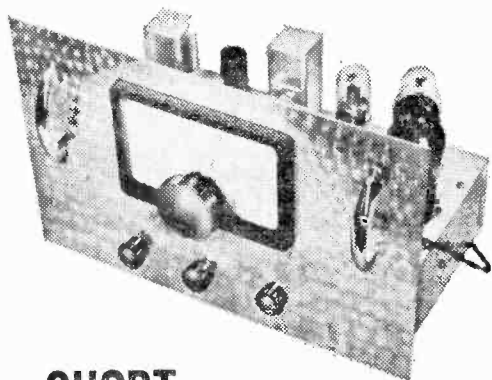

SHORT- WAVE SUPERHET and simple Alignment Oscillator

by H. Webster

MANY constructors make their introduction to short wave radio either by way of the familiar detector and i.f. receiver or alternatively via the t.r.f. receiver in which a stage of radio frequency amplification is interposed between the aerial and the detector stage.

These combinations have long been a favourite with the amateur, and although receivers of this type can be quite sensitive, particularly on the lower frequencies, they suffer from several serious defects. The most important of these are lack of selectivity, blocking by strong signals and the occurrence of dead spots when the aerial is directly coupled to the detector stage. A further, though possibly minor defect, is the element of skill required for the reception of weak signals.

Although the superhet receiver offers greater gain and selectivity, many beginners are deterred by the apparent complexity and the alignment of such a receiver.

It is true that a superhet receiver can be quite complex when one considers multi-tuned stages, automatic volume control systems, noise limiters and the like, in actual fact a good basic superhet

receiver can give an extremely good performance on the short wave ranges. Even without the foregoing items the performance is vastly superior to that of the t.r.f. type of receiver.

The receiver described in this article is intended to bridge the gap between the usual t.r.f. receiver and the more ambitious type of communications receiver. Although the receiver is basically quite simple and devoid of frills it gives an extremely good performance on all wave ranges. Careful attention has been paid to screening and to the use of good quality, low loss components in the receiver. Plug-in coils are used, the slight inconvenience entailed in band changing being outweighed by the gain in efficiency and ease of wiring.

Utilising Denco Maxi-Q coils, ranges 3, 4 and 5, the receiver covers 1.67 — 31.5Mc/s, but the range can be extended to cover the medium and long wave band by the use of the appropriate plug-in coils. Slight modification may be necessary if such coverage is desired. The modifications are quite simple and entail the substitution of C1, C2, C3 with 0.1 μ F capacitors. The appropriate padding capacitors Cp1 and Cp2 are also required in the oscillator section. As an aid to alignment, a simple alignment oscillator is also described.

CIRCUIT DESCRIPTION

The circuit diagram is shown in Fig. 1. The incoming radio frequency signal is fed via the combination of L1, L2, VC1, TC1 to the signal grid of V1 which is a triode hexode frequency changer. The oscillator section of V1 injects a signal whose frequency is determined by L3 and the associated capacitors. This signal is such that it is always higher than the signal frequency by 1.6Mc/s. Mixing of this higher frequency with the signal frequency produces an intermediate frequency of 1.6Mc/s in the anode circuit of V1.

The intermediate frequency transformer i.f.t.1 after rejecting unwanted frequency components produced in the mixing process, passes the i.f. signal to the grid of V2 which is a variable mu pentode. After further amplification by V2 the i.f. signal passes to the grid of V3 which is a medium impedance triode.

The detector V3 is of the so called infinite impedance type in which the load resistance is in the cathode circuit. Since considerable negative current feedback occurs, distortion is reduced to a very low level. At the same time the input impedance is extremely high and little loading of the grid tuned circuit occurs. In other words the selectivity is increased. Because some radio frequency component is invariably present in the output almost complete elimination is affected by C10 and C12. These capacitors have low reactances at radio frequencies and high reactances at audio frequencies. The resulting audio signal is fed via C11 to the volume control VR1 and then on to the grid of the first audio valve V4, which, like the detector valve is a medium impedance triode. V4 is resistance capacity coupled to the output valve V5 which is a beam power tetrode. Provision has been made for headphones by the insertion of a jack socket in the grid circuit of V5. When phones are used the output stage is rendered inoperative.

DESIGN CONSIDERATIONS

The intermediate frequency of 1.6Mc/s was chosen in preference to the more usual value of 470kc/s for two reasons. First, to avoid second channel interference and secondly, to avoid *pulling*. For newcomers to the field an explanation may not be amiss. The first effect arises because there are always two frequencies which when combined with a third frequency, in this case the oscillator frequency, produce the same intermediate frequency. Consider an example in which a receiver has an intermediate frequency of 100kc/s. If the frequency of the incoming signal is 1,000kc/s the oscillator must be tuned to 1,100kc/s in order that the difference or intermediate frequency of 100kc/s may be produced. Consider further a signal of frequency 1,200kc/s. This will again beat with the 1,100kc/s oscillator frequency to produce an i.f. of 100kc/s. Now since the i.f. transformer is tuned to 100kc/s it will accept this i.f. irrespective of the method of origin of this i.f.. In other words the i.f. transformer cannot discriminate between a station on 1,200kc/s and one on 1,000kc/s. The way to eliminate this so-called second channel interference is by adequate pre-selection ahead of the mixer stage. When one considers frequencies of the order of 5—30Mc/s this interference can be very troublesome, particularly when the i.f. is only a small fraction of the signal frequency. With an i.f. of 470kc/s at least two stages ahead of the mixer are required to give reasonable second channel rejection. An i.f. of 1.6Mc/s considerably reduces this interference and even without a tuned r.f. stage the effect only begins to show up at round about 20Mc/s. However, like all good things, this virtue must be paid for in other ways. As the i.f. is raised the selectivity and gain decrease. Although this loss can be compensated by further i.f. stages this would add unnecessary complication to the basic receiver. The selectivity and gain of the receiver described in this article were improved in two ways. First, by the selection of an infinite impedance detector and secondly by the introduction of regeneration in the i.f. stage. Regeneration is effected by loose coupling between the anode and grid of the i.f. stage pentode. The stability of the receiver is such that excellent control of regeneration can be made by this simple expedient.

The second effect is known as *pulling*. This effect is due to changes in oscillator frequency caused by the signal frequency. *Pulling* is caused by coupling of the input and the oscillator by means other than the ideal of pure electronic coupling in the mixer. The phenomenon can be alleviated by the use of a high i.f. and by adequate screening of the mixer and oscillator stages. These foregoing effects have been reduced to a minimum in the receiver by careful attention to screening and component layout.

Although a double triode such as the 6SN7 could have been used in place of the two separate triodes used in the detector and first audio stages, it was felt that the slight decrease in cost of the 6SN7 was hardly warranted by the increased complexity of wiring. The author offers no apologies for using the international octal series of valves in preference to miniature types. These valves were chosen because of their availability and cheapness.

At the same time they are robust and the comparatively large valve holders lend themselves to simplified wiring.

The power pack has been chosen for multi-purpose application since it was felt that the experimenter would have other uses for this unit. The cost of separate power units for each receiver and instrument that the experimenter is likely to use can be quite considerable and is, in many cases, needless duplication. The unit described in this article has a nominal output of 250V at 100mA which is in excess of that required by the receiver. The large reserve of power results in "cold running" of the power unit. A further advantage is that the excess current can be usefully employed if additional units such as converters are used with the receiver.

Considerable latitude is permissible in the choice of transformer for the power unit. Provided the transformer delivers 60—70mA at 250V this will be adequate for the needs of the set. However, if additional units are envisaged for use with the set, it would be wise to choose a transformer with a more generous rating.

It will be noted that a specific list of parts for the receiver proper has been made. Considerable thought went into the design and layout of the receiver and the author feels that adherence to this specified list is essential, particularly to the beginner in the field. The use of dubious surplus capacitors and resistors is to be deprecated.

A good dial drive is essential for tuning on the short wave bands. Many inferior drives suffer from backlash, their reset stability being poor. For this reason an Eddystone slow motion dial was chosen. The dial has five ranges in addition to the 0—100° scale and can be calibrated by the individual constructor.

The importance of the mechanical side of a receiver such as this cannot be stressed too highly. The chassis, screens and panel must be rigid to avoid undesirable capacitive changes. These changes can affect the frequency stability of the receiver. Attention to this aspect of receiver construction will be well repaid by a stable, good looking job. It is the author's experience that many constructors, somewhat understandably, tend to neglect the purely mechanical side of construction.

Two under chassis screens bolted together in a composite unit are used in the receiver. Apart from screening the oscillator and aerial sections they also serve as mounting brackets for the volume control and aerial trimmer. In addition a degree of rigidity is given to the chassis.

A word concerning alignment of a superhet may not be amiss at this point. The alignment of a superhet has probably deterred and disappointed so many constructors that either they have given up the attempt or have been unduly critical of the superhet. Generally, such constructors have been unable to avail themselves of the services of a signal generator. Now while it is possible to align a superhet receiver by trial and error the process is extremely tedious, particularly with a new receiver where the inductances are often well away from their required values. Even after such an alignment procedure the constructor is left with the thought that the receiver could be improved upon. In other words a considerable element of

doubt exists. The time taken up in such an attempt can often be spent more profitably in the construction of a signal source. Such a source need not be complex and for these reasons the construction of a single valve oscillator is described for the benefit of constructors without such an aid.

CONSTRUCTIONAL DETAILS—RECEIVER

The receiver is mounted on a universal 7in. x 13in. x 3in. chassis. The relevant dimensions and drilling details are given in Figs. 3, 8, 9 and 10. Note that the top panel supplied with the chassis is slightly less than the nominal 7in. x 13in. In the case of the author's receiver the actual size was 6 $\frac{1}{2}$ in. x 12 $\frac{1}{2}$ in. The drilling is best performed with the chassis unassembled. No mounting points for the twin gang capacitor have been indicated because it is easier to mount this unit when the panel and dial have been assembled.

The next stage is the marking out and drilling of the front panel. This panel is a nominal 9in. x 14in. chassis top plate. The actual dimensions are 8 $\frac{1}{2}$ in. x 13 $\frac{1}{2}$ in. On completion of the panel the dial and associated epicyclic drive are temporarily bolted to the panel. The chassis is then assembled and the panel and drive offered up to the chassis. The three holes in the panel should coincide with the three holes in the chassis front plate. Slight reaming of the holes may be necessary if the drilling has not been too accurate. Note that a slight overlap of the front panel occurs between the base and sides of the chassis. The height of the dial centre spindle above the chassis top should now be carefully measured. Two brackets to support the gang capacitor are then constructed as shown in Fig. 3. The mounting holes are slightly larger than the nominal 4BA clearance to allow some measure of flexibility in the final alignment of the gang capacitor shaft and the dial spindle. The two brackets are then bolted to the gang capacitor and a flexible coupler inserted on the shaft.

The length of the capacitor shaft should be $\frac{1}{2}$ in. If the shaft is longer than $\frac{1}{2}$ in., the excess should be removed. Great care is essential during this operation. It is recommended that the end of the shaft be held in a vice and gang capacitor covered with a cloth.

The gang capacitor with attached brackets is then offered up to the dial spindle making sure that the shaft is in exact alignment with the dial spindle. The chassis is then marked by inserting a sharp-pointed tool through the bracket base holes. The gang capacitor unit is then removed and the chassis drilled at the points indicated. The front panel may now be removed from the chassis.

UNDERCHASSIS SCREENING

The main chassis screen is constructed from a 3in. x 10in. chassis side plate. Cut away 2 $\frac{1}{2}$ in. and cut and bend the remaining piece to the shape shown in Fig. 9. The subsidiary screen is constructed from a 2 $\frac{1}{2}$ in. x 5in. piece of aluminium. Although it is possible by prior measurement to mark out the holes for the aerial trimmer capacitor TC1 and volume control VR1 the method calls for great accuracy. A better method utilises the following dodge. The main and subsidiary screens

are bolted together making sure that the bottom flanges sit neatly on a flat surface. The unit is then bolted to the chassis. Two spindle bushes are then inserted in the holes in the chassis front plate. The holding nuts are tightened and a 6in. length of $\frac{1}{8}$ in. diameter rod inserted through one of the bushes. A smear of paint is placed on the end of the rod which is then eased gently through the bush until the painted end makes contact with the screen. The process is repeated for the other hole. The screen unit is removed from the chassis and drilled in the positions indicated by the paint spots. Although the process of construction may appear tedious, care spent at this stage of the work is well worth while.

GENERAL ASSEMBLY AND WIRING OF RECEIVER

Wiring of the receiver is facilitated by working with the chassis dismantled. Remove the chassis top plate and bolt the screen in its original position. The valve holders are mounted noting that the holders for V1 and V2 are of the ceramic type. The remainder are standard moulded amphenol type. Before mounting the coil holders

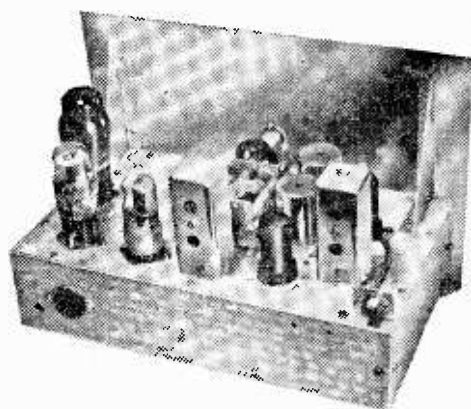

A rear view of the finished receiver.

in position the lids supplied with the coil screens are cut to the dimensions shown in Fig. 6a. The slots in the lids are best cut with a single edged razor blade. The gauge of metal is sufficiently thin to allow this procedure to be adopted. This method gives a neater hole than that obtained by punching or shearing. Two lids are required and are held in position by the valve holders. The author found that distortion of the lids was avoided if the ceramic holders were dismantled before fixing.

Solder tags are placed under the fixing bolts of each valve and coil holder. Note that a tag is placed on the fixing bolt of each coil holder above the chassis and near to the gang capacitor. It is important that the holders are mounted correctly orientated with the locating holes in the correct positions.

The intermediate frequency transformers are then mounted, ensuring that the access holes to the iron cores face to the rear of the chassis. This is important when the alignment process is carried out. The tag strips are then mounted. Four tag

strips are required, noting that two small strips are mounted, one adjacent to the oscillator coil holder, the other adjacent to V1 holder. The two small tag strips are obtained by removing the appropriate amount from 7-way strips.

The volume control and aerial trimming capacitor TC1 are mounted on the screening unit. Wiring of the receiver can now commence. Run the heater wiring round the perimeter of the base to minimise hum and interaction with other parts of the circuit. Note that the correct method of heater wiring is shown in Fig. 4. The remainder of the wiring is quite straightforward and no difficulties should be experienced. Wherever possible, short, stiff wiring should be employed, particularly in the signal frequency and oscillator sections. When the main wiring on the chassis plate is completed there remains the wiring of the oscillator trimmer TC2, output transformer T1, power input socket, phone jack and gang capacitor VC1/VC2.

The chassis side members are attached followed by the panel. Two spindle bushes for the volume control and aerial trimmer are screwed in position and the oscillator trimmer inserted in the remaining hole. Two wires are soldered to the tags on the gang capacitor stators and after bolting it to the chassis, are passed through the holes in the chassis. The two wires are then soldered to their appropriate points on the coil holders.

The frame of the gang capacitor is earthed by two heavy wires, outer braiding from screened cable being suitable. The two leads are taken to the fixing tags on the coil holders as shown in Fig. 3. Ensure that the dial movement is free and rotates smoothly over the entire range of travel. As a point of interest the gang capacitor is mounted on its side to facilitate coil changing.

GENERAL DETAILS OF COILS USED IN RECEIVER

The well known range of Denco "Maxi Q" plug-in coils is used in the receiver. Note that the blue type coils are used in the aerial section while the white type coils are used in the oscillator section. Automatic selection of the appropriate padding capacitors Cp1—Cp5 is made when the oscillator coil for a given range is plugged into the octal holder. To avoid confusion on the theoretical (Fig. 1) and main wiring diagram (Fig. 4) only one padding capacitor (Cp) has been indicated. This has been shown connected to pin 6 on L3/L4 coil holder. In fact, Cp5 will be wired in this position and the diagram below shows all the padding capacitors fitted. Cp1 and Cp2 may be ignored if long and medium wave reception is not contemplated. The underside pin connections for the aerial and oscillator coils for the various ranges are given below.

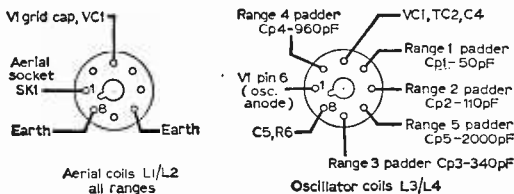

To avoid confusion the Denco range numbers for the various ranges in the receiver have been retained. For example, Range 3 1.67—5.3Mc/s. Range 4 5.0—15Mc/s. Range 5 10—31.5Mc/s.

The remainder of the wiring is now completed as shown in Fig. 4.

Now that the wiring of the receiver is complete a check on the receiver is made. A careful examination of the wiring against Fig. 4 should be made and any obvious mistakes remedied. Using a multi-range meter the resistance between the h.t. line and earth is measured. A reading of approximately 300kΩ should be obtained. Initially a somewhat lower reading will be observed due to the charging up of C9. After a short time the resistance will rise to the steady value indicated previously.

POWER UNIT

The author's unit was built on a 7in. x 4in. x 3in. aluminium chassis. Since it was felt that many constructors would possess a mains transformer or suitable power unit no hard and fast rules have been laid down for the construction of this unit. Provided the unit delivers 200—250V at 60—100mA, this is adequate for the needs of the set. A wiring diagram is given in Fig. 5. Power from the unit is taken from an octal socket mounted adjacent to the rectifier.

VOLTAGE CHECK ON RECEIVER

The loudspeaker is connected and a set of coils inserted in their sockets. The power unit is plugged into the octal socket at the rear of the receiver. When the unit is switched on any obvious signs of overheating should be noted; the power switched off and the fault remedied. With the receiver working correctly the following voltage readings should be obtained. The author used a 10,000Ω/V meter set to the 1,000V range for h.t. measurements and the 10V range for bias voltage measurements. With a less sensitive instrument lower readings will be obtained.

Valve	Anode	Screen	Cathode	H.T. line
V1	Hexode	100	3.7	220 V
	Triode			
	100			
V2	205	105	3.5	
V3	210	—	—	
V4	55	—	1.6	
V5	200	220	10.0	

ALIGNMENT PROCEDURE

The following notes are given for the benefit of constructors who have access to a signal generator. Insert a set of coils for the 1.67—5.3Mc/s range, noting that the blue coil is inserted in the aerial coil holder and the white coil in the oscillator coil holder. Connect the signal generator lead via a 0.1μF capacitor to the top grid cap of V1. Inject a modulated 1.6Mc/s signal and peak the cores of the i.f. transformers, starting with i.f.t.2. Gradually reduce the generator signal as the circuits come into line. This completes i.f. alignment.

Set the receiver dial to 100 and adjust the aerial and oscillator trimmers to approximately one third capacity. Inject a 1.67Mc/s signal via the top grid cap of V1 and peak the oscillator core until maximum response is obtained. Set the receiver dial to 0 and inject a 5.3Mc/s signal. Peak the oscillator trimmer on this signal. Repeat this procedure until no further adjustment is required.

Remove the coupling lead from V1 and inject a 1.835Mc/s signal via a dummy aerial or 400Ω resistor into the aerial socket. Set the receiver dial to 100 and slowly tune to the high frequency end of the band. The signal should be picked up at a dial reading of approximately 87. Peak the core of the aerial coil on this signal. Inject a signal of 4.5Mc/s and tune the receiver to this signal. (Dial approximately 9.) Peak the aerial trimmer on this signal. Repeat the process until no further adjustment is required. A check on the tracking can now be carried out. Inject a signal of 2.64Mc/s and tune the receiver to this signal. Tracking is satisfactory if no further increase in signal strength is obtained.

Range 4 (5—15Mc/s) and Range 5 (10.5—31.5Mc/s) can be aligned in a similar fashion. The alignment frequencies for these two ranges are given in the accompanying table.

Comprehensive details of these coils are given in the Denco Technical Bulletin DTB1.

Alignment points. Ranges 4 and 5

Range	Oscillator		Aerial		
	Cores Mc/s	Trimmer Mc/s	Cores Mc/s	Trimmer Mc/s	Tracking check Mc/s
4	5.0	15.0	5.5	13.5	7.93
5	10.5	31.5	11.55	16.65	28.36

When alignment is complete regeneration can be introduced into the i.f. amplifier in the following manner. Solder a short length of wire to the anode pin of V2 (pin 8). A 1in. length is ample. Slowly bend the wire towards the grid pin (pin 4). This capacitor is indicated by Cs in Fig. 1. The point at which oscillation commences is easily heard as a sudden increase in signal hiss. Reduce the coupling slightly until stable conditions are obtained. A useful increase in selectivity and sensitivity is obtained by this method.

ALIGNMENT OSCILLATOR

The oscillator used for alignment of the beginner's short wave superhet comprises a double triode valve arranged in a simple feedback circuit. Feedback from one triode section is fed back in the correct phase to the other triode section. The circuit diagram is shown in Fig. 14. This particular method of feedback permits the use of a two terminal coil in the grid circuit. The necessity for tapping or separate feedback coils is thus avoided. To avoid the complication of a modulating section the anodes of the double triode are fed with raw a.c. The 50c/s modulation was found to be very effective and no difficulty has been experienced in identification of the signal. A small transformer capable of supplying 150-200V a.c. for the anodes

and 6.3V for the heater is adequate. Only a small current is demanded by the instrument.

Three ranges are covered by the instrument, 700—2,000kc/s, 1.8—5.8Mc/s and 5—15Mc/s. These three ranges are sufficient for alignment of the receiver. The range of the oscillator can be extended either way if a fuller coverage is desired.

The oscillator is constructed on a small aluminium chassis 5in. x 3in. x 2½in. The coils, switch and associated capacitors and resistors are mounted below chassis while the variable capacitor is mounted above chassis. The wiring of the oscillator is not critical. A diagram of the prototype is given in Figs. 11 and 13.

The inductances for the three ranges were wound on ½in. diameter formers, the relevant winding details being given in the accompanying table.

L1	700 to 2000kc/s	105 turns, pile wound to occupy a length of ½in.
L2	1.8 to 5.8 Mc/s.	50 turns, close wound, length ¾in.
L3	5.0 to 15 Mc/s.	19 turns, spaced to occupy 1in.

All coils wound with 28s.w.g. enamelled wire on ½in. diameter formers.

THE DIAL DRIVE

A direct drive dial calibrated from 0—100 was used in the prototype. The accuracy of this dial was found to be more than adequate for alignment purposes.

CALIBRATION OF OSCILLATOR

Range 1. For the calibration of this range a domestic receiver covering the medium wave band is required. Switch on the oscillator and allow a few minutes to elapse so that steady running conditions may be attained. Tune the domestic receiver to the medium wave band and select a station of known frequency near to 700kc/s. The BBC North programme on 962kc/s is suitable. Place the generator near the receiver and slowly rotate the generator dial until zero beat is obtained. By adjusting the coupling between the oscillator and receiver the zero point can easily be obtained by observing the throbbing note which slowly falls in frequency as the null point is neared. Note the generator dial setting and the frequency of the station. Repeat this procedure with other

frequencies until the remainder of the medium wave band down to about 1,550kc/s is covered. In this way a complete set of readings can be obtained. The generator readings are next plotted against frequency on a sheet of graph paper. A curve will be obtained from which any frequency between 700 and 1,550kc/s can be obtained. For frequencies between 1,550 and 2,000kc/s the line may be extrapolated. Since the plot of frequency against dial readings is a curve the extrapolation procedure is subject to error. A better method for obtaining the 1.6 and 1.67Mc/s points, which are required for receiver alignment, is to plot wavelength against generator dial readings. A straight line is obtained which can be safely extrapolated. The accuracies of the 1.6 and 1.67Mc/s points are more than sufficient for receiver alignment. The relationship between frequency and wavelength is

$$W = \frac{300,000}{f}$$

where W is in metres and f is in kilocycles.

An actual plot obtained by the author is shown in Fig. 7. Note that some points may be slightly off the line. This is caused by several factors of which the most important are observer error and inaccuracies in the variable capacitor. When the points are made on the graph the straight line is drawn to give the best possible fit. The dotted line is the extrapolated portion of the line. From this dotted line are read off 1.6Mc/s, the i.f. and 1.67Mc/s required for range 3 alignment.

ALIGNMENT OF RECEIVER I.F. SECTION

Now that a 1.6Mc/s signal is available the i.f. section may be aligned as described in the receiver construction. Set the generator to 1.6Mc/s and wrap a piece of wire loosely round the top cap of V1. Run this lead near the generator. Coupling may be reduced by shortening the lead. Peak the cores of i.f.t.2 and i.f.t.1 for maximum noise and working with the smallest possible i.f. signal. I.F. alignment is now complete and on no account must the iron cores be disturbed.

ALIGNMENT OF 1.67Mc/s—5.3Mc/s RANGE OF RECEIVER

A set of coils to cover this frequency should have already been plugged in during i.f. alignment. Set the receiver dial to 100 and adjust the aerial and oscillator trimmers to roughly half capacity. From the graph find the generator reading corresponding to 1.67Mc/s (180m). Inject this signal via the top cap of V1 and peak the oscillator for maximum response. From the graph ascertain the generator reading corresponding to 1.325Mc/s (226.4m). Set the generator to this reading and slowly tune the receiver to the h.f. end of the band. Harmonics should be heard at 2.65, 3.975 and 5.3Mc/s. The oscillator trimmer is peaked on the 5.3Mc/s harmonic with the receiver dial at 0. Return to the i.f. end of the band and repeat the process until optimum results are obtained.

The coupling lead is taken from the top cap of V1 and inserted in the aerial socket. The core of the aerial coil is adjusted on a 1.67Mc/s signal

while the aerial trimmer is adjusted on the 5.3Mc/s harmonic of 1.325Mc/s. The exact procedure is as before. This completes the alignment of Range 3. Note the position of the pointer knob of the oscillator trimmer and mark this position on the panel.

A partial calibration of the receiver dial may now be carried out. From the graph determine the 1Mc/s point and inject this signal via the aerial socket. Tune the receiver from the l.f. to the h.f. end of the band. Four peaks corresponding to 2, 3, 4 and 5Mc/s should be heard. From the receiver dial read off the points corresponding to these frequencies. A record of these readings should be retained for future use. The 1.3—5.8Mc/s range of the generator may now be calibrated against range 3 of the receiver.

CALIBRATION OF THE 1.3—5.8Mc/s RANGE OF GENERATOR

Switch the generator to this range and set the receiver dial to the point corresponding to 2Mc/s. Adjust the generator dial until a signal is heard. Repeat for the 3, 4 and 5Mc/s points. This simple calibration is sufficient for alignment of range 4 of the receiver. Note the generator dial reading corresponding to the above points.

ALIGNMENT OF RECEIVER RANGE 4. 5—15Mc/s

The procedure is exactly the same as for that employed on Range 3 except that a 5Mc/s signal is injected for adjustment at the l.f. end of band. The 15Mc/s harmonic of 5Mc/s is used for alignment at the h.f. end of the band. Note that when 5Mc/s is injected peaks will be heard at 5, 10 and 15Mc/s. When alignment is satisfactory note the positions of these frequencies on the receiver dial. The 5—16Mc/s range of the generator may now be calibrated against these three points.

ALIGNMENT OF RECEIVER RANGE 5. 10.5—31.5Mc/s

On this range switch the generator to Range 3. At the l.f. end of band inject a 10Mc/s signal with the receiver dial set to 96°. The h.f. end of the band is peaked on the 30Mc/s harmonic of 15Mc/s with the receiver dial set at 5°. Note that at the h.f. end of this band two peaks will be heard on adjusting the oscillator trimmer. Select the peak requiring least trimmer capacity.

A fuller calibration of the receiver dial may now be carried out. Points for 2, 3, 4 and 5 Mc/s will have already been noted for Range 3. Inject a 1Mc/s signal into the aerial socket and note the positions on the dial at which the harmonics of 1Mc/s are received on Ranges 4 and 5. For example, on Range 4 calibration points at 5—15Mc/s will be obtained separated by 1Mc/s intervals. The points between the 1Mc/s intervals may be obtained as follows:

A glance at Fig. 13-14 will show that a blank position has been left on the switch. A long wave coil is inserted in this position and the coil can be conveniently placed above chassis. The aerial coupling winding on the coil may be ignored. Switch the generator to this range and place a

—continued on page 758

INVERTED V AERIAL

by R. F. Graham

FOR ALL-BAND RECEPTION AND TRANSMISSION
ON 160, 80, 40, 20, 15 AND 10 METRES

THIS aerial can be used for reception only, over the range 10-200 metres (30-1.5kc), or for both receiving and transmitting, on 160, 80, 40, 20, 15 and 10 metre bands. It is particularly intended for locations where only one pole or other high support is available.

The aerial is shown in Fig. 1, and the high anchor point needs to be about 38ft. above ground level. A pole may be secured to a chimney with TV-type lashings, or may be held with strong

pass through the insulators. An insulator is fitted each end.

If cords pass down to ground pegs, a total width of about 76ft. is required. If a building, fence, tree, or other convenient anchor point is available, this reduces the total space necessary for the aerial. Cord or polythene line is used between aerial insulators and anchor points. If the aerial is employed for transmitting, its ends should be out of reach of children.

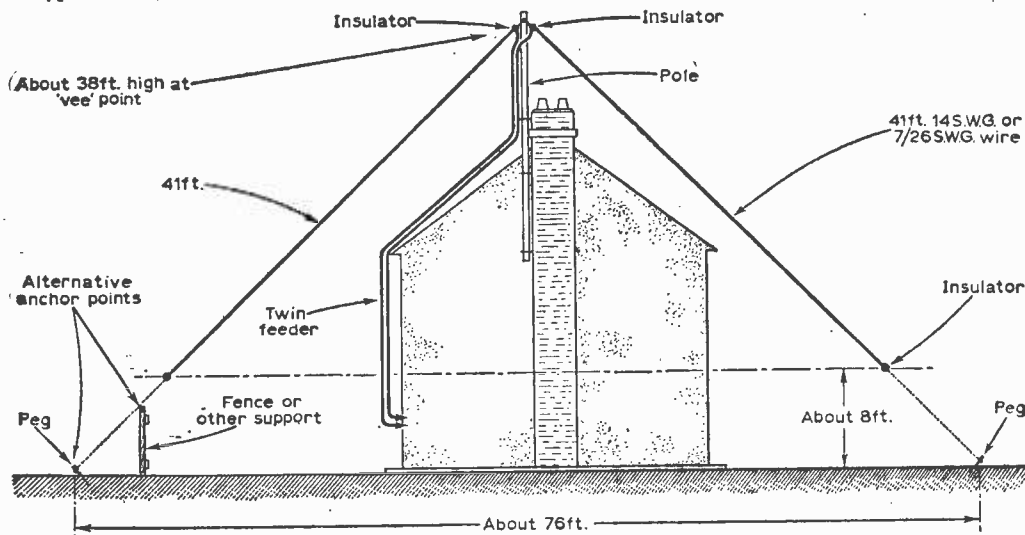

Fig. 1: The construction of the aerial.

brackets, or with spikes securing it in an angle between chimney and house. The aerial wires act as halcyards, helping to prevent sideways movement.

A piece of 2 x 3in. timber, free from knots, makes a good pole. A "ladder pole", available from large timber suppliers, is also inexpensive. If the supporting point is a little under 38ft. high, the lower ends of the aerial can be spread out more, or may be 6 or 7ft. above ground.

Each element of the aerial is 14s.w.g. hard drawn copper wire, or 7/26s.w.g. aerial wire. Each piece is 41½ft., to allow 3in. each end to

The apex of the aerial is most easily raised by threading a long line through an insulator or strong eyebolt at the pole top, before fixing the pole. The aerial can then be hoisted up, when ready.

Feeder

The aerial is designed to operate with an open-wire twin feeder, which has negligible losses at all the frequencies covered. The feeder is made from 7/26s.w.g. aerial wire, with 5in. or 6in. spreaders.

Ceramic spreaders of this kind can be purchased, or spreaders can be cut from insulating material. If the feeder is reasonably taut, one spreader every 4ft. to 5ft. will do.

If the aerial is to be used for reception and transmission on 3.5, 7, and 14Mc/s (80, 40 and 20m) bands only, then 300 ohm flat twin ribbon may be used for the feeder. The efficiency with this type of feeder is less than with an open wire feeder.

Each feeder wire is soldered to one of the 41ft. aerial elements. The open wire feeder should not touch the roof, pole, or walls. An extra insulator or two can be attached to the feeder, with a cord to any suitable point, to keep the feeder in position.

Coupling

There are several different ways in which the twin feeders can be coupled to the receiver or transmitter. The one chosen depends to some extent on the receiver or transmitter, and the purpose in view.

Receiver Dipole Input. Communications type receivers generally have a dipole or twin feeder input. There are then two aerial terminals for this purpose. One feeder wire is taken to each terminal. This method is simple, and can be used on all bands without adjustment. It is often employed with twin feeders, despite the fact that the best impedance match between feeder and receiver (and thus best signal strength) is only obtained on some frequencies.

Receiver Tuner. A tuner allows the aerial to be tuned to resonance, and also provides an impedance match. It thus gives best possible signal strength at all frequencies.

The tuner can be made as described for a transmitter tuner (Fig. 2) except that a wide-space tuning capacitor is not required, for reception. If the receiver has a 75Ω or similar aerial input, it is best to use a piece of 75Ω co-axial cable between tuner and receiver, with a coupling loop exactly as described for transmitting.

Some receivers have an input for 300-600Ω. If so, signal strength is improved by taking the receiver feeder to a tapping some turns out from the coil centre tap.

With a receiver tuner, the tuner variable capacitor is adjusted for best signal strength, as shown by the tuning meter, signal strength meter, or by maximum volume. The increase in signal strength obtained from the tuner will be important, on those frequencies where a bad impedance match would otherwise exist between feeder and receiver.

Transmitter Pi-Output. Twin feeder systems are sometimes operated directly from a transmitter pi-output circuit, one feeder wire being earthed at the transmitter. This method can be used when the feeder impedance falls within the range of impedances to which the transmitter output circuit can be adjusted.

In this case, the transmitter is loaded up into the aerial in exactly the same way as if an end-fed wire were in use.

Transmitter Tuner. This is the most satisfactory way of all-band operation, and the same tuner may be used for both receiver and transmitter. A suitable tuner circuit is shown in Fig. 2. The variable capacitor needs to have spacing about equal to that in the anode circuit of the transmitter P.A., to avoid sparking over.

A coil for 10-80 meters can be made by winding 26 turns of 18s.w.g. wire on a 2½in. diameter or similar former, turns being spaced to occupy about 3in. in all. The loop can be 3 turns of well insulated wire, over the centre of the 26 turn coil.

Any convenient length of 75Ω co-axial cable passes from the tuner to the transmitter pi-output socket.

In use, taps Y-Y are clipped on the coil at equal distances from the centre tap, to obtain resonance on the required band. This is most easily done by observing signal strength on the receiver, while tuning to some transmission in the required band. Clips X-X are placed at equal distances from the centre tap, until the transmitter can be loaded to the required input.

If a dipole or Zepp tuner is to hand, this may be used instead, with series tuning for low feeder impedances, and parallel tuning for high feeder impedances. The tuner is best housed in a case near the receiver or transmitter, so that it can be adjusted as required.

During tests, the aerial was found to give good results, for both receiving and transmitting. This was also so on Top Band (160m) where the performance exceeded that expected. ■

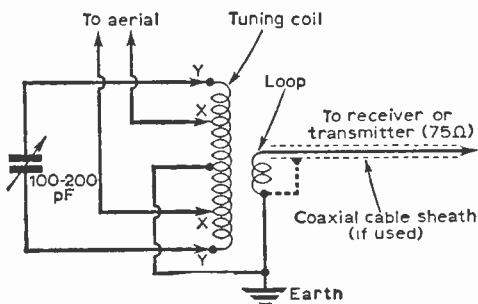

Fig. 2: The method of coupling a twin feeder.

DON'T FORGET YOUR

PTV

PRACTICAL TELEVISION

every month, 2s.

PREPARING FOR THE R.A.E.

BRIAN ROBINSON.

2: PERMANENT MAGNETS, ELECTROMAGNETS, INDUCTANCE AND CAPACITANCE

2.1 Permanent Magnets

THIS type of magnet retains its magnetism and is generally made of steel (modern magnets may be made of alloys such as Alnico, a combination of aluminium and nickel). The main uses of permanent magnets in radio work are in loudspeakers and moving coil meters. Magnets have a *North* and *South* pole and the magnetic field associated with a bar magnet takes the form of "lines of force". The magnetic field associated with a bar magnet is shown in Fig. 10 and that associated with a *North* and *South* pole in opposition is shown in Fig. 11.

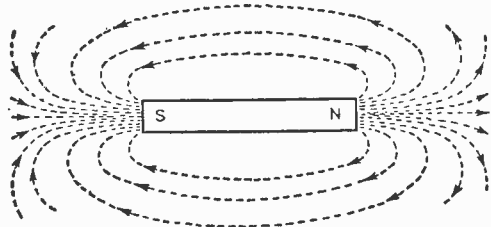

Fig. 10: Magnetic lines of force around a bar magnet.

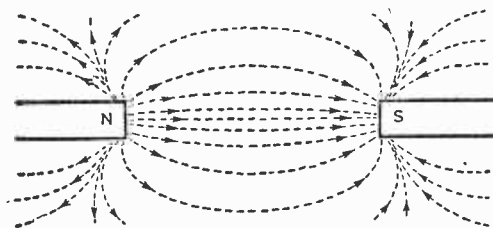

Fig. 10: Lines of force associated with a North and South pole in opposition.

2.2 The Loudspeakers

When a conductor such as a copper wire or coil is suspended between the poles of a magnet and a current is passed through the coil the coil will move. This principle is used in the loudspeakers. A coil is held between the poles of a magnet and is made to move or vibrate by passing a varying current through the coil. This varying current takes the form of speech or music in the form of

electrical impulses. The coil is connected to a paper cone which also vibrates and produces audible sounds.

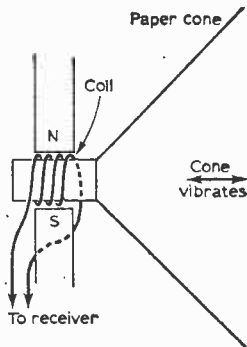

Fig. 12: In a loudspeaker, a paper cone is connected to a coil suspended between the poles of a magnet.

2.3 The Moving Coil Meter

This also uses the same principle as the loudspeaker. A constant current is, however, passed through the coil, which is connected to a pointer, and an indication is given which is proportional to the strength of the current. Moving coil meters can only be used to measure d.c. current but voltages can be measured by connecting a resistance in series with the meter. The formula used to convert a milliammeter into a voltmeter is:

$$R = \frac{E \times 1000}{I} - R_m$$

Where R is the desired series resistance E is the

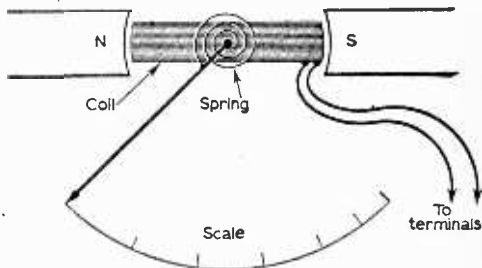

Fig. 13: The basic arrangement of the component parts of a moving coil meter.

desired full-scale reading of the voltmeter, I is the current drawn by the meter (in milliamps) and R is the resistance of the meter. A circuit and typical values are given in Fig. 14.

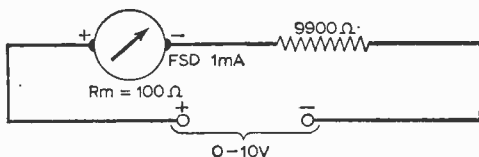
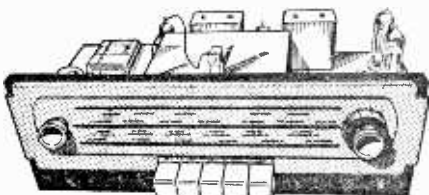
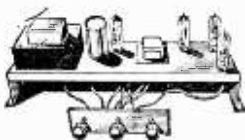

Fig. 14: A circuit for making voltage measurements.

BRAND NEW AM/FM (V.H.F.) RADIO GRAM CHASSIS AT £13.13.0 (Carriage Paid)



Chassis size 15 x 6 1/2 x 5 1/2 in. high. New manufacture. Dims 14 1/2 x 4 in. in 2 colours, predominantly gold, 200-250v. A.C. only. Pick-up, Ext. Speaker, Ae. E., and Dipole sockets. Five push buttons—OFF, L.W. M.W. F.M. and Gram. Aligned and tested. O.P. Transformer. Tone Control, 1000-1900 M.; 300-650 M.; 88-96 Mc/s. Valves E280 rec.; ECH81, EF90, EAB80, EL84, ECC83, ECC85. 10 x 6 in. ELLIPTICAL SPEAKER 25/- to purchasers of this chassis. TERMS: (Chassis) £3.10.0 down and 6 monthly payments of £2.4.0. Cheap Room Dipole for V.H.F., 12/6. Feeder 6d. per yard. ALTERNATIVE DESIGN, L.W. 1000-1900 M.; S.W. 19-15 Mc/s; M.W. 100-75 M.; V.H.F. 87-100 Mc/s. Gram position. Otherwise similar to above chassis. Price £15.15.0 (carr. paid). TERMS: £3.10.0 down and 6 monthly payments of £2.4.0. Circuit diagram 2/6.



PUSH-PULL O.P. AMPLIFIER £5.5.0

(6/- Carr.)
Brand new 200-240 A.C. mains Bass, treble and vol. controls, with valves E280, ECC83 and 2-EL84 giving full 8 w. Chassis 12 x 3 1/2 x 3 1/2 in. With o.p. trans for 2-3 ohm speaker. Front panel (normally screwed to chassis) may be removed and used as "flying panel".

(normally screwed to chassis) may be removed and used as "flying panel".

LAFAYETTE BRAND TAP

FULLY GUARANTEED AT RECORD LOW PRICES

MYLAR BASE		P.V.C. BASE	
5in. Double play, 1,200 ft.	15/-	5in. Standard play, 600ft.	8/6
5in. Double play, 1,800ft.	22/6	5in. Standard play, 850ft.	11/6
7in. Stand. play, 1,200ft.	12/6	ACETATE BASE	
7in. Long play, 1,800ft.	18/6	5in. Stand. play, 600ft.	8/-
7in. Double play, 2,400ft.	25/6	5in. Long play, 900ft.	10/-
		5 1/2 in. Long play, 1,200ft.	12/6
		7in. Long play, 1,800ft.	15/-
		MESSAGE TAPES	
TRIPLE PLAY		3in. Stand., 150ft.	3/6
3in. 450ft.	12/6	3in. Long Play, 225ft.	4/11
5in. 900ft.	22/6	5in. Double Play 500ft.	7/6
5in. 1,800ft.	42/6	7in. Triple, 600ft.	14/-
5in. 2,400ft.	55/-		
7in. 3,600ft. (Unboxed)	75/-		

P. & P. 1/- extra per reel; 4 reels and over Post Free

SELF-POWERED VHF TUNER CHASSIS Covering 88-95 Mc/s. Millard permeability tuner. Dims 8 x 6 x 6 in. high. Valves ECC85 and 2-EP89's plus 2 diodes with E280 rectifier. Mains transformer. Fully wired and tested ONLY £8.17.6 (carr. paid). Room dipole 12/6. Feeder 6d. per yard.

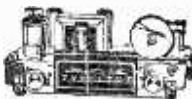

6-TRANSISTOR PORTABLE — Fully Built

The "SCALA" for only £7.10.6 carr. paid. 8 1/2 x 2 x 5 1/2 in. high. Choice of colours. Rexine. M.W. and L.W. Ferrite aerial Battery 2/9 extra. Printed circuit. Nicely styled. A professional job 3 1/2 in. speaker. Fully tunable M.W. and L.W. Superhet circuit.



BATTERY ELIMINATOR
For 4 Low Consumption Valves (96 range) 90v. 15 mA and 1.4v. 125mA 42/6 (4/- post). 200-250v. A.C. Also for 250mA 1.4 v. and 90v. 12mA at same price. Two separate units to replace existing batteries, 4 x 2 1/2 x 2 1/2 in. and 3 x 2 1/2 x 1 1/2 in.

ALL ITEMS ARE NEW AND FULLY BUILT UNLESS OTHERWISE STATED. TESTED BEFORE DESPATCH. Delivery by return. Terms available on items over £5. Send 6d. (stamps will do) for 20 page illustrated catalogue. C.O.D. 2/- extra. ALL ITEMS GUARANTEED 12 MONTHS. VALVES 3 MONTHS. Reprint overseas orders cannot be executed.

GLADSTONE RADIO

NOTE NEW ADDRESS—
66 ELMS ROAD, ALDERSHOT, Hants. (CLOSED W.I.D.)
(2 mins. from Station and Buses). Aldershot 22240

"REALISTIC" SEVEN



7 Transistor Superhet. 350 Milliwatt output. 4-inch speaker. All components mounted on a single printed circuit board size 5 1/2 x 5 1/2 in. in one complete assembly. Plastic cabinet, with carrying handle size 7 x 10 x 3 1/2 in. External socket for car aerial. Ferrite rod aerial. Price for the complete parcel including Transistors, Cabinet, Speaker etc. and full construction Data: **£5.19.6** P. & P. 4/6.

PP3 Battery 2/9. Data and instructions separately 2/6. Refunded if you purchase the parcel. Any parts supplied separately.

4 TRANSISTOR MINIATURE PUSH-PULL AUDIO AMPLIFIER HIGH IMPEDANCE

PRINTED CIRCUIT. 4in. x 2 1/2 in. x 1 1/2 in. over transformers. Output for 3-ohm speaker. Suitable for microphone, record player guitar and intercom. 9 volt battery required. Frequency range 100 cps. to 25 Kcps. Push-pull output class B. Instruction sheet provided. Fully wired ready for use. Two types: 200 mw. 25/6. 1 watt. 11/- P. & P. 2/6.

SINGLE RECORD PLAYER USING EMI DECK AND PICK UP

4 speed, 200-240v A.C. Valves, rectifier and ECL82. Cab. size 12 x 11 1/2 x 5 1/2 in. attrac. coloured imitation leather finish. Takes 7" & 10" records. £7.19.6 carr. paid.



ALTERNATIVE TYPE OF SINGLE RECORD PLAYER available using BSR GUT motor and pick up on one plate. Valves 1Y80 and 1X152. Cab. size 13 1/2 x 13 x 5 1/2 in. red or blue rexine. Takes 7 in., 10 in. & 12 in. records Price £8.0.6. carr. paid.

PROTECT AGAINST FIRE. AUTOMATIC FIRE ALARM



Sounds siren when air temperature reaches 125°F. Measures 6 x 2 1/2 x 1 1/2 in. Only 27/6. (Post 2/-). Or in Kit Form with calibrated Bi-metal contacts 22/6. (Post 2/-).

2 1/2 WATT AMPLIFIER
Our price ONLY 58/- (post 5/-): a few hundred only: valves EF91 and ECL82 with metal rectifier: 6 x 4 x 1 1/2 in. high (6in. over ECL82). Mains trans. and o.p. with vol. and tone controls: on-off; co-ax. input.

GRAMOPHONE AMPLIFIERS AND PLAYERS

11 watt type. With 6in. x 4in. speaker. Raffle 13 1/2 x 7 1/2 in. 204-240v. A.C. ECL82 and Rectifier. Tone and Volume On/off switch. Two knobs. Ready to play. 49/6, post 5/-.
4 watt type. Valves UY85, UF80 and UL84. 200-240v. A.C. Covered baffle 13 1/2 x 7 1/2 in. (6in. speaker), 3 front controls: bass, treble, on-off/vol. 60/-, post 5/-. Double wound mains transformer.
Cabinet to fit either type with plain motor board 42 carr. pd. Complete record player in beautifully styled cabinet, fully built (NOT A KIT), £10.17.6, with UA14 4-speed autochanger, or with Garrard Autoslim 4-speed autochanger, £11.5.0.
Single player in Cab., 13 1/2 x 5 1/2 in. B.S.R. Monarch 4-speed deck, £8.17.6.

QUALITY PUSH-PULL OUTPUT AMPLIFIER

Chassis 10 1/2 x 7 1/2 in. high over trans. Used, guaranteed and in excellent order. New valves E240, ECC83 and 2 x EL84; 3 watts. Mains trans. tapped 200-250 volts. O.p. Trans for 3, 4 or 15 ohms. Choke smoothing On/off/vol. and tone controls. For tuners, Record Players, etc. £3.15.0. P. & P. 6/-. We can modify for guitar input for 15/- extra.

TAPE RECORDER AMPLIFIER

Fully built. Front panel 12 1/2 x 3 in. Chassis size 10 1/2 x 5 1/2 in. Valves EF86, ECC83 and 2-EL84. Controls (1) MIC. Vol. (2) Tuner/P.U. Vol. (3) Play back or monitor. (4) Tone. 2 jack sockets for Tuner/P.U. and MIC socket for superlimpuse. separate power pack containing transformer and rectifier. For Collaro audio deck only. Price £8.14.0 (6/- P. & P.).

4-SPEED AUTOCHANGERS

BSR-UA14	£5.19.6
GARRARD AUTOSLIM	£8.10.0
STEREO	£7.5.0
AUTOSLIM DE LUXE AT6	£10.18.0
STEREO	£11.10.0

Carr. 3/- each

13 x 8 in. LOUDSPEAKER 49/6 (post 3/6)
Three ohm. Ceramic magnet of latest type. BRAND NEW.

HEATER TRANSFORMER

Mains input giving 6.3v. 2 amp. Size 2 1/2 x 2 1/2 in. (24in. over winding). 5/6 ea. Less 10% for 12. or 20% for 50. P. & P. 2/- for 1 to 6, post free more than six.

L.K. ELECTRONICS (Victoria) LTD.

17 GILLINGHAM ROW, LONDON S.W.1

Are now sole national concessionaires for the SIOUX 60 WATT GUITAR AMPLIFIER

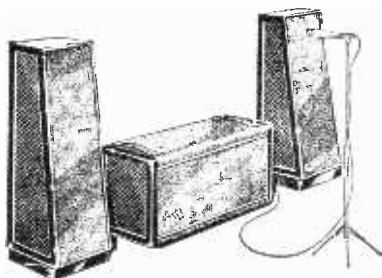

Incorporating—

10 high duty speakers in two columns of 5.

Designed to handle efficiently the full output of amplifier at frequencies down to 25 c.p.s.

Heavily made cabinet in two-tone Vynair.

For 200-250 v. to 50 c.p.s. A.C. mains operation.

Four jack socket inputs and two independent volume controls for simultaneous connection of up to four instrument pick-ups or microphones.

Level frequency response throughout the audible range.

MICROPHONE, STAND, LEADS—INCLUDED

OUR PRICE 35 gns. ONLY

PLEASE SEND S.A.E. FOR DETAILS

NEW NEW

not just 1 but 2 NEW TUNER-AMPLIFIERS

model 127 Stereo £37.10.0

model 127 Mono £26.10.0



Armstrong

Optional case (both models)
TEAK & VINYL HIDE £3. 10. 0
For full details, technical specification and list
of over 300 stockists, post coupon or write
mentioning PW. 12.64

Name

Address

PW 12.64

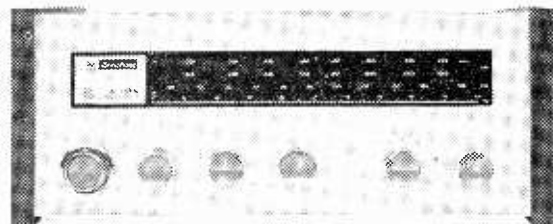

ARMSTRONG AUDIO LTD. WALTERS ROAD. LONDON N7

Wright + Connor

To convert a millimeter into an ammeter or a millimeter having a higher *full-scale deflection* a shunt resistance must be used. The formula used to find the value of the shunt is:

$$R = \frac{R_m}{n-1} \quad \text{where } R \text{ is the shunt resistance,}$$

R_m is the meter resistance and n is the factor by which the original f.s.d. has been multiplied. A typical example is shown in Fig. 15.

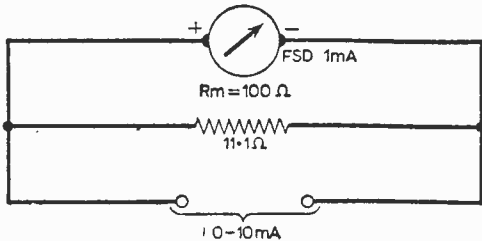

Fig. 15: Inclusion of the shunt resistor (11.1Ω) gives the millimeter a higher full-scale deflection.

2.4 The Electromagnet

When a coil of wire is wound round a piece of soft iron and a current is passed through the coil the soft iron will become magnetised. When the current is switched off the soft iron immediately loses its magnetism. This type of magnet is called an *electromagnet*. Electromagnets are generally used in electric bells and buzzers and relays, all three of which are really switching devices. See if you can work out how the relay switches on the current in a separate circuit in Fig. 16 and how the electric bell in Fig. 17 rings continuously.

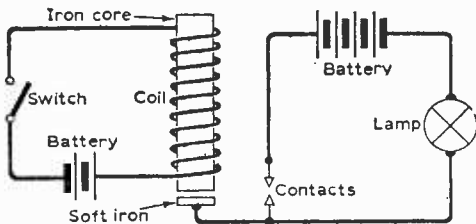

Fig. 16: Here an electromagnet is used to operate a relay for switching on the lamp.

2.5 Self-Inductance

If a wire is wound into a coil and a current is passed through the coil the coil will oppose any change in the value of the current passing through it. This property of opposing a change in current is called *inductance* and is due to the fact that a second current is *induced* in the coil which opposes the change in current. The amount of inductance possessed by a coil depends on the number of turns, the area of cross-section of the coil, the length of the winding and the material

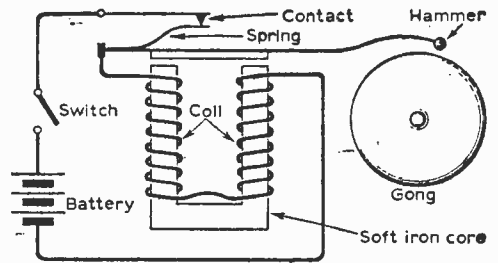

Fig. 17: The circuit of an electric bell.

on which the coil is wound. If a current passes through a coil the current does not at once rise to its maximum value because of the inductance of the coil. This is shown in Fig. 18.

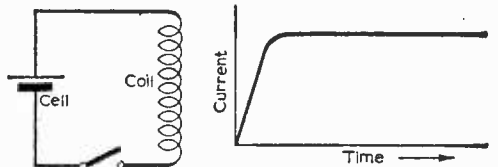

Fig. 18: The rise of current with time in the coil shown on the left, is illustrated graphically on the right.

Inductances are measured in *Henrys*. The Henry is a large unit and in radio frequency coils the inductance is generally measured in *microhenrys* ($\frac{1}{1,000,000}$) of a Henry. The inductance which acts when a current passes through a single coil is called *self-inductance*.

2.6 Mutual Inductance

When current flows through a coil a magnetic field is set up round the coil as shown in Fig. 19.

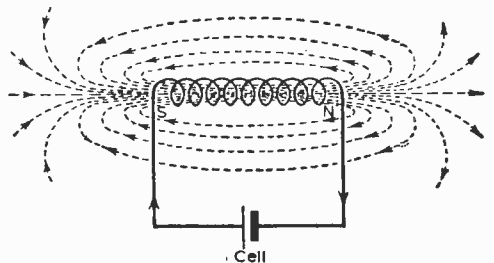

Fig. 19: The magnetic field set up around a coil of wire.

If a second coil is now brought near to the coil shown in Fig. 19 so that the lines of magnetic force "cut through" it a current will be produced in the second coil. This current is produced as a result of a *mutual inductance* between the two

coils. This is shown in Fig. 20, a milliammeter being used to demonstrate the induced current in the coil. The coil connected to the cell is called the *primary coil* and that in which the current flows is called the *secondary coil*.

Two coils such as those in Fig. 20 are said to be *coupled* and the coupling effect is greatest when the two coils are on the same axis and close together.

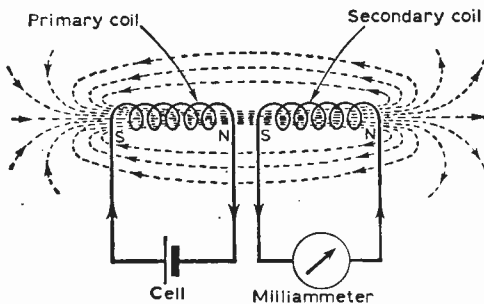

Fig. 20: The effect of placing one coil in close proximity to another.

2.7 Inductances used in Receiving and Transmitting Circuits

Adding an iron core (generally powdered iron) to a coil increases the inductance considerably and therefore for receiving purposes coils can be made very small. Also the inductance of a coil can be reduced by adding a core of a metal such as brass. As will be seen later when a.c. theory is dealt with the inductance of a coil varies according to the *frequency* of the current which passes through it. Generally, in transmitting circuits where there is considerable radio frequency power, the inductances used in the circuit will be self-supporting (i.e. not wound on a "former"), will be made of stout wire and will have an air core.

2.8 Capacitance

If two metal plates are separated by a small distance and connected to a battery and switch, as shown in Fig. 21, the instant the switch is closed

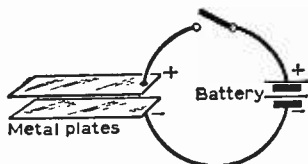

Fig. 21: How electrical capacitance is obtained.

electrons will travel from the upper plate towards the *positive* terminal of the battery and electrons will leave the *negative* terminal of the battery and travel to the lower plate. The plates are now said to be *charged*. The switch can now be opened but the plates will retain their new charge. The charges can be neutralised by *short-circuiting* the plates, a spark often resulting.

Two plates as shown can therefore be used to *store* an electrical charge and a device which can do this is called a *capacitor* or condenser. The *capacity* or *storing power* of a capacitor is dependent on the area of the plates, the number of plates, the distance between the plates and the material (*dielectric*) between the plates.

The unit of capacitance is the *farad*. This is too large for most radio applications and the

microfarad $\frac{1}{1,000,000}$ of a Farad and the *pico*farad or *micromicrofarad* $\frac{1}{1,000,000,000}$ of a microfarad are more commonly used.

Capacitors fall into two main types, *fixed* capacitors which have a fixed capacity and *variable* capacitors which have a variable capacity. The symbols for these two types are generally represented as shown in Fig. 22. Fixed capacitors are physically usually small and may

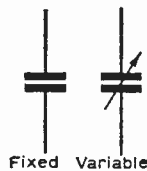

Fig. 22: The circuit symbols of capacitors fixed and variable.

often be made of metal foil with a thin layer of dielectric, such as waxed paper, between the plates. The capacitor may also be made of two long lengths of foil separated by waxed paper and the whole being wound cylindrically so as to occupy a small space only. A special type of fixed capacitor is called an *electrolytic capacitor* but this will be dealt with later.

Variable capacitors have two sets of plates, one set *variable* and the other *fixed*; moving the position of the variable plates alters the capacity of the arrangement. The two sets of plates are almost always separated by air but occasionally *mica* may be used.

The voltage which can be applied to a capacitor depends upon the distance between the plates and the material separating the plates. If too high a voltage is applied sparking will occur between the plates and the *breakdown voltage* of the capacitor will have been exceeded.

Question—

A meter has a full-scale deflection of 10mA and an internal resistance of 50Ω. Calculate, using Ohm's Law, the following:

- The value of the series resistance required to convert it into a voltmeter reading up to 250V.
- The value of the shunt resistance required to convert it into an ammeter reading to 2A.

Use the formulae given in the article to check your answers. Answers to Question 1 last month are given on page 790.

Part 3 Next Month

A MODEL CONTROL TRANSMITTER

by

F. G. Rayer G30GR

THE circuit shown here is extremely simple, and has proved to be very useful. When experimenting with radio control equipment indoors, power can be drawn from a small mains unit. This unit should deliver 6.3V a.c. for the 6C4 heater, and 10mA at 150V h.t. supply. When mains are not available, the mains unit is removed, and the transmitter operated from batteries. As 0.15A is drawn from the 6V supply, reasonable battery life is obtained.

Fig. 1 shows the transmitter circuit and battery connections. Any home-built or ready-made c.w. type receiver may be used. The transmitter is not suitable for controlling tone receivers. The unit is tuned to the required frequency by TC1 and the control switch or key used to control the model is connected in the 6C4 cathode.

The transmitter is built on a piece of thin paxolin 4in. x 4in. Drilling positions can be taken from Fig. 2. The valveholder requires a 1/8in. diameter hole. Short 6BA or similar bolts are provided with tags and fitted in the positions indicated, for battery, coil and key connections.

An extra tag is fitted at point 1, Fig. 2, and one projecting tag of TC1 is soldered to this. A stout lead passes from the centre tag of the trimmer, through a small hole, and to tag 3 in Fig. 3.

All underneath wiring is shown in Fig. 3, and leads and parts should be positioned approximately as illustrated. Wires are short and direct, and insulated sleeving is used on all leads. The wire ends of resistors and capacitors are cut down as necessary. Connections should be rigid, so 20 s.w.g. tinned copper wire, with 1 m.m. sleeving, will be satisfactory. A lead passes from h.t. positive to tag 2, as in Fig. 2.

Coil L1/L2

This need not be wound exactly as described, provided it can be tuned to 27Mc/s with TC1 trimmer about half closed. For this type of circuit, a self-supporting coil is not recommended. A smooth paxolin tube can be used as a former, though a former with notched ribs is better as turns are then evenly spaced and cannot move.

The former actually used was approximately 3/4in. across the ribs and 1 1/4in. long. L2 consists of 10 turns of 20s.w.g. tinned copper wire, the winding occupy-

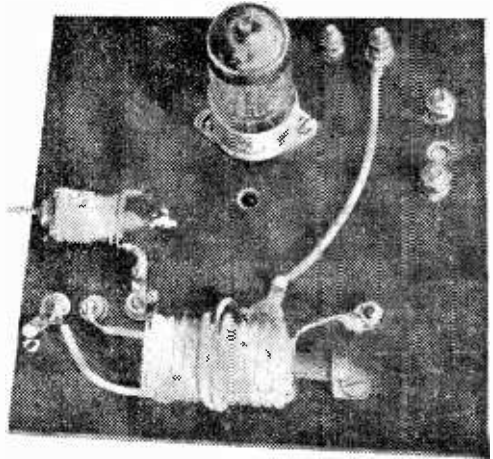

ing 1in. A short lead is soldered on the centre turn, this being the tapping 2 in Fig. 1. The ends of L2 coil are soldered to tags 1 and 3 in Fig. 2, and the tapping is soldered to tag 2.

Two turns of insulated wire are used for the aerial coupling winding L1. These are wound round the centre of L2 coil, the ends being twisted together, and taken to tags 4 and 5. In Fig. 2,

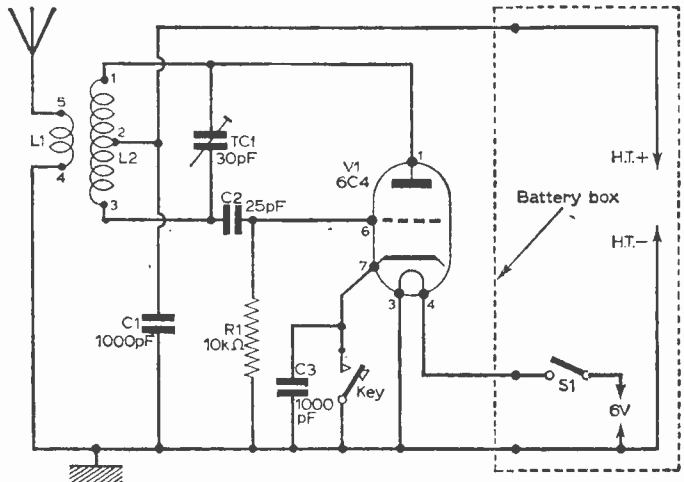

Fig. 1: The 27Mc/s transmitter circuit.

this winding and its connections are shown with broken lines.

A former which would hold 10 turns, $\frac{3}{8}$ in. in diameter, was tried, and was also satisfactory. A $\frac{2}{3}$ in. diameter former would also do well. Formers smaller than $\frac{3}{8}$ in. diameter are not recommended. The wire gauge and spacing between turns are not critical, provided the finished coil can be tuned around 27Mc/s. The finished coil was mounted with a $\frac{3}{4}$ in. bolt, spacer and bracket, as in Fig. 2.

Tuning and Aerial

The heater may be run from a.c. or d.c., the polarity with d.c. being unimportant. The h.t. supply is 90V to 150V according to power required or the supply available.

The transmitter must be tuned to a frequency in the **Model Control** band (26.96 — 27.28 Mc/s) before the aerial is attached. If desired, a test for r.f. can be made by soldering a 6V 0.06A bulb to a 2-turn loop, and bringing the loop near the transmitter coil. The bulb should light at reasonable brilliance.

To tune the transmitter, a calibrated wavemeter is required. The wavemeter is set to a frequency near the middle of the band (say about 27.1Mc/s) and is coupled to the transmitter coil. If the wavemeter has a bulb indicator, the wavemeter coil will need to be in line with the transmitter coil, with an inch or so between coils. Coupling should be loose (coils as far apart as possible, provided sufficient power is transferred to light the bulb). TC1 trimmer is then rotated until the wavemeter bulb lights best. A 9in. length of insulated tube, filed to engage the trimmer, is handy for tuning.

If the wavemeter has a sensitive moving-coil meter indicator, coupling between transmitter and wavemeter can be small, the units being separated by such distance as will give a satisfactory deflection of the meter.

If the coil has been wound to dimensions other than those given, the tuning range obtained may be unsuitable. If 27Mc/s is approached with TC1 trimmer

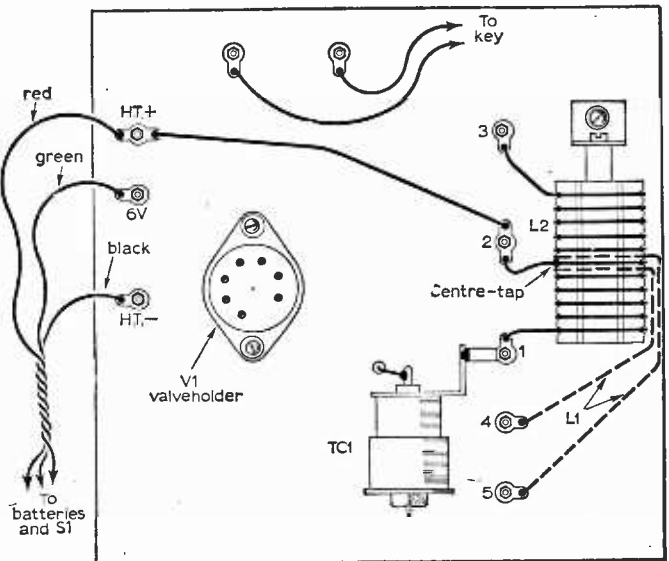

Fig. 2: Layout on top side of the chassis panel.

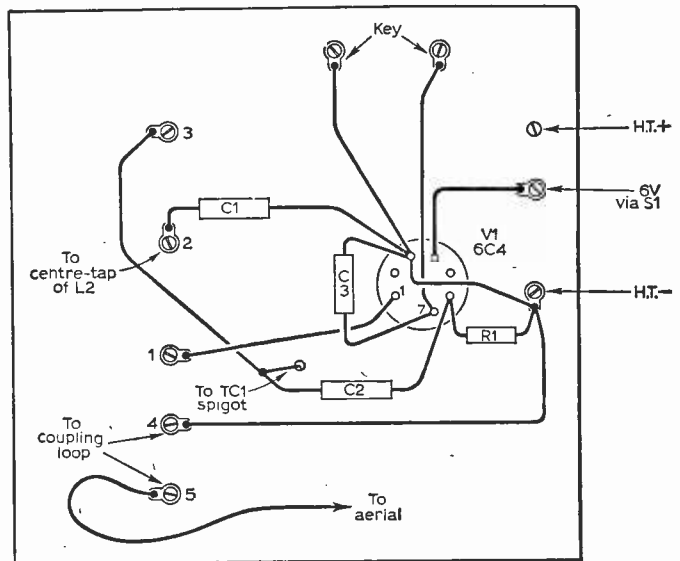

Fig. 3: Wiring on the underside.

COMPONENTS LIST

- R1 10kΩ 1W
 - C1 1000pF 250V or similar
 - C2 25pF mica or ceramic
 - C3 1000pF 250V or similar
 - V1 6C4
- One B7G valveholder. $1\frac{1}{2}$ in. x $\frac{3}{4}$ in. diameter coil former. 4 in. x 4 in. x $\frac{1}{8}$ in. paxolin panel. 20s.w.g. wire, 6BA nuts, bolts, connecting wire, etc.

—continued on page 782

monitoring a BIG

A RAPID FAULT-FINDING SYSTEM FOR COMMUNICATIONS RECEIVERS

Receiver

by S. Simpson

ANY item of electronic equipment is liable to break down but, in the case of communications receivers, such "down time" must be kept to a minimum if communication schedules are to be maintained. Rapid maintenance of the receiver when the fault has been found is very largely tied up with the design and layout of the receiver, but rapid fault *finding* can be greatly helped by a comprehensive monitoring system.

Monitoring a receiver such as that shown in Fig. 1 can be a very extensive arrangement if all possible points are to be covered. Obviously h.t. lines have a priority and one could feasibly monitor all h.t.-carrying electrodes at all valves.

One could also check all bias voltages where such are developed.

All this could lead to a monitoring system so complex that it might itself require monitoring to ensure its serviceability, to say nothing of the risk of malfunctioning of the receiver caused by interaction in the numerous monitor leads!

A compromise can, however, be obtained and is described in the following paragraphs. It leaves several gaps in information but does narrow the field such that the operator should be able, firstly, to say with fair certainty what has happened and, secondly, by using normal metering and tools to quickly clear the fault.

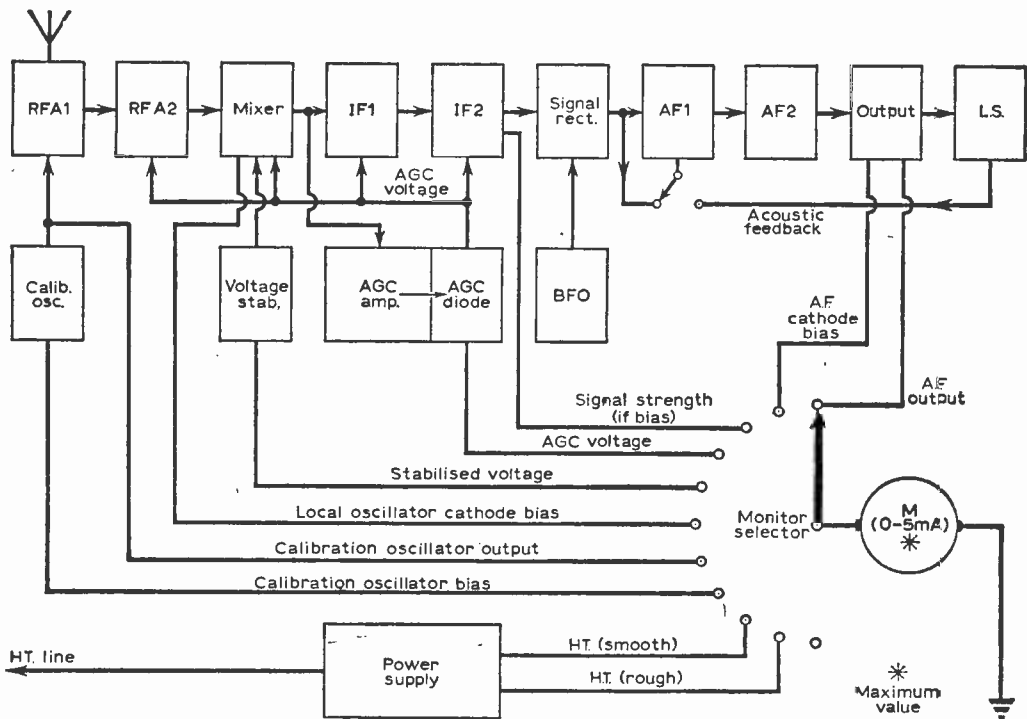

Fig. 1: A block diagram indicating the monitoring system in a typical communications receiver.

Monitoring Points

H.T. supplies must be known, thus the rough h.t. and smoothed supply are monitored. One thus has a check on the filter system, also a check on serious breakdown of decoupling capacitors. Working backward through the receiver the next useful point is the a.f. output signal (for a reason explained shortly). This signal is taken from the output transformer secondary, rectified, smoothed and passed as a fluctuating d.c. voltage to the monitor switch.

The a.f. output valve is a "hard" worker and a check on its bias condition is desirable. (The paralleled resistance of the meter will temporarily alter the actual operational bias but a reading taken during normal operations gives a figure for comparison when abnormal operation is suspected.)

- (4) The stabilised voltage applied to the local oscillator in the frequency changer; a voltage can be present even if the stabiliser valve has failed but will differ appreciably from normal.

With these facilities the operation of the entire receiver can be checked as follows:

- (1) The crystal calibrator is switched in.
- (2) The r.f. gain control is turned to maximum and the receiver tuned to a known harmonic on, say, the medium wave band if a 100kc/s crystal is in use.
- (3) A.G.C. is switched in, also b.f.o. at 1kc/s.
- (4) The monitor circuit is switched to i.f. cathode bias and the receiver carefully returned to maximum signal (minimum bias reading). This should coincide with a previously logged dial setting of the tuning capacitors.

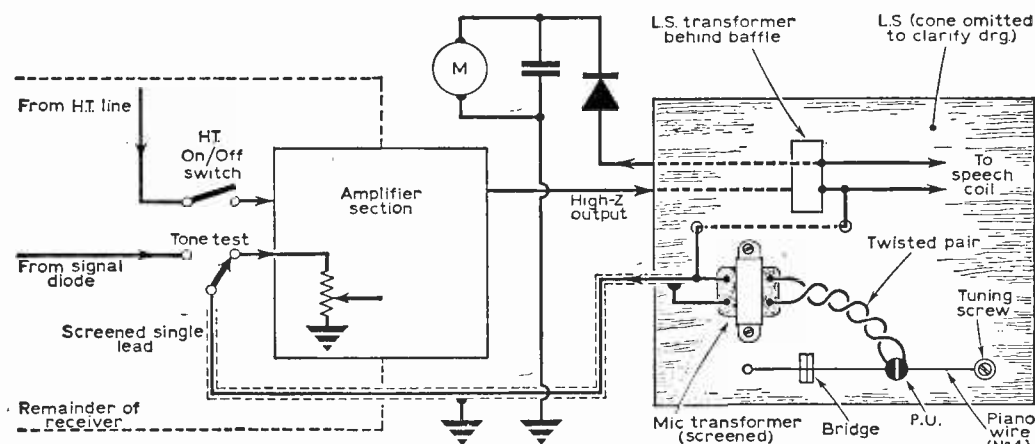

Fig. 2: A 'tone-test' arrangement for checking the a.f. amplifier stage of the receiver.

In the receiver shown amplified a.g.c. is used. The full output of the a.g.c. diode is monitored, also the cathode bias of the last controlled i.f. valve. Drift in tuning of that i.f. amplifier, which is part of the amplified a.g.c. system, is thus shown by a fall in diode output; a fault or drift in the main i.f. amplifier is also made apparent by comparing a known diode output against the effect of a.g.c. in the i.f. amplifier.

The question arises: How does one know that the a.g.c. i.f. amplifier is receiving a normal signal to cause it to produce a known diode output? This doubt is settled by further monitoring at the points listed below:

- (1) The r.f. output of the calibration oscillator, rectified by a diode, to show that r.f. is indeed coupled to the receiver input.
- (2) The cathode bias of the calibration oscillator to show whether the valve is oscillating normally (weak oscillation shows up as an increased voltage).
- (3) The cathode bias of the frequency changer (again weak or non-oscillation gives a noticeable rise above a normal operation figure).

- (5) The monitor circuit is now switched to a.f. output.
- (6) The a.f. gain control is set to a pre-determined position (gained from experience).
- (7) If the receiver is behaving normally a known figure of a.f. output is shown on the monitor.

The above procedure has proved satisfactory in checking the receiver diagrammed in Fig. 1 but will, of course, be modified to suit individual cases.

So far the monitor has covered the complete front end, the i.f. amplifier, the a.g.c. system and a check of a.f. output. It is, however, useful to be able to check the a.f. amplifier on its own and the following method, illustrated in Fig. 2, is used by the author for the purpose.

A taut 10in. length of piano wire is stretched across the wooden baffle board supporting the loudspeaker (tightening is achieved by passing one end of the wire through a hole drilled in the shank of a No. 6 wood screw which has been run well

—continued on page 758

Stentorian

HI-FI EQUIPMENT

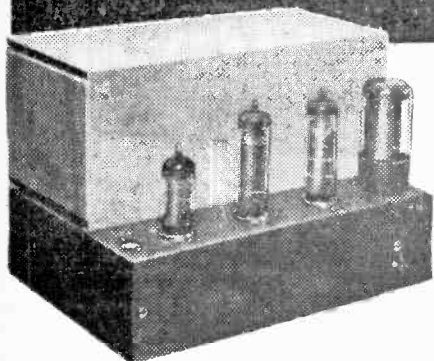
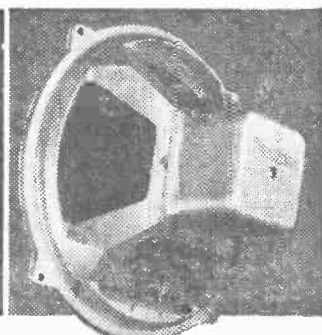

WB 12/14 AMPLIFIER

This is the heart of any sound reproduction system, particular attention having been paid to circuit design, layout and appearance.

MODEL H.F. 1016 'MAJOR'

This 10 inch, 16,000 gauss unit is specially suitable for use in the smaller type of enclosure having a volume of approximately 1½ cubic feet.

Type	Flux Density	Price
10" H.F.1012	12,000 gauss	£4 12 0
8" H.F.816	16,000 gauss	£6 6 0
8" H.F.812	12,000 gauss	£3 16 6
8" H.F.810	10,000 gauss	£2 17 0
T359 tweeter	9,000 gauss	£1 12 3
T816	16,000 gauss	£5 19 3
T10 tweeter	14,000 gauss	£4 12 9



WHITELEY ELECTRICAL RADIO COMPANY LTD.

MANSFIELD · NOTTS. Telephone: Mansfield 1762/5

New
THOUSANDS OF

TO NORTH LONDON
A CONSTRUCTORS PARADISE
COMPONENTS IN STOCK!

Including: Valves, Transistors, Resistances, Condensers, Plugs, Sockets, Ferrite Rods, Dropper Sections, Knobs, Transformers, L.O.P.T., F.O.P.T., S.O.P.T., Mains, Styli, Loudspeakers, Tapes and Spools, Indoor Aerials, Headphones, Earpieces, Record Decks and Many Others!

YOU NAME IT - WE HAVE IT!!

SPECIAL OPENING OFFER ★ £5!

17" Second-Hand TV's from

SEE THEM WORKING BEFORE YOU BUY!
DOZENS OF NO-GOERS FROM 5/- (Full of useful spares) Ideal for Beginners!

JOHN TRAPP SERVICE SHOP
at 52 COLERIDGE ROAD, THE BROADWAY,
CROUCH END, N.8.

TELEPHONE: MOUNTVIEW 1183

Designed for the electronics age...
PRIMAX and PRIMAXA solder guns

SPOTLIGHT SOLDER GUNS

Distributed by **S. KEMPNER LTD.**
29 PADDINGTON ST., LONDON, W.1. Tel: HUNter 0755

ELECTRONICS

LEARN - THE PRACTICAL WAY . . .

your career . . .
hobby . . .
own business . . . ?

The demand for good Electronic Engineers is increasing almost daily throughout the world. Electronics is now the most rapidly expanding of all industries with its applications reaching into almost every sphere of human activity. If you are looking for a new career with new opportunities, then now is the time to choose—Electronics. If you are already employed in this field—then now is the moment to seek high qualifications to secure the top jobs which are waiting to be filled. Most of all, the great potential of electronic development means unlimited scope for the future and will ensure a secure occupation for you—unlikely to be affected by possible future recessions in other industries.

The British National Radio School has had 25 years' experience of HOME STUDY coaching for students wishing to master the fascinating subjects of Electronics—whether the object be career or as a hobby or new interest. The School is entirely independent and specialises ONLY in the teaching of electronic subjects. It employs only fully qualified staff to conduct and supervise each individual course taken by a student and it is this close and personal contact between Tutor and Student which we believe makes possible the successful completion of a course of study.

A special feature of our system is that all courses start right from the beginning and no previous knowledge or experience is necessary or expected. Training is carried out in easy step-by-step stages using the most modern methods of tuition. The great advantage of the home study method is that it provides a complete self-contained course giving everything needed for the subject concerned and enabling work to be done in the comfort of one's own home and over any period of time desired.

EXAMINATION COURSES

- CITY & GUILDS TELECOM. TECHNICIANS CERT.
- CITY & GUILDS FULL TECHNOLOGICAL CERT.
- A.M.Brit.I.R.E. EXAMINATION.
- RADIO AMATEURS LICENCE EXAMINATION.
- P.M.G. CERTIFICATES FOR RADIO OPERATORS.
- R.T.E.B. SERVICING CERTIFICATES.

OTHER COURSES

- MATHEMATICS
- TELEVISION
- TRANSISTORS
- SERVO-MECHANISMS
- COMPUTERS
- RADAR & NAVIGATIONAL AIDS



Learn — by building — an international receiver in the top quality class . . . L.W. nine transistors . . . L.W. M.W. TWO SHORT WAVE Band and VHF/FM . . . incorporates every modern receiver design technique.

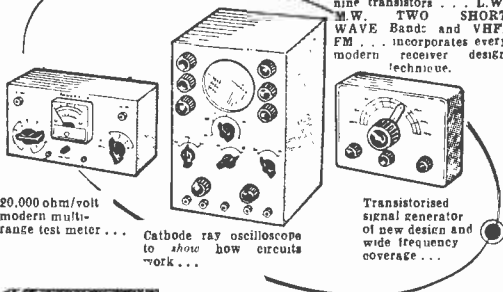

20,000 ohm/volt modern multi-range test meter . . .

Cathode ray oscilloscope to show how circuits work . . .

Transistorised signal generator of new design and wide frequency coverage . . .



Complete Picture way library of theory books and practical manuals. NO MATHEMATICS!

BUILD AND EXPERIMENT WITH ALL THE ABOVE—AS—YOU—LEARN . . .

This is a new complete experimental course comprising a mixture of theory and practical work using a very full range of electronic components and apparatus. Starting right from the beginning—or at a later stage if needed—the course enables the student to build up all the basic electronic circuits—amplifier; oscillator; rectifier; detector; etc.—and finally to the design, construction, testing and servicing of a latest design fully transistorised receiver using nine transistors and covering long and medium wave and TWO SHORT WAVEBANDS plus VHF/FM reception. It is of real luxury quality throughout—operates from a 9v. battery and can be used anywhere in the world. Every present-day technique in circuitry is covered and the course also includes multi-range test meter; signal generator and oscilloscope. By the end of the course the student will be able to deal with any type of servicing work with confidence and will also have a very useful workshop of equipment. Nearly 100 interesting and absorbing EXPERIMENTS are carried out during this comprehensive course enabling anyone to gain full mastery of electronics.

FREE



POST NOW

TO: BRITISH NATIONAL RADIO SCHOOL, RADIO HOUSE, READING, BERKS.

Please send me your free Brochure, giving details of your Courses, without any obligation, to—

NAME

ADDRESS

I am interested in

(We do not employ representatives) courses above PW 12.64

British National Radio School

A COMMENTARY BY HENRY

PRACTICALLY WIRELESS

No. 4 For the Present

THE national dailies are clamorous, just about now, with suggestions of seasonal gifts. The lady columnists slink between laden counters, licking their pencils, filling their notebooks with apt ideas.

In these days we have to shop *this* early for Christmas, otherwise the stores will only have Easter eggs on show.

Remembering some of the presents we have received from misguided maiden aunts, and malicious colleagues, we thought it could be a good notion to suggest a few suitable ideas for some of the characters who have haunted the radio enthusiast in these pages and elsewhere.

Simple gifts, as for example a second-hand flea-trainer's outfit for the chap who thinks up those diminutive designs which so tax the constructor's eyesight and defeat his fumbling fingers.

Or a "Lucky-Dip" parcel of unrelated oddments for the contributor whose constructional article advocates: "33 turns of 24s.w.g. enamelled copper on a $\frac{1}{4}$ in. former, and 100 turns of 42s.w.g. double-silk covered on XYZ former type 54321". I mean, have you ever tried to calculate how many inches (feet, yards?) make 100 turns of

42s.w.g., then ask for that odd length at your local factor's spares counter?

Then there is the chap who thought up the modern, plastic knob, which disintegrates at a touch. This horror—for which a replacement can seldom be obtained—has to be pulled or twisted off before any work can be done on the receiver. Perhaps a blown-out Chinese egg, suitably mounted?

And for the creator of the other kind of knob, with concealed security, a grub-screw beneath a flange, or an angled spring just beyond the reach of one's longest screwdriver, a set of wire puzzles.

A ball of tangled string would not be inappropriate as a gift for the bright bloke who thought up the combination of harness and printed circuit used on some television receivers. Tracing h.t. on these without a circuit diagram—and sometimes with one—is like touring Wales with a home-made map.

Don't let us forget, while on the subject of diagrams, two well-earned awards. First, one of those teasing "Present to follow" postcards we used to get at school for the producer of the radio for which a circuit is never—not nohow—obtainable. And a modern, do-it-yourself novel for the technical author whose manual flops about like a stranded fish, with components on one page, tables of values on another, and portions of the circuit scattered about like plums in an alms-house pudding.

Jig-saw puzzles used to be frequent presents when Henry was a lad. One of the interlocking type would do well for the designer of the set which used those banks of moulded components in which the middle one always seems to go.

Then there is always the tool and equipment market—we could think of more examples



A ball of tangled string.

here than the Editor would allow us to cite. But we must not forget to send a tube of burn salve to the genius who first thought up the method of mounting multi-contact switches in a printed-circuit panel. He must have burned his fingers mightily while mocking up that prototype.

Remember those games that used to swell our stockings, the ones that required the victim to get a dozen balls simultaneously on a dozen shallow depressions, annoyingly beneath glass? Suitable, don't you think, for the chap who wants us to hold four pen-light cells at once, or even five U-11 type cells, to make any test on a small transistor receiver that entails removing the back.

And, going even further back in memory, a cats-cradle of string for the inventor of some of the more irrational drive-cord designs. A rubber one, if such can be imagined, for the tape recorder brain who loops his belts around hidden pulleys in inaccessible places.

I leave you, gentle Reader, to think up gifts that might suit others of our tormentors. I must away to consult with fellow contributors to cook up something special for the Editor.



Lady columnists slink between laden counters.

An Experimenter's GALVANOMETER

BY C. J. PAULL

THIS article describes the construction of a moderately sensitive D'Arsonval-type galvanometer for the amateur experimenter. The complete instrument consists of three separate parts: (a) The galvanometer itself, (b) the lamp and lens assembly and (c) the scale over which the lightspot moves.

The Galvanometer (a)

This consists of a coil, two suspensions which act as current leads and provide the restoring force, a mirror glued to the bottom of the coil, a U-shaped magnet to provide the magnetic field

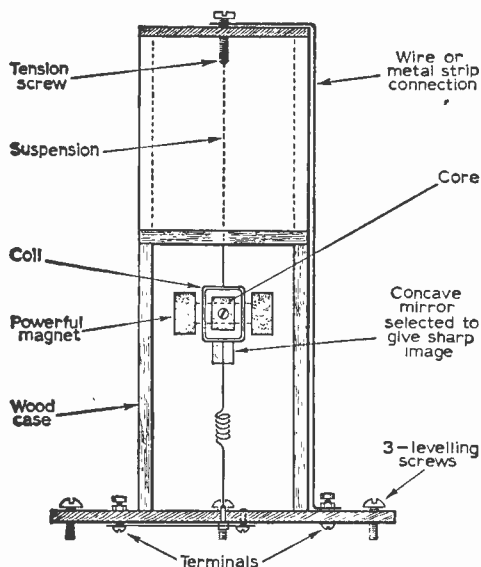

Fig. 1: This shows, approximately full-size, the construction of the galvanometer itself.

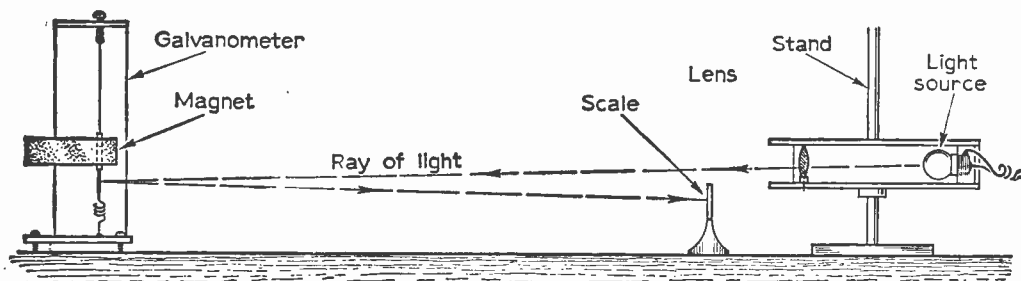

Fig. 2: The complete set-up of galvanometer, scale and light source. Approximate total cost of the complete instrument, 10s.

and a soft iron core to concentrate the field in the region of the coil.

The coil was made from 100 turns 36s.w.g. enamelled copper wire wound on a rectangular wooden former about $\frac{1}{4}$ in. narrower than the air gap of the magnet. After winding, the former was removed and a little glue rubbed into the coil to hold the strands of wire together.

The suspensions were made from "silver paper" (actually aluminium foil) cut to 1/100in. wide strips, 4in. long, with the ends widened to about $\frac{1}{4}$ in. to facilitate joining to the copper wire. The necessary fineness of the suspensions was achieved with the help of a very sharp pointed modelling knife, a steel rule to act as a guide and a sheet of aluminium to afford a suitable base for the cutting operation. The suspensions (above and below) were joined to the bared copper leads from the coil by winding them round and round these leads and then binding some fine copper wire over them to make certain of a good contact. The other ends were connected to suitable terminals at the top and bottom of the case by a similar method, the top terminal being rotatable.

A small, carefully chosen piece of a concave shaving mirror was stuck to the bottom of the coil.

The case was made from mahogany-faced ply and had the dimensions 1in. x 2 $\frac{1}{2}$ in. x 3in. with a removable glass panel inserted in the front.

The Lamp and Lens Assembly (b)

The lamp was rated at 6V 0.5A and the lens was an ordinary 1in. diameter magnifier, adjustable to between 3in. and 6in. from the lamp. A fine

—continued on page 794

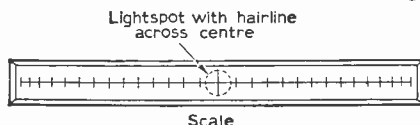

Fig. 3: Details of the scale.

PHOTOCONDUCTORS

BY B. R. GAINES

The Cadmium Sulphide Photo-conductive Cell in Practice

PART 1

UNTIL the advent of the photo-transistor, the only light-sensitive devices generally available were the barrier-cell used in photographic exposure meters, the photo-emissive cell used in sound-film projectors and the selenium photo-conductive cell (often made up from a burnt-out rectifier!).

None of these has the sufficient sensitivity or ease of use for practical general-purpose work, and it was only when photo-transistors became readily available about six years ago that real interest in light operated devices was stimulated.

Even photo-transistors have disadvantages in some applications however, especially where robustness, high-sensitivity, wide-range of illuminations, power-handling, voltage-handling or exact measurement of light intensity have to be catered for. There has, however, become available a device which fulfils all these requirements: this is the Cadmium Sulphide Photo-conductive Cell, which operates on the same principle as the old

Selenium Cell but is in all respects a great advance on these.

The characteristics of one very good example of this type of cell, the Ericsson K42, are shown in Fig. 1. The K42 may be regarded as a resistor whose resistance is determined by the amount of light falling upon its sensitive surface.

It is the enormous range of this resistance from 10Ω in bright sunlight to more than 10MΩ in darkness, from virtually short circuit to virtually open circuit, which makes this cell so useful.

Its colour response also does not have the great peak in the infra-red of photo-transistors and extends over the entire visual range, making the K42 suitable for light measurement.

The sensitive part of the K42 consists of a layer of cadmium sulphide with traces of copper and chlorine added. This unit is potted in epoxy resin inside a metal can behind a glass window sealed with silicone rubber.

Fig. 1 (below): Data on the Ericsson K42 photo-conductive cell.

- A: Maximum Ratings**
 Maximum Polarising Voltage 50V
 Maximum Photocurrent 50mA
 Maximum Power Dissipation 0.4W
 Ambient Temperature Range —25°C-60°C
- B: Sensitivity**

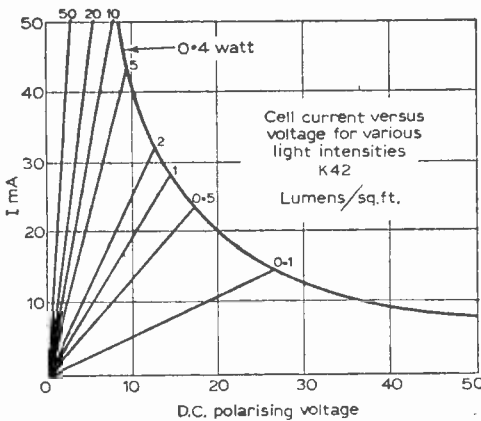

C: "Rule of Thumb" Sensitivity Guide

Cell Resistance in:

Bright Sunlight	10Ω
Daylight	60Ω
Late dusk	1kΩ
Darkness	10MΩ

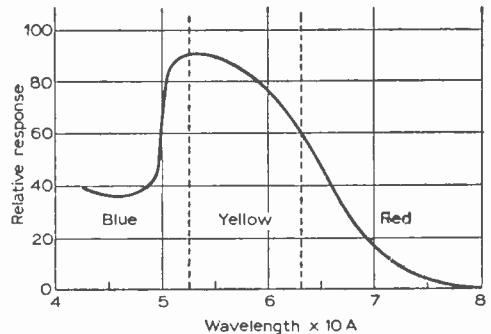

Fig. 2: This graph indicates the K42's relative response to different colours.

The system is extremely robust and moisture resistant, and the writer has certainly found no way of damaging the K42 except by using it with voltages and currents well outside the manufacturer's ratings. The constructional part of this article centres about the K42 and describes its use in light-operated switches and automatic volume controls.

Direct Operation of Relays

Because of its high sensitivity and ability to handle large currents the K42 is able to control relays directly without prior amplification; in this application it may be regarded as a variable resistance of 100Ω or less in light, 1kΩ in the dim light of late dusk, 10MΩ in darkness.

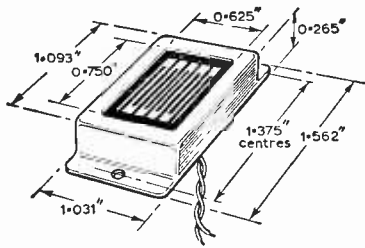

Fig. 3 (above): Dimensions and general appearance of the K42.

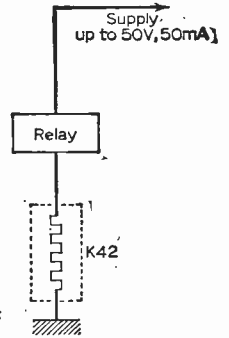
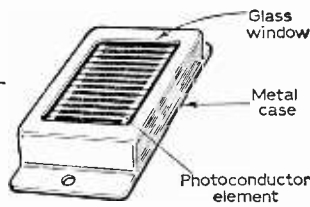

Fig. 4 (right): The K42 in series control of a relay.

Fig. 4 shows the simplest circuit for direct relay operation in which the K42 is placed in series with the relay coil and its power supply. When the photo-conductor is in darkness little current flows because its resistance is high, and the relay is open. When light falls on the cell its resistance decreases and sufficient current flows to close the relay.

Note that there is no need for a protective diode across the relay coil, since the K42 in series with the relay coil does *not* generate large back e.m.f.'s as do some transistor circuits.

In the operation of the circuit of Fig. 4, there is "electrical backlash" in that, whilst the relay may close on a certain current (about 6mA for a 1kΩ P.O. relay with one contact), it will not open again until the current falls rather below this (about 4mA for the relay considered).

This effect is of considerable importance in practical applications which require the relay to operate on currents due to slowly changing illumination.

If there is little backlash the relay tends to "chatter" when the light-level brings the current near its open/close point; backlash by making a very definite difference between open and close currents obviates this defect.

The only restriction on the relay used in Fig. 4 is that it should not require more than 50mA or 50V to operate. The writer has found that Post Office relays with coil resistances of about 1kΩ work satisfactorily on a supply of 12V and has designed parking light switches about these.

Almost any relay may be used however, and the simplest procedure with one of unknown properties is to find out what voltage will just cause it to operate and then to use a supply voltage about one and a half to two times this, subject to the restriction above.

Parking Light Switch

The simple circuit of Fig. 4 has insufficient backlash to guarantee chatter-free operation when the K42 is used to open and close a relay in the slowly changing light of dawn and dusk.

Additional backlash can be created by connecting a shunt resistor, R1 (Fig. 5), in parallel with the relay coil when the relay is open. This takes some of the

Fig. 5 (below): Here R1 is added in parallel with the relay to provide additional backlash. Its operation with R1 disconnected is described in the text.

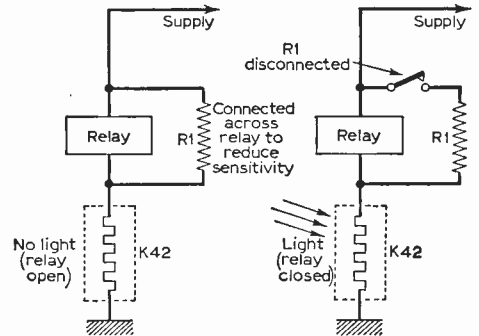

current supplied to the relay and thus reduces its sensitivity when open.

If R1 is disconnected once the relay has closed the sensitivity goes back to normal, and hence the difference between "open" and "close" currents has been made greater, i.e. the backlash has increased. In practice the relay is made to switch the shunt resistor in and out by means of its own contacts.

Fig. 6 shows a practical circuit for this type of parking light switch and the method of connecting it into the car wiring. The centre section is the

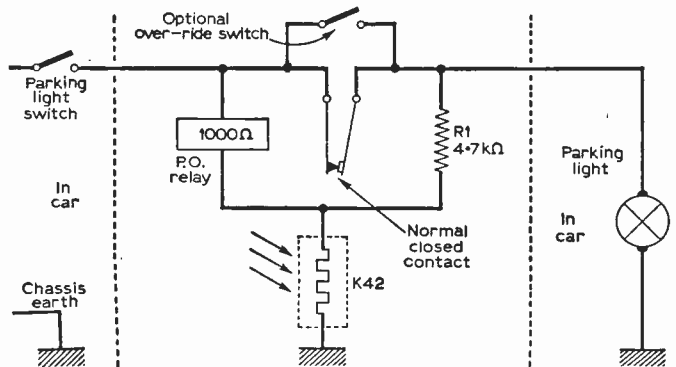

Fig. 6: A car parking light system using the K42.

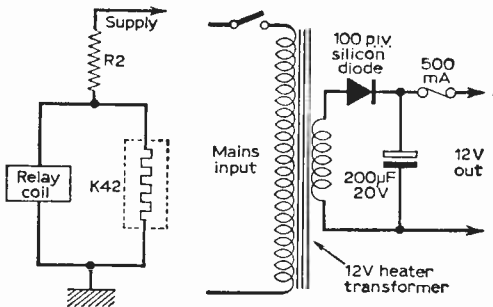

Fig. 7 (left): Parallel control of a relay.

Fig. 9 (right): A power supply for 12V relays.

switch itself which is essentially that of Fig. 4 with the addition of automatic backlash described above.

The K42 is in series with the relay coil, opening the relay during the night, and therefore the switch contact on the relay must be of the "normal-closed" type. This same contact is used to switch the shunt resistor R1 in parallel with the relay coil when the relay is closed, thus increasing the backlash as described above.

If a relay of different resistance to that shown is used, R1 should be changed to be about five times the relay resistance. The "over-ride" switch bypasses the relay contacts and converts the parking light to normal manual operation.

The actual details of construction and connection of the parking light switch will vary with the requirements of the individual car. The K42 must, of course, be placed so as to see the full effect of the ambient light, and the most convenient place to put it is just behind the front window facing outwards; it need not face straight up into the sky.

The relay unit can usually be found a place behind the dash or in the map or glove compartment: for reliability a sealed relay is preferable, and some protection of the contacts should in any case be provided.

The wire to the parking light may be broken into and the automatic switch fitted (Fig. 6) at any point after it has left the main lighting switch. The chassis-earth connection should be securely attached to the metal-work.

A 2A fuse in the 12V line is some worth-while protection against blowing the main car fuses when installing the unit!

Parking Light Switch II

In many towns parking lights are only required after 11 p.m. or when the street-lighting goes off, and the automatic switch has only to switch them off at dawn, there being no advantage in one

which would switch them on long before they were required.

This "single-shot" working has the advantage that relay chatter can be completely eliminated by a switch which switches off the lights automatically, but requires manual re-setting to switch them on. Then the relay opens at dawn and once open stays open.

The previous circuit could be changed to this mode of operation, but there is an alternative way of controlling a relay directly with a K42 which is sometimes advantageous and the writer will describe this rather than cover the same ground again.

In this mode of operation the K42 is connected in parallel with the relay coil and therefore shares with it the current supplied by R2 (Fig. 7). In darkness the K42 has a high resistance and all the current flows through the relay.

In light the K42 is low resistance and takes most of the current so that the relay opens. R2 should be greater than a third of the relay resistance and must limit the current through the K42 to less than 40mA.

This switch is converted to single-shot working described above, by arranging for the relay to cut off its own power supply when it opens, so that it cannot close again.

Fig. 8 shows a practical circuit for this type of parking light switch and the method of connecting

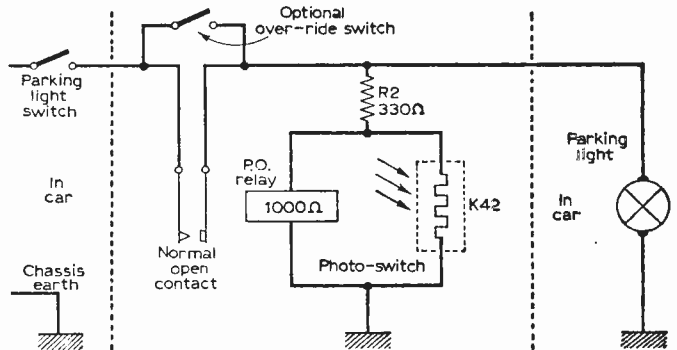

Fig. 8: A 'single-shot' parking light system (II).

it into the car wiring. Only one switch contact on the relay is used as before, but since the relay is now closed in darkness this must be of the "normal-open" type.

This contact not only controls the supply to the parking light but also that to the relay itself, and hence once the relay opens it cuts off its own supply and cannot close again.

When the lights are to be switched on at night the supply to the relay must be momentarily switched on, whence the relay will lock-in until it opens automatically at dawn.

The simplest way to do this is to push in the relay armature, which makes the relay contact and acts as the required starting switch; if some means of locking the armature in is also provided this

—continued on page 774

SAND-LOADED LOUDSPEAKER BAFFLES

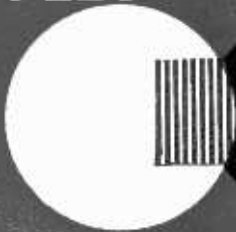

E. LAWRENCE

THE quality of sound produced by lower-priced tape-recorders and small radio receivers is of a high order bearing in mind the restricted space within the cabinet which must of necessity accommodate both the speaker and the rest of the "works" and it is generally appreciated that given a specially designed enclosure the same loudspeaker would perform more efficiently so that for the equivalent amount of electrical power a greater volume of sound over an extended frequency range would result.

In some cases a listener may wish to effect an improvement in his equipment but he will be deterred from embarking upon the project for fear that it will be a complicated task beyond his capabilities or resources or more likely he will doubt whether, as applied to inexpensive equipment, his efforts are likely to be rewarded with success.

If the reader wishes to prove to his own satisfaction the importance of the correct mounting of loudspeakers and has a spare which can be used as an extension unit, it is an easy matter to compare the effect of a rudimentary baffle, fashioned from a large piece of stiff cardboard with a central hole of appropriate size, added to the otherwise unmounted speaker while this is in operation, to observe the immediate improvement in reproduction especially in the lower register.

Even though this arrangement is not by any means ideal, the sound now has a more pleasant 'quality' compared to the thin 'toppy' effect without the baffle.

There is a risk, of course, that an ill-designed

or poorly constructed complex enclosure may prove disappointing where a well made simple one may give satisfaction, especially if it is desired to have the equipment in portable form for lectures and recitals where the question of transportation weighs heavily.

It is suggested that the reader who desires to find out whether his equipment is capable of producing better results may care to construct a plain baffle for test purposes and if he is satisfied with what he hears he can then convert it into something more elaborate.

WHY A BAFFLE IS NECESSARY

A full discussion of the theory governing this subject is beyond the scope of this brief article but it must be explained that the air vibrations which constitute the sound waves from the loudspeaker are the result of the reciprocating action of the cone.

It is easy to see that air compressed as the cone moves forward will escape round the unprotected edge of the speaker to reinforce the low pressure region created at the rear so that the two trains of waves, being in anti-phase, tend to cancel out; an effect which is less pronounced as the frequency rises, hence the apparent lack of bass.

By interposing a physical barrier between these two vibrating air masses it is possible to reduce the effect by a factor which depends upon the area of the baffle, which should be as large as possible, although in practice the dimensions need not exceed about three feet per side for reasonable performance from a small speaker.

It is important, however, to choose a material having sufficient density to prevent the structure yielding to the effects of the sound waves impinging upon it and thus transmitting the wave motion. It is especially important to avoid the natural frequency of vibration of the baffle falling within the frequency range of the equipment as such resonance can cause a very objectionable 'boominess'.

Mounting the speaker in a hole in a brick dividing wall between two rooms is an excellent practical solution to the problem but this and other bizarre ideas, often proposed in Hi-Fi circles, such as the use of a length of drainpipe or a brick corner cabinet are ideas which are seldom received with enthusiasm by other members of the family so that the average listener must be content with conventional materials such as thick plywood or blockboard.

MAKING A SIMPLE BAFFLE

Fig. 1 shows one way of making an efficient baffle from materials which at first seem unsuited to the task. Hardboard is an attractive alternative to the other popular materials by virtue of its cheapness but it lacks the requisite degree of density, a deficiency which can be overcome by producing a composite structure of cellular form in which the cavities are filled with sand.

The sheet of hardboard selected for the front is first prepared by cutting a circular hole of the required diameter to suit the loudspeaker. Strips of planed wood about 1in. square are then fixed round the edges and to form a square enclosing

the speaker opening with cross members inserted to sub-divide the intervening space. Liberal use of adhesive, supplemented by tacks, is recommended to ensure sound joints. Fig. 1a shows a detail of the construction.

When the adhesive is set, the cavities may be filled with dry sand which is settled by tapping the edge of the sheet. The second piece of hardboard, with a square central hole to match the wood frame surrounding the speaker then completes the assembly. It may be prudent to enclose the speaker in a fabric bag as a precaution against stray sand grains entering between the speech coil and the magnet gap.

It is advisable to ensure that the sand is quite dry to prevent deterioration due to dampness which could occur after a lapse of time and when securing the loudspeaker to the inside surface of the front sheet the use of bolts with wing nuts

will render its removal easy for storage and transportation. The face of the baffle may be covered with one of the ornamental woven fabrics. Attach a couple of rubber feet, a carrying handle and a hinged rear support with safety chain and the job will be finished.

The principle of sand loading is not, of course, confined to this simple form of baffle. Almost any enclosure will benefit from the increased density obtained in this way. A plain baffle modified to form a corner cabinet by including a port and a triangular plywood top is shown in Fig. 2.

The writer has successfully used a simple baffle mounted in a disused fireplace so that the chimney acts as the cabinet. In a large hall or on stage a temporary corner can be fashioned from two large plain rectangular sand-loaded panels set at right angles as shown in Fig. 3.

Figs. 1 to 4 below

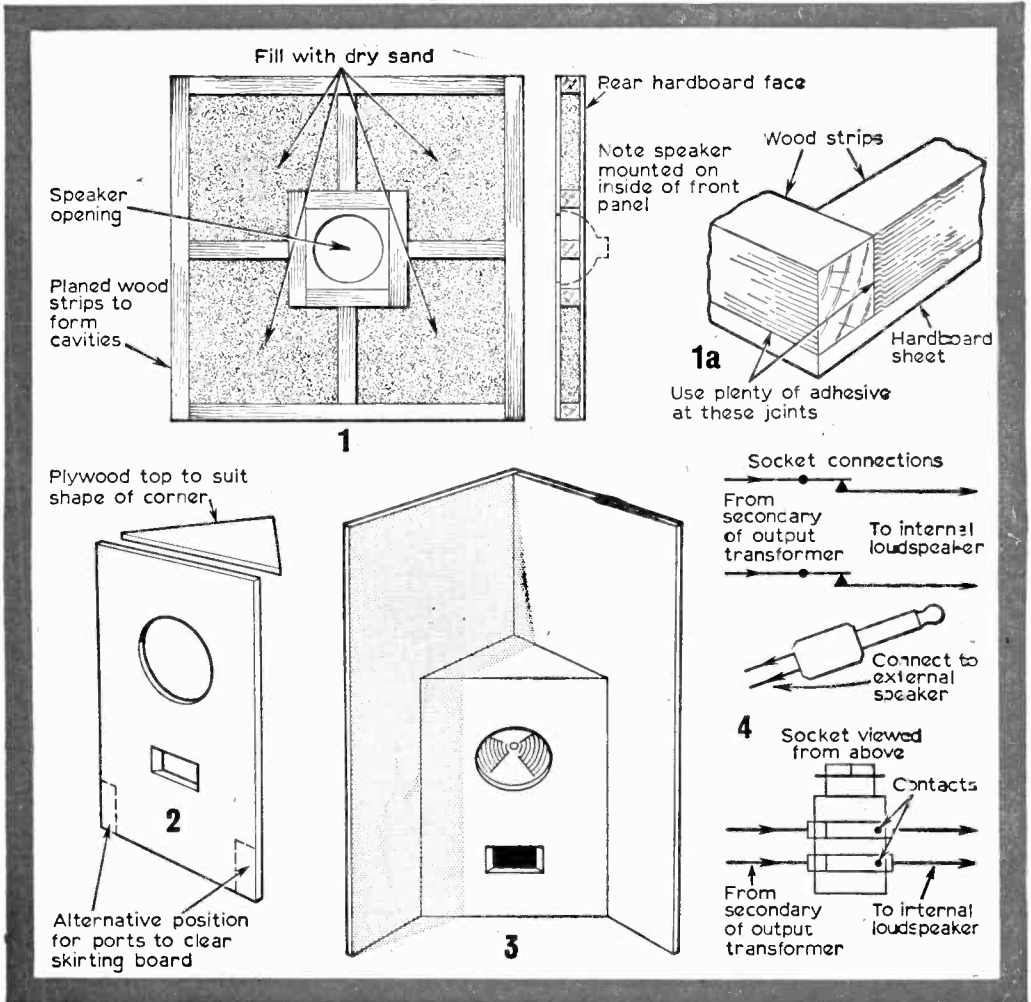

CONNECTING THE EXTERNAL SPEAKER

Most commercial tape-recorders and some radio receivers provide an outlet for an external loudspeaker and it is important to ensure that the component which you propose to use has a speech coil of the correct impedance.

If in doubt, consult the handbook or the manufacturer's agent and if it should happen that your loudspeaker has a 15Ω coil and the equipment is designed for 3Ω , or vice-versa, a special transformer, designated type WMT 1, is available from Messrs. Wharfedale to take care of this situation.

In the absence of an external speaker socket it is a simple matter to instal one. Purchase a standard telephone jack socket and plug and locate the former in a conveniently placed hole in the cabinet. Disconnect the internal speaker leads from the matching transformer and re-connect them to one side of the socket as shown. Connect the

internal speaker to the remaining contacts on the socket. For details of socket connection see Fig. 4.

The external loudspeaker should now be connected to the plug through a length of fairly thick flex, such as five ampere mains flex, and when the plug is inserted into the socket the internal speaker will be automatically disconnected as the external one becomes operative.

It is important not to use an audio amplifier without a speaker, or some other form of load, as this may be detrimental to the output transformer.

It must be stressed that you cannot make a silk purse from a sow's ear. In the type of equipment considered here, mediocre results are very often due to deficiencies in that part of the circuit which converts the electrical energy into sound and the use of a properly mounted external speaker will often give a very satisfying improvement for a small financial outlay. ■

MONITORING A BIG RECEIVER

—continued from page 748

into the board. The other end is looped around a strong steel pin).

A right-angled piece of aluminium is placed as a bridge under the wire at about one-third of its length from the pin and the wire then tuned to about 800c/s.

Under the wire an electromagnetic pick-up (made from an Eclipse button magnet wound with 200 turns of 36s.w.g. enamelled wire) is mounted. The output from the pick-up is passed into a microphone step-up transformer placed clear of the field from the loudspeaker output transformer.

The output from the transformer is passed by an earthed, screened lead to a switch ("tone test") on the receiver panel. Closing the switch applies the transformed output to the input of the a.f. amplifier and disconnects the diode output.

To test the amplifier the receiver h.t. switch is opened and the "tone test" switch closed. The monitor is set for a.f. output. The a.f. gain control is set to about half-travel and the h.t. switch is then closed.

The noise pulse emanating from the loudspeaker on application of h.t. will cause a wide range of frequency vibrations in the baffle board, also acoustic shock waves, and their combined effect will set the tone string into vibration.

This produces an output from the pick-up which passes to the amplifier, thence, if all is well, to the loudspeaker, thus sustaining the vibration which initiated the string movement. The note from the loudspeaker will build up to a maximum determined by the gain setting and the a.f. output can be visually checked at the monitor.

Knowing the output to be expected from a given a.f. gain setting the output performance of the amplifier (if not its quality!) can be checked.

The above systems still leave something to be desired but have proved quite effective in practice and are far better than nothing. To those readers who use a big set and have no means of monitoring other than an S-meter or a magic eye they may possibly cause some interesting thought on the subject. ■

SHORT-WAVE SUPERHET

—continued from page 737

domestic receiver tuned to the BBC Light Programme on 200kc/s near the generator. Tune the generator until zero beat is obtained. The 200kc/s signal may now be injected into the main receiver. In this way the points between the 1Mc/s intervals may be filled in. Note that for the higher harmonics the coupling between the generator and receiver will have to be increased.

The receiver dial is marked with *Indian* ink, using a fine nib. The author found that a gentle roughening of the dial surface with a moist rag smeared with a trace of scouring powder was necessary to achieve a good writing surface. Care is essential during this operation.

ALTERNATIVE USES

The author has found other uses for this simple generator. For example, because the oscillator is a two-terminal type coils may be matched exactly by inserting them in the grid circuit of the generator. With one coil in position the generator dial is set an arbitrary point and the signal tuned in on a receiver. The coil is removed and with the generator dial unchanged the other coil inserted. The turns on the coil are then adjusted until the radiated signal is picked up on the set. Similarly, by using known values of inductances the capacities of capacitors may be measured over the range 50—1,000pF.

The unit may also be used, if so desired, as an audio frequency source by modifying the oscillator as follows: Insert the secondary of an old audio frequency transformer between the blank position on the switch and earth. A capacitor of approximately 5,000pF should be placed in parallel with this secondary winding. Delete C1 and insert a 0.01 μ F capacitor in place of C1. Disconnect the a.c. source to the oscillator and connect the oscillator to a d.c. supply of approximately 200—250V. The heaters, of course, are still fed with 6.3V a.c. The audio output may be taken from the grid via a 0.01 μ F capacitor. ■

IMPROVEMENTS

to transistor portables

by J. Longrise

SEVERAL small improvements or modifications can be made to most home built transistor receivers, and it is useful to make some of these, to fill the need for an external aerial, personal phone, or other features not already provided. It is assumed that the receiver is in good condition, and may have been used for some time.

External Aerial

Due to directive effects and screening, the internal ferrite rod aerial is unsatisfactory in a vehicle. To overcome this, an outside aerial is often clipped to the vehicle window.

The external aerial is best coupled to the receiver by having a small additional winding on the ferrite rod, as in Fig. 1. This coil can be

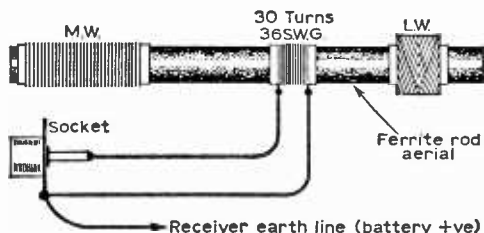

Fig. 1: A coupling coil for an external (car) aerial.

purchased, or may be about 30 turns of any thin insulated wire. A screened co-axial lead is generally taken from the vehicle aerial, so a co-axial socket is best on the receiver. The inner pin goes to the aerial, and the outer sleeve to the outer braiding of the co-axial cable.

If the external aerial is merely to increase range and sensitivity, the screened lead is not wanted, and is best omitted. A single socket of ordinary type will then do for the aerial connection. The loop is returned to the receiver earth line (battery positive). A telescopic or wire aerial can then be plugged in.

Reduction Drive

Many receivers have a knob directly on the tuning capacitor spindle. Miniature tuning capacitors of the type fitted in transistor sets may be obtained with integral reduction drive. This

has a ratio of about 6:1, and makes tuning easier.

With some receivers, a small ball drive can be fitted, as in Fig. 2. For example, this is possible in the PRACTICAL WIRELESS *Celeste* if the gang capacitor is moved to the rear of the panel.

Such epicyclic drives have a lug, which must be securely anchored. This may be done by using a long bolt and extra nuts or spacing washers, or fitting a strong bracket. The pointer rotates with the capacitor. The usual ball drive of this type has a ratio of about 6:1.

Typical Circuit

Fig. 3 is the circuit of a typical transistor receiver, which may be of ordinary size, or miniature type. This circuit is given to illustrate connections for other modifications. Most of the points covered would apply equally to somewhat different circuits.

Clamp Diode

In Fig. 3, automatic gain control bias is obtained from the diode, and applied to the base of Tr2, via R10. Much better control of strong transmissions will be obtained if a clamp diode is added. This requires 680Ω and 2.2kΩ resistors, a 2μF or similar capacitor, and a diode such as the OA79.

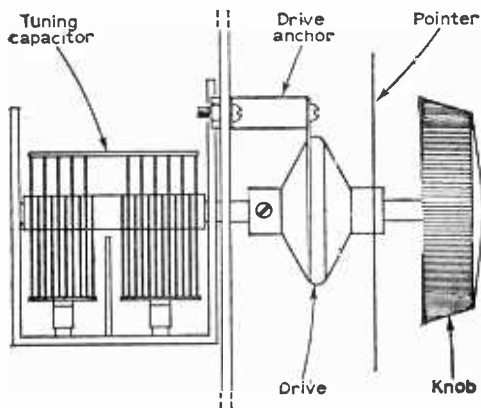

Fig. 2: Adding a ball drive to the tuning gang.

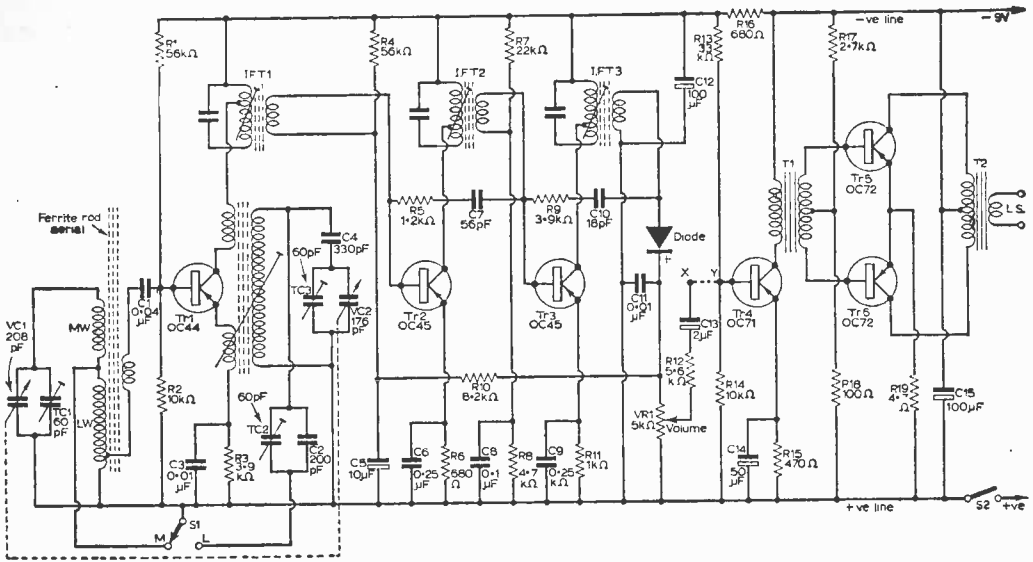

Fig. 3: A typical transistor superhet circuit used to indicate the various modifications.

The second i.f.t. is disconnected from the negative line, so that the 2.2kΩ resistor may be added, and the circuit changed to that in Fig. 4. Diode polarity is important. The original a.g.c. circuit is left unchanged.

Bias from the voltage drop in the 2.2kΩ resistor results in the diode only conducting when very strong signals are tuned in. This prevents overloading and improves the a.g.c. action at these signal levels.

Low Noise First I.F. Stage

A transistor receiver may have an almost silent background when a reasonably strong station is tuned in, but may have a severe background hiss on weak transmissions. This is because the gain of Tr2 in Fig. 3 is maximum with weak signals. With strong signals, Tr2 base voltage shifts in a positive direction, reducing gain and hiss.

The hiss may be bad if an unlucky combination of R4 and R10 makes Tr2 base voltage rather negative. If this is so, shunting a 33k, 47k or 100kΩ resistor across C5 may reduce the hiss considerably. Alternatively, R10 may be slightly reduced in value; or R4 may be increased in value.

With 10 per cent tolerance resistors, the actual base voltage of Tr2 may vary considerably, between different receivers. Tr2 base voltage must not be too far positive, or gain is reduced badly. If one of the transistors Tr2 or Tr3 is relatively noisy it should be in the Tr3 position.

Low Noise A.F. Stage

If bad background hiss is present, and does not change in volume when the 5kΩ volume control VR1 is adjusted, it is probably generated in the first audio amplifier stage. This is most likely when an additional audio amplifier precedes the driver, as in popular 7-transistor circuits.

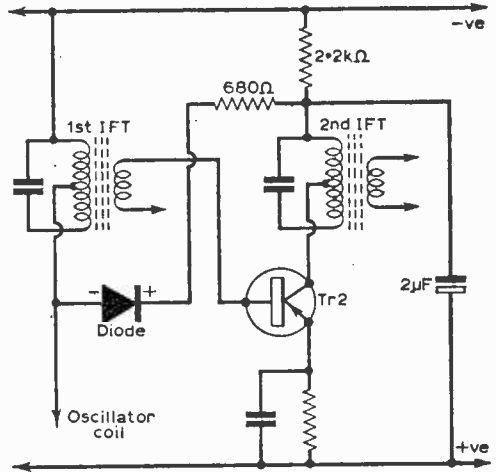

Fig. 4: A clamp diode circuit for improved control of strong transmissions.

If hiss arises in Tr4 in Fig. 3, it may be better to change R13 to 47kΩ, or to increase R15 to 1kΩ. Values in Fig. 3 are typical when Tr4 is the first audio amplifier and driver.

If an extra audio stage is wanted, or if an existing stage is already present before the driver and values are suspected, then the circuit in Fig. 5 may be adopted. Values are chosen to allow good amplification at moderate power levels, with low noise.

The amplifier in Fig. 5 can be added to a circuit like that in Fig. 3, by taking the OC71 base lead X to X in Fig. 3. The new coupling capacitor in

Fig. 5 goes to the existing driver base, Y, Tr4, in Fig. 3. The existing connection between X and Y in Fig. 3 is disconnected.

The additional audio stage is useful if the volume of some stations needs to be increased, though many receivers give an adequate performance with the arrangement in Fig. 3.

Battery Economy

An unfortunate combination of resistor values in the output stage, in particular, may reduce battery life, yet result in no improvement in performance. This may happen if R17 and R18 are 10 per cent tolerance resistors, and if R17 proves to be a little low in value, and R18 a little high. The current drawn by Tr5 and Tr6 may then be much higher than necessary.

If this is so, the simplest cure is to shunt R18 with another resistor, values from about 470Ω to 2kΩ being tried. This can be done with the set working. Or R17 may be increased in value. The receiver must not be switched on with R18 disconnected.

Should reproduction be distorted, especially when the battery is a little discharged, or when the receiver has been left in an unheated room in winter, R17 may be too high in value, and R18 too low. If so, shunt R17 with resistors of about 5kΩ to 15kΩ, or increase R18 in value. Tr5 and Tr6 should draw about 2mA, with no signal.

To obtain maximum gain and output, R19 is sometimes omitted, or is of very low value. This causes high peak currents. It is better that R19

should be 4.7Ω or 5.6Ω, which allows good power and sensitivity, with reasonable current drain.

Mains Powered Eliminator

When a receiver is often used indoors, and for long periods, it is economical to draw current from the mains. A suitable eliminator circuit is shown in Fig. 6.

An output of about 9V is obtained from a 18V secondary with centre tap. The 220Ω resistor helps to maintain a uniform voltage, with changes in current drawn. The 390Ω resistor and 0.25μF capacitor form a transient suppressor to protect the equipment from surges caused by switching on and off domestic apparatus.

Half-wave rectification is also satisfactory, though the capacitor should then be increased to 1000μF. For half-wave circuits, the transformer needs no secondary centre tap, and only one rectifier is required.

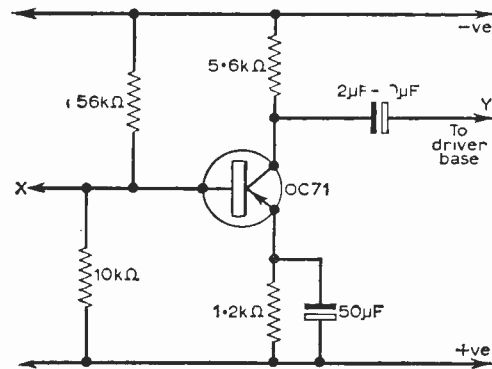

Fig. 5: A low noise first a.f. stage.

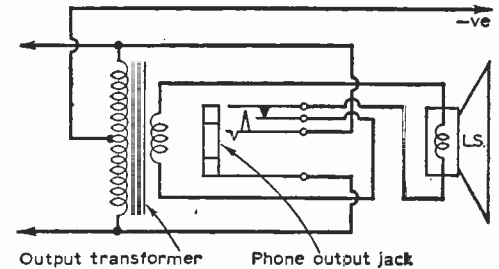

Fig. 7: Incorporating a phone jack socket which mutes the loudspeaker when the plug is inserted.

The unit is best built in an insulated case, with the socket strip taken from an old battery, so that the transistor receiver can be connected easily.

Phone Jack

Phones, or a personal phone, allow listening without any disturbance to other persons. If a jack is used with contacts which open when the plug is inserted, these contacts can silence the loudspeaker.

A circuit for this purpose is shown in Fig. 7, and does very well for most medium impedance phones. Few changes are needed to existing wiring.

With some receivers, a phone jack is simply connected so that phones may be plugged in while the speaker still operates. This is also quite useful, as the volume needed for the phones is quite small.

Occasionally, a jack for low resistance phones is wired in parallel with R18 in Fig. 3. The phones are then operated from the driver stage, and the reduction in resistance across R18 causes the output transistor base voltage to be more positive than usual, so almost cutting off the output transistors Tr5 and Tr6.

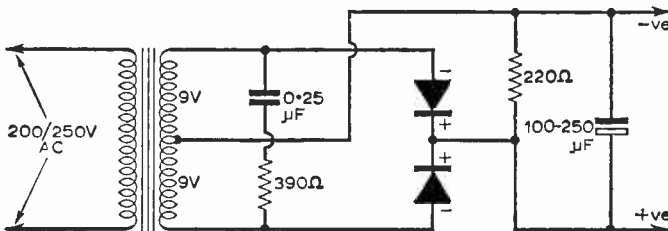

Fig. 6: A battery eliminator circuit for mains operation.

on the Short Waves

MONTHLY NEWS FOR DX LISTENERS

All times are in G.M.T.

All frequencies are in kc/s.

The Broadcast Bands—by John Guttridge

AS most aspects of interest to the new shortwave listener have been covered now in this feature, in future much more space will be devoted to schedule changes and observations of various stations. Information from readers will be a great help in making this as comprehensive as possible.

First this month, though, there is an announcement of interest to all shortwave listeners from the International Short Wave Club, which is at present conducting a poll (held every three years) to find the most popular short wave station.

All listeners, whether members of the club or not, are invited to take part. To do so all that is necessary is list your five favourite short wave stations in order of popularity, together with a short note explaining the reasons for your No. 1 choice.

Your vote should be sent to ISWC, London, S.E.16 by December 31st, 1964. Some winning stations have in the past given prizes for the best reasons put forward by listeners in support of their choice. ISWC, by the way, has just celebrated its 35th anniversary—congratulations!

Some good results in the 90 and 60 metre bands have been achieved recently by **D. A. Lavender** of Gravesend. He reports hearing *Radio Santa Fe*, Bogota, Colombia in Spanish from 0630—0730 on 4,965; *Radio Abidjan*, Ivory Coast, with news in French at 2225 on 4,940; *Radio Rumbos*, Venezuela, on 4,970 in Spanish at 2220; and *Radio Tananarive*, Malagasey Republic, with music and French on 3,232 between 2200—2230. On Sundays, he says, the programme continues until 2300.

Good reception of the European service of *Radio Habana* (Apt. Postal 7026, Habana, Cuba) is reported by **P. H. Holgate** of Blackpool. English is carried on 15,155 from 2010—2140.

Over in Ireland, **D. Walsh** has been picking up Damascus, Syria, on 15,165 in English from 1600—1630 and French from 1630—1700. **E. H. Conduit** of Wolverhampton, however, reports hearing these transmissions on 15,230.

D. Walsh also reports that the General Service of *Radio Japan*, Tokyo, Japan, is getting through between 0800 and 1200 on 15,310 and 1200 and 1400 on 9,740.

Several other stations are reported by **E. H. Conduit**. He says that relays of debates of the United Nations Security Council can be heard on 15,190/21,610. *The Voice of America*, Bound Brook, transmitter is used. *Radio Peking's* transmission to Australia in English comes in well at

0830—0930 on 15,060 he says. Finally he has heard *Radiodiffusion Television Marocaine* in English between 2030—2130 on 11,735. In London this programme has also been heard on 15,410.

From Arbroath in Scotland, **D. Taylor** reports on *Radio Vilnius*, Vilnius, Lithuania, U.S.S.R., which, he says, has an English transmission between 0000—0030 on a frequency in the 42 metre band.

Extensive frequency changes were made by *Radio Australia* (P.O. Box 428G, G.P.O. Melbourne, Australia) on October 24th. English transmissions affected are: To Southern Asia 2214—2345 on 15,220 and 1430—1730 on 9,570/7,220; to East Asia 0859—1000 on 11,810/9,570, 2059—2300 on 17,820/15,240, 2300—0015 on 15,240; to Mid Pacific Islands 0630—0915 on 11,710/9,570 and 1800—2115 on 9,600; to North Pacific Islands 0029—0645 on 15,240; to North America 0100—0345 on 17,840/15,220; to Africa 0400—0515 on 17,820/15,220.

The British Isles transmission on 11,710/9,570 moved to the new time of 0814—0915. French can now be heard at 2315—0015 on 17,820 and 0515—0615 on 11,710/15,180/15,220/17,820. Finally new frequencies for the 2245—2345 Indonesian transmission are 11,760/15,330/17,870. *Radio Australia's* programme for DX'ers may now be heard on Saturdays at 1930 and 2200, Sundays at 0500, 0900, 1300 and 1530, and Mondays at 0215.

A colourful QSL giving all verification details is issued free of charge by *Radio Warsaw*, Warsaw, to those who submit correct reception reports. Until April, Warsaw broadcasts in English to the British Isles as follows: 1830—1857, 1930—2000 and 2135—2155 on 6,135/7,125; 2030—2100 on 5,950/7,145; and 2230—2300 on 9,540/5,950 and 1,502 medium wave. Listeners' letters are answered on Thursdays during the 2030 and 2230 transmissions. You may also be able to pick up the Australian service which goes out from 0730—0800 and 0830—0900 on 15,120/11,840/9,675.

On November 1 the Swiss Broadcasting Corporation, Berne, put a new schedule into operation. It is valid until May 1st, 1965. Several quite sweeping changes are made including the switching of the British Isles transmission to the morning. It is now aired from 1200—1300 on 7,110/9,665. Other English transmissions are 0715—0845 to Japan and China on 9,670/11,865/15,305; 0900—1030 to Australia and South-east Asia on 0900—1030; 1315—1445 to India and

Why NOT BUILD ONE OF OUR PORTABLE TRANSISTOR RADIOS...

BACKED BY OUR SUPER AFTER SALES SERVICE

ROAMER SEVEN Mk III

5 WAVEBAND PORTABLE OR CAR RADIO
★ Now with PHILCO MICRO-ALLOY R.F. TRANSISTORS

Covers Medium and Long Waves, Trawler Band and two Short Waves to approx. 15 metres. Push-pull output for room filling volume from rich toned heavy duty 5in. speaker. Air spaced ganged tuning condenser. Ferrite rod aerial for M & L waves and telescopic aerial for S Waves. Real leather look case with gilt trim and shoulder and hand straps. Size 9 x 7 x 4in. approx. The perfect portable and the ideal car radio. (Uses PP3 battery available anywhere).
Total cost of parts now only **£5.19.6** P. & P. 5/6
Parts Price List and easy build plans 3/-

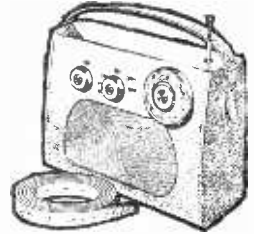

"... amazed at volume and performance... has really come up to the expectations."
S. G. Stockton-on-Tees.

● 8 stages—6 transistors and 2 diodes

Our latest completely portable transistor radio covering medium and long waves. Incorporates pre-tagged circuit board, 3in. heavy duty speaker, top grade transistors, volume control, tuning condenser, wave change slide switch, sensitive 5in. ferrite rod aerial. Push-pull output.

Wonderful reception of B.B.C. Home and Light, 208 and many Continental stations. Handsome leather-lock pocket size case, only 8 1/2 x 3 1/2 x 1 1/2 in. approx. with gilt speaker grille and supplied with hand and shoulder straps.
Parts Price List and Total cost of all **£3.9.6** P. & P. easy build plans 2/- parts now only 3/-

MELODY SIX

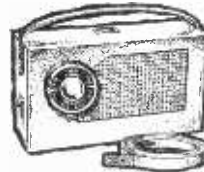

Wonderful reception of B.B.C. Home and Light, 208 and many Continental stations. Handsome leather-lock pocket size case, only 8 1/2 x 3 1/2 x 1 1/2 in. approx. with gilt speaker grille and supplied with hand and shoulder straps.
Parts Price List and Total cost of all **£3.9.6** P. & P. easy build plans 2/- parts now only 3/-

TRANSONA FIVE

"Home, Light, A.F.N., Lux. all at good volume"
G.P. Durham

● 7 stages—5 transistors and 2 diodes

Fully tunable over Medium and Long Waves and Trawler Band. Incorporates Ferrite rod aerial, tuning condenser, volume control, new type fine tone super dynamic 2in. speaker etc. Attractive case. Size 6 1/2 x 4 1/2 x 1 1/2 in.

Attractive case. Size 6 1/2 x 4 1/2 x 1 1/2 in. battery available anywhere.
Parts Price List and easy build plans 2/-

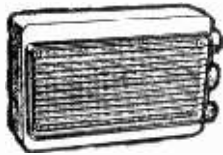

with red speaker grille. (Uses 12BR battery available anywhere).
Total cost of all parts now only **42/6** P. & P. 3/6

TRANSONA SIX

● 8 stages—6 transistors and 2 diodes

This is a top performance receiver covering full Medium and Long Waves and Trawler Band. High-grade approx. 3in. speaker makes listening a pleasure. Push-pull transformers for ample power. Ferrite rod aerial. Many stations listed in one evening including Luxembourg loud and clear. Attractive case in grey with red grille. Size 6 1/2 x 4 1/2 x 1 1/2 in. (Uses PP3 battery available anywhere).



Total cost of all parts now only **59/6** P. & P. 3/6
Parts Price List and easy build plans 2/-

POCKET FIVE

● 7 stages—5 transistors and 2 diodes

Covers Medium and Long Waves and Trawler Band, a feature usually found in only the most expensive radios. On test Home, Light, Luxembourg and many Continental stations were received loud and clear. Designed round super-sensitive Ferrite Rod Aerial and fine tone 2in. moving coil speaker, built into attractive black case with red speaker grille. Size 5 1/2 x 1 1/2 x 5/16 in. (Uses 12BR battery available anywhere).
Parts Price List and easy build plans 1/6.
Total cost of all parts now only **42/6** P. & P. 3/-

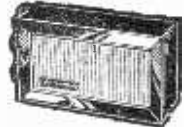

SUPER SEVEN

● 9 stages—7 transistors and 2 diodes

Covers Medium and Long Waves and Trawler Band. The ideal radio for home, car, or can be fitted with carrying strap for outdoor use. Completely portable—has built-in Ferrite rod aerial for wonderful reception. Special circuit incorporating 2 RF Stages, push-pull output, 3in speaker (will drive large speaker). Size 7 1/2 x 5 1/2 x 1 1/2 in. (Uses 1V battery, available anywhere).



Total cost of all parts now only **£3.19.6** P. & P. 3/6
Parts Price List and easy build plans 2/-

All components used in our receivers may be purchased separately if desired. Parts price lists and easy build plans supplied free with sets of parts or available separately at prices stated. Overseas post 10%.

ROAMER SIX NEW!!

★ NOW WITH PHILCO MICRO-ALLOY R.F. TRANSISTORS

● 6 WAVEBAND!!

● 8 stages—6 transistors and 2 diodes

Listen to stations half a world away with this 6 waveband portable. Tunable on Medium and Long waves, Trawler band and three Short Waves. Sensitive ferrite rod aerial and telescopic aerial for short waves. Top grade transistors, 3-inch speaker, handsome case with gilt fittings. Size 7 1/2 x 5 1/2 x 1 1/2 in. Carrying strap 2/- extra.

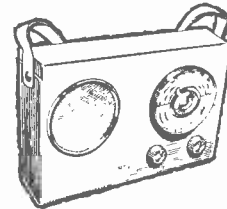

★ EXTRA BAND FOR EASIER TUNING OF LUX, ETC.
Parts Price List and Total cost of all easy build plans 2/- parts now only **£3.19.6** P. & P. 3/6

RADIO EXCHANGE CO.
61, HIGH STREET, BEDFORD. Phone: 2367

Callers side entrance
Barratts Shoe Shop
Open 9—5 p.m.
Sats. 10—12.30 p.m.



If you're thinking in terms of tape recording then the Brenell deck and complete recorders should be uppermost in your mind. The reliability, the versatility and the quality of manufacture are seldom equalled in other tape recorders (even in those costing much more).

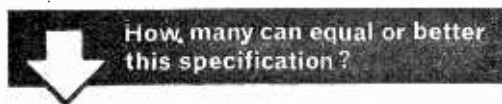

4 record/playback speeds $1\frac{7}{8}$, $3\frac{3}{4}$, $7\frac{1}{2}$ and 15 ips ● 3 motors ● low 'wow and flutter' content ● double-gapped ferrite erase head to minimise erase noise ● narrow-gapped record/playback head to give extended frequency response ● pause control ● superimpose control ● $8\frac{1}{4}$ " dia. reels ● fast rewind ● digital rev. counter.

MARK 5 Series 2 Deck

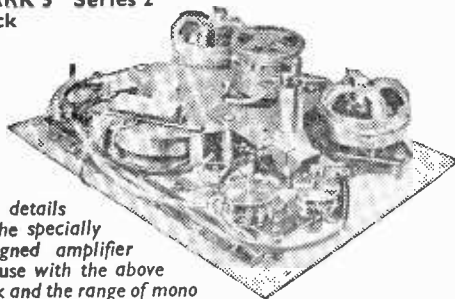

For details of the specially designed amplifier for use with the above deck and the range of mono and stereo recorders, write or telephone the sole manufacturers:



PLEASE NOTE
OUR NEW
ADDRESS:

BRENELL ENGINEERING CO. LTD.

231/5 Liverpool Road, London, N.1
Telephone: NORth 8271 (5 lines)

GD840



Do-it-yourselfers of all ages will welcome a Solon Electric Soldering Iron. The 25-watt model above, or 65-watt below, are ideal for radio work or household jobs.



Obtainable from your usual electrical or radio dealer from 24/8.

SOLON Electric Soldering Irons

11/64

LISTEN TO THE WORLD on TELSTAR our I-VALVE

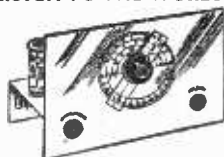

SHORT WAVE RADIO
Receives speech and music from all over the world. Price includes valve and one coil covering 40-100 metres. Can be extended to cover 10-100 metres. Can be converted to 2 or 3 valve and all-mains speaker use. Total Building Costs **35/-** P. & P. 2/-.

All parts available separately

READY TO USE POCKET RADIO

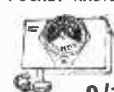

9/11
P. & P. 2/-.
Covers Medium waveband. No batteries needed. Complete with earpiece.

R.C.S. PERSONAL SET

Designed for personal listening without disturbing others. Supplied complete with battery and earpiece—no extras to buy! Sensitive one transistor diode circuit gives quality reproduction over medium wave band. Attractive case with large tuning dial. Ideal for use as tape tuner. Size only $3\frac{1}{2} \times 2\frac{1}{2} \times 1\frac{1}{2}$ in.



ONLY **27/6** P. & P. 2/-.

BATTERY ELIMINATORS

The ideal economical and safe way of running any TRANSISTOR RADIO, RECORD PLAYER, TAPE RECORDER, AMPLIFIER, etc. requiring voltages shown. Types Available: 9 v.; 5 v.; 4½ v. (single output). Size $3\frac{1}{2} \times 3 \times 1\frac{1}{2}$ in. PRICE 39/6 each. P. & P. 2/9. 9 v. + 9 v.; 6 v. + 6 v. or 4½ v. + 4½ v. (Two separate outputs). Size $3 \times 3 \times 2\frac{1}{2}$ in. PRICE 42/6 each. P. & P. 2/9. (Please state output required.)

All the above units are completely isolated from mains by double wound transformer ensuring 100% safety.

FOR THE CONSTRUCTOR

Easy to build CRYSTAL RECEIVER, 8/6. P. & P. 2/-.
Easy to build PERSONAL SET with earpiece, 27/6. P. & P. 2/-.
Easy to Build 3-TRANSISTOR SET with speaker, 37/6. P. & P. 2/-.

All parts available separately

R.C.S. PRODUCTS (RADIO) LTD.

11 Oliver Rd., London, E.17. (Mail Order only)
Export Trade Enquiries Invited

Africa on 9,535/11,865/17,845/17,795; 1500—1630 to Western North America on 15,305; 1500—1700 to the near and middle East on 9,535/9,665/11,865; and 0115—0245 to Eastern North America on 6,105/6,080/9,535. S.B.C.'s DX programme will as before be transmitted during Saturday's programmes.

An early morning 0600—0630 broadcast in English to Europe is now aired by the Canadian Broadcasting Corporation on 9,625. "Short wave listener's club" is now broadcast on Saturdays and

"Listeners' corner" on Sundays during the European transmission from 1215—1313. This is on 17,820/15,320.

Kol Israel, Jerusalem, Israël, has switched beams for its 2015—2045 English transmission. It now uses 9,625 to Europe and 9,009 to South Africa.

Finally a note on a fairly easy South American. *Radio Clube de Pernambuco*, Brazil, can be heard well on 11,865 after 2100. There is slight interference from the BBC on 11,862.

The Amateur Bands—by David Gibson G3JDG

THE Amateur Bands this month have proved quite interesting and DX has shone through here and there, although it has been a bit of a struggle at times.

160m

The first band out of the hat this month is "Top Band" and is proving to be very lively indeed. Some years ago when I was first licensed, "G" stations were the usual thing expected of the 1,800-2,000kc/s section.

By way of contrast one recent listening period of 30 minutes only logged GW3SUY (RST569), GW3TJE (569), G13JEX (579), OH3NY (569), and OK1AHB. Some 15—20 "G" stations were in evidence at the time, notable signals from "G's" 3ARD, 3SPJ, 3NTD, 3RBP and 6BX.

All were received on a dipole cut for 14,100 and just 15 feet high! Anyone with a decent aerial should be having a ball and American stations are rumoured to be roaming around top band. How about a postcard from you SWL's with a better antenna (or sharper ears)?

20m

From trawlers and top band out into the wild and woolly 20m. 14,000—14,350 is really hotting up these days and with the numerous contests which are in favour at the moment the band is really humming.

Newcomers might like to note that the band (as are all bands) is divided into two sectors, the CW sector and the Phone sector, the CW sector occupying the l.f. portion of the band. However there is no shortage of activity at either end of the 20m band at the moment.

The 1964 Scandinavian Activity Contest was very much in evidence and OH5SM, OH1VR, OH1QY, OH5NQ and OH0NI (Aaland Island) were worked in 14 minutes on a.m. 'phone. After this the novelty rather wore off, hearing the other station coming back "Ur 58082 73—CQ . . CQ . . etc."

Later in the month it was decided to check how popular single-sideband was by logging only stations using this mode of transmission in the 'phone sector of 20m. One sitting, over a period of 1½ hours resulted in some thirty stations logged on s.s.b.

"Twenty" at the moment dies out from about 01:00 onwards but from mid-afternoon till midnight it's a virtual hive of activity. Heard in one hour from 2045—2145: W9ECC, W1QCL, W2GWE, W4HCM/P, W0HLT, HB9NY, W9NWQ, W0QUU,

W8NKW, W9JT, VE3CB, W2KXL, W1HZ, W2SFP, W0VQ, K2UYG, CN8AX, W4HZR, K8LTT, W4ODL, CT1SQ, W4HZI, W8LXU, W3ZAO/MM (Maritime mobile), PY4AEB, SV0WGG (Crete) and K2YLM, all averaging five and eight except PY4AEB. All these with a dipole just 15ft high. Anyone with a beam hear anything else: JA—VK?

Speaking of VK, the VK/ZL contest might have afforded someone their first station from that part of the world, or was it the same as at G3JDG—rather quiet? At the time of writing the 'phone event has passed silently on but the c.w. event is scheduled for the coming weekend, needless to say the receiver is being checked and the dial polished in readiness.

15m

In the 15m band report last month I said that things at this QTH were rather dead. This brought a letter from K. J. Clark in London, N.15, reporting W2JY, G3CAZ, HL1JP, WA4YO, K1WPF and HL4OX, using an HE40 receiver acquired the day before, and the antenna a 30 foot vertical.

So there it is. There *are* stations about on 21 Mc/s so perhaps it's a question of what time to listen. K. J. Clark's times for the above list was the period 19:30—20:00.

40m

7000—7100 has been almost hopeless at the time of writing. Listening in the evenings from 1900 onward, European stations have appeared but the QRM from commercials (who have no right to be there anyway) makes it extremely difficult.

On one occasion a 9M call sign (Malaya) was located and read as 9M2L?? (either LD or LO or even LM), but due to terrific QRM from a commercial the station was lost. Remarks made at the time will not be repeated here!

A suggestion which might prove hopeful is that all licensed amateurs who run tests with the antenna connected, in future should do so on frequencies occupied by these stations. If this procedure were adopted on a world-wide scale it might well prove a success, especially if our friends in W-land joined in, since their licence permits them to run 1,000W as opposed to the British amateurs' 150W.

10m

Activity on the 10m band is still quite high. Local nets are very much in evidence still, though

—continued on page 786

TV & RADIO SHOW

Earls Court, August 24-September 5, 1964

"Practical Wireless" Report

★ A summary of new models seen at Earls Court and the trade exhibitions around London, and notes on design trends and features.

★ The tables list new models only and do not necessarily represent the complete range of the makers concerned.

★ For details of all the new TV sets, refer to the November issue of *Practical Television*.

CONTINUED FROM PAGE 640
OF THE NOVEMBER ISSUE

Last month, our Radio Show Report covered radiograms, transistor portables and table radios, leaving record players and tape recorders for comment this month.

Tape Recorders

This was perhaps the least novel market, makers concentrating more on general improvement than innovations. New models were shown by Dansette, Sound, Defiant, Ferguson, HMV, Ultra and the luggage makers, Wood and Son (Revelation), at Earls Court.

Outside the main show there was more variety from the many low-priced Japanese and German models to the very fine American design by Roberts shown by Argelane.

Those of most interest to enthusiasts were the newer Grundig offerings, including the TK32A at

49gns. which now includes a switch to cut out the automatic recording level circuit this firm brought in with a flourish originally.

The "automatic" facility has also been added to the two lower priced models, Auto-2 and Auto-4, 25 and 27gns., of the Elizabethan range, in a determined effort to capture the "pop" market. Similar circuitry can be incorporated in the new Sound range of five machines on demand at no extra cost, we are informed.

Of the Elizabethan offerings the two attractive newcomers were the stereo models LZ511 and

Model	Deck	Tracks	TAPE RECORDERS		Price	Features
			Speeds			
COSSOR 1606	Own	4	3 $\frac{1}{2}$		29 gns.	Transistorised. M/C Mic.
1607	Own	4	3 $\frac{1}{2}$, 1 $\frac{1}{2}$		57 gns.	Mono/Stereo Rec. and P/B Multiplay.
DANSETTE Empress	B.S.R.	4	7 $\frac{1}{2}$, 3 $\frac{1}{2}$, 1 $\frac{1}{2}$		37 gns.	Professional type control panel. Legs optional 7 in. spools.
DEFIANT T16	B.S.R.	4	3 $\frac{1}{2}$		38 gns.	Conso'ette
ELIZABETHAN LZ507	Own	4	7 $\frac{1}{2}$, 3 $\frac{1}{2}$, 1 $\frac{1}{2}$		49 gns.	Transistorised.
LZ511	Own	4	7 $\frac{1}{2}$, 3 $\frac{1}{2}$, 1 $\frac{1}{2}$		65 gns.	Stereo.
Auto-2	B.S.R.	2	3 $\frac{1}{2}$		26 gns.	Automatic Record.
Auto-4	B.S.R.	4	3 $\frac{1}{2}$		28 gns.	Automatic Record.
FERGUSON 3204	Thorn	4	3 $\frac{1}{2}$, 1 $\frac{1}{2}$		33 gns.	M/C Mic. Remote Sw.
3206	Thorn	2	3 $\frac{1}{2}$, 1 $\frac{1}{2}$		26 gns.	Key operation.
GRUNDIG TK23A	Own	4	3 $\frac{1}{2}$		49 gns.	Switched automatic.
TS19	Own	4	3 $\frac{1}{2}$		54 gns.	Wood case. Auto-stop.
HMV 2204B	Thorn	4	3 $\frac{1}{2}$, 1 $\frac{1}{2}$		36 gns.	8 x 5 ins. L/S.
KORTING MT3624	Own	4	7 $\frac{1}{2}$, 3 $\frac{1}{2}$, 1 $\frac{1}{2}$		95 gns.	Dubbing facilities. Fully stereo.
MARCONIPHONE 420.	Thorn	2	3 $\frac{1}{2}$, 1 $\frac{1}{2}$		25 gns.	Fast wind muting.
4204	Thorn	4	3 $\frac{1}{2}$, 1 $\frac{1}{2}$		33 gns.	Sync track replay. Auto control.
PHILIPS Stella	Not on show—see text for details.					
Peto Scott	Not on show—see text for details.					
REVELATION RT18	Collaro	2	7 $\frac{1}{2}$, 3 $\frac{1}{2}$, 1 $\frac{1}{2}$		42 gns.	To match R18 R/P.
ROBERTS (Argelane)	—	4	3 $\frac{1}{2}$, 7 $\frac{1}{2}$		£175	Stereo, two 5 x 7 in. speakers. Transportable.
SOUND TRE14	B.S.R.	2	3 $\frac{1}{2}$		24 gns.	5 $\frac{1}{2}$ in. spools.
TRE23	B.S.R.	4	3 $\frac{1}{2}$		30 gns.	DIN sockets (all models).
TRE32	B.S.R.	2	7 $\frac{1}{2}$, 3 $\frac{1}{2}$, 1 $\frac{1}{2}$		30 gns.	Auto-record (all models).
TRE34	B.S.R.	4	7 $\frac{1}{2}$, 3 $\frac{1}{2}$, 1 $\frac{1}{2}$		33 gns.	7 in. spools.
TRE40	B.S.R.	4	7 $\frac{1}{2}$, 3 $\frac{1}{2}$, 1 $\frac{1}{2}$		45 gns.	Separate tone controls. Mixing. Monitoring.
ULTRA 6202	Thorn	4	3 $\frac{1}{2}$, 1 $\frac{1}{2}$		33 gns.	Straight through amp. Remote control.

THE KEENESE TAPE RECORDER BARGAIN OF THE YEAR!



A 24 gns. Tape Recorder offered at the bargain price of only 15 gns. plus 10/- carr. Supplied in 3 Units already wired and tested. A modern Circuit for quality recording from Mike, Gram or Radio, using latest B.S.R. Twin Track Monardeck Type TD2. Valve line up—EF86, ECL82, EM84, EZ80 and Selenium Diode. Send for detailed list—3d. stamp.

Complete Kit comprising items below.

BARGAIN PRICE	15 Gns.	+10/- Carr.
2-tone Cabinet and 8in. x 5in. Speaker. Size 14in. x 10 1/2in. x 7 1/2in.	£3.10.0	+ 5/- Carr.
Wired Amplifier complete with 4 Valves, front Panel, Knobs, etc.	£5.12.8	+ 3/6 Carr.
B.S.R. Monardeck Type TD2	£7.7.0	+ 4/6 Carr.
Accessories: Mike, Tape, empty Reel, screened Lead and Plugs, Instructions, etc.	£1.0.0	+ 2/- Carr.

NEW BRITISH RECORDING TAPE

Famous Manufacturer. Bulk purchase, genuine recommended Tape Bargain. Unconditional Guarantee. Fitted Leader and Stop Foils (except 3in.).

Standard (PVC base)	Long Play (PVC base)	D'ble Play (Mylar base)
3in. 150ft. 3/8	225ft. 4/9	300ft. 6/6
6in. 600ft. 1/8	900ft. 15/-	1200ft. 25/-
6 1/2in. 350ft. 14/6	1200ft. 17/6	1800ft. 32/6
7in. 1200ft. 17/8	1800ft. 22/8	2400ft. 42/6

Post and Packing—3in. Reels, 6d. Each additional Reel, 3d. 4in. to 7in. Reels, 1/- Each additional Reel, 6d.

EMPTY TAPE REELS (Plastic): 3in. 1/3, 4in. 2/-, 5in. 2/-, 6in. 2/-, 7in. 2/3
PLASTIC REEL CONTAINERS (Cassettes): 3in. 1/3, 5in. 1/9, 5 1/2in. 2/-, 7in. 2/3

Condensers—Silver Mica. All values 2p/- to 1,000pF. 6d. each. Ditto. Ceramic 9d. Tub. 450V T.C.C. etc. 0.001 mFd to 0.01 and 0.1/350V. 9d. 0.02-0.1/500V. 1/- 0.25 Huns. 1/6. C5 T.C.C. 1/8, etc. etc. Close Tol. S/Micas—10% 3p/- 500pF. 9d. 500-5,000pF. 1/- 1% 2p/- 100pF. 9d. 100pF-500pF. 11d. 573pF. 5,000pF. 1/6. Resistors—Full Range 10 ohms-10 meg. ohms 30% 4 and 1/4 W. 3d. 1W. 5d. (Midjet type modern rating) 1W. 6d. 2W. 9d. Hi-Stab. 5% 1/4 W. 6d. (100 ohms-1 meg). Other values 9d. 1% 1/4 W. 1/8, etc. etc.

JASON FM TUNER UNITS
 Designer-approved kits of parts.
 FM71. 5 gns. 4 valves. 20/-
 FM72. £7. 5 valves. 35/- JTV
 MERCURY 10 gns. JTV £13.10.6
 4 valves. 25/6. NEW JASON FM
 HANDBOOK. 2/6. 48 hr. Alignment
 service. 7/6. P. & P. 2/6.

TRIMMERS. Ceramic (Compression Type)—30pF. 50pF. 70pF. 9d.; 100pF. 150pF. 1/3; 250pF. 1/8; 600pF. 1/9.
PHILIPS. Bee Hive Type (conc. air-spaced)—2-8pF. 1/-; 3-30pF. 1/9.

KNOBS—Modern Continental types Brown or Ivory with Gold Ring; 1" dia., 9d. each; 1 1/4" each; Brown or Ivory with Gold Centre. 1" dia., 10d. each; 1 1/4" each. LARGE SELECTION AVAILABLE.

METAL RECTIFIERS, STC Types— RM1, 4/9; RM2, 5/6; RM3, 7/6; RM4, 16/-; RM5, 21/-; RM4B, 17/6.

TUB-ELECTROLYTICS-CAN
 25/25v. 50/12v. 1/9; 8+8/450v. 4/6;
 50/50v. 100/125v. 2/-; 32+32/275v. 4/6
 8/450v. 4/350v. 2/8; 50/50/550v. 8/8
 18+18/450v. 5/6; 80/350/275v. 12/6
 32+32/450v. 6/6; 100+200/275v. 12/6

Volume Controls—5K-2 Meg. ohms. 3in. Spindles. Morganite Midjet Type 1 1/4in. diam. Guar. 1 year. LOJ or LLN. ratios less Sw. 3/-, DP. sw. 4/6. Twin stereo less Sw. 6/6. DP. Sw. 8/-, Specials to order.

WAVECHANCE SWITCHES. 1 p. 12-way, 2 p. 2-way, 3 p. 6-way, 3 p. 4-way, 4 p. 2-way, 1 p. 3-way, long spindle, 3/6 ea.

RECORD PLAYER CABINETS 59/6

Contemporary style, rexine covered cabinet in two-tone maroon and cream. Size 13 1/2" x 8 1/2", fitted with all accessories including baffle board and Vnair fret. Space available for all modern amplifiers and auto-changers etc. Uncut record, player mounting board 14 1/2" x 12" supplied.



2-VALVE 2 WATT AMPLIFIER
 EZ20 and Twin stage ECL82 with vol. and neg. feedback tone control. A.C. 200/250V with knobs, etc., ready wired to fit above cabinet. £2.17.6. P. & P. 1/6. 7" x 4" Speaker and trans., 2/- P. & P. 2/-.

COMPLETE R/PLAYER KIT. As ill. inc. BSR UA14 Unit. New Bargain Price Now Only £11.10.7. 7/6 carr. Double wound mains Tr. no live chassis.

BONDACOUST Speaker Cabinet Acoustic Wadding (lin. Chick approx.) 12in. wide, any length cut, 1/6 ft. 4/- yd. **TINNED COPPER WIRE.** 1lb. 22g. 2/6. **ERSIN MULTICORE SOLDER.** 60/40 3d. per yard. Cartons 2/6 etc.

TYGEN FRET (Contem. pat.) 12 x 12in. 2/-; 12 x 15in. 3/-; 12 x 2 1/2in. 4/-, etc.

EXPANDED ANODISED METAL. Attractive gilt finish. 4in. diamond mesh 4/8 sq. ft. Multiples of 6in. cut. Max. size 4ft. x 3ft. 47/6, plus carr.

ENAMELLED COPPER WIRE— 1lb. reels 14g-20g, 2/6; 22g-28g, 3/-; 30g-34g, 3/9; 36g-38g, 4/3; 39g-40g, 4/6, etc.



Est. 1949

MULLARD "3.3" HI-FI AMPLIFIER 3 VALVES 3 WATT

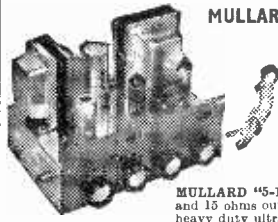

Hi-Fi quality at reasonable cost. Bass Boost and treble controls with 4-position selector switch. 40 ohm-100mV or 3V, less than 1% distortion. Bronze-escutcheon panel. Power take-off available. Complete Kit only £6.19.6. Carr. 5/-.

Wired and tested 8 gns.
MULLARD "45-10" AMPLIFIER. 5 valves 10W 3 and 15 ohms output. Mullard's famous circuit with heavy duty ultra-linear quality output transformer. Ready built £11.19.6.
£9.19.6
 Carr. and Ins. 7/6.

CONTROL PANEL KIT. Bass. Treble and Volume controls with 4-position selector switch and 11in. x 4in. escutcheon panel, £2.5.0. Carr. 2/6.
AMPLIFIER KIT AND CONTROL PANEL KIT. £11.19.6. Ditto, ready wired, £14.10.0.
2-VALVE PRE-AMP. UNIT. Based on Mullard's famous 2-valve (2xEP86) circuit with full equalisation, with volume, bass, treble and 5-position selector switch. Size 9" x 4" x 2 1/4". Complete Kit £5.19.6. Carr. 3/6.

6 VALVE AM-FM TUNER UNIT
 Med. and VHP 190 M-550 M, 85Mc/s-103Mc/s. 6 valves and metal rectifier. Set contained power unit. AC 200/250v. operation. Magic eye indicator, 3 push button controls, on/off. Med., VHP diode and high output sockets with gain control. Perspex front panel 11 1/2in. x 4in. with 7in. illuminated dial. Overall size 11 1/2in. x 4in. x 5 1/2in. A recommended Fidelity Unit for use with Mullard 3-3 5-10 amplifiers. Available only at present as built-up units, aligned and tested ready for use. Bargain price £12.10.0. Carr. 5/- Available shortly in Kit Form at approximately 10 gns.

DE-LUXE RECORD PLAYER KIT



Incorporating 4 Sp. Garrard Auto-Stop unit and Mullard latest 3 watt printed circuit amplifier (1X1, 36 and EZ 80), vol., bass and treble controls with 8" x 5" 10,000 line speaker. Contemporary styled 2-tone cabinet, charcoal-grey and off-white with matching blue relet. Size 17 1/2" x 18" x 8". A stylish unit capable of quality reproduction. Circuit and const. details 2/6 (free with kit)
COMPLETE KIT £13.19.6
 Carr. and ins. 10p. extra.
 Illuminated perspex control panel escutcheon 7/6 extra. Ready wired 30/- extra. Four contemporary mounting legs (6" or 13") 12/6 per set.

TRANSISTOR COMPONENTS

Midjet I.P.s—485 Ec/s 9/15in. diam. £1.10.0/5/8
 Osc. Coil M. & L.W. £1.10.0/5/8
 Midjet Driver Trans 3.5:1... 6/9
 Midjet Output Trans. Push-Pull—3 ohms... 8/9
 Elect. Condensers—Midjet Type 1 mFd-.50 mFd. ea. 1/8, 100 mFd. 2/-, 12V.
 Condensers 150 p. working: .01 mFd., .02 mFd., .03 mFd., .04 mFd., .05 mFd., .1 mFd., 1/- .25 mFd., 1/3; .5 mFd., 1/6, etc. Midjet Tuning Condensers. J.R. "OC" 208 pF and 175 pF. 8/6, ditto with trimmers, 9/6. J.R. 220 pF and 105 pF conc. slow motion 10/3. 365pF single 7/6. Sub. min. 4in. Dileum 100 pF. 300pF. 500pF. 7/6, each.
FERRITE AERIALS, M. & L.W.
 car aerial coil 9/3
 Midjet Vol Control with edge control knob, 5 K ohms, with switch 4/8; Ditto less switch 3/8. Speakers—E.M., 2in. Plessey 7/6 ohms 15/8, 2 1/2in. Continental 8 ohms 13/8, 7 x 4in. Plessey 3/6 ohms, 2/6.
 Ear Plug Phones—Min. Component type 3ft. aux., jack plug and socket. High Imp., 8/- Low Imp., 7/6.
 Brand New Mfrs. 1st grade, 1 OC4 & 2 OC45, 15/6, 1 OC8D 3 OC81, 5/6/8. All above and O.A.N. 32/6. Post Free.

7 VALVE AM/FM RADIOGRAM CHASSIS

Valve line-up ECC85, ECH81, EF89, EAB80, EL84, EM81, EZ80. Three Waveband and Switched Gram positions. Med. 200-550 m. Long 1,000-2,000 m. VHF/FM 88-95 Mc/s. Philips Continental Tuning Insert with permeability tuning on FM and combined AM/FM IF transformers. 400 Kc/s and 1.67 Mc/s. Dust core tuning all coils. Latest circuit including AVC and Neg. Feedback. Three watt output. Sensitivity and reproduction of a very high standard. Chassis size 13 1/2 x 6 1/2in. Height 7 1/2in. Edge illuminated glass dial 11 x 8 1/2in. Vertical position. Horizontal station names. Gold on brown background. A.C. 200/250v. operation. Magic-eye tuning. Circuit diagram now available. Aligned and tested ready for use £13.10.0 Carr. & Ins. 7/6
 Complete with 4 Knobs—wired or ivory to choice. Inlud. FM aerial 3/6 extra. 3 ohm P.M. Speaker only required. Recommended Quality Speakers 10in Elac H/D, 30/-; 13 1/2 x 8in. E.M.I. "Fidelity". 35/-; 13in. R.A. with cont. Tweeter, 42/6. Carr. 2/6.

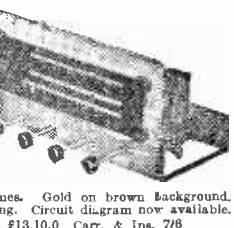

We manufacture all types Radio Mains Transl., Chokes, Quality O/P Trans., etc. Enquiries invited for Specials. Prototypes for small production runs. Quotations by return. Send for bargain list, 3d. stamp.
RADIO COMPONENT SPECIALISTS
 70 Bristock Road, Thornton Heath, Surrey. Hours: 9 a.m.—6 p.m. 1 p.m. Weds. THO 2158. Terms C.W.O. or C.O.D. Post and Packing up to 1 lb. 9d.; 1 lb. 1/3; 3 lb. 2/3; 5 lb. 2/9; 8 lb. 3/6.

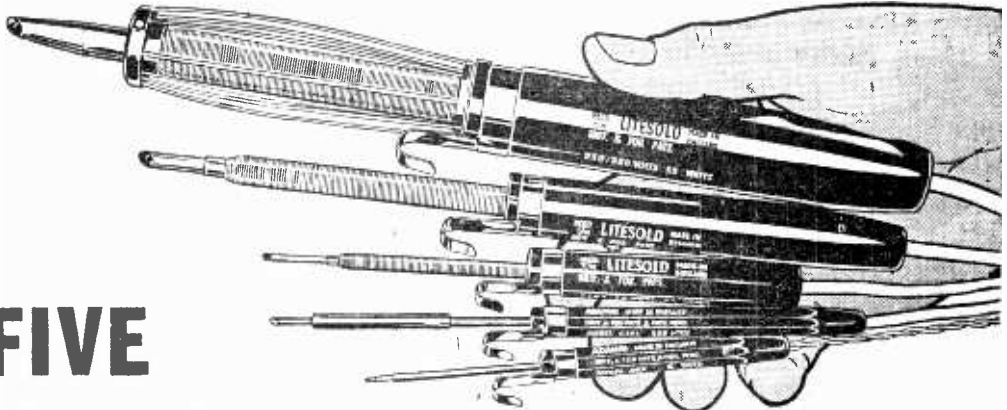

FIVE AGES!

This is a hand that can't be beaten. Five models from our tremendous range of soldering instruments. Superb performance. Amazingly compact. Developed to simplify YOUR soldering. Copper bits for greatest speed. Permatip bits for long life. May we deal you in?

Brochure P.W.10 post free on request

LIGHT SOLDERING DEVELOPMENTS LTD., 28, Sydenham Road, Croydon, Surrey
Telephone: CROydon 8589

THE 'REALISTIC' 7

Transistorised Portable Receiver made to the highest professional standard. Comprises 7 Mullard Trans. plus Crystal Diode, 350 milliwatt output to 4in. speaker.—I.F. frequency 470 Kcs—fully tunable over medium and long wavebands. Two-tone plastic cabinet with handle—size 7 x 10 x 3 1/2 in. fitted socket for car aerial. Complete with full instructions.

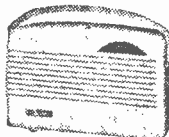

MAY BE BUILT FOR £5.19.6 All parts sold separately
Battery 3/9 extra

P. & P. 4/6 extra. (Circuit diagram 2/6, free if all parts bought.)
Also De Luxe Model with superior PVC covered wood cabinet and full view tuning dial.

ONLY £1 EXTRA All parts sold separately.
Battery 3/9 extra. P. & P. 4/6

T.V. POWER PACK

Takes a PY32 or 33. Contains: Filament transformer and smooth choke, mains dropping resistor, Btmistor, smoothing capacitor 100-200-16-16mfd. 275V/w. 350V surge. Also 16-16 mfd. 275V/w and sundry capacitors, resistors, etc. On metal chassis, size 6 x 4 1/2 in. x overall height 5 1/2 in. No circuit available.

WIRECOMP'S 12/6 valve 23/6 valve 3/6

SUPER AMERICAN TAPE

LAFAYETTE BRAND. FULLY GUARANTEED

MYLAR BASE	ACETATE BASE
5in. Double play, 1,200ft. 15/-	5in. Long play, 900ft. 10/-
5 1/2in. Long play, 1,200ft. 15/-	6 1/2in. Long play, 1,200ft. 12/6
5 1/2in. Double play, 1,300ft. 22/6	7in. Long play, 1,800ft. 15/-
7in. Stand. play, 1,200ft. 12/6	
7in. Long play, 1,800ft. 15/6	MESSAGE TAPES
7in. Double play, 2,400ft. 25/-	3in.—150ft. 3/6
3in. Triple play, 450ft. 12/6	3in.—225ft. 4/11
4in. Triple play, 900ft. 22/6	3in.—300ft. 7/6
5in. Triple play, 1,800ft. 42/6	
5 1/2in. Triple play, 2,400ft. 55/-	P.V.C. BASE
7in. Triple play, 3,600ft. 75/-	5in. Standard play, 600ft. 8/6
P. & P. 1/- extra per reel.	5 1/2in. Stand. play, 840ft. 11/6

4 reels and over Post Free.

WIRECOMP ELECTRONICS

378 HARROW ROAD, LONDON W9

TEL: CUNNINGHAM 9530

Hours of business: 9 a.m. to 8 p.m. Open all day
Saturday. Opposite Paddington General Hospital
Buses 18B and 36 pass the door.

Ready Built BOY'S TRANSISTOR RADIOS

2 transistor pocket radio. In plastic case. Size only 4in. x 2 1/2 in. x 1 1/2 in. Fitted with 2 1/2 in. speaker. Socket for personal earpiece. Works from PP3 type batt., tunable over full medium waveband. Supplied comp. with earpiece, carrying purse and 9-Volt batt. Ideal Birthday present. **WIRECOMP'S 42/-** Post Free

6 transistor model available 69/6 Post Free.

NEW SUPER MINIATURE POCKET RADIOS



THE SINCLAIR MICRO-6. Self-contained pocket radio. Size only 1 1/2 x 1 1/2 x 1/2 in. A marvel of modern miniaturisation—truly amazing performance. May be built in an evening. Complete with earphone and detailed construction data.

Can be built for only **59/6**
Mercury cell 1/11 extra (2 required).

THE SINCLAIR SLIMLINE. The new 2-transistor pocket radio size only 2 1/2 in. x 1 1/2 in. x 1 1/2 in. Micro alloy transistorised and printed circuit. All components available separately. Easy to assemble. **Can be built for 49/6**

THE TRANSIGRAM

A portable battery operated fully transistorised Record Player. Made by famous British manufacturer, fully guaranteed. Size 6 1/2 x 12 x 10 1/2 in., weight 10lbs. Operates on 6 U2 bats. 4 speeds—18", 33", 45 and 78 r.p.m. Goldring's cygnet player unit with light weight pick-up fitted with CM-69 turn over ceramic cartridge. Output 500 mw to 5 in. ceramic magnet speaker fitted into lid. Cabinet constructed of wood, covered in two tone (pale blue/grey) leather cloth. High quality amplifier with tone and vol. controls gives excellent reproduction. Plays 7, 10 and 12in. records.
Today's Value 12 Gns.
WIRECOMP'S £6.19.6
Carr. & Ins. 7/6.
New, boxed and guaranteed—ex. bats.



Transistorised TELEPHONE AMPLIFIER

Powerfully amplifies the incoming call and leaves you with both hands free while continuing your conversation normally. Pick-up is suction fixed to phone. Battery-operated at negligible cost. Fitted off switch for private conversation. Size 4 1/2 x 3 x 1 1/2 in. Complete with battery.
WIRECOMP'S PRICE 69/6 P. & P. 2/6.

Model	Player Unit	Price	Notes
ACE AP631	BSR UA15	19½ gns.	7 x 3½ in. L/S. 2W o/0.
ALBA 212B	BSR UA14	16 gns.	7 x 4 in. L/S.
DANSETTE Imperial	BSR Transcription	30 gns.	Separate tone controls. Diamond stylus. 9½ x 5½ in. speaker. 8W push-pull amplifier. Detachable legs.
DECCA RP205	Garrard AT5	32 gns.	Deram stereo cartridge. 8 x 5 in. speaker.
DEFIANT CPI	Garrard AT5	38 gns.	Part of Unit-plan, Consolette. Stereo facilities, less second speaker.
DYNATRON GR10	Garrard AT6	39 gns.	10 x 6 in. L/S. 5 watts push-pull output from 3-stage amplifier. Ronette cartridge, diamond stylus.
EKCO RP432	Garrard	27 gns.	Independent tone controls. Adaptable for stereo
FERRANTI RP1106	BSR UA15	27 gns.	7W output. Straight-through amplifier.
RPI105	Garrard	19 gns.	7 x 4 in. speaker.
FALCON Falcon	BSR UA16	14 gns.	2-valve amplifier.
FERGUSON 3006	Garrard AT5	27 gns.	Transistorised. Mic. input.
FIDELITY HF27	BSRUA25	15 gns.	—
HF28	BRS	24½ gns.	9 x 6 in. and tweeter L/S.
HACKER GP40	Garrard SP25	65 gns.	Consolette. Version of Serenade gram. less radio unit.
KOLSTER-BRANDES KP031	Garrard Autoslim	19½ gns.	Transistorised. 7 x 3½ in. L/S.
KP032	Garrard AT5	23½ gns.	Transistorised. 7 x 3½ in. L/S.
MARCONIPHONE 4006	BSR UA15	24 gns.	Transistorised. Mic. input.
MURPHY A-Major A851G	Garrard AT5 p	34 gns.	3W push-pull. 8 x 6 in. L/S and 4-in. tweeter. Sonetone head.
HMV 2010	Garrard AT5	45 gns.	Transistorised. Two side-mounted 8 x 5 in. speakers. Two tweeter.
PAM 5205	Garrard Autoslim	18 gns.	7 x 4 in. speaker
5206	BSRUA15	25 gns.	7W output. Separate tone controls.
PERDIO Deejay	BSR UA15	14 gns.	—
Startime	BSR UA15	17 gns.	Transistorised.
Starmaker	BSR UA15	19 gns.	Transistorised.
PYE Achoic	BSR UA15	69 gns.	Transistorised. Stereo. 6 loudspeakers. Butterfly head. 5W each channel.
Transistor Black Box	BSR 4-speed	41 gns.	Transistorised version of popular range.
REVELATION AP18	BSR UA15	28½ gns.	Impact cabinet. Stereo adapted. 6W p-p amp. 8 x 5 in. L/S. Separate tone controls.
R18	BSR UA14	23 gns.	Styled to match RT18 tape recorder.
REGENTONE TP431	Garrard Autoslim	19½ gns.	Transistorised.
TP432	BSR UA15	23½ gns.	Transistorised. Separate tone controls. Pilot lit.
RGD RP231	Garrard Autoslim	19½ gns.	Transistorised.
RP232	Garrard 3000	23½ gns.	Transistorised.
STELLA 571A	Philips. 4-sp.	27 gns.	Thermometer-type scale indicators.
ULTRA 6004	BSR UA15	15½ gns.	2½W output. 7 x 4 in. L/S.

LZ507. The former is an Anglicised version of their very successful American export with 6W output and two detachable speakers, while the latter is a fully transistorised mains model selling at only 49gns. with three speeds and two recording level meters.

Fidelity again showed established models and added their name to the list of those making a debut into stereo radiograms.

Record Players

Transistorisation, with its attendant advantages of instant operation, cooler running and claimed greater dependability, as well as an obvious weight saving, makes the record player market again newsworthy.

It was pleasing to note one subsidiary feature of this trend—the smaller, cheaper mains transformer could now be fitted on all models requiring the low power consumption of the “solid state” circuit and, consequently, the dangerous a.c./d.c. chassis was much less in evidence.

Common features were the front-facing speaker of generous proportions, more comprehensive tone control systems, provision of a tape socket (despite the strong copyright law against its use!) and input arrangements that allowed the record player to be employed as a straight-through amplifier, some makers featuring this as a speciality by also providing a microphone.

Lighter pick-ups, improved versions of the popular mechanisms and common provision of a stereo cartridge are to be found even in quite modest price brackets.

The new **Thorn** deck was much in evidence, being incorporated in models by Ferguson, HMV, Marconi, Ultra and the **Retra** “Five-Star”.

Kodak made news with a quadruple-play tape, type P400, made for portable battery tape recorders, on 3in. spools (or 3½in.) at £1 13s. 6d. and £2 2s. for 600ft and 800ft respectively, giving a playing time for an 800ft spool of 42min. at 3½in./sec.

One or two specialities made an impact, including the **Pye Achoic**, claimed to be the smallest truly stereo unit of quality performance. Side-mounted banks of two-plus tweeter speakers bounce the sound from adjacent walls. The deck uses the “butterfly” pick-up now widely employed by this company which tracks at only two grams but has a floating action, enabling the stylus to keep its groove, even on a warped record or under sudden shock.

Several newcomers to this field were noted. **Sound**, the Tape Recorder (Electronics) people, had a record player on show, as did **Perdio**, better known for portable radios, **Arnolds (Arts) Ltd.**, **Sanders (Electronics)** and **Robuk**.

Among those of particular interest outside Earl's Court was a stereo portable, battery-powered record player with hi-fi stereo headphones by **S. G. Brown**, marketed by **Lugton's**. With the addition of baffle speakers in matching shoulder bags this three-speed player at 32gns., plus 7gns. for the phones, makes a notable return to domestic entertainment for this firm.

PART 3—TRANSISTOR VOLTAGE AMPLIFIERS

Understanding SEMICONDUCTORS

BY LESLIE MOORE

CONTINUED FROM PAGE 666 OF THE NOVEMBER ISSUE

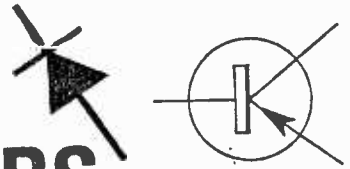

THE basic requirement of an amplifier is to make some electrical signal larger. The "voltage swing" or peak to peak voltage of the input signal should be known to enable the design of an amplifier. The frequency range of the input signal is also of great importance.

Input signals to transistor amplifiers are usually applied across the base-emitter terminals. The output is taken from the collector and emitter.

It was seen that the base current necessary to operate a transistor is in the order of microamps and a variation of a few μA base current produces a variation of mA collector current.

Consider the circuit in Fig. 19—B1 and R in series provide the emitter-base voltage, B2 and R' in series provide the collector-emitter voltage.

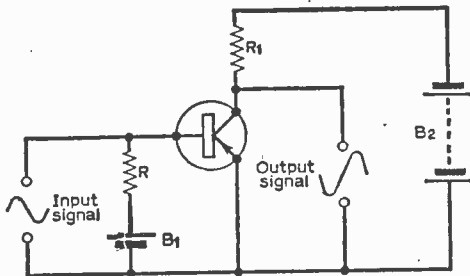

Fig. 19: Illustrating the principle of the transistor voltage amplifier.

Upon the application of a small alternating voltage signal across the base and emitter the collector current will also alternate. A rise of the input voltage will result in a decrease of collector current, a fall in input produces a collector current rise.

Assume the input signal voltage variation to be 0.1V causing a collector current swing of, say 10mA. A value of 500 Ω for R' would produce a voltage swing across R' of 10mA x 500 Ω = 5V by Ohm's law. This is the principle of the voltage amplifier.

There are several disadvantages, however, with the circuit in Fig. 19 and a more practical circuit is shown in Fig. 20. Only one battery is used in the circuit and the base-emitter bias has been

achieved by the inclusion of two additional resistors and a capacitor.

The values of components may be obtained simply with the aid of the transistor static characteristic curves and a knowledge of the current flow directions in the circuit. The current directions marked in Fig. 20 are those of hole conduction. R₁, R₂, R₃ and C provide the base-emitter bias.

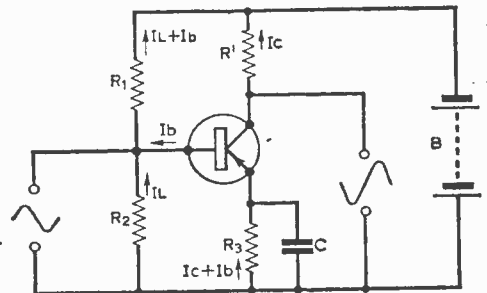

Fig. 20: Illustrating hole conduction in a p-n-p transistor voltage amplifier.

To obtain the static value of collector current a "load line" must be drawn on the output characteristic curves.

The position of the load line depends on two factors:

- (1) the value of supply voltage;
- (2) the value of R'.

Two points, one on the Vce axis and the other on the Ic axis of the output characteristic graph provide sufficient information to allow the construction of the load line.

When no current flows through the transistor (cut off) no current will flow through R' or through the emitter-resistor R₃, therefore the value of Vce is equal to the supply voltage. This point can be plotted on the Vce axis when the collector current is equal to zero.

For maximum collector current flow the transistor will be virtually a short circuit so that the whole supply voltage will be seen across R'.

From Ohm's law, maximum value of current is given by $\frac{V_s}{R'}$ amps.

TRADE ENQUIRIES
INVITED

RADIO CLEARANCE LTD.

Telephone: MUSEUM 9188
EST. 35 YRS.

THE OLDEST COMPONENT SPECIALISTS IN THE TRADE
27 TOTTENHAM COURT ROAD, LONDON W.1



"THE MINIGRAM"— LIMITED QUANTITY ONLY

Don't miss a chance like this!

Transistorised Record Player

FEATURES

- ★ Ready-built amplifier with four first-grade Mullard transistors.
- ★ Plays 45R.P.M. pop records.
- ★ Built-in automatic stop.
- ★ Lightweight and portable.
- ★ Instruction leaflet supplied.
- ★ Crystal pick-up with expendable Stylus, GP50 Type.
- ★ Operates from a 9V battery (3/9 ext.)
- ★ Available in two colours—cream/red or cream/blue.

- ★ A real "FAMILY FAVOURITE".
 - ★ Ideal for Teenagers.
 - ★ For use ANYWHERE.
 - ★ Hours of amusement for the younger members of the family.
 - ★ Assemble one of these amazing Players in less than 30 minutes, supplied in 3 complete units with only 10 connections to make.
- Approximate dimensions 9 3/4" x 4 1/4" x 4 1/4".

- A** Motor and pick-up deck.....(2/6 P. & P.) **39/6**
- B** Ready-built 4-transistor amplifier, complete with volume control and L'speaker (2/- P. & P.) **35/-**
- C** Portable two-tone case with handle, and expanded metal fret.....(2/- P. & P.) **5/-**

ONLY **79/6**

the complete Pckgs. (plus 5/- P. & P.) or any unit sold separately.

Loudspeaker Bargains Still Available

Enormous purchases of Brand New and Guaranteed Plessey loudspeakers enable us to offer these units at **THE LOWEST PRICES EVER!** Don't miss this golden opportunity to obtain a first-grade permanent-magnet **Loudspeaker** off the production line at **LESS THAN THE MANUFACTURER'S COST!** Read carefully the prepared list below and choose just the right speaker for the job—**COMPARE THE PRICES ANYWHERE!** **SELLING FAST—STOCKS CHANGING RAPIDLY.**

SCHEDULE OF LOUDSPEAKERS AVAILABLE

Diameter in inches	Gauss in lines	Imped. in ohms	Price	Diameter in inches	Gauss in lines	Imped. in ohms	Price	Diameter in inches	Gauss in lines	Imped. in ohms	Price	Diameter in inches	Gauss in lines	Imped. in ohms	Price
2	7000	80	8/-	2 1/2	9500	3	10/6	4 Twtr.	10000	3	11/6	5	9500	8	10/6
2	7000	35	8/6	3 1/2	9500	8	10/6	5	9500	15	12/-	5	9500	8	10/6
2 1/2	7000	50	8/6	3 1/2	7000	35	8/6	5	6000	3	8/-	5	9500	15	12/6
2 1/2	7000	80	8/-	3 1/2	9500	50	10/6	5	6000	5	8/-	5	8500	25	10/6
3	8500	3	10/-	4	7000	25	11/6	5	7000	5	8/6	5	9500	35	11/6
3	6000	9	8/6	4	6000	35	10/6	5	7000	5	8/6	6 1/2	7000	3	11/-
3	7000	5	9/-	4	7000	35	11/-	5	7000	3	9/-				
3	7000	35	9/-	4	9500	35W	11/6	5	8500	3	9/6				

Elliptical Size	Gauss in lines	Imped. in ohms	Price	Elliptical Size	Gauss in lines	Imped. in ohms	Price	Elliptical Size	Gauss in lines	Imped. in ohms	Price	Elliptical Size	Gauss in lines	Imped. in ohms	Price
5 x 3	6000	3	7/6	7 x 3 1/2	9500	3	10/6	8 x 2 1/2	7000	5	9/-	8 x 2 1/2	8500	5	9/6
5 x 3	6000	3	7/6	7 x 4	9500	3	11/-	8 x 2 1/2	9500	5	10/6	8 x 2 1/2	9500	5	10/6
5 x 3	7000	3	8/-	7 x 4	10000	3	12/6	8 x 2 1/2	10000	5	13/6	8 x 2 1/2	9500	4	10/-
5 x 3	9000	3	8/6	7 x 4	10000	15	13/6	8 x 2 1/2	9500	30	12/6	8 x 2 1/2	9500	5	10/-
5 x 3	9500	35	11/-	7 x 4	9500	30	12/6	8 x 3	8500	3	11/-	8 x 3	8500	3	11/-
				8 x 2 1/2	6000	3	8/6	8 x 5	10000	3	18/-				

ALLOW 2/- each Speaker for postage and packing, and please specify the exact requirements—the nearest available will be sent.

BOTH SETS STILL AVAILABLE HERE!

Ask for a demonstration in the shop.

"CAPRI"

Sensitive!
Super-selective!
Superb

Speaker!

NOW ONLY **79/6**

(2/- P. & Pkg.)
Pocket Superhet
MW and
Droitwich LW
Size 4 1/2 x 2 1/2 in.
Constructional data 1/9 Post free.



The best and easiest transistor built-yourself sets available.

Send S.A.E. for FREE PARTS LIST 6 First Grade MULLARD Transistors Diode(s) and all components BRAND NEW and GUARANTEED

Choice of a dozen stations in daylight ...

THE "CONTESSA"

"QUEEN OF THEM ALL"

To clear existing stock

ONLY **£7.19.6**

(3/6 P. & PKG.)

PORTABLE and CAR RADIO 2 WAVEBAND SUPERHET Construction manual 2/10 Post Free.

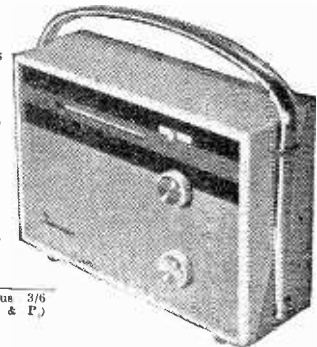

Inclusive price for all associated components, case, battery and Instruction Book complete in every detail. ANY PARTS SOLD SEPARATELY ON THE BUILD-AS-YOU-BUY SCHEME

CONTESSA Battery 5/6 extra, **£7.19.6** (plus 3/6 P. & P.)
CAPRI Battery 2/6 extra, **79/6** (plus 2/- P. & P.)

SELECTED BARGAINS

Beautifully geared AM/FM 2 gang Condensers, 4/6; AM/FM IPT'S 465 kc/s and 10.7 Mc/s, 4/6 pair; Magnavox Crystal Tape Recorder Mikes, 12/6 set; 3 watt Stereo Amplifiers, complete, ready to switch on, 79/6; PHONES—OAT9, OA9, CA9H, GD10, 2/- each. Sentercel rectifiers R3/2D-D3/2/V, 2/6 each. TRANSISTORS: OC45, 4/6; EXA101, 3/9; AF115, 4/6. Sub min. Germanium diode 1/3, M1 diode, 6d, each. Silicon diodes, 200 p.i.v., 200 mA 1/- each, 400 p.i.v., 330 mA, 2/6 each.

Please send STAMPED and ADDRESSED envelope with any enquiry. We reserve no catalogues—our stocks move too quickly! Kindly make provision for additional postage and packing charges to avoid delay. Terms: Cash With Order or C.O.D. on Orders over 10/-.

FOR THE FIRST TIME

Plug-in ELECTROLYTIC CAPACITORS

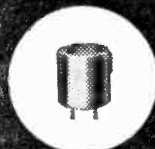
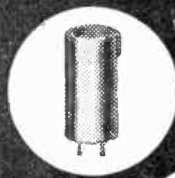

SMALL • FULLY ENCAPSULATED • PLASTIC CASED

These new T.C.C. small plastic-cased electrolytic capacitors have been specially developed for vertical mounting on printed circuit boards, and are designed for operation at temperatures from -20°C to $+60^{\circ}\text{C}$. Three case sizes are available in rated voltages up to 50V. The standard

LOW LEAKAGE CURRENT & LONG LIFE—assured by fully automatic winding of elements, avoiding handling of electrodes by operatives.

TERMINATIONS OF STEEL CORE

COPPER WIRE—specially solder coated for fast, ripple soldering technique.

tolerance of the range is -20% $+100\%$ of rated capacitance. The anodes are of super-purity aluminium, with all-welded internal connections. A special electrolyte ensures low impedance at all frequencies in the audio range.

QUICKER ASSEMBLY

Steel cored wire gives precision acceptance of capacitors when inserting into punched printed boards.

QUICKER IDENTIFICATION

Colour coding and embossed values enable instant selection of the right capacitance and voltage.

HIGHLY COMPETITIVE PRICES

Full full details please write for Technical Bulletin No. 102

THE TELEGRAPH CONDENSER CO. LTD.

NORTH ACTON, LONDON W.3 · Telephone: ACOrn 0061 (16 lines) Telegrams: Telefarad, Wesphone, London. Telex: 26J381
(also at) CHESSINGTON, SURREY · BATHGATE, SCOTLAND

BUY AND BUILD STAGE BY STAGE

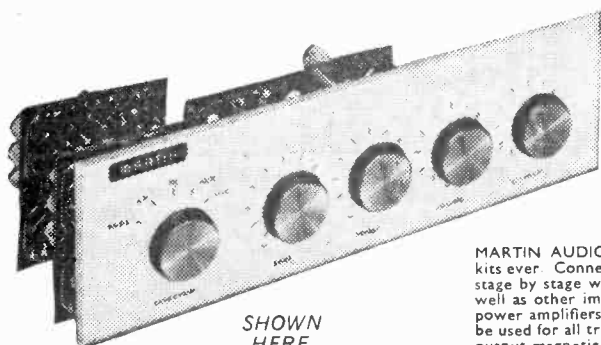

SHOWN
HERE

FROM A MONO AMPLIFIER TO
A 20 WATT INTEGRATED HI-FI
STEREO ASSEMBLY

★ FULLY TRANSISTORISED PRE-FABRICATED ADD-ON UNITS.

★ PROFESSIONAL STANDARDS OF PERFORMANCE AND APPEARANCE.

5-stage selector. Tone Control and Pre-amp Stages in Stereo complete with attractive escutcheon. This with two amplifiers and power supply comes to well under £30.

MARTIN AUDIOKITS are the most efficient and imaginatively designed kits ever. Connections are arranged to enable you to expand your assembly stage by stage with ease. The range includes: a unique 3-channel mixer as well as other important pre-amplifier stages, and you can choose 10 watt power amplifiers with either 3 or 15 ohms output. Martin equipment can be used for all true hi-fi requirements, including to-day's very best low-output magnetic pick-ups. Power pack Units are also available.

IMPORTANT
NEW LEAFLET

The new MARTIN AUDIOKIT Leaflet details in full the entire range of units. No one wishing to build all-transistor hi-fi should be without this information.

MARTIN
Audiokits

MARTIN ELECTRONICS LTD.
154/5 High St., Brentford, Middlesex. Phone 15Leworth 1161/2

MARTIN ELECTRONICS, 154 HIGH ST., BRENTFORD, MD'SEX.
Details of all MARTIN AUDIOKITS please

NAME

ADDRESS

BLOCK LETTERS

P.W.12

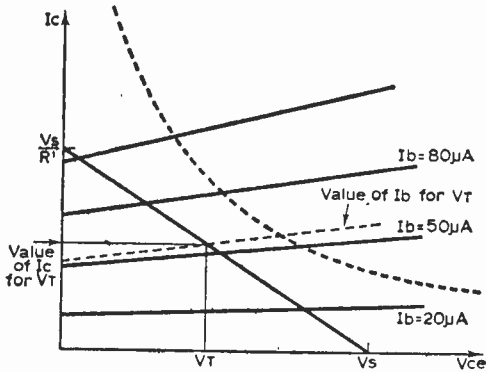

Fig. 21: Use of the load line for obtaining circuit parameters. The dotted line represents the power limitation curve set by the manufacturer.

A suitable working value of collector-emitter voltage is chosen (V_T in Fig. 21), and hence a value of base current and collector current from use of the load line.

The voltage drop across R_1 is calculated, again, by Ohm's law:

Voltage drop = $I_c \times R_1$ volts
 V_T is known

Therefore the voltage across R_3
 $= V_s - [(I_c \times R_1) + V_T]$.

From the appropriate input characteristic curve for the transistor (I_b against V_{be}), a static value of V_{be} may be obtained.

The voltage drop across R_2 must then be the voltage drop across R_3 less V_{be} .

i.e. Voltage drop = $[(R_3 \times (I_c + I_b)) - V_{be}]$.

By choice of a suitable value of I_L , a value of R_2 could then be calculated from:

$$\frac{[(R_3 \times (I_c + I_b)) - V_{be}]}{I_L} \Omega$$

The voltage across R_1 is the difference between the supply voltage and the voltage across R_2 . A value of I_L has been chosen, a value for I_b is taken from the load line and hence R_1 can also be calculated by Ohm's law.

It is important that the input signal neither saturates nor cuts off the transistor.

Some of the design points of a transistor amplifier have now been dealt with, but frequency range, which has only been briefly mentioned, can be the most important consideration.

The collector and emitter of a transistor themselves act as a capacitor, the value is extremely small but sufficiently large to limit a transistor's working frequency.

The required working frequency range of an amplifier is important as the gain of an amplifier varies with frequency due to a number of factors. These include frequency response of the transistor used, choice of components and type of inter-stage coupling.

An amplifier may consist of more than one transistor stage; Fig. 22 shows the circuit diagram for a typical two stage amplifier using R-C coupling.

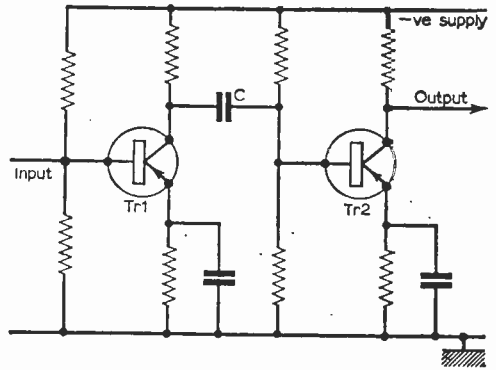

Fig. 22: A two-stage transistor voltage amplifier.

Capacitor C blocks any d.c. levels on the collector Tr1 from the base of Tr2 but allows an alternating signal to be passed on.

Capacitors oppose the flow of alternating currents to a certain amount, the amount of opposition depending on the frequency applied and the value of capacitance of the capacitor. Opposition of this kind is known as capacitive reactance.

Considering the first transistor stage of Fig. 22 we know that its output resistance can be large. Opposition to both a.c. and d.c. is known as impedance. The output impedance will also be large.

The input impedance of a common emitter transistor is small compared with its output impedance.

With reference to Fig. 22, if the first stage amplifies a signal with a factor of 40 (i.e. a gain of 40) and the second stage has a gain of 40, the overall gain of both amplifier stages will be:
 $40 \times 40 = 1600$

The second stage appears as a low impedance to the first, but the first stage has a high output impedance. The total effect is for the internal impedance of the source to "drop" a greater proportion of the output signal than is desired, the actual output being less than the theoretical value of 40 times the input value. The overall gain of the amplifier would effectively be less due to the "mismatch" of impedances.

A circuit with a considerably higher input impedance than the grounded emitter amplifier and a much lower output impedance could be included between the two amplifier stages to nullify the effect of mismatched impedances. The "emitter follower" is suitable for this purpose.

In Fig. 23, R_1 , R_2 , R_3 and C supply the V_{be} bias.

If the base were to go positive with respect to V_{be} , the current in the collector becomes smaller or the transistor appears to have a larger resistance. A greater proportion of the supply voltage is dropped across the transistor thus making the emitter go more positive.

Conversely, if the base were to go negative with respect to V_{be} , the emitter would go more negative.

Fig. 23: Common-emitter circuit diagram.

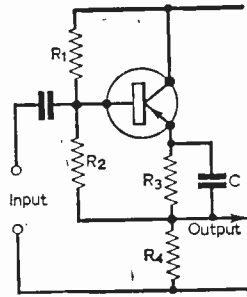

The gain of this circuit is slightly less than unity but the output voltage remains more or less constant for whatever load is applied to it providing the current being drawn is allowing the transistor to work within its power limitations.

We have then a method of providing a method of amplifier stage impedance matching.

It is often desirable to have a reasonable power output from an amplifier. Unfortunately the characteristics and limitations of the more inexpensive transistors do not allow a large power dissipation. Power transistors are expensive and require a high static current.

An amplifier known as a "push-pull" amplifier is very often used to overcome such difficulties. The circuit diagram is in Fig. 24.

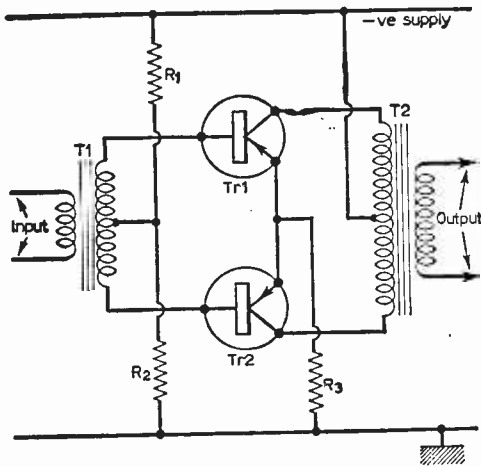

Fig. 24: The push-pull transistor amplifier.

To direct current the windings of the transformers are virtually short circuits. R_1 , R_2 and R_3 act as biasing resistors for both Tr_1 and Tr_2 .

Across the secondary windings of T_1 the positive and negative half cycles of the signal would alternatively act in opposite directions. Tr_1 will amplify one half of the cycle, Tr_2 will amplify the second. T_2 operates in the opposite manner to T_1 and an amplified output is obtained.

Part 4 follows next month

PHOTOCONDUCTORS

—continued from page 755

will serve as an over-ride switch, cutting out the photo-cell control and converting from automatic to manual operation.

Alternatively both starting and over-riding may be done electrically by fitting an over-ride switch as shown in the diagram. Switching this on momentarily locks in the relay at night, and leaving it on cuts out the automatic control: in some cars the parking-light switch position already provided may be used in this way.

The same considerations about construction and mounting applied to the previous switch also apply to this.

Light Operated Switches in General

The circuits so far described have obvious applications not only to parking light switches but also to automatic shop display-lighting switches, simple burglar alarm systems, automatic counters etc. The following notes will help the reader to modify the previous circuitry to his specific requirements.

In counters and alarms speed of operation is essential since the light beam may be broken for only a fraction of a second. The K42 cells do not change their resistance instantaneously when the illumination changes but have a time constant of about one tenth of a second. Thus the relay used must be sensitive and of the high-speed type.

In burglar alarm systems the alarm once set off by the breaking of a light-beam must continue to sound even when the beam is made again. Thus the single-shot working in which the relay cuts off its own power supply is essential; this also ensures that the alarm sounds if the power supply to the relay fails.

When controlling shop-lighting or any other high-power system it is essential to have heavy duty contacts on the relay. The light-contacts commonly found on P.O. relays rapidly deteriorate when used to switch high voltage and power.

There are cadmium sulphide photo-conductive cells which will operate a.c. relays direct from the mains, but these are larger and more expensive and the K42 will *not* do so. Some d.c. power supply must always be provided, either batteries or rectified a.c. The latter need not be well-smoothed, and a simple power supply to drive 12V relays is shown in Fig. 9.

The reader will notice that so far no provision has been made in the circuitry for adjustment of the sensitivity of the K42 control circuits. This is because optical adjustment by means of masks over the K42 is far easier, less wasteful of power and more reliable than electrical control.

The sensitivity of the K42 is proportional to the sensitive area exposed to light, and by placing masks over the glass window the sensitivity may easily be controlled.

Any opaque material may be used for masking and the writer has found black p.v.c. tape most useful. To make the K42 sensitive to light from one direction only it may be placed at the end of an opaque tube facing in that direction.

Part 2 next month

**FOR PEAK PERFORMANCE AT LOW COST —
PICK CODAR AMATEUR RADIO EQUIPMENT**



Advanced design and craftsmanship plus an unequalled reputation proved by the many hundreds of testimonials received from CODAR users is your guarantee of complete satisfaction. Only the best is good enough for CODAR—Mullard, Brimar, Jackson, Denco, Electronics, Thorn, A.E.I. are just some of the famous names built into CODAR equipment. CODAR-KITS are supplied with clear pictorial diagrams and easy to follow instructions—no technical knowledge or special tools are required for complete success. Build your Short Wave Station with CODAR-KITS and enjoy peak performance and world wide reception previously possible only from much more expensive equipment.
For illustrated leaflets giving fullest details send 6d. in stamps.

CODAR R.F. PRE-SELECTOR. Will considerably improve the performance of any superhet receiver. "Results are amazing." "Well worth the money." **MODEL P.R.30.** Uses EF183 Frame Grid tuned R.F. Amplifier and provides up to 20dB gain plus substantial image rejection. Improved signal/noise ratio and selectivity. Selector switch for either dipole or single wire antenna. Power requirements 180-250 volts 12 M/A H.T., 6.3 volts 3 amp L.T. Size 8 1/2 in. x 5 in. x 4 in. Ready built, complete with cables, plugs and instructions. £4.17.5. Carr. 3/-.
MODEL P.R. 30X. Self powered version for 200-250 V. A.C. and also provides 25 M/A at 200V. H.T. and 6.3V. 1 amp L.T. for other accessories. £7.2.0. Carr. 3/-.

CODAR "Q" MULTIPLIER, MODEL R.Q.10. For use with any superhet receiver with an I.F. between 450 and 470 Kc/s. Provides considerable increase in selectivity for either peaking or rejecting a signal on AM, CW or SSB. Both PEAK and NULL functions tuneable over receiver. I.F. passband B.P.O. facility included. Size 8 1/2 in. x 5 in. x 4 in. Power requirements 180-250V. H.T. at 6 M/A 6.3V. 3 amp L.T. Ready built complete with cables, plugs and instructions. £6.15.0. Carr. 3/-.
MODEL R.Q. 10X. Self powered version for 200-250V A.C. and also provides 25 M/A at 200V. H.T. and 6.3V. 1 amp L.T. for other accessories. £8.8.0. Carr. 3/-.

CODAR A.T.5. 12 WATT 2 BAND TRANSMITTER. The newest, most compact transmitter for fixed or mobile use on 160/80 metres. "The tiny TX with the BIG voice." Size only 8 1/2 in. x 5 in. x 4 in. (Base area is less than two-thirds of this page.) High stability new type calibrated V.F.O. 1.8-2.0 Mc/s and 3.5-3.9 Mc/s (up to 4 Mc/s export). Air-spaced CODAR-QOIL Pi-net output. P.A. Plate current meter plus neon indicator. Plate/screen modulator. AM/CW switch and Panel key jack. Plug changeover for 6 or 12 volt heater supply. Ready built £16.10.0. Carr. 4/-.
A.T.5 POWER SUPPLY UNITS. Type 250/5. For 200/250V A.C. with Stand by/Net/Transmit and aerial changeover switching. stabilised V.G. supply. neon standby/transmit indicator. £8.0.0. Carr. 6/-.
Type 12/MS 12V. Transistor power supply unit available shortly. (H.P. Terms Available)

CODAR-KIT MINI-CLIPPER—OUR FAMOUS SHORT WAVE RECEIVER. ★ Can be built in one evening ready to switch on and bring the World to your fingertips at very low cost. ★ Supplied complete with valve, one coil 25-75 metres and 4 page instruction manual. PRICE 39/6. Carr. 2/8. Extra Coils 4/9 available. Provision to add 2 transistor amplifier.

CODAR-KIT CR45 MAINS T.R.F. SHORT-WAVE RECEIVER. World wide reception—North and South America, Russia, India, Australia, Far East. Amateurs, Shipping, etc. ★ Separate electrical bandspread. ★ 3 slow motion vernier drives. ★ Low loss polystyrene plug-in coils, factory aligned. ★ Dials calibrated in frequencies and degrees. ★ Power output 3 watts for 2/3 ohm speaker. ★ Valve line up: ECC81, EL84, EZ80. **CODAR-KIT CR45** complete with valves, 3 coils (10-28, 25-75, 50-175 metres) and 11 page instruction manual (LESS Cabinet). £7.5.0. Carr. 4/6. Ckt. 45 CATHNET. 12 in. x 5 1/2 in. x 7 in. with sliding door for easy coil changing. 2S/6. Extra coils 4/9 each. Instruction manual only 4/- (credited on order). (Can now be supplied ready built—price on request.) (H.P. terms available.)

CODAR-KIT CR 66 COMMUNICATION RECEIVER. The finest superhet kit ever offered. ★ Covers 540 Kc/s—30 Mc/s in 4 bands. ★ Separate electrical bandspread. ★ Factory aligned Coil unit and I.F. Transformers. ★ Regenerative I.F. stage for maximum gain and B.F. O. for C.W. reception. ★ Power output 3 watts for 2/3 ohm speaker. ★ "Aim" controls: Aerial Trimmer, A.V.C., Standby, Bandswitch, A.F. Gain, I.F. Gain, B.F.O., etc. ★ Valve line up: ECH81, EBF89, ECC81, EL84, EZ80, EMB4. ★ Size 16 in. x 6 1/2 in. x 8 in. **CODAR-KIT CR 66.** Complete with 17 page instruction manual £19.10.0 (Ready-built £22.10.0). **CR 66 "S"** Motor Model Kit: £21.10.0 (Ready-built £24.10.0). Carr. 7/6 extra on all models. (H.P. terms available.) Instruction Manual only 7/6 (credited on order).

AS EXHIBITED AT THE 1964
R.S.G.B. RADIO COMMUNICATIONS EXHIBITION

CODAR RADIO COMPANY

G31RE G3HQC

BANK HOUSE, SOUTHWICK SQUARE
Southwick, Sussex. Tel. 3140

Canada; Codar Radio of Canada, Tweed, Ontario.

UNUSUAL SINGLE SPEAKER SYSTEM

A CONCRETE COLUMN

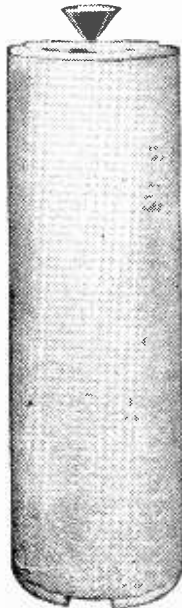

An inexpensive column speaker constructed from a concrete pipe and fitted with a good 8in. or 10in. unit has attracted much interest and admiration because of its clean open sound. Complete kits of wooden fixtures are available including absorbent wadding and diffusing cone.

Price £3.15.0 for 8" model. Recommended 8" unit—Super 8/RS/DD £6.14.2 including purchase tax.

Price £4.18.0 for 10" model. Recommended 10" units—Super 10/RS/DD £10.18.8; Golden 10/RS/DD £7.17.5; 10" Bronze/RS/DD £4.12.9. Prices include purchase tax.

Suitable concrete pipes can be purchased from builders' merchants at about 12/6 and 17/6

Descriptive leaflet free on request from:



WHARFEDALE WIRELESS WORKS LTD.
IDLE BRADFORD YORKSHIRE
Grams: Wharfedel Bradford
Phone: Idle 1235/6

GUITAR AMPLIFIERS WITH TREMOLO

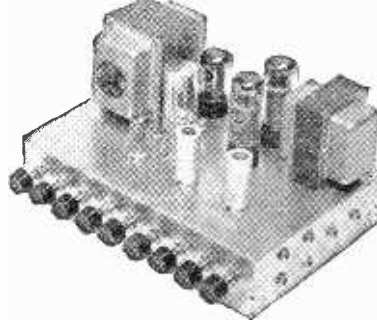

Five jack socket inputs, four with separate mixing volume controls, and one input "straight through". All inputs are of very high sensitivity, only 10 millivolts input is required for full output, making them suitable for all types of guitars and microphones. Separate Bass and Treble

controls, giving a wide range of lift and cut. Separate master gain control. Tremolo speed and depth controls. Jack socket for remote tremolo switchings. Outputs for 3 and 15 ohms speakers. Valves used in the 30 watt and 50 watt amplifier ECC83, ECC83, EL34, EL34, GZ34. In the 15 watt amplifier ECC83, ECC83, EL34, EL34, E291. An extra valve ECC83 is used in the tremolo circuit. The chassis is complete with baseplate and is solidly made of 18 gauge steel, finished silver grey hammer. Size 12 x 8 x 6 1/4 inches high.

PRICES—

50 watt with tremolo	£20.10.0
50 watt less tremolo	£19.10.0
30 watt with tremolo	£15.10.0
30 watt less tremolo	£14.10.0
15 watt with tremolo	£12.10.0
15 watt less tremolo	£11.10.0

Add carriage 10/- any amplifier. Send for free descriptive leaflet.

STROUD AUDIO

PAGANINI LANE, STROUD, GLOS.

Stroud 783

EXPRESS ELECTRONICS 32 SOUTH END CROYDON SURREY TEL. CRO 9186

VALVES NEW TESTED AND GUARANTEED FOR THREE MONTHS

10C1	5/8 6BA6	5/- 12K8G/T11/-	DL34	6/- EL84	7/- PY81	6/9
10C2	7/6 6BD5	7/- 12X7GT	7/6 DL36	7/6 E8155	10/- PY82	7/6
10C3	7/6 6B47	8/9 12N7	4/6 E191	4/- EY51	7/6 PY83	7/6
1F1	7/6 6RW7	7/- 16A5	9/- E1941	7/6 EY51	10/- R19	5/6
1F3	2/- 6I2	4/- 19AQ3	9/6 EBF80	8/6 EY56	6/9 85A1	9/6
1FD1	7/6 6I12	4/- 15L6GT	5/- ECF51	4/- E240	5/6 TT15	27/6
1FD9	5/6 6I8GT	2/- 30K1	7/6 EY52	6/9 E250	8/- U32	7/6
1F1	7/6 6K7G	5/6 30L1	7/6 ECC83	6/9 E251	6/9 178	5/-
1F10	5/6 6K9G	6/- 35L6GT	7/6 EY54	6/6 HV22	9/6 1142	7/6
1F11	8/- 6Q7	5/6 57G3	7/6 EY55	7/6 N17	5/6 UB41	8/6
1R5	5/6 6SL7GT	8/- 80	8/- ECF50	6/6 N18	5/6 UCH42	9/6
1R5	5/6 6SN7GT	7/6 DA F91	5/6 ECF52	7/6 N19	6/- UF41	8/6
1F1	2/- 6V6	7/6 DA F96	7/6 ECH42	9/- N709	7/- U141	8/6
1U5	5/6 6X4	5/- DF91	2/- ECH81	10/- PCC4	7/6 UY41	7/6
3Q4	5/6 6X5G	5/6 DF96	7/6 ECL80	8/6 PCF80	7/6 W17	2/-
3N4	8/- 1B3	4/- DH76	7/6 ECL82	7/6 PCF82	7/6 W76	4/6
3V4	8/- 9I7	9/6 DH77	5/- E41	8/- PCL82	8/6 W142	8/6
5Z4G	6/6 12AD6	7/6 DH142	8/6 EFS0	8/- PL84	5/6 X17	5/6
6AK5	5/6 12AT7	4/- DH130	10/- EFS6	9/- PL81	11/6 X142	9/-
6AL5	4/- 12AU7	6/9 DK91	5/6 EFS1	4/- PL82	7/- X150	9/-
6AM6	4/- 12AX7	6/9 DK96	7/6 EFS2	5/6 PL83	7/- Z77	4/-
6AT6	5/- 12BD6	4/6 DL92	5/6 EL41	9/6 PY33	12/6 ZL17	5/6

ASK FOR RESISTOR AND CAPACITOR COLOUR CODE FREE WITH EVERY PURCHASE

Latest model Radiogram Chassis, L.M.S.G. ext. LS and Tape sockets, complete with 10 or 12in. Speaker, £11.19.2.

High Stability Resistors 1W 5% 50Ω to 1M, 9d. Midget Ceramics 500 v., 9d. Coax. Super Quality 1in., 6d. yd. Plugs 9d. Sockets 9d. Silicon H.T. Rects. 250 v. 300 mA 1in. x 1in. 8/6. Contact Cooled 250 v. 50 mA, 8/6. 85 mA, 8/6.

NEW TRANSISTORS BY MULLARD. OC19, OC26 OC66, 25/- OC44, OC45, 5/- OC70, 8/- OC71, 5/- OC72, 8/- OC72 matched pair, 12/- OC74, OC75, OC75, 7/6; OC81, 6/- OC81 Matched pair, 12/- OC170 OC171 7/6.

VALVES MATCHED IN PAIRS

EL34, 27/6, EL84, 15/-, N709, 15/-, 6V6G, 15/-, Push-Pull O.P. Transformer, 21/-, 12in. 3Q (or 15Q) Speaker, 30/-, P. & P. 1/6, 12in. Baker's "Selhurst" 12in. 15Ω 15W Stairway, £5.5.0. 12in. Bass Heavy Duty 25W, £12.12.0. 15in. Auditorium 15Ω 50w., 18 gns.

SETS OF VALVES

DK91, DF91, DAF91, DL92 or DL94	17/6	ECH42, EF41, EBC41	
DK96, DF96, DAF96, DL96	22/6	EL41, E240	37/6
6K5, 6K7, 9Q7, 6V6, 5Z4 or 6X5G	19/6	ECH42, EF41, EBC41	
1R5, 1T4, 1R5, 384 or 3V4	17/6	UL41, UY41	35/6

Postages and packing 6d. Over £1 post free C.O.D. 4/-

BOOKS REVIEWED

STEREOPHONY, by N. V. Franssen.
Published by Philips Technical Library and distributed
in the U.K. and Eire by the Cleaver Hume Press Ltd.
86 pp., 6in. x 9in., 64 illustrations. Price 21s.

THIS book is rather different from most on the subject. It concerns itself mainly with the actual mechanism of hearing and offers many theories on this.

I found the book in no way practical, and rather heavy going, somewhat reminiscent of certain textbooks on psychology.

For the expert or someone who wants another facet of stereophony to examine then this is undoubtedly the book. If however, you are practically minded, or if you like your theory complete with diagrams and circuit values then it is not possible to recommend this volume to you.

The inside front cover assured me that certain principles would be made clear in a very readable and non-technical manner. Yet before I had gone 12 pages I was beset by 14 graphs, informed that

$\Delta t = 0:24 (a + \sin a)$ and also that $\psi(\Delta L, \Delta t) = \psi(0, \Delta t) + \psi(\Delta L, 0)$

There are only three chapters excluding the introduction and two appendix. To give an idea of the theme, chapter two is headed "The Faculty of Auditory Perspective", and is divided into various headings such as "The theory of intensity ratios"; "The theory of difference in timbre"; "Binaural frequency analysis" etc.

As may be judged by the above, the book is theoretical and somewhat specialised in its outlook. The curious will probably enjoy a browse through such a work, and the knowledgeable might perhaps find interest in the various theories contained therein. To the layman, beginner, and average radio enthusiast however, it is doubtful if there will be much of value offered by this book—D.J.G.

WIRELESS FOR BEGINNERS, by C. L. Bolz.
Published by George G. Harrap & Co. Ltd.
212 pp., 7½in. x 5in., boards. Price 18s.

ARE you a newcomer to the world of wireless? Do you come into the category of a novice? Would you like to read a book which will enlighten you without boring you?

If the answer is "yes" to these three questions, and your bank balance stands at 18s. or more, then purchase of the above book is recommended.

Everyone, no matter how clever, must always at some time or another have been a beginner. Intelligent reading of technical journals helps in the education of a particular subject, but the author of a technical magazine must, of necessity, limit his contribution to reasonable dimensions and omit many obvious points. Obvious to him and to more knowledgeable readers, but not to the poor novice. The reading of a good basic book, therefore, is a decided asset. In *Wireless for Beginners* a great number of the basic facts are presented in an easily digested form.

A criticism of the book would be that one or two statements in it are dogmatically alarming if not actually untrue. This is mentioned in all fairness to any beginner buying a copy after reading this review. One sentence on page 104 states that "Valve triode detectors are now never used at all". This is not strictly true as readers of *PRACTICAL WIRELESS* will know! Again, page 172—speaking in terms of 3-30 Mc/s the author says a station in Edinburgh would probably not produce any signal which could be picked up in London, yet the working of Scottish stations by London amateurs between 3 and 30 Mc/s is quite common.

One haffling part of the book is a sentence on page 174 which leads us to believe that f.m. is useless unless a limiter is used, and five pages further on assures us that a ratio detector can give good results without a limiter.

Other than these few small points, the book would appear to be a good "buy" from a beginner's point of view, especially to those who prefer "easy" reading.—B.S.A.

RADIO SERVICING MADE EASY, by Leonard C. Lane.
Two volumes. Published by Gernsback Library Inc.
191 pp. each volume, 8½in. x 5½in. Price 20s. each.

FIRST impression to be gleaned from a reading of these two volumes is that the "C" in the middle of the author's name stands for "Chatty". In a free and easy manner that must be envied by the British technical writer, accustomed to squeezing quarts of information into his publisher's pint pot, Mr. Lane spreads himself over and around his subject, omitting nothing.

Some indication of his confident approach can be given by a quote: ". . . you'll be able to look any radio set right in the face and say: See here. No nonsense out of you or else . . .!"

The irony of this is that, provided the reader can stomach the brashness, a real, working knowledge of radio sets, their circuitry and the servicing procedure that can unravel their faults, is contained in these twelve chapters.

Mr. Lane begins with transistors, the first chapter explaining the semi-conductors and their characteristics, with a venture into basic circuitry, while the second chapter goes into printed circuit boards and transistor testing. Only after sixty pages do we meet the question of servicing techniques. This book is worth buying for this chapter alone, and for the trouble-shooting charts, a feature of several transatlantic books that has been slow to catch on in this country.

Chapters 4 and 5 deal with auto-radios, ending with a few pages on the troubles that can crop up from the mechanical and electrical systems of the car itself. Chapter 6 takes us into Volume 2, and to a.m. receivers, valve-operated, that is. Next, we

meet f.m. sets, then a.m.-f.m. tuners, and so to the "good" stuff, to use the author's phraseology—the communications receiver.

Chapter 10 goes even further, dealing with marine receivers, while the mobile systems that are coming into more regular use are discussed in the next few pages. The final chapter covers miscellaneous receivers and a few special circuits.

At the end of each chapter a list of questions is given. These are carefully chosen—even provocatively chosen—to test the reader's attention to the foregoing text. These, in conjunction with the trouble-shooting charts, would be of help to the reader who wishes to use a work of this nature as a reference book. The comprehensive index at the end of each volume is also a helpful point. Despite a few insultingly childish illustrations, the drawings and photographs that are generously scattered throughout these pages do much to underline the author's points.

Given a tolerance of the patronising air which assumes the reader knows nothing, and an ability to discount some shocking doggerel and worse naivety, the casual reader might profit from these volumes. Whether he would be able to "jump right in with both feet" and earn a living by servicing radio receivers is another matter entirely.—H.W.H.

HOW TO READ SCHEMATIC DIAGRAMS, by Donald E. Herrington. Published by W. Foulsham & Co. Ltd. 128 pp., 6in. x 9in. Price 18s.

THE art of mastering the languages of different countries is practised by many people and these are usually referred to as linguists. A person referred to as a radio, wireless or electronics enthusiast also has to master a language—that of circuit diagrams.

A good map reader can win or lose a motor rally and so too the electronics hobbyist can make very little headway in the field of radio until he can "read" circuits.

If you are unable to follow circuit diagrams or are floundering then you can be saved! Mr Donald Herrington has thrown you a life-belt labelled "How to read schematic Diagrams".

Each chapter is not content merely to show a component and the symbol for it, but describes its construction, function and use. There are numerous photographs of the different components which will assist in identifying the actual article, together with many symbols of the same component which are likely to be encountered.

One small point is that there is a photograph on page 40, Fig. 4.1., which depicts two coils wound, according to the text, on phenolic coil formers. These are referred to as "air cored coils". To me an air cored coil is one which is self supporting, i.e. the core is air. The text states "as long as this form is not capable of being magnetized, the effect is the same as if no form were employed."

However, there assuredly is a difference, especially on short waves between winding a receiver or v.f.o. coil on cardboard and the same coil wound on ceramic.

The book is completely successful in accomplishing what it sets out to do—teach how to read schematic diagrams, and can be confidently

recommended at the reasonable price asked.—L.S.A.

ELECTRONICS DATA HANDBOOK, by Martin Clifford. Published by Gernsback Library Inc. 158 pp., 8½in. x 5½in. Price 23s.

THE formulas which form the basis of this book are many, and all of course, in some way relate to the subject of electronics. Now this might lead the average reader to expect a formidable mass of unintelligible equations with meaning only to an Oxford don. This is not the case however, as most of the formulas are arranged to follow on from one another in logical sequence with explanatory text between each. More than this, the author illustrates how formulas or groups of formulas are used to solve various problems.

For the serious amateur radio enthusiast then, this work of reference will be of use, for even the simplest circuit is subject to the basic laws which can also govern the operation of a computer.

Grouped under appropriate headings, formulas are easy to locate with complete information, lacking only practical examples which would have helped considerably in clarifying the equations.

In his introduction, the author says "A knowledge of elementary algebra and trigonometry and some skill in handling algebraic functions will be of considerable help." This recommendation should not deter the non-mathematical reader however, as there are several important chapters dealing with nothing much more complicated than impedance calculations. But Mr. Clifford is perhaps being optimistic if he expects an elementary knowledge to carry the reader through the higher maths which appear towards the end of the book.

Besides the numerous formulas the book includes a host of tables and useful information which will be found, for once, really useful, its presentation being clear and complete and not the usual jumble appended to many technical publications.

With the warning that this is an American publication (which of course means language difficulties) it must be considered a valuable library addition, containing facts and figures in one volume which would only otherwise be found scattered throughout a host of electronics textbooks.—P.R.R.

LAST MINUTE CHRISTMAS GIFTS

No need to rush out to the shops. Here's one you can arrange now... in a few moments... in the comfort of your own armchair. A year's subscription for PRACTICAL WIRELESS is the ideal gift for friends who are radio enthusiasts.

But hurry! You must send now to make sure that first copies arrive in time for Christmas. Simply send your friends' names and addresses, together with your own and remittance * to cover each subscription to The Subscription Manager (G.3), PRACTICAL WIRELESS, Tower House, Southampton Street, London, W.C.2. An attractive Christmas Greetings Card will be sent in your name to announce each gift.

* RATES (INCLUDING POSTAGE) FOR ONE YEAR (12 ISSUES): U.K. AND OVERSEAS £1 9s. 0d. U.S.A. \$4.25.

To make sure of your own copy why not place a regular order with your newsagent?



CLEAR PLASTIC PANEL METERS

First grade quality. Moving Coil panel meters, available for S.A.E. for illustrated leaflet. Discounts for quantity. Available as follows. Type MR. 38P 2 1/2" sq. front.

50μA	32/8	1A. DC	22/8
100μA	29/8	5A. DC	22/8
200μA	27/8	3V. DC	22/8
500μA	25/-	10V. DC	22/8
50-0-50μA	28/8	20V. DC	22/8
100-0-100μA	27/8	50V. DC	22/8
500-0-500μA	26/8	100V. DC	22/8
1-0-1mA	22/8	150V. DC	22/8
1mA	22/8	500V. DC	22/8
2mA	22/8	300V. DC	22/8
5mA	22/8	750V. DC	22/8
10mA	22/8	15V. AC	22/8
50mA	22/8	50V. AC	22/8
100mA	22/8	150V. AC	22/8
150mA	22/8	300V. AC	22/8
200mA	22/8	500V. AC	22/8
300mA	22/8	'S' Mr. 112A	22/8
500mA	22/8		22/8
750mA	22/8		22/8

Type MR. 52P. 2 1/2" sq. front.

50μA	57/8	1mA	32/8
100μA	47/8	10mA	32/8
100μA	37/8	100mA	32/8
500μA	37/8	100mA	32/8
50-0-50μA	57/8	1A. DC	32/8
100-0-100μA	47/8	300V. DC	32/8
300V. AC	32/8	'S' Mr. 112A	39/8

Type MR. 65P. 3x3 1/4" front.

50μA	59/8	1mA	35/-
100μA	49/8	10mA	35/-
500μA	49/8	100mA	35/-
50-0-50μA	59/8	1A. DC	35/-
100-0-100μA	49/8	300V. DC	35/-
VU Meter	59/8	300V. AC	35/-

Type MR. 85P. 4x4 1/4" front.

50μA	89/8	1mA	45/-
100μA	59/8	10mA	45/-
500μA	45/-	50mA	45/-
500μA	45/-	100mA	45/-
50-0-50μA	89/8	1 amp DC	45/-
100-0-100μA	59/8	5 amp DC	45/-
500-0-500μA	49/8	300V. AC	45/-
1-0-1mA	45/-	300V. DC	45/-



BAKELITE PANEL METERS

First grade quality. 3 1/4" square fronts.

25μA	65/-	100mA	29/8
50μA	49/8	1A. DC	29/8
100μA	39/8	5A. DC	29/8
500μA	35/-	1A. AC	29/8
50-0-50μA	42/8	5A. AC	29/8
100-0-100μA	39/8	10A. AC	29/8
50mV	39/8	30A. AC	29/8
100mV	39/8	50A. AC	29/8
1mA	29/8	300V. DC	29/8
5mA	29/8	300V. AC	29/8
10mA	29/8	300V. AC	29/8
10mA	29/8	VU Meter	49/8

*Moving iron. All others moving coil.

ILLUMINATED'S METERS

Cal. in 'S' units. 1mA. 35cps. 2 1/2" sq. front 29/8 P. & P. 1/2-1 1/4" sq. front 39/8 P. & P. 1/2-

FIELD TELEPHONES 'F'

Generator bell rings in. Perfect order. £4.18 pair. P. & P. 5/-

BEST BUY!

Send 1/- P.O. for full catalogue and lists. Open 9 a.m. to 6 p.m. Every day. Monday to Saturday. Trade supplied.

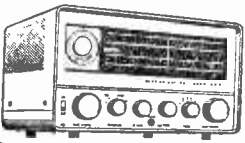

NEW LAFAYETTE COMMUNICATIONS RECEIVER

MODEL HA. 63

A SUPERB RECEIVER FOR ONLY **£27.10.0** Carr. 10/-

7 VALVES Plus Selenium Rectifier
4 BANDS Covering 560 kc/s-31 Mc/s.

● Illuminated "S" Meter ● 1.5 Microvolt Sensitivity ● Electrical bandspread ● Aerial trimmer ● Noise limiter ● B.F.O. ● R.F. stage ● Big slide rule dial ● Output or headphones or 4/8 Ω speaker ● Modern steel cabinet size 13in. x 7 1/2in. x 10in. ● Operation 220/240 volt A.C. S.A.E. for Full Details. Supplied Brand New and guaranteed with instruction manual. Matching Speaker in Cabinet 55/- FULL RANGE of Other LAFAYETTE RECEIVERS in Stock

MODEL HE-40 4 Bands 550Kc/s to 30Mc/s. **£19.19.0** Carr. 10/-

MODEL HE-30 9 valve 4 Bands, 550Kc/s to 30 Mc/s. **£35.0.0** Carr. 10/-

Each receiver supplied brand new and fully guaranteed complete with manual. All models for operation on 220/240 Volt A.C. S.A.E. for illustrated leaflet. Generous part exchange allowances.

TS. 75 20,000 O.P.V. PUSH BUTTON MULTI-TESTER

Large clear plastic scale. Simple operation. DC and AC volts up to 1,000V. Resistance up to 1 megohm. Current up to 250 mA. Decibels -20 to +30dB. Size 6 x 4 1/4 x 2 1/2in. Complete with leads batteries and instructions. Only £5.5.0. P. & P. 2/-.

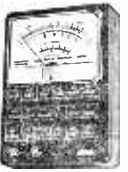

AR.88 L.F. RECEIVERS

New release. 75-550 Kc/s and 1.5-30.5 Mc/s on 6 bands. 110/230V A.C. Operation. Available in excellent condition. Fully tested and checked. £35 each. Carr. 30/-. A few AR.88D model receivers available in as new condition, £65 each. Carr. 30/-.

Brand New Double Beam CRT's Cossor 89D, 59/6. P.P. 4/6. Dumont K1051P1. 59/6. P.P. 4/6.

PROFESSIONAL 4-TRACK STEREO RECORD AND PLAYBACK TAPE DECK

Complete with 4 valve/4 transistor preamplifier. Will record and playback 1 track stereo or 4 track mono on 7 1/2 or 3 1/2 IPS. Twin meter level indicators, digital counter. Mic/gram/tuner inputs. Audio output 500 MW. Bias & Trace 80 Kc/s. Resonance 40-18,000 cps at 7 1/2; 40-12,000 CPS at 3 1/2 IPS. Motor 4-pole H.D. induction. Tape size up to 7in. 220/240V A.C. Size 13 x 10 1/2 x 6 1/2in. Line up: 4 x 25H73, 2 x 12AT7, 1 x 12AU7, 1 x 12BH7.

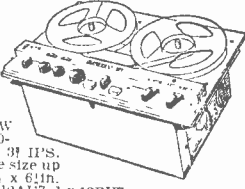

S.A.E. FOR FULL DETAILS. PRICE £2 (Gns. Carr. 15/-).

MULTI-METERS

Brand New—Fully Guaranteed. Lowest ever prices. Supplied with leads, batteries and instructions.

MODEL NH-200
30,000 o.p.v.
0/25/110/50/250/500/1,000V. DC
0/10/30/250/500V. AC
0/50μA/10/250mA
0/5K/500K/5 Meg Ω
99/8. P.P. 2/6.

MODEL AR-620
20,000 o.p.v.
0/10/50/250/500/1,000V AC and DC
0/500μA/10/250mA
0/10/100K/1 Meg Ω
250F—0.2mFd
0-500 Henrys
92/8. P.P. 2/6.

MODEL PT-34
1,000 o.p.v.
0/10/50/250/1,000V. AC and DC
0/10/100/500mA DC
0/100K Ω
39/8 P. P. 1/6.

MODEL 500. 30,000 o.p.v. 0/5/12/5/10/25/100/250/500/1,000V D.C. 0/2.5/10/25/100/250/500/1,000V. AC 0/50μA/5/50/500mA 12 amp. D.C. Meg/60 Meg c. £8.17.8 Post Paid.

STANCONI TF144G/4 STANDARD SIGNAL GENERATORS

First release of this late mark. 85Kc/s to 2Mc/s ± 1%. Output variable from 1μV to 1 volt. internal size wave modulation 400c/s up to 75% depth. Operation 200/260 volt A.C. Offered in really excellent condition. Like new, fully tested and guaranteed. £25. Carr. 30/-.

TE-20A R.F. SIGNAL GENERATOR

A precision signal generator of extremely high accuracy and quality. Six ranges from 120Kc/s to 130Mc/s on fundamentals with calibrated harmonics: from 120-300 Mc/s. 400 cps. IN.F. MOD. OR EXT. MOD. OUTPUTS MOD. R.F. UNMOD R.F. or 400 cps audio. R.F. output in excess of 100 mV. Large clear 5 inch dial. Hand-some grey metal case with handle. Size 7 1/2 x 4 1/2 x 4 1/2. Complete with leads. Operation 220/240 volts A.C. Supplied brand new and guaranteed. £12.19.6. Carr. 5/-.

SILICON RECTIFIERS

250 P.I.V.	750mA	3/-
200 P.I.V.	6 amp	5/6
100 P.I.V.	850mA	7/8
800 P.I.V.	300mA	5/8
200 P.I.V.	200mA	3/-
400 P.I.V.	500mA	3/8
150 P.I.V.	16mA	1/-
70 P.I.V.	1 amp	3/8
95 P.I.V.	3 amp	5/6

NEW LOW IMPEDANCE HEADSET

Latest Ministry Type. Rubber moulded. Fitted with std. Jack Plug. Brand New, boxed. 17/6 P. & P. 1/6.

CHAMOIS PADDED MOVING COIL HEADPHONES

Canadian noise excluding type. Complete with M/C microphone. New, boxed. 25/- P. & P. 2/6.

AUTO TRANSFORMERS

Step up or step down. Tapped 0/115/200/230/250V. 20W. 9/-; 60W. 12/6; 75/-; 15/6; 150W. 18/6; 200W. 22/6; 300W. 42/6; 500W. 67/6; 1,000W. 90/-; 1,500W. £8.19.6; 3,000W. £7.10.0; 7,500W. £15. (c only tapped 0/110/230V.). Post extra.

4-CHANNEL TRANSISTORISED MICROPHONE MIXER

Add musical high-lights and additional sound effects to your recordings. The MM-4 permits mixing of four signals such as microphone, records, tuner, etc. into single output. Input and output standard plugs. Fully transistorised and self contained in handsome case. NEW LOW PRICE 49/6. P. & P. 2/6.



TWO-WAY RADIOS

New improved 'LAFAYETTE' Model L 3 transistor. Range up to 1 mile. £8.17.6 per pair. Type 2, 9 transistor. Range up to 5 miles. £21 per pair. Postage extra. S.A.E. for full details.



G.W. SMITH & CO (RADIO) LIMITED
 Phone: GERRARD 8204/9155
 Cables: SMITHEX LESQUARE
 3-34 LISLE STREET, LONDON, W.C2

Easy-to-make cabinets to house your hi-fi

- 1 Tape deck/record storage
- 2 & 5 Loudspeaker
- 3 Record storage
- 4 Radio/record player

These easy-to-make sectional units are part of an outstanding new range of designer-styled cabinets for high fidelity sound equipment. They are the direct result of a close collaboration between well-known industrial designer Frank Guille Des RCA FSIA and Percy Wilson M.A. technical editor of "The Gramophone" and prominent authority on acoustical engineering. The cabinets which will house almost any combination of Hi-Fi equipment have been especially designed for making in Vipboard. Vipboard

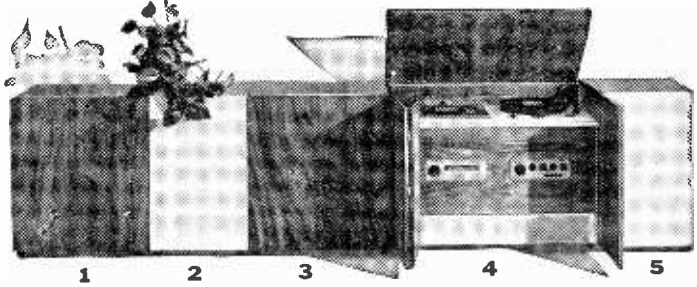

is a fine quality board with superior screw-holding qualities; specifically made for easy and economical furniture-making within the home. It comes in 20 standard sizes, fully veneered on all surfaces and ready

to polish. No special skills are required, and you need only basic household tools. Total cost of Vipboard for the cabinets shown above is £27.0.4. The individual cabinets cost from £2.8.11 (units 2 and 5).

Vipboard fully veneered chipboard with the natural wood finish

Find out how you can choose and build the units best suited to your Hi-Fi requirements—at a fraction of their "shop price". Ask for Free Instruction Leaflets and the Vipboard Furniture Brochure at your local Vipboard stockist, or write to: Vipboard Division, G.W.E. Boards Limited, 6 John Street, London WC1. Holborn 8421

TRANSISTORS					
AC115	4/-	OA79	3/-	OC75	5/8
AC155	4/-	OA81	2/-	OC78	8/6
AC156	5/8	OA85	3/-	OC78	8/6
AC154	5/8	OA86	4/-	OC79	8/6
AC113	5/8	OA90	3/-	OC81	5/8
AC157	7/-	OA91	3/-	OC82	10/-
AD140	25/-	OA95	3/8	OC83	4/-
AF102	27/6	OC18W	35/-	OC84	8/-
AF114	11/-	OC19	25/-	OC139	8/-
AF115	10/8	OC28	25/-	OC140	19/-
AF116	5/-	OC35	12/-	OC141	31/-
AF117	9/8	OC36	21/8	OC189	10/-
AF118	20/-	OC41	8/-	OC170	8/6
AF124	11/-	OC42	8/-	OC171	8/-
AF125	10/8	OC43	12/8	OC200	10/6
AF126	10/-	OC44	5/-	OC201	29/-
AF127	9/6	OC45	5/-	OC202	24/8
BY130	7/8	OC70	6/8	OC203	13/-
BY114	6/-	OC71	4/3	OC204	19/-
GET113	6/9	OC72	5/8	OC812	8/-
GET114	6/8	2xOC72	MAT100	7/9	
GET115	9/8	matched	MAT101	8/8	
GET116	17/8	OC73	16/-	MAT120	7/9
OA70	3/-	OC73	16/-	MAT121	8/6
OA73	3/-	OC74	8/-	ADT110	15/-

SETS OF TRANSISTORS
 Set No. 1: comprising OC44, 2 x OC45, OC81, matched pair £8.1.2.
 Set No. 2: comprising OC81, matched pair OC81, 12/6.

CATALOGUE
 Our latest 1964/65 Catalogue is now available. Copies have been sent to many of our regular customers. If you have not received your copy please drop us a card. Please send 1/- in stamps.
 Trade catalogue now available. Please apply on business letter-heading.

TERMS: Cash with Order or C.O.D. Postage and Packing Charges extra. Single valves 9d. Minimum Parcel Post charges 2/-. Please include sufficient postage with your order. Minimum C.O.D. fees and postage U.K. only. For full terms of business see inside cover of catalogue. Personal shoppers 9 a.m. to 5 p.m. Mon. to Friday, Saturday 10 a.m. to 1 p.m.

ALPHA RADIO SUPPLY CO.

103 LEEDS TERRACE
 WINTOUN STREET
 LEEDS 7



MULTI-RANGE TESTMETERS

Eagle TK20A	£2.9.8
Eagle EP30K	£6.19.8
Leather Case for above	19/6
Eagle EP50K	£9.19.6
Leather Case for above	29/6
Caby M1	£2.14.0
Caby A10	£4.17.8
Caby B40	£6.2.8
Altham 200H	£5.5.0
Taylor 127A	£10.10.0
Leather Case for above	£2.5.0

RECORD PLAYER AND TAPE DECK UNITS

BSR Monarch UA14	£6.8.0.
Stereo Version	£6.17.6.
BSR Monarch UA15	£6.19.6.
Stereo Version	£7.15.0.
BSR Monarch TU12	£3.10.0.
Battery version of above	£3.17.6.
BSK Monarch GUT	£3.17.6.
Battery version of above	£4.4.0.
BSR Monarch TD2 Tape deck, 2 track	£8.8.0.
4 track version of above	£9.9.0.
Garrard Autoslim	£6.19.6.
BSR Monarch TD10 Papedeck, 2 track	£9.9.0.
4 track version of above	£10.10.0.
Garrard Autoslim De Luxe Model AT6	£11.5.0.

MICROPHONES

MIC 39/1	32/6	DX 62 Dynamic	69/6
MIC 40	19/8	DX 29	49/6
MIC 45	19/6	CM21 Planet	12/6
Foster DFI Dynamic		DM175 Dynamic	49/6
600 ohms	39/6	DM11 Dynamic	105/-
Foster DFI Dynamic		GCM5 Guitar	12/6
50K ohms	39/6	BM3	45/-

All the above are listed and illustrated in our current catalogue along with mic. stands etc.

MAINS TRANSFORMERS

250-0-250V	80mA	0-4-6.3V	1A	0-4-5V	2A	Primaries 200/230/250V	21/9
300-0-300V	80mA	0-6-3V	4A	0-6-3V	1A		22/8
350-0-350V	80mA	0-4-6.3	4A	0-4-5V	2A		21/9
250-0-250V	100mA	0-6-3V	4A	0-5V	2A		27/6
350-0-350V	100mA	0-6-3V	4A	0-5V	2A		27/6
350-0-350V	200mA	0-6-3V	4A	0-5V	3A		55/-

BIG REDUCTIONS in EAGLE RANGE

TP.703	Tape Recorder	£18.18.0	UD.19HL	Microphone	£12.12.0
TL.206	Intercom	£9.19.8	MM4	Microphone Mixer	£2. 9.8
TA.790	Telephone Amplifier	£2.19.6	K4.16	Volume Control	3.0
100C	Microphone	£1.12.6	PVC.105	Variable Condenser	3.0
DM.614	Microphone	£1.12.6	TP.100	Telephone PU Coil	3.0
MC.70	Microphone	£2.12.6	MC.1	Crystal Cartridge	9.8
DM.145	Microphone	£4. 2. 6	EP.10K	10,000 OPV Multimeter	£3.19.6
DM.17HL	Microphone	£4. 2. 6	MR.2P	500µA Panel Meter	£1. 9.6
DM.16HL	Microphone	£4. 2. 6	OM.2B	Capacitance Sub. Box	£1. 2. 6
SMD.100	Microphone	£6.19.8	OM.G	Resistance Sub. Box	£1.12.6

IN ADDITION WE ARE NOW STOCKING:

FMT.640	F.M. Tuner	£19.19.8	EC36	Hi-Fi Cable	14.0
P.31	Standard Plug	(plus £3.4.0 tax) 2.6	ME.2	Hi-Fi Extension Cord	18.8
SP.31	Standard Shield Plug	2.6	EC25	Microphone Extension Cord	£1. 9.6
OC.34	Standard Socket	3.0			

A BAND II Preamplifier

for a boosted f.m. signal

by J. D. Benson

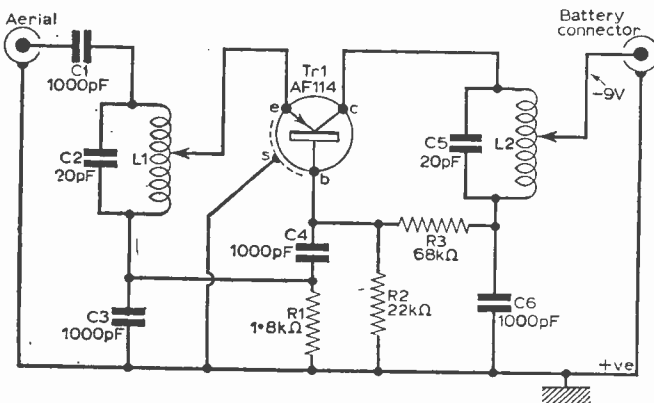

Fig. 1: The single-transistor preamplifier circuit.

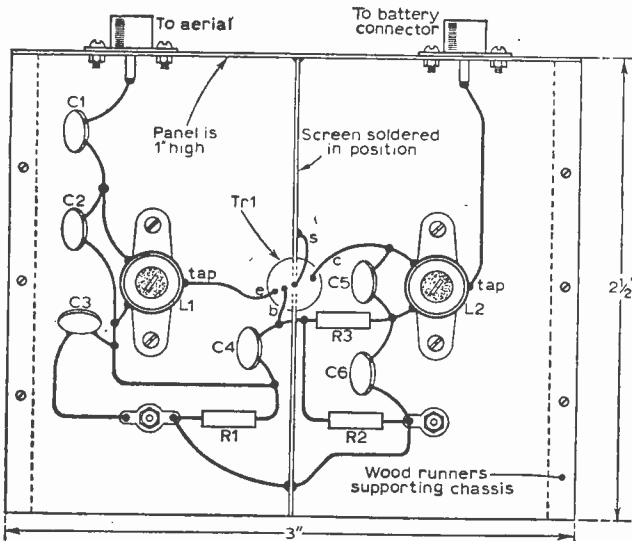

Fig. 2: The main wiring diagram.

THE experimenter who is in search of high-quality reproduction must invariably turn to the BBC f.m. transmission on Band II. The medium and long-wave stations with their very restricted bandwidth leave much to be desired even with the best of equipment. One of the stumbling blocks in the reception of f.m. is the fact that, if good reception is to be enjoyed, it is necessary to feed the receiver from an efficient aerial system. The answer to this problem is obviously an outdoor aerial, but, this in itself raises a problem, as most chimney stacks are already festooned with TV aerials and any addition greatly increases the risk of collapse during stormy weather. A strong signal is necessary in order to reduce the signal-to-noise ratio so that reception is free from man-made interference and the annoying background which a weak signal produces. The problem may seem insurmountable, but fortunately it can be overcome by amplifying the signal before it is fed into the receiver.

Positioning the Aerial

In most houses access to the roof is possible, and it is then quite easy to install an aerial of either professional or home-made construction. In positioning a roof aerial, care should be taken that it is located away from water tanks or any piping that may be there. The preamplifier which is about to be described can be fitted adjacent to the aerial and its power supply fed through the down-lead cable. The amplifier is designed around the AF114 Mullard transistor, but any other similar transistor can be used, provided it is of first-class quality, an inferior transistor will add to the background noise and ruin reception.

Amplifier Construction

In construction, the amplifier is straightforward, provided the design is adhered to, and good quality components used throughout. The chassis is a simple L-shape, and is preferably made of

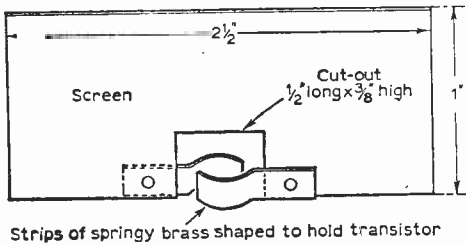

Fig. 3: Details of the screen.

copper. A screen is fitted which provides rigidity and also serves as a holder for the transistor. The shortest possible connections should be made throughout, especially to the transistor and, here a word of caution, a heat shunt—a pair of long-nosed pliers—must be used when making the transistor joints or it may be ruined. It will be noted that both aerial and output coils are tapped. The coils should be wound and made a tight fit on the formers and then cemented in position to prevent any change in inductance by movement or vibration. When thoroughly dry, the enamel can be carefully removed from the wire with a sharp-pointed knife and the tapping soldered on. In the case of the output coil, a little experimenting is called for to find the best position for the tap. Starting from the collector end of the coil, a point will be found where the amplifier becomes unstable; this can be recognised by a sudden change in current, if a milliammeter is used, or by a rushing noise if connected to the receiver. When either of these conditions obtain, the tap should then be moved back towards the collector end until the circuit is stable. The tapping wire should be attached to a piece of non-conducting material to eliminate unwanted capacities whilst the best position is being found.

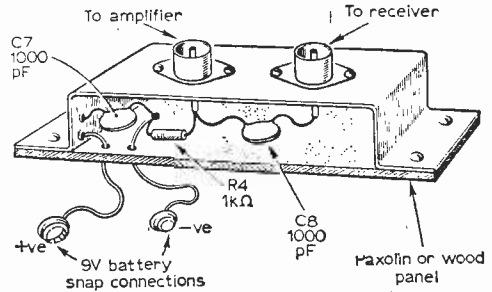

Fig. 4: Details of the battery connector.

During the locating of the tap, the dust core should be screwed in until level with the top of the former. Tuning should be carried out from the output coil first and then peaked for maximum by tuning the aerial coil, returning to the output coil and so on, until best results are obtained. A further refinement, an on/off switch, could be fitted to obviate the removal of aerial and receiver plugs each time the preamplifier is used. The total battery consumption is better than 2mA.

Outdoor Installation

If an outdoor aerial is to be used, then the pre-amplifier will be subjected to large changes in ambient temperature, from which the transistor must be protected in order to preserve the correct working conditions. The amplifier must be connected as close as possible to the aerial connection. A gain of 14-15 dB can be obtained from an amplifier of this type. The difference in reception with it is well worth the time and patience put into its construction. The battery connection fitting shown in Fig. 4 can be made to fit on top of the particular battery chosen and held in position by elastic bands.

COMPONENTS LIST

Resistors:

R1 1.8k Ω R2 22k Ω R3 68k Ω R4 1k Ω
All $\pm 10\%$ $\frac{1}{4}$ W carbon

Capacitors:

C1 1000pF C5 20pF
C2 20pF C6 1000pF
C3 1000pF C7 1000pF
C4 1000pF C8 1000pF
All ceramic.

Inductors:

L1 5 turns 22s.w.g. enamelled copper wire, spaced by diameter of wire. Tap at one turn from C1 end.
L2 5 turns 22s.w.g. enamelled copper wire, spaced by diameter of wire. See text for tapping.

Miscellaneous:

Tr1 AF114 transistor.
Two 7mm coil formers with cores (Alladin).
Length of 22s.w.g. enamelled copper wire. Two battery connectors. Copper for chassis and screen. Springy brass for transistor clip. Four coaxial sockets.

A MODEL CONTROL TRANSMITTER

—continued from page 746

fully unscrewed, the coil has too many turns. A turn or so should then be removed, or turns should be spaced farther apart. Alternatively, if TC1 is screwed down to full capacity, without 27Mc/s being reached, more turns are needed on the coil, or turns should be closer to each other.

For good range, a self-supporting vertical aerial about 8 ft. 6 in. long, is satisfactory. If the receiver is sensitive, and maximum range not required, a shorter aerial can be fitted. For moderate range, a 3 ft to 5 ft aerial will often suffice. The aerial can be telescopic, or made from interlocking rods, or may be of wire, supported by a thin bamboo, or by an insulator and string to an overhead point.

Tuning is slightly modified by the aerial, so the transmitter must be re-adjusted with the wave-meter, after the aerial is fitted. When testing and tuning, the key or switch wired to the "key" terminals should be closed, or these terminals should be connected together with wire. Though the transmitter can be battery operated, it should not be overlooked that the cathode takes 20 seconds or so to heat up.

SOUTH SUPPLIES

(ELECTRICAL LTD.)

Post Orders: 95, Old Kent Road, London, S.E.1

95, OLD KENT RD. S.E.1
72, BOROUGH HIGH ST. S.E.1
90, HIGH ST., EDGWARE
17, WOODFORD AVE. ILFORD

BER 5810
HOP 2125
EDG 6751
CRE 4815

EECO Model S.E.37B

Push Button 20,000 O.P.V. Test Meter
D.C. Volts: 0-10-50-250-500-1000
A.C. Volts: 0-10-50-250-500-1000
Current: 0-30A 10mA
50mA
Resistance: 0-5K Ω -500k Ω -5M Ω .
Inductance: 50H-5000H. Capacitance: 150pF-0.02 μ F. D.B. -20 Ω +22DB
20 Ω 30dB. The simplest and most efficient meter on the market at £22's below its true value. **£5.15.0**

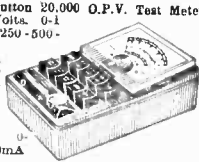

EECO Model S.E.550

100,000 O.P.V. PROFESSIONAL TEST METER
Highest accuracy
3% on D.C.V.
-5% on A.C.V.
4% on A.C.V.
D.C. Volts: 0-10-50-250 at 100,000 O.P.V.
0-500-1000 at 50,000 O.P.V.
A.C. Volts: 0-50-100-250-1000 at 12,500 O.P.V.
0-250-500-1000 at 500W.V.
0-250-500-1000 at 150mA.
Resistance: 0-20-20k-200k-2M.
100k-10k-100 Ω Centre Scale.
Decibels: -20 to 80 (0dB = 0.775V). **£7.19.0**

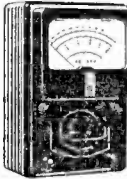

HOMER

4 Transistor
Tape Recorder
Power output
150mW
Frequency
response
300-40,000
C.F.S.
Recording D.C.
bias 1 track
Wow and
Flutter less
than 2%
Signal to
noise ratio
25db (1000c/s). Built in 2 1/2 in. b/w speaker. Battery life approx. 10 hours. Remote control switch on microphone gives many more uses to this tape recorder. It also has a built in amplifier socket for telephone amplification. Many other uses. It comes complete with microphone, personal earpiece with 3 in. Tape spare spool, batteries and this for **ONLY £5.15.0**, plus 5/6 P. & P. (Fully guaranteed).



SUN ACE

4 transistor new push button Super deluxe tape recorder circuit 4 transistors. Recording D.C. bias 1 track unit in 2 1/2 in. P.M. speaker. Recording time 17 mins approx. on 200ft. tape. Batteries 1 U2-1 P.P.S. Complete with crystal microphone, personal ear phone, 200ft. tape and reel, spare spool carrying strap and batteries. Wonderful value. At only **£4.15.0**, plus 4/9 P. & P. Fully guaranteed.



TECH. MODEL PV-58 VACUUM TUBE VOLTMETER

Finest design for stable and accurate measurement. 1% tolerance on all resistors. Large design 4 1/2" x 3 1/2" meter for accurate readings 11 meg-ohm input.
Ranges:
-D.C.V. 0-1.5-5-15-50-150-500-1500V.
+D.C.V. 0-1.5-5-15-50-150-500-1500V.
+A.C.V. 0-1.5-5-15-50-150-500-1500V. R.M.S.
0-1.4-4-14-40-140-1400-1400 P.P.
Resistance: 2 ohms to 1000 megohm.
Decibels: -10dB to +65dB.
Operation: 220/240V A.C. Size 7 x 4 1/2 x 4 in.
Each tester is supplied brand new and fully guaranteed complete with probe and operating instructions.
The finest value in testers available at only Complete **£12.19.6** P. & P. 8/6 ex.



EECO MODEL S.E.100 TRANSISTORISED VARIABLE D.C. POWER SUPPLY

Meter Ranges: Volt 0-20 V D.C. Current 0-20mA
Voltage Range: 0-20 Volt continuously variable
Maximum Current: Cap. 0-10V. 200mA Intermittent. 0-20V. 150mA
Impedance Source: Current position, 8.3 ohms. Voltage position 0.2 ohms.
Power input: 220/240 V. Size 6 x 3 1/2 x 2 1/2 in.
Fuse: 0.5 amp slow blow D.C. circuit.
The extremely wide variable voltage range, low A.C. ripple and source impedance of the S.E.100 makes it a most satisfactory power supply to operate transistor radios, hearing aids, pre-amplifiers instruments and other electronic devices under repair. The S.E.100 can be used in television and radio sets when an A.V.C. or voltage source as a D.C. filament supply operate rears; recharge small batteries and light electro plating as in dentistry. **£6.10.0** P. & P. 4/6. Fully guaranteed and complete with test lead, croc. clips and operating instructions.

EECO MODEL S.E.200 MINI-LAB TESTER

This remarkable meter has seven test instruments packed into one pocket size case which can be taken anywhere.
Resistance Substitution 100 Ω - 1K Ω - 10K Ω - 100K Ω - 1M Ω . Capacitance Substitution .002mf - .005mf - .01mf - .1mf and 1mf.
R.F. Signal Generator Frequency fixed at 446 Kc adjustable to 700 Kc output 30mV approx.
Audio Generator Frequency 400 cps Output 30mV approx. D.D. and A.O. Volts. 4 ranges 0-15-50-150-500 volts at 4000 O.P.V.
R.F. Field Strength Indicator Frequency range 1 to 140 Mc. Antenna 5 sections steel 10 1/2 in. Size 6 x 2 1/2 x 3 1/2 in.
The Mini-Lab is completely battery operated and suitable for quick checks in the service shop and home service case. **£8.19.6** each.
Complete with Test Prods. and Battery Fully Guaranteed.



EECO Model MS4 FLOOR STAND

Height fully opened 55 1/2 in.
Fully closed 33 in. Three sections fully telescopic. 1/2 in. dim. adaptor Price **36/6** ea. P. & P. Heavy cast iron base. Wonderful value.



MC 110 CRYSTAL MIC.

26/6 P. & P. with on/off switch and holder. Satin chrome finish.

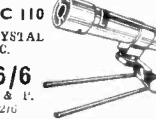

DM 260 DYNAMIC MIC

Sub-miniature type complete with stand. 52/6 P. & P.



MD 175 DYNAMIC MIC

sensitivity—55 dB at 1000 non-directional, latest American design. 45/- P. & P.

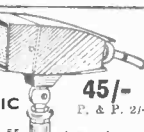

ACOS 45

Die cast, hand shaped body. Special offer 15/6 pms P. & P. 2/6.

MULTI METER BARGAIN. Model TK20A

1000 O.P.V. on both A.C. and D.C. A.C. and D.C. volts 0/15 0/150, 0/1000V. D.C. Current 0/150mA. Resistance 0/100k. Size 3 1/2 x 2 1/2 x 1 1/2 in. Meter size 2 1/2 x 1 1/2 in. Complete with test prods and batteries. Wonderful value at **31/6** Plus 1/6 P. & P.

RONETTE BINOFLUID B.F.40 STEREO CARTRIDGE

Freq. Res. 30-12,000 c/s. Sensitivity 180m V/cm/sec. Load 10 Ω 100 pl Complete with Sapphire Stylus. OUR PRICE 12/6 each. P. & P. 1/-.

RONETTE STEREO O.V.S. TURNOVER CARTRIDGE

with 2 Sapphire Stylus. OUR PRICE 10/6 each. P. & P. 1/-.

EECO 4-Ch. Transistorised MICROPHONE MIXER

49/6 Post paid
Give all your recording that professional touch. The Eeco mixer allows you to mix 4 signals such as—Micro-tape, records and tuner into a single output. Wonderful for groups amateurs recorders etc. Guaranteed to give hours of pleasure.

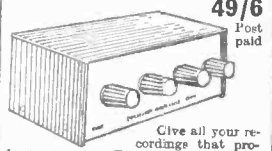

FAMOUS MAKES AMPS & PRE-AMPS

at Vastly Reduced Prices
3/4 watts £4.15.0. 4/5 watts £5.7.6.
5/5 watt set £11.5.0. 18 watt with separate Pre-amp £14.6.0. 30 watt, £15.5.6. 50 watt £20.1.3. Tremolo Unit £8.15.6. Tape Pre-amp £8.10.0.

MINIATURE PUSH-PULL AUDIO AMPLIFIER

4 Transistor
Output 200 mW. Low and high gain inputs to operate 3 1/2" speaker. Wonderful value. **31/6** P. & P. Complete with operating instructions.

A GENUINE 4 AMP BATTERY CHARGER For Only 45/-

45/- P. & P. 4/5

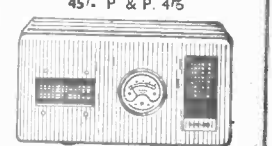

Made in England to our own specification and fully guaranteed. High-Low Med. clause rate. 6V. or 12V. Selector Plug. 200/250V. Mains Selector Plug. 3 amp Cartridge Fuse protection, complete with mains lead charging lead and crocodile clips.

MAXWELL BATTERY CHARGER

For your P.P.S transistor radios works direct from the mains 15/6 P. & P. Our Price **15/6** 1/6.

HIGH IMPEDANCE HEADSETS

2000 Ω or 4000 Ω Light. 13/6 P. & P. weight cream earpieces. **13/6** P. & P.

VANTAGE MAINS RADIOS.

5 valve sub-set with built in Ferrite tuning coil. **£3.15.0** plus 3/6 P. & P. Fully Guaranteed.



This wonderful little radio will receive all stations on Med. wave loud and clear inc. Luxembourg. Ideal for bedrooms kitchens or as a second main radio.

INTERCOM BABY/ALARM



Fully transistorised. Size 4 x 2 1/2 x 1 1/2 in. Complete with 60ft. of twin lex. P.P.S. batt. Push to call on sub station. P.P.S. to talk on master and volume control. Our Price **55/6** P. & P. 2/6.

WEYRAD

TRANSISTOR COILS

The P50 series remain the most popular and widely used components for Medium and Long-wave Transistor Superhets:—

P50/1AC Oscillator Coil for 176 pF tuning	5/4 ea.
P50/2CC 1st & 2nd I.F. Transformers	5/7 ea.
P50/3CC 3rd I.F. Transformers	6/- ea.
All mounted in individual cans $\frac{1}{16}$ in. diam. x $\frac{3}{8}$ in. high.				
RA2W Ferrite Rod Aerial 208 pF Tuning	12/6 ea.
LFDT4 Driver Transformers	9/6 ea.
OPTIA Output Transformers	10/6 ea.
PCAI Printed Circuit Panel	9/6 ea.
Constructor's Booklet	2/- ea.

VALVE RECEIVER COILS

Our individual "H" type iron-cored coils are without equal for the construction of a wide range of receivers. For the simplest T.R.F. sets covering one or more wave-bands the Aerial and H.F. Transformer coils are ideal. The standard superhet circuit using the ever popular triode-hexode frequency change layout would employ the Aerial and Oscillator coils and the coverage can be selected from 7 different bands ranging from 12.5 to 2,000 metres. For a really high-performance receiver an R.F. stage can be added by using the Aerial, H.F. Transformer and Oscillator Coils and a circuit is provided illustrating such a layout.

H Coils 3/9 each.

WEYMOUTH RADIO MANUFACTURING CO. LTD.
REGENT FACTORY, SCHOOL STREET,
WEYMOUTH, DORSET

**THE
 PEMBRIDGE
 COLLEGE
 OF ELECTRONICS
 PROVIDES TRAINING
 IN RADIO
 AND TELEVISION**

FULL-TIME COLLEGE COURSE IN RADIO AND TELEVISION

Our Course has now been extended to sixteen months' duration to include theoretical and practical instruction on transistor television receivers, U.H.F. television receivers and colour television.

Next course commences 5th January, 1965.

This Course is recognised by the Radio Trades Examination Board (R.T.E.B.) for the Radio and Television Servicing Certificate examinations.

Provides excellent practical experience on valve and transistor radio receivers and all well-known makes of television receivers.

To:
The Pembridge College of Electronics (Dept. P11)
34a Hereford Road, London, W.2.

Please send, without obligation, details of the Full-time Course in Radio and Television.

Name

Address

TRADE NEWS • TRADE NEWS • TRADE NEWS • TRADE NEWS • TRADE NEWS • TRADE NEWS

Mains Unit for Transistor Radios and Amplifiers

FROM RCS Products Ltd., comes a range of battery eliminators suitable for almost any transistor radio, battery record player, amplifier etc. All these mains units are completely isolated from the mains by a double wound mains transformer giving the highest safety factor.

Also available at 35s. retail is an eliminator for BBC-2 625-line booster units requiring a 12V or 18V d.c. supply. The eliminators are available with either a single or double d.c. output.

The range is as follows: single output units, 4.5V, 6V and 9V, at 29s. 6d. retail and the size, 2½in. x 3in. x 1½in.; two separate output units, 4.5V +4.5V, 6V +6V, 9V +9V, all at 42s. 6d. retail, all 3in. x 3in. x 2in.

The makers claim that these units are the cheapest of their kind, available with double wound mains transformers, currently available on the British market. Messrs RCS Products (Radio) Ltd., 11 Oliver Road, Walthamstow, London, E.17.

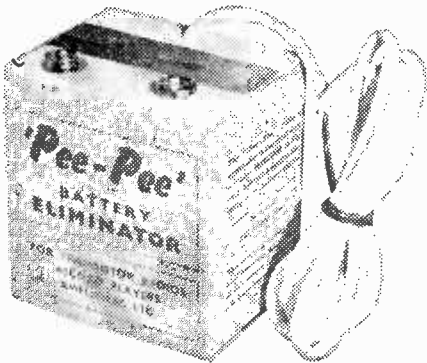

One of the battery eliminators available from R.C.S. Products Ltd.

Electrician's Tools

FROM the Continent come four new servicing aids. Griptou is a three-pronged trigger-operated gripping tool. It is 285mm long and the prongs open to 10mm; this makes the instrument particularly suitable for placing or retrieving objects in inaccessible places. The handle and trigger are of plastic, and the arm, which is flexible is made of polyamide. The powerful action of the return spring enables this tool to lift objects of up to 4½lbs.

Dynatest is a mains circuit tester incorporating a pilot light inside the handle. It is rated for

voltages of 120/220, and insulated to 10,000V.

Pick-fil is a brass pointed contact tester for printed circuit work, insulated to 10,000V. It can be supplied with a flexible extension lead, insulated for h.t. work to fit all standard testing apparatus. This lead can also be used with the Dynatest.

A rubber-headed mallet—a flexible, well insulated tube with a small rubber head—can be used by an electrician to locate faults with a gentle tap. Henri Picard & Frere Ltd., 34-35 Farnival Street, London, E.C.4.

Grampian Cardioid Microphone

DEVELOPED for users to whom overcoming background noise and acoustic feedback is a serious problem, the Cardioid Microphone type GC.1 is useful for many kinds of p.a. work.

As its name implies, this microphone has a heart-shaped polar response pattern with a front-to-back discrimination of approximately 15 to 20db over the mid-frequency range. The effective response of the GC.1 extends from 40c/s to 12kc/s with a gradually rising tilt towards the higher frequencies.

The non-metallic diaphragm is protected by a perforated steel plate, is non-hygroscopic and is resistant to temperature changes, corrosion and acoustic and mechanical shock.

The new Cardioid microphone developed by Grampian Reproducers Ltd. to overcome background noise and acoustic feedback.

The alloy casing of this unit is finished in Old Silver Polyurethane enamel and a Melamie primer and is fitted with a chrome plated bezel ring. The microphone is less than 6in. long and weighs less than 12ozs.

Cardioid microphones are available in four impedances from 25Ω to 50kΩ and are supplied complete with swivel holder, connector and detachable 18ft length of screened lead. Grampian Reproducers Ltd., Hanworth Trading Estate, Feltham, Middlesex.



Antex Lightweight Soldering Iron

THE latest addition to the Antex range of soldering irons is model C240N. It is fitted with "Ferraclad"—the new type bit which is claimed to last at least five times longer than ordinary nickel plated bits. The construction of the iron makes the bit instantly interchangeable, and with a low leakage current all risk of damage to transistors when soldering is virtually eliminated. Antex Ltd., Grosvenor House, Croydon, Surrey.



The latest Antex soldering iron, model C240N.

Regulated Power Supply

FROM K.L.B. comes the P.300 regulated power supply, with facilities for working on either conventional valve circuitry where it will provide 0—400V d.c. at up to 150mA or 0—50V d.c. for operating transistor equipment. Two meters are incorporated which offer comprehensive monitoring of both voltage and current. In addition, the P.300 provides the usual heater voltages and a low current negative bias supply. The K.L.B. P.300 is priced at £47. K.L.B. Electric Limited, Whitehorse Road, Croydon, Surrey.

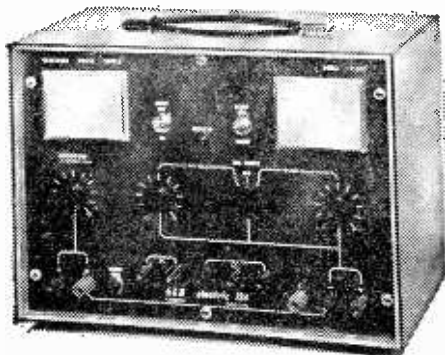

K.L.B.s P.300 regulated power supply unit.

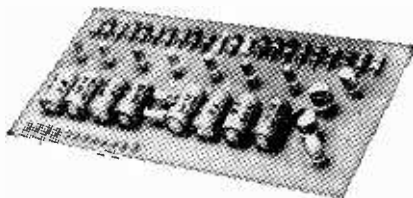

The new Sinclair 10W transistor amplifier, available in kit form or ready-assembled.

10W Transistor Amplifier

ANNOUNCED by Sinclair Radionics Ltd., is their 10W integrated amplifier. This amplifier uses the pulse-width modulation principle, permitting a large reduction in the power dissipation in the output transistors, so that no heat sink is required and small high frequency transistors can be used in place of the conventional l.f. power transistors.

The circuit embodies 11 transistors and has a transformerless output feeding into a 15Ω speaker.

The overall size of the "X-10" unit is 6in. x 3in x 1½in., and its weight is less than 5 ounces. The price is £5 19s. 6d. in component form, or £6 19s. 6d. built and tested.

A mains power pack, providing 12V is available at a price of £2 14s. *Technical Suppliers Ltd.*, (sole distributors) *Hudson House, 63 Goldhawk Road, London, W.12.*

ON THE SHORT WAVES

—continued from page 765

the only non-G heard so far was a UT5. However this was with a 20m dipole with the feeders strapped.

A thought for those wishing to try 10m and haven't much space for elaborate antennas is that a ground-plane is quite a compact aerial for this band and also is omni-directional.

Another point of interest for those learning or wishing to learn morse is a special slow morse transmission (3—4 w.p.m. up) between 28.100 and 28.300 by G3JDG (St Albans) on Sundays at 11-00 (120W to a dipole running NW/SE).

GENERAL NEWS

Items of general interest gleaned over the past month include the gen. that there are two DX-peditions afoot: VQ8AMR on Rodriguez Island and PY1CK on Trinade Island. But if you really want something unique to listen for, search on 2m for the call-sign K2QHZ, he drives a tractor in the

Baltimore district and has the rig on board complete with a five element beam (honest it's the truth).

Top band addicts please note the M.C.C. run by the *Short Wave Magazine* takes place this year on the weekend 14th and 15th November. There are two four-hour periods from 17-00—21-00, one on each day.

H.F. enthusiasts might like to be reminded of the 21/28Mc/s telephony contest on December 5th and 6th. Just gives you time to make up that ground-plane referred to earlier?

Incidentally, if you hear a Cyprus station (call sign 5B4), from now on it will either be a pirate or an illegal transmission anyway as all 5B4 licences have been suddenly and mysteriously withdrawn for some strange reason not yet made clear.

I would be very pleased to hear from any reader who listens or works the amateur bands 1.8—30Mc/s, just address to G3JDG, Amateur Band DX, c/o PRACTICAL WIRELESS, Tower House, Southampton Street, London, W.C.2.

That just about wraps it up for this month, time to hang up the headphones and go Q.R.T. to B.E.D. . . . well perhaps just a quick listen round on forty, perhaps that 9M2 . . . !

KEEP AN EYE ON THE FUTURE WITH PRACTICAL TELEVISION

The December issue of "Practical Television" speculates on the future of TV Receivers and reviews the situation of Indoor Aerials today.

The December issue of P.TV is on sale 20th November.

Don't Miss These Bargains

Transistor ferrite rod aerial with medium and long wave coils with circuit, 7/6.
 Oscillator Coil and set for I.F. transformers for transistor set with circuit, 12/6.
 Tuning condenser to suit, air-spaced with trimmers, 9/-.
 B140 but sub. min. 7mm, 10/- the set; two gang condensers to suit, 8/6. (Request sub. min. circuit.)
 Midset 3in. P.M. Loudspeaker 3 ohm 12/6, 8 ohm 13/6.
 Midset 208 pF +176 pF two-gang Tuning Condenser with trimmers for transistor set, Price 9/-.
 Push-Pull Transformer, sub-miniature 9/6, 0005 mfd. Single Tuning Condenser, Solid dielectric 1in. spindle for transistor of Crystal set, with spindle tapped 6 BA, 2/6.
 46 Sets (Receiver/Transmitter pack set). Unused sets complete except for crystals. Packed with parts and easily rebuildable into other gear. 19/6 each. Post 3/-.
 Battery Charger Kit, Comprises 5 amp. transformer, 5 amp. rectifier, metal case and meter to charge 6 or 12 cell batteries up to 5 amps. With variable charge rate, 39/6 each. Post and insurance, 3/6.
 Mains Transformer, 250.0-250 at 80 mA, 6.3 volts, 2a (normal mains input), 12/6 each. Carriage 2/6.
 Output Transformer, Standard pentode matching type, 4/6 each, 48/- per doz.
 Slide Switch, sub-miniature but dupl, 2/- each, 13/- per doz.
T.C.C. or Dubilier Tubular Condensers.
 .55 mf 500 v. 10/- doz.
 .25 mf 500 v. 7/6 doz.
 .25 mf 350 v. 6/- doz.
 .05 mf 500 v. 5/- doz.
 .01 mf 500 v. 4/- doz.
 .001 mf 1,000 v. 5/- doz.
 .001 mf 1,000 v. 6/- doz.
 .002 mf 1,000 v. 7/6 doz.
 .005 mf 1,000 v. 9/- doz.
 .02 mf 750 v. 8/6 doz.
 .01 mf 1,000 v. 10/- doz.
Battery Charger Rectifier—selenium 12-15 v. 5 amp. 9/6.
Metal Chassis—punched for Mullard 510 Amplifier, complete with inner screening sections and sleeve enamelled, 12/6 set.
Flament Transformer, 6.3 v. 1j amps., 6/6.
Neon Lamp—midset wire ended. Ideal mains test, etc., 2/-, 6v. GLO, 1/8.
Phillips Trimmers—0.3µF 1/- ea., 9/- doz.
Tax Panels, Ideal for constructors' experimental circuits, etc., 3 of each of 12 different types, 5/-.
Slideok Panel Mounting Fuses with carrier, 5 amp. 2/- each. 15 amp. 2/6 each.
Metal Rectifier, 250 v. 60-80 milliamps ideal for mains set or instrument or to replace that expensive valve, 4/6.
Plane Key Type Switches, 3 key type 3/-, 1 key type 3/8, 3 key type 4/8, post and packing 1/- regardless of number ordered.
500 MW Amplifier, Uses 3 transistors, 2 of which are in glass B push-pull for battery economy. Ideal little unit for baby alarm, record player, microcam, etc., etc. 19/6. Speaker 12/6 extra.
Electrolytic Condenser—Bargain, Sub-miniature type 50 m.f.d. 6v. made by T.C.C. 7/6 per dozen (minimum quantity supplied).
Transistor Set Cases, Finished in two-tone with handle and back, size 10j x 7j x 3j 15/- each plus 2/6 Carriage and Insurance.

Good Companion Mark IIIB

The 6 transistor set with the 5 transistor performance.
 Incorporating all the latest requirements. Anyone who can solder can make it. Many thousands already in use all over the country. Full coverage of Long and Medium wavebands. Fine looking cabinet, size 11" x 8" x 3". Q.P.P.I. Output approx. 750 mV. Output approx. 750 mV. Excellent reception of difficult stations like 2MS.
 Variable feet lock gives excellent tone. ONLY **£5.19.6**



Plus 4/- post and insurance.
OUR BARGAIN OF THE YEAR

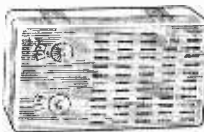

A complete kit of parts to build transistor 2 wave superhet receiver at only 39/6. Post & Ins. 3/6
"CORONET" Mk. IV
 It fully covers the medium waveband and that part of the long waveband to bring in B.B.C. Light. The circuit includes a highly efficient slab aerial and 25" P.M. speaker. Overall size approximately 4j x 2j x 1j in. Supplied complete with carrying case.

THIS MONTH'S SNIP

£5.10.0 Radio for only 37/6



Originally sold at £5.10.0, we now offer the "510" 5 Transistor Pocket Radio at only 37/6. The sets are complete but are "line rejects" so there will be some small faults to find. Components are all new and unused, and their retail value, even at today's lowered price, is over £4. Parts you will get include—
 Jackson "OO" Tuning Condenser, 9/-. Plesey Driver Transformer, 8/6. Goodman's or Plesey 3" speaker, 12/6. Morganite Volume Control with switch, 4/6. Philco RF Transistor 12/6. 8 T.C.C. matched output transistors and driver, 15/-. Plastic case with carrying handle, 7/6. 5 Electrolytic condensers, 7/6. 10 Resistors, 3/6. Ferrite Aerial 5/- and printed circuit board, trimmers, battery connectors, r.f. chokes, etc.
 All this fine equipment offered this month at only 37/6 plus 2/6, post and insurance.



MULTI-METER BARGAIN

Model number EP10K. Extra base fitted corner wise for compactness, extra accurate as it uses 1% components. Sensitivity 10,000 ohms per volt A.C. and D.C. ranges. D.C. voltage up to 1.2kV in 5 ranges. A.C. voltage up to 1.2kV 5 ranges. D.C. current up to 300mA 3 ranges. Resistance up to 2 meg. Capacities .005 to .15 mfd and decibels. Complete with full instructions and test prods and battery for ohms range. A real bargain not repeatable once stocks cleared. Price 69/6. Carriage and insurance 6/-.

THE STRAIGHT LINE AMPLIFIER

We call this the straight line amplifier because it is virtually distortionless, even at 10 watts. This is achieved by the careful use of feed back, choice of components and transformerless design. Sensitivity is 100 µV from 10K source. Push-pull output. For battery or mains operation. Model 815, 15 ohm output, £5.19.6 plus 2/6 post and insurance. Model 813, 3 ohm output, £5.10.0 plus 2/6. Mains Unit, 59/6. Pre-Amplifier, mono, 65/-, stereo, £10.19.6. F.M. Tuner for above, £7.19.6. Note (except for F.M. Tuner) all above are made up ready for use, fully guaranteed for 12 months.

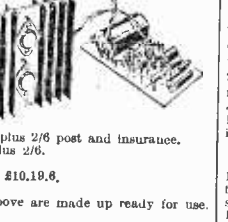

MAINS POWER PACK

Designed to operate transistor sets and amplifiers. Adjustable output 6v-9 to 12 volts for up to 500ma (class B working). Takes the place of any of the following batteries, PP1-PP3-PP4-PP6-PP7-PP9 and others. Kit comprises: mains transformer-rectifier, smoothing and load resistor 5000 and 500 mfd condensers, zener diode and instructions. Real snip at only 14/6 plus 2/6 post.

Infra Red Heaters

Make up one of these latest type heaters, ideal for bath-room, etc. They are simple to make from our easy-to-follow instructions—use silicon enclosed elements designed for the correct infra-red wavelength (3 microns). Price for 750 watt element and metal casing as illustrated 19/6, plus 2/6 post and insurance.



Brayhead Turret Tuner

Complete with Band 1 and Band 3 coils. New but removed from unused equipment. Less valves 1/- each, or with valves 25/- each. Post 2/6. Knobs 3/6 extra.

Waterproof Heater Wire

16 vdc, length 70 watts, self regulating temperature control. 10/-, post free.

Fluorescent Light Kits

For pelmet lighting, etc. Kit consists of super silver choke; 2 chrome clips to hold tube; 2 brass holders for tube and starter with a starter holder. Kit A for 80 watt tube at 27/6. Kit B for 40 watt tube at 19/6. Kit C for 2 x 2 ft. 20 w lamp 18/6. Kit D for 1 x 2 ft. 20 w lamp 18/6. Post and insurance 2/6 per kit.

Cabinet Snip

This fine cabinet as illustrated but less control knobs is available this month at a special snip price of 12/6, plus 3/6 post and insurance, size is 13 1/2 in. x 9 in. x 4 in. and it is nicely covered in two tone I.C.I. fabric.



Siemens High Speed Relay

Twinn 250 ohm coils adjustable tension change over contact—flat points 7/6. Post 1/-.

Five Core Cable

Idea for switching circuits, intercoms, P.A. rns etc. each core flex copper with rubber insulation, cores covered overall in tough rubber or P.V.C. Bd. per yd. or 30 yds. length 15/- plus 9/- post.

Making a Fan Heater

Miniature motor 2 1/2 in. long x 1 1/2 in. diameter, laminated poles. Operates off 20-30v. D.C. Original cost at least 43/- each. 8/6 plus 1/6 postage and insurance. Mains model 9/6, plus 2/6 postage and insurance.

Speaker Bargain

12in. High fidelity loud speaker. High flux permanent magnet type with standard 3 ohm speech coil. Will handle up to 12 watts. Brand new, by famous maker. Price 27/6 plus 3/6 post and insurance.



Where postage is not definitely stated add 2/- all orders under £3.

ELECTRONICS (CROYDON) LTD
 266 LONDON ROAD WEST CROYDON SURREY
 Post orders to: 43 Silverdale Road, Eastbourne, Sussex

HOME RADIO LTD. 187 LONDON RD., MITCHAM, SURREY *Phone MIT 3282

WE HAVE IN STOCK ALL THE RANGE OF ARMSTRONG TUNERS AND TUNER AMPLIFIERS

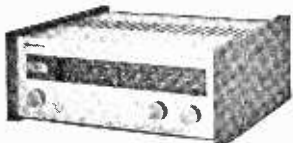

Model 223

Model 223 is an
AM/FM TUNER

PRICE **£28.15.0**

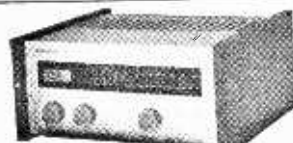

Model 224

Model 224 is an
FM TUNER

PRICE **£22.10.0**

Don't forget that the Home Radio Catalogue is the most comprehensive catalogue offered to the constructor to-day

PRICE **5/- PLUS 1/- POSTAGE AND PACKING**

TEST METERS



2,000 OHMS PER VOLT MODEL TP-10. Reads A.C. and D.C. volts up to 1,000; D.C. current to 500mA; Resistance to 1 Meg.; Capacitance to 1 μ F; Decibels from -20 to +36; Output jack for Audio measurements. Size: 3 $\frac{1}{2}$ x 6 x 1 $\frac{1}{2}$ in. **£8.19.6.**

DOUBLE BEAM OSCILLOSCOPE TUBES
Another purchaser of Type CV 1596 equivalent to Cosor 0912 used in Oscilloscopes by Cosor (339 series) and Hartley & Erskine (13 series) listed £12.
Brand new in Maker's **25/-** crates (Carriage 5/-).

HIGH FREQUENCY A.C. VOLTMETER. A First Grade Moving Iron Instrument with 6in. Mirror Scale, reading up to 150V. A.C. at 400 and 1,200-2,400 cycles. In substantial Oak case with removable lid overall size 8 $\frac{1}{2}$ x 8 $\frac{1}{2}$ x 5 $\frac{1}{2}$ in. Made for the Air Ministry by Everet Edgecumbe and in perfect order. Brand New and Unused. **ONLY £25.** Can also be supplied for 50 cycles, use either 0-150 or 0-360 volts

20,000 OHMS PER VOLT MODEL TP-58. Reads voltages up to 1,000 D.C. at 20,000 ohms per volt and A.C. at 10,000 o.p.v.; D.C. current to 500mA; Resistance to 10 Megs.; Capacitance to 0.01 μ F; Decibels from -20 to +36; size: 3 $\frac{1}{2}$ x 5 $\frac{1}{2}$ x 1 $\frac{1}{2}$ in. **£5.19.6.**

TRANSISTORISED INSULATION TESTER. One handed operation, no cranking of generator. 3 testing voltages 100, 250 and 600, to measure up to 500 Megohms. Complete with leather carrying case and test leads. **ONLY £17.10.0.** Illustrated details on request.

SUPER CRYSTAL STICK MIKE, complete with heavy desk stand neck cord, and screened lead. **ONLY 49/6** (post 2/6).

SPRAGUE CONDENSERS. Metal cases, wire end. New 0.1 mFd. 1,000 volt, 7/6 per dozen. Special quotes for quantities.

RESISTORS. 100 assorted values, our choice. New 7/6.

PANEL METERS

25 microamps D.C. 2 $\frac{1}{2}$ in. Prof. circular 59/6. 50 microamps D.C. 2 $\frac{1}{2}$ in. Flush circular. 59/6 100 microamps. D.C. 2 $\frac{1}{2}$ in. Flush circular 39/6. 40 amps. D.C. 2in. Prof. circular, 7/6. 500 volts A.C. 2 $\frac{1}{2}$ in. Flush circular, 25/-.

MOVING COIL STICK MIKE. complete with heavy desk stand, and screened lead **ONLY 59/6** (post 2/6).

ACOS 39/1 STICK MIKE with screened lead and table stand **ONLY 32/6** (post 1/6).

CRYSTAL DESK MIKE with screened lead and built-in stand. **ONLY 15/-** (post 1/6).

15 OHMS P.M. SPEAKERS. Special Heavy Duty 12in. **£5.5.0.**

Wharfedale W12EG 12in. for Lead Guitars, £10.10.0. Wharfedale E15EG 15 in. for Bass Guitars, £17.10.0. 12in. wedge type speaker cabinet, £2.17.6. (Please add 5/- carr. all items).

CONDENSERS. 100 assorted mica and silver mica. New 10/-.



VARIABLE VOLTAGE TRANSFORMERS. Fully shrouded. Input 230 v. A.C. 50/60 cycles. Output 0-200 v. 2.5 amps. type £5.17.5. 5 amps. type £9.10.0. Brand new import, fully guaranteed. Immediate delivery and service. Illustrated details on request.

20/- CONSTRUCTOR'S PARCEL. Assorted colours wiring wire solder, resistors, condensers, volume controls, tag panel. **ALL NEW** (post 2/6).

30,000 OHMS PER VOLT MODEL 500. Reads voltages up to 1,000 D.C. at 30,000 ohms per volt and A.C. at 15,000 o.p.v.; D.C. current to 12 amps. Resistance to 80 Megs.; Decibels from -20 to +56; Incorporates internal buzzer for audible warning of direct shorts and blocking condenser for A.F. output measurements. size 3 5/16 x 6 5/16 x 2 1/4in. **£8.19.6.**

LINEAR AMPLIFIERS. LG34, 4 watts, size 8 $\frac{1}{2}$ x 4 $\frac{1}{2}$ x 2 $\frac{1}{2}$ in. high. £5.5.0. L45A 5 watts, size 7 x 7 x 5in. high. £5.19.6. Protective cover, 12/6. L3/55 5 watts stereo, size 10 $\frac{1}{2}$ x 8 x 6in. £12.12.0, cover with carrying handles 25/-. "Diatonic" 10 watts Hi-Fi Ultra Linear Push-Pull, size 9 x 7 x 6 $\frac{1}{2}$ in. high. £12.12.0. Cover with carrying handles, 19/6. L1/10 10 watts Hi-Fi Ultra Linear size 9 x 7 x 6in. high. £13.13.0. Cover with carrying handles, 19/6. 30 watts Hi-Fi Ultra Linear size 12 $\frac{1}{2}$ x 9 x 7 $\frac{1}{2}$ in. high. £16.15.0. Cover with carrying handles, 25/-. L50 50 watts Hi-Fi Ultra Linear, size 14 x 10 x 8in. high. £23.2.0. Cover with carrying handles, 32/6. All amplifiers for normal A.C. mains, and ex stock. Details on request.

*"Tripletone" Convertible Amplifier, size 10 x 3 x 4 $\frac{1}{2}$ in. high. 4 watts output matched for 2-3 ohms, OR 2 amplifiers can be coupled together for STEREO £8.19.6 each.

*"Tripletone" F.M. Tuner, size 11 x 6 x 3in. high. Coverage 89-104 Mc/s. £13.19.6 (unpowered), or £15.14.6 (self powered). Details on request.

HETERODYNE FREQUENCY METERS TYPE LM14. Frequency range 125-20,000 kcs in 2 band. This is the United States Navy Model of the well-known P(22) Frequency Meter, but has many additional features which increase its usefulness. Voltage stabilisation circuits and Crystal control ensure extreme accuracy and in addition it is fitted with an Internal Modulation switch to allow use as a Signal Generator. Size only 8 $\frac{1}{2}$ x 8 x 8 $\frac{1}{2}$ in. Full information on request.

HARRIS ELECTRONICS (London) LTD.
138 GRAY'S INN ROAD, LONDON, W.C.1

Telephone T E Rminus 7937.

Please include carriage cost on ALL items

Open until 1 p.m. Saturdays. We are 2 mins. from High Holborn (Chancery Lane Station) and 5 mins. by bus from King's Cross

LIGHT-OPERATED SWITCH

BY
P. LISTER

THIS device can be constructed cheaply and easily. The circuit is of hybrid design, working the transistor in a different manner from usual.

Employing a Transistor

The prototype model was evolved to make use of an OC71 which had become chipped, the black paint being partially removed. This transistor is still in use in the original.

Any general-purpose transistor will do, providing it is of glass construction.

The first thing to do is to remove any light-excluding paint. After this has been carefully scraped off, the transistor can be tested for general light-sensitivity by measuring its photo-e.m.f. This is done by joining the collector and emitter and taking the junction to the negative terminal of a millimeter (1mA f.s.d. is ideal) whilst the base is taken to the positive terminal. If the transistor is now held near an electric light bulb (40W) there should be a deflection of 1mA or so. It will be found that the transistor is slightly more sensitive in some directions than others.

The Circuit

For its operation, the circuit does not rely on the transistor's property of developing a photo-e.m.f., but on its photo-resistance property. The resistance between the emitter and collector varies with the light falling on the transistor, the greater the light, the lower the resistance.

Originally the idea was to apply the photo-e.m.f. to the grid of a valve. This was not practical however, as the eight of a volt or so would not give a great enough anode current change to operate an ordinary relay.

It was thus decided to use the photo-resistance property and to make this varying resistance the cathode resistance, this being used to make the cathode more or less positive. When dark the cathode is far enough positive, that with the grid earthed, this now negative potential is enough

almost to cut-off the anode current and so render the relay de-energised. When the resistance of the transistor decreases—with an increase in light—the negative grid voltage decreases until it is more or less equal to the voltage dropped across the included cathode resistor (R_c) can be varied to suit the valve or to vary the sensitivity. In the prototype an EF73 was used for V1 but any moderately high gain valve will do, e.g. EF72, EF91, EF50, Z77.

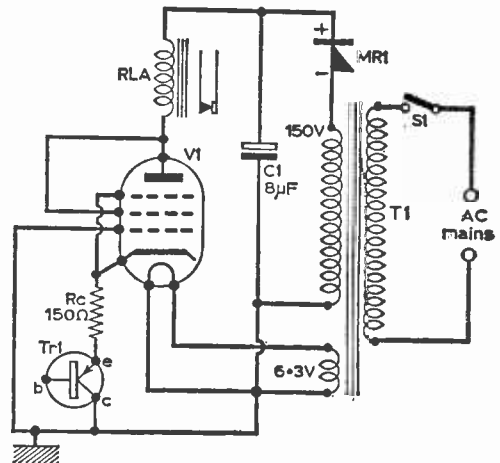

Fig. 1: The simple circuit of the device.

The Device in Operation

The prototype operated from a 40W lamp held at about 12. By the use of a lens and by experimenting to find the most sensitive spot on the transistor, this distance can be extended to several feet from a less powerful light source such as a torch.

A further refinement can be made by replacing the ordinary transistor with a photo-transistor, such as an OCP71 which has a built-in lens.

The power-pack can be any that will supply the required anode voltage and heater current; smoothing need not be great.

The uses of such a device are many, one of the most obvious being to operate garage doors from car headlights.

COMPONENTS LIST

V1	EF73, EF72, EF91, EF50, Z77, etc.
T1	Mains transformer to suit valve
Tr1	Almost any general-purpose transistor
RLA	4,000Ω to 5,000Ω relay
C1	8µF electrolytic
Rc	150Ω see text
MRI	Metal rectifier 15mA
SI	Mains on/off switch

CLUB

ACTON, BRENTFORD AND CHISWICK RADIO CLUB
Hon. Sec.: W. G. Dyer, G3GEH, 188 Gunnersbury Avenue, London, W.3.

When members meet at the Club headquarters on 10th November, they will hear a talk given by G3IGM entitled "Radio Test Gear".

BATH SPA RADIO CLUB
Hon. Sec.: G. C. Wynes G3TLV 14 Brook Road, East Twerton, Bath, Somerset.

With the recent move to new headquarters, this Club is now able to welcome local short-wave enthusiasts and visitors to any of its meetings at 7 Lambridge Mews, Larkhall, Bath. Meetings begin at 8 p.m. and are held every Monday and Thursday.

CHESTER AND DISTRICT AMATEUR RADIO SOCIETY
Hon. Sec.: P. J. Holland, Field House, 19 Kingsley Road, Gt. Boughton, Chester, Cheshire.

During October, members of this Society heard lectures at each of the three meetings.

The first was on 13th October, when H. Morriss (G3ATZ) gave a lecture on "Antennae". This was followed a week later by G3OWY's talk on "Receiver Selectivity" and on 27th October, "Interference Detection" was the subject of the lecture.

CITY OF BELFAST Y.M.C.A. RADIO CLUB
Hon. Sec.: C. J. Rourke, G13IVJ, 63 Kirkliston Park, Belfast 5, Northern Ireland.

This society's meetings are held every Wednesday and Saturday, beginning at 8 p.m. Visitors and new members will always be welcomed at these meetings. At the meeting for 7th October, members heard a lecture on "RTTY" by W. Kane (G13GQB).

NORTHERN HEIGHTS AMATEUR RADIO SOCIETY
Hon. Sec.: A. Robinson, G3MDW, Candy Cabin, Ogden, Halifax, Yorkshire.

After discussions and preparations on 14th October, a group from this Society manned a station (G3MVH) over the weekend of 17-18th, during the Scout "Jamboree-on-the-Air".

Later in the month, on the 21st, members of the Society and visitors to it enjoyed a recorded lecture by the famous American amateur, W1BB on "DXing on 160m".

28th October was ragchew night and the 31st, a party made a visit to the International Radio Communications Exhibition in London.

READING AMATEUR RADIO CLUB
Hon. Sec.: R. G. Nash, G3EJA, "Peacehaven", 9 Holybrook Road, Reading, Berkshire.

The October meeting of this Society was held on the 31st, when the subjects under discussion were TVI and BCI.

SPEN VALLEY AMATEUR RADIO SOCIETY

Hon. Sec.: N. Pride, 100 Raikes Lane, Birstall, Leeds.
On 15th October, Spen Valley A.R.S. was host to a number of visitors from other radio societies, and then on the 28th, Spen Valley members were the guests of Northern Heights Amateur Radio Society.

The lecture given at the meeting for 29th October was entitled "Radio Astronomy" and was delivered by W. J. Baggeley.

Activities for October ended with a visit by a group of members to the Radio Communications Exhibition.

UXBRIDGE RADIO SOCIETY
J. Batten, 36 Collingwood Road, Hillingdon Heath, Middlesex.

After the activity of the 17th and 18th October when the club participated in "Jamboree-on-the-Air", a surplus sale was held on the 19th.

Current constructional projects include work on a club receiver and conversions on a transceiver to cover top band and 80m.

WELLINGBOROUGH RADIO CLUB
Hon. Sec.: J. Baker, 34 Essex Road, Rushden, Northamptonshire.

The first meeting of October was the Annual General Meeting, when the Club's affairs came under discussion.

The three following meetings were devoted to lectures given on the 15th, 22nd and 29th. The subjects and lectures were, respectively, "Basic Radio Components" by D. Lyne, "The Radio Valve" by P. Butler and "The Transmitter and Receiver" by K. Knibs.

WESSEX AMATEUR RADIO GROUP
Hon. Sec.: P. Cutler, G3MXF, 43 Langside Avenue, Wallisdown, Poole, Dorset.

The Group's participation in the Scout "Jamboree-on-the-Air" was the operation of a station at a site near Brownsea Castle.

WEST KENT AMATEUR RADIO SOCIETY
Hon. Sec.: H. F. Richards, 17 Reynolds Lane, Tunbridge Wells, Kent.

At the 9th October meeting, members were given a guide to the communications receivers on the market, with off-air demonstrations and performance tests for illustration.

23rd October was "Audio Night" and two days later, a number of members visited the Decca Navigator Transmitting Station at East Hoathly.

PREPARING FOR THE R.A.E.

See page 744

ANSWERS to Question 1 given in the first part. Refer to Fig. 9, page 631, last month.

1. First find the value of the parallel connected resistances. Let the 4Ω resistance be R_1 , and 2Ω be R_2 .

$$R = \frac{R_1 \times R_2}{R_1 + R_2}$$

$$R = \frac{4 \times 2}{4 + 2}$$

$$R = 1.33\Omega$$

Total resistance in circuit will then be $1.33 + 6 = 7.33\Omega$

$$E = 10V, R = 7.33\Omega.$$

$$\text{from } I = \frac{E}{R}$$

$$I = \frac{10}{7.33}$$

Total current drawn = 1.36A

2. From $E = IR$
 $E = 1.36 \times 6$
Voltage across the 6Ω resistance will therefore = 8.16V

3. $I = 1.36A, R = 1.33\Omega$
From $W = I^2R$
 $W = 1.36 \times 1.36 \times 1.33$
Power dissipated by R_1 and $R_2 = 2.47W$

4. $E = 10V, I = 1.36A$
From $W = EI$
 $W = 10 \times 1.36$
Total power dissipated = 13.6W

5. First find voltage appearing across R_1 . Battery voltage = 10. Voltage across the 6Ω resistance = 8.16. \therefore voltage across $R_1 = 10 - 8.16 = 1.84V$

$$E = 1.84V, R = 4\Omega.$$

$$\text{From } I = \frac{E}{R}$$

$$I = \frac{1.84}{4}$$

Current flowing through 4Ω resistance = 0.46A

RETURN-OF-POST SERVICE

We offer a really efficient Mail Order Service on all items stocked. All cash orders are dealt with on the day of receipt
 ● Hire purchase orders are subject to slight delay but this is kept to the absolute minimum.

● MARTIN AUDIO KITS

High quality, easy to assemble Hi-Fi Units. Fully Transistorised for mono and stereo working. All units are assembled and tested and the constructor has only to link together the units chosen for any particular installation. The following units are available.
 Unit 1 Input selector 47/6.
 Unit 2 Pre-amplifier with volume control 37/6.
 Unit 3 Mixer Unit 79/6.
 Unit 4 Pre-amplifier with tone and volume controls 62/6.
 Unit 5 Main Amplifier 10 watt, 3 ohm output 55.12.6.
 Unit 7 Main Amplifier 10 watt, 15 ohm output 26.12.6.
 Unit 6 Power unit for unit 5 52/6.
 Unit 8 Power Unit for Unit 7 55/-.
 Unit 9A Special pre-amplifier for low output Pick-ups 55/-.
 Units 1, 2, 3 and 4 are available for stereo working at twice the prices shown. Small plastic enclosures are available for all combinations of units. Full details in the Martin Illustrated Leaflet, available free. H.P. Terms available on any combination of units.

● SPECIAL LOUSPEAKER BARGAINS

E.M.I. 13 x 8in. Elliptical. 10 watts, 3 ohms., 39/6. P. & P. 2/6.

● STEREO COMPONENTS

Morganite ganged potentiometers as specified for the Mullard circuits. ★ Log/Log. 50k, 500k, 1 meg., 2 meg. ★ Log/Log. 50k, 250k, 1 meg., 2 meg. ★ Lin/Lin 250k, 500k, 1 meg., 2 meg. All 10/6 each. Postage extra.

● GRAMOPHONE EQUIPMENT

ALL LATEST MODELS

ALL POST FREE	Cash Price	Deposit	Hire Purchase Mthly/Pmts.
GARRARD AUTOSLIM (Mono PU fixed head)	£8.17.6	£1.12.6	6 of £1
GARRARD AUTOSLIM De-Luxe (Mono PU)	£11. 9.0	£2. 6.0	12 of 16/11
GARRARD AUTOSLIM AT6 (Stereo/Mono PU)	£12. 5.4	£2. 8.4	12 of 18/-
GARRARD AUTOSLIM (Mono PU plug in head)	£7.19.6	£1.10.6	6 of £1.4.0
GARRARD A.T.5. (Mono PU plug in head)	£10. 8.2	£2. 4.2	12 of 15/4
B.S.R. UA15 (TC8 Mono PU)	£7.15.0	£1.18.0	8 of £1.2.0
B.S.R. UA15 (TC8 Stereo/LP78)	£8.15.0	£2. 6.0	6 of £1.4.0
B.S.R. TU2 (TC8 Mono PU)	£3.17.6	£1. 4.6	3 of £1.1.0
B.S.R. GU7 (TC8 Mono PU)	£4.18.8	£1. 8.8	3 of £1.6.8
GARRARD SRP10 (Mono PU)	£5.9.11	£1.12.11	3 of £1.9.0

TRANSCRIPTION UNITS
GARRARD 4HF (GC8 PU) £16.12.6 £3. 6.6 12 of £1.4.5
PHILIPS AG1016 (S/M PU) £12.12.0 £2.10.0 12 of 18/6
 Many of the above can be supplied for stereo working. See our Gramophone Equipment List for details.

● JASON F.M. TUNERS

We stock all parts needed for the construction of these excellent tuners. All parts can be supplied separately but we can offer attractive reductions in price if all items are purchased at same time as follows:

FMT2 (less power), £7.15.0.; **FMT2** (with power), £9.12.6.
FMT3 (less power), £9.9.6.; **FMT3** (with power), £11.7.6.
FMT4, £9.12.6.; **Mercury 2**, £10.14.6.; **JTV/2**, £14.12.6.
 Hire Purchase Terms available. Ask for list.

● PHILIPS ELECTRONIC ENGINEER KITS

The Philips EES. A wonderful new kit for the beginner. Eight different circuits can be built including two radio receivers, a gramophone amplifier and Morse practice set. High quality components only are supplied including Mullard Transistors. No soldering required—all components can be used again and again. Price £4.19.6.—post free.
 The Philips A20 Accessory Kit. This is for use with the EES Kit and it makes possible the construction of a further twelve circuits including an Electronic Organ and inter-comm set. Important. The A20 kit cannot be used by itself and is only suitable for use in conjunction with the EES. Price £3.9.6. post free.
 An illustrated leaflet is available free. Please send 3d. stamp for postage.

● OUTPUT TRANSFORMERS

GILSON: W0696A, W0696B, 60/6, post 2/6. W0892, 75/-, post 2/9. W0787, 32/6, post 1/6. W01796, 66/-, post 2/6. W1796A, 66/-, post 2/6. W01832, 92/6, post 2/6.
PARTRIDGE: P3667, 75/-, post 2/9. P4131, 75/-, post 2/9.
PARMELO: P2629, 49/9; P2642, 47/3; P2643, 49/9. All plus post 2/9.
P2641, 30/9, post 2/-; P2628, 16/9, post 2/-; P2632, 43/-, post 2/6.

★ TERMS OF BUSINESS

Cash with order or C.O.D. We charge C.O.D. orders as follows: Up to £5 minimum of 4/2. Over £5 and under £10, 2/8. Over £10, no charge. Postage extra on CASH order under £5 except where stated. Postage extra on overseas orders irrespective of price.

● SPECIAL OFFER PICK UP CARTRIDGES

RONETTE 106 Stereo/Mono Cartridge. List 59/4. OUR PRICE 23/6. B.S.R. TC8 M Mono, 19/6; **GARRARD GC8** and **GC2** Mono 15/-; All complete with fixing bracket and styl. All Post Free.

● ILLUSTRATED LISTS

Illustrated lists are available on LOUDSPEAKERS, TAPE DECKS, TEST GEAR, GRAMOPHONE EQUIPMENT, AMPLIFIERS. Any will be sent free upon request.

● AMPLIFIER KITS

We have full stocks of all components for the Mullard 510, Mullard 3-3, Mullard 2 and 3 Valve Pre-amp, Mullard Stereo, Mullard Mixer. Fully detailed list on any of these sent upon request.

Instruction Manual: All Mullard Audio Circuits in "Circuits or Audio Amplifiers", 9/5. Post Free.

● LATEST TEST METERS

	Cash Price	Deposit	Hire Purchase Mthly/Pmts.
AVO Model 8 Mark III	£24. 0.0	£4.16.0	12 of £1.15.2
AVO Model 7 Mark III	£22. 5.0	£4. 8.0	12 of £1.12.9
AVO Minor Mark 4	£9.10.0	£1.18.0	12 of 14/4
T.M.K. TP10	£3.19.6	£1. 3.6	3 of £1.2.0
T.M.K. TP5	£5.19.6	£1.15.6	3 of £1.1.4
T.M.K. Model 500	£8.19.6	£1.15.6	12 of 13/8
TAYLOR MODEL 127A	£10.10.0	£2. 2.0	12 of 15/8

Full details of any of the above supplied free on request.
 The AVO Models 7 and 8 are both latest models from current production—not to be confused with Government Surplus.

● TAPE RECORDING EQUIPMENT

TAPE DECKS	Cash Price	Deposit	Hire Purchase Mthly/Pmts.
ALL CARRIAGE FREE			
COLLARO STUDIO , latest model, two track, Bradmatic Heads	£10.19.6	£2. 3.6	12 of 16/4
Four tracks, Marriott Heads	£17.17.0	£3.12.0	12 of 26/2

MARTIN TAPE AMPLIFIER KITS
 Tape Amplifiers
 For Collaro 8311-V 2-Track £11.11.0. 8311-4 V 4-Track £12.12.0.
 Tape Pre-Amplifiers
 For Collaro 8319-CP 2-Track £8.5.0. 8319-CP 4-Track £9.9.0.
 Drop through assembly for mounting 8319 Pre-Amp under Collaro Deck, £11.1.6.
 Carry Cases with speaker. For Collaro Deck and 8311 Amplifier, £5.5.0.
H.P. TERMS available on decks, amp. and cases. Ask for quote
MULLARD TAPE AND PRE-AMPLIFIER KIT
 We stock complete kits and all separate components for the Mullard Tape Pre-Amplifier. Fully detailed list available.

● "SYNCHROTAPE" RECORDING TAPE

Low priced British tape, all reels fitted with leaders.
Standard Play: 600ft. (5") 13/6; 850ft. (5 1/2") 17/-; 1,200ft. (7") 21/-; 1,800ft. (9") 27/-; 2,400ft. (10") 33/-; 3,000ft. (11") 39/-; 3,600ft. (12") 45/-; 4,200ft. (13") 51/-; 4,800ft. (14") 57/-; 5,400ft. (15") 63/-; 6,000ft. (16") 69/-; 6,600ft. (17") 75/-; 7,200ft. (18") 81/-; 7,800ft. (19") 87/-; 8,400ft. (20") 93/-; 9,000ft. (21") 99/-; 9,600ft. (22") 105/-; 10,200ft. (23") 111/-; 10,800ft. (24") 117/-; 11,400ft. (25") 123/-; 12,000ft. (26") 129/-; 12,600ft. (27") 135/-; 13,200ft. (28") 141/-; 13,800ft. (29") 147/-; 14,400ft. (30") 153/-; 15,000ft. (31") 159/-; 15,600ft. (32") 165/-; 16,200ft. (33") 171/-; 16,800ft. (34") 177/-; 17,400ft. (35") 183/-; 18,000ft. (36") 189/-; 18,600ft. (37") 195/-; 19,200ft. (38") 201/-; 19,800ft. (39") 207/-; 20,400ft. (40") 213/-; 21,000ft. (41") 219/-; 21,600ft. (42") 225/-; 22,200ft. (43") 231/-; 22,800ft. (44") 237/-; 23,400ft. (45") 243/-; 24,000ft. (46") 249/-; 24,600ft. (47") 255/-; 25,200ft. (48") 261/-; 25,800ft. (49") 267/-; 26,400ft. (50") 273/-; 27,000ft. (51") 279/-; 27,600ft. (52") 285/-; 28,200ft. (53") 291/-; 28,800ft. (54") 297/-; 29,400ft. (55") 303/-; 30,000ft. (56") 309/-; 30,600ft. (57") 315/-; 31,200ft. (58") 321/-; 31,800ft. (59") 327/-; 32,400ft. (60") 333/-; 33,000ft. (61") 339/-; 33,600ft. (62") 345/-; 34,200ft. (63") 351/-; 34,800ft. (64") 357/-; 35,400ft. (65") 363/-; 36,000ft. (66") 369/-; 36,600ft. (67") 375/-; 37,200ft. (68") 381/-; 37,800ft. (69") 387/-; 38,400ft. (70") 393/-; 39,000ft. (71") 399/-; 39,600ft. (72") 405/-; 40,200ft. (73") 411/-; 40,800ft. (74") 417/-; 41,400ft. (75") 423/-; 42,000ft. (76") 429/-; 42,600ft. (77") 435/-; 43,200ft. (78") 441/-; 43,800ft. (79") 447/-; 44,400ft. (80") 453/-; 45,000ft. (81") 459/-; 45,600ft. (82") 465/-; 46,200ft. (83") 471/-; 46,800ft. (84") 477/-; 47,400ft. (85") 483/-; 48,000ft. (86") 489/-; 48,600ft. (87") 495/-; 49,200ft. (88") 501/-; 49,800ft. (89") 507/-; 50,400ft. (90") 513/-; 51,000ft. (91") 519/-; 51,600ft. (92") 525/-; 52,200ft. (93") 531/-; 52,800ft. (94") 537/-; 53,400ft. (95") 543/-; 54,000ft. (96") 549/-; 54,600ft. (97") 555/-; 55,200ft. (98") 561/-; 55,800ft. (99") 567/-; 56,400ft. (100") 573/-; 57,000ft. (101") 579/-; 57,600ft. (102") 585/-; 58,200ft. (103") 591/-; 58,800ft. (104") 597/-; 59,400ft. (105") 603/-; 60,000ft. (106") 609/-; 60,600ft. (107") 615/-; 61,200ft. (108") 621/-; 61,800ft. (109") 627/-; 62,400ft. (110") 633/-; 63,000ft. (111") 639/-; 63,600ft. (112") 645/-; 64,200ft. (113") 651/-; 64,800ft. (114") 657/-; 65,400ft. (115") 663/-; 66,000ft. (116") 669/-; 66,600ft. (117") 675/-; 67,200ft. (118") 681/-; 67,800ft. (119") 687/-; 68,400ft. (120") 693/-; 69,000ft. (121") 699/-; 69,600ft. (122") 705/-; 70,200ft. (123") 711/-; 70,800ft. (124") 717/-; 71,400ft. (125") 723/-; 72,000ft. (126") 729/-; 72,600ft. (127") 735/-; 73,200ft. (128") 741/-; 73,800ft. (129") 747/-; 74,400ft. (130") 753/-; 75,000ft. (131") 759/-; 75,600ft. (132") 765/-; 76,200ft. (133") 771/-; 76,800ft. (134") 777/-; 77,400ft. (135") 783/-; 78,000ft. (136") 789/-; 78,600ft. (137") 795/-; 79,200ft. (138") 801/-; 79,800ft. (139") 807/-; 80,400ft. (140") 813/-; 81,000ft. (141") 819/-; 81,600ft. (142") 825/-; 82,200ft. (143") 831/-; 82,800ft. (144") 837/-; 83,400ft. (145") 843/-; 84,000ft. (146") 849/-; 84,600ft. (147") 855/-; 85,200ft. (148") 861/-; 85,800ft. (149") 867/-; 86,400ft. (150") 873/-; 87,000ft. (151") 879/-; 87,600ft. (152") 885/-; 88,200ft. (153") 891/-; 88,800ft. (154") 897/-; 89,400ft. (155") 903/-; 90,000ft. (156") 909/-; 90,600ft. (157") 915/-; 91,200ft. (158") 921/-; 91,800ft. (159") 927/-; 92,400ft. (160") 933/-; 93,000ft. (161") 939/-; 93,600ft. (162") 945/-; 94,200ft. (163") 951/-; 94,800ft. (164") 957/-; 95,400ft. (165") 963/-; 96,000ft. (166") 969/-; 96,600ft. (167") 975/-; 97,200ft. (168") 981/-; 97,800ft. (169") 987/-; 98,400ft. (170") 993/-; 99,000ft. (171") 999/-; 99,600ft. (172") 1005/-; 100,200ft. (173") 1011/-; 100,800ft. (174") 1017/-; 101,400ft. (175") 1023/-; 102,000ft. (176") 1029/-; 102,600ft. (177") 1035/-; 103,200ft. (178") 1041/-; 103,800ft. (179") 1047/-; 104,400ft. (180") 1053/-; 105,000ft. (181") 1059/-; 105,600ft. (182") 1065/-; 106,200ft. (183") 1071/-; 106,800ft. (184") 1077/-; 107,400ft. (185") 1083/-; 108,000ft. (186") 1089/-; 108,600ft. (187") 1095/-; 109,200ft. (188") 1101/-; 109,800ft. (189") 1107/-; 110,400ft. (190") 1113/-; 111,000ft. (191") 1119/-; 111,600ft. (192") 1125/-; 112,200ft. (193") 1131/-; 112,800ft. (194") 1137/-; 113,400ft. (195") 1143/-; 114,000ft. (196") 1149/-; 114,600ft. (197") 1155/-; 115,200ft. (198") 1161/-; 115,800ft. (199") 1167/-; 116,400ft. (200") 1173/-; 117,000ft. (201") 1179/-; 117,600ft. (202") 1185/-; 118,200ft. (203") 1191/-; 118,800ft. (204") 1197/-; 119,400ft. (205") 1203/-; 120,000ft. (206") 1209/-; 120,600ft. (207") 1215/-; 121,200ft. (208") 1221/-; 121,800ft. (209") 1227/-; 122,400ft. (210") 1233/-; 123,000ft. (211") 1239/-; 123,600ft. (212") 1245/-; 124,200ft. (213") 1251/-; 124,800ft. (214") 1257/-; 125,400ft. (215") 1263/-; 126,000ft. (216") 1269/-; 126,600ft. (217") 1275/-; 127,200ft. (218") 1281/-; 127,800ft. (219") 1287/-; 128,400ft. (220") 1293/-; 129,000ft. (221") 1299/-; 129,600ft. (222") 1305/-; 130,200ft. (223") 1311/-; 130,800ft. (224") 1317/-; 131,400ft. (225") 1323/-; 132,000ft. (226") 1329/-; 132,600ft. (227") 1335/-; 133,200ft. (228") 1341/-; 133,800ft. (229") 1347/-; 134,400ft. (230") 1353/-; 135,000ft. (231") 1359/-; 135,600ft. (232") 1365/-; 136,200ft. (233") 1371/-; 136,800ft. (234") 1377/-; 137,400ft. (235") 1383/-; 138,000ft. (236") 1389/-; 138,600ft. (237") 1395/-; 139,200ft. (238") 1401/-; 139,800ft. (239") 1407/-; 140,400ft. (240") 1413/-; 141,000ft. (241") 1419/-; 141,600ft. (242") 1425/-; 142,200ft. (243") 1431/-; 142,800ft. (244") 1437/-; 143,400ft. (245") 1443/-; 144,000ft. (246") 1449/-; 144,600ft. (247") 1455/-; 145,200ft. (248") 1461/-; 145,800ft. (249") 1467/-; 146,400ft. (250") 1473/-; 147,000ft. (251") 1479/-; 147,600ft. (252") 1485/-; 148,200ft. (253") 1491/-; 148,800ft. (254") 1497/-; 149,400ft. (255") 1503/-; 150,000ft. (256") 1509/-; 150,600ft. (257") 1515/-; 151,200ft. (258") 1521/-; 151,800ft. (259") 1527/-; 152,400ft. (260") 1533/-; 153,000ft. (261") 1539/-; 153,600ft. (262") 1545/-; 154,200ft. (263") 1551/-; 154,800ft. (264") 1557/-; 155,400ft. (265") 1563/-; 156,000ft. (266") 1569/-; 156,600ft. (267") 1575/-; 157,200ft. (268") 1581/-; 157,800ft. (269") 1587/-; 158,400ft. (270") 1593/-; 159,000ft. (271") 1599/-; 159,600ft. (272") 1605/-; 160,200ft. (273") 1611/-; 160,800ft. (274") 1617/-; 161,400ft. (275") 1623/-; 162,000ft. (276") 1629/-; 162,600ft. (277") 1635/-; 163,200ft. (278") 1641/-; 163,800ft. (279") 1647/-; 164,400ft. (280") 1653/-; 165,000ft. (281") 1659/-; 165,600ft. (282") 1665/-; 166,200ft. (283") 1671/-; 166,800ft. (284") 1677/-; 167,400ft. (285") 1683/-; 168,000ft. (286") 1689/-; 168,600ft. (287") 1695/-; 169,200ft. (288") 1701/-; 169,800ft. (289") 1707/-; 170,400ft. (290") 1713/-; 171,000ft. (291") 1719/-; 171,600ft. (292") 1725/-; 172,200ft. (293") 1731/-; 172,800ft. (294") 1737/-; 173,400ft. (295") 1743/-; 174,000ft. (296") 1749/-; 174,600ft. (297") 1755/-; 175,200ft. (298") 1761/-; 175,800ft. (299") 1767/-; 176,400ft. (300") 1773/-; 177,000ft. (301") 1779/-; 177,600ft. (302") 1785/-; 178,200ft. (303") 1791/-; 178,800ft. (304") 1797/-; 179,400ft. (305") 1803/-; 180,000ft. (306") 1809/-; 180,600ft. (307") 1815/-; 181,200ft. (308") 1821/-; 181,800ft. (309") 1827/-; 182,400ft. (310") 1833/-; 183,000ft. (311") 1839/-; 183,600ft. (312") 1845/-; 184,200ft. (313") 1851/-; 184,800ft. (314") 1857/-; 185,400ft. (315") 1863/-; 186,000ft. (316") 1869/-; 186,600ft. (317") 1875/-; 187,200ft. (318") 1881/-; 187,800ft. (319") 1887/-; 188,400ft. (320") 1893/-; 189,000ft. (321") 1899/-; 189,600ft. (322") 1905/-; 190,200ft. (323") 1911/-; 190,800ft. (324") 1917/-; 191,400ft. (325") 1923/-; 192,000ft. (326") 1929/-; 192,600ft. (327") 1935/-; 193,200ft. (328") 1941/-; 193,800ft. (329") 1947/-; 194,400ft. (330") 1953/-; 195,000ft. (331") 1959/-; 195,600ft. (332") 1965/-; 196,200ft. (333") 1971/-; 196,800ft. (334") 1977/-; 197,400ft. (335") 1983/-; 198,000ft. (336") 1989/-; 198,600ft. (337") 1995/-; 199,200ft. (338") 2001/-; 199,800ft. (339") 2007/-; 200,400ft. (340") 2013/-; 201,000ft. (341") 2019/-; 201,600ft. (342") 2025/-; 202,200ft. (343") 2031/-; 202,800ft. (344") 2037/-; 203,400ft. (345") 2043/-; 204,000ft. (346") 2049/-; 204,600ft. (347") 2055/-; 205,200ft. (348") 2061/-; 205,800ft. (349") 2067/-; 206,400ft. (350") 2073/-; 207,000ft. (351") 2079/-; 207,600ft. (352") 2085/-; 208,200ft. (353") 2091/-; 208,800ft. (354") 2097/-; 209,400ft. (355") 2103/-; 210,000ft. (356") 2109/-; 210,600ft. (357") 2115/-; 211,200ft. (358") 2121/-; 211,800ft. (359") 2127/-; 212,400ft. (360") 2133/-; 213,000ft. (361") 2139/-; 213,600ft. (362") 2145/-; 214,200ft. (363") 2151/-; 214,800ft. (364") 2157/-; 2

LINEAR

For

HIGH SENSITIVITY
MAXIMUM RELIABILITY

HIGHEST FIDELITY
REASONABLE COST

We regret to announce that after maintaining our prices for seven years (with the exception of one unit) we are reluctantly announcing a revised price list.

L.50. 50 watt Amplifier approximately 14x10x8in. Sensitivity 25 m.v. output for 3 and 15 ohm Speakers. *Retail price 22 guineas.*

CONCHORD. 30 watt Hi-Fi Amplifier with two separately controlled inputs. *Retail price 17 guineas.*

L.10. 10 watt Hi-Fi Amplifier with separate pre-amp. *Retail Price 16 guineas.*

L.1/10. 10 watt Hi-Fi Amplifier with integral pre-amp. *Retail price 13½ guineas.*

DIATONIC. 10/14 watt Hi-Fi Amplifier with integral pre-amp. *Retail price 12½ guineas.*

L.5/5. Stereophonic Amplifier. Output 5 watts each channel. *Retail price 12½ guineas.*

Trade and Export Enquires invited—

LT.45X. Tape Amplifier with equalisation adjustment for 1½, 3½ and 7½in. per second. Suitable for Collaro Studio Tape Transcriptor. Complete with integral power pack. *Retail price 12½ guineas.*

LP.1. Tape Pre-Amplifier. As above but less power pack facilities.

L.45A. 4/5 watt Amplifier. *Retail price 6 guineas.*

LG.34. 3/4 watt Amplifier. Shelf mounting type for gram use. *Retail price £5.10.0.*

TREMOLO UNIT. For Guitar purposes to plug into mains Amplifier. *Retail price 4 guineas.*

LINEAR PRODUCTS LTD. ELECTRON WORKS *Tel. Leeds 63-0126 (3 lines)*
ARMLEY, LEEDS. S.A.E. for catalogue.

The COMMON-CORE Series

ILLUSTRATED COURSES OF ELEMENTARY TECHNICAL TRAINING

basic electronic circuits

THE AIM OF THIS TWO-PART SERIES IS TO ILLUSTRATE AND EXPLAIN A REPRESENTATIVE SELECTION OF THE PRINCIPAL "FAMILIES" OF CIRCUITS MOST USED IN RADAR AND ELECTRONICS ENGINEERING.

Section titles include:

Part 1

Waveforms: Pulse response in RC, RL and RLC Circuits; The Delay Line; Amplitude-Shaping Circuits; Rectangular Pulse Generators; Pulse-Lengthening and Pulse-Shortening Circuits.

Part 2

Sawtooth Voltage Generators (Constant-Current, Bootstrap, Miller and Miller Transistor); Sawtooth Current Generators (RCR and Miller-with-Step); Strobe Pulse Generators (Long-Tailed-Pair, Multiar, Phantastron and Phase-Shift).

BOTH VALVE AND TRANSISTOR TYPES OF EVERY CIRCUIT FAMILY ARE ILLUSTRATED AND EXPLAINED IN CAREFULLY-PLANNED PAGES

These two manuals were developed by a special Electronics Training Investigation Team of R.E.M.E. working in conjunction with Tech. Training Command of the R.A.F. and Decca Radar Limited

Also available in the Series

basic electricity : basic electronics
basic synchros & servomechanisms

DETAILED PROSPECTUS AND PRICES ON APPLICATION
THE TECHNICAL PRESS LTD., 112 WESTBOURNE GROVE, LONDON, W.2



LETTERS TO THE EDITOR

AMERICAN LITERATURE

SIR.—Having read (with great pleasure) many technical publications from the U.S.A. I really cannot agree with your correspondent James Goodwin (October issue) that there is anything at all “difficult” in them.

Surely all your readers are aware that what we call a valve they refer to as a *tube*; our anode is their *plate* and earth becomes *ground* on the other side of the Atlantic, together with *antenna* for aerial.

Most of these changes seem to me to be self-explanatory—like their “A”, “B” and “C” voltages for the power supplies l.t., h.t. and g.b. (grid bias).

The only real stumbling-block is in following the circuit diagrams as I personally much prefer the European idea of keeping the h.t. line “at the top of the page”. However, the Yanks’ method of keeping the power supplies at the bottom has one advantage—it is much easier to “follow” the a.c. signal through the circuit.

Talking of difficult circuit diagrams, how many readers have tried to unravel one in a French magazine—where the valves (or should I say tubes?) are all printed horizontally, probably the result of too much *vin rouge*?—D. BYRNE, G3KPO (Peterborough).

SIR.—Whilst I cannot help but endorse Mr. James Goodwin’s praise of your book reviews in the October issue of *PRACTICAL WIRELESS* I must disagree with his criticism of American technical literature. I have read several books from the U.S.A. on radio and electronics and have experienced little or no difficulty in following the text. Anyone with a modicum of intelligence and common sense should be able to “interpret” all these terms in a few moments. Many are more descriptive than the corresponding term used in England—*vacuum tube* for valve, *plate* for anode. For those who do have any difficulty, some of the British editions of American books have forewords written especially for British readers.

As for the circuit diagrams and symbols, whilst these look vastly different, on closer inspection the only real difference turns out to be the absence of a reference point in the form of a line representing chassis. Thus the whole diagram looks to be “falling apart”.

The real difficulty is in obtaining American components in Britain at prices comparable with the British ones. Coils and transistors are the worst in this respect. I have had to abandon

Whilst we are always pleased to assist readers with their technical difficulties, we regret that we are unable to supply diagrams or provide instructions for modifying commercial or surplus equipment. We cannot supply alternative details for receivers described in these pages. **WE CANNOT UNDERTAKE TO ANSWER QUERIES OVER THE TELEPHONE.** If a postal reply is required a stamped and addressed envelope must be enclosed with the coupon from page iii of the cover.

The Editor does not necessarily agree with the opinions expressed by his correspondents.

several interesting circuits because of the high cost or total unavailability of the suitable components.

No, it is not the theory which causes the trouble but putting it into practice.—D. C. BROWN (Leeds, Yorkshire).

COILS FOR THE SPECTREUPHON

SIR.—With reference to the above article in the October, 1964, issue of *PRACTICAL WIRELESS*, I should like to make the following comments: I found difficulty in obtaining the Denco coils suggested for use in the Euphon section of the unit. Having access to a commercial inductance bridge I wound the coils myself, the following being the details: 90 turns wound in two layers each of 45 turns on a 1½in. diameter former with 18s.w.g. enamelled copper wire give the required inductance. I constructed the Euphon section and the results were extremely satisfying. The unit adds more depth to a mono recording and gives the impression that one is in the same room as the recording artist. The balance control proved to be very critical to adjust and requires adjustment on each record. The latter disadvantage is offset, however, by the amazing performance of the unit.—D. AMYES (Hull, East Yorkshire).

REGENERATIVE RECEIVERS

SIR.—With reference to the “High Compression Front End” P.W., September, 1964) by C. Leslie Thomson. This small regenerative receiver is a hot little thing, one curious fact about the SB Transistor series and the MATs being that although the latter are, on the whole, considerably better performers, they are inferior to SBs in circuits like Mr. Thomson’s.

I have had lots of fun with regenerative receivers and I thought your author might like to hear of someone else who has also devoted quite some time (wasted, according to some!) to them.

In the 1961 *Electronic Experimenters’ Handbook* there is a similar circuit by Alvin Mason. The transformer used in my circuit was the Ardent 1001.

In the Gernsback Series “Transistor Projects” there is an outstanding circuit by Edwin Bohr. This one uses an SB100, though others in the SB and MAT series were tried and all performed well. The advantage of this type of set is that the transformer is eliminated, though it is true that the size of an extra mercury cell is almost as much. Discounting in each circuit the usual tuning arrangements, Bohr’s circuit has three resistors and no capacitors, as against Mr. Thomson’s five

resistors, three capacitors and an audio transformer (offset to some degree, it is agreed, by the absence of a second cell).

This little note on regenerative receivers would be very incomplete if mention were not made of what I have, so far, found to be the most extraordinary circuit, particularly in respect of audio quality. This is Wotton's "Amplified d.c. Transistor Receiver", described in P.W., February, 1961. Mr. Wotton's circuit is based on the original by Cleland in P.W., November, 1959, and merits the attention of all those interested in a really high quality receiver. I have built several versions and can honestly say that it is not over-difficult to build a sub-miniature set into a box smaller than the average matchbox. Naturally a mercury cell should be used.

Incidentally, replacing the first semiconductor with a MAT100 will, of course, improve the sensitivity, but there seems to be little point in doing so unless one likes to lie in bed at night and attempt to pull in some distant medium wave stations.

That this circuit is good has been testified by its inclusion in a well-known constructor's manual of transistor circuits. Apart from using different transistors the circuit, as far as I can see, is identical. The performance in so far as sensitivity and noise are concerned is better; but not because of circuit changes, rather component improvements.—H. A. L. WAGNER (Kuala Lumpur, Malaya).

REQUESTS FOR INFORMATION ARE INSERTED IN THIS COLUMN ON THE UNDERSTANDING THAT READERS USING THE SERVICE UNDERTAKE TO REPLY TO ALL OFFERS RECEIVED AND TO RETURN ALL DATA NOT REQUIRED. BECAUSE OF THE LARGE NUMBER OF REQUESTS RECEIVED, ILLEGIBLE WRITING WILL AUTOMATICALLY DISQUALIFY LETTERS FROM PUBLICATION. FOR THE SAME REASON, WE CANNOT GIVE SPACE TO REQUESTS FOR PAST ISSUES OF "PRACTICAL WIRELESS."

Sir—I would be grateful if any reader could sell or loan me . . .

. . . any details of the connections of an "Antinodal" coil covering 12-80m and manufactured by R.I. Limited.—J. M. Cranke, The Nook, 85 Castle Road, Newport, I.O.W.

. . . the circuit diagram for the Marconi receiver CR150 or CR150/2.—H. Humphries, The Old Vicarage, Gazeley, Newmarket, Suffolk.

. . . the manual and/or circuit diagram of the R1116A receiver.—A. D. Couchman, 3 Manor Grove, Sittingbourne, Kent.

. . . practical audio circuits using two 838 valves in push-pull.—I. R. Reynolds, 11 Bridge Street, Sturminster, Suffolk.

. . . the circuit diagram and any other information on the portable medium and long wave receiver PCR8.—D. Fitton, 80 Banastre Road, Southport, Lancashire.

. . . the circuit and any other details of the receiver B.34.—A. J. Harris, 74 Bodmin Road, Whittleigh, Plymouth, Devon.

. . . the blueprints for anything between a 4+4 and 10+10 stereo transistor preamp. If required I will return data by registered mail and refund postage.—4235873 J/T Phillip, L., 114 M.C.R.U., R.A.A.F. Butterworth, Penang, Malaysia.

. . . information on the modifications of the R1155 receiver.—N. Hood, 1 Rectory Lane, Letchcombe Basset, Wantage, Hertfordshire.

. . . the Eddystone 640 Handbook.—J. Farman, 84 Blackburn Road, Padiham, Nr. Burnley, Lancashire.

. . . any oscillator modification data for the R1392 v.h.f. receiver, or any other information.—V. Thomas, 8 Beaufort Crescent, Silverhill, St. Leonards-on-Sea, Sussex.

. . . the base connections and, or any other information regarding the cathode ray tube type CV960.—Philip Beet, 17 Firs Avenue, Alfreton, Derbyshire.

. . . a service sheet or instruction book for Ex-government

radio set No. 62 Mk. 2.—J. E. Pearce, 52 Cranford Lane, Heston, Middlesex.

. . . the circuit of the Marconi HP112 transmitter/receiver, also the circuit of the 38 set.—W. BURKE, 6 Belgrave Terrace, Glasgow W.2.

. . . the handbook and circuit for the R107 receiver and also any details of modifications.—R. WILD, 140 Nansen Road, Ward End, Birmingham 8.

. . . the circuit of the Dynaport No. 55 Radio.—G. WILSON, 62 Russell Road, Tottenham, London, N.15.

. . . circuit or any other information on the 19 set Mark 3.—A. Sellwood, 151 Chestnut Drive South, Leigh, Lancashire.

. . . details and circuit diagram of the Cossor Ex-Govt. Cathode Ray Indicator, Type 95, Ref. 10Q/16.—Flat 24, 4 Dryburgh Gardens, Dundee.

. . . any information on Receiver Type 73, also Transmitter Type 49.—E. S. WEBB, 6 Pond Hill, Halberton, Tiverton Devon.

CORRESPONDENTS WANTED

SIR—I am 17 years old and interested in all aspects of radio. I would be grateful if any reader about my own age or older would correspond with me. I am studying electronics at home and another home studier would be most suitable because we could help each other.—GERARD WALLACE (Ballyvaughan, County Clare, Eire).

SIR—I am interested in radio and electronics and would like to correspond with people who are interested in exchanging radio parts for Indian curios and novelties or anything of equal value from my country. The reason for this request is that radio components are not easily available here or are unduly expensive. I am 18 years old.—CHAIANJIT SINGH (122/Narmada, Indian Institute of Technology, Madras 3, India).

SIR—I am very keen on tape recording and would like to tapespond with anyone who shares my hobbies of C.W. and folk music, photography, sound effects and TV DX-ing. I have a two-track 3 $\frac{1}{2}$ i.p.s. Fidelity Argyll with maximum spool size of 5 $\frac{1}{2}$ in.—IAN UDEN (7 Ash Road, Strood, Kent).

AN EXPERIMENTER'S GALVANOMETER

—continued from page 752

straight wire was placed immediately in front of and in the middle of the lens.

The Scale

This was made from a strip of greaseproof paper with graduations on one side. The paper was held in position by a light balsa wood frame

These, (b) and (c), could be moved around until a sharp image of the lens was obtained on the scale after reflection from the mirror of the galvanometer.

The suspensions are not ideal as they are rather easily broken and sometimes do not quite return to zero after prolonged deflection, but they are quite satisfactory for many purposes. They are in fact, far better than the somewhat amateurish method of construction might lead one to expect.

The dimensions given are not intended to be exact but are a general guide to the construction

The sensitivity is approximately 25mm/ μ A at a scale distance of one metre.

The total resistance of the galvanometer, about 10 Ω , the period 6sec., external critical damping resistance 30 Ω .

NEW—BY RETURN POSTAL SERVICE BY CONCORD — LEADERS IN RADIO KITS

AMAZING RADIO!

CIGARETTE

ONLY 18/6



Yes, a perfectly ordinary packet of cigarettes!—but watch your friends' astonishment on hearing it fetch in station after station, loud and clear! Still holds 10 cigarettes—yet cleverly conceals highly sensitive, fully transistorised circuit (including tiny battery). Even a young boy can assemble it in under 2 hours. No soldering. No experience necessary. Only 16 connections to make. Ideal for taking to work with you. From our bulking testimonial file, Mr. D.B. of Huddersfield writes:—“... I have fitted the parts in and it is working wonderfully.” ALL PARTS including Semiconductors, A.B.C. Plans, etc. ONLY 18/6 plus 1/6 post, etc. (C.O.D. 1/6 ex.). (Parts available separately).

MAKE 5 DIFFERENT TRANSISTOR RADIOS FOR

35/-



NO EXPERIENCE NECESSARY. No soldering. Only 8 connections for first radio to work. Just look, you get Giant 4 colour box, 1ft. 2in. x 10 1/2in. x 2 1/2in. containing A.B.C. Plans, St. Tropez type Cabinet, Loudspeaker (alone 17/6), Earphone, 4 Semi-conductors, Coils, Condensers, Resistors, Tune Switch, Screws, etc. **YES—EVERYTHING!** Loud, clear English and Foreign reception. As supplied to Educational Authorities, H.M. Forces, etc. **TESTIMONIALS:** CALORE. Mr. R. O'D. of Londonderry writes:—“... I received your components and I must say that I am very satisfied with them. I have it all ready set up!” **COMPLETE, HOME RADIO COURSE.** Originally £8. **SEND ONLY 35/- plus 3/- post etc. (C.O.D. 3/- ex.).**

NEW RADIO

ANYONE CAN BUILD IN 2-3 HOURS

19/6

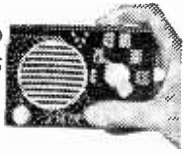

EVEN THE OLDER CHILDREN BUILD THEM! ... no soldering—only 16 connections! then hear it reach out bringing in station after station, loud and clear. Palm-of-hand size 4 1/2 x 2 1/2 x 1 1/2in. Many Testimonials: M.H. of Bradford, writes:—“... I have just completed one of your sets successfully, it is the first time I have ever tackled anything like a radio, and I must state here and now, I am amazed how easy it is to a layman like me. Your instructions and plan have obviously been very carefully thought out so that even the most dim can follow them.” Direct from Manufacturers to You. **SEND 19/6 plus 1/6 post etc. (C.O.D. 2/6 ex.).** **PARTS AVAILABLE SEPARATELY**

READ WHAT SATISFIED CUSTOMERS SAY

R.C. of HARRINGAY writes
Received with thanks Skyroma
... Very pleased. Working well.

L.S. of LONDON W.8 writes
... given it a good try out
and I am very pleased with
the results.

D.R. of GLASGOW writes
... it is a lovely little thing
and as clear as a bell.

J.W. of BRIGHTON writes
... I have recommended your
radio to many of my friends.

B.M. of HARROGATE writes
... I would like to thank
you ... It is a real bargain.

S.B. of SOMERSET writes
... delighted with this radio
... glad if you could send
one more.

T.F. of STEVENAGE writes
I would just like to say how
pleased my son is with this
radio.

W.R. of MIDDLESEX writes
Thank you for my dear
little radio. It is a real
treasure to me.

MINIATURE SPY CAMERA



ONLY 19/6 NO MORE TO PAY

World shattering Purchase by our FOREIGN AGENTS makes this exclusive scoop yours for ONLY 19/6. This exciting little 2 speed camera is not a toy but a precision-made photographic instrument in chromed steel and leather with minute multi-Magnifying Lens—each 14mm. film takes 10 pictures—size 1 1/2 x 2 1/2in.—Only 19/6. P. & P. 1/6 ex. (C.O.D. 2/6).

FREE Leather Carry-case. Six Rolls of Film.

TRANSISTOR POCKET RADIOS



ONLY 28/6 No More to Pay

BULK PURCHASE ENABLES US TO MAKE THIS FANTASTIC OFFER—AND OFFER MONEY BACK GUARANTEE!!! The “SAN REMO” ... so tuned that it brings the voices of star entertainers and vocalists dramatically to life—in your home, office, car. Only 4 1/2 x 2 1/2 x 1 1/2in. Fits easily into your pocket or handbag. Works for months off 1/2 battery. should last a lifetime. anyone can assemble it in an hour or two with our easy plan. Miniature speaker, carrying case—everything only 28/6, 1/6 P. & P. C.O.D. 1/6 extra. (Parts can be bought separately.) Limited period—so rush your order before it's too late. DEMONSTRATIONS DAILY.



THE MIAMI TRANSISTOR RADIO ONLY 17/6

Unbelievably small—outrageously cheap. You will be amazed at the fine quality of tone and volume of this great little radio. Only a fantastic 3 1/2 x 2 1/2 x 1 1/2in. the MIAMI will bring you great entertainment for months on an 8d. battery. Simple assembly plan with each set. ONLY 17/6. YES 17/6. Plus 1/6 P. & P. (C.O.D. 2/6 extra). Satisfaction guaranteed. Demonstrations given daily. Parts available separately if required.

MINIETTE 4-STAGE



with this newly designed MINIETTE 4-STAGE transistor set in very strong rear drilled LTRA MODERN 48E, size only 6 x 3 1/2 x 1 1/2in. Uses three transistors and diode and ELP-CONTAINED SPEAKER. Very sensitive, ideal for office, bedroom, holidays, etc. Months and months of listening off a 1/2 battery. can be built FOR 19/6 including Proper Case, miniature speaker. Simple as A.B.C. Pictorial Step-by-Step Plans. plus post and packing 1/6. Parts sold separately.

Fabulous ST. TROPEZ MK. 6

The Sensational Pocket Radio



This fantastic offer will amaze you—the beautifully compact ST. TROPEZ, measuring 4 1/2 x 3 x 1 1/2in. receives perfectly in bedroom, office or garden—over all medium waves including Luxembourg. Under 1d. per hour running cost. ANYONE can assemble it in one or two hours using our simple A.B.C. plan. 25/- P. & P. 2/6 extra. Case extra. Parts can be bought separately.

AMAZING NEW INVENTION

AUTOMATIC CAR LIGHTER ONLY 10/-



We have been lucky enough to purchase 1,500 only of these fully automatic Car Cigarette Dispenser/Lighters because of a frustrated export shipment. Originally made to sell at about 45/4. Robust and ingeniously designed to heavy chromium. Holds packet of cigarettes (any make and size) you reach out with one hand, press a button and a lighted cigarette is in your hand! Can be fitted by anyone in 2-3 minutes. For 6 or 12 volts, full connecting details—only one wire to connect. Each one in own coloured box, brand new and untouched. Only 10/-, add 1/6 P. & P.

RIGRET NO C.O.D. UNDER 10/6. ORDERS UNDER 10/6. ORDERS FROM ABROAD WELCOME BUT SORRY NO C.O.D.

CONCORD ELECTRONICS

LTD. (Dept. P.W.14) 9 Western Road, Hove, Sussex

Amplifier

by

***Be first to own the
only amplifier of its kind
in the world!***

FACTS YOU SHOULD KNOW ABOUT THE X-10

Number of transistors—11

Overall size— $6 \times 3 \times \frac{3}{4}$ in.

Input Sensitivity—1mV into 1K Ω

Suitable for all types of pick-ups, microphones, etc.

Total harmonic distortion—Less than 0.1%

Output power—10 watts

Output efficiency—about 95% compared with about 60% for conventional Class B outputs

Frequency response—5-20,000 c/s \pm 0.5dB

Speaker impedance—15 Ω

Damping factor—Greater than 100

Quiescent consumption—75mA

Supply voltage—12 volts

FULLY GUARANTEED

**NEVER ANYTHING LIKE IT BEFORE — AND
ITS PERFORMANCE IS FANTASTIC**

The SINCLAIR-X10 combined 10 watt amplifier and pre-amplifier (Pats. applied for) is so advanced in design that it outdates every type of amplifier ever made available to constructors, hi-fi enthusiasts, experimenters and industrial users.

The unique eleven transistor circuit specially developed for this amplifier solves once and for all problems inherent in conventional transistor amplifier design so that users of the Sinclair X-10 system enjoy far better reproduction, true 10 watt output for less current consumption (the amplifier will run for about 3 months from two 4/- Ever Ready 996 batteries) and great savings in

space AND COST. Furthermore, the Sinclair X-10 is so designed that with the aid of the manual included with each amplifier (built or in parts) the purchaser can select the tone control and input matching system appropriate to his requirements to make a hi-fi assembly for very little outlay. This is truly the amplifier of tomorrow—and it can be yours today!

NEW design principles performance

SINCLAIR X-10

COMBINED 10 WATT AMPLIFIER AND PRE-AMP

Breakthrough

SINCLAIR

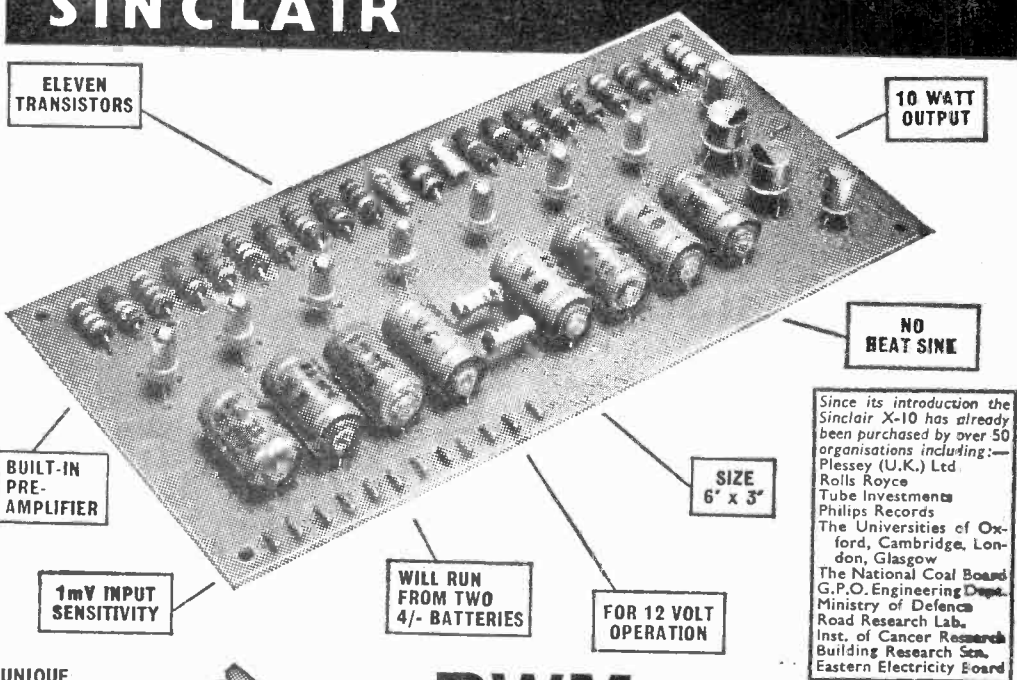

ELEVEN TRANSISTORS

10 WATT OUTPUT

NO HEAT SINK

BUILT-IN PRE-AMPLIFIER

SIZE 6" x 3"

1mV INPUT SENSITIVITY

WILL RUN FROM TWO 4/- BATTERIES

FOR 12 VOLT OPERATION

Since its introduction the Sinclair X-10 has already been purchased by over 50 organisations including:—
 Plessey (U.K.) Ltd
 Rolls Royce
 Tube Investments
 Philips Records
 The Universities of Oxford, Cambridge, London, Glasgow
 The National Coal Board
 G.P.O. Engineering Dept.
 Ministry of Defence
 Road Research Lab.
 Inst. of Cancer Research
 Building Research Sta.
 Eastern Electricity Board

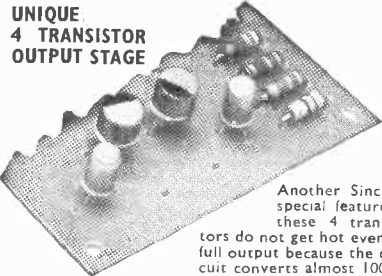

UNIQUE 4 TRANSISTOR OUTPUT STAGE

Another Sinclair special feature—these 4 transistors do not get hot even at full output because the circuit converts almost 100% of the power from battery

or mains unit into audio power for the loudspeaker.

PWM is the answer!

The principle of PULSE WIDTH MODULATION used in the X-10 is briefly as follows: A square wave of constant voltage amplitude and with a frequency of 50Kc/s is applied to the terminals of the load. As the load has a high impedance at this frequency negligible current flows through the voice coil of the speaker. In the absence of any input signal the mark space ratio of the square wave is unity—that is, the current flows for an equal period in each direction. When an input signal is applied the mark-space ratio changes with the result that there is a net current flowing through the voice coil which deflects the cone. When the input signal is at

any frequency up to 20Kc/s the net current is an exact replica of the input signal and is independent of the transfer characteristics of the output transistors. Thus the distortion figures can be incredibly low. The vital advantage of using P.W.M. is that the output transistors act as switches and therefore dissipate negligible power. Because of this we have been able to use 5Mc/s transistors in the output stage of the X-10. These transistors are small and require no heat sinks.

Price, inclusive of all parts and Instruction Manual for building X-10

£5-19-6

READY BUILT AND TESTED including Instructions Manual

£6-19-6

Mains Power Supply Unit (A.C. 200/240V)

£2-14-0

THE SINCLAIR X-10 MANUAL

Supplied with every Sinclair X-10 (purchased built or in parts) the X-10 Manual explains how the amplifier functions and how to add the correct tone and volume control system to suit your requirements exactly. A variety of systems is shown, none of which will add more than a few shillings to the original cost of your Sinclair X-10 amplifier, and because it is so simple to modify this part of the assembly, further matching is very easy should you change your type of pick-up or other input

Order form and further Sinclair designs on next pages

SINCLAIR RADIONICS LTD, COMBERTON, CAMBRIDGE

Telephone Comberton 682

Have YOU built

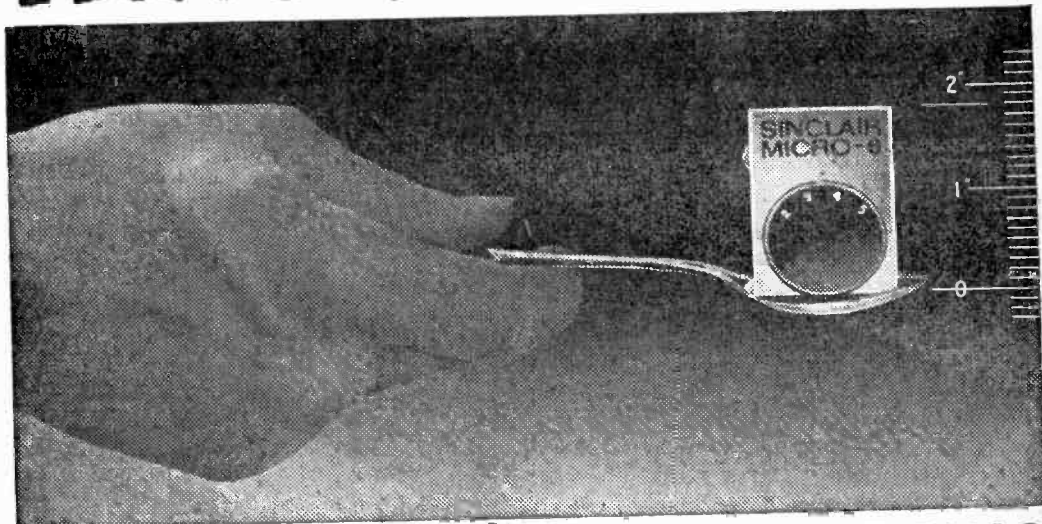

THE WORLD'S SMALLEST RADIO HAS FANTASTIC POWER AND PLAYS ANYWHERE

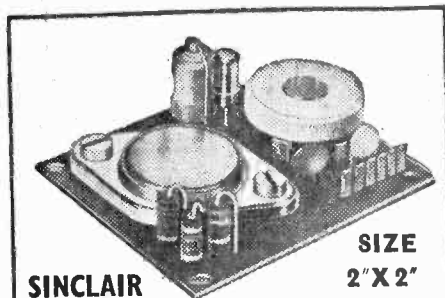

SIZE
2" X 2"

SINCLAIR

TR750 POWER AMPLIFIER

Designed to be used with the Micro-6 or Slimline. Will make a car-radio, record player, etc.

THE TR750 (for building yourself or available ready built) measures only 2" x 2" and includes volume control with switch. It will provide powerful loudspeaker reproduction from the Micro-6 or Slimline for use as a car radio or domestic or portable loudspeaker set. The TR750 also has many other applications such as record reproducer, intercom or baby alarm. An output of 750 milliwatts for feeding into a standard 25-30Ω loudspeaker requires only a 10mV input into 2kΩ. Frequency response 30-20,000 c/s ± 1dB. Power required—9 to 12 volts.

All parts with instructions come to

39/6

Ready built and tested with instructions

45/-

THE SINCLAIR MICRO-6 continues unchallenged as the most remarkable receiver of its kind ever made available to the public anywhere in the world and thousands have already been built. It has special 6-stage circuitry and is at the same time the smallest set on earth. Everything except the lightweight earpiece is contained in the smart, minute white, gold and black case which is appreciably smaller than a matchbox. With vernier-type tuning control bandspread over the higher frequency end of the medium waveband and powerful A.G.C. to ensure fade free reception of the most distant stations, the Micro-6 provides remarkable standards of performance. Quality of reproduction is outstandingly good and again and again the set is reported to give excellent results where other sets cannot be used at all. The Micro-6 cannot be too highly recommended, both as an intriguing design to build and a most practical radio to use.

- SIZE—1⁴/₈in. x 1³/₁₀in. x 1¹/₂in.
- WEIGHT—UNDER 1oz. INCLUDING BATTERIES
- TUNING—OVER MEDIUM WAVEBAND WITH BANDSPREAD FOR EASY RECEPTION OF LUXEMBOURG

SINCLAIR MICRO-6

BUILD IT IN AN EVENING

Although designed to standards of compactness never before thought possible, building is simple and straightforward. All parts including MAT transistors, diodes, printed circuit board, lightweight earpiece case and dial, and 8 page instructions manual come to

59/6

'TRANSRISTA' black nylon strap for wearing 7/6
the Micro-6 like a wrist watch

MERCURY MALLORY CELL 1/11 Pack of 6 10/6
Type ZM312 (2 required) each

USE THIS ORDER FORM

Telephone: COMBERTON 682

SINCLAIR RADIONICS LTD., COMBERTON, CAMBRIDGE

yours yet?

THE MICRO-6 USES THE SMALLEST COMPONENTS EVER MADE AVAILABLE TO HOME CONSTRUCTORS

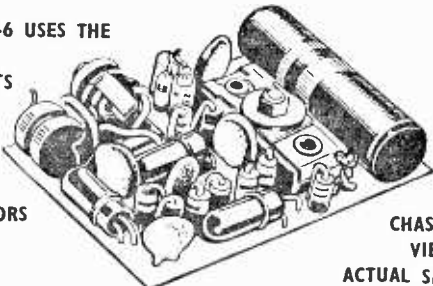

CHASSIS VIEW
ACTUAL SIZE

The Micro-6 uses only 3 special Micro-Alloy Transistors in a completely new six stage circuit as follows:—Two stages of R.F. which drives a high-gain 3-stage A.F. amplifier. Powerful A.G.C. applied to the first R.F. stage ensures fade-free reception from distant stations. Everything including ferrite rod aerial and batteries is contained within the elegant tiny case. The set is switched on by inserting the plug of the earpiece.

SIX STAGE CIRCUITRY AND POWER A.G.C.

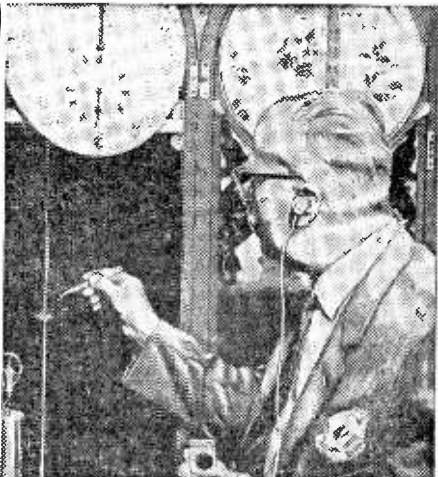
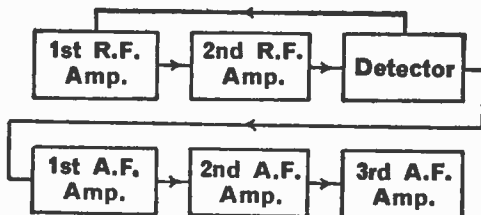

Mr Frank E. Holmes is a watch and clockmaker of Oxtou Birkenhead for whom precise time is vital. He uses his Micro-6 to check his standard clock against the Greenwich Time Signal—and no doubt listens to the other programmes too.



HER MASTER'S CHOICE. Jane, the well-loved dog of the Beckingham family in Whitchurch, Hants, genuinely enjoys a session with the Micro-6 although we are not told what her favourite programme is. Mr W. W. Beckingham who sent the photo states that Jane is a Micro-6 enthusiast (as are the rest of the family).

SINCLAIR MICRO-INJECTOR

An invaluable aid in fault tracing

Generates and injects a signal into any part of equipment at any frequency from 1 kc/s. to 30 mc/s. to locate faults rapidly. 1.8in. x 1.8in. x 0.6in. excluding probe. With full instructions.



Parts and instructions come to **27/6** Ready Built **32/6**

SINCLAIR SLIMLINE

The extra-easy to build pocket receiver

Ideal for newcomers. Has self contained aerial, takes standard PP5 battery. Measures only 2 1/4" x 1 1/2" x 1 1/2" and only 2 1/2 lbs. Turns over medium waveband. Great power and quality. All parts including royal blue and gold case, earpiece and instructions come to



49/6



From Mr Blair, of Stoke-on-Trent comes this photo which needs no explaining such is the contrast between the old and the new in radio listening.

UNIQUE SINCLAIR GUARANTEE

If you are not completely satisfied with your purchase (we are confident that you will be delighted) your full purchase price will be refunded instantly and without question. Full service facilities always available to Sinclair customers.

★ SINCLAIR X-10—SEE PRECEDING PAGES

TO SINCLAIR RADIONICS LTD., COMBERTON, CAMBRIDGE

Please send items detailed below

£ s. d.

NAME

Phone: COMBERTON 682

ADDRESS

TOTAL £

For which I enclose cash/cheque/monies order

BLOCK LETTERS

P.W. 12

RECEIVERS & COMPONENTS

COMPONENTS at give-away prices!
Transistors: Valves: Coaxial Cable:
Electrolytics: Vol Controls: Pre-sets:
Speakers: Test Meters: Recording
Tapes: Wiring Cable: Microphones:
Pick-up Cartridges: Soldering Irons:
Plugs, Sockets, Panels etc. Send a
3d. stamp for full price lists.
DIAMOND (Mail Order) Products,
(P.W.) BMC/DIA, London, W.C.1.

DIRECT TV REPLACEMENTS LTD.
largest stockists of TV Components
in the UK. Line Output Transform-
ers. Frame Output Transformers.
Deflector Coils for most makes.
Official sole suppliers for many set
makes. Same day Dispatch Service.
Terms C.O.D. or C.W.O. Send S.A.E.
For quotes. Day and Night Telephone
GIPsy Hill 6166 126 Hamilton Road,
West Norwood, S.E.27.

TAPE RECORDING CONTROL PANELS

New, comprising of the following very high grade components:

- 4in. V.U. Meter 100 micro amps F.S.D. with built-in panel U.S.H.T.
- Double Wire Wound Potentiometer.
- Single Wire Wound Potentiometer 1500 ohms.
- 24-way Painton Socket and Plug.
- 12-way Painton Socket only.
- Tape Speed Meter Head only.
- Double Pole Key Switches.
- 10-position 2-gang Rotary Switch.
- Push Button Switches.
- Panel Lights.

The following wire wound resistances all + or - 5%.

1-600 ohms	7-15 ohms	5-22 ohms
3-66 ohms	1-62 ohms	5-68 ohms

This must have cost £50 to make
OUR PRICE ONLY £5 Carriage and packing 10/.

C. W. WHEELHOUSE

11-55 BELL ROAD, HOUNSLOW, Middx.
Telephone: HOUNSLOW 8501

TRANSISTORS! Give away price.
NET124/5 Power Type, 6 for 10/-.
2S017 4W, up to 60Mc/s, 5/- each.
Post free. G. F. MILWARD 17 Peel
Close, Drayton Bassett, Staffs.

RESISTORS! You can't resist this!
1W, 1W, 2W Polythene wrapped on
cards of 10. Mixed values and wait-
ages £2/10/- per 1,000. G. F. MIL-
WARD, 17 Peel Close, Drayton
Bassett, Staffs.

AERIAL MATCHING TUNING UNITS

LATEST AMERICAN RELEASE BULK PURCHASE
OF 3,000

These well made tuning units made for the American
19 T.X.-R.X. are housed in a metal case, size
4 x 4 x 10in., using a large precision calibrated scale,
are an essential piece of equipment for the serious
T.X. or E.X. operator. This unit will match an
untuned wire or whip aerial to almost any short
wave receiver or transmitter, exceptionally good for
mobile top band use. This American version being
well noted as far superior to any other. GUAR-
ANTEED BRAND NEW only 20/-, post 7/6.
Instructions supplied.

PYE OR INVICTA LOUDSPEAKER UNITS

Enclosed in a brown wooden cabinet and carrying
handle side, using a silver speaker mesh. Complete
with 40ft. of lead and jack plug. A 10in. heavy duty
3 ohm speaker is used, being very useful for Groups.
Halls, P.A. work, etc. (made for any entertainment
use). BRAND NEW and BOXED only £22.15.0.
carr. 6/-, a fraction of cost.

88 T.X.-R.X. POWER UNIT

12V input to 90V, 7.5V, 1.4V stabilised output.
Also contains L.F. amplifier. These are sold BRAND
NEW with 4 B.7.G. valves, only 50/-, P.F. 5/-.

J. T. SUPPLY (Dept. D)
38 MEADOW LANE, LEEDS 11

RATES: 7/3 per line or part
thereof average five words to line,
minimum 2 lines. Box No. 1/- extra.
Advertisements must be prepaid and
addressed to the Advertisement
Manager, "Practical Wireless,"
Tower House, Southampton St.,
London W.C.2.

RECEIVERS & COMPONENTS

(continued)

R & R RADIO & T V SERVICE

Dept. P.W.
MARKET STREET, BACUP, LANCS.
Telephone 453

SALVAGE VALVES Tested before dispatch

6F13	4/6	10P14	5/-	1P182	3/6	20P4	6/6
6F18	4/6	20P5	6/6	10U1	7/6	30P16	5/-
EF80	1/6	30P4	4/-	10F1	1/6	PCX84	4/-
PC282	3/-	6F13	5/-	20E2	5/6	PCL83	5/-
E1L50	3/6	EB91	1/-	30F14	5/-	PY8	3/6
30P5	5/-	EF85	5/-	PY32	6/-	U801	6/-
PL135	6/-	63012	4/-	6V4GT	5/-	10F13	5/6
PF80	4/-	20P3	6/-	6F1	2/6	20D1	2/-
PL81	5/-	20P11	4/-	ECC81	3/-	30P12	5/-
P230	5/-	PL36	6/-	EY86	4/-	PY82	5/-
U329	5/-	PCL82	5/-				

Speakers, Ex-TV, 5in. round, 6 x 4in. 3/6; 8in.
round, 6/-; post 2/-.

Line Output Transformers available. State set
model No.

Turret Tuners, 3/-, post 2/-.

Scan Coils, etc. Quote set model No. with all en-
quiries and S.A.E. for prompt reply. All goods
subject to satisfaction or money refunded.

TRANSISTORS now half price.
unmarked but tested packets of 16;
unmarked, untested packets of 40;
diodes suitable as diodes packets of
80. All packets 10/- each, postage
1/-. Four packets post free C.W.O.
K. R. WHISTON (Dept. PWT), New
Mills, Stockport.

4 VALVE 4 WATT AMPLIFIER

"C" Core transform-
ers 110/230 volts
600 ohms of high
impedance input,
Output 600 ohms.
Controls: On/Off
switch. Gain control. Indicator light.
Valve inspection panel, 19 x 7 x 7in. Brand
New in makers cartons, £45.00. Carr. 12/6.
CONVERTOR. Run your mains shaver,
radio, record player, etc. from car battery.
New type vibrator converts 12V D.C. to 240V.
D.C. at 100mA Low Drain. Brand new
complete with spare fuses, battery clips,
etc. 25/-. Carr. 7/6.



TELESCOPIC AERIAL MASTS. Tubular
steel coppered, spray finish, ring cam
locking on each section provides for full
or any height required. Suitable all fixings
and base locations. Bottom section 1 1/2in.
diameter.

20ft. (4 section) Closed 5ft. 9in. Weight 16lbs.
55/-, Carr. 5/-.

34ft. (6 section) Closed 6ft. 6in. Weight 20lbs.
75/-, Carr. 5/-.

Further height by adding 3-ft. Whipsections
13/6. Carr. 1/6. Special price for quantities.
CHECK TELEPRINTERS. 7B Used
condition, £12.10.0. Post 2/6.

NEW CHAMOTTS 1.75-16 Mc/s 3 waveband
tunable, grid modulation using 813. Used
complete with all valves, circuit £7.10.0.
Carriage 10/-.

MOVING COIL HEADPHONES. BRAND
NEW. Chamotts padded, complete with jack
plug 15/6. Post 2/-.

ROTARY TRANSFORMERS. 12V D.C.
input, 300V D.C., 120mA output, note size
only 4 1/2 x 2 1/2 in. Post 2/6.

R.C.A. ARNDT RECEIVERS. Brand New.
£75. Carriage 30/-.

POWER UNIT. Type ZE12. Designed for
Canadian No. 52 receiver. 52/6. Carr. 5/-.
B44 Mc. H.L. Diode and rod aerials 30/-
per set, P. & P. 5/-. Microphone with
connecting plug 15/6. P. & P. 2/-. Battery
input and phone plugs, 5/- each. P. & P. 1/6.
Many other bargains. S.A.E. all enquiries.

A. J. THOMPSON

"FILING LODGE"

CODICOTE, HITCHIN, HERTS

Phone: CODICOTE 344

RECEIVERS & COMPONENTS

(continued)

NEW VALVE TESTERS £12.
Molinuex, Lowfield Heath, Sussex.

CLEARANCE

New valves—10D2 10L D11, 6F13, 6F15, 6F1,
6F12, 6L18, 6L18, 6L D20, 3P41, 5P51, T41,
TH41, U281, U282, U06, 6P33, 25Z5, 25Z6,
43, 57, 59, 79, all 2/6 each, 6P25 (6V5) P. & P.
6d., 6C9, U404, U09 at 7/6 each.

Used Valves—EP80, 10F1, 6F1 1/6 each,
ECL80, PY80, 6P25, 20P1, etc. 3/- each, P230
5/- each P. & P. 6d.

Many old Radio Valves available at 5/- each.
Laminated copper 6 x 4in., 2/-; Transistor
3 ohm output transformers 2/6. Tuning
Condensers 150 + 250pF with trimmers, 7/-
on/off, med., long wave miniature press
switch 4/6, similar piano key switch 3/6,
pax panels with diodes, resistors etc. (not
soldered in) 3/6. P. & P. 5d.

Huge parcel of condensers, resistors, trim-
mers, etc. (all new) 10/-, P. & P. 1/-.

Sound Vision, 137 Moulsham Street and
18 Market Road, Chelmsford

SPEAKER REPAIRS, cones fitted.
Satisfaction guaranteed. L. S.
REPAIRS, Pluckley, Ashford, Kent.

"HEATHKITS" can now be seen in
London and purchased on easy
terms. Free brochure. DIRECT TV
REPLACEMENTS LTD., Dept. PW7/9,
126 Hamilton Road, West Norwood,
S.E.27. GIPSY Hill 6166.

TUBES—FAMOUS MAKES!

MW43/69, AW43/80, MW36/24, AW43/88
etc Fully screened, aluminised, 100% new
(except glass). Mostly £4.15s. (12/6 cgs.),
LISTS. One Year's Guarantee Card.
STOP PRESS!—BY100/PY800 57/- doz
U.26 (equivalent) 8/6 each!

P. BEARMAN, 43 Leicester Road
New Barnet, Herts. Tel.: BAR 193-

SILICON TRANSISTORS p-n-p, max
ratings 20V, 50mA, 33mW, 2uA leakage.
Minimum beta of 10 at 5mA
1/6 each. Detector diodes 6d. "E
return" service. LONGLAND'S 34
Hounslow Road, Hanworth, Middx.



V.H.F. Receivers P104 (H1392), 100 to 15
Mc/s. 13 valves, B.F.O., A.G.C., R.F. and I.F.
gains, Tuning Meter, in good condition
complete with instructions to convert to
tunable or can be used crystal controlle
as is. £3.10.0. carriage 15/-.

Matching Power Supply for 230 volts A.C.
£25.00. Carriage 10/-.

Aerial Tuning Units. Made for Collir
TC512. 1 to 12 Mc/s. Good condition, 12/
Post paid.

Field Strength Meters, 100 to 150 Mc/
Telescopic chrome aerial, 2in. round 0-
MA. Meter, 155 valve needs 90 and 1.5 volt
batteries or can easily be replaced by
90V. Post paid.

Test Meters for SR522. Boxed 0 - 1 M
2in. round meter, 12/6. Post paid. Above tv
Items are in new condition.

SCR322 Ground Power Units, 230 volt
A.C., dry and clean, 50/- as they come.
Morse Key with lead and jack 4/6. Post 1

Headphones low impedance with lead a
jack, new 6/6, post 1/6.
(Carriage charges apply to England a
Wales only).



SUPER BREAKDOWN UNIT

Remote Control Unit Type F. New in sealed cartons, containing P.O. Relay 2,000 ohms Resistance, 100 volt Plessey Hand Generator, Telephone Ringing Bell A.C. 8 amp Morse Key on base, 2 D.P. D.T. Key Switches, Double Phone Jack, moulded 5 position 6 pole Yaxley Switch, induction Coil tapped 1-17-33 ohms. 7 Brass Screw Terminals on panels, plus Resistors. Condensers, Pointer Knobs. All in a handy metal box with hinged lid and side fasteners. Also web carry strap. Size 10 1/2 in. x 7 in. x 2 1/2 in., post free. Or items may be purchased separately. Relay 5/-, Hand Generator 7/6, Bell 5/-, Morse Key 4/6, Key Switches 5/- pair, Double Phone Jack 2/6, Yaxley Switch 2/-, Ind. Coil 2/-, Terminals 7 for 2/-, all post free.

Also available Key Switches. 4 pole 2 throw 3/6 each or 3 position D.P. plus D.P. centre off 5/- or rotary switch 6 pole 3 way 3/-.

Bank of 4 Pye Sockets with plugs and leads 5/- set. Ever Ready Batteries, 90 volts plus 4 1/2 volts 4/6 each.

Plessey 2-4-12-25 way plugs and sockets all 5/- pair.

Jones Plugs and Sockets 4-12-18-24-32 way all 5/- pair.

Special Lightweight 7 in. x 4 in., 3 ohm P.M. Speaker 6/-.

Metal Frames, suitable for stock, Job Cards, Bins, Crates, 2 1/2 in. x 5 in. 12/6 per 100—24 per 1,000.

19 in. RACK FITTING CABINET. 34" high by 21" deep with telescopic drawer slides. Louvred sides back and top. Brand new Swedish make, £4. only, plus B.R.S. delivery.

ECR Tube with Screen and Base with ECR 35 data, 25/-.

6UP7 Tube with Screen and Base, with data, 30/-.

20ft. Steel Telescopic Mast, 50/-.

COLLARO AUTO CHANGE

3 speed Gramophone Decks
Tested and guaranteed
Post free 50/- each
Brown or Cream

Copper Laminate Board, single or double sided, 5/- per square foot panels, either type 3ft. by 4ft., 33/-.

Eight Stab Resistors, 5%, 8d.; 2%, 9d.; 1% 1/-, Every six packed in 7-compartment linen finish component box. Unmarked.

Speakers, 3 ohm P.M. 5 in. 5/-, 6 in. 6/-, 7 x 4 in. 7/-, 8 in. 8/-, 10 in. 12/6.

U.K. ONLY

E. R. NICHOLLS

Mail Order and Retail Shop
40 LOWFIELD ROAD
of SHAW HEATH, STOCKPORT,
CHESHIRE.

FOR SALE

CONDENSER BARGAIN! Miniature paper condensers, 1/2 in. x 1/4 in. ideal for transistor sets. 0001, 001, 002, 005, 02, 04uf. Your choice 7/6 per 100 or £3 per 1,000. G. F. MILWARD, 17 Peel Close, Drayton Bassett, Staffs.

HAMMER FINISH PAINT. The modern finish for electronics. Can be brushed or sprayed. Blue or silver. 24oz tins 3/6, 1/2 pint 7/6, 1 pint 15/-. Post 6d. on any order. Trade supplied. FINNIGAN SPECIALITY PAINTS (PW), Mickley Square, Stocksfield, Northumberland.

MORSE MADE EASY!

The famous RHYTHM RECORDED COURSE cuts the practice time down to an absolute minimum!

One student, aged 20, took only 13 DAYS and another, aged 71, took only 6 WEEKS to obtain a G.P.O. pass certificate. If you wish to read Morse easily and naturally, please enclose two 3d. stamps for full explanatory booklet.

TO G3GHS, THE MORSE CENTRE, 45 GREEN LANE, PURLEY, SURREY.

5-TON FACTORY CLEARANCE. Radio, TV Electrical Components, in mixed parcels. Example: 28lb. mixed parcel £1, pp 7/6d. Speakers, grilles, valves, bases i.f.s. covers condensers etc. Hundred other items. S.A.E. List and Postal Orders to P. NEWTON, 16 Shalcross Crescent Hatfield, Herts.

ALBATROSS ENGINEERING CO.

INSTRUMENT DIVISION

78/80 High Street, Gosberton,
Spalding, Lincs.

Tel. Gosberton 458

- ★ Transistorised A.C. Millivoltmeter
- ★ 4 Ranges, 10 mV-100 volts.
- ★ Input Impedance 3 Megohms.
- ★ Response 10 c/s-50 Kc/s.
- ★ PRICE £5.8.10, Less Case.
- ★ Transistorised Generator
- ★ Frequency 1 Kc/s.
- ★ Output 200 millivolts variable at 5K ohms
- ★ PRICE £1.10.8, Less Case.
- ★ Transistorised Model Control Receiver
- ★ Frequency 2/Mc/s (variable).
- ★ 2 Transistors.
- ★ Supply 8 volts.
- ★ Size 2 1/2 x 1 1/2 in.
- ★ PRICE £1.19.6.
- ★ Transistor Test Set
- ★ Measures by Meter
- ★ Frequency 1 Kc/s.
- ★ Leakage Current.
- ★ Input resistance.
- ★ Short Circuit.
- ★ PRICE £5.19.6, Less Case.
- ★ Transistorised Mixer Unit
- ★ 4 Separate channels.
- ★ 4 Independent controls.
- ★ 1 Master control.
- ★ 10 dB Gain.
- ★ 9 v. Supply.
- ★ PRICE £5.19.6 in Case.

FOR SALE

(continued)

240 volt ELECTRIC POWER ANYWHERE

ANYTIME from 12 with CAR BATTERY

WITH THE AMERICAN DYNAMOTOR UNIT

Input 12v. output 200/250v. at 150 to 220 watts. Perfect for TELEVISION, POWER TOOLS and all universal A.C./D.C. ELECTRICAL EQUIPMENT, gives wonderful results. Price ONLY £8 + tax carriage. Send stamped envelope for full illustration details to: SCIENTIFIC PRODUCTS, CLEVELY, Lincs.

TESTED TRANSISTORS

All new, few equivalent.
OA202

1/- each, Red or White Spots.

2/- each, XA101, XA102, XB103, OA90, OC430, XA112, XA111.

3/- each, OC44, OC45, OC70, OC71, OC81, OC81D, OC200, GET16.

4/- each, AF114, AF115, AF117, OC170, OC171, SX658, XU611.

5/- each, OC72, OC139, OC140, OC204, ORP60, BY100, GET8.

10/- each, OC35, OC26, OC28, GET57, 2SO13. All new, few equivalent.

ZENER DIODES 4.7 v. to 33 volt 1/2 watt, 3/6 each. 1.5 watt, 5/- each, 7 watt, 6/- each.

Send 3d. stamp for Full Price List, and Free Equivalent Chart.

B. W. CURSONS

78 BROAD STREET
CANTERBURY, KENT

ELECTRIC SOLDERING-IRON



FANTASTIC BARGAIN OFFER

Lightweight Pistol Grip handle 40 watt, 240/250v. A.C. Solid copper bit. Detachable handle forms cover for iron when not in use. With 4ft. Safety 3-core flex. Indispensable for every home handyman. A boon to model makers and a necessity for every wireless enthusiast. Offered to P. & P. 1/- you at this new amazing price.

ONLY 9/6

G. H. SERVICE (Dept. P.W.3), Lusted Hall Lane, Tatsfield, Kent.

(continued overleaf)

WANTED

A PROMPT CASH OFFER for your surplus brand new Valves and Transistors. R.H.S., Beverley House, Mannville Terrace, Bradford 7.

WE BUY new valves for cash, large or small quantities, old types or the latest. Send details, quotations by return. **WALTONS WIRELESS STORES**, 15 Church Street, Wolverhampton.

WANTED VALVES ONLY

Must be new and boxed
Payment by return.

WILLIAM CARVIS LTD.
103 North Street, Leeds 7

WE BUY new Valves and transistors, Amplifiers, Short-wave Receivers and Components etc. **A.D.A. MANUFACTURING CO.**, 116 Alfreton Road, Nottingham.

MISCELLANEOUS

A WELL-KNOWN British Manufacturer of sound equipment seeks new ideas or inventions, and will be glad to consider any novel developments. Please write in full confidence to **Box No. 56**.

ELECTRONIC MUSIC?

Then how about making yourself an electric organ? Constructional data available—full circuits, drawings and notes! It has 5 octaves, 2 manuals and pedals with 24 stops—uses 41 valves. With its variable attack you can play Classics and Swing.

Write NOW for free leaflet and further details to **C. & S., 29 Maude Street, Darlington, Durham.** Send 2d. stamp.

LOUDSPEAKER REPAIRS, all makes, prompt delivery, 25 years' service to radio trade. Dept. P.W., **SOUND SERVICE RADIO**, 28 Gibbon Road, Kingston-on-Thames.

COIL, METAL WORK, ETC.
METAL RADIO CASES
CHASSIS ETC.

Precision Wound Supersensitive Coils—JDR1 Dual-Range Ferrite Rod Aerial, 8 x 1/4 in. with circuits, 10/-; JDR2 Matched Pair Dual-Range Coils with reaction and circuits, 7/6; JDRX1 Miniature Dual-Range Coil with reaction and circuits, 3/6; Printed Circuit Kit comprising 6 x 3in. printed circuit (of 3 transistor Reflex Radio), Ferrite Rod, All Coils with plans, 18/6, suitable Cabinet, 7/6; Radio or Instrument Case, crackle finished, 8 x 5 x 4in. with handles and front panel, 18/6. Add 1/- P. & P., over 10/- add 2/-.
Production Undertaken of Coils, Chassis, Metal Cases, lowest prices consistent with quality. **TRADE ENQUIRIES INVITED.**
JETRON ENGINEERING CO.
(Dept. PV 1), 9 Western Road, Hove
Catalogue of Coil Range, Metal Work, etc. 1/-

MISCELLANEOUS

(continued)

CONVERT ANY TV SET into an oscilloscope. Instructions and diagrams 12/8. **REDMOND**, 42 Dean Close, Portlisle, Sussex.

ALUMINIUM

Sheet for Radio Chassis and general use. Cut to size. Also Brass, Copper, steel, etc. in Sheets, Tubes, Rods, Fails, Sections, etc. Write for **FREE ILLUSTRATED PRICE LIST**. Callers welcome.

SENIOR METALS, Dept. R/6
35 St. Johns Road, Isleworth, Middx.
ISL: 0312.

SERVICE SHEETS

SERVICE SHEETS for all makes of Radio and TV 1925-1964. Prices from 1/- with free fault finding guide. S.A.E. inquiries. Catalogues of 6,000 models. 1/6, Valves, modern and obsolete. Radio/TV Books. S.A.E. lists. **HAMILTON RADIO**, Western Road, St. Leonards, Sussex.

S.E.S. SERVICE SHEETS for all TV Radio and Tape Recorders, etc. List 1/6 plus S.A.E. **SUN ELECTRICAL SERVICES**, 38 St. George's Road, Hastings, Sussex.

SERVICE SHEETS, also current and obsolete Valves for sale. **JOHN GILBERT TELEVISION**, 1b Shepherd's Bush Road, London, W12. Phone: SHE 8441.

SERVICE SHEETS

4/- ea., plus postage
We have the largest display of Service Sheets for all makes and types of Radios, Televisions, Tape Recorders, etc., in the country, and can supply by return of post.
To obtain the Service Sheet you require, please complete the attached coupon:

From: _____
Name: _____
Address: _____

To: **S.P. DISTRIBUTORS**
44 Old Bond St., London, W.1
Please supply Service Sheets for the following:

Make: _____
Model No.: _____ Radio/TV
Make: _____
Model No.: _____ Radio/TV
Make: _____
Model No.: _____ Radio/TV

I also require list of Service Sheets at 1/6.

I also require list of Manuals at 1/-.
(please delete items not applicable)

I enclose remittance of _____
MAIL ORDERS ONLY

SERVICE SHEETS

(continued)

SERVICE SHEETS, Radio and Television, 3/6 post paid. **VEST AND EMERY**, 17 Hollgarth St., Durham.

SERVICE SHEETS: Radio, TV, 5,000 models. List 1/-. S.A.E. inquiries. **TELRAY**, 11 Maudland Bank, Preston.

SOUND RECORDING

A UNIQUE BUY! Recording tape top brand, 7in. 2,400 ft. D.P. 25/-; 5 1/2in. 1,200 ft. 19/6d. P. & P. 1/6d. per spool. Bargains in all sizes. S.A.E. for list. We repair, buy and sell recorders. **E. C. Kingsley & Co. Ltd.**, 132 Tottenham Court Road, London.

METAL WORK

CABINETS • CASES CHASSIS

Anything in metal. "One-offs" a pleasure. Send your drawing for quote
Stove enamelled in any professional finish

MOSS, WATSON

40 Mount Pleasant Street, Oldham, Lancs. MAIN 9400

METAL WORK. All types cabinets, chassis, racks etc. to your specifications. **PHILPOTTS METAL WORKS LTD.**, Chapman St., Loughborough.

BUSINESS OPPORTUNITIES

IF YOU are a Self-employed TV Service Engineer wishing to increase your profits by at least 25% and receive free technical information send S.A.E. for details to **Box No. 56**.

SITUATIONS VACANT

I.E.R.E. CITY AND GUILDS and **R.T.E.B.** exams. Specialised I.C.S. home-study course will ensure success. For details of wide range of exam and diploma courses in Radio TV and Electronics, also new practical courses with kits, write to **I.C.S. (Dept. 542), Parkgate Road, London S.W.11.**

A.M.I.Mech.E., A.M.I.E.R.E., City & Guilds, G.C.E., etc., brings high pay and security. "No pass—no fee" terms. Over 95% successes. For details of Exams and courses in all branches of Engineering, Building, Electronics, etc., write for 148-page handbook—**FREE**. **B.I.E.T. (Dept. 242B), London, W.8.**

TV and Radio—A.M.I.E.R.E., City & Guilds, R.T.E.B. Cert., etc., "No pass—no fee" terms over 95% successes. For details of exams and home training courses (including practical apparatus in all branches of radio TV and electronics) write for 148-page Handbook—**free**. **B.I.E.T. (Dept. 242G), 28 Wright's Lane London W.8.**

SITUATIONS VACANT

(continued)

RADIO AND TV Exam. and Courses by Britain's finest Home-study School. Coaching for Brit.I.R.E. City and Guilds, Amateur's Licence, R.T.E.B., P.M.G. Cert., etc. FREE brochure from **BRITISH NATIONAL RADIO SCHOOL**, Russell Street, Reading.

RADIO COMPONENTS. assistant wanted for shop and Mail-order, excellent prospects for the right applicant. Apply in writing first to **HOME RADIO (Mitcham) LTD.**, Mitcham, Surrey.

RADIO TECHNICIAN

A number of suitably qualified candidates will be required for training, leading to permanent and pensionable employment. (Normally at Cheltenham but with opportunities for service abroad or appointment to other U.K. stations.)

Applicants must be 19 or over and be familiar with the use of Test Gear and have had Radio/Electronics workshop experience. They must offer at least "O" level GCE passes in English Language, Maths and/or Physics, or hold the City and Guilds Telecommunications Technician Intermediate Certificate or equivalent technical qualifications.

Pay according to age, e.g. at 19 £722 at 25 £929 (highest pay on entry) rising by four increments to £1,067.

Prospects of promotion to grades in salary range £997-£1,634.

Annual Leave allowance of 3 weeks 3 days, rising to 4 weeks 2 days.

Normal Civil Service sick leave regulations apply.

Apply:

RECRUITMENT OFFICER (RT 37)

Government Communication

Headquarters, Oakley, Priors Road, Cheltenham.

EDUCATIONAL

RADIO OFFICERS see the world. Seagoing and shore appointments. Our many recent successes provide additional trainee vacancies during 1964/65. Day and Boarding Students. Grants and scholarships available. Stamp for Prospectus, **WIRELESS COLLEGE**, Colwyn Bay.

CITY AND COUNTY OF BRISTOL EDUCATION COMMITTEE

BRISTOL TECHNICAL COLLEGE

Principal: E. Poole, B.Sc. (Eng.), M.I.Mech.E., M.I.Prod.E.

CAREERS IN RADIO AND RADAR

Marine Radio Officers

2-year full-time course for young men aged 16 upwards, leading to 1st and 2nd class P.M.G. Certificates and M.O.T Radar Maintenance Certificate.

Conversion Course (2nd class to 1st class). R.T. Courses (for Full or Restricted Licence).

Training given on the latest types of Marine and Aircraft Equipment in newly equipped Laboratories at

THE SCHOOL OF RADIO AND RADAR

Senior Lecturer: F. E. Barltrop

For details write to:

The Registrar, Bristol Technical College, Ashley Down, Bristol 7

EDUCATIONAL

(continued)

THE INCORPORATED PRACTITIONERS in Radio and Electronics (I.P.R.E. Ltd.). Membership Condition booklet 1/-. Sample copy of I.P.R.E. Official Journal 2/- post free. Dept. B Secretary, 32 Kidmore Road, Caversham, Reading, Berks.

$$X = \frac{-b \pm \sqrt{b^2 - 4ac}}{2a}$$

2a

DON'T FUMBLE with Formulae. Master Mathematics quickly and easily the Understandable Way.



The Dryden School of **UNDERSTANDABLE MATHEMATICS**
11 J. Dryden Chambers, Oxford St., London W.1.

Name _____
 Address _____

BECOME "TECHNICALLY QUALIFIED" in your spare time. Guaranteed Diploma and Exam Home-study Courses in Radio, TV Servicing and Maintenance. R.T.E.B., City and Guilds etc. Highly informative 120 page Guide—FREE. **CHAMBERS COLLEGE** (Dept. 363), 148, Holborn, London, E.C.1.

TRAIN FOR SUCCESS WITH ICS

Study at home for a progressive post in Radio, TV and Electronics. Expert tuition for I.E.R.E., City & Guilds (Telecoms and Radio Amateurs); R.T.E.B., etc. Many unique diploma courses incl. Colour TV, Electronics, Telemetry & Computers. Also self-build kit courses—valve and transistor. Write for **FREE prospectus** and find out how **ICS** can help you in your career.

ICS DEPT. 541 PARKGATE ROAD, LONDON, S.W.11.

BOOKS & PUBLICATIONS

FIND TV SET TROUBLES IN MINUTES from the great book. The Principles of TV Receiver Servicing. 10/6 all book houses and radio wholesalers. If not in stock from Dept. B Secretary, 32 Kidmore Road, Caversham, Reading, Berks.

RADIO BOOKS

TELEVISION & RADAR ENCYC. Published Price 30/-. Book Bargain 9/6
INDUSTRIAL TELEVISION
Published Price 15/-. Book Bargain 4/6

- STEREO FOR BEGINNERS** 8/6
- HI-FI FOR BEGINNERS** 8/6
- SOUND & CINE FOR BEGINNERS** 8/6
- AUDIO & ACOUSTICS** by BPEGS 11/6
- MORE about Loudspeakers** by Briggs 8/6
- CABINET Handbook** by Briggs 8/6
- OSCILLOSCOPE Book** 5/6
- USING an Oscilloscope** 7/-
- OSCILLOSCOPE Equipment** 5/6
- MULLARD Circs. for Audio Amp.** 7/6
- MULLARD Ref. Transistor Circs.** 13/6
- TRANSISTOR Circuits for Radio Control of Models** 8/-
- ELECTRONIC Novelties** 5/6
- ELECTRONIC Gadgets** 5/-
- RADIO Valve Data "Wireless World"** 8/6
- BEGINNER'S Guide to Radio, 2nd Edition** 9/6
- MODERN Transistor Circuits for Beginners** 8/-
- BASIC ELECTRONIC Circuits** 19/- each

Parts I and II in the Pictorial Approach to Learning series. The aim of this two part series is to illustrate and explain a selection of the principal circuits used in electronic engineering, both valve and transistor circuits are illustrated and explained in the picture caption technique.

All books include postage. List S.A.E.

SELRAY BOOK CO.

60 HAYES HILL, HAYES, BROMLEY KENT. Tel. HURstway 1818

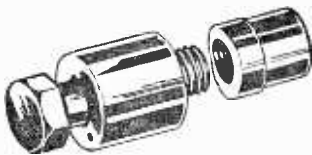

The PUNCH you need!

HOLE PUNCHES

Instant Type	6/10 ea.
1 1/2" diameter	6/10 ea.
Screw-up Type	
1 1/2" diameter Toggle switch	8/6 "
" " B7G	8/6 "
" " B8A, B9A	9/- "
" " "	9/6 "
" " "	10/2 "
" " "	10/8 "
" " "	11/8 "
1 1/2" diameter Int. Octal	13/4 "
" " "	16/2 "
" " "	18/1 1/2 "
" " B9G	21/8 "
" " "	24/4 "
2 3/8" " Meter	33/2 "

Complete Set £9.3.6.

No extra charge for postage and packing in the U.K.

Oliver & Randall Ltd

Dept. 7

7 KELSEY PARK ROAD BECKENHAM, KENT

Tel.: Beckenham 8262

Head Office and Warehouse:
44 WESTBOURNE GROVE
LONDON W2
Tel. PARK 5641/2/3

Z & I AERO SERVICES LTD.

Retail Shop:
85 TOTTENHAM COURT ROAD
LONDON W1
Tel. LANSHAM 8408

Please send all correspondence and Mail Orders to the Head Office

Table listing various electronic components such as valves (6A2, OB2, OC3, etc.), transistors (2N29, 2N36, etc.), and diodes (1N41, 1N47, etc.) with their respective part numbers and prices.

FIRST QUALITY FULLY GUARANTEED VALVES FOR EX STOCK DELIVERY

SEMICONDUCTOR RECTIFIERS

ZENER DIODES

CATHODE RAY TUBES

DIODES

When sending cash with order, please include 2/6 in £ for postage and handling. MINIMUM CHARGE 1/6.

FIRST-CLASS RADIO AND T.V. COURSES GET A CERTIFICATE

After brief, intensely interesting study—undertaken at home in your spare time—YOU can secure a recognised qualification or extend your knowledge of Radio and T.V. Let us show you how.

FREE GUIDE The New Free Guide contains 120 pages of information of the greatest importance to both the amateur and the man employed in the radio industry. Chambers College provides first rate postal courses for Radio Amateur Exams. R.T.E.B. Servicing Cert., C. & C. Telecoms., A.M.I.E.R.E. Guide also gives details of range of diploma courses in Radio/T.V. Servicing, Electronics and other branches of engineering, together with particulars of our remarkable Guarantee of SUCCESS OR NO FEE Write now for your copy of this invaluable publication. It may well prove to be the turning point in your career. FOUNDED 1885—OVER! 150,000 SUCCESSES CHAMBERS COLLEGE (Incorp. National Inst. of Engineering) (Dept. 461), 148 HOLBORN LONDON, E.C.1

Get your copy NOW... "PRACTICAL WIRELESS" RADIO AND TELEVISION REFERENCE DATA Contains full details of colour codes; everyday formulae, for calculating the values of biasing components, potential dividers, resonance, gain, etc.; aerial dimensions; a quick frequency-wavelength conversion table; stations and frequencies; common symbols and abbreviations; notes on amateur radio and a list of call-sign prefixes; communication receiver I.F.s; wire and cable data; battery equivalents; valve, transistor and picture tube pin connections, bases, ratings and equivalents. Illustrated. 10s. 6d. FROM ALL BOOKSELLERS ... or, in case of difficulty 11s. 6d. by post from GEORGE NEWNES LTD., Tower House, Southampton Street, London, W.C.2.

2 METRES 4 The thrills of VHF Amateur Radio can now be yours for as low as 42/6 complete kit (by post, carriage and packing 2/6 extra). Tuning range 70-150 Mc/s. Stamped addressed envelope for free copy of literature and full details. Newcomers to Short-Wave Radio ask for details of the famous "Globe-King" kits and receivers. Home and Overseas Sales.

AN ELECTRONIC ORGAN FOR THE HOME CONSTRUCTOR by A. Douglas 20/- Postage 1/- BASIC THEORY AND APPLICATIONS OF TRANSISTORS by U.S. Army. 10/- Postage 1/- TRANSISTOR IGNITION SYSTEMS HANDBOOK by Brice Ward, 20/- Postage 9d. A BEGINNER'S GUIDE TO RADIO 8/6 Postage 6d. ELECTRONIC TEST INSTRUMENT HANDBOOK by Joseph A. Risse. 35/- Postage 1/-. BEGINNER'S GUIDE TO ELECTRONICS by Terence L. Squires, 15/- Postage 8d. SHORT WAVE AMATEUR RADIO by J. Schaap, 21/- Postage 1/-. RADIO CONTROL FOR MODELS, SHIPS, BOATS AND AIRCRAFT by F. C. Judd, 15/- Postage 1/-. COMPLETE CATALOGUE 1/- THE MODERN BOOK CO. BRITAIN'S LARGEST STOCKISTS of British and American Technical Books 19-21 PRAD STREET LONDON, W.2 Phone: PADd nghton 4185 Open 6 days 9-6 p.m.

NOW ANYONE CAN AFFORD TO TRAIN TO BE AN EXPERT IN RADIO, TV, AND ELECTRONICS

Anyone can afford these amazing courses—anyone can understand this practical training—No complicated mathematics to hold you back—No old fashioned, obscure explanations to frustrate you! The lessons are **CRYSTAL CLEAR, PRACTICAL, EASY TO MASTER AND USE**—Early lessons make fundamentals clear even to the beginner, while other lessons will give you the practical "know-how" of an expert! Compare favourably with some courses costing very much more! By creating a mass market through large volume sales and eliminating individual letter writing we are able to pass on these savings directly to you! Each course is printed on extra large quarto size sheets and bound into one manual to simplify handling and distribution.

Please select the course most suitable for your requirements from the following:

No. 1. RADIO COURSE. Fundamental facts—Electrons—Conductors and insulators—Radio Batteries—Circuits—Magnetism—Ohm's Law—Resistor Colour Code—Chart—What resistor to use—Electro-Magnetism—Electro-magnetic Induction—Self Induction—Radio Frequency Inductance—Capacity Coupling—J.F. Transformers—Radio Coils—Radio Capacitors—The Farad—Dielectric—Capacitor Colour Code—Alternating Current Theory & Filters—Resonance and Resistance—Charts to calculate Capacity Frequency and Inductance—Handy Radio Formulae—Practical Aspects of Radio Servicing—Radio Valves—Transistor Theory—N Type Germanium—P Type Germanium—Diode Action—Transistor Action—D.C. Stabilization—Transistor Bias Adjustment—R.F. Amplification—Superheterodyne Principles—A.V.C. Power Supplies—Meters—Multitesters and Valve Testers—Point to Point Servicing—Signal Generators and Signal Tracers—Using an Oscilloscope for Servicing—Alignment—Amplifiers and P.A. Equipment—High Fidelity—Advantages of Jobs. Price for the complete course. **ONLY 38/-**. Plus postage 1/6.

No. 2. ELECTRONICS COURSE. Includes most of the above lessons plus L.O. and B. Combined Circuits—Resonance Phenomenon—Behaviour at Resonance—How Meters Work—Making a Voltmeter—Ohm meter Connections—Valve Audio Electron Behaviour—Triode—Characteristic Curves—Power Supplies—Audio Amplifiers—Microphones—Resistances—Coupling—Obtaining Grid Bias—Push Pull and Parallel—Phase Inverter Circuit—Radio Frequency Voltage Amplifiers—I.F. and Multiband Coils—Detection—Receiver Circuits—Results of Frequency Mixing—A.V.C.—Electronic Oscillators—Quartz Crystals—Radio Transmitter Circuits—Modulation and Tuning—Lines, Antennas and Radiation—Test Equipment Using Meters—Electronic Test Equipment—Electronic Bashing Circuits—Radio Coils—Compass—H.F. Heating—Thyratrons—Photo-Cell Equipment—Radio Coils—Compass—H.F. Heating—Inter-Communicators—Radio Servicing Techniques—Electric Printed Circuits. Price for the complete course. **ONLY 39/6**. Plus postage 1/6. Graduates of the Electronics Course can qualify for a certificate—Details sent with each order.

No. 3. TELEVISION COURSE. Effect of Mis-adjusted controls—Pictures of various faults—Service adjustments—Circuit Faults Indicated by a Poor Pattern—Finding Bad Valves by observing Picture Faults—Separate Channel I.F. System—Inter-carrier I.F. System—Negative Picture—Interference—Antenna Principles and Practices—U.H.F. Transmission Lines—Facts About the T.V. Signal to Help you in Service Work—Synchronizing Separators—T.V. Circuits—Interference—Video Amplifier—D.C. Restorer Circuit—Automatic Gain Control Circuits—Oscillators—Deflection Coils—Automatic Frequency Control Circuits—Analysis of Stagger Tuned I.F. Receiver—Analysis of Three Inter-carrier Type Receivers—The Vertical Deflection Circuit—The Horizontal Deflection Circuit—Waveforms—Schematics of various sections of a T.V.—U.H.F. Converters and Tuners—T.V. Test Equipment and Alignment—Analysis of Various Problems. Price for the complete course. **ONLY 38/-**. Plus postage 1/6.

UNCONDITIONALLY GUARANTEED TO GIVE COMPLETE SATISFACTION You must be convinced that this is the best value you have ever seen in Electronic, Radio or T.V. Training, otherwise you can return the course (or have your money refunded if sent with order) after you have examined it in your own home for a full seven days.

IF YOU SEND CASH WITH ORDER WE WILL INCLUDE A FREE 70-PAGE BOOK. Tick on the coupon one book for each course ordered with full cash. **RADIO SERVICING FAULT FINDING BOOK. TELEVISION FAULT BOOK. OSCILLOSCOPE BOOK.**

These free books are authoritative, and loaded with information. Would cost at least 5/- each if bought separately—by sending cash you reduce book-keeping and other costs, which savings we pass back to you!

FREE TRIAL OFFER

Pay only 5/- per week if you wish. Clip coupon right now for this special offer To: **Sim-Tech Book Company, Dept. G7, Gater's Mill, West End, Southampton Hants.**

- Please send the following courses for a full seven days' trial.
- No. 1. RADIO COURSE. No. 2. ELECTRONICS COURSE.
37/6, incl. postage. 41/-, incl. postage.
- No. 3. TELEVISION COURSE.
37/6, incl. postage.

(Free trial customers tick only one please). If not delighted, I may return the course post-paid without further obligation on my part. If otherwise I will pay cash price OR 5/- weekly until purchase price plus 2/6 service charge has been paid.

- Tick here if enclosing full purchase price.
- Please send me FREE. RADIO FAULT FINDING BOOK.
 FREE. T.V. FAULT FINDING BOOK. FREE. OSCILLOSCOPE BOOK.
- Amount enclosed £ _____

I understand that you will refund this money in full if I am not 100% satisfied. Overseas customers please send full amount (including Ireland).

NAME _____
ADDRESS _____
Countryside _____

Phone 1L Ford 621/3 Romford Road, Manor Park, E.12
6001/2/3 Liverpool St.—Manor Pk.—10 mins. Stamp For Free List

REGUNNED TUBES

21 in.	99/6		Guaranteed one year Carr. 10/6. Add 10/- refundable on OLD TUBE (110° Tubes in stock).
17 in.	79/6		
15, 14	59/6		
12 in.			

EX-MAINTENANCE TESTED TUBES
17in. — 35/- 14in. — 15/-
Carriage 5/- Satisfaction Guaranteed.

EX-RENTAL T.V. SETS

17in. £11.10.0
14in. £7.10.0
Carr. 14in. 20/- 17in. 30/-
Personal Collection Advised

12 months written guaranteed.

Channels for all areas.

AERIALS. BBC/ITV combined loft and room aerials—From 25/-
BBC2/UHF and colour aerials—From 29/6. SEND FOR FREE LIST.

VALVES 9d. each. 1,000's available. See our List.

CONDENSERS. 100—10/- New. Assorted electrolytics and p.p.s. P. & P. 2/6.
V/CONTROLS. 20—10/- A selection of types and sizes. P. & P. 2/6.
SPEAKERS, 7/9. 6in., 8in., 7 x 4in. and 8 x 8in. Ex. mid. Salvage. P. & P. 2/5.
NEONS. 25 box 2/- (S.B.C.D.P. fittings). Mains tester and visual reminders. P. & P. 1/-.

TRIPLET 1632 SIGNAL GENERATOR

Handsome well designed instrument, ex U.S.A. Forces. 100Kc/s to 120 Mc/s on fundamentals. 10 directly calibrated ranges. 6 valves, buffer amplifier, well screened ladder, attenuator, variable carrier level (100µA monitor meter), established H.T., Int. mod. Ext. mod. 1 Mc/s crystal mixing facilities for crystal check and for use as heterodyne wavemeter. In first-class condition, tested, with circuit attenuator, etc. In special portable case, operates from 115V A.C. 50 c/s (suitable auto transformer for 240V. A.C. operation, 17/6 extra). PRICE ONLY £12. Carr 10/-.

SILICON RECTIFIERS. Type BY100 (4in. x 4in.) will handle 250 volts at up to 500 mA. Replaces any TV metal rectifier. BRAND NEW—no seconds, 7/6.

AR-88 VIBRATOR PACKS. For 6V. operation. Complete with vibrator and OZ4 rectifier. NEW in original cartons. 17/6. P. & P. 2/6

AR-88 SPARE VALVES. Complete Set of BRAND NEW individual albed original valves (1-4). 50/- Plus 2/6 P. & P.

MOVING COIL PHONES. Finest quality Canadian with Chamols ear muffs and leather covered headband. With lead check and for use as heterodyne wavemeter. In first-class condition, tested, with circuit attenuator, etc. In special portable case, operates from 115V A.C. 50 c/s (suitable auto transformer for 240V. A.C. operation, 17/6 extra). PRICE ONLY £12. Carr 10/-.

MAGNETIC COUNTERS (ex-G.P.O.). 4 figures to 9,999. Coil mains or 24V. operation. Tested. (No reset), 5/- each. P. & P. 1/6 SPECIAL OFFER! 10 for 30/- P. & P. 6/-.

MICRO-AMMETER. 0-500µA. Made by R.C.A. Weston Westinghouse, and other famous American manufacturers. Circular 2 1/2in. flush panel mounting. Dials are engraved 0-15 (0-300 volts). As used in the American version of the "19 SET". TESTED AND GUARANTEED 15/-.

0-1mA 2 1/2in. circular flush panel mounting. Resistance 75 Ω 25/- 0-300V. A.C. (moving iron) 2 1/2in. circular flush panel mounting. 22/6. Post and packing 1/- per meter.

HEAVY DUTY TRANSFORMER. Input 220 to 250 volts A.C. mains (tapped every 5 volts). Output 50V. at 15 amps. A real rugged job. very conservatively rated. Size 7 1/2 x 5 1/2 x 7in. Weight 28 lbs. ONLY £5.19.6. Carr. 7/6.

CHARLES BRITAIN RADIO LTD
11 UPPER SAINT MARTINS LANE, LONDON W.C.2
TEMPle Bar 5040
Shop hours 9-6 p.m. (9-1 p.m. Thursday). Open all day Saturday

QUALITY TAPE RECORDER
 MT 1000. Fully Transistorised. Self-contained. Economical. Loudspeaker. Playback Eraser, etc. £8.19.6.

PROFESSIONAL RECORDER
 TP 708. Six Transistor, Capstan Drive. Two Speeds, Dual Track, Push-button Controls. Tape, Ideal Speech and Music. Many Refinements. £18.10.0.

INTERCOM OR BABY ALARM
 Fully Transistorised. Low Running Cost. Super Performance. Complete. £8.18.6.

MULTIWAY INTERCOM SYSTEM
 1P-7. Completely Transistorised Master Unit with Extension Indicators. Selector Switches. Volume Control. Completely Self-contained. Takes up to Six Extension Units. 12 Guineas.

EXTENSION UNITS
 for above, absolutely complete. 8 Guineas each.

COMMUNICATION RECEIVER
 RX. 60. 10-560 m. Continuous in Four Bands. 8 meter. Noise Limiter. Band Spread. B.P.O. 5" Speaker. etc. Three Aerials supplied giving professional reception. Quality Finish. £24.15.0.

PROFESSIONAL COMMUNICATION RECEIVER
 RX 80. Double Superhet. Five Wave Band. Calibrated Electrical Band Spread on 80m, 40m, 20m, 15m, 10m Bands. 8 Meter. Q Amplifier. Aerial Trimmer. etc. £45.0.0.

3-WATT STEREO AMPLIFIER
 SA.90. Frequency Response 60-15,000 Hz. Sensitivity 100 mV Stereo. Mono-Tuner-Phono. completely enclosed Gold/Black Quality Case. £9.10.0.

NEW LOWER PRICES

EAGLE PRODUCTS

COMPLETE WITH INSTRUCTIONS WHERE NECESSARY

SEND S.A.E. FOR FURTHER DETAILS OF ANY ITEM TO TECHNICAL TRADING CO., BRIGHTON

30-WATT STEREO AMPLIFIER
 SA.300. Superb Reproduction. Gold enclosed Finish. Many features including Hum Balance. Speaker Phasing. Rumble Filter Integrated Tone Control. Five Inputs. Selector Switch. Function Switch. 4, 8 and 16 ohm Outputs. Fantastic Value. £29.10.0.

40-WATT TRANSISTOR STEREO AMPLIFIER
 TSA. 218. Five Separate Inputs. Rumble Filter Scratch Filter. 16 Transistors. 115-240 VAC. Loudness Switch. Mode switch. Input Selector. Bass-Treble Balance Volume Control. Superb Quality. Years of Trouble-free Use. £49.10.0.

HIFI FM TUNER
 FMT. 640. Matches above Amplifiers. Sensitive 8-A.V.C. Circuit. Superb Styling. A.F.C. Built-in Power Pack. Individually factory aligned. 19 Guineas (+4/- P.T.).

LOUDSPEAKERS DUAL CONE 8"
 16-Watt, 50-16,000 C.P.S., 16 ohms, Total Imp. 53,000, 87/8.

CR.12A.E. 12"
 Twin Cone Peak Power 90-Watts, 16 ohms, 7 Guineas.

CR.30A.E. 12"
 Three-way speaker, Woofer made Range Radiator and Tweeter all within single speaker system. Phenomenal Bass!m, 16 ohms, 9 Guineas.

12" Ultra Linear Speaker, Peak 20-Watts, 16 ohms, Total Flux 20,000, Unbelievable performance. 12 Guineas.

SLIM AUDIO PANEL 601 SPEAKER SYSTEM
 A Built-in Crossover Network. Amazingly Realistic Performance. Superbly Finished Walnut Cabinet 21" x 11" x 4 1/2". Dimensions 50-15,000 C.P.S., 10-Watts, 16 ohms, 15 Guineas (+50/6 P.T.).
 AP.801. As above, but 20-Watts, 40-20,000 C.P.S., Size 29" x 21" x 4 1/2". 21 Guineas (+70/9 P.T.).

HORN TWEETER CT.10
 10-Watts, 15-18,000 C.P.S., 16 ohms, High Sensitivity. Amazing Value 97/6.

MM-4 FOUR CHANNEL MICROPHONE MIXER
 Ultra Compact. Fully Transistorised. Gain 8 db, Gold Finish, Four Volume Controls. Uses 9-V. Battery, 49/6.

MICROPHONES
 MM-71. Crystal. Compact Finish, screened lead, jack plug, 18/6.
 100 C. Three-Way Crystal "Stick" mic. Professional Finish, Built in On/Off Switch. Detachable Shielded Cable. Neck Cord, Chrome Finish, 8/6.
 MS 100 Desk Stand to match, 8/6.
 MC. 70. Studio Crystal mic, 26/0.
 Pick-up includes Sensitive Variable

"D" Cartridges, Complete Shielded Cable, Swivel Mounting, 52/6.
 DM.14.8. Miniature Dynamic mic. w/5" Stand, Cracker Iron Finish 62/6.
 DM. 11. Dynamic mic. with Base. 36/0 Swivel. 60-12,000 C.P.S. superb Mist Blue Finish, 5 Guineas.
 DM.10.H. Dual Impedance Dynamic. Striking Design, Outstanding Performance. Self-Adjusting Swivel Action, 40-15,000 C.P.S., 50 ohms Low, 50K High, 24/6.
 DM.17.H.L. A DM.16.H.L. but Directional Heavy Chrome Steel, On/Off Switch, Stand Adaptor 24/6.

MICROPHONE STANDS
 MS.100. Desk Stand, Gray Base with Short Chrome Stick, Standard Fitting, 8/6.
 DS.2. Heavy Duty Desk Stand, 29/6.
 PS.3. Floor Stand, Heavy Duty. Variable Height. Cast 19/6.
 Takes standard Microphones. £2.17.6.

PICK-UP ARMS
 PU. 190. Adjusted Arm Rest, Mono/Stereo Quality Turnover Cartridge, Magnetic Stylus Pressure. Professional Finish. 39/6.

MULTI-METERS
 TK.20.A. 8 Ranges AC/DC/Current/Resistance 0-100K. Moving Coil, 49/6.
 EP.10.K. 10,000 OPV. High Quality, 15 Ranges AC/DC/Current/Resistance, Accuracy +/- 3%. £19.6.
 EP.30.K. 30,000 OPV. 15 Ranges including resistance to 10 meg. £21.9.
 EP.20.K. Professional Quality, 22 Ranges AC / Volt. / Current / Resistance / Decibels / Capacitance. £29.15.6.

TEST EQUIPMENT
 ITT-1 Transistorised Signal Injector, Complete with Transistor Oscillator with Indicator Lamp, Detachable Test Probe and Instructions, 85/-.
 HF Field Indicator R.F.40. Tunes 1-250 Mc/s in Five Calibrated Bands with Telescopic Aerial Earphone. 300 UA Meter, 69/8.

VALUE IN VALVES																							
FREE TRANSIT INSURANCE. POSTAGE 1 valve 6d; 2-11/3; FREE OVER 12					BY RETURN OF POST-GUARANTEED 3 MONTHS																		
024	4/8	8B6G	15/-	6K80	5/-	7H7	5/-	1487	14/8	954	3/6	EBC01	5/6	EF40	11/-	EZ41	5/6	PCF89	13/6	PZ60	9/6	UCG26	7/8
1A7GT	7/6	6B16	5/-	6K8GT	8/3	757	8/3	11A4G	7/8	955	2/6	EBF90	7/6	EF41	8/6	EZ90	5/6	PCF90	6/6	R19	9/6	UCG36	8/8
1CG7	7/6	6B18	5/-	6K25	8/8	774	4/6	20D1	8/8	958	3/6	EBL31	10/6	EF84	8/8	EZ91	6/6	PCF82	6/6	SP41	2/3	UCG91	9/8
1MB0T	8/6	6B87	8/6	6L1	9/6	1001	9/6	30F2	9/6	9001	3/6	EBL39	8/6	EF85	8/6	EZ99	7/6	PCF89	7/6	TP1	2/6	UCG48	7/8
1R4	7/6	6B76	6/6	6L6	7/6	1008	14/7	30L1	16/6	9002	4/6	EBL31	10/6	EF86	6/6	EZ39	7/6	PCF86	6/6	TP4	6/8	UCG91	7/8
3D21	5/6	6C7	8/6	6L18	8/6	101F1	4/6	30P1	9/6	9003	4/6	EC08	4/6	EF89	7/6	HV22	6/6	PCL88	9/6	U14	7/6	UCG88	7/8
3A4	4/-	805	8/6	6L18	12/6	101P13	4/6	30P4	17/-	AZ31	2/6	EC08	4/6	EF89	6/6	KT80	8/6	PCL89	9/6	U14	7/6	UCG88	7/8
3A5	4/-	806	5/6	6L20	7/6	101P14	9/6	25A8G	8/-	830	4/6	EC034	9/6	EF91	3/-	KT86	14/-	PCL94	7/8	U18	7/6	UF41	6/8
3D6	4/-	809	11/-	6P25	8/6	10A87	7/6	25L9T	7/6	CB131	19/6	EC040	8/6	EF98	3/-	KT44	6/6	PCL96	7/8	U28	9/6	UF42	4/8
3Q4	5/-	80D10	17/-	6P28	9/6	10A88	9/6	25Z4G	7/-	CL33	9/-	EC008	4/6	EF108	9/6	KT48	8/6	PCL86	10/6	U28	12/6	UF81	6/8
3R40Y	8/6	8D1	3/-	6Q7G	6/-	12A76	6/6	30F5	6/-	UY1	7/6	EC083	5/6	EL32	8/6	KT73	5/6	PCN46	6/6	U28	7/6	UF82	7/6
5U40	4/-	8P1	4/6	6Q7GT	8/-	12A77	4/6	30F11	6/6	DAF91	4/6	EC034	7/6	EL33	6/6	KT68	12/6	PCN40	4/6	U35	12/6	UF89	5/8
5Y30	4/6	6P6G	3/6	6A7	4/6	10A76	4/6	30L15	8/6	DAF96	7/8	EC085	6/6	KL34	11/6	KT78	8/6	PL33	4/6	U50	4/6	UL44	14/-
5Y20T	4/-	6P13	4/6	6EK7	4/6	10A76	4/6	30P4	9/6	DF91	3/6	EC085	9/6	EL35	6/6	KT88	17/6	PL36	9/6	U17	2/6	UL48	8/8
6Z4	9/-	6P14	4/6	6SL7G	4/6	12A78	6/6	30P12	7/-	DF92	3/6	EC089	9/6	EL38	12/6	KTW61	5/6	PL38	17/6	U21	2/6	UL54	7/8
6Z4T	7/-	8P15	9/6	6SN7GT	4/6	12A78	6/6	30P1	8/6	DF96	7/8	EC089	8/6	EL41	8/6	KTW63	7/6	PL38	17/6	U28	8/6	UL54	7/8
6Z4GT	9/6	6P28	6/6	6SN7GT	4/6	12A78	6/6	30P4	8/6	DK92	7/-	EC081	11/6	EL48	7/6	KTW63	5/6	PL31	7/6	U28	8/6	UL54	7/8
8N0L2	9/-	6A68	6/-	6SQ7	5/6	12B6G	6/6	35L6GT	8/6	DK92	7/-	EC081	11/6	EL48	7/6	KTW63	5/6	PL31	7/6	U28	8/6	UL54	7/8
6A80	7/6	6J5GT	4/6	6V4GT	8/-	12B87	8/6	35W4	6/-	DK96	7/8	EC081	11/6	EL48	7/6	KTW63	5/6	PL31	7/6	U28	8/6	UL54	7/8
6A07	7/6	6J6	2/6	6V4GT	8/-	12B87	17/6	35Z4G	5/6	DL92	5/6	EC081	11/6	EL48	7/6	KTW63	5/6	PL31	7/6	U28	8/6	UL54	7/8
6A15	4/6	6J7G	4/6	6X4	4/6	12K7G	4/6	12K7G	4/6	DL96	6/6	EC081	7/6	EM30	7/6	KTW63	5/6	PL31	7/6	U28	8/6	UL54	7/8
6A25	5/6	6J7GT	7/6	6X6G	5/-	12K8	8/6	19B2T	19/6	DL96	7/8	EC081	7/6	EM30	7/6	KTW63	5/6	PL31	7/6	U28	8/6	UL54	7/8
6A35	6/-	6K8GT	7/6	6X6GT	5/6	12K90T	9/6	18B5TA	19/6	KA742	3/8	EC082	9/6	EM35	8/6	PT97	7/6	PS1	5/6	UB30	6/6	UL130	5/8
6A46	6/-	6K7G	9/6	7BB	9/-	12G7GT	5/-	807A	5/-	EB41	5/-	EC083	10/6	EY51	7/6	PC084	6/6	PS8	5/6	UB30	7/8	UL130	5/8
6A58	5/6	6K7GT	4/6	7C5	7/8	12K87	2/6	813	4/6	EB41	5/6	EC083	10/6	EY51	7/6	PC084	6/6	PS8	5/6	UB30	7/8	UL130	5/8
6A78	5/6	6K8	8/6	7C6	7/6	12K87	7/6	886A	12/6	EB41	4/6	EC083	10/6	EY51	7/6	PC084	6/6	PS8	5/6	UB30	7/8	UL130	5/8
6B88	5/6	6K8	8/6	7C6	7/6	12K87	7/6	886A	12/6	EB41	4/6	EC083	10/6	EY51	7/6	PC084	6/6	PS8	5/6	UB30	7/8	UL130	5/8

Tubes	HIGHEST QUALITY—COMPARE OUR PRICES	
	GUARANTEED 6 Months	NEW TYPES MW 81/74
MOST MULLARD.	12in.	£1.15.0 £3.10.0
EMITRON, EMI.	14in.	£2. 0.0 £4. 0.0
SCOPE, BRIMAR.	15/17in.	£2.15.0 £4.15.0
WAZDA, COSBOB.	21in.	£3.15.0 £5.15.0
FERRANTI TYPES		£6.0.0

TRANSISTORS
 Top Quality
 Huge reductions. Red Spot standard L.F. type now only 1d; White Spot R.F. 2/-, Mullard Matched Output Kits (OC81(1), 2-OC81(1), 18/8. Receiver Kit, OC44, OC49(2), OC81(1), 20/6. OC81(2), six transistors. 24/-

AF102 15/- OC28 12/6 OC21 5/6
 AF114 8/- OC38 14/- OC81D 5/6
 AF115 7/6 OC44 5/6 OC82 7/6
 AF116 7/6 OC45 8/- OC170 8/6
 AF117 7/- OC71 8/6 OC171 8/6
 AF127 9/6 OC72 8/6 XB104 6/6

SPECIAL TEMPORARY OFFER
 Due to huge bulk special purchase, we are offering MW 31/74 Tubes at the unequipped price of 29/-, MW 36/24 at 24/-, R.P. 12/5. The above are guaranteed for 6 months.

SILICON RECTIFIERS
 Guaranteed performance. Top Make. Tested 250V working.
 100mA 3/9 500mA (3 for 9/6) 3/9 (3 for 19/6) 7/6

TECHNICAL TRADING CO.

SHOPS RETAIL ONLY
 350-352 Stratford Road, Portsmouth (Tel. 22034)
 72 East Street, Southampton (Tel. 25851)

ALL MAIL ORDER, RETAIL SHOP AND W.F.I. ROOM
 11-12 NORTH ROAD, BRIGHTON Tel. 67999

We supply from stock most of the components and items specified or circuits published in this and other magazines and radio books. Let us quote for your circuit, first grade components at realistic prices.

All Parts in Stock for the following and ALL PW Designs
PW-6 Superhet.
PW S.W. Converter.
PW Beginners SW2.
PW Transistor Inverter.
PW Mains Power Pack.
PW Build and Learn Series.
PW Transistor 8w converter

Send S.A.E. with list of parts required for quotation.

CATALOGUE

86 pages fully detailed and illustrated with hundreds of new items and bargains. PRICE 2/6 Post Paid.

● **NEW VALVE, CRYSTAL TRANSISTOR LISTS FREE ON REQUEST**
 ● **OUR STOCKS ARE FAR TOO VAST TO ADVERTISE—A CATALOGUE IS THEREFORE, A MUST** ●



MAINS AND BATTERY RECORD AND TAPE DECKS

- All Decks Complete with Cartridges**
- ★ BSR UA14 4-speed Auto ... £5 16 6
 - ★ BSR UA15 4-speed Auto ... £6 19 6
 - ★ Garrard Autolism Auto ... £6 10 0
 - ★ Unpluggable Hd. Versn. Auto £6 19 6
 - ★ Battery Autolism ... £8 19 6
 - ★ Stereo Version Auto ... £7 19 6
 - ★ SRP10 4-speed Single Player ... £5 0 0
 - ★ SRP10 Battery Version ... £5 19 6
 - ★ BSR GU7 4-speed Single Player ... £5 0 0
 - ★ Garrard AT6 with Stereo Cartridge Autochanger ... £10 19 6
 - ★ AT6 Mono ... £10 10 0
 - ★ Collaro 2-track Studio Deck £10 10 0
 - ★ Collaro Studio 4-track Deck £13 19 6
 - ★ BSR TD2 2-track Deck ... £7 19 6
- P. & P. 3/6 any type above.
- ★ 9 volt Starr 45 r.p.m. ... 39/6
 - ★ 45 or 33 r.p.m. Starr 9V ... 89/6
 - ★ 45 r.p.m. Garrard 6V ... 35/6
 - ★ 4-speed B.S.R. 9V ... 59/6
 - ★ Garrard 9V, 2-speed, 2-track Tape Deck with cassette ... £11 15 0
- P. & P. 2/6 any of above.

NEW LOW PRICES



MULTI-METERS

Multi-range test meters featuring easy to read scales and provided with full operating instructions, lead and batteries. Suitable for amateurs, designers repair shops, all domestic uses. Full details and specification in our catalogue.

- PT34 1 Kohm/volt ... £1 19 6
- MI 2 " " ... £2 9 6
- THL33 2 " " ... £3 15 0
- ★ EPI0K 10 " " ... 79/6
- ★ ITI-2 20 " " ... 82/6
- ★ TP55 20 " " ... £5 19 6
- ★ EP30K 30 " " ... £5 10 0
- ★ 500 30 " " ... £8 19 6
- ★ EP50K 50 " " ... £8 10 0
- ★ EPI00K 100 " " ... £9 19 6

★ Leather Cases available.

RECORD/REPLAY/ERASE TAPE HEADS



Marriot Type R/RP/3 1/2 track record/replay head and Mullard type TS erase head with mounting post. **Bargain offer 15/- pair P.P. 9d.**

TRANSISTOR POCKET RADIOS

Ready to use complete with Battery, Leather Case, Earphone. P.P. 2/- any type. Fully Guaranteed.

- 6-Transistor De Luxe ... 69/6
- 7-Transistor Zephyr ... 79/6
- 6-Transistor MW/LW ... £5.19.6

TRANSISTOR PORTABLE TRANSCIEVERS

9-transistor Portable Transreceivers. Supplied complete with leather cases, batteries, aerials, etc. in presentation case. Range up to 5 miles in favourable conditions. Sizes 6 1/2 x 3 x 1 1/2 inches. Superhet crystal controlled on transmit and receive. Price £21 Per Pair. P.P. 3/6.

TRANSISTOR TRANSCIEVER
 3-transistor crystal controlled version of above. Range up to 1/2 mile. Price £8.19.6 Per Pair. P.P. 2/6.

A SELECTION FROM OUR STOCKS—NEW PRICES

- See Catalogue for full details.
- Sinclair Micro-6 (to build) ... 59/6
 - Sinclair TR 750 amp. (to build) ... 39/6
 - Sinclair Micro Injector (to build) ... 27/6
 - PP3 9 volt Battery Eliminator ... 18/6
 - Tape Jack Tuner ... 29/6
 - 10-Watt Horn Tweeter ... 27/6
 - 20-Watt Super Tweeter ... 69/6
 - Two-channel Mixer ... 15/-
 - 1 to 200 Mc/s F/str. Meter ... 59/6
 - 2-Watt 4-transistor 9 v. 3 ohm ... 49/6
 - 5-hole Chassis Punch Kit ... 49/6
 - Headphones 2K ohm 12K; 4K ohm Stereo Headphones 8 x 8 ohm ... 3 9s
 - Stereo Stethoscope Headset 8 x 8 ohm ... 25/-
 - Resistor Substitution Box ... 32/6
 - Crystal Mono Stethoscope Headset ... 10/6
 - Magnetic Mono Stethoscope Headset ... 12/6
 - Transistor Signal Injector ... 35/-
 - Fully Disappearing Car Aerial ... 8/6
 - Test Lead Kit with Pouch ... 22/6
 - Capacitor Substitution Box ... 22/6
 - De Luxe Stereo Headsets with junction box ... £6
 - 4-channel transistor mixer ... 49/6
 - ★ 3-Transistor MW Superhet tuner ... 67/6
 - ★ 4-Transistor Superhet MW/SW Tuner ... £7.9 6
 - Transistor Telephone Amplifier 59/6

FM VHF TUNING RANGE

Printed circuit construction. RF stage and osc./mixer stage, fully tunable 85 to 105 Mc/s. Completely screened. Requires UCC85 (8/6). Brand new in maker's cartons 15/-. P.P. 1/-. Supplied with circuit.

MULLARD POT CORES

- | | | |
|----------|-----------|-------------|
| LA1 12/6 | LA5 17/6 | LA45 15/- |
| LA2 15/- | LA6 22/6 | LA2503 15/- |
| LA3 19/6 | LA9 17/6 | LA2504 15/- |
| LA4 12/6 | LA10 17/6 | LA2505 17/6 |

- 30 watt Soldering Iron 14/6 P.P. 1/-
- Tape Demagnetiser 29/6
- 20 ohm 1 in. diam. mag. mic. ... 15/-
- Antex 15 watt min. soldering iron 29/6
- Earphones Mag. or Crystal ... 5/-
- Telephone Recording attachment ... 9/6
- Crystal Guitar contact mic. ... 12/6
- ★ 7-transistor Record Player or tuner amplifier with treble/bass and vol. controls, £5.19.6.
- ★ 4-Transistor 2 watt amplifiers. Kit, 39/6. P.P. 1/6. Built 49/6. P.P. 1/6.

RECORDING TAPE

Sin. 600ft., 12/6; Sin. 900ft., 15/-; 7in. 1,200ft., 18/6; 7in. 1,800ft., 25/-; 7in. 2,400ft., 27/6. Excellent quality.

● **SCOTCH BOY TAPE.** 3 1/2in., 300ft. L.P. complete with spare spool. 5/6 P.P. 9d.

BUILD A QUALITY TAPE RECORDER

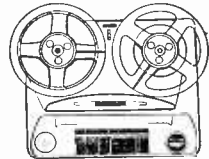

- ★ 6 Valve Printed Circuit designs. 2-track or 4-track units. 11 gns. 2-track, 12 gns. 4-track.
 - ★ Collaro Studio Decks. 2-track 10 gns. P.P. 3/6. 4-track £14. P.P. 3/6.
 - ★ Portable cabinets with Speakers, 5 gns. P.P. 3/6.
- Complete Systems**
 2-track £26, P.P. 8/6. 4-track £30, P.P. 8/6.
- **Complete in Every Detail**
 ● Leaflet on request also on amplifiers to use decks with existing hi-fi equipment.

NOMBREX TEST EQUIPMENT



All transistor portable units supplied with full instructions.

Leaflets on Request.

- ★ 150 Kc/s to 350 Mc/s generator. RF Mod., AF, 8 ranges. Leads, batteries, instructions, £9.10.0.
 - ★ Resistance/Capacitance Bridge. £8.5.0.
 - ★ Transistorised Power Supply, £6.10.0.
 - ★ Audio Generator, £16.15.0.
 - ★ Inductance Bridge, £18.
- Fully Guaranteed.**



CRYSTAL MICROPHONES

(See Catalogue for Full Range)

- Acos 39-1 Stick Microphone 32/6
- Acos 60-1 Stick Microphone 19/6
- Acos 40 Deck Microphone ... 15/-
- Acos 45 Hand Microphone 19/6
- Lapel/Hand Microphone ... 12/6
- 100C Stick with Stand ... 32/6
- BM3 Stick with Stand ... 49/6
- Lapel/Hand Magnetic ... 8/6

● **MINIGRAM PORTABLE TRANSISTOR RECORD PLAYER KIT**, as previously advertised. 79/6 P.P. 3/6 (Battery) 3/9.

QUARTZ CRYSTALS

100 kc/s 15/-; 500 kc/s 15/-; 455 kc/s 12/6; 456 kc/s 15/-; 27.255 Mc/s 15/-.
 Twin Crystal, 1 Mc/s, and 100 kc/s 22/6.
 Over 800 frequencies in stock.

Henry's Radio Ltd.

PADddington 1008/9

303 EDGWARE RD., LONDON W.2
 Open Monday to Sat. 9-6. Thurs. 1 o'clock.

PLEASE TURN TO BACK PAGE

PRACTICAL WIRELESS

blueprints

MOST of these blueprints are drawn full-size and although the issues containing descriptions of these sets are now out of print, constructional details are available free with each blueprint except for those marked thus (*).

Send (preferably) a postal order to cover the cost of the Blueprint (stamps over 6d. unacceptable) to PRACTICAL WIRELESS, Blueprint Dept., George Newnes, Ltd., Tower House, Southampton Street, London W.C.2.

DOUBLE-SIDED BLUEPRINTS

The Strand Amplifier	*
The PW Signal Generator	*
The Savoy VHF Tuner	*
The Mayfair Pre-amplifier	*
The Berkeley Loudspeaker Enclosure	*
The Luxembourg Tuner	*
The PW Troubadour	*
The PW Everest Tuner	*
The PW Britannic Two	*
The PW Mercury Six	*
The PW Regency	*
The PW International Short Wave Two	*
Beginner's Short Wave Two	*
S.W. Listener's Guide	*
Beginner's 10-watt Transmitter	*
Transmitting and Aerial Data...	*
P.W. "Sixteen" Multirange Meter	*
Test Meter Applications Chart	*
The Celeste 7-transistor Portable Radio	*
The Spinette Record Player	*
The P.W. 35-watt Guitar Amplifier	*
Transistor Radio Mains Unit	*
7 Mc/s Transceiver	*

RECEIVERS

5/-	The Tutor *	3/-
	The Citizen *	5/-
5/-	Dual-Wave Crystal Diode	PW95 2/6
	Modern One-valver	PW96 2/6
5/-	All-dry Three	PW97 3/6
	Modern Two-valver	PW98 3/6
7/6	A.C. Band-pass Three	PW99 4/-
	A.C. Coronet-4	PW100 4/-
6/-	A.C. D.C. Coronet	PW101 4/-
5/-	The PW Pocket Superhet	5/-

MISCELLANEOUS

5/-	The PW 3-speed Autogram	8/-
	The PW Monophonic Electric Organ	8/-
5/-	The PT Band III TV converter	1/6
5/-	The Mini-amp *	5/-
	The PT Olympic *	7/6
5/-	The PT Multimeter *	5/-

PLEASE NOTE that we can supply no blueprints other than those shown in the above list. Nor are we able to supply service sheets for commercial radio, TV or audio equipment.

QUERY SERVICE

The P.W. Query Service is designed primarily to answer queries on articles published in the magazine and to deal with problems which cannot easily be solved by reference to standard text books. In order to prevent unnecessary disappointment, prospective users of the service should note that:

(a) We cannot undertake to design equipment or to supply wiring diagrams or circuits, to individual requirements.

(b) We cannot supply detailed information for converting war surplus equipment, or to supply circuitry.

(c) It is usually impossible to supply information on imported domestic equipment owing to the lack of details available.

(d) We regret we are unable to answer technical queries over the telephone.

(e) It helps us if queries are clear and concise.

(f) **We cannot guarantee to answer any query not accompanied by the current query coupon and a stamped addressed envelope.**

QUERY COUPON

This coupon is available until 4th December, 1964 and must accompany all queries in accordance with the rules of our Query Service.

PRACTICAL WIRELESS, DECEMBER, 1964

First Class Designs — Proven Unbeatable Performance

FULL AFTER SALES SERVICE AND WARRANTY

● TRANSISTOR HIGH FIDELITY EQUIPMENT

MONO or STEREO 10 WATTS and 20 WATTS

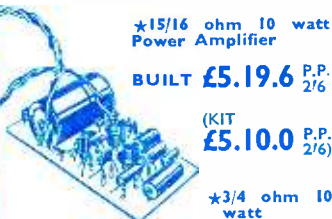

★15/16 ohm 10 watt Power Amplifier

BUILT £5.19.6 P.P. 2/6

(KIT £5.10.0 P.P. 2/6)

★3/4 ohm 10 watt

BUILT £5.10.0 P.P. 2/6

★MAINS UNITS 59/6 for one amplifier, or 69/6 to power two amplifiers

(KIT 99/6 P.P. 2/6)

PREAMPLIFIERS

● Mono full function pre-amplifier with 8 input positions. Low noise, high quality and sensitivity. Gives 10 watts with one power amplifier or 20 watts with two amplifiers. Size: 9 x 2½ x 2in.



BUILT £5.10.0 P.P. 2/-

(KIT 99/6 P.P. 2/-)

★Brown and Gold detailed front panel plate 8/6.



● STEREO PREAMPLIFIER

For use with two power amplifiers.

Size: 9 x 3¼ x 1½in.

PRICE BUILT £10.19.6 P.P. 3/6

★Dark Brown with Gold Front Panel 12/6.

● MULTI-INPUT PREAMPLIFIER

Simplified preamplifier for use with one or two power amplifiers, 8 inputs.

PRICE BUILT 65/- P.P. 1/6

★Front Panel Plate 6/6.

All the above preamplifiers can be used with any valve or transistor power amplifier requiring 250mV plate for full output. They can be operated with two 9 volt batteries in series or from the power amplifiers.



CIRCUITS AND DETAILS ON REQUEST

Demonstrations of above equipment and VHF FM Tuner can be heard during normal shop hours.

NEW!

TWO NEW PACKAGED TRANSISTOR QUALITY AMPLIFIERS

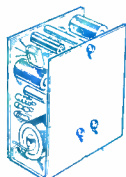

4 WATT and 1½ WATT

● 6-Transistor printed circuit designs. Push-pull output for 3 to 5 ohm speakers. Can be battery operated. 6mV into 1 Kohm sensitivity. Response 30 c/s to 15 kc/s. Input suitable for mics., P.A.'s. Three amp etc. Can be used with above preamplifiers for mono or stereo in any application requiring a low distortion low cost amplifier.

OVERALL SIZES: 2½ x 2 x 1½ inches.

● 4 watt version operates from 12 to 18 volts. PRICE BUILT 79/6 P.P. 1/6

● 1½ watt version from 9 to 12 volts. PRICE BUILT 65/- P.P. 1/6

★ CIRCUITS AND DETAILS ON REQUEST ★

NEW! ALL TRANSISTOR TWO WAVEBAND CAR RADIO

● 1 HOUR TO BUILD

with pre-assembled chassis and printed circuits

- ★ Full tuning on MW and LW with press button wave change
- ★ 6-Transistor, 2-diode plus VDR design
- ★ Push-pull output
- ★ Permeability tuning
- ★ Size 7 x 2 x 4in.
- ★ 12 volt positive earth or battery operated
- ★ Circuit and details on request



The "ROADSTER" Total Cost to Build £8.19.6 P.P. 3/6

- 7 x 4 inch high flux speaker and baffle plate 20/-
- 3-Section matching car aerial 19 6
- Fully guaranteed

The Roadster has terrific sensitivity with good quality proved by thousands of miles of test throughout the world.

1st AGAIN

"CONVAIR" PUSH-BUTTON MW/LW PORTABLE RADIO

Total Cost of ALL Parts

£7.19.6

P.P. 3/6

Batteries 6/- extra.



- A new design with amazing performance at a realistic price.

- New attractively designed portable cabinet with horizontal tuning and all stations marked. Colours Red or Blue with White.

Size 10 x 7 x 3½in.

ALL PARTS SOLD SEPARATELY

Leaflet on Request.

- New printed circuit 6-Transistor superhet design. Over 700mW push-pull output.

- Push-button selection of MW and LW with full tuning on both wavebands.

* The easiest to build—the best performance—realistic price.

VHF FM TRANSISTOR TUNER

- 5-Transistor.
- High Sensitivity.
- 4 Diodes.
- Full coverage 87 to 105 Mc/s.
- AFC and AVC.
- Up to 1 volt output.

Printed circuit design of high sensitivity and quality.

Output for valve or transistor amplifiers. Size 3½ x 2½ x 4in. Simplified building instructions. All parts sold separately.



TOTAL £7.19.6. P.P. 2/6

COST (Gold sprayed cabinet assembly 20/- extra).

Detailed Circuit Book on Request.

HENRY'S RADIO LTD. PADddington 1008/9.

303 EDGWARE ROAD, LONDON W.2.

(Open Monday to Saturday all day 9 a.m. to 6 p.m. Half-day Thursday 1 p.m.)

● Trade and Export enquiries invited

PLEASE TURN TO INSIDE PAGE

● ANYTHING TO DO WITH TRANSISTORS CONTACT US WITHOUT DELAY ●