

INSIDE! FREE 1/- BLUEPRINT OF PERSONAL PORTABLE



Vol. 28. No 545

MARCH, 1952

**EDITOR:
F.J.CAMM**

PRACTICAL WIRELESS



**A 4 VALVE
MIDGET
PORTABLE**

IN THIS ISSUE

A MUTUAL CONDUCTANCE BRIDGE
THE 'QUALITY' PROBLEM
A MULTI-RANGE OHMMETER



SHORT-WAVE SECTION
HARMONIC CRYSTAL OSCILLATORS
A SERVICING AID

The solder for all HOME TELEVISION CONSTRUCTOR SETS

Designers of television constructor sets know that the efficiency of their equipment depends on the solder used by the constructor—that's why they recommend Ersin Multicore for trouble-free, waste-free soldering. Ersin Multicore, the only solder containing three cores of extra-active, non-corrosive Ersin Flux, is obtainable from all leading radio shops. Ask for Cat. Ref. C.16018, 18 S.W.G. 60/40 High Tin Television and Radio Alloy. The size 1 Carton contains 37 feet of solder, costs 5/-.



Ersin Multicore Solder

In case of difficulty in obtaining supplies, please write to:

MULTICORE SOLDERS LTD.,
MELLIER HOUSE, ALBEMARLE STREET, LONDON, W.1 • RZGent 1471



high fidelity MICROPHONES

FOR PUBLIC ADDRESS, RECORDINGS, AMATEUR RADIO TRANSMITTERS

TYPE MIC 22



Incorporates Acos "Filtercel" insert giving extreme sensitivity and high fidelity. Response substantially flat from 40-5,000 cps. Vibration- and shock-proof. Not affected by low-frequency wind noises. Two alternative mountings available as illustrated (MIC 22-2 and MIC 22-1).

Price £6 6s. 0d. (either model).

TYPE MIC 16



Incorporates the Acos Floating Crystal Sound Cell giving a response substantially flat from 30-10,000 cps. Unaffected by vibration, shock and low-frequency wind noise. Alternative mountings as shown (MIC 16-2 and MIC 16-1).

Price £12 12s. 0d. (either model).

COSMOCORD LTD., ENFIELD, MIDDLESEX.

Armstrong

THE Chassis People

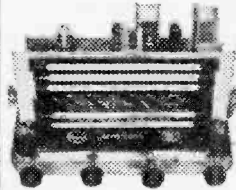

The prestige of Armstrong chassis is firmly based upon many years of constant endeavour to produce reliable and efficient receivers at an economical price. Our present range of chassis will even further advance the already high reputation enjoyed by our receivers.

We are delighted to give demonstrations in our showroom and our illustrated catalogue will be gladly sent on request.

MODEL EXP 125/3. 14-VALVE ALL-WAVE RADIOGRAM CHASSIS. 5 wave bands covering from 10.9 to 550 m. and 800 to 2,000 m. R.F. pre-amplifier. Two I.F. stages with variable selectivity. Bass and treble controls. 15-watt push-pull output. For A.C. mains. £36.15.0, plus P.T.

MODEL RF 104. 10-VALVE ALL-WAVE RADIO CHASSIS. 4 wave bands. R.F. pre-amplifier. Two I.F. stages with variable selectivity. 10-watt push-pull output. For A.C. mains. £24, plus P.T.

MODEL EXP 73. 8-STAGE ALL-WAVE RADIO CHASSIS. 3 wave bands. Variable selectivity. Fly-wheel tuning. 8-watt push-pull output with negative feedback. For A.C. mains. £17.15.0, plus P.T.

ARMSTRONG WIRELESS & TELEVISION CO., LTD.
Walters Road, Holloway, London, N.7. Tel.: NORTH 3213

SOUTHERN RADIO'S WIRELESS BARGAINS

WALKIE-TALKIE (TRANSMITTER-RECEIVER).—Type 38 Mark II. Complete with 5 valves, Throat Microphone, Headphones and Aerial. 7 mcs Amateur Band suitable for field use. Powerful Superhet Receiver. Modulated Transmitter. Guaranteed ready for the Air, less batteries, £31/0/-.

R.3545 TELEVISION UNITS.—Complete with 21 valves. 6 Stage 14 mcs I.F. Strip. Ideal for T.V. Conversion. Brand New in original wooden cases, £31/0/-.

G.E.C. "MINISCOPE" M86B. MINIATURE CATHODE RAY OSCILLOSCOPES.—1 1/2 in. Tube. Time Base, etc., etc. Brand New in Makers Sealed Cartons with Leatherette Carrying Case—£15/10/-, plus 5/- carriage.

LUFBRA HOLE CUTTERS.—Adjustable from 1/2 in. to 3 1/2 in. for use on Wood, Metal, Plastic, etc., 5/9. LUFBRA FLY CUTTERS, 14/6.

LIONEL "BUG" KEYS.—Genuine U.S.A. Automatic Morse Key, Type J36. Few only. £3/7/6.

THROAT MICROPHONES.—Magnetic type, complete with long lead and plug, 4/6.

HAND GENERATORS.—6 volts at 5 amps. With Crenk, 2/-.

PLASTIC TRANSPARENT MAP CASES.—14 in. by 10 1/2 in. Ideal for Maps, Charts, Display, Photographs, etc., 5/6.

STAR IDENTIFIERS.—With Hydrographic Office Modifications A-N Type I. Complete in case, 5/6.

MOVING COIL DIC METERS.—Brand new, 2 in. 0-2 mA., 0-5 mA., 0-30 mA., 0-20 volts, 9/6 each.

WESTECTORS.—Type WX6 and W112, 1/- each, 11/- doz.

MARCONI AERIAL FILTER UNITS.—Type "916" in conformity with P.O. Specification. Full instructions for fixing, 4/-.

CONTACTOR TIME SWITCHES.—10-hour movement, 2 impulses per second. Thermostatic Control in soundproof Cases, 11/6.

VISUAL INDICATOR UNIT, Type 3 (10Q/4).—Consists two Moving Coil movements, two Neons, etc. Easily convertible to very efficient M.C. Meters, 11/-.

Conversion fully described in "W.W." Sept., 1951.

Full list of Radio Publications, 2/3d.
SOUTHERN RADIO SUPPLY, LTD.,
11, LITTLE NEWPORT STREET, LONDON, W.C.2.
GERrad 6653.

NEW WINDSOR TESTGEAR



MODEL 45B

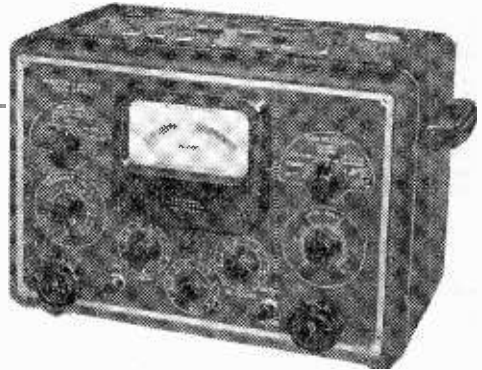

A comprehensive mutual conductance valve tester, suitable for most types of British, American and Continental receiving valves. Supplied with valve chart giving data for testing nearly 3,000 different valves. For use on A.C. Mains only.

TESTING FACILITIES

- ★ **MUTUAL CONDUCTANCE**
Two ranges : 0-3 mA/V and 0-15 mA/V.
- ★ **EMISSION.** Rectifiers and Diodes may be tested for emission.
- ★ **GAS TEST.** Press-button test shows abnormal positive or negative grid current.
- ★ **CATHODE LEAKAGE**
Tests for Heater/Cathode insulation up to 10 megohms, with heater at operating temperature.
- ★ **ELEMENT SHORTS.** Short-circuits between electrodes are clearly indicated.

Please write for details and information on other WINDSOR & TAYLOR products.

TAYLOR ELECTRICAL INSTRUMENTS LTD.

419-424 MONTROSE AVENUE, SLOUGH, BUCKS. Phone : SLOUGH 21381

RADIO EXCHANGE CO.

ERICSSON'S HIGH RESISTANCE PHONES, first grade. 4,000 ohms resistance, attractively finished in silver and black ; BRAND NEW, in presentation boxes. 17/6.

RECEIVER 1225. With five EF50's, two EF39's, one EB34 ; ideal for 2 metres. 39/6 (1/6 post).

VIBRATOR PACK 21, delivering approx. 140v. at 40mA., fully smoothed from 6v. input ; in NEW condition. 17 6.

ACCUMULATORS, multiplate, 7AH 2v., in celluloid cases. 3 1/2 in. x 1 1/2 in. x 4 in., 6/6.

MIDGET AMPLIFIERS. 5 in. x 3 in. x 3 1/2 in. ; with two 12SH7's and one 12SJ7, 15/-.

POWER PACK 532, with 5Z4, VU120 (5 kV), EHT rectifier, two 80v. transformers, choke, etc., complete with our 200/250v. 50 cps. conversion data to deliver approx. 1,800v. E.H.T. or 450v. 50 mA. (unsmoothed). 7 in. x 3 1/2 in. x 6 1/2 in., 20/6.

60v. BATTERIES, 4/9 each, two for 8/11 (1/8 post).

U.F.E. RECEIVERS, with 10 valves ; P40/S450B, covering 85/95 mc/s, ONLY 69/6 with circuit (post 1/8).

TRANSMITTER 21, Sending speech, CW or MCW, complete with valves, control panel and key. PA coils (not formers) and relays, stripped by M.O.S. ; may easily be replaced with aid of our circuit and instructions. Tune 4.2-7.5 and 18-31 mc/s. In first-class condition, 25/-.

CARRIER (S) LEVEL METERS, 2 mA FSD, 2 in. sq. flange mtg. NEW and boxed, 7/6 (6d. post).

CARBON MICROPHONES. In attractive hemispherical black cases with switch ; these have an excellent frequency response. NEW and boxed, 5/- (3d. post).

9, CAULDWELL STREET, BEDFORD.

Phone : 5568.

Convert that old Gramophone

OR OBSOLETE RADIOGRAM

into a MODERN All-WAVE RADIOGRAM

or POWERFUL RECORD PLAYER

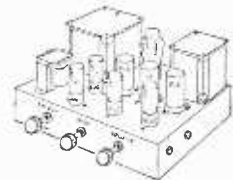
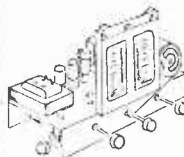

Our "Skyway"

2/6

POST FREE

only from

DESIGNS Book gives full details on how to build FOUR first-class Amplifiers and Radiogram chassis. No radio experience is required to understand the clear circuit diagrams and stage by stage wiring plans.

All parts and materials are easily obtainable, mostly without purchase tax. Performance equal to radiograms costing over £100

Frith RADIOCRAFT Ltd. PHONE 58927
69-71 CHURCH GATE · LEICESTER



Variable Coils...

-and wizard performance

NEW OSMOR "Q" RANGE COILS charm away all doubts difficulties and complications—thanks to their super-selectivity and sensitivity.

Consider these five star features:

★ Only 1in. high.

★ Variable iron dust cores.

★ Low-loss Polystyrene formers.

★ Packed in damp-proof containers.

★ Fitted tags for easy connection.

And they're backed by the OSMOR quality guarantee! Supplied with leaflet giving data, circuits, etc. 4/- each.

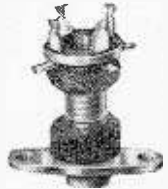

ACTUAL SIZE

COILPACKS. A full range is available for Superhet and T.R.F. Mains or Battery. Size only 1 1/2 in. high x 3 1/2 in. wide x 2 1/2 in. Ideal for the reliable construction of new sets, also for conversion of the 21 RECEIVER, TR., 1196, TYPE 18, WARTIME UTILITY and other receivers. Aligned and tested, with full circuits, etc. Fully descriptive leaflets available. **WARNING! Avoid inferior imitations. Genuine OSMOR Coilpacks are sold only under the name OSMOR.**

MATCHED COMPONENTS. Various types of OSMOR Dials, Chassis, I.F.S. Speakers, Transformers, etc., etc., to match our coils and coilpacks are all listed.

Send 5d. (stamps) for FREE CIRCUITS and full lists of coils, coilpacks and radio components.

OSMOR RADIO PRODUCTS LTD.

(Dept. P.22), BRIDGE VIEW WORKS, BOROUGH HILL-CROYDON, SURREY. Tel.: Croydon 51489

FOR RADIO OSMOR RELIABILITY



2-VOLT BATTERY VALVES. New and unused.

HL2, 4/6 each.
S.G. (Screen grid), 4/6 each.
KT2, 5/6 each.
Post 3d. per valve extra.
The set of 3 valves, 14/6. Post free.

DUAL WAVE COILS
M. & L. T.R.F. AE. and HF.
LASKY'S PRICE 5/11 Per pair.
Post 6d. extra.

INTER-COM UNIT SCOOP
Manufacturer's surplus. Brand new. For 6 station operation, uses 3-valves. 1 each 25/4, 25L6, and 6J7. AC/DC mains.
LASKY'S PRICE 69/6 Chassis less valves and indicator bulbs, carriage 2/6 extra.
Incomplete chassis, 35/-. Carriage 2/6 extra.
Chassis Cabinets. Light walnut veneer. 25/-. Carriage 2/6 extra.
Speaker cabinets. Suitable for use with 3in. speakers. Light walnut veneer. Supplied less speaker, 12/6. Carriage 2/6 extra.

SETS OF ENGRAVED KNOBS
1 each: Tuning, Volume, L.M.S.G., and Tone.
LASKY'S PRICE 4/- the set.
Post extra.

PRICE SLASH

AN ALL-WAVE RADIO RECEIVER
5 Valve s'het. Not a kit, but a factory-built job, fully assembled, aligned and tested. For A.C. mains. 200-230 volts. Features include:—5 new Brimar valves. 6in. p.m. speaker, variable tone control, large edgelit dial 7 1/2 in. square, 4 watta output, sockets for p.u. and extension speaker. 465 Kc.s. I.F.. A.V.C. 2 speed tuning.
LASKY'S PRICE £9.16.6. complete with valves and speaker. Carriage and packing, 10/6 extra.

DO NOT MISS THIS GREAT MONEY SAVING OPPORTUNITY.

COIL PACK SCOOP
No. 1. 3 Wavebands. 12-35 metres: 35-100 metres: 200-550 metres. 4in. spindle. 1 1/2 in. long wavechange switch. Completely assembled and wired. Size: 4in. x 4in. x 3in. **BRAND NEW.**
LASKY'S PRICE 16/- Circuit available Postage 1/- extra.
No. 2. Midget Coil Pack. 3 wavebands. Standard long, medium and short. 1 1/2 in. spindle. 2in. long wavechange switch. Completely assembled and wired. Size: 3 1/2 in. x 1 1/2 in. x 2 1/2 in. **BRAND NEW.**
LASKY'S 24/6 Circuit available. Price 1/- Postage 1/- extra.
ALL OTHER TYPES AND MAKES OF COIL PACKS AVAILABLE.
Osmor, Weymouth, Wearite, etc., etc.

LASKY'S OWN TEST PRODS
Made for safety.
Fused test prods. Fully insulated pencil type with retractable point. Contact is only made when desired by pressing top. Each prod contains a cartridge type fuse and spring.
LASKY'S 4/11 per pair (one red, one black). Post 6d. extra.

CAR BATTERIES
By DELCO-REMY. Ex-American Army. Absolutely perfect, brand new and unused, in maker's original packing.
No. 1. 6-volt 140 A.H. approx. Size: 7 1/2 in. deep, 13 1/2 in. wide, 8 1/2 in. high. In genuine hard rubber case.
LASKY'S PRICE £4/19/6
Carriage 7/6 extra.

No. 2. 6-volt 90 A.H. Size: 9in. wide, 7in. deep, 8in. high. In genuine hard rubber case.
LASKY'S PRICE 87/6
Carriage 7/6 extra.

VIBRATOR PACKS
12 volt input. Fitted with synchronous vibrator. Brand new and unused.
No. 1. Output 250 v. 100 M.a.
LASKY'S PRICE Complete 29/6
Less vibrator 20/-
No. 2. Output 150 v. 50 M.a.
LASKY'S PRICE Complete 25/-
Less Vibrator 17/6.
Carriage 2/6 per pack extra.

No. 3. For use with P.C.R. Philips Communication Receiver. Supplied complete with metal rectifiers, and vibrator, etc.
LASKY'S PRICE 39/6
Carriage 5/- extra.

LASKY'S RADIO,

379, HARROW ROAD, PADDINGTON, LONDON, W.9.

(Lasky's (Harrow Road) Ltd.)
'Phone: Cunningham 1979 and 7214.
Hours: Mon. to Sat. 9.30 a.m. to 6 p.m. Thurs., half-day.
Send a 2d. stamp with your name and address for a copy of our current Bulletin. We have large stocks of new surplus radio components, valves, transformers, etc., details of which are given in our Bulletin.

Practical Wireless

EVERY MONTH
VOL. XXVIII. No. 545 MARCH, 1952

Editor F.J. CAMM

20th YEAR
OF ISSUE

COMMENTS OF THE MONTH

By THE EDITOR

OUR FREE BLUEPRINT

The Mini-four Personal Portable

THE presentation in this issue of our blueprint for the Mini-four all-dry four-station pre-set miniature portable will, we are sure, be welcomed by all of our readers, especially those of long standing who remember those halcyon days of 1929 when we were able to present a free blueprint every three months. The paper position to-day is still problematical, and we shall not yet be able to revert to free gift blueprints with the same frequency.

We take pride, however, in the fact that at the earliest possible moment we have been able to make a start. The demand for such a design as the Mini-four has been insistent for the past four years—in fact, ever since power cuts commenced. The Mini-four is not only a useful stand-by receiver as well as one which can be used out of doors, but it is a receiver which is ideal for a beginner to construct.

It is not expensive; it can be built in an evening; all of the parts are available including the cabinet, and, of course, it carries our guarantee.

THE PT "ARGUS"

THE March issue of our companion journal *Practical Television* contains a free gift blueprint for the PT "Argus," a 21-valve 5-unit receiver of compact proportions which can be built for round about £20. It makes use of a 6in. tube—the famous VCR97. Full constructional details are incorporated in the issue. Copies will be on sale on February 22nd.

MATERIAL SHORTAGE

THE Government decision to introduce a system of allocation of steel supplies will, to some extent, affect the manufacture of wireless and television receivers. There is already a shortage of brass and other non-ferrous metals, and these shortages, coupled with the doubling of the Purchase Tax, are causing set manufacturers a great deal of concern. Undoubtedly there will be cuts in the supplies of other raw materials, now that the tooling up process in the rearmament programme is ended, and the call for the supply of materials for mass-production increases day by day.

Fortunately, readers of this journal in the main build their own receivers, and there are still

plenty of components available for building sets to most of the standard circuits. Skilled readers are enabled to adapt some of the ex-Government material which is available so cheaply from many of our advertisers.

ELECTRICAL POWER IN SCOTLAND

NOW that the plans for the development of hydro-electric power in Scotland are reaching fruition new markets are being opened out in the rural areas of that country, and this year should see over 20,000 Scottish homes equipped with radio for the first time. The sale of battery sets in those areas has increased during recent years but there will be a gradual change-over now to mains sets.

PREMIUMS FOR TECHNICAL WRITERS

AS from January 1st the Radio Industry Council announces that it will award premiums of 25 guineas each, with a maximum of six a year, to the authors of published articles which in the opinion of their panel of judges deserve recognition by the industry.

Only non-professional writers are eligible—that is to say those who are not paid a salary for writing and who do not earn more than 25 per cent. of their income from fees for articles or book royalties.

The awards will be made for articles published both at home and abroad in public newspapers and periodicals. Articles in trade journals are excluded.

"PRACTICAL ENGINEERING" FREE BOOKLETS

PRACTICAL ENGINEERING is published at 6d. every Friday. Included with every issue from February 29th, and extending for eight weeks, will be a free gift 20-page pocket book containing valuable workshop data of use to everyone employed in the engineering industries. These eight booklets cover general workshop formulae, workshop trigonometry, drills and drilling, turning and fitting, screw threads and screw-cutting, gears and gearing, etc. Those collecting the booklets may obtain for 1/3 a neat grease and waterproof pochette in which the series of eight booklets may be kept.—F.J.C.

ROUND the WORLD of WIRELESS

Broadcast Receiving Licences

THE following statement shows the approximate numbers of licences issued during the year ended November 30th, 1951.

Region	Number
London Postal	2,363,000
Home Counties	1,661,000
Midland	1,756,000
North-eastern	1,954,000
North-western	1,645,000
South-western	1,078,000
Welsh and Border Counties	735,000
Total England & Wales	11,192,000
Scotland	1,115,000
Northern Ireland	219,000
Grand Total	12,526,000

The above table includes 1,113,900 television licences. This was a record increase of 81,950 television licences over the previous month's figure.

B.I.R.E.

THE following meetings will be held in February, 1952:—

North-eastern Section.—Wednesday, February 13th, at 6 p.m. Neville Hall, Westgate Road, Newcastle-upon-Tyne. A symposium of papers by student members.

South Midlands Section.—Wednesday, February 13th, at 7.15 p.m. Corporation Street Civic Restaurant, Coventry. "Gas Discharge Devices as Switching Elements," by E. A. R. Peddle, B.Sc. (Research Laboratories, General Electric Co., Ltd.).

Scottish Section.—Thursday, February 14th, at 7 p.m. Natural Philosophy Department, The University, Edinburgh. The Clerk-Maxwell Memorial Lecture by Professor G. W. O. Howe, D.Sc., LL.D.

London Section.—Wednesday, February 20th, at 6.30 p.m. London School of Hygiene and Tropical Medicine, Keppel Street, Gower Street, London, W.C.1. "Search Radar for Civil Aircraft," by P. L. Stride (E. K. Cole, Ltd.).

West Midlands Section.—Tuesday, February 26th, at 7 p.m. Wolverhampton and Staffordshire Technical College. Details may be obtained from the local secretary.

A. H. Hunt, Ltd., Change of Name

AT an extraordinary general meeting held on December 17th, a resolution was made and adopted that the registered name of the company should include a reference to the products in which the company are specialists and which enjoy a world-wide reputation as "Hunts Capacitors." Therefore, the name has now been changed to A. H. Hunt (Capacitors) Ltd.

EKCO Car Radio Appointment

E. K. COLE, LTD., announce the appointment of Mr. K. C. Mason as car radio sales representative.

Mr. Mason joined EKCO in 1947 after service in the Army and later with the British Control Commission in Germany.

British Standard for Hearing Aid Batteries

THE British Standards Institution has issued a revision of B.S. 966, which was first published in 1949 and was restricted to high-tension batteries for hearing aids.

The present revision has been expanded to cover both high-tension and low-tension batteries for such purposes and specifies the designation, nominal voltages, dimensions and methods of connection. The test to be employed to determine the contact resistance of battery socket contacts is also given.

Copies of this standard may be obtained from the British Standards Institution, Sales Department, 24, Victoria Street, London, S.W.1, price 2s. post free.

W/B Speaker Lectures

MR. R. T. LAKIN, A.M.I.E.E., A.M.Brit.I.R.E., chief radio engineer of Whiteley Electrical Radio, has recently completed a series of lectures, dealing with Improvements in and Relating to Loudspeaker Design, at Newcastle, Rugby and Coventry to members of The British Institute of Radio Engineers.

Mr. Lakin dealt with the various types of loudspeakers, particularly

those using the electro-dynamic principle. Loudspeaker magnets were fully covered, commencing with the history of older types, up to the design and construction of modern magnets using anisotropic alloys.

BBC Publicity Department Moves

ON Friday, January 4th, the headquarters of the BBC Publicity Department removed from The Langham, Portland Place, W.1, to No. 12, Cavendish Place, W.1, just round the corner. The telephone number is the same: Langham 4468.

Experimental System for St. Paul's

A NEW experimental sound system for the reinforcement of speech has been installed for tests in St. Paul's Cathedral and is a combination of time-delay amplification and a new type of column loudspeaker which should help to master the difficult hearing conditions in the Cathedral.

The system is designed by the Building Research Station of the Department of Scientific and Industrial Research under the direction of P. H. Parkin, B.Sc., A.M.I.E.E., in collaboration with Pamphonic Reproducers, Ltd.

St. Paul's is a building in which speech is, at times, practically unintelligible. Any sound or spoken word takes approximately twelve seconds to fade away.

Obituary

THE death is recorded of Mr. Leslie McMichael, chairman of McMichael Radio, Ltd.

He died on November 17th at the age of 67 and was associated with the radio industry over a period of many years.

He was one of the founder members in 1913 of the London Wireless Club (afterwards the Wireless Society of London), and also of the National Association of Radio Manufacturers and Traders (now the B.R.E.M.A.). He was president of the Brit.I.R.E. between the years 1944-46, and was elected an honorary member of the Radio Society of Great Britain.

Council in New Jersey

MR. P. A. FLEMING, technical assistant to the B.V.A. secretary, attended the first general conference held by the Joint Electron Tube Engineering Council in New Jersey, U.S., last November.

He had been invited by the Radio-Television Manufacturers' Association of America and attended the conference representing the British Radio Valve Manufacturers' Association.

Miami Police Radio

THE police force of the City of Miami, Florida, has inaugurated 460 Mc/s two-way radio communication in its radio system.

The accepted communication band in the United States is 160 Mc/s, which was first used by Miami police radio system which now includes six two-way radio base stations and 270 two-way mobile radios.

Both systems were developed and built for the City of Miami by Motorola.

Sugar Ships to Have Pye Equipment

R. I. T. FALKNER, director in charge of sales of Rees Mace Marine, Ltd., the marine radio division of the Pye group, announces that three of the Tate and Lyle sugar vessels, bringing sugar from the West Indies, are to be fitted with Pye PTC115 radio-telephone sets, which will operate on the G.P.O. Thames radio scheme.

The ships are the *Sugar Producer*, *Sugar Transporter*, and *Sugar Refiner*. These ships are managed by R. S. Dalgleish, Ltd., of Newcastle-on-Tyne on behalf of Silvertown Services, Ltd., eight of whose tugs, operating on the Thames, are already installed with the Pye radio-telephone equipment.

Sugar Transporter is at present in Jamaica, and will be fitted when she arrives in the Thames in about a month's time. The other two ships will be fitted as they come into the Thames again.

Signal-Noise Ratio

AT a demonstration recently at the Royal Institution, Dr. J. H. Ratcliffe, of the Cavendish Laboratory, showed how it was possible to render audible signals below the level of receiver noise. To simulate the signals he used a low-power electric bulb, and for the receiver a photo-cell and amplifier. The "noise" from the light source was inaudible above

the amplifier noise when fed to a loudspeaker, but by means of a special arrangement in front of the photo-cell he produced an audible note on the loudspeaker proportional to the signal strength.

Multicore Record Export Sales

FIGURES produced by Multicore Solders, Ltd., statistics department, show that record sales of Ersin Multicore solder were achieved in export markets during 1951. The increase in actual solder length compared with 1950 exceeded 4,000 miles, more than the distance from England to the U.S.A.

During the year extra packings were developed for markets having particular requirements and, in some countries, this solder is now being wound on reels locally, the material being initially despatched in bulk from England. In other territories where actual ship-to-shore facilities do not exist due to shallow sea approaches, the solder is packed in special cases which enables it to be transferred to shore by means of surf boats.

Radio-controlled Robot

THE Glenn L. Martin Co. has developed for the American Air Force a radio-controlled jet-guided missile, the B-61 Matador.

Because of the nature of the high-frequency radio waves used to control its flight, the bomber is not able to exceed the horizon-to-horizon operating radius and is, intended primarily as a weapon of defence.

The robot is guided to its destination by a piloted plane

equipped with an electronic and radar system, but the plane may also be directed by space relay control stations spaced out over long distances.

Electronic Pioneer Honoured

E.M.I. RESEARCH LABORATORIES, LTD., are pleased to announce that Dr. J. D. McGee has been awarded the Order of the British Empire.

Dr. McGee is a senior scientist with E.M.I. Research Laboratories, Ltd., and was one of the team that evolved the all-electronic Emitron television system, which provided Britain with the world's first public television service.

E.M.I. Personnel in Broadcast

THE General Overseas Service of the BBC recently presented a series of broadcasts entitled "A Good Job." These programmes, produced by Richard Dowling, gave impressions of various British industries, primarily from the point of view of employees actually engaged on production.

One of these broadcasts featured the electrical and radio industry and was recorded at E.M.I., Hayes. Max Robertson, the well-known BBC commentator, interviewed several E.M.I. employees in various sections of the Machine, Assembly and Cabinet factories. An E.M.I. magnetic tape recorder was used to make the recording.

Many of the products discussed were for export, including car radios, domestic radio receivers, portable gramophones and electrical household appliances.



Recordings being made at E.M.I., Hayes, for use in the BBC Overseas Programme "A Good Job"—see paragraph above.

Radio Receiver Design at V.H.F.—5

FURTHER NOTES ON VALVE DESIGN AND TECHNIQUE

By G. P. Lowther

(Continued from page 78 February issue.)

A HIGH mutual conductance is unnecessary at low and medium frequencies because the gain (in the case of a pentode) = $G_m \cdot R_L$ where R_L is the load impedance. Since this impedance may be made very high, a high mutual conductance is not only unnecessary but even undesirable for normal applications in the interests of stability and uniformity of characteristics. At V.H.F., however, the input impedance of valves is low (e.g. that of an RL7 at 100 Mc/s = 2,500Ω) and losses are considerable, so that if a reasonably high gain is to be obtained, the slope must be as high as possible, and in practice may lie between 6 mA/V and 9 mA/V.

Every valve lead has self inductance, which, while it can be absorbed in series-tuned circuits, must be minimised. The filament and suppressor grid lead inductances are not normally important, but

L_c represents cathode lead inductance
 C_{gc} represents grid-cathode capacitance

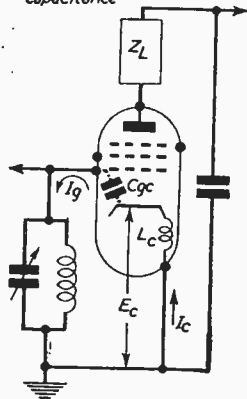

Fig. 17.—A typical valve stage showing current and various capacities in theoretical form.

those of the cathode and screening-grid are of considerable significance and may entirely upset the operation of the stage.

In Fig. 17 the cathode signal current I_c produces a drop across $L_c = E_c = \omega \cdot L_c \cdot I_c$ lagging 90°. This causes a current I_g through C_{gc} leading E_c by 90° and hence in phase with the input.

$$I_g = E_c \cdot \omega \cdot C_{gc} = \omega^2 \cdot L_c \cdot I_c \cdot C_{gc}$$

$$\text{but } G_m = \delta I_a \div \delta E_g \text{ and } G_c = \delta I_c \div \delta E_g$$

where G_c = cathode mutual conductance.

(Provided the screen current is not too high, G_c may be taken as approximately equal to G_m .)

Since $I_c = E_g \cdot G_c$

$$\text{therefore } I_g = \omega^2 \cdot L_c \cdot E_g \cdot G_c \cdot C_{gc}$$

$$\text{but the input impedance} = E_g \div I_g$$

$$= \frac{1}{\omega^2 \cdot C_{gc} \cdot L_c \cdot G_c}$$

To take two examples:

(a) Let $f = 10$ Mc/s, $C_{gc} = 10$ pF, $L_c = 0.05$ μH, $G_c = 6.5$ mA/V.

Then input conductance

$$= \frac{1}{R} = \omega^2 \cdot C_{gc} \cdot L_c \cdot G_c$$

$$= 4\pi^2 \times 10^{14} \times 10^{-11} \times 5 \times 10^{-8} \times 6.5 \times 10^{-3} \text{ mhos}$$

$$\text{and } R = 67,500\Omega$$

(b) Let $f = 200$ Mc/s, $C_{gc} = 8$ pF, $L_c = 0.02$ μH, $G_c = 6.5$ mA/V.

Then input conductance

$$= 4\pi^2 \times 4 \times 10^{16} \times 8 \times 10^{-12} \times 2 \times 10^{-8} \times 6.5 \times 10^{-3} \text{ mhos}$$

and $R = 610\Omega$
 Mutual inductances between leads are also important in valve design, but fortunately this is a valve manufacturer's worry! Screens are used to produce the desired results, while multiple cathode leads may be employed to reduce the inductance, a typical variation in input impedance being shown in Fig. 18.

At very high frequencies the transit time, i.e., the time taken for electrons to pass from the cathode to the grid and grid to anode, is comparable with the period of one cycle, and grid current flows even though the grid is negatively biased, thus reducing the input impedance of the valve to signal frequency currents.

The grid potential changes with the applied alternating signal, but the electrons cannot follow properly and lag behind. Thus, if the grid is becoming negative the number of electrons flowing to the anode becomes less but not to the same extent as those on the cathode side of the grid. Thus, there will be more electrons and hence a greater negative charge on the anode side of the grid. Hence, current will flow out of the grid due to electrostatic charges. When the grid becomes less negative current flows into it.

Another explanation may be supplied by reference to Figs. 19a and 19b. The cathode signal current I_c

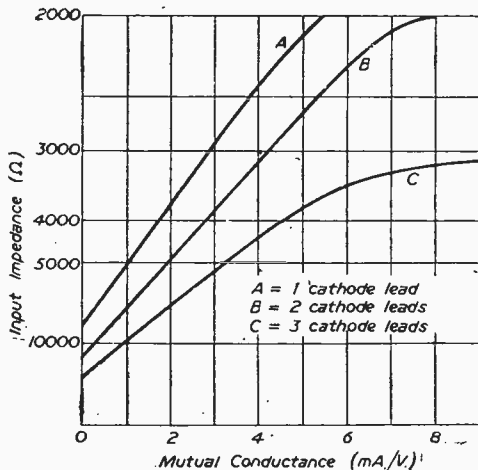

Fig. 18.—Graph showing variation of input impedance.

lags behind the grid voltage E_g by virtue of the finite transit time. The anode current I_a lags still more but has approximately the same amplitude as I_c . The difference between I_c and I_a must represent a grid current I_g , which may be resolved into reactive and resistive components X and R respectively. The former may be regarded as an additional capacity appearing between grid and cathode, the latter as "transit time damping."

Formulæ

Formulæ for calculating input damping and capacity are not sufficiently accurate for design purposes where the amateur is concerned, and it is advisable to use manufacturers' data or to use trial and error methods. A useful formula, however, is :

- $G = K.G_m.f^2.t^2$, where
- G = reciprocal of input resistance and is in mhos.
- G_m = mutual conductance in amps/volts.
- K = a constant dependent upon the electrode voltages and the ratio of transit times cathode-grid and grid-anode.
- f = frequency in cycles.
- t = time taken for an electron to travel from cathode to grid.

The value of the formula is its indication that the input impedance is dependent upon G_m and f^2 , i.e., for a given valve it varies inversely as the square of the frequency. Actually, at very high frequencies extrapolation from figures obtained at lower frequencies is more accurate than direct measurements, as the grid resistance appears too low due to the inductance of the grid lead. The following figures give the input impedances for various pentodes at 100 Mc/s :

Valve	G_m	Input Impedance
57	1.2 mA/V	1,500Ω
SP41	8.6 "	460Ω
EF6	2.5 "	2,000Ω
EF50	6.5 "	1,000Ω
EF91	7.5 "	800Ω
EF54	7.7 "	2,500Ω
954	1.4 "	20,000Ω

The last four valves are specially designed for V.H.F. working, "transit time damping" being minimised by reducing electrode dimensions and spacing. Increase in electrode potentials and reduction of the mutual conductance accomplishes the same result, but is impracticable owing to overheating and the necessity for maintaining as high a gain as possible. Fortunately, both "transit time damping" and that due to cathode lead inductance can be greatly reduced by compensating circuits without substantially re-

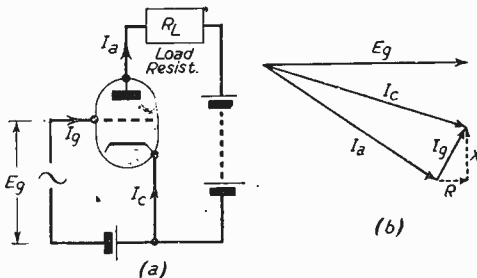

Fig. 19.—Circuit and vector showing cathode and anode current lag.

ducing the slope. It should be noted that the output impedance also drops with increasing frequency.

- C_{gc} represents the grid-cathode capacity.
- L_c represents the cathode lead inductance.
- R_c represents the cathode bias resistor.

In Fig. 20 grid current I_g flows as a result of the voltage E_c , which is built up by the cathode current I_c . If this voltage is to be a minimum, L_c (the cathode lead inductance) must be tuned out by a series condenser C_c without breaking the D.C. cathode path and is normally connected as shown in the diagram.

For proper decoupling to be achieved $\frac{1}{\omega C_c}$ must be much less than R_c , while if L_c is tuned out, $\omega L_c = \frac{1}{\omega C_c}$
 If $L_c = 0.02 \mu H$ and the frequency = 100 Mc/s
 $\omega L_c = 13 \Omega$.

Hence $C_c = 120 pF$.
 If the bias resistor $R_c = 200 \Omega$ decoupling will be reasonably satisfactory.

Clearly, the voltage E_c will never be zero since the parallel resistance R_c of 200Ω may be resolved

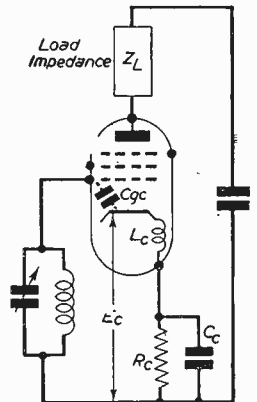

Fig. 20.—In this stage circuit, C_{gc} represents the grid-cathode capacity; L_c the cathode lead inductance, and R_c the cathode bias resistor.

into a series resistance of approximately 1Ω . This will be neglected in the following simplified analysis :

$$E_c = I_c \left(\omega L_c - \frac{1}{\omega C_c} \right)$$

$$\text{and } I_g = E_c \div \frac{1}{\omega C_{gc}}$$

$$= I_c \cdot \omega C_{gc} \left(\omega L_c - \frac{1}{\omega C_c} \right)$$

But $I_c = E_g G_c$ (where G_c = cathode mutual conductance).

$$\text{Therefore } I_g = C_{gc} \cdot E_g \cdot G_c \left(\omega^2 L_c - \frac{1}{C_c} \right)$$

$$\text{Since grid input resistance } R = \frac{E_g}{I_g}$$

$$\text{Therefore the grid input conductance} = \frac{1}{R} =$$

$$C_{gc} \cdot G_c \left(\omega^2 L_c - \frac{1}{C_c} \right)$$

The effect is even more marked at 200 Mc/s, where a condenser of 30 pF resonates with the cathode lead inductance.

$$\text{Suppose } L_c = 0.02 \mu H \quad f = 200 \text{ Mc/s}$$

$$C_{gc} = 8 pF \quad G_c = 6 \text{ mA/V}$$

Then if C_c is infinitely large, i.e., the cathode resistor is completely decoupled, the input resistance $R=634\Omega$ (neglecting the effect of R_c). As this condenser is reduced in value, the input resistance increases, thus reducing the damping on the tuned circuit, and then becomes negative, i.e., the valve oscillates, as shown in the following table :

C_c (pF)	20	25	31.7	35	40	50	100
$R(\Omega)$	-1,130	-2,480	± 00	6,850	3,160	1,800	965

It will be realised that the resistor R_c effectively determines the Q of the series-tuned cathode circuit, and that if the Q is high the input resistance, and hence the gain, will vary over the bandwidth, and in any case can only be adjusted for one frequency, since a variable condenser is scarcely a practicable proposition. Thus, for wide-band working the Q must be suitably reduced, though in normal experimental work this factor can be ignored. Nevertheless, this type of compensation is not very suitable if the total band of frequencies to be covered is greater than, say, ± 10 Mc/s at

Under normal operating conditions a Mullard EF50 without cathode compensation imposes a damping of about $4,000\Omega$ upon the preceding tuned circuit at 50 Mc/s. With a cathode resistor of 32Ω and a decoupling condenser of 50 pF the damping is only $19,000\Omega$.

If bias is applied to a valve (as happens when

A.V.C. is used), the change in mutual conductance (and therefore in gain) causes large variations in the input capacity and input resistance, as indicated by Fig. 21 for an EF50 at 50 Mc/s. If the bias is applied to the suppressor instead of to the control grid, the variations take place in the opposite sense, so that by feeding the bias through a suitable dividing network the input capacity and resistance will remain substantially constant. If, in addition, a partially bypassed cathode resistor is included in the circuit as shown in Fig. 22, the damping not only remains fairly constant, but is considerably reduced, as indicated in Fig. 23.

Since for most V.H.F. applications fading can be ignored and so A.V.C. is unnecessary, only the cathode compensating circuit is normally employed.

At high frequencies there are two principal sources of noise: (a) thermal, (b) valve, or shot noise.

(a) *Thermal noise.*—An electric current is not a smooth flow of "force," but the steady movement of discrete electrons. If it is compared with the power exerted by water, it is more analogous to a fall of rain, which is the summation of a vast number of small drops, than to the flow of water from a tap. Thus, although the electric current will average out to a steady value, there will be small variations and irregularities that will constitute a source of noise.

(To be continued.)

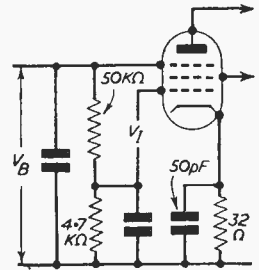

Fig. 22.—Here V_1 is the input signal and V_B the A.V.C. bias.

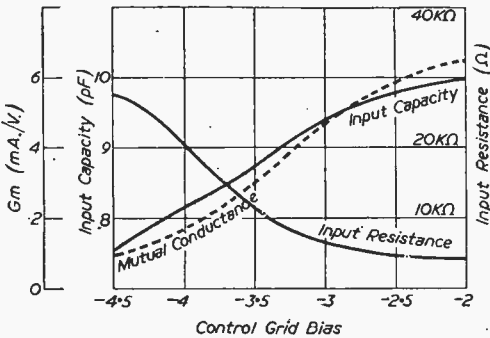

Fig. 21.—Graph showing variation of input capacity and resistance with variations in bias.

200 Mc/s. The input resistance may also be increased by adding external inductance to other electrodes such as the screening grid, but this is not normally as convenient.

"Transit time damping" may be eliminated by using an unbypassed cathode resistor, but this, of course, means that conditions will not be correct for cathode lead compensation. Also, there will be negative feed-back since both input and output signal frequency currents will develop an E.M.F. across the cathode resistor, the E.M.F.s being 180 deg. out of phase. Feedback reduces the mutual conductance from G_m to approximately $\frac{1}{1 + G_m R_c}$

Suppose $G_m=6$ mA/V and $R_c=200\Omega$, then the reduction in G_m and therefore in gain=2.2 times, or 7 db. While the formulæ give an indication of suitable component values, in practice a compromise is adopted whereby the cathode resistor is partially bypassed so as to compensate, at least in part, for both cathode lead inductance and transit time effects. This may be done by trial and error, or more simply by consulting valve manufacturers' data sheets, though unfortunately such details are only given for a very limited number of valves.

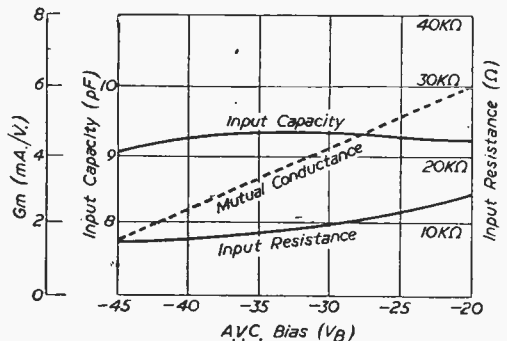
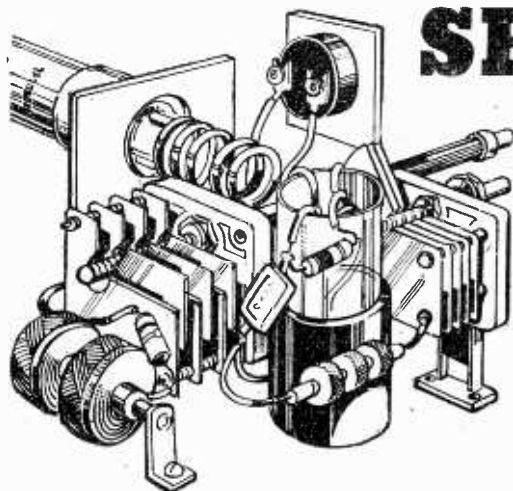

Fig. 23.—Compare this with Fig. 21.

SHORT-WAVE SECTION

BAND-SPREADING IN S.W. RECEIVERS

By A. W. Mann



BAND-SPREADING as applied to short-wave receivers was in general use in the United States much earlier than was the case in Europe. The parallel method was the most popular, owing to its simplicity, but over here little interest was shown simply because the few articles which were devoted to the subject were lacking in practical detail. This meant that unless one was prepared to devote time to experiments the slow-motion tuning dial reigned supreme.

It is of little use to tell the reader to fit a low-capacity variable condenser in parallel with the main one and leave it at that.

Some writers of years ago apparently overlooked that point, and the most suitable tuning capacity to use with a given value of band-setter was a matter for experiment.

The writer tried various capacities, and found that the spread was either too little or too great. It was fortunate that, at the time, one particular make of the 100 pF type condenser which could be dismantled was available. This was reassembled with two stator plates and one rotor plate, double spaced, and provided the desired amount of spread.

Fig. 1 shows the parallel method in theoretical form. Some may perhaps disagree, but the writer considers that the parallel method is a very satisfactory one in many respects. Providing that there is sufficient panel space available for mounting an additional tuning dial, it can be applied to most receivers.

Commercial Applications

This simple method is incorporated in the design of several commercially-produced communication receivers. Hallicrafter, for example, used a combined band-setting and band-spreading condenser assembly very successfully.

The T.R.F.

The average home-constructed T.R.F. receiver can be band-spread in the detector stage, without applying it to the H.F. stage, in cases where separate controls are used. In the case of ganged tuning, the H.F. and detector stages may be band-spread providing

that matched coils are used and that facilities for accurate tracking are available.

Disadvantages

The disadvantage of the parallel method is, however, that in order to cover the 1.7 Mc/s band two settings of the band-setting condenser are necessary.

That should not cause undue worry to users of the general coverage type of receiver. The tuning capacity values specified in Fig. 1 should meet most requirements.

Using a Tapped Coil

Fig. 2 shows the theoretical details of the tapped coil method. This was at one time extensively used in simple amateur-built receivers designed solely for amateur band coverage.

Anyone desiring to build a regenerative receiver of the O-V-1 type using this method of band-spread

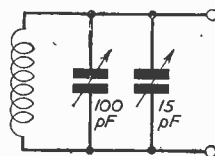

Fig. 1.—Simple condenser band-spreading.

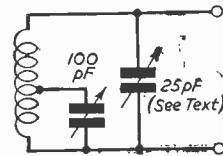

Fig. 2.—The tapped coil method.

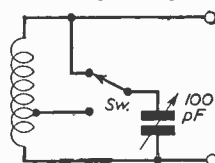

Fig. 3.—Tapped or full coil.

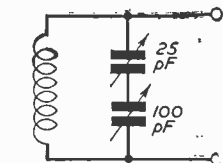

Fig. 4.—The series method.

should note that six-pin coil formers can be used. Two pins for the grid winding, two for the reaction winding, and one of the remaining pins for the tapping point.

The band-spread capacity as shown at Fig. 2 is 100 pF. The specified trimming capacity is 25 pF, but this may be increased to 100 pF, depending on the coil used, the bands to be covered and the amount of spread required.

Providing that the correct coil turn, and the correct part of that turn, can be found and the tap taken from there, the trimmer condenser could be omitted.

Patience and Skill

Those with experience of tapping close-wound,

small diameter coils will agree that it is not easy.

A very small spring clip is required, and this will require suitable grooves filed in the jaws in order to make a good firm contact with the wire. Unless widely-spaced tinned-copper wire coils of substantial gauge are used, clip tapping is apt to be unsatisfactory due to the clip moving, and the consequent short-circuiting of adjacent turns. When accurate calibration is required, a soldered tapping lead is essential.

Rather than advise the reader to find the correct tapping and leave him to it, I would suggest that the trimming capacity should be incorporated, and a clip should only be used in the initial experiments.

If the capacity of each condenser is 100 pF, a reasonable amount of variation in the tappings of individual coils will be obtainable.

Full Coverage

Fig. 3 shows details of an alternative method which provides either band-spread or full coverage as required. The difficulty in this instance will be to find the correct tapping point.

Series Method

The series method of band spreading is shown at Fig. 4 with the 100 pF band-spreader and 25 pF band-setter, the total capacity of the condensers being less than the capacity of either.

Other Methods

There are various other methods which are but complicated variations of the basic idea, different spreading capacities being switched into circuit together with each range of coils.

Such ideas are all right if there is sufficient space available for the various controls. This factor should be borne in mind when designing the receiver.

None but the most experienced would attempt the incorporation of elaborate constant band-spread arrangements, and therefore I am not including any in this article. There is no reason why less elaborate methods should not be tried. A few suggestions should help.

The How and Why

Our interests may centre around all-band listening.

In this case the usefulness of a variable band-setter is beyond question. On the other hand, one may specialise in amateur band reception or, for that matter, short-wave broadcast listening.

When home-made coils are used there is considerable scope for experiment with a view to obtaining a reasonable amount of spread throughout the full tuning range.

A low capacity tuning condenser such as a .00005 or .00007 μ F could be used in conjunction with a really good S.M. dial, and suitable coils wound so that each amateur band would spread over, say, 60 degs. of the dial scale.

This of course will do away with the necessity for a separate band-spread condenser. The snag here is that a considerable number of coils would be required to cover all bands.

Caution

It should be noted when using commercial type moulded coil formers that these do not lend themselves to repeated unsoldering. Loose pins sometimes result.

S.M. Dials

It is the practice in some cases to fit a good slow-motion dial to the band-spread condenser and a plain knob or one of the pointer type to the band-setter. A far more satisfactory method is to use two slow-motion dials, unless of course the band-setter is of the click-stop type.

The usefulness of the receiver will be considerably increased if the band-setter dial is calibrated and the appropriate charts are drawn out from the calibration data. One can cover a whole series of coil ranges by doing so, if the charts are used in conjunction with notes as to band-spreader settings. When calibrating, the band-spread condenser should be set and left at the centre of the scale.

An even better idea is to build and calibrate a heterodyne type wavemeter. It should be remembered that commercial C.W. stations and short-wave broadcasters of known frequency can be found on the air throughout the day. Thus calibration is now much easier and takes less time than was the case in the early days.

The Moon as a Reflector

THE possibility of using the surface of the moon as a radio reflector has resulted in some very practical experiments, recently carried out by the Collins Radio Company at Cedar Rapids, Iowa, U.S.A., by one-way telegraphic communications sent out by a high-power 418 Mc/s transmitter there, and also by a special low-noise, narrow-band receiving equipment set up near Washington, D.C., by the National Bureau of Standards. The results obtained up to December 4th last indicate that the use of the moon as a reflector for relaying television, VHF or UHF signals is not as yet practicable.

Signal/Noise Ratio

It was observed that even with a 30ft. paraboloid antenna and a receiver with a 1 kc/s bandwidth at the receiving point, the signal level was but a few db

above the noise level of the receiver. It would appear that the band necessary in television, for instance, would render the signal-to-noise ratio far too low. The experiments have also so far proved that reflection from the lunar surface is very low and tends to fade rapidly, which may be in part due to the many discrete areas on our satellite, and also by the relative phase variations caused by its liberation. Even if a very powerful signal could be beamed at the moon the reflected signal may be unusable as the result of a multiplicity of vivid ghost images.

In the sphere of lunar relay up to the present we can only hope for low-speed telegraphic or teletype signalling. I am grateful to Mr. Irvin H. Gerks, the research specialist of the Collins Radio Company, for the up-to-date data in this branch of radio engineering.—COLIN JOHNSTON ROBB.

THE MINI-FOUR PERSONAL PORTABLE

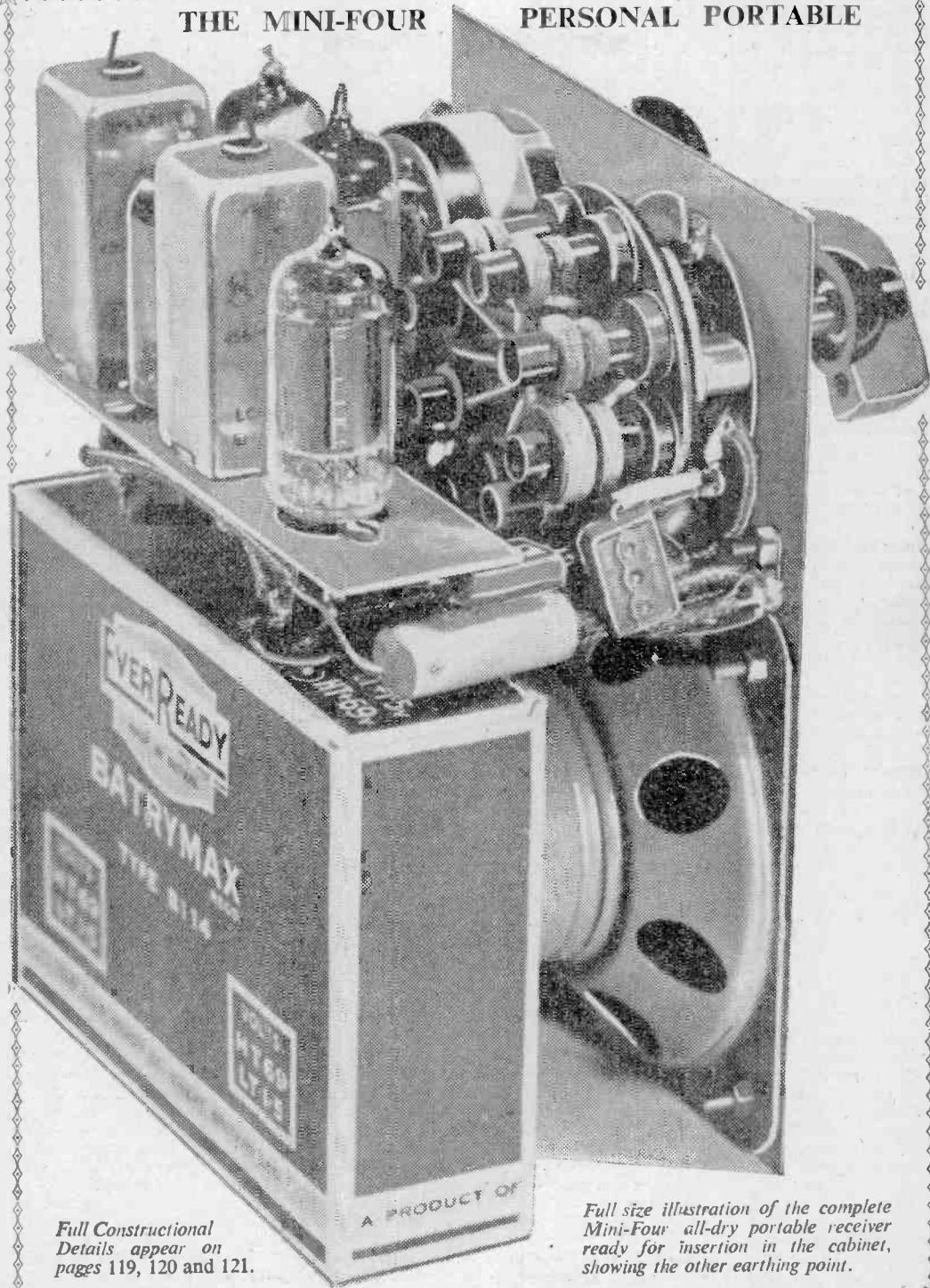

Full Constructional
Details appear on
pages 119, 120 and 121.

Full size illustration of the complete
Mini-Four all-dry portable receiver
ready for insertion in the cabinet,
showing the other earthing point.

For the Transmitter

Harmonic Crystal Oscillators—1

CRYSTAL CIRCUITS AND OTHER DETAILS FOR THE EXPERIMENTER

By G. Elliott

THE generation of harmonics of the fundamental frequency of a crystal in the tri-tet or the grid-plate oscillator circuits is well known to most transmitting amateurs and will not be discussed here. Other less conventional circuits are now available, some of which will generate harmonics up to the fifteenth or higher. Such circuits are very useful in V.H.F. working to reduce the number of multiplying stages required in crystal-controlled transmitters and receivers. In general, the lower order harmonics of normal crystals up to the ninth can be obtained with sufficient power to be useful in transmitters, while the higher harmonics are useful in crystal-controlled receivers.

Harmonic Crystals

It is not possible to produce fundamental crystals on frequencies above about 15 Mc/s, as the quartz plate becomes too thin to have reasonable strength, but many manufacturers produce harmonic crystals which are specially ground to be active at a harmonic, generally the third. By using a tetrode or pentode oscillator valve, tuning the screen circuit to the crystal frequency and suitably tuning the anode, higher harmonics can be extracted. For example, a 24 Mc/s harmonic cut crystal will give good output on 72 Mc/s in the circuit shown in Fig. 1. The 6AG7 is a useful valve in this application, as, due to its high mutual conductance, it gives good output, even with crystals of low activity. Harmonic crystals have the reputation of being more easily damaged by overloading than normal types, and for this reason are not popular with many amateurs. In the circuit shown, the screen voltage should not exceed 150 volts, to avoid excessive crystal current, and the circuits are tuned in the normal manner for a dip in the anode current. The size of the anode coil given is only approximate and may vary as a result of the method of coupling to the following stage and the input capacity of the following valve.

The Squier Oscillator

Special circuits have recently been devised for the direct production of harmonics from normal crystals and are becoming popular as the crystals are more robust, cheaper and more readily obtainable. Large numbers have been available from Government-surplus dealers in frequencies suitable for amateur use. The Squier circuit is shown in Fig. 2, and makes use of controlled regeneration to facilitate crystal oscillation. A feed-back coil is formed by tapping the earth point on L1 and the crystal is series resonant in the grid circuit. The circuit L1, C1 is tuned to the crystal harmonic, causing the crystal to "take off" on that frequency, and the tapping point is adjusted so that there is insufficient regeneration for the circuit to oscillate independently of the crystal via the crystal electrode capacity. One triode section of a 6J6 or 12AT7 is usually recommended for use in this circuit, and the values of components

given in Fig. 2 apply to that type of valve and for operation on 24 Mc/s from an 8 Mc/s crystal. The frequency can then be multiplied into the 144 Mc/s band, the second half of the 6J6 or 12AT7 generally being used for doubling or trebling.

For use in a crystal-controlled converter on 144 Mc/s, L1, C1 will be tuned to a lower frequency, together with a suitable crystal to generate the I.F. and, as less power is required, R1 can be increased to 10,000 ohms, R2 to 50,000 ohms and C3 decreased to about 30 pF. The tuning procedure in the Squier circuit is to insert a 0.5 mA meter in the grid circuit jack J and to tune C1 for maximum grid current. Grid current should only flow over a small range of the tuning condenser, and if obtained over the whole range generally indicates that there is excessive feed-back and that the circuit is oscillating independently of the crystal. If this is so, the tapping on L1 should be moved to decrease the value of the feed-back coil. By beating a stable receiver against the oscillator only a very slight change in beat note should be observed over the whole range of C1 at which the circuit will oscillate. It is not advisable to use more than about 200 volts on the

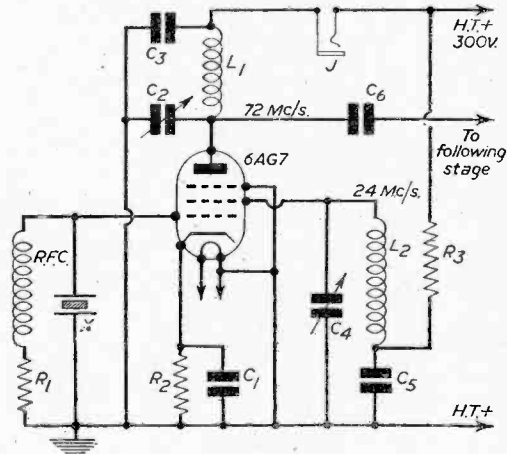

Fig. 1.—Oscillator circuit for harmonic crystals.

COMPONENTS (Fig. 1)	
X—24 Mc/s harmonic crystal.	C2—20 pF air spaced.
RFC—1.25 mH.	C3—500 pF mica.
R1—10 to 20 KΩ ½ watt.	C4—40 pF air spaced.
R2—100Ω ½ watt.	C5—0.001 μF mica.
R3—22 KΩ 1 watt.	C6—300 pF mica.
C1—75-100 pF mica.	J—Anode current jack.
L1—0.15 μH (16 S.W.G., 3 turns, ½ in. diam., ½ in. long).	
L2—2 μH 22 (S.W.G., 13 turns, ½ in. diam., 1 in. long).	

oscillator for transmission purposes, to avoid crystal heating, and considerably lower voltages may be used in crystal-controlled converters. Overheating of the crystals in this circuit may cause the frequency to drift several hundred kc/s, or sometimes to jump suddenly to another value. The frequency of the oscillator is slightly sensitive to large changes of anode voltage, which may sometimes occur during the keying of a transmitter, giving rise to a chirpy signal. If large voltage surges are liable to occur, it is best to use a stabilised supply to the oscillator.

It is usual to make use of the third harmonic in the Squier oscillator, but some crystals will "take off" on their fifth harmonic, although with less power output. In this way a 7.2 Mc/s crystal will oscillate on 36 Mc/s, which can then be multiplied into the 144 Mc/s band as before.

Generation of Overtone Oscillations

Before proceeding to describe other circuits it is useful at this stage to explain how a crystal can

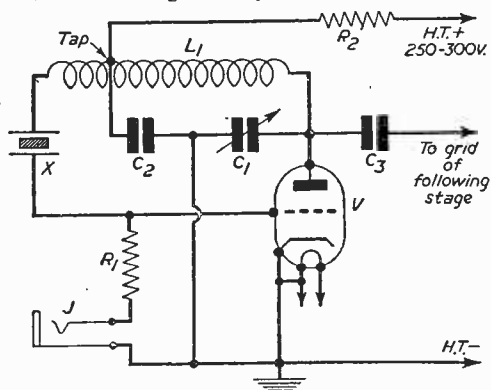

Fig. 2.—Squier crystal oscillator circuit.

COMPONENTS (Fig. 2).

- X—8 Mc/s or other suitable Crystal.
- R1—3.3 KΩ ½ watt, or 10 KΩ ½ watt for receiver oscillator.
- R2—10 KΩ 2 watt, or 50 KΩ 1 watt for receiver oscillator.
- C1—40 pF air spaced.
- C2—0.001 μF mica.
- C3—0.001 μF mica, or 30 pF for receiver oscillator.
- J—Grid current jack.
- V—½ of 6J6 or 12AT7.
- L1—For 24 Mc/s — 2μH (20 S.W.G., 13 turns, ½ in. diam., 1 in. long), tapped at 3 or 4 turns from grid. Also suitable for receiver oscillator use down to 20 Mc/s.

oscillate at frequencies higher than its fundamental. Plates may be cut from a quartz crystal in many different planes and these cuts all have their different characteristic modes of vibration. Crystals of AT and BT cuts at their fundamental frequency vibrate by a shear movement parallel to the faces of the plate, as shown in Fig. 3A. The term "harmonic," given in the description of the Squier circuit, is not strictly correct, as the higher frequencies are not electrical harmonics but mechanical harmonics or "overtones." An AT or BT cut crystal oscillating in

the third overtone is shown in Fig. 3B, where it can be seen that the crystal is vibrating in three layers instead of one. Overtones do not differ from true harmonics by more than about 0.1 per cent., so that for practical purposes one need not worry about the frequency difference unless a crystal brings the frequency right on the edge of, an amateur band. As only AT and BT cut crystals give this overtone operation, one must be careful to select the correct type of crystal for the harmonic circuits described in this article. The crystals are mounted between two plates with slightly raised lands at each corner, as shown in Fig. 3C, and are thus clamped at each corner, the rest of the crystal being separated from the electrodes by a very small air gap on each side.

Fortunately, the BT cut is one of the most common types produced at the present time. It is suitable for crystals in the range 4,500-15,000 Kc/s, the AT cut being used for lower frequencies, and it has a low temperature coefficient. Most of the Government-surplus crystals are of this type, including all the American FT243 pattern, so supplies are readily obtainable.

Pentode Overtone Oscillator

A circuit has recently been described which is superior to the Squier oscillator in the generation of overtones higher than the third. Nearly all good AT and BT cut crystals show activity on the fifth, seventh, ninth, eleventh and thirteenth overtones and some even up to the twenty-ninth overtone. It should be noted that only odd overtones are available, due to the characteristics of the mechanical vibration of the crystals. In the Squier circuit, oscillation cannot usually be obtained above the fifth overtone, but by using a high-slope V.H.F. pentode, such as the 6AK5 or 717A, which needs very little power in the grid circuit, the higher overtones are readily available. The pentode circuit is shown in Fig. 4, where it can be seen that the crystal is connected between grid and earth in a conventional manner. The failure of a conventional oscillator to generate higher harmonics can be analysed as follows:

Let us suppose that the crystal is connected between grid and earth and the anode circuit can be tuned to the fundamental frequency or its harmonics. A typical 10 Mc/s crystal with a Q of 160,000 is equivalent to a circuit consisting of an inductance of 0.025 H tuned by 0.01μF, the circuit resistance being 10 ohms.

(To be continued.)

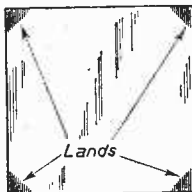
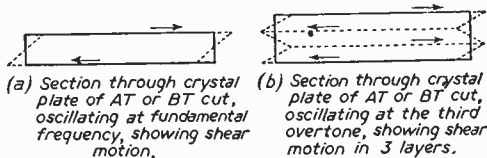

(c) Crystal clamping electrode for AT or BT cut crystals showing the raised lands at each corner.

Fig. 3.—Diagrams of AT and BT cut crystals.

FREQUENCY MODULATION

6.--PRACTICAL CIRCUIT DETAILS

By J. F. Golding

(Continued from page 58 February issue.)

VALVE V1, the R.F. amplifier valve, is a type EF50 high-gain pentode, working on the portion of its characteristic where the mutual conductance is at a maximum consistent with a reasonably low input impedance. This is achieved by operating the valve with an anode and screen voltage of 250 v. and a negative grid-bias voltage of 0.4v. provided by the 32Ω cathode resistor R1, the anode current being about 12.5 mA under these conditions.

The grid/cathode capacitance, at the operating frequency, is approximately 8 pF so that, if the input circuit is to be sufficiently stable, a total tuning capacitance of about 20 pF is advisable. The value of inductor L1 should, therefore, be $0.15\mu\text{H}$. This inductor may be self supporting, wound of $5\frac{1}{2}$ turns of 18 s.w.g. copper wire, the diameter of the coil being 0.3 inches and the turns spaced to give a length of 0.3 inches. The tuning capacitance is provided by the Cc of the valve and wiring, capacitor C1 and capacitor C4(a) in parallel, as shown in Fig. 20. The former of these two condensers is a 15 pF low-loss trimmer, while C4(a) is part of a three-gang unit having a capacitance change of 5.5 pF for each section.

The aerial coupling coil L2 consists of three turns of 18 s.w.g. copper wire, space wound to a diameter of 0.6 inches and a length of 0.25 inches. It should be mounted concentrically with inductor L1 and the middle of the centre turn tapped and connected to chassis.

Due to the loading of the aerial circuit and the low-grid input resistance of valve V1—about 3,000

Ω at 90 Mc/s—a Q value of 10 must be regarded as reasonable. The bandwidth of this input circuit is, therefore, approximately 8 Mc/s, so that accurate tracking is not only quite unnecessary, but may be fairly difficult.

The anode tuning circuit, consisting of inductor L3 and capacitors C5 and C4(b), is physically the same as the grid input circuit. Since the inter-electrode capacitance of the valve between anode and cathode is somewhat less than that between grid and cathode, the setting of capacitor C5 should theoretically be at a correspondingly higher capacitance value than that of C1. In practice, however, no hard and fast rules can be applied to these settings because the stray capacitance and inductance due to the wiring may either correct or aggravate any errors of this description.

The Frequency Changer

This comprises two units, the oscillator and the mixer. Since the frequency stability of the former has a considerable influence on the performance of the receiver, care must be exercised to prevent any appreciable drift after the valve has "warmed up" and to prevent its output becoming frequency

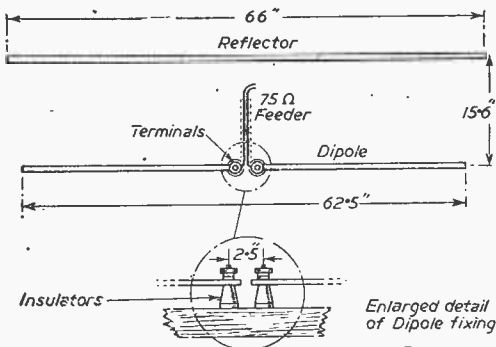

Fig. 19.—The dipole aerial.

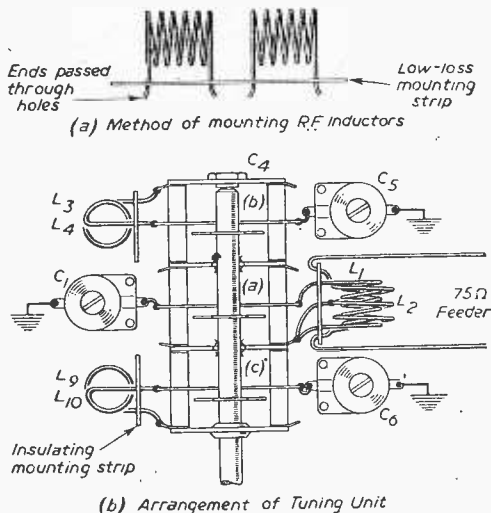

Fig. 20.—Details of the coils and tuning unit.

modulated by any hum or ripple voltages in its supply.

The oscillator valve V6 shown in Fig. 21 is a type RL16 V.H.F. triode. The anode voltage is stabilised at approximately 150 v. by means of a neon stabiliser circuit (not shown) consisting of a resistor and neon "valve" in series between the 250 v. H.T. line and chassis. The oscillator anode supply is taken from the anode of the neon so that the stabiliser forms a potential divider. Since the resistance of a neon is inversely proportional to the voltage across it, a high degree of stabilisation and smoothing results. To prevent any hum modulation from the heater supply, it is advisable to apply a D.C. heater voltage derived from a separate winding on the mains transformer via a metal rectifier and R/C smoothing circuit.

In order that capacitors C4(c) and C6 may have one side connected to chassis, the anode of the valve is effectively earthed by means of a 100 pF capacitor C28, and the 100Ω cathode resistor R16 is wire wound to form an effective R.F. choke and isolate the cathode from chassis.

The tuning circuit is similar to the anode and grid circuit of valve V1. As the bandwidth of the pre-selector circuits is broad and since the operating frequency range is small and has its centre point at a considerably higher frequency than the I.F., any series capacitors for tracking purposes are quite unnecessary. The frequency of the oscillator should be adjusted, by means of trimmer capacitor C6, to be 4.5 Mc/s below the resonant frequency of V1 anode circuit.

The mixer circuit is identical to the basic circuit given in the previous article, except that a V.H.F. detector crystal is used in place of the diode. Inductor L4 is exactly similar to L3 and is mounted on the same axis, the ends of the two coils being separated by a spacing of about 0.25 inches. Inductor L10 is also a similar coil coupled to L9 in exactly the same way.

The Tuning Unit

It has been explained in the foregoing that the tuning unit comprises a three-gang capacitor C4, three trimmer capacitors C1, C5 and C6, and three tuning inductors L1, L3 and L9. It is essential,

in the construction of this unit, that the wiring be kept as short as possible in order to avoid losses due to R.F. resistance and stray capacitance and inductance.

The best method of mounting the inductors is to fit each coil, together with its respective coupling winding, on to a strip of low-loss insulating material as shown in Fig. 20(a) and to solder the wire ends directly to the tags of the tuning capacitor. In order to avoid feed-back instability between inductors L3 and L1 the physical arrangement shown in Fig. 20(b) should be observed. Pulling of the oscillator frequency due to coupling between L3 and L9 can be reduced to a negligible amount by arranging that the coupling L4 and L10 windings are connected in opposition so that any direct coupling is cancelled out.

The I.F. Amplifier

This is a three-stage amplifier having a total maximum gain of approximately 100 dbs. It employs three type EF50 valves V2, V3 and V4, automatic gain control being applied by means of a separate diode D1 to prevent overloading on strong signals. The diode is a type EA50 fed via a 100 pF capacitor from the anode of the final I.F. valve. The load resistor R15 should be adjusted to give a D.C. bias voltage of about 2.5 v. for an R.F. signal of 10 v. at V4 anode. At this setting, an increase of input signal strength of 1,000 times merely doubles the output voltage from the amplifier.

The cathode bias resistors R2, R6 and R10 have a value of 30 ohms and apply about 0.4 v. bias to prevent the valve running to grid current when no signal is applied. Capacitors C11, C16 and C20 are .001μF mica dielectric type.

The first I.F. transformer T1 is an overcoupled circuit using mutual capacitance coupling and giving the familiar double hump characteristic. Inductors L5 and L6 have an inductance value of about 13.25 μH which is adjustable by means of a dust core. Capacitors C7 and C8 are 100 pF, mica or ceramic dielectric capacitors. Capacitor C9 is a 1,500 pF variable trimmer and can be used to adjust the pass band to its correct width.

When aligning the circuit, by means of a signal generator, a peak at 4.4 Mc/s should be obtained by

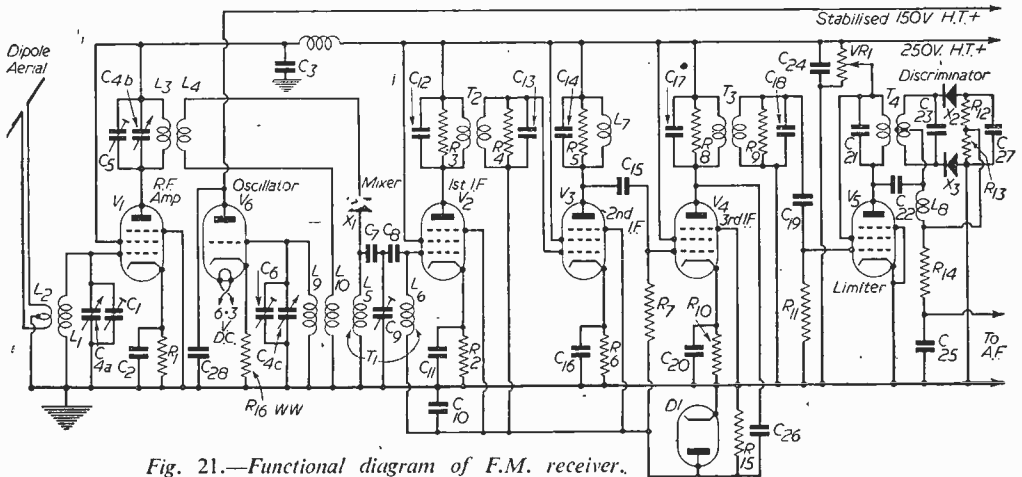

Fig. 21.—Functional diagram of F.M. receiver.

the adjustment of L5 and L6, then the second peak at 4.6 Mc/s should be tuned by means of capacitor C9. These adjustments are somewhat interdependent and, if a large movement is necessary, should be repeated until the correct bandwidth is obtained.

Tuned transformers T2 and T3 are critically coupled to provide a bandwidth of ± 100 kc/s at 6 db below the resonance level. The inductance of the windings should be $26.5 \mu\text{H}$ with a tuning capacitance of 50 pF . If the spacing between the windings is adjusted to give a mutual inductance of $1.1 \mu\text{H}$, the Q of the circuits must be reduced to approximately 22.5 in order to give the correct response characteristic. Assuming an initial Q of about ± 100 for the undamped circuits, resistors R3, R4, R8 and R9 should have a value of $20 \text{ k}\Omega$.

The anode load of valve V3 consists of a single tuned circuit resonating at 4.5 Mc/s and having a bandwidth of ± 100 kc/s at 6 db below the resonance level. The component values are the same as for the critically coupled stages. Inductor L7 is $26.5 \mu\text{H}$, capacitor C14 is 50 pF and resistor R5 is $20 \text{ k}\Omega$.

The coupling to the grid of the succeeding valve is effected by means of a capacitor C15; having a value of $.001 \mu\text{F}$, and resistor R7, the value of which is $10 \text{ k}\Omega$.

The windings of transformers T2 and T3 and inductor L7 consist of 490 turns of 36 s.w.g. enamelled copper wire close wound on a former of 0.5in. diameter. The inductance is adjusted to resonance by means of an iron-dust core. In the case of the transformers, the two windings should be on the same former with a spacing between them of 0.8in.

The windings of L6 and L7 are similar and each consists of 320 turns of 36 s.w.g. enamelled copper wire close wound on a 0.5in. diameter former. Tuning is again accomplished by means of an adjustable iron-dust core.

In order to avoid self oscillation of the I.F. amplifier great care must be taken to screen all those components mounted above the chassis and to make sure that all the earthing connections for each stage are returned to the same point on the chassis. Feed-back due to direct radiation below the chassis can be considerably reduced by building the I.F. strip on to a separate narrow chassis of channel section, which bolts on to the upper surface of the main chassis. This narrow chassis then becomes effectively a wave guide, having an attenuation to radiated waves of low radio frequencies of approximately 6.5 db per-unit-width along its longitudinal dimension.

The Limiter Stage

The amplitude limiter V5 is a type KTW63 pentode valve. Limiting of the negative peak is brought about due to the self-bias action of capacitor C19 and

resistor R11, their values being 100 pF and $0.1 \text{ M}\Omega$ respectively. The $50 \text{ k}\Omega$ potentiometer PTR.1 is adjusted to provide an anode and screen voltage of 45 v. which produces anode-bend limiting of the positive peaks.

The anode load comprises the primary circuit of tuned transformer T4, which is really part of the discriminator circuit.

The Discriminator

The phase discriminator shown in Fig. 21 differs from those described in previous articles in this

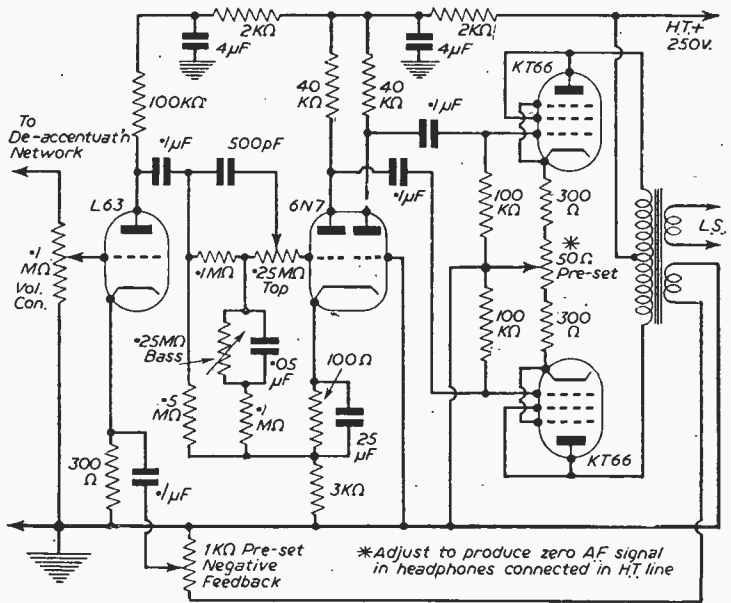

Fig. 22.—Circuit diagram of suitable A.F. amplifier.

series only in that germanium crystals X2 and X3 are used instead of diode detectors.

The primary circuit of transformer T4 is a $13.25 \mu\text{H}$ inductor having a Q value of about 100, tuned by capacitor C21 which has a value of 100 pF . Permeability tuning is used and the winding is similar to that described for inductors L6 and L7. The secondary winding of $26.5 \mu\text{H}$ is mounted on the same former, spaced from the primary by 0.8in. It consists of 490 turns of 36 s.w.g. enamelled copper wire close wound and centre tapped at 245 turns and permeability tuned. The tuning capacitor C23 is a 50 pF ceramic disc type.

The R.F. choke L8 is layer wound of 36 s.w.g. double-silk-covered copper wire to an inductance of 0.5 mH .

Two $0.1 \text{ M}\Omega$ resistors, R12 and R13, form the loads for the crystal "diodes," their centre point being connected to the 100 micro-second de-accentuation network, comprising resistor R14 and capacitor C25, and thence to the audio amplifier.

The A.F. Amplifier

This may be of any high-fidelity design. The circuit in Fig. 22 shows a suitable amplifier which will be described next month.

(To be continued)

The "Quality" Problem

HINTS ON IMPROVING LOUDSPEAKER PERFORMANCE

By W. J. Delaney (G2FMY)

THE recent correspondence on the "quality" problem has shown that there is a definite and strong desire on the part of the majority of readers to obtain better quality than that normally associated with standard broadcast apparatus. Coupled with this is the fact that there are two or three loudspeakers on the market which cost nearly £100 or more, and there is a market for these. Unfortunately, however, the larger part of our readers cannot afford such a large sum of money, although they would like something different from the ordinary run of loudspeaker. What can be done, therefore, to improve the usual reproduction in cases where really good quality amplifiers have been built or purchased? The specification of some of the good amplifiers will show that in most cases the range of frequencies covered is up to 10,000 or more c.p.s., and the lower ranges are usually catered for by cabinet design. It is, of course, rather too much to expect a single ordinary type of speaker to go up to this high range and, as the correspondence already referred to has shown, most readers are now aware of the fact that the upper range is probably more important than the bass—either because of the "quality" it gives to individual instruments, or to overcome defects in the general amplifier design. It will be admitted that in the past too much attention has been paid to the bass, the assumption being that the "top" could take care of itself, or that the amplifier did not deal with very high frequencies and therefore there was nothing to reproduce.

diaphragm to aid in getting better top. There is no doubt, however, that to do the same justice to both ends of the scale the ideal plan is a dual reproducing system, one reproducer being chosen to handle all the lower frequencies, and the other to handle the upper part of the scale. At once the question of expense crops up as this means two separate loudspeakers. This is not the only additional cost, however, as maximum performance would only be obtained if some means were provided to ensure that each speaker dealt only with the limited frequency range for which it was intended. This calls for a filter network, which can also be quite expensive. How then can the average amateur cope with this problem at reasonable cost?

Choice of Speaker

There are two or three ideas which recommend themselves and which are not expensive compared with the ideal. Firstly, it will be assumed that a good speaker is already in use and this will obviously have been chosen to give good low-note reproduction. We are therefore only concerned with improving top and thus a top-note speaker has to be obtained. Special small horn units are available, but again these are expensive. Small 3 1/2 in. P.M. units are, however, reasonably cheap and can be adapted for our purpose. They will not, of course, handle the 10 watts or so which may be expected from the usual quality amplifier, and therefore in use they have to be protected in some way. If the two speakers are

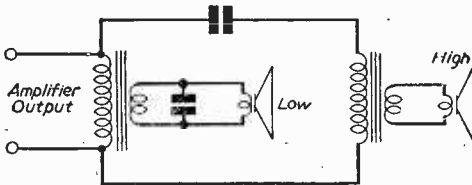

Fig. 1.—Two speakers may be wired in this manner to cover both ends of the scale.

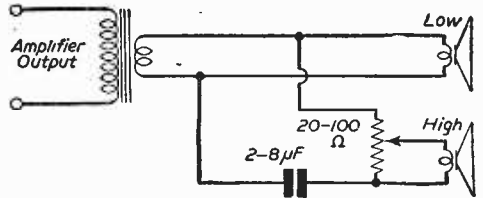

Fig. 2.—A simple cross-over scheme to avoid overloading the small "top" speaker.

Single Cones

A glance at one or two catalogues will show that the ordinary type of speaker is quoted as having a range of from about 60 to 10,000 cycles, but amplifiers such as the Williamson, for instance, are indicated as going up to 20,000 c.p.s. A single cone, say of 10 or 12 inches, chosen for good low-note response cannot be expected to deal with anything above 10,000 c.p.s. unless specially designed, and various special diaphragms have been introduced to try to cover these higher ranges. Duplex diaphragms, specially "tapered" cones and specially designed speech coil assemblies, all play their part in giving better high-note response, and there are one or two speakers (the Axiom, for instance) in which a special additional cone is attached to the normal

connected in parallel (making due allowance for correct matching to the amplifier output), the simplest way of protecting the small speaker is to connect a 1 or 2 μ F condenser in series with it. This will cut down the L.F. being fed to it and act as a form of frequency filter. It may be desired to retain the matching transformer on it and the arrangement is as shown in Fig. 1. Here, also, a condenser is shown shunted across the low-note speaker to act in a similar manner. A few experiments will show the best values for both condensers to suit the characteristics of both amplifier and loudspeakers. An alternative idea is shown in Fig. 2., where the small speaker is fed through a low-value variable resistance, which acts both as a filter and a

volume control, to provide a suitable balance.

The cone of the small loudspeaker may be treated, if desired, to improve its "hardness." The simplest plan is to paint it on both sides at once with thin shellac. The cone may be distorted if only one side is treated. If you can centre it accurately, you can try making a new cone of thin hard paper, such as two-sheet Bristol Board. Whatever arrangement is used, the two speakers should finally be mounted as close together as possible, and when connected up must be in phase. That is, both cones must move forward at the same time, or they will tend to cancel out. Fortunately, it can generally be heard when they are the correct way round as the output seems louder when they are correct. If cabinet room permits, it might be worth while to construct a short wide-mouthed metal horn to attach in front of the small speaker and mount this towards the top of the cabinet, as it should be borne in mind that the top notes are not radiated in the same manner as low notes but are directed straight out, so that you must be right in front of the speaker to hear them correctly. A wide-mouthed horn will tend to spread the "beam" and cover a wider area.

Filter

If a really satisfactory small top-note speaker is

obtained it might be thought worth while to construct a proper frequency filter to feed both speakers, and in that case the arrangement is as shown in Fig. 3. Again, however, values are critical and depend not

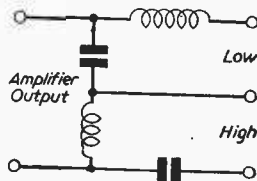

Fig. 3.—A simple cross-over network for dual speakers.

only upon the characteristics of the amplifier and loudspeakers, but also on the frequency at which it is desired to operate each speaker. The function of the filter is to feed all frequencies up to a certain value to the low-note speaker and all above that to the other one, and the cross-over frequency, as it is called, may be from 1,000 cycles upwards. Suitable chokes may be obtained from firms who specialise in quality equipment, such as Webb's Radio. As a matter of interest the arrangement shown in Fig. 2 has a cross-over frequency at approximately 2,000 cycles.

News from the Clubs

THE HOUNSLOW AND DISTRICT RADIO SOCIETY

Secretary : J. Clarke, 124, Springwell Road, Heston, Middlesex.

A TOP band portable QRP. Tx., mainly for use on field days, is under construction. The practical problems encountered have given valuable instruction to those members who have not yet built their own Tx.

The club has once again obtained the use of Grove Road School, Hounslow, Middlesex, for meetings on alternate Thursday evenings, the next being on February 21st, at 7.30 p.m.

SOUTH MANCHESTER RADIO CLUB

Hon. Sec. : F. H. Hudson, 21, Ashbourne Road, Stretford, Manchester.

THE club recently acquired more suitable premises situated at Ladybarn House, Mauldeth Road, Manchester, 14. These new premises fill a long-standing need and mark an important milestone in the club's history, in the main the club having now a separate room for station operation, G3FVA, and greater facilities for all activities. Meetings are held alternate Friday evenings as usual, and a comprehensive programme has been arranged for the present season. February 1st—members' problems answered. February 15th—TV and TV.I. Other interesting items will be announced later.

SLADE RADIO SOCIETY

Hon. Sec. : C. N. Smart, 110, Woolmore Road, Erdington, Birmingham, 23.

A SOCIAL evening of fun and games held during the Xmas season was highly successful, and members and visitors had an enjoyable time. This meeting was followed by a brains trust on January 4th, a team of members answering questions on a wide variety of radio topics.

Lectures arranged for the future include, "The Generation of Electrical Power," on February 15th, and "Selected Topics from Nuclear Physics," on February 29th.

Meetings are held at the Parochial Hall, Broomfield Road, Erdington, Birmingham, on alternate Fridays, commencing at 7.45 p.m.

WORCESTER AND DISTRICT AMATEUR RADIO CLUB

Hon. Sec. : J. Morris Casey, 4, Kennels Road, Station Road, Fernhill Heath, Worcestershire.

AFTER a "rest" for 12 months, G8JC is again hon. secretary of the club and forthwith meetings will be held each Thursday at 7 p.m., at the City Library and Museum (basement), when old and new members will be given a warm welcome. An open meeting is being arranged in the near future and readers are asked to watch for shop window posters announcing the date.

Those interested in ham radio—young and old, male and female, are cordially invited to the club meetings, or write the secretary for particulars.

BIRMINGHAM AND DISTRICT SHORT-WAVE SOCIETY

Hon. Sec. : A. O. Frearson, 66, Wheelwright Road, Erdington, Birmingham, 24.

THE society meets on the second Monday of each month, at the Colmore Inn, Church Street, Birmingham, at 7.45 p.m. Future programmes are as follows :

February 11th. A talk, by Mr. R. Yates, "An Introduction to VHF and Microwaves."

March 10th. A joint talk, by Messrs. Burton and Frearson, "Short-wave Listening and Keeping a Log."

A technical class is held on the fourth Monday in each month on the same premises. This has proved very popular and is of great help to those members who are hoping to obtain their tickets.

New members will always be welcome at any of the meetings.

THE KINGSTON AND DISTRICT AMATEUR RADIO

Hon. Sec. : C. S. Babbs, B.Sc., G3GVU, 28, Grove Lane, Kingston-upon-Thames, Kingston.

THE New Year opened on January 2nd with a very successful junk sale, at which 44 members were present.

Classes in radio theory with practical demonstrations have been arranged and commenced on Friday, January 11th. These are continuing fortnightly. Morse classes are also being held.

For the usual Wednesday meetings the programme includes film strips, talks on power supplies, television, aerials, etc.; G6CL is lecturing on "The History of Amateur Radio," on February 27th.

New members continue to be attracted to the society and visitors are always welcome at our headquarters, Penrhyn House, 5, Penrhyn Road, Kingston.

TORBAY AMATEUR RADIO SOCIETY

Hon. Sec. : W. A. Launder, B.Sc. (Eng.), G3FHI, 15, Cambridge Road, St. Marychurch, Torquay.

MEMBERS of the Dartmouth Amateur Radio Club attended to hear Mr. Cawley, G2GM, give an interesting talk on the "Basics of a 3-stage Transmitter."

The president of the T.A.R.S., G5SY, was welcomed back after his recent long indisposition.

R. J. Whinall, hon. technical adviser to the Torquay Gramophone Society, will speak in February on "Links in the High-quality Chain."

The society meets every third Saturday in the month at the Y.M.C.A., Castle Road, Torquay, at 7.30 p.m.

Visitors interested are welcome to attend.

PREMIER RADIO CO.

(REGD.) B. H. MORRIS & CO. (RADIO) LTD. ESTAB. 40 YEARS

STAND No. 210

WE CORDIALLY INVITE YOU TO VISIT OUR STAND AT THE 'DAILY IDEAL HOME EXHIBITION' CHILDREN'S SECTION (Ground Floor) EMPIRE HALL MARCH 4th - 29th

(Dept. P.W.) 207 · EDGWARE ROAD · LONDON · W.2
 Open till 6 p.m. Saturdays. Phones: AMB. 4033 & PAD. 327112
 TERMS OF BUSINESS: CASH WITH ORDER OR C.O.D. OVER £1. Please add 1/- for Postal Orders under 10.-, 1/6 under 40.- unless otherwise stated.

BALANCED ARMATURE LOW RESISTANCE HEADPHONES, Type 1, 5/11 pair.
BALANCED ARMATURE LOW RESISTANCE HEADPHONES, Type 2, 7/11 pair.
HIGH RESISTANCE HEADPHONES, 12/6 pair.
LIGHTWEIGHT HIGH RESISTANCE HEADPHONES, 14/6 pair.
MOVING REED HEADPHONES, Type 3, 8/11 set.
CARBON HAND MICROPHONE, super quality, with switch in handle. Type 3A, 3/11.
BRAND NEW R1155 RECEIVERS, in original cases, complete with 10 valves. £12/10/-, 7/6 Packing and carriage.
BRAND NEW R1355 RECEIVERS, in original cases, as specified for the "Inexpensive Television," complete with 11 valves, £22/15/-, 7/6 Packing and carriage.
TUNING CONDENSERS, 4-Gang, .0005 mfd. Ceramic insulation, in. spindle, 5/-, 3-Gang, .0005 mfd., in. spindle, 7/6.
GERMANIUM CRYSTAL DIODES, wire ends, midret size. The Ideal Crystal Detector, G.E.C. or B.T.H. 4/6 each.
THREE-PIECE AERIAL
 Ex U.S.A. copper-plated steel, highly flexible with non-stick screw joints, tapering in. to in. Brand new, in container, 6/9, packing and carriage, 1/6. Insulated Base, 2/6.

BUILD A PROFESSIONAL LOOKING RADIO AT LESS THAN HALF TO-DAY'S PRICE

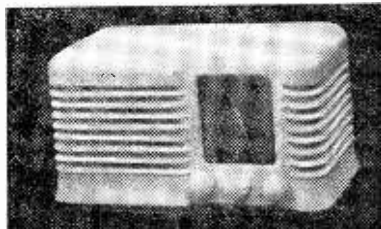

We can supply all the parts to help you.
Bakelite Cabinet (Brown or Ivory), 17/6. Packing and insurance, 2/6.
Punched Chassis, 3 valve plus rectifier T.R.F., 3/9
Engraved Glass Dial, 180-550 and 800-2,200 m., 1/6 with station names, new wavebands.
T.R.F. COILS 180-550, 800-2,200 metres, pair 6/6
Drum (2in. diam.) 1/6
Driving Head 4d
Double Pointer 3d.
Spring 6d.
Nylon Cord (yard) 2/6
Dial Front Plate 2/6

SEND 1/6 FOR EASY-TO-FOLLOW POINT-TO-POINT DIAGRAMS AND CIRCUIT DIAGRAM, which show you how YOU can build the Receiver illustrated at HALF TO-DAY'S PRICE.
THE COMPLETE KIT to construct a 3-valve plus rectifier TRF Receiver for use on 200/250 v. A.C. mains can be supplied at £6. 9s. 6d., plus 2/6 packing and carriage.
 Each Kit is complete in every detail, nothing has to be made or improvised. Easy-to-follow, point-to-point diagrams are supplied, making construction very simple. The Dial is illuminated and the Receiver, housed in a Bakelite Cabinet size 12in. x 5in. x 5in., presents an attractive appearance. The valve line-up is 71A - H.F. Pentode, VR116 - Detector, ATP4 - Output, and Metal Rectifier.
 Waveband coverage is for the medium and long bands. Choice of Walnut or Ivory coloured Cabinet.
I.F. U.S.A. U.H.F. AERIAL with Untuned Detector Stage consisting of VR92 Valve. Brand new 5/-.
CRYSTAL MICROPHONE
 An entirely insulated crystal microphone which can be safely used on A.C./D.C. amplifiers. High impedance. No background noise, really natural tone. The Ideal Mike for tape, wire and disc recording and sound projectors. Price 22/6.

IMPORTANT ANNOUNCEMENT: We cannot accept responsibility for, or guarantee any kit or component sold as a Premier product by firms other than ourselves. All prices quoted are those ruling at the time of submitting advertisement copy, and are subject to alteration without notice.

PRATTS RADIO

1070 Harrow Road, London, N.W.10
 Tel. : LADbroke 1734.

(Nr. Scrubbs Lane)

AMPLIFIERS READY TO USE



MODEL AC10E (as illustrated), 20 watt, 4 valve unit, neg. feedback, separate mike stage and separate mike and gram inputs, 2 faders and tone-control, input volts, mike .002 gram 21v., £9-18-6.

MODEL AC18E, 6-valve unit with p/ull output of 10 watts and separate mike and gram inputs, 2 faders and tone-control, feedback over 3 stages. Input volts, mike .002 gram 3v., £14-14-0.
MODEL AC10E, D.C./A.C. mains, p/ull output of 10 watts. Spec. as AC18E. £12-12-0. All above are complete with cases and chrome handles. Outputs match 3, 8, 15 ohm speakers.

MODEL AC8C, 5-valve chassis with p/ull output of 10 watts. For record or radio reproduction. Output to 3, 8, 15 ohms. H.T. and L.T. supply for feeder. £9-18-6.

MODEL AC4C (A.C.) or MODEL U4C (D.C./A.C.) 3 valve 4 watt amplifier chassis for records, etc. Output to 3 ohms. £5-9-6. All units are carriage paid. As supplied to hundreds of domestic and industrial users since 1945. Stamp for fuller details.

For use with the above amplifiers. Sold separately if desired, Rothermel D104 Crystal Microphone. £5-5-0. Acos 22-1, 22-2, £6-6-0. Collaro Record Players (A.C. only) with motor, turntable pick-up and auto-stop. Magnetic. £6-9-6; Crystal. £5-15-6.

SPEAKERS, Rola 10in., 35/-; 8in., 30/-; Gramplan 12in., £7. Goodmans 12in., £8-12-6. Microphone cable, 1/6 yd. Stylus needles, play 8,000 records, 6/6. Jack plugs, 1/9 each.

COILS, Denco L.M. wave, T.R.F. with reaction, 6/6; Wearite "P" coils, 3/- each; Weymouth "H" 3/6 each; Weymouth I.F.S., 15/- pair; Wearite standard, 10/- each; Miniature, 10/6 each.

TRANSFORMERS, ETC., 2 x 350v., 0-4-5v., 2a., 0-4-5v., 4a., 19/6; ditto, 2 x 250v., 15/6. Speaker Transformers, 6V to 3 ohms, 4/3; 6V to 3, 8, 15 ohms, 19/6. 154/354 Miniature type, 5/3.

CHOKES, 60 m.a., 15 hy., 300 ohms, 5/3; 100 m.a., 20 hy., 400 ohms, 16/6; 150 m.a., 10 hy., 200 ohms, 16/6; 90 m.a., 10 hy., 180 ohms, 13/6.

VAR. CONDENSERS, Solid dielectric, .0003 or .0005, 4/- each; **FIXED CONDENSERS** (only 1951 stock offered), 8-4, 4/9; 9-18, 7/3; 21 500v. 50 mfd. 5v., 2/3; 25 mfd. 25v., 2/3. .0001, .0002, .0003, 8d.; .0005, .001, .002, .005, 9d.; .01, .05, 1 mfd., 10/4d.
MISCELLANEOUS, 6K7, 6J7, 6J5, all 7/6; 155, 154, 354, 174, 175, all 9/6 each; 3a., droppers, 800 ohms, 4/6; 2a., 1,000 ohms, 4/6. BTG bases, 9d. Linecord, 3a. 80 ohms, 1/-, 7d. ft.
 All goods new. Post paid over £1. C.W.C. or C.O.D.

GRAM MOTORS & PICK-UPS

for MICRO-GROOVE & STANDARD RECORDS



"X-ray" view of MU-10

B.S.R. MU-10 motor for 33 & 78 r.p.m. Speed change by reversing drive pulley. 10in. turntable 100-250v. £3.15s.



MU-14 de luxe model with ROTACAM instant speed change for 33 45 & 78 r.p.m. £6. 10s.

GU-4A Three-speed RADIOGRAM UNIT

Now available for the home market, this new combined unit uses the popular MU-14 motor on unit plate with pickup and AUTO-STOP.

The pickup of the Acos dual purpose type fitted with a sapphire lens. Beautifully finished in mottle enamel. £10.



All post free! in U.K.!

Full list including Auto changers on request!

Frith **RADIOCRAFT** LTD. 69-71 CHURCH GATE-LEICESTER

RADIO SUPPLY CO.

15, WELLINGTON ST., LEEDS, 1.

Post Terms C.W.O. or C.O.D. No C.O.D. under £1. Postage 1/3 charged on orders under £3. Open to callers 9 a.m. to 5.30 p.m. Saturdays until 1 p.m.

R.S.C. MAINS TRANSFORMERS

Fully Guaranteed, Interleaved, and Impregnated. Primaries 200-230-250v

50 c/s Screened.

260-0-260 v 70 ma., 6.3 v 2 a., 5 v 2 a.	13/9
260-0-260 v 80 ma., 6.3 v 3 a., 5 v 2 a.	14/11
350-0-350 v 80 ma., 6.3 v 2 a., 5 v 2 a.	15/11
350-0-250 v 80 ma., 6.3 v 3 a., 5 v 2 a.	19/9
350-0-350 v 90 ma., 6.3 v 3 a., 5 v 2 a.	19/9
250-0-250 v 100 ma., 6.3 v 4 a., 5 v 3 a.	21/9
250-0-250 v 100 ma., 6.3 v 6 a., 5 v 3 a.	21/9
for R1355 conversion	25/9
350-0-350 v 100 ma., 6.3 v 4 v 4 a. C.T. 0-4-5 v 3 a.	21/11
350-0-350 v 120 ma., 6.3 v 4 a., 5 v 3 a.	25/9
350-0-350 v 150 ma., 6.3 v 4 a., 5 v 3 a.	27/11

CLAMPED UPRIGHT MOUNTING

250-0-250 v 100 ma., 6.3 v 4 v 4 a. C.T. 0-4-5 v 3 a.	21/11
250-0-250 v 100 ma., 6.3 v 6 a., 5 v 3 a.	25/9
for 1355 conversion	25/9
300-0-300 v 100 ma., 6.3 v 4 v 4 a. C.T. 0-4-5 v 3 a.	21/11
350-0-350 v 100 ma., 6.3 v 3 a., 5 v 3 a.	21/6
350-0-350 v 150 ma., 6.3 v 4 a., 5 v 3 a.	27/9

FULLY SHROUDED UPRIGHT

250-0-250 v 60 ma., 6.3 v 2 a., 5 v 2 a. Midget type 21-3-3in.	16/9
250-0-250 v 70 ma., 6.3 v 2 a., 5 v 2 a.	18/9
350-0-350 v 100 ma., 6.3 v 4 v 4 a. C.T. 0-4-5 v 3 a.	24/9
350-0-350 v 150 ma., 6.3 v 4 a., 5 v 3 a.	31/-
350-0-350 v 250 ma., 6.3 v 6 a., 4 v 3 a.	31/-
0-4 v 2 a., 4 v 3 a. for Electronic Eng. Television.	65/-
425-0-425 v 200 ma., 6.3 v 4 v 4 a. C.T. 6.3 v 4 v 4 a. C.T. 0-4-5 v 3 a. suitable Williamson Amplifier	48/9
325-0-325 v 20 ma., 6.3 v 0.5 a., 6.3 v 1.5 a. for Williamson Preamp.	17/6

FILAMENT TRANSFORMERS

All with 200-250 v 50 c/s primaries	6.3 v 2 a., 7/6; 0-4-6.3 v 2 a., 7/9; 12 v 1 a., 7/11; 6.3 v 3 a., 10/11; 6.3 v 6 a., 18/9; 0-2-4-5-6.3 v 4 a., 16/9; 12 v 3 a., or 24 v 1.5 a., 16/9
-------------------------------------	---

CHARGER TRANSFORMERS

All with 200-230-250 v 50 c/s Primaries	0-9-15 v 1.5 a., 12/9; 0-9-15 v 3 a., 15/9; 0-9-15 v 6 a., 21/9; 0-4-9-15-24 v 3 a., 21/9; 0-9-15-30 v 3 a., 22/9
---	---

SMOOTHING CHOKES

200 ma. 5 h. 100 ohms	7/6
100 ma. 10 h. 100 ohms	7/6
80 ma. 10 h. 100 ohms	5/9
80 ma. 10 h. 350 ohms	5/6
50 ma. 50 h. 1,500 ohms (suitable Williamson Preamp.)	8/6

AUTO TRANSFORMERS

100 watts 110-200-230-250 v	19/9
-----------------------------	------

ELIMINATOR TRANSFORMERS

Primaries 200-250 v 50 c/s. 120 v 40 ma.	7/11
120-0-120 v 30 ma., 4 v i a.	12/9

OUTPUT TRANSFORMERS

Midget Battery, Pentode 66:1 for 3S4, etc.	3/6
Small Pentode, 5,000 ohms to 3 ohms	3/9
Standard Pentode 8,000 ohms to 3 ohms	4/9
Multi ratio 40 ma., 30:1, 45:1, 60:1, 90:1 Class B Push-Pull	5/3
Push-Pull 8 watts 6V6 to 3 ohms	8/9
Push-Pull 10-12 watts 6V6 to 3 or 15 ohms	15/11
Push-Pull 10-12 watt to match 6L6, PX4, 6V6, etc., to 3-5-8 or 15 ohms	15/11
Push-Pull 15-18 watts to match 6L6, etc., to 3 or 15 ohm Speaker	21/9

NEW EX-GOVT. VALVES, DL 1/3:

HL210, 1/11; EA50, 954, 956, VU120A, 2/9;	5G215, 3/9; 12H6 Met. 1/11; 9D2, 2/11;
M32PB, 4/6; KT2, 4/9; 12SK7 Met. 6/5G7;	12SH7 Met. 5/9; 6S67 Met. 6S57 Met.
6C5 Met. 12C8 Met. 12SK7 Met. 12SQ7 Met.	12SR7 Met. 6/9; 6K7G, 6J7 Met. 6J7G.

KTZ63, 6K7 Met. 12A6 Met. 7/6; EP39, 6K6G7, 8/9; 5U4G, 6X5GT, VP4B, PEN46, SP4B, MHLDe, 9/6; 5Y3G, KT66, EB91, 10/6; 6Q7G, 10/11; 6K3G, 11/9; 6A8G, 12/9.

SPECIAL OFFERS. Mains Trans. 200-230 v Primaries, 6.3 v 1.5 a. small 5/9

P.M. SPEAKERS. All 2-3 ohms. 5in. F.W., 11/9; 5in. Rola with Trans., 15/9; 6in. F.W., 14/11; 8in. Plessey, 14/11; 8in. Rola, 17/9; 10in. F.W., 25/9.

M.E. SPEAKERS R.A. (2-3 ohms) Field 600 ohms, 12/9.

RECEIVER CHASSIS, Undrilled, 16s.w.g., aluminium 10-5i-2in., 3/6; 11-6-2in., 3/11; 12-8-2in., 4/11; 16-8-2in., 6/9; 20-8-2in., 7/11.

AMPLIFIER CHASSIS, Undrilled, 16 s.w.g. aluminium, 12-8-2in., 7/11; 16-8-2in., 10/11; 20-8-2in., 13/6.

SELENIUM RECTIFIERS. Ex New Equipment. 230 v 50 ma. (small), 4/9; 120-0-120 v 60 ma., 4/6; 250-500 v 60 ma., 6/9; 500 v 30 ma., 6/9; New 12-15 v 1.5 a. F.W., 7/6.

MISC. ITEMS. Ex-Govt. chokes 100 ma., 10 h., 100 ohms. Tropicalised, 3/11; Vol. Controls, 200 k. long spindle, 1/3 ea., 12/6 doz.; Ex-Govt. R1124 Units, 1.75 valves, 10/9.

ELECTROLYTICS, Tubular 8 mfd. 350 v, 1/11; 8 mfd. 450 v., 2/3; Can 16 mfd. 450 v., 2/11; 3-16 mfd. 450 v., 4/6; 12-12 mfd. 350v., 3/3; 16-16 mfd. 450 v., 5/3; 32 mfd. 350 v., 4/3; 32 mfd. 450 v., 5/9; 32-32 mfd. 350 v., 6/6; 32-32 mfd. 450 v., 7/6.

FULL RANGE OF STANDARD COMPONENTS AVAILABLE AT KEEN PRICES. ALL GOODS GUARANTEED AND NEW, UNLESS OTHERWISE STATED. QUANTITY QUOTATIONS GIVEN FOR STANDARD TYPES OR SPECIALS. S.A.E. PLEASE WITH ALL ENQUIRIES. FULL STOCK LIST 4d. SPECIAL LIST FOR TRADE, 4d.

FREE TO AMBITIOUS ENGINEERS!

This 144-page Book

Have you sent for your copy?

'ENGINEERING OPPORTUNITIES'

is a highly informative guide to the best-paid Engineering posts. It tells you how you can quickly prepare at home on "NO PASS-NO FEE" terms for a recognised engineering qualification, outlines the widest range of modern Home-Study Courses in all branches of Engineering and explains the benefits of our Employment Dept. If you're earning less than £14 a week you cannot afford to miss reading this unique book. Send for your copy to-day—FREE.

--- FREE COUPON ---

Please send me your FREE 144-page "ENGINEERING OPPORTUNITIES"

NAME
ADDRESS

Subject or Exam, that interests me
British Institute of Engineering Technology
409B, Shakespeare House,
17119, Stratford Place, London, W.1

WHICH IS YOUR PET SUBJECT?

Mechanical Eng.
Electrical Eng.
Civil Engineering
Radio Engineering
Automobile Eng.
Aeronautical Eng.
Production Eng.
Building, Plastics,
Draughtsmanship
Television, etc.

GET SOME LETTERS AFTER YOUR

NAME!
A.M.Mech.E.
A.M.I.C.E.
A.M.I.P.E.
A.M.I.M.I.
L.I.O.B.
A.F.R.Ae.S.
B.Sc.
A.M.Brit.I.R.E.
CITY & GUILDS
GEN. CERT.
OF EDUCATION
etc., etc.

"ADCOLA" SOLDERING INSTRUMENTS

Regd. Trade Mark



Regd. Design No. 800902

(British, U.S. and Foreign Patents)

For Wireless and Television Assembly

The advanced design of the Adcola Instruments meets the modern requirements of Television, Telecommunication and

Radar Engineers

SUPPLIED FOR ALL VOLT RANGES FROM 617v. to 230/250v.

3/16in. dia. Bit. Standard Model	22/6
1/2in. dia. Bit. Standard Model	25/-
3/16in. dia. Detachable Bit. Model	30/-

Sole Manufacturers:

ADCOLA PRODUCTS LIMITED

GENERAL OFFICES & WORKS: CRANMER COURT, CLAPHAM HIGH STREET, LONDON, S.W.4. (MACaulay 4272)

TAMSA

TAPE AND WIRE RECORDING.

Write for the latest price list of the following:
RECORD, PLAYBACK & ERASE HEADS
TAMSA TAPE RECORDING PANELS
RECORD PLAYBACK AMPLIFIERS
OSCILLATOR COILS & UNITS

TAPE: E.M.I.	WIRE: On standard
G.E.C.	1/2, 3/4, and 1 hr
"SCOTCH BOY"	Spools.
5", 7", 11", Spools.	

Constructor's Envelopes. Books on Tape Recording.

Manufactured by

AUDIGRAPH LTD.

Dept. MR.6, 74, Great Hampton Street, HOCKLEY, BIRMINGHAM, 18.

BIET

A Multi-range Ohmmeter

MAKING A TEST INSTRUMENT WITH A HIGH ACCURACY FACTOR

By K. C. Foster

FEW experimenters have not, at some time, either made or purchased an ohmmeter of some sort, and the commonest type has a single range capable of measuring up to about 100,000Ω. The circuit normally consists of a test cell or battery in series with a milliammeter and potentiometer as in Fig. 1.

If the milliammeter has a full-scale deflection of 1 mA, and a total resistance of 100Ω, the potentiometer must be adjusted to a value of 1,400Ω in order to give a full-scale deflection with a battery of 1.5 volts when the test leads are short-circuited, i.e., when the resistance to be tested is zero ohms. If a resistor of 1,500Ω is connected in the test leads the meter will indicate half the full-scale reading. If the battery voltage falls to 1.2 volts, however, the potentiometer must be re-adjusted to a value of 1,100Ω in order to gain a full-scale deflection

more accommodating and we can arrange for R1 to be either a 500Ω potentiometer or a 350Ω potentiometer in series with a 150 Ω fixed resistor.

Circuit Arrangement

The total resistance of the ohmmeter will be approximately 1,000Ω, and can be made up to 1,000Ω by slightly increasing the value of R2. If a standard 1.5 volt cell is used, the value of R2 should be calculated to give a total resistance of 1,000Ω at 1.5 volt, since it will be at this value that most of the readings will be taken, and inaccuracies due to ageing of the cell will be reduced to a minimum. A value of 930Ω will be about right, the actual resistance required being 933.3Ω.

If we take 10 mA as being the minimum readable indication on the meter we shall be able to measure any resistance between 10Ω and 100,000Ω. In order to read higher values than 100,000Ω the voltage of the test battery must be increased, and if it is raised to 15 volts the scale readings will be increased tenfold, while 150 volts will give 100 times the scale reading, thus allowing 10 MΩ to be measured comfortably. It is, of course, necessary to increase the value of R2 accordingly and values of 10,000Ω and 100,000Ω respectively will be quite satisfactory.

Low Values

To read values of less than 10Ω we should require a battery of less than 1.5 volts for this circuit, which is not practicable, but we can get over the difficulty by applying a shunt resistance as in Fig. 3.

R1 remains as before, R2 is fixed at 930Ω and R3 is set to give the ohmmeter a total resistance equal to the required mid-scale reading. For range 4 this would be 100Ω and the value of R3 would be $\frac{1000 \times 100}{1000 - 100} = 111.1\Omega$. This will give a scale reading from 1Ω to 10,000Ω Range 5 reading from 1Ω to 1,000Ω would require R3 to be 10.1Ω and for range 6 .01Ω to 100Ω R3 becomes 1.001Ω.

On range 6, however, a total current of 1.5A is required and polarisation is troublesome if a

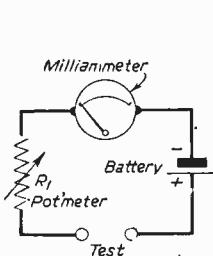

Fig. 1.—Normal test meter circuit.

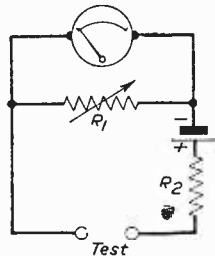

Fig. 2.—One method of reducing errors.

with the leads short-circuited, and in this case a 1,200Ω resistor joined in the test leads would give a half-scale deflection. In other words the meter becomes 25 per cent. inaccurate.

We can reduce this error considerably, however, by utilising the circuit shown in Fig. 2, where the zero adjusting potentiometer is connected in parallel with the meter.

R2 is a guarding resistance which prevents the meter being overloaded when R1 is at its maximum value. Using a 1.2 volt cell and neglecting the shunting effect of R1, the value of R2 would be $\frac{1.2 \times 1,000}{1} - 100 = 1,100\Omega$. The voltage of a fresh dry cell is approximately 1.6 volts, so that without the shunt a current of $\frac{1.6}{1,200} = .0013$ A would flow through the meter. As we only require a maximum of 1 mA through the meter the shunt resistance must be arranged to pass the other .3 mA and its value would then be $\frac{1}{.3} \times 100 = 300\Omega$. With a 1.2 volt cell, however, R1 would require to be of infinite resistance, which is not practicable. We can, however, arrange for the total current supplied by the cell to be 1.5 mA at 1.5 volts. This will give us the following values: R2=900Ω, R1 max.=500Ω, R1 min.=166Ω. These figures are much

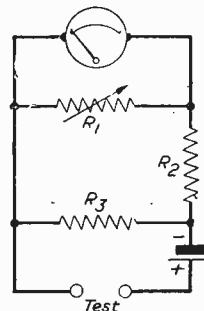

Fig. 3.—Further modification.

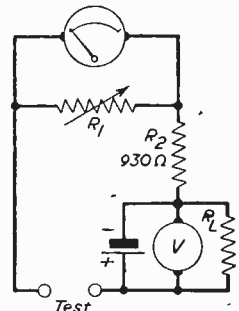

Fig. 5.—Circuit for adjusting shunts.

dry cell is used. The best way out of this difficulty is to use a Nife cell. This will give almost unlimited current at a steady voltage and is almost indestructible. A 6 ampere-hour cell is obtainable from ex-Army stores for a few shillings and makes an ideal test cell.

Fig. 4 shows the circuit of the complete multi-range ohmmeter, giving values required for use with a meter of 100Ω and 1 mA full-scale deflection when test voltages of 1.5 volts, 15 volts, and 150 volts are used.

The table gives the values of R2 which will be required when a Nife cell is used in conjunction with 15-volt and 150-volt dry batteries. The value of R1 should be increased to $1,000\Omega$ in order to allow the cell voltage to fall to 1.1 volts. There is no reason why a meter of different characteristics should not be used, but the resistor values must be modified accordingly.

Calibration

Calibration of the instrument can be carried out by connecting resistors of known value to the test leads (a graduated resistance box is of great value if available), or by the method described by D. Cave in the June 1951 issue.

The shunt resistors for ranges 4, 5 and 6 are a little tricky since they cannot be purchased ready made. The best way of making them is to wind the resistors to a value slightly above the required value and connect the meter as in Fig. 5. This circuit is the same as for range 3 but with the addition of a load resistance and voltmeter across the test cell. The load resistance RL should be of such a value that approximately 1.2 A flows from the cell. Potentiometer R1 is then adjusted to give a full-scale reading when the test leads are short-circuited and the voltmeter reading is noted. The shunt resistor for range 4 is then connected and adjusted until a milliammeter connected in the test leads indicates a current equal to the test cell voltage divided by 100. Without altering the potentiometer the shunt resistor for range

5 is next connected and adjusted until the current reading is 10 times that of range 4. Finally, disconnect the load resistor RL and connect and adjust the shunt resistor for range 6 until the current reading is equal to the test cell voltage. The purpose of the load resistance RL, of course, is to keep the test cell voltage as nearly constant as possible during the measurement of the shunt resistors, and it will save excessive drain on the cell if this resistor can be switched out of circuit when measurements are not actually being made.

Marconi Equipment for "Gothic"

SPECIAL radio equipment, to supplement the Shaw Savill liner *Gothic's* normal Marconi Marine installation, has been provided by The Marconi International Marine Communication Co., Ltd., and Marconi's Wireless Telegraph Co., Ltd., for the forthcoming Commonwealth tour of T.R.H. The Princess Elizabeth and The Duke of Edinburgh.

Requirements to be met on such an occasion are naturally far in excess of those of normal commercial voyages. Apart from State and naval radio traffic, heavy Press demands are anticipated, and facilities are also required for BBC use twice daily during the voyage. BBC "live" voice broadcasts may also be made direct from the *Gothic* from time to time, while extensive sound-reproducing and recording arrangements are also necessary.

The two Marconi companies have co-operated with the Admiralty to meet these requirements. Special high-power radiotelephones and high-speed radiotelegraph equipment have been installed by Marconi's Wireless Telegraph Co., Ltd. The SWB11X transmitter is the first of its kind to be fitted on board ship, and it is believed that this is the first occasion on which a transmitter of this power—7 kW.—has been installed in a merchant vessel. Three receivers are provided with this transmitter—one Type OC13 for transmission checking purposes, one Type CR150/3 as a traffic receiver, and a Type CR150/5 to provide cueing facilities at various BBC commentary points.

This complete installation provides for hand-speed or high-speed wireless telegraphy as well as ship-shore telephony, and facilities are available for the transmission and reception of "scrambled" speech if required.

Except for frequency changing the transmitter equipment will be operated by remote control from the forward wireless room, and can be modulated by the microphone at any one of the BBC commentary positions. Mr. A. J. G. Corbett, one of the Company's engineers, will sail with the vessel.

The *Gothic's* normal Marconi Marine radio equipment has also been supplemented for the Royal tour. Her "Oceanspan" main transmitter has been replaced by a "Worldspan," the most powerful in the range supplied by The Marconi International Marine Communication Co., Ltd., while one "Mercury" and two "Electra" receivers have been installed in addition to the "Yeoman" receiver already fitted. This communication equipment will handle Press and commercial traffic and also, if necessary, take any overflow of naval traffic.

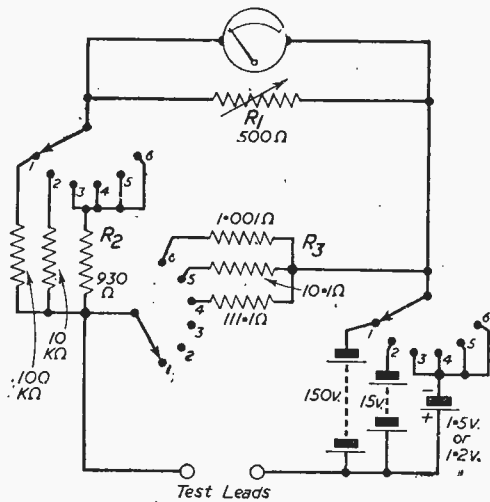

Range	1	2	3	4	5	6
Value of R2	100KΩ	10KΩ	917Ω	917Ω	917Ω	917Ω

Fig. 4.—Circuit of the complete ohmmeter.

OUR FREE GIFT BLUEPRINT

THE MINI-FOUR

FULL CONSTRUCTIONAL DETAILS OF OUR
NEW MIDGET PORTABLE

THE midget or personal type of receiver gains in popularity each week and there is now a big demand for this type of set. Where a television receiver is in use it often happens that one or more members of the family wish to hear a particular radio item, and during power cuts, or for late-night listening, this type of receiver fulfils a long-felt want. The usual arrangement is a superhet to give sufficient sensitivity, and to keep the size and weight down it is usually battery operated, utilising the all-dry type of valve. In some cases an aerial is desirable, either because of a poor locality or because of the distance away at which the transmitter is situated, but it is possible with a suitable receiver to have a choice of at least two stations without any external aerial. In order to keep down the overall weight combined L.T. and H.T. batteries are used, but it must be emphasised that these are not intended for long periods of listening.

In response to many demands we have designed a receiver which covers the above specification, and it is presented in this issue in full-size blueprint form. The accompanying illustrations show the receiver, that on page 107 being full size. From these it will be seen that the receiver is, in effect, a miniaturised version of any standard type of portable, the front panel carrying the loudspeaker and controls, and the main components, valves, etc., being mounted on a shelf. The combined battery fits at the back behind the loudspeaker and the whole drops into the carrying case which is available from J. Tallon & Sons of Rugby, price 13/6 (delivered).

The Circuit

As will be seen from the blueprint, the circuit is a four-valve combination incorporating the superhet principle. The circuit provides a frequency-changer, I.F. stage, diode rectifier, L.F. amplifier and pentode output. The valves are of the B7G midget type selected from the Mullard range, and the I.F. transformers are the latest midgets in the Wearite range, with both windings tuned. The heart of any receiver is the tuning circuit, and in this model we have chosen the new midget coil turret supplied by Stern Radio. This is a miniature rotary unit carrying aerial and oscillator coils and designed for pre-set tuning of four stations. Each coil is of the iron-cored type and the coils are mounted on a rotating plate which wipes over four contacts. Thus only four connections have to be made to the unit, and rotation of the control knob brings each coil into circuit successively. The inductances are so chosen that one can select three stations from the medium waveband and one from the long waves, and the actual stations chosen will, of course, depend upon the locality.

A measure of A.V.C. is incorporated in the circuit, and this is very effective, as will be found if a length of wire is attached to the aerial terminal on the coil unit. With a short length of wire, in the London area the local station can be tuned in, and any increase in the length of the wire, or gripping of the end of the wire, does not result in any noticeable increase in strength. I.F. filtering is simple but complete, and the circuit is quite stable when the I.F.s are properly adjusted.

The loudspeaker fitted is a 3½ in. unit from the W.B. range, which gives a reasonable quality of reproduction, bearing in mind the size of the receiver. Some midgets are fitted with a 2 in. speaker unit, but we considered that it was worth while to use a larger unit, so that a reasonable volume could be obtained on musical items without that thin, high-pitched tone usually given by midgets. A simple tone-controlling device is fitted to lower the pitch slightly. Finally it has been thought worth while to fit an electrolytic smoothing condenser across the H.T. supply, and as a result the receiver conforms almost to normal full-size broadcast receiver practice. As already pointed out, however, this type of receiver is really only intended for intermittent use, and the battery specified will give roughly 30 hours' use if used regularly for about 20 minutes a day. Obviously if not used so often the battery will last longer, but this particular battery should not be used if it is required to listen to, say, a complete programme of one hour's duration. For those who require a small set of this type for use under these conditions, it would be preferable to house the actual receiver in a larger cabinet, and then to use separate L.T. and H.T. batteries, selecting these from the larger capacity ranges. There is then no reason why the receiver should not be constructed as a standard



A 4-valve superhet with A.V.C. and auto-bias pre-set tuning of l.l.w. and 3 m.w. stations.

domestic set, although the cabinet size will be dictated by the batteries chosen.

Construction

As already mentioned, the layout is more or less standard practice. The front panel is made from aluminium, although this is not made part of the final cabinet design. It simplifies handling, however, and enables the receiver to be constructed and tested as a complete unit, which may be handled quite roughly without damage. It may then be dropped into the cabinet, which has a centralised speaker fret and presents a neater appearance as the screw or bolt heads are covered. The panel should be drilled as shown on the blueprint and, of course, it is not essential to adhere to the loudspeaker aperture illustrated here. This was adopted by us for simplicity and strength, but if a rotary cutter is available there is no reason why a circular hole should not be cut out, or a clean rectangle without the centre cross bar. The two holes above the coil unit fixing hole are for access to the trimmers, as the valve and I.F. transformer prevent the trimmers being adjusted from the rear.

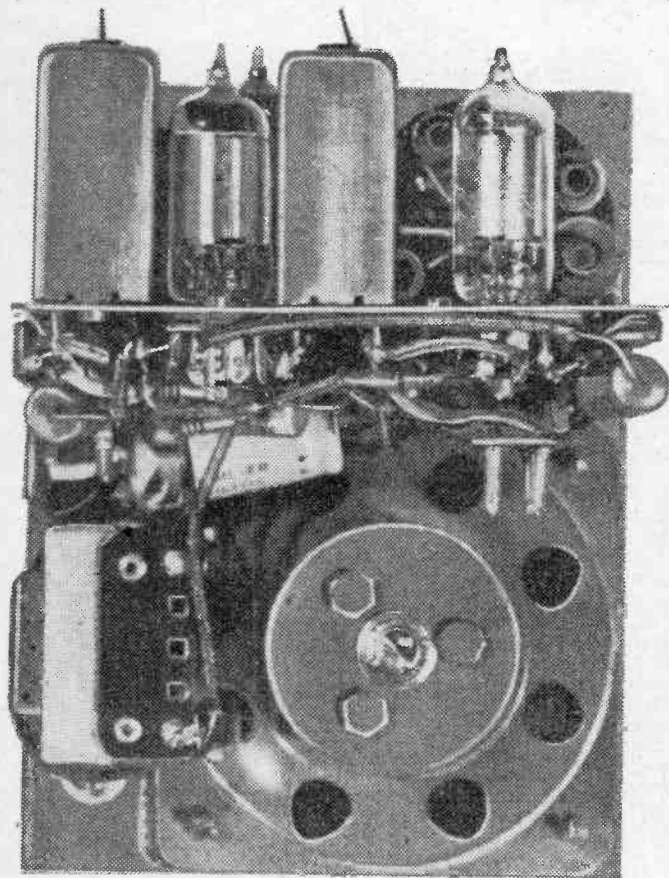

Rear view of receiver without battery.

The chassis or shelf should next be drilled and cut, noting that the turn-down at the lower edge, as shown on the blueprint, is drilled with a pair of holes which correspond to those on the panel. All drilling sizes are given and in view of the absence of weight quite thin metal may be used. Although we suggest aluminium (in view of its softness and ease of working), there is no reason why brass or copper should not be employed if desired, but sheet iron should not be used.

Components

The list of parts given on the blueprint are those which were actually used in the original model, and if possible these should be duplicated in view of their physical and electrical characteristics. Note particularly that the switch mounted, on the volume control must be of the double-pole type as if is desirable to open the H.T. circuit as well as the L.T. in order to avoid the battery discharging itself through the electrolytic or wiring.

Mount the valveholders and I.F. transformers on the chassis and commence wiring this, following the layout of the wires as near as possible. Note particularly the position which is adopted for the "earth" connection, which is split into two in this receiver, and this must be adhered to in the interests of stability. No difficulty should be experienced in the wiring, and it is not essential to use insulated sleeving for the wires. This was done in the original to assist in the photographic illustrations and in one or two places where the wires pass close together as they may get pushed into contact when changing the battery. The various photographs will show where the different condensers are tucked away, and when the chassis itself has been wired the speaker and transformer, the coil unit and the volume control should be mounted on the front panel. Wire the transformer to the speech coil and then bolt up the chassis and complete the wiring. Note that the tag on the right-hand side of the panel (viewed from the back of the receiver) is used only as a common anchoring point for certain "earth" leads, and nothing is bolted to this point. A standard soldering tag is locked under the nut, and the same method is used at the opposite end of the panel for the other "earth" point. If a really hot soldering iron is not



This view shows

available for use it will probably be found preferable to attach the earth points to the tag whilst this is held away from the panel in a small pair of pliers, as the surrounding metal will cool off the iron if this is of the small electrically heated type. No attempt should be made to make soldered connections by leaving the iron in contact with the point so as to heat up the surrounding metal, as the condensers, etc., will be damaged by the excessive heat. Where two or more contacts are made to one point it is preferable to hold the contacts in position with a thin-nosed pair of pliers and solder them at one operation, rather than to attach them one at a time.

This not only may result in the first contact coming away when the second is placed on, but the second application of heat may result in damage to the component.

Testing

When the wiring is complete it should be carefully checked with

the most suitable in your locality the following table gives the frequency coverage of each setting of the coil turret control knob.

Position 1 (maximum rotation anti-clockwise)—100-1,620 kc/s.

Position 2—680-1,220 kc/s.

Position 3—568-850 kc/s.

Position 4 (maximum rotation clockwise)—150-280 kc/s (long waves).

Find the frequency of your local and set the coil unit to cover the band embracing that frequency. Switch on and turn up the volume to full and with a trimmer (preferably made from a plastic or bone knitting needle sharpened to a screwdriver point) adjust the oscillator core (lower hole). If nothing can be heard as the trimmer is turned through the coil (take care not to bring it out so that it is broken when the turret is rotated), remove the aerial lead from the green tag on the coil unit and attach it to the yellow tag. It should then be possible to hear even a very weak station.

(To be continued)

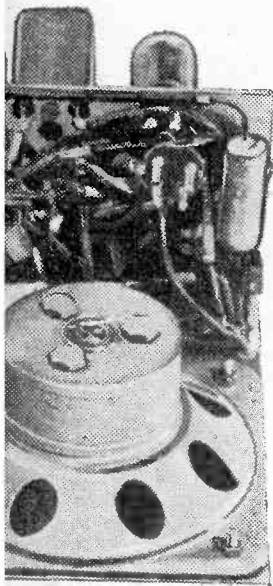

Detail of the compact wiring.

the diagram, and, if possible, with the theoretical circuit. The I.F. transformers are supplied with all four circuits accurately tuned to 465 kc/s, but inter-circuit wiring will obviously upset the alignment slightly. If a signal generator is not available the best way of getting the circuits accurately aligned is to attach about 15ft or 20ft. of thin single flex to the aerial contact on the coil unit (green). Incidentally, it will be found that the contacts on this unit are rather close together and to prevent them from being short-circuited against each other it is preferable to bend one up and its neighbour down, to ensure that they will remain clear of each other. With the aerial lead laid out turn the coil unit to one of the medium-wave settings—choosing that which covers the station nearest to you. To assist you in deciding which is

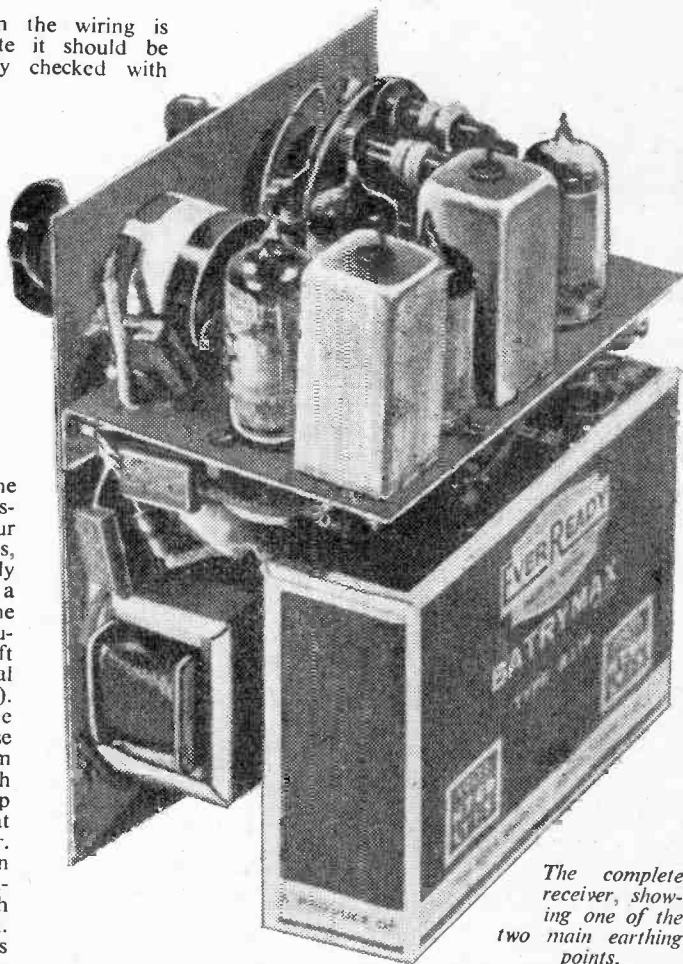

The complete receiver, showing one of the two main earthing points.

PRESENTED WITH
PRACTICAL WIRELESS
ISSUE DATED
MARCH 1952

THE "Mini-Four"

PUBLISHED BY GEO. NEWNES LTD., TOWER HOUSE, SOUTHAMPTON ST., STRAND, W.C.2

4-STATION
MIDGET
PORTABLE

PRICE
1/-

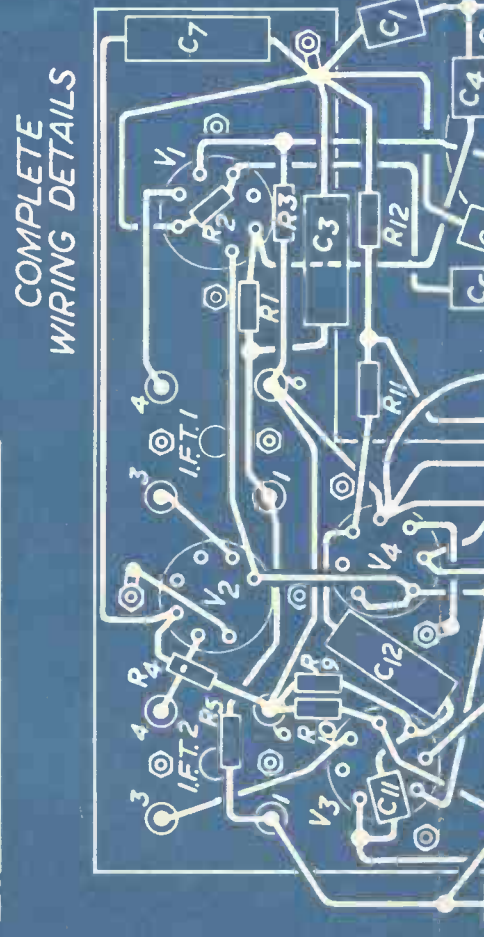
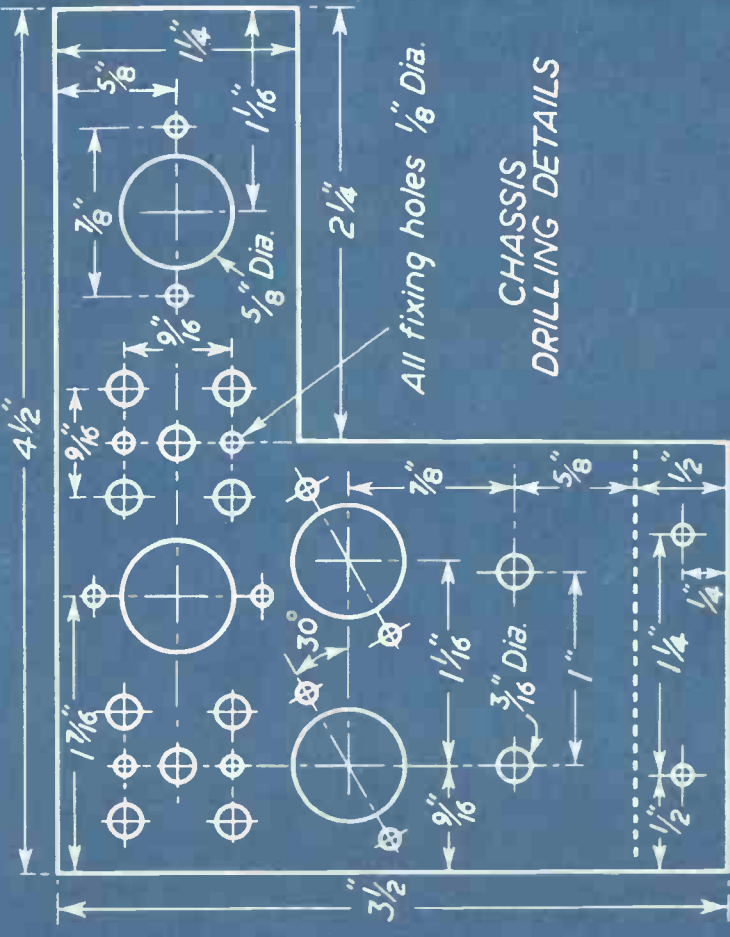
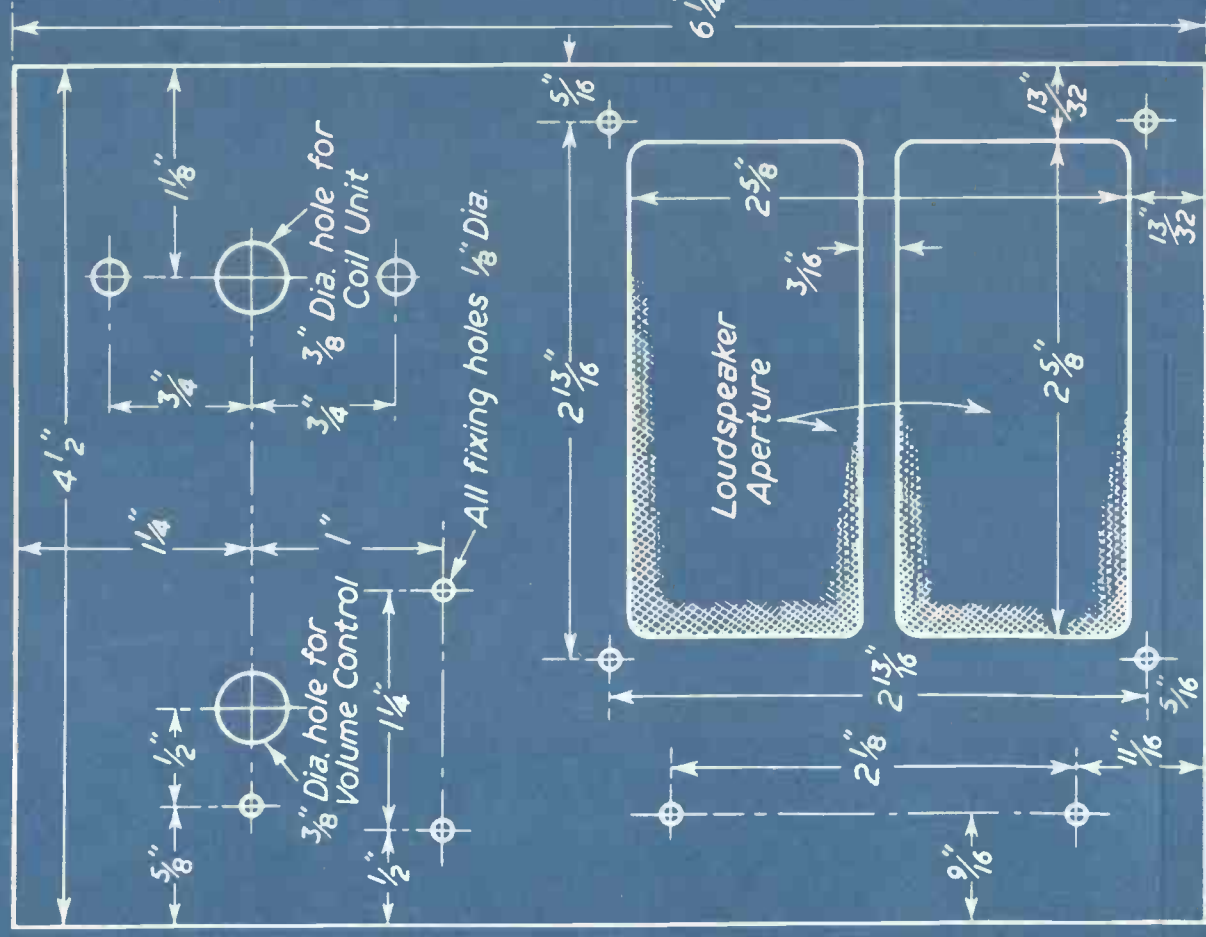

PANEL DRILLING DETAILS

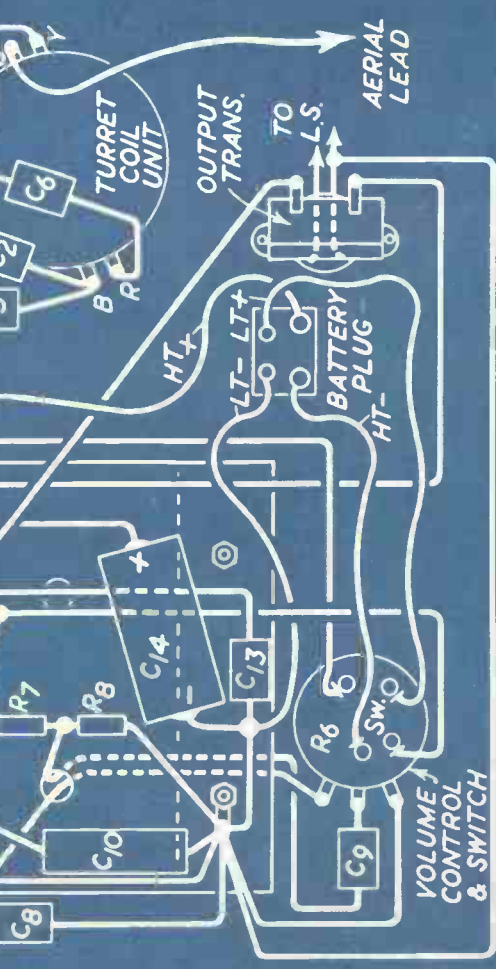

LIST OF PARTS

- 5..... 100pF Type 635 250v.w. Condenser
 - 2..... 150pF " " " "
 - 2..... 1000pF " " " "
 - 1..... 0.01μF " 460 " " "
 - 3..... 0.1μF " 410 " " "
 - 1..... 8μF " BR815 Electrolytic
 - 1..... 1000Ω " BTS 1/2 w. Resistor
 - 3..... 22KΩ " " " "
 - 1..... 100KΩ " " " "
 - 1..... 470KΩ " " " "
 - 2..... 1MΩ " " " "
 - 2..... 2.2MΩ " " " "
 - 1..... 6.8MΩ " " " "
 - 1..... 5MΩ " " " "
- Type C Potentiometer, with D.P. Switch (Dubilier)

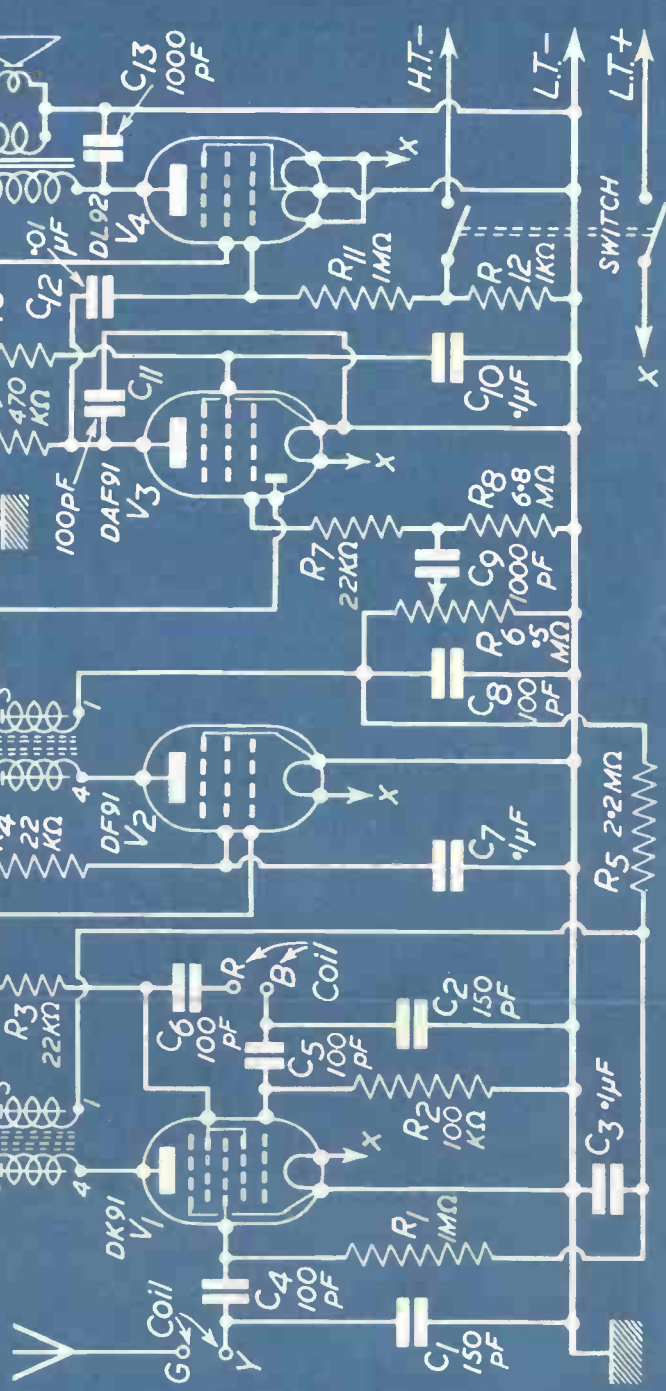

- 2... Type 800 IF Transformers. (Wright & Weaire)
- 1..... Turret Coil Unit, Type CT9 (Stern Radio)
- 1..... Combined HT & LT Battery, Type B114 (Ever Ready Ltd.)
- 1..... 4-Pin Plug, Type 2745 (Cinch)
- 4..... B7G Valveholders, Type 76/437 (Cinch)
- 4... Valves; Types DK91, DF91, DAF91 & DL92 (Mullard)
- 1..... 3 1/2" Dia. Loudspeaker, Type S3.57 with Transformer, ratio 55:1 (Whiteley Electrical)
- 2..... Control knobs, (Bulgin) Also aluminium for chassis, wire, sleeving, nuts, bolts, etc.,



On Your Wavelength

—By Thermion—

Brickbats

AS I expected, I received a few brickbats from readers who disagreed with my views on the decision of the BBC to reduce the number of dance-band broadcasts. My fear, you will remember, was that half the number would be able to make twice the amount of noise. I am quite prepared to concede that not everyone agrees with those views. If I happen to be a vegetarian (as a fact I am a carnivore) I do not expect everyone else to be a vegetarian. But in this feature I am expected to express *my* views.

There are the correspondence pages in which you can express yours. I am quite unrepentant about what I wrote; I still think that far too much time is devoted by the BBC to dance-bands. Incidentally, how many people dance to BBC broadcasts? These bands increase and multiply with the rapidity almost of germs. A crooner or a trumpeter falls out with his leader and forms his own band. The whole question is do we want so many bands? Two or three should surely provide all the dance-music necessary.

Blueprints

I WELCOME the reintroduction of the free gift blueprints. It seems such a long time ago since we heard of "Boom Sets." The blueprint given with this issue is a move towards the reintroduction of those happy times which we enjoyed in 1939. Do you remember some of the blueprints which this journal sponsored?

I still receive letters from readers praising the performance of sets built from them over 15 years ago. Only the other day I had a letter from a reader praising the performance of the A.C. Fury Four, the design for which we published in the early 'thirties. It would be difficult to say which has been the most popular of the PRACTICAL WIRELESS circuits. Personally, I liked the £5 Superhet, and still operate one. It has been revived by new valves from time to time, but its quality is still magnificent. The original speaker—a Whiteley—is still in it.

How many readers are still operating some of these old receivers, I wonder? Unfortunately, the war put paid to free gift blueprints, and it is unlikely that they will even now appear with the same frequency as in the pre-war years. But, still, a start has been made.

The decision to issue a blueprint for a midget portable of the all-dry battery type reflects the growing interest in the "personal" type of receiver. In the past several designs have been published herein, and they have all aroused great interest.

It is true to say that several thousands of them have been built.

Licence Dodgers

IN the course of conversation with a prominent member of the BBC the other day, who was bemoaning the fact that the State was to take £2,000,000 from their revenue at a time when they could do with even more money to carry out the recommendations of the Beveridge Report, he said, as a sort of aside, that if all the people operating wireless and television sets paid their licence fee the BBC would be some tens of thousands of pounds better off.

I expressed the view that I did not think very many people dodged the licence fee, but he assured me that there must be some hundreds of thousands. It is difficult, he said, to trace, but he had arrived at his figure by an analysis of sales of wireless receivers during the past five years, and making a fair allowance for those which have been smashed he still insisted that licence fees did not coincide with the sales. I pointed out that sales were not a fair index, for a man may scrap an existing receiver or put it in the loft and buy another. His reply to that was that very few people scrap wireless receivers to-day.

I stressed the fact that manufacturers had set their faces against repairing any sets made prior to 1939, and this must affect his analysis. However, he was not to be convinced. Incidentally, is it not a national scandal that manufacturers should adopt this attitude? There is a shortage of materials, there is an ever-growing need to export a higher percentage of what we make, and I therefore should have thought that those people wishing to hang on to their old sets until times are more prosperous were acting in the national interests.

A friend of mine the other day showed me an excellent radiogram which required a new transformer and a new switch. He had tried everywhere to get the set repaired, including the manufacturers who sent him a snooty letter implying that he had had his money's worth out of it, and that he should scrap it and buy another. This letter was followed up by a personal visit from the local agent offering hire purchase terms. The agent was informed that if the purchase of a new receiver were to be contemplated, it would not be selected from the range of this particular manufacturer.

Fortunately, I was able to put this reader in touch with a reliable amateur who had the set going in a couple of evenings. Successful salesmanship to-day seems to be based on the idea that you must persuade people every couple of years to scrap what they have and buy something new.

That is where the amateur scores. He builds his own receivers and knows what to do when they go wrong. He saves purchase tax, and is able also to help his neighbours.

WIRELESS COILS, CHOKES AND TRANSFORMERS
8th Edition now ready. Price 6/- by post 6/6d.

A Mutual Conductance Bridge

A USEFUL VALVE TESTER FOR LABORATORY OR WORKSHOP

By R. MANTON

WHEN testing valves, the agreement, or lack of it, of the value of the mutual conductance, or "slope," with that given by the makers is, perhaps, the best guide to the goodness or otherwise of the valve. The modern high-slope pentodes used in television and other high-frequency amplifiers are, in general, worked into anode loads which are small compared with the valve anode resistance, and thus the stage gain.

$$A = \frac{gR_a R_L}{R_a + R_L}$$

becomes very nearly equal to gR_L , since R_L in the denominator can be neglected in comparison with R_a , leaving

$$A = \frac{gR_a R_L}{R_a} = gR_L$$

Thus the mutual conductance is the only valve parameter of interest in this case, and in many other applications it is the one of chief interest. A bridge is here described with which mutual conductance may be readily measured.

The Principles

The bridge uses the cathode follower principle

Note: All screening of leads is connected to chassis. Resistors are 1/4 watt unless otherwise stated.

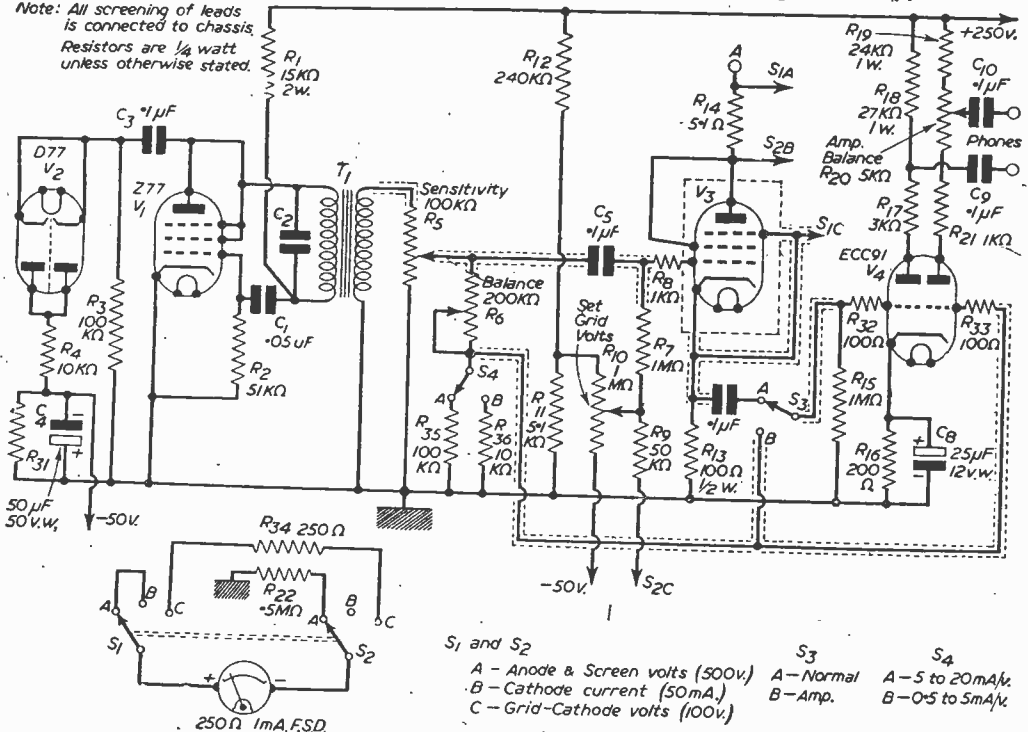

- S₁ and S₂
 - A - Anode & Screen volts (500V.)
 - B - Cathode current (50mA.)
 - C - Grid-Cathode volts (100V.)
- S₃
 - A - Normal
 - B - Amp.
- S₄
 - A - S to 20mA/V
 - B - 0.5 to 5mA/V

Fig. 5.—Circuit of the tester. Note that R9 may be 20KΩ+30KΩ, and R22 may be 200KΩ+300KΩ and R34 may be 120Ω+130Ω if it is desired to keep to standard values.

as a basis. In Fig. 1a a cathode follower is depicted, grid bias and H.T. supplies being omitted for simplicity. The anode is shown earthed, since in an actual circuit it would be decoupled to earth, and therefore effectively earthed as far as alternating currents are concerned. The alternating input voltage e_i is shown, e_o being the output. The

gain of this circuit $\frac{e_o}{e_i}$ is equal to

$$\frac{R_k}{\frac{1}{g} + R_k + \frac{R_k}{\mu}}$$

This gain can be obtained from the equivalent potential divider shown in Fig. 1b. The top arm of the potential divider is

$$\frac{1}{g} + \frac{R_k}{\mu}$$

Since $\mu = gR_a$ this can be written

$$\frac{1}{g} + \frac{R_k}{gR_a} = \frac{1}{g} \left(1 + \frac{R_k}{R_a} \right)$$

Thus if R_k is small compared with R_a , the top arm can be reduced to $\frac{1}{g}$.

Then the potentiometer becomes as in Fig. 1c. This can be used as one side of a Wheatstone bridge, as in Fig. 2, and if some detecting device

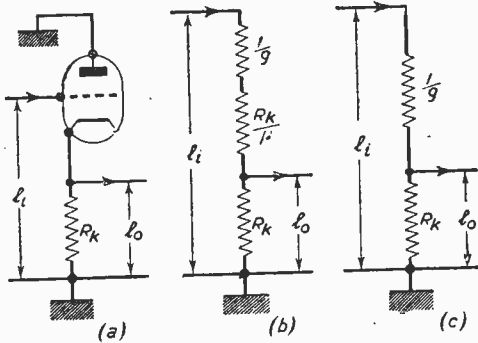

Fig. 1.—Valve circuit, to illustrate function of the bridge.

is put across X-Y and the bridge is balanced, then

$$\frac{R_a}{R_b} = \frac{1}{R_k} = \frac{g}{R_k}$$

If R_k is some fixed, known resistance and if the ratio $\frac{R_a}{R_b}$ is known, then the value of g can be found since

$$g = \frac{R_b}{R_a} + \frac{1}{R_k}$$

The arrangement is drawn with an actual valve in Fig. 3. In the practical form of the bridge, the ratio arm R_a is made variable, while R_b is fixed and is of known value. An amplifier and earphones are used to detect the balance across X-Y, and an audio oscillator is used to provide the input signal e_i so that a practical diagram of the apparatus is as in Fig. 4.

The Circuit

Turning now to Fig. 5, in which is shown the complete instrument, apart from the power supply, V3 is the valve under test, R13 being equivalent to R_k and R6 being the variable ratio arm, while R35 and R36 are alternative fixed ones to provide two ranges of slope measurement. The junction

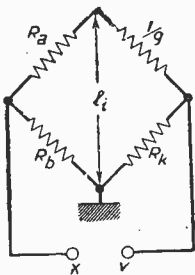

Fig. 2.—Standard bridge circuit.

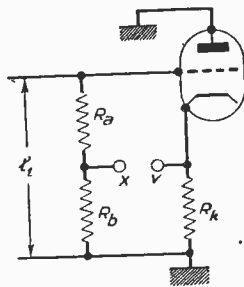

Fig. 3.—Compare this with Fig. 2.

of R6 and R35 or R36, and the cathode of V3 are the points X and Y which are taken to the amplifier V4. The input to V3 is provided by oscillator V1, the output from which is taken via potentiometer R5 which serves as a sensitivity control. Part of the oscillator output is rectified by V2, and after smoothing is used to provide a source of negative bias, a variable amount of which is applied to V3 grid via R10. Thus the current in V3 can be adjusted to the value required for the test. A variable H.T. voltage for V3 is applied at A, and provision is made for measuring the grid and H.T. voltages applied V3, and for measuring the current in V3. In general valves to be tested will be triodes or pentodes although V3 is shown as a pentode it is triode connected (screen connected to anode).

It should be noted that this bridge measures the slope effective in the cathode. In the case of pentodes, this cathode slope will not be the same as that operative in the anode circuit. The slope in the anode is equal to that in the cathode multiplied by the ratio

$$\frac{\text{anode current}}{\text{cathode current}}$$

i.e. $g_{\text{anode}} = g_{\text{cathode}} \times \frac{i_a}{i_k}$

Typical values are

- $i_k = 10 \text{ mA.}$
- $i_a = 8 \text{ mA.}$
- $i_{\text{screen grid}} = 2 \text{ mA.}$

in which case the anode slope will be $.8 \times$ cathode slope. It is, of course, the anode slope which must be used when calculating the gain of a valve working into an anode load.

Considering the circuit in more detail, the oscillator is a conventional Hartley, the transformer T_1 being tuned by C_2 . The value of C_2 is not given, since it depends on the particular transformer used and on the frequency desired. The precise frequency is not important, a value somewhere about 1,000 c/s being suitable.

The voltage applied at A to the valve under test is variable from +100v. to +250v., while a range of current in V3 from zero to 50 mA is catered for. This current may be varied by R_{10} which varies the grid voltage of V3 from -50v. to +5v. It is not intended that the grid of the test valve should ever be run positive to the cathode, but a valve taking 50 mA cathode current will develop a cathode bias of 5 volts across R_{13} , so that to be able to bring the actual grid-to-cathode voltage as near zero as

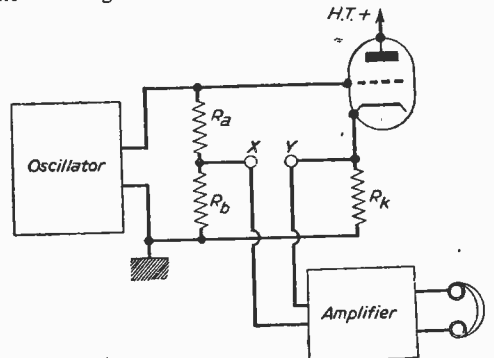

Fig. 4.—Practical arrangement of the tester scheme.

desired, the grid voltage must be able to go 5v. positive. The grid-to-cathode voltage is indicated on the meter when S_1 and S_2 are in position C. The meter takes 1 mA at full scale, and a resistance equal to the meter resistance of 250Ω is in parallel with it, so that the current down R_3 ($50K\Omega$) is 2 mA, giving full scale deflection for 100v. across the combination. In position A the anode and screen volts on V_3 are indicated. The series resistance in this case is $500K\Omega$ (R_{22}), and the meter is not shunted, thus full scale corresponds to 500v. In position B the meter is in parallel with R_{14} and thus indicates the anode and screen current in V_3 . The value of 5.1Ω for R_{14} gives full scale deflection for a current in V_3 of 50 mA. If a 1 mA meter is used of resistance different from 250Ω the value of R_{14} must be changed. If the meter resistance is R ohms then the value of R_{14} should be $\frac{R}{49}$ ohms. The values of R_3 and R_{24} need not be changed provided the meter gives full scale deflection for 1 mA, but the resistance of R_{34} must be changed to equal that of the meter.

The cathode resistance (R_{13}) is made 100Ω , this being low enough to ensure that the ratio $\frac{R_k}{R_a}$ is much less than one, as was previously stated to be necessary.

The alternative ratio arm resistors R_{34} and R_{36} are $100K\Omega$ and $10K\Omega$. With a $200K\Omega$ variable resistor for R_{35} , a range of ratios from 0 to 2 is obtained with S_1 in position A, and 0 to 20 with S_1 in position B. From the formula previously given for finding the slope,

$$g = \frac{R_b}{R_a} \times \frac{1}{R_k}$$

it can be seen that the ranges of slope are \propto to

5 mA/v. in position A and \propto to 0.5 mA/v. in position B. In position A of S_1 the central position of balance control R_6 will correspond to a slope of 10 mA/v., and in position B the central position will correspond to 1 mA/v. Thus a total range of slope from 0.5 mA/v. to 20 mA/v. can easily be covered, which will include most valves likely to be encountered.

The twin triode amplifier V_4 must have exactly equal gain in each half. Any inequality of gain will result in a balance across the phones in the anode circuits in a position where there is not a balance between the two grids. To ensure equality of gain, switch S_3 is provided, which joins together the two grids of V_4 , thus putting the same input on each. Preset potentiometer R_{20} is then adjusted for no sound in the phones, indicating that there is exactly the same alternating voltage on each side of the phones. R_5 should be turned up so that there is sufficient signal for this adjustment. The amplifier being thus balanced, S_3 is returned to normal.

The -50 v. supply is required to give very little current, about 1 mA. or so, and thus loads the oscillator very little. Depending on the transformer used, the oscillator voltage will vary somewhat, but should in any case be of sufficient amplitude to provide at least 50 v.

Power Supply

The power supply (Fig. 6) is quite conventional as far as the +250 v. supply is concerned. From this +250 v. a series resistor $R(23-28)$, variable in steps, feeds the point A, the anode and screen supply of the valve under test: A valve V_6 is arranged to draw a variable current through the series resistance, thus producing a variable voltage drop across it and varying the voltage available at A. V_6 current is controlled by the variable grid voltage applied via

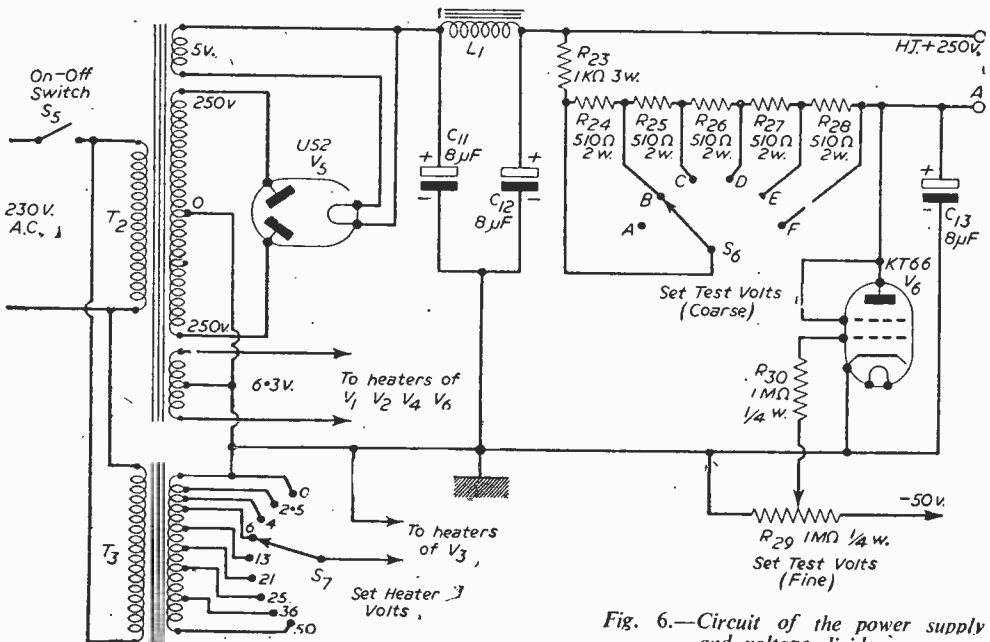

Fig. 6.—Circuit of the power supply and voltage divider.

R_{29} from the -50 v. supply. When R_{29} slider is at the earthy end, V_6 has zero bias. The valve will now pass quite considerable current, but this is prevented from rising to a dangerous value by the fact that even if R_{21-28} are shorted out, there still remains $1,000\Omega$ (R_{23}), the drop across which keeps the anode and screen voltage on V_6 down to a safe level. Thus even with zero bias V_6 cannot be overrun, and grid current is kept down to a safe level by R_{30} .

The transformer T3 provides a range of voltages to cope with all likely heater requirements of the valve under test. The windings up to 6 v. should be capable of passing 2 A., but $\frac{1}{2}$ A. will suffice for the tappings higher than 6 v.

Wiring and Layout

The wiring and layout of the instrument are not critical, but care should be taken to screen the oscillator from the rest of the bridge and to screen, as indicated in the circuit diagram, leads carrying signal voltages. For T_1 almost any transformer of the intervalve coupling type should do. Some have a fairly low natural frequency and in this case C_2 may possibly be omitted. The negative supply voltage is not critical and should lie between -35 v. and -50 v. To obtain a suitable voltage, R_{31} and possibly R_4 should be adjusted, though R_4 should not be reduced below $1k\Omega$. R_1 may also be adjusted to vary the amplitude of the oscillation, thus altering the negative supply volts, but should not be reduced below about $10k\Omega$.

The choke L_1 in the power supply should have a fairly low resistance in order to keep the $+250$ v. supply regulation good. Transformer T_2 should be 250-0-250, and the 6.3 v. winding needs to pass 3 A. T_3 may easily be wound on an old mains transformer, the primary of which is intact. Before removing unwanted windings, the turns-per-volt required

should be found by counting the number of turns on one of the unwanted windings the voltage of which is known. The number of turns for the new winding can then be readily calculated.

The question of holders for the valve under test depends largely on the requirements and inclinations of the user. A set of valveholders of types likely to be required may be made up, each holder on a separate fitting such as a brass plate about 2in. square which may be quickly clipped into position on the bridge. A set of 12 holders covers most valve types, i.e., British five- and seven-pin; American and Mazda octal; American U.X. six- and seven-pin; side contact five and eight contacts; B9G (EF50 base); B7G; Noval; American loctal. Connections are conveniently made with short leads carrying wander plugs fitting into sockets connected to the valveholder tags. Seven connections are required: three grids, anode, cathode and heaters.

When the unit is complete, before switching on, V_6 should be removed, S_1 and S_2 should be turned to position A, and no valve should be in the test position. Switch on and the meter should read about 250 v. Turn R_5 to the maximum position and a loud oscillator signal should be heard in the phones. Turn S_1 and S_2 to position C; turn R_{10} to the most negative end, and adjust R_{31} and R_{14} until the meter reads about 50 v. Now put S_3 into position B and balance the amplifier as already described. Insert V_6 and check that the voltage as measured by the meter with S_1 and S_2 in position A is variable by R_{29} .

Calibration

All being well, the bridge is now ready for calibrating. With no valve in the test position, a 0-10,000 Ω decade resistance box should be connected between the V_3 cathode end of R_{13} and the junction of R_6 and C_5 . The resistance box is now set to a series of values and the bridge is balanced for each one. The reciprocal of the value of resistance turned up on the box is the value of the slope to be marked on the scale. That is, a value of 2,000 Ω on the box corresponds to a slope value of $\frac{1}{2,000}$ amps/volt = .5 mA./v., a value of 100 Ω corresponds to a slope of 10 mA./v., and so on. So a series of as many points as required can be marked on the mutual conductance scales.

A decade resistance box may not be available, and in this case the scale on to which the mutual conductance values are to be marked should first be marked with a scale of angular degrees. This may be done with a protractor and should be marked in 5 deg. steps from 0 to 360 deg. A series of accurate (1 per cent.) fixed resistors should, now be

(Concluded on page 130.)

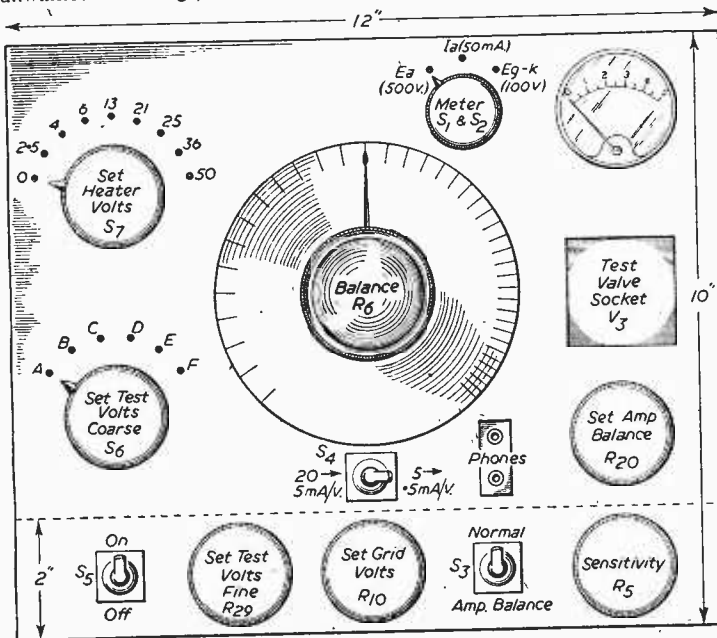
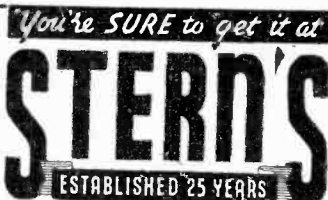

Fig. 7.—Panel layout of the completed instrument.

**BUILD YOUR OWN
MODERN RECEIVER
for
HALF the normal cost**



**SOME POPULAR KITS
and CIRCUITS for
EASY ASSEMBLY by the
HOME CONSTRUCTOR**

- ★ **A MIDGET 4-STATION "PRE-SET" SUPERHET. RECEIVER** for A.C. mains. Designed to receive any three stations on Medium Waveband and one on Long Wave by the turn of a Rotary Switch, no Tuning being necessary. The Complete Assembly Instructions, showing the Wiring Diagram, Component Layout, and Point to Point connections, together with a Component Price List, available for 1/9.
- ★ **A 4-VALVE T.R.F. BATTERY PORTABLE "PERSONAL" SET**, available as a Complete Kit of Parts or by purchase of the Components separately. The complete price details, including an individual Component Price List, are included in our set of Assembly Instructions, which is obtainable for 9d.
- ★ **A MIDGET 4-VALVE SUPERHET, PERSONAL SET**, covering Long and Medium Wavebands and designed for Mains or Battery operation. This receiver is designed to operate on A.C. mains or by an "All-dry" Battery; either method is selected by means of a Rotary Switch. It is so designed that the Mains Section is supplied as a separate section which may be incorporated at any time. The set, therefore, can be made either as an "All-dry" Battery Personal set or as a Midget Receiver for Combined Mains/Battery operation. The Assembly Instructions, which include Wiring Diagrams and Practical Component Layouts, are available for 1/9. This includes a separate Components Price List.
- ★ **TUNING UNITS**. A publication showing how to make three different types of Tuning Units. 1. A 1-Valve T.R.F. Unit, covering Long and Medium Wavebands. 2. A Superhet. Unit, covering S., M. and L. Wavebands. 3. A 4-Valve "Pre-Set" Station Superhet. Unit, providing three Stations on Medium and one Station on Long Waves. The Manual, price 2/6, shows Wiring Diagrams, Practical Layouts and Component Price Lists.
- ★ **THE MIDGET A.C. MAINS 3-VALVE RECEIVER** as designed and published by "Wireless World," covering Long and Medium Wavebands. Cost of all Components to build this set is £4/17/9. A reprint of the complete Assembly Instructions, including Practical Layouts, is available for 9d.
- ★ **THE "WIRELESS WORLD" MIDGET A.C. MAINS 2-VALVE RECEIVER**. We can supply all the components including Valves and M/Coil Speaker, to build this set for £3/10/0. Reprint of the original Assembly Instructions and Circuit may be obtained for 9d.
- ★ **THE "SUMMER ALL-DRY" BATTERY PORTABLE**, as published in the June issue of "Practical Wireless." We can supply from stock all of the Components to build this Midget 3-Valve Receiver. A reprint of the complete article and circuits, including Practical Layout and Component Price List is available for 1/-.
- ★ **A COMPLETE KIT OF PARTS** to build a MIDGET "All-dry" BATTERY ELIMINATOR, giving approx. 60 volts and 1.4 volts. This eliminator is suitable for use with 4-valve Superhet. Personal Sets. It is easily and quickly assembled and is housed in a case size 4 1/2 in. x 1 1/2 in. x 3 1/2 in. Price of Complete Kit, 42/6. In addition we can offer a similar complete kit to provide approx. 90 volts and 1.4 volts. Size of assembled unit 7 in. x 2 1/2 in. x 1 1/2 in. Price 47/6.
- ★ For £6/5/0. A Complete Kit of Parts, including Drilled Chassis and Valves, to build a 6 to 8 watt **PUSH-PULL AMPLIFIER** for operation on A.C. Mains. Incorporates a Tone Control and is suitable for use with any type of pick-up. The complete set of Assembly Circuits, including Practical Layouts, is available for 9d.

★ Send 9d. P.O. for our NEW STOCK LIST, showing many KITS OF PARTS for Sets and Battery Chargers and "hundreds" of Wireless Components. When ordering please cover cost of postage and packing.

STERN RADIO LTD., 109 & 115, FLEET STREET, E.C.4.

Telephone :
CENTRAL 5814 & 2280

RADIO MAIL

4, RALEIGH STREET, NOTTINGHAM

V.H.F. PRE-AMPLIFIER UNITS. A two-stage amplifier employing two EF50's on a totally enclosed chassis 2 x 3 1/2 x 3 1/2 ins., plus the height of the EF50's. All tuned circuits tune to Sutton Coldfield television frequency except one, which is easily altered. Details of changes required for T.V. use are supplied with each Unit. Brand new in original transit box, with trimming tool, plugs and cables. **LIMITED STOCKS** at the bargain price of 12/- less valves, or 23/6 with valves.

**GUARANTEED FIRST-GRADE EQUIPMENT
BRAND NEW PERFECT POST PAID**

MOVING-COIL HEADPHONES. New and unsoiled in original boxes, 13/6 pair. **CO-AXIAL TYPE SCREENED CABLE.** Light-weight, stranded inner conductor 14/36, plastic insulation, ideal for P.A. mike leads, etc., 7d. yard or 6d. yard for 12 yards or more. **CARBON MIKES.** Switch in handle, flex lead, 2-pin plug, 4/11. **MOVING-COIL MIKES,** in polished bakelite case with built-in switch, 6/9. **EX-W.D. UNITS,** type 9263a, 2 1/2 ins. diam., ideal speaker for midget receiver or intercom, boxed, 6/6. **CONDENSERS,** cardboard, toulard, 1 mfd. 350v., 3d.; 20 pf. Ceramicons, 3d.; .001 mfd. moulded, 1 mfd. 1,000 v., Micamold, metal cased tubular, 10d.; 1 mfd. 1,000 v. oil-filled, U.S.A., 7/6. **WAFER SWITCHES,** 3-pole 6-way, 8d. **COLVERN WIRE-WOUND POT'S,** 25,000, 11/9; 20,000 heavy duty, 3/9; totally enclosed and ungraded. **DIMMERS,** 100 ohms, variable resistance, 1 A, enclosed, 2/6. **PRESSED METAL BOXES,** hinged lid, 9 1/2 x 6 x 4 1/2 ins., 4/- **METER RECTIFIERS,** 5 mA., 5/-. **THERMOSTATS,** heavy contacts, 50°F., plus or minus 10. **R.F. METER UNITS,** .05 A T/C 2in. Meter, and resistors, in metal box, 3 x 2 1/2 x 2 ins., 6/9. **FUSE BRIDGES AND HOLDERS,** 15 A, 1/3. **CO-AX CABLE,** 3 ft. lengths, 3 for 2/6. **EF50 RETAINERS,** 4d. **VALVES,** ex-Govt., boxed, guaranteed. SP61, 3/3; EA50, 2/3; VP23, 5/6; ATP4, 3/3; VS110, 5/6; 7V7, 7/6. Genuine RCA 954 acorn pentodes, makers' boxes, 4/6.

DUKE'S

COLOUR TELEVISION.—The newest development in television colour filter can treble your viewing pleasure. Gives beautiful natural colour tints to the picture. Blue, pink and green filter for a 10in. screen. Price 10/9 each. For 12in. screen, 12/6 each. For 15in. screen, 19/6.

PERSONAL RECEIVERS.—Price 25/12/6. Our very Popular 4-valve TRF kit for A.C. or Universal, which you can build yourself with the aid of our complete instructions, including point to point wiring. Choice of green, brown or ivory cabinet in beautiful plastic. Turn advantage of this bargain offer before prices rise. Assembled ready for use, 35/- extra. Postage and packing, 2/6 extra.

COACH SEATS.—Price 45/- each, complete with double seat and back, width 35in. Moquette covered, or hide covered and spring upholstered. Dunlopillo filling, 5/- extra. Carriage extra. Outside London area, please mention nearest railway station.

T.V. LENSES.—Enlarges picture 1 1/2 times. For 8in. and 9in. screens, 55/-. For 10in. and 12in. screens, 75/-. Tinted for Anti-glare and daylight viewing, 5/- extra. Postage, 2/6 extra.

WIRE-WOUND RESISTANCES.—Price 1/9 each. Made by The International Resistance Co., Philadelphia, 1 meg., 1 watt at 1 per cent. accuracy. A precision job wound on a ceramic former, size 1 1/2 in. long by 1/2 in. diameter. Postage 3d.

BARGAINS IN WIRE.—Nickel Chrome and Spring Steel Wire. Sizes .014in. and .032in. in 50yd. and 25yd. reels respectively. Spring Steel wire, 1/- per reel. 5 reels for 4/-. Nickel Chrome wire, 4/6 per reel. Postage 1/- per reel. This wire is practically unobtainable at these prices to-day.

VALVES.—We are one of London's largest stockists of new valves of all types. Send for our valve list. We may have that valve you have been searching for, and ask for our catalogue of radio and electrical bargains.

TRANSFORMERS.—Standard O.P. Trans. 3/9 each. Postage, 1/-. Salvage Mains Trans. price 7/9 each. Postage 1/-. 260-0-260 6.3 v., 3 a. Tapped for 240, 210, 115 and 0. 6.3 v., 1 a. Tested and guaranteed. Worth double.

EARPHONES.—Type DLR 2 and DLR 5. Price 8/9 each. A super-balanced sound powered phone which is so sensitive that it can be used as a telephone without batteries. We have a limited stock of these X.W.D. units in excellent condition. Postage 1/- per set.

Money Back Guarantee. Cash with Order or C.O.D.
DUKES 621, Romford Rd., Manor Park, London, E.12.

also at 219, Ilford Lane, Ilford, Essex, ILFord 0295,
GRANGEWOOD 677.
MAIL ORDER OFFICE AT 621

CLYDESDALE

Bargains in Ex-Services Radio and Electronic Equipment

RADIO CABINET

A handsome walnut finish wooden cabinet, well ventilated, with removable back panel. External dim.: Ht. 91 x 17 x 8 1/2 in. approx. External appearance facing cabinet. Speaker opening right side. Ht. 5 1/2 in. Lth. 4 1/2 in. Dial opening, left side. Ht. 3 1/2 in. Lth. 5 1/2 in. Internal dim.: Ht. 8 1/2 in. x 7 1/2 in. approx.
CLYDESDALE'S 25/- each POST PAID PRICE ONLY

RADIO CABINET

Smart Plastic Cabinet, with ornamental speaker grille and dial apertures, top front centre. Colours : Walnut, Mahogany, White and Black. External Dimensions : Ht. 12 x 7 1/2 x 6 1/2 in. Internal dimensions : Ht. 11 x 6 1/2 x 4 1/2 in.
CLYDESDALE'S 15/- each POST PAID PRICE ONLY

APS-13 T/R CHASSIS. Less Valves. Partly stripped by M.O.S. Tx. section removed, still contains 7 tropicalized 30 Mc/s I.F. Trans., motor generator, B7C and other valveholders, etc., etc., in metal case, 15 1/2 x 7 1/2 x 7 in. Wgt., 12 1/2 lb.
CLYDESDALE'S 21/- each POST PAID PRICE ONLY

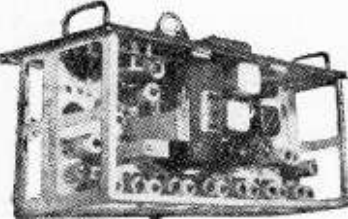

For the Low Cost "PRACTICAL TELEVISION Receiver INDICATOR UNIT TYPE 62 IN MAKER'S ORIGINAL CASE Containing : VCR97 C.R.T. with mu-metal screen, 100 K/cs, Crystal unit 10XC/2, 16/VR65's (SP61), 2/VR54's (EB34), 2/VR92's (EA50), plus various pots, switches, H.V., cons., resistors, etc., built on metal chassis to fit box 18 x 3 1/2 x 1 1/2 in. All controls brought to front panel beside viewing screen.
CLYDESDALE'S £5.9.6 CARRIAGE PAID PRICE ONLY

Also available in used, fair conditions.
CLYDESDALE'S 79/6 each CARR. PRICE ONLY

70.80 ohms, CO-AXIAL CABLE. Dia. 5 mm., polythene insulation. Ideal for T.V. aerials. Price, 1/3 per yard. Mini. quantity, 10 yds., or 100 yd. coil at 85 each.

8in. P.M. LOUDSPEAKER

With transformer, standard chassis type. Brand new in original carton.
CLYDESDALE'S 17/6 each POST PAID PRICE ONLY

12 VOLT MOBILE AMPLIFIER

A compact 4 valve (2/EL35, EF36, ECC31). 3 stage amplifier, output 15 watts ; rotary generator ; power unit ; input 12 volts 96 watts. Provision for 10 ohm L.S., M.C. Mic., and Gram. In metal cabinet, 13 x 9 x 9 in.
CLYDESDALE'S £9.9.0 CARRIAGE PAID PRICE ONLY

Order direct from:

2, BRIDGE ST., GLASGOW, C.5.

Visit our Branches in Scotland, England and N. Ireland.

CLYDESDALE SUPPLY CO. LTD.

'Phone : SOUTH 2706/9

THE R3601 RECEIVER UNIT

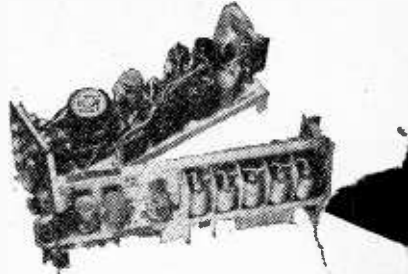

A 15 valve (6V6, VU39A, 4/SP61, 4/EA50, 2/EF54, EF50, EC52, VU111) dual chassis radar receiver for 223 Mc/s with 13 Mc/s I.F. strip, R.F. section, high cycle power section, antenna switch, relay, etc., etc. In metal case, 18 x 9 x 8 in.
CLYDESDALE'S £4.12.6 CARRIAGE PAID PRICE ONLY

R3170A RECEIVER UNIT

A 16 valve (2/EF54, EC52, 8/EF50, 2/EA50, 52A, CV188, VU111) Radar chassis with 30 Mc/s I.F. strip, etc., original range about 200 Mc/s, suitable for T.V. conversion.
CLYDESDALE'S £4.12.6 CARRIAGE PAID PRICE ONLY

NEW LIST NO. 8

Giving details and illustrations of ex-Services items and cancelling all previous lists and supplements.

Now Ready 1/6

Price credited on first purchase of 10/- or over.

HIGHSTONE UTILITIES

Soldering Irons, streamlined iron, with curved Pencil Bit, 200/250 v. 50 w., 10/- Standard Iron, with adjustable bit 200/250 v. 60 w., 12/- Heavy Duty Iron, 150 w., 15/6, all post 6d. Magnets, small ex 2in. meters, 1/- each, post 3d. Telephone Hand Generator with handle, 7/6, post 1/6. Bell, 3/6, post 6d.

Crystal Sets, which are fitted with a permanent crystal detector. Why not have a set in your own room—10/6, post 6d. De Luxe receiver in polished oak cabinet, 18/6, post 1/- Spare Permanent Detectors, 2/- each. When ordered separately, 2/6. With clips and screws, 2/10, post 3d.

Headphones, in good order, 5/6 ; better pair, 7/6. New Headphones, 10/- a pair. Balanced armature type (very sensitive), 12/6 a pair, all post 8d. New Simple Earpieces, 3/6. Bal. armature type, 4/6 ; ex-R.A.F. earpieces, 2/-, post 4d. All headphones listed are suitable for use with our crystal sets. Hand Microphones, with switch in handle and lead, 4/- Similar instrument, moving coil, 7/6, post 6d.

Sparkling Plug Neon Testers, with vost pocket clip, 3/3, and with gauge, 3/6, post 3d. Ex-R.A.F. 2-Valve (2-volt) Amplifiers, can be used to make up a deaf aid outfit, intercommunication system, or with crystal set, complete with valves and fitting instructions, 20/-, post 1/8. D.H.O., less valves, 10/- Wooden box to hold amplifier, 2/- extra. One valve amplifier, complete with valve 10/6, post 1/3.

Meters, 10v., 21in. Rectifier (a.c.) in wooden carrying case, 14/6 ; 15v., 2 1/2 in. m.c., 9/6 ; 150v., 2 1/2 in. m.c., 10/- ; 5.5 amp., 2 1/2 in. T.C., 5/- ; 4 amp., 2 1/2 in. T.C., 2/- extra ; Meter Movements. Units containing two 500 microamps, 6/- All meters post extra. Money refunded if not completely satisfied.

HIGHSTONE UTILITIES.

58, New Wanstead, London, E.11. Letters only. New Illustrated List sent on request with 14d. stamp and s.a.e.

ARMY MORSE KEY and Buzzer Practice Set, 6/6.

TYPE 18 TX CHASSIS, partly stripped, but can be put into working order ; less valves 16/6.

U.S. PHONE TRANSFORMERS for matching LO to HI impedance phases, 2/6.

NEW UNSPILLABLE EXIDE PO-2 accumulators, 11A.H. 4 1/2 x 3 1/2 x 2 1/2 in. 19/6.

TR196 CIRCUIT AND CONVERSION DATA, 1/3. 1147 A or B. 1/6.

New IN34 CRYSTAL DIODES, 5/6.

P.M. SPEAKERS. W.B. 2 1/2 in., 14/6 ; Sin. Rola, 21/-.

MOVING-COIL MICROPHONES with switch, 6/6. Trans. to match, 5/-.

6v. VIBRATOR PACK in black steel case, 7 1/2 x 5 1/2 x 3 1/2 in. Output 200 v. 40 mA., 22/6.

SELENIUM RECTIFIERS. F.W. 6 or 12v. 4 A., 26/- ; F.W. 6-12v. 3 A., 14/6. 1/2 A. 5/6.

ARMY CARBON MICROPHONE, with switch, 4/6. Trans. to match, 3/6.

TRANSFORMERS, 200-240 volts, tapped 3-4-5-6-8-9-10-12-15-18-20-24 and 30 volts at 2 amps., 21/3 Post Paid.

SCOPE UNIT, VCR138. 3 1/2 in. C.R.T. mu-metal shield, 2 FR50s and 2 EBC34s. etc. Can be modified to standard Oscilloscope in a few hours. In steel case 6 x 6 x 1 1/2 in. Price 70/- All Carriage Paid

THE RADIO & ELECTRICAL MART

253b, Portobello Road, London, W.11. 'Phone : Park 6026.

JOHN FARMER

18. MULTIPLE L.T. TRANSFORMERS, input 200-220-240v., 50 c/s, 1 phase. Output 30v. at 2 amps., tapped at 3-4-5-6-8-9-10-12-15-18-20 and 24v. Brand new, boxed, 22/6 each, post 1/3. 19. WESTINGHOUSE RECTIFIERS, selenium full-wave bridge, D.C. output 12v. at 2 amps., from input of 15v. A.C. To charge 6v. battery, input 8v. A.C. to charge 2v. accumulator, input 15 1/2 v. A.C. Ideal for use with item 18 above. New, unused, with fixing brackets, 15/- each, post 8d. 266. MUIRHEAD VERNIER DRIVES, type D. Ratio 40:1, marked 0-180 degs., illuminated cursor, easy panel fitting for lin. shafts. These popular slow-motion drives are new, boxed, priced at 8/6 each, post 6d. 138. "PVE" 45 MC/S I.F. STRIPS. A ready-made vision unit for the London freq. Complete with six EF50's and one EA50. New, unused, 60/- each, post 1/6. 223. VARIABLE RHEOSTATS, "Zenith", 0.4 ohms, 25 amps. helical screw traverse, laminated contacts, wire wound, vitreous steel formers, base mounting and brackets. Unused, 7/6 each, post 1/6. 234. TRANSFORMERS, Pri. 230v. output 18v. at 2 amps. Taken from new equipment, 15/- each, post 1/6. 272. "RECORD" BOND TESTERS, 0 to 0.1 ohms, 2 1/2 in. scale, battery compartment in brown bakelite case, size 6 1/2 in. x 4 1/2 in., with leather shoulder straps, new, unused, 20/- each, post 1/6. 57. PAF-MEKO RADIO TRANSFORMERS, drop-through shrouded type. Input 110-220-240v. Output 230-0-250v. at 90ma., 5v. at 2 amps., 6.3v. at 3 amps., screen. Brand new, boxed, 20/- each, post 1/3. 170. GERMANIUM CRYSTAL RECTIFIERS, with wire ends, highest grade, 4/6 each, post 3d.

Send now for our catalogue and price list. The address is:-

JOHN FARMER (Dept. A.3), 194, HARBORNE PARK RD., HARBORNE, B'HAM 17

Tel. : HARBORNE 1309.

A SERVICING AID

A SIMPLE DEVICE FOR MEASURING CURRENT CONSUMPTION

By G. Jensen

THE instrument here described is, as far as I know, not widely used in England. It is simply a meter used to measure the total current consumption of the radio set under repair. Here in Denmark it is very common; all well-equipped workshops have one, and it is in constant use, since all radio sets coming in for repair are usually first plugged into the power socket, thereby connecting it up with the meter.

By doing this, one is often able to see at once what the probable fault in the set is, and occasionally be able to prevent further damage to the set by switching off, if excessive current drain is being indicated on the meter.

The instrument is a milliammeter connected in series with the receiver and the power line as shown in Fig. 1. It is usually included on the instrument panel along with other instruments, switches, etc., and a separate socket is provided on the panel so that, by just plugging the apparatus under test into this socket, it is automatically placed in series with the meter.

The Meter

This should have a full-scale reading of at least 500 mA or preferably 1,000 mA. The 500 mA full-scale reading will be sufficient for most four- and five-valve receivers, while a full-scale reading of 1,000 mA will be necessary for the larger sets with push-pull output stages, and also for sets employing an energised speaker.

The meter should be of sturdy build, with a heavy pointer so it will not be bent if it momentarily should happen to go off scale. It should have a large scale so that one can easily distinguish a difference in reading of 5 mA.

If the local power happens to be D.C., either a moving-iron or a moving-coil meter can be used, while if the power is A.C. a moving-iron meter can be used, or the moving-coil meter be provided with a suitable rectifier.

As mentioned above, the meter will indicate the total current consumption of the radio set under test, and one can gain quite a lot of information on a faulty receiver, particularly when the fault is in the power supply or in the output stage as many faults here are associated with either a decrease or increase in the current consumption of the receiver.

Using the Meter

By testing various types of receivers one will soon be able to estimate what the approximate current consumption of the receiver under test should be, taking into account the number and types of valves and whether it is a universal receiver or an A.C. receiver, and also be able to recognise any appreciable deviation from the normal current consumption.

For the purpose of illustration here are some examples of the way in which faults are indicated on the instrument and found easily. These faults can, of course, easily be found in the ordinary

manner by means of the volt - milli - ohmmeter (universal meter), but the advantage of the use of this instrument is that it will often indicate the probable fault just by plugging the set in and without doing any dismantling of the set.

Here in Denmark almost all radio receivers are of the A.C./D.C. type, and we will assume that we have such a set in for repair. The set has a valve-type rectifier with a heater current of 200 mA. The set is plugged into the socket connected with the meter and switched on; we should now get a reading of approximately 200 mA on the meter. If there is no reading, this will indicate either a break in the heater circuit (probably a dial lamp), or that the on/off switch is faulty. We might also get too low a reading which would mean excessive resistance in the heater circuit, and this could be due to a valve or a voltage-dropping resistance incorrectly wired.

As the valves warm up and the rectifier starts passing current, the reading on the meter should increase by about 60-100 mA, dependent upon the set in question and particularly the type of the output valve(s). If, after the warming-up period, no rise in current is observed, it means that the rectifier fuse has blown or that the rectifier valve is not passing any current.

In the case where some current rise is shown, but it is below normal, it could be due to a run-down reservoir condenser, a worn-out rectifier or output valve, or perhaps will indicate that the bias on the output valve is too high.

If the current rises to a value appreciably above normal and perhaps keeps on rising, switch off at once, as this will indicate a short-circuit in the power supply (most likely a bad electrolytic condenser) or the output valve is faulty or not getting its proper grid bias. In this instance, one can, by switching off, prevent further damage such as burned-out resistors or damage to the rectifier valve.

A Check

After having made repairs in the power stage or output stage, it is a good point to watch the meter carefully after having switched on in case any

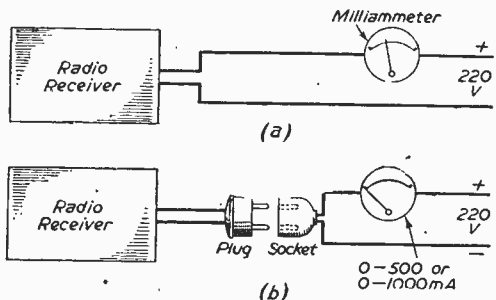

Fig. 1—(above) Basic arrangement and (below) practical arrangement.

mistakes have been made in the replacements of parts, or a defective electrolytic condenser has been put in.

When dealing with a receiver having an intermittent fault, or where the fault only occurs after the set has been on for some time, it is advantageous to have the meter in circuit, since when the fault occurs it may cause a change in the current reading, either momentarily or permanently; and this will give a clue to the location of the defective component or valve.

U.S. Radar Warning System

THE Official Gazette of the U.S. Patent Office, published in October, 1951, gave a description of an invention made by Brig. General David Sarnoff, chairman of the Board of the Radio Corporation of America, of an automatic early warning system. The U.S. Patent Office has granted him Patent No. 2571386, which he assigned to the R.C.A.

The invention relates to an automatic early warning system which combines the principles of television, radar, microwave relay and the latest methods of detection and direction-finding. The new system can utilise equipment already developed and in use.

In describing the principles of the system disclosed in this patent, Dr. Elmer W. Engstrom, vice-president in charge of R.C.A. Laboratories Division, with headquarters at the David Sarnoff Research Centre, Princeton, N.J., said:

"General Sarnoff's patent discloses a method and means for surveillance of a string of areas off-shore, or remote from the borders of a country, for detection of 'planes, guided missiles, enemy vessels, or other targets in those areas. It provides for instantaneous communication of running target positions to a central intelligence station or command post within the country.

"The patent describes a method and means for dispatching fighter aircraft and directing them to the enemy 'planes, guided missiles or the like, that have been detected.

"It also describes means for early interception of report and control signals sent from and to a guided missile, and the radiating of identical signals for jamming of the channel, or counter-controlling of the missile.

"The system proposed by General Sarnoff would enable detection at much greater distances than is now feasible. At the same time it would transmit the information to a control centre that could act immediately. By this new method, counter-measures will have a greater opportunity to deal with enemy 'planes or guided missiles that might be carrying atomic bombs and to destroy them at sea before they can reach their targets on land.

"A further object of this invention is to provide an improved radar fence with a greater depth of protected area.

"The patent specification includes information about an airborne radar net for national defence in which a succession of 'planes leaving shore on a predetermined course search the specified area with radar equipment. The information thus compiled is then relayed automatically from the 'lead 'plane successively through the trailing 'planes and finally to the control centre on the home base. In this

(Continued at foot of next column)

Having given some of the more obvious faults and defects which will be indicated on the meter, it will be seen that this is a time-saving instrument and a worthwhile addition to any workshop. Some of the faults mentioned will give aural indication, which will give a clue to the fault; but it will be found that the instrument gives its indication of the fault and thereby assists in locating and clearing the defect more quickly and thus saves time, a big factor in radio service work.

A MUTUAL CONDUCTANCE BRIDGE

(Continued from page 126)

connected between the same points as those to which the resistance box was to be connected, and the bridge balanced for each resistance, the corresponding slope values being again the reciprocals of the resistance values. The resistances should range from 50Ω to $2,000\Omega$ and should be as many as may be obtained and be evenly spaced out in the range. For each value of resistance—and so for each value of mutual conductance—a reading of position of the pointer of R_6 should be noted down. Finally a graph should be plotted of mutual conductance against the angle of R_6 pointer. When the graph is complete, the position at which any desired value of mutual conductance is to be marked on the scale can be read off the graph.

TERMINOLOGY

R_a	= valve anode resistance
R_L	= anode load resistance
g	= mutual conductance
i_a	= anode current
i_k	= cathode current
μ	= valve amplification factor

When using the bridge, before making a measurement, the correct current and anode voltage, as recommended by the makers, for the valve under test should be set up by means of R_{10} , and R_{20} and S_6 . The sensitivity control should be kept down as far as is convenient in order to keep the current swing in the valve as small as possible. Large current swings will give inaccurate readings, since the valve will not then be passing the recommended current, or anything near it, for a large proportion of the time during which the test is being made.

(Continued from column 1)

way the radar net is moved continuously across vast distances covering possible enemy invasion routes.

"By adding a television camera to the 'plane's equipment, as explained in the patent specification, the radar information, together with dial readings indicating airspeed, compass bearing, altitude of the craft and any other needed facts, can be relayed to the Control Centre in the form of a continuously changing television picture.

"General Sarnoff's patent also describes means for intercepting the control and position signals transmitted by an enemy to and from a guided missile and the immediate radiation of identical signals for the purpose of eliminating enemy control over the winged weapon. In this way, the missile could be directed on a new path which would be continued until its fuel is exhausted and it falls harmlessly into the sea or on an uninhabited land area."

WE SPECIALISE IN
BSR
GRAMOPHONE MOTORS
DE LUXE MOTOR UNIT MU 15

Specification

SPEED ... 78 R.P.M.
 MAINS INPUT ... 200/250 volts, 50 cycles, A.C. Other voltages and frequencies to order.

MAINS CONSUMPTION ... Approx. 10 watts
 TURNTABLE ... 8in. diameter
 NET WEIGHT ... 2 lb.

This unit can be used with any normal type of pick-up. Its constancy of speed and ample torque make it suitable for lightweight or the heavier types.

£3 CASH or 10/- Deposit and 12 monthly payments of 7/6

3-SPEED MOTOR UNIT Type MUI4

The ingenious and simple method of speed change is positive and smooth of action. It is achieved simply by a movement of the speed change knob.

No belts of any type are used, a fact which greatly adds to reliability and eliminates the inherent "wow" defects of the belt type of three-speed motor.

Smoothness of action is assured by employing the BSR de Luxe 4 pole motor, which is noted for its low rumble and vibration factor

Special Features

- ★ 10in. diameter heavy pressed steel turntable, fitted on a precision ground taper steel spindle.
- ★ Self-lubricating bearings employed throughout, ensuring a long life of quiet running.
- ★ Speed change from 78 to 45 or 33½ R.P.M. simply and instantaneously effected.
- ★ Uniform turntable speeds under widely varying loads.
- ★ No stray field radiation noticeable with any type of pick-up.
- ★ Is ideal for use with any type of crystal or magnetic pick-up

£6.8.6 CASH or 29/- Deposit and 12 monthly payments of 11/8

MOS MAIL ORDER SUPPLY COMPANY
 The Radio Centre
 33 Tottenham Court Road, London, W.1.

FREE! to those who wish to Qualify in any of these subjects



- ACCOUNTANCY EXAMS ★ AVIATION—ENGINEERING AND WIRELESS ★ BOOK-KEEPING ★ CIVIL SERVICE ★ COMMERCIAL ART ★ ALL COMMERCIAL SUBJECTS ★ CIVIL ENGINEERING ★ DRAUGHTSMANSHIP ★ ELECTRICAL ENGINEERING—CITY AND GUILDS CERT. ★ GENERAL CERT. OF EDUCATION ★ HIGS, TOOLS AND FIXTURES ★ JOURNALISM ★ MATHEMATICS ★ MECHANICAL ENGINEERING—M.I.MECH.E., CITY AND GUILDS ★ PLASTICS ★ PRESS TOOLWORK ★ RADIO SERVICE ENGINEERING ★ RADIO (SHORT WAVE) ★ SALESMANSHIP ★ SECRETARIAL EXAMS. ★ SHORTHAND ★ SHORT TECHNICAL COURSES ★ SURVEYING ★ TELECOMMUNICATIONS ★ TELEVISION ★ WORKS MANAGEMENT.

This book costs you nothing. But it offers you success in terms of your career.

TEAR OUT

To the Governor, Dept. C.104,
The BENNETT COLLEGE
 Sheffield, Eng. Send me the free book on how I can Qualify

in.....(subject)

NAME.....

ADDRESS.....

..... AGE (if under 21).....

Please Write in Block Letters.

By Post, specialised tutors in these and many other subjects give individual attention to Bennett College Students. Tuition is guaranteed until you Qualify. State your subject. Send coupon for prospectus.

You can start on a Bennett Course FOR ONLY **30/-** and 15/- monthly.

Three Waveband Coil Pack, iron cored coil 16-50, 180-550, 1,000-2,000 metres. I.F. frequency, 465 kc/s. Size 4 1/2 in. x 1 1/2 in. x 2 in. 24/- Post paid. Double-ended Perspex trimming tool given free with each pack.

Constructor's parcel comprising 5-valve Superhet chassis with transformer, I.F. valve-holder and cut-out, size 18 in. x 5 1/2 in. x 2 1/2 in., with L.M. and S. scale, size 7 in. x 5 in. Back plate, 2 supporting brackets, drive drum pointer, 2 speed spindle, spring, 3 pulleys and 5 international valve-holders, 11/6, post paid.

To the purchasers of the above parcel, Coil Pack at the reduced price of 17/6, post paid.

Mains or Battery Superhet Portable Coils. Comprising medium-wave frame aerial and long-wave loading coil, used as aerial coils. Midget iron-cored screened L/M osc. coils, complete with circuit, I.F., frequency 465 kc/s, 9/6.

Metal Rectifier, 250 v., 50 mA., latest midget Selenium, 6/6. **Output Transformers.** Standard type 5,000-ohms imp., 2-ohms speech coil, 4/0; Push-Pull 6 v., 6 matching 10-watt 2-ohms speech coil, 6/9. Miniature type 42-1, 3/3.



PERSONAL PORTABLE CABINET in cream - coloured plastic; size 7 x 4 1/2 x 3 in. Complete 4-valve chassis. Takes miniature 90 v. and 71 v. batteries, 13/6. **POST PAID.**

2 1/2 in. P.M. Speaker to fit above, 13/6. Miniature output transformer, 5/-.

Miniature wave-change switch, 1/9.

Miniature 1-spole 4-way used as Volume and Off, 1/9.

4 B7G valve holders, 2/-.

Midget twin gang lin. dia. 1 in. long and pair medium and long-wave TRF coils 1 in. long x 1 in. wide; complete with 4-valve mill-dry mains and battery circuit, 8/6.

Tuning scale and four knobs, 2/6.

Condenser Kit, comprising 11 miniature condensers, 4/6.

Resistor Kit, comprising 12 miniature resistors, 3/6.

The above receiver (less valves and batteries) could be built for approximately 55/-.

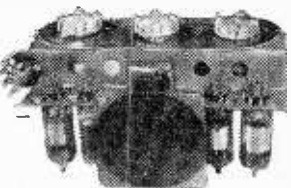

View of chassis as it would look when assembled with valves inserted.

Midget Bakelite Cabinet. 7 in. x 5 1/2 in. x 5 in. c/w 5-valve S.H. chassis, med. long wave scale and back (takes std. twin-gang condenser and 3 in. speaker), 15/- P. & F. 13/6.

Wave-change Switches. 6-pole 3-way, 2/-; 3-pole 2-way, 1/3; 4-pole 3-way, 1/9; 5-pole 2-way midget, 1/9. P. & P. 3d. each.

Pre-Aligned Midget 465 kc/s Q.120. 9/- per pair. **Miniature 465 kc/s I.F.s.** Q.120, per pair, 10/-.

465 kc/s Midget I.F.s. Q.120, size 1 1/2 in. long, 1 in. wide, 1 in. deep. Pre-aligned adjustable iron-dust cores, pair, 12/6.

Iron-cored 465 kc/s Whistle Filter, each 2/6. **Valve-holders.** Paxolin international octal, 4d. each. Moulded international octal, 7d. each. EF50 ceramic, 7d. each. Moulded B7G slightly soiled, 6d. each.

Trimmers. 5-40 pf., 5d.; 10-110, 10-250, 10-450 pf., 10d.

Twin-gang .0005 Tuning Condensers. 5-. With trimmers, 7/6. Midget .00037 dust cover and trimmers, 8/6.

Constructor's Parcel, comprising chassis 10.5x12in. with speaker and valve-holder cut-outs, 5 in. P.M. speaker with transformer, twin gang with trimmers, pair T.R.F. coils long and medium, iron cored, four valve-holders, 20 k. volume control and wave-change switch. Post paid, 21/-.

P.M. SPEAKERS

	with trans.	less trans.
2 1/2 in.	13/6	13/6
3 in.	11/6	11/6
5 in.	15/-	12/6
6 in.	14/6	11/6
8 in.	17/-	14/6

Post and Packing on each of the above 1/- extra.
 Terms of business:—Cash with order. Dispatch of goods within three days from receipt of order. Where post and packing charge is not stated, please add 6d. up to 10/-, 1/- up to £1 and 1/6 up to £2. All enquiries and Lists, stamped, addressed envelope.

D. COHEN

RADIO AND TELEVISION COMPONENTS
23, HIGH STREET, AGTON, W.3.
 (Opposite Granada Cinema)

Hours of Business:—Saturdays 9-6 p.m. Wednesdays 9-1 p.m. Other days 9-4.30 p.m.



HAVE YOU BEEN INTRODUCED?

This picture on our Handbook is symbolic to many thousands of men like yourself. For them it means success—not failure! By following the TWELVE circuits and full details given in OUR NEW ENLARGED "HOW TO CONSTRUCT" they now enjoy greater pleasure (and profit!) by building their own Radio and Test Equipment! Remember, the secret is in our unique LIFE-SIZE "EASY-AS-ABC" point-to-point CONSTRUCTION SHEETS. Every part is broken down to a simple sub-assembly which, together with our system of identifying ALL parts, ensures that even the COMPLETE NOVICE can build our most complicated circuit knowing success is assured! ALL components are standardised so that many circuits can be built WITH THE SAME COMPONENTS! And REMEMBER—NO ALIGNMENT IS REQUIRED! The price? An absolute CWT at 2/6! SEND NOW for YOUR copy, obtainable ONLY from

RODING LABORATORIES (Dept. PW.1)
694, Lea Bridge Road, London, E.10.

TRANSFORMERS

M.T.1.—250-0-250 v. 80 mA; 0-4 v. 5 a.; 6.3 v. 3.5 a., 0-4.5 v. 2 a.
M.T.2.—Same as M.T.1. but 350-0-350 v. M.T.3.—30 v.; 2 a.; tapped every 3 volts. All primaries tapped for 200

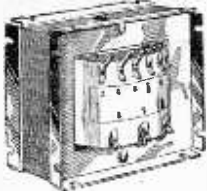

M.T.4. Auto 0-10-120-200-230-250 v. 100 watts. Examine what you buy. From component dealers or write to us if you obtainable. The maximum price for these transformers is 24/- each.

THE DOUGLAS COIL CO.,
BRINKLOW, RUGBY.

CABBI PLANS

BUILD YOUR OWN RADIO CABINETS!

We offer exclusive cabinet designs for Radios, Radio-grams, Table-grams, and Extension Speakers.

Send S.A.E. for Illustrated Brochure.
216, FOOTSCRAY ROAD, NEW ELTHAM, S.E.9.

SPECIAL OFFER BARNBURY STOCK

150 only
3 Valve TRF Long & Med. Wave Battery Sets with Output Trans. Less Valves & Speaker.

18/6 Post Paid.
Stamp for Lists. Tel.: St. Albans 595.1.

BOLD & BURROWS
12, Verulam Rd., St. Albans, Herts.

Best Buy at Britain's

COMMUNICATION RECEIVER RL155.—Absolutely Brand New and in perfect working order. £13.18.6, plus 10/6 carriage and packing in original transit case. To those not familiar with the set full technical details can be supplied for 1/3 post paid.

RL155 POWER PACK AND OUTPUT STAGE.—Assembled in a neat black case size 8 1/2 in. x 9 in. x 4 in.—enable the receiver to be operated direct from A.C. mains. Price £4.10.0 carriage paid.

"SCOPE BARGAIN.—Erskine Lab., Ltd., Oscilloscope Type 1/B. Ready for use on 200/240 volts A.C. mains complete with valves and CRT in black metal case with carrying handle. Brand new and boxed with circuit. Special bargain price only £10.10.0, plus 5/- carriage.

SPECIAL PURPOSE VALVES.—VT501 (C7H), 5/-; 6E4 2/6; VR138 (EP54), 6/6; E114B 2/6; VR55a (SP4), 3/-. Hundreds of other types in stock. Post 6d. extra for 1 to 4 valves.

EX-GOVERNMENT H.T. BATTERIES.—50 volts and 1.5 volts. Size 8 1/2 in. x 4 in. x 3 in. Tested O.K. on load. Price 6/-, plus 1/6 post.

SYLVANIA RED EP50's.—Brand new at 8/6 each. British types (tested), 5/- each.

MANSBRIDGE BLOCK CONDENSERS.—10 mfd. 1,000 volts test, 3 for 10/6 post paid.

MAJNS TRANSFORMERS.—3 types, all standard primaries. Universal mounting. (1) 350-0-350 v. 80 mA., 0-4-6.3 v. 4A., 0-4-5 v. 2 A., (2) 250-0-250 v. 80 mA., 0-4-6.3 v. 4 A., 0-4-5 v. 2 A., (3) 30 v. 2 Amps. Tapped at 3 v., 4 v., 5 v., 6 v., 8 v., 9 v., 10 v., 12 v., 15 v., 18 v., 20 v., 24 v. All these transformers are brand new and boxed, fully guaranteed and priced at 18/6 each, plus 9d. post.

Callers—we are one minute from Leicester Square and Lisie Street



CHARLES BRITAIN (RADIO) LTD.

11, Upper Saint Martin's Lane, London, W.C.2. TEM. 0545
Shop hours. 9-5 p.m. (9-1 p.m. Thursday)
OPEN ALL DAY SATURDAY

SPARKS' DATA SHEETS

Are the Safest, Simplest and Finest Constructional Sheets of Tested and Guaranteed Radio Designs Second to None. JUST RELEASED!

THE "CHUMMY" PORTABLE

An All-dry 2-Valver which does give really good 'Phone sigs. on Med. and Long-waves. Self-contained aerial and batteries. Tested in Dorset 70 miles from nearest Regional Station and 115 miles from Droitwich, both giving very good 'Phone sigs. Size approx. 8 in. x 4 in. x 2 in. Data Sheet with instructions 3/- plus 2/d. stamp.

THE "MIDDY"

An All-dry 2-Valver for use with Aerial and Earth. Gives fine Speaker results on Med. and Long-waves plus "Ship-to-Shore" Transmissions. Tested in Dorset Compact and Easy to Build. Ideal Set for the Car, Beside, Caravan and as a Power Cup Stand-by. Data Sheet, etc., 3/- plus 2/d. stamp.

REMEMBER SPARKS' SETS SET THE STANDARD
STAMP FOR LIST COMPONENTS SUPPLIED

L. ORMOND SPARKS (P),
48A, HIGH STREET, SWANAGE, DORSET



Accurately tests High, Low and Grid Bias Batteries. Write for leaflet 29 M.

RUNBAKEN MANCHESTER

Cabinets of Distinction...

Send 6d. for Latest Illustrated Catalogue.

Chassis

A.C., 5-valve 3 w/b Superhet Radiogram chassis. Absolutely complete kit of parts, including wiring diagram £10.15.0
Or fully wired and tested £12.10.0

Amplifiers

Four to fifteen watts output. Wired, or in kit form, from £3.19.6
Full details of above available on request.

LEWIS RADIO CO.

Correspondence to:—(Dept. K.14),
322, HIGH RD., WOOD GREEN,
LONDON, N.22.

Callers to —
120, GREEN LANES,
PALMERS GREEN,
LONDON, N.13
BOWes Park 6064

NEW GOODS ONLY

CONDENSERS.—450 V.W. 1 mfd. 2/9; 4.3/3; 8.3/5; 16.4/6; 32.5/11; 6.3/8; 8-16; 7.6; 16-16; 10/6; 50/7; 2 mfd. 3/-; 4.3/5; 8.3/9; 16.4/9; 3.8; 7.6; 8-16; 8/8; 16-16; 9.9; 25 x 25 v. 25 x 50 v. 50 x 12 v. 2/3; 60 x 50 v. 2/10; Tubulars. 500 V.W. up to .0005, 8d.; to .005, 10d.; to .04, 11d.; to .1, 1/2; to .25, 1/6; to .2/3, 1 mfd. 3/-; Moulded Mica. up to 1003. 10d.; to .01, 1/6; 5/11; Mica. up to 100 pf. 9d.; to 500 pf. 1/-; to 1,000 pf. 1/2; 2,000, 3,000 pf. 1/3.

VOLUME CONTROLS.—Lg. spdl's. All values, 3/6; with S.W. 5/3; D.p. 3/6; 6/-; Semi Midget type. 1. 1. 2 meg. 5/-; with S.W. 7/-; D. S.W. 8/-; Wire Wound. less S.W. 1 K. to 80 K. 6/6; 100 K. 7/9.

RESISTORS.—All values, 1 W. 5d.; 1 W. 6d.; 1 W. 8d.; 2 W. 1/4d.; Wire Wound. 5 W. up to 5 K. 2/-; 10 W. up to 10 K. 2/9. All View-Master TV. Parts Supplied. Terms: Orders up to 10/-, post 4d.; up to £1. 6d. Over, Post Free. Cash with Order.

RADIOLECTRON

22, Frances Street, Scunthorpe, LINCOLNSHIRE.

COILS

For Summer All-Dry Portable. 4/3 each. All-Dry 3-Band-3 (August), 6/6 pair. A.C. Mains Midget (Oct./Nov.), 6/6 pair. I.R.F. Coils less reaction. 5/6 pair. Miniature Coil Pack. L.M.S. 2/7.6, or make your own. 18/6, all parts inc. L., and M.W. Crystal Set Coil. 3/3. High Q. Miniature I.F.T.s. 465 Kc., 13/6 pair. Red Fernpex Indicator Dial Lamp Holders. 6d., 10 amp. Toggles, 9d., etc. Trade Terms available.

T. G. HOWELL

29, McWilliam Road, Brighton. Mail Order Only.

YOU READ MUSIC?

*Then how about making yourself an electronic organ. Constructional data available—full circuit, drawings and notes. It has 5 octaves, 2 manuals and pedals with 24 stops—uses 41 valves. With its variable attack you can play Classics and Swing.

Write NOW for free booklet and further details to: C. G. S., 10a, Duke Street, Darlington, Durham.

A Simple Alignment Indicator

A TRIMMING AID

By James S. Kendall

IT is essential in aligning modern radio receivers and television sets to have an accurate means of determining when a circuit is tuned to resonance. This unit can be made out of war surplus for about 10 shillings. It is very simple, and can be built as a separate bench unit or incorporated in the same case as a signal generator. The load it exerts on the circuit under test is very low but capacitive.

The parts required are :

- A piece of aluminium or copper 6in. x 1½in.
- One International Octal valveholder.
- Two 6 B.A. screws and nuts.
- One 10 MΩ resistor (½ watt).
- One 1 MΩ resistor (½ watt).
- One 100 pF capacitor.
- One 6U5G "Magic Eye" tuning indicator.

Construction

The bracket consists of a piece of metal 6in. x 1½in., with two right-angle bends (see Fig. 1). These two bends require a little care. It must be remembered that the marking-out must be done on the inside of the fold. If it is done on the outside of the bend the metal tends to split down the scriber mark ; this not only gives an untidy finish but weakens the bracket. The holes to take the two 6 B.A. screws for fixing the valveholder are drilled with a ¼in. drill. The best way to take out the 1½in. hole for the valveholder is with either a tank-cutter or with one of those very excellent Q-Max cutters.

After the bracket is finished, the valveholder is fixed to it. The components are connected direct to the valveholder as shown in Fig. 2. Pin number six on the valveholder is used as a fixing tag for the A.C. end of the 100 pF capacitor (which should be of mica and about 500 V.D.C. working). In the case of mounting the unit on an existing signal generator, a 1in. hole is made in a convenient place on the front, two fixing holes made (¼in. diameter) and the unit mounted by them. The amount of power used by the unit is 4 mA at 250 volts and 0.3 amps at 6.3 volts. Three plug sockets should also be mounted close to the unit to facilitate connection to the set under test.

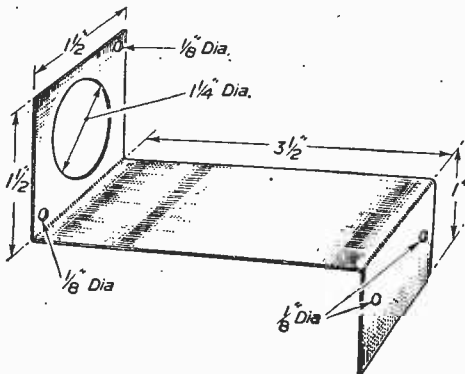

Fig. 1.—Details of the bracket for the unit.

If the unit is to be used apart from a fixed power supply, the power can be obtained from the set under test providing, of course, the set has 6.3 volt valves. The heater power is then obtained by connecting the heater leads across the heater of one of the valves in the receiver. The H.T.— is obtained by

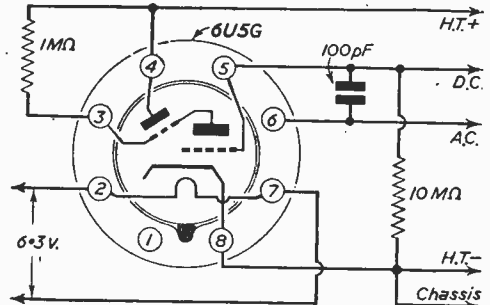

Fig. 2.—Circuit of the indicator.

connecting the cathode of the tester to the chassis of the receiver, and the H.T.+ is obtained from the smoothing condenser or other convenient place.

Application

To use the indicator for aligning a radio or television receiver using a diode detector, connect the D.C. socket to the diode load and tune the relevant trimmers for a maximum shadow on the indicator ; this can best be done using an unmodulated signal. In the case of an anode bend or infinite impedance detector, the A.C. socket is used and a modulated signal must be used ; the tuning is again carried out for as large a shadow as possible.

The unit can also be used for fault-finding by the signal tracer method by using a probe (an ordinary lead will do) connected to the A.C. socket. A modulated or unmodulated signal can be fed into the aerial socket and the signal traced through the set by touching the probe on first the grid then the anodes of the various valves, starting with the valve nearest to the aerial ; the shadow will get larger and larger as progress is made through the receiver. This is due, of course, to the amplification of the various stages. The fault is in the components between the last point you get a " shadow " and the first point you do not. It is also possible to test whether or not the oscillator section of the frequency-changer valve is functioning by touching the probe on to the oscillator grid ; a large shadow on A.C. indicates that the section is working.

THE PRACTICAL WIRELESS ENCYCLOPEDIA

12th Edition
By F. J. CAMM

Price 21/-, or 21/10 by post from :

GEORGE NEWNES LTD., Tower House,
Southampton Street, Strand, W.C.2.

Programme Pointers

A MONTHLY CRITIQUE BY MAURICE REEVE

THE Christmas seasonal programmes must ever be a problem to both thoughtful programme designers and listeners alike, so long as broadcasting is run on its present lines. For instance, I refuse to believe that more than a handful of people would listen at 8.15 a.m. on Christmas Eve to "Morning Music" and to a recital which immediately followed it, given by a soprano and a cellist; neither do I believe that more than a sprinkling tuned in to "Toytown," Ethel Smith on records or "Postman's Knock" at 8.15, 8.30 or 9 respectively on Christmas morning. Similarly, on Boxing morning, when practically the entire nation is either having a glorious lie-in after its exertions of the day before, or is away from home, do I credit that anyone troubled themselves over further "morning music," 8.15; Christmas in Canada, 9; or O'Flaherty's short story, "Spring Sowing," 9.30. (Incidentally, I should have loathed being commissioned to give a piano recital immediately following His Majesty's broadcast on Christmas afternoon. Millions of sets must have been switched off as soon as it was over. But that was Mr. Frank Lafitte's hard fate, none the less.)

Why doesn't the BBC partially do what the whole business and newspaper community does entirely, namely, shut-up shop and relax? It could easily provide in about six hours on each wavelength, all the broadcasting that is really wanted and gets properly listened to, and then we could have programmes of real quality that would be worth while timing our dinners to. If all this dead wood was ruthlessly cut away, how much more enjoyable and appreciated the remainder would seem. A quarter of an hour, for tuning in purposes, preceding news bulletins, followed by a complete close down after each. Then the trip round the Empire preceding the King's address, followed by another silence until the six-o'clock news which would usher in an evening on all three programmes of items of compelling interest and outstanding ability. The procedure for Boxing Day, plus some sporting commentaries, should be much the same.

Good Items

Of the many items which struck me as particularly good were "Woman's Hour Christmas Party," the talk on the *Discovery* and the *Fram*. One Minute, Please, Twenty Questions and Pinero's "His House in Order," with Sir Godfrey Tearle and distinguished colleagues. These all took place on Christmas Eve. On Christmas Day there were, of course, The Gifts of Christmas, Memories of Itma, We Beg to Differ, Take It From Here, and Edward Gordon Craig's—Ellen Terry's son—reminiscences of Irving, not, by the way, a review of the recent monumental life of Irving, which I was rather hoping it would be. On Boxing Day, hours and hours of mediocrity were interspersed with a symphony concert—solo pianist, Abby Simon—and The Winter's Tale. These grievously overlapped, only one being possible in its entirety. Have a Go would have been enjoyable, but it had to give way to the aforementioned as we have it every week.

I was one, as I believe, of the vast majority, who

took no notice of the morning programmes. I expect the hour and a half's adaptation of "King's Rhapsody" pleased many, but I plumped for Shakespeare and Beethoven. I have set out the above items in chronological sequence and not in any special order of merit.

Plays

There has been an exceptionally large number of excellent and interesting plays lately. The late James Bridie's "Mr. Bolphy" tells of a visit among us of the devil, in the person of Mr. Bolphy, and of the much-needed shaking up he gave our complacency and self-satisfaction. Abraham Sofaer very good. Wilfred Grantham's "Mary Tudor" gave an unusual facet of this tragic, and usually labelled bloody, daughter of bluff King Hal. Instead of, as one might have expected, an imperious monarch ordering the butchery and racking of Protestants hip and thigh, right, left and centre, with our nostrils savouring burning flesh and heretical Bibles, we had a picture of a most charming, lovable and feminine woman, who was far more afraid of her sister's alleged conspiracies than of either Cranmer or Latimer. The religious persecutions, which make the reign famous in history, formed the merest background. When I say that Flora Robson, C.B.E., that specialist in both Catholic and Protestant ladies of the Tudor period, played Mary, my adjectives become redundant. Maxine Audley was a kittenish and elusive Elizabeth.

"His House in Order," by a master craftsman, told with great power and feeling of a husband's reactions on learning of his wife's past, and that his son was not in reality his own. That the painful discovery was made quite fortuitously, and that a greater dramatist turned Pinero's plays into something of museum pieces, didn't in the least detract from a wholly welcome revival. Sir Godfrey Tearle gives the production the greatest distinction. "Epitaph for a Spy" gave a welcome French angle to thrillers—most refreshing. "The Judge's Story," from Charles Morgan's novel, told of a dear old boy's sacrifice to honour a wager out of love for the daughter of the woman he didn't marry.

Clifford Curzon, most eminent of English pianists, gave a first-class talk on his teacher, Schnabel, and the New London Quartet, with co-operating artists, played Schubert's wonderful Octet, Op. 166 beautifully.

NEWNES METRIC & DECIMAL TABLES

By F. J. CAMM

3/6, or 4/- by post from

Geo. Newnes, Ltd., Tower House,
Southampton St., Strand, W.C.2.



**DEPT. P.W.
18 TOTTENHAM CT. RD.
LONDON, W.1.**

MUSEUM 4539/2453

MAINS TRANSFORMERS (all upright output in lb):

- Fv. 200-240 v., sec. 350-0-350 v. 80 mA., 6-1 v. 5 a., 6.3 v. 4 a., 0-4.5 v. 2 a. Price 21/- plus 1/- post.
- Pri. 200-240 v., Sec. 3 v. 4 v., 5 v., 6 v., 8 v., 9 v., 10 v., 12 v., 15 v., 18 v., 20 v., 24 v., 30 v., 2 a. Price 19/6 plus 1/- post.
- Pri. 200-240 v., Sec. 350-0-350 v. 60 mA., 6.3 v. 3 a., 5 v. 2 a. Price 21/6, plus 1/- post.
- Pri. 200-240 v., Sec. 350-0-350 v. 80 mA., 6.3 v. 3 a., 5 v. 2 a. Price 27/6, plus 1/- post.
- Pri. 200-240 v., Sec. 250-0-250 v. 120 mA., 6.3 v. 7 a., 5 v. 3 a. Price 28/6, plus 1/- post.
- Pri. 200-240 v., Sec. 350-0-350 v. 120 mA., 6.3 v. 5 a., 5 v. 3 a. Price 37/6 plus 1/- post.
- Pri. 200-240 v., Sec. 300-0-300 v. 100 mA., 6.3 v. 3 a., 5 v. 2 a. Price 21/6, plus 1/- post.
- Pri. 200-280 v., 6.3 v. 1.3 a. Price 7/6, plus 6d. post.
- Pri. 200-230 v., 4 v. 2 a. Price 7/6, plus 6d. post.

CHOKES :

20 Hy. 10 mA. 1,000 ohms	5/6
60 Hy. 20 mA. 1,000 ohms	6/6
60 Hy. 30 mA. 1,000 ohms	6/6
15 Hy. 60 mA. 300 ohms	5/6
20 Hy. 60 mA. 500 ohms	9/6
10 Hy. 100 mA. 300 ohms	14/-
10 Hy. 150 mA. 200 ohms	15/-
15 Hy. 150 mA. 170 ohms	17/9
5 Hy. 250 mA. 80 ohms	18/-

Postage and packing, 9d. extra.

- OUTPUT TRANSFORMERS :**
- Wharfedale OF3. Ratios, 30, 60 and 90 : 1, at 7/-.
 - Wharfedale type P. Ratios, 30, 60, 45 and 90 : 1, at 8/6.
 - Wharfedale type GFS. Ratios, 12, 18, 24, 30, 36, 48, 60 and 72 : 1, at 12/6.
 - Wharfedale Universal. Ratios 40 CT., 60 CT. and 80 : 1 CT., at 16/6.
 - Wharfedale W.12. Ratios 15, 22 and 45 : 1.25/-.
- PICK-UPS :**
- Marconi No. 14 with Transformer... £2 8 4
 - Coinciseur with Transformer... £2 8 4
 - Goldring No. 100... £1 15 11
 - Goldring No. 121, Lightweight... £2 13 9
 - Goldring Headset with three heads... £8 15 6
- Postage 1/6 extra.
- Collaro AC514 A.C. Motor and pick-up. £8 10 5, plus 1/6 post.
- Coinciseur 2-speed Motor and T/Tabie, £20 19 3, plus 3/6 post.

- SPEAKERS :**
- 5in. 3 ohms W/B. Stentorian... 19 6
 - 5in. 3 ohms ELAC... 15 0
 - 8in. 3 ohms Plessey... 17 6
 - 6in. 3 ohms Plessey... 18 6
- Post 1/- extra.
- "DENCO" ALIGNMENT OSCILLATOR**
D.A.O.I. This unit provides a modulated signal for the alignment of I.F. Amplifiers, etc. The two standard frequencies of 465 kc/s and 1.6 mc/s are selected by the turn of a switch. Price 47/6, plus 1/- post.
- A.D.S. QUALITY AMPLIFIER.** Full constructional details of our 41 watt quality Amplifier are available, including circuit diagram and layout pictures. Post free 10d. Complete set of components for above Amplifier, including cabinet finished in black crackle. Price £7/15/0.
- Completed Amplifier available constructed and fully tested. Price £8/17/6.

FULL MAIL ORDER FACILITIES

Shop Hours: Monday-Friday: 9-3.30 p.m.
Sats. 9-1.

BATTERY SUPERSHEDDER.—Will save battery users pounds. Operates from a 2-VOLT ACCUMULATOR and delivers constant H.T. of 67 volts at 4.7 ma., 130 volts at 13-25 m.a., and 1.4v. L.T. if required. American made, and originally intended for Walkie-talkie equipment, this unit is easily adapted for use with any battery set, and fully illustrated details are supplied. ONLY 60/- (postage, etc., 2/-).

PYE 45 MC/S I.F. STRIP.—Ready made for London frequency vision channel. Complete with 6 valves EF50 and an EA50, and details of very slight modifications required. ONLY 59/6 (postage, etc., 2/6).

I.F. STRIP TYPE 194.—An easily modified I.F. Strip recommended for TV constructors who want good results at moderate cost, or for those who have built televisions but are having trouble in the vision or sound receivers. This 6-stage strip measures 18in. x 5in. x 5in., and contains 6 valves VR65, 1 of VR92, and 1 of VR53 or VR56. Mod. data supplied. BRAND NEW. ONLY 45/- (postage, etc., 2/6).

10-VALVE 11-TUBE SUPERHET. ZC8931.—For long-distance TV results. Valve line-up is 6 of VR65, 2 of VR92, and 1 each VR138 and VR137, and the 12 mc/s 6-stage I.F. Strip gives tremendous amplification with ample bandwidth of 4 mc/s. or 45% modified, full details supplied. ONLY 59/6 (carriage 5/-).

RDFI RECEIVER.—The unit described in October 1951 issue of *Practical Television* for conversion into a 2-CHANNEL TELEVISION RECEIVER, giving SOUND AND EXCELLENT condition, and complete with 14 valves : 5 of SP61, 2 of P61, 3 of EA50, and 1 each CV63, EB34, EC62, 5Z4, and a reprint of the above article. ONLY 49/6 (carriage, etc., 5/-).

R.L.S. RECEIVER POWER PACK with built-in output stage. A special factory-made job designed to plug on to the set and operate it without any internal modification. Will drive any size low impedance P.M. speaker. Housed in attractive black crackle metal cabinet and complete with valves. ONLY 45/10 (carriage, etc., 5/-).

BALANCED-ARMATURE EARPIECES—High grade ex-Govt. Make excellent midset speaker. ONLY 3/9 (postage 6d., 45/- doz., carriage paid).

100-MICROAMPS METER.—21in. flush-mounting. Widely calibrated scale of 15 divisions marked "Yards," which can be re-written to suit requirements. These movements are almost unobtainable to-day and being BRAND NEW IN MAKER'S CARTONS are a saving at ONLY 39/6. (CAR OR STORAGE BATTERIES). By famous American makers. BRAND NEW AND UNUSED, these have genuine hard rubber cases. 6 v. 77 a.h. "PHILCO" size. 10in. long. 7in. wide. 8 1/2in. high. ONLY 82/6. 6 v. 90 a.h. "THOR" size 8 1/2in. long x 6 1/2in. wide x 7 1/2in. high. ONLY 87/6 (carriage 5/- each battery).

EX-W-D. TRANSFORMERS.—All Heavy Duty, with 230/250v. Primaries. Type A has Secondaries of 300, 250v. and 4v. 3 amps. ONLY 22/6. Type B is an E.H.T. transformer with Secondaries of 2v. 1.5 amps., 300v. 10 m.a., 520v. 10 m.a., 1,400v. 2 m.a. ONLY 21/-. Type C is a Filament Transformer with Secondaries of 6.3v. 7.7 amps., 4.2v. 2.5 amps., 4v. 1 amp. ONLY 19/6. Also available is a companion CHOKE of 30H 150 m.a. at ONLY 12/6. ALL ABOVE ITEMS BRAND NEW AND UNUSED. Postage on each item 1/6.

MURKIN'S SLOW-MOTION DRIVE.—A really precision product of this famous maker : 3in. in diameter with edge marked 0-180. Complete with cursor. BRAND NEW IN MAKER'S CARTONS. ONLY 8/6 (postage 1/-).

CONDENSERS.—Paper, metal cases.—1 mfd., 3,000 volts. 4/6; electrolytics (can unless stated) : 8 mfd. 450v.. 2/6 ; 8 x 8 500v. 4/9 ; 8 x 16 450v.. 5/9 ; 16 500v. cardboard, 6/- ; 16 450v. can, 5/6 ; 15 x 16 500v.. 7/- ; 24 350v. cardboard, 4/6 ; 25 25v.. 1/6 ; 22 350v. 2/9 ; 50 12v. can or card, 1/- ; 32 x 16 450v. 6/6. Postage 1/- please on orders under 1l.

Cash with order, please, and print name and address clearly. Amounts given for carriage refer to inland only.

U.E.I. CORPORATION
The Radio Corner.
138 Gray's Inn Rd., LONDON, W.C.1

Open until 1 p.m. Saturdays. We are 2 mins. from High Holborn (Chancery Lane Stn.) and 5 mins. by bus from King's Cross.

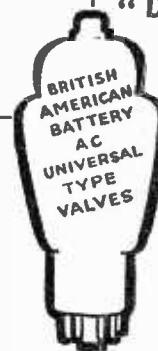

"DEMOBBED VALVES" MANUAL

2/3
Post Free
giving equivalents of British and American Service and Cross Reference of Commercial types, with an appendix of B.V.A. Equivalents and comprehensive Price List. We have still some valves left at

PRE-BUDGET rates which are actually sold at the old price.

EXPORT

to all parts of the Commonwealth and beyond—safely packed, fully insured (no C.O.D.) and free of tax.

—If yours is a (RARE) Valve problem BULLS are the people most likely to solve it.

NEW!—COLOUR Television Filters for Viewing in three delightful colours, giving a three-colour pastel shade picture on any black and white screen.

9in. and 10in.	12in.	15in.
10/9	12/6	19/6

(Post 1/-)

AMERICAN Type Electric SPRAYERS, British made. Just plug in and spray. No vacuum cleaner or compressor needed. Easier than a brush and twice as fast. A.C. Model £3.15.0. Post 1/6.

TAYLOR METERS EASY TERMS
New Range at Reduced Prices up to 10 months, and very nearly cash price.

PIFCO ALL-IN-ONE RADIOMETER A.C. and D.C., test everything in radio. Complete with test prods 27/6. Post 1/6.

SERVICE SHEETS.—The one you require, if available, enclosed in a dozen assorted, our choice, 10/6.

CONDENSER TESTERS & RECTIFIER UNITS.—Plugs straight into A.C. mains, 200/240 v., and is indispensable for examination of condensers. Very slight and intermittent leakages which cannot be discovered by conventional instruments can be traced by this unit. Complete 39/6. Post 1/-.

B.T.H. Germanium Crystal Diodes. Sale Price 3/-.

1,000 mfd., 12 v. Block Electrolytics. Brand New, 7/6.

E.F.6. Valves Rare Type. Reduced to 12/6.

1952 MAILING LIST FREE
Coupon for Special Bargain Offers.

NAME

ADDRESS

Please write in BLOCK LETTERS and Post to P.W.3.

RADIO BULLS VALVES
246 HIGH ST. HARLESDEN MIDX
SCP

ALPHA OFFERS

VALVES Guaranteed new and boxed. Some Government surplus.

VALVE	PRICE	VALVE	PRICE
024	8/9	PM202	7/6
1G8	7/6	PM2A	7/6
1CG8T	8/6	1LN5	6/9
1T4	9/6	1LD5	6/9
184	9/6	624	7/3
1R5	9/6	5B4	8/6
185	9/6	6B8	7/9
1AG7	7/6	CV135	8/6
384	10/6	6L7	8/6
3Q4	9/6	6R7	9/6
3V4	9/6	6F7	9/6
3D6	7/6	KT30	10/6
3Q5GT	8/6	N78	8/6
3C4	7/6	DD13	7/6
38	7/6	SP13	4/6
Z66	11/9	CV72	4/6
ML6	6/9	CV73	4/6
7K7	9/6	6W3	9/6
7C5	9/6	6K6GT	8/6
7F6	9/6	19	6/6
7B7	9/6	15	6/6
8D14	4/6	MKT4	10/6
8N7	7/6	2A3	7/6
8D2	4/6	KT233	7/9
9D2	4/6	MS/PEN	7/9
2X2	5/6	6SH7	7/6
KTZ41	7/9	42	9/6
6C6	7/6	524H	9/6
6D9	8/6	3AGT	9/6
934	2/9	6AC7	6/9
935	5/6	6AG7	6/9
956	2/9	6CG7	7/9
6K7G	6/6	6J7	7/6
8F41	4/6	6V6GT	7/6
8F61	4/6	KT33C	11/6
8F50	6/6	VU39	9/6
6H6	4/6	EL32	7/6
8B34	4/6	EK32	7/6
8J60T	5/6	21580	7/6
8F39	5/6	68K	12/6
VU120A	4/6	VP231	7/6
VU111	4/6	PE257	7/6
Z21	8/6	1625	6/9

Cash with order or C.O.D. List available 3d.
 MAIL ORDER ONLY. SEE OTHER ADVERT.
ALPHA RADIO SUPPLY CO.
 5/6 Vince's Chambers, Victoria Square, Leeds. 1

VALVE BARGAINS

807, VR150/30, 8/6 each or 3 for 24/-; 1L4, 3A4, 3Q4, 7/6 each or 3 for 20/-; EL32, 6/6 each or 3 for 17/-; Also a few sealed but O.K. PTLs three for 20/-; TT11, EF36, three for 10/-; ML6, three for 7/6. All guaranteed. 6J6, 3A5, 20/-; EF30, ECL80, 17/6; X78, EC91, CV139, 6B4G, X61M, CCR35, 15/-; 6K8, 6A8, 12K8, 25L6, 12/6; X88, EL33, KT61, KT68, KT33C, 6AG5, 6SN7, 6L6, PEN383, 6E5, PX25, 10/-; Y63, GTIC, VP41, 8/6; 6L7, KT61, EBC33, N18, 7/6; 6C4, 6K7, 6N7, 12A6, 6/6; 9002, 6J5, 6C5, 5/-; FA50, 2-6, 12 pin heavy-duty P.M. speakers, 11/6; 10 465 kc/s. i.f.s. 1 in. x 1 1/4 in. x 3 1/4 in., 7/6; 10 watt push-pull O.P.T., 6V6s to 3 ohms, 6/6. 2-gang, 5000 tuning condensers, 5/-; 10 henry 80 ma. chokes, 4/-; PARMEKO 10H, 100 ma. chokes, 6/6. VOLUMIC CONTROLS, with D.P. switch, long spindle, 10 k, 50 k, 1 meg., 1/2 meg., 4/-; EDDYSTONE 6-pin coils, 2/6 each. Formers, 1/3. Please include 9d. postage on orders under £1. Send S.A.E. for New Year Bargain List.

ELECTRAD RADIO
 69, HIGH STREET, BELFAST, N.I.

VALVES New Boxed and Guaranteed

6K8	12/6	12K8	12/6	EF55	12/6
6K7	7/6	12K7	10/6	KT61	12/6
6V6	10/6	12Q7	10/6	KT41	12/6
5Z4	9/6	25L6	10/6	ECL80	12/6
6C7	11/6	50L6	10/6	PZ30	12/6
5U4	10/6	3524	11/6	MU14	9/6
EF91	11/6	Y63	8/6	1S5, etc.	9/6

and many others. Lists, 2d.

FX-EQUIP.—Soldered, Tested, O.K. VR91, SP61, SP41, VR53, VR56, VR57, 5/6 for £1.

ELECTROLYTICS.—B.E.C. tub, midgeet, 8/450 v., 2/6. Ditto, 8+9 mfd., 4/-; T.C.C. can, 16/450 v., 3/6. Ditto, 8/16 mfd., 5/-; 3 mfd., Dup., Dilitric, 3/-; 16 mfd., Dilitric, 4/-; T.C.C., 25/25 v., 1/9.

VOL. CONTROLS (Midgeet).—Edlwan, guar. 12 months. All valves. Long spindle. Less sw., 3/-; S.P. sw., 4/-; D.P. sw., 4/9. 80Ω COAX., 1/4 in. diam. 10d. yd. Resistors, 1w, 4d.; 1/2 w, 6d.; 1/4 w, 3d. Core solder, 16 v., 80/40 Grade 4d. yd. Post 6d. Over £1 FREE.

T.R.S. 71 Meadway Rd., E. Croydon
 Croydon 307, Whitehorse Road, West Thos. 1955

NORMAN H. FIELD
 68, HURST ST., BIRMINGHAM, 5.
 Mail Order Dept.
 64-65, CHURCH LANE,
 WOLVERHAMPTON.
CHEAPER VALVES

At 12/6: 6K8G, ECC32, 5Y3/524, 6Q7, X61-6SN7, KT68, 6F6, At 10/-: 1616, 68Q7, PEN46, 12SL7, 50YG/GT, At 9/-: 6F7, 807, ARP6, 6X5, KT63, 1T4, 184, 185, 1S5, At 7/6: VT52, EL32, EBC33, VR55, 7R7, 7T, 6K7, 6J7, VR150, 6G6/GT, 1A5/GT, 7C7, VR119, 6V7/G, 7C5, ARTP2, TP25, OZ4, 12A6, 12AC7, VR198, At 7/-: 6B8, 6B8/G, 1G6/GT/C, 6K7G, VR53, EF39, EF36, At 6/6: 6AB7, 6D6, VT224, RK34, 2C34, AR8, HL23DD, At 5/6: 6S87, 12C8, 12S27, 6C5/GT, 6L7, 12J5, 6J7/G, 6SH7/G, VR91, EF50, 12D6, 6SK7, TT11, VT501, At 5/-: 6J5, 12SK7, 6SK7/GT, 2A3, VU133, 2V3G, 1625, VT51, PEN220A, VR118, KT2, At 4/6: 6J5/G, 6J5/GT, 12S17, 12H6, VU120, At 3/6: RKR72, ARP3, 9D2, 6H6, At 3/3: VR18, 2158C, 2X2, VU111, HL2, VR21, VR69, P61, VR205, SP61, VR65A, SP41, At 2/6: VR55, EB34, VR22, EA50, VR78, DI, At 1/9: 7193.

WE STOCK ALL VIEWMASTER VALVES. SEND FOR OUR CHEAPER VALVE LIST.

SWITCHES, YAXLEY, NEW. 4-pole, 2-way 3-bank, 3/6; 3-pole, 3-way, 3-bank, 3/6. **BELLING-LIFE PLUGS & SOCKETTS.** 5-pin, NEW, Pair, 2/3. **465 I.F. TRANSFORMERS.** Pair, 6/6. **E.H.T. TRANSFORMERS.** 2,500 v. 5 ma, 4 v. 2 amp., 0.24 v. 4 amp., 210-250 v., 50 cycle, L.C. Completely Wax Impregnated. Guaranteed, 4/9.

ROTAHY CONVERTERS. Approx. 6 v. input, 220 v. 80 ma. output, 12/6. **LOOP AERIALS.** 1155 D.F., 8/6. **NIFE ACCUMULATORS.** 2.5 v. 15 ah. Metal-cased, 7/6. **CRYSTALS.** 500 kc/s., 7/-.

CONDENSERS. 8 mid. 600 v., Screw-hole Fixing, 2/-; **CHOKES.** 60 ohms, 200 ma, 3 1/4 in. x 2 1/4 in. 2 pin. Potted. Suitable Viewmaster, 4/-.

Please include something for postage. Money-back guarantee.

WALTON'S OF WOLVERHAMPTON

60 VOLT STANDARD H.T. BATTERIES.—6/- (post 1/-), 2 for 11/- (post 1/6).

72 VOLT + 1 1/2 VOLT.—Layer Type, 6/-, post 9d.

2-WAY TELEPHONE SETS.—Consisting of 2 Telemicrophones and approximately 12 yds. of twin cable. 10/6 each, post 1/6.

A.F.3. INTERVAL TRANSFORMERS, 3/6 each, post 9d.

25 WATT "COLLINS" MODULATION TRANSFORMERS.—Ratio 1:1, Impedance 6,000. New, boxed, 15/- each, post 1/-.

4,000 OHM SUPER-SENSITIVE PHONES.—By "S. G. Brown," complete with special ear-pads, lead and plug. Brand new in boxes. 15/- each, post 1/-.

POWERFUL 24 VOLT CAMERA MOTOR.—A.C. or D.C. 15/- each, post 1/6.

HEAVY DUTY 8in. EXTENSION SPEAKERS.—25/- each, post 1/-.

2 VOLT ACCUMULATORS.—Approx. 14 A.H. 5/- each, post 1/6.

AERIAL RODS.—3 Tapered rods, screwed joints, assembled length 12ft., complete in fibre case. The finest rods made. 10/6 each, passenger train, 2/6.

Send S.A.E. and 3d. for Special List, **WALTON'S WIRELESS STORES,** 48, Stafford St., Wolverhampton

LYONS RADIO LTD.

3, GOLDHAWK ROAD, Dept. M.P. SHEPHERDS BUSH, LONDON, W.12
 Telephone: SHEpherds Bush 1729

POWER UNITS TYPE 87. Rotary converter units for 24v. D.C. input and having a twin output of 250v. D.C. at 50 ma, and 6.5v. at 2.5 A. Can be operated in reverse from D.C. mains or 6v. Totally enclosed in neat metal case, 8 1/4 x 6 1/4 x 4 1/4 ins. In good condition and working order. PRICE 9/6, post 2/-.

ELECTRIC MOTORS. These useful motors are in new condition and for 12v. A.C. or D.C. operation. Dimensions: 2 1/2 in. diameter x 4 in. long. Spindle dia. 1/16 in. and protrudes 1 in. PRICE 14/-, post 1/-.

VALVE SPECIALS. VR136 (EF54), VR31 (EF50), VU120A, 6/6 each. VR32 (EA50), 3/6; VU111, 5/-; VU120 (HVR2), 8/6. All 3/6 and unused. Post 1/- up to 3/- over, free.

POWER UNITS NO. 1. Originally designed for use with the Army T/P.38. Comprises a 12v. vibrator cap output 120v. smoothed D.C. at 30 ma.) with a single stage L.F. amplifier employing valve type AT4 (not supplied). The whole fits into metal case approx. 11 1/2 x 6 x 4 ins. In good, clean condition. PRICE 18/6, Post 2/-.

MICROPHONE CABLE, etc. A screened conductor with outer insulating cover which gives it the appearance of coax. cable. Ideal for mike lead. 12 yards, 8/6; 13-50 yds., 8d. per yd.; over 50 yds., 7d. per yd.; 100 yd. coil, 50/-.

INDICATOR UNITS TYPE ASB4. The U.S.A. version of our type 6. Contains many useful components, including C.R. tube 5EP1, 3-6HO's of 4-6AT7's, pots., switches, etc. PRICE 90/-, carriage 7/6.

SELENIUM RECTIFIERS. Half-wave, 250v. 50 ma., 5/6 post free. Half-wave 6v. 1/3rd amp., 3 for 5/6 or 6 for 9/6 post free.

VALVES!

A—Original cartons.		B—Unused and Boxed.				
Type	A/B	Type	A	B	Type	A/B
2X3	4/9	6Q7	10/6	EB34	—	2/6
6B8	7/-	6Q7GT/13	11/6	EC31	—	5/6
6C4	7/6	6R7	10/-	EC53	—	5/-
6P4G	9/6	6SH7	6/9	EL32	9/6	8/6
6J5	9/6	6SR7/GT	8/9	HL133D	12/6	6/6
5J4GT	5/9	6V6G	—	KT61	—	8/6
6J7G	8/6	6V6GT12	10/6	KTZ63	—	7/-
6K6GT	8/6	12H6	—	29	Pen383	9/6
6K7	7/6	6J9	8/9	HT223	—	12/6
6K7G	7/3	954	3/6	VP133	—	9/-
6K7GT	6/9	7193	3/6	VR150	10/-	—
8K4T	12/6	2A5A9	3/6	VU111	3/6	—

8K41 ex-equipment, sealed but tested, 2/6.

ELECTROLYTICS!

2,000 mfd. 15 v., Mallory cans, 8/6.
 20 mfd. 50 v., 1/3. 32-16 mfd. 50 v., 5/-.
 20 mfd. 25 v., 1/9. 32-32 mfd. 350 v., 5/9.
 30 mfd. 100 v. 9d. 32-32 mfd. 350 v., 6/9.
 100 mfd. 50 v., 1/6d. 16-16 mfd. 500 v., 4/9.
 "ELAC" 5in. P.M. LOUDSPEAKERS. Maker's cartons, a quality job only 13/9 (post 1/-). Send S.A.E. for current list. Orders over £1 post free. Otherwise please add 6d.

R. E. D. & CO. LTD.
 2A, Burnley Road, Ainsdale, Southport.

RADIO G200 ANNOUNCES

6K8GT, X61, VR105, 6Q7G, 6Q7T, 6SQ7, 6C7, 12KBY, 12Q7GT, X76, 6SN7, EK32, B36, 12SN7, 6B8, KT66, 6L6, EBC33, JC5, 3Q5, 3B7/1291, 12SA7, EHC35, 11/6. 6AC7, 6AB7, 6C4, 6F6, 6K6GT, 6G6G, 6B4G, 6J7G, 6J7GT, 6SC7, 12A6, Pen46, KT41, 2A3, 6U4GT, 5Y3GT, 5Z4GT, 6SC7, 8/6, 1A5GT, 1G6GT, TT11, 6K7GT, 6C4, 6C5GT, 6J5, 6J5GT, 6SK7GT, 6SS7, 6N7G, 6SH7, 12C8, 12S27, CT27, 12SK7, KT61, KT63, KT33C, KT36, SP22, EF54, EC52, EF36, 954, 956, ACGPen, 9006, EC52, 7/6. 6SH7, 12SH7, 6H6, 6K7G, 6J5G, 6J5GT, 7193, VU120A, RK34/CV18, ARP3, VU120A, 5/-, 2X2A, 12HG, DI, V178, VR92, 3/6.

TRADE AND OVERSEAS ENQUIRIES INVITED

ARTHUR HOILE
 55, Union Street, Maidstone, Kent
 Phone: 2812.

OPEN TO DISCUSSION



The Editor does not necessarily agree with the opinions expressed by his correspondents. All letters must be accompanied by the name and address of the sender (not necessarily for publication).

A "Personal" Communication Receiver

SIR,—In the February issue you printed an article on "A 'Personal' Communication Receiver" by T. W. Dresser.

I should like to point out to anyone who may intend to build this very interesting receiver that the circuit as drawn in Fig. 1 shows an octode frequency changer as V2, but the valve specified (type 6SA7) has no electrode which can be used as oscillator anode.

It would appear, however, that a 6A8 (or 6A7, U.X. base) valve would function quite satisfactorily as V2.—H. E. HOWARD (Bournemouth).

Negative Feedback

SIR,—In criticising Mr. G. E. Briddon's article on negative feedback, Mr. J. R. Rutland, in the February issue, has overlooked the main intention of the circuit which, incidentally, is similar to one designed by Bush Radio Ltd., and called "bi-focal."

This term explains fully the function of the circuit in allowing a high degree of negative feedback on high-power signals (which corresponds to a low volume-control setting), yet permitting high sensitivity for weaker signals on turning up the control which lowers the ratio of feedback.

Mr. Rutland has only considered one value of signal input, whereas, of course, the whole circuit relies on many and varied strengths for its necessity.

Incidentally, the bi-focal circuit is so good that upon slowly "retarding" the volume control on a musical passage, it requires very little imagination to hear the bass apparently remaining at the same level, whilst the middle register, to which the selective feedback is tuned, reduces at the normal rate.

I trust the foregoing will allow Mr. Rutland to appreciate the idea of the circuit more than he first realised.—R. WILSON (Burnley).

Car Static

SIR,—Perhaps I can be of help to Mr. Reynolds (February issue), as part of my job as auto-electrician is the installation of car radio.

I have only once come across static causing interference on a car. This was finally traced to the vehicle wheels. The static was apparently generated by the friction between the brake linings and the steel brake drums, the wheel and drums being insulated by the oil film covering the wheel bearings. The remedy on this car was to fit a light spring between the wheel disc and the end of the axle shaft.

I have only once had a case of shock from a car apparently caused by static. This was accidentally caused by the owner fitting his spare wheel! I can only assume that the spare wheel was a better conductor than the other four wheels!

May I suggest that the interference Mr. Reynolds is experiencing is more likely to be due to either the dynamo or H.T. system of his car. The interference is either being radiated and picked up by the aerial, or is travelling to the set via the L.T. supply lead.

The normal "suppression" for a commercial car radio is as follows: a 5,000Ω resistor in the coil to distributor H.T. lead, as near the distributor as possible; 1 μF condenser between the short-wave terminal of the coil and earth; a 1 μF condenser between positive on the dynamo and earth. Earth, of course, being the chassis or body of the car.

Other points are: to make as direct a connection as possible to the battery, preferably screened. This applies to the aerial lead also. The screening should be earthed at both ends.

Most commercial sets have interference traps "built in," usually in the form of choke and condenser networks. Even so it is often necessary to resort to bonding of various parts of the car to each other, and the re-mounting of H.T. leads, etc., nearer to the engine to afford better screening.

Various car electrical accessories can cause interference, and all have their many remedies. I hope that from the foregoing Mr. Reynolds may find something to give him a "lead." Should, however, he still be in trouble, if he would care to write to me c/o the Editor, I will do my best to help.—K. T. ROGERS (Ledbury).

Dry Battery Regeneration

SIR,—In your article on the subject of Dry Battery Regenerators, you have, I think, overlooked the following facts.

In your second paragraph, you say "reactivation" has hitherto been deemed impossible, and that many attempts have been made, etc., and have all failed.

This just is not so. For well over thirty years, it has been well known that any ordinary Leclanché type dry cell can be recharged, simply by passing a reverse current through it from the mains (D.C.). Obviously it is best to do it in small doses, and to replace about the same amount of zinc back on the case that you have dissolved off. You must never let the zinc can puncture right through. Actually, dry cell electrolyte is not a very good plating solution, so the result in practice is not always as good as one expects.

Many patents have been taken out on the subject all over the world, but to avoid a tedious search, any interested reader is referred to "Literature Search on Dry Cell Technology," by Bohn and Weil, sponsored by the U.S. Signal Corps Engineering Laboratories, Fort Monmouth, New Jersey, which I imagine can be seen either in the Patent Office Library or the British Museum.—P. F. HARRISON (Birmingham).

"Disc or Tape?"

SIR,—My interest was aroused by the letter from Z. M. F. Preece in last month's issue of PRACTICAL WIRELESS, as I have experimented with a home-constructed disc recorder during the past few months.

The tracking gear utilises some silver steel rod on a length of $\frac{1}{16}$ in. B.S.F. studding. I made the cutting head from a pre-war pick-up, and an ordinary gramophone motor is employed to turn the blank disc.

Although a great deal of amusement may be obtained in this way, I think that it is useless to attempt any serious recording with such apparatus.—R. MARSH (N.21).

Jet Navigation

SIR,—We read with extreme indignation the article "Jet Navigation" in the January issue on the so-called uselessness of the "aural-null" type V.H.F.—D/F.

In your article you state the near impossibility of giving a first-class bearing to an aircraft flying in excess of 300 m.p.h.

If an aircraft flying at 600 m.p.h. was 30 miles away from an aerodrome, the "distance" given as an example in your article, it would take three minutes to reach the aerodrome.

It takes at the "maximum" only 10 seconds to receive a transmission and pass a first-class bearing, a five-second transmission is sufficient to take a first-class bearing. Therefore in your three minutes you could pass at least 15 bearings.

Your article doubts the possibility of taking one first-class bearing.

We speak with experience of D/F on various types of jet aircraft.—K. GRAY, K. SMITH (Sywell).

(The Marconi Company, who supplied the information, reply as follows: We think it is fairly obvious from the passage concerned that we and your correspondents are talking of two different things.

They mention the "so-called uselessness of the aural-null type V.H.F. D.F." There is no mention whatsoever in the article of aural-null V.H.F. D.F. We say, "... aural-null methods but the time lag required for tuning, checking for true or reciprocal bearings, reading off and transmitting the information to the aircraft..." and we think it is clear from the wording of this passage that we refer to M/F D.F., when the signal from an approaching aircraft has to be tuned-in on the receiver before a bearing can be taken.

We would also point out that in the example given by your correspondents—an aircraft 30 miles away from an aerodrome travelling at 600 miles per hour—the 10-second lag means that the aircraft is nearly two miles away from its original position by the time the bearing is passed back, even if the whole function does only take 10 seconds and is a first-class bearing.

Finally, we would say that there is no intention whatsoever of disparaging the skill and speed of ground

D.F. operators, whose excellent work over many years is acknowledged by everyone in aeronautical circles.—V. E. Hughes (Press Officer, Marconi's W/T Co., Ltd.).

A 5-band V.F.O. Unit

SIR,—With reference to my article in the January issue, I should like to point out a few errors which appear to have inadvertently cropped up.

First of all, the screen grids of V2 and V3 should be bypassed by a $.01\mu\text{F}$ capacitor and not as shown in Fig. 1.

In the list of components, C2, C7 and C8 are listed as " $8\mu\text{F}$ at 450 volts working." These should be $.01\mu\text{F}$ also.

The output from V2 is taken via C9 to the control grid of V3 via R9, the 100 Ω grid stopper. The junction of C9 and R9 is shown connected to the 6V6 cathode (V2); this is completely wrong since the output from V2 is bypassed to earth via R8. The junction of C9 and R9 should be connected to the earth line via a 1 megohm resistor.—WM. A. HOPE (Roxburgh).

Noise Levels

SIR,—I really must disagree with Mr. T. W. Dresser's statement ("A Personal Communications Receiver") that an R.F. stage in front of the first frequency-changer "is some help in reducing second channel images, but also brings up the noise level and is, therefore, a poor remedy."

A well-designed R.F. stage will do a lot towards reducing second channel interference and will definitely improve the signal-to-noise ratio.

The first two stages in Mr. Dresser's set are frequency changers and a frequency changer has an extremely high equivalent noise resistance and very little gain at high frequencies. If little or no noise can be heard from the speaker I would suggest that this is due to the extraordinary R/C network between detector and first A.F., giving an entirely unnecessary and undesirable amount of top cut (the attenuation of the "top" would start at approximately two cycles per sec.). One has only to try the effect on any set of connecting a $.1\mu\text{F}$. condenser between the grid of the first A.F. valve and the chassis (or "earth" line), as Mr. Dresser has done with C15.

There are several other points in this receiver that call for criticism, i.e., the A.V.C. controlling only a frequency changer would give little control and would tend to cause cross-modulation and overloading.

C14 serves no useful purpose and could be left out, whereas padding condensers (osc. section V1) should have been put in. Spacing the turns on a coil would tend to have the opposite effect to that of padding.—C. K. DREW (Exeter).

BOOKS RECEIVED

- RADAR AND ELECTRONIC NAVIGATION.** By G. J. Connenberg. 272 pp., 196 illus. Published by George Newnes, Ltd. Price 3/6.
- TRANSMITTING VALVES.** By Ir. J. P. Heyboer and Ir. P. Zijlstra. 284 pp., 256 illus. Published by Philips Technical Library.
- APPLICATION OF THE ELECTRONIC VALVE.** By Dr. B. G. Dammers, Ing. J. Haantjes, J. Otte and Ir. H. van Suchtelen. 431 pp., 343 illus. Published by Philips Technical Library.
- ENCYCLOPEDIA ON CATHODE-RAY OSCILLOSCOPES AND THEIR USES.** By John F. Rider and Seymour D. Uslan. 982 pp. Published (in Gt. Britain) by Chapman and Hall, Ltd. Price 75/-.

"YOU CAN RELY ON US"
FOR CLEAN COMPONENTS
AT COMPETITIVE PRICES

I.F. TRANSFORMERS.—RS/GB, 465 kc/s, 12/6 pair; midget Wearite M800, 21/- pair; super midget, RSRs, 465 kc/s, 21/- pair.

VOLUME CONTROLS.—Standard, less switch, 2/9; with switch, 4/3; Midget types, 3/6 and 5/- with switch; Wirewound types, Colvern preset, 3/6; standard, 5/6. All standard values stocked.

VALVEHOLDERS.—Int. octal, 6d.; Mazda octal, 6d.; British 5 and 7 pin, 6d.; local, 1/3; B7G, 1/-; EF50 (ceramic), 1/-; UK American, 6d.; B12A (duo-decal), 2/6; Noval (B9A), 1/-; B8G, 1/3.

FILAMENT TRANSFORMERS.—200/240 v. tapped to 6.3 1/1 amp midget, 8/6; multi-secondary, 3 v. to 30 v. at 2 a., tapped primary, 21/-.

COILS.—Wearite "P" coils, 3/- each, full range; Weymouth "H" coils, 3/6. "K" coils, 4/9; CT2W2, 9/6 pair; CS3W3, 11/9 pair; MW/LW TRF pair with reaction, 7/6; Viewmaster coils for London, 22/-; Birmingham, 29/6; Holme Moss, 28/-; Electronic Holme Moss coils, 19/6; L9 Viewmaster choke coil, 2/-.

RECTIFIERS.—WX6, 3/7; WX3, 3/7; 14D36, 11/-; 14A86, 18/3; 36 EHT 100, 27/10; 5 ma 12 v, 1/-; 1 ma meter, 11/4; 12 v. 1a., 7/6.

HIGH VOLTAGE CONDENSERS.—New T.C.C. .001 6 Kv., 4/6; .001 12 Kv., 7/6; .1 mfd. 5 Kv., 12/6; .01 mfd. 6 Kv., 4/6; .01 2,500 v., surplus, 1/-; .01 mfd. 5 Kv., surplus, 3/6.

HIGH IMPEDANCE HEADPHONES.—New American surplus, unused, 12/6 pair.

CERAMIC TRIMMERS.—50 pf., 9d.; 100 pf., 1/-; 150 pf., 1/7; 250 pf., 1/7; 500 pf., 2/-; 750 pf., 2/3; 1,000 pf., 2/6.

SPEAKER TRANSFORMERS.—Standard Pentode, 4/6; Midget Pentode, 4/-; Triode type, 4/6; Super Midget for 154, 354 valves, 4/3; push/pull new transformers, PAX41 for two PX2 in pipull, 10 watts, 33/-; 15 watt, push/pull, 6L6 primary 5,000, secondary 15, 7.5, 3.75 or 2.5, 42/-; Multiratio OP transformers, MR7, 14, 18, 19, 22, 25 to 1, also 26, 36, 33, 44, 66, 100 to 1, centre-tapped, 7-30 watts, 18/9; Wharfedale, type "E", 30, 45, 60, 90 to 1, 7/2; Elstone multi-ratio, 7/6.

MAINS TRANSFORMERS.—SR 350 80 ma 200/230/250 v. to 350-0-350 v. 6.3 v. 4 a. tapped at 4 v. 5 v. at 2 amps tapped at 4 v., 24/-; SR250 80 ma. as SR350, but 250-0-250 v., 24/-; 60 ma Trans., 250-0-250 6.3 v. 3 a., 5 v. 2 a., small dimensions, 22/6.

MISCELLANEOUS.—Octal valve cans, 1/6; Viewmaster envelope, 5/-; London, Birmingham, Holme Moss (state which) easy built television, 2/6; B.T.H. Germanium crystals, 5/6; Qmax cutters, 11in., 14/6, 1in., 11/3, 11in., 15/6, 1in., 11/3, all sizes stocked; Solon soldering iron, pencil bit, 22/6; oval bit, 21/-, state voltage.

Stockists of: W. B. Haynes, Elstone. Weymouth, Wearite, Bulgin T.C.C., Ediswan, Morganite, Ampilon, all B.V.A. valves. Write for Bargain Valve List, 120 types surplus valves.

32-page catalogue, with circuits, No. 10, 6d.

RADIO SERVICING CO.
444, WANDSWORTH ROAD,
CLAPHAM, LONDON, S.W.8

Telephone: MACaulay 1555.
77, 77A, 168, 169 Buses: S.R. Station,
Wandsworth Road.



The "Fluxite Quins" at Work
"Our 'gram needs repairing I fear,
That auto-change acts pretty queer.
A touch of FLUXITE
Will soon stop the flight
Of these records that whizz past your ear!"

See that FLUXITE is always by you
—in the house—garage—workshop—
wherever speedy soldering is needed.
Used for over 40 years in Govern-
ment works and by leading engineers
and manufacturers. Of all ironmongers
—in tins, from 1/- upwards.
The FLUXITE GUN puts FLUXITE
where you want it by a simple pressure.
Price 2/6, or filled 3/6.

FLUXITE
SIMPLIFIES ALL SOLDERING

Write for Book on the Art of "SOFT"
Soldering and for Leaflets on CASE-
HARDENING STEEL and TEMPERING
TOOLS with FLUXITE. Price 1/6d. each.
FLUXITE Ltd., Dept. W.P.
Bermondsey Street, London, S.E.1.

ELECTRADIX
BARGAINS

MORSE PRACTICE KITS on baseboard fitted A.M. precision Key, twin-coil Buzzer, battery holder and terminals with connection diagram and single phone with head-band and cord, 7/6.

MORSE KEYS. A.M. type, 2/6, post 9d. Practice Key on wood base with space for buzzer and brass terminals, 2/6, post 9d.

BUZZERS. Practical type tunable note, in metal case, 2/6, post 6d. Twin Coil, new G.P.O. type, 2/6, post 6d. Townsend high note wave meter Buzzer, 5/-.

MAGNETS. Swift Levick S.L.S. 36 circular horseshoe 1 1/2 in. diam., 3/4 in. thick, 1/2 in. Polar gap, drilled poles, weight 2oz., lift 3lb., 2/6 each. Alni disc Magnets 3/6 in. diam., 3/4 in. thick, 3/16 in. centre hole, 3/6. D.C. Electro Magnets, twin coil, weight 10oz., lift 4lb. on 6 v., 3lb. on 4 v. and 1 1/2 lb. on 2 v., new surplus, 5/-, post 6d.

RECTIFIERS. 1/2 wave Selenium, 500 volts 40 ma., 7/6, 20 volts 1 1/2 amps., 15/-.

CONDENSERS. 250 volt Paper 1 plus 1 mfd. and 2 mfd., 7/6 doz. Hermetically sealed, 8 mfd. 400 volts, 4 mfd, 1,000 volts, 2 mfd, 2,500 volts; send for special list.

Microphones, Morse Keys, Buzzers, Meters, Motors, Dynamos, Alternators, Metal Rectifiers, Battery Chargers, Transformers, Lighting Plancs. Send us your enquiries.

ELECTRADIX RADIOS
214, Queenstown Road, London, S.W.8
Telephone: MACaulay 2159



WE ARE PLEASED

to say new supplies of the efficient and popular Eddystone "740" Receiver are now available.

EDDYSTONE
"740"

COMMUNICATIONS RECEIVER

A.C. operation 110 & 220/250 volts (also 6 volts operation from external vibrator unit 687/1, price £8/10/6). Eight modern valves, all BBA bases.

FOUR BANDS cover 30.6 Mc/s to 1.4 Mc/s continuous (9.8 to 21.43 metres) and 205 to 620 metres. Beat Frequency Oscillator, Noise limiter, R.F. stages.

PRECISION TUNING. 14011 with auxiliary scale giving equivalent tuning length of 60in. for each band. Provision for plugging in external "S" meter.

PRICE **£38.15s**

(Also available under Webb's Extended Payment Scheme, deposit £7/15/- and twelve monthly payments of £2/16/0.)

The Eddystone "740" is a British-made Communications Receiver of proved efficiency and reliability and is covered by a comprehensive 12 months' Guarantee.

COMMUNICATIONS RECEIVER
ALIGNMENT

If you already have a Communications Receiver Webb's Service Department will realign and undertake complete service making it equal to new. We give you a test report showing:

- 1.F. Sensitivity.
- 1.F. Selectivity.
- R.F. and I.F. Sensitivity of all Wave Bands at maker's alignment points.
- R.F. and I.F. Signal to Noise Ratio of each Wave Band at alignment points.
- Image Ratio on each Band.
- A.V.C. Characteristics.

WE SPECIALIZE IN THE SERVICING OF COMPLEX COMMUNICATION RECEIVERS AND FOR THIS WORK OUR DEPARTMENT IS SECOND TO NONE.



14, SOHO ST., OXFORD ST., LONDON, W.1.

Telephone: GERrard 2089
Hours: 9—5.30, Sats. 9—1.

THE MODERN BOOK CO.

World-Radio Handbook for Listeners, 1952.
Price 8s. 6d. Postage 4d.

World Radio Valve Handbook.
Price 11s. 6d. Postage 4d.

Radio Engineering, by Norris.
Price 15s. 0d. Postage 10d.

Radio Laboratory Handbook, by M. G. Scroggie.
Price 15s. 0d. Postage 6d.

Wireless Servicing Manual, by W. T. Cocking.
Price 12s. 6d. Postage 6d.

Practical Wireless Encyclopaedia, by F. J. Camm.
Price 21s. 0d. Postage 9d.

Radio Servicing, by A. Marcus.
Price 35s. 0d. Postage is. 0d.

Sound Reproduction, by G. A. Briggs.
Price 10s. 6d. Postage 6d.

Basic Mathematics for Radio Students, by P. M. Colebrook.
Price 10s. 6d. Postage 6d.

Radio Engineers' Handbook, by F. E. Terman.
Price 50s. 0d. Postage is. 0d.

Radio Upkeep and Repairs, by A. T. Witts.
Price 7s. 6d. Postage 9d.

Osram Valve Manual, Part One.
Price 5s. 0d. Postage 6d.

Reference Data for Radio Engineers, compiled by W. L. McPherson.
Price 7s. 0d. Postage 6d.

Radio Valve Data, compiled by 'Wireless World.'
Price 3s. 6d. Postage 3d.

Magnetic Tape Recording, by P. A. Tarry.
Price 6s. 6d. Postage 3d.

We have the finest selection of British and American radio books in the country. Complete lists on application.

19-23 PRAED STREET (Dept. P.3), LONDON, W.2. PAddington 4185

VALVES.—1A5GT, 8/6; 6J6, 12/6; 6SL7, 9/6; 6AC7, 7/6; 6SA7GT, 7/6; 6N7GT, 7/6; 6B8, 6/6; EF92, 11/6; EF91, 10/-; EB91, 10/-; 12K8GT, 7/6; 12Q7GT, 7/6; 12SL7GT, 7/6; 1289A, 7/6; 12J5GT, 6/-; 12S8T, 6/-; 12A6, 6/-; 807, 10/-; 1625, 7/6; 25A8, 8/6; PEN46, 10/-; 7F8, 25/-; KT241, 7/6; 717A, 7/6; VR54, 4/6; VR66, 6/-; VR92, 2/6.

SPECIAL OFFER SOILED EX-EQUIP.—VR53, 2/-; VR91, 4/-.

CONDENSERS, BLOCK.—5 mfd., 1 mfd., 2 mfd., 400 v. working, D.C.; approx. 3in. high, 2in. wide. Any 3 for 2/6.

CONDENSERS.—Sprague Tubular. .01 mfd., 1,000 v. D.C., 9d.

ADMIRALTY S.M. DIAL.—31in. diameter, 100:1 ratio, White Ivorine Dial, beautifully made, 6/-.

CHOKES.—20 Hy. 10 m/a., approx. 2in. x 1 1/2in. x 2in., 3/-.

METAL RECTIFIERS.—6-12 v. 1 amp., 10/-.

SIGNAL GENERATOR (Type 22).—200 mc/s. easily converted to 144 mc/s or T.V. band, complete with 6 v. Vibrator Pack in black metal case, 30/-.

MAINS DROPPER.—717 ohms tapped at 110 ohms, .2 amp., 2/-.

All prices include postage or carriage.

J. B. SERVICE
(BEXLEYHEATH) LTD
5, MAYPLACE ROAD WEST,
BEXLEYHEATH, KENT.

HOURS : 9.30 to 6 (Wednesday 1 o'clock).
Open all day Saturday.

104, Brockley Rise, Honor Oak Park, S.E.23. 200 yds. "Chandos" Bus Terminus.
Open Saturday only, 9 to 6.
Mail Order Dept., Bexleyheath.
Regret no lists.

G. E. C. GERMANIUM CRYSTAL DIODES

LATEST, SMALLEST SUPREME CRYSTAL DETECTOR.
Midget Size, 5/16in. x 3/16in.
Wire Ends for Easy Fixing
4/6 each, postage 2 1/2d.

Wiring instructions for a cheap, simple but high quality Crystal Set included. Technical Details and Selected Types available.

SILICON CRYSTAL VALVE
3/6 each, postage 2 1/2d.
Fixing Brackets 3d. Extra.

COPPER INSTRUMENT WIRE
ENAMELLED, TINNED, LITZ, COTTON AND SILK COVERED.
Most gauges available.
B.A. SCREWS, NUTS, WASHERS, soldering tags, eyelets and rivets. EBONITE AND BAKELITE PANELS TUFNOL ROD, PAXOLIN TYPE COIL FORMERS AND TUBES, ERIC & DUBILIER RESISTORS.
Latest Radio Publications. SEND STAMP FOR LISTS.

CRYSTAL SET
INCORPORATING THE SILICON CRYSTAL VALVE
Adjustable Iron Cored Coil.

RECEPTION GUARANTEED
Polished wood cabinet, 15/-, post 9d. A REAL CRYSTAL SET, NOT A TOY.

POST RADIO SUPPLIES
33 Bourne Gardens, London, E.4

Amateur Radio Enthusiasts THE INCOMPARABLE GLOBE-KING

SINGLE VALVE S.W. RECEIVER
● WORLD - WIDE RANGE 11-100 METRES ● CRYSTAL-CLEAR NOISE-FREE RECEPTION ● ELECTRICAL BAND - SPREAD TUNING ● EXTREMELY LOW RUNNING COSTS
Catalogue Free. Stamp for postage.

JOHNSONS (RADIO)
46, FRIAR STREET, WORCESTER

TRANSFORMERS

No. 1. 250-0-250v. 80 ma. 0-4v. 5a. 6.3v. 3.5a. 0-4-5v. 2a., 17/-.

No. 2. As No. 1 but 350-0-350v., 17/-.

No. 3. 26v. 2.5a. tapped to give almost any voltage up to 26v. ideal for chargers, models, W.D. motors, etc., 16/6.

No. 4. 4v.-9v.-20v. 4 amp. For 2, 6 and 12 volt chargers, 16/-.

No. 5. Auto wound, 10-0-110-200-230-250v. 150 watts. For general voltage changing, up or down, 16/6.

No. 6. 250-0-250v. 100 ma. 6.3v. 3.5a. 5v. 2a., 22/-.

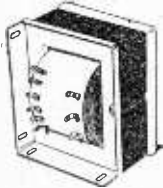

All types upright or drop through. No others available. Primaries on 1, 2, 4 and 6 tapped 200-230-250v. Interleaved, impregnated, Screened, Guaranteed.

Terms: C.W.O., C.O.D. or pro forma. Postage 1/6 l to 3.

HILLFIELDS RADIO,
8, BURNHAM ROAD,
WHITLEY, COVENTRY

YOU can become a first-class RADIO ENGINEER

We are specialists in Home-study Tuition in Radio, Television and Mathematics. Post coupon now for free booklet and learn how you can qualify for well-paid employment or profitable spare-time work.

T. & C. RADIO COLLEGE

...Post in unsealed envelope, 1 1/2d. postage...
To: R. Heath Bradley, T.C.R.C.,
36, Northfield Road,
Ringwood, Hants.

NAME
ADDRESS

P 122

TESTOSCOPE Mains Tester

For high and low voltage testing—1-30 and 100-850 volts A.C. or D.C.
Write for interesting leaflet 29F.



RUNBAKEN - MANCHESTER

14

TESTED CIRCUITS of Superhets, T.R.F. Sets, Feeder Units, Amplifiers, Power Pack, Signal Tracer, etc., which

YOU CAN MAKE
are contained in our
NEW

CONSTRUCTORS HANDBOOK
PRICE 2/6 ONLY

Other notable inclusions in this Handbook are the DETAILED DIAGRAMS and INSTRUCTIONS for building our POPULAR SUPERHET COIL PACK and, of course, pages of Servicing and Constructional Information, Formulae, etc. Full Illustrated Catalogue of our extensive stock sent with each Handbook.

Get Your Copy TODAY from
SUPACOILS
98, GREENWAY AVENUE, LONDON, E.17.

News from the Trade

Wolf Electric Soldering Irons

NEW additions to the range of Wolf Electric Soldering Irons have recently been announced and all these are the straight handle type. They comprise three models—Types 22, 32 and 42, which, whilst retaining all the general features so popular in the original range, have been designed to meet the demand for conventional straight handle types of Wolf design and manufacture.

Amongst the first important users of these new models was the G.P.O. Engineering Department. To them the straight handle soldering iron is indispensable in their work, involving as it does the daily soldering of many thousands of connections in telephone exchanges throughout the country.

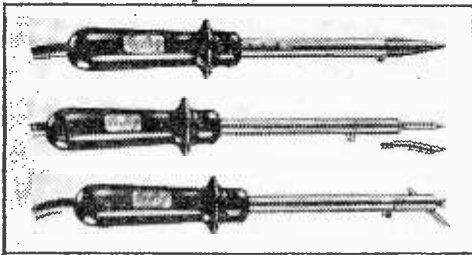

A group of the new Wolf Soldering Irons

In this respect they were desirous of standardising upon an electric iron of unusually high efficiency in a range of models for all standard voltages to meet the consistent and exacting requirements of constant use.

In keeping with all other models the heating elements are designed to concentrate heat on the working point providing a rapid and constant heat. They are sturdily built to withstand heavy usage and are fitted with hard wooden handles with a heat deflecting skirt.—Wolf Electric Tools, Ltd., Pioneer Works, Hanger Lane, W.5.

Plessey Shrouded Loudspeakers

THE new range of shrouded permanent magnet loudspeakers introduced by The Plessey Company, Ltd., Ilford, Essex, offers to manufacturers fifty-six alternative units designed to satisfy a wide diversity of requirements. On all models, a choice of cones is available having performance characteristics adapted for various classes of receivers, including special lightweight cones on the smaller units designed for maximum sensitivity on battery-operated sets.

Four circular sizes of loudspeaker, of 5in., 6½in., 8in. and 10in., and one elliptical, of 6in. by 4in., are each available in a choice of four flux densities, viz., 7,000, 8,500, 10,000 and 12,000 lines/sq. cm. Both the elliptical and the smallest circular model

have ¾in. pole pieces, while that of the largest is 1in. in diameter. The two intermediate sizes may be ordered with either ¾in. or 1in. pole pieces as required.

Employing in each case the well known Plessey aluminium voice-coil former, centred by means of a diaphragm-type rear suspension, these loudspeakers, though normally of 3 ohms impedance, may alternatively be supplied with an impedance value of 5 ohms. Where required, transformers may be factory mounted.

Throughout the range, the unique method of fixing the top plate, and the provision of a dust cap within the pot, protect the pole piece and the air gap from dust and atmospheric corrosion.

The loudspeakers are stove enamelled, on an automatic electrostatic spray unit, in "satin bronze." Pleasing in appearance, this finish affords excellent protection against all forms of corrosion.—Plessey Co., Ltd., Ilford, Essex.

A New Console Ferguson Radiogram

A NEW radiogram is now available in the Ferguson range. The specification is as follows:

Circuit: 5-valve, 3-waveband automatic three-speed superhet radiogram, covering 733 to 2,050 m., 184 to 575 m. and 15.7 to 55.4 m. External speaker sockets, with muting switch for internal speaker.

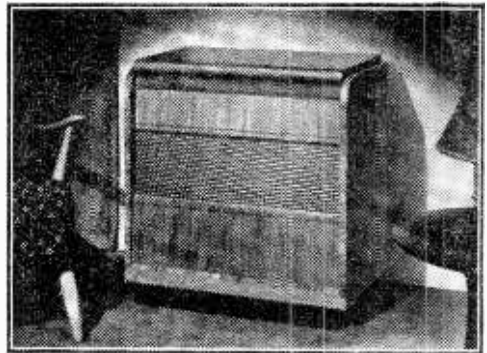

The new Ferguson Radiogram.

200/210, 220/230, 240/250 A.C. only (50 cycles).

Controls: Tuning, Waveband/Gram Selector, Volume Control, Tone and on/off switch.

Speaker: 8in. P.M. moving coil.

Scale: Illuminated 3-colour scale, calibrated in metres, with station names.

Gram Unit: Three-speed Garrard auto-changer Type RC72, for 10in. or 12in. records, with microcell crystal head with dual-purpose stylus for standard and long-playing records.

Cabinet: Moderate-sized walnut Console, of restrained modern design, with speaker grille of non-soiling fabric of exclusive design. 25½in. wide by 26in. high by 15½in. deep.

Editorial and Advertisement Offices:

"Practical Wireless," George Newnes, Ltd., Tower House, Southampton Street, Strand, W.C.2. Phone: Temple Bar 4363.

Telegrams: Newnes, Rand, London.

Registered at the G.P.O. for transmission by Canadian Magazine Post.

The Editor will be pleased to consider articles of a practical nature suitable for publication in "Practical Wireless." Such articles should be written on one side of the paper only, and should contain the name and address of the sender. Whilst the Editor does not hold himself responsible for manuscripts, every effort will be made to return them if a stamped and addressed envelope is enclosed. All correspondence intended for the Editor should be addressed: The Editor, "Practical Wireless," George Newnes, Ltd., Tower House, Southampton Street, Strand, W.C.2. Owing to the rapid progress in the design of wireless apparatus and to our efforts to keep our readers in touch with the latest developments, we give no warranty that apparatus described in our columns is not the subject of letters patent. Copyright in all drawings, photographs and articles published in "Practical Wireless" is specifically reserved throughout the countries signatory to the Berne Convention and the U.S.A. Reproductions or imitations of any of these are therefore expressly forbidden. "Practical Wireless" incorporates "Amateur Wireless."

BOOKS

R.S.G.B. Amateur Radio Call Book, 6,000 British Isles Callsigns, 56 pp., 3/9; **Transmitting Licence**, 32 pp., 1/-; **Service Valve Equivalents**, 32 pp., 1/3; **Simple Transmitting Equipment**, 52 pp., 2/3; **Receivers**, 96 pp., 3/9; **Valve Technique**, 104 pp., 3/9; **V.H.F. Technique**, 96 pp., 3/9; **Television Interference**, 40 pp., 2/3; **R.S.G.B. Bulletin**, current issue, 1/6. Five recent issues 2/6. Prices include postage. **RADIO SOCIETY OF GREAT BRITAIN**, 28, Little Russell St., London, W.C.1.

SPECIAL NEW YEAR OFFER! To clear our small remaining stock we are offering our 56-page book "A Portable Televisor (which gives full details for building either a 3in. or 6in. mains or battery, complete sound and vision receiver), for only 2/-, post paid. "Personal Portables" still at 2/8. **BRADBROOKS**, Sennen, Penzance, Cornwall.

BRITISH SHORT WAVE LEAGUE is devoted to the interests of amateur radio enthusiasts. Publishes 12-page "BSWL Review," monthly (members only). Offers many services and activity departments. World wide membership. Founded 1935. Apply for details to: **BRITISH SHORT WAVE LEAGUE**, 55, Victoria St., London, S.W.1. (Abbey 2384.)

I.P.R.E. TECHNICAL PUBLICATIONS: 5,500 Alignment Peaks for Superheterodynes, 5/9, post free. Data for constructing TV Aerial Strength Meter, 7/6. Sample copy The Practical Radio Engineer, quarterly publication of the Institute, 2/-; membership and examination data 1/-; Secretary, I.P.R.E., 20, Fairfield Rd., London, N.8.

ALL MAGAZINES.—We can arrange subscriptions to any British or foreign wireless and TV magazine. Send to-day for our free booklet giving details and prices. **WILLEN LTD.** (Dept. 40), 101, Fleet St., London, E.C.4.

RECEIVERS & COMPONENTS

EX MANRS. 3-valve AC/DC Amplifiers, less valves, 24/6 post free. New Valves, 6V6, 5Z4, 5U4, 6Q7, 10/- each. New Stock Condensers, 4mf 2/-, 16mf 3/-, 8x16mf 4/3, 16x16 4/6, 32x32 6/6, 450v. Card/tub. 8mf/500v 3/4, 16/500 4/6. Doz. lots any type less 10%. Special offer: 8in. P.M. Spkrs. at half list price, 15/- post paid. New list, s.a.c. D. F. STRANGE, 52, Pendlestone Rd., Walthamstow, E.17.

WALNUT RADIOGRAM CABINETS. Stamp details. **E. WISKER**, 501, Hale End Rd., Highams Park, E.4.

TR9 Transmitter and Receiver with 9 valves less crystal. 5 minute conversion and over 50 stations may be heard. 20/- post paid; details 1/-. **AUTOREX MOTORS**, New Whittington, Chesterfield.

ARDEN 5. 3W/B Superhet. Chassis, gram switching, glass dial, 8in. M/C speaker. £11/10/-; carr. and packing. 2/6. P.C. for further details. **ARDEN RADIO MFG. CO.**, 141, Kineton Green Rd., Birmingham, 27.

PHILIPS and Mullard Neg. Feedback Output Trans.; special rewind; service delivery by return; year guarantee. **A. McLUCKIE**, 141, Lower St., Carlisle.

RATES: 4/- per line or part thereof, average five words to line, minimum 2 lines. Box No. 6d. extra. Advertisements must be prepaid and addressed to Advertisement Manager, "Practical Wireless," Tower House, Southampton St., Strand, London, W.C.2.

EDIE'S STUDIOS, Chelsea, H.M.V. Speakers, brand new and boxed; 9in. Mains, energised, 1500 ohm field, with heavy-duty Pentode Trans., 17/6, post 2/6; 6in. heavy-duty Magnet and Trans., 1500 ohm field, 17/6, post 2/6; E.M.I. Autochanger Units, 8 records, complete with lightweight pick-up, brand new and boxed, but less spindle, £9 ea.; H.M.V. push-button Units, mechanical type with 6 buttons and .0005 2 gang, 25/- ea.; H.M.V. Motor Tuning Units, complete with 3 gang, new, £25/- ea.; T.C.C. 12+12 mfd, small can, 350v wkg., 2/9 ea.; SenterCel metal Rcs., 125v, 60 ma, 3/6 ea.; Metalar Electric Clocks, 4in. dial, brand new, and boxed, listed at £3/18/9, our price 35/-, post 2/6. Special Offers.—Garrard Motor and Pick-up Units for A.C. mains, complete with auto stop and turntable already mounted on a board, and ready to drop in a radio-gram, £4/10/-, 6/- post; Ekco Chassis, 4 valve, plus metal rec., A.C., D.C., complete with all valves and speaker and aerial tested before despatch, £3/10/-, 6/- carr.; Philco Cathedral model, reconditioned, inc. cabinets repolished, A.C.-D.C., 5 valves, £5/5/-, 6/- carr. Please note: All the Ekco components advertised in previous issues are still available, send for list, terms, etc. **EDIE'S STUDIOS**, 255, Fulham Rd., Chelsea, S.W.3. (Telephone: FLAXman 5587.)

ELECTROLYTICS, ELECTROLYTICS. All guaranteed, aluminum can type, all std. size, 8 mfd x 500v wkg, 1/9 ea., 18/- dz.; 12+12 mfd x 350v wkg, 4/- ea., 45/- dz.; 2 mfd x 350v wkg 1/6 ea., 10/- dz.; 200 mfd x 12v wkg, 6d. ea., 4/6 dz. Paxolin valveholders (ex-equipment). International Octal or Mazda Octal, 1/9 dz.; Speaker fabric, 1/9 sq. ft.; Sleeving, 1/- dz. yds.; 15in. TV Mask, 6/6 ea.; 2 amp 1000 ohm tapped Droppers, 3/9 ea., 42/- dz.; 1 mfd x 350v tub., 2/9 dz., .01 x 1000v tub., 3/6 dz. Thousands of components available. 3d. stamp for latest list. **SUSSEX ELECTRONICS**, Princes St., Brighton.

EVERYTHING for radio constructors. Condensers, Coils, Valves, Resistors, etc. Send stamp for list. **SMITH**, 98, West End Road, Morecambe. Quick service.

NUTS, BOLTS, etc., ass., 2/- lb.; B7G Holders, 6d.; Aerials, 75ft., 1/3. List 2d. **CARTER'S**, 578, Washwood Heath Rd., Birmingham, 8.

MAGSLIP Transmitters from 10/- Ideal for distant control of radio receivers, antenna direction, indication, etc., etc. Stamp for details. **ENGINEERING FACILITIES, LTD.**, 29, Rea St., Birmingham, 5.

MIDDLESBROUGH Viewmaster TV, constructional details, 5/-, plus 4d. post. Tape Recorders, Valves, etc. Send for lists. **PALMERS** of Middlesbrough, Ltd., 114, Waterloo Rd., and 106, Newport Rd.

1/500 TUBULARS, 5d.; LT Rects., 1/6; 2v soiled Triodes, 1/-; 1/250, 3d.; 1.2K 10w, 6d. Posts extra. S.A.E. lists. Wanted, 5-Pin Plugs, ZA24884. **ANNAKIN**, 23, Ashfield Place, Otley, Yorks.

YOU ARE INVITED to call and hear the wonderful new "Symphony" range of N.R.E.S. Audio Amplifiers with their three separate channels giving independent control of bass, middle and top; 5-watt model 9j gns., 10-watt model (with push-pull triode output), 15 gns. If you cannot call, send two 2d. stamps for full Catalogue and Bargain Supplement. **Decca A.C. Gram. Motors**, adjustable for 33 $\frac{1}{3}$ or 78 r.p.m., with turntable, £3/16/10; ditto, with switch for 33 $\frac{1}{3}$, 45 and 78 r.p.m., £7/3/4, post 2/6. Decca Pickup to match, fitted with ACOS hi-fi crystal cartridge and permanent sapphire, with either Std. or L.P. head, 54/0, or with both heads, 86/-; Garrard top quality centre-drive A.C. Gram. Motors, with variable speed and full 12in. turntable, £5/17/6, post 2/6. Collaro A.C. 3-speed Autochangers—just come in—£15/10/6, carr. 5/-, complete with plug-in ACOS GP head for Std. and L.P. Ditto, single speed (78), complete with pickup head, £11/16/9, carr. 5/-; Record Player Cases, 15in. x 13in. x 7in., beautifully covered in real rexine, sprung carrying handle, uncut motorboard, 57/6, post 2/6. Cabinets 15in. wide x 14in. deep x 10in. high. Finished in french-polished figured walnut, hinged lid, suitable for table Radiogram, Microgram, Record Player or Recorder. Price £3/5/-, plus carr. and pack, 5/-. Bass Reflex Cabinet Kits, 2ft. 6in. high, patent 4in. thick acoustic timber; give superb bass response, 8in. speaker model, 85/7 10in. s.m., 97/6; 12in. s.m., 107/6. 7/6; ready built, 7/6 extra. **NORTHERN RADIO SERVICES**, 16, King's College Rd., London, N.W.3. (Primrose 8314.)

HANNEY OF BATH offers: **W.B.** 10in. concentric duplex speakers, £6/15/-; **W.B.** Stentorian speakers, less transformer, 3 ohm coil, 21in., 18/6, 3in., 19/6, 5in., 21/-, 6in., 24/6, 8in., 26/9, 9in., 36/9, 10in., 44/6; Acos GP 20 Pickups, standard or L.P. £3/11/5, heads only, 43/4; Decca (BSR) Gram Motors, 2-speed, 74/4, 3-speed, £7/3/4; Collaro RC 500 Autochangers, with crystal P.U., £12/2/6; Acos Crystal Mikes, type 22-2, £6/6; Brimar Metal Rectifiers, RM1 4/6, RM2 5/-, RM3 6/-, DRM1B 10/-, DRM2B 11/-, DRM3B 13/-; GEC Germanium crystals, 4/- each; Coils. Wearite "P" coils, all types, 3/- each; Weymouth "H" coils, 3/9 each; Atkins High "Q" coils, 3/6 each; Denco Type "C" TRF coils, 8/6 pair; Weymouth TRF coils, 10/3 pair; R.M. TRF coils, 15/- pair; Coil-pack, Wearite type 705, 53/8; Osmor "Q" type HO, 52/-; HF stage, 21/8; Osmor "Q" battery pack, 54/2. All components still available for the Viewmaster, W.W. TV receiver, E.E. TV receiver, P.W./P.T. TV receiver and Williamson Amplifier, as previously advertised. Send 6d. stamp now for our new catalogue which lists almost everything you require; c.w.o. or c.o.d., all goods post free over £1. **L. F. HANNEY**, 77, Lower Bristol Rd., Bath. (Tel.: 3911.)

R. F. UNITS, type 24 and 24 mod. 27, 15/- ea.; R 1125 with 6 universal valves, 30/-; Metal Rectifiers, 12v 1a., 11/6; Delay Switches with 7-day clockwork movement, 21/-; Chore Horse lighting sets, 12-15v 300 watt., £16/10/- ea., Elecs., 8 x 16mfd, 450v, 4/-; Valves 9001 7/6, 6AK5 10/6, others from 1/6. We still have plenty of Government surplus bargains in stock. Send S.A.E. for list. Also Lenses and Prisms and general optical gear. Booklet "How to use ex-Gov. Lenses and Prisms," 2/6. **H. ENGLISH**, Rayleigh Rd., Hutton, Brentwood, Essex.

WALNUT Radiogram Cabinets of distinction; stamp details. R. SHAW, 69, Fairlop Rd., E.11.

AMAZING VALUE: Meters, Relays, Valves, etc.; surplus to requirements; to clear, 5/- and 10/- parcels. Send P.O. now to avoid disappointment. DAVIES, 10, North Av., Prestatyn, Flint.

ELECTRIC GRAM, motor, 12in. turntable; Universal Avomitor; Coil Pick-up, new; other items; reasonable prices; stamp. Box No. 214.

"WILTON" Battery D.x.5 Chassis Receiver; first grade Al. panels, 16 gauge, any size; send s.a.e. WILTON RADIO, 30, Giants Grave Rd., Neath.

RADIO SUPPLY CO., 15, Wellington St., Leeds 1. Manufacturers' surplus items. Smoothing Chokes, 80ma, 10h, 250 ohms, tropicalised, 4/3; 90ma, 10h, 100 ohms, 3/11; 2-gang Variables .0005mfd, 5/11; Output Transformers, 5000 ohms to 3 ohms (trap.) 50 ma, 3/11; Can Electrolytics, 25 mfd, 25v, 10d., 16 mfd, 450v, 2/9, 2000 mfd, 15v 7/6. Ex-Gov. Lines: Potted Chokes, 60 ma, 10h, 200 ohms, 4/6; Tropicalised Chokes, 60 ma, 20-30h, 1000 ohms, 3/11; Sprague, 0.1 mfd plus 0.1 mfd, 2000v, Conds., 4/6. All goods guaranteed; c.w.o. over £1; post 1/3 extra under £3; list 4d.

SYNCHRONOUS MOTORS, 200-250v, A.C., 50 cycles, clock type, 12/6 each, 1/- postage; suitable for model engineers. UNIVERSAL ELECTRICAL, 217a, City Rd., London, E.C.1.

VALVES

VIEWMASTER valves, as specified, all guaranteed brand new and boxed, comprising 5 EF50, 1 KT61, 1 6Z25, 1 EBC33, 1 EB91, 2 6K25, 1 6P28, set of 12 6E9/9/6, PL38, EY51, 18/6, PZ30, GZ32, 13/6; ECL80, UCH42, 6C9, 10C1, 6F15, 10F9, 10P13, 12/6; UBC41, UF41, EC91, 10LD11, UL41, 10/9; EF91, 6P12, 6AM6, UO9, U404, UY41, 10/-; EB91, 6AL5, AZ31, 9/-; 1R5, 155, 1T4, 3V4, 8/9; 354, 10/-; HVR2A, EF50, EF8, KT2, 7/6; 6K7G, 6K7G1, 6/6; 9D2, 4/6. All valves guaranteed brand new and boxed. P.M. Speakers, Elac 2in. and 3in., Plessey 5in. and Truvox 6in., all at 12/6; Plessey 8in., 13/6; c.w.o.; post paid 20/-. READERS RADIO, 24, Colberg Place, Stamford Hill, London, N.16.

VALVES wanted, types 1R5, 155, 1T4, 154, 6K7, 6Q7, 6V6, 5Z4, 6K8, 805, 807, 811, 813 and 832; highest prices paid instantly. Box 211, c/o PRACTICAL WIRELESS.

400 NEW VALVES at bargain prices; all types; state requirements; stamp please. TABNER, Ickleford, Hitchin, Herts.

TAPE RECORDINGS, ETC.

TAPE RECORDING.—The latest Linc-A-Tone Recording Panels; speeds 3in., 7in. and 15in. per sec.; operated by push buttons, fast rewind, freedom from wow; precision built, £20. The complete Recording Unit with amplifier, microphone, tape, etc., in attractive walnut cabinet, price £68. Order now, delivery good. MORECAMBE SOUND SERVICE, "Sealand Works," Cross Cop, Morecambe.

RECORDING WIRE, stainless steel, 3,600ft. reels, 5/6; Constructional details, 1/6. 12, Rosendale Ave., Blackley, Manchester, 9.

REPAIRS AND REWINDS

LOUDSPEAKERS repaired promptly. MODEL LOUDSPEAKER SERVICE 34a, Bullingdon Road, Oxford.

VACUUM CLEANERS and Gram. Motors, repairs our speciality. Armature rewinds, new bearings and commutators fitted, also transformers rewound, speakers repaired. Competitive prices. Trade enquiries invited, 7 days' c.o.d. service. Send s.a.e. for price lists to: A.D.S. CO. (V.E.M., Dept.), 261-3, Lichfield Rd., Aston, Birmingham, 6. Est. 1935.

A SCOTTISH Winding Service.—All types of Transformers, Chokes, Field Coils, etc. Rewound and manufactured to highest standards. Write for details: WILFLO PRODUCTS, 230-254, Brand St., Glasgow, S.W.1. (Telephone: Ibrox 0140.)

★ A New Receiver for the ★
Home Constructor

**THE "TWIN" ONE VALVE
POCKET RECEIVER**

This interesting circuit is designed around the famous "twin" valve now available as a British midget type operating from midget dry batteries. The receiver requires no aerial, earth, or external power supplies, the batteries being entirely self-contained.

As a result of the use of midget components, and the elimination of tuning coils, the set when not in use slips easily into the jacket pocket.

This receiver can be used anywhere, indoors or out, giving powerful headphone reception of many stations on the medium waveband. Full instructions, Circuit, Point-to-Point Wiring Diagram and Component List.

Price, 3/3, post free

SWIFT RADIO (W),
137, COTHAM BROW, BRISTOL, 6

Orders by post only

**STOCKTAKING SPECIAL
RADIO UNLIMITED
ELM ROAD, LONDON, E.17.**

CONDENSERS.—ELECTEC., 450 v.v., 4 mfd., 1/6; 8, 2/3; 16, 3/-; 8 x 16, 4/3; 16 x 16, 4/6; 32 x 32, 5/9; 500 v.v., 8 mfd., 2/6; 16, 3/9. Bias 25/25, 1/9; 50, 50. Tubulars, 1, 500v., 6/- dozen.

VOLUME CONTROLS.—L/spdls., all values, 2/6; W/sw., 4/-; 1 and 2 meg., DP/sw., 4/6.

TRANSFORMERS.—Mains, 300-0-300, 6v. 4a, 3v. 2a, 100 M/A, 23/- inc. post. Output: Stnd. Pend., tapped, 3/9. I.F. Trans.: 465 kc/s, 7/6 pair. Mic Trans., 2/9.

VALVES.—Guaranteed new and boxed. 5Z4, APV4, 6Q7, 6K8, EP91, 6V6, 10/-; 6K7, EF36, EK32, EF39, 12A6, VR101, 6B8, EF50, KT2, 6J7, 6D6, SP61, SP41, EF8, 6/6 each; EB91, 8/-; 1T4, 1S4, 1S5, 1S5, 3/7/6 set of 4. Tested Red EF50, 5 for 29/6.

Hundreds other types in stock. Stamp list.

EDUCATIONAL

NO B.N.R.S. Student has ever failed to pass his examinations after completing our appropriate study course. Now in our eleventh year and this claim is still true. All our courses are conducted by correspondence and our syllabus includes Brit.I.R.E., City and Guilds exams. Also maths, physics and radar. Nothing succeeds like success and what we have done a thousand times already for your colleagues, we can do again, for you—and all for £1/1/- per month. Free booklet from BRITISH NATIONAL RADIO SCHOOL, 66, Addiscombe Road, Croydon, Surrey. (Telephone: ADDISCOME 3341.)

FREE! Brochure giving details of Home Study Training in Radio, Television, and all branches of Electronics. Courses for the hobby enthusiast or for those aiming at the A.M.Brit.I.R.E., City and Guilds Telecommunications, P.T.E.B., and other Professional examinations. Train with the College operated by Britain's largest Electronic organization; moderate fees. Write to E.M.I. INSTITUTES, Postal Division, Dept. PW28, 43, Grove Park Rd., London, W.4. (Chiswick 4417.) (Associated with H.M.V.)

THE INSTITUTE of Practical Radio Engineers have available Home Study Courses covering elementary, theoretical, mathematical, practical and laboratory tuition in radio and television engineering; the text is suitable coaching matter for I.P.R.E. Service, entry and progressive exams. Tuition fees at pre-war rates are moderate. The Syllabus of Instructional Text may be obtained, post free, from the SECRETARY, Fairfield Road, Crouch End, N.8.

MERCHANT NAVY and Air Radio. Here is an opportunity to train as Radio officer. The big liners are open to you, but you must qualify for the P.M.G. Certificate. Day, Evening and "Radiocerts" postal courses. S.A.E. for prospectus from Director, THE WIRELESS SCHOOL, 21, Manor Gardens, Holloway, London, N.7. (Est'd 30 yrs.) (Phone: ARC 3694.) Students deferred from Military Service.

A.M.I.MECH.E., A.M.Brit.I.R.E., City and Guilds, etc.,—on "no pass—no fee" terms; over 95% successes. For details of exams. and courses in all branches of engineering, building, etc., write for 144-page handbook—free. B.I.E.T. (Dept. 242B), 17, Stratford Place, London, W.1.

WIRELESS.—Postal Course in theory for Amateur Transmitting License, complete with text-book, at moderate fee; also instruction at school for P.M.G.'s Certificates to become Radio Officers in Merchant Navy; at good salaries. Recognised by Ministry of Education. Apply B.S.T., LTD., 179, Clapham Road, London, S.W.9. (Est. 1906.)

SEE THE WORLD.—600 Radio Officers required. Send 2d. stamp for prospectus to Britain's leading college. We train most in shortest period at lowest cost. WIRELESS COLLEGE, Colwyn Bay.

MODERN ELECTRICS LTD.

164, Charing Cross Road, London, W.C.2

'Phone : TEMple Bar 7587

Immediate delivery from stock

Export enquiries welcomed

	£	s.	d.
CONNOISSEUR 2-speed			
Motors	22	18	6
CONNOISSEUR Pickups ...	10	0	8
Std. and Microgroove Standard	4	11	5
ACOS, G.P.20 PIU	3	11	5
ACOS, LP. and Std. Heads ...	2	3	4
DECCA, Pickup	3	15	4
DECCA, Motors—			
33 $\frac{1}{3}$ and 78 speed	3	14	4
33 $\frac{1}{3}$ -45 and 78 speed	7	3	4

TEST GEAR

AVO—			
Models 7, 8	19	10	0
D.C. Minor	5	5	0
Uniminer	10	10	0
Univ. Bridge	25	0	0

SIGNAL GEN.—			
Wide Band	30	0	0
Valve Tester	50	0	0
Electronic Test Meter	40	0	0

TAYLOR, ALL TAYLOR TEST GEAR IN STOCK. Still available on H.P. Send S.A.E. for catalogue and terms.

MORSE CODE Training



COURSES for BEGINNERS and OPERATORS, also a SPECIAL COURSE for passing the G.P.O. Morse Test for securing an AMATEUR'S TRANSMITTING LICENCE.

Send for the Candler BOOK OF FACTS It gives details of all Courses.

THE CANDLER SYSTEM CO. (Dept. 5LO), 52b, Abingdon Road, Kensington, London, W.8.

Candler System Co., Denver, Colorado, U.S.A.

TR9 SHORT-WAVE RECEIVERS. 21-80 metres, complete with 6 battery-operated valves, 15/6; less valves, 5/6, post 2/6. **VCR97** (full-size picture), brand new and boxed, 35/-, post 5/-. **THROAT Mikes** (new), 2/11 pair, post 6d. **BRAND NEW VIBRATORS**, 6-volt 4-pin, 5/9; 5-pin, 7/-; 12-volt 4-pin, 7/-, post 6d. **TWIN-GANG 1 MEG. POTS.** 2/6; 2 meg. pots. 1/11; 100K pots. with Switch, 2/9; 1 meg. with Switch, 3/6, post extra. **NEW VALVES:** VU111, 2/6; KT241, 4/6; EA50, 2/6; ATP4, 3/6; 12SR7, 9/6; 12SJ7, 8/6; 12S17, 7/9; 12SA7, 12/6; 837, 9/6; 31B, 3/6; 1LD5, 1LN5, 4/6 each; 8D2, 3/6; 1A5, EC52, 5/- each; 6B8, 5/6. Post extra. **63-VOLT IET BATTERIES** (New), 5/6, post 1/-. **BROMIDE PAPER** (Normal), Glossy, 1 gross packet, 51 x 51 in., 5/6, post 6d. **TRUVOX, P.M.**, 6in. Speaker, new, 15/-, post 9d.

WANTED: Valves, Receivers and Equipment.

STAN WILLETTS,

43rd SPON LANE, WEST BROMWICH, STAFFS.

L-R-S CASH OR EASY TERMS

Limited Stock Immediate Delivery

ARMSTRONG ALL-WAVE CHASSIS

MODEL EXP. 73. CASH £25/12/4 or £6 with order and 11 monthly instalments of 40/-

MODEL RF. 104. CASH £34/12/10 or £9 deposit with order and 14 monthly instalments of 40/-

MODEL EXP. 125/3. CASH £53/0/10 or £15 with order and 14 monthly instalments of 60/-
Passenger carriage 10/- extra, payable with deposit.

LOUDSPEAKERS

GOODMAN'S AUDIUM 60.

CASH £8/12/8 or £2/5/0 with order and 7 mthly. instalments of 20/-
AXIOM 150. CASH £10/5/6 or £3 with order and 8 mthly. instalments of 20/-

WHARFDALE W.12.CS. CASH £9 or £3 with order and 7 monthly instalments of 20/-

W.15.CS. CASH £15 or £4/5/0 with order and 8 mthly. instalments of 30/-

THE AMAZING NEW REMINGTON CONTOUR 6 ELECTRIC SHAVER will give you the finest possible shave, in the easiest way imaginable.

Available on **TEN DAYS' FREE TRIAL** on receipt of 25/- deposit (returnable if not entirely satisfactory) and 8 monthly instalments of 20/-
A.C./D.C. 200/250v.
Cash Price £9/19/6.
Other voltages available.

Illustrated leaflets on request.

THE LONDON RADIO SUPPLY COMPANY Est. 1925
BALCOMBE, SUSSEX

ALPHA OFFERS

VOLUME CONTROLS. 100K Ω , $\frac{1}{2}$ meg Ω , 1 meg Ω , 2 meg Ω , with S.P.S., 4/3 each. 25K Ω , 50K Ω , $\frac{1}{2}$ meg Ω , 1 meg Ω , 1 meg Ω , 2 meg Ω , with D.P.S., 5/- each. 30K Ω , $\frac{1}{2}$ meg Ω , 1 meg Ω , 1 meg Ω , 1.5 meg Ω , LEBS switch, 2/3 each.

EX-GOVERNMENT SURPLUS— 1 K Ω , 2K Ω , 5K Ω , 20K Ω , 25K Ω , 50K Ω , 100K Ω , 120K Ω , ALL CARBON TRACK, 1/- each. 5 Ω , 200 Ω , 20K Ω WIRE WOUND, 1/- each.

STANDARD CAN CONDENSERS. 8 mfd., 450 V., 1/11 each. 16 mfd. 350 V., 2/9 each. 32 mfd. 350 V., 4/- each. 16 mfd. 500 V., 3/9 each. 24 mfd. 350 V., 4/9 each. 16 x 16 mfd. 450 V., 4/9 each.

SPEAKERS. 3in. 3 Ω FOR PERSONAL SETS, 12/6 each, post 6d. Output Transformer to suit 134, 384, etc., 4/6 each. 5in. 3 Ω lightweight, 12/6 each, post 9d. 8in. 3 Ω lightweight, 14/6 each, post 1/-.

10in. 3 Ω robust Job large magnet, 22/6, post 1/6. 6in. 3 Ω with dust cover, 13/6 each, post 1/-.

17/8 each, post 1/6. 8in. 3 Ω Mains energised, 600 Ω field, 15/9 each, post 1/6.

STANDARD 3 GANG. .0003 mt. Ceramic insulation tin. spindle, 7/- each.

HEAVY DUTY COOKER SWITCH. 4 Position Switch. Porcelain and Bakelite Insulation, 4/- each, post 1/- ea.

CHOKES. Ex-Government equipment. midjet 15 Ω 1H. 500 M/A. pitch dipped, 2/- each. Large type, 600 Ω 120 M/A., 5/- each.

MIDGET CHASSIS. Holes cut out for Valve Holders, Speakers, and Controls, etc., 1/- each. Post and Pkg., 1/-

INDICATOR LAMPS. Single hole fixing, metal construction—as fitted on ex-Govt. telephone sets etc.—will take standard MES Bulb, 1/9 ea.

MICROPHONE INSERTS. Ex-Govt., by Truvor and Tannoy, 1/8 ea.

MULDED MICA CONDENSERS. .0001, .0002, .0003, .0005, .0004, .00027, .01, .001, .002, .003, .005, .0003, .00005, All 5/6 doz.

METAL RECTIFIERS. 12 volt $\frac{1}{2}$ amp., 1/- each. 2 volt $\frac{1}{2}$ amp., 5/- each. 300 volt 80 M/A., 5/6 each. 250 volt 75 M/A., 5/6 each. 12 volt 3 amp., 18/6 each. 200 volt 60 M/A., 4/9 each.

Full range of condensers, resistors, etc., write for list (3d. stamp).

TERMS: Cash with order or C.O.D. Please add 1/- postage under £1; 1/8 under £2.

ALPHA RADIO SUPPLY CO.
5/6 Vince's Chambers, Victoria Sq., Leeds 1

LONDON CENTRAL RADIO STORES

PHILCO SETS RECONDITIONED GUARANTEED (UNIVERSAL MAINS)

ALL WAVE TABLE MODEL. Medium r Dark Walnut Cabinet. Excellent Performance. 5-Valve, £8/15/-. Size 18 $\frac{1}{2}$ x 20 x 9 $\frac{1}{2}$. Carriage and Packing 10/6 extra.

LARGE TABLE MODEL in Light Walnut. With Large Dial in Metres and Frequency. 2-Waveband. Exceptional High Gain, 115/-, 10/6 Carriage and Packing. 5-Valve. Size 19 x 16 x 10 $\frac{1}{2}$.

MEDIUM TABLE MODEL known as Cathedral Model. 2 Waveband 110/-, 10/6 Carriage and Packing. 5-Valve. Size 19 x 14 x 10.

SEE LAST ISSUE

Carriage charges relate to Inland only.

WE WANT TO BUY RADIO EQUIPMENT—AMPLIFIERS—TAPE RECORDERS—TELEVISION TEST EQUIPMENT—COMPONENTS

LONDON CENTRAL RADIO STORES

23, LISLE STREET, W.C.2

Phone/Grams: GERrard 2969

THE *Fidelia*

7

Luxury 7-valve Radiogram chassis £21-15-0. Also 9-valve De Luxe Chassis at £25-5-0, and 5-valve model at £15-15-0. Data sheets on request.

ELECTRO Acoustic
-DEVELOPMENTS-
2 Amburst Road, Teloscombe Cliffs, Sussex

H.A.C. SHORTWAVE EQUIPMENT

Noted for over 18 years for S.W. Receivers and Kits of Quality.

Improved designs with Denco coils—
One-Valve Kit, Model "C" Price, 25/-
Two " " " " 50/-

All kits complete with all components, accessories, and full instructions. Before ordering call and inspect a demonstration receiver, or send stamped, addressed envelope for descriptive catalogue.

"H.A.C." SHORT-WAVE PRODUCTS
(Dept. TH), 11, Old Bond Street, London, W.1.

Practical Wireless BLUEPRINT SERVICE

PRACTICAL WIRELESS

*No. of
Blueprint*

CRYSTAL SETS

Blueprints, 1s. each.

- 1937 Crystal Receiver .. PW1*
The "Junior" Crystal Set PW94*

STRAIGHT SETS

Battery Operated

- One-Valve : Blueprints, 2s. each.
The "Pyramid" One-valver (HF Pen) .. PW93*
- Two-valve : Blueprints, 2s.
The Signet Two (D & L F) PW76*

- Three-valve : Blueprints, 2s. each.
Summit Three (HF Pen, D₂ Pen) PW37*
- The "Rapide" Straight 3 (D, 2 LF (RC & Trans)) PW82*

- F. J. Camm's "Sprite" Three (HF, Pen, D, Tet) PW87*

- Four-valve : Blueprints, 2s. each.
Fury Four Super (SG, SG, D, Pen) PW34C*

Mains Operated

- Two-valve : Blueprints, 2s. each.
Selectone A.C. Radiogram Two (D, Pow) PW19*

- Three-valve : Blueprints, 2s. each.
Double - Diode - Triode Three (HF Pen, DDT, Pen) PW23*

- Four-valve : Blueprints, 2s. each.
A.C. Fury Four (SG, SG, D, Pen) PW20*
- A.C. Hall-Mark (HF Pen, D, Push-Pull) .. PW45*

SUPERHETS

- Battery Sets : Blueprints, 2s. each.
F. J. Camm's 2-valve Superhet PW52*

*No. of
Blueprint*

SHORT-WAVE SETS

Battery Operated

- One-valve : Blueprint, 2s.
Simple S.W. One-valver PW88*
- Two-valve : Blueprints, 2s. each.
Midget Short-wave Two (D, Pen) PW38A*
- Three-valve : Blueprints, 2s. each.
Experimenter's Short-wave Three (SG, D, Pow) PW30A*
- The Prefect 3 (D, 2 LF (RC and Trans)) .. PW63*
- The Band-spread S.W. Three (HF Pen, D (Pen), Pen) PW68*

PORTABLES

- Four-valve : Blueprint, 2s.
"Imp" Portable 4 (D, LF, LF, Pen) .. PW86*

MISCELLANEOUS

- Blueprint, 2s.
S.W. Converter-Adapter (1 valve) PW48A*

TELEVISION

- The Practical Television Receiver, (3 sheets) 10/6

AMATEUR WIRELESS AND WIRELESS MAGAZINE

STRAIGHT SETS

Battery Operated

- One-valve : Blueprint, 2s.
B.B.C. Special One-valver AW387*
- Two-valve : Blueprints, 2s. each.
A modern Two-valver .. WM409*

Mains Operated

- Two-valve : Blueprints, 2s. each.
Consoelectric Two (D, Pen), A.C. AW403

SPECIAL NOTICE

THESE blueprints are drawn full size. The issues containing descriptions of these sets are now out of print, but an asterisk beside the blueprint number denotes that constructional details are available, free with the blueprint.

The index letters which precede the Blueprint Number indicate the periodical in which the description appears: Thus P.W. refers to PRACTICAL WIRELESS, A.W. to Amateur Wireless, W.M. to Wireless Magazine.

Send (preferably) a postal order to cover the cost of the Blueprint (stamps over 6d. unacceptable) to PRACTICAL WIRELESS Blueprint Dept., George Newnes, Ltd., Tower House, Southampton Street, Strand, W.C.2.

*No. of
Blueprint*

SHORT-WAVE SETS

Battery Operated

- One-valve : Blueprints, 2s. each.
S.W. One-valver for America AW429*
- Two-valve : Blueprints, 2s. each.
Ultra-short Battery Two (SG, det Pen) WM402*

- Four-valve : Blueprints, 3s. each.
A.W. Short-Wave World-beater (HF Pen, D, RC, Trans) AW436*

- Standard Four-valver Short-waver (SG, D, LF, P) WM383*

Mains Operated

- Four-valve : Blueprints, 3s.
Standard Four-valve A.C. Short-waver (SG, D, RC, Trans) WM391*

MISCELLANEOUS

- Enthusiast's Power Amplifier (10 Watts) (3/-) WM387*
- Listener's 5-watt A.C. Amplifier (3/-) .. WM392*
- Harris Electrogram battery amplifier (2/-) WM399*
- De Luxe Concert A.C. Electrogram (2/-) .. WM403*

HINTS COUPON

This coupon is available until March, 3rd, 1952, and must accompany all Practical Hints.
PRACTICAL WIRELESS, MAR., 1952.

7 VALVE 5 WAVEBAND RADIO CHASSIS

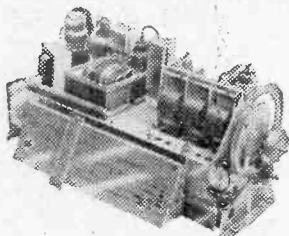

A famous set by a famous manufacturer. Undoubtedly a serious listener's receiver. Special features are H.F. stage and tuning indicator. Tunes up to 11-metre band. Price new with all valves, but less speaker, £14.19.6. Carriage and packing 15/-, partly returnable. A.C. mains and Car battery models available.

DEMOBLED VALVES

Gives the commercial equivalents of many thousands of Service valves, an invaluable publication recently revised.



Price 2s.

Orders are dealt with by our Ruislip depot. To avoid delay address to: E.P.E. Ltd. (Dept. 7), Windmill Hill, Ruislip, Middx. Include extra 2/6 under £2. 1/9 under £1.



PRECISION EQUIPMENT

RADIO-GRAM CABINETS

Full size console type cabinets with highly polished walnut finish. Designed to take standard type auto change gram unit. You can have these at £12/10/0 each, which means a really nice radio-gram for less than £30, for we can supply a 5-valve, 3-waveband chassis at £10/10/0 (minor alterations to the radio chassis will, of course, be necessary).

Special Offer. Gram units ordinary from £5.5.0. Auto from £11.15.0. Cabinet complete with auto change gram unit and pick-up £22.10.0.



MULTI-SPEED MOTORS

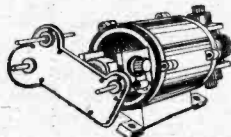

You can adjust this motor to almost any speed you want. It will work directly off A.C. mains; or if you require greater power or greater speed work it through a metal rectifier. This motor is fitted with a gear box enabling speeds down as low as 1 r.p.m. to be obtained. Price 14/6, postage and packing 1/6 extra.

BATTERY PERSONAL CHASSIS

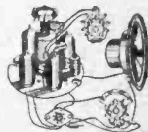

This 4 valve all dry battery operated receiver is of such small dimensions that it will fit into a cabinet only about 6in. x 4in. x 3in. and still leave ample room for batteries. The chassis is all wired and complete with speaker, volume control, wave change switch, etc., etc., and only first grade components have been used.

Prices are:
Chassis complete except for valves (three type 174 and one type 3V4), operates on long and medium wavebands, 59.6.

• Ditto, but medium waveband only, 49.6.
• Add 2/6 to cover postage and insurance.

'SOMWEAVE'

We can offer you a really lovely loud speaker fabric 'somweave' at approximately a third of to-day's cost. It is 42in. wide and our price is 12/- per yard, or panels 12in. x 12in. 1/9 each. This is also very suitable for covering rough wooden cases for portable radio-grams, amplifiers, etc.

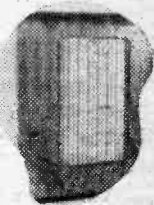

EQUIP YOUR DEN

You often need to measure capacity of small condensers, so why not make a unit to do this? We can supply circuit diagram and all parts. Total cost being only 10/- Battery Model, 25/- Mains Model. Circuit separately 1/6 refunded if you buy the kit.

152-153 FLEET STREET, E.C.4, and at
WINDMILL HILL, RUISLIP MANOR, MIDDX.



HOME STUDY

backs radio experience with
sound technical knowledge

MANY men who wished to link their radio experience with a sound technological background have received successful instruction by means of an I.C.S. Course. Its value has been proved not only to amateurs but to men who already have a professional interest in radio and television engineering, including those taking qualifying examinations. It is invaluable, also, to Students who wish to prepare themselves for a job in this field. Courses of Instruction covering radio and, if necessary, television include the following:

Complete Radio Engineering, Radio Service Engineers Radio Service and Sales, Advanced Short-Wave Radio Elementary Electronics, Radar, Radio and Television Technology

And the following Radio Examinations:

British Institution of Radio Engineers
P.M.G. Certificates for Wireless Operators
City and Guilds Telecommunications

Write today for our FREE "Radio" booklet, which fully describes the above I.C.S. Courses. Fees are moderate and include all books required. **GENEROUS DISCOUNT TO H.M. FORCES.**

International CORRESPONDENCE SCHOOLS

Dept. 170a, International Bldgs., Kingsway, London, W.C.2

G2AK

This Month's Bargains

G2AK

All types of Osmor, Weymouth, Denco and Wearite Coils always in stock.

MIDGET SPEAKERS. W.B., 2in., 16/6; Philips, 3in., 15/-; W.B., 5in., 16/-; Elac, 6in., 17/6; P. & P., 1/-.

TEST PRODS. for test meters. Red and black, 4/6 pair.
ELAC FOCUS UNITS. for triode and tetrode tubes. P.M. type: List, 30/-. Our price, 20/-, post 7 ree.

T.V. TUBE MASKS, brand new, new ratio, 15/- each, post free.

SELENIUM RECTIFIERS, 250 v. 60 m.a. D.C. output. New, 7/6 each.

MORSE PRACTICE SETS, with double-action buzzer, output for 'phones, excellent key, require only 4½ v. battery. As new, 7/6, P. & P., 1/-.

MIDGET OUTPUT TRANSFORMERS for personal portables, 6/- Standard pen.; 5/6. Mike trans. for M.C. mikes, 2/- for carbon, 1/3 each.

XTAL DIODES, 3/9 each. Germanium diodes, 5/6 each.
MICROPHONES, Carbon inserts, 2/6 each. M.C., No. 7, 3/11. Loud hailer, 7/6.

AVO MULTIPLIERS, 4,800 volt, for model 40, 5/-, post 9d.
POTENTIOMETERS. 20 k. and 25 k. W.W. 5 w., 2/- each. Carbon, 50 k., 100 k., 1 meg. and 2 meg., 1/6 each. 500 ohm H.D. toroidal, 3/6 each.

TWIN FEEDER. 300 ohm H.D. Twin, 5d. yd. Standard K25 300 ohm, 9d. yd. K24 150 ohm, 9d. yd. Coax. T.V. cable, 1in., 1/3 yd. Packing and postage on cables, 1/6.

SPECIAL VALVE OFFER. Kit of 4 midget 1.4 v. valves, 1 each 15S, 1R5, 1T4 and 1S4, 30/- or 8/6 each, separately. Postage free on all orders over 1/- except where specifically stated. **PLEASE PRINT YOUR NAME AND ADDRESS.**

CHAS. H. YOUNG, G2AK

All callers to 110 Dale End, Birmingham
CENTRAL 1635

Mail Orders to 102 Holloway Head, Birmingham
MIDLAND 3254