

BUILDING THE MINI-SET

PRACTICAL

FEBRUARY
1957

EDITOR: F.J. CAMM

WIRELESS

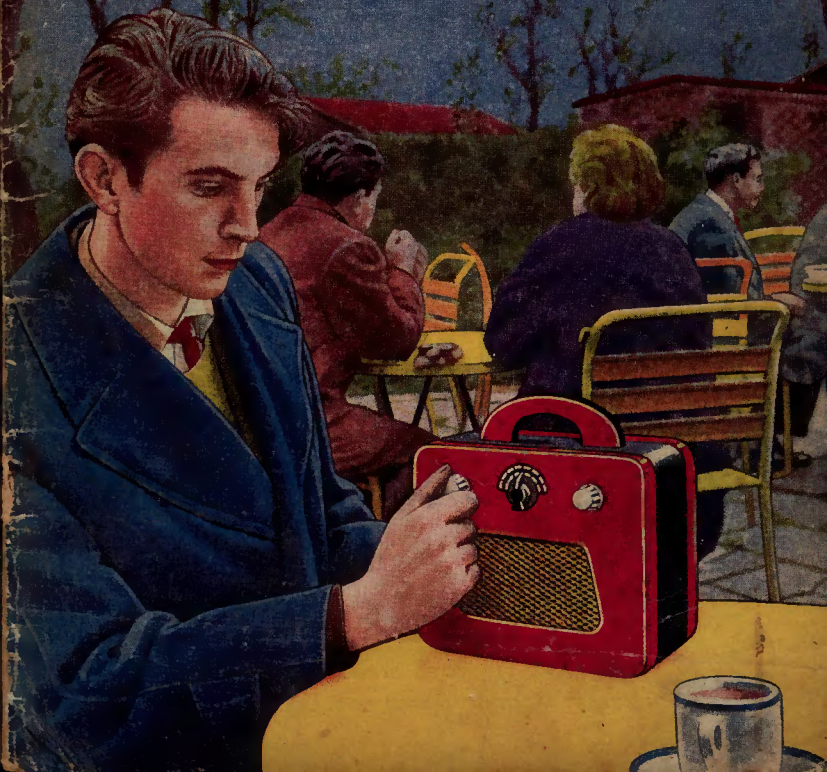

Supreme in Service

'MICROMITE'

DRY ELECTROLYTIC CONDENSERS

These small but high quality electrolytics have proved so popular that the range has been greatly extended. The use of high-gain etched foil electrodes keeps size and weight down, making the condensers suitable for suspension wiring. Conservatively rated; long shelf life ensured; green plastic insulating sleeving prevents short-circuits.

Capacity in μ F.	Peak Wkg. Volts	Surge Volts	Dimns. in Ins.		Type No.	List Price Each
			Length	Diam.		
50	12	15	1 1/2"	1 1/8"	CE87B	2/9
25	50	60	1 1/2"	1 1/8"	CE88DE	3/-
1	350	400	1 1/2"	1 1/8"	CE86L	2/6
8	350	400	1 1/2"	1 1/8"	CE99LE	3/3
16	350	400	2 1/2"	1 1/8"	CE91LE	4/-
32	350	400	2 1/2"	1 1/8"	CE93LE	6/-
4	450	550	1 1/2"	1 1/8"	CE99PE	3/3
8	450	550	1 1/2"	1 1/8"	CE90PE	3/6
16	450	550	1 1/2"	1 1/8"	CE92PE	5/-
32	450	550	2 1/2"	1 1/8"	CE94PE	7/6



THE TELEGRAPH CONDENSER CO. LTD

RADIO DIVISION : NORTH ACTON • LONDON • W.3 • Telephone : ACOrr 0061

Stentorian VHF/FM TUNER

NEW!

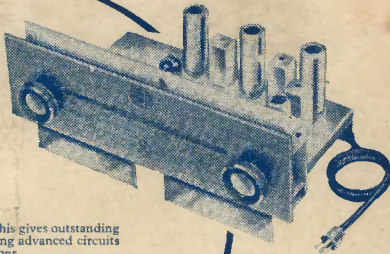

Built to the usual WB standard of craftsmanship, this gives outstanding performance, due to specialised design incorporating advanced circuits to take full advantage of the VHF/FM transmissions.

Permeability tuning, automatic frequency control, and temperature-controlled circuits give rock-steady tuning with no drift. Foster Seeley discriminator and cathode follower circuit. The wide frequency range—87.5–108 Mc/s.—covers all proposed British stations, and also those on the Continent and in U.S.A. Latest type tuning indicator.

The high sensitivity enables this Tuner to be used in areas where FM transmissions are normally regarded as out of range. No interference with television, due to negligible radiation figure.

Price £25 (inc. P.T.)

See and hear this and all other Stentorian High Fidelity equipment at our London office (109 Kingsway, W.C.2) any Saturday between 9 a.m. and 12 noon. Leaflets on all the outstanding W.B. products on request.



High Fidelity at realistic cost

WHITELEY ELECTRICAL RADIO CO. LTD • MANSFIELD • NOTTS

BEGINNERS! — BUILD A CHEAP EASY-TO-MAKE SET



47/6

Build this exceptionally sensitive double triode radio. Uses unique assembly system and can be built by anyone without any radio knowledge whatever in 45 minutes. Black-oxide steel case with specially made black and gold dial with stations printed. Size of radio only 6 1/2 in. x 5 in. x 2 in. Covers all Medium and Long waves—uses one only all-dry battery. H.T. consumption only 1 to 1.5 mA. Uses personal phone. Ideal for Bedroom, Garden, Holidays, etc. Many unsolicited testimonials. Mr. Norton of Oxford, writes: *Yesterday evening on the London wireless, I counted 32 separate stations. I am very pleased with the set, which is well worth the money. BILD THE "SKYPOCKET" NOW! Total building cost—Everything down to last nut and bolt—47s (Postage, etc., 2s)—with full set of clear, easy-to-follow plans. (Parts sold separately. Priced Parts Lists, etc., 1s.)*

LOOK!



LOOK THIS POCKET RADIO FOR ONLY 37/6

AT LAST! In response to many requests we now present the **DOUBLE TRIODE "SKYPOCKET"**—a beautifully designed precision **POCKET RADIO**. No radio knowledge needed—**EVERY SINGLE PART TESTED BEFORE DESPATCH**; our simple, pictorial plans take you step-by-step. This set has a remarkable sensitivity due to painstaking design. Covers all medium waves 300 to 350 Metres. Size only 5 1/2 in. x 3 in. x 2 1/2 in. in Strons, transparent case with panel, cover and Ivorine dial. A really personal-phone, pocket-radio with **DETACHABLE ROD AERIAL**. Self-contained all-dry battery operation. Average building time 1 hour. **Total Building Cost—including Case, Double Triode Valves, etc., in fact, everything down to the last nut and bolt—ONLY 37s. 6d.** with plans, Postage, etc., 2s. C.O.D. 1s extra. (Parts sold separately. Priced Parts List, etc., 1s. 10s.) Demand is certain to be heavy—so **SEND TODAY!**



107/6

Total building cost including choice of beautiful walnut veneered cabinet or Ivory or brown bakelite. This is the lowest possible price consistent with high quality. No radio knowledge whatever needed... can be built by anyone in 2-3 hours, using our very simple easy-to-follow diagrams. The circuit of the **"OCEAN-HOPPER"** covers all medium and long waves with optional negative feedback, has razor-edge selectivity, and exceptionally good tone. Price also includes ready drilled and punched chassis, set of simple easy-to-follow plans—in fact, everything! All parts sparkling brand new—no junk! Every single part tested before despatching. Uses standard octal-base valve; 6X3 high-frequency pentode feeding into 6X5 audio-band detector triode, coupled to 6V80 powerful output beam-power tetrode, fed by robust rectifier. For A.C. mains, 200-250 Volts (low running cost—approximately 18 Watts 1/2). Size 12 in. x 6 in. x 5 in. **Build this long range powerful midset NOW.** All parts and set of plans, 107s. 6d. (Post and Packing 3s.) Parts sold separately. Priced Parts List, 1s



WE'VE DONE IT AGAIN!... our design department in response to a great many requests have designed this **"SKYPIEKE" Vest-Pocket TRANSMITTER RADIO** which gives a superb performance. It is powerful and highly sensitive. Size only 4 in. x 3 1/2 in. x 1 in. the weight under 7 ozs. 1—yet it is a **TWO-STAGE** receiver covering all medium-waves, working entirely off a tiny "perlight" battery, which costs 6d.—fits inside the case—and lasts many months. Uses personal phone and has push-button **LUMINOUS On/Off Switch**. Every part tested before despatch! **SPECIAL, STEP-BY-STEP PLANS FOR ABSOLUTE BEGINNERS**. Total building cost including case, transistors, etc., everything down to the last nut and bolt—**ONLY 57s 6d.** with plans, Postage, etc., 2s. C.O.D. 1s extra. (Parts sold separately. Priced parts list, etc., 1s.) As the building cost is absolutely "rocketton" it will increase later! **DEMAND WILL BE VERY HEAVY—SO SEND TODAY!**

CAN BE BUILT FOR 57/6

BUILD THIS 'FRYING-PAN' SET FOR ONLY 77/6

BUILD YOUR MOTHER OR WIFE this Frying-Pan radio! Highly sensitive circuit covering all Medium and Long Waves. Has normal size speaker and gives excellent tone due to wall to wall effect. Costs only 1d. for about 75 hours use. Ideal for the kitchen, bedroom, etc. Robust design. For A.C. mains: 200-250 volts. **TOTAL BUILDING COST** including mirror-finish frying-pan, double-triode valves, step-by-step beginner's plans, nuts, bolts, etc., **ONLY 77s 6d.** Postage, etc., 2s. C.O.D. 1s extra. (Parts sold separately. Priced parts list, etc., 1s.) **PRICES MAY GO UP!—SEND NOW.**



BUILD THE 'MINIATOM' FOR 59/6

INTRODUCING THE 'MINIATOM'—to fill a big need! An exceptionally powerful, all-mains one valve. Size only 5 1/2 in. x 4 1/2 in. x 2 1/2 in. **NO AERIAL ON EARTH NEEDED!** Costs approximately 1d. for 250 hours use. Uses latest contact-coated rectifier and works headphones completely hum-free—for personal listening, hear all the Continental programmes in bed without disturbing others—it has **LUMINOUS push-button on/off switch** and station printed dial. For A.C. mains 200-250 volts. Covers all Medium-Waves (provision for including Four-Waves). **REALLY LOW BUILDING COST OF ONLY 59s 6d.** including Case, Valve, Nuts, Bolts, Step-by-Step Beginner's Plans, etc.—**EVERYTHING!** Postage, etc., 2s. C.O.D. 1s extra. (Parts sold separately. Priced parts list, etc., 1s.) **THIS WILL BE A WINNER—SO SEND NOW!**



CONCORD ELECTRONICS
69, PRESTON STREET, BRIGHTON

Dept. PWF

Orders dispatched by return of post. Cheques accepted. Cash on delivery 2/6 extra. Suppliers to Schools, Universities, Government and Research Establishments. Complete range of components and valves stocked. CALLERS WELCOME. Shop Hours: 9 a.m. to 5 p.m. (1 p.m. Thursdays).

LASKY'S RADIO

RECORD PLAYERS

Garrard RC120/H. 3-spd. auto and manual changer (List £12/15/-), £7/19/6. Post 3/6.

Collaro RC3/554. 3-spd. single player. £6/10/-. Post free.
B.S.R. TUB. 3-spd. single player, 92/6. Post 3/6.

DECCA PICK-UP with t.o. crystal head HI/G. 1 p. and standard, brown, with rest. 32/6. Post 2/6.

Ditto, B.S.R., cream finish, 35/-. Post 2/6.

BRAND NEW AND PERFECT 16" METAL CONE C. R. TUBES

Brief Specification: 6.3 v. htr., ion trap, 14 kV. E.H.T., wide angle 70 degrees, standard 38 mm. neck, duodecal base, mag. focus and deflection. Length 12-11/16in. Circular shape. Guaranteed by us for 3 months. List £23/9/10.

LASKY'S PRICE **£8.9.6** Carr. & Insur. 2/6 extra.

LASKY'S BATTERY PORTABLE FOR HOME CONSTRUCTION ON PRINTED CIRCUIT

CAN BE BUILT FOR **7 GNS.**

Carr. & Packing 3/6 extra.



COMPLETE PARCEL contains printed circuit, all components, valves, case, diagram, and all instructions for building this latest design 4-valve superhet portable, med. and long waves. All components available separately.

CIRCUIT DIAGRAM, data, instructions, and shopping list, 1/6 post free.

POWER UNIT for above, also suitable for other battery portables. Complete Kit including printed circuit, 45/-.

TRANSISTORS, SPECIAL OFFER. Junction type suitable for use in local station receivers, amplifiers, pre-amplifiers, etc. Each, 10/- Post free.



A REALLY FIRST CLASS F.M. TUNER

FOR HOME CONSTRUCTION ON A PRINTED CIRCUIT

Note these star features —

- ★ High Sensitivity.
- ★ All Brand New T.C.C. Condensers.
- ★ Aerial Coil and R.F. Coupling Coil Printed on circuit.
- ★ 5 Valves & 2 Germanium Diodes.

By the use of a printed circuit the I.F. and R.F. amplifiers are extremely stable at maximum gain and results are consistent on all tuners.

Valve line-up —
R.F. Amplifier, 2719 or EF80.
Mixer and Osc., 8719 or ECC85.
1st I.F. amp., W719 or EF85.
2nd I.F. amp. W719 or EF85.
2 Germanium Diodes GEX34.
Driver Limiter, 2719 or EF80.

CAN BE BUILT FOR 8 GNS. approx.

Full instructions, data, and illustrations 2/6 post free.

All parts available separately.

LASKY'S (HARROW ROAD) LTD.

42, TOTTENHAM COURT ROAD, W.1. Telephone: MUScum 2605.
370, HARROW ROAD, PADDINGTON, W.9. LAD 4075 and CUN 1729.
Open all day SATURDAY. Half day Thursday.
PLEASE ADDRESS ALL MAIL ORDERS TO HARROW ROAD.

TV • VALVES • RADIO

6J5	5/-	7C5	8/6	EF50	4/-
6J7	7/6	5Z4	8/6	EF54	5/6
6V6	8/6	5U4G	8/6	EF91	8/6
6K7	6/-	80	9/-	EF37A	9/-
6K8	11/-	VU39	8/6	ECH42	10/6
6SN7	8/6	PCF80	9/6	EL91	5/6
6SL7	8/6	5Y3	8/6	EY51	13/6
6SK7	4/6	12A6	7/-	EZ80	8/6
6SL7	7/6	12AH7	12/-	HL23DD	8/6
PY80	10/6	12AT7	10/6	ECC81	10/6
6AL5	7/6	12AU7	10/6	ECC82	10/6
6J6	7/6	12AX7	10/6	ECC83	10/6
6C4	6/-	12SH7	10/6	ECC84	10/6
6X5	7/6	12Q7	9/-	ECC85	12/6
6X4	7/6	12K7	7/6	ECC85	10/6
6AG7	9/-	35Z4	8/6	ECL80	10/6
PL81	12/6	1T4	7/-	PCC84	10/6
PL82	11/-	354	8/6	PCF82	10/6
PL83	12/6	807	7/-	PCF82	12/6
6AC7	5/6	832	22/6	Input 28 v. D.C. 1.6 amp.	£1
6H6	2/6	955	5/-	Output 230 v. D.C. 100 mA.	£1
6A7	11/6	EF36	4/-	Input 27 v. D.C. 1.4 amp.	22/6
6B4	6/-	EF39	7/6	Output 285 v. D.C. 60 mA.	22/6
6Y6	8/6	EF42	12/6		
6U4	15/6				
6L6	12/-				
6AM6	8/6				
7H7	8/6				
7Y4	8/6				

R1155 RECEIVER

EX R.A.F.

'NICE' CONDITION **£6** AIR-TESTED
10/- Carriage.

POWER UNIT

For above RX, with 6V6 output stage. Input 200-250 A.C.

£4 Carriage 5/-.

BENDIX TA 12G TX

£4.10.0

New condition. With 3 807, 4 12SK7 Valves. A Bargain while they last.

TELEPHONE HANDSETS

Sound-powered, no batteries required.

£1 Per Pair.

DYNAMOTORS

Ex U.S.A. Surplus, new condition.

Input 28 v. D.C. 1.6 amp. £1
Output 230 v. D.C. 100 mA. £1
Input 27 v. D.C. 1.4 amp. 22/6
Output 285 v. D.C. 60 mA. 22/6

CONDENSERS.

100 Assorted .1 mfd. 5 pF. 15/-.

RESISTORS

100 Assorted 1/2, 1, 2 watts, 12/6.

METERS

8 Assorted mA, m/c, T.C. £1.2.6

30, 50, 100, 200, 300, 500 mA. Meters, 5/6 each. 1.5 kV. Electrostatic, 12/6. 250-0-250 micro-amp., £1. 0-500 micro-amp. Meter, 15/-.

TELESCOPIC AERIALS

Extend from 12m. to 14ft., 8/-.

CONDENSERS — Electrolytic.

450 volt working. 8 mfd., 2/6; 16 mfd., 3/3; 8+8 mfd., 3/9; 20 mfd., 3/-; 8+16 mfd., 4/6; 16+16 mfd., 4/6; 32+32 mfd., 6/- Bias, 25/25, 50/50, 2/- each.

POIS.—W/W or Switch to 2 meg., 2/6 each. with Switch, 100 K., 1, 1, 2 meg., 4/- each.

SP41, SP61, RK34 2/6 each.

VINERS

(MIDDLESBROUGH)

26, East St., Middlesbrough

TEL: 3418.

Built to the highest standard!

CABINETS



CAT. No. CAB/02. A well-designed Bureau-type cabinet in a medium size. Veneered in a highly figured Walnut. Outside dimensions, length 29 1/2 in., depth 18 in., height 30 in. Sliding control panel on right-hand side approx. 12 in. x 16 in. Removable baseboard on right-hand side approx. 13 in. x 15 in. Large round compartment inside the cabinet, located at the top on left-hand side.

CASH ONLY 12 Gns.

Packing and Carriage 30/-.

CAT. No. CAB/03. A magnificent Bureau-type Cabinet of the very highest quality in specially selected Walnut veneered exterior. Light Sycamore interior with Bevels lining to match. Outside dimensions, length 34 in., depth 17 1/2 in., height 30 in. Sliding control panel on right-hand side approx. 14 in. x 16 in. Removable baseboard on right side approx. 14 in. x 13 in. Two full-sized felt lined compartments in the lower half.

CASH

16 1/2 Gns. or on Credit Terms.
Packing and Carriage 25/-.

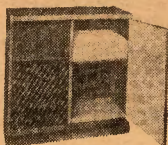
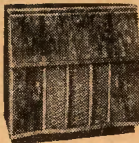

CAT. No. CAB/04. Walnut veneered de luxe cabinet of the very highest quality with sycamore-lined interior and pull-out base on the right-hand side running on high quality ball bearings. Large well-covered leather board with speaker cut-out on right-hand side below chrome control panel. Overall size 26 in. long x 30 in. high x 17 in. deep.

CASH

£13.10.0 or on Credit Terms.
Packing and Carriage 20/-.

CHASSIS

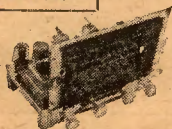

Superb Chassis of Latest Design and Technique. General Specifications applicable to all models. A.C. 200/250 volts 50 cycles only. Built-in 10 multi-coil windings plus dial of the horizontal type. Six-motion tuning drive. Full provision of Automatic Volume Control. Negative feedback from output transformer secondary. Nodes provided for Aerial, Earth, Gens, Pick-up and Extension Speaker. Connections provided to Gram. Motor controlled by Chassis On/Off switch. All inductances have an exceptionally high-Q value. The Audio Section is designed for fine tone reproduction on Radio and Gramophone. The Lane couplers have been given an extra wide range to embrace all types of soundings.

CAT. No. CR/AFM49/PP. 6 valves Superb set with FM V.H.F. Band. 4 wavebands. Push-pull output including 2 loudspeakers.

26 Gns.

Packing and Carriage 15/-

or on Credit Terms

CAT. No. CR/AFM47. 7 valves Superb set with FM V.H.F. Band

23 1/2 Gns.

Packing and Carriage 15/-

or on Credit Terms

CAT. No. CR/A. 5 valves Superb set with 4 wavebands.

12 Gns.

Packing and Carriage 12.0.

TUNER UNITS

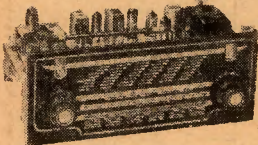

AM/FM (Four Waveband) Six valves superb set with permanently tuned FM V.H.F. band. Magic Eye tuning. FM band sensitivity of 6.0 microvolts. Minimum oscillator radiation. Less than 20 kilocycle drift. Signal-to-noise ratio better than 20 db. Size 12 1/2 in. long x 6 1/2 in. high x 7 1/2 in. deep. Guaranteed 12 months for chassis and 3 months for valves.

CASH 22 Gns.

FM TUNERS

Six valves with grounded grid R.F. stage followed by audio mixer using a PCCS twin triode in tuned permeability tuned unit. Two tuned stages ensure maximum gain with 6AL6 double diode mix ratio detector. Frequency coverage of 85-101 megacycles allows adequate overlap. Very finest quality throughout.



CAT. No. FMT/A. Complete unit in Cabinet with Maylong tuning. Boxed. 12 in. long x 6 1/2 in. overall depth x 7 1/2 in. high approx. **CASH**

16 1/2 Gns.

Packing and Carriage 12.0.

or on Credit Terms.

CAT. No. FMT/B. Chassis only including Magic Eye. Unboxed. 11 1/2 in. long x 5 1/2 in. overall depth x 4 in. high.

CASH £13.15.0

Packing and Carriage 12.0.

★ **LOUDSPEAKERS, GRAM AMPLIFIERS, TAPE-RECORDER** equipment, etc., available at keenest prices. Send for large illustrated Catalogue.

ALL FULLY GUARANTEED. Generous extended credit terms on orders exceeding £15. Dealers supplied at full discounts.

DOMESTIC DIRECT SALES LTD

90 JUDD STREET, LONDON, W.C.1. Telephone: TERminus 9876



INFRAY LAMP

Means real comfort in bed as it emits Infra Red Rays which warm and keep you healthy.

- Economical.
- Costs only 1d. per hour (eiecy at K. per unit).
- Absolutely safe, no health or fire risk.
- Ideal for many other uses—over pet's basket, rearing pup, chicks, over desk, work bench, etc.
- All complete and ready to work.

Price 36/-

Post & Packing 2/-



F.M. TUNER

This tuner is based upon the very successful circuit, published by Data Publications. We have made up models at all branches and will readily demonstrate. Stability is extremely good and making and aligning most simple. Cost of all parts, including valves, prepared metal chassis, wound coils and stove enamelled scale, slow-motion drive, pointer, tuning knob, in fact, everything needed is £6.12.6. Data is included free with the parts as it is available separately, price 2/-. Extra for fringe area model, 20/-.

SOMWEAVE



This is really lovely loud-speaker fabric we offer at approximately a third of to-day's cost. It is 42in. wide and our price is 12/- per yard, or panels 12in. x 12in., 1/9 each. This is also very suitable for covering ply wood & n.c. case, for portable radio amplifiers, etc.

The "ESTRONIC" Band III Converter

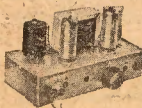

To-day's best value in Band III converter suitable for your T.V. or money refunded. Complete ready to operate, 59/6 non-mains or 69/6 mains, post and insurance 3/6.

CABINETS FOR ALL

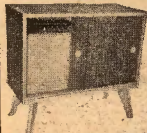

The CONTINA

Another addition to our range of cabinets. This is of new revolutionary design, styled after the best of continental radios. Externally, it is finished in highly polished dark walnut veneer, with paneling picked out in gold. Interior is of same very high standard, its veneer being also picked with the dark

light mahogany which contrasts very pleasingly against the dark walnut and generally gives a very pleasing appearance. The doors slide on metal runners and are fitted with gold inset finger plates. A really excellent cabinet for any home—size 34 1/2" long, 1 ft. 8 1/2" deep, 21 1/2" high, including legs which are 10 1/2" from floor. Motor board 12" x 18 1/2", equipment aperture 17 1/2" x 21 1/2", gives ample space for 8in. speaker. Ample storage space for recordings. Price £19/18/-, carriage and insurance 20/-.



TRANSISTORS

Red spot replaces Mullard OCT1, etc., 10/-
Blue spot suitable R.F. up to 1.6 Mc/s, 15/- each.



POCKET TRANSISTOR RECEIVER

All the parts to build cigarette box size receiver, £2.17.6, includes Ferrite serials but not the ear-piece, battery or case.

The "CRISPIAN" Portable Radio



A 4-valve truly portable battery set with very many good features as follows: Ferrite rod aerials, low consumption valves, superhet circuit with A.V.C. ready-built and aligned chassis if required, beautiful two tone cabinet covered with I.C.I. rexine and Zygax. Guaranteed results on long and medium waves anywhere. All parts, including speaker and cabinet, are available separately or if all ordered together the price is £7/15/- complete, post and ins. 3/6, ready-built chassis 30/- extra. Instruction booklet free with parts or available separately price 1/6.

INSTANTUS HEATER

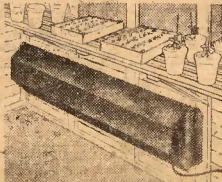

Practical Converter heater 1 kW. 40/-, made from heavy gauge sheet steel (galvanised). Can be used for any size house, up to three heaters can be controlled by one thermostat.
Price £2-10-0 or with thermostat £4-5-0, carriage 5/-.



Wrap our heater cable around the pipes in your loft to prevent a freeze up. 21 yards with full instructions! Minor pack 14 yards, £1-10-0. Major pack 28 yards, £1-10-0.

COMPONENT BARGAINS

Tubular Ceramics 2,000 pf., 1,000 pf., 500 pf. all 5/- per dozen.

.1 mfd. 350-volt metal sealed condensers by Dullister—small size 3/6 doz. or 36/- gross.

Philips Trimmers 0-30 pf. 1/- each or 11/- doz.

Moulded Mica Condensers, well mixed assortment 3/- doz., 36/- gross, silver Mica, well mixed assortment, 3/- doz., 36/- gross.

50 mfd. 50 v. Bias Condensers T.O.C. 1/6 each, 15/- per doz.

Ceramic Trimmers, 5 to 20 pf., 6/- each, 5/- doz., 20 to 60 pf. 9d. each, 8/- doz., 20 to 100 pf. 1/3 each, 12/- doz.

Earpiece-microphone, American midget type 3/6 each, 36/- doz.



NEW CIRCUIT

OCCASIONAL 50. We have evolved a new D.F. circuit and have had really good results, equal in fact to many superhets. You really should try this circuit. All parts including valves (6X7, 6Y7, 6Y9 and 6X3) and bakelite case with back coat, only £5/10/-, plus 2/6 post and insurance. Data included with the parts is also available separately, price 2/-.

DON'T STUMBLE IN THE DARK



Install 2-way switches. Our outfit comprises: 30 yds. Multi-core cable, two 2-way switches, two wood blocks. Full instructions, 15/6 each (post and insurance 2/6).

ELECTRIC BLANKET WIRE

Waterproof P.V.C. covered, so blanket washable. 161 ohms per foot—1/6 per yard, 13 yards, ideal for average blanket, £1 post free.

THE SKYSEARCHER

An all mains set for 19.6

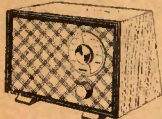

This is a 2-valve plus-metal rectifier set, useful as an educational set for beginners, also makes a fine second set for the bedroom, workshop, etc. All parts, less cabinet, chassis and speaker, 19.6. Post & Ins. 2s. Data free with parts or available separately 1.6. 3-valve battery version also available at the same price.

FLUORESCENT LIGHTS



These are a complete fluorescent lighting fitting. Built-in ballast and starters—size enamelled white and ready to work. Ideal for the kitchen, over the workbench and in similar locations. Single 40, 4ft. 3in. long, uses a 40 watt tube. Price 39.6 complete with tube. Carriage and Ins. 4.6. Twin 20. Uses 2 20-watt standard tubes. Price 29.6 less tubes. Carriage and Ins. 3.6.



MULLARD AMPLIFIER "510"

A Quality Amplifier designed by Mullard. Power output exceeds 10 watts. Frequency response almost flat from 10 to 20,000 C.P.S. For use with the Aeos "HI Q" and other good pick-ups. Made up and ready to work. Is 21.10/- or 35/- deposit, plus 10/- carriage and insurance.

19.6 AMPLIFIER



Construct a powerful three-valve mains amplifier. Ideal for dances, parties, etc. Complete less chassis, cabinet and speaker (available if required). Data 1.6 (free with parts).

THE UNI-T.V.

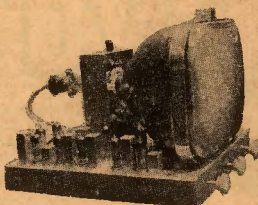

Undoubtedly the most up-to-date television for the home constructor. You can build all or only part and the set when finished will be equal to a factory-made equivalent. What other constructor T.V. has all these features:

- ★ Made up units if required.
- ★ All miniature valves.
- ★ Metal rectifier.
- ★ No expensive transformers.
- ★ 13-channel circuitry.
- ★ Multi-vibrator time bases.
- ★ Ferruxoabe, E.H.T. and scan coils.
- ★ 34.38 Mo's I.F.
- ★ Suitable for any modern 12, 14 or 17in. tube.
- ★ Modern contemporary cabinet if required.

The building cost (less tube) is only 231.10.0. plus 10/- carriage and insurance. All parts guaranteed 12 months. Full information and data free with parts or available, separately, price 3.6.

T.V. Commercialising Outfit

Do it yourself—it's really quite easy. You will manage it in an evening and we guarantee **STRESSFUL RESULTS OR MONEY BACK.**

Our parcel contains:—
I.T.A. Aerial, 36ft. I.T.A. Down Lead, I.T.A. Converter, I.T.A. BIC Interference Minibuster.

A special bargain price for all the above items if bought together is 29.10.- Or 11.10.- down and 8 payments of 21. (Post and Insurance 4s). Full details with illustrations 1.6.



OFFICE INTERCOM.

This is a 2-station "master" unit comprising an A.C. mains operated push-pull amplifier with built-in P.M. speaker which acts as microphone or loud-speaker depending on whether switch is set to "talk" or "listen." Complete in polished cabinet ready to work. Complete with one sub and 100ft. twin wire, 66.19.6. plus 3.6 carriage and insurance. Sub stations 19.6 each.

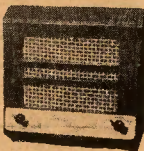

CHASSIS ASSEMBLY



Superhet Chassis, 3-waveband, coloured scale, scale pan, pulleys, driving head, springs, drum, etc. Scale size 14in. x 3 1/2in. Chassis size 15in. x 10in. x 2 1/2in. Price 13.- plus 1.6 post. Note: We can supply cabinet for this. Price 39.6 plus 6.- carr. and insurance.

MAINS-MINI



Uses high-efficiency coils, covers long and medium wavebands and fits into the neat white or brown bakelite cabinet—limited quantity only. All the parts, including cabinet, valves, in fact, everything, 24.10.0. plus 3.6 post. Constructional data free with the parts, or available separately 1.6.

HUGE MINISTRY PURCHASE

R.1155—yours for £2 down

Frequency 75 Kcs to 12 Mcs—10 valves—metal case—robust receiver

—cost

over

£80 to

make—

will

save

years of

service,

very

little used. Price £10 or 5 pay-

ments of 2.

Carr. & start case 15.- ea.

CAR TRANSFER CHARGER KIT

All parts to build 6- and 12-volt

charger which can be connected to a

"big" battery and will enable

the car to be started instantly. Kit

comprising the following:—

Mains transformer 29.6

5-amp. rectifier 17.6

Regulator Stud Switch 3.6

Resistance wire 5.6

Resistance Former 5.6

Mains on/off Switch 2.6

6-amp. Moving Coil Meter 12.6

Constructional Data 1.6

or if bought all together price is 92.6

plus 2.- post and packings.

THERMOSTATS



Useful for the control of appliances such as convectors, electric heaters, hot plates, etc. Adjustable to operate over the temperature range 90-560 deg. F. 11 amp., 3.6; 15 amp., 8.6. 2 amp., QMB, 5.6; 15 amp., QMB, 15.-.

ELECTRONIC PRECISION EQUIPMENT, LTD.

Post orders should be addressed to E.P.E., LTD., Dept. 7, Sutton Road, Eastbourne.

Personal shoppers to one of these addresses please.

388, London Road,
Croydon.

42-46, Windmill Hill,
Ruislip, Middx.
Phone: RUISLIP 3780

152-3, Fleet Street,
E.C.4.
Phone: FLEET 2833

29 Strand Green Rd.,
Finbury Park, N.4.
Phone: ARCHWAY 1049

249, Kilmara High
Road, Kilmara.

Half day, Wednesday.

Half day, Wednesday.

Half day, Saturday.

Half day, Thursday.

MALDA VALA 4621.

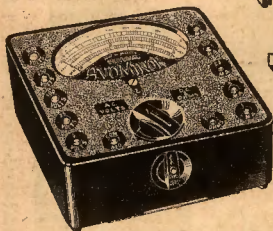
**MODEL 1**

D.C. VOLTAGE: 0 to 500 volts.
A.C. VOLTAGE: 0 to 500 volts.
D.C. CURRENT: 0 to 500 mA.
RESISTANCE: 0 to 20,000 Ω .
 Total resistance of meter: 200,000 Ω .
SENSITIVITY: 400 Ω/V .

MODEL 2

D.C. VOLTAGE: 0 to 1,000 volts.
A.C. VOLTAGE: 0 to 1,000 volts.
D.C. CURRENT: 0 to 500 mA.
RESISTANCE: 0 to 200,000 Ω .
 Total resistance of meter: 4 M Ω .
SENSITIVITY: 4,000 Ω/V .

Write for a free copy of the latest Comprehensive Guide to "Avo" Instruments.

'AVO' Precision

ELECTRICAL TESTING INSTRUMENTS

A dependably accurate instrument for testing and fault location is indispensable to the amateur who builds or services his own set.

The UNIVERSAL AVOMINOR

(as illustrated) is a highly accurate moving-coil instrument, conveniently compact, for measuring A.C. and D.C. voltage, D.C. current, and also resistance; 22 ranges of readings on a 3-inch scale.

Size: 4 1/2 ins. x 3 1/2 ins. x 1 1/2 ins.
 Nett weight: 18 ozs.

List Price: £12 : 0 : 0

Complete with leads, interchangeable prods and crocodile clips, and instruction book.

The D.C. AVOMINOR

is a 2 1/2-inch moving coil meter providing 14 ranges of readings of D.C. voltage, current and resistance up to 600 volts, 120 milliamps, and 3 megohms respectively. Total resistance 100,000 ohms.

Size: 4 1/2 ins. x 3 1/2 ins. x 1 1/2 ins.
 Nett weight: 12 ozs.

Nett weight: 12 ozs.

Complete as above
 List Price: £5 : 5 : 0

Sole Proprietors and Manufacturers:—
AUTOMATIC COIL WINDER & ELECTRICAL EQUIPMENT CO., LTD.
 Avocat House, 92/96, Vauxhall Bridge Rd., London, S.W.1. VICtoria 3434 (9 lines)



POST THE COUPON TODAY FOR OUR BROCHURE ON THE LATEST METHODS OF HOME TRAINING FOR OVER 150 CAREERS & HOBBIES

PRIVATE AND INDIVIDUAL TUITION IN YOUR OWN HOME

City and Guilds Grouped Certificates in Telecommunications: A.M. Brit. I.R.E. Examination, Radio Amateur's Licence, Radio and Television Servicing Certificates, General Radio and Television Courses, Radar, Sound Recording, etc. Also Courses in all other branches of Engineering and Commerce.

The advantages of E.M.I. training ★ The teaching methods are planned to meet modern industrial requirements. ★ We offer training in all subjects which provide lucrative jobs or interesting hobbies. ★ A tutor is personally allotted by name to ensure private and individual tuition. ★ Free advice covering all aspects of training is given to students before and after enrolling with us.

NEW LEARN THE PRACTICAL WAY

With many of our courses we supply actual equipment. Courses include: Radio, Television, Electronics, Draughtsmanship, Carpentry, Photography, and Commercial Art, etc.

**Courses from
15/- per month**

POST THIS COUPON TODAY

Send without obligation your FREE book,
 E.M.I. INSTITUTES, Dept. 32K
 43-Grove Park Road, London, W.4.
 Phone: Chiswick 4417/8.

NAME _____

ADDRESS _____

FEB. _____

SUBJECT(S) OF INTEREST _____

EMI INSTITUTES

The only Postal College which is part of
 a world-wide Industrial Organisation

R.S.C. BATTERY CHARGING EQUIPMENT

All for A.C. MAINS 200-250 v., 50 c/c.s. Guaranteed 12 months.

ASSEMBLED CHARGERS

- 6 v. 1 amp. 19/9
 - 6 v. or 12 v. 1 amp. 25/9
 - 6 v. 2 amps. 29/9
 - 6 v. or 12 v. 2 amps. 38/9
 - 6 v. or 12 v. 4 amps. 59/9
- Above ready for use. With mains and output leads.

HEAVY DUTY KIT

12 v. 30 amp. Suitable for Garage or farm with a number of vehicles. Mains Input 200-250 v., 50 c/s. Outputs: 12 v. 15 amp. twice. Consists of Mains Trans. 2 Metal Rectifiers, 2 Meters, 4 Fuses, 4 Terminals, 3 Rheostats and circuit. Only 9 cns., carr. 15/-.

BATTERY CHARGER KITS

Consisting of Mains Transformer, F.W. Bridge, Metal Rectifier, well ventilated steel case. Fuses, Fuse-holders, Croonmeters panels and circuit. Carr. 2/9 each.

- 6 v. or 12 v. 1 amp. 22/9
- 6 v. 2 amps. 25/9
- 6 v. or 12 v. 2 amps. 31/9
- 6 v. or 12 v. 4 amps. 40/9

BATTERY CHARGER KIT

Consisting of F.W. Bridge Rectifier 612 v. 5 a. Mains Trans. 0-9-15 v. 6 a. output and variable charge rheostat with knob. Only 45/9.

ASSEMBLED CHARGER

6 v. or 12 v. 2 amps. Aluminometer 3 1/2 d. scale. 6 C. 6.0 pilot for 6 v. or 12 v. Louvered metal case, finished attractive hammer blue. Ready for use. W. 1 1/2 x 4 1/8 x 4 and output leads. Double Fused. Only 46/9 Carr. 3/6

Assembled 6 v. or 12 v. 4 amps. Fitted Ammeter and variable charge selector. Also selector plus for 6 v. or 12 v. charging. Double fused. Well ventilated steel case with blue hammer finish. **69/9**

Ready for use with mains and output leads. Carr. 3/6.



R.S.C. MAINS TRANSFORMERS (FULLY GUARANTEED)

Interwound and Impregnated.

- Primaries 200-250-250 v. 50 c/s. Screened.
- TOP SHROUDED DROP THROUGH**
- 250-0-250 v. 70 ma. 8.3 v. 2.5a. 13/9
 - 250-0-250 v. 70 ma. 8.3 v. 5 v. 2a. 16/9
 - 350-0-350 v. 70 ma. 6.3 v. 2.5a. 16/9
 - 350-0-350 v. 100 ma. 6.3 v. 2.5 a. 2 v. 2a. 18/9
 - 350-0-350 v. 100 ma. 8.3 v. 4 a. 5 v. 3 a. 22/9
 - 350-0-350 v. 100 ma. 8.3 v. 4 a. 5 v. 3 a. 22/9
 - 350-0-350 v. 100 ma. 6.3 v. 4 a. C.T. 23/9
 - 0-4-5 v. 3 a. 23/9
 - 350-0-350 v. 150 ma. 8.3 v. 4 a. 5 v. 3 a. 29/9

E.H.T. TRANSFORMERS

- 2,500 v. 5 mA. 2-0-2 v. 1.1 a. 2-0-2 v. 1.1 a. for VORBY, VCH57, etc. 38/6

ELIMINATOR TRANSFORMERS

- Primaries 200-250 v. 50 c/s. 14/9
- 120 v. 40 ma. 5-0-5 v. 1 v. 3 a. 16/9
- 90 v. 15 ma. 4-0-4 v. 900 ma. 9/9

CHARGER TRANSFORMERS

- All with 300-350-250 v. 50 c/s Primaries:
- 6 v. 11 a. 11/9
 - 0-5-5 v. 3 a. 16/9
 - 0-3.5-17 v. 3 a. 17/9
 - 0-5-5-0-17.5 v. 4 a. 18/9
 - 0-9-15 v. 5 a. 19/9
 - 0-9-15 v. 5 a. 22/9

SMOOTHING CHOKES

- 250 ma 5 H 100 ohms 12/9
- 150 ma 7 H 10-200 ohms 11/9
- 100 ma 10 H 200 ohms 8/9
- 80 ma 16 H 500 ohms 4/9
- 60 ma 10 H 400 ohms 4/11

MIDRANGE BATTERY TRANSFORMERS

- Output: Battery Pentode 8: 1 for 357, etc. 3/9
- Small Pentode, 5,000 Ω to 30 Ω 3/9
 - Small Pentode, 7,000 Ω to 30 Ω 3/9
 - Standard Pentode, 3,000 Ω to 30 Ω 4/9
 - Standard Pentode, 18,000 Ω to 30 Ω 4/9
 - Multi-ratio 40 ma. 39.1, 45.1, 60.1, 75.1, 90.1, 105.1, 120.1, 135.1, 150.1, 165.1, 180.1, 195.1, 210.1, 225.1, 240.1, 255.1, 270.1, 285.1, 300.1, 315.1, 330.1, 345.1, 360.1, 375.1, 390.1, 405.1, 420.1, 435.1, 450.1, 465.1, 480.1, 495.1, 510.1, 525.1, 540.1, 555.1, 570.1, 585.1, 600.1, 615.1, 630.1, 645.1, 660.1, 675.1, 690.1, 705.1, 720.1, 735.1, 750.1, 765.1, 780.1, 795.1, 810.1, 825.1, 840.1, 855.1, 870.1, 885.1, 900.1, 915.1, 930.1, 945.1, 960.1, 975.1, 990.1, 1005.1, 1020.1, 1035.1, 1050.1, 1065.1, 1080.1, 1095.1, 1110.1, 1125.1, 1140.1, 1155.1, 1170.1, 1185.1, 1200.1, 1215.1, 1230.1, 1245.1, 1260.1, 1275.1, 1290.1, 1305.1, 1320.1, 1335.1, 1350.1, 1365.1, 1380.1, 1395.1, 1410.1, 1425.1, 1440.1, 1455.1, 1470.1, 1485.1, 1500.1, 1515.1, 1530.1, 1545.1, 1560.1, 1575.1, 1590.1, 1605.1, 1620.1, 1635.1, 1650.1, 1665.1, 1680.1, 1695.1, 1710.1, 1725.1, 1740.1, 1755.1, 1770.1, 1785.1, 1800.1, 1815.1, 1830.1, 1845.1, 1860.1, 1875.1, 1890.1, 1905.1, 1920.1, 1935.1, 1950.1, 1965.1, 1980.1, 1995.1, 2010.1, 2025.1, 2040.1, 2055.1, 2070.1, 2085.1, 2100.1, 2115.1, 2130.1, 2145.1, 2160.1, 2175.1, 2190.1, 2205.1, 2220.1, 2235.1, 2250.1, 2265.1, 2280.1, 2295.1, 2310.1, 2325.1, 2340.1, 2355.1, 2370.1, 2385.1, 2400.1, 2415.1, 2430.1, 2445.1, 2460.1, 2475.1, 2490.1, 2505.1, 2520.1, 2535.1, 2550.1, 2565.1, 2580.1, 2595.1, 2610.1, 2625.1, 2640.1, 2655.1, 2670.1, 2685.1, 2700.1, 2715.1, 2730.1, 2745.1, 2760.1, 2775.1, 2790.1, 2805.1, 2820.1, 2835.1, 2850.1, 2865.1, 2880.1, 2895.1, 2910.1, 2925.1, 2940.1, 2955.1, 2970.1, 2985.1, 3000.1, 3015.1, 3030.1, 3045.1, 3060.1, 3075.1, 3090.1, 3105.1, 3120.1, 3135.1, 3150.1, 3165.1, 3180.1, 3195.1, 3210.1, 3225.1, 3240.1, 3255.1, 3270.1, 3285.1, 3300.1, 3315.1, 3330.1, 3345.1, 3360.1, 3375.1, 3390.1, 3405.1, 3420.1, 3435.1, 3450.1, 3465.1, 3480.1, 3495.1, 3510.1, 3525.1, 3540.1, 3555.1, 3570.1, 3585.1, 3600.1, 3615.1, 3630.1, 3645.1, 3660.1, 3675.1, 3690.1, 3705.1, 3720.1, 3735.1, 3750.1, 3765.1, 3780.1, 3795.1, 3810.1, 3825.1, 3840.1, 3855.1, 3870.1, 3885.1, 3900.1, 3915.1, 3930.1, 3945.1, 3960.1, 3975.1, 3990.1, 4005.1, 4020.1, 4035.1, 4050.1, 4065.1, 4080.1, 4095.1, 4110.1, 4125.1, 4140.1, 4155.1, 4170.1, 4185.1, 4200.1, 4215.1, 4230.1, 4245.1, 4260.1, 4275.1, 4290.1, 4305.1, 4320.1, 4335.1, 4350.1, 4365.1, 4380.1, 4395.1, 4410.1, 4425.1, 4440.1, 4455.1, 4470.1, 4485.1, 4500.1, 4515.1, 4530.1, 4545.1, 4560.1, 4575.1, 4590.1, 4605.1, 4620.1, 4635.1, 4650.1, 4665.1, 4680.1, 4695.1, 4710.1, 4725.1, 4740.1, 4755.1, 4770.1, 4785.1, 4800.1, 4815.1, 4830.1, 4845.1, 4860.1, 4875.1, 4890.1, 4905.1, 4920.1, 4935.1, 4950.1, 4965.1, 4980.1, 4995.1, 5010.1, 5025.1, 5040.1, 5055.1, 5070.1, 5085.1, 5100.1, 5115.1, 5130.1, 5145.1, 5160.1, 5175.1, 5190.1, 5205.1, 5220.1, 5235.1, 5250.1, 5265.1, 5280.1, 5295.1, 5310.1, 5325.1, 5340.1, 5355.1, 5370.1, 5385.1, 5400.1, 5415.1, 5430.1, 5445.1, 5460.1, 5475.1, 5490.1, 5505.1, 5520.1, 5535.1, 5550.1, 5565.1, 5580.1, 5595.1, 5610.1, 5625.1, 5640.1, 5655.1, 5670.1, 5685.1, 5700.1, 5715.1, 5730.1, 5745.1, 5760.1, 5775.1, 5790.1, 5805.1, 5820.1, 5835.1, 5850.1, 5865.1, 5880.1, 5895.1, 5910.1, 5925.1, 5940.1, 5955.1, 5970.1, 5985.1, 6000.1, 6015.1, 6030.1, 6045.1, 6060.1, 6075.1, 6090.1, 6105.1, 6120.1, 6135.1, 6150.1, 6165.1, 6180.1, 6195.1, 6210.1, 6225.1, 6240.1, 6255.1, 6270.1, 6285.1, 6300.1, 6315.1, 6330.1, 6345.1, 6360.1, 6375.1, 6390.1, 6405.1, 6420.1, 6435.1, 6450.1, 6465.1, 6480.1, 6495.1, 6510.1, 6525.1, 6540.1, 6555.1, 6570.1, 6585.1, 6600.1, 6615.1, 6630.1, 6645.1, 6660.1, 6675.1, 6690.1, 6705.1, 6720.1, 6735.1, 6750.1, 6765.1, 6780.1, 6795.1, 6810.1, 6825.1, 6840.1, 6855.1, 6870.1, 6885.1, 6900.1, 6915.1, 6930.1, 6945.1, 6960.1, 6975.1, 6990.1, 7005.1, 7020.1, 7035.1, 7050.1, 7065.1, 7080.1, 7095.1, 7110.1, 7125.1, 7140.1, 7155.1, 7170.1, 7185.1, 7200.1, 7215.1, 7230.1, 7245.1, 7260.1, 7275.1, 7290.1, 7305.1, 7320.1, 7335.1, 7350.1, 7365.1, 7380.1, 7395.1, 7410.1, 7425.1, 7440.1, 7455.1, 7470.1, 7485.1, 7500.1, 7515.1, 7530.1, 7545.1, 7560.1, 7575.1, 7590.1, 7605.1, 7620.1, 7635.1, 7650.1, 7665.1, 7680.1, 7695.1, 7710.1, 7725.1, 7740.1, 7755.1, 7770.1, 7785.1, 7800.1, 7815.1, 7830.1, 7845.1, 7860.1, 7875.1, 7890.1, 7905.1, 7920.1, 7935.1, 7950.1, 7965.1, 7980.1, 7995.1, 8010.1, 8025.1, 8040.1, 8055.1, 8070.1, 8085.1, 8100.1, 8115.1, 8130.1, 8145.1, 8160.1, 8175.1, 8190.1, 8205.1, 8220.1, 8235.1, 8250.1, 8265.1, 8280.1, 8295.1, 8310.1, 8325.1, 8340.1, 8355.1, 8370.1, 8385.1, 8400.1, 8415.1, 8430.1, 8445.1, 8460.1, 8475.1, 8490.1, 8505.1, 8520.1, 8535.1, 8550.1, 8565.1, 8580.1, 8595.1, 8610.1, 8625.1, 8640.1, 8655.1, 8670.1, 8685.1, 8700.1, 8715.1, 8730.1, 8745.1, 8760.1, 8775.1, 8790.1, 8805.1, 8820.1, 8835.1, 8850.1, 8865.1, 8880.1, 8895.1, 8910.1, 8925.1, 8940.1, 8955.1, 8970.1, 8985.1, 9000.1, 9015.1, 9030.1, 9045.1, 9060.1, 9075.1, 9090.1, 9105.1, 9120.1, 9135.1, 9150.1, 9165.1, 9180.1, 9195.1, 9210.1, 9225.1, 9240.1, 9255.1, 9270.1, 9285.1, 9300.1, 9315.1, 9330.1, 9345.1, 9360.1, 9375.1, 9390.1, 9405.1, 9420.1, 9435.1, 9450.1, 9465.1, 9480.1, 9495.1, 9510.1, 9525.1, 9540.1, 9555.1, 9570.1, 9585.1, 9600.1, 9615.1, 9630.1, 9645.1, 9660.1, 9675.1, 9690.1, 9705.1, 9720.1, 9735.1, 9750.1, 9765.1, 9780.1, 9795.1, 9810.1, 9825.1, 9840.1, 9855.1, 9870.1, 9885.1, 9900.1, 9915.1, 9930.1, 9945.1, 9960.1, 9975.1, 9990.1, 10005.1, 10020.1, 10035.1, 10050.1, 10065.1, 10080.1, 10095.1, 10110.1, 10125.1, 10140.1, 10155.1, 10170.1, 10185.1, 10200.1, 10215.1, 10230.1, 10245.1, 10260.1, 10275.1, 10290.1, 10305.1, 10320.1, 10335.1, 10350.1, 10365.1, 10380.1, 10395.1, 10410.1, 10425.1, 10440.1, 10455.1, 10470.1, 10485.1, 10500.1, 10515.1, 10530.1, 10545.1, 10560.1, 10575.1, 10590.1, 10605.1, 10620.1, 10635.1, 10650.1, 10665.1, 10680.1, 10695.1, 10710.1, 10725.1, 10740.1, 10755.1, 10770.1, 10785.1, 10800.1, 10815.1, 10830.1, 10845.1, 10860.1, 10875.1, 10890.1, 10905.1, 10920.1, 10935.1, 10950.1, 10965.1, 10980.1, 10995.1, 11010.1, 11025.1, 11040.1, 11055.1, 11070.1, 11085.1, 11100.1, 11115.1, 11130.1, 11145.1, 11160.1, 11175.1, 11190.1, 11205.1, 11220.1, 11235.1, 11250.1, 11265.1, 11280.1, 11295.1, 11310.1, 11325.1, 11340.1, 11355.1, 11370.1, 11385.1, 11400.1, 11415.1, 11430.1, 11445.1, 11460.1, 11475.1, 11490.1, 11505.1, 11520.1, 11535.1, 11550.1, 11565.1, 11580.1, 11595.1, 11610.1, 11625.1, 11640.1, 11655.1, 11670.1, 11685.1, 11700.1, 11715.1, 11730.1, 11745.1, 11760.1, 11775.1, 11790.1, 11805.1, 11820.1, 11835.1, 11850.1, 11865.1, 11880.1, 11895.1, 11910.1, 11925.1, 11940.1, 11955.1, 11970.1, 11985.1, 12000.1, 12015.1, 12030.1, 12045.1, 12060.1, 12075.1, 12090.1, 12105.1, 12120.1, 12135.1, 12150.1, 12165.1, 12180.1, 12195.1, 12210.1, 12225.1, 12240.1, 12255.1, 12270.1, 12285.1, 12300.1, 12315.1, 12330.1, 12345.1, 12360.1, 12375.1, 12390.1, 12405.1, 12420.1, 12435.1, 12450.1, 12465.1, 12480.1, 12495.1, 12510.1, 12525.1, 12540.1, 12555.1, 12570.1, 12585.1, 12600.1, 12615.1, 12630.1, 12645.1, 12660.1, 12675.1, 12690.1, 12705.1, 12720.1, 12735.1, 12750.1, 12765.1, 12780.1, 12795.1, 12810.1, 12825.1, 12840.1, 12855.1, 12870.1, 12885.1, 12900.1, 12915.1, 12930.1, 12945.1, 12960.1, 12975.1, 12990.1, 13005.1, 13020.1, 13035.1, 13050.1, 13065.1, 13080.1, 13095.1, 13110.1, 13125.1, 13140.1, 13155.1, 13170.1, 13185.1, 13200.1, 13215.1, 13230.1, 13245.1, 13260.1, 13275.1, 13290.1, 13305.1, 13320.1, 13335.1, 13350.1, 13365.1, 13380.1, 13395.1, 13410.1, 13425.1, 13440.1, 13455.1, 13470.1, 13485.1, 13500.1, 13515.1, 13530.1, 13545.1, 13560.1, 13575.1, 13590.1, 13605.1, 13620.1, 13635.1, 13650.1, 13665.1, 13680.1, 13695.1, 13710.1, 13725.1, 13740.1, 13755.1, 13770.1, 13785.1, 13800.1, 13815.1, 13830.1, 13845.1, 13860.1, 13875.1, 13890.1, 13905.1, 13920.1, 13935.1, 13950.1, 13965.1, 13980.1, 13995.1, 14010.1, 14025.1, 14040.1, 14055.1, 14070.1, 14085.1, 14100.1, 14115.1, 14130.1, 14145.1, 14160.1, 14175.1, 14190.1, 14205.1, 14220.1, 14235.1, 14250.1, 14265.1, 14280.1, 14295.1, 14310.1, 14325.1, 14340.1, 14355.1, 14370.1, 14385.1, 14400.1, 14415.1, 14430.1, 14445.1, 14460.1, 14475.1, 14490.1, 14505.1, 14520.1, 14535.1, 14550.1, 14565.1, 14580.1, 14595.1, 14610.1, 14625.1, 14640.1, 14655.1, 14670.1, 14685.1, 14700.1, 14715.1, 14730.1, 14745.1, 14760.1, 14775.1, 14790.1, 14805.1, 14820.1, 14835.1, 14850.1, 14865.1, 14880.1, 14895.1, 14910.1, 14925.1, 14940.1, 14955.1, 14970.1, 14985.1, 15000.1, 15015.1, 15030.1, 15045.1, 15060.1, 15075.1, 15090.1, 15105.1, 15120.1, 15135.1, 15150.1, 15165.1, 15180.1, 15195.1, 15210.1, 15225.1, 15240.1, 15255.1, 15270.1, 15285.1, 15300.1, 15315.1, 15330.1, 15345.1, 15360.1, 15375.1, 15390.1, 15405.1, 15420.1, 15435.1, 15450.1, 15465.1, 15480.1, 15495.1, 15510.1, 15525.1, 15540.1, 15555.1, 15570.1, 15585.1, 15600.1, 15615.1, 15630.1, 15645.1, 15660.1, 15675.1, 15690.1, 15705.1, 15720.1, 15735.1, 15750.1, 15765.1, 15780.1, 15795.1, 15810.1, 15825.1, 15840.1, 15855.1, 15870.1, 15885.1, 15900.1, 15915.1, 15930.1, 15945.1, 15960.1, 15975.1, 15990.1, 16005.1, 16020.1, 16035.1, 16050.1, 16065.1, 16080.1, 16095.1, 16110.1, 16125.1, 16140.1, 16155.1, 16170.1, 16185.1, 16200.1, 16215.1, 16230.1, 16245.1, 16260.1, 16275.1, 16290.1, 16305.1, 16320.1, 16335.1, 16350.1, 16365.1, 16380.1, 16395.1, 16410.1, 16425.1, 16440.1, 16455.1, 16470.1, 16485.1, 16500.1, 16515.1, 16530.1, 16545.1, 16560.1, 16575.1, 16590.1, 16605.1, 16620.1, 16635.1, 16650.1, 16665.1, 16680.1, 16695.1, 16710.1, 16725.1, 16740.1, 16755.1, 16770.1, 16785.1, 16800.1, 16815.1, 16830.1, 16845.1, 16860.1, 16875.1, 16890.1, 16905.1, 16920.1, 16935.1, 16950.1, 16965.1, 16980.1, 16995.1, 17010.1, 17025.1, 17040.1, 17

R.S.C. AB ULTRA LINEAR 12 WATT AMPLIFIER

NEW 1956 Model High-Fidelity Push-Pull Amplifier with "Built-In" Tone Control, Pre-amplifier stages, High sensitivity, Includes 3 valves, 1800 output. Quality sectionally wound output transformer, specially designed for Ultra Linear operation and variable audio condensers of current manufacture. **INDIVIDUAL CONTROLS FOR BASS AND TREBLE**. Lit. No. 27-13-6. Frequency response + 3 db. 30-30,000 c/s. Six negative feedback loops. Hum level 7 db. down. **ON/OFF** control. **TERMS** required for **FULL OUTPUT**. Suitable for use with all makes and types of pick-ups and practically all other amplifiers. Comparable with the very best designs.

FOR STANDARD or LONG-PLAYING REC. OR I.R.S. FOR MUSICAL INSTRUMENTS.

Such as **STRING BASS, GUITARS**, etc. **PUT SOCKET** with plus provides 300 v. 20 mA. and 6.3 v. 1.5 a. For supply of a **RADIO FEEDER UNIT**. Size approx. 12-8 1/2 in. For A.C. mains 200-250 v. 50 c/s. Output 12 watts and 15 ohm speaker. Kit is complete to last net. Chassis is fully punched. Full instructions and wiring diagrams supplied. Unapproachable value at £7.15, or factory built 45/- extra. Carriage 10/-. If required louvered metal cover with 2

£7-15-0

SU PERFECT FEEDER UNIT

Design of a high quality Radio Tuner Unit (specially suitable for use with any of our Amplifiers). Delayed A.V.C. Very high Percentage modulation. Tone control. Tuner can be handled without distortion. The W. Ch. sw. incorporates Gram. position. Controls include W. Ch. and L.T. Only 2 amp. v. 15 mA. H.T. and L.T. of 6.3 v. 1 amp. required from amplifier. Size of unit approx. 9-6 1/2 in. high. Simple alignment procedure. Point-to-point wiring diagrams. In-struction and priced parts list with illustrations. 2/8. Total including cost. £4.15. - For descriptive leaflet send S.A.E.

GARRARD 3-SPEED MIXER AUTO-CHANGER RC110. For Standard A.C. mains 200-250 v. 50 c/s. Current Model. Brand new, factory. Provision for taking in and playing High-Fidelity turnover pick-up head with dual sapphire point styli for Standard or Long-playing records. Very limited number at only £7.19.6. (arr. 3/6).

LINKAR L45 MINIATURE 4.5 WATT QUALITY AMPLIFIER. Suitable for use with Garrard B.S.R. or any other record-playing unit and most microphones. Total negative feedback 12 db. Separate Bass and Treble Controls. For convenience when mounted in cabinet, mains switch is incorporated in control. For A.C. mains input of 200-250 v. 50 c/s. Output for 2.3 ohm speaker. Three miniature Mullard valves used. Size of unit only 6-5 1/2 in. high. Chassis is fully isolated from mains. Guaranteed 12 months. Only £5.19.6.

ELLIPTICAL P.M. SPEAKER. 7 x 4 in. Godmans. Suitable for above, 19.6.

LINEAR "DIATONIC" 10 WATT HIGH FIDELITY PUSH PULL ULTRA LINEAR AMPLIFIER. For 200-250 v. 50 c/s. A.C. Mains. Values line-up ECC83, ECC89, EL84, EL84, E231 miniature Mullard. The unit has self-contained Pre-amplifier Tone Control stages and separate Bass and Treble Controls. Independent Mike and Gram input sockets are provided. Total harmonic distortion only 0.25% at 6 watts. Due to use of latest miniature components of proved reliability series used. Size of unit Output Matchings for 3 and 15 ohm speakers. Finished in attractive stoved Gold-Brass hammer finish. Price £8/- or Deposit 25/- plus 10% cart. and 8 monthly payments of 28/9. Send S.A.E. for full details.

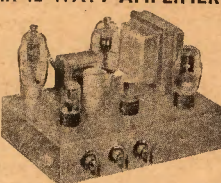

carrying handles can be supplied for 17/6. Additional input socket with associated V.C. Control so that two different inputs such as Gram and Mike or Tape and Radio can be mixed, can be provided for 13/- extra. Guaranteed 12 months. Lit. No. 27-13-6. **TERMS** on assembled two input model. **DEPOSIT** 25-6 and nine monthly payments of 28/9. **HIGH-FIDELITY MICROPHONES and SPEAKERS** in stock. Cash each price. **TERMS** if supplied with amplifier.

R.S.C. 4.5 WATT AS HIGH-GAIN AMPLIFIER

A highly sensitive 4-valve quality amplifier for the home, small club, etc. Only 50 millivolts input is required for full output so that it is suitable for use with the latest high-fidelity pick-up heads, in addition to all other types of pick-ups and practically all makes. Separate Bass and Treble Controls are provided. These give full long-playing record equalisation. Hum level is negligible being 71 db. down. 15 db. of negative feedback is used. H.T. of 300 v. 25 mA. and L.T. of 6.3 v. 1.5 a. is available for the supply of a Radio Feeder Unit, or Tape Deck pre-amplifier. For A.C. mains input of 200-250 v. 50 c/s. Chassis is not alive. Kit is complete in every detail and includes fully punched chassis (with baseplate) with Blue Hammer finish and point-to-point wiring diagrams and instructions. Exceptional value at only £4.15/- or assembled ready for use 25/- extra, plus 3/6 cart.

PLESSEY 10in. P.M. 8 OHM SPEAKER with High Flux Density Magnet Recommended for use with above AS, A7, or Linker L45 Amplifiers. Price 28/9. **B.S.C. TAI HIGH QUALITY TAPE DECK AMPLIFIER.** For ALL Tape Decks with High Impedance, Playback and Record Heads, such as Truvox, etc. (Unit can now Ready for be supplied for use with latest Use ONLY Goddard Tape Transcriber; refer to TAIC). For A.C. Mains 230-250 v. 50 c/s. **11 GNS.**

Positive compensated identification for recording level by Magic Eye. Recording facilities for 15, 7 1/2 or 3 1/2 in. per sec. Automatic equalisation at the turn of a knob. Linear frequency response of + 3 db. 50-11,000 c/s. Negative feedback equalisation. Minimum microphony and hum. High output with completely effective groove and distortionless reproduction. Sensitivity is 18 millivolts so that any kind of crystal microphone is suitable. Only 50 millivolts minimum input required from Recording head. Provision is made for feeding a P.A. amplifier. Unit can also be used as a gram amplifier requiring input of 75 v. R.M.S. Carriage 7/6. Illustrated leaflet 6d.

R.S.C. 30 WATT ULTRA LINEAR HIGH-FIDELITY AMPLIFIER A6

A highly sensitive Push-Pull, high output unit with self-contained Pre-amp. Tone Control Stages. Certain performance features compare equally with most expensive amplifiers available. Hum level 70 db. down. Frequency response + 3 db. 30-30,000 c/s. A specially designed sectionally wound ultra linear output transformer with 80 output valves. All components are chosen for reliability. Six valves are used, and separate Bass and Treble controls. Minimum input required for full output only 30 millivolts so that ANY KIND OF MICROPHONE OR PICK-UP IS SUITABLE. The unit is designed for CLUBS, SCHOOLS, THEATRES, DANCE HALLS or OUTDOOR FUNCTIONS, etc. For use with Electronic ORGAN, GUITAR, STRING BASS, etc. For standard or long-playing records, **OUTPUT SOCKET PROVIDES** 1.2 amp. and H.T. for a **RADIO FEEDER UNIT**. Amplifier operates on 200-250 v. 50 c/s. 12 watts into 15 ohm speaker. Complete kit of parts with fully punched chassis and point-to-point wiring diagrams and instructions. If required cover as for A8 can be supplied for 17/6. An extra input socket with associated V.C. control so that two separate inputs such as Gram and Mike or Tape and Radio can be mixed, can be provided for 13/- extra. The amplifier can be supplied, factory built with 12 months' guarantee, for 50/- extra. **TERMS** for assembled two input model: **DEPOSIT** 28/9 and 8 monthly payments of 28/9.

9 GNS.

R.C.A. 30 WATT RE-ENTRANT SPEAKERS 15 ohm or 8 ohm match input. For Outdoor use only. 3 C.S. P.M. SPEAKERS. All 23 ohms. 5in. Godmans, 17/9. 6in. Plessey, 16/9. 8in. B.S.C. 10in. Elips, 26/6. 12in. Plessey, 29/11. 16in. W.B. "Sterionair" 9 or 15 ohms type HF102 10 watts, high fidelity, 26/6. Only recommended for use with our A6 amplifier, 24/10/9. 12in. Plessey 15 ohm 10 watts, 56/9.

PLESSEY DUAL CONCENTRIC 12in. 15 ohm HIGH FIDELITY SPEAKER with 12 in. diameter completely separate elliptical speaker with choke, condenser, etc.) providing extraordinarily realistic reproduction. Recommended for use with our A6 or similar amplifier. Rated 10 watts. Price complete, only £5.17.6.

M.F. SPEAKERS 2.5 ohms, 8in. R.A. Field, 60 ohms, 11/9.

COAXIAL Cable 75 ohms, 1/2 in. 9d. yard. Twin Screened Feeder, 11/4. yard.

SELENIUM RECTIFIERS

6.2 v. 1 a.	4/11	6.2 v. 2 a. H.V.	2/9
6.2 v. 2 a.	5/11	10 v. 100 mA. H.V.	2/9
6.2 v. 4 a.	11/9	150 v. 100 mA. H.V.	5/9
6.2 v. 4 a.	14/9	250 v. 80 mA. H.V.	5/9
6.2 v. 10 a.	22/9	250 v. 150 mA. H.V.	7/9
12 v. 10 a.	28/9	300 v. 250 mA. H.V.	7/9

R.S.C. 3-4 WATT A7 HIGH-GAIN AMPLIFIER

For 200-250 v. 50 c/s. Mains Input. Appearance and Specification, with exception of output wattage, as A5. Complete Kit with diagrams. 22/9. Assembled 22/6 extra. Carr. 3/6.

THE SKYFORD T.R.F. RECEIVER A design of a 3-valve 200-250 v. A.C. Mains receiver with minimum distortion. It consists of 3 variable tuned circuits, the first stage followed by a low distortion anode band detector. Power pentode output in standard 50 ohm valve line up, 8K7, 5Y61, 6F8G. Selectivity and quality are well up to standard, and simplicity of construction is a special feature. Point-to-point wiring diagrams, instructions and parts list. 4/6. This receiver can be built for a maximum of £40.8. 1200-1500 Hz. Brown or Cream Bakelite or Walnut veneered wood cabinet 12 x 6 1/2 x 9 1/2 in.

TERMS: C.W.O. or C.O.D. NO C.O.D. under £1. Post 19 extra under £2: 2/9 extra under £5. Open 9 to 5.30; Sat. until 1 p.m. Catalogue 6d., Trade List 5d. S.A.E. with all enquiries.

RAYSON SUPPLY CO. LTD.
32, THE CALLS, LEEDS, 2

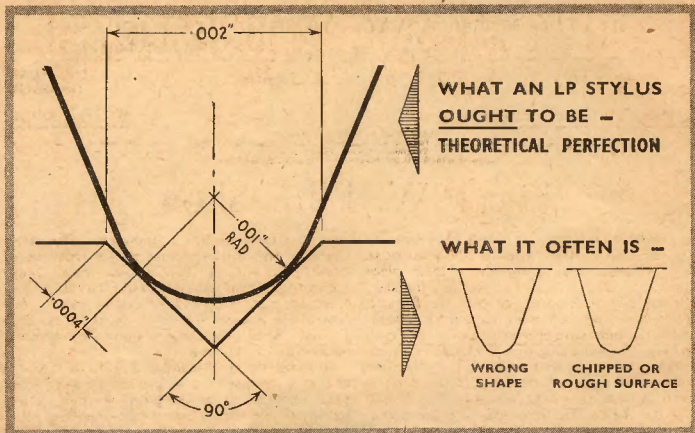

acos X 500 *

REPLACEABLE STYLI, AS FITTED TO ALL ACOS CRYSTAL AND CERAMIC PICK-UP CARTRIDGES HAVE PERFECT SHAPE, SIZE AND FINISH

* ACOS Styli have to pass a quality inspection at x 500 magnification. Only in this way can some faults, which may have important effects on reproduction or record or stylus wear, be reliably detected. The standards we set ourselves are high but practical. They are reflected not only in ACOS products but also in the record reproducing equipment in which ACOS pick-ups or cartridges are fitted.



always well ahead

COSMOCORD LIMITED, Eleanor Cross Road,
Waltham Cross, Herts. Waltham Cross 5206

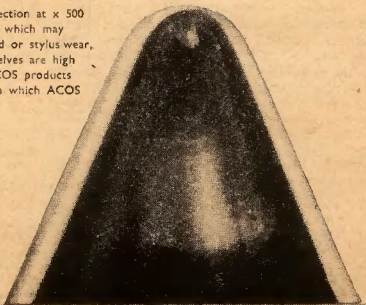

PRACTICAL WIRELESS

EVERY MONTH

VOL. XXXII, No. 602, FEB., 1957

EDITOR: F. J. GAMM

24th YEAR
OF ISSUE

COMMENTS OF THE MONTH

BY THE EDITOR

Editorial and Advertising Offices:
 "Practical Wireless," George Newnes, Ltd., Tower House, Southampton Street, Strand, W.C.2. Phone: Temple Bar 4963.
 Telegrams: Newnes, Road, London.
 Registered at the G.P.O. for transmission by Canadian Magazine Post.

The P.W. Film Show

A REMINDER that you still have time to apply for a free ticket for the PRACTICAL WIRELESS Film Show which takes place at the Caxton Hall (Great Hall Site) on Thursday, February 21st, at 8 p.m. The films run for well over an hour and there is an interval for refreshments. The films have been produced by Mullard, Ltd., one of the leading manufacturers of valves and TV tubes, and I am grateful to them for their co-operation in providing the film for what is bound to be a most interesting evening. I shall be in the chair. The films deal with the manufacture of valves and transistors and when they were shown to the trade I made the suggestion that members of the public and especially my readers should be afforded the opportunity of seeing these excellent films, which are highly interesting and educational.

Readers wishing to attend should send in their requests for tickets to "Film Show," PRACTICAL WIRELESS, address as on this page. The hall accommodates 500 people and tickets will be despatched to the first applicants, so send your application in now, as there is bound to be a large demand for the 500 seats which are available.

BINDERS FOR P.W.

WILL readers please state when ordering self-binders for PRACTICAL WIRELESS (details were given on page 689 of our issue dated December, 1956) the volume number they require blocked on the spine. Some readers are ordering more than one binder with the obvious intention of binding past volumes. In such cases the number of every volume must be stated. Even if ordering a single binder, however, please state the volume number.

"AMPLIFIERS: DESIGN AND CONSTRUCTION"

WE have just issued at 17s. 6d., or 18s. 3d. by post, "Amplifiers: Design and Construction," which contains designs for radio, gramophone, tape deck and P.A. amplifiers with a

special chapter on D.C. amplifiers. The early chapters deal with amplifier design from basic principles. All of the designs have been exhaustively tested and perfected in the PRACTICAL WIRELESS laboratory and, of course, include the best of the designs dealt with in articles in this journal. Send orders to the Book Department, address as on this page.

A reminder that readers may have free of charge a complete catalogue of all our technical publications covering engineering, radio, television, electricity, electronics, building, etc., by applying on a postcard to the same address.

QUERISTS PLEASE NOTE

WILL querists please note that we only reply to those who have enclosed a stamped and addressed envelope and a coupon cut from the current issue. Our query service is not open to all and sundry. It is a free service to readers of this paper only and we must insist, therefore, upon the coupon and a stamped and addressed envelope being enclosed as evidence of readership. We receive a large number of queries every day with neither coupon nor stamped and addressed envelope, and in view of the volume of correspondence we are receiving we must confine the service to our readers only.

One other point; we are receiving a large number of questions relating to commercial receivers, and we would prefer that readers wrote direct to the firms concerned. Equally we must decline to answer questions relating to receivers and apparatus described in our contemporaries, most of whom do not have a free advisory service.

CONTRIBUTIONS

WE welcome contributions of a practical nature, especially constructional articles. These should be about 1,500 words in length and be accompanied by rough sketches, photographs and sources of supply. Preference is given to those articles not designed around ex-Government equipment.—F. J. C.

**OUR NEXT ISSUE, DATED MARCH, WILL BE
 PUBLISHED ON FEBRUARY 7th**

Round the World of Wireless



Broadcast Receiving Licences

THE following statement shows the approximate number of Broadcast Receiving Licences in force at the end of October, 1956, in respect of wireless receiving stations situated within the various Postal Regions of England, Wales, Scotland and Northern Ireland. The numbers include Licences issued to blind persons without payment.

Region	Total
London Postal	1,260,908
Home Counties	1,254,527
Midland	975,909
North Eastern	1,274,265
North Western	962,208
South Western	794,547
Wales and Border Counties	501,660
<hr/>	
Total England and Wales	7,024,424
Scotland	901,589
Northern Ireland	202,656
<hr/>	
Grand Total	8,128,669

Police V.H.F.

THE Metropolitan Police have placed an order with Marconi's Wireless Telegraph Company Ltd. for the supply of 50 of the new Marconi 10-watt F.M. mobile transmitter/receivers type HP81B.

The Marconi type HP81B is the latest of the HP80 series of 10-watt mobile V.H.F. radio-telephones. Its compact and rugged construction makes it eminently suitable for use in cars, harbour craft, naval vessels or for general point-to-point communication links.

The standard type HP81B equipment comprises a frequency-modulated transmitter/receiver with a control unit and a loudspeaker, all of which are separate entities, thus permitting the maximum amount of flexibility in installation. Either a telephone handset or a hand microphone may be used, press-switches being incorporated in these instruments for instantaneous changeover from "transmit" to "receive." Facilities exist for the provision of a loud-hailer.

Up to seven crystal-controlled channels with independent adjustment of each spot frequency are available within any $\frac{1}{2}$ Mc/s section of the frequency range (70-100 Mc/s). The channels are selected by a rotary switch mounted on the control unit. Provision is

By "QUESTOR"

made for operating with 50 kc/s channel separation; alternatively, operation with 25 kc/s channel separation can be effected. The mode of operation can be common frequency (simplex) or dual frequency (simplex or duplex).

Opening of the BBC's V.H.F. Sound Broadcasting Station at Holme Moss, near Huddersfield

THE BBC's Very High Frequency (V.H.F.) sound broadcasting station at Holme Moss, near Huddersfield, was brought into service on December 10. This new station, which is on the same site as the BBC's Holme Moss Television Station, transmits the North of England Home Service on 93.7 Mc/s, the Light Programme on 89.3 Mc/s and the Third Programme on 91.5 Mc/s, each with an effective radiated power of 120 kW. As at other BBC V.H.F. sound broadcasting stations, the transmissions are horizontally

polarised which means that receiving aerials will need to be fixed horizontally.

The area in which satisfactory reception is expected has a population of approximately 14 million people. It includes Yorkshire, with the exception of the northern and extreme eastern parts of the North Riding; Lancashire as far north as Morecambe Bay; Lincolnshire with the exception of the extreme eastern and southern parts; Cheshire; Derbyshire; Nottinghamshire; north Leicestershire; north Shropshire; most of Staffordshire; the northern part of Anglesy; Flintshire, and most of Denbighshire.

Mr. E. K. Cole to Visit the Far East

MR. E. K. COLE, Chairman and Managing Director of E. K. Cole, Ltd., left Britain on Saturday, December 1, bound for Australia, where he will see for himself the progress being made by his associate company in Sydney—Ediswan-Ekco (Aust.) Ptd. Ltd.—which is jointly owned with Associated Electrical Industries Ltd.

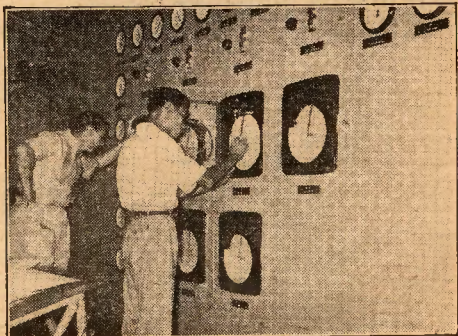

A remote control device, operated from a tanker moored at the end of submarine cargo loading lines three and a half miles out at sea, which is capable of stopping the cargo-loading pumps on shore, has recently been installed at a cost of £10,000 at Lutong Refinery in Sarawak, British Borneo. This equipment, now in service, was developed jointly by Shell and the General Electric Company, Limited, London.

Television receivers are coming off the Sydney production lines at an increasing rate to meet the demand arising from the opening of the Australian television service.

First port-of-call before Australia will be U.S.A., where already Ekco radio receivers and heating and electronic equipment are well known.

serve them, and those who visit the new premises will find complete technical and information services available. In addition there will be extensive showrooms, a demonstration centre and cinema.

Mullard House, as this new building will be called, has been built by Capital and Counties Property Co. Ltd., and will be occupied by Mullard Limited on a long lease. The main contractors were Lavender, MacMillan (Contractors) Ltd. and the architects for this project were Robert Sharp & Son.

The move will take place in the near future and eventually all head office staff will be accommodated in this new building.

Unique Recording Experiment

TWO young British explorers, Mr. and Mrs. G. Durrell, of Bournemouth, will soon be in the jungles of the British Cameroons, where they intend to conduct a unique experiment—recording the family life of the gorilla.

Well known to a large listening and viewing public, Mr. and Mrs. Durrell will spend eight months in the northern part of the Cameroons. It is their third expedition there.

Although they will also be collecting fauna for zoos in Britain, America and the Continent, recording the mating and family life of the gorilla will be the major item in their programme.

When Mr. and Mrs. Durrell decided on the experiment they sought the help of Minnesota Mining and Manufacturing Company recording experts.

As a result of exhaustive tests, 14,000ft. of Scotch Boy tape of special strength and high fidelity will be used. This tape is particularly suitable for regions where temperatures and humidity are high, as its water absorption is practically nil because of the super-

strong polyester base. It is unaffected over a range of 150 deg. C.

Two New Radio-telephone Services

CABLE AND WIRELESS LTD. announce that a radio-telephone service was opened on December 1st between the United Kingdom and Fiji by linking the U.K.-Sydney and Sydney-Suva services. The cost of a three-minute call is £3 15s., with a report charge of 4s.

A direct radio-telephone service has also been opened between Amman (Jordan) and Djeddah (Saudi Arabia). The charge for a three-minute call is the equivalent of £1 10s., and the service is available on Mondays, Wednesdays and Saturdays between 13.00 and 14.00 hours G.M.T.

Radio and Electronic Component Show

RECOGNISED as one of the most important technical displays of the year in Great Britain, the 14th annual exhibition organised by the Radio and Electronic Component Manufacturers' Federation is to be held at Grosvenor House and Park Lane House, Park Lane, London, W.1, from Monday, April 8, to Thursday, April 11, 1957.

Formerly known as the Radio Component Show, the title has now been changed to Radio and Electronic Component Show to be more descriptive of its scope, covering as it does components for the radio, television, telecommunications and electronic industries in their widest aspects.

The exhibition has grown from year to year—next year 160 manufacturers are expected to exhibit—and this has necessitated holding it in two sections which, however, are close together and will be organised and operated as a single exhibition.

For overseas visitors and other special guests a preview is being held from 10 a.m. to 2 p.m. on the first day, April 8. Admission is by ticket obtainable from the Secretary, R.E.C.M.F., 21, Tothill Street, Westminster, London, S.W.1.

Radio Show

A REMINDER that the 24th National Radio Show will be held at Earls Court, London, from Wednesday, August 28, to Saturday, September 7, 1957. There will be a preview on Tuesday, August 27.

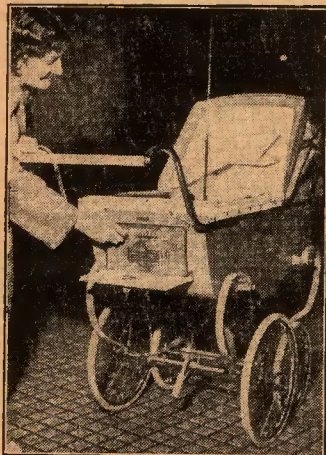

A novel installation from France. It is not stated whether the installation is for the benefit of the baby or its mother.

Ekco have considerable interests in New Zealand and India, and during his forthcoming overseas tour Mr. Cole plans to visit The National Ekco Radio and Engineering Co. Ltd., Bombay, and The Ultimate-Ekco (N.Z.) Co. Ltd., Auckland.

Mullard House

MULLARD LIMITED will shortly be moving into their new headquarters at Torrington Place, W.C.1. For some years now several departments of the organisation have been temporarily accommodated in a number of separate premises and the move will eventually bring all departments under one roof.

Customers of the company will benefit from the centralisation of the various departments which

AN ACORN A.C. ALL WAVE SIGNAL GENERATOR

A NOVEL UNIT FOR THE EXPERIMENTER
AND SERVICEMAN

By F. G. Rayer

THE circuit described here has the particular advantage of low cost, as only a single valve is used and relatively few components. Despite this, it will produce an R.F. signal, on the fundamental, between 16 and 2,200 metres, modulated or unmodulated at will. For lower wavelengths than 16 metres harmonics may be used, as with most commercial signal generators of the less costly type. The generator will also produce an A.F. note of adjustable frequency, and this is useful for checking A.F. circuits. As tuning is continuous in four bands, operation is also possible upon the intermediate frequency of any standard receiver, for I.F. circuit alignment.

The circuit is shown in Fig. 1, and employs a 954 Acorn, which is of small size and easily obtainable at low cost from many sources. Oscillation is obtained by means of cathode tapping on the four coils. The grid condenser is relatively large (.001 μ F) so that at high grid leak values grid blocking arises, the valve going in and out of oscillation at audio frequency. The frequency of grid blocking rises as the .5 megohm control is moved towards minimum value, until the effect ceases, and an unmodulated R.F. signal is then obtained. The R.F. signal is taken from

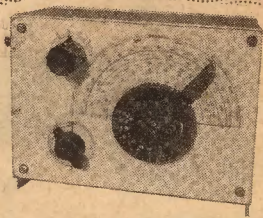

CI, which is of very low value. When an A.F. signal is required this is taken from the A.F. output terminal, the note being adjusted by the .5 megohm control. Values other than the 954, of H.F. pentode type, will operate in the same manner with these values.

A small eliminator type transformer is used for heater supply and H.T. Only a low H.T. voltage is necessary, around 45 volts being most suitable. The D.C. obtained from the metal rectifier is smoothed by two 2 μ F condensers, and a 2K resistor. These values are in no way critical. If the H.T. secondary delivers a higher voltage the 2K and 5K resistors can be of higher value to compensate for this.

Coil Details

Four coils are required with cathode tapping at approximately the centre. The actual position of the

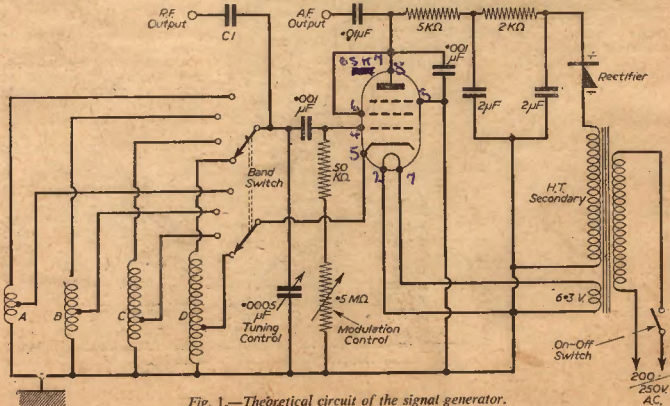

Fig. 1.—Theoretical circuit of the signal generator.

will not be necessary if the transformer has tags for primary connections.

For ease of operation directly-calibrated tuning scales are used, as shown in Fig. 5. These are drawn on stout card, together with markings for the band switch, etc. This card is bolted to the front of the containing case. After wavelength calibration a piece of celluloid or Perspex of the same size may be bolted on top of the card to preserve markings.

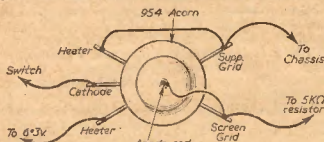

Fig. 4.—Valve connections.

A large ex-service tuning knob with celluloid cursor is used, and no reduction drive is necessary. Such a cursor may readily be made and screwed to a knob of instrument type, about 2in. in diameter. As an aid to initial calibration a degree scale, marked 0 to 180, is also provided in the position shown.

An initial test should be made to see that the generator oscillates on all bands and that modulation may be obtained at will by operating the .5 megohm control. Lack of oscillation on any band may indicate switch or coil wiring is incorrect. Since the A.F. note is produced in the way explained the presence of this at all positions of the band switch will show that the generator is operating properly.

The back must be fixed firmly in position before calibrating the tuning scales.

Methods of Calibration

If a ready-calibrated signal generator can be used calibration is very easy. In each method a receiver tunable over long, medium and short waves will be required. A superhet can be used, but a T.R.F.

receiver with reaction is much better. If reaction is advanced until the receiver is on the point of oscillation, tuning can be for zero beat, and this will be more accurate than is possible with a superhet. The calibrated generator is set to some definite tuning point and the signal tuned in on the receiver. The home-built generator is then tuned until its note is also accurately in tune on the receiver. The wavelength (or frequency) reading on the calibrated unit may then be marked upon the appropriate scale on the home-built generator.

If no ready-calibrated generator is to hand perfectly satisfactory calibration of the home-built generator is by no means difficult, but will take longer. BBC stations will furnish many tuning points for the receiver. The generator is then tuned until its note is at maximum volume, and the wavelength is marked on the scale. At the same time the degree reading is noted as exactly as possible upon a wavelength graph. Several M.W. stations will allow the M.W. graph to be completed, and the wavelengths

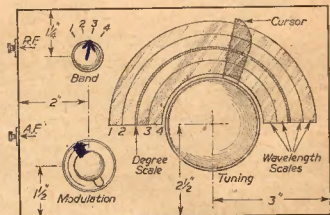

Fig. 5.—Panel layout.

falling within this can then be transferred to the scale on the generator by reference to the degree readings.

Harmonics can then be used to fill in other scales and points where no stations are available. For this

purpose the receiver will always be tuned to some multiple of frequencies on the generator. For example, if the generator were tuned to 500 kc/s (600 metres) its note would be heard also on 1,000 kc/s (300 metres), 1,500 kc/s (200 metres) and so on. But it would not be heard on 250 kc/s (1,200 metres), etc., because these are not multiples of the fundamental (500 kc/s). With a T.R.F. receiver it is possible to hear up to the sixth or eighth harmonic. It is also possible to obtain tuning points on higher wavelengths by adjusting both generator and receiver. For example, the generator may be tuned to 350 metres, and the receiver tuned to this signal. The receiver is then left untouched, and the generator tuned to higher wavelengths until its note is heard. It will then be on half the frequency of the receiver, or twice the wavelength—700 metres.

Repeat the procedure with other wavelengths.

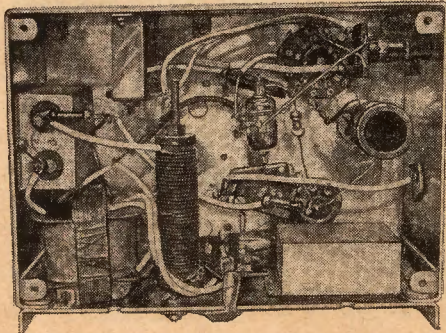
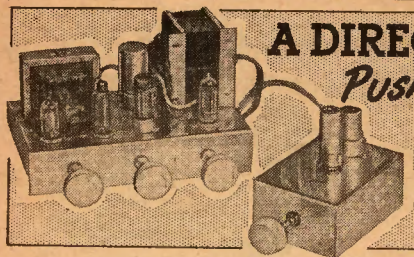

Fig. 6.—View of the interior. Compare with Fig. 3.



A DIRECT-COUPLED *Push-Pull* AMPLIFIER

A USEFUL AMPLIFIER, WITH TONE CONTROL AND PRE-AMPLIFIER

By J. S. Kendall

(Continued from page 758 January issue)

LAST month we finished with the essential details of a suitable pre-amplifier and at the foot of this page we now show the theoretical circuit of this section. This shows, on the right, the frequency-correction circuit for various recordings. It will be remembered that the tone-control circuit was described in the first section of this article and it is built as a portion of the main amplifier. This tone-control arrangement is, however, a bone of contention among many amateurs. Some say it should not be used at all, and that the amplifier and reproducing chain should be as straight as possible, and that the music or speech should be reproduced just as it comes over either on the radio, from a tape or from records. They hold that the control engineers at these various recording channels make the necessary adjustments, and that it is often difficult to know whether your own adjustment of the tone controls is not, in fact, introducing a wrong balance. However, the tone-control section does enable one to make a cut in top or emphasise bass if, for some reason, one feels that the balance is not correct or is not to one's

own particular liking. It would, however, be difficult to adjust these controls when changing records, and each disc would then have to contain on the label the settings of the various controls which had been found by previous playings to be most suitable. This means that when a disc is changed, or on changing over from standard to L.P., the settings would have to be changed, and it is obviously preferable if a fixed corrector circuit can be incorporated so that a switch may be marked with the indications for Standard L.P., 45 or 33, etc., and this would enable a fixed correction to be applied to all records in each class, leaving the tone controls at "level" or making individual adjustments as required. It will be appreciated that, owing to the method used in recordings each type of disc does have to have some form of correction applied, and if a L.P. disc is played on an uncorrected circuit it will be found high-pitched, whilst if this is corrected by some network and without alteration when a Standard is played it will be found lacking in top.

The frequency correcting network is, therefore,

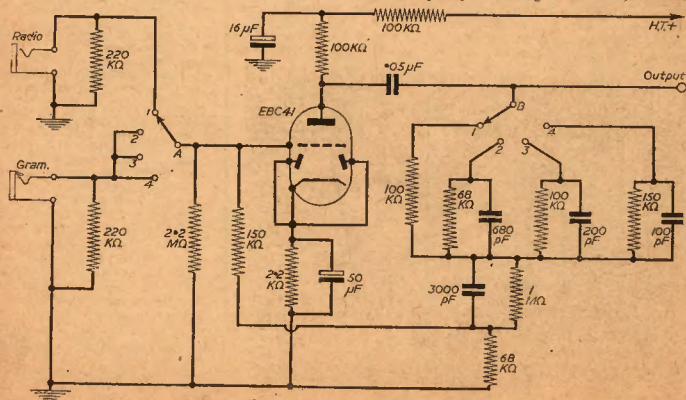

Fig. 7.—Theoretical circuit of the pre-amplifier.

part of the pre-amplifier and it will be seen to consist of the usual fixed resistors and capacitors, and the control is effected by means of a two-pole four-way rotary switch. In addition to carrying out the function of changing the correction network, it also makes the necessary modification to the input circuit for radio or records, a single position with correction being provided for the radio input, and the three remaining positions being strapped on the input side for records. Two standard sockets are provided for the input, and these should be preferably the small Bulgin types with suitable plugs, the latter being provided with screened cable from the pick-up or radio set.

Wiring

Fig. 8 shows the wiring of the pre-amplifier and the illustration on the right shows the inside view of the actual unit. The layout is simple and no difficulty should be experienced in wiring.

Valve Substitution

Readers often write and ask whether such and such a valve may be used in place of one specified in our published circuits. Valves that are shown

in the manufacturers' lists as direct substitutes will work in orthodox types of circuit, but not necessarily in direct-coupled amplifiers. The use of the N709 in place of the specified EL84

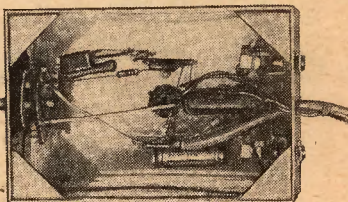

Underside view of the pre-amp.

valves presents no trouble, and in fact it is quite possible to use one of each in this amplifier. In a 20 watt version, however, details of which will be given later, the specified output valve is an EL34, and although the KT66 is a rated equivalent it cannot

be used in the direct-coupled circuit. This will be explained later. The Z729, however, appears to have the same characteristics as the EF86 used in the first stage of this amplifier, but it is not, in

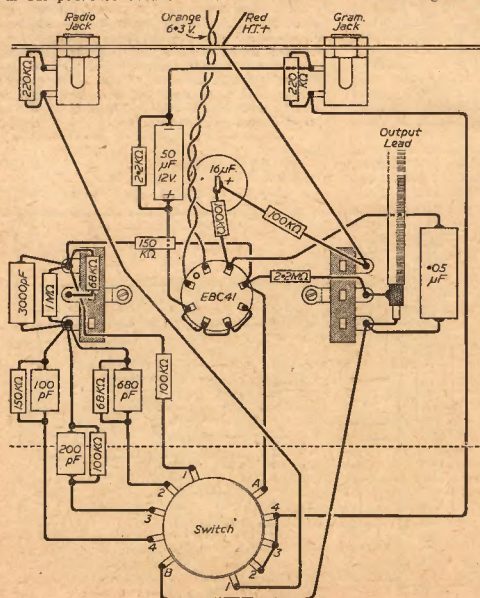

Fig. 8.—Wiring diagram of the pre-amp.

COMPONENTS LIST FOR PRE-AMPLIFIER

- 1 chassis, Kendall and Mousley Ltd.
- 1 B8A valveholder, McMurdo.
- 1 EBC41, Mullard Ltd.
- 2 J6 Bulgin Plugs.
- 1 100 pF Ceramicap "Lab."
- 1 200 pF Ceramicap "Lab."
- 1 680 pF Ceramicap "Lab."
- 1 3,000 pF Ceramicap "Lab."
- 1 .05 µF paper.
- 1 50 µF 12 volt.
- 1 16 µF 500 volt, can type.
- 1 switch, Kendall and Mousley Ltd.
- Screws, tags, wires, screened cable and octal plug.
- 1 "T" 2.2 M ohm, "Lab."
- 2 "T" 220 K ohm, "Lab."
- 2 "T" 150 K ohm, "Lab."
- 1 "T" 2.2 K ohm, "Lab."
- 2 "T" 68 K ohm, "Lab."
- 4 "T" 100 K ohm, "Lab."
- 1 "T" 1 M ohm, "Lab."

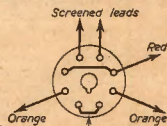

Fig. 9.—Wiring of the plug mentioned last month.

practice, quite the same. However, it may be found with some specimens that a balance can be found at the extreme end of the balance control. A DH77, whilst it has the same characteristics as the EBC41 used in the pre-amplifier, has a different base, and therefore is not interchangeable, but if it is desired to use it the base may be changed to suit and it will work satisfactorily.

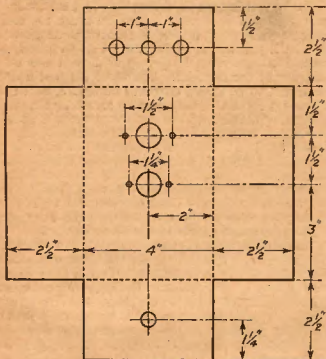

Fig. 10.—Details of the chassis for the pre-amp.

Speaker

Whilst the amplifier may be used in a small hall, the question of using a high-note or tweeter speaker may arise.

The output impedance of the normal amplifier is a matter of 4 ohms. That is not the actual resistance of the speaker coil but its apparent resistance to a frequency of 1,000 cycles. For higher power amplifiers where several speakers are to be used, the line or lead loss for a 4 ohms impedance is high, so an output of 15 ohms is used. It will be appreciated that with an amplifier one requires to have the maximum amount of the output transferred into usable sound and not lost in the wiring. It will be seen that if the leads to the speaker are of any length they will have a comparable resistance with that of the impedance of the speaker. For example, if the leads are of 1 ohm and the speaker of 4 ohms, 20 per cent. of the total power will be lost in the lines as well as there being a 20 per cent. miss-match applied to the amplifier. This latter, with amplifiers with heavy feedback, is not nearly so important as those without. Using the same leads and speaker of 15 ohms impedance, the loss would only be 1/16th and the miss-match 6 per cent.

If the speakers are to be a permanent fixture, then the ends of the leads can be soldered direct to the tags of the speakers. However, it is not always possible to leave the speakers *in situ*. In this case, it is a good plan to terminate the wires on a socket. There are on the market a series of different types, some using flat pins made especially for the job. Jack plugs and sockets are very useful, and the P38P plug made by Bulgin is ideal as it is certainly not easy to damage. The insulation of the cover is of the soft plastic type

and not the usual hard and brittle material so often met with.

Where very long lines are met with, such as would be the case in factories and places with a long distance from the amplifier to the speakers, it is best to match the amplifier to a "600" ohm line. At the other end the line can be matched down to the speaker. This system is also of use where a large number of speakers are to be used, as one does not get the large variation in volume between speakers at different points along the line. Whilst on the matter of differing volume levels with speakers, where several rooms are to be fed, it is a good plan to use the Stentorian Senior speaker made by W.B. as it is a first-class reproducer and has its own volume control. (A feature of the range of all Stentorian speakers.)

One of the features of negative feedback with amplifiers is as mentioned before, that it makes the matching of the speakers to the amplifiers less critical and allows a far wider scope for switching in and out of loads. However, it is always desirable, if possible, to match correctly to the amplifier. With multi-speaker systems this can be done with a parallel or series combination, or both together. For example, an amplifier of 15 ohms output impedance is to be used in a hall and the speakers chosen are all of 4 ohms, then it is quite in order to join them all in series making a total of 16 ohms for the load. Here a point comes in; one must be very careful just how the speakers are joined in series, as if incorrectly done one or more of the speakers will be cancelling out the output of the others. In the case of two speakers working against the other two, a very large proportion of the sound would be lost. The effect of this cancellation also gives odd tonal effects at certain parts

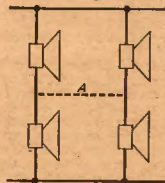

Fig. 11.—Multiple speaker connections.

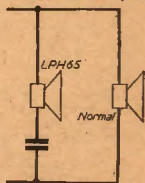

Fig. 12.—A cross-over arrangement for a tweeter.

of a hall, as it will completely eliminate certain bands of frequencies. The easiest method of ensuring that they are correctly joined up is to use coloured wire for the job, and make sure that if, say, the tags are at the bottom of the speaker, you start at the right from the amplifier, then the left tag to right on the next, and so on. On the last speaker the return wire to the amplifier will go on the left-hand tag. Of course, the speakers may be mounted in any manner, and in some cases in differing tag positions, one can then, to avoid confusion, work clockwise with the wiring as it were, in at the one tag and out clockwise from it.

Parallel connection of speakers is met with at times where, say, four 15 ohm speakers are to be joined to a 4 ohm amplifier. Here the matter of connecting the speakers is again of equally great importance. The four speakers can be joined in parallel to give just slightly under 4 ohms impedance.

(To be continued.)

The Effects of Screening on Coils

MATERIALS AND TEMPERATURE AFFECT THE "Q" OF A COIL AS EXPLAINED HERE

By R. H. Mapplebeck

IN the early days of radio the tuning coils were mounted in the open for easy access, but with the evolution of the multi-electrode valve increasing sensitivity and circuit complexity it was soon found essential substantially to confine all electromagnetic and electrostatic flux by screening coils from each other and from neighbouring components to prevent instability from feedback due to stray coupling.

Today the screening of coils is inclined to be taken for granted, but it is both useful and interesting to know just why this has to be done and what is the effect of placing a coil inside a screening can, not only on the coil but on the circuit in which it is functioning.

In general, coils may be divided into two main categories, high frequency and low frequency, but as may be expected the material for shielding an L.F. coil would not be suitable for an H.F. coil.

Electromagnetic Screening

Screening cans of high permeability are used when the magnetic flux is unidirectional or from a low-frequency source. The magnetic flux lines are prevented from extending beyond the container by such materials which act as a virtual magnetic short circuit, giving an effect analogous to that which a Faraday cage has on electrostatic flux. Fig. 1 (a) and (b) illustrates the disposition of magnetic flux when a solenoid is placed inside a container made of magnetic material of high permeability at low flux densities such as mu-metal.

In general, electromagnetic shielding extends over the audio frequency range up to about 10 Kc/s, though depending upon requirements it may be found necessary to use a combination of both electromagnetic and electrostatic shielding. Such circumstances may occur in a screened and balanced transformer where, to preserve balance, the different sections of the windings may need to be shielded from capacity effects as well as inductive. Such transformers usually employ electrostatic shielding between primary and secondary consisting of metal foil arranged so that its surface is approximately parallel with the magnetic field, but provided with an insulated gap to prevent it becoming a short-circuited turn. This method of screening is used on transformers which range from mains frequencies up to radio frequencies in Band II.

Electrostatic Shielding

This form of shielding extends from the frequency where the electromagnetic ceases, that is from about 10 Kc/s upwards.

The distribution of electrostatic flux for a coil both outside and inside an aluminium can is shown at Fig. 2 (a) and (b).

It is difficult to assign a transitional point where the shielding ceases to be efficient as magnetic shielding and becomes more efficient as electrostatic shielding, because as the frequency of a magnetic field becomes higher, more satisfactory shielding is obtained by the use of shielding material having

high electrical conductivity, as already mentioned.

The magnetic flux in attempting to pass through such a shield induces voltages that set up eddy currents which assist in blocking the magnetic flux and prevent it penetrating the shield. This eddy current effect increases with frequency and with the conductivity of the material. Therefore the best metals are found to be silver, copper, aluminium, etc., and effectively form a Faraday cage by screening the parts external to the shield from electrostatic effects within. The exact nature of the shielding material is not important, but aluminium is popular on account of its lightness, ease of working and high conductivity. Its relative resistivity to copper is 1.64 to 1, and although copper has largely been superseded by the latter metal, it is still used occasionally with silver plating for high efficiency standard coils associated with special test gear such as Q-meters.

The eddy currents just referred to do not penetrate the screen material deeply so the thickness of the can is determined more by mechanical considerations. For instance, the minimum thickness for adequate shielding at 100 Kc/s is 0.0325in. Coil cans are invariably not thinner than 20 s.w.g. or 0.036in., which is greater than that required for minimum shielding. At higher frequencies, of course, the required thickness decreases.

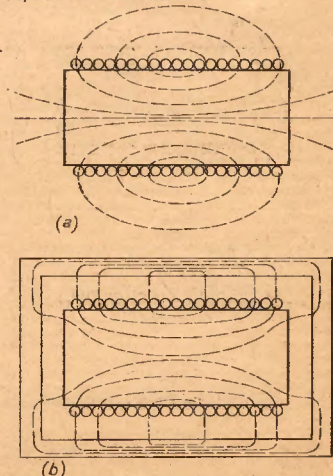

Fig. 1.—Disposition of electromagnetic flux (a) outside and (b) inside a screening can.

RADIO COMPONENTS — RETURN-OF-POST SERVICE

Details of some of the items from our extensive stock of Radio and Television components are given below. All items are usually held in stock and all orders are normally dealt with on the day they are received.

OSRAM 212 PULS AMPLIFIER

INSTRUCTION MANUAL, 4/- PRICE LIST Free.

RESISTORS, Lab. Kits, Main Amplifier, only 33.4. Includes the three potentiometers, Passive Unit, 6/-. Pre-amplifier, 14/3.

TCC CONDENSERS, Main Amplifier, 65/-, Passive Unit, 12/3. Pre-Amplifier, 18/9.

All resistors and condensers are available separately. Full details in list.

OUTPUT TRANSFORMERS, Partridge P3591A, 90/-, Gilson W0710, 52/6, Whitely, 32/-.

MAINS TRANSFORMERS, Partridge H300 110 (P3591B), 75/-, Elstone M7912, 40/8, Whitely, 78/-.

SMOOTHING CHOKES, Partridge C10 135, 23/6, Whitely, 15/3.

SWITCHES, Specialist Switches, Main Amplifier, 14/- the pair, Passive Unit, 11/6, Pre-Amplifier, 10/8.

CHASSIS, Drilled, Whitely, steel, gold finish, 34/3. Denco, plain aluminium 14/6.

VALVES, Main Amplifier only, Tele-Radio, 14/6. Denco, 6/6. Drilled for Passive or Pre-Amp., Denco, 7/6.

VALVES, 2729, Osram, 24/4; alternative, 15/-, B329, Osram, 19/6; alternative, 10/-, N708, Osram, 10/- each; alternative, 12/- each, 1708, Osram, 11/10.

COMPONENTS by Balguy, Belling Lee and all other items are always in stock. Full details are given in our free price list.

COMPLETE KITS, Main Amplifier only.

KIT A, Complete Kit with Partridge Transformers and Choke, Whitely Chassis and new Osram Valves, £25.5.0.

KIT B, Complete Kit with Partridge Transformers and Choke, Denco Chassis and alternative valves, £21.17.0.

KIT C, Cheaper Kit with Elstone Mains Transformer, Gilson Output Transformer, Whitely Choke, Denco Chassis and alternative valves, £29.17.0. Remember that these kits are really complete.

PASSIVE UNIT if required with the above kits, £2.13.0 extra.

PRE-AMPLIFIER if required with the above, £4.15.0 extra with Osram Valve or £4.6.0 extra with alternative valve.

G.E.C. METAL CONE SPEAKER, always in stock at £9.5.0.

CREDIT TERMS, Complete or part kits can be supplied on Credit Terms. Please state exact requirements and we will send a quotation.

GRAMOPHONE EQUIPMENT

BSR UA8 MONARCH RECORD CHANGER.—The latest 4-speed model. Acos turn-over carriage. Price £9.15.0. Credit Terms Deposit £1.13.0 and seven monthly payments of £1.6.0.

BSR TU8 MOTOR AND PICK-UP.—Three speed motor and separate pick-up. The pick-up is fitted with the Acos turn-over crystal carriage. £4.17.6.

COLLARO TRANSCRIPTION MOTOR.—Complete with the Transcription pick-up and insert, £19.10.0. Can be supplied less pick-up at £14.18.0.

TV PATTERN REMOVAL UNIT

Spencer West Type 54. These units will give considerable assistance in removing patterning on the ITA picture. Complete with instruction leaflet, 25/-.

Osram Band 1 Filter. For removing RHC signal when it is entering the converter via the ITA aerial, 10/-.

TRANSISTORS

MULLARD.—OC70, 21/-; OC71, 24/-; OC72, 30/-. Matched Pairs, 60/-, 87C, TUI (3X300N), 40/-; TUI (3X301N), 45/-; TUI (3X302N), 50/-; DS, 18/-; TS, 21/-; TS, 24/-; TPI, 40/-.

CRYSTAL SET COMPONENTS

COILS.—Teleton HAX 3. Specially made for use with Crystal Diodes. Suitable diodes 2/6.

TUNING CONDENSER.—005 mfd., 2 1/2

CHASSIS.—Small metal chassis with tuning scale and sockets for aerial, earth and phones, 2/9.

TUNING KNOB.—1/-.

CONDENSERS AND RESISTORS

We carry a wide range of these and fully detailed lists are available free of charge.

VIEW MASTER CONVERTER

INSTRUCTION MANUAL is now available. The Manual is a reprint of the articles in "Practical Television". Price 2/6, postage 3d.

TELEVISION ATTENT ATTEN

Belling Lee Co-Axial plug-in Type. Available in 6db, 12db, 18db, 24db and 30 db. 4/6 each.

COAXIAL CABLE

The very best quality semi-atripead. Entirely suitable for Band III and F.M. 10d. per yard; 82/6 per 100 yard drum.

CREDIT TERMS.—Anything we sell can be supplied on Credit Terms. The deposit is 3/- in the £ and the balance payable over 7 months. Send details of your exact requirements and we will submit a quotation.

TERMS OF BUSINESS.—Cash with order or C.O.D. Please add postage under £3. We charge C.O.D. fees on C.O.D. orders under £5.

MULLARD 510 AMPLIFIER

INSTRUCTION MANUAL, 3/6 PRICE LIST Free.

RESISTORS, Lab. Kits, MA1056. All resistors and potentiometers for the Main Amplifier only. R1-R39, 39/-, MA10/PA/8.

All resistors and potentiometers for Main Amplifiers and Pre-Amplifier Version B, R2-R32, R27-R29, R31-R36, 57/6. MA10/PA/4 (or Version A) potentiometer only, £21.8.6. 16/10.

CONDENSERS, TCC Kits, Main Amplifier, 45/-. Our alternative kit for Main Amplifier, 30/-. TCC Kits for Pre-Amplifiers, Version C, 15/-, Version B, 24/3.

CHASSIS, Denco, Aluminium ready drilled, Main Amplifier with base plate, 19/6. Pre-Amplifiers, Version A, 8/6. Version B, 12/6.

PRINTED PANELS, Denco, Main Amplifier, 6/6. Pre-Amplifiers, Version A, 1/6, Version B, 2/6.

OUTPUT TRANSFORMERS, Partridge P3667 (tapped for 5 k and 8 k load), 52/6. Elstone OT3 (6 k), 45/-. Elstone OT3 (8 k), 45/-. Elstone OP67 (6 k), 40/-. OP7A (6 k) 40/-. Gilson W066A (6 k), 47/6, W066B (6 k), 47/6.

MAINS TRANSFORMERS, Elstone MT/510 Main Amplifier only, 36/-. Elstone MT/MU for amplifier when Pre-Amplifier or FM Tuner are used, 42/6.

VALVES, E789, Mullard, 24/4; alternative, 15/-, 8C83 Mullard 19/6; alternative, 10/-, E184 Mullard, 16/-; alternative, 12/-, E261 Mullard, 11/10, E261 Mullard, 11/10.

COMPONENTS by Balguy, Belling Lee and all other items always in stock. Full details are given in our free list.

COMPLETE KITS, Main Amplifier only. Note—These kits include the MT/All Mains Transformer. If the pre-amplifier or FM Tuner are to be used the MT/MU Transformer is required.

Elicon Plugs and Sockets will also be required and the price of these and the difference on the transformer must be added to the kit.

KIT A, Complete kit with TCC Condensers, Mullard Valves and Partridge Output Transformer, £16.6.0.

KIT B, As Kit A, but with alternative valves and condenser, £13.18.0.

KIT C, As Kit B, but with Elision Output Transformer, £13.4.0.

PRE-AMPLIFIER KITS, Version A with Mullard Valve, £5.4.0, with Alternative valve, £4.15.0, Version B with Mullard Valve, £6.10.0, with alternative valve, £3.10.0.

PRINTED CIRCUIT ITEMS, All in stock.

Chassis, Special TCC Printed Circuit Panel, 22/6. Denco Me Kit A frame to support the TCC panel with small chassis for FoVe: Unit, 15/-.

Condensers, TCC Special Kit, 45/-, Valve Holders, Special Printed Circuit type, 1/- each.

WHITELY CABINETS

All these Cabinets are packed flat for easy home assembly. The new Junior Base Reflex Corner Console, £9.9.0, Base Reflex Console, £10.10.0, Senior Base Reflex Corner Console, £11.11.0. All the other Whitely types are available. Illustrated leaflet available free. Credit terms on these cabinets with a speaker if required.

WHITELY SPEAKERS

The Whitely Hi-Fi range of speakers. 10in. HF1012, 99/9. 9in. HF1012, 88/8. 8in. HF812, £4.5.6. 8in. TH16 the new Treble speaker, £6.10.0. Whitely Cross Unit, CX150 for the TH16, 36/8. 8in. HF816, £6.17.0. T10 Tweeter, 84/-, Cross-over Unit, CX300 for this tweeter, 80/-. Detailed leaflet on all W.B. Speakers available.

TEST INSTRUMENTS

AVO Meter Model 8, £23.10.0. **AVO Meter Model 7**, £19.10.0. **RADAR Kilovoltmeter** for E.H.T. Measurements, 3 to 30 kv., £37.17.3.

TEL. TWEEETER SPEAKERS

The new Moring Coil LSH83, 59/8. Cross-over chokes, 84 mH, 9 mH, 8 mH, 1.75 mH, All 3/6 each. Electrostatic, LSH18, 12/6, LSH14, 17/8, LSH100, 21/-, 65 mH cross-over chokes, 7/8 each.

PAPER BLOCK CONDENSERS

Very high grade 2 mfd. 350 v. Paper Block Condensers. Ideal for making up the capacity required for cross-over networks, 2/- each, Brand new. Not ex-Government.

WATTS RADIO

8, APPLE MARKET
KINGSTON-ON-THAMES, SURREY

Telephone: KINGSTON 4099

Shop Hours: Monday, Tuesday, Thursday—9 a.m. to 5.30 p.m. Wednesday—9 a.m. to 1 p.m. Friday, Saturday—9 a.m. to 6 p.m.

For a regular
smooth response curve

You need a PHILIPS dual-cone loudspeaker

Made in Holland



A special dual-cone design distinguishes Philips high fidelity speakers, resulting in energy transmissions almost independent of frequency. This ensures that, in an ordinary room, sound pressure within an angle of 90 degrees varies by not more than six decibels; while the excellent spatial distribution of acoustic energy—even at the highest frequencies—is obtained by Philips choice of coupling factor between high-range and low-range cones.

The small cone acts as a high tone radiator for frequencies above 10,000 cycles and as a diffuser for frequencies below 10,000 cycles from the large cone. The large cone itself acts as a low tone radiator below 10,000 cycles, and as a reflector for the high notes above this frequency. The distribution of sound over the entire frequency range is thus much wider than on a normal loudspeaker. These loudspeakers have a very smooth response curve combined with a low resonance frequency.

N.B. Any of these speakers may be used on their own or with another suitable loudspeaker using a crossover unit.

The Philips dual-cone loudspeaker comes in two sizes: 8" and 12", price 6l gns. (tax paid) and 10 gns. respectively. There is also a single-cone loudspeaker, available in the same two sizes: price £6.2s. 6d. (tax paid) and £10.0s. 0d. respectively.

For full details write to:



PHILIPS ELECTRICAL LTD

Musical Equipment Dept. • Century House
Shaftesbury Avenue • London • WC2

(PA436)

PREMIER RADIO COMPANY

B. H. MORRIS & CO. (RADIO) LTD.

OPEN TILL
8 P.M. SATURDAYS

(Dept. P.W.) 207, EDGWARE ROAD, LONDON, W.2

Telephone: AMBASSADOR 4033
PADDDINGTON 3271-2

BUILD THESE NEW PREMIER DESIGNS

2-BAND T.R.F. RECEIVER

MAY BE BUILT FOR **£5.15.0** Plus 3/- Pkg. & Post.

2-Band Super-hot Receivers may be built for £7.19.6 plus pkg. & carr. 3/-. These two receivers use the latest type circuitry and are fitted into attractive cabinets 12in. x 8in. x 5in. in either walnut or ivory bakelite or wood. Individual instruction books 1/- each, post free.



ALL-DRY BATTERY PORTABLE RADIO RECEIVER

MAY BE BUILT FOR **£7.8.0**

Plus 3/- Pkg. & Postage

4 Miniature valves in a superb circuit covering medium and long waves. Rexins covered cabinets 11in. x 10in. x 5in. in contrasting colours, wine with grey panel. Instruction book 1/6 post free, which includes full constructional details and list of priced components.



4-WATT AMPLIFIER

MAY BE BUILT FOR **£4.10.0** Plus 2/6 Pkg. & Carr.

Valve line-up 6SL7, 6V6 and 6X5. FOR A.C. MAINS 200-250 VOLTS. Suitable for either 3-ohm or 15-ohm Speakers. Negative feedback. Any type of pick-up may be used. Overall size 2in. x 7in. x 5in. Price of Amplifier complete, tested and ready for use, 25s.0 plus 3/6 pkg. and carr.

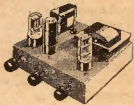

A STEEL CASE IS NOW AVAILABLE, COMPLETE WITH ENGRAVED PANEL, 15/6 EXTRA.

MULLARD AMPLIFIER KIT

Why not make the Best!

All the components for model S10, PLUS preamplifier on one chassis (total six valves) may be purchased for £12.12.0, plus pkg. & post 7/6, or preamplifier and tone control in a separate unit, £14.14.0 plus pkg. & post 7/6.

NOW SUPPLIED WITH ULTRALINEAR OUTPUT TRANSFORMER.

Send for the Premier WIDE ANGLE TELEVISION booklet, 3/6 post free.

COMPACT GRAM AMPLIFIER



Suitable for any type of Pick-up. Volume and tone control fitted with knobs. Overall size 7in. long x 3in. wide x 2in. high. Complete and ready for use.

£2.19.6

Plus packing & postage 2/6.

GRAM UNITS

B.S.R. 4-Speed

Autochanger.
£9.15.0 plus 3/- pkg. & post.
R.N.T. TUS 3-Speed
£4.12.6 plus 2/6 pkg. & post.

A NEW TAPE RECORDER

CREDIT TERMS DEPOSIT £5

and 8 monthly payments of £4.18.6

H.P. TERMS 1 DEPOSIT £20

and 12 monthly payments of £1.17.1

Cash price £40 plus packing and carriage 21/-. Case finished in Brown and Antique Fawn. Size 16in. x 12in. x 7in. with the very latest type Continental Reels. For A.C. mains 200-250 volts, 50 cycles.

SEND FOR LEAFLET
SEND 2/6 STAMP FOR OUR 1957 CATALOGUE



On Your Wavelength

BY THERMION

Seen-ee-Eye!

I KNEW it would happen! As soon as our BBC announcers have to announce a foreign place which is in the news they go into solemn conclave to arrive at some obscure and totally incorrect way of pronouncing it. When Sinai came into the news I expected the announcers to mispronounce it and I was not disappointed. It's so frightfully BBC to pronounce a word or a name different from the accepted standard. It makes them appear so very superior and the listeners so uneducated, especially those who presume that if the BBC says it it must be right. During the war, in the days of Al Varleydell (whom you will remember I took to task for mispronouncing his own name, which is Alvar Lidel), there was the announcer who indulged in that monstrosity "the Ukryne" for Ukraine. Now we have Seen-ee-eye, for Sinai, which it correctly is. You and I and everyone else have been taught to pronounce it that way (Syn-ay-eye). Could not someone at the BBC check up with various Embassies on English pronunciations of foreign place-names before putting these absurdities on the air?

American Midgets

I HAVE, in past issues, written quite a lot about midgets, and invited readers to submit details of any they have made. Nothing really midget, however, came along. They were mostly of the all-dry type and designed round a fairly large battery. The receiver itself was small enough, but there is no advantage in making a tiny receiver unless it makes use of equally midget batteries. In America there are many commercial really midget receivers yielding good volume and having reasonable long-life batteries, and they sell in large numbers. They are not intended, of course, for domestic purposes, but for the odd occasion when you are out and want to listen to the news. They can be toned down so that only the owner hears the transmission. Such receivers have never attracted manufacturers over here and I am quite certain there would be a large demand for them if some manufacturer took his courage into his hands and put such a set on the market. Midget batteries having quite long life are available (indeed, one is incorporated in a pocket lighter in this country) and with transistors, printed circuits, midget resistors, condensers and loudspeakers I see no reason why they should not be produced. I handled one the other day which was smaller than a cigar box in area and only 1/2 in. thick. It easily slid into the side pocket and reproduction was of good quality. No one, of course, would expect such a receiver to be a quality receiver, nor would they expect it to be a globe trotter. It would be a truly personal receiver.

Last year the sales of television receivers exceeded the sales of radio receivers. Manufacturers should, therefore, be seeking new markets and I suggest that the really midget portable, now that the ingredients are there for making it, would provide them.

Guineas for Photographs

READERS are always interested in how other readers conduct their hobbies and I therefore offer prizes of a guinea each to the sender of every photograph of a wireless den selected for publication. The photograph should be accompanied by a brief description of the den and the name and address of the sender. Address your photographs to Den, PRACTICAL WIRELESS, address as on the editorial page.

Decline in Amateur Transmissions?

SEVERAL of my friends, who were keen amateur transmitters, have dispersed their gear and gone in for building sound receivers and TV receiving sets or S.W. receivers. I wonder if there is a general decline in interest in this subject? This journal has regularly encouraged amateur transmitters and the book published by the proprietors of this journal, entitled "Wireless Transmission," continues to sell a considerable number of copies every year. I am informed, however, that the number of queries received by this journal has dropped over the years. The R.S.G.B., of course, could confirm or deny that there is any general decline, but their membership figures alone would not be a reliable guide because amateur transmitters continue their membership long after they have ceased active transmission. In fact, the friends to whom I have referred still retain their membership out of loyalty to the R.S.G.B. which has done so much to foster interest in amateur transmission. I enjoy listening in to these transmissions.

Legion of Honour De Forest

MY congratulations to Dr. Lee de Forest on being made an officer of the Legion of Honour. The Cross of the Legion was presented to him in Paris by the French Minister of Industry and Commerce on the occasion of the 50th anniversary of de Forest's invention of the triode. High tribute was paid to the valuable contributions of Dr. de Forest to the science of electronics.

Building a Car Radio Set

OUR companion monthly, PRACTICAL MOTORIST AND MOTOR CYCLIST, contains a very detailed article on building a compact and sensitive car radio receiver. The R.F. and I.F. stages make use of 6 BA6's, because those valves combine vari-mu characteristics with a relatively high mutual conductance. A 6BE6 is employed for the frequency changer, although it is here adapted for use as a self-excited mixer. This means that the oscillator coil is tapped to the cathode. The article includes details of coil construction, although the standard type of single-winding oscillator coils can easily be modified by unwinding the requisite number of turns, making the taps and carefully rewinding. This puts the tap at the finish of the winding. A car radio has to contend with noise, and in the receiver described the signal-to-noise ratio has been given special consideration.

BULK TAPE ERASER

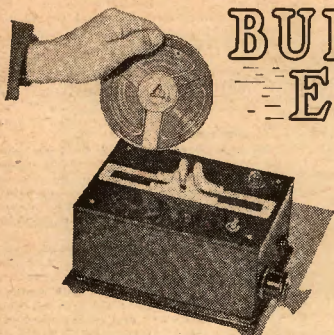

A USEFUL DEVICE TO ERASE TAPES QUICKLY WITHOUT WAITING WHILST THEY ARE RUN THROUGH THE TAPE DECK

By Edward Davis, Assoc.I.E.E.

of the design are adhered to, the possibilities of modifications and variations from the original are manifold and leave plenty of scope for individual ingenuity, having in mind, of course, what suitable components and/or material and constructional facilities might well be available in each constructor's workshop.

MANY readers may well have come up against the question of removing effectively and quickly all traces of recorded matter from spools of recorded tapes.

In the author's case the matter arose mainly owing to the fact that a small battery-cum-spring-driven portable, self-contained, personal tape recorder had been acquired, and whilst found very useful and amusing, no "erase head" was included in the working mechanism. Once a spool of tape had been recorded it was necessary to borrow the local recording gear and have the spool run through and "erased" before the tape could be used again. This, with its attendant inconveniences, caused the author to find some other method of carrying this out so as to re-use the tapes on the portable recorder as required and to save waste and expense.

Whilst no originality is claimed for the piece of apparatus about to be described the construction will be found interesting and, so long as the basic principles

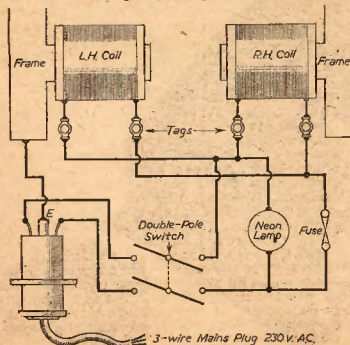

Fig. 1.—Internal wiring of the eraser.

Design

The present equipment was constructed to operate for short periods on standard electrical supply, 230/250 volts 50 Ω A.C. current only, but no doubt

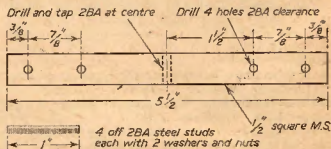

Fig. 3.—Details of magnet fixings.

readers could work out necessary modifications required in the coil formation and windings for alternative voltages and current supplies, and whilst D.C. supplies are now fast becoming obsolete, where such exist a somewhat different coil technique would be required.

In its final form the present "eraser" is designed round the coils forming the magnetic field. After much trial and error a pair of coils complete with laminated pole pieces were taken from two surplus

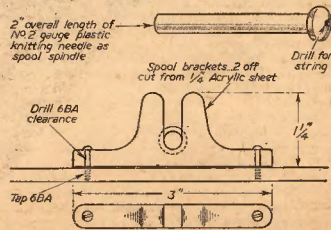

Fig. 5.—Details of the spool bracket.

24/28 volts D.C. aircraft relays—all unnecessary parts having been discarded—and the pair of coils and pole pieces so left were mounted opposite each other on a short length of $\frac{1}{2}$ in. square M.S. bar, all as shown on

of the pair of coils and laminations used in the author's set-up which may be helpful should any reader wish to start construction from scratch.

Wiring

Other than two suitable coils being found or made up to give a suitable "magnetic flux" no special components are needed. As will be seen by the internal wiring diagram the author included a standard three-pin mains outlet—a D.P.S.T. mains voltage toggle switch, an S.P. mains cartridge fuse, and a miniature Arcolite neon indicator lamp; these latter being connected in the live lead.

The author has made every attempt to give the completed "eraser" a very professional instrument finish. The cabinet, constructed of $\frac{1}{2}$ in. Obeche, being sprayed three coats of coach-finish black cellulose and mounted on rubber feet. The thin white "escutcheon" over the spool insertion slot was fret-cut from

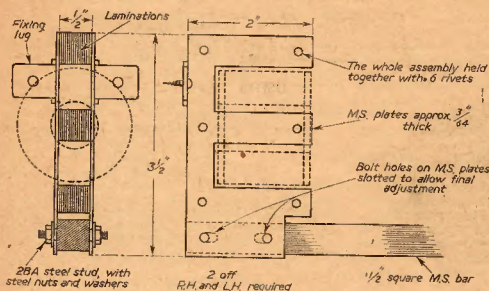

Fig. 2.—Detail of the laminated cores.

the accompanying drawings. This forms the heart of the "eraser."

Although the design of the "eraser" constructed by the author was primarily intended for use of the 5 in. tape spools as a maximum it was, nevertheless, so constructed that up to 7 in. spools can be accommodated into the "field," some tolerance being allowed on the bearings for carrying the removal spindle as required, as will be observed from the sketches of this part of the apparatus. They are cut from $\frac{1}{2}$ in. acrylic sheet.

It was, however, later observed that when the 7 in. spools of recorded tape were inserted for erasure there might possibly remain a portion of the tape near the hub and, particularly if the spool contained its maximum quantity of tape, a similar portion of tape near the perimeter still containing audible signs of non-erasure.

This fault can, however, be overcome in the event of an "eraser" being required for definite use of 7 in. spools; this will be seen from the sketch showing the coil cores forming part of the laminations being slightly offset and so to broaden the magnetic field.

It may well be worth while to mention at this stage that the apparatus may equally well be constructed to take the spools inserted in a horizontal plane.

Full technical and dimensional details are given up

of one of the coils.

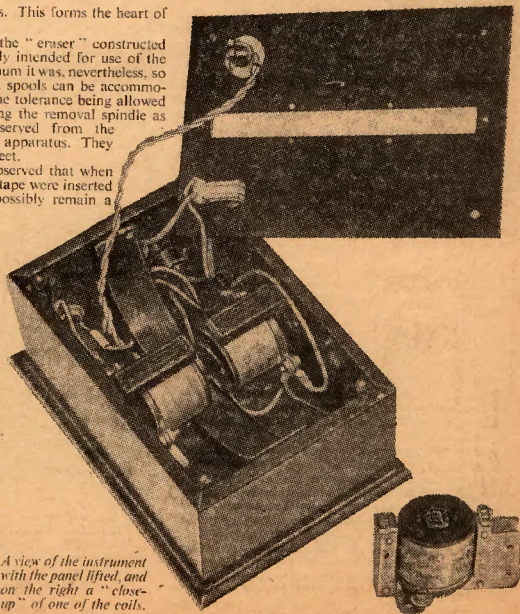

white opal acetate sheet, the top being $\frac{1}{8}$ in. black acrylic sheet with polished edges. Any colours may, if the two magnetic coils are correctly connected so as to be pulling towards each other.

The Cabinet

In case any reader wishes to reproduce a cabinet similar to that shown, the base was 8 $\frac{1}{2}$ in. by 6 $\frac{1}{2}$ in. with the two short sides 5 $\frac{1}{8}$ in. by 3 $\frac{1}{8}$ in. and the two long sides 8 $\frac{1}{2}$ in. by 3 $\frac{1}{8}$ in. The top was made from acrylic sheet (black) and measures 8 $\frac{1}{2}$ in. by 5 $\frac{1}{8}$ in. The inside measure was 7 $\frac{1}{4}$ in. by 4 $\frac{1}{8}$ in., and small pieces of quadrant were fitted in each corner to which the top panel was screwed. As a refinement, four small rubber feet were screwed to the base, and the upper edges of this were rounded off. If coils cannot be obtained, a bobbin should be made to fit the laminations shown in Fig. 2 and these should be wound full with 22 D.C.C. wire. The resistance of the originals was 170 Ω .

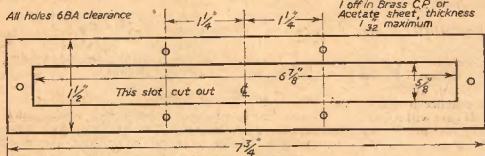

Fig. 4.—Detail of the overlay escutcheon.

of course, be used to choice. All screws visible are chrome-plated. The positioning of the components is not important and may well suit the reader's choice. The photograph of the completed article well illustrates a suitable layout. An improvement might well be added in the form of a small engraved tablet reading: "TO ERASE. Switch on before inserting spool of recorded tape; revolve spool slowly by hand, whilst fully inserted with spindle in position, for, say, half a dozen complete revolutions. Do not,

of course, be used to choice. All screws visible are chrome-plated. The positioning of the components is not important and may well suit the reader's choice. The photograph of the completed article well illustrates a suitable layout. An improvement might well be added in the form of a small engraved tablet reading: "TO ERASE. Switch on before inserting spool of recorded tape; revolve spool slowly by hand, whilst fully inserted with spindle in position, for, say, half a dozen complete revolutions. Do not,

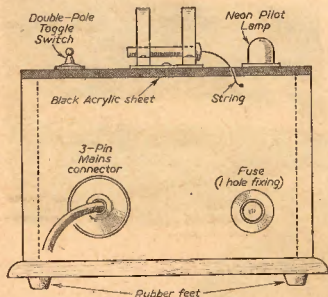

Fig. 6.—End view of the cabinet.

switch off before removing spool after rotating. Do not switch on unless a spool of tape is in the spool carrier." The above, giving an outline of operating procedure, can, of course, be considerably condensed for engraving. Should a metal cabinet be preferred, a ferrous metal should not be used, aluminium being the most suitable.

When carrying out final wiring a good heavy power flex or 3.029 wire should be used, either rubber or P.V.C., and as far as possible all wires kept apart and connections soldered either direct or via suitable solder tags. It is important to remember that the pair of coil windings should be connected in parallel, and that the coils must be so connected that they "pull" together and not repel. In order to make sure of this before finally mounting both magnetic coils one should be left free to move on the connecting bar, when upon switching on the current by temporary connections, if necessary, it will be easily ascertained

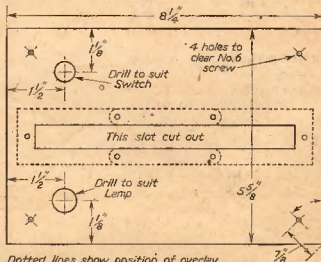

Fig. 9.—Detail of top panel.

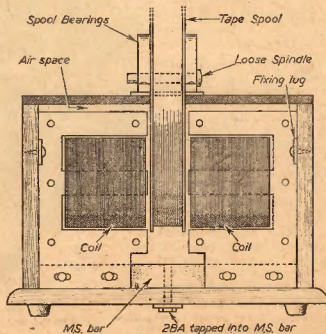

Fig. 7.—Sketch showing spool in position.

The Suppression of Interference

POINTS TO BE CONSIDERED WHEN INSTALLING CAR RADIO RECEIVERS

RECENTLY, a well-known radio manufacturer introduced a car radio to be installed by the purchaser himself. Suppression equipment is provided with the radio, and in practice it will be found that a very large proportion of cars will require little in the way of special precautions and it will only be necessary to fix the receiver and aerial to the vehicle, connect up the battery supply to the receiver, fitting a suppressor in the main distributor lead, to achieve completely satisfactory results.

In some cases, however, it may not be quite so straightforward, and it is the writer's aim to illustrate all the suppression problems that could possibly be met with, and their various remedies. It is earnestly hoped that the following discourse will not convey the impression that the installation of a wireless receiver in a vehicle is a big undertaking only capable of being carried out by an expert.

Ignition Interference via Aerial or Lead-in

If interference is picked up only when the aerial is connected, it is reasonable to assume that the aerial, or the lead-in, is transferring interference into the receiver. First, disconnect the aerial from its lead-in and ascertain whether interference is still present. If this is the case, the trouble lies in lack of bonding of the outer screen of the lead-in to the vehicle. Eliminating the lead-in as the offender, interference may still be present and being picked up by the aerial itself. The suggested treatment for the different types of aerials is as follows:

(a) Roof Aerial

Interference is usually caused by re-radiation from the car wiring to the roof light, trafficators or other accessories which are in close proximity to the aerial. The remedy is to by-pass these leads at the fusebox or insert a filter in the lead at the fusebox end. A useful filter should consist of a closely-wound coil (in diameter made up of 14/16 s.w.g. D.C.C. copper wire, with two .25 to .5 μ F condensers connected, one between each end of the coil and earth.

(b) Telescopic (Whip) Type Aerial

This type of aerial should be mounted as far away as possible from the ignition coil, distributor and sparking plugs and preferably

on the side of the car nearest to the receiver so that the lead-in is as short as possible.

(c) Under-car Type of Aerials

Re-radiated interference from various sources such as exhaust pipe, brake cables or rods, tail lamp wiring, etc., is liable to be picked up by this type of aerial. Bond exhaust pipe, brake rods, etc., to chassis with heavy copper braid, allowing sufficient slack in the braid to allow for movement. Tail light leads and/or other wires should be treated by fitting filters as previously described. Keep the under-car type of aerial as far away from the exhaust pipe as possible and on the side remote from the ignition coil. The best signal-to-noise ratio is obtained by

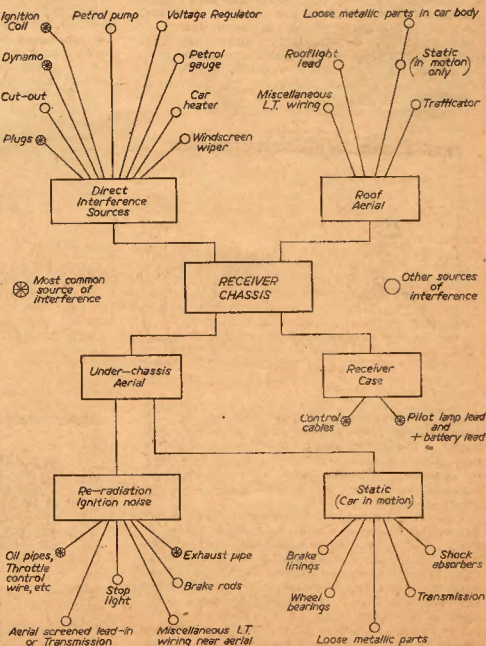

A chart showing interference sources.

fitting this aerial as low as practicable, consistent with the ground clearance of the vehicle.

Ignition Interference

This type of interference is identified by a staccato "clicking" sound at tick-over speeds, increasing in periodicity as the engine speed increases.

First ascertain whether or not the ignition interference is present with the aerial disconnected. Assuming that disconnecting the aerial does stop the noise, it is safe to assume that the interference is being picked up by the aerial or lead-in; either directly from the points of the sparking plugs, or due to the ignition wiring being too close to the aerial. Fitting a resistance suppressor (approximately 10,000 Ω) in the lead between the coil and the distributor head, as closely as possible to the distributor, should effect a cure. In extreme cases the fitting of suppressors at both ends of the lead and possibly additional suppressors to each sparking plug may be required.

If the latter are fitted they should be as close as possible to the sparking plug, but plug suppressors are seldom required with the modern well-designed receiver. Odd cases have been known where it was necessary to alter the position of the ignition coil, or even screen this component in a metal box. Other difficult cases have been cured by screening the sparking plug and distributor leads in flexible copper braid tubes. Generally, however, the only remedy needed is the fitting of a distributor suppressor, provided the aerial has been mounted in a carefully selected position.

It is a good idea to connect the aerial to its lead-in and to move the aerial about in relationship to the vehicle until a point most free from interference is obtained, when the aerial can then be secured. Make sure that the screening of the lead-in from the aerial to the set is bonded to the vehicle in a sufficient number of places. It is essential that it is bonded at least once, and this should be as close to the aerial as possible, using a short length of copper braid. Most of the modern aerials bond themselves automatically on fixing (ensure that the metal is thoroughly cleaned at the fixing point). Make sure also that the set itself is making a first class electrical connection with the bulkhead, dashboard or place of mounting.

In the case of engines which are rubber mounted it is worth while to bond engine to chassis with heavy flexible copper braid in several places. Bonding together the silencer, exhaust and tail-pipes is also advantageous.

The roof aerial is the type most free from interference pick-up troubles, but where interference is experienced check on the bonding of the lead-in and suspect wires which run near to the aerial, e.g., leads to roof light, spotlights, petrol gauge, etc. By a simple process of elimination, using a by-pass condenser, the faulty lead can be found and very often only the one condenser is required.

Any interference from electric screen wipers, electrically operated pumps, trafficators, etc., can be eliminated by using these condensers. (See chart.)

As previously mentioned, it is of the utmost importance that the receiver case is making good electrical contact with the car body, and also that any bolts, fixing screws, control cables, etc., on or entering the case are well earthed.

The battery supply leads may also have R.F. interference induced in them. Also, if the receiver battery lead is connected to the ammeter it must be remem-

bered that this instrument is connected directly to the ignition system. A condenser of .5 μ F to 2 μ F placed between this point and earth will eliminate the trouble. A 1 μ F condenser placed between the "S.W." terminal on the coil and chassis earth will sometimes cure interference via the L.T. supply.

If R.F. interference is being picked up by control cables, oil pipes, etc., which run from the engine compartment through the bulkhead and are near to the receiver and/or its external connections, this can be removed by bonding these to chassis earth.

Static Interference

This is experienced usually only when the vehicle is in motion and can be intermittent or continuous.

In the case of intermittent noises, the trouble is often to be found where movement is taking place between two parts of the vehicle which are not electrically connected, and the cure is to bond the two parts together with copper braid.

Continuous interference is often associated with brake shoes, wheel bearings or fan belt. Static generated by rubbing brake shoes can often be removed by adjustment of the shoes to give clearance, and, failing this, by bonding.

Front wheels offend the most, and sometimes packing the hubs with a good quality graphite grease after removing the old grease will ensure success.

Braze static can generally be cured by connecting the brake shoes with copper braid to the axle. (Leave sufficient slack for free movement.) Interference from the dynamo which can best be described as a whine can be easily cured by fitting a 1 μ F condenser between the "field" terminal of the dynamo and earth.

Static discharge from fan belt or pulley can be cured by smearing with a light coating of graphite—soft lead pencil will often do this job most satisfactorily.

General Hints

1. Bonding. As a general rule bonding wires that are up to 4in. long should be made with $\frac{1}{16}$ in. wide braid, 4in.-8in. long with $\frac{1}{8}$ in. wide braid, and above 8in. with $\frac{1}{4}$ in. wide braid. Of course, $\frac{1}{16}$ in. braid can be used in single, double or treble strands and perhaps this is the cheapest way to buy it.

Always use the shortest possible length of bonding and try several strips of braid if each in turn is reducing the interference. Good electrical connections are absolutely essential for good results cannot be obtained without them.

2. Ensure that all leads which have been screened and isolated and which are carrying H.T. have adequate insulation.

3. Make a thorough check of those H.T. leads for noises may result from defective ignition wiring causing intermittent arcs to earth. Do this checking in the dark by increasing the engine revolutions and inspecting the wiring for visible arcing, particularly in the region of the H.T. terminal on the ignition coil.

Replace any defective wires immediately.

4. By-pass condensers and suppressor resistors should always be installed as close to the source of interference as is practicable and any external leads on these components should be kept as short as possible.

5. When testing keep one's body away from the ignition system and ensure that the engine bonnet when closed is effectively earthed to the chassis.

COMPLETE KITS OF PARTS for the "HI-FI" ENTHUSIAST

The MULLARD "5-10" MAIN AMPLIFIER



This is the very latest design and needs no recommendation from us. Our Kit is complete to Mullard's specification, including the latest GILSON ULTRA LINEAR OUTPUT TRANSFORMER and the entire MULLARD Valve line up. ALL SPECIFIED COMPONENTS are supplied. **PRICE OF COMPLETE KIT OF PARTS £11.10.** (Plus 5/- carr. & ins.)

The full SPECIFICATION and PRACTICAL BUILDING INSTRUCTIONS for these Units are available for 1/6 each. SPECIAL PRICE REDUCTION on the two complete Kits—Mullard 5-10 and "Fidelity" Pre-amplifier for £16.10. We also supply both fully assembled and ready for use for £19.10.

STERN'S "Fidelity" PRE-AMPLIFIER-TONE CONTROL UNIT

"A design for the music lover"



Briefly it has inputs for all types of MICROPHONES, HIGH and LOW GAIN PICK UPS and a RADIO TUNING UNIT. It incorporates (a) GRAM EQUALISING CONTROL, (b) SPECTRUM FILTER, (c) Continuously variable BASS and TREBLE CONTROLS and a variable OUTPUT CONTROL which enables its use with any type of Amplifier.

PRICE OF COMPLETE KIT OF PARTS (Plus 5/- carr. & ins.) £6.60. WE ALSO OFFER IT ASSEMBLED, READY FOR USE, £8.00.

Full BUILDING INSTRUCTIONS for these units are available for 1/6 each. SPECIAL PRICE REDUCTION on the two complete Kits—Mullard 5-10 and "Fidelity" Pre-amplifier for £16.10. We also supply both fully assembled and ready for use for £19.10.

STERN'S "HIGH QUALITY" 8-10 WATT AMPLIFIER



Has power supply of 5 Radio Tuning Unit.

PRICE OF COMPLETE KIT OF PARTS (Plus 5/- carr. & ins.) £7.10.0. SUPPLIED ASSEMBLED AND READY FOR USE, £9.10.0.

Proved one of the most popular models yet offered to the HOME CONSTRUCTOR. Provides excellent reproduction up to 8 watts, employing 6V6's in a push-pull, incorporating negative feedback. Provides for use of both 3 and 15 ohm speakers.

MODERNIZE YOUR OLD RADIOGRAM

★ THE LATEST A.M. F.M. RADIOGRAM CHASSIS. A NEW 4-SPEED AUTOCHANGER.

The NEW ARMSTRONG PB. 409 A.M. F.M. Radiogram Chassis

"A chassis for those who want the highest quality." ● A 9 valve line up employing the latest MULLARD reinforced-type valves. ● Provides complete coverage of the V.H.F. M. Transmissions plus the Short, Medium and Long Wavebands. ● Has Push-Pull Output. ● Has Negative Feedback for 8 watts peak output. ● Quick Action "Piano Key" Selectors and separate Bass and Treble Indicators. ● Has "Magic Eye" Tuning Indicator. ● Dimensions 13in. x 9 1/2in. x 8in. high. Dial size 1 1/2in. x 5 1/2in.

PRICE £29.8.0. TERMS: Credit £7.0 and 9 monthly payments of £2.14.0 (Plus 5/- carr. & ins.). H.P. £27.14.0 and 12 monthly payments of £1.7.5. SEND S.A.E. FOR ILLUSTRATED LEAFLET.

STERN'S NEW "Fidelity" COMBINED AM/FM

Radiogram Chassis. A genuinely hand-made chassis providing really high quality on both Radio and Gram.

PRICE £26.15.0

(Plus 7/6 carr. & ins.). TERMS: Credit Deposit £8.14.0 and 9 monthly payments of £2.9.0. H.P. Deposit £13.7.5, and 12 monthly payments of £1.4.11.

BRIEFLY IT HAS :-

An 8 valve line up incorporating the latest MULLARD preferred-type valves. ● Provides complete coverage of the V.H.F./M waveband plus the SHORT, MEDIUM and LONG wavebands. ● Has E.L.A.'s in Push-Pull with negative feedback of 6 watts output. ● Employs "Piano Key" Selector Switches and a Variable Tone Control. ● Contains Gram input socket for both Crystal and Magnetic Pick-ups. ● Provides for use of either 3 or 15 ohm Speakers. ● Has "Magic Eye" Tuning Indicator. ● Dimensions 13in. x 9 1/2in. x 8in. high. Dial size 1 1/2in. x 5 1/2in.

RECORD PLAYERS THE VERY LATEST MODELS ARE OFFERED AT

● TRANSCRIPTION UNITS. ● 3 and 4 SPEED AUTOCHANGERS. ● 2 and 3 MANUAL CONTROL POSITION. Send S.A.E. for ILLUSTRATED AND DESCRIPTIVE LEAFLET.

GREATLY REDUCED PRICES

● TRANSCRIPTION UNITS. ● 3 and 4 SPEED AUTOCHANGERS. ● 2 and 3 MANUAL CONTROL POSITION. Send S.A.E. for ILLUSTRATED AND DESCRIPTIVE LEAFLET.

STERN'S "F.M." TUNING UNIT

A 5-valve Tuner incorporating the latest Mullard Permeability Tuning Ear and a "Magic Eye" Tuning Indicator.

PRICE ASSEMBLED £14.10.0. (Plus 7/6 carriage and insurance).

TERMS: (a) Hire Purchase: Deposit £7.5.0 and 9 monthly payments of 18/-; (b) Credit: Deposit £2.12.9 and 9 monthly payments of £1.2.7.

THE COMBINED AM/FM TUNER is precisely similar in appearance to the above and incorporates 7 valves. It provides complete coverage of F.M. Transmissions and MEDIUM WAVEBAND giving a good selection of foreign stations.

PRICE £18.18.0 TERMS: (a) Hire Purchase: Deposit £9.9.0 and 10 monthly payments of £1.1.0. (b) Credit: Deposit £4.15.0 and 9 monthly payments of £1.14.7.

Expressly developed for very high quality reproduction of Gram, Records and particularly suitable for high quality reproductions of the F.M. transmissions. Two models are available:

(a) The "COMPACT 5-2" A Two-stage high sensitivity Amplifier having SEPARATE BASS and TREBLE CONTROLS and designed to give up to approx. 6 watts with very pleasing quality. **PRICE £5.15.0.** (Plus 5/- carr. & ins.)

(b) The "COMPACT 5-3" A Three-stage version of the "5-2" model but in this case having an additional stage and incorporating Negative Feedback. **PRICE £6.16.0.** (Plus 5/- carr. & ins.)

A separate POWER SUPPLY UNIT to operate with these amplifiers is available for £2.10.0. Has additional supply available for £1.10.0.

AN EXCEPTIONAL £7.19.6.

"CASH ONLY" OFFER (Plus 5/- carr. & ins.)

THE NEW 4-SPEED B.S.R. MONARCH

● Complete with High Fidelity Crystal "Turn-over" Head which incorporates separate styli for L.P. and 78 r.p.m. records. ● A "MIXER" Unit that will auto-change on 7in., 10in. and 12in. records of same speed. ● Incorporates the Manual Control position.



STERN'S "COMPACT 5" AMPLIFIERS

(a) The "COMPACT 5-2" A Two-stage high sensitivity Amplifier having SEPARATE BASS and TREBLE CONTROLS and designed to give up to approx. 6 watts with very pleasing quality. **PRICE £5.15.0.** (Plus 5/- carr. & ins.)

(b) The "COMPACT 5-3" A Three-stage version of the "5-2" model but in this case having an additional stage and incorporating Negative Feedback. **PRICE £6.16.0.** (Plus 5/- carr. & ins.)

A separate POWER SUPPLY UNIT to operate with these amplifiers is available for £2.10.0. Has additional supply available for £1.10.0.

CALLERS ONLY

We have in stock various Kits of Parts including F.M. Tuners, A.M. F.M. Tuners, Midret Battery Portable, Mats Units, etc., etc.

STERN RADIO LTD. 109 & 115 FLEET STREET, LONDON, E.C.4.

Telephone: F.I. Est 5412/34

Junction Transistors by G.E.C.

GET 3 · GET 4 · GET 6

The accumulated improvements resulting from a year's run on pilot plant of EW53, EW58 and EW59 have been incorporated in the factory product which is being issued under references GET 3, GET 4 and GET 6.



GET 3 · GET 4

These are general purpose transistors for 6 and 12V operation. They are capable of a good HF performance and can be used in amplifiers at 315 and 465 kc/s.

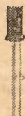

GET 6

A low noise junction transistor. This transistor features an extremely low noise level which has hitherto been unobtainable with transistors.

Noise factor 6dB

$f = 1\text{ kc}$

$V_C = 2\text{V}$

$R_B = 500\Omega$

$I_C = 0.5\text{mA}$

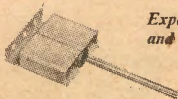

Experimental type EW70 is at the moment in pilot plant production and available to equipment manufacturers.

Two watts of audio are available from a pair under class B push-pull conditions. This performance is obtainable combined with the high frequency performance typical of a small transistor.

Full particulars of these devices can be obtained from

G.E.C. VALVE & ELECTRONICS DEPT.

THE GENERAL ELECTRIC CO. LTD., MAGNET HOUSE, KINGSWAY, LONDON, W.2

GLADSTONE RADIO—

Again the Lowest price

QUALITY F.M. TUNER UNIT

SPECIAL PRICE **£5-12-6**

(P. & P. 2/6—C.O.D. 1/6)

Circuit similar to that described in Data Publications, Ltd., Radio Reprint No. 2 (3rd Edition). Price includes all components, including chassis, dial, drive, diodes, valves, nuts, bolts and, in fact, everything needed. This is a Kit.

Extra components for Fringe Area, 15/-.
Power Pack Components, 30/- extra.

WHY PAY MORE?

Booklet, 2/3 (supplied with orders). Write for details (S.A.E., please).

0.1 mf 4 kV. w T.C.C. 5in. x 1 1/2in. dia., single hole fixing, condenser, 4/-.
0.01 mf 5 kV. w moulded tubular and 0.05 mf 5 kV, 3/-.
32-32 mf 350 v. electrolytic 1 1/2in. can., 4/-. Many others.

GLADSTONE RADIO

P.O. BOX 8, 82B, HIGH ST., CAMBERLEY, SURREY

Open Saturdays to 5 p.m. Phone : 2633



ONLY 92/6



LOOK, ONLY £8.12.6!

BRAND NEW — NOT SEALED in maker's "SURPLUS" cartons. Latest Monarch 4-speed record player complete with High-Fidelity "turnover" head. Type HGP 27-1. Capacity of 10 Records, plays 12in., 10in. and 7in. Intermixed in any order, 78, 45, 33 and 16 r.p.m. For A.C. mains 100 to 250 volts. Exclusive "magdisk" selector gives quickest and quietest change over. With full instructions and fixing plans. Limited quantity at 23-18-6, plus 4/6 Post, Packing, etc. C.O.D. 2/- extra. **SEND NOW WHILE STOCKS LAST!**—modernise your radio-gram, and increase its value.

NEW in maker's sealed cartons—limited quantity of the famous 3-speed record player, exceptionally easy to fix, with lightweight pick-up, incorporating "Acos" crystal turn-over head and separate supple styli for Standard and Long-Playing. With full instructions, and fixing plans. **Unbeatable price 92.6, plus 3/6 Post, Packing, etc. C.O.D. 2/- extra. RUSH YOUR ORDER NOW — BEFORE IT'S TOO LATE!**

GIFT AT 57/6! SPECIAL

LIMITED OFFER! Midget 2 stage amplifier for grams, etc., has own smoothing supplies, metal rectifier, filament supplies, etc. Two controls. On/Off with Volume and Tone Control, and OWN INDICATOR LIGHT FITTED! Output 2 watts (approx.). It even has own output transformer. Just connect to normal 3 ohm speaker, uses triode amplifier feeding into pentode output. Size only 4 1/2in. x 4 1/2in. x 2 in. Made by a leading Radio Manufacturer. **RUSH YOUR ORDER NOW WHILE STOCKS LAST!** Absolute gift at 57/6 (includes valves, etc.). Plus 2/6 Post & Packing. C.O.D. 2/- extra.



CONCORD ELECTRONICS
67, PRESTON STREET BRIGHTON

5

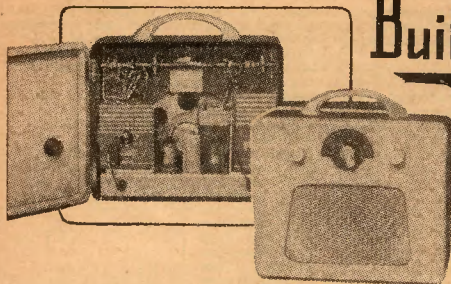

Building the MINI-SET

The use of a transformer overcomes the drawback of a live chassis, and with the valves used, reduces the heat generated in the set to a very small amount. Finally, the use of external aerials or trailing wires has been overcome by the use of a "Ferrite rod" internal aerial.

Circuit Description

THE writer has for some years been interested in the construction of midget radio receivers for mains operation, but with each design published there has always been the usual drawbacks such as "live chassis," excessive heat and the inconvenience of a trailing wire for an aerial. In the design about to be described, it is hoped that the drawbacks mentioned above have been overcome.

With the introduction of television preamplifiers and Band III converters there became available to the home constructor a small mains transformer with an output of 6.3 volt 1 amp and 200 volt 25 mA. The Mini-set has been designed to operate from one of these transformers, and with careful selection of valves and components it has been found possible to produce a set giving a very good performance and at the same time to keep within the current limitations of the small mains transformer.

one section of a midget 500 pF tuning condenser (C3) with trimmer (C1) connected across L1 for medium-wave operation, and trimmer (C2) connected across L2 for long-wave operation.

Valve 1 is an Osram X78 triode hexode frequency changer with the cathode connected internally to heater. The internal connection is made at pin 3, and therefore this pin must be connected to chassis. Osram Q08 and Q09 are medium- and long-wave oscillator coils tuning by C7 second section of the 500 pF midget tuning condenser and medium-wave trimming by C6.

Valve 2 is a Brimar 6BJ6 R.F. pentode with a heater rating of 6.3 volt, 15 amp, and operates as an I.F. amplifier in conjunction with I.F. 1 and I.F. 2, Wearite I.F. transformers type M800.

Valve 3 is a Brimar 6AT6 double diode triode and is connected as signal diode, A.V.C. diode and L.F. amplifier.

A miniature A.C. Mains-operated receiver using B7G Base valves and a Ferrite Rod Aerial and
A miniature Battery-operated receiver using the new low-consumption valves and a Ferrite Rod Aerial.

By S. E. Addis

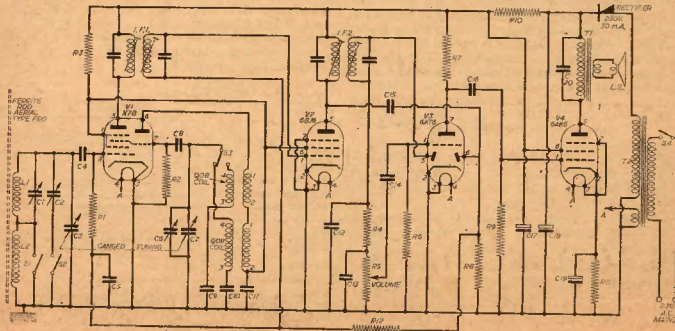

Fig. 1.—Theoretical circuit of the Mains version.

Valve 4 is a Brimar 6AK6 output pentode with a heater current rating of .15 amp. and together with the other three valves makes a total heater consumption of .9 amp.

Power Supply

With an input of 230 volt A.C. the mains transformer gave an H.T. output voltage of 180 volt half-wave which is fed to a small contact cooled rectifier, the smoothing being carried out by C17 and C18 and R10. Final H.T. voltage is about 170 volt and the consumption 23 mA.

Construction

As will be seen from the illustrations, the receiver is constructed on a small chassis and front panel, the chassis being 8 in. x 2 1/2 in. x 1 in. and the panel 8 in. x 6 1/2 in. In practice it was found that if the sides of the panel were bent up, this gave added strength.

After all holes have been drilled and the cut-out made for the loudspeaker, the tuning condenser, volume control, wavechange switch and trimmers may be mounted on the front panel. The mains transformer should be mounted on the panel as near as possible to the volume control in order to give plenty of clearance from the output transformer which is mounted on the chassis.

The Ferrite rod aerial is mounted on two brackets which may be of an insulating material such as Paxolin. They should consist of two strips 2 1/2 in. x 1/2 in. with a 1/4 in. hole drilled at one end to carry a rubber grommet. After the rubber grommet has been inserted in the hole, the Ferrite rod should be pushed into the grommet. It has been found possible to mount the Ferrite rod aerial on aluminium brackets and this method has been used very successfully in the prototype. If metal brackets are used it is very important to note that the fixing holes should be made at the end of the strip to form a slot and not a complete round hole.

It would appear that if a complete hole in a metal bracket is used it has the effect of a "shorted turn" and spoils performance.

When mounting the Ferrite rod aerial care should be taken as the Ferrite material is very brittle and will break if dropped. The aerial should be mounted with the long-wave coil nearest to the wave-change switch. This will keep the long-wave coil clear of any metal parts which might otherwise tend to make a noisy background. If either of the coils are removed from the rod, care should be taken to see that they are

replaced the right way round and with the turns running in the right direction, otherwise performance will be impaired.

After the valveholders, I.F. transformers, smoothing condenser and output transformer have been fixed to the chassis, the panel and chassis may be fixed together by means of the two lower bolts which secure the loudspeaker.

The oscillator coils should now be fixed to the panel and wiring can be commenced.

It was felt that with this type of design, the leads from the wavechange switch to the frequency changer

valve would be rather long, but in practice it was found that they were very little longer than when using a coil pack and that performance was in no way impaired.

The contact cooled rectifier is mounted on the front panel behind the output transformer and although no heat could be detected from this component it is as well to mount the rectifier as far away from the edge of the panel as possible as the surrounding metal is used to conduct away any heat which may be generated.

It has been found that the receiver will feed a tape recorder, and for those constructors requiring this feature, outlet sockets can be

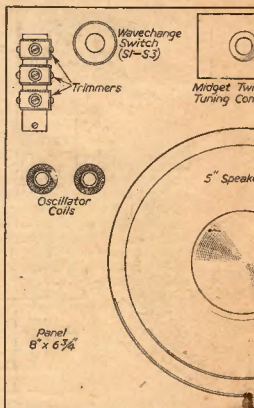
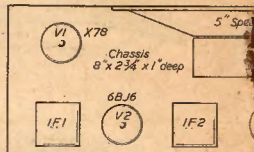

LIST OF PARTS

Resistors

- R1—1 meg. 1/2 watt.
- R2—27 K 1/2 watt.
- R3—22 K 1/2 watt.
- R4—47 K 1/2 watt.
- R5—1/2 meg. Volume Control.
- R6—10 meg. 1/2 watt.
- R7—270 K 1/2 watt.
- R8—2.2 meg. 1/2 watt.
- R9—330 K 1/2 watt.
- R10—2.2 K 1/2 watt.
- R11—470 ohm. 1/2 watt.
- R12—2.2 meg. 1/2 watt.

Condensers

- C1—50 pF Trimmer.
- C2—100 pF Trimmer
- C3—500 pF Tuner.
- C4—150 pF Silver Mica.
- C5—.01 μF Tubular 150 VW.
- C6—500 pF Osc. Tuner.
- C7—50 pF Trimmer.
- C8—150 pF Silver Mica.
- C9—470 pF Silver Mica.
- C10—150 pF Silver Mica.
- C11—.01 μF Tubular 150 VW.
- C12—100 pF Silver Mica.
- C13—100 pF Silver Mica.
- C14—.01 μF Tubular 350 VW.

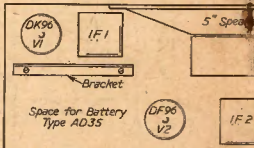
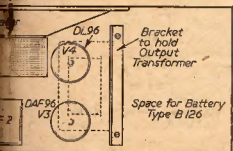
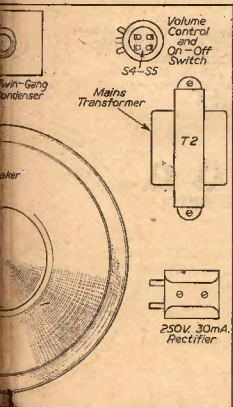
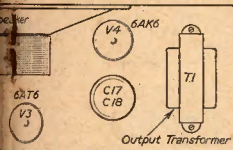

Fig. 2.—Layout of Mains and battery m panel vie

mounted on the chassis permanently. One socket is connected to chassis and the other socket is connected to the junction of R4 and R5. It is a good idea to mount a short tag strip under the chassis to provide an anchoring point for some of the wiring.

When connecting the output transformer it should be noted that the H.T. connection is made to the junction of the rectifier and C18. This provides maximum voltage for the output valve with no noticeable increase in hum and also permits R10 to be of small rating.



models and, in the centre, the rear of view.

When working the set will be found to be very cool running and with only a slight amount of heat generated. Due to the method of connection there should be no heat from R10 smoothing resistor, the midget mains transformer should be only slightly warm, and the bulb temperature of the valves is the only other heat present in set.

For constructors wishing to try substitute valves or components it should be pointed out that every care should be taken not to exceed the rating of the transformer in use. The valves in the set have been carefully chosen so as not to go beyond the limitations of a small preamplifier on either the H.T. or the L.T. windings.

As a safeguard against damage to the rectifier or mains transformer, which can be caused by accidentally short circuiting the H.T. line, a 60 mA fuse may be connected between the rectifier and the output transformer. The fuse may conveniently be mounted on the mains transformer.

When carrying out the wiring of the volume control the leads should be carried out with screened wire and C12 should be mounted across the tags on the volume control. This will avoid the possibility of any grid hum.

It will be noted from the circuit diagram that the long waveband oscillator coil has no trimmer connected across it. This component was found to be unnecessary but a 4-way trimmer strip was used so the top trimmer was left unconnected.

Alignment

After the wiring has been completed and checked the receiver should be connected to the mains and switched on. A slight hum should be heard if the ear is placed close to the loudspeaker. If no hum is present a check should be made for H.T. voltage and examination of the fuse if fitted.

If the I.F. transformers, oscillator coils and Ferrite rod aerial are new and as received from the manufacturers, it should be possible to tune in a signal without any adjustment. Should no signal be heard a short length of wire may be connected to the grid of the frequency changer. Once a signal has been located the cores of the I.F. transformers should be carefully adjusted for maximum volume. Switch the set to medium waveband and tune in a station at the H.F. or low wavelength end of the dial, as near as possible to 200 metres, and adjust the medium waveband trimmer for maximum volume. Tune in a station as near as possible to 500 metres, and carefully slide the medium-wave coil on the Ferrite rod first towards the end of the rod and then back towards the centre of the rod. It will be found that the station will peak. Having got the feel of these operations the receiver alignment can be completed by first identifying a station at each end of the waveband. If the position of these stations does not match up with the dial readings, adjustment may be made with the oscillator trimmer for the station nearest 200 metres and the oscillator core for the station nearest to 500 metres. Having got the station to match up with the dial readings the aerial trimmer and coil and then trimmer again, in that order, should be peaked for maximum signal strength. It is

LIST OF PARTS — continued

C15—20 pF Silver Mica.
C16—.01 μ F Tubular 350 VW.
C17—32 μ F 350 VW. Electrolytic.
C18—32 μ F 350 VW. Electrolytic.
C19—25 μ F 25 VW. Electrolytic.
C20—.01 μ F Tubular 350 VW.
Ferrite Rod Aerial Osc : Coils type and Q08 and Q09 (Osmor).
465 Kc/s I.F. Transformers Type M800 (Wearite).
Portable type Tuning Scale.
T1 Output Transformer 80-1.
T2 Midget Mains Transformer.
Mains input. 6.3 v. 1 amp and 200 ϕ . 25 mA output.

Contact Cooled Midget Rectifier 250 v. 30mA.
3-pole 2-way wave change switch.
C3 & C6 500 pF Midget Twin Gang Tuner.
R5 Midget $\frac{1}{2}$ meg. Volume Control with Switch.
4 B7G Valveholders.
2 Round Knobs.
1 Pointer Knob.

Valves
V1—X78 Osram. V2—6BJ6 Brimar.
V3—6AT6 Brimar.
V4—6AK6 Brimar.
ELAC 5in. Loudspeaker (Type 5/56).

most important that final adjustment should always be made on the trimmer and not on the Ferrite rod coil. This is because slight alterations to the medium waveband trimmer does not affect performance at the high wavelength end of the band, whereas slight movement of the medium waveband coil on the Ferrite rod will greatly affect performance at the low wavelength end of the band.

The receiver should now be switched to the long waves, and the Light Programme on 1,500 metres tuned in. Slight adjustment of the long-wave oscillator core will bring the station into its proper position on the dial. Move the long waveband coil

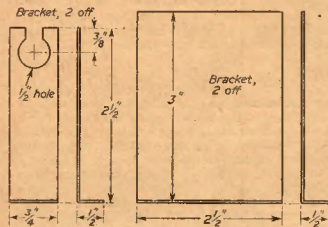

Fig. 3.—Details of the Ferrite rod mount.

on the Ferrite rod to a position about 1 in. from the end of the rod then peak the station with the long waveband trimmer.

After all alignment operations have been carried out the coils should be sealed to the Ferrite rod and slight readjustment of the medium waveband trimmer made for maximum performance. It will be found that the receiver is directional and may be rotated

TUNING CONDENSER REPAIRS

(Continued from page 814)

Next we feed the drive cord over the second pulley and down to the spindle, securing the cord on pulley with tape to prevent it "floating" as the necessary fiddling of the succeeding action takes place.

Direction of rotation of cord around spindle depends upon the disposition of drum, pulleys and spindle. Points to be watched for are cords that cross and loops that run along the shank. Study of the layout will usually show that there is a "natural" angle for the cord to follow.

Approximately two turns of cord around spindle will be needed. In the case of the layout in Fig. 1, two and a half turns are used, the extra half turn taking the cord back in the direction of the drum.

There is no advantage in adding extra turns to the drive spindle. The extra friction obtained in this way is more than offset by the possibility of the cord riding on itself and jamming.

Having lapped the spindle shank we feed the remaining end of cord up and over the drum and around its rim to the aperture. If tape is used once again to secure the cord just prior to the aperture the next action will be considerably easier.

The spring is fitted into place, the end of drive cord passing through its loop, and tension taken up on the cord. There should be no slack at any point—but no

for maximum signal strength from a given station. This property has been found very useful in overcoming interference on certain wavelengths.

Cabinet

This type of receiver is usually housed in a portable style cabinet and so one of this type was made and can be seen in the photograph. The top, bottom and sides are of 6 mm. 5-ply and the front and back are of 3 mm. 3-ply. The front is first drilled for the controls and a cut-out made for the speaker opening. Next, the plywood is built up into the form of a box with glue and panel pins and put aside to dry.

The top and bottom edges are rounded off with a file or sander and the whole box finally smoothed off. Two pencil lines should be drawn round the box, one 1/4 in. from the front edge of the box and one 1/4 in. from the back edge. A saw cut should now be made round the front edge about 1/16 in. deep, taking care to keep to the line so that it forms a neat groove right round the box.

The back may now be sawn off and cleaned up and the whole is ready for covering with leathercloth. This material is obtainable from furnishers and hardware stores and the constructor should obtain the thin type of leathercloth as this is easiest to work with.

The cabinet is designed to be covered in two colours, the front and back in a light shade with a contrasting colour round the centre.

The leathercloth is stuck to the plywood with glue and carefully pressed down into the sawcut where the two colours meet. If only one colour is required the sawcut round the front of the cabinet should be omitted. The back of the cabinet should be covered as a separate operation and fixed with two hinges and a small case clip used for keeping the back closed.

Finally, a plastic cabinet handle is secured to the top for carrying and the receiver is complete.

(To be continued.)

overstrain either. Check that the cord is following its route correctly before finally securing to the spring.

Lastly, remove the securing adhesive tapes, fit pointer and adjust. Check that the pointer slide does not "ride up" at the ends, or jam due to friction and that the pointer itself does not foul backplate, dial or—when reassembled—cabinet interior.

Condensers

Before leaving the subject, a few remarks on ganged condensers may be appropriate.

A common fault is that of "noisy tuning," usually the result of metallic dust particles having found their way between the vanes. If blowing out with a bicycle pump does not clear them they can often be burned off by application of H.T. to the stator connection—taking care to disconnect the existing lead first!

Where a definite short-circuit exists this will often be due to the outer, split segments having become displaced. Care should be taken in straightening these. It needs only one false move to distort a whole section of rotor. It is seldom necessary to touch the locknut on the rotor bush.

The position of the short-circuit can be found by connecting a meter or test lamp across the condenser (once again, disconnect the existing lead), and rotating the spindle.

A NEW *Dulci* TRIUMPH IN SOUND REALISM

At low Cost Price £9.9.0

MODEL G.A.4 HIGH FIDELITY AMPLIFIER

4 watt 4 valve circuit with a frequency response of 40-15,000 c.p.s. Neat Control Panel, size 6in. x 4in., on fly leads for individual mounting (main chassis, 14in. x 4in. x 5 1/2in.). Input/selector switch matching to Radio, L.P. and 78 r.p.m. records. Separate Bass and Treble Controls giving wide range of cut and lift. Volume Control. Rotatable Mains Transformer for hum cancellation.

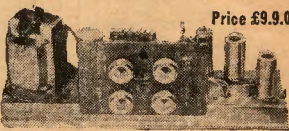

H.4 RADIOGRAM CHASSIS AM/FM

7 valve 4 wave band superhet with F.M. (VHF). Magic Eye tuning indicator. High sensitivity. Bell-clear quality. Dial size 1 1/2in. x 5 1/2in. Sockets to connect Speaker (3 and 15 ohm).

Pickup, Aerial, Earth, F.M. Dipole and provide power for Gram. Motor from mains.

Price £24 . 6 . 6 inc. tax.



F.M. (VHF) TUNER

Outstanding design and performance. Self-powered to work direct into your Amplifier or Radio. Magic Eye tuning indicator. 3-stage I.F. amplifier. Preset output level. Panel size 10 1/2in. x 5 1/2in. (cut out 9 1/2in. x 5in.). Switching incorporated for connection to Pickup sockets. Amplifiers and Tape Recorders. 75 ohm Aerial input. Negligible radiation. Highly sensitive and designed for top quality reproduction.

Price £17 . 10 . 3 inc. tax.

All these Chassis use the latest B.V.A. glass miniature valves. For use on 200/250 volt A.C. Mains. H.4T (AM/FM) Tuner Self-powered for Radio or Amplifier. Price £20.17.0 inc. tax. We supply and fit our pre-amplifier to Collaro Tape Transcriptors.

Direct from Manufacturer to all other Enthusiasts.

WRITE FOR DETAILS TO REF. P.W.

THE DULCI COMPANY LTD., 97-99 Villiers Road, London N.W.2.

WILLESDEN 6678

TRANSISTOR PUSH-PULL AUDIO AMPLIFIER

(100 Milliwatts Output) Build this Push-Pull Amplifier which is ideal for Crystal or Magnetic Pickup Amplification, Baby Alarm, Microphone Amplifier, etc. Powered by 6-volt Dry Battery lasting for months.

Complete Kit of Parts including 4 Transistors and all Components with Circuit (less speaker), £4.10.0

TRANSISTOR SQUARE WAVE GENERATOR

Ideal for signal tracing. Complete Kit with 2 Transistors and Components and Circuit, 25/-

TRANSISTOR SIGNAL TRACER

Complete Kit with 2 Transistors, Components and Phones with Circuit, 42/6.

CATHODE RAY TUBES

YR138A £1.15.0
YR138A, 2 1/2in. £1.15.0
YR397, Guaranteed full T.V. picture (corr. 2/-) 22.0.0

YR517C, Guaranteed full T.V. picture, £1.15.0

MU-METAL SCREENS for YR397 or 517, 10/-
6in. ENLARGER for YR397 or 517, P.P. 18/- 27/6.

TRANSISTORS

JUNCTION TYPE (Red-Spot) (P.N.P.) OFFERED AT LESS THAN HALF-PRICE.

Designed for A.F. application up to 800 Kcs and are suitable for use in amplifiers, Signal Tracers, Local Station Receivers, Radio Control, Oscillators, Transistor Voltmeters, Baby Alarms, Microphone Pre-Amplifiers, etc.

10/- EACH

(Tested and complete with Data & Circuits.)

N.B. These Transistors may be used in place of Mullard OCT1 or similar Transistors.

R.F. TRANSISTORS (BLUE SPOT) 1.8 Mc/s 15/- each.

PRE-SELECTED TRANSISTOR-IN PUSH-PULL PORTABLE SIX PERCENT

Just switch to your favourite Station. No tuning, no aerial or earth. Pre-select 3 Stations. Complete with all components and six Transistors, 7 x 4 Elliptical speaker, Teletron Superhet Coils and I.F.T.'s. Powered by 7 1/2 v. dry battery which lasts for months. 150 Milliwatts output. All the above with Circuits, etc. Ready to assemble. £9.0.0.

Or with Matched Mullard OCT's (200 Milliwatts Output) and 7 x 4 Elliptical High Resistance Speaker 30/- extra.

Suitable Plastic Cabinet. Easy to assemble 18/6.

Call and hear demonstration model working.

Please note that these Red Spot Transistors are ideal for most circuits including "W.W." Pocket Transistor Receiver and Transistor Amplifier. All Transistors are British Manufactured and Guaranteed. Send for Circuits and Data.

INDICATOR UNIT

TYPE 182A Unit contains VCR37 Cathode Ray 8in. tube, complete with Mu-Metal screen. 21 Valve (2-EP20, 4-EPF1, 3-2A50, 2-EB34. Plus Pots., Switches, H.V. Cond., Resistor, Mithrene 3/4 M Dial, Double Deck Chassis and Crystal. BRAND NEW ORIGINAL CASE, 57/6. Carr. free.

62A INDUATOR UNIT Containing VCR37 with Mu-Metal Screen. 21 Valve (2-EP20, 4-EPF1, 3-2A50, 2-EB34. Plus Pots., Switches, H.V. Cond., Resistor, Mithrene 3/4 M Dial, Double Deck Chassis and Crystal. BRAND NEW ORIGINAL CASE, 57/6. Carr. free.

1355 RECEIVER Complete with 11 valves 3-EP21, 5UG, VU13, VR2. As specified for inexpensive T.V. In absolute new condition, 57/6. (corr. 5/-) R.F. 24 10/-, R.F. 25 12/6. R.F. 26 25/- Brand new with valves, corr. 2/6.

MINIATURE I.F. STREP TYPE "373" 6-78 MEQ. Brand new miniature I.F. Strip size 10Hin. x 4Hin. x 5in. 10th. Valve 10th-up; 2-EP22; 3-EPF1 and EB01. With circuit. With valves 45/- (less valves 8/- Post free.)

HENRY'S (RADIO LTD.)

5, HARROW ROAD, PADDINGTON, LONDON, W.2.

TEL.: PADDINGTON 1008-9, 1400

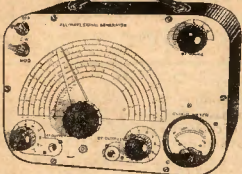

COMPLETELY BUILT SIGNAL GENERATOR

Coverage 120 Kcs-230 Kcs, 300 Kcs-600 Kcs, 900 Kcs-2.75 Mcs, 2.75 Mcs-8.5 Mcs, 8 Mcs-26 Mcs, 16 Mcs-56 Mcs, 24 Mcs-84 Mcs. Metal case 10in. x 9 1/2in. x 4 1/2in. Size of scale 6 1/2in. x 3 1/2in. 2 valves and rectifier. A.C. mains 200-250 v. Internal modulation of 400 c.p.s. to a depth of 30 per cent., modulated or unmodulated R.F. output continuously variable 100 milli-volts C.W. and mod. switch, variable A.F. output and moving coil output meter. Black crackle finished case and white panel. Accuracy plus or minus 2%. £419.8 or 34/- deposit and 3 monthly payments 25/- P. & P. 4/6 extra.

COMMERCIAL TELEVISION CONVERTER SUITABLE ANY T.V. ALL CHANNELS

NO ALTERATIONS TO SET
Complete with built-in power supply 250-250 v. A.C. mains. Crackle finish case 5 1/2in. long, 3 1/2in. wide, 4 1/2in. high. Incorporating gain control and bang switch. Illustrated with cover removed.

£3.19.6 Plus P. & P. 2/6.

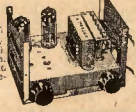

Heater Transformer. Pfd 200-250 v. 6 v. 11 amp. 6/-.
Extension Speaker cabinet in polished walnut, complete with 8in. P.M. P. & P. 3/-, 2/6.
8in. P.M. Speakers, removed from chassis, fully guaranteed. All by famous manufacturers. P. & P. 1/6. 12/6.

FAMOUS MAKE TURRET "TELETUNER"

Covers all Channels, Bands 1 and 3. Valves used: PCC84, R.F. double triode, cascade R.F. amplifier, PCF60, triode pentode i.c. and mixer. I.F. output 33.8 Mcs. Easily modified to other I.F. outputs. Full instructions and circuit diagram supplied. Complete with 12 Coil Sets. 99/6 post Knobs, 2/6.

Volume Controls. Long spindle less switch, 50 K., 500 K., 1 meg., 2/6 each. P. & P. 3/6 each.

Volume Controls. Long spindle and switch, 1, 1 and 2 meg., 1/2 each, 10 K. and 50 K., 3/6 each. 1 and 1 meg. long spindle, double pole switch, miniature, 5/-.

Standard Wave-change Switches. 4-pole 3-way, 1/9; 5-pole 3-way, 1/9. Miniature 3-pole 4-way, 4-pole 3-way, 2/6. 2-pole 11-way twin wafers, 5/-; 1-pole 12-way single wafers, 4/-; 1,200 ft. High Fidelity recording tape on plastic spool, 12/6. plus 1/- P. & P.

GARRARD RC/110 3-SPEED AUTOMATIC MIXER CHANGER



Will take 10 records, 7in., 10in. or 12in. mixed, turnover crystal head, brand new, current model. A.C. mains 200-250 v. (List price 134/-).

£7.19.6

P. & P. 3/6.

SIGNAL & PATTERN GENERATOR

Coverage 7 Mcs-210 Mcs. In five bands, all on fundamentals, slow-motion running, audio output, 3 vertical and horizontal bars, logging scale. In grey hammer finished case with carrying handle. Accuracy ± 1%. A.C. mains 200-250 v.

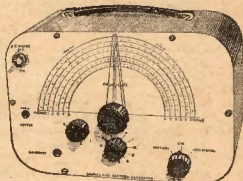

£6.19.6

P. & P. 5/6.

Or £3 deposit and 3 payments of 30/-.

COLLARO RC54

3-SPEED AUTOMATIC CHANGER

will take 10 records mixed.

STUDIO '0' PICK-UP
A.C. mains 200/250 v.

£7.19.6 Plus P & P 5/-.



P.M. SPEAKERS, 6in., closed field, 18.6. 8in. closed field, 20.6. 10in. closed field, 25/-, 12in., 25/- P. & P. on each 2/-.
Valveholders. Fxvolo coil, 4d. Moulded oval, 7d. EF50. 7d. Moulded BTG, 7d. Local amphenol, 7d. Local box, 7d. Mazda Amp., 7d. Mazda pack, 4d. B8A, B9A amphenol, 7d. BTG with screening cap, 1/6. Diodeal pair, 8d. Twin-gang .0005 Tuning Condensers, 5/- With trimmers, 7/6.

AC/DC MULTI-METER KIT



Comprising 2in. moving coil meter scale calibrated in AC/DC volts, ohms and milli-amps. Voltage range AC/DC 0-10, 0-100 and 0-500. Milli-amps 0-10, 0-100. Ohms 0-1,000 and 0-10,000. Front panel, range switch, wire wound pot. (for ohms zero setting) two toggle switches, resistors and meter rectifier. Complete in case, grey Plus hammer finish. P. & P. 1/6

Point to point wiring diagram 1/- free with Kit.

Potato & Vegetable Peeler, by famous manufacturer, capacity 4 lbs., complete with water pump. All aluminium construction, white stove-enamelled finish. Originally intended for adaptation on an electrical food-mixer, can easily be converted for hand operation. 39/6. P. & P. 0/-.

T.R.F. KIT in PLASTIC CABINET

3 valve plus metal rectifier, A.C. mains 200-250 v. Medium and Long waves. In pastel blue or brown. Valve line-up: 2 V88s and VT32. Size 15 1/2in. long by 9in. high by 7in. deep. £3.19.6 P. & P. 4/6.

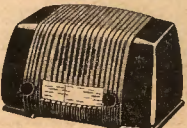

Point to point wiring diagram 1/6 free with Kit.

Where post and packing charge is not stated, please add 3.6 up to 10/-, 2/- up to £1 and 2.6 up to £2. All enquiries S.A.E. Lists 6d. each. Goods not despatched outside U.K.

RADIO & T.V. COMPONENTS (Acton) LTD.
23, HIGH STREET, ACTON, LONDON, W.3

BENTLEY ACOUSTIC CORPORATION LTD.

EXPRESS SERVICE !!!
 C.O.D. ORDERS RECEIVED BY 3.30 P.M. EITHER
 BY LETTER, PHONE, OR WIRE, DESPATCHED
 SAME AFTERNOON.

THE VALVE SPECIALISTS
 38 CHALCOT RD., LONDON, N.W.1
 PR/mrose 9090

UNIQUE OFFER
 INSURANCE AGAINST DAMAGE
 IN TRANSIT FOR ONLY 6S. EXTRA.
 TIME IN CLAIMS AND WORRY!

67A	6-	8AB5	10/0	8F19	12/0	6X3	7-	58A7	0/0	7-	DC90	7-	6V30	8-	6Z63	12/0	N142	10/0	R12	10/0	VY41	0/0
73A	8-	6AC7	0/0	8F19	12/0	6X3	0/0	58C7	7/0	7-	DC93	11-	6V30	8-	6Z63	14/0	N140	10/0	R10	7/0	VY37	0/0
73B	0-	6AC7	0/0	8F19	12/0	6X3	12/0	58C7	7/0	7-	DC90	8-	6V30	8-	6Z63	12/0	N142	11-	8P47	0/0	VY40A	20-
74	12/0	6AC7	12/0	8F19	12/0	6X3	12/0	58C7	7/0	8-	DC93	11-	6V30	8-	6Z63	14/0	N140	10/0	R10	7/0	VY37	0/0
75	0-	6A29	8-	6F22	10/0	7A7	12/0	58A1	0/0	8-	DC93	8-	6V30	8-	6Z63	12/0	N142	11-	8P47	0/0	VY40A	20-
76	0/0	6A29	8-	6F22	10/0	7A7	12/0	58A1	0/0	8-	DC93	8-	6V30	8-	6Z63	12/0	N142	11-	8P47	0/0	VY40A	20-
77	0/0	6A29	8-	6F22	10/0	7A7	12/0	58A1	0/0	8-	DC93	8-	6V30	8-	6Z63	12/0	N142	11-	8P47	0/0	VY40A	20-
78	0/0	6A29	8-	6F22	10/0	7A7	12/0	58A1	0/0	8-	DC93	8-	6V30	8-	6Z63	12/0	N142	11-	8P47	0/0	VY40A	20-
79	0/0	6A29	8-	6F22	10/0	7A7	12/0	58A1	0/0	8-	DC93	8-	6V30	8-	6Z63	12/0	N142	11-	8P47	0/0	VY40A	20-
80	0/0	6A29	8-	6F22	10/0	7A7	12/0	58A1	0/0	8-	DC93	8-	6V30	8-	6Z63	12/0	N142	11-	8P47	0/0	VY40A	20-
81	0/0	6A29	8-	6F22	10/0	7A7	12/0	58A1	0/0	8-	DC93	8-	6V30	8-	6Z63	12/0	N142	11-	8P47	0/0	VY40A	20-
82	0/0	6A29	8-	6F22	10/0	7A7	12/0	58A1	0/0	8-	DC93	8-	6V30	8-	6Z63	12/0	N142	11-	8P47	0/0	VY40A	20-
83	0/0	6A29	8-	6F22	10/0	7A7	12/0	58A1	0/0	8-	DC93	8-	6V30	8-	6Z63	12/0	N142	11-	8P47	0/0	VY40A	20-
84	0/0	6A29	8-	6F22	10/0	7A7	12/0	58A1	0/0	8-	DC93	8-	6V30	8-	6Z63	12/0	N142	11-	8P47	0/0	VY40A	20-
85	0/0	6A29	8-	6F22	10/0	7A7	12/0	58A1	0/0	8-	DC93	8-	6V30	8-	6Z63	12/0	N142	11-	8P47	0/0	VY40A	20-
86	0/0	6A29	8-	6F22	10/0	7A7	12/0	58A1	0/0	8-	DC93	8-	6V30	8-	6Z63	12/0	N142	11-	8P47	0/0	VY40A	20-
87	0/0	6A29	8-	6F22	10/0	7A7	12/0	58A1	0/0	8-	DC93	8-	6V30	8-	6Z63	12/0	N142	11-	8P47	0/0	VY40A	20-
88	0/0	6A29	8-	6F22	10/0	7A7	12/0	58A1	0/0	8-	DC93	8-	6V30	8-	6Z63	12/0	N142	11-	8P47	0/0	VY40A	20-
89	0/0	6A29	8-	6F22	10/0	7A7	12/0	58A1	0/0	8-	DC93	8-	6V30	8-	6Z63	12/0	N142	11-	8P47	0/0	VY40A	20-
90	0/0	6A29	8-	6F22	10/0	7A7	12/0	58A1	0/0	8-	DC93	8-	6V30	8-	6Z63	12/0	N142	11-	8P47	0/0	VY40A	20-
91	0/0	6A29	8-	6F22	10/0	7A7	12/0	58A1	0/0	8-	DC93	8-	6V30	8-	6Z63	12/0	N142	11-	8P47	0/0	VY40A	20-
92	0/0	6A29	8-	6F22	10/0	7A7	12/0	58A1	0/0	8-	DC93	8-	6V30	8-	6Z63	12/0	N142	11-	8P47	0/0	VY40A	20-
93	0/0	6A29	8-	6F22	10/0	7A7	12/0	58A1	0/0	8-	DC93	8-	6V30	8-	6Z63	12/0	N142	11-	8P47	0/0	VY40A	20-
94	0/0	6A29	8-	6F22	10/0	7A7	12/0	58A1	0/0	8-	DC93	8-	6V30	8-	6Z63	12/0	N142	11-	8P47	0/0	VY40A	20-
95	0/0	6A29	8-	6F22	10/0	7A7	12/0	58A1	0/0	8-	DC93	8-	6V30	8-	6Z63	12/0	N142	11-	8P47	0/0	VY40A	20-
96	0/0	6A29	8-	6F22	10/0	7A7	12/0	58A1	0/0	8-	DC93	8-	6V30	8-	6Z63	12/0	N142	11-	8P47	0/0	VY40A	20-
97	0/0	6A29	8-	6F22	10/0	7A7	12/0	58A1	0/0	8-	DC93	8-	6V30	8-	6Z63	12/0	N142	11-	8P47	0/0	VY40A	20-
98	0/0	6A29	8-	6F22	10/0	7A7	12/0	58A1	0/0	8-	DC93	8-	6V30	8-	6Z63	12/0	N142	11-	8P47	0/0	VY40A	20-
99	0/0	6A29	8-	6F22	10/0	7A7	12/0	58A1	0/0	8-	DC93	8-	6V30	8-	6Z63	12/0	N142	11-	8P47	0/0	VY40A	20-
100	0/0	6A29	8-	6F22	10/0	7A7	12/0	58A1	0/0	8-	DC93	8-	6V30	8-	6Z63	12/0	N142	11-	8P47	0/0	VY40A	20-

Terms of business—Cash with order or C.O.D. only. Orders value 5s or more sent postpaid. Free. Orders below 5s sent 6s. per valve. C.O.D. orders—Minimum fee, including post and packing, 5s. We are open for personal shoppers, Mon.-Fri. 9.30-5.30, Sat. 9.30-1.30.

CRYSTAL DIODES (Pt. Grids), OA71, 6X41, 6X62, 31, 6X108, all 7s. each.

All valves new, boxed, tax paid, and subject to makers' guarantee. First grade goods only, no seconds or rejects. All orders received by first post despatched same day. B.A.F. for free complete list, with terms of guarantee and conditions of sale.

FREE TO AMBITIOUS ENGINEERS!

This 144-page Book

Have you sent for your copy?

ENGINEERING OPPORTUNITIES
 is a highly informative guide to the best-paid Engineering posts. It tells you how you can quickly prepare at home on a **NO PASS—NO FEE** basis for a recognised Engineering qualification, outlines the widest range of modern Home-Study Courses in all branches of Engineering and explains the benefits of our Employment Dept. If you're earning less than £15 a week you cannot afford to miss reading this unique book. Send for your copy to-day—FREE.

WHICH IS YOUR PET SUBJECT?
 Mechanical Eng.
 Civil Engineering
 Electrical Engineering
 Automobile Eng.
 Aeronautical Eng.
 Production Eng.
 Building, Plastics, Draughtsmanship
 Television, etc.

GET SOME LETTERS AFTER YOUR NAME!
 A.M.I.Mech.E.
 A.M.I.C.E.
 A.M.I.E.
 A.M.I.P.
 I.L.O.B.
 A.F.R.A.E.S.
 B.Sc.
 A.M.Brit.I.R.E.
 CITY & GUILD'S
 GEN. CERT.
 OF EDUCATION
 etc., etc.

FREE COUPON—
 Please send me your FREE 144-page "ENGINEERING OPPORTUNITIES"

NAME

ADDRESS

Subject or Exam. that interests me

British Institute of Engineering Technology
 409B, College House, 29-31, Wright's Lane,
 Kensington, W.8.



SOUTHERN RADIO'S WIRELESS BARGAINS

TRANSCEIVERS. Type "38" (Walkie-Talkie). Complete with 5 Valves. In Metal Carrying Case. Ready for use. Less external attachments. 30/- per set. ATTACHMENTS for use with "38" TRANSCEIVER: HEADPHONES, 15/6; THROAT MICROPHONE with Lead & Plug, 4/6; JUNCTION BOX, 2/6; AERIAL, 2/6.

TRANSCEIVERS. Type "1B" Mark III. TWO UNITS (Receiver & Sender) contained in Metal Case. Complete with Six Valves, Microammeter, etc. LESS EXTERNAL ATTACHMENTS. 44/10/-.

TRANSmitters. T-1154—Complete all valves, etc., etc. Perfect order, 3 frequencies. £2/7/6 in transit case. Delivered U.K.

RECEIVERS. Type "109" 8-Valve S.V. Receiver with VIBRATOR PACK for 6 Volts. Built-in Speaker. METAL CASE, 25s.

BOMBASIGHT COMPUTERS. E.R.A.F. BRAND NEW. A Wealth of Components. CYCLO MOTOR, REV. QUANTERS, GEAR WHEELS, etc., etc. Ideal for Model Makers, Experimenters, etc., £3.

LUFBRA HOLE CUTTERS. Adjustable 1/16 to 3/16 in. For Metal, Wood, Plastic, etc., 7/-.

RESISTANCES. 100 ASSORTED USEFUL VALUES. Wire Ended, 12/6 per 100.

CONDENSERS. 100 ASSORTED. Mica, Metal Tubular, etc., 15/- per 100.

PLASTIC CASES. 14in. x 10 1/2in. Transparent. Ideal for Maps, Display, etc., 5/6.

STAR IDENTIFIERS. Type I-A-N. Covers both Hemispheres, in Case, 5/6.

CONTACTOR TIME SWITCHES. In Sound-proof Case, Clockwork Movement. 2 Impulses per sec. Thermostatic Control, 11/6.

REMOTE CONTACTORS for use with above, 7/6.

MORSE PRACTICE SET with Buzzer or Base, 6/9. Complete with Battery, 9/6.

MORSE TAPPERS, Sds. 3/6; Midget, 2/9.

METERS & AIRCRAFT INSTRUMENTS. Only need Adjustment or with broken Cases. TWELVE INSTRUMENTS, Transit Case, 3 brand new Aircraft Instruments. 35/- for 12.

CRYSTAL MONITORS. Type 2. New in Transit Case. Less Valves, 8/6.

Postage & Carriage extra. Full List of RADIO BOOKS, 2/6.

SOUTHERN RADIO SUPPLY LTD.
 11, LITTLE NEWPORT ST., LONDON, W.6.2. GERARD 6653

EQUALISING CIRCUITS

USEFUL DESIGN DATA FOR THE A.F. ENTHUSIAST

By Hugh Guy

(Continued from page 748, January issue)

Bass Cut

A VERY simple form of bass cut circuit is often used in amplifiers whose function it is to reproduce only speech frequencies. The cut is introduced to reduce the effects of mains hum and is effected in the normal R.C. coupling by using a low value of condenser.

Such a condenser, of course, has a high reactance at low frequencies and a large proportion of any low-frequency signal passing through the coupling is dropped across the condenser leaving comparatively little across the associated grid leak for subsequent amplification.

The response of this form of coupling is exactly the reverse of that of Fig. 2b which can, therefore, be used as a design chart for this type of coupling, reading + "dbs" for - "dbs" on the vertical scale.

A rather novel circuit for bass boosting has been developed around the cathode follower and is an adaptation of a circuit widely used in television techniques for the high frequency compensation of video amplifiers. It relies for its operation on the effect of only partially decoupling the cathode resistor in an amplifying stage.

It was mentioned earlier that the gain of a pentode is GmR_L . Strictly this is only true if there is no cathode resistor in circuit; should there be such a resistor, R , then even if it is decoupled by a condenser C_k , the gain now becomes

$$G = \frac{Gm R_L}{1 + Gk Z_k} \quad \text{where } Z_k \text{ is the parallel impedance}$$

of C_k and R , and is $\frac{R}{\sqrt{1 + (WCR)^2}}$

and Gk is the mutual conductance or slope of the valve at the cathode. It is not often realised that the cathode slope is greater than that of the anode and in the case of the 277, Gk is $1.25 \times Gm$ over a wide range of anode voltage.

Returning to the question of pentode gain, however, it is apparent from the formula above that, due to the decrease of Z_k with increasing frequency, the gain will increase as the frequency rises.

To dispel any qualms the reader may have over his existing circuitry it should be mentioned that when a normal amplifying stage is built using a cathode resistor for bias purposes, as a rule the value of bypass condenser used is sufficiently large

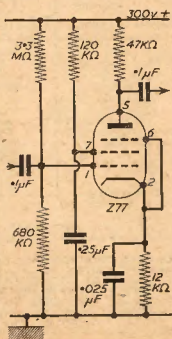

Fig. 5A.—Practical bass cut circuit.

to reduce the value of Z_k to a negligibly small value. Hence it is quite legitimate, under such conditions, to assume that the gain is constant at all useful frequencies, and is GmR_L .

If the cathode impedance Z_k at low frequencies is denoted by Z_k' , and that at high frequencies by Z_k'' , then the ratio of the gains at high and low frequencies will be given by A , and

$$A = \frac{1 + Gk \cdot Z_k'}{1 + Gk \cdot Z_k''}$$

where $Z_k' = \frac{R}{\sqrt{1 + (\omega' CR)^2}}$ i.e. at low frequencies

$$\text{and } Z_k'' = \frac{R}{\sqrt{1 + (\omega'' CR)^2}}$$

This value A , then, is the "lift" that the circuit will give. As it stands, however, the formula is rather unwieldy and to eliminate the square root signs we may make one or two simplifications which do not detract from the accuracy of the result to any extent.

If we always make $\omega' CR = 3$, then Z_k' is approximately $R/3$. Also if we call the ratio of the highest frequency to the lowest frequency n , then $n = \frac{\omega''}{\omega'}$, and

Z_k'' is approximately $R/3n$. A little trouble on the part of the reader will enable him easily to deduce these simplifications if he so desires.

Armed with easier symbols we can now return to the formula for A .

$$\text{Thus } A = \frac{1 + Gk \cdot R/3}{1 + Gk \cdot R/3n} = \left(\frac{3 + Gk \cdot R}{3n + Gk \cdot R} \right) \cdot n.$$

We will invariably know the amount of lift, A , we require, and also the ratio of the upper and lower frequencies, n , in which we intend to accomplish this lift. Having selected a valve we will know the value of Gk . The only unknown now is R , the value of the cathode resistor. Changing the above formula around gives us this value as

$$R = \frac{3n(A-1)}{Gk(n-A)}$$

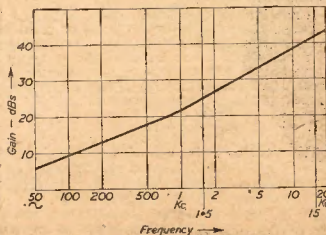

Fig. 5B.—Response of bass cut circuit.

From this formula, therefore, we can determine the value of the cathode resistor. To obtain the value of the condenser, we revert to the earlier assumption where we made $\omega'CR=3$. Knowing that ω' is 2π times the lower frequency, and the value of R ,

we can obtain the value of C which is $C = \frac{3}{2\pi f'R}$

This method gives us the components we require to produce a given lift in a given range of frequencies.

Just to show how the method works out in practice, let us consider a simple example, and examine the response actually obtained from such a circuit when it is built, to see how design and practice compare.

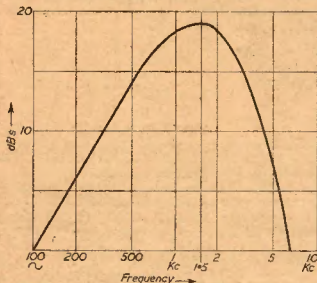

Fig. 6(a).—Tape playback characteristic.

Practical Example

Imagine we are trying to improve the high frequency response of a tape recorder.

We require a lift of 7 over the frequency range 1.5 kc/s. to 15 kc/s. to offset the characteristic tape playback droop illustrated in Fig. 6a. Hence n in the formula is 10. In practice the amount of droop varies considerably from one machine to another depending on several factors; amongst these are the applied recording equalisation, the type of head in use, and the coercivity of the tape being used.

Normally the amount of lift would be expressed in decibels in common with normal A.F. practice and a lift, or voltage gain ratio of 7 corresponds to a lift of 16.9 db.

It remains now to choose a valve for the stage in question. Considering the Z77 again, valve data informs us that a Gk or cathode mutual conductance of 5 mA/v can be realised when the valve draws approximately 3.5mA anode current. We can now proceed to determine the value of R , and substituting in the appropriate formula gives R as:

$$R = \frac{3 \times 10}{5} \cdot \frac{(7-1)}{(10-7)} = 12k.$$

The value of C is next solved from $\omega'CR=3$, where $\omega' = 2\pi \times 1,500$. Thus $C = 0.025\mu f$.

To obtain the necessary bias for the valve necessitates returning the grid to a positive potential, a few volts negative with respect to the cathode voltage and the final circuit for the stage appears as shown in Fig. 5a. The plotted response of this circuit, given in Fig. 5b, shows the accuracy of the design method,

where the lift over the specified range is seen to be 7.36 or 17.34 db.

Tape Recorder Equalisation

The general playback response of a tape recorded follows the curve of Fig. 6a, and it is seen to consist of a steady rise at the rate of 6 db per octave from the low frequency end to a maximum at about 1.5 kc/s. This frequency, or crossover as it is sometimes called, varies from one type of amplifier to another, of course, but after the crossover, the frequency fall off tends to be rather curved, and therefore perfect equalisation is extremely difficult, unless feedback techniques are used.

The bass response can be equalised by the type of circuit outlined earlier, but the treble attenuation this circuit produces will extend beyond the crossover frequency. It is, therefore, necessary to devise a circuit which is dormant up to the crossover frequency, but then produces the equalising curved response, at the same time nullifying the effect of the continued treble cut introduced by the bass response circuit.

Such a circuit exists in the form shown in Fig. 6b. It consists of the customary C and R shunting the anode load of the valve. In series with this arrangement, however, is a parallel tuned circuit, CT and LT , which is designed to resonate at approximately 6 kc/s.

At low frequencies, when the bass correcting network is effective, the impedance of the high-frequency network is negligible and hence the gain increases steadily at 6 db per octave, as desired. After the crossover frequency, however, the reactance of the condenser C is very low, and the impedance

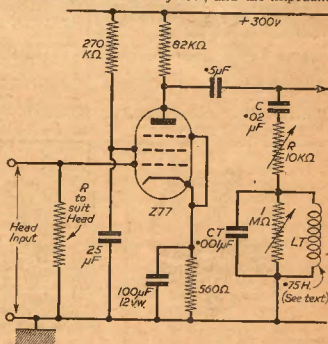
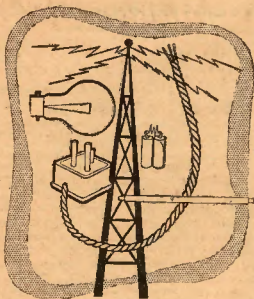

Fig. 6(b).—Tape playback equaliser.

of the parallel tuned circuit increases to a maximum at 6 kc/s, and hence the gain increases also, following the characteristic of the impedance variation with frequency. The shape of the characteristic can be controlled within limits by adjusting the variable damping resistor across the tuned circuit.

Similarly, the 3 db point and hence the position of the bass correction can be shifted by variation of the resistance in this network.



ON THE BEAM

Smith's have books on the newest developments in radio and television circuit design, construction and servicing. No matter what your problems or interests are, you can be sure of getting the books you need through your local branch of Smith's. Books not available on demand can be quickly obtained from Head Office. Lists of the standard works on any subject gladly supplied.

• Stationery and printing can also be supplied by your nearest Smith's branch.

W. H. SMITH & SON

for technical books

HEAD OFFICE: STRAND HOUSE, LONDON, W.C.2

ELECTRIC CONVECTOR FIRES 99/6

2 k/watt (1 or 2 units per hour)
Switched. Gilt finish. Illuminated
grilla. Size 24in. x 18in. x 7 1/2in. deep.
200-250 volt AC/DC. Famous mmfr.
Ideal for home, office, works. Ins.
Carr. 10/6.



FIRES 19/6

Ideal present, hammered finish, 200-250 volt. Wattage 500,
750, 1,000. (Please state preference.) Carr. 3/6.

17" RECTANGULAR T.V. TUBES 14"
£7.10.0. On 6 month guarantee. £5.10.0.
15/6 Ins., Carr.

16" - 15" - 14" ROUND £5

3 month guarantee.

Remember most 9in. and 12in. sets can be fitted with a 15in.
tube with little or no alteration to the set. Ins. Carr. 15/6.

8" P.M. SPEAKERS 8/9

Ideal for fitting in small cabinet or cupboard door for the
lady of the house to follow that T.V. or radio programme.
Buy now. While stocks last. P. & P. 1/9.

REMEMBER SATURDAY OPEN ALL DAY

1957 CATALOGUE FREE

DUKE & CO. (PW)
621, Romford Rd., Manor Park, London, E.12
GRA. 6677-8

ADCOLA

REGISTERED TRADE MARK
(Regd. Trade Mark)

SOLDERING EQUIPMENT

ILLUSTRATED

**3/8" Detachable
bit type (List
No. 64)**

**Protective Shield
(List No. 68)**

Catalogues sent
FREE

Telephones :
MAcaulay 4272
& 3101



British and
Foreign Patns.

Reg. Designs,
etc.

Head Office, Sales

**ADCOLA
PRODUCTS
LTD.**

Gauden Road,
Clapham High
St., London,
S.W.4

A Transformer for a Single-valve Output Stage

USING AN OLD COMPONENT AND SIMPLE FORMULÆ TO OBTAIN THE DESIRED PERFORMANCE

By N. P. Fish

THERE is a widespread idea that satisfying reproduction in the home cannot be obtained without a 10-watt amplifier employing a push-pull output stage. An actual listening comparison between such equipment and a conventional "domestic" receiver with single pentode output valve usually argues convincingly in favour of the larger output. Yet, of an available 10 watts, how many are called for in the course of ordinary domestic listening? A simple output meter in the speech coil circuit of the loudspeaker will cause eyebrows to be raised!

The writer has recently constructed a three-watt amplifier to a published design and has paid special attention to the problem of feeding a good, clean 3 watts, at all required frequencies, from the output valve anode to the speech coil of the speaker. With this achieved and with a good, wide range, adequately baffled loudspeaker, then the gulf between the 3-watt output and the much more ambitious (and expensive!) "hi-fi" equipment narrows so much that at times it cannot be detected.

The object of this article is to take the reader through the various steps which lead to the successful construction of that vital component, the output transformer. The transformer described is for use in an EL84 output stage; other values of anode current and load impedance would, of course, be used in the calculations as valve and circuit conditions dictate.

First let us see where an inadequately designed transformer fails when used with a single-valve output stage. Fig. 1 is a graph showing how magnetic flux in the core of the transformer increases as current in the primary winding increases. Suppose this winding to consist of 1,000 turns; then 25 mA (.025 A) \times 1,000 gives 25 ampere-turns to magnetise the core, and the graph shows that the core will be magnetised to the point p on the curve where the flux, read on the vertical scale, is 22,500 lines. Increasing current from 0 to 25 mA increases flux proportionately—the graph is a straight line over this part. But whereas increasing current from 10 to 25 mA increases flux from 9,000 to 22,500 lines, i.e., by 13,500 lines, a further equal increase to 40 mA only increases flux by 7,500 lines. This is because at the point p the core is about to saturate and become increasingly less responsive to changes in magnetising ampere-turns.

Now suppose this primary winding to be connected in the anode circuit of an output valve whose steady anode current is 25 mA. The core will be held steadily magnetised to the point p. Then let an alternating current with a peak value of 15 mA be superimposed on the 25 mA D.C. anode current. The valve's anode current will now be rising to 40 mA and falling to 15 mA during each cycle. This is shown on the graph by the wave-form plotted below the horizontal scale. To the right is plotted a wave-form showing how the flux in the core varies in

response to the changing anode current. This wave-form can equally well represent voltages across both primary and secondary of the transformer, since voltage is proportional to flux. Obviously, here we have a very distorted picture of the original current wave-form, and at the loudspeaker the transformer's inability to deal with large current and voltage swings will manifest itself by lack of bass, where voltage and current swings are greatest. The damage has been done by allowing the core to saturate; this is largely as a result of the D.C. anode current pushing the working point p too far up the curve. In passing it may be noted that this problem of core saturation does not arise with a push-pull output stage as the ampere-turns due to the anode currents of the two valves cancel each other out. Which is why some push-pull amplifiers are better than they otherwise might be! And having seen one important reason why some single-valve output stages are worse than they might be, the gulf begins to narrow.

First Steps

From the spares-box or among the unused ex-government gear choose an old transformer or choke with a suitable core. It should be appreciably larger than the conventional "loudspeaker transformer," but not quite of mains transformer size. The centre limb might conveniently have a cross-sectional area of $\frac{1}{4}$ sq. in. There must be sufficient window space for the windings. Fig. 2 shows the core selected by the

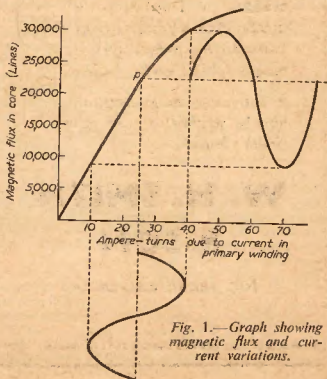

Fig. 1.—Graph showing magnetic flux and current variations.

writer, that of an ex-government, 5 henry 200 mA choke. Remember that more iron in the core means proportionately fewer turns on the windings. Strip the core down, taking particular care of the frame and clamping bolts. Discard the old windings and give it a clean up generally. Pickling in strong caustic soda solution will remove old varnish from frame and bolts. Remove obvious rust from the core laminations, but do not scrape them to expose bright metal. At this stage it would be as well to repeat the fundamental transformer equation to which frequent recourse will have to be made.

$$E = \frac{4.44 \Phi f t}{100,000,000}$$

E = R.M.S. volts across winding.

Φ = Maximum number of lines of magnetic flux reached in each half cycle.

f = frequency in cycles per second.

t = number of turns on winding.

This equation will be rearranged from time to time.

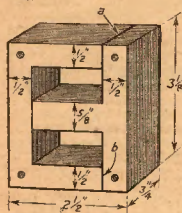

Fig. 2.—Details of the core.

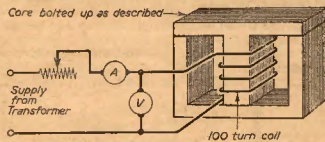

Fig. 3.—The set-up for measuring magnetising current.

Magnetic Measurements on Core

It would be merely groping in the dark to proceed further without reliable knowledge of the magnetic behaviour of the selected core. This will be obtained by actual measurement and the following apparatus will be necessary: an A.C. ammeter, say 0.3 amp.; an A.C. voltmeter, 0-12 volt; a transformer, preferably tapped, giving about 15 volts 2 amp., and a variable resistance about 5Ω and capable of carrying 3 amp. The transformer may present a little difficulty; a receiver mains transformer with valve and rectifier heater windings connected in series would provide rather over 12 volts and tapings as well. The resistance can be improvised by making crocodile clip connection to a length of fire-element or even galvanised wire. The resourceful reader will have no difficulty in arranging gear to give him the necessary readings. One point is important; a separate ammeter is essential; it is useless to expect a single multi-range instrument to serve by disconnecting it as an ammeter when current has been adjusted and then taking the voltage reading.

Make a rough cardboard former to fit the centre limb of the core and on it wind 100 turns of about 20 s.w.g. wire. This is a search coil which will provide a known number of ampere-turns to magnetise the core. It can be wound quite roughly. Carefully reassemble core with the search coil in place. Butt joints between the stampings should be carefully tapped close and the whole core firmly bolted in its

frame. Connect it up on the test bench as shown in Fig. 3. The object now is to take a series of readings each giving current through the winding and the voltage set up across the winding. The IR drop in the search coil will be negligible so the voltmeter reading may be taken wholly as volts induced in it by the changing flux. It is ampere-turns that matter rather than the R.M.S. amps, indicated by the ammeter. This point is mentioned as the reader may find it expedient to tap his search coil at, say, 50 turns, and change his tapping as the readings proceed. Start with a small current and increase for each reading until further ampere-turns produce little increase in voltage. Tabulate the readings as shown in Fig. 4 which gives the figures obtained by the writer with his core. These figures will be used in the few simple calculations which follow, so that in working out his design from his own results the reader will have no difficulty in substituting his own figures.

Plot the Curve

The next step is to construct a graph from the figures given in the table. Do this to a conveniently large scale so that there will be no difficulty in taking readings from it. The horizontal scale is

marked off in ampere-turns R.M.S. and the vertical scale in volts R.M.S. Make fine neat crosses at the points where the ampere-turns line and the voltage line intersect for each reading. Then draw a fine, evenly curving line through the crosses. Do not worry if some of the crosses lie a little above or below the curve, which should follow an even course through the mean positions of the crosses. Such crosses as lie off this curve merely indicate slight errors of manipulation or reading. This, then, is the magnetisation curve of the chosen core. Fig. 5 shows the magnetisation curve of the writer's core, plotted from the data tabulated in Fig. 4. A further, and extremely useful, vertical scale can now be added to the graph. This will show the value of Φ for any point on the curve, and therefore for any number of ampere-turns. Rearrange the transformer equation thus:—

$$\Phi = \frac{E \times 100,000,000}{4.44 f t}$$

For E put in the highest voltage reading given by the table (Fig. 4), for f the mains frequency (50), and for t the number of search coil turns in use when the reading was taken. In the present case this gives:

$$\Phi = \frac{9.8 \times 100,000,000}{4.44 \times 50 \times 100} = 44,000 \text{ lines.}$$

Draw a vertical line to the left of the voltage scale on the graph; carry across to this a line from the point on the voltage scale corresponding to the voltage used in the above flux calculation; mark this point on the flux scale with the value given by the calculation. The vertical distance between this and the horizontal line of the graph must now be divided evenly, say in five thousands, to give a scale from 0 to the calculated flux value. Dividing up this

(Continued on page 845)

Wanted!

QUALIFIED MEN AND WOMEN

Industry & Commerce offer their best posts to those with the necessary qualifications—such posts that will bring personal satisfaction, happiness, good money and security. As part of a modern industrial organisation, we have skilled knowledge of what is required in industry to-day and the best means of training personnel for its present day and future requirements. We specialise also in teaching for hobbies, new interests or part-time occupations in any of the subjects listed below. Make your own choice and write to us to-day for further information. There is no obligation of any kind.

OUR BACKGROUND!

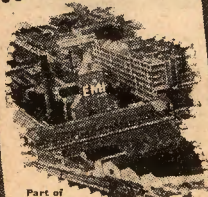

Part of
The E.M.I.
Factories at Hayes,
England, occupying over 150 acres.

The only Home Study College
operated by a world-wide
manufacturing organisation

EMI INSTITUTES

PERSONAL & INDIVIDUAL TRAINING IN—

Accountancy	Customs Officer	Languages	Refrigeration
Advertising	Draughtsmanship	Management	Sales Management
Aeronautical Eng.	Economics	Maintenance Eng.	Sanitary
A.R.B. Licences	Electrical Eng.	Mathematics	Engineering
Art (Fashion, Illustrating, Humorous)	Electrical Installations	M.C.A. Licences	Salesmanship
Automobile Eng.	Electronics	Mechanical Eng.	Secretaryship
Banking	Electronic	Metalurgy	Shorthand & Typing
Book-keeping	Draughtsmanship	Motor Eng.	Short Story Writing
Building	Eng. Drawing	Painting & Decorating	Sound Recording
Business	Export	Photography	& Reproduction
Management	Heating & Ventilation Eng.	P.M.G. Certs.	Telecommunications
Carpentry	High Speed Oil Engines	Police	Television Time & Motion
Chemistry	Industrial Admin.	Production Eng.	Tracing
City & Guilds Exams	Jig & Tool Design	Production	Welding
Civil Service	Journalism	Radar	Workshop Practice
Commercial Subjects		Radio Amateurs (C.B.G.) Licences	Works Management and many others
Commercial Art & Drawing		Radio & Television Servicing	

Also courses for GENERAL CERTIFICATE OF EDUCATION, A.M.I.H.&V.E., A.M.S.E., A.M.Brit.I.R.E., A.M.I.Mech.E., A.M.I.E.D., A.M.I.M.I., A.F.R.Ae.S., A.M.I.P.E., A.M.I.L.A., A.C.C.A., A.C.I.S., A.C.C.S., A.C.W.A., City & Guilds Examinations, R.T.E.B. Serv. Cert., R.S.A. Certificates, etc.

NEW! Courses with PRACTICAL EQUIPMENT

in RADIO • TELEVISION • MECHANICS
CHEMISTRY • ELECTRICITY
DRAUGHTSMANSHIP • PHOTOGRAPHY etc., etc.



COURSES FROM 15/- PER MONTH
POST THIS TODAY

E.M.I. INSTITUTES, Dept. 32, London, W.4.

NAME _____ AGE _____
(if under 21)

ADDRESS _____

Subject(s) with/without equipment _____

FEB.

We shall not worry you with personal visits

BLOCK COPS
PLEASE

IC 92

FREE

—Part of "His Master's Voice", Marconiphone, etc. etc.

HOME CONSTRUCTORS SAY**!! IT'S THE BEST !!****THE "SUPEREX 55" BATTERY PORTABLE RECEIVER**

A first-class receiver guaranteed to give good reception throughout the country. Equal in appearance and performance to most commercial models. Cabinet size: 10 $\frac{1}{2}$ " x 8 $\frac{1}{2}$ " x 4 $\frac{1}{2}$ ". All parts available separately.

Building Cost, £7. 15. 0.

Plus 4/- Carriage.

Send 1/6 for SUPEREX CONSTRUCTION Booklet.



- FOUR VALVE SUPERHET
- LONG AND MEDIUM WAVE
- LARGE ELLIPTICAL SPEAKER
- 87G MINIATURE VALVES
- SIMPLE CONSTRUCTION

**THE SUPERIOR BUREAU****PRICE****16 $\frac{1}{2}$ GNS.**

Plus 25/- Carriage

Very elegant in highly figured walnut veneer with internal panels in sycamore. Sloping radio panel size 16" long x 10 $\frac{1}{2}$ " high. Uncut motor board size 15 $\frac{1}{2}$ " long x 13 $\frac{1}{2}$ " back to front. Lid panelled in beige leatherette. Two large storage cupboards. Speaker chamber large enough for 12" speaker. Overall cabinet size 35" high, 34" long, 16 $\frac{1}{2}$ " deep.

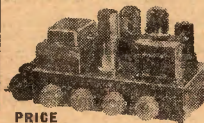
S.R. 3-4 WATT AMPLIFIER**PRICE****£5. 15. 0**

Plus 3/6 postage and packing. (30-days' valves).

High quality three valve three watt amplifier for A.C. Mains 200/250 volts. Four controls give a wide tone variation. 3 ohm speaker output. Chassis fully isolated. Valve line-up: 65G7, 6V6, 6X5. Bronze finished chassis size 8in. x 4in. x 5in. high. Supplied built and tested, and guaranteed for twelve months (30-days' valves).

TERMS

C.W.O.

OR

C.O.D.

U.K.

ONLY.

Superior
Radio supplies
37 HILLSIDE, (HARROW ROAD)
STONEBRIDGE, NW10, Elgar 3644

"You can rely on us"

LARGE STOCKISTS OF RADIO AND ELECTRONIC COMPONENTS

H.P. on INSTRUMENTS, "912" and MULLARD AMPLIFIER KITS, SOUND-MASTER, VIEWMASTER, Etc., Etc.

RESISTORS — STANDARD, MIDGET, HIGH STABILITY, PRECISION; TAPPED VOL. CONTROLS, Etc., Etc.

SEND FOR LIST.

Proprietary catalogues available to Manufacturers' Laboratories, Education Authorities, etc.

RADIO SERVICING CO.,

82, SOUTH EALING ROAD,
LONDON, W.5.

EAL 5737

COMMUNICATIONS RECEIVER R-1155—The famous Bomber Command Set. Covers 18.8-75 Mcs. 7.5-3.0 Mcs. 1,500-500 kc/s. 500-250 kc/s. 250-75 kc/s. BRAND NEW. ONLY £11.19.6. tested working before despatch and supplied with 14-page booklet which gives technical information, circuits, etc. (available separately) 19/-.

A.C. MAINS POWER PACK OUTPUT STAGE. In black metal case. Enables receiver to be operated immediately by just plugging in. Supplied WITH built-in 8in. speaker. £5.5.0 or De Luxe Model with 8in. speaker. £6.10.0. 1.628 speaker. £4.10.0. DEDUCT 1/- IF PURCHASING RECEIVER & POWER PACK TOGETHER.

Add carriage costs of 10/- for receiver, 5/- for power pack.

AMERICAN "COMMAND" RECEIVERS—These compact receivers which can be used for a variety of purposes are offered at ridiculously low prices while stocks last. Complete with 5 metal type valves, 1 each of 12X8, 12X7, 12A6, and 3 of 12S-77 in aluminium case size 11" x 8 $\frac{1}{2}$ " x 5". Used, but in very good condition, although cuses may be somewhat dented. Circuits supplied. First come first served. Choice of models. BC454 (3rd mos.) 27.6. BC453 (190-550 kc/s. the renowned "Q" Five). 59.6. and a few of the 1.6-3.0 mos. model 65.-. (Carriage, etc., 3.-.)

COLLINS TTS TRANSMITTERS—Special offer of these famous American Transmitters. Frequency ranges 1.5-12.0 mc/s. in 3 bands. Employs 7 valves, 2 of 1625 in P.A. Stage, 1625 buffer and 1625 modulator stage, 3 of 12A6 in oscillator stage. Radio telephone or radio teletype. Provision for VFO or Crystal Control. 4 crystal positions. Has plate and aerial current meters. In BRAND NEW CONDITION, ONLY £12.10.0. Matching receivers available £9.10.0. or THE PAIR £20. (Carriage 10/- each.)

CLASS D WAVEMETER

Another purchase of this famous crystal-controlled wavemeter which has been repeatedly reviewed and recommended in the "E.S.G.B." Bulletin as being suitable for amateur transmitters. Covers 1.5-8.0 mc/s. and is complete with 500,000 kc/s. crystal, 2 valves PCHS, two 6-volt vibrators and instruction manual. Designed for V.C. operation, but simple mod. data for A.C. supplied. BRAND NEW IN MAKER'S TRANSIT CASES, ONLY £5.19.6. Transformer for A.C. modification, 7/6.

U.E.I. CORPORATION 138, Gray's Inn Road, London, W.C.1. (Phone: T.ERminous 7997)
Open until 1 p.m. Saturdays. We are 2 miles from High Holborn (Chancery Lane Station), and 5 miles, by bus from King's Cross.

scale should be quite simple and extreme accuracy is not called for. The completed graph is shown in Fig. 5 and it now presents the "vital statistics" of the core in a readily accessible manner.

Valve Requirements

Consider an EL84 valve delivering 3 watts into a 5,000 ohm load. The equation for power in a circuit is:—

$$W = \frac{E^2}{R} \text{ or } E^2 = WR \quad \text{where } \begin{cases} W = \text{power in watts.} \\ E = \text{volts R.M.S.} \\ R = \text{resistance in ohms} \end{cases}$$

$$\text{putting in values } E^2 = 3 \times 5,000 \\ \text{and } E = \sqrt{15,000} = 123 \text{ volts.}$$

So that at 3 watts output there will be at the anode of the EL84 an alternating voltage of 123 volts R.M.S. superimposed on the 300 volt H.T. supply. This A.C. voltage must, of course, appear across the primary of the output transformer at the lowest frequency which is to be reproduced. For convenience, and a small margin of safety, call it 125 volts.

Having seen what the valve will demand of the transformer primary, turn to the graph again to find out how these demands can be met. With no signal the steady anode current of the valve must magnetise the core to a point at the middle of the straight part of its magnetisation curve. The reader must fix this point for himself on his own graph. In Fig. 5, it is marked at p where the flux is 17,000 lines, and the voltage it sets up across a 100 turn coil is 3.6 volts. This, of course, at a frequency of 50 cycles. These figures will be used again, and should be noted. When the valve is handling a signal, flux will rise and fall above and below this working point value of 17,000 lines by an amount which must be the Φ of the transformer equation.

Looking at the graph, it will be seen that flux cannot be allowed to rise above 32,000 lines, for fear of going "round the bend." For the transformer calculation Φ may, therefore, be taken as 32,000 - 17,000 = 15,000 lines. The reader will obtain his own figure from his graph, the pattern being clear. Sufficient data have now been accumulated to enable the transformer equation to be used to find the number of turns required by the output transformer primary.

$E = 125$ volts, $\Phi = 15,000$ lines, $f =$ lowest frequency to be reproduced—say 40 cycles.

Rearrange the equation thus:—

$$t = \frac{E \times 100,000,000}{4.44 \Phi f}$$

$$\text{put in values } t = \frac{125 \times 100,000,000}{4.44 \times 15,000 \times 40} = 4,700 \text{ turns.}$$

Now these turns on the transformer primary will be carrying the valve anode current. Take this as 40 mA (.04 A). Multiplying amps. by turns gives $.04 \times 4,700 = 188$ ampere-turns. The graph shows that these ampere-turns would magnetise the core well

beyond the chosen working point. This would be disastrous and will be corrected by introducing an air-gap into the magnetic circuit of the core. But this adjustment will be left until final assembly of the transformer.

The secondary winding must now be considered. The number of turns on this depends on the impedance of the speaker to be used. This impedance appears at the transformer primary winding multiplied by the square of the transformer turns ratio. The ratio of primary to secondary turns on the transformer will, therefore, have to be the square root of the number by which the speaker impedance has to be multiplied to make it equal to the load impedance required by the valve. The formula is:

$$r = \sqrt{\frac{RL}{Rs}} \quad \text{where } \begin{cases} r = \text{pri/sec ratio.} \\ RL = \text{valve load impedance.} \\ Rs = \text{speaker impedance.} \end{cases}$$

It is convenient to be able to match either a 15 Ω speaker or a 3.75 Ω speaker to the valve, so alternative impedance outputs are desirable from the transformer secondary. For a 15 Ω output the turns ratio must be:

$$r = \sqrt{\frac{5,000}{15}} = 18.3:1 \text{ and for a } 3.75 \Omega \text{ output the} \\ \text{turns ratio must be } r = \sqrt{\frac{5,000}{3.75}} = 36:1$$

Dividing these ratios into the primary turns gives for 15 Ω , $\frac{4,700}{18.3} = 257$ turns and for 3.75 Ω , $\frac{4,700}{36} = 114$ turns. A 257 turn secondary will, therefore, be used, tapped at 114 turns to provide a 3.75 Ω output.

Construction

It is not proposed to describe the winding of the transformer in detail. Every serious reader will by now have had some experience of coil winding of this kind and will have evolved his own techniques. The writer made up a bobbin with paxolin cheeks and partition pieces to provide three equal winding spaces. A cement made by dissolving Perspex in chloroform is a very useful adhesive. Cheeks and partition pieces must be adequately supported during winding or they will be pushed out of place. Choice of wire gauge is dictated by the window area of the core stampings. Wire tables and simple arithmetic soon settle this issue. It is essential to keep the D.C. resistance of primary and secondary as low as possible. If, for instance, the resistance of the primary is allowed to be as high as 1,000 Ω , then at 40 mA the valve anode will be robbed of 40 volts H.T., and its output considerably lowered.

In addition, power which should be fed to the speaker is dissipated in the primary winding. A secondary winding which is supplying 3 watts to a 3 Ω speaker is generating 3 volts to drive 1 amp. through the speaker winding and through itself. If

Search Coil turns	100	100	100	100	100	100	100	100	100	100	100	100	100	100	100	100	100	100
Volts R.M.S.	.8	1.6	2.4	3.15	3.9	4.85	5.6	6.4	7.0	7.6	8.1	8.5	9.0	9.3	9.5	9.8		
Amps. R.M.S.	.2	.4	.6	.8	1.0	1.2	1.4	1.6	1.8	2.0	2.2	2.4	2.6	2.8	3.0	3.4		
Ampere-turns	20	40	60	80	100	120	140	160	180	200	220	240	260	280	300	340		

Fig. 4.—How the readings are tabulated.

the resistance of the secondary winding is allowed to be as high as 3Ω , current is halved and power loss becomes considerable because of the doubled impedance. Things may not be quite as bad as this, but use wire gauges to fill all available winding space. The writer used 36 s.w.g. enamelled for his primary, which was wound in two sections with the secondary between them. This is desirable in every case to obtain maximum coupling between the windings. The first 114 turns of the secondary (3.75Ω) were wound with 22 s.w.g. enamelled and the remaining secondary turns with 24 s.w.g. With the 15Ω winding current is less, there is more voltage to play with, and the effect of winding resistance not quite so serious.

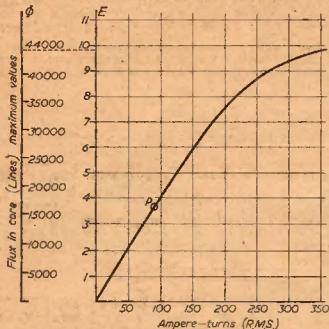

Fig. 5.—The magnetisation curve of the chosen core.

Assembly and Gap Adjustment

Assemble the core around the bobbin with all the "U" stampings facing in one direction and all the "T" stampings in the other. The core is shown assembled in this way in Fig. 2. Where the two stacks of stampings meet, at a and b, insert small pieces of some hard, incompressible insulating material, each about .01in. thick. Thin paxofin will do. The writer used mica; this is convenient because its thickness can easily be built up or reduced. Tap the stampings gently together, compressing the mica in the gaps. Bolt up securely in the frames and connect up to the measuring equipment on the test bench. This time the 3.75Ω secondary winding will be used to provide the known number of ampere-turns which will be exactly equal to those set up by the primary when it is carrying the valve anode current. These will be .04 amp. (for EL84) by number of primary turns. In the present case this is $.04 \times 4,700 = 188$ as noted previously. Now comes a snag, but not an insurmountable one. The curve on the graph indicates the maximum flux value reached during each half cycle of alternating current, because voltage is proportional to maximum value of flux. But the ampere-turns scale is based on the R.M.S. value of the current which is only .7 of the maximum value reached by the current in any half cycle. This means that at the point corresponding to 70 ampere-turns on the scale the flux value shown by the curve is that which is set up at the instant the current is peaking up to 100

ampere-turns. Now, a steady D.C. maintains a steady "peak" value all the time. Therefore, to reach the same point on the curve, using A.C., as would be reached by 188 ampere-turns D.C., it will be necessary to multiply the 188 by .7 and then adjust the search coil current to provide the reduced number of indicated ampere-turns. $188 \times .7 = 132$ ampere-turns to be provided by the 114 turn coil. Dividing ampere-turns by turns to find the amps.

required gives $\frac{132}{114} = 1.16$ amps., to which reading the ammeter must be kept while adjusting the core gap. It was noted previously that with flux at 17,000 lines, the chosen working point, the voltage set up across the 100-turn search coil was 3.6 volts. Across the 114 turns the same flux will set up a proportionately higher voltage: $3.6 \times \frac{114}{100} = 4.1$ volts. The stage is now set

for the final adjustment of the core gap. This is done by adjusting the thickness of the mica spacing pieces until with 1.16 amps through the 3.75Ω winding a voltage of 4.1 volts is obtained across the winding, and this with the stampings tapped as close as the spacers will permit them and with the core firmly bolted up. Switch off for each adjustment of the spacers and readjust current for every reading.

Your Own Data

When the correct readings have been obtained, check over the frame bolts and test again. In describing the adjustment of the core, flux, voltage, current and ampere-turns figures have been used which relate, of course, to the writer's transformer. All essential substitutions will become obvious to the reader as he takes his own readings and records his own data.

PRACTICAL TELEVISION JAN. ISSUE NOW ON SALE PRICE 1/3d.

The current issue of our companion paper *PRACTICAL TELEVISION* which is now on sale contains a very interesting article on the A.T.V. Empires. Several well-known Empire Theatres or Music Halls have been taken over by the I.T.A., and our contributor has visited them, both in London and Manchester, and the article contains interesting details of them, together with illustrations of various aspects of the set-up.

For the practical man there is an article on Slot Aerials, both indoor and outdoor. The article covers both the Band I and the Band III arrangements. On the subject of aerials there is also an article on the Filters and Crossovers which are often used to couple various aerials together and to remove certain forms of interference. A continuation of the article on Using the Oscilloscope gives typical oscillograms found in various parts of different commercial television receivers, as a guide to being able to diagnose faults.

The Servicing article this month covers the Bush TV1 and TV2, whilst the Beginner's Guide to Television deals further with colour tubes and the problems of Bands, Wavelengths and Frequencies.

Your Problems Solved, Underneath the Dipole, Correspondence and Telenews, together with Data Sheet No. 2 on the G.E.C. BT3251 and BT9343 completes this issue.

MAXI-Q

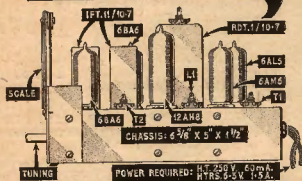

F.M. TUNER

"Q" of each winding is 90 and the coupling critical. Dimensions as PDT.1. IFT.11/10.7/L. As IFT.11/10.7 but with secondary tap for limiter input circuits, price 6/-. Coil Type L1, T1, and T2. These coils are specially designed for use in the "MAXI-Q" F.M. TUNER, price 3/11 each. Chassis and screens for the above unit, completely punched in aluminium, price 7/6.

Obtainable from all reputable stockists or direct from works. GENERAL CATALOGUE covering technical information on full range of components, 1/- post free.

DENCO (CLACTON) LTD., 357/9 Old Road, Clacton-on-Sea, Essex

STOP PRESS:

- "OSRAM" F.M. TUNER completely assembled and valued at £16/16/- inc. P.T.
- "MULLARD" TAPE RECORDER. Amplifier Chassis, Type 'A'—31/6; Type 'B'—31/6. Power Pack Chassis, 11/6.
- "MULLARD" 20 WATT AMPLIFIER. Chassis and Base 34/-. Pre-Amp Chassis, 25/-. Transformer Covers (3), 32/-.
- "MULLARD" 3 valve 3 watt chassis, 10/6.
- "MAXI-Q" 60 Kc/s TAPE DECK OSCILLATOR COIL, TDO.1, 5/-.

Great Britain's Valve Mail-Order House



SALE

- Home Electric Kits 12/6.
- 5-Blade Saw 2/6.
- Wire Coils 2/- 4 mid. Cond. 2/-
- N.T.H. Germanium Diode with Circuit 2/-
- Electric Saw 58/-
- Elec. Pen 10/-.

THE SKYSEARCHER

An all mains sets for 19/6

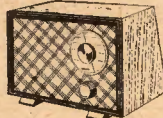

This is a 2-valve plus metal rectifier set useful as an educational set for beginners, and also makes a fine accent set for the bedroom, workshop, etc. All parts, less cabinet, chassis and speaker. 19/6. Post & Ins. 2/-. Data free with parts or available sep. 1/6.

METER SALE

- Measura 60/-
- Ferranti 25
- Taylor 110 Sold
- Triplet (U.S.A.) 29
- Ave 40 Sold



SERVICE SHEETS
The one you require enclosed if available at a dozen assorted of our best choice. 10/6

- | Headphones | Contact coils and Eared rectifiers |
|-----------------|------------------------------------|
| Low Res. 8/- | 16RC. 1-1-16-1 ... 10/2 |
| High Res. 17/6 | 16RA. 1-1-16-1 ... 12/10 |
| Soldering Irons | 16RB. 1-1-16-1 ... 8/4 |
| With Scon | 16RC. 1-2-8-3 ... 28/- |
| Indicator 21/8 | 16A. 97 ... 21/10 |
| Industrial Size | 16A. 97 ... 28/2 |
| Testers | 16A. 100 ... 27/8 |
| A.C./D.C. 7/6 | 16B. 130 ... 32/10 |
| | 16W7 ... 28/3 |
| | X66 ... 26/6 |

SALE

- Volume Controls with Switch 5/-
- Less switch 3/8
- Wear-Res Coils 2/-
- 4 mid. Cond. 2/-
- N.T.H. Germanium Diode with Circuit 2/-
- Polish 4/-
- Barbata Adhesive Thread 1/-
- Convent. Tps 5/-
- Radio Maps 6/-
- Bulbin Buzzers 3/-
- Speaker Cone Gauges 1/6

SALE

- A few only T.R.F. Sets, completely new, 65/-, p. & p. 4/-.
- Crystal Receiver Kits, 5/-.

Continental Potasio Feelers (last shipment), 36/-, post paid.

"No-Silver" Silver Plating. Do your own Plating on Copper, Brass, Nickel, Chrome, 5/8

SALE

- McMurdo BSG Local Holders, doz. 4/-
- Quico Soldering Taster 62/6
- AMMETERS 0-6 8/-
- 30-0-30 7/-
- Spirit Blow Lamp 22/6
- Multicoore Solder 6d.

RADIO BULLS VALVES

DEMOBBED VALVES 2/6

Giving equivalents of British and American service and Cross Reference of Commercial Types with an Appendix of B.V.A. Equivalents and Comprehensive Price List. We have still some Valves left at very old Budget Rates (25/3) which are actually sold at the old price. (1951 rate).

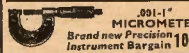

Chassis Cutters with Keys



The easiest and quickest way of cutting holes in sheet metal. The cutter consists of three parts: a die, a punch and an Allen screw. The operation is quite simple. Prices (incl. key): size 1in. 12/6; 1in. 14/6; 1in. 16/6; 1in. 18/6; 1in. 20/6; 1in. 22/6; 1in. 24/6; 1in. 26/6; 1in. 28/6; 1in. 30/6; 1in. 32/6; 1in. 34/6; 1in. 36/6; 1in. 38/6; 1in. 40/6; 1in. 42/6; 1in. 44/6; 1in. 46/6; 1in. 48/6; 1in. 50/6; 1in. 52/6; 1in. 54/6; 1in. 56/6; 1in. 58/6; 1in. 60/6; 1in. 62/6; 1in. 64/6; 1in. 66/6; 1in. 68/6; 1in. 70/6; 1in. 72/6; 1in. 74/6; 1in. 76/6; 1in. 78/6; 1in. 80/6; 1in. 82/6; 1in. 84/6; 1in. 86/6; 1in. 88/6; 1in. 90/6; 1in. 92/6; 1in. 94/6; 1in. 96/6; 1in. 98/6; 1in. 100/6.

PIFCO

- All-In-one Radiometers A.C./D.C.
- *Circuit Test.
- *L.T. & H.T. Tests.
- *W.A. Test.
- *Valve Test.
- Continuity and Resistance Tests. Complete with Test Leads. Post 1/- 32/6



FREQUENCY MODULATION ENGINEERING

T/V ENGINEERING

RADIO SERVICING

RADIO ENGINEERING

RADAR ENGINEERING

BASIC ELECTRONICS **INDUSTRIAL ELECTRONICS**

ELECTRONIC ENGINEERING

PRACTICAL, UP-TO-THE-MINUTE I.C.S. training . . .

can help you to attain one of the many well-paid posts that exist today in the radio world. Prepare yourself now, at home and in your own time, with the expert help of I.C.S. tutors. The cost of an I.C.S. Course is moderate and includes all books,

Complete the coupon below and post it to us today for further details of the Course which interests you. Write to: Dept. 170F, I.C.S., 71 Kingsway, W.C.2.

INTERNATIONAL CORRESPONDENCE SCHOOLS

DEPT. 170F, INTERNATIONAL BUILDINGS, KINGSWAY, LONDON, W.C.2.

Please send **FREE** book on.....

NAME.....AGE.....
(Block letters please)

ADDRESS.....

OCCUPATION.....2.57

INTERNATIONAL CORRESPONDENCE SCHOOLS

BUILD THIS AUTHENTIC JASON F.M. KIT

4 VALVES

STABLE

EASY CONSTRUCTION

Complete kit of quality components less valves **£5.5.0.** Fringe-area version (less valves) **£4.0.0.** Power-pack kit, **£1.9.**

● **JASON "ARGONAUT" A.M.-F.M. KITS**

For building as a tuning unit or complete self-powered receiver. Book by Data Publications, 2/- (2/3 post free).

FROM LEADING STOCKISTS, or in cases of difficulty:

JASON MOTOR & ELECTRONIC CO.
328, Criklewood Lane, London, N.W.2.

Phone: **SPE 7050**

Best Buy at Britain's

TWO-WAY MORSE TRAINING SETS. WT Mk. 2. Consists of two valve oscillators (AR12's) (one with pitch control), for one or two operators. Has provision for creating "Atmospheres." In polished oak case 12in. x 10in. x 8in., wt., 18 lbs. Complete with valves, leads, 2 keys, 7-way terminal board, circuit and instructions but less batteries and phones. Ideal for Cadets, Scouts, etc. SMDP. 19.6. Headphones for above, 10.6 pair.

RESISTORS. Latest miniature insulated Dubilier 1 watt type BTS. (Wired ends. Useful values. ONLY 10/- for 100 assorted 1/2 and 1 watt. Eris, etc.; 1 gross assorted, 10/-.

FIELD TELEPHONES. Army type D; Mk. 6. Hozer calling. Ideal for building sites, farm, workshops, etc. Complete with handset and batteries. Tested before despatch. 39.6 each.

SOUND-POWERED HANDSETS.—Suitable for telephone. Balanced armature microphone and earpiece. No batteries required. 10.6 each. Biggest mike and pr. headphones, as above. 19.6 set.

LOEAN LINDA TUBE CHASSIS.—Complete with ACET CRT and screen, but less valves and crystal. New condition. 29.6.

WIRELESS SETS No. 17. Mk. 2. A portable 2 valve transmitter for RT communication, freq. 44-91 Mc/s. Easily converted to the new 70 Mc/s band! Complete with valves, H.R. headphones and microphone. Requires 120 v. H.T. and 2 v. D.C. SPEAKER. An 8in. F.M. unit contained in beautiful black crackle cabinet, suitable for AR88, etc. BRAND NEW. Price only, 45/-.

D.I. VOLTAGE BLOWERS. 12 and 24 v. Ideal for hair driers, car heaters, etc., 25/- plus 2/6 postage.

INSTRUMENT TRANSFORMERS. Parfaco.—230 v. A.C. input 5.65-30-105 v. 85 m.A. 5.5 v. 5 Amp. 0.9 v. 3 Amp. output. Shrouded, 8 1/2in. x 3 1/2in. High. 15/-.

HEAVY DUTY I.T. TRANSFORMERS.—200-250 v. A.C. input, 30 v. tapped at 19 v. 30 Amps. output, 5 1/2in. x 9 1/2in. x 7 1/2in. High, wt. 24 lbs., 65/-.

TREE-ORF CABLE. 23.36, rubber ins., circular, padded, cotton covered, Marcon. 12 yds. 6/- or 100 yds. 60/6.

RCA SPEAKER. An 8in. F.M. unit contained in beautiful black crackle cabinet, suitable for AR88, etc. BRAND NEW. Price only, 45/-.

D.I. VOLTAGE BLOWERS. 12 and 24 v. Ideal for hair driers, car heaters, etc., 25/- plus 2/6 postage.

INSTRUMENT TRANSFORMERS. Parfaco.—230 v. A.C. input 5.65-30-105 v. 85 m.A. 5.5 v. 5 Amp. 0.9 v. 3 Amp. output. Shrouded, 8 1/2in. x 3 1/2in. High. 15/-.

HEAVY DUTY I.T. TRANSFORMERS.—200-250 v. A.C. input, 30 v. tapped at 19 v. 30 Amps. output, 5 1/2in. x 9 1/2in. x 7 1/2in. High, wt. 24 lbs., 65/-.

PLEASE ADD POSTAGE OR CARRIAGE ON ALL ITEMS

CHARLES BRITAIN (RADIO) LTD.
11, Upper Saint Martin's Lane, London, W.C.2.

Temple Bar 0454

Shop hours 9-6 p.m. (9-1 p.m. Thursday). Open All Day Saturday.

Alternative Mains-bridge Energising Circuits

MODIFICATIONS TO THE NOVEL C/R BRIDGE

By F. W. Austin

CERTAIN readers have found difficulty in obtaining a suitable mains transformer for use with the *Novel C/R Bridge*, described in the January, 1955, issue of this journal. There may also be others who are interested and would like to know of alternative arrangements for energising the bridge.

The principal difficulty appears to be the additional 50 volts/50 mA. winding which is commonly used on mains-energised bridges in general. This difficulty

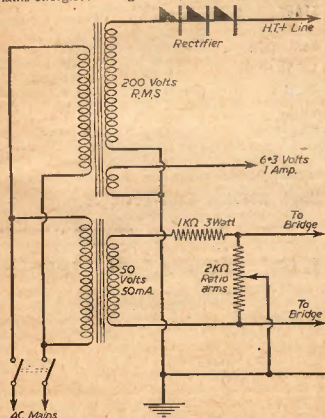

Fig. 1.—Direct substitution (separate transformer).

was foreseen at the time of constructing the original model and different methods were tried out with varying success, but it must be appreciated by all readers that a mains-driven bridge could hardly be presented at the outset in any other than approved and conventional style.

The problem has now been thoroughly explored and certain recommendations can be made.

Direct Substitution

The simplest and most satisfactory course is to employ a *separate* transformer with mains input, supplying the 50 volts/50 mA. from the secondary winding as shown in Fig. 1.

Voltage "Step-up" Method

If we cannot obtain the separate transformer as above, we must discover how such a voltage can be obtained by other means. If the 6.3 volts winding of our mains transformer can be "stepped-up" we have a most excellent alternative.

Transformers "In Reverse"

This will entail the use of a transformer in reverse (in other words, making use of a low-impedance secondary winding as a "primary" input source, whilst using the original primary as a "secondary" for energising the bridge). In making our choice for this purpose there is a certain latitude permissible, but an L.S. Output Transformer and a Television Frame Output Transformer, have both been found entirely suitable.

"Tapping" the Input

Fig. 2 shows the most convenient and practical means of employing this method with such transformers. The resistor marked simply "R" in the circuit can be a 20 ohms variable component as usually employed for volume control purposes on low-impedance extension speakers. This resistor is adjusted until a voltage of between 30 and 35 volts A.C. is obtained across the 2 K ratio arms.

If the constructor wishes to try this arrangement out before incorporation in the bridge, *great care must be taken* to ensure that the output from the transformer has 3,000 ohms load shunted across it before taking any measurements. Unloaded transformers employed in this manner are capable of delivering quite a nasty shock unless one is fully prepared. The shunt loads the transformer and limits the output to reasonable proportions.

When the correct voltage has been secured, the resistor "R" may be replaced by a fixed component equal to the value of "R" remaining in circuit. It may even be dispensed with entirely if the voltage output stipulated is not exceeded. One Frame Output Transformer tried by the author needed no limiter for the input and delivered approximately 26 volts across the ratio arms. This was found quite adequate for operating the bridge on all ranges.

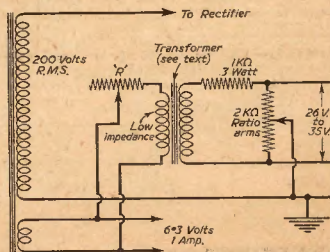

Fig. 2.—Alternative arrangement using transformers "in reverse" (see text).

"Infra-red—Its Problems and Possibilities"

THE FOLLOWING IS AN EXTRACT FROM THE SYNOPSIS OF A LECTURE GIVEN TO THE RADAR ASSOCIATION ON NOVEMBER 14th, 1956

There is a well-known saying which goes "I shall not believe it until I see it with my own eyes." The eye is, of course, a very well designed receiver of electro-magnetic radiation working on a narrow band of wavelengths around $1/2,000$ th of a millimetre, i.e., 0.5 microns (1 micron is one-millionth of a metre). It sees each particular wavelength as a colour: for example, at 0.4 microns it sees violet and at 0.75 microns it sees red. Beyond 0.75 microns, where the eye ceases to respond, and up to 1,000 microns lies the infra-red. The region immediately beyond 1,000 microns, or 1 millimetre, is the radar spectrum well known to the Radar Association, and although the first wavelength to be used for equipment works on 8 millimetres (high resolution airfield radars) this is only because techniques are as yet insufficiently developed on wavelengths below 8 millimetres.

The main advantage of short radar wavelength is that it gives high resolution with a small aerial size. The resolution of a radar act is proportional to D/λ , where D is the diameter of the scanner and λ the wavelength. Thus on X band (wavelength 3 cm.) a radar with a 1ft. diameter scanner can separate out two aircraft at 5 miles range if they are 1 mile apart. On a wavelength of 8 millimetres it could distinguish between them if they were 1/4 mile apart. In the infra-red on a wavelength of 1/500 millimetre (2 microns) an infra-red receiver even with a 3in. diameter scanner could resolve the separate engines on a single aircraft at a range of 5 miles.

Transmission

All warm bodies transmit infra-red radiation, the amount and wavelength depending on the temperature of the body and on its surface. The amount transmitted depends on the fourth power of the temperature, i.e., $P \propto T^4$. Thus a body at $1,000^\circ\text{K}$ ($^\circ\text{K} = ^\circ\text{C} + 273$), say, a jet engine, transmits more than 250 times as much power as a kettle of boiling water with a temperature of 373°K . In addition, the band of wavelengths transmitted is also a function of the temperature, the wavelength λ max. on which maximum power is transmitted being given by the simple formula

$$\lambda \text{ max.} = \frac{3,000}{T^\circ\text{K}} \text{ microns.}$$

Thus we see that for the following bodies the λ max. is as follows

Radiating Body	Temperature °K	λ max. in microns
Sun	6,000	0.5 (visible light)
Jet aircraft engine ...	1,000	3.0
Piston-engined aircraft	750	4.0
Kettle with boiling water	373	8.0
Human body ...	200	10.0

Thus, theoretically, we have only to make a receiver to work on the various wavelengths and we can detect the body concerned—the hotter the body the easier the problem is because the more power it transmits.

Reception

Broad-band receivers which receive all infra-red wavelengths equally well have been known for many years. These are the thermal detectors known as radiation thermo-couples and bolometers. They rely for their action on the warming-up effect of the incoming radiation and in general they are too sluggish in their response-time to detect rapidly moving objects, although they are still widely used for laboratory measurements.

The modern infra-red detector is one based on a German war-time development—photo-conductivity in the infra-red. In this type of detector a semi-conductor is used—the same class of material as is used in transistors. A semi-conductor, as its name implies, is a material that lies between a conductor and an insulator as far as its electrical properties go. In a photo-conductor infra-red detector the semi-conductor is in the form of a thin layer between the electrodes, across which a potential is supplied. The resistance of the layer is usually fairly high (in excess of 1,000,000 ohms) and when infra-red radiation is allowed to fall on it the resistance drops, and this in turn indicated by a fall in the applied potential. This type of detector does not require that the temperature of the layer shall change—the effect is caused by the absorption of radiation in the layer. Thus each unit of infra-red radiation absorbed releases an electron in the layer which would not normally have been free, and these freed electrons flow across the layer and add to the steady leak current caused by the applied voltage. The effect causes measurable changes in voltage for very small amounts of infra-red radiation, and, what is very important, the change takes place in a few micro-seconds. Thus even the Fairey Delta II will only have gone about 2in. in the time that it takes a photo-conductor to respond!

Selective Devices

These photo-conductor detectors only work over certain wavelength ranges, i.e., they are selective, and the particular semi-conductor material must be chosen to suit the required wavelength. The most common materials for the layers are lead sulphide which responds to about 3 microns, lead telluride, which responds to 4.5 microns, lead selenide to 6 microns, indium antimonide to 7 microns, and germanium which responds out to very long wavelengths—possibly 100 microns. All these materials must be specially treated to give them infra-red sensitivity, and all of them with the exception of lead sulphide and possibly lead selenide need to be kept cool, i.e., refrigerated, to make them sensitive.

HOME RADIO OF MITCHAM

187, LONDON ROAD, MITCHAM, SURREY

MIT. 3282

The full range of

EDDYSTONE

short wave components in stock. Eddystone catalogue price 1/-.

THE BEGINNERS "SHORT WAVE 3"

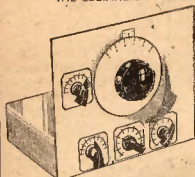

We can supply all the parts for this efficient A.C. operated short wave receiver. Ideal for serious long distance reception and also as stand-by set, or as a compact bedside receiver. Detailed price list will be sent on request. This set was fully described and illustrated in the Practical Wireless, Nov. and Dec. issues.

MULLARD 5 VALVE 10 WATT

Quality Amplifier

Full

Constructional Details including F.M. Tuner and Price List, 3/6.

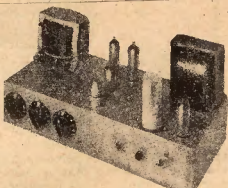

THE "JASON" F.M. TUNER KIT

The most successful Home Constructor design ever produced. Build yours to-day and enjoy the thrill of Hi-Fi crystal clear reception. All parts standard and in stock. Full constructional data including points-to-point and price list. PRICE 2/-.

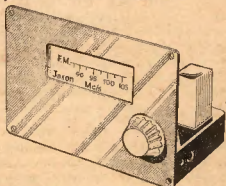

WE CARRY THE FULL RANGE OF W.B. STENTORIAN SPEAKERS AND CABINETS.

Full Details on Request.



ALL THESE FINE BARGAINS ARE AT The Walk-around Shop

BENDIX TRANSMITTERS. Type T.A. 128 Master oscillator type transmitter. 4 channel 40 W. operation provide telephone, CW or MCW in frequency ranges of 300-600 kc/s, 3-4.8 Mc/s, 4-6.4 Mc/s, 4.37-7 Mc/s. Each of the 4 channels has its own oscillator and uses a 12.5K 7. The IPA stage consists of an 807, while the PA is two 807s in parallel. Size 10 1/2 in. x 6 1/2 in. x 15 1/2 in. Price £3/15/- plus 10/- carr.

RHIS RECEIVERS. Air Tested in good secondhand condition. Price £6/5/- plus 10/- packing and carriage.

R.F. UNITS. R.F. 24, 20-30 Mc/s Switched Tuning. Valved 9/6 ea. R.F. 25, 40-50 Mc/s Tuning. Valved 9/6 ea. R.F. 26, 50-65 Mc/s Variable Tuning. Valved as new. 25/- ea. R.F. 26. A few with damaged dials. 20/- ea. Packing and postage 3/- each type.

TYPE 62A INDICATORS. Ideal for conversion to oscilloscopes, T.V. units, etc. Containing YCR97, 12 VR91 (EF50), 2 VR54 (EB34), 3 VR92 (EA50), 4 CV118 (SP61) Slow-motion dial, 13 Pots and scores of useful components. Size 8 1/2 in. x 11 1/2 in. x 18 in. In wooden packing case. £3 carriage 7/6.

OCTAL PLUGS. (Bulgin bakelite type.) 2/6 each p.p.

HEATER TRANSFORMERS. 6.3 volt, 1/2 amp. Brand new. 6/6 each, plus 1/- p.p.

SPECIAL OFFER

MALLORY VIBRATOR PACKS. 12 volt 150 volt 40 mA. Brand new and boxed, size 5 1/2 in. x 5 1/2 in. x 3 in., 12/6 each p.p. CR300/1. Receiver and Power Supplies. Available for colliers only.

ZIN. MAGSLIPS. Cycle transmitters and receiver units. Accurate to 1/10th deg. Guaranteed good working order. 35/- a pair, plus 3/- p.p.

AN/APNI TRANSDUCER. This unit consists of Magnet, and Coil which is attached to an aluminium diaphragm suspended freely and perforated to prevent air damping. Mounted on a Ceramic cover which sits over the diaphragm is a form of 2-Gang capacitor which has a swing from 10-50 pF. The above unit is used as part of Wobblers described on page 252 of the June '57 Wireless World. PRICE 7/6 p.p.

PROOPS Dept. 'P', 52 Tottenham Court Road, BROS. LTD. London, W.1. LANgham Q141
Shop Hours : 9-6 p.m. Thursday : 9-1 p.m. Open all day Saturdays

THE FAMOUS BENNETT COLLEGE can train your mind to SUCCESS

THROUGH
PERSONAL POSTAL TUITION
A FREE book vital to your career!

WHAT CAREER DO YOU WANT?

Building
Carpentry
Commercial Art
Diesel Engines
Draughtsmanship
Electrical Eng.
Fire Engineering
Mechanical Eng.
Quantity Surveying
Radio Eng.
Surveying
Telecommunications
Television

Accountancy Exams
Auctioneer's Exams
Book-keeping

General Education
Languages
Mathematics
Police Subjects
Salesmanship
Secretarial Exams
 shorthand
Short Story Writing
and many others
GENERAL CERT.
OF EDUCATION

Read how the famous Bennett College can help you to success! Send now for this recently published "FREE" book, "Train your mind to SUCCESS", which tells you about The Bennett College proven success in postal tuition . . . and how it can help you to success in your career.



To The Bennett College (Dept. B.104N), Shillall
 Please send me, without obligation, a free copy of
 "Train your mind to SUCCESS" and the College
 Prospectus on? _____
 NAME _____
 ADDRESS _____
 AGE (if under 21) _____ Please write in Block Letters

THIS COUPON
COULD BE YOUR
PERSONAL PASSPORT
TO SUCCESS.
Send it NOW!

WEYRAD

"H" TYPE COILS—FOR MANUFACTURERS, SERVICE ENGINEERS AND INDIVIDUAL CONSTRUCTORS

A low-priced, soundly-designed Range of Coils, providing continuous coverage from 12 to 2,000 metres in 6 Bands.

The coils are supplied in individual aerial, H.F. transformer and oscillator versions for each band. Iron dust cores are adjusted by means of a threaded brass stem with a screwdriver slot which permits fine adjustment of inductance without the danger of damage to cores. Circuit connections are made to 4 tags at the end of the former. Single 6 B.A. mounting.

"H" type coils are recommended for many popular circuits including the "Practical Wireless" AC/DC 3-valve Superhet and are widely used for servicing and conversion purposes.

RETAIL PRICE.....3/9 EACH

ILLUSTRATED FOLDER.....3d.

A.M./F.M. RECEIVER BOOKLET 2/6.

WEYMOUTH RADIO MANUFACTURING CO., LTD.
CRESCENT STREET, WEYMOUTH, DORSET

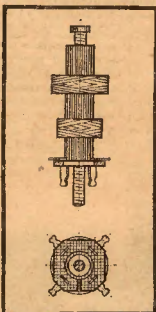

RANGES:

- Band 1—800-2,000 mtrs.
- Band 2—250-800 mtrs.
- Band 3—190-550 mtrs.
- Band 4—90-250 mtrs.
- Band 5—33-100 mtrs.
- Band 6—16-50 mtrs.
- Band 7—12-37 mtrs.

Coils are coded according to type and range :
HA 1 = Band 1 aerial
HO 3 = Band 3 oscillator

VALVES • SAME DAY SERVICE

All Guaranteed New and Boxed

14V	120	1R5	185	1T4	1U5	3B4	DAF91
DF91	DK91	DL92	DL94	any 4	any 4	any 4	any 4
1A70T12	6	5V6G	7	6	DK96	8	EY90
12CA7	11	6V6GT	7	6	DL94	8	EZ90
115GT	6	6X4	7	6	DL35	11	EZ91
11	6	6XGT	6	6	DL85	8	EZ90
115GT	7	7	8	8	RAF210	6	FW4500
11	7	7C5	8	8	EB91	8	8
1R5	8	7C6	8	8	EB33	7	6
185	7	7H7	8	8	EB34	10	10
1T4	3	7S7	9	9	EB70	6	7
3A5	6	7Y3	8	8	BCC40	11	8
3C4	8	10E1	13	8	ECC81	9	8
3Q5GT	8	10F9	8	8	ECC83	9	8
384	7	12AH6	10	8	ECC412	6	8
3V4	8	12AT7	8	8	ECC86	9	8
5U4G	8	12AU7	7	8	ECC1	8	8
5Y3GT	7	12J7GT	8	8	ECP8012	6	16
5Z4C	8	10	10	8	ECP813	6	16
6AK5	4	12K7GT	8	8	EZ45	10	8
6AL5	6	9	8	8	ECH42	8	8
6AM9	7	12K9GT	8	8	10	16	8
6AQ5	7	14	8	8	ECH81	8	8
6AT9	8	12Q7GT	8	8	EL80	10	8
6BA6	7	14	8	8	EF87A	8	8
6BB5	7	14S7	14	8	EF93	8	8
6BR7	13	25L6GT	8	8	EF99	8	8
6BW6	7	8	8	8	EF90	11	8
6F1	13	25Z4C	8	8	EF41	9	8
6F6G	6	35L6GT	8	8	EF92	12	8
6F13	13	35Z4GT	8	8	EF90	7	8
6F15	13	50L6GT	8	8	EF99	9	8
6G6	8	8	8	8	EF98	8	8
6J7C	7	8	8	8	EF98	12	8
6K7C	5	CL33	14	8	EP91	7	8
6K7GT	6	DA2511	11	8	EP92	6	8
6K9Z	7	DAF36	8	8	EL32	6	8
6K9ZT	9	DC500	8	8	EL33	14	8
6K9ZT	9	DF53	11	8	EL32	10	8
6SNTGT	DP96	8	8	8	EL42	12	8
6T7	7	DH77	8	8	EL43	10	8
6T7GT	8	DX32	12	8	EL43	10	8
14	8	DX32	12	8	EL43	10	8
14	8	DX32	12	8	EL43	10	8

READERS RADIO
24, COLBERG PLACE, STAMFORD
HILL, LONDON, N.16 STA. 4537

FIRST-CLASS RADIO COURSES...

GET A CERTIFICATE!

QUALIFY AT HOME—IN SPARE TIME

After brief, intensely interesting study—undertaken at home in your spare time—YOU can secure your professional qualification. Prepare for YOUR share in the post-war boom in Radio. Let us show you how!

FREE GUIDE

The New Free Guide contains 132 pages of information of the greatest importance to those seeking such success-compelling qualifications as A.M. Brit. I.R.E., City and Guilds Final Radio, P.M.G. Radio Amateurs, Exams., Gen. Cert. of Educ., London B.S.C. (Eng.), A.M.I.P.E., A.M.I.Mech.E., Draughtsmanship (all branches), etc., together with particulars of our remarkable Guarantee of SUCCESS OR NO FEE

Write now for your copy of this invaluable publication. It may well prove to be the turning point in your career.

FOUNDED 1885—OVER
150,000 SUCCESSSES—
NATIONAL INSTITUTE OF
ENGINEERING
(Dept. 461), 143, HOLBORN,
LONDON, E.C.1.

COPPER WIRE

ENAMELLED, TINNED, LITZ, COTTON AND SILK COVERED. RESISTANCE WIRES. 1 oz., 2 oz. & 4 oz. REELS. All gauges available. B.A. SCREWS, NUTS, WASHERS, soldering tags, eyelets and rivets. EBONITE AND BAKELITE PANELS, TUFNOL ROD, PAXOLIN TYPE COIL FORMERS AND TUBES. ALL DIAMETERS. Latest Radio Publications. SEND STAMP FOR LISTS

SPECIAL OFFER

G.E.C., B.T.H. & WESTINGHOUSE
GERMANIUM
CRYSTAL DIODES

1/- each. Postage 2d.

Diagrams and three Crystal Set Circuits Free with each diode. A large purchase of these fully GUARANTEED diodes from the manufacturers enables us to make this attractive offer.

CRYSTAL SET
INCORPORATING THE SILICON
CRYSTAL VALVE
Adjustable Iron Coated Coil.
RECEPTION GUARANTEED
Polished wood cabinet, 15" post 1/3
A REAL CRYSTAL SET, NOT A TOY
POST RADIO SUPPLIES
33 Bourne Gardens, London, E.4

News from the Trade

NEW PLESSEY TURRET TERMINAL

A NEW type of rolled turret terminal, which combines similar efficiency with lower cost when compared with conventional types made from solid materials, is now being manufactured by the Plessey Company, Limited.

The design of this new terminal represents a considerable advance on previous types as a series of serrations has been added to the underside of the flange, thus preventing the terminal from rotating when overheated or when knocked.

Designed to meet the requirements of the Joint Services Radio Component Specification, these Plessey turret lugs are made from brass to B.S.27 and are silver plated.

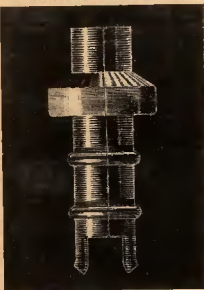

A view of the
new Plessey
Turret Terminal

Terminals of this type are particularly useful in that they can be applied to tag-boards and terminal strips made to manufacturer's individual requirements.

They are available in two sizes as follows:

X.T.1 with a base diameter of 0.078in., for use where maximum wire size for centre hole is no greater than 0.028in. diameter (22 s.w.g.).

X.T.2 with a base diameter of 0.100in., for use where maximum wire size for centre hole is no greater than 0.048in. diameter (18 s.w.g.).—Plessey Co., Ltd., Ilford, Essex.

SIEMENS-EDISWAN TRANSISTORS

THE Siemens-Ediswan Organisation now manufacture a complete range of hermetically sealed transistors, covering uses for low frequency amplifiers, intermediate frequency amplifiers, radio receivers and recording/reproducing equipment.

Other types of transistors are being actively developed by Siemens-Ediswan Laboratories. Literature is available from the Edison Swan Electric Co., 155, Charing Cross Road, London, W.C.2.

E.M.I. HAND STROBOSCOPE

A NEW Hand Stroboscope (Type 5) is the latest addition to the range of EMI Stroboscopes which includes the well-known high power white light type 3 and the general purpose Type 4.

The Type 5 is a hand-held instrument built on simple and robust lines and designed primarily for use in small workshops, factories and garages for the obser-

vation of rotating and reciprocating machinery. Its scale covers a range of 300 to 6,000 r.p.m., and operation is from A.C. mains of 220-240 volts, 50 cycles.

The price of the Type 5 Stroboscope is £18 18s. 0d., and it is now available for early delivery.—EMI Electronics Ltd., Hayes, Middlesex, England.

CHANGE OF ADDRESS

RUNBAKEN ELECTRICAL PRODUCTS have recently removed their head office, sales and service departments and account offices into a new building at 45, Oxford Road, Manchester, 1.

A USEFUL HANDBOOK

ELECTROTHERMAL ENGINEERING have recently published the second edition of their well-known valve retainer and valve data handbook.

This book has been brought right up to date and considerably enlarged to include the majority of CV valves and their commercial equivalents with the appropriate data on retainers and top-cap connectors.

Copies are available from the publishers, Electrothermal Engineering Limited, 270, Neville Road, London, E.7.

NEW MULLARD VALVE FOR U.H.F. MOBILE RADIO

THE V.H.F. band now in use for mobile radio was allocated for Band III television some time ago. Eventually, therefore, it will be cleared of mobile users, who may have to move to a new U.H.F. band (450-460 Mc/s). At present, no British mobile station operates in this band, largely because technical problems bound up with the use of ultra high frequencies greatly increase the cost of suitable equipment over that for V.H.F. working. One such problem is that radio valves suitable for the V.H.F. band may be quite inefficient at the new frequencies. Valves for U.H.F. working available up to now have tended to be rather bulky, expensive, and of high power consumption.

A new Mullard valve, the QOV02-6, marks an improvement on all three counts. Little bigger than one of the miniature receiving valves of a modern television set, it will function efficiently up to 500 Mc/s, giving enough power output for mobile working.

The QOV02-6 is a miniature double tetrode power amplifier valve on the novel (B9A) base. Its centre-tapped heater can be operated from either a 12.6 volt, 0.4 amp. or a 6.3 volt, 0.8 amp. supply. A high value of mutual conductance (7 mA/v per section) has been obtained by incorporating the latest type of control grid, by means of which very fine grid wires are positioned very close to the cathode. The grid-anode capacitances are internally neutralised, so that stable operation is obtained when the two sections are used in push-pull amplifier circuits.

As a power amplifier at 490 Mc/s, the QOV02-6 delivers 3.5 w. to the aerial under typical circuit conditions when operated at maximum ratings with anode and screen modulation. The drive power needed is 1.4 w., and this can readily be obtained from another QOV02-6 operating as a frequency tripler from about 163 Mc/s. The H.T. voltage needed is 180 volts. No special cooling arrangements are necessary.—Mullard Ltd., Century House, Shaftesbury Avenue, W.C.2.

Programme Pointers



NONE of the plays in the R. C. Sherriff Festival equalled "Journey's End" in those qualities of heart and mind that go to the making of the really "great" play. But they make good entertainment. Each asks us to ponder over some social problem or other. In "The Telescope," for example, we are confronted with the family life and background of children in the East End of London. One boy in particular, with a very bad record, comes under the aegis of the new vicar, a young man whose forebears he considers were largely responsible for the squalid conditions he finds in his new parish. Promising to do "all he can" for the lad the boy lies to him over the loss of a telescope from a local shop. The police come. A false statement from the vicar will save him untold hardship as well as his place in the merchant navy. But the untruth is not forthcoming, and we are left with the young delinquent cursing the vicar in no measured terms. Typical Sherriff.

The piece was well acted by, among others, Sebastian Shaw as the vicar and Bunny May. They brought conviction to the characters.

"Mathray Beacon" was a strong and original piece of play writing, by Giles Cooper, about an unusual army detachment. It had an awful lot of "shuns" in it, and various other commands. Maurice Denham was excellent as the ranker type of officer, Lieut. Gann, who gives all these orders.

Shaw's "You Never Can Tell" rippled along with inconsequential gaiety (he wouldn't mind my saying that as he only ranked it as a box-office pot boiler himself). Rowena Cooper as Dolly, Robert Bernal as Valentine "the five-shilling dentist," Allan Geayes as Crampton the landlord, Eric Anderson as McComas the lawyer, all shone in the good cast.

Flotsam's new role of presager of items in verse and with tinkling accompaniment won't be everybody's cup of tea. Perhaps it is a slight infiltration from across the ocean; I wouldn't know. Or maybe it has its own personal significance: again I am in the dark. One can only hope that, like fine days in summer, it will be used sparingly.

Music

"Music to Remember" is a pleasant series of concerts given by the various regional and provincial orchestras on Mondays between seven and eight on the Home service. Each item is prefaced with specially unsophisticated remarks by various well-known musical broadcasters and commentators. The programmes are, almost without exception, blameless and unexceptionable, consisting, as they do, of the most popular numbers from the most popular repertoires. Large audiences—they are held in public—applaud them to the echo.

The title of the series gives rise to speculation as to what apparently should be remembered and, by their planned omission, those works which presumably are best forgotten. Needless to say, wide

Our Critic, Maurice Reeve, Reviews Some Recent Programmes

differences of view would be revealed on this if a referendum were taken, especially concerning those compositions we have not yet heard. Many of these would receive votes for inclusion. But, rather like Caesar's Wife, or The Golden Treasury, there are other times and other programmes over which the feathers of criticism can be let fly. Sufficient is it that these particular ones possess considerable entertainment value to those large numbers who like a nice dollop of jam on an already well sweetened pudding. And who can blame them?

Shaw

Admirers of Shaw's "St. Joan" must have turned with avidity to a Frenchman's treatment of the same subject. Anouilh's "The Lark" was given twice on the "third." Whilst I preferred Shaw's greater passion and forthrightness the Frenchman's clarity and cold logic were fascinating. Of one scene there cannot, surely, be two opinions. Of Joan's renunciation of her confession. Shaw has built up one of the great climaxes of all stage drama. Anouilh's interpretation contains nothing that is dramatically comparable.

The piece was beautifully given and produced. Monica Grey played Joan. It was greatly praised by the critics when produced in London last year.

Hancock

The episode of "Hancock's Half Hour" I recently listened to concerned his making a statue *à la* Henry Moore. To obtain material for it he demolished Waterloo Bridge, Nelson's Column and various other public monuments. Imaginary news bulletins were broadcast giving day-to-day progress reports on the destructive work. It was all mildly amusing. Someone I was listening with told me it was not one of the best. I hope she was right.

Coates

The gulls continue to mew, the waves to break on the rocks and Eric Coates's music to beguile us regularly every Monday at 1.10, as Roy Plumley insinuatingly invites us to join some well-known person on his "desert island," accompanied by the eight records and unlimited supply of needles. Knowing both what a "desert" and an "island" are, I have always been at a loss to get at the geographical definition of a "desert island," my gazetteer being unhelpful. The signature tune of this series clearly connects it, as I say, with waves, birds and surf. But why? It might, surely, just as likely be an oasis in the Sahara.

Stern's NEW!! "fidelity"

A TAPE RECORDER WITH EVERYTHING EXCEPT A HIGH PRICE

BEFORE CHOOSING YOUR TAPE RECORDER YOU MUST HEAR THIS NEW "fidelity" MODEL. It HAS... The BRENEL 3 Speed Tape Deck and a "fidelity" Tape Amplifier, based on a new design by the MULLARD TECHNICIANS and which we consider to be one of the best now available... Truly HIGH FIDELITY RECORDINGS are obtainable.

HOME CONSTRUCTORS

YOU CAN BUILD THE COMPLETE RECORDER for **£42/10**

(plus £1.0.0 carriage and insurance of which 10/- refunded on return of Packing Case).

TERMS: Deposit **£10.12.6** and 9 monthly payments of **£3.17.11** or Deposit **£21.5.1** and 12 monthly payments of **£1.18.5**. The BRENEL TAPE DECK and the "fidelity" TAPE AMPLIFIER are supplied tested and ready for use, and the actual assembly of the Recorder is extremely simple involving only a few connections for which a step-by-step chart is supplied.

IF YOU OWN YOUR OWN CABINET WE WILL SUPPLY... The BRENEL TAPE DECK, the "fidelity" TAPE AMPLIFIER, MATCHED P.M. SPEAKER and 1,200 ft. reel PLASTIC TAPE.

ALL FOR **£36**

(plus £1.0.0 carriage and insurance of which 10/- refunded on return of Packing Case).

TERMS: Deposit **£9.0.0** and 9 monthly payments of **£3.6.0** or Deposit **£18.0.0** and 12 monthly payments of **£1.13.5**.

PRICE OF COMPLETE RECORDER

Including Moving Coil Mike and 1,200 ft. Reel of Tape **£46/0**

(plus £1.0.0 carriage and insurance of which 10/- refunded on return of Packing Case.)

TERMS: CREDIT SALE TERMS Deposit **£11.10.0** and 9 monthly payments of **£4.4.0**. HIRE PURCHASE TERMS Deposit **£22.0.0** and 12 monthly payments of **£2.2.8**.

MODEL HF/TR2 AMPLIFIER

Expressly designed to meet the requirements of enthusiasts for High-Fidelity reproduction.

Based on a new design developed by the MULLARD TECHNICIANS, and only really high grade components are incorporated, truly HIGH FIDELITY recordings are obtainable whilst "Hi-Fi" reproduction is assured by use of a high quality Output Transformer by GILSON.

THE MODEL HF/TR2 "Fidelity" TAPE AMPLIFIER, including POWER SUPPLY UNIT and MATCHED SPEAKER is available separately for **£16.16.0**. THE 3-Speed BRENEL DECK also available for **£18.18.0**.

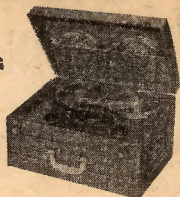

If you cannot call and hear this recorder—send S.A.E. for fully descriptive leaflet.

- High Quality Output Transformer by Gilson.
- 3 Speeds 31, 71 and 16in. TWIN TRACK.
- Position provided for use as straight Amplifier.
- Efficient Tone Control arrangement.
- High grade Components throughout.
- Two position equaliser for 31 and 71in.
- Monitor and Extension Speaker Sockets are provided.
- Beautiful styling of Cabinet.

STERN RADIO LIMITED

109 & 115 FLEET ST., E.C.4.

Phone: FLec Street 5812, 3/4

HANNEY offers Components for

OSRAM 912 PLUS AMPLIFIER
OSRAM 912 PASSIVE UNIT
OSRAM 912 PRE-AMPLIFIER
OSRAM F.M. PLUS TUNER

MULLARD 510 AMPLIFIER
MULLARD 510 "A" PRE-AMPLIFIER
MULLARD 510 "B" PRE-AMPLIFIER
MULLARD 3/3 AMPLIFIER
MULLARD F.M. TUNER UNIT

"WIRELESS WORLD" F.M. TUNER UNIT
DENCO MAXI-Q F.M. TUNER UNIT

Manually available:

912 PLUS AMPLIFIER—4/-; OSRAM F.M. PLUS TUNER—2/6; MULLARD HIGH QUALITY AMPLIFIER MANUAL (contains F.M. details)—3/6; DENCO F.M. TUNER—1/6.

Send 21d. postage, stating lists required. General Components list also available.

L. F. HANNEY
77, Lower Bristol Road Bath

G2AK This Month's Bargains

Don't miss this one!

CRYSTAL HAND MICROPHONES



As illustrated, in silver hammer case with polished grille, handle and 4 feet screened lead. ONLY 21/-.

REPANCO, DENCO, EDDYSTONE, etc. Coils and components always available at standard list prices, full range of resistors, ceramic and S/M Condensers. From Stock.

HEADPHONES. H.R. Type 4,000 ohms, very sensitive. Only 12/6 pr. Post 1/6. C.L.R. type (low res.) 8/6. Post 1/6. AMERICAN BREAST MIKES, swivel head, push to talk and lock-on switch. Excellent job. Only 12/6. Post 1/6. BRITISH BREAST MIKES complete with pr. of H.R. 4,000 ohm phones in wooden carrying case. New W.D. stock, unrepeatable at 17/6. Post 2/-.

AERIAL WIRE. Copper, 7/25 stranded: 140ft. 10/-, 70ft. 5/-; Hard Drawn 14g.: 140ft., 17/-; 70ft., 8/6. P. & p. 2/-.

RIBBED GLASS 3in. AERIAL INSULATORS, 1/6 ea., or 6 for 7/6. 12 or more post free. Small Shell Porcelain, 4/6 ea., or 4/- doz.

CONDENSERS. 8µF 600 v. Trop. 750 v. normal condensers. NEW, ex W.D. stock, 5/6. P. & p. 1/6. New TCC Type III. 8 mid. 1,000 v. D.C. wk'g. (List over £3.) OUR PRICE 10/6. P. & p. 1/9.

No C.O.D. an orders under £1.

PLEASE PRINT YOUR NAME AND ADDRESS

CHAS. H. YOUNG LTD.

Dept. 'P' 110, Dale End, Birmingham 4. (CEN 1635)

I DID IT MYSELF!

You will say, and it is so easy.

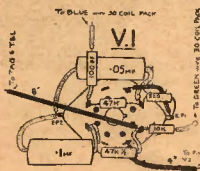

This very much reduced reproduction of a sub-assembly from one of our series of "LIFE-SIZE," "EASY-AS-A.B.C." CONSTRUCTION SHEETS illustrates how really simple radio assembly can be for the Home Constructor! If you have average ability you could tackle any, or all, of our range of GUARANTEED OUTFITS! Knows that with the help of the pre-aligned units failure is virtually impossible! No previous radio knowledge necessary.

The 1957 issue of our Handbook is beautifully printed on glossy art paper with a full colour cover! Packed with technical data, set building and servicing hints, facts and formulae, resistance colour code, soldering hints, etc., together with descriptions, full parts lists and circuits of modern receivers, tape recorder, feeder units, etc., etc. (for list see previous ads.). Send 2/6 (plus 4d. post).

• AND our renowned "Easy-as-A.B.C." FULL SIZE Construction Sheets are available FREE with orders enabling even the beginner to get professional results first time! Coil packs and I.F.T.s pre-aligned. We supply ALL parts for ALL circuits. NEVER BEFORE HAS THERE BEEN A BOOK SO VALUABLE TO NOVICE AND EXPERT ALIKE! GET YOUR COPY—DON'T DELAY—SEND TODAY!

RODING LABORATORIES

(Dept. TC27) Bournemouth Airport, Christchurch, Hants

GET THE RODING HOME CONSTRUCTOR'S HANDBOOK.

TELETRON FERRITE ROD AERIALS

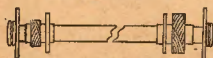

Wound on high permeability Ferroxcube rod. MW., 8/9; Dual-wave, 12/9.

TRANSISTOR COILS

315 kc/s, I.F.T.s and Osc. coils in cans (1 x 3/4 in.), 6/6 each. MW. Transistor Ferrite Aerial (type FRM/2), 10/- each.

Stamp for complete list and circuits.

THE TELETRON CO.,
LTD.
266, Nightingale Road,
London, N.9
HOW 2527

6/12 volt Rectifiers. 1 amp, 7/6; 2 amp, 10/-; 3 amp, 12/6; 8 amp., 35/- P. & P. 1/6. Charger Transformer. 1 amp., 14/6. P. & P. 2/-.

Special Heavy Duty Transformer. 400-0-400 v. 200 mA. 5 v. 2.5 a. 4 v. 2.5 a. 6.3 v. 5 a. 4 v. 4 a. 25/- P. & P. 3/-. Mains Radio Transformer. 250-0-250 v. 80 mA. 6.3 v. 4 a. Suitable for use with 6X5 rectifier. 7/6. P. & P. 2/6.

.25 M.P. Electric Motors, Single phase. Self-starting. Brand new by E.D.C. Foot mounted. Guaranteed. 97/6. Carriage 5/- .5 mA Relays. 2 windings, 1,000 ohms and 4 ohms. Adjustable contacts. 3/6. P. & P. 1/-.

12 volt Mobile Public Address Equipment. Complete with loud speaker and crystal mike. 12 watts output. New condition. 117/10. C.P.

Money back guarantee on everything. When in Exeter call and see our large stocks.

ELECTROSURP
120, Fore Street, Exeter

Phone 56697.

RADIO AND TELEVISION COMPONENTS

All parts in stock for: Viewmaster, Soundmaster, Teleking, etc. Easy Terms available. 2id. stamp (only) for Catalogue.

JAMES H. MARTIN & CO.,
FINCHWAITE, NEWBY BRIDGE,
ULVERSTON, LANCs.

UNIVERSAL SHUNTS. 1% accuracy for any 1 mA or 500 μ A meter. Only one simple adjustment to make, no calibrating meter required. With instructions. Guaranteed one year. AS05 (5 mA) covers 2, 10, 20, 100 and 500 mA. SS1 (1 mA) covers 2, 10, 50, 200 mA and 1 amp. Price 15/6.

SHUNTS for all meters with ranges to your specification. Reasonable prices. Please give meter details, accuracy required, etc. RESISTANCE BOX STANDARDS. Twelve wirewound resistors, 1, 2, 2.5, 10, 20, 50, 100, 200, 500 ohms to give any value between steps, and 1.10 ohms in 10m steps. 0.5% accuracy, 30-; 0.2%, 41-; 0.1% to 10 to 11.10 in 10 ohm steps 0.5%, 30-; 0.2%, 43-. Dia but 1 to 11.10 in 1 ohm steps (16 resistors) 0.5%, 42-; 0.2%, 58-.

BRIDGE RATIO ARMS. 1,000 ohms tapped at 100 and 10 ohms. Pair gives ratios of 100, 10, 1, 0.1, 0.01 to 1, accuracy 0.1%, 19/6 pair.

PRECISION WIREWOUND RESISTORS. Any value 1 to 1,000 ohms, 0.5%, 2/9; 0.2%, 3/9. 1,000 to 5,000 ohms, 0.5%, 3/3; 0.2%, 4/3. CALIBRATED POTENTIOMETERS FOR R.C. BRIDGE EN. A set Wirewound. Pots complete with hand calibrated scale suitable for workshop RC Bridge, 10/6 with circuit.

AVO VALVE TESTER. Roller panel type, used, in good condition, 29.15.0 post paid.

AVO SIGNAL GENERATOR. Used, good condition, 19/6 model, 57.10.0 post paid. Another with mains transformer fault, 86.5.0 post paid.

AMPLIOM A/C D.C. TESTMETER 10 range. Used, good condition, 43.10.0 post paid. 100 Kva Crystals, 10/- each.

S.A.E. with enquiries, please.

PLANET INSTRUMENT CO.
25, Dominion Ave., Leeds, 7.

LYONS RADIO LTD.

Dept. M.P., 3, GOLDHAWK ROAD,
SHEPHERDS BUSH, LONDON, W.12.

Telephone: SHEPHERDS Bush 1728.

RECEPTION SETS TYPE R.109. EX-ARMY 8 valve superhet. receivers employing 5 ARPIPs (VP28) and 3 ARSs (HU.310D). P.R.109 12 v. 12 x 11in. In good condition. power pack for operation from 6v. accumulator. Frequency range 1.8 to 8.8 Mc/s (65 to 147 metres). Front panel is fitted with all controls including R.T.C.W. switch and 2 jacks for stereoscopic headphone reception. Size 12 v. 12 x 11in. In good condition. supplied with circuit diagram and aerial tested. PRICE ONLY 85/- or less unless PRICE ONLY 45/- Carriage 10/-.

AMERICAN I.P.F. UTIN. Contains wealth of useful components including relays, 10 valves (6-8HT's, 2-718's, 2-616's) and rotary converter rated at 400v. D.C. output for B.V. D.C. input. One end of converter is fitted as a Blower Motor which operates from either 6v. or 12v. accumulator. The other end is fitted with a 4 x 4 box, easily removed if desired, and the two driving shafts which protrude rotate at approx. 4 and 16 r.p.m. for 1/2v. input and half this for 6v. input. In good condition. PRICE ONLY 30/-, carriage 5/-.

LORENZ HIGH FREQ. PENCY SPEAKERS. Specially designed to reproduce those higher frequencies in the sound spectrum from 1.0 to 20 Kc/s. Connected across your existing speaker is essential to bring reproduction to life and for it to acquire a sparkle and realism previously unobtainable. Essential for the high quality reproduction of modern I.P. recordings, M. and T.V. transmissions. Can be used with any standard speaker and loaded up to 25 watts. Size approx. 2in. dia. x 2 1/2in. deep. Supplied with full connection details and S.A.E. for further particulars. PRICE 9/6, post free.

Open to Discussion



The Editor does not necessarily agree with opinions expressed by his correspondents

Amateur Licence

SIR,—I note from recent correspondence in "Open to Discussion" that S.W. listeners continue to press for the issue of novice licences, seizing every opportunity to reopen the campaign.

Having read "Thermion's" article several times I still cannot reconcile the need for a national amateurs' association with the need for a novice licence. To start with, the article deals specifically with those interested only in reception, which implies those who do not wish to graduate to a transmitting licence; why then the red herring in the shape of the novice licence?

Discounting the many ingenious excuses put forward to support the case for novice licences, it is patently obvious that the root of the matter is the apathetic approach by a minority of listeners to the technical and Morse examinations.

If, as one correspondent suggests, the G.P.O. requirements are a deterrent to the listener, this surely is a matter for the listener's conscience, and not a reason for circumventing them.

Those whose ultimate goal is a transmitting licence should, by virtue of their interest and determination, accept the examinations as a necessary and justifiable test of their competency to operate transmitting equipment in order to fulfil the conditions of the licence.

The demands for novice licences are in reality individual admissions of the lack of ability and determination to tackle these examinations and should be dismissed as such.

There is only one way to make the grade in this life, that is to work for it, and it is to be hoped that the present widespread doctrine of "something for nothing" is not allowed to spread to amateur radio.

—L. O. RICHARDSON (Kent).

SIR,—With respect to the letters of H. F. Barker and L. G. Hutton: (a) Of what use is the G.P.O. Morse test for an operator who intends to use phone only? Admittedly it is necessary for the code operator in order that he does not spoil other people's Q.S.O.s. But no amount of experience with the key will make a phone operator operate any better.

(b) Originally one used to obtain a transmitting licence by filling in a question paper sent to you by the G.P.O. Surely this principle could be used for a "novice" licence? This would give the "ham to be" some practical experience so that he could then take his R.A.E. and his Morse test and become an operator with the authority of the ham today.

(c) In U.S.A. there are several grades of licences. Surely if that principle was adopted in this country a great many problems would be solved? The various licence grades could be allocated roughly as follows:

(1) Novice: The applicant must complete question paper sent to him under the invigilation of someone else who then has to sign the answer paper to say that the applicant did not cheat.

Allowed only to use crystal controlled transmitters.

Allowed to operate on restricted frequencies.

Allowed to use certain types of emission only.

Allowed to operate with restricted power.

And a licensed amateur must examine the station before it goes on the air

and then every month afterwards, signing the log book at each visit.

(2) Phone: For the operator who intends to work phone only:

Must have radio amateurs' examination.

Morse test not necessary.

(3) General: For the phone and C.W. operator as the present-day licence with both Morse test and radio amateurs' examination necessary.

I shall await with interest any correspondence concerning the above.—F. B. BLAKE (G6786) (Beaconsfield, Bucks).

SIR,—I was indeed interested in the letter under the above heading in your December issue.

In the late 'thirties I dabbled (as a schoolboy) in S.W. listening on a very meagre pocket, and am under the impression that there were two different licences for transmitting—full power and "artificial aerial." I am now a married man with my own family and find it impossible to purchase the necessary equipment to break into the licensing operators' field, as the requirements needed are indeed expensive and would have to be purchased outright, whereas a "novice licensee" or "half-power type" could learn the use of his smaller equipment and slowly build up his apparatus as well as his knowledge until he could join the "full powered brigade." Is not this one of the biggest stumbling blocks?

This class would be of immense value to the Services in the case of another national emergency, requiring minimum training, possibly limited to the apparatus in use.

May I suggest representations be made to the P.M.G. on these lines? I would leave the initial vetting to a P.O. official rather than a licensed operator, mainly on the ground that "official vetting"

Whilst we are always pleased to assist readers with their technical difficulties, we regret that we are unable to supply diagrams or provide instructions for modifying commercial or surplus equipment. We cannot supply alternative details for receivers described in these pages. WE CANNOT UNDERTAKE TO ANSWER QUERIES OVER THE TELEPHONE. If a postal reply is required a stamped and addressed envelope must be enclosed with the coupon from page iii of cover.

would avoid trouble with that body of persons in the future.

Analysing it down I would say: (a) Limited power for transmitting (say 100 mile radius). (b) Crystal-controlled equipment tested beforehand by P.O. official who could call and inspect for a small charge and possibly give advice on operation. (c) Knowledge of Morse code, say 5/6 w.p.m. (which is most essential to start in the field). (d) Small annual fee.

I would be prepared to put my name to such representation.—D. A. GRIFFITH (Wisbech).

Battery-operated Tape Recorder

SIR.—I have received since publication of the article "Battery Operated Tape Recorder" many enquiries regarding technical aspects of the instrument. I have, therefore, picked out those queries which occur many times and enumerate them and their answers below.

(1) What is the valve line-up?

Three 6AR2s and one 6AT6.

(2) Can the instrument be converted to operate from the mains?

For this one would require a conversion unit supplying 90 volts H.T. and 3 volts L.T. from 250 volt A.C. supply. Such a device could easily be constructed. However, a far superior plan would be to redesign the amplifier using mains valves.

(3) Would it be in order to use an electric gramophone motor to drive a capstan?

This would indeed be possible. The only reason why a clockwork motor was referred to was to make the instrument independent of the mains. Capstan drive is, of course, superior to direct drive, in that the tape speed is constant.

(4) How are recordings erased?

Fig. 8 in the article shows erasing. The tape is made to run past a smooth permanent magnet. This, in effect, saturates the tape with magnetism, thereby destroying the recording.

(5) Is there any danger of the biasing magnet erasing the recordings as they are made?

No, providing the magnet is placed as shown in Fig. 7. Simply, the tape must pass the magnet before the recording head.—B. L. WILKINSON (Exeter).

A Transistor Hint

SIR.—Is it generally known that with a minute voltage at one side of a germanium diode and 1.6 volts from a grid bias battery at the other an astonishing degree of amplification can be realised? The circuit to achieve this result is simplicity itself, but I will not bore readers with the details as this field is already well mapped.

Actually I discovered this phenomenon quite by accident when carrying out some experiments on inductance.—ROBERT D. McCAWLEY (Beasley).

Radio Society Correspondents Wanted

SIR.—The radio society of which I am a member would be very interested to hear from other

school societies. If any other schools are interested we will gladly take up correspondence with them. We should be grateful for the help of hams and amateurs with spare radio parts because the increased price range for radio parts is making it increasingly difficult to run a radio society efficiently.—C. J. LAWSON (Bootham School, York).

A Reader's Views

SIR.—As a reader of PRACTICAL WIRELESS since round about 1948 might I give my views?

First of all about these nice bright covers: they may look attractive on the bookshop counter, but when I buy a different radio magazine at odd times it is because the front cover has a list of articles, one of which I wanted to read. A list just like PRACTICAL WIRELESS used to print.

Having got past the cover next comes "Open to Discussion." It is nice to read the other chaps' views, stuff put together and results. So why not an extra page?

After this I read Mr. Camm's "Comments of the Month."

Then "Servicing Radio Receivers," always hoping it will be one I own. Although it works it would still be of interest to see the circuit.

For F.M. I use the Denco unit and a Williamson amplifier. Would an expert like to say the point of de-emphasis in the F.M. unit only to do the opposite on the pre-amp. As is well known, loud speaker response is not so good at the top end. As cutting top cuts some noise, why not at the last stage?

Taking the other end of tone control, how nice some of the old pre-war sets sound as far as bass response goes, even although you might have only a 6in. speaker. I think this is because the boost is just low enough to miss speech and catch music, whereas on these push-pull amplifiers any boosting of bass is at so low a frequency it can only be heard once in a while.

The aerial for F.M. that I use is supported by old ban sticks and string over the front room. A reflector is used, a former dinghy aerial. Although shop type aerials have been tried, one up a 25ft. pole, this ugly mess still gives most signal. On the EM80 it is just enough to send the bright light to where the glass curves.

Speakers used—one 12in. Goodman's and an electrostatic tweeter. I think the cross-over frequency of the latter is too high (2,000 c.p.s.) for it to do much good, or maybe the output is just not up to moving coil standards.

One tip before I close. With push-on spring-loaded knobs I find a little solder on the spindle makes the loose ones fit much better than trying to wedge them with matchsticks, etc. The solder being soft is easy to file to shape.—G. ARTHURELL (Croydon).

WIRELESS COILS, CHOKES AND TRANSFORMERS

8th Edition.

Price 6/-. by post 6/9.

The Editor will be pleased to consider articles of a practical nature suitable for publication in "Practical Wireless." Such articles should be written on one side of the paper only, and should contain the name and address of the sender. Whilst the Editor does not hold himself responsible for manuscripts, every effort will be made to return them if a stamped and addressed envelope is enclosed. All correspondence intended for Owing to the rapid progress in the design of wireless apparatus and to our efforts to keep our readers in touch with the latest developments, Copyright in all drawings, photographs and articles published in "Practical Wireless" is specifically reserved throughout the countries signatory to the Berne Convention and the U.S.A. Reproductions or imitations of any of these are therefore expressly forbidden. "Practical Wireless" incorporates "Amateur Wireless."

SUPPRESSING RADIO & TELEVISION INTERFERENCE

by B. L. Morley. 5/- Postage 4d.

TRANSISTOR CIRCUIT HANDBOOK. By L. E. Garner, Jr. 40/- Postage 1/-

IMPROVE YOUR RECEPTION. By J. Curá and L. Stanley. 5/- Postage 4d.

TRANSISTOR TECHNIQUES. A Gernsback Laboratory publication No. 61. 12/- Postage 6d.

TV CONVERSION FOR I.T.A. By C. E. Lorch. Price. 25/- Postage 9d.

MAINTAINING HI-FI EQUIPMENT. By J. Marshall. 23/- Postage 1/-

RADIO VALVE DATA. Compiled by "Wireless World." 4/6 Postage 6d.

RADIO DESIGNER'S HANDBOOK. By F. Langford-Smith. 42/- Postage 1/-

The MODERN BOOK CO.

BRITAIN'S LARGEST STOCKISTS of British and American Technical Books

19-23, PRAED ST., LONDON, W.2

Write or call for our catalogue. Phone: PADdington 4185. Open 6 days 9 p.m.

YOU CAN MAKE MONEY!

Our 'Know-How' shows the easy way
NO RADIO KNOWLEDGE NECESSARY

... for the "GOOD COMPANION" Portable

Use long nights and spare time profitably. Make these superb Battery Portables for yourself and your friends—our 'Faultless Technique' makes it so easy.

- 4 VALVE SUPERHET
- MEDIUM & LONG WAVES
- ONLY SCREWDRIVER, PLIERS & SOLDERING IRON NEEDED
- 7 GNS. COMPLETE WITH EASY INSTRUCTIONS



YOU CAN'T GO WRONG WITH THE NEW "FAULTLESS" TECHNIQUE—WRITE FOR DETAILS NOW—ONLY 1/6 POST FREE!

The **SIMPLE SUPERHET** at **ONLY 139/6**
A perfect 5 Valve Superhet for Home Construction—just the job! (plus 2/8 p. & p.)

The **METEOR III TRF** at **ONLY 109/6**
The 3 Valve with the BIG output (plus 2/8 p. & p.)
—ideal for the beginner!

Send for 'Know How' Diagrams—**ONLY 1/6 POST FREE.**
(Tell us which set you prefer)

NORMAN H. FIELD Electronics

Dept. PH., 68, Hurst St., Birmingham, 5. Birmingham's Largest Constructors' Store

ALFRED PADGETT

40, MEADOW LANE, LEEDS 11
TEL.: CLECKHATON 99.

RADIO VALVES with 90 days guarantee, post 5d. per valve. Doz. lots post free. Less 5%.

6E30, 4/-; 6K7, 2/-; 607 (British), 4/-; 6SN7, 6/-; 6X5, 4/6; 6C6, 3/6; 6E4, 1/3; 5004, 6d.; CV63, 1/-; 616, 6d.; 6EM4, 1/3; 2X2, 1/6; 6V111, 1/6; 6V137, 1/3; 6V130, 4/-; 6V165, 1/6; 6V169, 1/-; 6V164, 6d.; 612, 1/-; 6E8, 2/-; 6D5, 3/-; 6J5, 3/6; 6T30C, 6/-; U16, 6/6; KT2, 3/6; 6EM4B, 2/6; 6V160, 3/4; 6C4, 5/-; 6AC5, 5/-; 6AC7M, 4/-; 6LS10, 2/6; 6E60, 6/6.

250 ONLY. RECOMMENDED 80 WATT LATEST TYPE QUICK START FLUORESCENT BALLAST UNIT. 12 months guarantee. 17/6, post 3/-, 200-250 volts A.C. Worth five times the price offered.

50 FT. 1 M.M. SLEEVING. 1/-, post 7d.

AMERICAN MADE RTG VALVE PIN STRAIGHTENER. Bench Type 2/6, post 1/-. This little gadget will save you pounds.

12 AND 6 VOLT DOUBLE CONTACT LAMPS. 12 watt. New and Boxed. 1/-, post 6d. 9/- a doz. Post free.

TN1154 MODEL N. Three valve band, new condition. Complete with 4 valves and two meters. 17/6, post 12/-.

NEW RECEIVERS. RDF.1. less valves, 5/6, carr. 7/6. Circuit for conversion to two meters. Price 2/- extra.

WIND E.A. NUTS AND BOLTS. 1lb. weight, 1/-, post 9d.

NEW EFO VALVE BANES. Ceramic. 3d. each, 2/6 doz. Post free.

SMALL 24 VOLT A.C.D.C. MOTOR. 1.833 revs. 1/2 in. Good torque on 12 volts. Brand New. 3/6, post 1/6.

MIXED RADIO PANELS. Full of resistors and condensers. 4/6 for 12, post free.

PARTS REMOVED FROM NEW T.A.B. UNITS. Micrometer Drive, complete. 2/6, post 1/-. Handies, 8d., post 6d. Coil Formers (Pot), 6d., post 6d. Switch and Knob, 9d., post 6d.

WHY WASTE TIME

Give that set its best chance
FIT QUALITY COMPONENTS

Catalogue 1/-

Parts for the following:	Manual
Osram '912' Plus Amplifier ...	4/-
Mullard 10-watt Amplifier ...	3/6
The Coventry	} 1/-
2-watt Amplifier ...	
4-watt Amplifier ...	
6-watt Quality Amplifier	} 1/-
The Coventry A.M. Tuner Unit	
Denco F.M. Tuner Unit ...	1/6

Complete Component Price Lists will be supplied with each Manual

COVENTRY RADIO

EST. 1925

169, DUNSTABLE ROAD,
LUTON,
BEDS.

Phone: Luton 2677

1-Finger Pianists

Build your own electronic keyboard and play everything! Send for free leaflet. Guitar, cello, flute and trumpet are all easy. Write now...

C & S, 10 Duke St., Darlington, Co. Durham

W. B. SUPPLIES

96, OLDHAM STREET, MANCHESTER, 4
TERMS.—Cash with order. Orders under 25/- add 9d., over 25/- add 13 postage.

SPECIAL OFFER. Collaro RC54 Auto-change Units, 3-speed, packed in maker's sealed cartons, guaranteed perfect. Our price 7 gns. plus 5/- carriage.

Mains-bridge Condensers.—4 mid. 500 v. and 8 mid. 500 v. 2/- 5/- 1 mid. 4,000 v. 2/-; Gas Cond.; 8 mid. 500 v. 1/8.

H.F. Tubes on Sin. former, ideal crystal set coil, 1/-.

Microamp Meters. Double movement, 10/-.

Mixed Resistors. 3 doz. 5/-; Condensers 3 doz. 5/-. Our selection. 5K wire wound pots, pre-set, 1/-.

Headphones suitable for Tape Recorders, 10/-.

Morse Keys, Air Ministry. 2/6.

Amplifiers for Record Changers, one valve plus rectifier, 50/-.

T.V. Aerial Book on how to make aerials for Bands 1 and II. 2/9, post paid.

Coaxial Cable (I.T.V.) 22ft. length. 3/3. Radio Aerials, insulated, 50ft. 1/9; 100ft., 3/-; Speaker Fret, expanded metal (gold), 12in. x 12in., 6d.; 15in. x 12in., 6/8; Neon Screwdrivers, 110 v. to 380 v., 3/11.

Combination Box Spanners, interchangeable, 2, 3, 4, 5, 6 B.A., 3/11. Variable Condensers, air spaced, 40 pF., 1/-; 75 pF., 2/-; 115 pF., 2/6; 75 pF. Twin, 3/6.

Filter Trans. 230 volt, 6.3 volt 2 amp, 6/6; C.R.T. Isolation Trans. with 25% boost, 2 volt input or 6.3 volt input, 10/- each.

Crossover Units for BBC & I.T.V., 7/6.

Portable Amplifiers complete with crystal m.c. on foot stand and cabinet speaker all enclosed in speaker case. Ideal for clubs, etc. 18 gns.

TV and Radio—A.M. Brit. I.R.E. on "no pass—no fee" terms. Over 85% successes. Details of exams. and home training courses in all branches of radio and T.V. write for 144-page handbook free. B.I.E.T. (Dept. 242G), 29, Wright's Lane, London, W.8.

INCORPORATED Practical Radio Engineers home study courses of Radio and TV Engineering are recognised by the trade as outstanding and authoritative. Moderate fees to 2 limited number of students only. Status of Instructional Text is free. "The Practical Radio Engineer" journal, sample copy 2/-, 6,000 Alignment Peaks for Superhets, 5/9. Membership and Entry Conditions booklet, 1/-. All post free from the SECRETARY, I.P.R.E., 30, Fairfield Road, London, N.8.

CITY AND GUILDS (Electrical, etc.) on "no pass—no fee" terms. Over 95% successes. For full details of modern courses in all branches of Electrical Technology send for our 144-page handbook free and post free. B.I.E.T. (Dept. 242A), 29, Wright's Lane, London, W.8.

VALVES—Guaranteed

DAF91 6/6	VU111 3/6	8B9W 6/6	6X4 6/6
EA50 2/-	W77 5/-	9C25 6/-	6X5 7/6
8B23 7/6	0Z4 5/-	9CH6 7/-	7H7 7/6
8CC3 8/6	1SS 6/6	8F12 7/-	8D2 4/6
8F9 5/6	1U6 4/6	6J5 5/6	6Y4 7/6
8F20 5/-	4D1 4/6	8K7G 4/6	9D2 5/6
8F31 7/-	6AR 7/6	8SA7 8/6	7D8 7/6
8L32 6/-	6AR 7/6	8S27M 6/6	12BA6 7/6
PC8A 7/6	6AM5 7/6	6SN7GT 12BB6 7/6	12BE6 7/6
11L 6/6	6AQ3 7/6	8U 12BH 7/6	8U 12BT 8/6
PT81 10/-	6AF5 7/6	6U5(X) 12K7 8/6	12K7 8/6
VT11 4/-	6BS 7/6	6US(X) 12X7 8/6	12X7 8/6
VR6A 3/6	8BE9 7/6	7 7/6	15D2 8/6
VR8 3/6	8BE9 7/6	6L7 6/6	6CS 6/6
VT20 3/6	8BS7 7/6	6V6 7/6	50L6 6/6

Postage 6d. extra. (Also all components)
"Jason", F.M. Tuner Kit, complete, £17.78, plus 26p. post.

TELEKIT SUPPLY

104, High Street, Bokenham, Kent
Phone: BEC 3720.

NEW BOOKS

Quintus Radio and T.V. Diary 1957, price 4/3, postage 4d.
Improve your T.V. Reception, by John Cura, 5/-, postage 4d.
Radio Valve Data, by *Wireless World* (New Edition), 4/6, postage 5d.
Transistor Technique (Gernsbaek Library), 12/-, postage 5d.
World Radio Handbook 1957, by Lund Johansen, 12/6, postage 1/-.
The Home Electrician, by F. J. Cannon, 12/6, postage 5d.
Impressing Radio and T.V. Interference, by Morley, 5/-, postage 4d.
Beginner's Guide to Radio, by E. J. Cannon, 7/6, postage 5d.
Loudspeakers, by Briggs, 7/6, postage 6d.

UNIVERSAL BOOK CO.

12, Little Newport Street, London, W.2
(adjoining Lisle Street)

Morse Code operating . . . as a 'PROFESSION'

45 years of teaching Morse Code is proof of the efficiency of the Candler system.
Send 2/6. stamp for Permanent Plans and Full Details of all Courses.

CANDLER SYSTEM CO., Dept. 51.0
25B, Abingdon Road, London, W.8.
Candler System Co., Denver, Colorado, U.S.A.

THE ROYAL NEW ZEALAND AIR FORCE

has vacancies for
BRITISH EX-SERVICEMEN

in the following trades:

RADIO MECHANICS RADAR MECHANICS

Commencing pay between £10.16.2 per week and £17.1.3 per week according to previous experience. Ages between 21 and 40, married or single. This is an opportunity to start a new life in New Zealand with excellent conditions of service and free passage. Limited vacancies also exist in other trade groups. Write for full information to:—

**THE ROYAL
NEW ZEALAND AIR FORCE
HEADQUARTERS (Dept. P.W.)
ADELPHI BUILDING
JOHN ADAM ST., LONDON
W.C.2.**

VACANCIES FOR SKILLED CRAFTSMEN IN GOVERNMENT SERVICE AT CHELTENHAM

Experienced in one or more of the following:—

- Maintenance of radio communication receivers.
- Sub-assembly lay-out, wiring and testing of radio type chassis.
- Cabling, wiring and adjustment of telephone type equipment.
- Fault finding in, and maintenance of, electronic apparatus.
- Maintenance of Teletypewriters or Cypher Machines and associated telegraph equipment.

BASIC PAY: £2 11s. 4d., plus up to £2 10s. merit pay, assessed at interview and based on ability and experience.
Opportunities for permanent and pensionable posts.
Five-day week, good working conditions, single accommodation available.

Apply to: Personnel Officer
G.C.H.Q. (FOREIGN OFFICE)
53, Clarence Street, Cheltenham.

GALPIN'S Electrical Stores

Send for Free List for Small Power Transformers, Electric Light and Slot Meters, Volt, Amp and Milliampmeters, etc., Transformers made to order!

Radio Bargains for Visitors.
OPEN ALL DAY SATURDAY.

408 HIGH ST. LEWISHAM
LONDON, S.E. 13 (N. Station Lewisham Junction)

OSCILLOSCOPE

(MINIATURE TYPE)

Supplied in kit form for workshop or experimental use. Complete with full instructional notes saving details of applications to radio work. Can be operated from power supply of most AC domestic radio receiver equipment or from power unit supplied as an extra.



Price £10 (inc. post/pkgs.)

(Power unit, if required, £3 extra)

Order now or send stamp for further details to:

**E.M.I. INSTITUTES,
Dept. 37, LONDON, W.4**

(Associated with "His Master's Voice", etc.)

VALVES

New Tested and Guaranteed

1R5	7/6	6BR7	8/6	8CH5	9/-	8E84	10/6
1S5	7/6	6BW7	7/6	8CH42	10/-	8Y51	11/6
1T4	7/6	6J5	6/6	8E10	10/-	8Z60	8/-
354	7/6	12AT7	7/6	8E100	10/-	KT3C	7/6
3V4	7/6	12AU7	8/-	10	10/6	UB4C	10/-
524C	8/6	50T	8/6	8F9	8/6	10-UCH210	10/-
6AL5	8/6	8Y5	8/6	8F41	10/-	UCH210	10/-
6AM6	7/6	8E84	8/6	8F9	9/6	UF41	10/-
6AT6	8/-	8E8F9	8/6	4B	4/6	UL1	10/-
6BE6	7/6	8/6	8/6	10-UL1	10/-	UY41	8/-

MATCHED PAIRS, REL. 23: 1- 6V6 and GT. 17;- 8W6, 18;- 1- KT3C, 19/6; 807, 14/8 per pair.
VOL. MC. CONTROLS, small, long spd., L.S. 3;- 8 P., 4;- 4 D.P. 4/8. All values, **PAPER BLOCKS, 4 mil., 1,000 v. wks., 2/8.** 1/2 & P. 6d.

R. J. COOPER (G8BX)

32, SOUTH END, CROYDON, SURREY
Croydon 0186

ASTRAL RADIO PRODUCTS

'HOME RADIO', 32 page illustrated booklet, simple wiring instructions for Crystal Set, 1, 2, 3 Valves, 2/-, post 3d.
'TRF COILS', Specified for Bridge Push-button 4, etc., 8/6 per, post 6d.
'Summer All Dry Portable', Modern 1 Valve, Modern 2 Valve, B 7 Battery Miniature, etc., 4/3, post 3d.
'IFT's Miniature', 1, 2, 3, 4, 5 in cons. Extra high Q. Special offer, 8/6 per, post 6d.
K COILS, F.A.C. B plus 3, 3/3 each, post 6d.
F.R.A.M. AERIALS, M.V., 5/-, post 4d.
B.F. CHOKE (Osmer O.C.I.), 6/9, post 4d.
Crystal Set Coils, L & M.W., 2/8, post 4d.

82, Centurion Road, Brighton

ANNAK'S WINTER BARGAINS

Balanced Armature phone inset, 30 ohms. New, Boxed, 2/10. Unit with toggle switch, 2 of 23 v. widgeo lamp, New, Boxed, 1/6. Morse keys, well made, 3/3. Thermal Delay Relays, 6v. New, Boxed, 2/10. Unit with lamp Thermic couple 2A, meter, New, Boxed, 7/6. Mains Transf. 200-240 v. in 110 v. 30 mA. out., 5/9. Mains Transf. 100-240 v. in, 140 v. 250 mA. out., 12/8. All in stock. Free. Mainland only. Money Back Guarantee. Free Lists, 25, ASHFIELD PLACE, OTLEY, YORKS.

RES/CAP. BRIDGE 35/-

Checks all types of resistors and condensers

Easy to Build Up Easy to Use
READY CALIBRATED

Stamp for details of this and other kits.
RADIO MAIL, 6 Ratisch St., Nottingham

YOU CAN BUILD A QUALITY TAPE RECORDER

with
"ASPDEN"

Tape Deck and Amplifier Kits



TAPE DECKS. 2 speed, twin track, easy to assemble kits, fully complete with finest motor and Ferroxcube heads.

Model 521 for 5in. spools, kit, £7/10/-

Model 721 for 7in. spools, kit, £8/10/-

Either model assembled and tested, 27/6 extra.

AMPLIFIER kit, 23 watt, record replay with two recording positions, neon indicator, etc., £5/18/- . Power pack kit for above, £2/18/6 (both without valves). Carr. and packing extra.

THIS TAPE DECK AND AMPLIFIER IS BEING USED IN THE ANTARCTIC BY A MEMBER OF THE EXPEDITION.

From the Equator to the Pole they are giving good service.

Mr. S., of Twickenham, writes:

"The whole assembly has a smooth sweet run, which is worthy of the most expensive deck. May I congratulate you on the fine value your deck offers."

Send a stamp for full particulars to:—

W. S. ASPDEN 10, Market St., Wexham,
KIRKHAM, LANCs.

Train for a wonderful
future in—

ELECTRONICS

Train to meet the need for pioneers in this
expanding field.

Every day the demand for the expert in electronics grows. Radio, television, radar and the whole field of industrial automation are rapidly expanding, and the trained specialist assures for himself a well-paid career in this quickly developing profession. Here is your opportunity to enter for

1-year course

Full-time day course in the Principles and Practice of Radio and Television. Mainly designed for the training of Radio and Television Servicing Engineers. Next course, commencing May 22nd, is already fully booked. Enrolments for following course, commencing September 11th, now being accepted.

The E.M.I. College of Electronics

Dept. 32, 10, Pembridge Square, London, W.2.

Telephone: BA Yswater 5131/2

The College associated with a world-wide electronics industry, including "His Master's Voice," Marconiphone, Columbia, etc.

Taylor

**JUNIOR
UNIVERSAL
METER**



Model 120A

A small 21-range instrument ideal for the enthusiastic amateur. Sensitivity is 1,000 o.p.v. A.C. and D.C. Accuracy: 2% D.C.; 3% A.C.

RANGES

Volts D.C.: 0-25-10-50-250-500-1,000-2,500.

Volts A.C.: 0-10-50-250-500-1,000-2,500.

Milliamps D.C.: 0-1-10-50-500-5,000.

Resistance: 0-2,000 ohms, 0-200,000 ohms.

Can be extended to 20 megohms. Automatic overload protection fitted to meter movement.

PRICE £9.15.0. PROMPT DELIVERY

CREDIT TERMS: Nine monthly payments of £1.4.4.

TAYLOR ELECTRICAL INSTRUMENTS LTD.

Montrose Avenue, Slough, Bucks.
Telephone: Slough 21381. Cables: Taylins, Slough

SPECIAL OFFER

of this famous chassis

BURGOYNE 8 VALVE RADIOGRAM CHASSIS R.G. I.

↓
YOURS

for the first of 9 equal
monthly payments of

only
51/4

**NO
INTEREST
CHARGES**

E. & G. MAIL ORDER SUPPLY CO.

The Radio Centre

33 Tottenham Court Road, London, W.1.

Tel.: MUScum 6667

TWO YEARS'
GUARANTEE

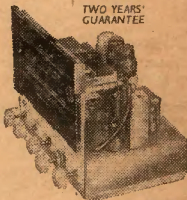

200/250v.

Carriage & Packing 7/6. Cash Price 22 gns.

A fine chassis for the connoisseur wanting only the best at a price within his means. Undistorted push-pull output giving 8 watts of quality reproduction—and using negative feedback. Separate bass and treble controls.

Practical Wireless

BLUEPRINT SERVICE

PRACTICAL WIRELESS

No. of
BlueprintNo. of
Blueprint

CRYSTAL SETS

2/- each		
1937 Crystal Receiver ...	PW71*	
The "Junior" Crystal Set ...	PW94*	
2/6 each		
Dual-Wave "Crystal Diode" ...	PW95*	

STRAIGHT SETS

Battery Operated

One-valve : 2/6 each		
The "Pyramid" One-valver (HF Pen) ...	PW93*	
The Modern One-valver ...	PW96*	
Two-valve : 2/6 each		
The Signet Two (D & LF) ...	PW76*	
3/6 each		
Modern Two-valver (two band receiver) ...	PW98*	
Three-valve : 2/6 each		
Summit Three (HF Pen, D Pen) ...	PW37*	
The "Rapid" Straight 3 (D, 2 LF (RC & Trans)) ...	PW82*	

F. J. Camm's "Sprite" Three (HF, Pen, D, Tet) ...	PW87*	
---	-------	--

3/6 each		
The All-dry Three ...	PW97*	

Four-valve : 2/6 each		
-----------------------	--	--

Fury Four Super (SG, SG, D, Pen) ...	PW34C*	
--------------------------------------	--------	--

Mains Operated

Two-valve : 2/6 each		
Selectone A.C. Radiogram Two (D, Pow) ...	PW19*	

Three-valve : 4/- each		
A.C. Band-Pass 3 ...	PW99*	

Four-valve : 2/6 each		
A.C. Fury Four (SG, SG, D, Pen) ...	PW20*	

A.C. Half-Mark (HF Pen, D, Push Pull) ...	PW45*	
---	-------	--

SUPERHERTS

Battery Sets : 2/6 each		
F. J. Camm's 2-valve Superhet ...	PW52*	

Mains Operated : 4/- each		
"Coronet" A.C.4 ...	PW100*	
AC/DC "Coronet" Four	PW101*	

SHORT-WAVE SETS

Battery Operated

One-valve : 2/6 each		
Simple S.W. One-valver	PW88*	

Two-valve : 2/6 each		
Midget Short-wave Two (D, Pen) ...	PW38A*	

Three-valve : 2/6 each		
Experimenter's Short-wave Three (SG, D, Pow) ...	PW30A*	

The Prefect 3 (D, 2 LF (RC and Trans)) ...	PW63*	
--	-------	--

The Band-spread S.W. Three (HF, Pen, D, (Pen), Pen) ...	PW68*	
---	-------	--

PORTABLES

2/-		
The "Mini-Four" All-dry (4-valve superhet)		

MISCELLANEOUS

2/6 each		
S.W. Converter-Adapter (1 valve) ...	PW48A*	

The P.W. 3-speed Autogram ...	(2 sheets), 8/-*	
-------------------------------	------------------	--

The P.W. Monophonic Electronic Organ (2 sheets), 8/-		
--	--	--

TELEVISION

The "Argus" (6in. C.R. Tube), 3/-*		
------------------------------------	--	--

The "Super-Visor" (3 sheets), 8/-*		
------------------------------------	--	--

The "Simplex" ...	3/6*	
-------------------	------	--

The P.T. Band III Converter	1/6*	
-----------------------------	------	--

All the following blueprints, as well as the PRACTICAL WIRELESS numbers before 98 are pre-war designs, kept in circulation for those amateurs who wish to utilize old components which they may have in their spare box. The majority of the components for these receivers are no longer stocked by retailers.

AMATEUR WIRELESS AND WIRELESS MAGAZINE

STRAIGHT SETS

Battery Operated

One-valve : 2/6		
B.B.C. Special One-valver ...	AW387*	

Mains Operated

Two-valve : 2/6 each		
Consoelectric Two (D, Pen), A.C. ...	AW403	

SPECIAL NOTE

THESE blueprints are drawn full size. The issues containing descriptions of these sets are now out of print, but an asterisk denotes that constructional details are available, free with the blueprint.

The index letters which precede the Blueprint Number indicate the period in which the description appears. Thus P.W. refers to PRACTICAL WIRELESS, A.W. to *Amateur Wireless*, W.M. to *Wireless Magazine*.

Send (preferably a postal order to cover the cost of the Blueprint (stamps over 6d. unacceptable) to PRACTICAL WIRELESS, Blueprint Dept., George Newnes, Ltd., Tower House, Southampton Street, Strand, W.C.2.

No. of
Blueprint

SHORT-WAVE SETS

Battery Operated

One-valve : 2/6 each		
S.W. One-valver for American ...	AW429*	

Two-valve : 2/6 each		
Ultra-short Battery Two (SG, det Pen) ...	WM402*	

Four-valve : 3/6 each		
A.W. Short Wave World-beater (HF Pen, D, RC, Trans) ...	AW436*	

Standard Four-valver Short-waver (SG, D, I.F. P) ...	WM383*	
--	--------	--

Mains Operated

Four-valve : 3/6		
Standard Four-valve A.C. Short-waver (SG, D, RC, Trans) ...	WM391*	

MISCELLANEOUS

Enthusiast's Power Amplifier (10 Watts) (3/6)	WM387*	
---	--------	--

Listener's 5-watt A.C. Amplifier (3/6)	WM392*	
--	--------	--

De Luxe Concert A.C. Electrograph (2/6)	WM403*	
---	--------	--

QUERY COUPON

This coupon is available until Feb. 6th, 1957 and must accompany all Queries, sent in accord with the notice on our "Open to Discussion" page, PRACTICAL WIRELESS, Feb. 1957.

Still only 5 connections
Smaller in size
many plus features.

The New
AMAZINGLY ROBUST

CIRCUITS & WIRING DIAGRAMS
Q-pack
FROM
4/9/-
FREE

JIFFY PUNCH

FERRITE ROD AERIALS

For cutting smaller holes neatly with one blow of a light hammer

HOLE	RETAIL
1 in. x 1 1/2 in.	19/6
1 in. x 1 1/4 in.	18/9
1 in. x 1 1/8 in.	22/6
1 in. x 2 in.	27/3

1/2 in. 6/6
3/4 in. 7/6
1 in. 8/9

BAND III Converter

Kit £3.5.0
Ready wired £4
Postage and packing 3/-

OSMOR NEW ASSEMBLY DIAG

Calibrated for Osmor Coils and Coil-packs 24/6
Bronze Finish Escutcheon 4/-

High "Q" M.W., 8/9
M. & L.W., 12/9

BAND I FILTER
Rejects B.B.C. from I.T.A. aerial. Suitable for all makes.

10 1/2 in. instructions

Fitted in 2 minutes

Entirely New Design

POTTED COILS HIGH "Q"

Simple press home fixing 5/-

STATION SEPARATOR

Price 10/6

Send 7d. in stamps for circuits, wiring diagrams, coil-pack leaflets, component lists, chassis drawings, templates and switch tuned frequency controlled FM Tuner, price lists.

OSMOR RADIO PRODUCTS. LTD. P.W.7 418 Brighton Road, South Croydon, Surrey. Telephone Croydon 5148/9.

Trace the Trouble in a Trice

PIFCO ALL-IN-ONE RADIOMETER

★ Circuit Test
★ L.T. & H.T. Tests
★ mA Test
★ Valve Test

Use the Pifco All-in-One Radiometer for the practical testing of all types of radio and electrical apparatus. You can carry out continuity and resistance tests, check H.T., L.T., and G.B. voltages, also Household Appliances, Car Lighting Systems, Bell Circuits, etc. May be used on A.C. or D.C. mains.

OBTAINABLE FROM YOUR LOCAL DEALER.
Write for informative folder 10/-

ONLY **32/6** COMPLETE

PIFCO LTD., WATLING ST., MANCHESTER 4
and 36-37, UPPER THAMES ST., LONDON, E.C.4

CONSTRUCTORS build these at DOWN-TO-EARTH PRICES

PERSONAL PORTABLE RADIO 30/-

This little set was designed to give you a real personal portable radio that you can enjoy anywhere without disturbing others. Use it on camping trips, in bed, in your office, or just anywhere. Send 2/- for layout, wiring diagram and Components Price List.

1v SHORT-WAVE RADIO 30/-

- ★ Covers 10-100 metres
- ★ World-wide reception
- ★ Low drain valve.
- ★ Picture diagram and instructions for beginners.
- ★ Assembling time 1 hr.

This 1v S.W. receiver can be built from our list of components for 30/- including valve and 1 coil covering 20-40 metres. Provision is made to increase to 2 or 3 valves if required. All components can be purchased separately and are colour-coded so that the beginner can build this set quite easily.

Post and Packing: Under 10/- add 9d.; under 40/- add 1/6; over POST FREE.

Send 2/- for specification, wiring diagram, layout and price list to—
R.C.S. PRODUCTS (RADIO) LTD
OLIVER ROAD, LONDON, E.17. Mail order only.