

A BATTERY OPERATED TAPE RECORDER

# PRACTICAL <sup>1/3</sup>

SEPTEMBER  
1956

EDITED BY JACOB GANN

# WIRELESS



# CERAMICS

## for all electronic applications

Silvered Ceramic Condensers cover a variety of useful shapes, including Pearls, Discs, Beads and Tubes, and have many applications in R.F. circuits — particularly where ultra-high frequencies are present, when their low inductance and excellent power factor are of special advantage. A wide choice of negative and positive temperature co-efficients permits the temperature compensation of other components, and frequency stabilisation of tuned circuits.

### HI-K CERAMIC DISCS

for decoupling purposes in T.V. and spark suppression in small electrical apparatus—extremely low inductances. Up to 10,000 pF at 500 v. D.C. working. Finished in a moisture-resisting compound that does not soften or crack up to 100°C.

### LOW-K TUBULARS

with the choice of four temperature co-efficients and a wide range of capacity values, serve many purposes in general circuitry.

### HI-K TUBULARS

combine high capacity with small physical size: used widely as by-pass condensers in T.V. and other H.F. receivers where low inductance is of special value.

### LOW-K PEARLS

of up to 10 pF capacity and LOW-K DISCS of up to 50 pF, with high negative temperature co-efficient permitting compensation of other components and frequency stabilisation in tuned circuits.

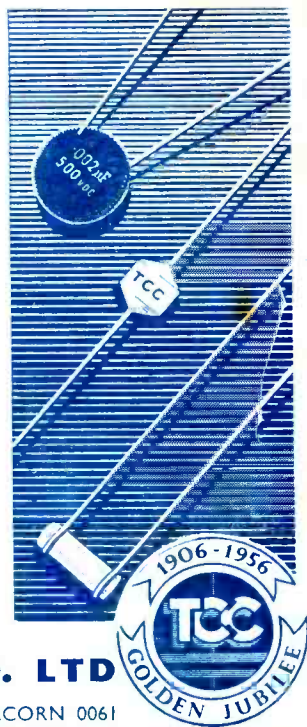

## THE TELEGRAPH CONDENSER CO. LTD

RADIO DIVISION: NORTH ACTON · LONDON · W.3 · Telephone: ACORN 0061

CONSTRUCTORS build these at

### DOWN-TO-EARTH PRICES

PERSONAL  
PORTABLE  
RADIO

30/-

This little set was designed to give you a real personal portable radio that you can enjoy anywhere without disturbing others. Use it on camping trips, in bed, in your office, or just anywhere. Send 2/- for layout, Wiring diagram and Components Price List.



### 1v SHORT-WAVE RADIO

- ★ Covers 10-100 metres
- ★ World-wide reception
- ★ Low drain valve.
- ★ Picture diagram and instructions for beginners.
- ★ Assembling time 1 hr

30/-



This 1 valve S.W. receiver can be built from our list of components for 30/-, including valve and 1 coil covering 20-40 metres. Provision is made to increase to 2 or 3 valves if required. All components can be purchased separately and are colour-coded so that the beginner can build this set quite easily.

Send 2/- for specification, wiring diagram, layout and price list to:—

**R.C.S. PRODUCTS (RADIO) LTD**  
11 OLIVER ROAD, LONDON, E.17. Mail order only.

Trace the Trouble  
in a Trice



**PIFCO**  
ALL-IN-ONE  
RADIOMETER

- ★ Circuit Test
- ★ L.T. & H.T. Tests
- ★ mA Test
- ★ Valve Test

Use the PIFCO All-in-One RADIOMETER for the practical testing of all types of radio and electrical apparatus. You can carry out continuity and resistance tests, check H.T., L.T., and G.B. voltages, also Household Appliances, Car Lighting Systems, Bell Circuits, etc. May be used on A.C. or D.C. mains.

Obtainable from your local dealers.

Write for informative folder to:—

★ ONLY  
**32/6**  
COMPLETE

**PIFCO LTD., WATLING ST., MANCHESTER 4**  
and 36-37, UPPER THAMES ST., LONDON, E.C.4



**UNDOUBTEDLY THE BEST VALUE YET OFFERED**

**Stern's "Fidelity" Tape Recorder**  
**ASSEMBLED & READY FOR USE £43**

(Plus £1.10.0 Carr. and Insurance. £1 is refunded when packing case is returned to us. Terms £21.10.0 deposit and 12 monthly payments of £1.10.10 or £11.0.0 deposit and 9 months of £3.13.3

**!! HOME CONSTRUCTORS !!**  
**- BUILD IT YOURSELF FOR £40**

The Truvox Tape Deck and the Quality Amplifier are supplied tested and ready for use. The actual assembly of the Recorder is simple and only involves a few connections (a connection chart is supplied for this purpose). The items illustrated and described form the complete equipment and each are available for sale separately.

**MODEL TR/1F QUALITY AMPLIFIER**

This amplifier has been expressly designed to meet the requirements of

enthusiasts for fidelity reproduction, and in particular to CORRECTLY operate the above TRUVOX DECK. It is supplied complete with a matched Elliptical 3 ohm P.M. Speaker. It incorporates an efficient Tone Control arrangement and has a Magic Eye Level Indicator (Operative on Record). It can also be used as a general purpose Amplifier for high quality reproduction of gramophone records direct from a Gram Unit. Price £14.14.0.

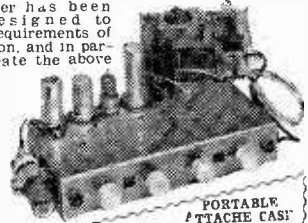

**PORTABLE ATTACHE CASE**  
 Neat, compact and attractively finished. It contains 4 pins concealed pockets for Mike, Mains lead and reel of tape.

**TRUVOX TAPE DECK**  
**MODEL Mx. III/TR/1u**

This is Truvox's new "small" design being only 14in. x 13in. The whole instrument is built to close engineering limits resulting in the minimum of "wow" and "flutter" values. It will play the NEW PRE-RECORDED TAPES and takes all standard tapes up to 1,200ft. £23.2.0.

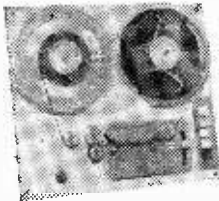

**SEND S.A.E. FOR DESCRIPTIVE LEAFLET INCLUDING PRICE DETAILS & H.P. TERMS**

**SCOTSBOY MAGNETIC RECORDING TAPE**  
 Supplied complete with a 1,200ft. reel of Scotsboy Tape. Price 25/  
**MODEL MIC33/1 ACOS CRYSTAL MICROPHONE**

A highly sensitive Mike which accurately matches the input arrangement of the Amplifier. Price £2.10.0.

**STERN RADIO LTD.**  
 109 & 115, FLEET STREET, E.C.4  
 Tel.: FLEet 5812-3-4.

**EXPAND AND**

**Laboratory Balanced.** The TSL LORENZ LP312-2 is a main bass 12in. diaxial speaker combined with two LPH65 electro-magnetic high frequency TREBLE units permanently mounted coaxially across the front of the main bass speaker at such an angle to give full spherical binaural response. All are laboratory balanced and matched for perfect tone with a frequency range of 20 cycles to 22,500 cycles essentially level output. To ensure level frequency response the voice coils of the two treble speakers are fed through a specially designed crossover network which balances the frequency response of the three speakers as a combined unit.



**IMPROVE ANY**

The TSL LORENZ LPH65 is the basic treble speaker used in the TSL LORENZ S and System. Round in shape to ensure smooth melodious sound the plastic cone is fully tropicalised. Special features are the super high flux density magnet of 17,500 gauss and non-perforated back plate.

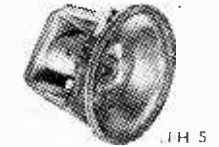

**SOUND SYSTEM**

**SPECIFICATION LP312-2**

IMPEDANCE 15 ohms; FREQUENCY RANGE 20-22,500 c/s; POWER RATING 25 w.; PEAK POWER RATING 40 w.; DIAMETER Bass 12 inches Treble 2 1/2 inches; DEPTH Bass 7 1/2 inches Treble 2 inches; BAFFLE OPENING 10 1/2 inches; SPEECH COIL DIAMETER Bass 1.5 inches Treble 1/2 inch; FUNDAMENTAL RESONANCE Bass 20 c/s Treble 1,600 c/s; FLUX DENSITY Bass 17,500 gauss Treble 17,500 gauss; INTERMODULATION PRODUCTS under 0.5%; CROSSOVER FREQUENCY 2,000 c/s; FINISH, Grey and blue vitreous anti-corrosion stove enamel. RETAIL PRICE, £14.19.6. (Not subject to Purchase Tax.)

Exclusively distributed to the Radio Trade & Industry throughout Great Britain and the Commonwealth by:

**SUPER HIGH FIDELITY THIS YEAR**

Let your ears be your judge... crisp, clear natural reproduction without coloration with TSL LORENZ speaker units. Ten years ahead in engineering and design this speaker unit will enable you to design and build up a sound system in your own home which will truly add the miracle of LIFE to the magic of music...

**No Extra Cost.** You get these extra features: at no extra cost with every TSL LORENZ Sound system... Greater output and more sensitivity... heavy duty oversize speech coil... Super high flux magnet... Permanently flexible self-damped cone... Multi-parameter cone fully tropicalised... Sealed in air gap... built-in centralising device for perfect gap alignment.

Improve your own H.F. Sound System. For those devotees of high fidelity who possess bass speakers fitting one or more LPH65 treble units will greatly extend your range of super fidelity reproduction. They are, without a doubt, the most sensitive and efficient treble reproducers research has revealed to date. The non-perforated back plate ensures that the LPH65 can be used with any other speakers irrespective of make or type without interaction taking place.

**SPECIFICATION LPH65**  
**HIGH FREQUENCY CONE-HORN TYPE TREBLE UNIT**

IMPEDANCE 5.5 ohms; FREQUENCY RANGE WITH SUITABLE HIGH PASS FILTER CONDENSER 2,000-22,500 c/s; POWER RATING AS A SINGLE UNIT 3 w.; PEAK POWER RATING AS A SINGLE UNIT 5 w.; DIAMETER 2 1/2 inches; DEPTH 2 inches BAFFLE OPENING 2 1/2 inches. PRICE 39/6. (Including Purchase Tax.)



Ask your local retailer for full details, including Bass Reflex enclosure.

**3-WAVE SUPERHET**

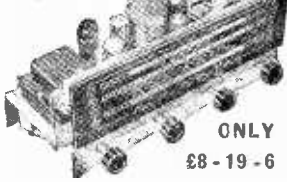

**ONLY £8-19-6**

This is a 5-valve A.C./D.C. superhet covering the usual long, medium and short wavebands. It has a particularly fine clear dial with an extra long pointer travel. Osram valves are used and the chassis is complete and ready to operate. Chassis size 15 x 6 x 6in. Price £8 19/6, complete with 6in. or 6 1/2in. speaker. Carriage and insurance 10/-. H.P. terms if required.

**CHASSIS ASSEMBLY**



Three-colour 3-waveband scale covering standard, Long, Medium, and Short wavebands, scale pan, chassis, punched for standard 5-valve superhet, pulley driving head, springs, etc., to suit. Scale size 14 1/2 x 3 1/2in. Chassis size 15 x 5 1/2 x 2 1/2in. deep. Price 15/- plus 1/3 post. Note—This is the one that fits our 4/6 table cabinet.

**NEW CIRCUIT**

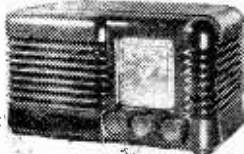

**OCCASIONAL 5B**—we have evolved a new T.H.F. circuit and have had really good results, equal in fact to many superhets. You really should try this circuit. All parts including valves (6K7, 6J7, 6F6, and 6X5) and Bakelite case with back cost only £5 10/-, plus 2/6 post and insurance. Data included with the parts is also available separately, price 2/-.

**THE CLEVELAND ORGANTONE**

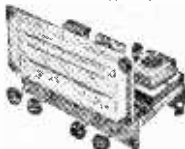

5 valve 3 waveband superhet covering Long, Medium and Short waves. Osram miniature valves—low loss iron coils—permeability—tuned I.F.S.—full A.V.C.—variable negative feed-back—gram. position—4 watts out—particularly fine tone. Chassis size 7in. x 7in. x 7in. approx. Tested in difficult areas, where exceptional results have been obtained. Price £11 10/0 or £13/10/0 depot. Carriage and ins. 10/-.

**STOP PRESS SNIP**

1 MFD 350v. Tubular Metal Case Condenser 3/- per dozen. gross lots post free otherwise add 1/-.

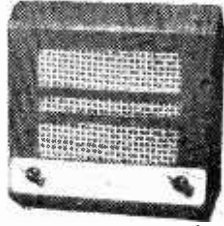

**OFFICE INTERCOM.**

This is a 2-station "master" unit comprising an A.C. mains operated push-pull amplifier with built-in P.M. speaker which acts as microphone or loudspeaker depending on whether switch is set to "talk" or "listen." Complete in polished cabinet ready to work. Price only £4 19/6, plus 3/6 carriage and insurance. Sub stations 19/6 each.

**RECORD PLAYER £4/10/0**

3-speed Gramophone Motor



Latest rim drive 3-speed motor with metal turntable and rubber mat. Small mod. makes speed easily variable for special effects and dance work.

**Hi-Fi Pick-up**  
Using famous Cosmocord Hi-G turn-over crystal. Separate sapphire for each speed. Neat bakelite case with pressure adjustment.  
**Special Snip Offer This Month**  
The two units for £4 10/-, plus 5/- post and insurance, or made up or board as illustrated, £5 10/-, plus 5/- post.

**THIS MONTH'S SNIP RADIO SCALES 6/6 DOZEN**

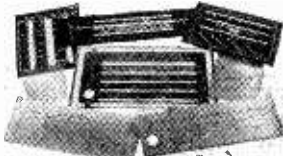

An exceptional bargain this month is our assorted parcel of radio scales. A most useful collection for all who make up experimental or other radios. We offer twelve assorted scales mostly in two or three colours for 6/6, plus 2/6 post and packing. Limited quantity only.

**CAR STARTER CHARGER KIT.**

All parts to build 6- and 12-volt charger which can be connected to a "flat" battery and will enable the car to be started instantly. Kit comprising the following—  
Mains transformer..... 19/6  
3-amp. rectifier..... 17/6  
Regulator Stud Switch..... 3/6  
Resistance Wire..... 2/-  
Resistance Former..... 2/6  
Mains on/off Switch..... 1/-  
0.5 amp. Moving Coil Meter..... 9/6  
Constructional Data..... 1/6  
or if bought all together price is 52/6, plus 2/- post and packing.

**OFFICE TELEPHONES**

New G.P.O. telephone sets with internal bell and push button switch easily connected together to form office intercom. Price £2 10/0 each. Post etc., 2/6.



**IMPULSE RELAY**



Somewhat soiled due to storage but mechanically O.K. Price 2/6, few new and unused 6/6 each, plus 9d. post. Booklet giving some circuits price 1/- post free.

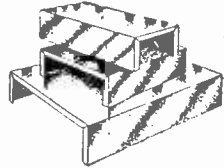

**BLANK CHASSIS 18 S.W.G. Aluminium**

7 x 3 1/2 x 2.....	3/9	14 x 10 x 3.....	7/9
9 1/2 x 4 1/2 x 2 1/2.....	5/-	16 x 10 1/2 x 3.....	8/3
10 x 8 x 2 1/2.....	5/6	16 x 12 x 3.....	8/8
10 x 5 1/2 x 2 1/2.....	5/-	19 1/2 x 9 x 2 1/2.....	8/3
12 x 9 x 2 1/2.....	7/-	20 x 10 x 3.....	10/-
14 x 9 1/2 x 2 1/2.....	7/6		



**CONNECTING WIRE**

P.V.C. covered in 100ft. coils—2.9 a coil or four coils different colours, 10/- post free.

**FINE TUNERS**

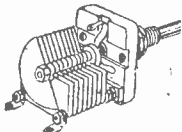

Ceramic trimmers all with 1/2in. slides of fair length. 5, 10, 15, 30, P.F. at 2/3 each or 24/- per dozen.

**W.D. CIRCUIT DETAILS**

Diagrams and other information extracted from official manuals. All 1 6 per copy, 12 for 15/-.  
American Service  
Sheets  
A-134 R.109  
BC-348 76 receiver  
BC-312 R2B/ARC5  
R.103A R1116/A  
B.C.342 RA.1B  
RA-1B AR8FD  
R-208 AN/APA-1  
R-1155 78  
R-1124A 76  
R-1132A/R-1481 R.T.18  
R-1147 CAY-46-AAM-  
R-1224A RADAR  
R-1082 A.S.B.-3  
R-1357 Indicator 62A  
B.C.1206-A/B Indicator A.S.B.3  
B-155-A (or -B) Indicator 62  
B-154-A (or -B) Indicator 6K  
B-153-A (or -B) R.F. unit 24  
Transmitter T1154 R.F. unit 26  
Fifty-eight walkie R.F. unit 25  
talkie R.F. unit 27  
Frequency meter Wireless set No.19  
B.C.221 Demobbed valves

**HUGE MINISTRY PURCHASE**  
R.1155—yours for £2 down

Frequency 75 kc/s to 18 mc/s—10 valves—metal case—robust receiver—cost over £60 to make—will give years of service, very little used. Price £10 or 5 payments of £2. Curr. & transit case 15/- ex.

**ENGINEERS 1" MICROMETER**  
Brand new and perfect—invaluable to engineers, apprentices, model makers, students, etc. Only 10/- post free.

**5-VALVE SUPERHET YOURS FOR ONLY £1 DOWN**



Chassis size approx. 9 1/2 x 7 1/2 x 4 1/2. First-class components. A.C. mains operation. Three waves (medium and two shorts). Complete with five valves, ready to work. New and unused. Cash price £5 19/6, or 5 payments of £1 (curr. and ins. 7/6).

**TRANSFORMER 8N1P**

11/6  
Post 2/-

Fully shrouded—standard 200-250 v. primary (200-280) at 80 m.a. 6.3 v. at 3 amp., 5 v. at 2 amp.



**HIGH VOLTAGE TESTER**



An instrument that will measure voltages up to 10,000 but which draws no current from the source, will probably be a valuable addition to your workshop equipment. It can be made entirely from odds and ends. Booklet giving full instructions, plans, etc., 2/6 post free.

**MAINS-MINI**



Uses high-efficiency coils—covers long and medium wavebands and fits into the neat white or brown bakelite cabinet—limited quantity only. All the parts, including cabinet, valves, in fact, everything, £4 10/0, plus 3/6 post. Constructional data free with the parts, or available separately 1/6.

**The "CRISPIAN" Portable Radio**



A 4-valve truly portable battery set with very many good features as follows: Ferrite rod aerials, low consumption valves, superhet circuit with A.V.C., ready-built and aligned chassis if required, beautiful two-tone cabinet covered with I.C.I. Roxine and Tzran. Guaranteed results on long and medium waves anywhere.

All parts, including speaker and cabinet, are available separately or if all ordered together the price is £7.15 complete, post and ins. 3.6. ready-built chassis 30/- extra. Instruction booklet free with parts or available separately price 1/6.

**GRAMOPHONE AUTO-CHANGERS**

The latest models by very famous manufacturers. 2-speed with crystal turn over pick-up, brand new and perfect, in original cartons. Prices from 7/15/0, carriage, ins. etc., 7/3.



**14" T.V. CABINET**



14 in. T.V. cabinet of the latest styling made by one of our most famous firms—beautifully veneered and polished—limited quantity—19/6 each. Carriage and packing 3/6 extra.

**THE STATESMAN**



**THIS IS ON OFFER AT APPROX. HALF COST TO MAKE.**

An impressive costly looking cabinet originally designed for T.V. but simple modification makes the cabinet suitable for radio-gram amplifier, tape recorder, or reflex speaker—size 23in. wide, 22in. deep and 37 1/2 in. high. Limited quantity at £8/15/- each—carriage 12/6.

**"The ESTRONIC" Band III Converter**

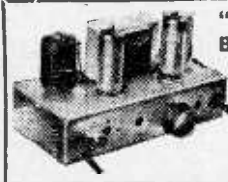

To-day's best value in Band III converters suitable for your T.V. or money refunded. Complete ready to operate. 59/6 non mains or 85/- mains, post and insurance 3/6.

**ELECTRIC BLANKET WIRE**

Waterproof P.V.C. covered, so blanket washable. 161 ohms per foot—1.6 per yard. 14 yards ideal for average blanket. £1 post free.

**THE TWIN 20**



This is a complete fluorescent lighting fitting. It has built-in ballast and starters—stove enamelled white and ready to work. It is an ideal unit for the kitchen, over the work-bench, and in similar locations. It uses two 20-watt lamps. Price, complete less tubes, 29/6, or with two tubes, 39/6. Post and insurance 5/-. Extra 20-watt tubes, 7/6 each.

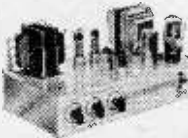

**MULLARD AMPLIFIER "510"**

A Quality Amplifier designed by Mullard. Power output exceeds 10 watts. Frequency response almost flat from 10 to 20,000 C.P.S. For use with the Acos "III G" and other good pick-ups. Made up and ready to work is £12/10/-, plus 10/- curr. and insurance.

**MULTI-METER KIT**



Parts suitable for making a multimeter to measure volts, milliamperes and ohms. Kit containing all the essential items including moving-coil meter, resistors, range selector, calibrated scale, etc., etc. is only 15/-, plus 1/- post and packing.

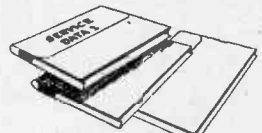

**SERVICE DATA**

100 service sheets, covering British receivers which have been sold in big quantities and which every service engineer is ultimately bound to meet. The following makers are included: Aerodyne, Albs, Bush, Cossor, Ekco, Ever-Ready, Ferguson, Ferranti, G.E.C., H.M.V., Kolster Brandes, Lissen, McMichael, Marconi, Mullard, Murphy, Philco, Philips, Pye, Ultra. Undoubtedly a mine of information invaluable to all who earn their living from radio servicing. Price £1 for the complete folder.

**ELECTRONIC PRECISION EQUIPMENT, LTD.**

Post orders should be addressed to E.P.E., LTD., Dept. 5, Sutton Road, Eastbourne. Post enquiries to Eastbourne with stamped envelope, please.

42-46, Windmill Hill, Rushin, Middx. Phone: RUSL 117 6780. Half day, Wednesday.  
152-3, Fleet Street, E.C.4. Phone: FLEET 2939. Half day, Saturday.  
29, Stroud Green Rd., Highbury Park, N.4. Phone: ARCHWAY 1949. Half day, Thursday.  
243, Kilburn High Road, Kilburn, Maida Vale 4921.

**MAXI-Q**  
REGD.

**"MAXI-Q" IS THE REGISTERED TRADE MARK OF DENCO (CLACTON) LTD. IT IS ALSO A MARK OF TECHNICAL SUPERIORITY AND GUARANTEED QUALITY**

Coverage from 3.8 to 2,000 metres in 7 ranges—  
Each coil is packed in an aluminium container which may be used as a screening can for the coil itself—Brass threaded adjustable iron cores—  
Colour coded moulded polystyrene formers—  
Chassis/Plug-in Technical Bulletin DTB.1 1/6—  
Dual Purpose Technical Bulletin, DTB.4 1/6—  
Colour Code Identified Coils: BLUE Signal Grid Coil with Aerial Coupling winding—YELLOW Signal Grid Coil with inervalve coupling winding—GREEN Grid Coil with reaction and coupling windings—RED Superhet Oscillator for I.F. of 465 Kc/s—WHITE Superhet Oscillator for 1.6 Mc/s. Prices range from 3/11 to 4/9 each. Five Colour Glass Scale, Back Plate, Pointer, Pulleys and Cord for use with 315 pF tuning condensers. Coverage (1) 150-400 Kc/s; (2) 530-1600 Kc/s; (3) 1.5-4 Mc/s; (4) 4-12 Mc/s; (5) 10-30 Mc/s. Price 12/6.

Obtainable from all reputable stockists or direct from works. General Catalogue covering technical information on full range of components 1/- post paid.

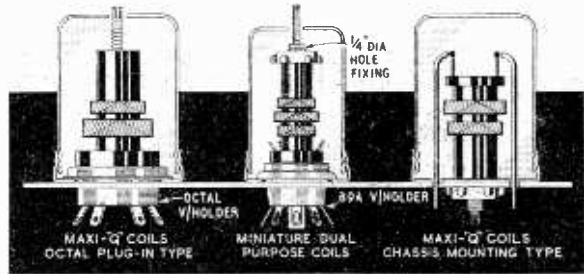

**DENCO (Clacton) LTD • 357/9 Old Road • Clacton-on-Sea • Essex**

**STOP PRESS:** "MAXI-Q" F.M. Tuner Unit assembled and valved at £9/19/6 inc. Power pack at £3. "OSRAM" F.M. Tuner completely assembled and valved at £30/16/- inc.

Complete metalwork for the T.C.C. printed circuit versions of the "OSRAM 912" and "MULLARD 5-10" Amplifiers, 15/- each.

"5-10" Pre-Amplifier Chassis and Front Panel, Type "A" 8/6; Type "B" 12/6. Separate Printed Gold finished panels available. Type "A" 7/6; Type "B" 2/6.

**HENRY'S**  
(RADIO LTD.)

**U.S.A. TEST METER**  
25 ranges. 1,000Ωp. volt. A.C. and D.C. Readings 10-6,000 volt. Milliamps 1mA-600 mA. Ohms 0-5 meg. Decibels -10 to +70 DB. Complete with internal batteries, leads and instruction book. £6/19/6

**MINIATURE I.F. STRIP TYPE** 373 9-72 MEG. Brand new miniature I.F. Strip size 10lin. x 24in. x 3in. high. Valve line-up: 2-EF92, 3-EF91 and EB91. With circuit. Price (less valves) 7/6. P. & P. 1/6. This I.F. Strip is part of above equipment.

**U.S.A. INDICATOR UNIT** BC 929-3. Complete with 3BP1 C/R tube and screen. 7 valves—2-6SN7GT, 2-6HG7, 6G6, 2X2, 6X5G, volume controls, condensers, etc. Ideal for portable scope. In black crackle case size 15 1/2in. x 9in. x 9in. BRAND NEW. 65/- carr. FREE.

**TR 1196 RECEIVER** Complete with 6 valves: 2-EF86, 2-EF39, 1-BK32, 1-EB23, 465 I.F.T., ideal for conversion. In absolute new condition. 27/6. P.P. 2/6, with circuit.

**TR 1196 TRANSMITTER** Transmitter section comprising EL32, EF50, VT501, Relay etc., 12/6. P.P. 2/6. **COMPLETE TRANSMITTER RECEIVER** with 24 v. power-pack in original transit case. £74/3/3 P. 5/-.

**TRANSISTORS OFFERED AT LESS THAN HALF PRICE**  
This Junction Transistor Type P.N.P. is designed for A.P. application up to 300 Kc/s and is suitable for use in Radio Control, Signal Tracers, Local Station Receivers, Oscillators, Transistor Voltmeters and Experimental work, etc. (Complete with Technical Data and Circuit) **10/- EACH**  
ELECTRICAL DATA:  
Maximum collector voltage — 5 volts  
Peak collector voltage — 10 mA  
Maximum collector current — 10 mA  
Maximum emitter current — 25 mA  
Maximum power dissipation — 25 mW

**CATHODE RAY TUBES**  
**VCR139A WITH SCREEN** £1 15 0  
VCR139A. 24in. C/R Tube. Brand new in original cartons (carr. free) £1 15 0  
VCR97. Guaranteed full TV picture (carr. 2/-) £2 0 0  
VCR517C. Guaranteed full TV picture (carr. 2/-) £1 15 0  
**MU-METAL SCREENS** for VCR97 or 517. P.P. 1/6. 10 0  
VCR97. Slight out-off. Carr. 2/- 15 0  
3BP1. Brand new. £1 10 0

**B.S.R. RECORD CHANGERS**  
Very latest type "Monarch" in hammered gold finish. 3-speed with HGP37 crystal turnover pick-up. Plays mixed records. Brand new and guaranteed. Listed at £15/10/0. £7/19/6, carr. paid.

**TRANSMITTER RECEIVER "38"**  
**WALKIE-TALKIE SETS**  
Special offer of above set, complete with 5 valves, 4-ARP12 and ATP4, with circuit. Range 7.4 to 9 Mc/s. These sets are not guaranteed but are serviceable. 25/- Junction box, 2/6 extra.

**SPECIAL REDUCTION FOR SETS OF VALVES**  
1A7GT, 1N5GT, 1H5GT, 1A5GT (or 1Q5GT or 3Q5GT)..... 37/6 Set  
10 EF50 (ex-Brand New Units) 5/- each..... 45/- ..  
10 EF50 (Red Sylvania, ex-new units) 6/- each..... 55/- ..  
6K8G, 6K7G, 6Q7G, 5Z4G, 6V6G..... 35/- ..  
1H5, 1S5, 1T4, 1S4 or (3S4 or 3V4)..... 32/6 ..  
DK99, DF56, DAF36, DL36..... 32/6 ..  
6K8G, 6K7G, 6Q7G, 25A6G, 25Z5 (or 25Z6G)..... 37/6 ..  
12K8GT, 12K7GT, 12Q7GT, 35Z4GT, 35L6GT (or 50L6GT) 37/6 ..  
12A7GT, 12S7GT, 12S9GT, 35Z4GT, 35L6GT or 50L6GT 35/- ..

**CRYSEAL MICROPHONE INSERTS**  
Ideal for Tape Recording, Gramophone Amplifier, etc. Very sensitive. Guaranteed and Tested, 5/- (ex-units), or 8/6 Brand new and boxed.



**62A INDICATOR UNIT**  
Containing VCR97 with Mu-Metal Screen, 21 Valves: 12-EF50, 4-SP61, 3-EA50, 2-EB34, Plus Pots., Switches, H.V. Cond., Resistors, Muirhead S.M. Dial, Double Deck Chassis and Crystal. BRAND NEW ORIGINAL CASES, 67/6. Carr. 7/6.

**INDICATOR UNIT TYPE 182A**  
Unit contains VCR517 Cathode Ray 6in. tube, complete with Mu-Metal screen, 3-EF50, 4SP61 and 1-5U4G valves. 9 wirewound volume controls and quantity of resistors and condensers. Offered BRAND NEW (less relay) at 67/6. Plus 7/6 carr. "Radio-Constructor" scope circuit included.

**GARRARD 3-SPEED MIXER AUTO-CHANGER Model RC110**  
A.C. 200/250. List price £14/13/- Brand New. £5/18/6. P. & P. 5/-.

# 2 'musts'

## for the home constructor



C.101

### THE G.E.C. 'nine-one-two PLUS'

The publication contains step by step wiring instructions for this high quality Amplifier together with many additional features of exceptional interest to the Home Constructor.

PRICE **4/-** from your dealer or by post—5d. extra—from the G.E.C. Valve and Electronics Dept.

### THE "FM PLUS" TUNER

The "FM PLUS" Tuner is ideal for use with the 'nine-one-two PLUS' Amplifier and the publication gives constructional details and suggests circuits for inter-station noise suppression and a 'magic eye' tuning indicator.

PRICE **2/6** from your dealer or by post—5d. extra—from the G.E.C. Valve and Electronics Dept.



*Both these publications are obtainable from the G.E.C. Stand at the Radio Show.*

THE GENERAL ELECTRIC CO. LTD · MAGNET HOUSE · KINGSWAY · LONDON WC2

## R.S.C. BATTERY CHARGING EQUIPMENT.

**ASSEMBLED CHARGERS**  
 6 v. 1 amp. .... 19/9  
 6 v. or 12 v. 1 amp. .... 25/9  
 6 v. 2 amps. .... 39/9  
 6 v. or 12 v. 2 amps. .... 38/9  
 6 v. or 12 v. 4 amps. .... 56/9  
 Above ready for use. Carr. 2/9.  
 With mains and output leads.

**HEAVY DUTY KIT**  
 12 v. 30 amp. Suitable for Garage or firm with a number of vehicles. Mains Input 200/250 v. 50 c/s. Outputs 12 v. 15 amp. etc. Consists of Mains Trans. 2 Metal Rectifiers. 2 Meters, 4 Fuses, 4 Terminals, 2 Rheostats and circuit. Only 9 gns., carr. 15/-.

**BATTERY CHARGER KITS**  
 Consisting of Mains Transformer, F.W. Bridge, Metal Rectifier, well ventilated steel case, Fuses, Fuse-holders, Grommets, panels and circuit. Carr. 2/6 extra.  
 6 v. or 12 v. 1 amp. .... 22/9  
 6 v. 2 amps. .... 25/9  
 6 v. or 12 v. 2 amps. .... 31/6  
 6 v. or 12 v. 4 amps. .... 49/9

**BATTERY CHARGER KIT**  
 Consisting of F.W. Bridge Rectifier 6/12 v. 3 a. Mains Trans. 0-9-15 v. 6 a. output and variable charge rheostat with knob. Only 45/9.

**ASSEMBLED CHARGER**  
 6 v. or 12 v. 2 amps. Fitted Ammeter and selector plug for 6 v. or 12 v. Louvred metal case, finished attractive hammer blue. Ready for use. With mains and output leads. Double Fused. Only Carr. 3/6. **46/9**

All for A.C. MAINS 200-250 v., 50 c/s. Guaranteed 12 months.



Assembled 6 v. or 12 v. 4 amps. Fitted Ammeter and variable charge selector. Also selector plug for 6 v. or 12 v. charging. Double Fused. Lilted steel case with blue hammer finish. **69/6**  
 Ready for use with mains and output leads. Carr. 3/6

## R.S.C. MAINS TRANSFORMERS (FULLY GUARANTEED)

Interleaved and impregnated. Primaries 200-230-250 v. 50 c/s Screened. **TOP SHROUDED DROP THROUGH**  
 250-0-250 v. 70 mA. 6.3 v. 2.5 a. .... 13/9  
 250-0-250 v. 70 mA. 6.3 v. 2.5 v. 2 a. .... 16/9  
 300-0-300 v. 70 mA. 6.3 v. 2.5 a. .... 16/9  
 350-0-350 v. 80 mA. 6.3 v. 2.5 v. 2 a. .... 18/9  
 250-0-250 v. 100 mA. 6.3 v. 4 a. 5 v. 3 a. 22/9  
 300-0-300 v. 100 mA. 6.3 v. 4 a. 5 v. 3 a. 22/9  
 350-0-350 v. 100 mA. 6.3 v. 4 a. 5 v. 3 a. 22/9  
 350-0-350 v. 100 mA. 6.3 v. 4 a. C.T. 0-5 v. 3 a. .... 21/9  
 350-0-350 v. 150 mA. 6.3 v. 4 a. 5 v. 3 a. .... 29/9

**FULLY SHROUDED UPRIGHT**  
 250-0-250 v. 60 mA. 6.3 v. 2 a. 5 v. 2 a. .... 17/6  
 Midget type 21-3-8in. .... 17/6  
 350-0-350 v. 70 mA. 6.3 v. 2.5 v. 2 a. .... 19/9  
 250-0-250 v. 100 mA. C.3 v. 4 v. 4 a. C.T. 0-4-5 v. 3 a. .... 26/9  
 250-0-250 v. 100 mA. 6.3 v. 6 a. 5 v. 3 a. .... 31/9  
 For R1353 conversion .... 31/9  
 300-0-300 v. 100 mA. 6.3 v. 4 v. 4 a. C.T. 0-4-5 v. 3 a. .... 26/9  
 350-0-350 v. 100 mA. 6.3 v. 2.5 v. 3 a. 23/9  
 350-0-350 v. 100 mA. 6.3 v. 4 v. 4 a. C.T. 0-4-5 v. 3 a. .... 27/9  
 350-0-350 v. 150 mA. 6.3 v. 4 a. 5 v. 3 a. 33/9  
 350-0-350 v. 150 mA. 6.3 v. 2 a. 6.3 v. 2 a. 5 v. 3 a. .... 35/9  
 425-0-425 v. 200 mA. 6.3 v. 4 a. C.T. 6.3 v. 4 a. C.T. 5 v. 3 a. Suitable Williamson Amplifier, etc. .... 49/9  
 450-0-450 v. 250 mA. 6.3 v. 6 a. 6.3 v. 6 a. 6 v. 3 a. .... 69/9

**E.H.T. TRANSFORMERS**  
 2,500 v. 5 mA. 2-0-2 v. 1.1 a. 2-0-2 v. 1.1a for VCR37, VCR517, etc. .... 36/6

**ELIMINATOR TRANSFORMERS**  
 Primaries 200-250 v. 50 c/s .... 14/9  
 120 v. 40 mA. 5-0-5 v. 1 a. .... 15/9  
 90 v. 15 mA. 4-0-4 v. 500 mA. .... 8/9

**SMALL POTTED MAINS TRANSF.**  
 Removed from New Ex-Govt. units. Primary 200-250 v. 50 c/s. Suitable 250-0-250 v. 60 mA. 6.3 v. 2 a. 5 v. 2 a. Size 31 x 41 x 3in. .... **11/9**

**FILAMENT TRANSFORMERS**  
 All with 200-250 v. 50 c/s primaries 6.3 v. 1.5 a. 5/9; 6.3 v. 2 a. 7/6; 0-4-6.3 v. 2 a. 7/9; 12 v. 1 a. 7/11; 6.3 v. 3 a. 8/11; 6.3 v. 6 a. 17/6; 12 v. 3 a. or 24 v. 1.5 a. 17/6.

**CHARGER TRANSFORMERS**  
 All with 200-230-250 v. 50 c/s Primaries: 0-9-15 v. 1 a. 11/9; 0-9-15 v. 3 a. 16/9; 0-3.5-9-17 v. 3 a. 17/9; 0-3.5-9-17.5 v. 4 a. 18/9; 0-9-15 v. 5 a. 19/9; 0-9-15 v. 6 a. 22/9

**SMOOTHING CHOKES**  
 250 mA 5 H 100 ohms .... 11/9  
 150 mA 10 H 200 ohms .... 11/9  
 100 mA 10 H 200 ohms .... 8/9  
 80 mA 10 H 350 ohms .... 5/6  
 80 mA 10 H 400 ohms .... 4/11

**OUTPUT TRANSFORMERS**  
 Midget Battery Pentode 66: 1 for 854, etc. .... 3/9  
 Small Pentode, 5,000 Ω to 3 Ω .... 3/9  
 Standard Pentode, 5,000 Ω to 3 Ω .... 4/9  
 Standard Pentode, 718,000 Ω to 3 Ω .... 4/9  
 Multi-ratio 40 mA, 30 : 1, 43 : 1, 60 : 1, 90 : 1, Class B Push-Pull .... 5/6  
 Push-Pull 10-12 watts 6V6 to 3 Ω or 15 Ω .... 15/9  
 Push-Pull 10-12 watts to match 6V6 to 3-5 Ω or 15 Ω .... 16/9  
 Push-Pull 15-18 watts, 6L6, KT66 .... 22/9  
 Push-Pull 20 watts, sectionally wound 6L6, KT66, etc., to 3 or 15 Ω 47/9  
 Williamson type exact to spec. .... 55/-

**SILVER MICA CONDENSERS.** 5, 10, 15, 20, 25, 30, 35, 40, 50, 100, 120, 150, 200, 230, 300, 400, 500, 1,000 (0.001 mfd.), 2,000 pfd. (0.002 mfd.). 6d. each; 3/9 doz. One type.

**H.T. ELIMINATOR AND TRICKLE CHARGER KIT** Input 200-250 v. A.C. Output 120 v. 40 mA. Fully smoothed and rectified supply to charge 2 v. accumulator. Price with louvred metal case and circuit. 29/6. Or ready for use, 8/9 extra.

## R.S.C. BATTERY TO MAINS CONVERSION UNITS

Type BMI. An all dry battery eliminator. Size 51 x 41 x 2in. approx. Completely replaces batteries supplying 1.4 v. and 90 v. where A.C. mains 200-250 v. 50 c/s. Is available. Suitable for all battery receivers requiring 1.4 v. and 90 v. This includes latest low consumption types. Complete kit with diagrams and ready for use, 46/9.



Type BM2. Size 8 x 5 x 4 in. Supplies 120 v. 50 v., and 60 v., 40 mA. and 2 v. 0.4 a. to 1 amp. fully smoothed. Thereby replacing both H.T. batteries and L.T. 2 v. accumulators. When connected to A.C. mains supply 200-250 v. 50 c/s. **SUITABLE FOR ALL BATTERY RECEIVERS** normally using 2 v. Accumulator. Complete kit of parts with diagrams and instructions 49/9, or ready for use 59/6.

**SPECIAL OFFERS** 8.5 mfd. 450 v. small can electrolytics in lots of six, 1/6 ea. Small. 0.005 mfd. 2 Gangs, 4/9 ea.

**T.V. CABINETS.** Leading manufacturers surplus. Attractive design. Walnut veneered. Type for 12in. Tube, 29/6. Type with doors for 15, 16, or 17in. Tube, £3-19.8. Carr. 7/6.

**VOLUME CONTROLS** with long (1in. diam.) spindle, all valves less switch 2/9; with switch 2/9; with D.P. switch 4/11

**SPEAKERS.** Ready for use in walnut veneered cabinet. 6in. 2-3 ohms, 29/6. 8in. 2-3 ohms, 35/9. very limited number.



**GARRARD** RCT2A 3-speed Auto-changers with latest type High Fidelity Turnover Pick-up Head. 6 Gns., plus 7/6 cab.

**MANUFACTURERS' SURPLUS MAINS TRANSFORMERS.** Primaries 250-250 v. 50 c/s. Fully shrouded upright mounting 425-0-425 v. 150 mA. 6.3 v. 3 a. 5 v. 3 a. 29/11, post 2/- Wearble 325-0-325 v. 100 mA. 6.3 v. 2.5 a. 5 v. 2 a. 19/9.

**EX-GOVT. TRANSF.** 230/250 v. 50 c/s. 8.8 v. 4 a. 9/9; 460 v. 200 mA. 6.3 v. 5 a. 25/9; 300-0-300 v. 150 mA. 4 v. 3 a. 9/9; 0-16-18-20 v. 35 a. 69/6, carr. 7/6.

**EX-GOVT. SMOOTHING CHOKES**  
 250 mA 5 H 50 ohms .... 12/9  
 150 mA. 10 H 100 ohms .... 11/9  
 150 mA. C-10 H 150 ohms Trop. .... 6/9  
 100 mA. 10 H 150 ohms Tropicalised .... 3/11  
 L.T. type 1 amp. 2 ohms .... 2/6

**EX-GOVT. METAL BLOCK (PAPER) CONDENSERS**  
 4 mfd. 500 v., 2/9; 8-8 mfd. 500 v., 6/9; 8 mfd. 500 v., 5/9; 10 mfd. 500 v., 6/9; 15 mfd. 500 v., 6/9; 4 mfd. 400 v. plus 2 mfd. 250 v., 1/11.

**EX-GOVT. E.H.T. SMOOTHERS**  
 5 mfd. 2,500 v. Blocks, 3/9; 1 mfd. plus 1 mfd. 8,000 v. 9/6.

**EX-GOVT. ELECTROLYTICS.** Removed from unused equipment. 8-16 mfd. 550 v., 1/3; 16-16 mfd. 350 v., 1/3; 1,000 mfd. 6 v., with chip. 1.9; 50 mfd. 50 v., with chip, 9d.

**CONTROL PANEL** with six position, 3 wafers Yaxley switch, pointer knob, 2 S.P.S.T. switches, various plugs and sockets. Only 1/6.

**EX-GOVT. VALVES (NEW)**

1T4	7/9	EF80	8/9	EB33	7/9
1R5	7/9	EF39	5/9	6AT6	7/9
1S5	7/9	6V6GT	6/9	EB91	8/9
354	8/9	6X5GT	7/9	EC83	9/9
5U4G	9/9	6L6G	11/9	6X4	4/9
5Y4G	8/11	8X7	7/9	EL32	9/9
6Z4G	9/9	12A6	7/9	EL31	5/9
6K7G	5/9	15D2	4/9	KT44	8/9
6K8G	9/9	2524G	9/9	KT66	11/9
6SN7GT	8/9	3524GT	9/9	SP41	11/11
6S7GT	6/9	6L6C	11/9	SP61	2/9
6F6G	7/9	MH4	4/9	FX25	14/9

**EX-GOVT. UNIT RDEL** Brand new, cartoned. Complete with 14 valves, including 5Z4, E.H.T. rectifier, Mains Trans. Choke, etc. Only 29/9, carr. 7/6.

**ELECTROLYTICS** (current production) NOT Ex-Govt.

Tubular Types	8 mfd. 600 v.	2.11
16 mfd. 500 v.	3/9	
16 μF 450 v. ... 1/9	16 mfd. 350 v.	1/11
2 v. 500 v. ... 2/6	16 μF 450 v. ...	2/9
16 μF 350 v. ... 2/3	32 μF 350 v. ...	2/11
16 μF 450 v. ... 2/9	32 mfd. 450 v.	4/9
1C/F 500 v. ... 3/9	64 mfd. 450 v.	3/11
32 μF 350 v. ... 3/9	100 mfd. 450 v.	4/9
32 mfd. 500 v. 5/9	8-8 μF 450 v. ...	2/9
25 μF 25 v. ... 1/3	8-16 μF 450 v. ...	2/11
50 μF 12 v. ... 1/3	16-16 μF 450 v. ...	3/11
50 mfd. 25 v. ... 1/6	16-32 μF 350 v. ...	4/9
50 μF 50 v. ... 1/9	32-32 μF 450 v. ...	5/9
100 mfd. 12 v. 1/9	60-100 mfd.	
100 mfd. 25 v. 2/3	350 v.	6/11
	64-120 mfd. 350v. 7/9	
	100-200 mfd.	
	275 v.	6/9

Many others in stock.  
**HUNTS MOLDSAL CONDENSERS.** 305 mfd. 400 v., 01 mfd. 400 v. 04 mfd. 500 v., 5/6 doz. (one type); 1 mfd. 500 v., 8d. ea.; .25 mfd. 500 v., 1/3; .5 mfd. 500 v., 1/8 ea.



**R.S.C. A8 ULTRA LINEAR 12 WATT AMPLIFIER**

NEW 1956 Model High-Fidelity Push-Pull Amplifier with "Built-in" Tone Control. Pre-amplifier stages. High sensitivity. Includes 5 valves (807 outputs). High quality sectionally wound output transformer specially designed for Ultra Linear operation, and reliable small condensers of current manufacture. **INDIVIDUAL CONTROLS FOR BASS AND TREBLE**, "Lift" and "Cut". Frequency response  $\pm 3$  db. 30-30,000 c/c. Six negative feedback loops. Hum level 71 db. down. ONLY 70 millivolts INPUT required for FULL OUTPUT. Suitable for use with all makes and types of pick-ups and practically all microphones. Comparable with the very best designs. For STANDARD or LONG-PLAYING RECORDS. For MUSICAL INSTRUMENTS such as STRING BASS, GUITARS, etc. **OUTPUT SOCKET** with plug provides 300 v. 20 mA. and 6.3 v. 1.5 a. For supply of a **RADIO FEEDER UNIT**. Size approx. 12.9" x 7". For A.C. mains 200-250 v. 50 c/c. Outputs for 3 and 15 ohm speakers. Kit is complete to last nut. Chassis is fully punched. Full instructions and point-to-point wiring diagrams supplied. Unapproachable value at £7/15/-, or factory built £5/- extra. Carriage 10/-.

**£7-15-0**

**FOUR STAGE RADIO FEEDER UNIT**. Design of a High-Fidelity Tuner Unit T.R.F. L. & M. Wave. Full decoupling. Only 250-400 v. 10-15 mA. H.T. required from main amplifier. Three valves and low distortion Germanium diode detector. Flat-topped response characteristic. Loaded H.F. coils. Two variable-Mu controlled H.F. stages. 3-Gang condenser tuning. Detailed wiring diagrams, parts lists and illustration. 9/3. Total building cost. £3/15/-.

**QUALITY SUPERHET FEEDER UNIT DESIGN**. L. & M. Wave. Detailed Wiring Diagram, instructions, parts list and illustration. 2/6. Unit can be built for £4/15/-.

**GARRARD 3-SPEED AUTO-CHANGER RC10**. Current Model. Brand new, carton. Provision for taking 10 records. Fitted High-Fidelity turnover pick-up head with dual sapphire point stylus for Standard or Long-playing records. Very limited number at only 89/17/6. Carr. 5/6.

**DECCA RECORD PLAYING DESK** with High-Fidelity crystal pick-up. Turnover head has dual sapphire point stylus for Standard or Long-playing records. 33 $\frac{1}{3}$  and 78 r.p.m. For mains supply 200-250 v. 50 c/c. A.C. Brand new, carton. Only 28/17/6. Carr. 5/6.

**DEFIANT RECORD PLAYING UNITS** Turntable for standard 10in. and 12in. 70 r.p.m. records (fitted auto-stop) and high impedance magnetic pick-up, mounted in attractive polished walnut finish drawer-type cabinet. Exceptional value at 45/17/6, plus 7/6 carr.

**B.S.R. MONARCH 3-SPEED MIXER AUTOCHANGER**. For standard 200-250 v. 50 c/c mains. Autochanges on all 3 speeds. Plays Ten mixed 7in., 10in. and 12in. records. Separate sapphire stylus for L.P. and 78 r.p.m. High-fidelity type crystal pick-up. Minimum baseboard size needed 14in. x 12in. x 5in. high. Brand new, carton. at £7 15/-, carr. 3/6.

**WALNUT VENERED CABINETS**. (Ex. leading manufacturers Table Radiogram Cabinets) designed for above B.S.R. Changers. Brand new, carton. Only 83/19/6. Carr. 7/6.

**3-4 WATT QUALITY AMPLIFIER**. Designed for use with B.S.R. Auto-changer and above cabinets. Fitted separate Bass and Treble controls. Vol. Control and mains switch. Latest type B.V.A. valves used. For 200-250 v. A.C. mains. Ready for use. Only 23/19/6, carr. 3/6.

**ELLIPTICAL P.M. SPEAKER**. 7 x 4in. Goodmans. Suitable for above. 19/8.

Terms: C.W.O. or C.O.D. No C.O.D. under £1. Post 1/6 extra under £2. Open 9 to 5.30: Sats. until 1 p.m. Catalogue 6d., Trade List 5d. S.A.E. with all enquiries.

**RADIO SUPPLY CO. 32, THE CALLS, LEEDS, 2**

**R.S.C. 30 WATT ULTRA LINEAR HIGH-FIDELITY AMPLIFIER A6**

A highly sensitive Push-Pull, high output unit with self-contained Pre-amp, Tone Control Stages. Certified performance figures compare equally with most expensive amplifiers available. Hum level 70 db. down. Frequency response  $\pm 3$  db. 30-30,000 c/c/s. A specially designed sectionally wound ultra linear output transformer is used with 807 output valves. All components are chosen for reliability. Six valves are used, and separate Bass and Treble controls. Minimum input required for full output is only 30 millivolts so that ANY KIND OF MICROPHONE OR PICK-UP IS SUITABLE. The unit is designed for CLUBS, SCHOOLS, THEATRES, DANCE HALLS or OUTDOOR FUNCTIONS, etc. For use with Electronic ORGAN, GUITAR, STRING BASS, etc. For standard or long-playing records. **OUTPUT SOCKET FOR RADIO FEEDER UNIT**. Amplifier operates on 200-250 v. 50 c/c. A.C. Mains and has outputs for 3 and 15 ohm speakers. Complete kit of parts with fully punched chassis and point-to-point wiring diagrams and instructions. If required cover as for A8.

**9 GNS.**

two separate inputs such as Gram and Mike can be mixed, can be provided for 13" extra. The amplifier can be supplied, factory built with 12 months' guarantee for 50% extra. TERMS for assembled two input model: DEPOSIT 28/9 and 9 monthly payments of 28/9.

**P.M. SPEAKERS**. All 2-3 ohms. 5in. Goodmans, 18/9. 6in. Plessey, 16/9. 8in. Plessey, 16/9. 8in. R.A. Field, 19/9. 10in. Plessey Heavy duty, 26/9. 10in. R.A. Field, 26/9. 12in. Plessey, 20/11. 10in. W.B. "Stentorian" 3 or 15 ohms type HF10.12 10 watts, high-fidelity type. Highly recommended for use with any of our amplifiers, £4/10/9.

**PLESSEY DUAL CONCENTRIC 12in. 15 ohm HIGH FIDELITY SPEAKER** with built-in tweeter (completely separate elliptical speaker with choke condensers, etc.) providing extraordinarily realistic reproduction when used with our A8 or similar amplifier. Rated 10 watts. Price complete, only 25/17/6.

**M.E. SPEAKERS** 2-3 ohms. 8in. R.A. Field, 6/00 ohms, 11/9. 10in. R.A. Field, 1,000 ohms, 23/9. 10in. R.A. Field, 1,500 ohms, 23/9.

**COAXIAL CABLE** 75 ohms, 4in. 8d. Yard. Twin Screened Feeder, 11d. yard.

**SELENIUM RECTIFIERS**

F.W. Bridge Type	L.T. Types H.W.	H.T. Types H.W.
6/12 v. 1 a. 5/9	6-12 v. Ja. H.W., 2/9	
6/12 v. 2 a. 8/9		
6/12 v. 3 a. 12/9	150 v. 40 mA. 3/6	
6/12 v. 4 a. 16/9	250 v. 50 mA. 5/9	
6/12 v. 6 a. 19/9	250 v. 150 mA. 9/9	
6/12 v. 10 a. 25/9	300 v. 250 mA. 12/6	

**R.S.C. 3-4 WATT A7 HIGH-GAIN AMPLIFIER** For 230-250 v. 50 c/c. Mains input. Appearance and Specification with exception of output wattage, as A5. Complete kit with wiring diagrams, £3/15/- Assembled 22/6 extra. Carr. 3/6.

**THE SKYFOR T.R.F. RECEIVER** A design of a 3-valve 230-250 v. A.C. Mains receiver with selenium rectifier. It consists of a variable-Mu high-gain H.F. stage followed by a low distortion anode bend detector. Power pentode output is used. Valve line up being 6K7, 6P61, 6F6G. Selectivity and quality are well up to standard, and simplicity of construction is a special feature. Point-to-point wiring diagrams, instructions, and parts list, 1/9. This receiver can be built for a maximum of £4/19/6 including attractive Brown or Cream Bakelite or Walnut veneered wood cabinet 12 x 8 $\frac{1}{2}$  x 5 $\frac{1}{2}$  in.

£2 : 2/9 extra under £5. (LEDS) LTD.

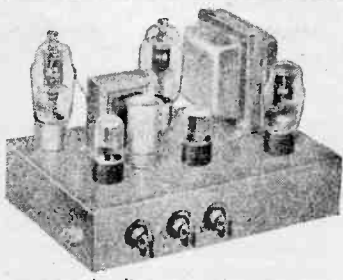

carrying handles can be supplied of 17/6. Additional input socket with associate Vol. Control so that two different inputs such as Gram and "Mike" or Tape and Radio can be mixed, can be provided for 13" extra. TERMS on assembled two input model. DEPOSIT 25/6 and nine monthly payments 22/4. **HIGH-FIDELITY MICROPHONES and SPEAKERS** in stock. Keen cash prices or H.P. terms if supplied with amplifier.

**R.S.C. 4.5 WATT A5 HIGH-GAIN AMPLIFIER**

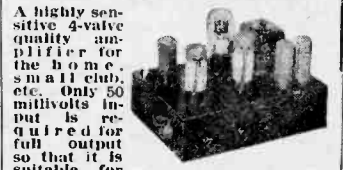

A highly sensitive 4-valve quality amplifier for the home, 5 in a 11 unit, etc. Only 50 millivolts input is required for full output so that it is suitable for use with the latest high-fidelity pick-up heads, in addition to all other types of pick-ups and practically all mikes. Separate Bass and Treble Controls are provided. These give full long-playing record equalisation. Hum level is negligible being 71 db. down. 15 db. of negative feedback is used. H.T. of 300 v., 25 mA. and L.T. of 6.3 v. 1.5 a. is available for the supply of a Radio Feeder Unit, or Tape Deck preamplifier. For A.C. mains input of 200-250 v. 50 c/c. Chassis is not alive. Kit is complete in every detail and includes fully punched chassis (with baseplate) with green crackle finish, and point-to-point wiring diagrams and instructions. Exceptional value at only 24/15/-, or assembled ready for use 25/- extra, plus 3/6 carr.

**R.S.C. TA1 HIGH QUALITY TAPE DECK AMPLIFIER**. For ALL Tape Decks with High Impedance, Playback and Erase Heads, such as Lane, Truvox etc. Adjustment Ready for to type of deck made by Use ONLY alteration of a resistor. For A.C. Mains 230-250 v. 50 c/c.

**11 GNS.**

Positive compensated identification of recording level by Magic Eye. Recording facilities for 35, 71 or 31in. per sec. Automatic equalisation at the turn of a knob. Linear frequency response of  $\pm 3$  db. 50-11,000 c.p.s. Negative feedback equalisation. Minimum microphony and hum. High output with completely effective erasure and distortionless reproduction. Sensitivity is 15 millivolts so that any kind of crystal microphone is suitable. Only 2 millivolts minimum output required from Recording head. Provision is made for feeding a P.A. amplifier. Unit can also be used as a gram-amplifier requiring input of 0.75v. R.M.S. Carriage 7/6. Illustrated leaflet 6d.

**PICK-UPS**. Collaro high-fidelity high impedance magnetic type. Only 31/6. Brand New.

Terms: C.W.O. or C.O.D. No C.O.D. under £1. Post 1/6 extra under £2. Open 9 to 5.30: Sats. until 1 p.m. Catalogue 6d., Trade List 5d. S.A.E. with all enquiries.

# BRIMAR

**TRIPLE-TESTED**

# Transistors

save space power & weight

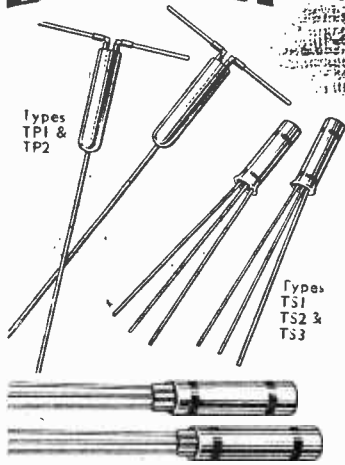

Types TP1 & TP2

Types TS1, TS2 & TS3

Types TJ1, TJ2 & TJ3

These long-life transistors in your circuits will save space and power and incidentally save weight. Exhaustive tests by our unique triple-test process have proved their reliability over a long period.

Their small size and low consumption permit the design of light, compact equipment and; since the cases are of metal, there is little danger of accidental fracture.

The BRIMAR TP1 and TP2 are point contact n type, germanium transistors. Type TP1 may be used in control and switching circuits at frequencies up to 100 Kc/s and will work consistently and reliably within this range. Type TP2 may be used as an amplifier or oscillator at frequencies up to 2 Mc/s. Collector dissipation 150 mW max. at 20° C. The BRIMAR TS1, TS2 and TS3 are p.n.p. alloyed junction transistors intended for use in low frequency applications up to 500 Kc/s. These transistors are fully hermetically sealed. They are thus immune from the effects of humidity and noxious atmospheric conditions. The collector dissipation of these types is 50 mW at 20° C. The TJ1, TJ2 and TJ3 are similar to the TS1, TS2 and TS3, but have a collector dissipation of 200 mW at 20° C. and are somewhat larger in size.

Send for data sheets of these transistors

**Standard Telephones and Cables Limited** FOOTSCRAY, SIDCUP, KENT Footscray 3333

**Experts everywhere**

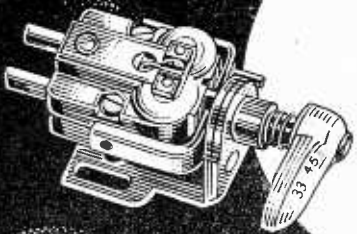

**agree**



**JANUARY 1955** This latest Goldring No. 500 is a complete answer  
P. WILSON, M.A. "The Gramophone"  
**APRIL 1955** Difficult to improve on the price and performance  
D. W. ALDOUS, M.Inst.E., M.B.K.S. "Record Review"  
**JUNE 1955** Rated best Cartridge—best buy  
Special Report on 26 Hi-Fi Pick-Ups by a leading Testing Organisation, U.S.A.  
**JANUARY 1956** A lovely Pick-Up  
P. WILSON, M.A. "The Gramophone"  
**FEBRUARY 1956** In terms of what you receive for dollars spent the No. 500  
is a noteworthy bargain  
"High Fidelity" "U.S.A."  
**MARCH 1956** One of the things audiophiles have prayed for  
"Audio-High Fidelity" "U.S.A."  
**APRIL 1956** This No. 500 is capable of a truly outstanding performance  
D. W. ALDOUS, M.Inst.E., M.B.K.S. "Record Review"

**GOLDRING VARIABLE RELUCTANCE CARTRIDGE No. 500**

Type 500 (2 Sapphires) £2.10.0	P.T. 19/6	<b>COMPLETE IN PICK UP ARM</b>
Type 500/S.D. (1 Sapphire, Standard, 1 Diamond LP) £6.0.0	P.T. £2.6.10	L56/500 £5. 0.0 P.T. £1.19.0
SUPER 500/MSD £7.1.0	P.T. £2.15.0	L56/500 S.D. £8.10.0 P.T. £3. 6.4

Write for Technical Reports and reprints to :

**GOLDRING Manufacturing Company (Great Britain) LTD**  
416 & 418 HIGH RD., LEYTONSTONE, LONDON, E.11 TEL. LEYTONSTONE 8149-4-5



# FOR VALVES—GUARANTEED NEW AND BOXED

OZ4	5/6	6P14	12/6
LA3	2/6	6P15	14/-
1A3GT	6/6	6P15	14/-
1A7	11/6	6G6G	4/-
1C5GT	9/6	6H6	3/6
1H5GT	10/6	6J5G/GT	5/-
1L4	6/6	6J5M	8/6
1LD3	6/9	6J6	7/6
1M	10/6	6L7G	6/6
1R3	8/-	6K6/GT	7/-
1R5	7/6	6K7G/GT	7/-
1T4	7/6	6L7	6/9
1U5	8/-	6K7	6/9
2X3	8/-	6K8G	8/9
3A4	7/-	6K8GT	8/6
3Q4	9/6	6L6G	9/-
3Q5	10/-	6L7M	7/6
3I6	5/6	6N7	7/-
3R4	7/6	6Q7G/GT	8/-
3Y4	8/6	6L7	6/9
4D1	3/-	68A/GT	8/-
4T8A	12/-	68G7	7/6
42	8/-	68H7	6/6
5R40y	9/6	68J7GT	8/-
5U4	8/-	68K7	5/6
6Y3GT	8/6	68L7	8/-
5Z3	8/6	68N7	9/6
5Z4G	8/9	68Q7	9/6
6A7	11/6	68S7	8/-
6A8GT	10/6	6U4GT	15/-
6A7	6/6	6T5G	8/6
6A15	6/6	6U7G	9/-
6AK3	6/6	6V6G/GT	8/-
6AL5	7/-	6X4	7/6
6AM5	5/-	6X4	8/-
6AMB	7/6	6X5G/GT	9/6
6AE3	9/-	6Y4	7/9
6AT9	8/9	7B6	9/6
6B4	5/-	7B7	9/6
6B8	4/-	7C5	8/6
6B4A	8/-	7C6	9/6
6B5B	8/-	7H7	8/6
6B4V	8/6	7C7	8/-
6C4	7/-	7R7	8/6
6C5GT	7/6	7R7	9/6
6C6	6/6	7Y4	8/6
6C8	2/6	7Y5	10/6
6C10	10/6	7T	8/-
6C16	8/-	80	8/6
6D6	7/3	807	6/6
6F1	13/6	812	2/9
6F9F	7/6	9D2	3/9
6FGN	7/6	9001	5/6

9003	5/6	ECC31	9/6
9004	5/6	ECC84	12/6
9006	6/-	ECC85	10/-
954	2/-	ECF82	115/-
955	4/9	ECR35	11/6
956	3/6	ECH42	10/6
1061	12/6	ECL90	10/6
1062	10/6	EP22	8/6
1061	12/6	EP40	11/6
1092	12/6	EP41	11/-
10912	11/6	EP42	13/6
10914	13/6	EP80	10/-
10915	13/6	EP85	12/6
12AH7	6/6	EP89	13/6
12AT7	9/-	EL41	10/6
12AU7	9/6	EL84	12/-
12AX7	10/-	EL91	5/-
12BE6	10/-	EM34	11/6
12B16	8/-	EM60	11/-
12C5	4/6	EY51	11/6
12J7	9/6	EZ40	10/-
12K7	9/-	EZ41	11/-
12K8	11/-	EZ80	10/6
12Q7	9/6	EY86	14/6
12R7	12/6	EY148	8/6
12S47	7/6	EY91	7/-
12SH7	5/6	FW4/500	VR34
12SJ7	8/-	VR35	7/6
12SK7	6/6	VR36	9/-
12SQ7	9/6	VR37	8/-
12T6	12/6	VR65	3/6
20D1	12/6	HL1320	4/-
20L1	12/6	HL23D	8/-
2210G	10/-	HP21C	6/9
2516GT	9/6	HP4101	5/-
25U4GT	12/6	IG2	9/6
25V5G	10/-	IN5	10/6
25Z4G	9/6	KL35	9/9
25Z6G	9/6	KT2	5/-
25Z6GT	9/6	KT33C	10/6
35L5GT	9/6	KT61	13/-
35V4	9/6	KT60	11/-
35Z4	8/6	KTW61	7/9
50L6	8/6	KTW63	8/6
50B	8/-	KTZ41	6/-
ACU/PEN	7/-	LP220	6/9
AS125	7/-	MS/PEN	5/-
ATP4	5/-	P41	6/9
C30A	8/-	P215	5/-
C36A	8/-	PEN25	6/-
CB11	12/6	PEN44	8/-
CB12	12/6	PEN48	8/6
DH75M	10/6	PEN220A	3/-
DAP42	12/6	PCCS4	4/-
EB41	9/-	POF80	9/-
EB41	10/-	POF82	12/6
EBF80	11/-	PCL83	12/6
PI81	12/6	VR116	7/6
PI82	10/-	VR119	4/-
PI83	13/-	VR136	7/6
PP25	5/-	VR137	5/6
PX25	13/6	VR150/30	8/-
PY80	10/-	VP23	8/-
PY82	10/6	VR70	9/-
PY82	10/6	VR71	6/6
QP21	7/6	VR81	5/6
R19	13/6	VR18YL	7/6
SP23	6/-	VR22	3/-
SP220	6/9	VR66	3/9
U10	9/-	VR91	5/6
U22	8/-	VR102	2/-
U25	13/6	VR105/30	7/6
U40C	10/-	VR116	7/6
U404	11/6	VR119	4/-
UAF42	12/6	VR136	7/6
UB41	8/6	VR137	5/6
UBC41	11/-	VR150/30	8/-
UCH42	11/-	VP23	8/-
UF41	11/6	VR70	9/-
UL41	11/6	VR71	6/6
UY41	10/6	VR81	5/6
VR34	2/-	VR18YL	7/6
VR35	7/6	VR22	3/-
VR36	9/-	VR66	3/9
VR37	8/-	VR91	5/6
VR65	3/6	VR102	2/-
VR65A	3/3	VR105/30	7/6
VR66	3/9	VR116	7/6
VR91	5/6	VR119	4/-
VR18YL	7/6	VR136	7/6
VR22	3/-	VR137	5/6
VR53	6/6	VR150/30	8/-
VR54	2/-	VP23	8/-
VR55	7/6	VR70	9/-
VR56	9/-	VR71	6/6
VR57	8/-	VR81	5/6
VR65	3/6	VR102	2/-
VR65A	3/3	VR105/30	7/6
VR66	3/9	VR116	7/6
VR91	5/6	VR119	4/-
VR102	2/-	VR136	7/6
VR105/30	7/6	VR137	5/6
VR116	7/6	VR150/30	8/-
VR119	4/-	VP23	8/-
VR136	7/6	VR70	9/-
VR137	5/6	VR71	6/6
VR150/30	8/-	VR81	5/6

## A NEW ALPHA KIT FOR YOU TO BUILD

Modern Portable. A.C./D.C. Mains/Battery Receiver. Four valves (DK96, DL96, etc.), 2 Waveband Superhet. In an attractive Lizard Grey Case, size 8 3/4 in. x 8 3/4 in. x 4 1/2 in.



Full Kit of Parts down to last nut and bolt.

### £9.9.0

Or if you prefer you can build the battery version first for £7.17.6 and add the mains components later.

Post extra on Kit, 2/6.  
Full Circuit Diagram, Shopping List, and Point-to-Point Wiring Diagram, 2/6.

## MAINS TRANSFORMERS 3 WAY MOUNTING TYPE

MT1:	Primary: 200-220-240 v. Secondaries: 250-0-250 v. 80 ma/0.6-3 v. 4 amp. 0-4 v. 2 amp. Both tapped at 4 v.....each	18/6
MT2:	Primary: 200-220-240 v. Secondaries: 350-0-350 v. 80 ma/0-6.3 v. 4 amp. 0-5 v. 2 amp. Both tapped at 4 v.....each	18/6
MT3:	Primary: 200-220-240 v. Secondary: 30 v. 2 amps. Taps at 3 v., 4 v., 6 v., 8 v., 9 v., 10 v., 15 v., 18 v., 20 v., 24 v.....each	18/6

Please add 2/- per transformer post and packing.



**LOUDSPEAKER CABINETS**  
This attractive walnut finished cabinet is available for 6 1/2 in. or 8 in. speaker units. Metal speaker fret, complete with back and rubber feet.  
6 1/2 in. type: Measures 8 1/2 in. x 8 1/2 in. x 4 1/2 in. at base. Price 18/6 each.  
8 in. type: Measures 10 1/2 in. x 10 1/2 in. x 5 in. at base. Price 20/6 each.  
6 in. type: Measures 6 1/2 in. x 4 1/2 in. x 7 1/2 in., 16/6.

### PUBLICATIONS

No. 124—Bernard's Radio Manual AT GLANCE EQUIVALENTS. \* More than 8,000 Valves listed. \* All Equivalents shown on one line. \* Army, Air Force, Navy types. \* Complete CV to Commercial Listing. 5/-  
No. 124—F.M. Tuner Construction by W. J. May. \* Easy to Build. Point to Point Wiring. \* Super High Fidelity Response. \* 32 Pages. \* All Components for this Circuit available ex stock. 2/6

If you are not in possession of our 1956 24-page illustrated catalogue, please forward 6d. for your copy.

**WIRE WOUND CONTROLS**  
By Colvern, etc., all with 1 in. spindle  
5 ohms, 100 ohms, 200 ohms, 250 ohms, 500 ohms, 1K ohms, 5K ohms, 10K ohms, 20K ohms, 25K ohms and 50K ohms. All 2/6 each.

### CHOKES

20H, 250 ohms, 60 M/A. Clamp construction, each.....	7/-
10H, 200 ohms, 90 M/A. Clamp construction, each.....	9/3
10H, 200 ohms, 150 M/A. Clamp construction, each.....	13/-
10H, 300 ohms, 40 M/A. Midget Clamp construction, each.....	7/3

### TRANSFORMERS FOR BATTERY CHARGERS

230 v. Input Tapped 6-12 v. 1 amp., each.....	13/6
230 v. Input Tapped 6-12 v. 3 amp. (Both with tap on Primary for 2.5 v. Pilot light), each.....	18/-

### HEATER AUTO TRANSFORMERS

Designed to adapt common low tension voltages 4 v., 5 v., 6.3 v. at 3 amps., centre tapped and interchangeable, each..... 7/9

### TYANA SOLDERING IRON

Lightweight 40 watt iron, with easily replaceable elements and bits. 200/250 v., price 18/9 each.

### G.E.C. CABINET LOUD-SPEAKERS,

Cat. No. BC1953  
8in. P.M. moving coil loudspeaker unit, 2/4 ohms with volume control in very attractive cabinet. Price 52/6 each, post 2/6.

### CONDENSERS

BEC 100 MFD 25 v.....	1/9
BEC 500 MFD 12 v.....	1/9
TCC 25 MFD 25 v.....	1/3
DUBLIER 100 MFD 12 v.....	1/9
BEC 50 MFD 50 v.....	2/-
TCC 50 MFD 50 v.....	1/9
TCC 50 MFD 25 v.....	1/9
TCC 250 MFD 12 v.....	1/6
BEC 250 MFD 25 v.....	1/6
BEC 12 MFD 50 v.....	1/6
TCC 50 MFD 12 v.....	1/9
BEC 250-250 MFD 6 v.....	1/6
DUBLIER 50-12 MFD 12 v.....	1/9

### OUTPUT TRANSFORMERS

Multi Ratio Type, each..... 6/6  
Midget for 384 Output, each..... 4/6  
Standard 5,000 ohms, each..... 4/6  
Standard 10,000 ohms, each..... 4/6  
Ignacik Jack Plugs, each..... 2/3  
Bell Lee 7-pin Plug and Socket, each..... 1/6

WHEN ORDERING PLEASE QUOTE "DEPT. P.W."

# ALPHA

RADIO SUPPLY CO.

## 5/6 VINCES CHAMBERS

## VICTORIA SQUARE

# LEEDS I.

**TERMS:** Cash with order or C.O.D. Postage and Packing charges extra, as follows:  
Orders value 10/- add 1/-;  
20/- add 1/6; 40/- add 2/-; £5 add 3/- unless otherwise stated.  
Minimum C.O.D. fee and postage 3/-. All single valves postage 6d.  
**MAIL ORDER ONLY**

# Cosmocord's New Premises

*mean even better all round service  
to all users of ACOS products*

**Cosmocord Ltd.,**  
Eleanor Cross Road,  
**Waltham Cross,**  
Hertfordshire.  
Tel: Waltham Cross 5206\*

700 St. Cambridge Rd.  
Enfield  
Middlesex.

**COME TO THE  
radio show  
EARLS COURT  
AUG 22-SEPT 1**

**STAND No. 202**

An expanding business needs expanding premises, and as the limit has been reached at our Enfield Works we have moved to modern and much larger premises at Waltham Cross — right next to the railway station. Here we have more elbow-room for continued progress in the development and manufacture of ACOS Pick-ups, Microphones and Plastic Mouldings — and for providing even better service to customers throughout the industry.

*\* Incidentally, customers in the London telephone area who wish to telephone us can do so on the automatic system by dialling WA4 5206.*

**acos.**

# PRACTICAL WIRELESS

EVERY MONTH

VOL. XXXII, No. 597, SEPT., 1956

EDITOR : F. J. GAMM

24th YEAR  
OF ISSUE

COMMENTS OF THE MONTH

BY THE EDITOR

Editorial and Advertisement Offices:  
"Practical Wireless," George Hewnes, Ltd., Tower House, Southampton Street, Strand, W.C.2. Phone: Temple Bar 4333.  
Telegrams: NEWSWA, RAJL, LONDON.  
Registered at the G.P.O. for transmission by Canadian Magazine Post.

## Valve Prices

AS from July 2nd valve prices as well as TV tubes were reduced by amounts varying from 10 per cent. to 33½ per cent. Valve manufacture is controlled in this country, as elsewhere, by a monopoly. Prices are agreed between the various manufacturers and they are unaffected to any great extent by free competition. It is generally known by the public that the selling price of valves and TV tubes has no sensible relation to manufacturing costs. A valve which may cost 1s. or so to make reaches the public at 15s., although set manufacturers are able to obtain them at greatly reduced prices. It may be that the spotlight on monopolies directed by the Royal Commission which is examining monopolies considered to be not in the public interest, has had something to do with this belated cut, which we are certain could have taken place years ago.

Most of the patents relating to the valves have now expired, so the question of royalty payments does not arise, yet as each patent lapsed prices were not lowered by the amount of royalty payable on each valve. It is understandable in the early days of a new industry that a certain amount of commercial exploitation will take place. The enthusiasm of the public damps its sense of values and high prices not justified by manufacturing costs and normal profits can easily be extracted. Unfortunately, as the industries develop, trade associations are formed to avoid what is known as a price-cutting war. Trade associations can perform a most useful function in stabilising prices at a reasonable level, so that employees can be paid reasonable wages. Some of them, unfortunately, go outside their original terms of reference. We know that the prices of labour, raw materials and distribution have soared in the past 10 years and manufacturers also have to provide for the much higher rate of taxation now imposed upon them; but allowing for all these factors, prices could come down. The sales of radio receivers are falling and it may be that that factor alone could cause manufacturers to bring their prices more in alignment with the economic position. Otherwise, unemployment in the industry must continue to grow.

### A NEW EXHIBITION

THE first Music-Trades Exhibition will be held from August 28th to 31st at Park Lane House, Park Lane, London. Thus, it will for a few days coincide with the Radio Show, which is to be held at Earls Court from August 22nd to September 21st. Unfortunately, this exhibition is only open to the trade. Its introduction, however, indicates that at last the musical trades have realised that something must be done to meet the competition of radio and TV which is seriously affecting the sales of items such as pianos and stringed instruments. Fewer people, in this canned music era, are learning to play the piano and the fact must be faced that that is a tendency which cannot now be arrested. It would be impossible for a family to listen to radio and TV whilst children are practising scales. Indeed, radio and TV are said to be interfering with the education of the nation because homework is being neglected.

On the other hand, the demand for electronic organs, as our recent series of articles has shown, continues to increase and it may be that within the next 20 years this will replace its older percussion counterpart. The electronic organ, however, still has a long way to go before it can really compete with the piano and it may be that special music will have to be written for it in view of the fact that there cannot be a sustaining pedal.

### PRINTED CIRCUITS

MORE manufacturers are adopting the principle of the printed circuit, which makes assembly cheaper and wiring-up mistakes impossible. Coupled with the increasing use of transistors in certain stages and the production of midget components, it is surprising that the physical dimensions of radio receivers have not been considerably reduced. This is probably because, as a manufacturer recently pointed out, set makers tend to hang on too long to their old cabinet designs. Now that plastics are being generally used for cabinets, the time has come when really attractive and small receivers could be produced.—F. J. C.

# Round the World of Wireless



By "QUESTOR"

## Broadcast Receiving Licences

THE following statement shows the approximate number of Broadcast Licences in force at the end of May, 1956 in respect of wireless receiving stations situated within the various Postal Regions of England, Wales, Scotland and Northern Ireland. The numbers include licences issued to blind persons without payment.

Region	Totals
London Postal ... ..	1,301,508
Home Counties ... ..	1,294,450
Midland ... ..	1,013,011
North Eastern ... ..	1,321,339
North Western ... ..	1,006,107
South Western ... ..	830,939
Wales and Border Counties ... ..	520,649
Total England and Wales ... ..	7,288,003
Scotland ... ..	935,787
Northern Ireland ... ..	206,639
Grand Total ... ..	8,430,429

## Radio and TV Sales

THE expected seasonal movement of sales of radio and television receivers from March to April shows falls of 10 and 13 per cent. this year, according to the monthly retail survey of the British Radio Equipment Manufacturers' Association, compared with falls of 17 per cent. and 12 per cent. in 1955.

Sales of radiograms, which fell by 33 per cent. from March to April in 1955, rose by 8 per cent. this year. This is looked upon as a reaction from the exceptionally low sales of radiograms in the first quarter of 1956, which were 50 per cent. lower than in 1955.

No significant change took place in April in the proportion of radio and television receiver sales under hire purchase or credit arrangements, but for radiograms the percentage rose from 54 per cent. in March to 63 per cent. in April.

## Television and Radio Developments in Australia

NEGOTIATIONS are at an advanced stage for the formation of a new Australian company to be owned jointly by Associated Electrical Industries, Ltd., and E. K. Cole, Ltd., in connection with television and radio developments.

It is proposed that the authorised capital will be £A1,000,000 and that this will be provided as the project develops.

Discussions are proceeding for

the distribution and servicing of the products of the new company to be dealt with by Australian Electrical Industries Pty., Ltd., which may also in the future participate in the new company.

## Even Smaller Transistors

FROM America comes news of the development and production of miniaturised transistors. It is stated that these are so small that 20 of them can be placed on a penny. They are of the p-n-p type with a gain of 70 db. The wafer of germanium which forms the basis of the transistor is smaller than a pinhead and the leads are soldered to a spot of iridium on each face of the wafer. The makers, Philco, when exhibiting the components at a recent convention, showed at the same time a complete amplifier built round them no larger than an average thumbnail.

## Mr. E. W. Chivers

THE Ministry of Supply announces that Mr. E. W. Chivers has been appointed

Principal Superintendent of the Electronics Division of the Armament Research and Development Establishment at Fort Halstead, Sevenoaks, Kent. Mr. Chivers takes up his new appointment in September, 1956.

## Latest Ship-to-Shore Telephone

PYE MARINE, LTD., has been awarded a contract by the G.P.O. to supply and install a frequency modulated very high frequency coastal radio telephone station. This, the first of its kind to be set up in Britain, will be in operation on the Clyde this autumn, and should, in the view of the authorities, be of great assistance to shipping and trade.

The Clyde station, using the "first choice International Marine V.H.F. Public Correspondence Channel" (frequencies 157.4 Mc/s receive, 161.9 Mc/s transmit), will also be the first station to operate to the new international Maritime F.M. Standards proposed by the United Kingdom. The installation on the Clyde will be based on the F.M. version of the Pye Telecommunication "Ranger" series of equipment now going into production—the most modern mobile radio units in Europe—and will employ 100-watt transmitters.

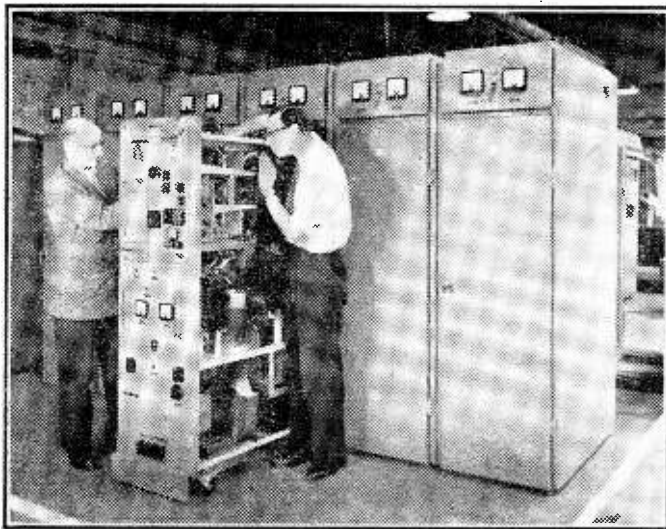

Greenland radio station equipment, supplied by Marconi's, being assembled ready for despatch, at Chelmsford.

### Two New Standards

TWO Standards were issued in July as follows: Memorandum on the design of electrical apparatus having double insulation (B.S. 2754: 1956). Methods of testing vulcanised rubber (B.S. 903, Part C3: 1956).

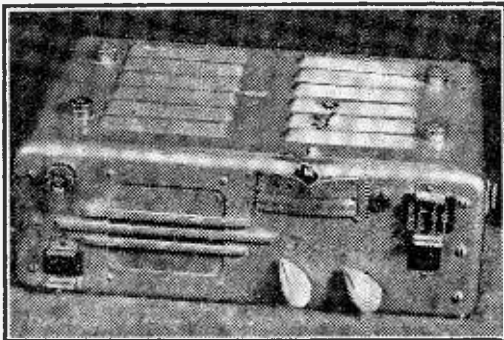

The damaged Transmitter-Receiver referred to on this page.

### Tesla Anniversary

THE hundredth anniversary of the birth of Nikola Tesla was celebrated on July 9th. The modern electric power system is based on Tesla's rotating field multiphase alternating current ideas, invented about 1890, and it is often stated of him that his patents were so advanced that they expired before they could be put to practical use. He even produced a radio-guided submarine in the 1890s.

### Malayan Terrorist Casualty

THE illustration above shows a Marconi V.H.F. Transmitter/Receiver type HP.11, which was hit by bullets during a terrorist attack on a rubber estate in Malaya. One bullet went straight through, and the exit hole can be seen in the front of the set. Another lodged inside the set after passing through a valve and screening can.

The manager of the estate reported:—

"We use five sets of this type for security on this estate; one in the central police post, one in the estate armoured car and three in outlying divisions.

"On March 24th in the early hours of the morning an unknown number of bandits fired into the police post in the Penari division doing little harm other than damaging the V.H.F. set and completely writing off a small battery receiver belonging to the

police. The fire was returned and the bandits withdrew."

The set was sent to the nearest Marconi depot for examination. When the valve and screening can were replaced the set was found to be fully operational, and is once again in service.

### More Successes by E.M.I. Trainees

IN this year's Craftsmanship Competition organised by the Physical Society, E.M.I. trainees have continued their record of successes in this annual nationwide event open to many technical industries and institutions, and attracting hundreds of entries. The official results are:—

#### Draughtsmanship

**Junior Grade.**—1st, D. J. Stevens, E.M.I. Engineering Development, 2nd year apprentice, age 18; 2nd, M. H. Thornhill, E.M.I. Engineering Development, 3rd year apprentice, age 19. Hon. Mention, J. N. Manley, E.M.I. Engineering Development, 2nd year apprentice, age 18.

**Senior Grade.**—Equal 2nd, D. T. Thomas, E.M.I. Engineering Development, 3rd year apprentice, age 19, and K. A. Battle, E.M.I. Engineering Development, 4th year apprentice, age 20. 3rd, T. M. Lawmon, E.M.I. Engineering Development, 4th year apprentice, age 19.

\* Senior Grade prizewinners last year.)

**Sylvanus B. Thompson Prize.**—Hon. Mention, J. P. Simms, E.M.I. Engineering Development, 4th year apprentice, age 20.

(First prizewinner Senior Grade last year.)

**Craftsmanship.**—Class 4 (Blown Glass and Silica Ware).

1st, D. B. Tuckwell, E.M.I. Research Laboratories, 4th year apprentice, age 20. 3rd, A. G. Thompson, E.M.I. Research Laboratories, 3rd year apprentice, age 20.

### Paris Starts Radio Taxi Service

REPORTS received by Pye Telecommunications Ltd., who have fitted out 50 Paris taxis with mobile radio, indicate that the service, which started early in the year, is likely to be a great success with Parisians.

The control station, at the Head Offices of the Compagnie de Voitures of the Société Générale de Location, is in rue Broca. An aerial is installed in the rue Jean-Baptiste Clement—one of the highest points in Montmartre—and linked directly to the central exchange in rue Broca.

M. Robert Catherine, the managing director, expects that within a year 400 taxis will be fitted with radio. "We want to recapture the suburban clientele we lost several years ago," he said, "and we believe that this innovation answers a real public need."

A French newspaper reports, "Rue Broca is already snowed under with inquiries."

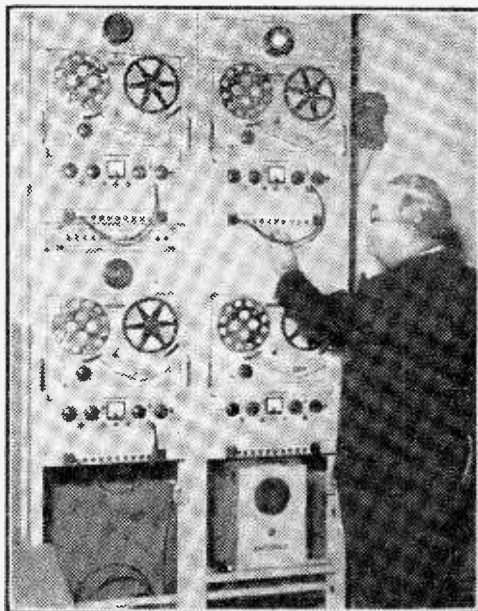

Switching on the latest weather report for public reception on the 'phone in London. This is heard on dialling WEA. 1122.

# An Experimental Power Pack

PRINCIPLES OF DESIGN  
AND SOME PRACTICAL  
CONSTRUCTIONAL DETAILS

By T. S. Skeet

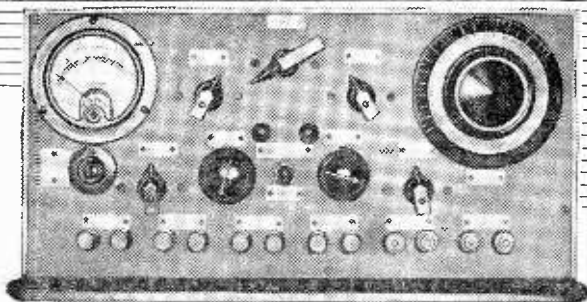

AT some time or other every enthusiast who carries out experiments involving the use of thermionic valves comes to the conclusion that the temporary provision of power supply for the valves in question takes up more time than does the experiment. The writer realised this many years ago; but it was not until the availability of war disposals equipment gave, as it were, a nudge to his elbow that he did anything about it, and then he did it so thoroughly that the making of the power unit became for a time of more importance than the experiments in question. Needing recently to use the power pack after a lapse of some two years, the author found that he had forgotten, to some extent, the functions of the various pieces of apparatus which go to make up the complete unit, and is of opinion that the time taken to familiarise himself with the unit will not be wasted if he can interest others in the apparatus in question.

The power pack is made up on a base of  $\frac{3}{4}$  in. plywood  $15\frac{1}{2}$  in. by 11 in. with an ebonite front panel  $14\frac{1}{2}$  in. by 7 in., on which all the control equipment is mounted. The whole of the unit, with the exception of the front panel, of course, is enclosed by a one-piece, four-sided aluminium cover, which readily drops into position and is secured by screws. The cover has a small portion of the end faces cut away,

to give access to certain output jacks and to the 230 volt 50 cycle input. All outputs are brought out to terminals on the front panel and some of the outputs are duplicated on jacks to facilitate connection of pieces of test apparatus in frequent use.

The illustration above shows the front panel and it will be seen that there are 17 labels indicating the functions of the controls and enumerating the various outputs. They layout of this panel will be given next month.

## Voltmeter Range Switch (S1)

There are eight ranges, from left to right, as follows: Full scale deflection represents 1,000 volts, 500 volts, 100, 50, 10, 5, half a volt and 100 microamperes.

## Voltmeter Selector Switch (S2)

This switch connects the voltmeter as follows: *Position 1*, to the 150 volt supply. *Position 2*, to the 350 volt supply. *Position 3*, to the "Insulation Test" circuit; in this position there will be no deflection unless the "Insulation Test" terminals are "strapped," in which case the voltage will be 960 volts and current will be 96 microamperes. When this supply is used to test the insulation of a piece of apparatus which has no measurable leak the voltage will be over 1,000 volts. The very high resistance (10

megohms) of this testing circuit is of considerable advantage when testing capacitors because, should the capacitor have a leak, say, of 10 megohms, the voltage applied to it will then be around 500 volts; and if the capacitor leak is one megohm the voltage applied by the tester will be only 90 volts. The writer has never broken down a capacitor by using this tester and many a "low" one has been restored to service by the author's process of boiling in paraffin wax (the capacitor, not the author). *Position 4* of the voltmeter selector switch connects the voltmeter via its range switch to the pair of terminals marked "voltmeter" on the front panel, for use in association with external measurements within its range. The voltmeter external terminals are under label 13.

## Potentiometer Selector Switch (S3)

Four positions. No. 1, 150 volt circuit potentiometer. No. 2, 350 volt

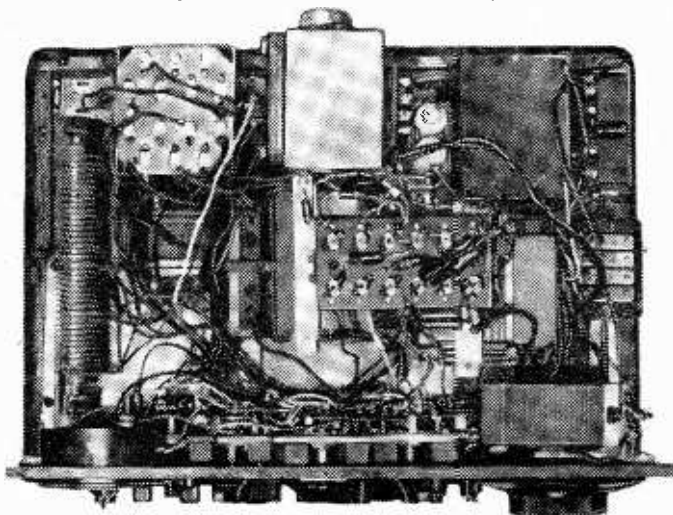

Top view of the completed unit.



potentiometer in circuit. No. 3, neither potentiometer in circuit. No. 4, both potentiometers in circuit. When this switch is in *position 3* both potentiometers are available as variable series resistors, but the values may be reduced to zero by means of the potentiometer control knobs.

#### Potentiometer in 150 volt circuit (R1)

#### Indicator Lamps. 150 volts, 350 volts

This label appears beneath a green and a red glass window, behind which are two torch lamp bulbs fed respectively from the small and large transformers. Either lamp glowing indicates that the associated transformer is "alive."

#### 350 volt Fine Control (R2)

The main 350 volt potentiometer is behind the large dial at the right-hand top corner of the panel.

#### Voltmeter Shunt

Switch S6, which connects a shunt across the microammeter (full scale deflection 100 microamps.) to make the FSD milliamps. This is to permit small currents to be taken from the 960 volt supply for external use other than "insulation testing"; and to give external access to the milliamperemeter.

#### Insulation Tester (S4)

This simple looking two-way switch has twenty-four contacts, twenty-two of which are in use. The switch is used to convert the 350 volt rectifier into a voltage-doubler and to connect the "doubled" output in series with that from the 150 volt rectifier. This is the circuit which supplies the voltage for insulation testing.

#### Transformer Selector Switch (S5)

*Position 1*, small transformer. *Position 2*, large transformer. *Position 3*, neither transformer. *Position 4*, both transformers.

#### Power Section

7,000 ohm potentiometer (R3) in the 350 volt circuit.

Mains switch (S7).

Insulation Test Terminals.

Terminals for external use of voltmeter.

150 volt supply.

350 volt supply.

4 volts A.C.

6.3 volts A.C.

In addition to the front panel layout drawing, there

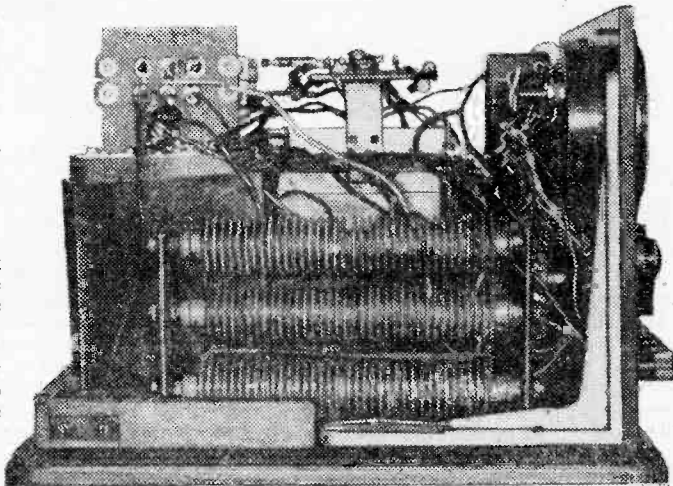

Side view showing the selenium rectifiers.

are two diagrams, one of which is the circuit diagram and the other the wiring diagram; the latter will indicate to the initiated that the setting up of the circuit is a job with plenty of interest.

The voltage values for the 350 volt and 150 volt supplies, quoted in the text, are the nominal values which were aimed at in the design; but the actual voltage output is 380 on no load and 290 volts, with a 36 milliamperemeter load; whilst the other supply, nominally 150 volts, is 170 volts on no load and is

#### LIST OF COMPONENTS

Transformer for the 350 volt supply. Primary tapped 200, 220 and 240 volts. Heater winding 4 volts and 6.3 volts. High tension output 100, 150 or 300 volts.

Transformer for the grid supply. Mains winding 230 volts. Secondary 150 volts and second-secondary 2 volts for operation of the green pilot lamp.

Rectifier for 350 volt supply. Two bars each of 36 discs arranged in "bridge" formation.

Rectifier for 150 volt supply. One bar of 36 selenium discs, rearranged as explained in the text to provide full wave rectification.

Twenty-eight microfarads of paper capacitors.

Four Yaxley type switches.

One six-pole two-way switch.

One large 7,000 ohm potentiometer with 100 ohm series resistor for fine adjustment (for 350 volt circuit).

One small 100,000 ohm potentiometer for the 150 volt circuit.

One microammeter. 100 microamps FSD.

One small switch for shunting the microammeter.

One toggle-switch for mains supply circuit.

Two small indicator lamps. Red for 350 volt circuit, green for 150 volt circuit.

One two-pin "fused" plug for mains input.

Eight insulated type terminals. Four other terminals.

Two jack-type connectors for low-tension supply.

Two jack-type connectors for 350 volt and 150 volt supply.

Resistors for voltmeter to a total of 10 megohms.

Dial for 350 volt circuit potentiometer.

Two knobs for small variable resistors.

Five pointer type knobs for (1) voltmeter range switch. (2) voltmeter circuit selector switch.

(3) potentiometer selector switch. (4) transformer selector switch. (5) voltage doubler switch.

Two smoothing chokes for 350 volt and 150 volt circuits.

down to 120 volts with a load of 15 milliamperes. This is not a matter of any consequence, however, as the supply is nominally only required to supply grid voltage with zero current. The four pairs of terminals, 12, 13, 14 and 15, have insulated coverings.

The code letters A, B, C, D and E on the schematic diagram relate to the switches similarly marked on the wiring diagram and the figures indicate the particular contacts in use for a given switching condition.

fact, most of the wiring is not visible, or even available for maintenance, on account of the large amount of apparatus in a limited space, and it is this fact which makes the unit appear untidy when the cover is removed and which will probably be evident in the photographs. One bit of foresight has saved the author a considerable amount of work. When the unit was designed the panel carrying the voltmeter series resistors was fixed in the horizontal plane and at the top of the unit. This was done because the resistors, to a total of 10 megohms, were nearly all of the carbon rod type and the author knew from experience that this type of resistor is subject to considerable changes with time; particularly in respect to values of over one megohm, which may increase by almost 100 per cent. with age. On check up in preparation for this article two such changes were observed and two resistors had to be replaced by six others selected from a large stock and chosen to provide in combination the same values as the two faulty units.

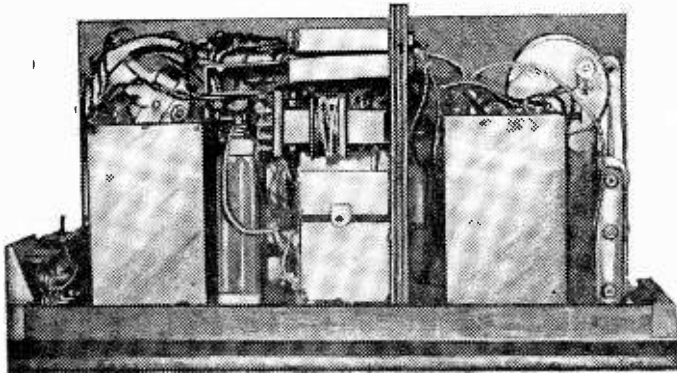

Rear view of the unit.

It will be noticed that the wiring diagram is drawn reversed, as it were, in relation to the front panel drawing: this is considered to be a reasonable arrangement, as the view from the rear, if indeed the wiring could be seen readily, would be reversed. In

Construction

Any reader who wishes to fix up something on the same lines for his own use would no doubt be competent to arrange available apparatus on the lines best suited to his own requirements; but it is felt that the article would be incomplete without some reference to the design

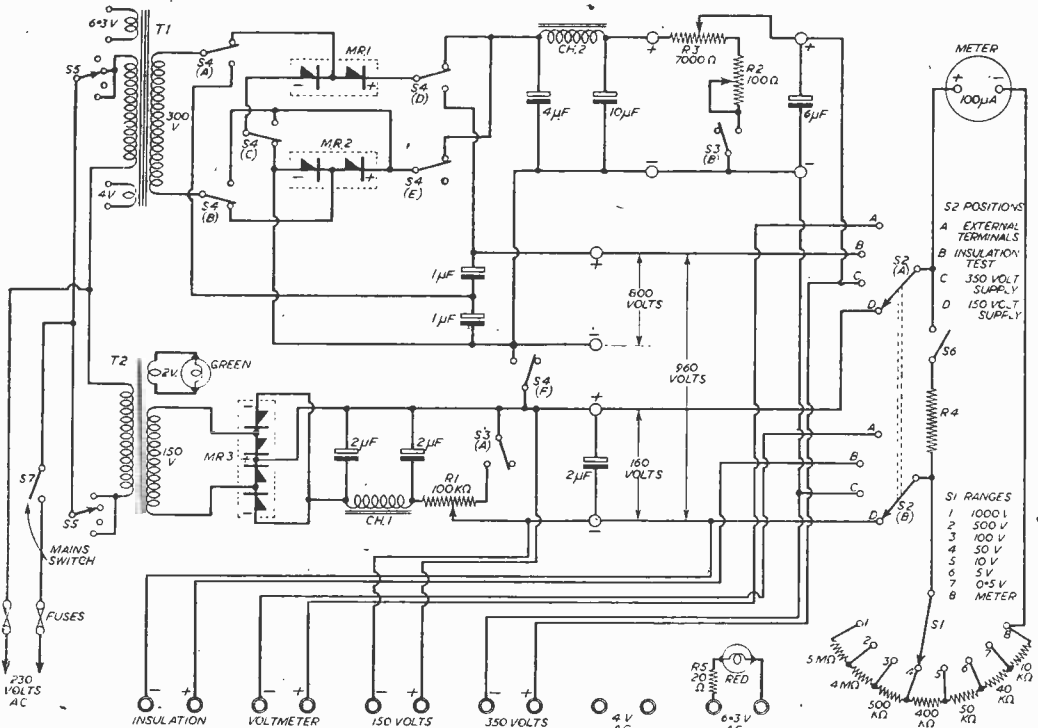

Fig. 1.—Theoretical circuit of the power pack.

and construction of the instrument illustrated by the photographs. These cover all that can be seen of the unit when the aluminium cover is removed.

There are 26 wires leaving the front panel to connect with apparatus mounted on the base of the unit and the latter is so packed with apparatus that the wiring of the panel had to be carried out whilst the panel was detached from the case. (The panel is held in position by No. 4 B.A. screws, screwed into two

vertical cast aluminium brackets.) This condition means that the wires which connect the panel equipment to the apparatus in the case had to be very much longer than would otherwise be necessary.

Five of the six rotary switches are of the "Yaxley" wafer type. They were all "four-pole two-way" when purchased, and are ex-Government stock, but they have been modified to convert them as required.

(To be continued)

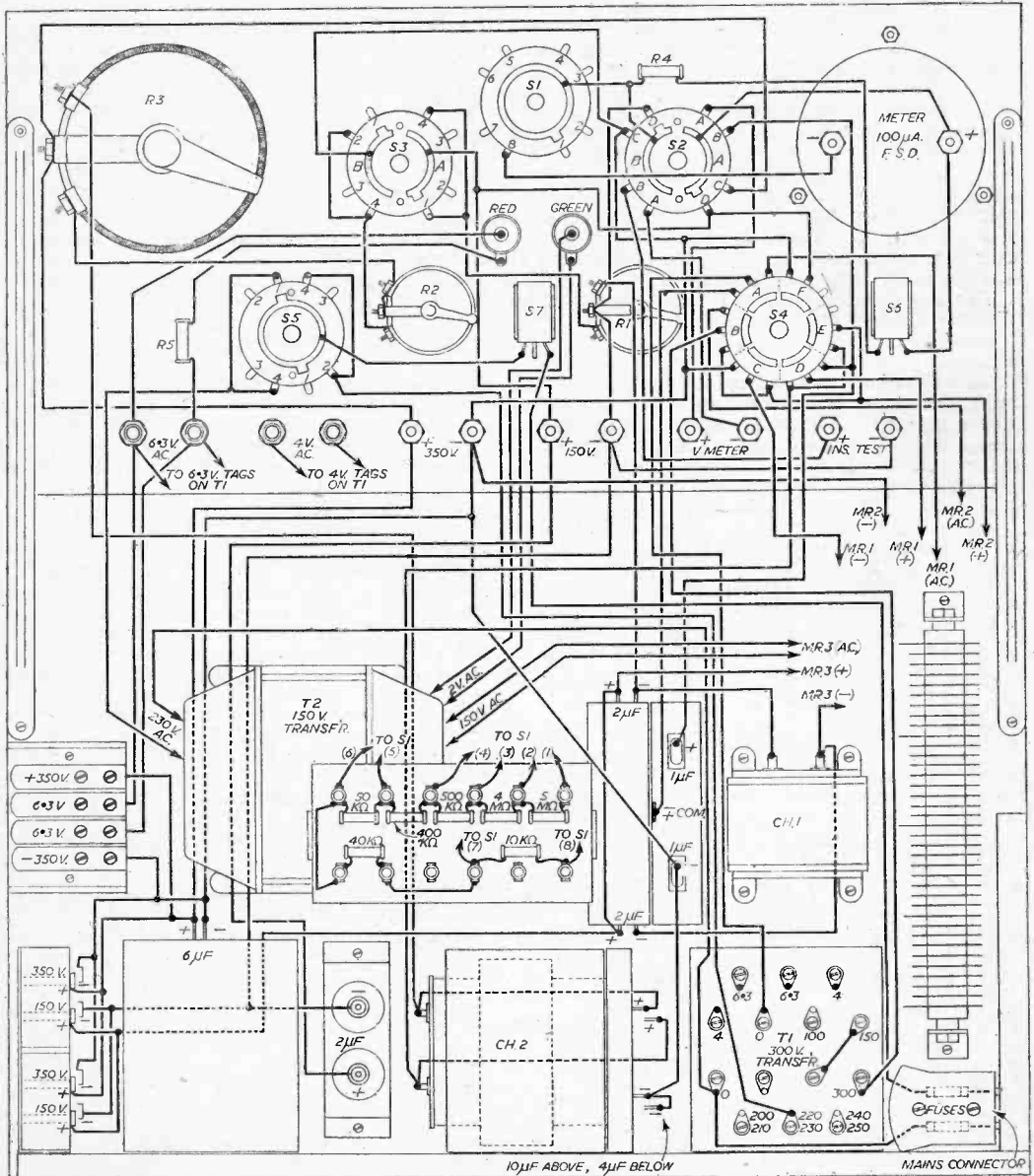

Fig. 2.—Wiring details of the power pack.

# The Simplicity Transistor Two

A CIRCUIT SUITABLE FOR POCKET PORTABLE AND SIMILAR USES

By F. M. White

**N**OW that transistors are more freely obtainable on the retail market, the writer has spent a considerable time trying out various circuits with a view to obtaining reliable loudspeaker reception from not more than two transistors. The circuit finally chosen has many advantages. It is simple, economical to build and to run and, above all, uses only components which are easily obtainable. The last point is an important one, for although transistors themselves can now be bought, nevertheless such items as matching transformers for inter-stage use cannot. It should, however, be mentioned that this virtue in the chosen circuit is quite fortuitous; the primary concern was to find the most efficient circuit, and the fact that the set can be built out of the spares box is a happy accident.

For the detector stage the circuit described by Captain Graham in a recent issue of PRACTICAL WIRELESS was found to be superior to any other. Basically, readers will remember, this was as in Fig. 1.

This was found to function reasonably well with a variety of tuning coils, but exceptionally well with a Teletron type HAX. In fact, the success of the final circuit depends largely on the use of this coil and two other "musts"; one, an efficient earth, and two, that the red end of the germanium diode is connected to the coil; this is essential.

For the amplifying stage the writer is indebted to a 12-year-old schoolboy who evolved a circuit of startling simplicity which nevertheless proved remarkably efficient. This is simply a form of direct coupling, with the collector of the first transistor fed direct to the emitter of the second, and the emitter of the first through a  $1\frac{1}{2}$ -volt battery to base of the second. The full circuit is given in Fig. 2.

## Components

The transistors used are the junction type. Various makes and types have been tried, all successfully. Likewise, various types of germanium diode have been found satisfactory, from the ex-govt. type up-

wards, provided they are connected the right way round. No harm results if they are incorrectly connected, except a diminution of the signal, so constructors may wish to reverse the leads to ensure that the right way round is finally adopted. Similarly, no harm is done if connections to base and emitter are reversed to either transistor, though in this case there will be no signal. These points are mentioned because transistors are reputedly delicate and certainly expensive items, easily damaged in some circuits if incorrectly connected. The only way of ruining them in the chosen circuit is to reverse the polarity of the battery. This is a certain way to ruin them, and it is essential to realise that the earth line with transistors is *positive*.

The only component deserving any further mention is the output transformer. Experiments showed that optimum matching required a step-down ratio of about 20 : 1. The Wharfedale multi-ratio transformer, type G.P.8, provides satisfactory ratios of 18 : 1 and 24 : 1. A Norman component with primary designed for mains and battery pentodes also provides an excellent match; here the mains pentode ratio is 50 : 1 and the battery pentode 75 : 1. Using the two tags not normally recommended results in a ratio of 25 : 1.

The matching, however, is not critical, and in the two prototypes standard "midget" transformers were used for economy of space.

No constructional details are given, for the final form of the receiver can be suited to the individual constructor. Of the two prototypes one was "built round" a 9-volt grid-bias battery; this used a 500 pF solid dielectric condenser for tuning. The second was built round a  $3\frac{1}{2}$ in. speaker, using two  $4\frac{1}{2}$ -volt torch batteries in series, with tuning by a 250 pF trimmer. The cabinet measures 4in. square by 3in. deep—a real pocket radio.

The batteries for the two transistors must be separate: no attempt should be made to take two tappings from one battery. Current consumption is a

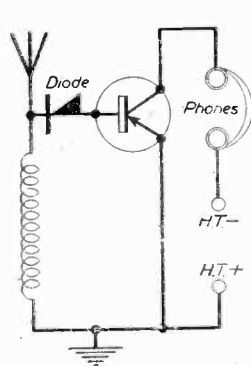

Fig. 1.—Basic detector circuit.

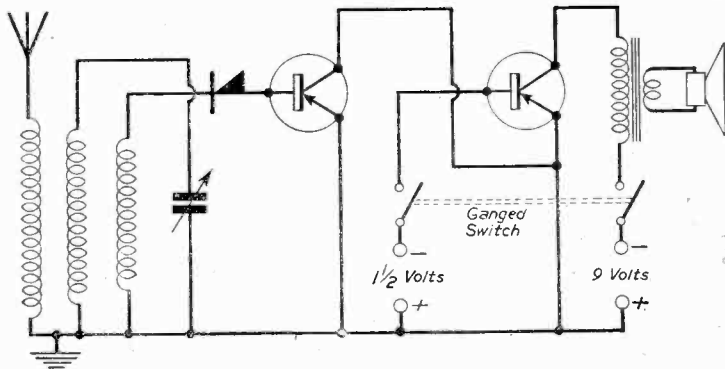

Fig. 2.—Circuit of the Simplicity Transistor Two.

fraction of a milliamp at the first transistor, so the slimmest pencil type  $1\frac{1}{2}$ -volt cell can be used, and its life should be almost equal to its shelf life. At the second transistor consumption is about 5 mA. Consumption varies at both transistors with the strength of the signal, falling to almost zero at the

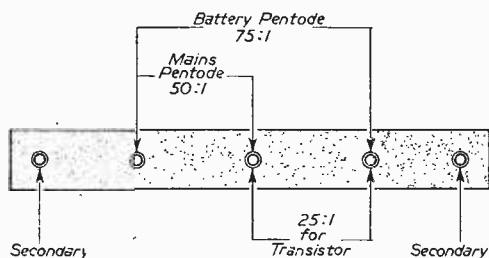

Fig. 3.—Transformer connection details.

first and to 1 mA at the second. A 10 mA meter connected in the second lead forms a highly efficient tuning indicator.

Wire-ended transistors can be suspended in the

wiring and, incidentally, the first can be securely anchored by passing two of its three wires through the small slots in the tag ring of the HAX coil. (Fig. 4.)

It is advisable to make all soldered connections as quickly as possible, since excessive heat can upset the transistor's delicate adjustment. A simple thermal-shunt should be employed and this need be no more than to hold the wire near to the point to be soldered in a pair of metal pliers.

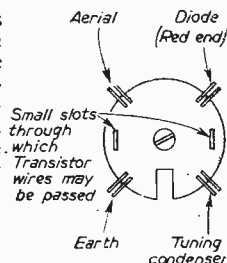

### Results

As for results, comfortable loudspeaker-reception has been obtained on an indoor aerial (in loft) from the Home, Light and Third transmitters in the London area (Teddington); from the Home on a picture-rail aerial and from all three on an outdoor aerial in Cambridge. Finally, it should be repeated that an efficient earth is a necessity.

## Constructing V.H.F. Equipment

By E. G. Bulley

THIS equipment must be of the highest standard, and it is advisable to use good quality components that are designed for use at such high frequencies. Failure to do so will result in very poor reception and unlimited interference.

The chassis should be made from either copper or aluminium, and each stage should be assembled in its own compartment and completely screened with the same material as that of the chassis; each interstage vertical shield should be securely bolted to the chassis so as to obtain a good electrical connection and so provide effective screening.

This, however, does not apply to the audio frequency stage. Nevertheless, the various stages must be connected by the shortest possible connections and, as adopted in television practice, the earthing should all be taken to one point in each stage.

This method of earthing does to a certain extent prevent unwanted coupling between stages, which would cause instability. Instability can result from circulating currents being set up in the chassis.

The reader will, therefore, appreciate that the layout of any V.H.F. receiver is important, and furthermore, as the leads are carrying R.F. currents, they, too, must be short and direct. The wiring is however, slightly heavier than that used in ordinary receiver practice.

### Insulation

With circuits operating at very high frequencies it is necessary to pay special attention to the insulators. These should be of low-loss ceramic, polystyrene or P.T.F.E. The latter is much more expensive than the former two.

Low-loss ceramics are readily available, and the reader should have little difficulty in obtaining them; one must, however, avoid paxolin or similar materials at these frequencies, as they are very "lossy." Whilst on the subject of insulation, it may be as well to mention valve and coil sockets. These, also, should

be of low loss ceramic, polystyrene or P.T.F.E., but one must be extremely careful when making soldered connections to the tags that are moulded in the sockets, as the two latter materials soften with heat, resulting in the loosening of the tags or contacts.

Coils should be wound with copper wire on formers of the materials just mentioned, and it is advisable for the wire to be silver plated to reduce the skin resistance. Should, however, the reader prefer to purchase his coils, there are various reputable makes on the market, these being silver plated.

The next consideration is that of condensers; little difficulty should be encountered here, because vast strides have been made in their design. Ceramic condensers of many values are readily available and are preferred for V.H.F. work. However, one can, of course, use the mica tag type.

The ceramic condensers are physically small and have very low loss, whereas the mica type are much larger in comparison.

Tuning condensers are available already silver plated, and should be assembled as far away from the chassis as possible.

Valves really require little mention here, as reference to any valve manual will provide the reader with the necessary information as to their suitability. Such valves are, however, based mainly with the B7G, B9A or B9G type of base; these bases are all glass with fairly heavy pins sealed into them. Suitable valves for these frequencies should have low inter-electrode capacities with a fairly high amplification factor. In operation it is advisable to include suitable R.F. chokes in the heater leads. These can be readily made, but there again, there are many types available that are small and compact and are designed for such purposes.

"Hand capacity" effect is encountered by many constructors; that is to say, as one attempts to tune the receiver to a certain frequency, the receiver circuit is unbalanced, thus causing fading or in some cases "howling." This, however, can be the result of poor layout and as a result of the R.F. currents reaching the A.F. stage. Suitable by-pass condensers and chokes will assist in preventing this trouble.

# Push-pull Amplification

AN EXPLANATION AND A PRACTICAL AMPLIFIER EMPLOYING THE CIRCUIT

By R. Hindle

WHEN more power output is required than can be obtained from a given valve the obvious course is to look for a larger valve; but this is not always a simple matter. Often an easier course is to connect two similar valves in parallel, i.e., connecting each electrode of one valve to the similar electrode of the other and then connecting into the circuit exactly as if a single valve. Double the output will then be available for the same input signal and the effective ra, and consequently optimum load, will be a half that for one valve. Clearly, the total anode current will be double that for one valve and as this current has to pass through the primary of the output transformer this component will have to be larger, more difficult to design and much more expensive because it is important that the current flowing through it does not bring it near to saturation. This means a large core and altogether a very substantial component. The reduction of optimum load to a half follows from the normal theory of two resistances in parallel.

Just as resistors and other components can be connected in series as well as in parallel, so can output valves, where again the available power output will be of the order of twice that for a single valve. In order to economise in the way of H.T. volts, however, it is desirable to put the valves in series only from a signal point of view, but leaving them in parallel so far as D.C. is concerned. As a result, only the same H.T. voltage is required as did the single valve though, of course, twice the current is drawn. The basic circuit is given in Fig. 1(a); from which it will be seen that the parallel connection from the point of view of H.T. is obtained by feeding the H.T. to a centre-tap on the transformer primary, from which the current divides into two, one stream for each valve. Bearing in mind that the winding is, in fact, all one and is laid on in one direction throughout, the current in the two halves will be in opposite directions (i.e., if in the upper half current flows clockwise, in the lower half it must pass anti-clockwise). The result is that the magnetic effect of the current in one half is neutralised by the magnetic

effect of that in the other half and the core is relieved of the saturation effect that caused difficulty with parallel valves and with large single valves. A suitable push-pull output transformer is, therefore, easier and cheaper to produce and the risk of saturation distortion is minimised.

Other and perhaps more important advantages are also derived from this circuit. The signal output currents from the anodes of the valves are fed into the extreme ends of the primary windings and consequently they must be arranged to be of opposite phase (i.e., the top end being positive when the lower end is negative) to be additive; if both were positive at the same time the two signals would cancel each other. Being anti-phased, however, they will cancel each other out in the part of the circuit in which they are in parallel, i.e., in the common H.T. feed. This means that there is less risk of feedback to earlier stages via the H.T. impedance and consequently the decoupling components can be less ambitious. The signal components are also in parallel in the common cathode biasing resistor if used (Fig. 1(b)) and so no bypass capacitor is needed. Supposing also that some hum voltage exists in the H.T. supply. As this is fed into the centre-tap the field created in one half of the primary cancels out the similar but opposite field due to the other half and the net result is to prevent hum appearing in the secondary and in the speaker. Less smoothing is required, therefore, for the output stage where due to the current involved smoothing is expensive.

## Distortion

Now supposing that one valve of the pair introduces distortion due to its non-linearity; then as the other valve is identical and is working under similar circumstances it is reasonable to assume that similar

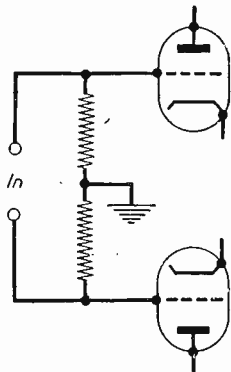
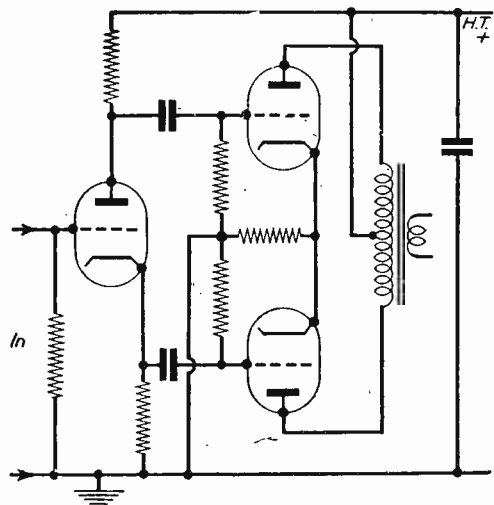

Fig. 2 (left).—The simplest form of phase inversion.

Fig. 3 (right).—A phase inverter and push-pull stages.



distortion will be produced by it, but in this case the distortions will not necessarily be added in the output transformer as are the amplified signals from the previous stage. On the contrary, it is found that even harmonics (i.e., the second, fourth, etc.) cancel out, assuming, of course, that the push-pull stage is correctly balanced, though odd harmonics persist.

Distortion caused by single-ended triode amplifiers is largely second harmonic so in this case a very considerable improvement arises from the use of a push-pull circuit; pentodes give chiefly third harmonic and so results are not so much improved when they are worked in push-pull. Beam tetrodes, the most common type of output valves to-day, are somewhere between the triode and the pentode from the point of view of distortion, giving less third harmonic than pentodes though they are not so good as triodes in this respect. The two valves being effectively in series from a signal point of view the optimum anode-to-anode load would be expected to be twice that of a single valve. In fact, it will be noticed that this is not always so according to the valve makers; the reason is that the degree of the various types of harmonic distortion present depends on the load and consequently the makers specify a load for the valves in push-pull to give the minimum odd harmonic: the even harmonic is then probably more than need be, but as explained will cancel out in the output transformer.

#### Phase Inversion

It has been assumed above that the signals fed into the grids of the push-pull output valves would produce signals at their anodes that are additive in effect. This requires that the output signals are in opposite phase, the top of the transformer being positive at the instant when the lower end is negative, and for the outputs of these two valves to be in opposite phase their inputs must also be in opposite phase. The simplest way of achieving this is as in Fig. 2 where the input signal is developed across a resistance, the exact centre of which is connected to earth. As the two halves of the resistor are equal, and as they are carrying the same signal current, then obviously they must have equal signals across them and when the upper end is positive with regard to the earth connection the lower end must be negative. The signal between one end and earth is fed to each output valve. Now this is all very well, but it means that both sides of the signal fed into the resistor of Fig. 2 are remote from earth. Occasionally this can be done, possibly when a pick-up with two separate leads brought out is used, neither of which is connected to the frame of the pick-up nor to the screen of the wire, though in practice the screen of the connector is used as one connection in most pick-ups and in that case it is impracticable. It is possible also to arrange the load of a receiver diode detector in this way but again there are difficulties in the way and this mode of phase splitting is rarely used.

By interposing a valve between the input signal and the push-pull grids it is possible to accept a signal with one side earthed and the method is shown in basic detail in Fig. 3. It may not be so obvious that the anode and the cathode resistors of V1 are, in fact, a centre-tapped resistance until it is remembered that the H.T. line, to which the anode resistor is connected, is tied down to earth by means of the final smoothing capacitor, the reactance of which to audio frequencies is negligible. The two resistors together and in

series form the load into which V1 is working and so long as they are equal in value equal signals will be generated across them because the same signal current is flowing through each.

Unfortunately, the signal across the cathode resistor is in the input as well as the output circuit. The signal effectively fed into a valve is that between its grid and its cathode and in the present case this consists of the incoming signal in series with that across the cathode resistor. Now when the grid goes more negative as a result of the incoming signal less anode current will flow, less voltage will be dropped across the cathode resistor and the cathode will change towards earth potential, i.e., it will go more negative. In other words the cathode output signal moves in the same direction as the grid input signal; if both grid and cathode move negatively the net voltage operating the valve must be less than either grid to earth signal or the cathode to earth signal.

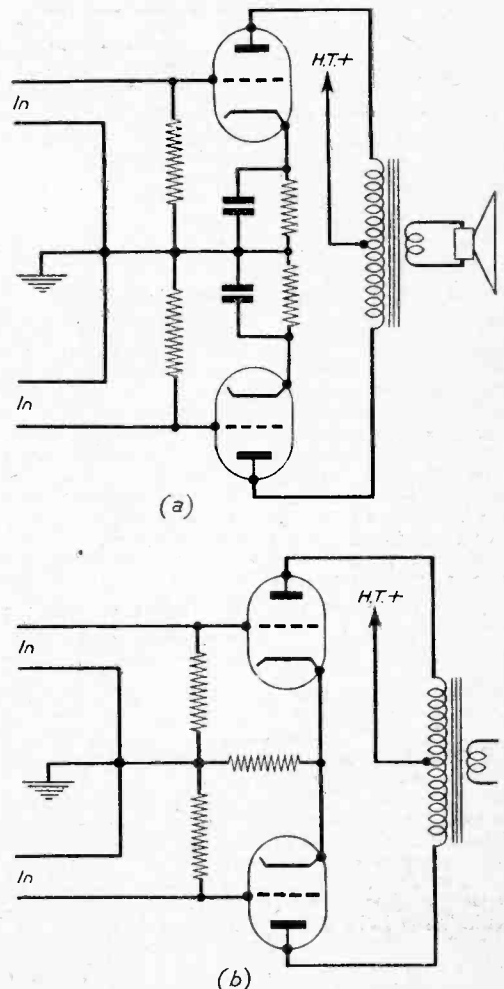

Fig. 1 (top).—The basic push-pull circuit and, in the lower illustration, the common cathode bias arrangement.

Supposing the cathode output signal were equal in amplitude to the grid input signal; then, in effect, there would be no signal at all between grid and cathode and so the valve could give no output; but it was stipulated that there should be a signal out from the cathode equal to the anode signal, so obviously these conditions are impossible in practice. Similarly, it is impossible for the cathode output signal to be bigger than the input signal, and there is left the only practicable situation—the cathode output signal is inevitably smaller than the input signal. In practice, the cathode output is actually approximately nine-tenths of the input. The anode output has been left until now to look

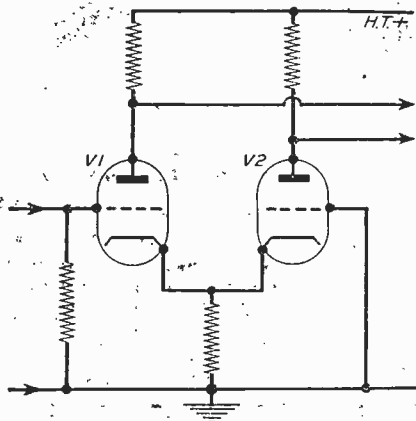

Fig. 4.—A cathode coupled phase inverter.

after itself, but as anode and cathode resistors were made equal the signal across them must be equal as already pointed out, and so the total output signal is  $2 \times .9$  or 1.8 times the input. This is not a very great contribution to the amplification of the equipment but this method of phase inversion is theoretically and in practice a very satisfactory one that is easily set up and is used in the design to follow.

#### Cathode Coupled Inverter

There are many other ways of obtaining the necessary phase reversal and an alternative that is often used for audio amplifiers is given in Fig. 4. This is the cathode coupled circuit, and the first valve of the combination looks very much like the previous circuit, having a load resistor at both anode and cathode. The vital difference is, however, that this valve does not give out an equal signal at cathode and anode; the cathode signal is, in fact, the input to the second valve of the inverter and is about equal to half the incoming signal so that both valves of the combination are receiving equal signals and so, assuming that they are similar valves with equal anode load resistors, the valves will give equal outputs at their anodes. As was seen above, the signal at the cathode is in phase with that at the grid, i.e., when the grid signal at V1 goes negative, the cathode signal goes negative, and so the cathode of V2 goes negative, whereas V2 grid is tied to earth so that it is just the same as if V2 grid were positive; thus, the two valves are accepting signals of opposite phase and consequently their outputs are of opposite phase as is required to feed push-pull valves.

How is it then that in this case the cathode signal is no more than half the input signal whereas in the previous case it was equal to the anode signal? It is not because the cathode resistor is small; in fact, it is made as big as other factors will allow. The reason is that the signal currents from both valves are flowing through the same resistor, that of one valve being in opposition to that from the other. If the two currents were equal they would completely cancel and there would be no signal input to the second valve—and therefore there would be no signal current through the valve so they could not be equal signal currents from each valve. Obviously, therefore, the signal currents must be different, the amount of difference being such as will produce the signal input to the second valve across the cathode resistor so that the larger the cathode resistor the less the net signal current required to produce the correct input voltage to the second valve, and therefore the less need the valve currents be out of balance. For instance, if the signal from the previous stage is 4 volts and therefore a signal at the cathodes of the valves (i.e., the input to the second valve) needs to be of the order of 2 volts a cathode resistor of  $20 \text{ K}\Omega$  will require the valve currents to be out of balance by only a tenth of a milliamp. and that cannot be considered a serious out-of-balance condition, using the readily available components of average tolerance. It will be noticed that the circuit tends to keep the currents near balance, not the voltages, whereas it is the anode voltage signals that are fed on to the push-pull stage so that it is essential to ensure that the anode resistors of the valves are of equal value; or, rather, to be really clever, the resistors can be made slightly different in size to compensate for the inevitable slight difference in the valve currents so that the voltage output signals are exactly equal.

#### Practical Design

In order to illustrate better the principles of push-pull and phase inversion a design for a simple, but very good, quality amplifier is now given. This can be fed by signals from any of the feeders already described in the past in these pages. The complete circuit diagram will be given in Fig. 5 next month from which it will be seen that the push-pull output valves are fed from a phase inverter of the first type described above, the second half of V1 having equal resistors at its anode and cathode. The first half of V1 is used as a straight audio amplifier stage to give adequate signal input to the phase inverter which, it will be remembered, contributes practically nothing to the gain of the amplifier. There are a number of new features and these will be explained.

First, the output valves are connected neither as triodes nor as tetrodes, but as something between the two. The screen grids are connected to taps between the extremes of the transformer primary and its centre-tap. If they were connected to the extremes they would operate as triodes whereas if they were moved to the centre-tap the valves would operate as tetrodes with all their faults. The method here used is known as the "super-linear" way of working though this must not be taken as meaning that they are working more linearly than if connected as triodes. The aim is to obtain something approaching the fidelity of triodes with something like the efficiency of tetrodes—an attempt to get the best of both worlds which is, in practice, successful.

(To be continued)



# PREMIER RADIO COMPANY

B. H. MORRIS & CO. (RADIO) LTD.

OPEN TILL  
6 P.M. SATURDAYS

(Dept. P.W.) 207, EDGWARE ROAD, LONDON, W.2

Telephone :  
AMBASSADOR 4333  
PADDDINGTON 3271-2

## BUILD THESE NEW PREMIER DESIGNS

### 3-BAND SUPERHET RECEIVER

MAY BE BUILT FOR **£7.19.6** Plus 3/- Pk. & Carr.

2 Band T.R.F. Receiver may be built for **£5.15.0** plus packing & post 3/-. These two receivers use the latest type circuitry and are fitted into attractive cabinets 12in. x 6 1/2in. x 5 1/2in. in either walnut or ivory bakelite or wood. Individual instruction books 1/- each, post free.

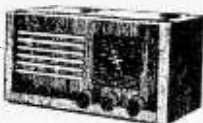

### ALL-DRY BATTERY PORTABLE RADIO RECEIVER

MAY BE BUILT FOR **£7.8.0**

Plus 3/- Pkg. & Postage  
4 Miniature valves in a superhet circuit covering medium and long waves. Rex-line covered cabinets 11 1/2in. x 10in. x 5 1/2in., in contrasting colours, wine with grey panel. Instruction book 1/3 post free, which includes full constructional details and list of priced components.



### 4-WATT AMPLIFIER

MAY BE BUILT FOR **£4.10.0** Plus 2/6 Pkg. & Carr.

Valve line-up 6SL7, 6V6 and 6X5. FOR A.C. MAINS 200/250 VOLTS. Suitable for either 3-ohm or 15-ohm Speakers. Negative feedback. Any type of pick-up may be used. Overall size 9in. x 7in. x 5in. Price of Amplifier complete, tested and ready for use, **£5.5.0** plus 3/6 pkg. & carr.

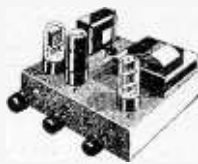

A STEEL CASE IS NOW AVAILABLE, COMPLETE WITH ENGRAVED PANEL, 21/- EXTRA.

### CABINETS—PORTABLE

Model PC/2 Grey Lizard Rexine covered, 45/- Overall dimensions 15in. x 13in. x 6in. Clearance under lid when closed 3in. De-Luxe model, wine and grey, 55/6.

Model PC/3 Rexine type covering in grey, 69/-. De-Luxe model, 79/6.

Overall dimensions 16 1/2in. x 14 1/2in. x 10 1/2in. Clearance under lid when closed 6 1/2in. All the above Cabinets are supplied with Panel, Carrying Handle and Clips. Packing and Postage 2/6.

Send for the Premier WIDE ANGLE TELEVISOR booklet, 3/6 post free.

### COMPACT GRAM AMPLIFIER

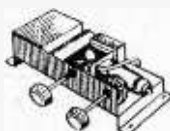

Suitable for any type of Pick-up. Volume and tone control fitted with knobs. Overall size 7 1/2in. long x 3 1/2in. wide x 2 1/2in. high. Complete and ready for use.

**£2.19.6**

Plus packing & postage 2/6

### GRAM UNITS

B.S.R. 4-Speed Autochanger, **£9.15.0** plus 5/- pkg. & post.  
B.S.R. TU 3 Speed, **£4.12.6** plus 2/6 pkg. & post.

### A NEW TAPE RECORDER

CREDIT TERMS DEPOSIT **£5** and 8 monthly payments of **£4.18.6**

H.P. TERMS 1 DEPOSIT **£20** and 12 monthly payments of **£1.17.1**

Cash price **£40** plus packing and carriage 21/-. Case finished in Brown and Antique Fawn. Size 13in. x 12 1/2in. x 7 1/2in. with the very latest type Continental fittings. For A.C. mains 200-250 volts, 50 cycles.

SEND FOR LEAFLET

## data for AUDIOPHILES\*

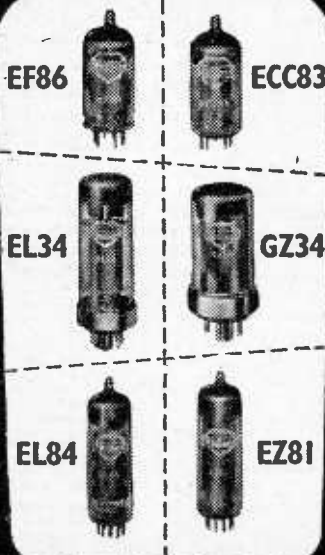

Audiophiles all over the world are demanding Mullard audio valves for their high quality sound equipment. And who can blame them when they know that the Mullard World Series of Audio Valves is the finest in the world. Fill in the coupon below for free data on Mullard World Series Audio Valves.

\* *Audiophile—Enthusiast for high quality sound reproduction who is satisfied with nothing but the best.*

This popular book is available now from most dealers, price 3/6d. It contains designs and full constructional details of the new Mullard EL34 High Quality 20 Watt Amplifier, a Mullard Band II F.M. Tuner, pre-amplifiers for the Mullard EL34 Amplifier and for the popular Mullard 5 Valve 10 Watt Amplifier, together with other useful technical information.



## Mullard WORLD SERIES AUDIO VALVES



Mullard Ltd., Publicity Division, Kington House, Shaftesbury Av., London. WC2

### COUPON

To Mullard Ltd., Publicity Division  
Please send me, free of charge, leaflets on the Mullard World Series of Audio Valves, and details of "High Quality Sound Reproduction".

NAME .....

ADDRESS .....

# LASKY'S PAGE OF MONEY-SAVING OFFERS

## MOVING COIL PM SPEAKERS

3in. and 3 1/2in. 19/6; 5in. 16/6; 6 1/2in. 17/6; 8in. 25/-; 10in. 26/6; 12in. 29/6.  
6 1/2in. with trans., 21/-  
7 x 4 Elliptical, 19/6  
10 x 6 Elliptical, 32/6

## CRYSTAL CARTRIDGES

B.S.R., complete with two styl. also Acos type HGP.37, I.P. and standard Post Free. **18/6**

## DECCA XMS P.U. HEADS

L.P. and standard, complete with styl. Pcr pair. **79/6**  
Post 3/6.  
Singly. 42/-, post extra.

## JASON "ARGONAUT" AM/FM TUNER

A super-sensitive Tuner for F.M. and medium waves. Complete parcel with power supplies. **£13.19.6** Post 3/6.

DATA BOOK 2/- post free. All components available separately, price list free.

Chassis Assembly, 57/9. Post 2/6. I.F. and Coil Set, 78/-, Post 1/6.

## JASON F.M. TUNER

Special Parcel containing data book, chassis, front end, dial, drive, tuning cond., full set of coils, ratio detector, etc., **68/9**  
Post 2/6.

Book, with price list. 2/-  
This tuner can be built for £6.15.0, plus 3/6 post.

## LASKY'S RADIO CONSTRUCTOR PARCELS

Each complete with your choice of Cabinet, 12 x 8 1/2 x 5 1/2 in. deep, walnut or ivory plastic or wood with walnut veneer.

**PARCEL NO. 1.** Everything to build a 4-valve, 3-wave superhet for 200/250 A.C. mains. Uses 6K8, 6K7, 6Q7, 6V6 valves. CAN BE BUILT FOR £7.19.6.

**PARCEL NO. 2.** Everything to build a T.R.F. 3-valve set for 200/250 A.C. mains, med. and long wave. Uses 6K7G, 6J7, 6V6 and metal rectifiers. CAN BE BUILT FOR £5.10.0. Post 2/6. INSTRUCTION BOOKS, 1/- each post free. All components available separately.

## BUILD A FIRST CLASS TAPE RECORDER AT POUNDS SAVING

Send for details of Lasky's New Portable Tape Recorder Kit, comprising fully fitted Case, Truvox Deck, Amplifier, Elliptical Speaker, 1.200 ft. E.M.I. Tape, Plastic Spool and full instructions. Price of the COMPLETE KIT **£35** Carr. & Pk's. 25/- extra.

## BIGGEST BARGAIN EVER OFFERED IN TV CATHODE RAY TUBES!

### BRAND NEW, PERFECT 16" METAL CONE C.R.T.



A big new purchase of these tubes enables us to still further reduce our price from £9.19.6 to **£8.9.6**. 8.3 v. heater, Ion trap, 14 K.v. E.H.T., wide angle 70°, standard 38 m.m. neck, duodecal base, magnetic focus and deflection. Length 17 1/2 16in. Gives large black and white picture 11in. x 14 1/2in.

Unused in original cartons. Guaranteed by us 3 months. Full data, connections and suggested time bases supplied with every Tube.

LISTED AT **LASKY'S PRICE £8.9.6**  
**£23.9.10**

Carr. & Insur., 22/6 extra.

Masks, Anti-Corona Rings, Bases and Ion Traps available. Note to Previous Customers: As a gesture of goodwill to customers who paid our former price of £9.19.6, we will make a rebate of £1.10.0 in the form of a merchandise credit note. Proof of purchase must be furnished and claims must be made by September 14th, 1956.

## NEW BATTERY PORTABLE FOR HOME CONSTRUCTION ON PRINTED CIRCUIT

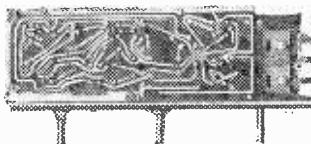

CAN BE BUILT FOR

**£7.7.0**

APPROX.

Uses all latest innovations, giving simplicity of construction with fine quality. The PRINTED CIRCUIT completely eliminates wiring errors.

10 STAR FEATURES make this the finest Portable Radio ever offered to the home constructor. Peak value for money has been obtained without sacrifice of quality or design.

- ★ PRINTED CIRCUIT 7 1/2 x 2 1/2in.
- ★ 4-valve Superhet. med. and ion; w.vt.
- ★ Low Consumption Valves. Double battery life.
- ★ Ferrite Rod Internal Aerial.
- ★ 3 or 5in. P.M. Moving Coil Speaker (your choice).

- ★ Brand New T.C.C. Capacitors.
- ★ Automatic Volume Control.
- ★ New Style Contemporary Case.
- ★ Lightweight and of Handsome Appearance.
- ★ Every Component available separately.

CIRCUIT DIAGRAM, assembly data, all instructions and shopping list, 1/6, post free.

DEMONSTRATION MODELS AT BOTH OUR ADDRESSES



## 5-VALVE RADIOGRAM CHASSIS

A.C. mains, 3-wave superhet. Large full vision dial, 11 1/2 x 4 1/2 in. Overall dim. 14 x 6 x 7 1/2 in. Valve line-up: 12AN8, 6AB6, 6AT6, 6BW6, 6X4.

LASKY'S PRICE, complete with valves, **£9.19.6**  
Carr. 7/6.

Table Cabinet for above, complete with 6 1/2 in. P.M. speaker, 49/9.

## TURRET "TELETUNER"

Complete with 7 coil sets, 1 to 5, 8 and 9. Covers Band I and III, London and Birmingham. Valves used: PC64, R.F. double triode, cascade R.F. amplifier, PCF89, triode pentode t.c. and mixer, I.F. output 33-38 Mc/s, easily modified to other I.F. outputs. With full instructions and circuit diagram. **99/6**, Post 2/6. Knobs, 3/6.

## 3-WATT MIDGET AMPLIFIER

A.C./D.C., very high gain. 4 valves: 2 U41 (D.P.), UCH42, UAF42. Input voltage 100/110, easily converted to 230 v. Ideal for record players, recorders, baby alarms, etc. Fully assembled, with valves and circuit diagram. NOW ONLY **50/-**  
Carr. 5/-

## 5-VALVE RADIO CHASSIS BARGAIN

Brand new A.C./D.C. 200/250 v. I.F. 485 kc/s A.V.C. 4-watts output, 3 station pre-set, frame aerial, fully aligned. Chassis 10 x 5 1/2 in., max. height 5 1/2 in. Wired ready for use with the addition of a speaker and output trans., 2 controls, volume and station switch. Valves used: 10C1, 10F9 or UF41, 10LD11, 10P14, U404 or UY41.

Lasky's Price, less valves, **52/6**  
Post 3/6

## 3-SPD. AUTO-CHANGERS

Brand new in makers' cartons - GARRARD RC.110. STILL FURTHER REDUCED. Complete with t.o. crystal pick-up. Cream/brown enamel finished. List £14.13.0.  
Lasky's Price **£7.19.6**  
Carr. 5/-

GARRARD RC.90. Full length arm with two Decca XMS heads. List £20.15.0.  
Lasky's Price **£13.19.6**

With GC.2 t.o. crystal p.u., £15.15.0. Carr. 5/-

BSR Monarch, £7.19.6. Carr. 3/6.

COLLAR RC.54, with Studio O t.o. crystal p.u., £9.19.6  
Carr. 5/-

## SINGLE RECORD PLAYERS

B.S.R. type TU.8, 3-spd. motor, turntable and HGP.59 t.o. crystal p.u., complete with two styl.

Lasky's Price **92/6**, Post 3/6.

Without pick-up, 57/6. Post 2/6.

SEND FOR OUR NEW LIST, enclosing 3d. stamp.



## LASKY'S (HARROW ROAD) LTD.

42, TOTTENHAM COURT ROAD, W.1.  
Between T.C.R. and Goodge St. Stns. NUS 2605  
370, HARROW ROAD, PADDDINGTON, W.9.  
Opp. Paddington Hosp. LAD 4075 & CUN 1979  
Open all day Saturday, early closing Thursday

ALL MAIL ORDERS TO HARROW ROAD PLEASE



# 'On Your Wavelength'

BY THERMION

## New Look For Cabinets

ONE of our leading plastic manufacturers who produces a large proportion of our plastic radio cases recently issued a suggestion to radio set manufacturers to design small lightweight cabinets more in keeping with the present miniature components. Firms are still using largish cabinets to house very small chassis. Such small cabinets could help to reduce the cost of radio receivers and thereby encourage sales. When plastic cabinets were first introduced the public did not take kindly to them. They were looked upon as being far inferior to wooden ones. Personally, I would rather have a plastic cabinet than a piece of veneered three-ply, finished in cellulose to imitate French polishing. But cabinet design generally has got too bizarre and Yankie. The design is jazzed up and looks anything but attractive. I therefore support the view for a change to a more sober but none the less attractive design. Some may object that a plastic cabinet affects the tone of the reproduction, but it need not do so if it is correctly designed. The one disadvantage is that most plastics age-harden and are readily broken if accidentally knocked.

There is no reason to-day why a radio set should occupy a large space in a room. Even radiograms are coming down in size. Of course, the quality fanatics will tell you that you must have a large baffle and therefore a large cabinet. One crank I know has a baffle holding an exponential loudspeaker which is almost as large as one of the walls of the room. He fondly imagines that he is getting better quality as a result. He is not, although he is blithely unconscious of the unsightliness of this monstrosity.

## The Quality Fans

BY the way, what has happened to all our quality protagonists like Bonavia Hunt and others? We have not heard from them lately, and I am beginning to wonder whether they have changed their views about quality. They used to scream out for special components, criticise all existing speakers and circuits, forgetful of the fact that they were so small in number that no manufacturer would cater for them.

## Reception in Sheffield

IN the past few years I have received many letters from readers in the Sheffield district complaining about bad reception and particularly bad TV reception. I am glad, therefore, that the matter was raised in Parliament, when the Postmaster-General was asked how many complaints he had received this year. He replied that 810 complaints were received up to the middle of May. The trouble is generally due to electrical interference, most of which has been suppressed. Although Sheffield lies well within the normal range of the BBC's high-power transmitter at Holme Moss, reception conditions in

the area vary considerably because of the hilly nature of the country.

## Those Organs

ONE or two readers disagree with my views about electronic organs. The fact is that it is not a musical instrument properly so described, that is, within its class. I do not like them. I think they murder music. You remember the definition of an oboe—an ill woodwind which nobody blows good; or the definition of bagpipes—an instrument which makes a noise, but by a merciful dispensation of providence does not also smell; or of a fugue—a composition where, as the voices one by one come in, the audience one by one go out. When the organ is played I am one of those who go out. Its place is in a cathedral, where church music is played in a dim religious light. It is there intended to create the atmosphere of gloom and misery. Perhaps that is why to-day our churches are empty.

## Mrs. Dale's Diary

AT the risk (one which I seem always to run!) of being considered a churl, may I also say that I think feature programmes, such as Mrs. Dale's Diary, Life With The Lyons, and similar programmes, have been running far too long, and destroy the original zest for listening to them. If variety is the spice of life, it should certainly be the seasoning of radio. The material and the presentation of Mrs. Dale's Diary is puerile and nauseating, as well as being quite untrue to life. There is an unnatural friendliness between the various members of the Dale family. In ordinary life there would be the odd quarrel or two, and a leavening of those family clashes which unite it. Not in Mrs. Dale's Diary; they seem to live a life of going somewhere and mouthing words about trifling things too unreal to be fact, and too uninteresting to be fiction. In any case, it has had a fair run, like Life With The Lyons, and I think that they should be rested for a few years.

## Talks about Books

AGAIN, why is that in the radio talks on books by the critics only fiction, biography and travel are selected? Technical books, and scientific books are never selected: yet it is true to say that to-day nearly everyone is interested in some technical, scientific or practical subject. A monthly review of the latest books would be of enormous value to the listening public. No one could be expected to follow all the publishers' announcements in various selected journals. Incidentally, the books which are mentioned over the radio are very few in number and it strikes me as being very unfair discrimination to spend half an hour discussing three books out of the dozens of different titles which are published every month.

# TRANSMITTING TOPICS

## UNUSUAL AERIAL IDEAS

By O. J. Russell, B.Sc.(Hons.), G3BHJ



It is clear that there is a great interest in aerial ideas, particularly from correspondence received regarding previous articles on this subject. In many cases the use of a directive aerial having gain will result in an effective transmitter power gain that is achieved economically, and without transmitter modifications. In any case, if one is running the limit of allowed power, only an aerial system having gain will permit of a further extension of the signal. Many other factors cause a great interest in aerial systems,

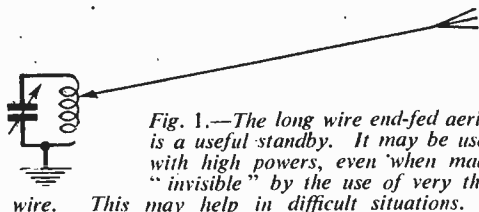

Fig. 1.—The long wire end-fed aerial is a useful standby. It may be used with high powers, even when made "invisible" by the use of very thin wire. This may help in difficult situations.

as for example, the possibility of simple yet effective directive systems on reception enabling heavy QRM to be eliminated. In other cases, due to the exigencies of modern existence in council flats and restricted sites, some unobtrusive form of aerial is needed to overcome local restrictions. All these factors, therefore, result in a very great interest in aerial ideas that may help an amateur in an "impossible" location to operate.

Nowadays, situations are "impossible" for several reasons. Generally, landlords or councils may place an embargo on aeriels. However, even where no restrictions exist, space may be so limited that the erection of an efficient aerial system seems hopeless. Moreover, the difficulties of the transmitting amateur are generally more trying, for reasonable reception even of DX signals is quite feasible with a few feet of wire on the floor. . . all signals are merely cut down proportionally. However, the radiated signal is restricted in power compared with the powerful QRM, so that the transmitter is heavily handicapped in competition with other signals. The fact that the situation is never hopeless must be borne in mind. Thus transistor rigs with power inputs of some 30 milliwatts have covered ranges of several hundred miles, admittedly with good aeriels. However, this offers hope that even a very poor system with 150 watts will enable some QSOs to be made.

The simplest and most effective aerial for situations that are "difficult" in the several senses of the word is the long wire end-fed arrangement (Fig. 1). Where the "difficulty" consists of a direct embargo on outdoor aeriels, the "invisible" long wire is the solution recommended. A fine wire of gauge from 32 upwards is completely invisible to casual inspection. Even when one knows "where to look," a thin

enamelled wire is often difficult to locate. Moreover, to make the best of it, the lightest supports, and miniature insulators made from polythene extracted from coaxial cable lengths, keep weight, and visibility, down. A rubber band is often helpful in the system to absorb wind strain and, to avoid breaks in windy weather, plenty of slack should be left in the wire which will then survive an amazing amount of high wind due to the very low "windage." Trees are a useful support for such "invisible" aeriels, and cases of very long wires up to some 200ft. or 300ft. have been described. It should be noted that an "invisible" wire of great length may be used in cases where the weight of a thicker wire could not be supported. An "invisible" wire of light thin-wire makes an ideal aerial for field days or other outdoor QRP excursions.

A thin wire is recommended, therefore, when conventional thick wire aeriels are not practicable. In view of the use of these wires for power inputs up to some 150 watts, there appears to be little danger of excessive dissipation burning out the aerial. However, many amateurs are in such a position that an outside wire of any description is difficult or impossible. This often occurs in a flat, where purely structural details of the building prevent access to open spaces. An indoor aerial is thus the only alternative left.

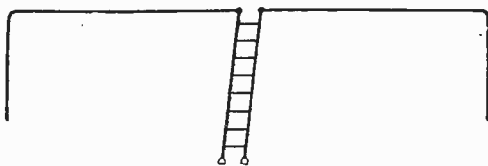

Fig. 2.—An indoor dipole can be accommodated for 10 metres and 21 Mc/s by allowing the ends to hang downwards where space does not permit a clear run.

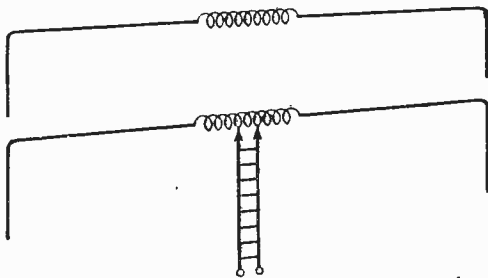

Fig. 3.—Compacted centre-loaded elements with or without bent end wires permit operation of a two-element beam indoors or in restricted spaces on at least 14 Mc/s.

### Indoor Aerials

Even a random length of wire may be utilised as an indoor system for transmission purposes. However, on the higher bands, 10 metres particularly, it is possible to use a full length dipole. Even a small room which does not give even the 16ft. span needed for 10 metres, can still accommodate a 10-metre band dipole if the ends are allowed to hang down (Fig. 2). In fact, by clipping suitable lengths of wire to the picture rails, and allowing the ends to hang down, a complete three-element beam may be erected indoors for at least 10 metres. As the entire aerial is within easy reach, lengths can be pruned and

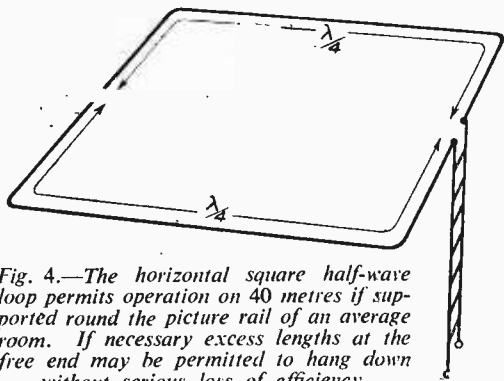

Fig. 4.—The horizontal square half-wave loop permits operation on 40 metres if supported round the picture rail of an average room. If necessary excess lengths at the free end may be permitted to hang down without serious loss of efficiency.

adjusted to compensate for the effect of the walls, and the beam tuned up accurately for maximum gain and efficiency. Indoor aerials, if they can be tuned up appear to operate quite efficiently if located as far as possible from water tanks and other large metallic objects, and good DX is easily worked on 10 metres with such aerials. Beam direction changes by clipping the beam to alternative positions on the picture rail are quite simple, and such a system can be confidently recommended.

The use of "loaded" elements to "compact" beam elements has been mentioned previously. For the bands of 21 Mc/s and 14 Mc/s, loading coils in the centre of dipoles and elements enable compacted beams to be used. If a 10-metre dipole is used, this can be centre loaded to enable it to be used on both 21 Mc/s and 20 metres by appropriate loading coils. Thus a 16ft. element can be used on three bands. However, due to the lowering of feed point impedances, generally a three element beam using loaded elements gives little advantage over a two-element beam, and a two-element beam using loaded elements is recommended for such experiments (Fig. 3).

The lower frequency bands do not offer the same scope for experiments with restricted or loaded aerials. On 40 metres a "horizontal loop" aerial (Fig. 4) is recommended. The overall wire length is one-half wavelength and it will be found that the average room will neatly accommodate such an aerial tucked into the picture rail. The ends, if the room is too small, may be allowed to hang down at the open end. The centre may be fed with tuned 300 ohm line and the aerial behaves exactly like a tuned half-wave dipole. In fact, its radiation pattern and efficiency are not inferior to a conventional dipole. However, while such a wire may be centre loaded up

to 80 metres, it is not usable on its second harmonic. A smaller loop half-wave for 20 metres would perform equally well on 20 metres. On 40 metres at an average location some 20 countries were worked by the writer of 40 metre C.W. using such an aerial tucked into the picture rail. Phone contacts with only some 16 watts of grid modulated phone were also achieved. This aerial is a type seldom mentioned in textbooks for H.F. operation, although it is basically a single element of early "Turnstile" types of V.H.F. aerial systems. In fact, such aerials may be stacked, although this is seldom practicable indoors. In the case of very small gardens of roughly square shape such an aerial could be used outdoors and will perform well if suitable support points can be arranged.

### Topband and 3.5 Mc/s

For the topband and for 3.5 Mc/s things become even more difficult. Where an attic is available, or loft space beneath the roof exists, a long length of wire may be zigzagged (Fig. 5) to give an aerial capable of giving results on 3.5 and also on 160 metres. These may be tuned up against ground as Marconi systems of even end-fed as if they were long wires.

Incidentally, those working topband with wires thrown out of the windows of a building and where a long earth lead is inevitable, may be interested in trying the inverse feeding system of Fig. 6. Instead of the usual series tuned "base loading" system, try the parallel tuned "high voltage" feeding of short wires; say, those around 30ft. in length. This may be combined with earthing the distant end with or without a base loading coil. The author has obtained good results recently on a short aerial of some 30ft. on topband merely by feeding it directly from a parallel tuned circuit. The wire actually sloped downwards towards ground from a window only 20ft. above ground, but loaded up well and

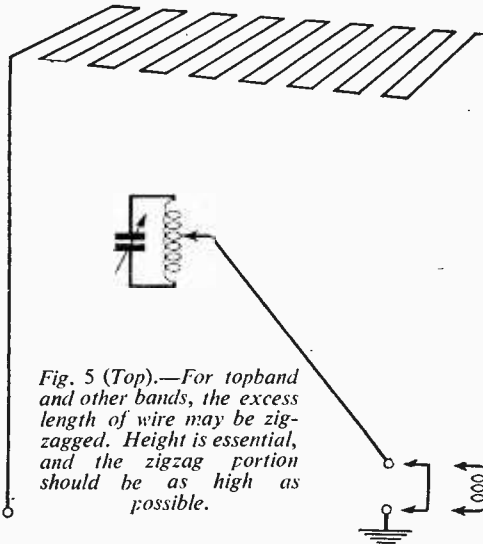

Fig. 5 (Top).—For topband and other bands, the excess length of wire may be zigzagged. Height is essential, and the zigzag portion should be as high as possible.

Fig. 6 (Bottom).—"Hot end" parallel feeding of a Marconi type aerial. For short aerials, depending on circumstances, the end distant from the feeding end may be left free, earthed or loaded to ground via an earthed loading coil.

enabled several old acquaintances to be contacted on topband over the holidays. For various reasons it was not possible to erect a more elaborate aerial; nevertheless the system appeared to radiate well and many enjoyable contacts ensued. It should be noted that inverse feeding of a Marconi type system at the "free" end, rather than the earthed or nominally "cold" end, may actually be more efficient under some conditions. This is not because aerial efficiency as such is increased, but because the coupling circuit losses may be lower under some conditions with such an arrangement. Tilted, vertical or even horizontal wires may be used with this system and it is suggested that users of short base loaded and fed Marconi aerials try the result of feeding them at the "free" or "hot" end while retaining the earthed end loading coil. It is possible that in some cases efficient loading may be achieved by what is virtually "voltage" feeding, even when the other end of the aerial is not earthed, so that a further means of experimenting with Marconi systems becomes possible, so that some experimenters may be able to obtain increased radiation efficiency under their particular conditions. It is, of course, not necessarily an improvement under all Marconi aerial conditions, as it depends upon coupling circuit considerations rather than upon the aerial arrangement itself. However, it is strongly recommended as a basis for experimentation, especially for those operating topband with short aerials dictated by locational difficulties.

#### Directional Systems

A further interesting possibility is the use of directive aerials upon topband and 80 metres. On these bands loop or similar aerials, if used for transmitting, become very, very inefficient, so that even a very short wire aerial is generally superior. The use of directional reception aerial systems is extremely useful, particularly on topband, as interference may often be largely overcome. This applies not only to the heavy summer static, which is often very directional in origin, but also to the many highpower coastal and shipping stations which operate on the band. Often, a distant amateur is unaware that at the reception point his signals may be badly interfered with by these QRO coastal signals. In such cases, a directional receiving aid may be invaluable in enabling weak DX signals to be resolved.

For directional reception, the conventional type of frame aerial may be used. It is necessary to tune a frame aerial for maximum efficiency, which will be somewhat low, unless a frame greater than 1ft. square is used. While the frame aerial is an old standby, there is nowadays a much more compact yet efficient directive receiving device which is of some interest to amateurs. This is the "inductor," which consists of a long, thin rod of high permeability dust core material, fitted with a small pick-up coil. The "inductor coil," due to the use of high-permeability core material, has a high pickup, and is often employed in portable broadcast receivers and mains transportables as the aerial. This device is quite compact, for the inductor rod is about 1ft. long, while the coil is extremely small in size. It exhibits marked directional properties, and should make an effective directional receiving system for the topband. Such "inductor coils" are available from various advertisers. Here again, the coil should be tuned, and it may be that some turns may have to be removed from a medium-wave "inductor coil" to enable the topband to be efficiently tuned in.

Using the medium-wave coil of a "Teletron" inductor coil with the author's HRO, it was found possible to peak up the topband signals to very good volume indeed using a standard 500 pF receiving variable in the circuit of Fig. 7. In practice, a somewhat smaller variable—possibly a 160 pF receiving type—would be suitable. One end of the inductor coil was taken to the aerial terminal of the HRO, the other side of the HRO aerial coil being grounded. The "inductor coil" was returned to ground via the 500 pF condenser as shown. Good volume and directivity were obtained. The injection of a little

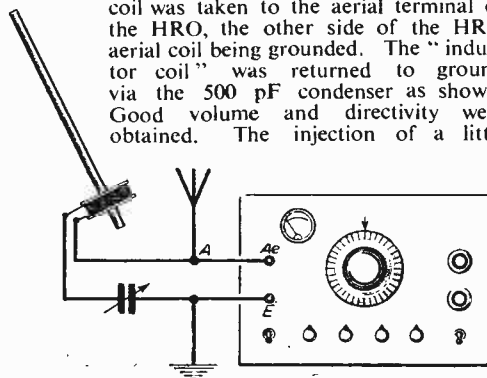

Fig. 7.—Using an "inductor coil" aerial with a communications type receiver. A short vertical aerial attached to "A" may assist when very sharp nulls are needed. Generally only a foot or two of wire suffices for this. The "inductor coil" in any case has sharp directivity, and may enable interference to be nullified or greatly reduced when receiving weak signals.

"aerial" pickup from a very short length of wire will improve the null directivity in the usual method used with D.F. loops. This idea can, in fact, be confidently recommended to those troubled with QRM on topband reception. The arrangement shown was found superior to unearthing the HRO aerial coil and running the system ungrounded. This is probably accidental, and with other set-ups it is possible that an ungrounded aerial coil system may be found superior. In any case, it does offer a further field for experiment for those working on topband as a useful adjunct in the reception of stations troubled by QRM.

There seems no reason why a device of the "inductor coil" type should not be used upon 80 metres as well. This would mean that a smaller coil would be needed to resonate the inductor system. Experimenters could easily wind such a coil and slip it over one end of the "inductor" stick of high permeability material. Remember that the coil *must* be tuned for adequate pickup. The "Teletron" coil used has a very high-Q and is Litz wound. This should be remembered if any attempt is made to strip turns off the coil, as each strand requires to be soldered for optimum efficiency. It is noted that the tremendous QRM from S9 plus signals on 3.5 Mc/s would appear to make an 80-metre "inductor coil" an interesting proposition in enabling much of the QRM to be removed. Generally, of course, the aim is to "null" out the QRM, rather than to merely point the device in the direction giving the loudest signal from the wanted station. It is hoped, perhaps, that later on some notes may be published if an "inductor stick" suitable for both the 1.8 Mc/s and 3.5 Mc/s bands can be tested on these bands.

# The R.1155 Communications Receiver

MODIFICATIONS TO THIS POPULAR EX-GOVERNMENT UNIT

By K. A. Brook

**N**O doubt there are many readers who own this receiver and have heard that the M.F./D.F. circuits are of little use, but have been puzzled as to a method of removal of these circuits without damaging the receiver proper by removal of wrong components. The purpose of this article is first to describe how to remove these components in a methodical manner.

Other modifications to be described are:

1. The fitting of an output stage inside the receiver with alternative outputs for either 'phones or speaker.
2. The building-in of a power pack, utilising the space made available by removal of the M.F. components.
3. The reduction of noise in the receiver.
4. The fitting of a crash limiter stage.

Before commencing these modifications, the set

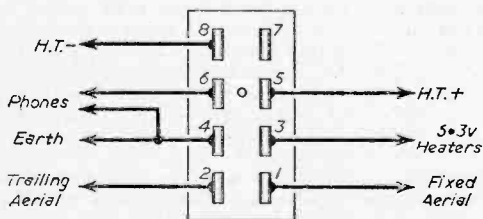

Fig. 1.—The "To Transmitter" Jones plug connections.

should be made to operate satisfactorily, as this may save a great deal of trouble later.

At this point, a word or two on operating the receiver may not be out of place.

It will be noticed that in the bottom right-hand corner of the front panel are three Jones plugs—one four-pin and two eight-pin plugs. One of the eight-pin plugs is marked "To Transmitter." It is via this plug that supplies reach the set. (See Fig. 1.) An important point is that H.T. - is *not* returned to chassis. Most constructors will have a power supply which could be used for checking the receiver. The H.T. - should be isolated and H.T. + should be about 220 volts. The heater wires are connected to pins 3 and 4. A pair of high impedance 'phones are attached to pins 4 and 6. It now only remains to connect an aerial, and it will be noticed that there are two. On the aircraft were three aeriels: a loop aerial for use in direction-finding, a fixed aerial used on ranges 1 and 2, and a trailing aerial used on ranges 3, 4 and 5. As range 3 covers the majority of the medium waveband, this will be the easiest for checking, so the aerial should be connected to pin 2. During this operation of checking, the M.F. valves may be removed. These may be located with reference to Fig. 2. The functions of the valves are as follows:

- |                           |             |
|---------------------------|-------------|
| V1.—R.F. Amplifier        | 6K7 or EF33 |
| V2.—Frequency Changer     | 6K8 or X65  |
| V3.—First I.F. Amplifier  | 6K7 or EF39 |
| V4.—Second I.F. Amplifier | 6K7 or EF39 |

V5.—Heterodyne Oscillator and A.V.C. diode

6Q7 or EBC33

V6.—Detector, and A.F. Amplifier

6Q7 or EBC33

Suitable valves are suggested after the valve function.

After these tests have been made and the receiver is working satisfactorily, we are now in a position to commence the modifications.

## Removal of the M.F./D.F. Circuits.

These circuits operate almost independently of the main receiver (some components are common to both H.F. and M.F. circuits). The valves concerned are three in number—two VR99A triode hexodes (DF1 and DF2 in Fig. 2), and one VR101 double triode (DF3 in Fig. 2). The former are aerial switching valves and the latter a meter switching valve.

There are several reasons for removal of these components:

1. To reduce the drain on the supply.
2. To enable a power pack to be fitted on the chassis.
3. To enable an output stage to be fitted on the chassis (although the speaker must be external if it is to be any reasonable size).

It will be found easiest to commence dismantling operations with DF1 and DF2, which can be located by reference to Fig. 2. A start can be made by removing the two multiple capacitors (0.1 + 0.1 + 0.1  $\mu$ F) situated between the two valveholders. Next remove the common cathode resistor (240 $\Omega$ ), and the other leads can then be cut off. It will be found that some of these leads terminate at a transformer located beneath the magic eye. If the magic eye can be removed from the bracket, and the bracket itself loosened, it will be possible to take out the transformer. It was thought that it may be possible to use this transformer as a basis for the output transformer, but the laminations appeared to be unsuitable. The four resistors on top of this transformer are in the M.F. circuits, and may be additions to the spares box.

Next the group board behind the two valveholders

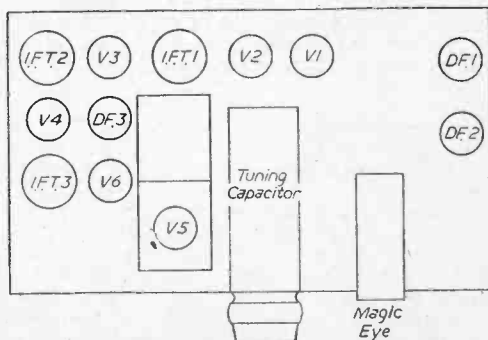

Fig. 2.—Layout of some of the major components.

should be tackled. All components may be removed together with the wiring, some of which is connected to two coils mounted on a bracket behind the cover containing the trimmers. These coils together with the bracket are removed. This more or less completes removal of the triode hexode circuits. When removing the heater connections to these two valves, be sure

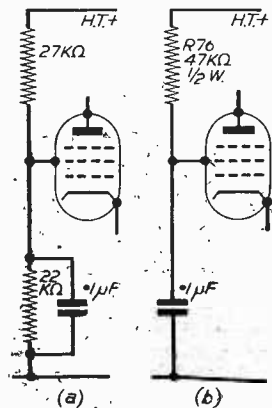

Fig. 4.—The screen feed network and the modified arrangement.

care must be taken with the heater and earth connections, as some heater leads terminate at the meter plug, and these leads should be removed and refitted on to pin 3 of the "To Transmitter" plug. An earth should be treated in the same manner, unless the earth pin on the "To Transmitter" plug is independently connected to chassis.

Whilst in the region of the plugs we may as well deal with the "To Loop Aerial" plug, from which the two earth leads may be severed. (These are the two top connections with the chassis inverted.) It must be decided whether the loop aerial connection is to be used. If it is, disconnect the bottom two leads and reconnect one of them to chassis. The other lead should be suitably insulated and left free for the time being. In the author's experience, however, this loop connection was not of any real value on any of the five ranges, but is included for the sake of completeness.

Now we may deal with the meter switching valve,

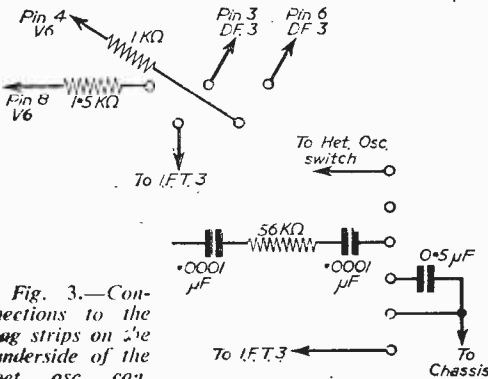

Fig. 3.—Connections to the tag strips on the underside of the het. osc. can.

whose position may be located with reference to Fig. 2. (This valve is DF3.) All wires except the ones to pins 2 and 7 should be cut. This leaves the heater connections intact for a valve to be added later. Leads again may be traced back to source and removed.

We now come to a most difficult part of the proceedings. This is the removal of the components in the rear section of the aluminium box containing the heterodyne oscillator valve. When the top is removed the components immediately visible are a multiple paper capacitor (2.5 + 2.5 + 1μF) and a coil in a cylindrical can. All leads may be cut off as all components in this can are in the M.F. circuits. The leads on the little tag strip at the side may be cut off and traced back, etc. In doing so, a couple of screened cables will lose their outer sheath connection to chassis and these chassis connections must be renewed. Turning back to the box, cut off the leads to the coil and capacitor. The top fixing screw may now be removed but the bottom screw is rather more difficult. If one owns an angle screwdriver it may be possible to remove the screw without undue difficulty, otherwise it will be necessary to remove the fixing nuts of the adjacent I.F. can. The can may be moved aside enough to allow a straight screwdriver to fit into the screw slot. If one is unlucky and screw and nut turn together, the only remedy is to remove the head of the screw by means of a hammer and a cold chisel. It will be found necessary to remove the coil and a similar coil underneath that before the capacitor can be withdrawn. When this has been done a bank of five .005 μF mica capacitors will be seen, held by a couple of long .6 B.A. screws. It may be possible to remove these without much difficulty, but as a last resort the cold chisel may be necessary for the bottom screw. Another coil in a can is below these capacitors and this, too, should be removed.

At the bottom of the dividing wall between the two halves of the can will be seen a gronmet carrying a black wire which will be open circuited due to the removal operations. This is the chassis connection of the heater of the heterodyne oscillator valve (V5 in Fig. 2), and should be reconnected to chassis. This may be facilitated by removal of the tag strip in the bottom of the compartment by withdrawal of the screws holding this strip underneath the chassis. The black lead may then be pulled through the resulting space and soldered to any convenient earthed tag.

It will be found that one lead from IFT3 (see Fig. 2) goes to one of the tags in the strip mentioned in the previous paragraph. This may be cut off and shortened so that just a short length projects from the I.F. can. It is more trouble than it is worth to open the can and remove it completely.

The valve next to the meter valve can now be dealt with (V6 in Fig. 2). One of the functions of this valve was as a meter limiting diode and it is with this that we are concerned. The two diodes are connected to pins 4 and 6. The correct diode may easily be ascertained since the lead to the detector diode disappears inside the can of IFT3. On the limiter diode a 1 KΩ resistor is connected between the relevant pin and a tag on a small strip (see Fig. 3). This 1 KΩ resistor and all the other connections on this strip may be removed.

Next remove the two potentiometers on the left-hand (top corner of the front panel. These are labelled "Meter Balance" and "Meter Amplitude."

(Continued on page 465)



# NEW! THE PRACTICAL WAY

of learning **RADIO • TELEVISION • ELECTRONICS**  
**AMATEUR S.W. RADIO • MECHANICS • PHOTOGRAPHY • CARPENTRY • ETC.**



**DO IT YOURSELF!**  
**IN YOUR OWN HOME — IN YOUR OWN TIME**

An entirely new series of courses designed to teach Radio, Television and Electronics more quickly and thoroughly than any other method. Specially prepared sets of radio parts are supplied and with these we teach you, in your own home, the working of fundamental electronic circuits and bring you easily to the point when you can construct and service radio receivers, etc.

Whether you are a student for an examination; starting a new hobby; intent upon a career in industry; or running your own business — these Practical Courses are ideal and may be yours at very moderate cost.

With these outfits, which you receive upon enrolment and which remain your property, you are instructed how to build basic Electronic Circuits (Amplifiers, Oscillators, Power Units, etc.) leading to designing, testing and servicing of complete Radio and Television Receivers.

Photograph of E.M.I. factories at Hayes—our industrial background.

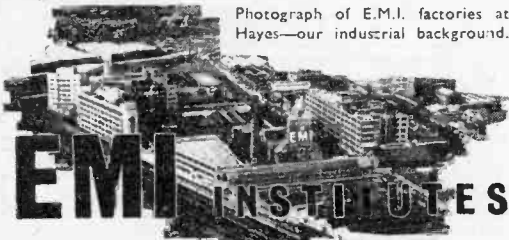

Ar. Educational Organisation associated with the E.M.I. group of Companies including: 'HIS MASTER'S VOICE', COLUMBIA, etc.

**OTHER COURSES WITH PRACTICAL EQUIPMENT INCLUDE: RADIO (Elementary and Advanced) • TELEVISION MECHANICS • ELECTRICITY • CHEMISTRY PHOTOGRAPHY • CARPENTRY.**

Also Draftsmanship • Commercial Art • Amateur S.W. Radio • Languages • Simple Electrical Repairs in the Home • Painting and Decorating • Etc. • Etc.

With these outfits, you are given instructions that teach you the basic principles in the subject concerned.

**NEW TELEVISION COURSE**

including a complete set of equipment dealing with the design, construction and servicing of a high quality television receiver.

**COURSES**

(with equipment) also available in many other Engineering subjects.

**COURSES FROM 15/- PER MONTH**



To E.M.I. INSTITUTES,  
 Dept. 32, 43 Grove Park Road,  
 London, W.4.

NAME \_\_\_\_\_

ADDRESS \_\_\_\_\_

SUBJECT(S) OF INTEREST \_\_\_\_\_

REPT. (We shall not worry you with personal visits)

K761

**LANDING LAMP.** 24 volt motor and lamp, new. £1.

**DOME FITTING (S.B.C.).** Suitable for interior lamp, caravan or boat, etc. 4/-. New in boxes.

**PACKARD-BELL AMPLIFIER.** New valves and handbook. 12/6 each.

**GERMANIUM DIODE.** 2/- each.

**RELAYS.** G.P.O. type, etc. Large stock all types. Bulkhead fittings, weatherproof (alloy case) with switch, £1/2/6. L.R. Headphone, 7/6 pair. Lendex 230 v. A.C. Relays, 8/6.

**JASON F.M. TUNER KITS**  
COMPLETE WITH VALVES & JASON DIAL

£7.0.0

T.1403 TX  
A FEW LEFT (LESS VALVES)

£3.10.0

**THROAT MICROPHONE.** Brand new. 5/6.

**HEADSET & BREAST MIC.** Complete in case. 12/6.

**VARIABLE RESISTANCE.** W/V, 50 ohms 1 amp. 6/-.

## VALVES

EF36 4/-	ECC81 10/6	1T4 7/-
EF50 4/-	10/6	1R5 8/6
EF54 5/-	ECC82 10/6	EF37A 9/-
EF80 10/6	10/6	PL81 12/6
EF39 7/6	ECC83 10/6	PL82 9/6
SP61 2/6	10/6	PL83 10/6
SP41 2/6	ECL80 8/6	EZ41 8/6
X65 10/-	11/-	EZ80 8/6
PY80 9/6	ECC85 9/6	D1 2/-
PY81 9/6	EA50 2/-	VP23 5/-
KT33C 9/6	Y63 6/6	6X5 7/6
6V6 8/6	EY51 13/6	5Z4 8/6
EF91 8/6	6X4 6/9	5U4 8/6
12SH7 7/-	807 7/-	80 8/6
6K7 7/-	6L6 11/-	12J5 5/-
9001 3/9	12A6 7/6	6S17 7/6
955 5/-	6SK7 4/6	6J5 5/-
6SN7 8/6	6K8G 11/-	954 3/6
6N7(M) 7/-	6AK5 7/-	6AL5 7/6
6C4 7/-	6AC7 6/-	6SA7 7/6
IS5 8/6	6SL7 8/-	6J6 6/-
ECC31 7/-	6AG7(M) 9/-	1S4 9/-
		3S4 8/6

**TA12G TX**  
Reduced. This Month's Bargain  
**£4.10.0**

**RF24 UNITS.** Brand new in maker's cartons. 15/-.

**PVS SLEEVED WIRE.** 22 s.w.g., 10 colours, 2d. per yard. Ex-R.A.F. Heavy Duty 24 volt 60 amp. Switch, 1/6.

**TRANSFORMERS.** All 230 v. A.C. 50 c.p.s. mains, 14/20 volt 20 amp., £3 : 14/17 volt 20 amp., £3 : 3.5/9 v./17 v. 4 amp., £1/2/6 : 9 v./17 v. 1.5 amp., 13/6 : 350-250-0-250-350 v. 6.3 v. 3 a., 4 v. 2 a., £1.

**CONDENSERS (ELECTROLYTIC).** 450 volt wkg., 8 mfd., 2/6 : 8+8, 3/6 : 16 mfd., 4/6 : 16+8 mfd., 3/9 : 16+16, 3/6 : 32+32 mfd., 6/-.

**CONDENSERS.** Assorted. 100 for 15/-.

**ASSORTED RESISTORS.** 1/4, 1/2, 1, 2 watt, 12/6 per 100. All our selection. Welwyn Vitreous Resistors, 5 watt, 1/6.

**POTENTIOMETERS.** All values, to 2 meg., 2/6 each : with switch, 4/6.

**R71 CHASSIS** (less valves). 100-124 Mc/s, V.H.F. with circuit, 10/-.

**SPOT LAMPS** (less bulb). 7/6.

T.18 set, TX section, less meter and valves, 7/6.

**B3 VAC PUMPS.** New. £1.

## VINERS

(MIDDLESBROUGH)

26, EAST ST., MIDDLESBROUGH

TEL. : MID 3418

Still only 5 connections  
Smaller in size  
many plus features  
The New  
AMAZINGLY ROBUST

Q-pack FROM 42/-

CIRCUITS & WIRING DIAGRAMS

**FREE**

## OSMOR NEW STATION SEPARATOR

This improved type incorporates a special coil which has a peak performance on the station for which it is designed. As the inductance at maximum "Q" is only variable by a small degree, please state precisely the Station you wish to receive clearly. It will only operate on one Station. Price 10/6.



### BAND 1 FILTER

Rejects B.B.C. from I.T.A. aerial and improves picture. Suitable for all makes.  
10/- inc. instructions. Fitted in 2 minutes.

### OSMOR HIGH 'Q' POTTED COILS

FOR MW or LW SELECTIVITY 5/- EACH. IDEAL FOR MODERNISING YOUR FAVOURITE SET.  
NEW OSMOR BATTERY MAINS SHEET. EMPLOYING FERRITE ROD AERIAL. COMPLETE KIT £9.9.0. WITH FULL CONSTRUCTIONAL INFORMATION.



### FERRITE ROD AERIAL

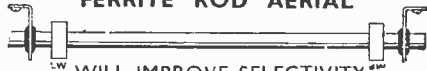

WILL IMPROVE SELECTIVITY

MW (TYPE QFR3) M2, 8/9. FOR MAINS OR BATTERY SETS. M. & LW (TYPE QRF4), 12/9.  
CHASSIS, WIRING DIAGRAM & ALL COMPONENTS AVAILABLE FOR P.W. "SEVEN-FIVE SHEET. RECEIVER."

We keep right up to date in building the latest circuits published in "Practical Wireless" "Wireless World," and "Radio Constructor," and we stock the components specified. Send 7½d. in stamps for circuits, wiring diagrams, fully descriptive literature together with coil and coil-pack leaflets, components lists, chassis drawings and templates.

**OSMOR RADIO PRODUCTS LTD.** 418 Brighton Road, South Croydon Surrey. Telephone Croydon 5148.9.

The latter is best removed by withdrawal of the screws holding the plate to which it is fixed. Here, again, the leads may be cut off the potentiometers, traced to source and removed.

The "Meter Deflection" switch should now be tackled. Hold the lug on the side of the switch with a pair of pliers and then withdraw the screw. The switch itself can now be removed in the normal manner, cutting the leads and tracing back.

The knob of the "Aural Sense" switch is held by a grub screw on the underside of the knob. Now remove switch, cut and trace back leads, etc.

Where leads terminate at a Yaxley switch, cut off leads up to the switch contact, but should there be any other leads on the contact, leave them severely alone. It is easy to cut off too much and then have to spend hours servicing a fault that could easily have been avoided.

Now the remaining item is the "To Transmitter" Jones plug where all the input power leads should be connected. After the set has been checked once more these leads should now be removed, starting with the aerial pins (1 and 2). These leads can now be dealt with in conjunction with the loop aerial connection mentioned above. These are two possibilities here. Either the three leads can be connected to three wander sockets and the required aerial is then selected by plugging in to the appropriate socket, or, a single socket may be employed, the three leads being connected to a single pole three-way rotary switch, which is then used as an aerial selector. This latter is perhaps the better method.

The 'phones connection on pin 6 should now be removed. This will be fitted to a jack socket and this will be described later in the section on the output stage.

The remaining leads should be removed individually and labelled for future reference, after which the three Jones plugs may be removed.

This now completes the removal work.

It must now be finally decided what modifications are to be made to the receiver, but the modifications to be described are those that the author incorporated in his own receiver.

A choice of output valve depends on power output required, H.T. current consumed and heater current consumed. As it is unlikely that the power output requirements will be large, a valve with economical current consumption would be preferable. A suitable valve, one of which the author fitted, is the Mullard EL91, which consumes 0.2 amps. heater current and only 20 mA. H.T. current.

With the set in its present state (i.e., less output stage and M.F. components) it can consume up to 75 mA. H.T. current according to switch settings, and this figure must be taken into account when a suitable transformer is to be made or bought.

Should it be desired to reduce the H.T. current drain, this can be accomplished by modification of the screen circuits of V1, V2, V3 and V4. At present these screens are fed from potentiometer networks, as shown in Fig. 4(a). These may be modified to the form shown in Fig. 4(b), which should result in a reduction in drain of the order of 20 mA. The disadvantage of doing this is that a screen potentiometer network tends to maintain the screen voltage constant to a greater degree than the modified form shown. Hence, the potentiometer tends to maintain the stage gain substantially constant, and this is a very desirable feature.

## The Output Stage

The set is more versatile if it will operate either 'phones or speaker and the circuit shown in Fig. 5 was designed with this end in view.

It may be thought strange that circuit references commence at rather high numbers. This is due to the fact that the original Air Ministry references were left without alteration, with the exception of valves in one or two cases. The original set references contained resistors up to R70 and capacitors up to C.110.

The transformer T1 must first be located, and with the chassis inverted this is located behind the front panel towards the left-hand side. One of the secondary connections is wired to chassis and this must be removed and reconnected to H.T.—.

R71 is fitted to provide a grid path to earth for V8 when 'phones are being used.

C112, R75 function as a tone control and provides a certain amount of top cut. It may be omitted if desired.

Next, a note on the jack socket may be advisable. As shown in Fig. 6, this has four contacts. When the plug is out, contacts 1 and 2 are shorted. Insertion of the plug opens contacts 1 and 2, short circuits contacts 3 and 4, connects the body of the

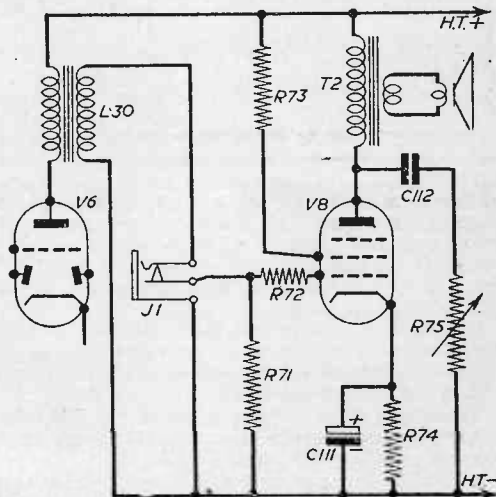

Fig. 5.—Added output stage circuit diagram.

### ADDITIONAL COMPONENTS (Fig. 5)

- V8—Mullard EL91.
  - R71—27 K 20% Erie Type 9.
  - R72—10 K 20% Erie Type 9.
  - R73—100  $\Omega$  20% Erie Type 9.
  - R74—680  $\Omega$  20% Erie Type 8.
  - R75—25 K Potentiometer Carbon.
  - C111—25  $\mu$ F 25 v. Electrolytic.
  - C112—0.01  $\mu$ F 350 volt working.
  - T2—Output transformer to match 16,000  $\Omega$  to 2-15  $\Omega$  according to speech coil impedance of speaker.
  - J1—Jack socket, one make, one break, Igranite Type P73.
- All other components not mentioned in the above list are already in circuit.



# A Battery-Operated TAPE RECORDER

By B. E. Wilkinson

**T**APE recorders, although increasing in popularity, are still expensive items, and few designs are available for building simple, inexpensive recorders. Yet it is possible to construct for a very modest sum a machine which will record and reproduce speech and music very reasonably. The details which follow are constructional data, for a four-valve battery-operated tape recorder which can be made for a very low cost indeed.

It is assumed that the reader is familiar with the basic principles of magnetic recording, so that nothing is necessary in that respect. The recorder has two systems, mechanical and electrical, the mechanical system being the means by which the tape is made to move over the record/playback head, and consists of motors, tape spools, tape guides, brakes, etc.

The electrical system consists of the record/playback amplifier switching and biasing system. This is mentioned in some detail as the constructional data will be given in this sequence.

The required parts are as follows: A gramophone motor (clockwork) to drive the spools. An ex-Army "38" Set, loudspeaker (plus output transformer), play/record head, switches, wire for wiring, microphone (ex-Army balanced armature type), batteries (H.T. 90 v. L.T. 3 v. flashlamp battery), 6 B.A. nuts, bolts, etc. The "38" Set can be obtained from dealers in Government surplus electrical equipment at prices varying from £1 to 30s. The play/record head is probably the most expensive item, the one used being a Tapemaster Senior, price 45s., available from various advertisers in this journal. It is possible to make one's own play/record heads, but in the interests of quality commercially made heads are far superior.

## The Mechanical System

It is not proposed to give details of case measurements, deck measurements, etc., as it is probable that

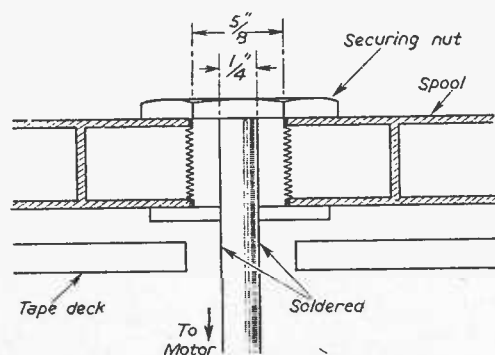

Fig. 1.—Method of fixing spool to spindle of gramophone motor.



each reader will have his own ideas as to the shape and size of his recorder. The author's machine was built in an ex-R.A.F. modulation indicator box, measuring approximately  $6\frac{1}{2} \times 10\frac{1}{2} \times 8$  in. The necessary layout will therefore be described, leaving measurement, etc., to the reader's preference.

It is necessary that the tape recorder motor should have very constant speed. Should the speed vary slightly the speed of the tape will vary and this will affect the output from the speaker. Thus, we must pick a motor with automatic and accurate speed

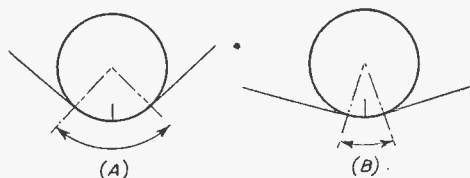

Fig. 3.—Showing how the tape should pass over the head. In "A" the area at contact is too large. In "B" the area is smaller, the contact pressure being greater.

control. Gramophone motors are admirable for this purpose, as they possess a very efficient governor system. Clockwork gramophone motors can be obtained fairly easily from old acoustic gramophones. After the motor has been removed from the gramophone it should be thoroughly cleaned and oiled, particular attention being paid to the governor.

In the recorder the motor will drive the tape directly, so we must alter the driving shaft to take a tape spool. This is fairly easily achieved as follows. The tapered shaft of the motor is turned down to  $\frac{1}{8}$  in. diameter rod, and soldered to it is a collar ( $\frac{1}{8}$  in. centre  $\frac{3}{16}$  in. threaded external diameter) such as are found on potentiometers or reaction condensers, and are used to secure them to panels. The collar must be soldered to the shaft, so that when the spool (whose central hole is widened to  $\frac{3}{16}$  in.) is slid over it

it will clear the tape deck with the motor in position. A securing nut on the end of the collar protruding above the spool will now lock the spool tight.

The tape is wound on the spool just described from another spool, suitably placed on the deck. This spool is screwed to a similar collar, which is free to rotate on a short length of  $\frac{1}{2}$  in. brass rod, threaded (female 4 B.A.) and screwed to the tape deck. The positioning of this second spool is important, as if the tape takes too devious a route to the first spool it will become strained, yet if it goes straight from one spool to the other there will be a tendency to jerk. Thus a certain amount of tension is necessary and this is provided by two rollers. A suggested layout is shown in Fig. 2. The rollers are shown in Fig. 4. They consist of  $\frac{1}{2}$  in. brass rod with  $\frac{1}{8}$  in. brass rod internally  $\frac{1}{8}$  in. drilled as roller. Base of central rod is drilled and tapped to take 4 B.A. bolt,

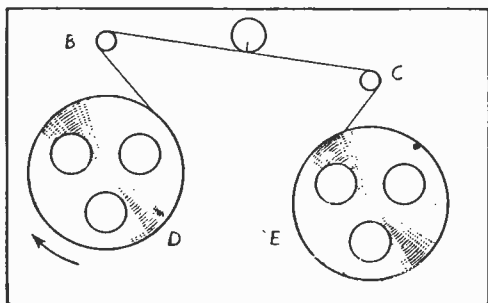

Fig. 2.—Suggested layout for the tape deck.

which secures roller to tape deck. The collar at the top is soldered to the central rod, while the one at the base is loose. To deaden mechanical noise a thin paper or cardboard shim can be placed at A. The central spindle should be sparingly oiled with a light oil to reduce friction.

The positions of rollers B and C are such that the tape between BC is always fairly taut. Damping the movement of spool E by means of a light spring will also help to keep the tape steady.

The position of the play/record head at A is very important. The tape should not on the one hand just touch the head, on the other hand it should not make more contact than is necessary. Fig. 3 makes this point clear.

Speed of the tape is controlled by an extension to the speed control lever on the gramophone motor. The useful speed range is about 60-90 r.p.m. Although the motor speed is constant the tape speed is not. As tape is wound on to spool D its radius increases, and thus the tape is drawn on at an ever-increasing rate. This, however, does not affect the recording, providing that it is played back on the same spools. In other

words, if the increase in speed for playback is the same as the increase in speed for record the recording is unaffected.

Let us suppose our take-up spool has an initial diameter of 2 in. and its speed is 60 r.p.m. The tape is being moved across the head at  $2\pi r$  in./sec. =

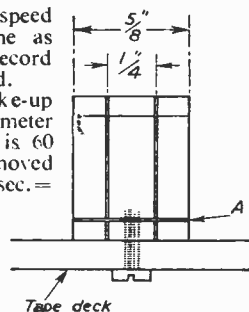
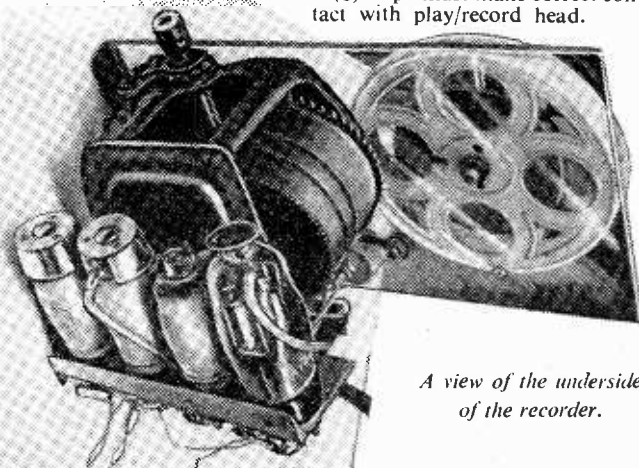

Fig. 4.—Details of the roller. The cardboard shim at "A" deadens noise.

6.28 in./sec. By the time that sufficient tape has been taken up to increase the effective diameter to 4 in. the tape speed will be 12.56 in./sec. This is rather high, and although we cannot, using the present system, prevent an increase in tape speed, we can reduce this by (a) increasing the initial radius of the take-up spool and (b) reducing the speed of the motor.

It will be appreciated that whereas at a low initial radius a comparatively small amount of tape is wound on, producing a large change of radius, at a large initial radius a large amount of tape is wound on for a small change in radius. For example, at an initial radius of 1 in. 6.28 in. (approx.) of tape will be taken on for 100 revolutions. At a radius of 2 in. for 100 revolutions 1,256 in. of tape will be taken on. Thus for the same change in radius (100 times the thickness of the tape in both cases) we are able to take on twice the amount of tape. Reducing the speed of the motor will now give us the original tape speed we require with (and this is the point) reduced rate of increase in tape speed. Sufficient then has now been said, concerning the mechanical system. The layout can be varied to suit individual requirements, but in all cases the following points must be observed:

- (a) System must be such that tape moves smoothly and steadily.
- (b) Tape must make correct contact with play/record head.



A view of the underside of the recorder.

- (c) Tape must move across head at correct height.
- (d) Motor, rollers, spools, etc., must run smoothly, paper or cardboard washers being used if necessary to deaden mechanical noise.

**The Electrical System**

Amplifiers for magnetic recorders need a very high gain, due to the small amount of signal available from the recording medium. Generally speaking, increasing the amplifier gain increases the valve noise and the level of distortion. It is thus necessary that the amplifier be carefully designed to give a high gain without the introduction of extraneous noise. As previously mentioned, a reasonable amplifier can readily be built from an ex-Army "38" Set.

The set, which is a five-valve trans-receiver, should first be stripped of all components except the valveholders. The chassis should now be cut down until its measurements are those shown in Fig. 5. This entails the removal of one valveholder and half the chassis longitudinally. A projecting piece is left which is bent through a right angle, and drilled to take the two matching transformers (the only two in the set) on the upper part of the chassis. It should be stated that chassis measurements given are only to make the amplifier compact, and that the reader may prefer to make up his own chassis to his own specification. Before wiring up the chassis it is well to decide how it will fit into the finished recorder. Fixing holes can then be drilled. In the author's machine two lugs R and K (Fig. 5) are used to secure the amplifier to the base of the gramophone motor.

Fig. 6 shows the circuit diagram of the amplifier. It is a straightforward four-valve, resistance-capacity coupled amplifier. The first three valves are used when recording, the matching transformer to the play/record head forming the anode load of the third valve, and all four valves are used for playback.

Begin by wiring up the filament or cathode circuit. Join all of pins No. 1 (marked on the black plastic valveholders), and taking the final one away to L.T.+. Pins 5 and 6 (suppressor grid and metallising)

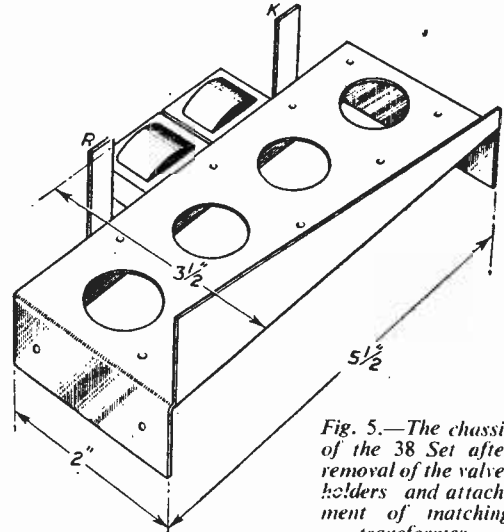

Fig. 5.—The chassis of the 38 Set after removal of the valveholders and attachment of matching transformer.

on V1, V2 and V3 can be taken to the chassis (earth), and so can pin 8, on all the valves.

Connect pin 4 on V1, V2 and V3, through 18 K. resistors, to an H.T.+ line, which for convenience we can take as pin 2 on V1 (this pin has no connection with the valve). The pins 2 and 7 on V1, V2 and V3 all have no connections with the valves so that they can be joined and used as a common H.T.+ line. This enables us to keep leads from anode to H.T.+ as short as possible: Pins 4 on V1, V2 and V3 should also be taken through .01  $\mu$ F condensers to earth.

The anodes of V1 and V2 are now taken to H.T.+, through 47 K $\Omega$  resistors ( $\frac{1}{2}$  watt). The high resistance winding of one of the matching transformers should form the anode load of V3, being connected between

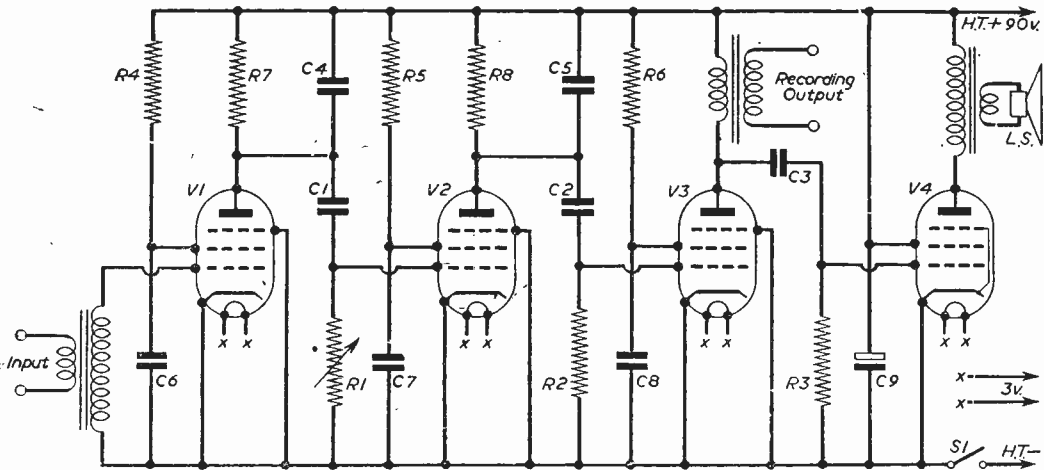
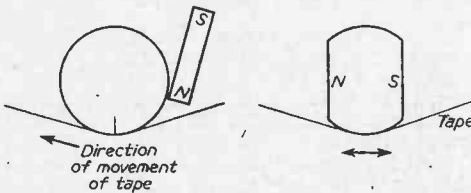

Fig. 6.—The circuit diagram. A list of the components appears on page 473.

pin 3 of this valve and H.T.+ . This now forms the recording output.

We can now deal with anode to grid inter-valve connections. The anode of V1 (pin 3) is taken through C1 to the grid of V2 (top-cap). This grid is then taken through a .25MΩ potentiometer to earth. The anode of V2 (pin 3) is taken through C2 to the grid of V3 (top-cap). This grid is taken through a .25 MΩ fixed resistor to earth. The anode of V3, (pin 3) is taken through C3 to the grid of V4 (pin 5) and this grid is taken to earth through a .25 MΩ resistor. The screen of V4 (pin 4) can be taken directly to the H.T.+ line. It is unnecessary to earth the suppressor grid, as this is effected internally. The anode of V4 (top-cap) is now connected through the high resistance winding of the output transformer to the H.T.+ line. The high resistance winding of the second matching transformer, is connected between the grid of V1 (top-cap), and earth.

In magnetic recording the higher frequencies always record more successfully than the lower ones. If we therefore recorded through the amplifier as described so far, at playback we should notice that the bass notes of music were much softer than the treble ones, the lowest bass notes being almost inaudible. We therefore incorporate components



Figs. 7 and 8.—Method of permanent-magnet biasing.

in the circuit which will provide "bass lift." Actually the method used in this recorder does not "lift" the power of the lower frequencies, but cuts down the power of the higher frequencies. The amplifier is fairly powerful, and thus the by-passing of some high frequency power is permissible. To achieve this we insert .002μF condensers between the anodes and H.T.+ of V1 and V2. These condensers provide a low reactance to earth for the higher frequencies. The amplifier is now virtually complete, and the power supplies can be introduced (H.T. 90 v., L.T. 3 v.). Four-way plastic-covered cable is the most successful for carrying the power to the set, as it provides H.T.+ , L.T.+ , H.T.- , L.T.- . The H.T.+ is taken to pin 2 on V1, H.T.- to earth, L.T.- to earth, and L.T.+ to pin 1 on either V1, V2, V3 or V4.

The on/off switch is most suitably placed in the H.T.- lead (see Fig. 6). (Play/record switching will be dealt with later.) We are now ready to test the amplifier. The power supply is connected up, and across the primary of the input transformer we connect a microphone, or even a gramophone pick-up. If the amplifier is functioning correctly, and the volume control is at maximum, small taps with a finger on the microphone or gramophone

pick-up will produce very much louder knocks from the loudspeaker. The loudspeaker used in the author's

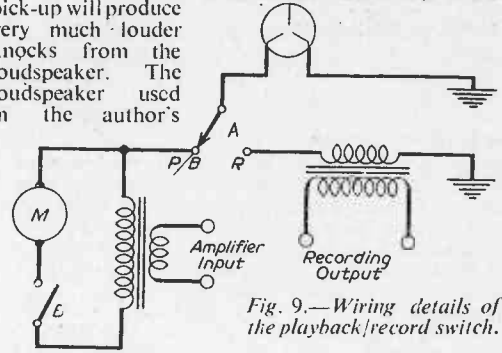

Fig. 9.—Wiring details of the playback/record switch.

recorder is a 3in., taken from a battery portable. However, it is not necessary to use a very small speaker, as the output from the ATP4 is considerable, and will easily operate larger models.

It is possible that on switching on for the first time the amplifier will oscillate violently. This is because on the chassis the valves are very close together, and feed-back from one to another can easily take place. Therefore, the leads going to the grids of all the valves should be screened. Also the grids of V1, V2 and V3 should be screened, as they are fairly close together. If now oscillation still persists one should seek the cause under the chassis. Ensure that anode and grid leads do not run parallel and that all leads are as short as possible. All transformer cores should be earthed and so should one side of the speaker coil. It will be found that one side of the low-resistance winding of both matching transformers is earthed and so also are the cores.

Once the amplifier is functioning correctly (it should be able to hold the volume control at a maximum without breaking into oscillation) we can try it in conjunction with the tape deck.

Obtain some tape and, if possible, have a signal put on it by a commercial recorder. Now connect the leads from the play/record head to the amplifier input and switch on. If a permanent magnet is moved to and fro above the head a gentle hissing should be heard from the speaker. This indicates

(Continued on page 473)

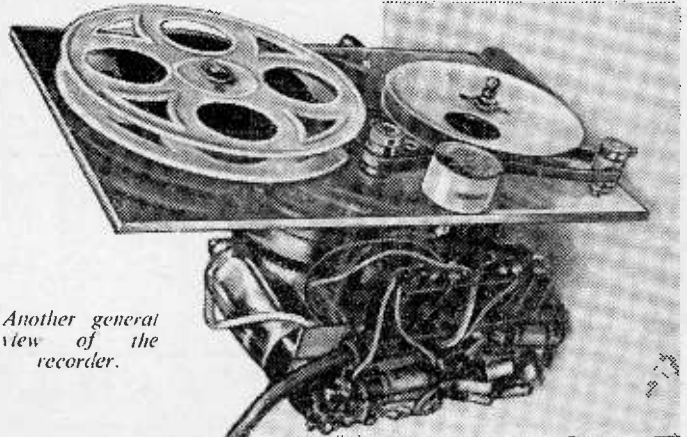

Another general view of the recorder.



**G.R.T. ISOLATION TRANSFORMER**

Type A. Low leakage windings. Ratio 1:1.25 giving a 25% boost on secondary.  
 2 v., 10.6; 4 v., 10.6; 6 v., 10.6; 10.8 v., 10.6; 13.3 v., 10.6.  
 Ditto with mains primaries. 12/6 each.  
 Type B. Mains Input 220/240 volts. Multi Output 2, 4, 6.3, 7.5, 10 and 13 volts. Input 100 or 200 taps which increase in volts by 25% and 50% respectively. Low capacity, suitable for most Cathode Ray Tubes. With Tag Panel, 21/- each.  
 Type C. Low capacity wound transformer for use with 2 watt tubes with falling emf. Input 220/240 volts. Output 2.2, 2.2+2.3 volts at 2 amps. With Tag Panel, 17/6 each.  
**NOTE.**—It is essential to use mains primary types with T.V. receivers having series-connected heaters.

**TRIMMERS, Ceramic.** 50, 50, 70 pf., 9d. 100 pf. 150 pf., 1.3; 250 pf., 1.6; 500 pf., 750 pf., 1.9.  
**RESISTORS.** All values. 10 ohms to 10 meg. 1/2 w., 4d.; 1 w., 6d.; 1 1/2 w., 8d.; 2 w., 1.-  
**HIGH STABILITY.** 1/2 w., 1/2.-; Preferred values 100 ohms to 10 meg. 1/2 w., 1.2-  
 5 watt) **WIRE-WOUND RESISTORS** 1.3  
 10 watt) 25 ohms—10,000 ohms..... 1.6  
 15 watt) 1.2-  
 15,000 ohms—50,000 ohms, 5 w., 1.9; 10 w., 2.3.  
**KNOBBS, GOLD ENGRAVED.**—Walnut or Ivory, 12in. diam., 1/6 each. Not engraved, 1/- each.

**12/6 PURETONE RECORDING TAPE**

1,200 ft. on standard fitting 7" Plastic reels. Brand new, boxed, 12.6.  
 Spools 5" metal, 1.6, 7" plastic, 4.3.

**OP Transformers.** Heavy Duty 50 mA. 4.6. Multiform, push-pull, 6.6. Tapped small pentode, 3.9. L.F. CHOKES 15/10 H. 600.5 mA. 5/-; 10 H. 120 mA. 10/6; 15 H. 150 mA. 12.6.

**MAINS TRANS.** 330-0-330, 50 mA. 6.3 v. tapped 4 v., 5 v., 7 v. 2.4/-; ditto 250-0-250, 21.2.

**HEATER TRANS.** Tapped primary, 200-250 v., 6.3 v. 1 amp., 7/6; tapped sec., 2, 4, 6.3 v., 14 amp., 8/6. **VC87 TESTED FULL PICTURE. 22.**

**COPPER PLATED AERIAL RODS.** 1/4 12in. push fitting, 3/- doz. p. & p. 1/2-

**ALADDIN FORMERS** and core, 12in., 8d.; 10in., 10d.; 8in., 10d. Formers with Caps and Core, 8in. sq., 1/4 1/4in. and 7in. sq., 2/4in., 2/- ea.

**TYANA.**—Midget Soldering Iron, 200/220 v. to 230/250 v., 16/8. Solon Midget Iron, 24/-.

**MIKE TRANS.** Ratio 50:1, 8/6 each.

**MAINS DROPPERS.** 3 x 1/4in. Ad. Sliders, 3 amp., 750 ohms, 4/3. 2 amp., 1,400 ohms, 4/3.

**LINE CORD.** 3 amp., 60 ohms per foot, .2 amp., 100 ohms per foot, 2 way, 6d. per foot, 3-way, 7d. per foot.

**LOUDSPEAKERS P.M. 3 OHM.**

8in. Goodman, 17/6. 7in. x 4in. Goodman, 21/-; 3in. square, Elac, 21/-; 8in. in. Elac, 22/6.

6in. Goodman, 18/6. 10in. R. & A., 30/-; 6in. ditto w/Trans., 21/-; 12in. Plessey, 30/-.

8in. M.E. 2.5 k. or 2k. field, tapped O.P. trans., 24/6.

**CRYSTAL DIODE, G.E.C. 2/-.** Crystal Box, 12/-; **GC24.** 4/-; 30 Circuits for Germanium Diodes, 3/6.

**HIGH RESISTANCE PHONES.** 4,000 ohms, 17/6 p.

**CRYSTAL MIKE INSERT** by Acos, precision engineered. Size only 1 1/2 x 3/16in. Bargain Price 6/6. No transformer required.

**SWITCH CLEANER** Fluid, squirt spout, 4/3 tin.

**TWIN GANG TUNING CONDENSERS.** .0005 mfd. midget with trimmers, 9/8; .375 p. midget less trimmers, 6/8; .0005 standard size with trimmers and feet, 9/-; less trimmers, 8/-; ditto, oiled, 2/6.

**SPEAKER FRET.** Woven Plastic Tygan, Walnut tone, 11in. wide, 2/- per foot. Expanded metal, gold 9" x 12in., Silver, 15in. x 19in., 2/- each.

**VALVES**

A SMALL SELECTION FROM OUR STOCKS		New & Guaranteed	
All Boxed	1/6	8/6	10/6
8/6	5/6	1P50	6/6
1R5	4/6	854	6A1.5
1P4	9/12	2/6	6J5
184	EF50	2X2	6K6
185	Equip.	E1148	6K7G
3V4	8P61	E1284	6L6
5Y4	8P41	HV2	6N6
6AM6	EP92	3/6	(near)
6AT6		3/6	EP41
6J7	7/6	6H6	EP81
6K8	6B25	7/6	EL11
6N7	6B6V	6V6	EL22
6V6GT	6P6	6X5	EP22
EB33	6K7GT	807	EP41
EP50	6K7M	EP29	EP23
Sylv. Red	12K8, 12Q7, 12K7, 35L6, 55Z4		6Y7
EP91	Special Price 37/6—The Set.		X79

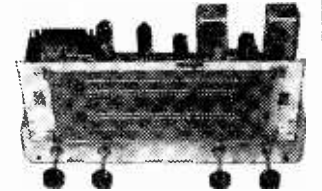

**ALL WAVE RADIOGRAM CHASSIS**

THREE WAVEBANDS FIVE VALVES  
 M.W. 19 m.—30 m. LATEST MULLARD  
 M.W. 200 m.—550 m. ECH42, EP41, EBC41,  
 L.W. 500 m.—2,000 m. EL41, EZ40,  
 12 month Guarantee.

A.C. 200-250 v. 3-way Switch; Short-Medium-Long Gram. A.V.C. and Negative feedback. 4.2 watts. Chassis 13 1/2 x 5 1/2 1/2 in. Chassis Dial 14 x 4 1/2 in. horizontal or vertical available. 2 Pilot Lamps, Four Knobs, Walnut or Ivory. Aligned and calibrated. Chassis isolated from mains. I.T.S.L. Tweeter Supplied Free!

**10 gns.** Carr. & Ins., 4/6.  
 TERMS: Deposit £5.50 and six monthly payments of £1.

**MATCHED SPEAKERS FOR ABOVE CHASSIS**  
 Sin. 19 6; 10in. 25/-; 12in., 30/-.

**R.C.S. SCOOP**

Collaro Auto-changer RC531 for 7.8 r.p.m. 19in. and 12in. records. Brand new in maker's boxes! High impedance lightweight Pick-up with sapphire needle, will match any Amplifier or Radiol. Less than half price.  
**£5.19.6.** Carr. and Ins., 5/6.

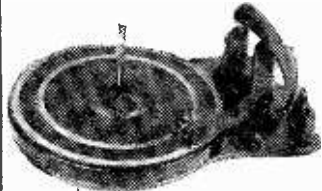

**£7-19-6** Post Free.

Terms: Deposit £4 and six monthly payments of 15/6.  
 Brand new Plessey 3-speed Autochanger Mixer Unit for 7, 10 and 12in. Records. Twin Hi-Fi Xial Head with Duo-point sapphire stylus. Plays 4,000 records. Spring mountaint, Base-board required, 15 1/2 x 12in. Height 3 1/2 in. Depth 2in. Super Quality, 200/250 v. A.C.  
 Walnut Veneered Playing Desk cut out ready for Plessey, only sold complete with Changer 10/6 extra.

**ALLDRY UNIT POWER PACK.**

Replaces Battery B114, etc. 50 v. plus 1 1/2 v. Size 4 1/2 in. x 3 1/2 in. x 1 1/2 in. 4-pin socket. Same as battery. ONLY 1/- a year to run on A.C. 200-250 v. FAMOUS MAKE. LIST PRICE, 65/- OUR PRICE, 39/6. Ready for use.

**B.S.R. MONARCH.**

3-speed Motor and Turntable with selecting switch for 33, 45 and 78 r.p.m. records, 100-120 v. and 200-250 v. A.C. 50 cps. Also B.S.R. MONARCH Lightweight Pick-up with Acos Xtal (turnover head, separate Sapphire stylus for L.P. and Standard records. SPECIAL OFFER, the TWO: £4.15.6, post 2/8.  
**T.V. PRE-AMP (McMICHAEL).** Tunable channels 1 to 5. (With Amplify Output of your Band 3 Converter). Midget size. High Gain Fringe Model, B.V.A. Valve. Full instructions. Ready for use. (H.M.T. 200 v. L.T. 6.3 v., 3 amp. required.) BRAND NEW, 25/- each.  
**SPECIAL MAINS POWER PACK** for above, 25/- extra.  
**SUPERHEAT COIL PACK.** 27.6. Miniature size 2 1/2 in. x 2 1/2 in. 1 1/2 in. High "Q" Dust Cored Coils. Short, Medium, Long. Gram Switching. Single hole fixing. Complete with connection diagram, and circuit.

**TELEPHONE BAND III CONVERTER**

For London, Midland and Northern Transmissions.  
 Suitable all T.V. makes. T.R.F. or Superhet. All wound coils, two EP80 valves, all components, punched chassis, circuit diagram, wiring plans. COMPLETE KIT for mains operation 200-250 v. A.C. £5.10.0.

As ABOVE less POWER PACK. Requires 200 v. 20 mA. H.T. 6.3 v., 6 amp. L.T. £2.5.0.  
 Mains Transformers to above Spec. ... 10/6  
 Min. Westinghouse Rect. ditto ... 8/6  
 B.B.C.L.T.A. Aerial crossover unit ... 7/6  
 Punched and drilled chassis ... 3/8  
 Larger chassis for Mains Model ... 15/-  
 Full plans and circuit details... ... 6d.

**Volume Controls 80 ohm COAX**

Low spindles. Guaranteed. Semi-air spaced Polyethylene insulated. Lin. dia. 10,000 ohms to 2 Meg. Stranded core. 9d. 10,000 ohms to 2 Meg. D.P.S.W. Losses cut 50%. 3/- 4/- 4.8  
 Lin or Log Tracks. 1/4 in. Coax. 8d. yd.

**COAX PLUS... 1/- DOUBLE SOCKET ... 1.3**

**SOCKETS** ... 1/- **OUTLET BOXES** ... 4/6  
**BALANCED FEEDER** 3d. 6d. 9d. or 30 ohms.  
**DITO SCREENED** per yd. 1/-, 30 ohms only.  
**WIRE-WOUND POTS, 3 WATT.** Pre-Set Min. T.V. Type. All values 25 ohms to 30 K. 3/- ea. 50 K. 4/- (carbon 30 K. to 2 in., 3/-).  
**WIRE-WOUND 4 WATT.** Pots. 2 1/2 in. Spindle. Values: 100 ohms to 50 K. 5/6. 100 ohm, 6/6.  
**CONDENSERS.** 20 kv. 60 pf. 400 mfd. 7 kv. T.C.C. 5/6. Ditto, 20 kv., 9/6; 100 pf. to 500 pf. .05, .1, 1/2, .25, 1/2, .5, 1.9; 1,450 v. 9d. mfd.; 1,900 v. 1/3; 1 mfd., 2,000 volts, 4/-.  
**CERAMIC CONDS.** 500 v., 3 pf. to .01 mfd., 10d.  
**SILVER MICA CONDENSERS.** 100 v., 5 pf. to 100 pf., 1/-; 600 pf. to 3,000 pf., 1.3. **DITTO** 1/-, 1.5 pf. to 300 pf., 1.9; 315 pf. to 1,000 pf., 2/-.

**I.F. TRANSFORMERS 7/6 pair**

465 Kcs. Stur tuning Miniature Can., 2 1/2 in. x 1 1/2 in. High Q and good bandwidth. By Pye Radio. Data sheet supplied.

**NEW ELECTROLYTICS. FAMOUS MAKES**

TUBULAR	TUBULAR	CAN TYPES	CAN TYPES
1/275 v. 2/-	100/25 v. 2/-	8+16/500 v. 5/6	16+16/450 v. 5/6
2/450 v. 2/3	8+8/500 v. 4/6	16+24/350 v. 4/6	16+24/350 v. 4/6
4/450 v. 2/-	16+16/500 v. 4/6	32+32/350 v. 4/6	32+32/350 v. 4/6
8/300 v. 2/3	CAN TYPES	32+32/450 v. 4/6	32+32/450 v. 4/6
16/450 v. 3/6	Clips	50+50/350 v. 7/6	50+50/350 v. 7/6
16/300 v. 4/-	16/450 v. 3/6	6+6+120/350 v. 11/6	6+6+120/350 v. 11/6
32/300 v. 5/6	32/350 v. 4/-	100+120/275 v. 12/6	100+120/275 v. 12/6
52/25 v. 1/8	60/350 v. 5/6	1,000+1,000/9 v. 6/6	1,000+1,000/9 v. 6/6
52/25 v. 2/3	3/8 50/12 v. 2/-		
50/250 v. 2/-	8+16/450 v. 3/6		
Screw Base Type 212, 8/500 v. 2/6	16/500 v. 4/-		
<b>SERTEK RECTIFIERS. E.H.T. TYPE FLY-BAK VOLTAGES.</b> K3/25 2 kV., 4/3; K3/40 3.2 kV., 6/-; K3/45 3.6 kV., 6/6; K3/50 4 kV., 7/3; K3/60 4 kV., 12/8; <b>MAINS TYPE.</b> RM1, 125 v., 60 mA., 4/-; RM2, 120 mA., 4/9; RM3, 120 mA., 5/9; RM4, 250 v., 275 mA., 16/-.			
<b>G.E.C. Neon Oscill.</b> M.B.C. 180 v., .5 mA., 2/6.			
<b>COILS</b> Wreath, "P" type, 3/- each. Oscon Midget "C" type all, ditto type all, ditto, all ranges.			
<b>TELEFORM L &amp; Mel.</b> with reaction, 3/6.			
<b>H.F. CHOKES,</b> iron cored, 14 m.w., 3/- each.			

**ALUMINIUM CHASSIS.**

18 x 4 w.g. drilled. With 4 sides, riveted corners and lattice fixing holes, 2 1/2 in., 4 in., 4/6; 3 x 4 in., 5/9; 1 1/2 x 7 in., 6/9; 1 1/2 x 9 in., 8/6; 1 1/2 x 11 in., 10/6; 1 1/2 x 14 in., 12/6; 1 1/2 x 16 x 11 in., 16/6.

**FULL WAVE BRIDGE SELENIUM RECTIFIERS.**

2, 6 or 12 v. 1 amp., 8/9; 2 a., 11/3; 4 a., 17/6. **CHARGER TRANSFORMERS.** Tapped input 200/250 v. for charging at 2, 6 or 12 v., 1 amp., 13/6; 4 amp., 21/-.

**ALL BERNARDS books in stock.**

**VALVE MANUALS I & II, 5/- ea. part.**  
**VALVE and TV TUBE equivalents book, 5/-.**  
**ACID HYDROMETER.** New Ex Govt. Unbreakable. Packed in metal case 7 x 1 1/2 in. dia., 4/6.  
**WAVELENGTH SWITCHES.**  
 5 p. 4-way 5 waffer, long spindle ... .. 6.6  
 2 p. 2-way, 3 p. 2-way, short spindle... .. 2/6  
 2 p. 6-way, 4 p. 2-way, 4 p. 3-way, long spindle 3/6  
 3 p. 4-way, 1 p. 12-way, long spindle... .. 3/6  
**VALVE HOLDERS.** Per. Int. Oct. 4d., EF50, EA50, 6d., B12A, CRT, 1.3. Ex. and Amer. 4.5, 6.7 and 9 pin, 1/-.  
**MOULDED Mazda and Int. Oct. 6d.**  
 B7G, B8A, B8G, B9A, 9d., B7G with cap 1/6.  
**VC87 2/6.** B9A with cap 2/6.  
**CERAMIC E50, B7G, B9A.** Int. Oct. 1/-, B7G with cap 1/9.  
**BLACK CRACKLE PAINT,** air drying, 3/- tin.

**RADIO COMPONENT SPECIALISTS 307 WHITEHORSE RD., WEST CROYDON**  
 OPEN ALL DAY—(Wed. 1 p.m.) 10 page list 3d.  
 Tel. THO 1665, Buses 133 or 68 pass door. 48-hour postal Service. P. & P., 1/-. £2 orders post free. (Export Extra) C.O.D. Service 1/6

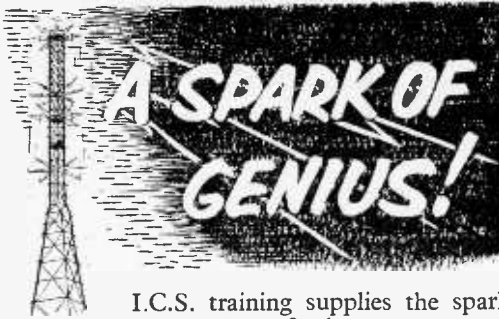

I.C.S. training supplies the spark you need to further your career. The Courses I.C.S. offer are practical and up-to-date, they recognise the present emphasis on Frequency Modulation, and can help you attain one of the many well-paid posts that exist today in the radio world. Prepare yourself now, at home and in your own time, with the expert help of I.C.S. tutors. The cost of an I.C.S. Course is moderate and includes all books.

*Among the I.C.S. Courses available are:*

- FREQUENCY MODULATION ENGINEERING
- T/V ENGINEERING
- RADIO SERVICING
- RADIO ENGINEERING
- RADAR ENGINEERING
- BASIC ELECTRONICS
- INDUSTRIAL ELECTRONICS
- ELECTRONIC ENGINEERING

Complete the coupon below and post it to us today for further details of the Course which interests you. Write to: Dept. 170E, I.C.S., 71 Kingsway, W.C.2.

INTERNATIONAL CORRESPONDENCE SCHOOLS  
 DEPT. 170E, INTERNATIONAL BUILDINGS, KINGSWAY, LONDON, W.C.2.

Please send FREE book on .....

NAME..... AGE.....  
 (Block letters please)

ADDRESS .....

.....

OCCUPATION .....

**INTERNATIONAL CORRESPONDENCE SCHOOLS**

**BUILD YOUR OWN TAPE RECORDER NOW**

with the  
**" ASPDEN "**  
 Tape Deck and Amplifier Kits

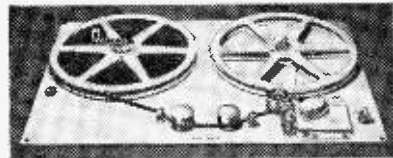

**TAPE DECKS :**  
 Compact Model 521, 5in. reels, kit, £7/10/-.  
 Standard Model 721, 7in. reels, kit, £8/10/-.  
 Two speed, twin track, precision machined parts, easy to assemble, full assembly drawings and instructions, finest motor. High quality Ferroxcube Heads. Either deck fully built and tested, 27/6 extra.

**AMPLIFIER :**  
 Record/replay, 2 1/2 watts, neon indicator, 2 recording positions, kit, £5/18/-.  
 Power pack for above, kit, £2/18/6 (both without valves).

Carr. & packing extra.  
 " ... I am very pleased indeed with the performance of the tape recorder."—D. E. Notts.

Send stamp for full details to:—  
**W. S. ASPDEN** 10, Market St., Weham, KIRKHAM, LANGS.

**MAKE SOUND JOINTS SIMPLY BY USING Multicore**

**ERSIN MULTICORE**

Contains 5 cores of extra-active, non-corrosive Ersin Flux. Prevents oxidation and cleans surface oxides.

**SIZE 1 CARTON**  
 5/-



**HANDYMAN'S CARTON**  
 Suitable for 200 average joints. 6d.

Wherever precision soldering is essential, manufacturers, engineers and handymen rely on MULTICORE. There's a MULTICORE SOLDER just made for the job you have in hand. Here are some of them.

**ARAX MULTICORE**

**FOR METAL FABRICATION**  
 (Not wire-to-tag joints)

Contains 2 cores. of Arax flux. Flux residue is easily removed with water.



**SIZE 8 CARTON**  
 5/-

Handymans Carton 6d.

**HOME CONSTRUCTORS 2 1/8 PACK**

In addition to the well-known Home Constructors Pack (containing 19ft. of 18 s.w.g. 60/40 alloy) a similar pack is now available containing 40ft. of 22 s.w.g. 60/40 alloy especially suitable for printed circuits.



**BIB WIRE STRIPPER AND CUTTER**

Strips insulation without nicking wire, cuts wire cleanly, splits extruded flex 3/16 each



**MULTICORE SOLDERS LTD.,**

MULTICORE WORKS, HEMEL HEMPSTEAD, HERTS. (BOXMOOR 3833)

that the head and the amplifier are working correctly. Now set the motor in motion and allow the tape to move past the head. The recording on the tape should now be heard. It should be explained why it is advised that the first signal on the tape should be put on by a commercial machine. If there is any distortion at playback on our recorder, then we can be fairly certain that it is in our amplifier and not on the tape. Once we are certain that distortion is not present during playback, we are ready to make our first recording. However, it is necessary for the recording head to be biased correctly so that the signal is applied across the linear portion of the transfer characteristic. Without bias, the recording is so distorted as to be unrecognisable. Bias is generally achieved by means of an oscillator, or it can be achieved by means of a D.C. applied across the head. This latter method is highly undesirable, as damage to the head can result. The method of bias used by the recorder described is permanent magnet biasing. A fairly strong magnet (Eclipse horseshoe magnet, priced at approximately 2s. 9d.) is placed in a definite position by the recording head. Fig. 7 shows how this is effected. The tape is moving from right to left and the magnet is placed on the right of the head, with the North Pole against the head. In the case of the Tapemaster Senior play/record head the nut on the base should be removed and the iron screen taken off. If this is not done the magnet will not bias the head. Experiment will determine the optimum position for the magnet.

For recording a microphone (ex-Army balanced armature type is suitable) is connected to the amplifier input, and the recording output (low-resistance winding of transformer in anode of V3) is connected

to the head. Having recorded, the securing nut on the take-up spool is loosened off, and the tape rewound back on to the other spool by hand (this is much simpler than it sounds). The amplifier is connected up for playback and the quality of the recording studied.

It should be pointed out that the amount of signal fed to the amplifier when recording is much greater than that fed to the amplifier when playing back. Thus it will be necessary to have the volume control "turned" back a little when recording to avoid overloading the valves.

As one amplifier is being used for both recording and playback, it is necessary to switch the head to the amplifier input for playback and to the recording output for recording. Also when recording it is necessary to switch the microphone into the amplifier input. Fig. 9 shows how this switching is achieved. For recording, switch A must be in the R position and switch B closed to bring in the microphone for playback; B is open while A is in the P/B position. To avoid feedback both cores of the matching transformers and one side of the recording head must be earthed. If the amplifier is functioning correctly, yet the recordings made are distorted, one should look to the microphone.

LIST OF RESISTOR AND CONDENSER VALUES

R1, R2, & R3—25 M $\Omega$	C4—.002 $\mu$ F
R4, R5, & R6—18-20 k $\Omega$	C5—.002 $\mu$ F
R7, R8—47 k $\Omega$	C6, C7, & C8—.01-.1 $\mu$ F
C1, C2, & C3—.01 $\mu$ F	C9—16 $\mu$ F (electrolytic)

## Some Facts About Neon Stabilisers

THE necessity of a constant voltage source can be provided by the neon stabiliser; this can be considered as the simplest method of stabilising voltages when compared with complex circuit arrangements using tetrodes or pentodes.

Such tubes are designed to give a constant voltage

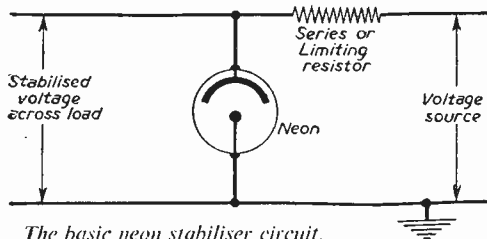

The basic neon stabiliser circuit.

within certain current limits; that is to say, as the supply voltage varies in magnitude the output voltage or voltage across the load will be relatively constant. The limits of the load currents naturally depend upon the tube design, such features as gas pressure at which the tube is filled, the electrode design, not forgetting, of course, the physical size.

To appreciate the operation of the stabiliser, consider one with two or more electrodes. Now, as the electrical potential or pressure is increased between

the electrodes, the neon gas ionises and is recognised by the glow discharge as the ionisation phenomenon occurs. This results in a current passing through the tube; thus at the same time a sudden drop in voltage occurs. This drop remains constant over a fairly wide current range. However, if the input voltage increases, the current likewise increases and thus the output voltage to the load would remain the same, or in other words "constant"; furthermore, the voltage drop across the resistor in series with the tube, increases because of the increased current passing through it.

It is an important fact that neon stabilisers require an external resistance, otherwise destruction of the tube would result. The load, however, is in parallel with the stabiliser.

One must bear in mind that the voltage source across which the stabiliser is connected, must be higher than the actual striking voltage of the neon. The striking voltage is approximately 25 per cent. to 30 per cent. above that of the operating voltage of the neon stabiliser. Furthermore, one must bear in mind that the load current must not exceed that which the neon tube is designed to withstand, otherwise the stabilising characteristic will be affected. As a point of interest, the value of the series resistor can be calculated from the following equation and should prove useful to the user of such tubes.

$$\text{Resistance in ohms} = \frac{\text{Source voltage} - \text{Voltage drop across neon}}{\text{Max. current in mA of neon}}$$

To conclude this resumé, the output voltage from the stabiliser is equal to the voltage across the source less the voltage drop across the neon tube.

# Programme Pointers



## The Archers

**T**HE Archers! This remarkable family, together with their many friends, relatives and associates, persist in all their vitality, virility and never-ageing existence. The BBC without the Archer saga entertaining us nightly as punctually as Big Ben itself strikes would be as unthinkable and as difficult to contemplate as would London without that broad-grinned apostle of punctuality and bonhomie. What just is it that it has which nothing else on the air seems quite to achieve? "What have you got that I haven't?" Two thoughts occurred to me whilst listening to a few excerpts from it a week or two ago. One critical and the other facetious.

Apart from the fact, mentioned on this page before; that the only really decent signature tune to be heard anywhere helps it enormously, and ushers it on to the stage with the greatest éclat and aplomb, I wondered whether its popularity wasn't also aided and abetted by just that element of agelessness. No one ever gets any older. Whilst we ourselves feel the years roll by and our joints stiffen, Walter Gabriel, Mrs. P., Dan and Doris themselves are exactly as when we first met them, is it 10 years ago? Old Walter would surely have gone by now in real life! He would more surely have married Mrs. P! (But what a gap that would have left for the authors to fill up!) It is true that there was one death, but it was only a *morte de convenance* and doesn't invalidate the general claim of the cast to immortality. I really think there may be something in the supposition.

The other thought was that I casted the story with famous BBC personalities. For example, I gave Dan Archer to Gilbert Harding and Doris to Gladys Young, Wilfred Pickles to Jack Archer, John Snagge Mr. Fairbrother, Rob Wilton Walter Gabriel, Elsie Walters Mrs. P., and so on and so on. Perhaps readers would like to try their hand at the game!

To sum up, "The Archers" is peopled with real people, leading real lives and doing real things, to a greater extent than any other regular feature in contemporary radio—with the possible exception of several of the items in "Children's Hour."

## Twenty Questions

This same feeling, in an even stronger wave, came over me when I turned on "Twenty Questions" after a long interval. It seemed as though this ever popular feature had not only been in existence always—one can scarcely recall the time when we were without it—but that in 1984 Gilbert Harding, Jack Train, Richard Dimpleby, Anona Winn, Joy Adamson, Kenneth Horne and Norman Hackforth will be the only things remaining of the civilisation that will then be destroyed. It radiates a feeling of timelessness and inevitability that can only be compared to the weather forecasts and certain signature tunes. But, unlike those monolithic impedimenta to a natural state of society, it is pleasant entertainment.

Our Critic, Maurice  
Reeve, Reviews Some  
Recent Programmes

## Reminiscences of W. G. Robertson

Sir Compton Mackenzie has always been among the small band of broadcasters whose personalities the radio instantly picks up and relays for our equally lightning-like recognition. His eleven readings from the reminiscences of W. Graham Robertson, chiefly about great stage personalities of the 1890s, were delightful entertainment. Whilst mentioning one of the more pleasing voices we hear occasionally it is only fair to note, to me, one of the less enjoyable types, heard all too frequently, namely, Robin Boyle. His hesitant, rather whiny and microphone shy utterances, which take us "out and about" most Saturday afternoons, irritate rather than encourage; deter, rather than urge on.

## Blithe Spirit

Michael Denison's and Dulcie Gray's pointed, underlined and quite brilliant performance of Noël Coward's excellent "Blithe Spirit" was repeated, with first rate support from Winifred Oughton as the medium, Thelma Scott, Maihri Russell, T. St. G. Barry and Catherine Salkeld. The ironic and astringent wit of this sophisticated dialogue was emphasised and fully brought out.

Further, whilst mentioning dreadful signature tunes, my pleasure at noticing that probably the most diabolical of them all—the one half-way through "What Do You Know?"—was missing was mingled with satisfaction. For I pointed out on this page some time ago its unpardonable and unforgivable beastliness!

## Journey Through Subtopia

An enjoyable and what should be a useful series of talks is being given by Sir Hugh Casson, called "Journey Through Subtopia." Six in all, Sir Hugh is postulating the question, with an expert's eye, "Is England turning into a desert of wire, brick and concrete?" The answer seems to be the usual mixture of "yes" and "no." But, with records of residents, he skillfully presents pictures which many can see for themselves, and with which they can agree or disagree to their hearts' content.

## Bow Bells

Louis McNeice's "Bow Bells" was a sentimental picture of what probably went on in the precincts of the famous church throughout its history. But I wonder whether fourteenth-century children would have ever said, "I can't wait till those ladies, or their palfreys, get cracking"?

**\* built to the highest standard!**

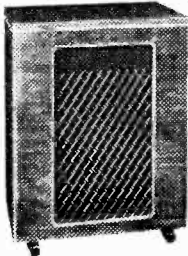

**★ CABINET CAT. No. CAB/01**

A very high quality Cabinet in a modern design. Exterior veneered in a highly figured Walnut. Solid Black-board lift-up top with all interiors veneered in Sycamore. Full silk front. 27in. x 16in. x 32in. high.

**CASH ONLY £8**

*Packing and Carriage 15/-.*

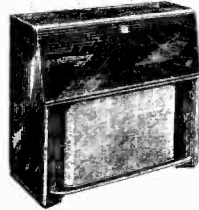

**★ CABINET CAT. No. CAB/02**

A well designed Bureau-type cabinet in a medium size. Veneered in a highly figured Walnut. Outside dimensions, length 29in., depth 16in., height 32in. Sloping control panel on right-hand side approx. 13in. x 10in. Removable baseboard on right-hand side, approx. 13in. x 15in. Lower record compartment inside the cabinet, located at the top on left-hand side.

**CASH ONLY 12 Gns.**

*Packing and Carriage 20/-.*

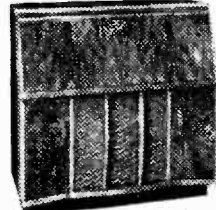

**★ CABINET CAT. No. CAB/03**

A magnificent Bureau-type Cabinet of the very highest quality in specially selected Walnut veneered exterior. Light Sycamore interior with Rexine lining to match. Outside dimensions, length 34in., depth, 17in., height 33in. Sloping control panel on right-hand side approx 16in. x 10in. Removable baseboard on right side approx. 15in. x 15in. Two full-sized felt lined compartments in the lower half.

**CASH 16 1/2 Gns.**  
or on Credit Terms.  
*Packing and Carriage 25/-.*

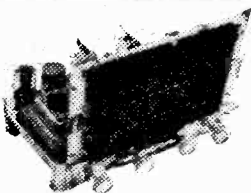

**★ RADIO and RADIOGRAM CHASSIS**

Superhet. Chassis of Latest Design and Technique. General Specifications applicable to all models. A.C. 200/250 volts 50 cycles only. Suitably lit multi-coloured glass dial of the horizontal type. Slow motion tuning drive. Full provision of Automatic Volume Control. Negative feed-back from output transformer secondary. Sockets provided for Aerial, Earth, Gram, Pick-up and Extension Speaker. Connections provided to Gram. Motor controlled by Chassis On/Off switch. All impedances have an exceptionally high Q value. The Audio Section is designed for first rate reproduction on Radio and Gramophone. The tone controls have been given an extra wide range to embrace all types of record ages.

**CAT. No. CR/A. 5-valve Superhet, 3 wavebands. 12 Gns.**  
*Packing and Carriage 12/6.*

**CAT. No. CR/AFM47. 7-valve Superhet with FM/VHF Band. 23 1/2 Gns.**  
(4 wavebands).  
or on Credit Terms  
*Packing and Carriage 15/-.*

**CAT. No. CR/AFM48 PP. 9-valve Superhet with FM/VHF Band (4 wavebands). Push-pull output including 2 loudspeakers. 26 Gns.**  
or on Credit Terms  
*Packing and Carriage 15/-.*

**★ F.M./V.H.F. TUNERS**

Self powered. Six valves with grounded grid R.F. stage followed by additive mixer using a 6X85 twin triode in sealed permeability tuned unit. Two I.F. stages ensure maximum gain with 6AL5 double diode as ratio detector. Frequency coverage of 85-191 megacycles allows adequate overlap. Very fluent quality throughout.

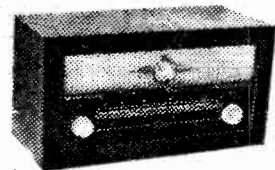

**CAT. No. TMT/A**

Complete unit in Cabinet with Magic-eye tuning. Boxed, 13in. long x 6in. overall depth x 7in. high (approx.).  
**CASH 16 1/2 Gns.**  
or on Credit Terms.

*Packing and Carriage 12/6.*

**★ AUTOMATIC RECORD CHANGERS**

All automatic Record Changers are of the latest type and unused.

**CAT. No. RC A.** This is the latest multi-speed changer incorporating 16 r.p.m. for "talking-books," and arrangement for manual control. Fitted with high fidelity Crystal Turnover Pick-up Head. A.C. mains 200/250 volts, 50 cycles only.

**CASH £9.15.0**  
*Packing and Carriage 12/6.*

**CAT. No. RC/B.** Latest Garrard RCSS model, fitted with 44"2 Crystal Turnover Pick-up Head. A.C. 200/250 volts, 50 cycles.  
**CASH £13.0.0**  
*Packing and Carriage 12/6.*



**CAT. No. TMT/3**

Chassis only excluding Magic-eye. Unboxed, 11in. long x 3in. overall depth x 4in. high.

**CASH £13.15.0**

*Packing and Carriage 12/6.*

**★ Loudspeakers ★ Gram Amplifiers, etc.**  
Available at keenest prices.

**ALL FULLY GUARANTEED**

Generous extended credit terms on orders exceeding £15.

Dealers supplied at full discount. Send for complete catalogue.

All enquiries (excluding Northern Area) to:

■ Northern enquiries only (not Scotland & N. Ireland) to:

**DOMESTIC**

**MAYLIT LTD**

**DIRECT SALES LTD.**

**90 JUDD ST., LONDON, W.C.1. TER. 9876**

■ **3 MARLBOROUGH RD., ALTRINCHAM, CHESHIRE**

■ Telephone enquiries: **ALTRINCHAM 4045**

**BENDIX COMMAND RECEIVERS**

Another grand purchase of these receivers, absolutely brand new and complete with all valves. 3 12SK7, 1 12K8, 2 12SR7 and 1 12A6. Free circuit with all receivers. Type BC453. Q filter 190-550 kc/s, 59/6 each; Type BC.XXX Top band, 1.5-3 mc/s, 65/- each.

**METER BARGAINS**

50 microamp, 2 1/2 in. F.M.M.C. ...	59/6
50 m/amp., 2 in. F.M.M.C. ...	7/6
150 m/amp., 2 in. F.M.M.C. ...	6/9
200 m/amp., 2 1/2 in. F.M.M.C. ...	9/6
1 amp. R.F. 2 1/2 in. F.M.T.C. ...	6/9
1 amp. R.F. 2 1/2 in. Pj. T.C. ...	5/-
4 amp. R.F. 2 in. F.M.T.C. ...	5/-
300 volt D.C. 2 in. F.M.M.C. ...	10/6
300 volt A.C. 2 1/2 in. F.M.M.I. ...	25/-
500/10/500 microamp 2 1/2 in. F.M.M.C. ...	25/-

**No. 234 POWER UNITS.** Input 200/250 volt A.C. Output 240 volt 150 ma. and 6.3 volt 6 amp. Double choke and condenser smoothed. Fitted 2 1/2 in. moving iron meter to read input A.C. volts and output D.C. volts. 19 in. rack mounting. Price 69/6 each.

**SMOOTHING CHOKE BARGAINS**

Parmeko 8 henry 250 ma. ...	10/6
G.B. 20 henry 175 ma. ...	10/6
Collins 8 henry 100 ma. ...	8/6
Parmeko 9 henry 100ma. ...	7/6
Parmeko swinging 3.6-4.2h. 250 ma. ...	10/6
Parmeko C core 4 henry 22.5 ma. ...	4/6

**AERIAL WIRE.** 300ft. reel of bare copper wire, 3/6 reel.

**FIELD TELEPHONES.** Type Don.

Mk. 5. Ideal for inter office or house communication. Supplied complete with all equipment and two 1.5 v. cells to operate. Price 39/6 each.

**G.W. SMITH & CO**  
(RADIO) LIMITED  
3-34 LISLE STREET, LONDON, W.C.2  
TELEPHONE: GERRARD 8204/9155

**DEAF AIDS**  
Brand new chassis complete with three valves, crystal mike, tone and volume controls, etc. Less only outside bakelite case. 19/6 each. Clip in batteries 2/9 pr. Miniature earpieces to match, 3/6. Leads 1/-. Spare valves. CK505, 2/6 each. Spare 1 meg. pots with switch, 1/-.

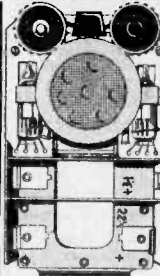

**COLLINS MODULATION TRANSFORMER.** Push-pull 807-807, 12/6 each.  
**AR.88 SWITCH ASSEMBLIES, 17/6**  
**GEAR DRIVE ASSEMBLIES, 10/6**

**AMERICAN SPEAKERS.** Brand new 8 inch 3 ohm speakers in handsome black crackle cabinet. Ideal for HAMS or extension, only 39/6 each.

**HOURS OF BUSINESS:** 9 a.m.—6 p.m., Thursday, 1 p.m. Open all day Saturday.

Please print name and address clearly and include postage or carriage on all items.

**GRAM MOTOR BARGAIN**  
Garrard 200/250 volt A.C. gram motors, complete with turntable. Adjustable speed 0-45 r.p.m. Ideal for L.P. records. Only 22/6 each.

**TRANSISTOR TRANSFORMERS.** Cut-pout or inter-stage, 2/6. R.E.P. Dual range coil, 2/6. Crystal Diodes, 10d.

**JACK PLUG LEADS.** 6 ft. screened lead fitted with two standard jack plugs, 3/- each.

**EDDYSTONE 12 VOLT ROTARIES.** Input 12 volt D.C. Output 180 volt D.C. 65 ma. Fully smoothed and housed in grey metal case, 19/6 each.

**BUZZERS.** Brand new and boxed. Operates from 3/6 volt D.C. Only 2/6 each.

**CRYSTAL MICROPHONE INSERTS.** Ideal for amplifiers, etc., 4/6 each.

**METER SWITCHES.** Single pole 12 position 8 banks. Only 7/6 each.

**TRANSFORMER BARGAINS**  
1. Input 230 volt 50 cycle. Output 5, 10, 15, 20, 25, or 30 volt 5 amp., only 29/6 each.  
2. Input 230 volts 50 cycle. Output 7, 14, 21 or 28 volts 12 amps., 42/6 each.

**MIDGET H.T. TRANSFORMERS.** Input 220/240 volt. Output 200 volts 25 ma. and 6.3 volt 1 amp. 10/6 each. Midget metal rectifier to match, 7/6.

**COSSOR DOUBLE BEAM 'SCOPES.** Reconditioned and supplied in perfect condition. Operation 200/250 volt A.C. Price £21 each.

**FOR ALL RADIO COMPONENTS . . .**



**CHASSIS**

Aluminium Undrilled with Reinforced Corners. Available in the following sizes:

6in. x 4in. x 2 1/2in., each	4/8
8in. x 6in. x 2 1/2in., each	6/3
10in. x 7in. x 2 1/2in., each	7/3
12in. x 8in. x 2 1/2in., each	5/9
12in. x 5in. x 2 1/2in., each	6/9
12in. x 8in. x 2 1/2in., each	8/6
14in. x 8in. x 2 1/2in., each	6/-
14in. x 9in. x 2 1/2in., each	12/-
16in. x 6in. x 2 1/2in., each	8/6
16in. x 10in. x 2 1/2in., each	14/-

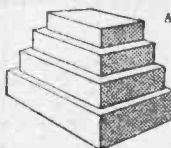

All are four-sided—ideal for radio receivers—amplifiers—power packs, etc.

**ELECTRIC MOTOR.**—For A.C. mains, 200/250 volts. Suitable for Model Makers, or fitting a grinding-wheel. 17/8 each. Same type with Reduction Gears, 18/6 each. Packing & Postage, 3/- each.

**LOUDSPEAKERS**

All PM Types less Transformer

6in. Types by Elac., Lectrona, Celestian, etc.	17/8
4 1/2in. Types by Goodmans, Rola, R. & A.	18/3
8in. Types by Goodmans, Plessey, R. & A.	19/6
10in. Types by R. & A., Celestian, etc.	25/8
6 1/2in. Water Speaker by Truvox, suitable for Car Radio, etc.	20/-
12in. Plessey Lightweight	35/-
Elliptical Speakers, Goodmans, 4in. x 7in.	19/3

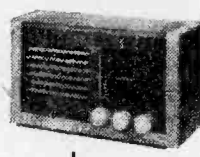
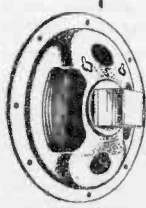

**ALPHA 3 VALVE T.R.F. KIT**  
£3.10.9

- ★ Easy to Build.
- ★ Valves 6J7, 6K7, 6V6GT plus metal rectifier.
- ★ Walnut cabinet.

Full instructions, point to point wiring diagram. Circuit diagram, and full shopping list 1/-. All components may be purchased separately.

**★ CONTROL KNOBS IN MODERN STYLING**

Tastefully and clearly engraved in gold. These Mouldings are available in two colours: Walnut and Ivory. They are suitable for use with 1/2 in. spindles and are simply and firmly held by means of a grub screw and locking nut. Prices: Type "A"—1/8 each. Type "B"—1/2 each. Plain Knobs can be supplied in either size or colour: Price 1/- each and 6d. each respectively. Inscriptions available: RAUTE: "Volume," "V/L/On-Off," "Wave-change," "Tuning," "S.M.L. (trans)," "Radio-Grant," "Tone," "On-off," TELEVISION: "Contrast," "Brilliance," "Brilliance/On-off," "Focus," "Brightness," AMPLIFIER: "Treble," "Bass" (plus any of those shown above). TAPE RECORDER: "Record-Play."

Mail Order only. For terms see our advertisement on Page No. 441. WHEN ORDERING PLEASE QUOTE "DEPT. P.W."



5/6 VINCES CHAMBERS  
VICTORIA SQUARE  
LEEDS 1.



**Choke Stage (Fig. 2)**

If difficulty is experienced with transformers, choke capacity feed is simpler. The capacitor may be from 4  $\mu$ F upwards, the higher the better for low audio frequencies. Chokes may be 10- to 20-henry low-resistance types as for transformers. One high-voltage transformer winding may be used as a choke. In other respects the circuit is the same as Fig. 1.

**Push-pull Transformer Stage (Fig. 3)**

The output transformer T2 now makes use of the

\* One OC72 is better than two OC71's in parallel

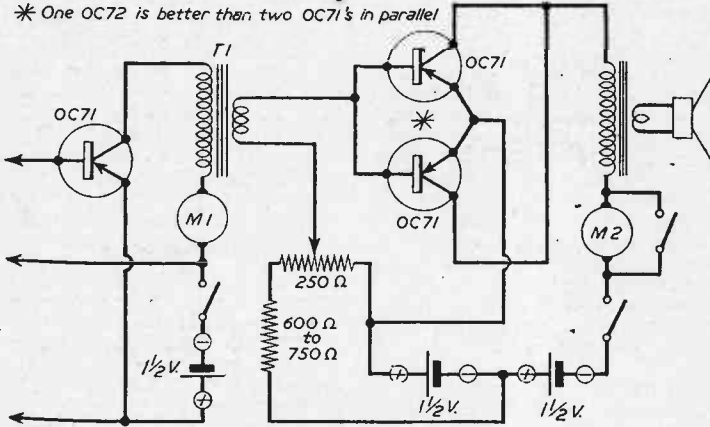

Fig. 2.—A choke-coupled stage.

centre tap and should be of a higher voltage type for ratio to match the 15-ohm speaker. On the other hand, T1 should have fewer secondary turns. Mains 0 and 250 as input and 150-0-150 suffice. Adjust both potentiometers for a reading of 2 mA on M2 and M3 so that each transistor gives equal output: the M1 as before—about 1 1/2 mA. But owing to push-pull action, smaller readings give good fidelity.

**Another Push-pull (Fig. 4)**

In this circuit parts of the potentiometer resistances are excluded from the output circuit, but the centre taps from T1 and T2 are not connected to the same 3-volt battery. There is no definite earth, so to speak. Transformers are direct coupled and music can be heard from previous stage with batteries off. Feedback is bound to occur and it may set up oscillations. Push-pull circuits are not as simple as they appear, and feedback may occur even through transistors in some cases.

**Push-pull Circuit (Fig. 5)**

This is a well-balanced circuit with minimum resistance in the output, and the batteries are both connected at the transformer centre taps, or leads. However, T1 must have two quite separate and identical secondary windings for adjusting

Two meters M2 and M3 are necessary to balance output correctly

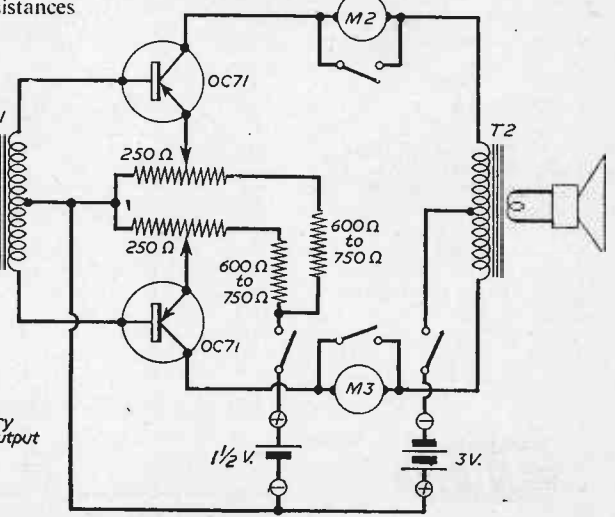

Fig. 3.—A push-pull circuit.

correct bias to each transistor. Even if the two transistors are supplied perfectly matched, there is no guarantee that they will remain thus all the time. The two pots. provide correct matching at all times.

The only way to obtain a suitable T1 transformer is by writing to makers of repute who specialise. All the windings should have less than 300 ohms D.C. resistance, each secondary with fewer turns than primary and a ratio of about 3 : 1. The primary is to carry 2 mA from a 3-volt dry battery as maximum and only 1 1/2 volts or 2 volts normally. Peak voltage

output across a non-inductive resistance instead of primary is 1,200 ohms at 400 c/s audio; this may be taken to be the impedance required for the primary, at about 3 to 8 milliwatts, from an OC71 transistor, to an output stage. Audio peaks average less than 1 mA in the primary, each secondary to carry about 130  $\mu$ A at 0.25 volts maximum D.C. bias, and maximum peak audio output of about 3 mA and 0.5 volts for each OC72 input in push-pull. Considerably smaller than power mains types can be made for these small wattages, but not as small as the available miniature types for transistors, designed for use with high-voltage batteries, which are more costly and bulky than a suitable T1, which

does not wear out.

Both pots. should be turned to zero before switching on or off. M2 and M3 should be 100 mA type to carry audio peaks, although the bias reading may be less than 5 mA. After adjusting bias for listening, short M2 and M3 by switching on S3. If there is any positive feedback, oscillation or noise with no input signal, then reverse connections to one or other of the T1 secondaries.

(Continued on page 481)



## BAND 3 T/V CONVERTER—183 Mc/s - 196 Mc/s

Suitable for London, Birmingham and Northern Transmission

£2-5-0 post free.

A highly successful unit (W, World circuit), incorporating variable oscillator tuning, Midget BVA valves, etc. Chassis size 7 x 4 x 2 1/2 in. Thousands already in use. Suitable for most types of T.V. sets. TRF or Superhet. Kit of parts 45/-, Blueprint 1/6, Power pack kit 30/-, Switch kit (Band 1—Band 3 Ae switching),

6/6—all Post Free. Wiring and aligning of above 20/- extra. Full range of Band 3 aerials in stock. Adaptors from 7/6 per set. Indoor dipoles, 6/6. Outdoor with cables, 13/9. Band 1—Band 3 cross-over filter unit, 7/6. Variable attenuators 6 ab—36 ab, 7/6. BBC Break-through Filter, suitable for BBC pattern rejector, 8/6.

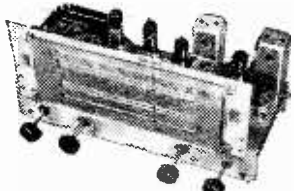

### Volume Controls

Log. ratios, 10,000 ohms — 2 Meg. ohms. Long spinelles. 1 year guarantee. Midget Edman type. No. Sw. S.P. Sw. D.P. Sw. 3/- 4/- 4/9  
Linear Ratio, 10,000 ohms — 2 Meg. ohms. Less switch, 4/- each.  
Coax plugs, 1/2. Coax sockets, 1/2. Couplers 1/3. Outlet boxes, 4/6.

### 80 ohm COAX

STANDARD (in. diam.) Polythene insulated. GRADE "A" ONLY  
8d. yd.  
SPECIAL — Semi-air spaced polythene. 80 ohm Coax (in. diam.) Stranded core. Losses cut 50%.  
9d. yd.

TWIN FEEDER, 80 ohms, 6d. yd.; 300 ohms, 8d. yd.  
TWIN SCREEN FEEDER, 80 ohms, 1.3 yd.  
50 OHM COAX CABLE 8d. per yd. (in. dia.)  
TRIMMERS, Ceramic, 4 pf.—70 pf., 8d. 100 pf., 150 pf., 1/3; 250 pf., 1/3; 600 pf., 1/9. PHILIPS Resective Type—2 to 8 pf. or 3 to 30 pf., 1/3 each.  
RESISTORS—Pref. values 10 ohms 10 megohms.

### CARBON WIRE WOUND

20% Type. 1 w. 3d.; 1 w. 5d.; 1 w. 8d.  
10% Type. 1 w. 2d.; 1 w. 4d.; 1 w. 6d.  
1% Hi-Stab. 1 w. 2/-  
WIRE-WOUND POTS. Pre-Set Min. T.V. Type. Kauried Slotted Knob. All values 25 ohms to 30 K., 3/- ea. 50 K., 4/-; Ditto Carbon Track 50 K. to 2 Meg., 3/-.

### LAB OLVEREN, Etc.

3w. LAB OLVEREN, Etc. Standard Size Pots, 2/1n. Spindle, High Grade. All Values. 100 ohms to 50 K., 5/6; 100 K., 6/6; W/W EXT. SPEAKER CONTROL 10 0. 3/-.

### CONDENSERS, —Mica or S. Mica.

All pref. values. 3 pf. to 680 pf., 6d. ea. Ceramic types. 2.2 pf.—5,000 pf. as available, 8d. each. Tubulars, 450 v., Hunts and T.C.C. 3005, 301, 305, 31 and 1 150 v. 9d., 42, 65, 1 500 v. Hunts Mediald., 1/-, 25 Hunts, 1/6; 5 Hunts, 1/9; 1 1,500 v. T.C.C. (Simplex), 3/6; 3001, 6 kV., T.C.C., 5/6; .001 12.5 kV. T.C.C., 9/6.  
SILVER MICA CONDENSERS.— 10% 1.5 pf. to 500 pf., 1/-; 600 pf. to 3,000 pf., 1.3; 1% 1.5 pf. to 500 pf., 1/9; 515 pf. to 3,000 pf., 2/-.  
STANDARD 3 WAVEBAND COIL PACK. Size 2 1/2 in. x 2 1/2 in. x 1 1/2 in. depth. 4 pos. Switching. Long. Med. Short. Gram. Dust-core coils preinducted for 465 Kc/s I.F. Complete with trimmer, ready to use. A very sensitive and efficient Coil Pack. Manufacturer's Surplus. Bargain Offer. 30/-.

### NEW VALVES GUARANTEED

1R5, 1T4, 7.6 DAF96 9/- ECH81 12/6 E240 10/- 1R5, 1R4 7.6 DP96 9/- ECL80 12/6 E280 13/- 3R4, 3V4 8/- DK96 9/- EF41 10/6 M4 5/6 3Z4 8/- DL96 9/- EF50 10/- PCC84 12/6 6AT5 8/- RA50 2/- EF50 10/- PCF80 12/6 6CH6 10/- EB91 7/6 Equip. 5/6 PCF82 12/6 6GH6 3/6 EB41 10/- EF80 10/- PCL83 12/6 6K7 6/6 EB33 8/6 EF85 10/- PL51 12/6 6CA 9/- EB32 12/6 EF86 13/6 PL82 10/- 6Q7 8/6 EB34 13/6 EF89 10/- PL83 12/6 6N7 9/- EB35 13/6 EF91 8/6 PY80 11/- 6V6 7/6 EB80 12/6 EL41 11/6 PY81 12/6 6X4 8/6 EB38 13/6 EL84 12/6 PY82 12/6 6X5 8/- EB42 10/6 EB51 12/6 PY83 12/6 and hundreds of others at Bargain Prices.  
SPECIAL PRICE PER SET. 1R5, 1T4, 1R5, and 3R4 or 3V4 ... 27/6 6K8, 6K7, 6Q7, 6V6, 5Z4 or 6X5 ... 35/-  
SPEAKER FRET—Expanded Bronze anodized metal 5in. x 2in. 2.3; 12in. x 8in. 3/-; 12in. x 12in. 4.3; 12in. x 15in. 6/-; 24in. x 12in. 8/6, etc.



3 VALVE AMPLIFIER  
With variable Tone and Volume controls. 3 Midget R.V.A. valves. 4 watts output. Neg. feedback. Chassis isolated from Mains. A.C. 200 250 v. A quality amplifier at an economical price. PRICE £3.19.6. Carr. 2/6. Wired and tested, 15/- extra. Blueprint, circuit and instr., 1/6 (free with kit).

ALL WAVE RADIOGRAM CHASSIS 3 WAVEBANDS, 5 VALVES S.W. 16 in.—30 in. LATEST MIDGET B.V.A. SERIES L.W. 800 m.—2,000 m. Brand new and guar. A.C. 200/250 v. 4 pos. W.C. sw. short-medium-Long-Gram. P.U. socket. High Q dust core coils. Latest circuit technique. delayed AVC and neg. feedback. G.P. 4 watts. Chassis size, 13 1/2 x 5 1/2 x 2 1/2 in. Dial 10in. x 4 1/2 in. Hor. or vert. station names. Walnut or ivory knobs to choice. Aligned and calibrated ready for use. Sensitivity and Quality at Low Cost. Chassis isolated from mains. BARGAIN PRICE £9.15.0 Carr. and ins., 4/6. 8" or 10in. speakers to match. 7 Valve De Luxe, push-pull version, 7 watt output, £12.10.0. Carr. & ins. 5/- BARGAIN VALUE IN AUTO CHANGERS 3 speed auto change mixers for 7in., 10in., & 12in. records. Light eight Xtal P.U. with tuner. Duo-point sapphire stylus for Hi-Fi reproduction. Latest models—Modern styling. All brand new, boxed and guar. A.C. 200/250 v. only. P.L.R.S.E.V. £8.10/- BSR MONARCH, 81 gns. GARRARD MC110, £9.10/- COLLARO MC54, £20.10/- All suitable for our Radiogram Chassis.

### QUALITY FLOURESCENT FITTINGS

Ideal for home or workshop. 4ft., 220-250 v., complete with tube, ballast unit, etc., ready for use. Famous manufacturer's surplus offered at approx. half price. Starter switch type, 42 s. Quick start type, 47/8. Carr. and ins., 7/6 extra.

LOUDBEAKER (87 mc/s—105 mc/s), by Jason. As tested and approved by Radio Constructor. Complete kit of parts to build this modern highly successful unit, drilled chassis and J.B. dial, coils and cans. 4 B.V.A. miniature valves and all components etc., for only £8.10.0, post free. SUPERIOR TYPE GLASS DIAL—Calibrate in Mc/s and edge fit by 2 pilot loops, 12/6 extra. Illustrated handbook with full details, 2/-, post free.

### ELECTROLYTICS ALL TYPES NEW STOCK

Tubular Wire Ends	32-32/350 v. B.E.C. 5/6
25-25 v. 50/12 v.	3/9
50 50 v. 4/500 v.	2/-
100/25 v. B.E.C.	2/6
2/450 v.	2/6
16/450 v. B.E.C.	2/8
8+8 500 v. Dub.	4/6
8+16 450 v. Hubs.	4/6
16/450 v. B.E.C.	3/6
16/800 v. Dub.	4/6
16+16/450 v. B.E.C. 5/6	6/6
32/350 v. Dub.	4/6
32 500 v. Dub.	5/6
50+20/350 v. B.E.C. 6/6	6/6
6,000 mfd. 6 v.	3/9

### I.F. TRANSFORMERS—465 kc/s

Brand new ex-manufacturer's midget I.F.T., size 2 1/2 in. x 1 1/2 in., dust core tuning, I.F.T. wound coils, High Q. Bargain offer, 7/6 pair.

### MAINS TRANSFORMERS.—Made in our own Workshops to Top Grade spec.

Fully interleaved and impregnated. RADIO AND AMPLIFIER TYPE.—250 v., 60 ma. P.W. sec., 5 v. or 6.5 v. 1 a. rect. 6.3 v. 2.5 a. set HTR, 21/-, etc. C.R.T. HTR. ISOLATION TYPE.—Low leakage with or without 25% rec. boost voltage. Ratio 1:1 or 1.25:2 v., 4 v., 6 v. or 13 v. 10/6 ea. Ditto with mains primaries 200/250 v., 12/6. Special, to order. SPECIAL TYPE.—To designer spec. Viewmaster, 35/-; Mullard Amp., 35/-; Osram 912, 35/-; HEATER TRANSF.—Prim. 200/250 v. 6.3 v. 1 1/2 a. or 4 v. 2 a., or 12 v. 75, 7/6; 6.3 v. 3 a. or 5 v. 3 a., 10/6. L.F. CHOKES.—10 H. 65 ma., 5/-; 15 H. 100 ma., 10/6; 16 H., 120 ma., 10/6; 20 H. 150 ma., 15/6; Simplex, 10/4; Soundmaster, 10/8. OUTPUT TRANSF.—Standard pentode, 4/8; ditto tapped pentode, 4/8; small pentode, 3/9; Midget battery pentode (1R4, etc.), 4/6. SOLON SOLDERING IRONS (200-220 v. or 230-250v.) 25 watt, instrument type, 21/-; 65 watt, Pencil Bit Type, 26/8; 65 watt, Oval Bit Type, 25/-; Comprehensive stock of spares available. LOUDBEAKER (87 mc/s—105 mc/s), 5in. Celes., 17/6; 6in. Celes., 18/6; 7 in. 4in. Goodman's Elliptical, 16/6; 8in. Ebor., 20/-; 8in. Goodman's special, 21/6; 10in. R. and A., 25/-; 12in. Plessey, 35/-; 8in. M.E. 2 k. ohms field, tapped O.P. trans., 24/6; 3 1/2in. Elac., 17/6. SCOTCH BOY, EMITAPE, etc., 30/-; Long playing, 1 1/2in. reels, 45/-; Paper tape, good quality, 1,200 ft., 12/6.



## TRS RADIO COMPONENT SPECIALISTS (Est. 1946)

70 BRIGSTOCK ROAD, THORNTON HEATH, SURREY (THO 2188)

50 yards Thornton Heath Station. Buses 130A, 133, 159, 166 & 190

Listed above are only a few items from our very 'large stock' See 3d. stamp today for Complete Bargain list. Hours: 9 a.m.—6 p.m. 1 p.m. Wed. OPEN ALL DAY SAT.

Terms C.W.O. or C.O.D. Kindly make cheques, P.O.s, etc. payable to TRS. Post/Packing up to £4.7d., 11d. 1/2, 51d. 1/6, 51d. 2/-, 101d. 2/9.

## "I'M SET TO GO PLACES... with you!"



The **SUPEREX "55" Battery Portable**  
A first-class receiver guaranteed to give good reception throughout the country. Equal in appearance and performance to most commercial models. Cabinet size: 10 $\frac{1}{2}$ " x 8 $\frac{1}{2}$ " x 4 $\frac{1}{2}$ ". All parts available separately.

**Building Cost, £7.15.0.**  
**Plus 4/- Carriage.**  
Send 1/6 for Superex Construction Booklet.

- **FOUR VALVE SUPERHET**
- **LONG AND MEDIUM WAVE**
- **LARGE ELLIPTICAL SPEAKER**
- **B7G MINIATURE VALVES**
- **SIMPLE CONSTRUCTION**



## THE SUPERIOR BUREAU



**PRICE  
£17.0.0**

Plus 25/- Carriage.

Very elegant in highly figured walnut veneer with internal panels in sycamore. Sloping radio panel size 16" long x 10 $\frac{1}{2}$ " high. Uncut motor board size 15 $\frac{1}{2}$ " long x 13 $\frac{1}{2}$ " back to front. Lid panelled in beige leatherette. Two large storage cupboards. Speaker chamber large enough for 12" speaker. Overall cabinet size 35" high, 34" long, 16 $\frac{1}{2}$ " deep.

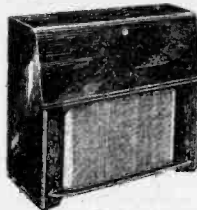

### THE COMPACT BUREAU

A well-designed Bureau-type cabinet in a medium size. Veneered in a highly figured walnut. Outside dimensions: length, 29 $\frac{1}{2}$ "; depth, 16"; height, 32". Sloping control panel on right-hand side approx. 13" x 10 $\frac{1}{2}$ ". Removable baseboard on right-hand side approx. 13 $\frac{1}{2}$ " x 13". Large storage compartment located inside the cabinet above motor board.

**PRICE £12.12.0. Plus 20/- Carriage.**

**TERMS  
CASH  
WITH  
ORDER  
OR  
C.O.D.  
U.K.  
ONLY**

**Superior**  
*Radio supplies*  
37 HILLSIDE, (HARROW ROAD)  
STONEBRIDGE, N.W.10. Elgar 3644

## HOME RADIO OF MITCHAM

187, LONDON ROAD, MITCHAM, SURREY

MIT. 3282

For WHARFEDALE Hi-Fi speakers and cabinets designed especially for the smaller room.

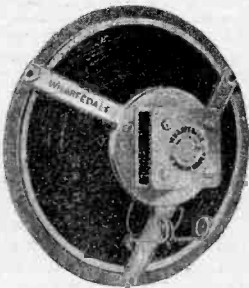

### 10" BRONZE/CSB

**£5.11.3**

Flux Density 10,000 lines; Total Fflux 39,500 lines; Speech Coil 2/3 ohms or 12/15 ohms; 5 watts input; Dust proof assembly.

This new addition to the WHARFEDALE range brings high quality reproduction within reach of most pockets. The cloth suspension and cone with bakelised apex give wide range smooth response, with a fundamental resonance between 30 and 38 cycles. Each speaker individually tested and calibrated.

The 10in. BRONZE/CSB is suitable for use in the Bronze Reflex cabinet and other reflex enclosures. The unit is hand-made by experts to the same high standards as the more expensive Wharfedale CS speakers.

### BRONZE REFLEX CABINET

The Bronze Reflex Cabinet has been designed specially for the new 10in. BRONZE/CSB unit,

but it can be used with any good 10in. loudspeaker having an open baffle resonance below 45 c/s.

This cabinet is acoustically treated and fitted with the new Wharfedale Acoustic Filter which reduces distortion at low frequencies and gives a smoother mid-range response. The bass is remarkably full, clean and crisp for such a small enclosure, and the loading on the cone is so well maintained that the 10in. BRONZE/CSB will handle peak inputs of 10 watts when reproducing heavy orchestral and organ music. The cabinet is strongly constructed from high grade 3/4in. plywood, veneered walnut (oak and mahogany veneer to order at the same price). The front is covered with untarnishable expanded aluminium mesh, anodised bronze. **£14**

Patent App. No. 4483/56.

**SUPER "THREE" High flux tweeter unit £6.13.3. CABINET for above with volume control and crossover condenser £3.10.0.**

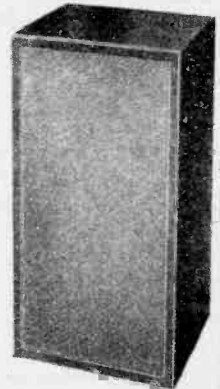

Send 2½d. stamp for full details or call for demonstration.

This is the best third stage to add, and two OC71 types may be tried with a 3-volt battery and 1½ mA bias for each.

**Direct Coupling (Fig. 6)**

This is the simplest method for the time being. When OC72 transistors become available, one can be used instead of the two OC71 in parallel.

A loop aerial is shown and will suffice for a local station if not too weak. More distant stations require an indoor aerial and earth, and a tapped, tuned coil for loose coupling.

It is to be noted that transistor Tr2 receives the hot end of the input to its base, whereas the output transistors receive it to emitters. In both cases, as the signal rises to a peak, the hot end becomes more positive. Now as the base becomes more positive, output from its transistor falls (this also acts as a safety cut-off when inputs are dangerously excessive, see November issue), but when the emitter becomes more positive, output from its transistor

than the bases. This produces a bias, M2 about 4 mA, for two output transistors when the choke alone is about 130 ohms. This bias can be increased on M2 or reduced by adjusting the 100-K. pot. with very little change on M1. So M1 can be dispensed with, using only the 100 K. pot. and M2 for all biases. If the choke has too high a resistance there will be too much bias for output and not enough for Tr2 and no efficient remedy; but if the choke has less than desired resistance a fixed resistor can be added. The meter should be watched during the first half hour or so of listening; readings may rise slowly 1 mA or more, the pot. should be readjusted to 3 mA or less for two transistors and about 1½ if only one is used, for output.

This receiver becomes a very powerful deaf-aid if a good crystal microphone is plugged in, instead of the loop-coil, and a pair of 50-ohm balanced armature phones are used instead of the output transformer and speaker. The microphone should be kept far away from the earphones to prevent feed-back whistles. If a speaker is used it should be in another room, to avoid overload feed-back shrieks. Microphone leads should be short and preferably screened co-axial. Useful for listening to a baby asleep; or a sick person may call on the extension speaker.

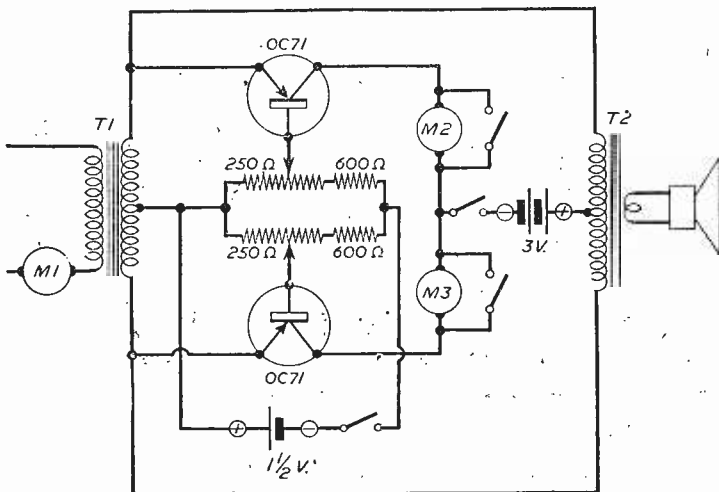

Fig. 4.—An alternative push-pull circuit.

rises. Therefore, output bias point may be set at the very bottom of the steep curve so that peak signals rise up the whole length. Volume is then at maximum. This cannot be achieved with transformer-coupling; Fig. 1. Audio peaks from a secondary go up and down and bias cannot be set at half-way up the slope, viz., 5 mA, but to a safe value of about 3 mA for OC71. Bias for push-pull class B or C may be reduced, to keep transistors cool. Each transistor then works alternately, utilising all the permissible slope, and the output wattage and volume is much greater.

The 100-ohm pot. is for adjusting bias to output transistors. A suitable fixed resistor can be used instead. If the choke has the exact D.C. resistance, even the fixed resistor is not necessary. Batteries should be switched on and off with the 100 K. pot. set to minimum bias for meter readings M1 about 0.2 mA and M2 near zero. When the pot. is adjusted for M1 to read 1.5 mA a current flows through the choke and there is a potential difference across it, so that the output emitters are at a higher voltage-

**Another Direct Coupled Circuit (Fig. 7)**

This circuit (which will be given next month) is more sensitive than No. 6, but it has no safety cut-off because transistor Tr1 is connected to Tr2 emitter instead of base. All transistors can be damaged by excessive input. Special mA meters must act as overload switches. It is shown for academic reasons and the novel biasing for OC70 and OC71. Biasing for OC72 is the same as in Fig. 6 except that the base is connected to the (-) on the 3-volt battery. Two identical chokes are shown, but the first receives much less audio wattage and can have a higher resistance. OC70 works on the flat part of the curve and the 100-ohm pot. is to move the working point only slightly away from zero. The diode is also more sensitive when a small bias current passes through. If more than 0.2 mA is passed, then sensitivity is reduced. Bias for OC71 and OC72 is by means of the 200-ohm pot. for a reading of about 1.4 mA on M2 and 2 mA on M3. Push-pull output can obviously be used. This circuit is quite good, it has been used several months, but is not recommended except for experts using only a loop, and perhaps a very loosely-coupled aerial coil with a very short aerial.

A 1,000-ohm variable resistor with an off position is shown instead of a switch for turning on the 4½-volt battery gradually to avoid induction shocks to OC72, especially if fixed resistors are used instead of the two 100-ohm pots. shown, and M1 and M2 are not used.

Finally, yet another stage of audio is not advisable ;

it is too unwieldy. When R.F. transistors are available a very nice portable superhet could be made. Meanwhile there is no harm trying to devise means and ways of using available, so-called low-noise transistors for R.F. amplification. Tests indicate possibilities. Eventually a silicon type will probably be the best. At present it is difficult to make even a silicon diode. To ascertain what can be done with bad com-

ponents, a small portable was hay-wired into a plastic food-box 5½ in. by 3 in. x 2¼ in. deep. Circuit Fig. 1 was modified for only one 1½-volt No. U2 battery and one output OC71, fixed resistors for bias, except the 100 K. pot. which was actually 60K with a switch attached. The second and output transistors were out of the junk-box, partly damaged by accidentally touching the wrong battery with a lead meant for another battery. The diode cost 1s. 6d. in glass with a yellow spot, was tested O.K. (before purchase). Transformer primary 500 ohms (not very good), but small, and so there was room to spare including a tuning condenser and a crystal mike (which could be

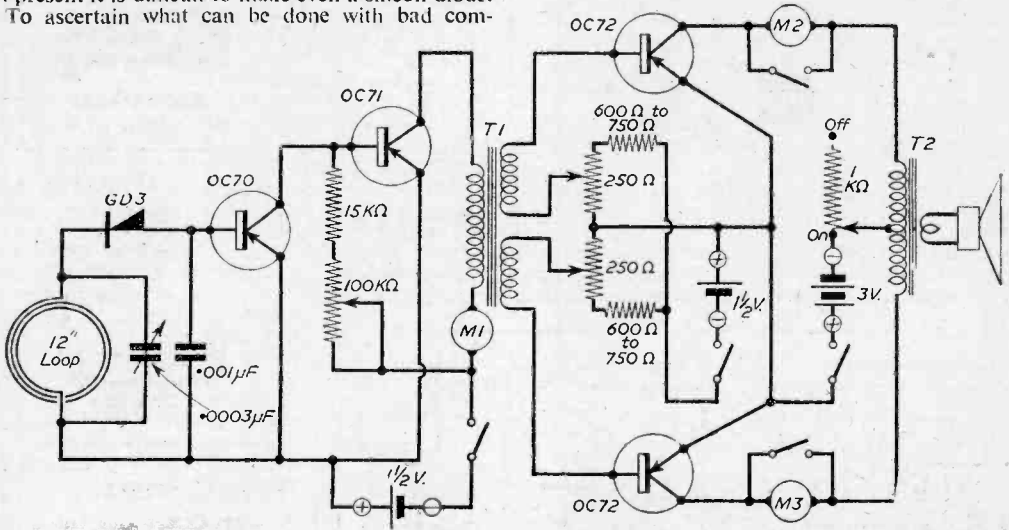

Fig. 5.—A more powerful push-pull arrangement.

ponents, a small portable was hay-wired into a plastic food-box 5½ in. by 3 in. x 2¼ in. deep. Circuit Fig. 1 was modified for only one 1½-volt No. U2 battery and one output OC71, fixed resistors for bias, except the 100 K. pot. which was actually 60K with a switch attached. The second and output transistors were out of the junk-box, partly damaged by accidentally touching the wrong battery with a lead meant for another battery. The diode cost 1s. 6d. in glass with a yellow spot, was tested O.K. (before purchase). Transformer primary 500 ohms (not very good), but small, and so there was room to spare including a tuning condenser and a crystal mike (which could be

BBC Light could be heard in north and parts of south London. Passing Brookman's Park, with aerials almost overhead, distortion and noise was deafening, but the safety cut-off prevented further damage to transistors and they are the same as before. As a deaf-aid with shorted coil it surpassed all expectations. With coil not shorted it worked as wireless and deaf-aid combined. But as a wireless alone (mike shorted) it is not recommended.

The loop coil consisted of 31 turns Litz 27/0076 wound on a flat disk with 14 radial slots ¼ in wide. Inside dia. 4 in. and 8 in. outside dia.

(To be continued)

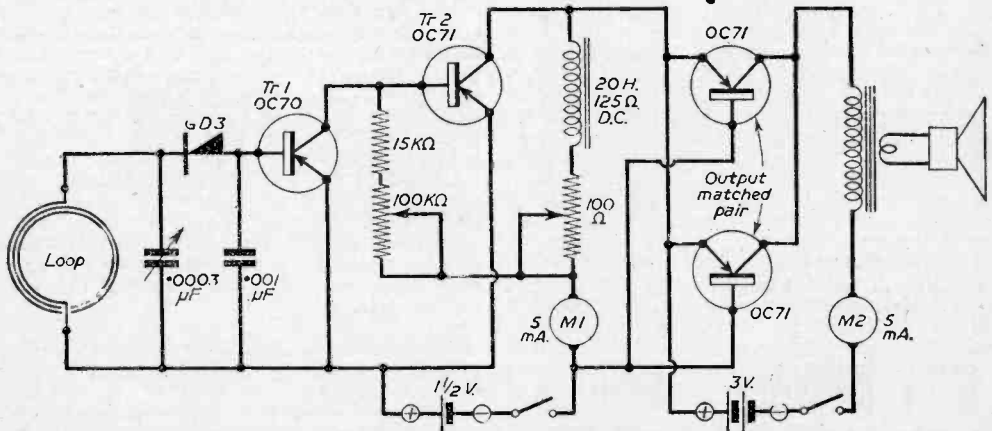

Fig. 6.—A direct-coupled circuit.



**COMPLETELY BUILT SIGNAL GENERATOR**

Coverage 120 Kc/s-320 Kc/s, 300 Kc/s-500 Kc/s, 900 Kc/s-2.75 Mc/s, 2.75 Mc/s-6.5 Mc/s, 8 Mc/s-28 Mc/s, 16 Mc/s-56 Mc/s, 24 Mc/s-84 Mc/s. Metal case 10in. x 6in. x 4in. Size of scale, 6in. x 3in. 2 valves and rectifier. A.C. mains 230-250 v. Internal modulation of 400 c.p.s. to a depth of 30 per cent., modulated or unmodulated R.F. output continuously variable 100 milli-volts. C.W. and mod. switch, variable A.F. output and moving coil output meter. Black crackle finished case and white panel. Accuracy plus or minus 2%. £4/19/6 or 34/- deposit and 3 monthly payments 25/- P. & P. 4/6 extra.

Three-speed automatic changer, B.S.R. Monarch, current model. Will take 7in., 10in. or 12in. records mixed. Turnover crystal head, cream finish. VERY LIMITED QUANTITY. A.C. mains 200/250. £7/15/6. P. & P. 3/-.

**COMMERCIAL TELEVISION CONVERTER**

SUITABLE ANY T.V. NO ALTERATIONS TO SET. Complete with built-in power supply. 230-250 v. A.C. mains. Crackle finish case 5 1/2 in. long, 3 1/2 in. wide, 4 1/2 in. high. Incorporating gain control and band switch. Illustrated with cover removed. £3. 19. 6 Plus P. & P. 2/6 Less Power supply £2/19/6. P. & P. 2/6



Heater Transformer. Pri. 230-250 v. 6v. 1 1/2 amp., 6/- Extension Speaker cabinet in polished walnut, complete with 8in. P.M. P. & P. 3/- 24/6.

8in. P.M. Speakers, removed from chassis, fully guaranteed. All by famous manufacturers. P. & P. 1/6. 12/6.

Volume Controls. Long spindle less switch, 50 K., 500 K., 1 meg., 2/6 each. P. & P. 3d. each.

**GARRARD RC/110 3-SPEED AUTOMATIC CHANGER**

1) records, turnover crystal head, brand new. A.C. mains 100/250 v. ... £8. 19. 6 LIST PRICE £14/10/0. P. & P. 5/-

Volume Controls. Long spindle and switch. 1/2, 1, and 2 meg., 4/- each. 10 K. and 50 K., 3/6 each. 1 and 1 meg., long spine lid, double pole switch, miniature, 5/-.

Standard Wave-change Switches, 4-pole 3-way, 1 1/9 : 5-pole 3-way, 1/9. Miniature 3-pole 4-way, 4-pole 3-way, 2/6. 2-pole 11-way twin water, 5/-, 1-pole 12-way single water, 4/-.

**16" TUBE BY FAMOUS MANUFACTURER**

Brand new E.H.T. 14 Kv. Heater 6.3 volts 0.6 amp., guaranteed 3 months. £9. 19. 6 E. H. T. and scanning components. Post, packing and available. insurance 22/6. H.P. terms available.

1,200 ft. High Impedance recording tape on aluminium spool 12.6 post. paid.

Polishing attachment for electric drills. Quarter-inch spindle. Chromium-plated. 5in. brush. 3 polishing cloths and one sheep-skin mop, mounted on a 3in. rubber cup. P. & P., 1/6. 12/6. Spare sheep-skin mops, 2/6 each.

**R. & T.V. COMPONENTS (ACTON) LTD.**

23, HIGH STREET, ACTON, LONDON, W.3

**3-speed TRANSCRIPTION MOTOR BY FAMOUS MANUFACTURER**

Complete Kit of parts comprising accurately balanced precision made heavy turntable with rubber mat, large constant speed condenser, starting motor, base plate. Can be assembled in half-an-hour. A.C. Mains 200/250 v. Fully guaranteed. Parts sold separately.



£6. 19. 6 Post paid.

**4 VALVE ALL-DRY SUPERHET PORTABLE KIT**

Medium and long waves. In grey leatherette. Size 9in. x 7in. x 6in. Valve line-up: 1T4, 1R5, 1S5, 3V4. Complete kit of parts (less batteries).



£6. 6. 0 Plus Post & Packing 2/6

**T.R.F. KIT in PLASTIC CABINET**

3 valve plus metal rectifier, A.C. mains 200-250 v. Medium and Long waves. In pastel blue or brown. Valve line-up: 2 VR555 and VT52. Size 15 1/2 in. long by 9in. high by 7in. deep.

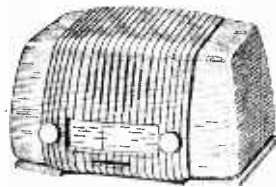

£3. 19. 6 P. & P. 4/6

Used Metal Rectifier, 230 v. 50 mA., 3/6 : gang with trimmers, 6/6 : M. & L. T.R.F. coils, 5/- : 3 Govt. valves, 3 v h and circuit, 4/6 : heater trans., 6/- : volume control with switch, 3/6 : wave-change switch, 2/- : 32 x 32 mfd., 4/- : bias condenser, 1/- : resistor kit, 2/- : condenser kit, 4/-.

P.M. SPEAKERS, 6in., closed field, 18/6. 8in. closed field, 20/6. 10in. closed field, 25/-, 12in., 25/-, 3in., 16/6. P. & P. on each 2 -.

Valveholders. Paxolin octal, 4d. Moulded octal, 7d. EF50, 7d. Moulded B7G, 7d. Loctal amphenol, 7d. Loctal pax., 7d. Mazda Amph., 7d. Mazda pax., 4d. B9A, B9A amphenol, 7d. B7G with screening can, 1/6. Duodecal paxolin, 9d.

Twin-gang .0005 Tuning Condensers, 5/- With trimmers, 6/6.

32 mfd., 350 wkg. ...	2/-	16+16 mfd., 350 wkg. ...	3/3
16 x 24 350 wkg. ...	4/-	60+100 mfd., 200 v. wkg. ...	7/-
4 mfd., 200 wkg. ...	1/3	50 mfd., 180 wkg. ...	1/9
40 mfd., 450 wkg. ...	3/6	65 mfd., 220 wkg. ...	1/6
16 x 8 mfd., 500 wkg. ...	4/6	8 mfd., 150 wkg. ...	1/6
16 x 16 mfd., 500 wkg. ...	5/9	50 mfd., 12 wkg. ...	11d.
16 x 16 mfd., 450 wkg. ...	3/9	50 mfd., 50 wkg. ...	1/9
32 x 32 mfd., 350 wkg. ...	4/-	Miniature wire ends	
25 mfd., 25 wkg. ...	11d.	moulded 100 pf., 500 pf.,	
250 mfd., 12 v. wkg. ...	1/-	and 100 ea. ...	7d.
16 mfd., 500 wkg. wire	3/3	260-0-260 80 mA., 4 v. 4 a.	
ends ...	3/3	4 v. 2 a. ...	14/6
C mfd., 500 v. wkg. wire	2/6	250 v. 350 mA., 6.3 v. 4 a.	
ends ...	2/6	twice, 2 v. 2 a. ...	19/6
8 mfd., 350 v. wkg. tag	1/6	Auto-trans. input 200 250	
ends ...	1/6	ends, 11 1/2 500 v. 250 mA., 5 v.	
100 mfd., 350 wkg. ...	4/-	4 a. twice 2 v. 2 a. ...	19/6

Potato & Vegetable Peeler, by famous manufacturer, capacity 4 1/2 lbs., complete with water pump. All aluminium construction, white stove-enamelled finish. Originally intended for adaptation on an electrical food-mixer, can easily be converted for hand operation. 39/6. P. & P. 3/-.

Where post and packing charge is not stated, please add 1/6 up to 10/-, 2/- up to £1 and £ 3 up to £2. All enquiries S.A.E. Lists 5d. each.

# LANE

# TAPE UNIT

## MARK 6

### A Top Class Recording Machine Designed for You, the Home Constructor

#### Features Include—

- Three high grade motors.
- Positive braking on all functions.
- Twin track heads.
- Electro magnetic erase.

The Unit is finished in quality stove enamel and tape speeds are  $3\frac{3}{4}$ "/Sec. and  $7\frac{1}{2}$ "/Sec. For use on 200-250v A.C. only.



PRICE

## £18. 10. 0.

From your dealer.

In case of difficulty write to :—

## VERDIK SALES LTD.

8 RUPERT COURT, WARDOUR STREET, LONDON W.1

Telephone: GERrard 8266

### CERAMICS REDUCED !!

Tremendous popularity of our 500 v. ceramic condensers enables us to reduce prices and extend range. You can now save money, save space and get a quality job. 1, 2, 3, 4.7, 7.5, 10, 15, 22, 27, 33, 39, 47, 55, 75, 100, 150, 220, 330, 470, 1,000, 1,500, 2,000, 3,000 pF, 8d., 7/6 doz. 5,000, 10,000 pF, 10d., 9/6 doz.

**WIRE-WOUND RESISTORS** (Silicone coated).—25, 50, 100, 150, 200, 250, 350, 500, 1 K., 1.5 K., 2 K., 2.5 K., 3.5 K., 5 K., 6.8 K., 10 K., 15 w., 1/3; 10 w., 1/3; 15 w., 1/3; 15 K., 18 K., 20 K., 25 K., 35 K., 5 w., 1/3; 10 w., 2/3; 17 K., 5 w., 2/3; 10 w., 2/6.

**VALVEHOLDERS**.—Octal, 17C, 85A, 1; with can, 2/.

**PLUGS FOR VALVEHOLDERS**.—International octal, 2/3; B7I and B7A, 1/9 (very neat).

**EXPANDED POLYTHENE COAX** (Suitable Bands 1 & 2).—9d. yd.

**COAX FITTINGS**.—Plugs. Male (solderless), 1/2; female, 2/; Socket, 1/3. Outlet box, 4/6. Coupler (dble. sect.), 1/6.

**LATEST "GEN" BOOKS** (All post 4d.)  
**PRACTICAL TRANSISTORS & TRANSISTOR CIRCUITS** How to make and use, 3/6.  
**TRANSISTORS & CRYSTAL DIODES** Clear, simple, but thorough. Theory & circuits, 5/.

**RADIO CONTROLLED MODELS FOR AMATEURS**. Theory and construction, various systems, 5/.

**VALVE EQUIVALENTS**, Genuinely at-a-glance, 5/.

**PRACTICAL P.M. FM** fully explained with lots of circuits for home constructors, 5/.

**PRICES GLASSED—MUST CLEAR !!**

**VALVES**. Original Cartons: 6SK7, metal, 3/9; 6X4GT, 4/9; 6HG, 2/9. Unused & boxed: 6U, 4/1; 6/9; 80 (5 v. rect.), 6/9; EB34, 1/3; 12HG, 1/.

**ELECTROLYTICS**.—16-22 250 v., 3/9; 40 350 v., 2/9.

**SLEEPING**.—1 min. bore Peribraid, 226 yds. on reel, only 9/6 post 2/6 (plus please note).

**VCR 97 tubes**, 17/8, carriage 2/6. Slight restriction one axis only, outside mask if this axis is used for frame scan.

**25 CARBON RESISTORS**, 1 to 5 WATT, 5/.

All unused. Famous makes. Worth triple.

**MICA CONDENSERS**.—Unusual, U.S.A. and U.K. makes. Wire ended. 75, 2,000, 5,000 pF, 1/9 doz.

**POTENTIOMETERS** (with spindle).—Unused many boxed. 5 K., 500 K., 1/3; 6 for 5/8.

**TWIN SCREENED CABLE**, 6d. yd. (Heavy duty). Send 3d. for full list.

Post, etc. extra on orders under 2/.

**REED & FORD** 39 BURNLEY RD., AINSDALE, SOUTHPORT

### LYONS RADIO LTD.

Dept. M.P., 3, GOLDHAWK ROAD, SHEPHERD'S BUSH, LONDON, W.12.

Telephone: SHEPherds Bush 1729

**RADIO EXHIBITION**. As in the past several years we are holding a SPECIAL BARGAIN SALE commencing with the opening of the Radio Exhibition. Our premises are only a little over a mile from Earl's Court, so if in town why not pay us a visit and secure some of the many bargains which will be displayed, all at clearance prices. Despatch of purchases gladly arranged.

**AMERICAN L.F.P. UNITS**. Contain 2 relays, three sets of cam operated contacts, ten 1.0 valve-holders, Sprague and moulded mica condensers, resistors, carbon pile voltage regulator, etc., etc. 10 valves (6-65H7, 2-65E6, 2-7193), also a rotary converter rated for 18 volt D.C. input and 480 volt D.C. output. Operate quite well from 6 volt and 12 volt D.C. input. One end of converter is fitted with a fan and the other end a gear box both of which can easily be taken off if required. The gear box reduces speed of rotation to two driving shafts which rotate at approx. 4 and 16 r.p.m. for 12 volt input or half this speed for 6 volt input. In good condition. PRICE ONLY 30/-, carriage 5/.

**LORENZ HIGH FREQUENCY SPEAKERS**. These P.M. electro-dynamic speakers are specially designed to reproduce those higher frequencies in the sound spectrum from 1.6 to 20 kc/s. Connected across your existing speaker is sufficient to bring reproduction to life and for it to acquire a realism and sparkle previously unobtainable. Essential for the high quality reproduction of modern L.P. recordings, F.M. and T.V. transmissions. Can be used with any standard speaker and loaded up to 25 watts. Size approx. 2 1/2 in. dia. x 2 1/2 in. deep. Full connection details with each speaker. PRICE 39/6 or send S.A.E. for further details.

### ALFRED PADGETT

40, MEADOW LANE, LEEDS 11

Tel.: Cleckheaton 99

**Tube Unit BC929A**. Complete with 7BP1 6in. tube. Less valves. This is a score all but made. £15.0. Carriage 7/6. (Tube guaranteed.)

**TX1154 Model II**. In maker's cases. Four-wave model. The best of all 1154 sets. All all. chassis. 37/6. Carriage 12/6. (Complete with all valves.)

**TX1154 Model N**. Three-wave model. Complete with all valves, 25 -. Carriage 12/6. (Not so clean TX1154 model N sets at 15.-. Carriage 12.-.)

**R.D.F.1. Sets**. Complete with 5 VR65, 1 CV65, 1 VR137, 2 VR65, 1 VR54 and 3 VR62. Less power packs, 15/-. Carriage 7/6. Throw away your 1355 and 26 units and make a better job of your TV set-up with this unit. **Small Metal Rectifiers**. 12 months' guarantee. 250 volts at 100 milli. 6/6. Post 3/6.

**50 Pencil Rectifier**. 1/8. Post 9d.

**Solder Flux**. 2oz. tin, 4d. Post 6d. 3/6 per doz. post free.

**Celluloid Cement**. Very useful to have in the workshop, 1/- per tin. Post 6d.

**24 Volt Motor**. A.C. D.C., 1,800 revs. Works O.K. from 12 volts. Ideal motor for car fan, etc. Over 1,000 sold. 3/6. Post and packing, 2/.

**Handy Box of B.A. Nuts and Bolts**. 1lb. weight, 1/- Post 9d.

**Micrometer Dial Drive** removed from new T.U.B. units, 2/6. Post 1/-. Handles from T.U.B. units, 9d. each. Post 6d. 8/- doz. post free.

**New 3BP1 Tube**, with Base and Screen. 1/6. Insurance and packing 4/.

**Radio Valves** with a 90 days' guarantee. Post 9d. per valve. Doz. lots less 5% post free.

8P2, 1/-; 6H6, 1/-; CV6, 1/-; CV63, 1/-; VR66, 1/-; VR65, 1/6; VR55A, 2/-; VU11, 1/6; VR92, 8d.; VR54, 6d.; 2X2, 1/3; 8X5, 5/-; 6G8, 3/6; 6SN7, 6/6; KT2, 3/6; HL2, 1/3; 6Y7 (Yank), 6/-; 6Y7 (British), 4/-; 6SK7, metal, 5/-; 6T5, 3/6; 12J5, 2/6; 6D6, 3/6; 6BT9, 3/6; 6KT9, 3/6; 6AB7, 5/-; 12BH, 1/6; 201, 5/-; 603, 1/6; 165, 1/9; ACUPen, 2/6; 733C, 6/-; 854 1/3; U11, 6/6; VT18, 30/-; Tpe 46, 5/-.

# Servicing Radio Receivers



**T**HE Bush DAC10 is a popular receiver which, although first released during 1950, has had a long run under various modifications. The set is housed in a plastic cabinet of modern styling and features press-button tuning for three stations and press-button waveband changing. It uses four valves (plus rectifier) in a two-band superhet circuit, embodies an internal frame aerial and is suitable for use on A.C. or D.C. mains of 200-250 volts.

## The Frequency Changer Section

The complete circuit of the receiver is shown at Fig. 1. The signals in the frame aerials L1 and L2 are either tuned by C1 section of the tuning gang or pre-tuned by the press-button trimmers T1, T2 and T3. For the sake of simplicity, the switch contacts on the press-button unit are drawn in the open position and we have not attempted to identify them. Usually very little goes wrong with this unit and, in any case, if it has to be taken out for a repair or replacement it is well worth while clearly to mark the wires and associate them with the tags on the unit. It is best to draw a rough sketch of the wiring and tag positions.

It often happens that the press-button switches become somewhat intermittent in operation after the receiver has been in service for several years. If examination shows that the press-button unit is full of dust this should be blown out with the aid of a bicycle pump, making use of the connector to secure a greater pressure. A soft brush also helps in removing dust which has become caked on the switch contacts. When the dust has been completely removed the contacts should be treated with a few drops of special switch cleaner. The treatment should be assisted by vigorously working the press-buttons for two or three minutes after application of the fluid.

If this treatment does not effect a complete cure (it is most unusual if it does not) the switch contacts are probably badly worn and replacement of the unit should be contemplated.

The signals thus tuned are applied to the signal grid of the hexode section of the triode-hexode frequency changer valve V1. The triode section operates as the local oscillator, and coupling between the oscillator and hexode takes place within the valve. The press-button switches also select either the M.W. (L3/4) or L.W. (L5/6) oscillator coils.

## THE BUSH DAC10

By Gordon J. King, A.M.I.P.R.E.

Coils L7, L8 and L9 serve to provide pre-set oscillator tuning. An intermediate frequency of 465 kc/s is produced across I.F.T.1 in the anode circuit of V1.

If the receiver appears to have plenty of life and if clicks are heard when the push-buttons are depressed, but it is found impossible to receive signals, attention should be paid to the 50 pF capacitor in the oscillator grid circuit and the 0.05  $\mu$ F capacitor connected between chassis and the lower end of L6. If either of these becomes open-circuited complete failure of the oscillator circuit results.

Intermittent operation or intermittent "rushing" noises in the loudspeaker often indicates that V1 is noisy. This can be proved by turning up the volume and adjusting the tuning to a quiet part of the dial and then gently tapping the valve with the handle of a screwdriver. Bangs and crackles from the loudspeaker mean either that the valve is in urgent need of replacement or that its pins are not making very good contact with the valveholder sockets. Wriggling the valve in the holder proves this latter possibility. It is not easy to tighten the valveholder sockets, but cleaning the pins with fine emery cloth generally solves the problem. In some cases, though, it may be found necessary to replace the valveholder.

## The I.F. Stage

The signals in the I.F. transformer are carried by way of the 220 ohm grid stopper resistor to the control grid of the UF41 I.F. amplifier valve V2. This works in fairly conventional mode, though one thing which is not very often found is the 10 K $\Omega$  decoupling resistor and associated 0.05  $\mu$ F capacitor

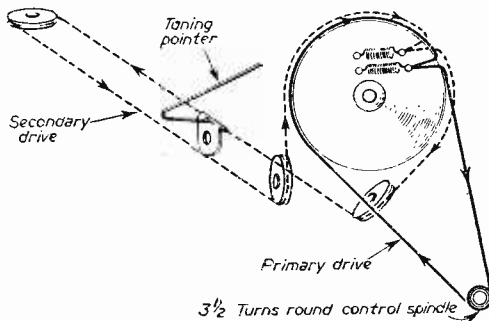

Fig. 4.—Details of the cord tuning drive.





# COMPLETE KITS of PARTS for the "Hi-Fi" ENTHUSIAST

The MULLARD "5-10" MAIN AMPLIFIER



This is the very latest design and needs no recommendation from us. Our Kit is complete to Mullard's specification, including the latest GILSON ULTRA LINEAR OUTPUT TRANSFORMER and the entire MULLARD Valve line up. ALL SPECIFIED COMPONENTS are supplied. **PRICE OF COMPLETE KIT OF PARTS £11.10.** (Plus 5/- carr. and ins.)

STERN'S "fidelity" PRE-AMPLIFIER-TONE CONTROL UNIT  
"A design for the music lover"



Briefly it has inputs for all types of MICROPHONES, HIGH and LOW GAIN PICK UPS and a RADIO TUNING UNIT. It incorporates (a) GRAM EQUALISING CONTROL. (b) STEEPCUT FILTER. (c) Continuously variable BASS and TREBLE CONTROLS and a variable OUTPUT CONTROL which enables its use with any type of Amplifier. **PRICE OF COMPLETE KIT OF PARTS (Plus 5/- carr. and ins.) £6.60.** WE ALSO OFFER IT ASSEMBLED. **READY FOR USE, £8.** (Plus 5/- carr. & ins.)

STERN'S HIGH QUALITY 10 WATT POWER AMPLIFIER

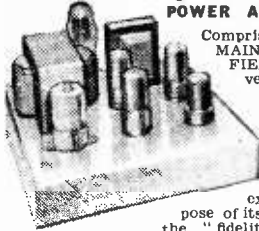

Comprises the MAIN AMPLIFIER of our very popular 8-10 watt design, which we have modified with the express purpose of its use with the "fidelity" PRE-AMPLIFIER illustrated alongside. TWO 6V6's are used in push-pull and the resultant reproduction is genuinely in the Hi-Fi fidelity class, yet the total cost is ridiculously low. **PRICE OF COMPLETE KIT OF PARTS (Main Amplifier only.) (Plus 5/- carr. & ins.) £7.70.**

**THE full SPECIFICATION and BUILDING INSTRUCTIONS for these three Units are available for 1/6 each. THEY include COMPONENT PRICE LISTS and simple "wire-to-wire" PRACTICAL DIAGRAMS.**

## SPECIAL PRICE REDUCTIONS . . . FOR PURCHASERS OF A COMPLETE "Hi-Fi" AMPLIFIER

WE WILL SUPPLY (a) COMPLETE KIT OF PARTS to build THE MULLARD "5-10" MAIN AMPLIFIER and the STERN'S "fidelity" PRE-AMPLIFIER-TONE CONTROL UNIT for **£16/16/-** (plus 7/6 carr. and ins.), or we will supply THE TWO UNITS MADE UP and READY FOR USE for **£19/19/-** (plus 7/6 carr. and ins.). Terms : Deposit **£9/19/-** and 12 monthly payments of **18/7** or **£5/-** deposit and 9 months of **£1/16/7**. (b) COMPLETE KIT OF PARTS to build the HIGH QUALITY 8-10 WATT POWER AMPLIFIER and the "fidelity" PRE-AMPLIFIER-TONE CONTROL UNIT for **£13/-** (plus 7/6 carr. and ins.) or we will supply THE TWO UNITS MADE UP and READY FOR USE for **£15/15/-** (plus 7/6 carr. and ins.). Terms : Deposit **£7/17/6**. 10 monthly payments of **13/9**, or **£4/-** deposit and 9 months of **£1/3/9**. **QUALITY OF THIS NATURE HAS NEVER BEFORE BEEN OFFERED AT SUCH LOW COST.**

## AN EXCEPTIONAL OFFER FOR CASH ONLY £7.70.

The B.S.K. MONARCH 3-SPEED AUTOCHANGER

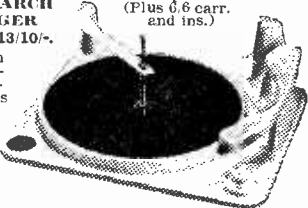

**NORMAL PRICE £13/10/-**  
● Complete with High Fidelity Crystal "Turn-over" Head which incorporates separate stylus or L.P. and 78 r.p.m. records. ● A "MIXER" Unit that will autochange on 7in., 10in. and 12in. records.  
● Brand New in Maker's Cartons, complete with mounting instructions.

(Plus 6/6 carr. and ins.)

## A REALLY GENUINE PRICE REDUCTION

A BULK PURCHASE ENABLES US TO OFFER THESE RECEIVER CHASSIS AT SUCH LOW PRICES. Each is BRAND NEW and FULLY GUARANTEED.

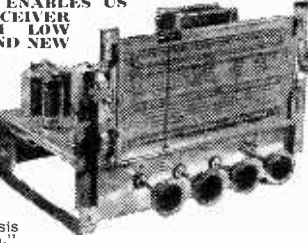

The MODEL B.35 valve 3-waveband A.C. mains Superhet. Designed to the most modern specification, great attention having been given to the quality of reproduction which gives excellent clarity of speech and music on both gram. and radio, making them the ideal replacement chassis for that "old radiogram." etc.: Valve Line-up, 6BE6-6BA6-6AT6-6BW6-6X4; coverage: sht. 16-30, med. 187-350, lr. 900-2,000 metres. (Plus 7/6 carr. & ins.) H.P. Terms: Deposit **PRICE, £11.10.** £5/16.- and 7 monthly payments of 19/3.

## DESIGNS FOR THE HOME CONSTRUCTOR

THE COMPLETE SPECIFICATIONS OF THE FOLLOWING UNITS ARE AVAILABLE FOR 1/6 EACH. THESE MANUALS ALSO INCLUDE THEORETICAL and PRACTICAL WIRING DIAGRAMS, AND A COMPLETE COMPONENT PRICE LIST.

The "wire-to-wire" Practical Diagrams are very simple to follow and are drawn for the "inexperienced" Constructor.

- STERN'S F.M. TUNING UNIT . . . A 5-valve Tuner incorporating the latest Mullard Permeability Tuning Heart and a "Magic Eye" Tuning Indicator and can be completely built for **£10/-**. It is now available.
- STERN'S COMBINED A.M./F.M. TUNING UNIT . . . Precisely similar to the F.M. Tuner, but also incorporates the MEDIUM WAVEBAND. It can be completely built for **£13/10/-**.
- THE Denco F.M. TUNING UNIT . . . The complete set of SPECIFIED COMPONENTS to build this can be supplied for **£7/2/8**, this includes the Denco Dial and Drive Assembly.
- STERN'S HIGH QUALITY 8-10 WATT AMPLIFIER . . . Designed for High Quality reproduction up to an output level of 10 watts, having 6V6's in Push-Pull and incorporating negative feedback. It is one of the most successful Amplifiers (in the lower price range) yet offered to the Home Constructor. WE can supply the complete Kit ex-stock. **£7/10/-**.
- STERN'S "JUNIOR" PRE-AMPLIFIER-TONE CONTROL UNIT . . . Provides full control of BASS and TREBLE in conjunction with main VOLUME CONTROL and can be used with any Amplifier. The unit contains its own POWER SUPPLY . . . THE COMPLETE KIT OF PARTS is available at **£3/16/8**.
- STERN'S "PERSONAL SET" BATTERY ELIMINATORS . . . Complete Kits OF PARTS to build Midget "All-dry" Battery Eliminators (a) Providing approx. 69 Volts at 10 m/a and 1.4 Volts at 250 m/a. Price **£2/6**. (b) Providing approx. 90 Volts at 10 m/a and 1.4 Volts at 250 m/a. Price **£4/6**.

ALL COMPONENTS TO BUILD THESE AMPLIFIERS, TUNERS, ETC., ARE AVAILABLE FOR SALE SEPARATELY. CONSTRUCTORS CAN, THEREFORE, GRADUALLY BUILD ANY UNIT.

(a) The "COMPACT 5-2" A Two-stage high sensitivity Amplifier having SEPARATE BASS and TREBLE CONTROLS and designed to give up to approx. 5 watts with very pleasing quality. **PRICE £5/15/-** (plus 5/- carr. and in.).

(b) The "COMPACT 5-3" A Three-stage version of the "5-2" model, but in this case having an additional stage and incorporating Negative Feedback. **PRICE £6/16/-** (plus 5/- carr. and insurance).

## STERN'S 'COMPACT 5' AMPLIFIERS



Expressly developed for very high quality reproduction of Gram. Records and particularly suitable for high quality reproductions of the F.M. transmissions. Two models are available: A separate POWER SUPPLY UNIT to operate with these amplifiers is available for **£2/10/-** (plus 2/- carr. & ins.). Has additional supply available for Radio Tuner, etc.

**STERN RADIO LTD. 109 & 115 FLEET STREET, LONDON, E.C.4.** Telephone: F1 Est 5812/3/4

# BUILD AN INEXPENSIVE QUALITY RADIO!

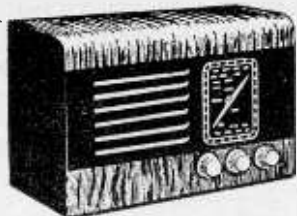

107/6

Total building cost including choice of beautiful walnut veneered cabinet or ivory or brown bakelite. This is the lowest possible price consistent with high quality. No radio knowledge whatever needed... can be built by anyone in 2-3 hours, using our very simple easy-to-follow diagrams. This terrific new circuit covers all medium and long waves with optional negative feedback, has razor-edge selectivity, and exceptionally good tone. Price also includes ready drilled and punched chassis, set of simple easy-to-follow plans—in fact, everything! All parts sparkling brand new—no junk! Every single part tested before despatching. Uses standard octal-base valves: 6K7G high-frequency pentode feeding into 6J5C anode-bend detector triode, coupled to 6V8C powerful output beam-power tetrode, fed by robust rectifier. For A.C. Mains, 200-250 Volts (low running costs—approximately 18 Watts!). Size 12in. x 6in. x 5in. Build this long range powerful midset NOW. All parts and set of plans, 25/7.6. (Post and packing 3/6.) Priced Parts Lists, 2/-.

## AT LAST! — A POCKET RADIO

THAT CAN  
BE BUILT  
FOR ONLY **37/6**

In response to many requests we now present the "SKYPOCKET", a beautifully designed precision POCKET RADIO. Can be built by anyone without any radio knowledge whatever—EVERY SINGLE PART TESTED BEFORE DESPATCH; our simple, pictorial plans take you step-by-step. This set has a remarkable sensitivity due to painstaking design and careful choice of component values. Covers all medium waves 200 to 550 Metres, including "Home," "Light," "Luxembourg," etc. Size only 5 1/2in. x 3in. x 2 1/2in. in Strong, Transparent case with panel, cover and special station-printed ivoryine dial. A really personal pocket-radio WITH OWN DETACHABLE 10" AERIAL, ideal for Bedroom, Garden, Holidays. Second-set, etc. Completely all-dry battery operation with special low consumption. Specially chosen high-efficiency coil. Average building time 1 hour. Total Building Cost—including Case, Valve, etc., in fact, everything down to the last nut and bolt—ONLY 37/6, with plans. Postage, etc., 2/-, C.O.D. 1/6 extra. (Parts sold separately. Priced Parts Lists, etc., 1/6.) Demand is certain to be heavy—so SEND TODAY!



47/6

Build this exceptionally sensitive twin-triode radio. Uses unique assembly system and can be built by anyone without any radio knowledge whatever in 45 minutes. Handsome made black and gold dial with stations printed. Size of radio only 6 1/2in. x 5in. x 3in. Covers all Medium and Long waves—uses one only all-dry battery. H.T. consumption only 1 to 1.5 mA. Ideal for Bedroom, Garden, Holidays, etc. Many unsolicited testimonials. Mr. Norton, of Oxted, writes: "Yesterday evening on the Medium waveband, I counted 32 separate stations; I am very pleased with the set, which is well worth the money. Total building cost—Everything down to last nut and bolt—47/6 (Postage etc., 2/-)—with full set of clear, easy-to-follow plans (For Headphone Reception). Cost of Extra Valve, Speaker, Parts, etc., 38s. 6d. All these fit inside Case or parts sold separately (Priced Parts Lists, 2/-).

**CONCORD ELECTRONICS (Dept. PWA), 39, QUEENS ROAD, BRIGHTON, 1**

Orders despatched by return of post. Cheques accepted. Cash on delivery 1/6 extra. Suppliers to Schools, Universities, Government and Research Establishments. Complete range of components and valves stocked.

## FREE TO AMBITIOUS ENGINEERS!

This 144-page Book

Have you sent for your copy?



**'ENGINEERING OPPORTUNITIES'** is a highly informative guide to the best-paid Engineering posts. It tells you how you can quickly prepare at home on "NO PASS—NO FEE" terms for a recognised engineering qualification, outlines the widest range of modern Home-Study Courses in all branches of Engineering and explains the benefits of our Employment Dept. If you're earning less than £15 a week you cannot afford to miss reading this unique book. Send for your copy to-day—FREE.

FREE COUPON

Please send me your FREE 144-page 'ENGINEERING OPPORTUNITIES'

NAME .....  
ADDRESS .....

Subject or Exam. ....  
that interests me .....

British Institute of Engineering Technology  
409B, College House, 29-31, Wright's Lane,  
Kensington, W.8.

### WHICH IS YOUR PET SUBJECT?

- Mechanical Eng.
  - Electrical Eng.
  - Civil Engineering
  - Radio Engineering
  - Automobile Eng.
  - Aeronautical Eng.
  - Production Eng.
  - Building, Plastics, Draughtsmanship
  - Television, etc.
- GET SOME LETTERS AFTER YOUR NAME!**
- A.M.I.Mech.E.
  - A.M.I.C.E.
  - A.M.I.P.E.
  - A.M.I.M.I.
  - L.I.O.B.
  - A.F.R.Ae.S.
  - B.Sc.
  - A.M.Brit.I.R.E.
  - CITY & GUILDS
  - GEN. CERT.
  - OF EDUCATION
  - etc., etc.

# BIET

## Best Buy at Britain's

**TWO-WAY MORSE TRAINING SETS, W/T Mk. 3.** Consists of two valve oscillators (AR12's) (one with pitch control), for one or two operators. Has provision for creating "Atmospherics." In polished oak case 12 1/2in. x 10 1/2in. x 8 1/2in. Wt. 16 lbs. Complete with valves, leads, 2 keys, 7-way terminal board, circuit and instructions, but less batteries and 'phones. Ideal for Cadets, Scouts, etc. SNIP. 19/6.

**RESISTORS.** Latest miniature insulated Dubilier 1 watt type BTS. Wire ends. Useful values. ONLY 10/- for 100 assorted! 1/4 and 1 watt, Erie, etc., 1 gross assorted, 10/-.

**FIELD TELEPHONES.** Army type D, Mk. 5, Buzzer calling. Ideal for building sites, farm, workshops, etc. Complete with handset and batteries. Tested before despatch. 39/6 each.

**SOUND-POWERED HANDSETS.**—Similar to telephone. Balanced armature microphone and earpiece. No batteries, required 10/6 each. Breast mike and pr. headphones, as above. 12/6 set.

**COMMAND RECEIVERS.** Complete with 6 metal valves. 3 12SK7, 1 12K6, 1 12SR7 and 1 12A6. Size 5in. x 5 1/2in. x 1 1/2in. deep. In very good condition. Less dynamometer. FREE CIRCUIT WITH EACH SET.  
BC455, 6-9 Mc/s. 25/- BC453 (the famous Q5'er), 100-550 Kc/s. 59/6.  
BC454, 3-8 Mc/s. 27/6. BCXXX ("Trawler" band), 1.5-3 Mc/s. 65/-.

**THREE-CORE CABLE.** 23/36, rubber insul., circular, padded, cotton covered, maroon. 12 yds 9/- or 100 yds 59/6.

**RCA SPEAKER.**—An 8in. P.M. unit contained in beautiful black crackle cabinet, suitable for AR33, etc. BRAND NEW. Price only 45/-.

**DUAL VOLTAGE BLOWERS.**—12 and 24 v. Ideal for hair driers, car heaters, etc.. 25/- plus 2/6 postage.

**INSTRUMENT TRANSFORMERS, Parmeko.**—230 v. A.C. input. 0.65-130-195 v. 85 mA. 6.3 v. 5 Amp. 6.3 v. 3 Amp output. Shrouded. 3 1/2in. x 3 1/2in. x 3 1/2in. high. 15/-.

**HEAVY DUTY L.F. TRANSFORMERS.**—200-250 v. A.C. input. 30 v. tapped at 10 v. 38 Amps output, 5 1/2in. x 6in. x 7in. high, wt. 24 lbs. 55/-.

**MINIATURE MODEL MOTORS.**—2in. long x 1 1/2in. diam., 3/16in. diam. spindle, weight 5 ozs. Will work from 6-volt dry battery and are reversible. Ball bearings. Price 8/6.

**WE CAN ONLY ADVERTISE** a small selection of our vast and varied stocks of valves, meters, components, indicator units, chassis, receivers, etc. Callers welcome, quotations by return.

**PLEASE ADD POSTAGE OR CARRIAGE ON ALL ITEMS**  
**CHARLES BRITAIN (RADIO) LTD.**  
11, Upper Saint Martin's Lane, London, W.C.2.  
Temple Bar 0545

Shop hours 9-6 p.m. (9-1 p.m. Thursday) Open All Day Saturday

negative feedback is developed across the 150 ohm cathode resistor.

R2 is the mains dropper resistor, which is tapped to cater for various mains voltages. The voltage at one of the tappings is applied, via a 250 ohm surge limiting resistor, to the anode of the H.T. rectifier valve UY41 V5. The rectified voltage at the valve cathode is smoothed by C3/4 and filtered by the 10 K resistor. The pilot bulbs are energised by the volts drop in the mains return circuit, the 250 ohm resistor acting as a shunt. The heaters of the valves are connected in series in the pattern shown on the circuit. S1/2 is the mains on-off switch which is a part of the volume control.

Excessive distortion accompanied by an increase of voltage at the cathode of V4 is generally caused by a leak in the 0.01  $\mu$ F grid coupling capacitor. A high hum level should lead to investigation of the condition of the electrolytic smoothing unit C3/4.

### I.F. Alignment

As this receiver has a "live" chassis, it is desirable to employ isolating capacitors between the output leads of the signal generator and the circuits to which they need to be connected. To indicate output an A.C. voltmeter should be connected, via suitable isolating capacitors, between V4 anode and chassis. A modulated signal should be used for all adjustments.

Tune the receiver to 300 metres M.W. and the signal generator to 465 kc/s, and inject the signal between the control grid of V2 and chassis. Adjust T16 and T15 (Fig. 3) for maximum output. Inject the signal between the control grid of V1 and chassis and adjust T14 and T13 (Fig. 3) for maximum output, reducing the signal from the generator as the circuits approach correct alignment—do not readjust T16 and T15.

### R.F. and Oscillator Alignment

Since it is necessary to remove the chassis from the cabinet for these operations, the alignment scale, situated just above the press-button unit, provides the necessary alignment reference points.

In order to avoid loading the R.F. circuits, the signal generator must not be connected direct to the circuit. Sufficient signal transfer is obtained from the generator to the frame aerials by means either of a 12in. length of wire connected to the "live" output terminal of the generator, or by using a 12in. loop connected between the "live" and earth terminals of the generator. The improvised radiator should be placed about 12in. away from the frame aerials of the receiver, and the generator adjusted for a high output.

Tune the receiver to reference point 0.6 M.W. on the alignment scale and radiate a 600 kc/s signal. Adjust T12 (Fig. 2) for maximum output. Tune the receiver to 1.5 M.W. and the generator to 1,500 kc/s and adjust T11 and T4 (Fig. 2) for maximum output. Repeat these adjustments, if necessary, to secure optimum accuracy over the M.W. band.

Tune the receiver to reference point 0.15 on the alignment scale and radiate a 150 kc/s signal L.W. Adjust T9 (Fig. 2) for maximum output. Tune the receiver to 0.3 L.W. and the generator to 300 kc/s and adjust T10 and T5 (Fig. 2) for maximum output. If necessary, repeat these adjustments for minimum tracking error.

### Adjusting the Pre-set Stations

The push-buttons as numbered on Fig. 3 are (1) M.W. manual, (2) L.W. manual, (3) 200-350 metres pre-set, (4) 325-550 metres pre-set, (5) 1,100-1,875 metres pre-set.

Trimmers T6 and T3, T7 and T2, T8 and T1 correspond to the pre-set buttons 3 to 5 respectively. The first trimmer in each case corresponds to the oscillator which is best adjusted roughly by means of a signal generator and then tuned accurately on the stations. The second trimmer in each case corres-

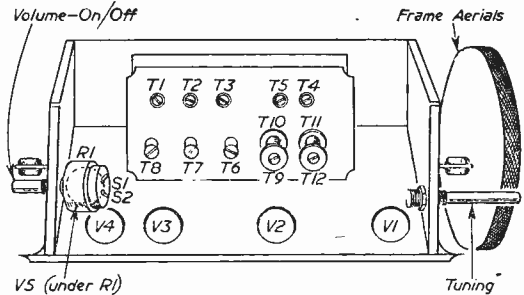

Fig. 2.—The underside view of the chassis.

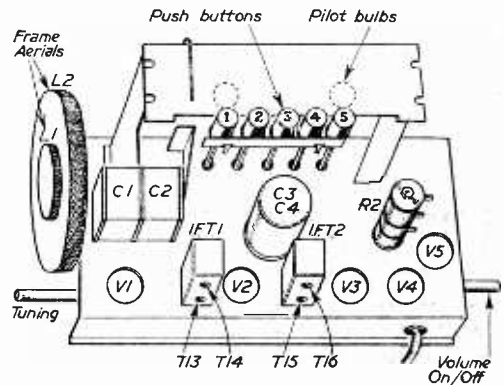

Fig. 3.—A top view of the chassis.

ponds to the R.F. circuits and should be adjusted for maximum volume. The positions of the trimmers are shown on the underside view of the chassis at Fig. 2.

### The Dial Drive

Fig. 4 shows the method of re-cording the drive assembly. It will be seen that two drives are employed; the primary drive which, from the tuning spindle, actuates the tuning gang, and the secondary drive whose purpose is to provide a scale indication. Nylon braided glass yarn is most suitable for these purposes. Approximately 2ft. is required for the primary drive and 3ft. for the secondary drive.

### REFRESHER COURSE IN MATHEMATICS

8/6, by post 8/10. 4th Edition.

By F. J. CAMM

From: GEORGE NEWNES, LTD.

Tower House, Southampton Street, Strand, W.C.2

# Rack or Case-mounted Instruments?

A NEAT ALTERNATIVE TYPE OF MOUNTING

By F. W. Austin

**T**HERE will always be argument where the merits of single instruments for a specific purpose, or combined instruments for multiple purposes are concerned. It is not possible to resolve this problem by a hard set of rules, nor to reach any definite conclusion acceptable to everyone.

On the one hand the single instrument such as a signal generator with self-contained power pack, will serve one purpose (receiver alignment) admirably. On the other hand, a multiple unit consisting of signal generator, signal tracer and output meter (or valve-voltmeter) will serve most amateur radio requirements. The multiple unit is often bulky and heavy to carry around. Failure in the power section of such an instrument brings all work to a stop until rectified.

The single instrument is reasonably light and can be used in conjunction with other units or independently. Here again, difficulty can be encountered in the growing number of instruments, all of which need some sort of casing to keep out dust and guard against an unfortunate shock from the power section.

Keeping an open mind on the subject, the following suggestion is put forward as a means of solving the problem of casing for those preferring single units.

Different instruments usually have a different size of front panel, one from another. In general, the larger the panel the larger will be the chassis. Therefore, if we have (or obtain) a metal case suitable for our largest instrument—by simply changing the front panels of the smaller instruments to suit the larger case, all the instruments will have uniform panel fixing and can be accommodated one above another

in a rack. The case then becomes an auxiliary to every instrument, in which the appropriate instrument can be carried around to suit the particular needs: the case, in fact, only being used for transportation.

As this article is only in the form of a suggestion, readers wishing to know further about the framework of the rack are referred to the article entitled "Experimental Chassis Construction," in the November, 1955 issue of *Practical Television*.

The drawings have been made as lucid as possible and no great difficulty should be encountered in construction. The frame consists of two side-runners made of angle section aluminium material which is cut to "V" shape at intervals along its length to form an oblong shape when bent at each "V." The cross-pieces which complete the box shape of the rack are of stair carpet-retainer aluminium material (or bar section). These should be fitted on the *inside* of runners to give flush fitting for top, back and bottom sheet.

The top, back and bottom of rack, being one single sheet bent to shape, will brace the frame and give additional strength. Two single sheets of aluminium form the sides and complete the rack.

The front "lips" of the rack frame should be drilled and tapped to conform with the fixing arrangements of the carrying case. The illustrations make the objective clear and the matter has been tackled from the transportation angle in the first instance. The method suggested will ensure that a case is always available in which to carry any instrument required and the rack provides compact housing for the instruments as a whole.

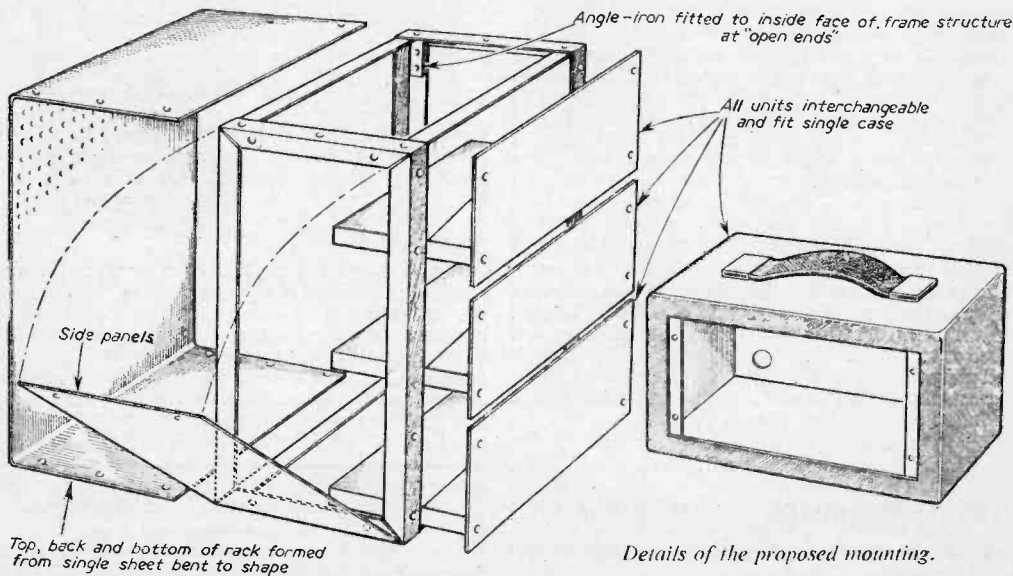

## NOW YOU CAN BUILD A £30 HI-FI AMPLIFIER FOR ONLY £18.10.0!

By really new circuitry, simplified design  
and careful selection of components

*Smith's*  
of  
**EDGWARE ROAD**

*Component Specialists for over 25 years*

have produced in kit form a 10-watt Amplifier which ranks with the highest-priced factory-made amplifiers on the market. This means that anyone who can make a good soldered joint and follow the simple instructions and diagrams provided, can now enjoy high-fidelity reproduction such as could only previously be obtained from equipment costing at least £30.

Come and hear this remarkable Amplifier in our new demonstration room at the address below. If unable to do this, send 2/6 for illustrated instruction booklet, which may be deducted from the price of the kit.

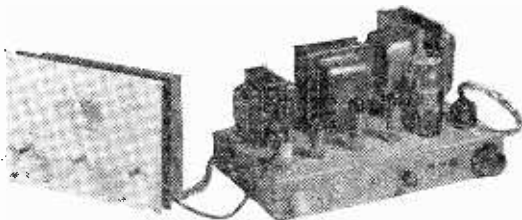

The Cooper-Smith Model BPI.  
High-Fidelity Amplifier and Control Unit. Complete Kit of Parts with Valves, £18.10.0. Carriage paid in U.K.

#### TECHNICAL DETAILS:

**Output:** 10 watts rated, 12 watts peak.  
**Harmonic distortion:** .15% at 12 watts. .1% at 10 watts.  
**Frequency response:**  $\pm 1$  db 20-25,000 cps at 8 watts.  
**Circuitry:** Push-pull throughout incorporating cross-coupled phase inverter and ultra-linear output stage.  
**Valve line-up:** 12AX7-12AU7-12AX7-2  $\times$  EL84-5Z4 Rectifier.  
**Mains input:** 200-220-240 V., 50 cps. Spare power: generous transformer rating allows up to 30 mA H.T. and 1.5 A. L.T. to be drawn for Tuning Unit, etc.  
**Hum and noise:** 80 db. below rated output.  
**Power consumption:** Approximately 60 watts.  
**Inputs:** Radio: High level pick-up; Low level pick-up; Tape replay, for play-back of tapes; Tape record.  
**Controls:** Bass lift and cut; Treble lift and cut; Volume and on-off. Selector Switch: Radio; Crystal pick-up; L.P. magnetic pick-up; Standard magnetic pick-up; Tape.

**H. L. SMITH & CO., LTD.**  
287/289, EDGWARE ROAD, LONDON, W.2. Tel.: PAD 5891

## JASON FOR F.M.

An easy-to-build Tuner using four valves Type Z77/EF91. Providing leads are kept short and soldered joints are well made, good results are guaranteed. The useful range is at least 60 miles from the station. The Book also gives details of a Fringe Area version which has an aerial sensitivity of 5 micro-volts for good limiting. Book (Data Publications), price 2/-. All components (less valves), **£5.5.0.**

For the more experienced, the Medium Wave and F.M. Tuner is available. This may be built either as a tuner or receiver. The Assembly is supplied with the centre holes blocked by easily removable plastic discs. F.M. sensitivity is 15 micro-volts. Components (less valves) to build Receiver, **£11.10.0.** Tuner, **£10.10.0.**

*Available from our usual stockists.*

S.A.E., please, for Component Price Lists.

**THE JASON MOTOR & ELECTRONIC CO.**

328, Cricklewood Lane, London, N.W.2. SPE 7050.

*Taylor*

### JUNIOR UNIVERSAL METER



#### Model 120A

A small 19-range instrument ideal for the enthusiastic amateur. Sensitivity is 1,000  $\mu$ p.v. A.C. and D.C. Accuracy: 2% D.C.; 3% A.C.

#### RANGES

**Volts D.C.:** 0-25-10-50-250-500-1,000-2,500.  
**Volts A.C.:** 0-10-50-250-500-1,000-2,500.  
**Milliamps D.C.:** 0-1-10-50-500-5,000.  
**Resistance:** 0-2,000 ohms, 0-200,000 ohms.  
Can be extended to 20 megohms. Automatic overload protection fitted to meter movement.

**PRICE £9.15.0. PROMPT DELIVERY**  
**CREDIT TERMS:** Nine monthly payments of £1.4.4.

**TAYLOR ELECTRICAL INSTRUMENTS LTD.**

Montrose Avenue, Slough, Bucks.  
Telephone: Slough 21381. Cables: Taylins, Slough

**IT'S NEW!**

**BUILD THIS  
FRYING-PAN  
RADIO FOR**

**NO RADIO KNOWLEDGE  
WHATEVER NEEDED!**

Can be built by anyone in an evening using our step-by-step, easy-to-follow plans. Total building cost including mirror finish frying-pan and everything down to the last nut and bolt only 79/6, Post Free. It is a **REAL ALL-ELECTRIC RADIO** with normal size speaker, etc. Exceptionally sensitive circuit covering all Medium and Long Wavebands. **RECEIVES "HOME," "LIGHT," "LUXEMBOURG," "A.F.N.,"** Etc., Etc., really beautiful tone due to "wall-baffle" effect. Size only 9in. Diameter, 2in. Deep, and handle 7in. Long. Hangs anywhere—**IDEAL FOR KITCHEN, BEDROOM, ETC.** (Mains lead passes unnoticed through the hollow handle). **AMPLE VOLUME. RUNNING COSTS ONLY 1d. FOR 75 HOURS!** Weight only 3½ lbs. For A.C. Mains 200 to 250 Volts. Robust design and should last a lifetime. **EACH PART TESTED BEFORE DESPATCH, AND YOU CAN'T FAIL BECAUSE OUR EASY-TO-FOLLOW PLANS TAKE YOU STEP-BY-STEP. BUILD ONE OF THESE AMAZING LOW-PRICED SETS—NOW!** Total building cost including full set of plans 79/6 Post Free. (Parts may be bought separately, Parts Lists 2/6.) **LIMITED QUANTITY. Send Cheque or Postal Order Today! Please cross Postal Orders.** (C.O.D. 2/- extra.)



**ONLY  
79/6  
POST  
FREE**

**Eastbourne Radio Co. (Dept. PW3) 30, OCKLYNGE RD., EASTBOURNE, SUSSEX**

**THE FAMOUS BENNETT COLLEGE can train your mind to SUCCESS**

- WHAT CAREER DO YOU WANT?**
- Building
  - Carpentry
  - Commercial Art
  - Diesel Engines
  - Draughtsmanship
  - Electrical Eng.
  - Fire Engineering
  - Mechanical Eng.
  - Quantity Surveying
  - Radio Eng.
  - Surveying
  - Telecommunications
  - Television
  - Accountancy Exams.
  - Auctioneer's Exams.
  - Book-keeping
  - Civil Service
  - General Education
  - Journalism
  - Languages
  - Mathematics
  - Police Subjects
  - Salesmanship
  - Secretarial Exams.
  - Shorthand
  - Short Story Writing
  - and many others
- GENERAL CERT. OF EDUCATION**

**THROUGH PERSONAL POSTAL TUITION**  
A FREE book vital to your career!

Read how the famous Bennett College can help you to success! Send now for this recently published FREE book, "Train your mind to SUCCESS", which tells you about The Bennett College proven success in postal tuition... and how it can help you to success in your career.



To The Bennett College (Dept. 1.104N), Shemeld  
Please send me, without obligation, a free copy of "Train your mind to SUCCESS" and the College Prospectus on:

SUBJECT \_\_\_\_\_  
NAME \_\_\_\_\_  
ADDRESS \_\_\_\_\_  
AGE (if under 21) \_\_\_\_\_ Please write in Block Letters

**THIS COUPON  
COULD BE YOUR  
PERSONAL POSTAL  
TO SUCCESS.  
Send it NOW!**

**ENTHUSIASTS WHO KNOW SPECIFY**

**Dulci**  
**RADIO AND  
RADIOGRAM  
CHASSIS**

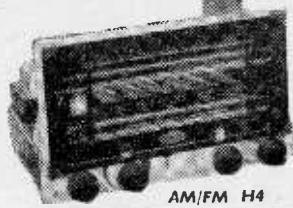

The H4 chassis offers the finest value to the customer. Designed for first rate reproduction of radio and gramophone. Wide range tone control and an output transformer of liberal capacity is fitted. High Q inductances. Ferrite aerials for medium and long waves. Oscillator compensated for zero drift and enclosed in die cast case for minimum radiation. 4 wavebands including F.M. Latest miniature tuning indicator output impedances 3 or 15 ohms. **£24.6.6 inc. tax**  
**Model F.3.** 3 Wavebands, 5 Valves, 4 watt output, wide range tone control. **£14.11.11 inc. tax**  
**Model F.3, P.P.** 3 Wavebands, 7 Valves, 6 watt push-pull output. Separate Bass and Treble controls. **£18.15. 4 inc. tax**

**CHASSIS ARE ASSEMBLED AND READY FOR USE. BUILT TO HIGHEST TECHNICAL STANDARDS. FULLY GUARANTEED.**

Also manufacturers of  
Radio Tuners  
Tape Recorders.

We have designed an approved **PRE-AMPLIFIER for the New COLLARO Tape Transcriber.** Apply for details.

**DULCI COMPANY LTD.**

97 VILLIERS ROAD, LONDON, N.W.2  
Telephone: WILlesden 6678.

**HANNEY of BATH offers:—**

**VIEWMASTER 3-STATION TV TUNER** (P. Television).—Denco coilset with screens, can and screws, 30/-; Denco switch, Fine Tuner, Coil mounting plates and tag panel, 27/-; Kit of resistors, 7/6; TCC condensers kit with 2 printed circuits, valveholders, etc., 43/-; Gain controls, 3/3 each; Co-ax P/Skit, 2/6; Valve cans, 1/3 each. Complete kit of parts for the TUNER, with the 2 Genuine MULLARD Valves, nuts, bolts, wire co-ax., etc., £8/19/6. Denco Coilset for conversion of the V-Master S/V chassis to the I.F. amplifier, 20/- OR Complete kit of S/V conversion components, 39/8. All Standard V-Master items in stock. Full list available.

**MULLARD 3-VALVE 3-WATT AMPLIFIER.**—Punched chassis, 10/6; Gilson Trans., Mains, 35/-; Output, 25/6; Elstone Trans., Mains, 35/-; Output, 21/-; Condenser kit, 20/-; Resistor kit with 3 pots., 22/3. Complete kit with Genuine Mullard VALVES 28/19/6. Full list available.

**MULLARD 510 AMPLIFIER.**—Erie Resistors, 27/-; TCC Condensers, 45/-; Elstone Mains Trans., 36/- (100 m.a.); 42/6 (120 m.a.); Output Trans., 45/- (6K. or 8K.); Gilson mains trans., 60/- (143 m.a.); Output trans., 47/6 (6K. or 8K.); Ultra linear type, 52/3; Partridge Mains trans., 65/6; Output trans., P.367, 55/6; Partridge Ultra Linear type P.4014, 98/6; Denco punched chassis, 19/6, with base plate; Printed front panel, 6/6; Type "A" and "B" Chassis (panel not printed), 8/6 and 12/6 respectively; condensers, "A", 15/6; "B", 24/6; Resistors, "A", 17/6; "B", 35/6 (with pots.). Full list available, giving details of complete kits.

**OSRAM 912 PLUS AMPLIFIER.**—Erie resistor kit, 17/4; Erie 1 meg. pots, 4/6 each; TCC condenser kit, 55/-; PART-RIDGE components with loose lead terminations (includes packing charge), Mains trans., 65/6; choke, 34/6; output trans., 85/6; W.B. components, Choke, 18/9; output trans., 32/-; Denco drilled chassis, 14/6; Denco 912 Plus printed panel, 7/6; pre-amp or passive chassis, 6/-. Full list available.

**COMPONENTS** are still available for the following F.M. TUNERS: Wireless World, Mullard, Osram 912, Denco Maxi-3. List available.

**WIRE ANGLE COMPONENTS.** ALLEN, Teleking Chassis, 50/-; Coilsets (TK and Super-Visor), 44/6; LO.308, 40/-; FO.305, 21/-; DC.300c., 39/6; FC302, 31/-; GL.16 and 18, 7/6 each; SC.312, 21/-; AT.310, 30/-; OP.117, 9/-; BT.314, 15/-; DENCO Chassis Magnaview, 37/6; Chassis, Super-Visor, 51/6; Coil sets Magnaview, 41/2; WA/DCAI, 43/-; WA/FCAL, 31/-; WALC and WCL, 7/6 each; WA/FMAL, 21/-; WA/LOT1, 42/-; WA/BT1, 16/-.

Send stamp for lists. Please add 2/- postage to all orders under £3 (excess refunded).

**L. F. HANNEY**  
**77, LOWER BRISTOL ROAD, BATH**  
Tel.: 3811

# SHORT-WAVE SECTION

PRE-WAR ALL-WAVE RECEIVERS AND THE  
NON-TECHNICAL LISTENER

By A. W. Mann

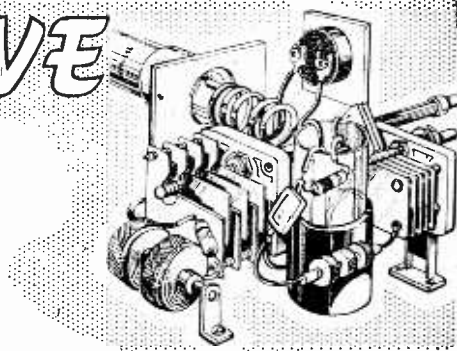

**T**HE introduction of the so-called all-wave receiver on the American market took place some time before British manufacturers turned their attention to the production of that type of receiver. Among the products of various manufacturers were on the one hand a few receivers which were in effect simply medium- and long-wave receivers with a very restricted short-wave range added, it seemed, as an afterthought. They were, as might be expected, lacking in sensitivity and of low efficiency.

On the other hand there was some very efficient ones designed and produced in this country, which on test out-performed several of the lower-priced communications types which at the time were being imported from America.

I well remember the comments of a well-known short-wave writer who had carried out a long series of tests with one of the top class low-priced all-wave types. Here we have a first-class receiver which is very much superior to the usual run and far better than certain communications types used in comparative tests. If some enterprising manufacturer would take a similar chassis, add a BFO and bandspread, many amateurs would find it to be an ideal communications receiver.

At the time there was not one communications receiver of British manufacture on the home market, and the better class American products were very expensive.

## All-wave Listeners

Now there are, no doubt, a considerable number of short-wave listeners who were first introduced to the higher frequency bands via an all-wave receiver, some of whom later built or purchased a special short-wave receiver or a bigger and better all-wave type.

Further, there are others who while prospective short-wave listeners are neither experimental or home-construction minded, nor can they afford to buy one of the latest or even a good second-hand communications receiver. What is more, a modern wide coverage all-wave receiver is equally out of the question.

## A Worth-while Proposition

The situation as outlined would appear to be hopeless but for one factor. There are undoubtedly some of the best all-wave type receivers to be found in the shops of dealers throughout the country which have been taken in part exchange for a television set or the latest F.M. type models. Likely they were

used little if at all on the short-wave bands. The valves are old and maybe need replacing. The main thing, however, is that some of their owners wish to keep up with the Joneses and must have the latest.

Under the circumstances outlined it is quite possible that some dealers and private owners would be willing to dispose of such receivers at a price that, providing they were in reasonable condition and of reputable makes, would justify the necessary expense of revamping them.

In purchasing second-hand radio apparatus one must exercise care. From the viewpoint of this article it is the short-wave performance for which the receiver is to be purchased. The first thing is to hear the receiver in operation and try the dial drive and waveband switching over the full coverage. Check the tuning dial calibration and look for mechanical faults, especially where cord drives are used.

A receiver tuning dial which produces metallic scraping noises when used on the short-wave bands cannot be tolerated. The receiver must, above all, cover a wide tuning range over the short-wave tuning section of the dial.

## Technical Data

The purpose of this article is to provide as much technical data as possible concerning some of the best all-wave type pre-war models which the author considers will meet the requirements of those who are considering the purchase of this type with short-wave listening the foremost consideration.

Contrary to what the author considers to be misguided opinion, the date of manufacture may date the cabinet work, but does not date a receiver's performance. An all-wave type receiver which will provide broadcast band reception of a high order under the present state of those bands, and in addition, highly satisfactory short-wave reception under band conditions quite different to those existing when the receiver was designed might appear unique, but there are some capable of doing so. Among them are the first two models about to be discussed.

## Marconi & H.M.V.

In 1936 Marconi introduced their Model 345 and H.M.V. Model 480 four-band receivers. Both models incorporated identical chassis. The same applies to the 365 and 485 radiogram models of the respective companies.

The table models were much favoured by short-wave enthusiasts and on test by technical publications were designated as an outstanding receiver capable

of providing superior short-wave performance. As this model was designed with a balanced performance throughout its range as the foundation its popularity is understandable.

This receiver is a six-valve superheterodyne with the following valve line-up. R.F. stage VMP4G, Signal fre. amp. Triode Hexode FC, X41 I.F. amp. VMP4G, DDT and 2nd det. MHD4, output N41 Pen. Rectifier U12.

The delayed A.V.C. system used is very effective, especially on the short waves.

A single-tuned circuit is used before the R.F. V.M. pentode, the latter being transformer coupled to the mixer. Apart from its value as an amplifier at signal frequency, this stage, together with the single stage of I.F. at 460 Kc/s, provides a high signal-to-noise ratio and the complete elimination of second channel effects throughout the full tuning range of the receiver.

The tuning dial, which is of the Airplane type, is calibrated in metres on all bands. Two-ratio tuning drive is employed which incorporates in addition to the main pointer a smaller one which traverses a 0 to 100 deg. scale. This is a very useful form of mechanical bandspread and assures accurate logging so that given transmissions may be returned to when desired.

The tuning range of this receiver is a very useful one from all points of view. 16.5 M to 2,200 M. The short waves are from 16.5 M to 140 M without a gap. Separate, switched tone and bass controls are incorporated. Mains energised 6in. loudspeaker, 3 watts output A.C. mains 220-250 v. 40-60 cycles.

### Valve Replacements

In cases where the specified valves or satisfactory replacements would be difficult to obtain, such receivers should not be considered. In the case of the above mentioned models, suitable valves are more or less generally available.

### Pilot

The first Pilot models to appear in this country were imported from the U.S.A. Later their manufacture was undertaken in this country, as in the case of current models.

These receivers were of sound design and were used by many successful DX experts. As in the case of the Marconi Model 345, the writer writes concerning them from personal experience. The first British models were produced in, I believe, 1936.

### Model 65

This was a U.S.A. product. Variations of this model were available for use aboard ship, and the author can recall one chief engineer who claimed consistent reception of the BBC Empire transmissions in any part of the world in which the ship happened to be.

The valve line up—R.F. 6D6, 1st det. osc. 6A7, I.F. 6D6, 2nd det. and A.V.C. type 75, output 42 pentode rect. 80. This model had a 5in. twin pointer compass type tuning dial, the usual variable tone and volume control, and the following tuning ratios 12.5 and 95 to 1 respectively.

The tuning ranges being as follows:  
16 M to 50 M, 48 M to 150 M, 170 M to 555 M and 700 M to 2,000 M.

The British Model U650 was similar to the Model 65. The compass type dial being somewhat larger

than in the American produced model, and include the now well-known type of tuning eye.

The valves used in this model are two 6D6, 6A7, 75, 42, 6G5 and 80. The tuning range 16 M to 52 M, 48 M to 150 M, 175 M to 550 M, 750 M to 2,100 M. Mains energised M.C. speaker 3 watts output.

### Pilot 115

This is an eleven valve receiver and, like all those previously described, A.C. mains operated.

Valve line up: R.F. 6D6, 1st det 6A7, Osc. 76, two I.F.s 6D6, diode det 85, 1st L.F. 76, P.P. output two type 42, Inter station clarifier 6C6, rect. 5Z3.

The tuning range is an extensive one and includes the 14 M, 20 M, 40 M, 80 M, 160 M, amateur bands also trawler bands, and is divided as follows: 12.7 M to 32.5 M, 38 M to 80 M, 70 M to 190 M, 190 M to 550 M, and 800 M to 2,000 M.

This receiver on test at the author's location would bring in the American, Australian and other distant short-wave broadcasting station transmissions with terrific loudspeaker volume. Those transmissions were then radiated on comparatively low power if judged by present-day standards. A ten-inch mains energised loudspeaker dealt very effectively with the rated undistorted output of twelve watts. The compass type tuning dial was of the two ratio kind common to Pilot sets but somewhat larger than that fitted to earlier models. Calibrated in wavelengths and station names.

### Points to Consider

In this article I have discussed in detail a selected number of pre-war all-wave type receivers of which I have practical knowledge and operating experience. One can learn quite a lot from a detailed specification, still more from a theoretical circuit diagram but extensive air tests are the deciding factor as to the good and not so good. There were, of course, many more of different makes and perhaps equal merit produced during pre-war years, several of which I am aware but which I had not the opportunity of trying out.

The most extensively tested of those selected and previously outlined is the Marconi 345, the particular receiver in question being located in a coastal town within 200 yards of the North Sea in an area entirely free from electrical interference at that time. Even with valves as old as the receiver, apart from the I.F., the overall performance was impressive.

Now overhauled and completely revalved with the specified types or suitable replacements, it is numbered amongst the rest of the writer's short-wave equipment.

The foregoing brings us to further points of discussion. Readers who are interested in what may aptly be termed a short cut to short-wave reception, the purchase of a second-hand all-wave receiver, should not be based on bargain price. First it is essential to find out the year of manufacture, the types of valves used, if they are readily available. If radio service data is available from advertisers in radio journals. In addition, the receiver should be heard in operation and tried out on all bands.

One should not expect the performance to equal a new receiver so far as volume is concerned, but the selectivity should be reasonably good. Other than receivers of the superhet type should not be considered as very few commercial T.R.F.s reach the standard of their home-constructed counterparts, and to attempt modifications would be a waste of time in the writer's opinion, based on past experience.



## TECHNICAL TRADING CO.

**BSS (CR100) COMMUNICATION RECEIVERS.**—10-4,000 metres, Xtal. Complete 11 valves, good condition, untested. £12.10, carr. 12/6.

**TAPE RECORDER CASES.**—Blue rexine, hinged lid, double locks, carrying handle, size 10in. w x 12in. d. x 9in. h., 25/-, carr. 3/6. Ditto, beige, de luxe, surplus famous make, 45/-, carr. 4/6.

**ORGANTONE RADIOGRAM CHASSIS.**—All wave, 5 valve, A.C. Mains, Boxed, £7.18, carr. 3/6.

**"TECHTRAD" SUPERHET COILS.**—Consisting Med. and Long (both aerial and osc). Wave Coils with full instructions, 8/-. Pair Quality Midget 128, 8/6. Or both items, 16/.

**ALUMINIUM CHASSIS.**—6in. x 4in. x 1 1/2in., 3/-; 5in. x 5in. x 1 1/2in., 3/6; 8in. x 6in. x 2 1/2in., 4/9; 8in. x 10in. x 2in., 5/8. Post 9d.

**5in. P.M. SPEAKERS.**—Top Makes, 12/6. Ditto, tested ex. expt., 8/6. 7 x 4 Elliptical, 18/-. W/Trans., 21/6. Post 1/3.

**RECORDING TAPE.**—Well known make, 1,200ft. Reels. Big Purchase enables us to sell at 18/- reel. Post 9d.

**TEST SETS, TYPE 882.**—For receiver testing, incorporating 6 valves, oscillator, noise generated, sensitivity test 500 mA. meter. 200/250 v. A.C. Power Pack in transit case unused, £3.15, carr. 7/6.

**F.M. RECEIVERS.**—Consisting 6 valve sensitive chassis, latest miniature valves, 7 x 4 Elliptical speaker, beautiful cabinet. Listed £20, our price £11 complete, carr. paid.

**RESPONDER RECEIVERS.**—Ideal T.V./F.M. use, all new. Type 7, 9 valves, VR137, VR136, 8P61, EA30, 38/-, carr. 4/-. Type P25.—10 valves, VU120, 5Z4, 82A, 8P61, EC52, EA30, 55/-, carr. 9/-. Type 5.—15 valves, Magic Fly, 5Z4, 8P61, VR136, VR137, EA30, P61, beautiful 200/250 v. A.C. Power Pack, £4.15, carr. 7/6.

**V.H.F. RECEIVERS, TYPE P40.**—Size 10in. x 4in. x 5in., 10 valves, 6V6, EF34, EP30, 6J5, EC52, Superhet, Crackle finish, 55/-, 200/250 v. A.C. Power Packs, same size, giving 170 v. 60 mA., 12 v. 2 1/2 a., 40/-, £4.18 both units.

**V.H.F. TRANSMITTERS.**—12in. x 5in. x 6in., matching above, 6 valves, 2-ECC82, 6V6, 3-RK34, beautiful finish, 55/-, 200/250 v. A.C. Power Packs to match same size, giving 300 v. 200 mA., 12 v. 3 a., 55/-, 25.5.0 both units.

**INDICATORS TYPE 95.**—VCR97, 16 valves, 49/-, carr. 7/6. **CONDENSERS.**—Latest ceramic, 10, 20, 50, 300, 1,000, 3,000 pf., 5/- doz., post pd.

**LATEST ELECTRET TUBES.**—100 mfd., 6 vr., 1/-; 8 mfd., 250 vr., 1/3; 16+10, 350 vv. 3/-.

**RESISTANCES.**—1 w. ceramic, 47Ω-1 mΩ, 2/- doz., 10/- 100. **AMPHENOL VALVEHOLDERS.**—Octal, 88A, B7G, B9A, B9C, 6/- doz. B9A w/screen, 1/3, 12/- doz. **W.W. PRESET POTS.**—500 Ω, 1K, 2.5K, 5K, 10K, 20K, 25K, 2/- ea. 12 volt 10Ω-20 Ω **AMPLIFIERS.**—Inbuilt motor gen., compact, ideal outdoor work, pushpull 4L6, and 2 double triodes, cost approx. £30, good cond., untested, £25.10, carr. 10/.

EB34, 2/-; 8P61, 8P210, 3/6; 6J5G, 4/-; 6J7G, EF92, PY31, 4/6; 6AL5, 5/-; 6AG5, EL91, 5/6; 6K7M, VR150/20, 6/-; 6AK5, 6C4, 6P6G, 6/6, 6/6; 12AX7, EOC31, E235, 8/-; 6P33, U22, 8/6; 813, 50/-.

**350/352, FRATTON ROAD, PORTSMOUTH**  
**PORTSMOUTH'S RADIO, TV AND TOOL SHOP**

## A REALLY SELECTIVE 5-VALVE SUPERHET



**139/6**  
Plus 2/8 for Postage & Packing

Our "know-how" shows you the easy way to surprise friends with this Superb Superhet. **NO RADIO KNOWLEDGE NECESSARY.** Easy to read step-by-step instructions and Diagrams. We guarantee it to work. Only tools needed are Pliers, Screwdriver and Soldering Iron.

**IDEAL FOR BEGINNERS . . . A TRF.**  
... Let us show you how simple a 3 Valve TRF Receiver can be to make our way and how amazed you will be. Easy-to-Follow instructions take the headaches out of construction. Hundreds already working all over the country. 109/6, plus 2/8 post and packing.

**A PROFESSIONAL JOB MADE SIMPLE**  
Nothing to lose—OUR MONEY-BACK guarantee covers you. Complete parts available for the above receivers in Cream or Brown cabinets. . . . Write to-day and get started on the fascinating Hobby of Electronics.

**EASY INSTRUCTIONS WITH OUR "KNOW-HOW" DIAGRAMS, 1/- POST FREE. SEND TO-DAY.**

**NORMAN H. FIELD, Electronics**  
Dept. PW, 68, HURST STREET, BIRMINGHAM, 5  
Birmingham's Largest Constructors' Store

## REPANCO HIGH-GAIN COILS

**DUAL-RANGE MINIATURE CRYSTAL SET COIL** with circuit. Type DRX1. 2/6.

**DUAL-RANGE COIL** with Reaction. With 2 mains, 2 battery and transistor circuits. Type DRR2. 4/-.

**MATCHED PAIR DUAL-RANGE T.R.F. COILS** with Reaction. With battery, mains and feeder unit circuits. Type DRM3. 8/- pair.

**PAIR DUAL-RANGE SUPERHET COILS** with mains and battery circuits. Type SH4. 8/- pair.

**FERRITE ROD AERIAL.** Long and Medium wave. Complete with fixing brackets. Type FRI. 12/6.

**MINIATURE I.F. TRANSFORMERS.** Pre-aligned 465 kc/s. 13/16in. x 13/16in. x 1 1/2in. For battery or mains receivers. Type MSE. 12/6 pair.

**"R" COILS.** Miniature Iron Dust Cored.

Range	Aerial	H.F.	Osc.	Price
800-2,000 m.	RA1	RHF1	RO1	3/3 each
190- 550 m.	RA2	RHF2	RO2	3/3 each
70- 230 m.	RA3	RHF3	RO3	3/3 each
15- 50 m.	RA4	RHF4	RO4	3/3 each

(Trade Supplied.) Post 3d. on all orders.

**RADIO EXPERIMENTAL PRODUCTS LTD.**  
33, Much Park Street, Coventry  
Telephone : 62572

## "You can rely on us"

LARGE STOCKISTS OF RADIO AND ELECTRONIC COMPONENTS

H.P. on INSTRUMENTS, "912" and MULLARD AMPLIFIER KITS, SOUND-MASTER, VIEWMASTER, Etc., Etc.

RESISTORS — STANDARD, MIDGET, HIGH STABILITY, PRECISION; TAPPED VOL. CONTROLS, Etc., Etc.

SEND FOR LIST.

Proprietary catalogues available to Manufacturers' laboratories, Education Authorities, etc.

**RADIO SERVICING CO.,**  
82, SOUTH EALING ROAD,  
LONDON, W.5.  
EAL 5737

# FIRST-CLASS RADIO COURSES . . .

## GET A CERTIFICATE!

### QUALIFY AT HOME—IN SPARE TIME

After brief, intensely interesting study undertaken at home in your spare time—**YOU** can secure your professional qualification. Prepare for **YOUR** share in the post-war boom in Radio. Let us show you how!

### FREE GUIDE

The New Free Guide contains 132 pages of information of the greatest importance to those seeking such success-compelling qualifications as **A.M.Brit.I.R.E., City and Guilds Final Radio, P.M.G. Radio Amateurs, Exams., Gen. Cert. of Educ., London B.Sc. (Eng.), A.M.I.P.E., A.M.I.Mech.E., Draughtsmanship (all branches), etc.,** together with particulars of our remarkable Guarantee of

### SUCCESS OR NO FEE

Write now for your copy of this invaluable publication. It may well prove to be the turning point in your career.

FOUNDED 1885—OVER 150,000 SUCCESSES

### NATIONAL INSTITUTE OF ENGINEERING

(Dept. 461), 148, HOLBORN, LONDON, E.C.1

## THE VALVE SPECIALISTS

# Bentley Acoustic Corp. Ltd.

38, CHALCOT ROAD N.W.1

PRImrose 9090

1st grade goods only. No reconds or rejects.

0Z4	6/-	6BK7	5/6	813	70/-	GZ52	12/6
1A3	8/-	6BL7	8/-	868A	12/6	8K9	5/-
1A5	6/-	6B7	8/-	88	10/6	8E24	12/6
1D3	8/6	6B87	7/6	868	9/-	8K90	10/-
1H5	11/-	6U4	14/6	1203	7/-	8L2	3/6
1L4	7/6	6U7	9/6	5703	12/6	8L13C	7/6
1LD5	5/-	6V6G	7/-	7193	2/6	8L23	10/6
1LH3	5/-	6V6GT	7/6	7473	7/6	8L41	7/6
1N5	11/-	6X4	7/6	8003	5/6	8L4DD	12/6
1R3	9/-	6X5	7/6	9003	4/6		
1S5	7/6	6Z4/84	12/6	9006	6/-	8V2A	7/6
1F9	7/6	6Z6	12/6	AC/HL/		KBC32	8/6
1T5	7/-	7A7	7/6	10D1	15/-	KF33	8/6
2A3	12/6	7B7	8/6	ACQPen	8/6	KL55	8/6
2C26	4/-	7C5	8/-	AC/P4	8/-	KT2	5/6
2D13C	7/6	7C6	8/-	AP4	7/6	KT36C	10/-
2X2	4/6	7H7	8/-	ATP4	3/6	KTW61	7/6
3A4	7/6	7Q7	8/-	AZ1	12/6	KTW62	7/6
3B5	8/6	7R7	8/6	B8	12/6	KTW63	7/6
3B7	8/6	7V7	8/6	BL63	7/6	KTZ65	6/6
3D6	2/6	7Y4	8/6	CK523	6/6	L63	6/6
3Q5	9/6	8A5	12/6	CK525	6/6	LN300	12/6
3R4	7/6	8B2	12/6	CV85	12/6	MH4	5/6
3K8	10/-	912	3/-	111	3/6	MH4	7/6
6U4	8/-	10C2	10/-	D63	3/6	MU14	8/6
5V4	10/-	10D1	7/6	DAF96	5/6	MU14	7/6
5X4	10/-	10F1	10/-	DDC90	8/6	OC3	9/-
5Y3	7/6	12A6	6/6	DF96	8/6	OD8	9/-
6Y4	10/-	12A8	8/6	DF92	8/6	PABC90	
6Z4	8/6	12A17	12/6	DF96	8/6		
6A8	10/-	12A18	12/6	DI2	15/-	PC84	15/-
6A8	10/-	12A17	8/6	DI33	11/-	PC85	12/6
6AB7	8/-	12A17	8/6	DI96	9/6	PCF90	8/6
6AB3	11/-	12AX7	10/6	DI910	10/6	PCF92	11/6
6AC5	8/6	12B46	9/6	EA50	2/6	PCF92	12/6
6AC5	6/6	12B10	10/-	EA50	2/6	PCN5	6/6
6AG7	12/6	12E1	30/-	EABC80	8/6	Pen40	6/6
6AJ8	10/-	12H6	3/-	EAF42	12/6	PL81	11/-
6AK5	5/-	12J80T	6/-	EB31	2/6	PL82	12/6
6AK8	10/-	12J7	9/6	EB41	5/6	PL83	9/6
6AL5	6/6	12K5	7/6	EB91	6/6	PM12	4/6
6AM3	5/-	12Q7	9/6	EBG3	12/6	PM12M	6/6
6AQ7	7/6	12S47	8/6	EBC33	7/6	PM2B	12/6
6AQ8	12/6	12S67	7/6	EBC41	10/-	PV80	10/-
6AT6	8/6	12S67	7/6	EBP80	10/-	PV81	10/-
6B4	3/-	12SH7	5/6	EB52	5/6	PV82	9/6
6B7	10/6	12SJ7	5/-	EB51	6/-	PV83	10/-
6BA6	7/6	12SK7	6/6	ECC32	10/6	QP21	7/-
6BQ4	2/-	12S47	8/6	ECC33	8/6	QP22B	12/6
6BRM	4/6	12S47	7/6	ECC35	11/6	15	12/-
6BE6	7/6	12T30	7/6	ECC40	13/6	QP23	5/6
6BG6	12/6	12Y4	10/6	ECC81	9/6	Q813015	
6BJ6	8/-	13SP4	10/6	ECC82	10/6	8D6	7/6
6BV6	7/6	13VPA	10/6	ECC83	10/6	8P27	8/6
6BV7	10/-	14R7	10/6	ECC84	12/6	8P47	12/6
6B3	10/-	16A5	10/6	ECC85	10/-	8P81	3/6
6B7	10/-	19H1	10/6	ECC91	6/-	TD2A	2/6
6C4	7/-	26L1	10/6	ECP80	12/6	TH23	12/6
6C8	6/6	20P3	12/6	ECP82	15/-	TP22	10/6
6C9	8/-	25Z4	9/6	ECH35	11/6	15	12/-
6C16	9/-	27Z5	9/6	ECH42	10/6	UL7	12/6
6D1	6/6	27	7/6	ECH81	9/-	U22	7/6
6D6	12/6	28D2	7/6	ECL80	10/-	U23	15/-
6F6G	7/6	30	7/6	EP6	10/6	U30	7/6
6F7	10/6	30C1	12/6	EP9	12/6	U229	12/6
6F9	10/6	30L1	12/6	EP26	4/6	UAP42	11/-
6F13	12/6	31	7/6	EP27A	9/-	UB41	9/-
6F15	12/6	35L	9/-	EP28	6/-	UCH49	10/6
6F17	12/6	35Z1	8/6	EP40	11/-	UF41	9/6
6F32	10/6	35Z5	8/6	EP41	9/6	UF42	13/-
6F33	12/6	35L1	12/6	EP42	12/6	UL1	10/6
6G6	6/6	41MP	12/6	EP36A	7/-	UL43	10/6
6H6G	2/6	41MTL	7/6	EP36C	5/-	UY4	10/6
6H0M	3/6	45Z5	12/6	EP51	5/-	V1507	5/-
6J50	5/-	50C5	10/-	EP53	10/-	V18492A	
6J5GT	8/6	50L6	8/6	EP85	9/6		
6K7	5/-	57	8/6	EP86	12/6	VMS15	15/-
6J7C	6/-	58	8/6	EP89	10/-	VP27	8/3
6K6	7/6	61BT	12/6	EP91	9/-	VP47	12/6
6K7D	6/-	61MP	10/6	EP92	6/6	VP25	6/6
6K8G	8/-	61RPT	15/-	EL22	6/6	VP4	7/6
6L1	7/6	61RPT	15/-	EL41	10/6	VP13	10/6
6L6Q	9/-	76	7/6	EL42	13/-	VT501	6/6
0L7	7/6	77	3/-	EL91	15/-	X66	10/6
6N7	7/-	78	3/6	EL94	11/-	XRV10	6/6
6Q7	8/6	80	8/6	ELM31	10/-	XP42	6/6
6RGT	8/6	83	2/6	EL51	11/-	XH1.5	4/-
6R7	8/6	150R2	12/6	EL86	12/-	XG1.5	4/-
6S47	8/-	210L1	8/-	EZ40	8/-	Y63	7/6
6S67	6/6	240Q1	10/6	EZ41	11/-	Y65	10/6
6S7	8/-	807	8/6	EZ80	8/6	Z77	9/-
6S77	5/-	808	25/-	VC13	12/6	Z719	10/6

Crystal Diodes. OA71, GEN31, CG6E, M1, CG10E, all 7/- each.  
All boxed. Full maker's guarantee. Post 6d. each. Despatch (optional) 6d. per 50. Orders before 1.30 p.m. Why not phone or wire that urgent order for immediate despatch C.O.D.? FREE list and conditions of sale S.A.E.

# The "TYANA" Standard Soldering Iron

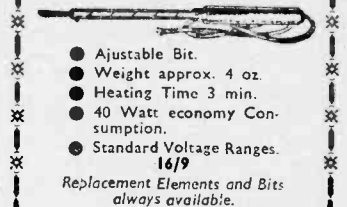

- Adjustable Bit.
- Weight approx. 4 oz.
- Heating Time 3 min.
- 40 Watt economy Consumption.
- Standard Voltage Ranges.

16/9  
Replacement Elements and Bits always available.

## "DIPLOMA" HEADPHONES

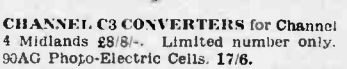

Lightweight High Resistance (4,000 ohms). Complete with cord. 17/6  
Ideal for CRYSTAL SETS

## KENROY LIMITED

152/297 UPPER ST., ISLINGTON, LONDON, N.1.  
Telephone: Canonbury 4905-4663

# SPECIAL OFFER

CHANNEL C3 CONVERTERS for Channel 4 Midlands 28/8/- Limited number only. 90AG Photo-Electric Cells. 17/6.  
TOOLS for the HOME ENGINEER. Combination 4 Screwdrivers 7/6 the set. Pocket Neon Screwdriver/Mains Tester. 5/6. Combination Pliers, insulated handles, 10/6. Hi-Stab Resistors 2/- Vitreous Wire Wound Resistors. 2/3. Most Values. Mains Droppers .2 amp. 1,000 ohms, 6/- .3 amp. 800 ohms, 7/3.

CARBON PRE-SETS. Linear, moulded knob. 2K, 5K, 20K, 150K, 250K, 500K. 1 meg. 3/-.

RADIO AMATEURS AND ENGINEERS Send 6/- for a copy of our list of components, etc. Includes Ban III Aerials & Converters, Taylor Meters, Valves, all types of Capacitors, Bernards & Norman Price Books, T.S.L. Speakers & F.M. Tuner Components, etc., etc.

# RADIO HAM SHACK LTD.

155, SWAN ARCADE, BRADFORD 1. YORKS.

## TELETRON FERRITE ROD AERIALS

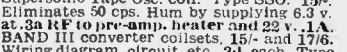

Wound on high permeability Ferroxcube rod. MW.8.9. Dual wave, 12.9.  
Supersonic Tape Osc. coil. Type SSO. 15/- Eliminates 50 cps. Hum by supplying 6.3 v. at 3a rF to pre-amp. heater and 22 v. 1.A. BAND III converter coils, 15/- and 17/6. Wiring diagram, circuit, etc., 3d. each. Type HAX selective crystal diode coil for MW, 3/- HAX.L.3/6. Dual TRF coils, matched pairs 7/- Transistor coils, I.F.T.s, etc. Available from leading stockists. Stamp for complete list and circuits.

THE TELETRON CO. LTD., 266, Nightingale Rd., London, N.9 HOW 2527

# WIRELESS SERVICING MANUAL

by W. T. COCKING  
NEW 9th EDITION 17/6  
Postage 1/-

THE 3RD AUDIO ANTHOLOGY. Published by Radio Magazines, Inc. 20s. 0d. Postage Is.

ELECTRONIC MUSICAL INSTRUMENTS. By R. H. Dorf. 55s. 0d. Postage Is.

MAINTENANCE MANUAL. By Mullard. 10s. 6d. Postage 9d.

THE RADIO AMATEUR'S HANDBOOK. By A. R. R. L. 30s. 0d. Postage Is. 3d.

THE V.T.V.M. By R. Samuel. 20s. 0d. Postage Is.

TELEVISION ENGINEERING PRINCIPLES & PRACTICE, Vol. 2. VIDEO-FREQUENCY AMPLIFICATION. 35s. 0d. Postage Is.

# The MODERN BOOK CO.

BRITAIN'S LARGEST STOCKISTS of British and American Technical Books  
Write or call for our 1956 catalogue.  
19-23, PRAED ST., LONDON W.2  
Home: PADDINGTON 4185  
Open 6 days 9-6 p.m.

# Open to Discussion



The Editor does not necessarily agree with opinions expressed by his correspondents

## Reports Wanted

**SIR**,—No. 114 Squadron Air Training Corps have formed an Amateur Radio Club and will be on the air on Sunday mornings between 10.30 and 12.30 hours, and Tuesday and Thursday evenings between 19.30 and 21.30 hours in the 40- and 80-metre bands in 'phone and C.W., using the call-sign G3LAF and G4GB/A.

Reports on transmission will be welcomed by the signals section at the following address: No. 114 Squadron A.T.C. Amateur Radio Club, No. 4 Maintenance Unit, R.A.F., West Ruislip, Middx.—A. MORRIS. (Ruislip).

## A Transistor Diode Portable

**SIR**,—A slip has occurred in Fig. 3 of the article in the August issue. The 25  $\mu$ F condenser and connection to earth should be omitted, and the polarity of the coupling condenser (2  $\mu$ F) should be reversed.—R. V. MOORE (Sheffield).

## R1124 for F.M.

**SIR**,—In your companion paper, *Practical Television*, you recently dealt with the conversion of the ex-Service receiver R1124 for TV sound.

Could not this receiver be converted for use on the V.H.F. bands 81.1 to 93.5 Mc/s? Perhaps a reader has carried out such a modification successfully and could supply some details.—V. DOWNS (Harrow).

## Recording Contact Wanted

**SIR**,—I am interested in tape-recording, and as only a novice in this particular line of radio would be pleased to correspond with others who have taken up this fascinating subject.—A. F. WALTON (396, Moorside Road, Tagley, Bradford, 2, Yorks).

## A 3½ in. Oscilloscope

**SIR**,—With reference to the push-pull amplifiers of Mr. Courela's oscilloscope, Mr. Kendall in his letter states that this is a very good circuit, but I disagree, for the following reason. The first half of the 12AT7 may be regarded as a cathode-follower with an anode load, but it is a well-known property of cathode-followers that only a small proportion of the applied voltage appears between cathode and grid. On the other hand, the grid of the second portion of the 12AT7 is held at earth potential by C2 and, as almost all of the applied voltage appears between cathode and ground, this second portion receives far more signal than the other. Thus, the output is seriously unbalanced. The remedy for this is to disconnect R2

and R5 from R3, R4 and apply a suitable positive potential to them via a potential divider from the H.T. line.—R. TRING (London, N.4).

## Evening Courses

**SIR**,—Readers may be interested to learn of the courses listed below which are to be held at Brentford Evening Institute during the session 1956-57.

(1) Radio Amateur's class preparing students for the C. & G. examination for Radio Amateurs held in May next. This is held on Wednesday evenings.

(2) Radio Servicing class (first year). This is held on Mondays.

(3) Radio Servicing class (second year). This is held on Tuesday evenings. Television is included in this course.

(4) Morse Transmission class for beginners—held on Thursdays.

(5) Morse Transmission class for advanced students—held on Tuesdays.

(6) Mathematics for students of the radio courses—held on Thursdays.

All classes are held between 7 and 9 p.m.

Classes 1 and 2 are suitable for students with no previous knowledge of the subjects.

Fees range from 10s. to 15s. per session of 37 weeks. Enrolment is at Brentford Evening Institute, Clifden Road, Brentford, from 7 to 9 p.m. on September 10th-14th inclusive. Classes commence in the following week.—J. R. HAMILTON (Hayes).

## Three-valve A.C./D.C. Receiver

**SIR**,—With reference to the letter from Mr. R. W. Sheppard published in the July issue of *PRACTICAL WIRELESS* in the "Open to Discussion" column, we note that this correspondent recommends the use of our "H" type coils in the three-valve A.C./D.C. receiver recently described in your journal. Unfortunately, an error has crept into the letter which we should like to correct, as it may save your readers some difficulty. Our "H" type coils are quite suitable for use in the circuit, but it should be borne in mind that the long-wave coils are the HA1 and HO1, whilst the medium-wave coils are the HA3 and HO3.

As your correspondent points out, the coupling winding on each of the coils is not used in this particular circuit, so that no connections need be made to the green and blue tags.

A minor error has occurred on the circuit diagram which shows the medium- and long-wave coils as being primary and secondaries of the same transformer. This is, of course, not the case, as both windings are on separate formers.

We hope that this information will assist any of

Whilst we are always pleased to assist readers with their technical difficulties, we regret that we are unable to supply diagrams or provide instructions for modifying commercial or surplus equipment. We cannot supply alternative details for receivers described in these pages. WE CANNOT UNDERTAKE TO ANSWER QUERIES OVER THE TELEPHONE. If a postal reply is required a stamped and addressed envelope must be enclosed with the coupon from page iii of cover.

your readers who may be constructing this receiver with our coils. In this connection we would also like to point out that our standard type P5 I.F. transformers are also readily available and should provide very good results in this circuit.—W. BUDD (Weymouth Radio Mfg. Co., Ltd., Weymouth).

#### International Sound Recording Contest

**SIR**,—Readers will no doubt be interested in the 5th International Amateur Sound Recording Contest.

The snag is that entries must be submitted to Paris by September 15th, and we have only just received copies of the forms (in French) which we have translated and had printed in English for enthusiasts over here anxious to participate. We learn that in previous contests not one British entry has been received, which reflects on our amateur enthusiasts. Admittedly, publicity has been very poor on this competition but one would think a few tapes or discs would have been submitted.

Copies of the form and regulations can be obtained, on receipt of a stamped addressed envelope, to Mr. H. J. Houlgate, 12, Strongbow Road, Eltham, London, S.E.9. We are told that, if the British entries are good enough, and available in some form (copies or originals) for consideration by a committee of the B.S.R.A., the material could be sent to the BBC, who have expressed interest in the contest for a possible programme.—D. W. ALDOUS (British Sound Recording Association).

#### Frame Aerial Satisfaction

**SIR**,—Of late our local station North Home has become impossible to listen to after dark owing to cross modulation with a foreign station. The other services which can be received here hardly fare any better and favourite foreign stations sometimes become just a hideous noise.

On listening to a portable radio I was struck by the interference-free reception which was obviously not entirely due to small output, and the only technical difference being the use of a frame aerial.

Experimentally, I nailed a crosspiece 2ft. long with peg each end and two more pegs to a broom handle to form a diamond and mounted this in a block of wood. Around the pegs I wound twelve turns of 28 s.w.g. enamelled wire lying handy, the ends going to a short length of tightly twisted flex. Next I removed the aerial and earth and plugged in the two ends of the flex, and orientating the aerial on North Home, switched on.

In the words of a radio comedian, I was amazed! The cross chatter and ripple were completely eliminated, and with no diminution of strength the station was crystal clear. On tuning over the dial I found my old T.R.F. with two stages of H.F. had the sharpness of tuning of a superhet, and the orientation of the aerial just right for most of the stations to which I normally listen, including Radio Luxembourg, and the Long Wave Light programme was if anything stronger than before. I gave the aerial a real test

by tuning to Welsh Home Service. Here this is not only badly cross modulated by what seems to be two other stations but has a terrific swing up and down in signal strength. The difference was here even more remarkable. As before the interference was gone and, strangely, so also had the wobble. The station was as clear and steady as the North Home. I am now devising means of incorporating the frame aerial into a piece of furniture and my ugly outside aerial comes down.—A. POULSON (Wirral).

#### F.M. Results

**SIR**,—I should like to hear what other readers have experienced on the much boosted F.M. transmissions. I went to a lot of trouble to try out the idea on my location but the results have not proved very satisfactory. I cannot see the great improvement in quality which it is supposed to give, neither can I notice the freedom from interference. The cars passing sound just as bad and in fact I think the fading is worse. Can it be that the circuit I am using is bad, or the aerial is poor (I bought it, by the way, and it was not cheap), or that my location is not good enough. I actually fitted a switch so that I could rapidly change from BBC Home to the F.M. whilst an item was on, and if anything I prefer the medium waves. I wonder if we could hear what other readers have found?—G. PRENTIS (Elstree).

#### Radio Show Surprises

**SIR**,—Now that the Radio Show is here again I suppose we shall be regaled in the popular press with accounts of revolutionary developments in the industry—only to find out on our visits that "there is nothing new under the sun." Why do manufacturers try to outdo one another in producing something different, instead of trying to improve the servicing position. Surely new sets mean in many cases new components and the serviceman cannot hope to stock up with these, or alternatively fails to keep adequate replacements for older sets in case they become out of date. Still, perhaps without these new lines development would stagnate and we would not have a change to reap the advantage of new circuitry, etc. Let us hope that one year there will be something really "new" at Earls Court.—G. R. TRENTHAM (Middlesbrough).

#### Radio Amateurs' Examination Classes

**SIR**,—As last year we will again be holding classes at Wembley Evening Institute, Copland School, High Road, Wembley, Middlesex, to prepare candidates for the City and Guilds Radio Amateurs' Examination. There will also be Morse practice classes.

The classes will be held on Mondays and Thursdays, Morse 7.0 to 8.0 p.m., Radio Theory 8.0 to 10.0 p.m. Enrolment is at the school on Monday, September 10th, to Thursday, September 13th, between 7.0 and 9.0 p.m. and the classes start during the week beginning September 17th.—A. J. BAYLISS (Wembley Evening Institute).

The Editor will be pleased to consider articles of a practical nature suitable for publication in "Practical Wireless." Such articles should be written on one side of the paper only, and should contain the name and address of the sender. Whilst the Editor does not hold himself responsible for manuscripts, every effort will be made to return them if a stamped and addressed envelope is enclosed. All correspondence intended for the Editor should be addressed: The Editor, "Practical Wireless," George Newman, Ltd., Tower House, Southampton Street, Strand, W.C.2. Owing to the rapid progress in the design of wireless apparatus and to our efforts to keep our readers in touch with the latest developments, we give no warranty that apparatus described in our columns is not the subject of letters patent. Copyright in all drawings, photographs and articles published in "Practical Wireless" is specifically reserved throughout the countries signatory to the Berne Convention and the U.S.A. Reproductions or imitations of any of these are therefore expressly forbidden. "Practical Wireless" incorporates "Amateur Wireless."

**COPPER WIRE**

ENAMELLED, TINNED, LITZ,  
COTTON AND SILK COVERED.  
RESISTANCE WIRES,  
1oz., 2 oz. & 4 oz. REELS.  
All gauges available.

B.A. SCREWS, NUTS, WASHERS,  
soldering tags, eyelets and rivets.  
EBONITE AND BAKELITE PANELS,  
TUFNOL ROD, PAXOLIN TYPE COIL  
FORMERS AND TUBES.

ALL DIAMETERS.  
Latest Radio Publications.  
SEND STAMP FOR LISTS

**SPECIAL OFFER**

**G.E.C. & B.T.H.  
GERMANIUM  
CRYSTAL DIODES**

1/- each. Postage 2½d.

Diagrams and three Crystal Set Circuits  
Free with each diode.

A large purchase of these fully  
**GUARANTEED** diodes from the  
manufacturers enables us to make this  
attractive offer.

**CRYSTAL SET**

INCORPORATING THE SILICON  
CRYSTAL VALVE

Adjustable Iron Cored Coil.

**RECEPTION GUARANTEED**

Polished wood cabinet, 15/-, post 1/3

A REAL CRYSTAL SET, NOT A TOY

**POST RADIO SUPPLIES**

33 Bourne Gardens, London, E.4.

**TO BE SURE**

**GET  
THE  
RODING  
HOME**



"If you  
want  
to  
save  
time and  
money!"

**CONSTRUCTOR'S HANDBOOK**

Our latest issue is beautifully printed on glossy art paper with a full colour cover! Packed with technical data, set building and servicing hints, facts and formulae, resistance colour code, soldering hints, etc., together with descriptions, full parts lists and circuits of 22 famous outfits as listed below. Send 2/6 (plus 4d. post).

- \*3-valve superhet Feeder Unit.
- \*4-valve superhet Feeder Unit (R.F. stage), with hi-fi and gram, switching.
- \*Amplifier/Power pack for both above.
- \*5-valve Superhet A.C. with gram.
- \*5-valve Superhet A.C./D.C.
- \*6-valve Superhet A.C. (R.F. stage).
- \*6-valve Superhet A.C./D.C. (R.F. stage).
- \*Simple Continuity Tester.
- \*Magic Eye unit.
- \*Modified 40 Feeder Unit Circuit.
- \*"P.W." Coronet AC4 Superhet.
- \*"P.W." Coronet A.C. D.C. 4 Superhet.
- \*"P.W." Coronet Battery 4 Superhet.
- \*Tape Recorder.
- \*3in. Oscilloscope.
- \*8-valve Communications Receiver.
- \*Signal Tracer.
- \*5-watt quality Amplifier.
- \*10-watt high-fidelity push-pull Amplifier.
- \*Signal Generator.
- \*Crystal Set.
- \*Local station high-fidelity T.R.F. Feeder unit.

Our renowned "Easy-as-A.B.C." FULL SIZE Construction Sheets are available FREE with orders enabling even the beginner to get professional results first time!

Coil packs and I.F.T.s pre-aligned. We supply ALL parts for ALL circuits.  
**NEVER BEFORE HAS THERE BEEN A BOOK SO VALUABLE TO NOVICE AND EXPERT ALIKE!**

**RODING LABORATORIES**

(Dept. TC7) Bournemouth Airport, Christchurch, Hants.

**SOUTHERN RADIO'S WIRELESS BARGAINS**

**TRANSRECEIVERS.** Type "38" (Walkie-Talkie). Complete with 5 Valves. In Metal Carrying Case. Ready for use. Less external attachments, 30/- per set. ATTACHMENTS for use with "38" TRANSRECEIVER: HEADPHONES, 15/6; THROAT MICROPHONE with Lead & Plug, 4/6; JUNCTION BOX, 2/6; AERIAL, 2/6.

**TRANSRECEIVERS.** Type "18" Mark III. TWO UNITS (Receiver & Sender) contained in Metal Case. Complete with Six Valves, Microammeter, etc. LESS EXTERNAL ATTACHMENTS, £4/10/-.

**TRANSMITTERS.**—T.1154—Complete all valves, etc., etc. Perfect order. 3 frequencies. £2/7/6 in transit case. Delivered U.K.

**RECEIVERS.** Type "109." 8-Valve S.W. Receiver with VIBRATOR PACK for 6 Volts. Built-in Speaker. METAL CASE. £5.

**BOMBIGHT COMPUTERS.** Ex-R.A.F. BRAND NEW. A Wealth of Components. GYRO MOTORS, REV. COUNTERS, GEAR WHEELS, etc., etc. Ideal for Model Makers, Experimenters, etc., £3.

**LUFBRA HOLE CUTTERS.** Adjustable ½ in. to 3½ in. For Metal, Wood, Plastic, etc., 7/-.

**RESISTANCES.** 100 ASSORTED USEFUL VALUES. Wire Ended, 12/6 per 100.

**CONDENSERS.** 100 ASSORTED. Mica, Metal Tubular, etc., 15/- per 100.

**PLASTIC CASES.** 14in. x 10½in. Transparent. Ideal for Maps, Display, etc., 5/6.

**STAR IDENTIFIERS.** Type I A-N. Covers both Hemispheres, in Case, 5/6.

**CONTACTOR TIME SWITCHES.** In Sound-proof Case, Clockwork Movement. 2 Impulses per sec. Thermostatic Control, 11/6.

**REMOTE CONTACTORS** for use with above, 7/6.  
**MORSE PRACTICE SET** with Buzzer on Base, 6/9. Complete with Battery, 9/6. **MORSE TAPPERS**, Std. 3/6; Midget, 2/9.

**METERS & AIRCRAFT INSTRUMENTS.** Only need Adjustment or with broken Cases. **TWELVE INSTRUMENTS**, including 3 brand new Aircraft Instruments. 35/- for 12.

**CRYSTAL MONITORS.** Type 2. New in Transit Case. Less Valves, 8/-.

Postage or Carriage extra. Full List of RADIO BOOKS, 2½d.

**SOUTHERN RADIO SUPPLY LTD.,**

11, LITTLE NEWPORT ST., LONDON, W.C.2. GERrard 6653

**A Selection of fine Bargains at  
The Walk-around Shop**

**AN/APNI TRANSDUCER.** This unit consists of Magnet and Coil which is attached to an aluminium diaphragm suspended freely and air perforated to prevent air damping. Mounted on a ceramic cover which sits over the diaphragm is a form of 2-gang capacitor which has a swing from 10-50 pf. The above unit is used as part of Wobblulator described on page 252 of the June Wireless World. Price 7/6, post paid.

**I.F. Amplifier Unit.** 460 Kc/s. with IT4 Brand New and Boxed. Fully screened in plug in Box. Size 2½" x 1" x 4½" Price 10/- ea. with circuit. Plus 1/- p.p.

**R.F. Units.** R.F.25 40-50 Mc/s, switched tuning, valved, 9/6 ea.; R.F.26 50-65 Mc/s, variable tuning, valved (New), 25/- ea. Packing and postage 2/- ea.

**Vibrator Packs (Mallory).** 12V input 150V 40 mA, size 5½" x 5½" x 3", 17/6 each; 12V input 275V 80 mA, size 5½" x 5½" x 3", 25/- each; 6V input 275V 80mA, size 4½" x 6" x 4½" with harness, 35/- each. All plus 2/6 p.p.

**Miniature I.F. Strips.** Size 10½" x 10½" x 3". Frequency 9.72 Mc/s. Line-up: 2 EF.92's and 1 EF.91 I.F., Amps. EB.91 DET/AGC., EF.91 AGC Amp. and EF.91 limiter. Circuit supplied. Price, less valves, 8/- each, post paid.

**Bendix I.F. Transformers.** 1.63 Megs. Complete in cans set of 2 New and Boxed. Size 2" x 1½" x 3½" Price 5/- each, post & pkg. 1/6.

**Bendix Potted Audio Output Transformers.** Complete with Integral Smoothing Choke Rating 4½ watt. 9,000 ohms Primary. 600 and 4,000 ohms Secondary. Size: 4" x 1½" x 2" New and Boxed. Price 4/6 each, post & pkg. 1/6.

**Make a Miniature Pocket Radio.** Incorporating high "Q" technique using the new Ferrite rod. Made possible by simple conversion of an ex-Govt. hearing aid, £2.6.0, post paid, with circuit diagram, kit of components and full instructions. Batteries extra: 1.5V l.t. (type D18), 8d.; 30V h.t. (type B119), 4/3.

**NOTE: ORDERS AND ENQUIRIES TO DEPT. 'P'**

**PROOPS BROS. LTD.** Telephone LANgham 0141  
52 Tottenham Court Road, London, W.1.

Shop Hours: 9-6 p.m. Thursday; 9-1 p.m. Open all day Saturdays

**RECEIVERS & COMPONENTS**

**MAKING YOUR OWN?** Telescopes, Enlargers, Projectors, or, in fact, anything using lenses. Then get our booklets "How to use Ex-Gov. Lenses & Prisms," price 2/6 ea. Comprehensive lists of optical, radio and scientific equipment free for s.a.e. H. W. ENGLISH, Rayleigh Rd., Hutton, Brentwood, Essex.

**AMERICAN RADIO** Plans and Devices. Now available. Hundreds of new and startling devices you can make. Only designs of this type available in UK. Receivers, walkie-talkies, amplifiers, recorders, magic eye alarms, etc., etc. Full lists, data, illustrations. Free for stamp. Send to-day—A.P.S. (PW), Sedgford, King's Lynn.

**MIDDLESBROUGH.** Largest stocks on N-East coast. Radio, TV components. FM Kits, Gram Cabinets, Tape Decks, Leak Amplifiers, Valves, etc. Callers only. PALMERS, 106, Newport Road. (Phone: 3096.)

**OSMOR** would like you to have Free Practical Wiring Diagrams of the latest published circuits with full lists of components required. Send 7d. (stamps) to OSMOR RADIO PRODUCTS LTD., 418, Brighton Rd., Sth. Croydon. (Croydon 5148.) (See advert., page 464.)

**THE HIWAYMAN.** A new super Portable Radio for the home constructor; all-dry 4-valve superhet with Ferrite rod aerial; easy wiring diagrams and instructions, 1/6 (post 3d.). RADIO EXPERIMENTAL PRODUCTS LTD., 33, Much Park St., Coventry.

**GUARANTEED TELEVISION,** 12in. models, first-class picture, 5-channel, £30 each; carriage paid. THE GRAMOPHONE SHOP, 19-21, Brockley Rise, Forest Hill, S.E.23.

**SUPER-TONIC SUN-RAY LAMPS.** Ultra-Violet Infra-Red combined. Superb therapeutic quality, controlled output, automatic exposure. All mains. Listed £7/10/-; our price 80/- S.A.E. Illustrated brochure, Dept. 14. SCIENTIFIC PRODUCTS, Cleveleys, Lancs.

**ENGRAVING.**—Amateurs and trade surplus can be undertaken by getting in touch with A. G. ENGRAVING, now at 292, Earsfield Rd., London, S.W.18. (BAT 9897.) (Engravers to well-known makers of Electronic Equipment used by the Aircraft Industry. A.W.R.E., etc.)

**LOUDSPEAKERS** repaired promptly. MODEL LOUDSPEAKER SERVICE, Bullington Rd., Oxford.

**"THE TALK OF THE TOWN,"** Audio Amplifier, AC mains, 3 stage, ideal for mic, gram, F.M. tuner, etc., fully wired and tested, complete with all valves, 59/6, post free; Push-pull 5-valve AC Amplifier, high-grade components throughout, limited supplies at £5/15/6; Diode Crystal Receiver, 90/-; 3-speed Gram. Unit and P/up, 90/-; 3-speed Auto-change Unit, £7/10/-; 4-speed Auto-change Unit, £8/12/6; Speakers, 6in. 15/-, 8in. 15/-, 12in. 27/6; T.S.L. E/static Spkrs, LSH75 9/-; LSH518 13/-, LSH100 15/-; Diode 1/6, Diode Coil 1/6, 0005 S/di/c. 3/-; Valves, 12K7, 12Q7, 3524, all at 6/9. 15,000 Valves in stock. New lists, stamp please. RADIO UNLIMITED, Elm Road, London, E.17. Mail order Dept. 50, Hoe Street, London, E.17. (Telephone: LAR 6377.)

**EX. A.M.** High tension Batteries, all perfect and guaranteed. 120v. small, 4/9; 90 x 1 1/2, 5/9; 67iv. 4/9; 60 x 1 1/2, 22iv. 7/3; 30v. 2/-; s.a.e. for list. All inc. p. and p. DIGGINS, 129, Radnor St., M/c. 15.

**RATES:** 5/6 per line or part thereof, average five words to line, minimum 2 lines. Box No. 1/- extra. Advertisements must be prepaid and addressed to Advertisement Manager, "Practical Wireless" Tower House, Southampton St., Strand, London, W.C.2.

**EX. AIR MINISTRY** Identification Units, type RDF No. 1, ZC.13312, all as new. 32/6 each unit; carr. fwd. All steel chassis in steel case, with controls on front panel only. measurements, 11in. x 7in. x 12in., weight 25lbs. Each unit contains many useful components and the following valves: 1 5Z4G, 1 VR54, 5 VR65, 2 VR66, 3 VR92, 1 CV63, and 1 VR137. From: J. A. B. JACOBSEN LIMITED, 23, Ritherdon Rd., Balham, London, S.W.17.

**HAM SELLING UP—931A'S.** 25/-; 832, 25/-; 813, 45/-; PW'S, PT'S, etc. S.A.E. details, 22, Muchelney Rd., Morden, Surrey.

**B.S.R. Monarch** 3-speed Autochange Units, new, in maker's sealed carton, guarantee, complete with instructions, template, suspension springs, £9/15/-; carriage paid; immediate delivery. TOMLINS, 127, Brockley Rise, Forest Hill, S.E.23.

**RADAR TRANSMITTER.** Any surplus 10 c.m. Army types, 3Mk2, 4Mk6, 3Mk7, or similar. Complete with magnetron, magnet pulsing arrangements, associated transformers and alternator; in working order. Box No. 275, c/o PRACTICAL WIRELESS.

**METAL RECTIFIERS,** 3/9, 250v. 10ma. tested, guaranteed, post 1/3; 8in. P.M. Speakers, 8/9, std., 3-5 ohms, guaranteed, post 1/9; O.F. Transformers, 1/3, std., 2-5 ohms, guaranteed, post 9d.; Receiver, No. 71, 6/9, X.W.D., works V.H.F., free drawings, less valves, post 1/9; Transmitter, No. 50, 6/9, V.H.F. coils, tuning conds., resist., etc., free drawing, less valves, post 1/9; Amplifier, 165, 5/9, trans., resist., free drawing, post 1/9. DUKE & CO., 62, Romford Road, London, E.2. (GRA 6677.)

**TELEVISION,** 9in. Models, £6/10/-; 12in. Models, £15; all makes working; carriage paid. TOMLINS, 127, Brockley Rise, Forest Hill, S.E.23

**I.F. TRANSFORMERS,** 465 Kc/s, Litz Wind, 2 1/2in. x 4in. x 4in., 5/6 per pair; Collaro RC 54 3-speed Record Changers, £9/7/6, p. and p. 3/6; Output Transformers, 6,000/3 ohms, 4/-; 5in. PM Speakers, 14/6; post/packing and c.o.d. extra. All goods advertised August still available. OLIVERS, 55, Havlock Road, Torquay.

**ALL TYPES** of Valves required for cash. State quantity and condition. RADIO FACILITIES LTD., 38, Chalcot Road, N.W.1. (PRImrose 9090.)

**SEND TO-DAY** for our stock list of T.V. and Radio Bargains, C.R.T.S. Valves, Speakers and all Components. We are the cheapest people in the trade. All goods sold by us are guaranteed. VIDEO ELECTRONICS (LONDON) LTD., Dept. P.W., 16/22, Bacon Street, London, E.1.

**SEVERAL EARLY MODELS** 9in. Television, complete and mostly working, £5/5/- each; carriage pd. TOMLINS, 127, Brockley Rise, Forest Hill, S.E.23. (FOR 5497.)

**FM-KIT SETS,** Type P4 combines med. wave and power supply with push-pull output, price £19. Type PA for FM only, £5. Completed receivers: A £7/10/-, P4 £23. Kits are aligned for you. Guaranteed valves and components. Demonstrations at Marlborough Yard, Archway, N.19.

**SERVICE SHEETS,** T.V. and Radio, over 2,000 models, sale or hire. Valves and Components S.A.E. with enquiries. W. J. GILBERT, 24, Frithville Gardens, London, W.12.

**BOOKS**

**I.P.R.E. TECHNICAL PUBLICATIONS,** 6,500 Alignment Peaks for Super-heterodynes, 5/9, post free. Data for constructing TV Aerial Strength Meter, 7/6. Sample copy. The Practical Radio Engineer, quarterly publication of the Institute, 2/- membership and examination data, 1/-; Secretary, I.P.R.E., 20, Fairfield Rd., London, N.8.

**AMERICAN MAGAZINES.** One year's "Audio," 35/-; "High Fidelity," 50/-; "Specimens 4/- and 5/-, respectively. Full list from WILEY LTD. (Dept. 40), 9, Drapers' Gardens, London, E.C.2.

**VALVES**

**WANTED.** Valves, EY51, ECL80, KT61, 6U4GT, PL91, 3524, etc., etc., prompt cash. W.M. CARVIS LTD., 103, North Street, Leeds, 7.

**EDUCATIONAL**

**CITY AND GUILDS** (Electrical, etc.) on "no pass—no fee" terms. Over 95% successes. For full details of modern courses in all branches of Electrical Technology send for our 144-page handbook—free and post free. B.I.E.T. (Dept. 242A), 29, Wright's Lane, London, W.8.

**FREE!** Brochure giving details of Home Study Training in Radio, Television, and all branches of Electronics. Courses for the Hobby Enthusiast or for those aiming at the A.M.Brit.I.R.E., City and Guilds, R.T.E.B., and other Professional examinations. Train with the college operated by Britain's largest Electronics organisation. Moderate fees. Write to E.M.I. INSTITUTES, Dept. PW28, London, W.4.

**WIRELESS.** See the World as a Radio Officer in the Merchant Navy; short training period; low fees; scholarships, etc., available. Boarding and Day students. Stamp for prospectus. WIRELESS COLLEGE, Colwyn Bay.

**WIRELESS.**—Day and Evening Class instruction for P.M.G. Certificate of Proficiency and Amateur Wireless Licence. Morse instruction only if required, also postal courses. Apply BST., LTD., 179, Clapham Rd., London, S.W.9.

**MERCHANT NAVY** Wireless School, Overseas House, Brooks' Bar, M/cr 16.

**THE INSTITUTE** of Practical Radio Engineers Home Study Courses are suitable coaching text for I.P.R.E. and other qualifying examinations. Fees are moderate. Syllabus of seven modern courses free from SECRETARY, I.P.R.E., 20, Fairfield Road, London, N.8.

**CITY OF PLYMOUTH EDUCATION COMMITTEE.**—Plymouth and Devonport Technical College. Principal: John Graymore, M.Sc., Ph.D., F.R.I.C., F.C.S. Radio Officer's Course. Next full-time Course leading to P.M.G. Certificate commences September, 1956. Intending students should apply early to the PRINCIPAL, giving particulars of previous education.

**THERE IS** a national shortage of Mercantile Radio Officers. Why not make Communications your career? You can be assured of a sea-going appointment after qualifying at THE SCHOOL OF MARINE RADIO AND RADAR (A.S.T.), Hamble, Southampton. For details apply Commandant, quoting A.12.

**T/V AND RADIO.**—A.M. Brit. I.R.E., City and Guilds, R.T.E.B. Cert., etc., on "no pass—no fee" terms. Over 95% successes. Details of exams. and home training courses in all branches of radio and T/V. Write for 144-page handbook free. B.I.E.T. (Dept. 242G), 29, Wright's Lane, London, W.8.

**COVENTRY TECHNICAL COLLEGE.** Session 1956-57. Electronic Engineering. Applications invited for entry to next 3-year full-time course commencing September, 1956, from those requiring comprehensive training to an advanced level in Electronic Engineering, qualifying for technical posts in Radio, Telecommunications, Television and Industrial Electronics. Syllabus will cover requirements of C. and G., Brit. I.R.E., and I.E.E. examinations. Entry age 16 or over. Application forms and further information from Principal, Coventry Technical College. —W. L. CHINN, Director of Education.

**SITUATIONS VACANT**

**HEARING AID Service Mechanics** reqd. at once. Knowledge of L.F. amplification and miniature circuits essential. Interesting work, good wages and conditions. Apply Box No. 276, c/o PRACTICAL WIRELESS, or phone: W. J. S. Welbeck 8247.

**GRAM-PAK AMPLIFIERS**

Complete £3.19.6 P. & P. 2/6

This midget 4-watt amplifier fits neatly into any record player leaving ample room for speaker. 6" x 2" x 11". Suitable with any speaker and all modern crystal 3-speed pick-ups. For 200-25J V. A.C. Perfect, distortionless, quality guaranteed.

**ACCESSORIES:**

BSR crystal turnover P.U., £1.14.6.  
7" x 4" elliptical speakers, 18s. 6d.  
BSR 3-speed player unit with above P.U., £4.12.6.

The complete outfit ready for your cabinet, £9.10.0 post free.

cd. stamp for details of this and other models.

**ELECTRO-ACOUSTIC LABS.**

TAIN: ROSS-SHIRE: SCOTLAND

**F M and H I-F I Components**

DENCO F.M. TUNER circuits 1s. 6d.  
RADIO CONST'R. F.M. .. 2s. 0d.  
MULLARD AMPLIFIERS .. 3s. 6d.  
OSRAM 912 PLUS .. 4s. 0d.

Separate price lists available on request to

**J. T. FILMER MAYPOLE ESTATE, BEXLEY, KENT.**

Tel. Bexleyheath 7267.

**ALL MAINS 3**

Fine Midget 3-valve Mains Receiver. Home, Light, etc., at good strength. Build your own 3 valves, ready wound coil, tuning condenser, mains transformer — everything except speaker and cabinet (av. if required). Data av. separate 2/.



Post 1/6 32/6

**John Bull** (Dept. P.W.9), 246 High St., Harlesden, N.W.10

**RADIO VALVE SUPPLY GLAZEBURY, NR. MANCHESTER**

**VALVES GUARANTEED.**

6SN7	6/6 GLEM	9/- EF91	6/- 5Z4	8/-
6SL7	5/6 6V6	6/6 EF90	9/- 5Z3	8/-
6C8	6/6 6AC7	5/6 ECL80 10/-	5P81	2/-
6P6	6/6 12AU7	8/- PL81	9/6 SP41	1/6
6BH7	5/- EY91	6/- PY81	10/- 956	2/6
6J5	4/6 EF50	4/- KT33C	9/6 EL91	6/-

PLEASE ADD 6D. POSTAGE

**SITUATIONS VACANT**

**THE ROYAL NEW ZEALAND AIR FORCE**

has vacancies for **BRITISH EX-SERVICEMEN**

in the following trades :-

**RADIO MECHANICS  
RADAR MECHANICS**

Commencing pay between £10.8.2 per week and £17.1.3 per week according to previous experience. Ages between 21 and 40, married or single. This is an opportunity to start a new life in New Zealand with excellent conditions of service and free passage. Limited vacancies also exist in other trade groups. Write for full information to :-

**THE ROYAL NEW ZEALAND AIR FORCE HEADQUARTERS (Dept. P.W.)**

**ADELPHI BUILDING,  
JOHN ADAM ST., LONDON, W.C.2.**

**VACANCIES FOR SKILLED CRAFTSMEN IN GOVERNMENT SERVICE AT CHELTENHAM**

Experienced in one or more of the following:

1. Instrument Makers with fitting and machine shop experience in light engineering.
2. Maintenance of radio communication receivers.
3. Sub-assembly lay-out, wiring and testing of radio type chassis.
4. Cabling, wiring and adjustment of telephone type equipment.
5. Maintenance of teleprinters or cypher machines and associated telegraph equipment.
6. Fault finding in, and maintenance of, electronic apparatus.

**BASIC PAY:** £8 11s. 4d. plus up to £2 10s. merit pay, assessed at interview and based on ability and experience.

Opportunities for permanent and pensionable posts.

5-day week—good working conditions—single accommodation available.

Apply to:  
Personnel Officer, G.C.H.G. (FOREIGN OFFICE),  
53, Clarence Street, Cheltenham.

**RADIO & TELEVISION SERVICE ENGINEERS**

QUALIFIED MEN FOR **HAMMERSMITH AND PLAISTOW E. DEPOTS.**

5s. 0d. per hour. Time and half over 44.

T.U. Conditions. Pension scheme Holiday and sickness benefits Staff canteen.

Superannuation Scheme.

Apply to:- Staff Office,

**LONDON CO-OPERATIVE SOCIETY LTD.,  
54, MARYLAND STREET, STRATFORD, E.15.**

**SKILLED RADIO MECHANICS** and Servicemen. A large organisation has vacancies for men who are prepared to travel and work anywhere in the world. Periods abroad from 6 to 24 months. Salary £75 per month, plus all found. Candidates must be single, medically fit and have a good knowledge of radio theory and practice. Initial engagements 1 to 3 years, with excellent opportunities for men with ability and right temperament to obtain permanencies. Write Box PW.439, c/o 191, Gresham House, E.C.2.

**ELECTRONIC WIREMEN** required for small assembly work; women considered. Must be able to work from prototypes; further training will be given if necessary. 5-day week and free lunches. Apply **PERSONNEL Manager, Holwood, Keston, Kent.**

**VALVES. SAME DAY SERVICE**

**All Guaranteed New and Boxed**

1.4v. midget, 1R5, 1S5, 1U5, 1T4, 354, DAF91, DF91, DK91, DL82, DL94; any 4 for 27/6.  
1A7GT12, 6SN7G7, EF96 9/6 EY51 10/6  
1CGT11, 8/6 DH7 8/6 E240 9/6  
1D5 11/- 6U4GT15/- DK32 12/6 GZ32 15/-  
1H5GT 6V6G 7/6 DK92 7/6 HVR2A  
11/6 6V6GT 7/6 DK96 9/6  
1N5GT 6X4 7/6 DL33 11/6 KT33C 7/-  
11/6 6X5GT 6/9 DL33 11/6 10/6  
1R5 8/6 EB7 8/6 DL96 9/6 KT83 7/6  
1S5 7/6 TC5 8/6 BAF42 11/6 MU14 9/-  
1T4 7/6 TC6 8/6 EB91 6/9 PCC84 9/6  
1U5 7/6 TH7 7/6 EBC33 7/6 PCF80 9/-  
3Q5 7/6 T57 8/6 EBC41 10/- PCF82 11/6  
3A5GT 7Y4 8/6 EBF80 10/6 PEN36C  
11/6 10C1 13/6 ECC40 16/-  
3S4 7/6 10C2 10/- 13/6 PEN45 16/-  
3V4 8/6 10F1 10/- ECC81 10/- PEN46 7/-  
5U4G 8/6 10LD11/- ECC83 10/- PL81 11/9  
5Y3GT 7/9 10/6 ECC91 6/- PL82 9/6  
5Z4G 9/- 12AT7 8/9 ECF80 12/6  
6AK5 5/- 12AU7 8/6 ECH35 11/- PY80 9/-  
6AL5 6/9 12J7GT 8/6 ECH35 11/- PY81 10/-  
6AM6 7/6 9/6 ECH42 10/- PY82 7/9  
6AQ5 7/6 12K7GT 9/6 10/6 PZ30 15/-  
6AT76 8/6 12KR8T ECH81 9/6 U22 8/6  
6B6 7/6 12/6 ECL80 10/- U25 12/6  
6BB5 7/6 12Q7GT 8/6 ECF37A U50 7/6  
6BWV 7/9 9/6 U78 7/6  
6C9 10/- 14S7 15/6 EF39 10/6 UAF42  
6F1 13/- 20L1 10/9 EF40 17/- 11/6  
6F6G 7/6 25L8GT 8/6 EF41 10/- UBC41 9/-  
6F13 13/- 25Z4C 9/6 EF42 12/6 UCH42 9/-  
6F15 11/6 35L6GT 9/6 EF50 7/6 10/9  
6J6 6/- 35Z4GT 8/6 EF89 9/6 UF41 9/6  
6J7G 7/6 50L6GT 8/9 EF85 9/6 UL41 10/6  
6KTG 6/- AZ1 11/6 EF86 12/6 U07 11/6  
3KTGT 6/- DCH35 16/- EF91 7/6 UY41 8/6  
3K8G 8/6 D15 7/- EF92 6/6 V24B 15/6  
6KRGT 9/6 DAC32 11/6 EL32 8/6 W7 6/6  
6L8 10/6 DAF96 9/6 EL41 10/6 X79 12/6  
6LD20 9/6 DCC90 7/6 EL84 10/6 Y63 7/6  
6Q7GT 9/6 DF33 11/6 EM34 10/6 Z77 7/6

**READERS RADIO 24, COLBERG PLACE, STAMFORD HILL, LONDON, N.16. STA. 4587**

Wireless Servicing Manual, by W. T. Cocking. Complete new edition, 17/6. Postage 1/-.

Television Engineering Vol. 2. B.B.C. training manual by Amos and Birkenshaw, 35/- Postage 1/-.

T.V. Picture Faults, new revised edition by J. Cura. 3/3. Postage 0d.

How to Listen to the World, 1956 edition by O. Lund Johansen. 4/6. Postage 3d.

Brimar Valve & Teletube Manual, No. 6. 5/- Postage 0d.

Radio Servicing Pocket Book, by E. Molloy, 10/6. Postage 6d.

Load-speakers, by Briggs, 7/6. Postage. 0d. Please write or call for Lists.

**UNIVERSAL BOOK CO.**

12 LITTLE NEWPORT ST., LONDON, W.C.2 (Adjoining Lisie Street.)

# NEW!

1956 EDITION of  
**Our Supa-Handbook**  
"The Home Constructor"  
**JUST OUT!** incorporating

- ★**B.F.O. UNIT**.—For converting your receiver to "Communications." (Circuit and full constructional details).
- ★**I.F. STAGE**.—Adding an I.F. stage to increase your set's gain and selectivity.
- ★**MAGIC EYE**.—Details for incorporating a Tuning Indicator for accurate tuning.
- ★**23 CIRCUITS**.—Superhets, T.B.F. Sets, Amplifiers, Feeder Units, Test Equipment, etc.
- ★**SUPERHETS**.—Full constructional details, supa-simplified layout and point-to-point wiring diagrams for building a variety of superhets.
- ★**COIL PACK**.—Full constructional details for building a superhet coil pack.
- ★**CAR RADIO**.—Full constructional details.
- ★**BATTERY CHARGER**.—Details for building a CHEAP charger for your car battery.
- ★**RADIO GEN.**—Pages of information, Resistance Colour Code, Formulae, and "know-how."
- ★**CATALOGUE**.—Profusely illustrated price list of components. All for 2/6 (plus 3d. post). Send for your copy to-day!

**SUPACOILS** (D.p. Pt. 9.)  
21, Markhouse Road, London, E.17  
Telephone: KEY 6886

## CERAMIC CAPACITORS

**DISC**.—Modern capacitors for decoupling uses. Midget, non-inductive, excellent insulation. Ideal for T.V. and V.H.F. 500 v. D.C. (300 v. A.C.) working:—470 pF, 0.001  $\mu$ F, dia. 5/16in.; 0.002  $\mu$ F, 0.003  $\mu$ F, dia. in.; 0.005  $\mu$ F, dia. 5/8in. Each 9d.

**HI-K TUBULAR**.—Similar dielectric and insulation to above. Midget tubular construction, 500 v. D.C. Working:—0.0005  $\mu$ F, 0.001  $\mu$ F, 0.0015  $\mu$ F, 0.0002  $\mu$ F, 0.003  $\mu$ F, 10 d. each; 0.005  $\mu$ F, 0.01  $\mu$ F, 1/- each.

**NEGATIVE TEMPERATURE COEFFICIENT**.—For tuned circuits where compensation is required: 3, 4.7, 6.8, 10, 15, 30, 50, 75, 100 pF. 1/- each.

Minimum postage 6d. on orders under £2.

**SOUTHERN RADIO & ELECTRICAL SUPPLIES**  
**SORAD WORKS, REDLYNCH SALISBURY, WILTS**  
Telephone: Downton 207

## 1-finger Pianists

Build your own electronic keyboard and play everything! Send for free leaflet. Guitar, cello, flute and trumpet are all easy. Write now...

**C & S, 10 Duke St., Darlington, Co. Durham**

*Solder with*  
**LITESOL**  
REGD TRADE MARK

"PERMATIP"  
AND  
"PERMABIT"  
INSTRUMENTS  
FOR  
GREATER  
SOLDERING  
EFFICIENCY



The soldering bit which maintains its face indefinitely without attention. 25 models available for mains or low voltage supply. Bit sizes 3/32 to 3/8 inch. Full details in booklet S.P.10 from sole manufacturers:—

**LIGHT SOLDERING DEVELOPMENTS LTD.,**  
106, GEORGE STREET, CROYDON,  
SURREY. Tel. CROYTON 8589.

## SPECIAL OFFER OF RECORD CHANGERS

- GARRARD RC89**. Latest Garrard Three Speed changer. Fitted with GC2 Turn over cartridge. £13.5.0.
- COLLARO RC54**. The well known Collaro Changer. Three speed. Fitted with the Studio Pick Up. £9.0.0. This changer is also available fitted to a wooden plinth. £10.10.0.
- BSR MONARCH**. The very latest FOUR SPEED model. Gives 16, 33, 45 and 78 r.p.m. Acos cartridge fitted. £7.19.6.
- Carriage 5/- for all Models.  
Credit sale terms available.
- WATTS RADIO**  
8, Apple Market, Kingston on Thames,  
SURREY  
Telephone: KINGSTON 4099.

**MORSE CODE TRAINING**  
Send for the Candler  
**BOOK OF FACTS**  
It gives details of all Courses which include a Special one for acquiring amateur licence.  
**CANDLER SYSTEM CO. Dept. 5LO**  
52b, Abingdon Road, London, W.8  
Candler System Co., Denver, Colorado, U.S.A.

**ANNAKIN'S SUPER BARGAINS**  
Amplifier Unit No. 445.—With 2 1P4, 3 1A4, 2 CV448 diodes, 47 other miniature parts. New. Boxed, 32/-.

12 v. Mallory Vibrator Packs.—250 v. 80 mA., out. 20/3.

2-gan: 250 pF Condensers.—New. Boxed, 3/6.

230 v. Mains Transformer.—550-0-550 v., 120 mA., 6.3 v. 2.5 a., 6.3 v. 0.3 a., 5 v. 2 a. Ex-Navy. 22/6.

All above POST FREE. Money Back Guarantee.

25, Ashfield Place, OTLEY, YORKS.

**BENSON'S BETTER BARGAINS**

**BRAND NEW** Command Receivers 1.5-3 Mc/s. 0 valve, less dynamotor, 55/- (post 1/4). **BEACON TX RXS.** AN/PFN-1A, 214-204 Mc/s. Valves: 2/6AK5, 5/9005, 2/9001. Includes serial, phones and 6 volt vibrapack, £5 delivered (J.B. AN/PFN-2. As above but with 1/1B3, 2/1A5, 5/3A5 valves and double 2 volt vibrapack, £5.15.0. (Each in waterproof case), with handbook, R/KS, 112, 114 (R/P/97), with 8/EF91, 2/EL91, 6 gang tuner, new, 37/6, less valves, 7/6. Circuit 1/-.

**MOTORS:** Gram., 230 v. Induction, 78 r.p.m. with governor (Garrard), 30/- (post 2/9). **SYNCH.** 230 v. geared to 1 r.p.m. final, new, 22/6. Synch. 100 v. 3,900 r.p.m. 16 VA., 10/-.

**TRANSFORMERS,** new, Primary 230 v. 50 c. Sec. HW 0.5 A.; (additive to 221-247 v.) 15/- (corr. 2/9).

**BRAND NEW UNITS.** TYPES R.F. 28 or 27, 27/6 (postage 2/6); RF21, RF22, soiled 10/6.

**AERIAL RELAYS** (co-axial) 6/0 1/2 24 v., 7/6. **TYPE 78A,** 23 v., or manual 15/- (post 2/9). **DYNAMOTORS,** D.C. 6 v. Input, 250 v. 80 mA. output, 11/6. Filters for these, 2/6. **EDDYSTONE** 12 v. to 190 v. 75 mA., cased, 15/- (post 2/6). 12 v. to 300 v. 200 mA., cased, 16/- (corr. 2/6).

**CLOCKWORK** Connectors, 2 impulses per sec. 8/6. U.S.A. type, small, 9/6. **THROAT MICS.,** U.S.A., new, 2/6. **METAL RECTIFIERS:** 600 v. 30 mA., 8/-; 500 v. 500 mA., 10/6. 1,000 v. 50 mA., 7/6. **R1355 1P** Strips only, complete, new, with valves, 25/-; less valves, 12/9 (post 2/6). **SPLITTERS,** 15 a., G.E.C. D.P. switch, 4 fuses, new, 15/6. **I.F. AMPLIFIER** 178, 13.0 m.c/s. with valves, 15/6 (postage 2/6 each). **BENDIX RA-10,** 4 Wavebands, 8 valves, New, £2/10/- (corr. 10/-). **RELAYS,** 6 v. 2 break, 1/6. **I.F.T.'S** 10/13 m.c/s., canned, new, 1/3. **R1155** Colpacks, new, 12/6. Used, 9/6.

**XTALS.** Octal, 6.2 m.c/s. and 8 m.c/s., each 5/-. Toggle switches, new, metal DPST, 2/-; Water Switches, 1 pole 11/6; 2 pole, 3/6; 6 v. 2 w. 4 b.; 2 p., 3 w., 2 b.; 1 p., 6 w., 5 b., 2/6; 2 p. 2 w., 1 b., 1/3. **CHOKES,** 1/6. 10 H. 120 mA., screened, 7/6; 10 H. 200 mA., 8/6; 5 H. 200 mA., 5/6.

List and enquiries: S.A.F. please 1 Terms: C.W.O. Postage extra. Immediate despatch. Callers and Post W. A. BENSON (PW), 303 Rathbone Road, Liverpool, 13. STO. 1604. Callers, SUPERADIO (W/chapel) LTD., 116 Whitechapel, Liverpool, 1. ROY. 1130.

## BROOKS (RADIO)

4 Charles Street, Morecambe, Lancs.

**Tested—VALUES—Guaranteed**

1A7	11/-	6X5	6/6	EF80	10/-
1C5	9/6	7B7	8/6	EP85	11/6
1H5	9/6	7C5	8/6	EL41	10/6
1N5	9/6	7C7	8/6	EM34	10/6
1R5	7/6	7S7	8/6	EY51	12/6
1T4	7/-	12K7	8/6	EZ40	8/6
351	7/6	12K8	9/6	PC281	8/6
3V4	8/-	12Q7	8/6	PCF82	12/-
5U4	8/6	25Z4	8/6	PL41	11/6
6X3	7/6	381A	8/6	PL82	9/6
5Y4	8/6	35Z4	8/6	PL83	12/-
6AL5	6/6	8/0	8/0	PY80	9/6
6AM6	8/6	EAB30	10/-	PY81	10/-
6AT6	8/-	EAF42	10/-	PY82	9/-
6B6A	8/6	EB34	10/6	PY83	11/6
6BE6	8/6	EBF30	10/6	UBC41	9/6
6K7	5/6	ECC81	11/-	UC542	11/6
6K8	8/6	ECC82	11/-	UL41	10/6
6Q7	9/-	ECC83	11/-	UY41	8/6
6N7	8/6	ECH42	11/-	VU38	8/6
6V4	7/6	ECL80	11/-		

plus 6d. per valve, post and packing.  
**BAND III AERIALS** (10ft type) Suitable with slight adaptation for outdoor use. 3-element, 33.6 element, 45/6.  
**CROSSOVER UNITS** (Band I and III), 11.6. Plus 9d. P. & P.  
**GILLONE** Convertors. 8 gns. post free.  
**AERIALS.** Co-ax for Band III lead-ins. 30 s. 3d.  
Solderless CO-AX Plugs. 1/3 each.

**RADIO AND TELEVISION COMPONENTS**

All parts in stock for: **Viewmaster, Soundmaster, Teleking, etc.**  
Easy Terms available.  
2jd. stamp (only) for Catalogue.

**JAMES H. MARTIN & CO.,**  
LINTHWAITE, NEWBY BRIDGE,  
ULVERSTON, LANCs.





**SPECIAL OFFER**

of this famous chassis

**BURGOYNE 8 VALVE RADIOGRAM CHASSIS R.G. I**

**↓**  
**YOURS**

for the first of 9 equal monthly payments of

only  
**51/4**

**NO INTEREST CHARGES**

**E. & G. MAIL ORDER SUPPLY CO.**

The Radio Centre

33 Tottenham Court Road, London, W.1.

Tel.: MUSEum 6667.

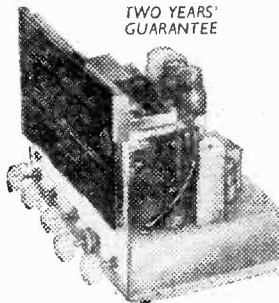

TWO YEARS' GUARANTEE

200/250v.

Carriage & Packing 7/6. Cash Price 22 gns.

A fine chassis for the connoisseur wanting only the best at a price within his means. Undistorted push-pull output giving 8 watts of quality reproduction—and using negative feedback. Separate bass and treble controls.

**MAKE THE MOST OF YOUR TAPE-RECORDER**

with  
**LUSTRETTE**  
*Dynamic*  
**Microphone**

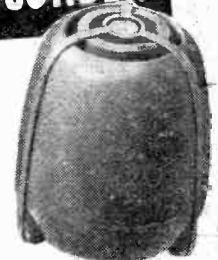

**ACCLAIMED EVERYWHERE FOR ITS WONDERFUL REPRODUCTION**

Plugs straight into any tape-recorder to provide brilliant new high-fidelity recordings for amazingly modest cost. The "Lustrette" is omni-directional, completely faithful to the original sound and unaffected by temperature and weather variations. It is also of robust construction and can be used as both hand and stand instrument. This is the ideal replacement microphone for all types including crystal and condenser.

**67/6**

The "Lustrette" is made by Lustraphone, whose reputation for making quality microphones for every purpose is world-wide. Carries the full Lustraphone Guarantee.

In Ivory Plastic housing, 2½ in. wide, with 9ft. cable.

Literature on request from:

**ST. GEORGE'S WORKS, LUSTRAPHONE LTD. REGENTS PARK ROAD, LONDON N.W.1**

Phone: PRImrose 8844.

**G2AK This Month's Bargains**

Don't miss this one!

**CRYSTAL HAND MICROPHONES**

As illustrated, in silver hammer case with polished grille, handle and 4 feet screened lead. ONLY 21/-.



**ABSORPTION WAVEMETERS**

3.00 to 35.00 Mc/s in 3 switched bands. 3.5, 7, 14, 21 and 28 Mc/s Ham bands marked on scale. Complete with indicator bulb. A MUST for any Ham Shack. ONLY 15/- each, p. & p. 1/-.

**AERIAL WIRE.** Copper, 7/25 stranded; 140ft., 12/- 70ft., 5/-; Hard Drawn 14g: 140ft., 17/-; 70ft., 6/6. P. & p. 2/-.

**GLASS INSULATORS.** 1/6 each. Small shell ditto, 4/d. each or 4/- doz. plus postage.

**CONDENSERS.** 8½F 600 v. Trop. 750 v. normal condensers. NEW, ex W.D. stock, 5/6, p. & p. 1/6.

**New TCC Type III.** 8 mid; 1,000 v. D.C. wk'g (List over £3). OUR PRICE 10/6, p. & p. 1/9.

**FLASH!!! EDDYSTONE 883.**

New Ham Band only Receiver.

**JUST OUT!** Send s.a.e. for details.

No C.O.D. on orders under £1.

PLEASE PRINT YOUR NAME AND ADDRESS.

**CHAS. H. YOUNG LTD.**

All callers  
119, Dale End,  
Birmingham 4 (CEN 1635)

Mail Orders to Dept. "P"  
102, Holloway Head,  
Birmingham 1 (MID 3254)

**COMMUNICATIONS RECEIVER R.1155.**—The famous Bomber Command Set. Covers 18.5-7.5 Mc/s, 7.5-3.0 Mc/s, 1,500-600 kc/s, 500-200 kc/s, 200-75 kc/s. BRAND NEW ONLY £11.19.6. ALL tested working before despatch and supplied with 14-page booklet which gives technical information, circuits, etc. (available separately 1/3).

**A.C. MAINS POWER PACK OUTPUT STAGE.** in black metal case. Enables receiver to be operated immediately by just plugging in. Supplied WITH built-in speaker £5.5.0 or LESS speaker. £4.10.0.

DEDUCT 10/- IF PURCHASING RECEIVER & POWER PACK TOGETHER.

Add carriage costs of 10/8 for receiver, 5/- for power pack.

**AMERICAN "COMMAND" RECEIVERS.**—Huge purchase from the Air Ministry. These famous compact receivers which can be used for a variety of purposes are offered at ridiculously low prices while stocks last. Complete with 6 metal type valves.

1 each of 12K3, 12SR7, 12A6, and 3 of 12S17, in aluminium case size 11" x 5 1/2" x 5". Used, but in very good condition, although cases may be somewhat dented. Circuits supplied. First come, first served. Choice of models. BC435 (6-9 mcs), 25/-; BC454 (3-6 mcs), 27/6; BC453 (190-550 kc/s, the renowned "Q" filter), 50/6, and a few of the 1.5-3.0 mcs. model 65/- (Carriage, etc., 3/-).

**COLLINS TOS TRANSMITTERS.**—Special offer of these famous American Transmitters. Frequency range 1.5-12.0 mcs in 3 bands. Employs 7 valves: 2 of 1B25 in P.A. Stage, 1B25 buffer and 1B25 modulator Stage, 3 of 12A6 in oscillator stage. Radio telephone or radio telegraph. Provision for VFO or Crystal Control. 4 crystal positions. Has plate and aerial current meters. In BRAND NEW CONDITION. ONLY £12.10.0. Matching receivers available £8.10.0, or THE PAIR £20. (Carriage 10/- each.)

**CLASS D WAVEMETER**

Another purchase of this famous crystal-controlled wavemeter which has been repeatedly reviewed and recommended in the "R.S.G.B." Bulletin as being suitable for amateur transmitters. Covers 1.9-3.0 Mc/s, and is complete with 100/1,000 kc/s crystal, 2 valves ECH35, two 6-volt vibrators and instruction manual. Designed for 6 v. D.C. operation, but simple mod. data for A.C. supplied. BRAND NEW IN MAKER'S TRANSMIT CASES. ONLY £5/10/6. Transformer for A.C. modification, 7/6.

**U.E.I. CORPORATION 138, Gray's Inn Road, London, W.C.1 (Phone: TERRAINUS 7937)**

Open until 1 p.m. Saturdays. We are 2 mins. from Highgate (Hoborn) (Chancery Lane Station), and 5 mins. by bus from King's Cross.

Practical Wireless

**BLUEPRINT SERVICE**

**PRACTICAL WIRELESS**

*No. of  
Blueprint*

**CRYSTAL SETS**

- 1/6d. each
- 1937 Crystal Receiver ... PW71\*
- The "Junior" Crystal Set ... PW94\*
- 2s. each
- Dual-Wave "Crystal Diode" ... PW95\*

**STRAIGHT SETS**

*Battery Operated.*

- One-valve : 2s. each
- The "Pyramid" One-valver (HF Pen) ... PW93\*
- The Modern One-valver ... PW96\*
- Two-valve : 2s. each
- The Signet Two (D & LF) ... PW76\*
- 3s. each
- Modern Two-valver (two band receiver) ... PW98\*
- Three-valve : 2s. each
- Summit Three (HF Pen, D, Pen) ... PW37\*
- The "Rapide" Straight 3 (D, 2 LF (RC & Trans)) ... PW82\*
- F. J. Camm's "Sprite" Three (HF, Pen, D, Tet) ... PW87\*
- 3s. each
- The All-dry Three ... PW97\*
- Four-valve : 2s. each
- Fury Four Super (SG, SG, D, Pen) ... PW34C\*

*Mains Operated*

- Two-valve : 2s. each
- Selectone A.C. Radiogram Two (D, Pow) ... PW19\*
- Three-valve : 3s. 6d. each
- A.C. Band-Pass 3 ... PW99\*
- Four-valve : 2s. each
- A.C. Fury Four (SG, SG, D, Pen) ... PW20\*
- A.C. Hall-Mark (HF Pen, D, Push Pull) ... PW45\*

**SUPERHETS**

- Battery Sets : 2s. each
- F. J. Camm's 2-valve Superhet ... PW52\*
- Mains Operated : 3s. 6d. each
- "Coronet" A.C.4 ... PW100\*
- AC/DC "Coronet" Four ... PW101\*

*No. of  
Blueprint*

**SHORT-WAVE SETS**

*Battery Operated.*

- One-valve : 2s. each
- Simple S.W. One-valver ... PW88\*
- Two-valve : 2s. each
- Midget Short-wave Two (D, Pen) ... PW38A\*
- Three-valve : 2s. each
- Experimenter's Short-wave Three (SG, D, Pow) ... PW30A\*
- The Perfect 3 (D, 2 LF (RC and Trans)) ... PW63\*
- The Band-spread S.W. Three (HF, Pen, D, (Pen), Pen) ... PW68\*

**PORTABLES**

- 1s. 6d.
- The "Mini-Four" All-dry (4-valve superhet) \*

**MISCELLANEOUS**

- 2s. each.
- S.W. Converter-Adapter (I valve) ... PW48A\*
- The P.W. 3-speed Autogram ... (2 sheets), 7s. 6d.\*
- The P.W. Electronic Organ (2 sheets), 7s. 6d.\*

**TELEVISION**

- The "Argus" (6in. C.R. Tube), 2/6\*
- The "Super-Visor" (3 sheets), 7/6\*
- The "Simplex" ... 3/-\*
- The P.T. Band III Converter 1/-\*

*All the following blueprints, as well as the PRACTICAL WIRELESS numbers below 91 are pre-war designs, kept in circulation for those amateurs who wish to utilise old components which they may have in their stores box. The majority of the components for these receivers are no longer stocked by retailers.*

**AMATEUR WIRELESS AND WIRELESS MAGAZINE**

**STRAIGHT SETS**

*Battery Operated.*

- One-valve : 2s.
- B.B.C. Special One-valver ... AW387\*
- Mains Operated
- Two-valve : 2s. each
- Consoelectric Two (D, Pen), A.C. ... AW403

**SPECIAL NOTE**

THESE blueprints are drawn full size. The issues containing descriptions of these sets are now out of print, but an asterisk denotes that constructional details are available, free with the blueprint.

The index letters which precede the Blueprint Number indicate the periodical in which the description appears. Thus P.W. refers to PRACTICAL WIRELESS, A.W. to Amateur Wireless, W.M. to Wireless Magazine.

Send (preferably) a postal order to cover the cost of the Blueprint (stamps over 6d. unacceptable) to PRACTICAL WIRELESS, Blueprint Dept., George Newnes, Ltd., Tower House, Southampton Street, Strand, W.C.2.

*No. of  
Blueprint*

**SHORT-WAVE SETS**

*Battery Operated*

- One-valve : 2s. each
- S.W. One-valver for American ... AW429\*
- Two-valve : 2s. each
- Ultra-short Battery Two (SG, det Pen) ... WM402\*
- Four-valve : 3s. each
- A.W. Short Wave World-beater (HF Pen, D, RC, Trans) ... AW436\*
- Standard Four-valver Short-waver (SG, D, LF, Pt) ... WM383\*

*Mains Operated*

- Four-valve : 3s.
- Standard Four-valve A.C. Short-waver (SG, D, RC, Trans) ... WM391\*

**MISCELLANEOUS**

- Enthusiast's Power Amplifier (10 Watts) (3/-) WM387\*
- Listener's 5-watt A.C. Amplifier (3/-) ... WM392\*
- De Luxe Concert A.C. Electrogram (2/-) ... WM403\*

**QUERY COUPON**

This coupon is available until Sept. 6th, 1956 and must accompany all Queries, sent in accord with the notice on our "Open to Discussion" page. PRACTICAL WIRELESS, Sept. 1956.

# BUILD IN A BJ ARM

AND add fidelity to your installation

BY OVERCOMING TRACKING ERROR IT MEANS

- LONGER RECORD LIFE
- EXTENDED OVERALL FREQUENCY RESPONSE
- FREEDOM FROM DISTORTIONS

PRACTICAL WIRELESS says:—

Test records appeared to sound even better than with our hitherto standard equipment, "rumble" which was previously audible on an organ test record, appeared non-existent. Every serious "hi-fi" enthusiast should try to make this part of his installation.

Send for Fully Illustrated Leaflets:

(Dept. D) BURNE-JONES, MAGNUM HOUSE, SUNNINGDALE ROAD, CHEAM, SURREY.



BJ ARM	...	£2.4.11
P.T.	...	18/-
BJ PLUG-IN SHELL	...	17/3
P.T.	...	6/11
BJ SUPER 90 ARM	...	11 gns.
(Studio Model)	...	£4.12.5
P.T.	...	

## THE "WEYRAD" AM/FM RECEIVER

A COMPLETELY NEW DESIGN SPECIALLY DEVELOPED  
FOR THE AMATEUR CONSTRUCTOR

This publication gives full information on the Assembly and Alignment of a Four-Band Seven-valve Receiver, including All Chassis details, Circuits and Wiring Diagram.

Up-to-the-minute components and valves provide a high standard of performance (equivalent to an eight-valve circuit) and complete coverage of the sound broadcast bands, ensuring that the set will not "date" for many years.

- ★ Latest Type Mullard Valves
- ★ "Weyrad" Coil Pack, I.F. Transformers, Tuning Scale, I.F. Filter, Mains and Output Transformers
- ★ Aluminium Chassis available with all punching and bending complete
- ★ All Condensers, Resistors and other components by well-known manufacturers

FULLY ILLUSTRATED BOOKLET, PRICE 2s. 6d.

WEYMOUTH RADIO MANUFACTURING CO., LTD., CRESCENT ST.  
WEYMOUTH, DORSET