

PRACTICAL WIRELESS, MARCH 1950

9^D

Vol. 26 No. 324

MARCH, 1950

EDITOR:
F.J. CAMM

PRACTICAL WIRELESS

AND PRACTICE



CHIEF CONTENTS

P.W. Television Receiver
Bandsearcher Unit



Simple Tone Controls
Meter Problems

**The Solder
which is
recommended
for the
View Master
and other
Television Kits**



As recommended by the designer, use only ERSIN MULTICORE SOLDER—the Solder wire containing 3 cores of non-corrosive Ersin Flux. 60 ft. of 18 S.W.G. High Tin Television and Radio Solder, 60/40 alloy, is contained in Size 1 Cartons, Cat. Ref. C.16018. Price 5/- retail.

Obtainable from all leading radio shops.

In case of difficulty write to:

MULTICORE SOLDERS LTD.

Mettler House, Albemarle Street, London, W.1. REGent 1411

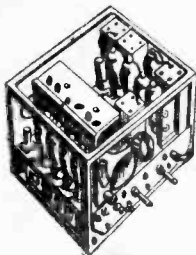

WIRELESS SET No. 21. A new supply of these well-known units has just arrived. Functioning as an 8-valve superhet on 4.2-7.5 mc.s. and as a double superhet (9 valves) from 18-31 mc.s. They use 6 VP23's and 3 HL23DD's—2v. valves, and resistors in each filament circuit enables a 6v. L.T. supply to be used. With crash limiter BFO 9 valves and circuit they are in first class condition, and a bargain at 35 - carr. paid.

POWER UNIT 21. This 6v. vibrator pack is designed to feed the W S 21, and also supplies sufficient H.T. to drive the associated transmitter (not released by the B.O.T.). Out is approx. 200v. at

40 mA., and the two units may be mounted together to form a small, compact kit, operating entirely from a 6v. supply. **OUR PRICE, only 18/6.**

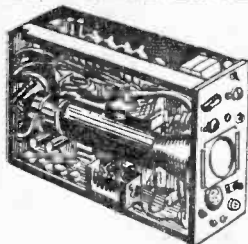

PU 19 containing rotary converter (540v. at 40 mA., and 275v. at 110 mA.), and a 275v vibrator pack, mounted on one chassis, and with 12 or 24v. input—sacrificed at 12/6.

NOISE LIMITERS, a double-diode sub-assy. ready to fit in ANY superhet. Complete and boxed, with instructions, 3/6.

S.I.C. RECEIVERS. Still a few of these now famous units, for the world's "cheapest television." Complete with 17 valves, 30/-, Data 3/-.

INDICATOR 198. Still a few of these left! The 3in. CRT, 4SP61's and host of components make this the ideal Oscilloscope unit. In sealed makers' cartons, 22.

RADIO EXCHANGE CO. 9 CAULDWELL STREET, BEDFORD Phone: 5568

EDX.22E



**The best
HIGH
and
LOW**

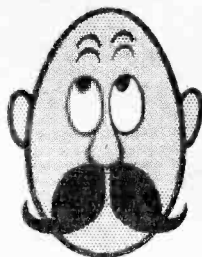

Exide LOW TENSION
ACCUMULATORS
AND Drydex
HIGH TENSION BATTERIES

for better battery radio reception

ISSUED BY
CHLORIDE BATTERIES LIMITED

Vision in Design

The ADVANCE Signal Generator

(Type E2)

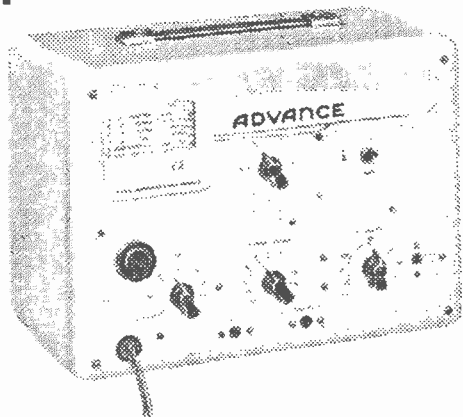

The Advance Signal Generator Type E.2 has been designed with an eye to future developments in the Radio and Television fields. Its wide range of frequencies—from 100 Kc/s to 100 Mc/s on fundamentals—caters for the rising frequency requirements of modern radio and communications. It is a fine example of 'Advance' design and manufacture.

This generator offers an instrument of laboratory standard at a price within the reach of moderate purses. The remarkably high frequency accuracy of $\pm 1\%$ extends over the whole range.

SEND FOR FULLY DESCRIPTIVE LEAFLET.

Range : 100 Kc/s-100 Mc/s in 6 bands.
 Frequency : Guaranteed within ± 1 per cent.
 Output : Approximately 1 volt unattenuated and variable from $1\mu\text{V}$ to 100 mV into a 75-ohm load through a matched transmission line.
 Stray Field : Less than $3\mu\text{V}$ at 100 Mc/s.
 Illuminated Dial : Total scale length, 30in.
 Power Supply : 110, 210, 230, 250 volts ; 40-100 c/s.
 Dimension : $9\frac{1}{2}$ in. high x 13in. wide x 8in. deep.
 Weight : 15 lb.



ADVANCE COMPONENTS LTD., BACK RD., SHERNHALL ST., WALTHAMSTOW, LONDON, E.17
 Telephone : LARKSwood 4366-7-8

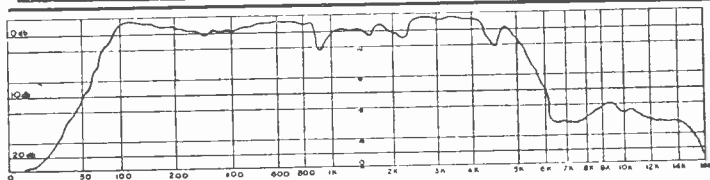

The above curve will show you at once why this new twin-reproducer, incorporating two independent loudspeakers, has been so enthusiastically welcomed by quality fans.

Never before has so wide a range been covered so evenly by a small domestic instrument. Although moderately priced, this is a high-fidelity speaker in the best sense of the word. Leaflet on application, with pleasure.

SPECIFICATION : Series Gap magnet of Alcomax 3.
 Flux in LF gap 12,000 gauss on 1" pole
 " " HF " 13,000 gauss " " "
 Power handling capacity, 6 watts. Frequency range 50-14,000 c.p.s. Fundamental bass resonance, 65 c.p.s.

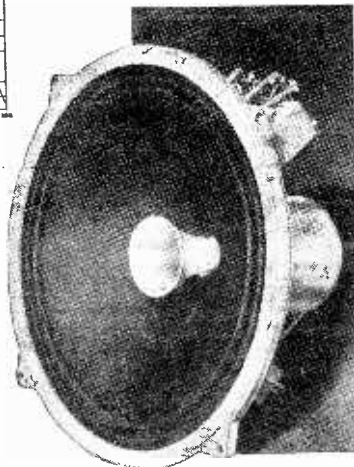

PRICE £6-6-0

Complete with matching transformer and filter condenser.

De Luxe table cabinet model £11.3.0

Corner console model, less transformer £12.12.0



Stentorian
Concentric Duplex
 HIGH FIDELITY REPRODUCER

WHITELEY ELECTRICAL RADIO CO. LTD · MANSFIELD · NOTTS · ENGLAND

Practical Wireless

18th YEAR
OF ISSUE

and PRACTICAL TELEVISION

EVERY MONTH.
VOL. XXVI. No. 524 MARCH, 1950

Editor E. J. CAMM

COMMENTS OF THE MONTH

BY THE EDITOR

Waste of Programme Time

THESE are two national hobbies which are growing in popularity. The first is the evergreen problem as to whether Shakespeare, Bacon, the Earl of Essex, the Earl of Southampton, Ben Jonson or Christopher Marlowe wrote Shakespeare's plays, and the second is the criticism of English words and phraseology. The B.B.C. likes to join in both of these frays by wasting (we use the word advisedly) programme time upon them. Such arguments do not lead anywhere, and accurate conclusions cannot be reached.

We are referring in particular to a series of broadcasts on the use of words evidently prepared by someone who has more than a nodding acquaintance with A. P. Herbert's "What A Word!" and Ivor Brown's "A Word in Your Ear." The author of these talks would reduce the English language to about one hundred words. We must not use the word "proceed," but "go." He thinks that the use of a polysyllabic word where a monosyllabic word would do is sheer pomposity and showing off. Whilst we do not believe in calling a lie a mendacious and prevaricative concatenation of terminological inexactitudes, we deprecate the advice that all writing should be reduced to the low level of the first-standard schoolboy essayist. According to this broadcaster, Shakespeare would appear to be a pompous ass. All novelists would use a vocabulary

giving to others, for it does not itself make use of simple language. It would appear that the author of these talks doesn't like the English dictionary. We should all write in exactly the same style. That can be the argument of one with a poor vocabulary who is jealous of anyone who has a good one, much as a man who does not understand mathematics pooh-poohs figures. What is the object of these broadcasts? And is it not a piece of showing off to presume to advise some millions of listeners as to their phraseology? Is that not a piece of inexcusable pomposity? And what are the qualifications of the individual concerned to poise himself on his self-made pedestal and wag the minatory finger at listeners as if they were a pack of ignorant school-children?

We suggest to the B.B.C. that this and similar programmes could well be dropped. We do not wish to go back to the schoolroom when we listen-in, and in any case, such talks should be given by acknowledged grammarians of the calibre of the late Mr. Fowler.

Midget Components

COMPONENTS have been steadily reduced in size during the past ten years, and this has enabled designers to produce compact and really efficient

midget receivers with a performance superior to their larger relatives of earlier years. In these days of housing shortage, small flats, basement and tenement lodgings, people have not the space for bulky apparatus, although midget components were not produced with that object in view. Valves of certain types are less than a quarter of their former size. Some of the other types are due for dwarfing. They look gargantuan when used in a circuit employing the tinier components. We have midget speakers, midget resistors, midget coils, midget transformers, and midget fixed and variable condensers. Let us have a complete range of really midget valves. We are, of course, referring to receiving valves. There are many practical reasons why transmitting valves must necessarily be large.

Most commercial receivers could be reduced in size.—F. J. C.

Editorial and Advertisement Offices:
"Practical Wireless," George Newnes, Ltd.,
Tower House, Southampton Street, Strand,
W.C.2. Phone: Temple Bar 4363.
Telegrams: Newnes, Rand, London.
Registered at the G.P.O. for transmission by
Canadian Magazine Post.

The Editor will be pleased to consider articles of a practical nature suitable for publication in "Practical Wireless." Such articles should be written on one side of the paper only, and should contain the name and address of the sender. Whilst the Editor does not hold himself responsible for manuscripts, every effort will be made to return them if a stamped and addressed envelope is enclosed. All correspondence intended for the Editor should be addressed: The Editor, "Practical Wireless," George Newnes, Ltd., Tower House, Southampton Street, Strand, W.C.2.
Owing to the rapid progress in the design of wireless apparatus and to our efforts to keep our readers in touch with the latest developments, we give no warranty that apparatus described in our columns is not the subject of letters patent.

Copyright in all drawings, photographs and articles published in "Practical Wireless" is specifically reserved throughout the countries signatory to the Berne Convention and the U.S.A. Reproductions or imitations of any of these are therefore expressly forbidden. "Practical Wireless" incorporates "Amateur Wireless."

of not more than one hundred words, and there would be no such thing as style in writing. Words are in the dictionary to be used, and no one wants any advice from the B.B.C., or via the B.B.C., on what words they should or should not use. The enlargement of the vocabulary is one of the objects of education, and the habit of consulting a dictionary every time a strange word is encountered is one that is encouraged in every school and college. And who is the special broadcaster concerned, to tell us that it is pompous to call a man an inebriate instead of a drunkard? The whole art of composition depends upon the use of words, and the more of them, the better. Everyone with a taste for reading likes to read an author with a polished style, with a good command of words, and the ability to make them sparkle on the page. In any case, the B.B.C. might usefully take the advice it is

ROUND the WORLD of WIRELESS

Broadcast Receiving Licences

THE following statement shows the approximate number of licences issued during the year ended November 30th, 1949:

Region	Number
London Postal	2,301,000
Home Counties	1,628,000
Midland	1,665,000
North-eastern	1,865,000
North-western	1,572,000
South-western	1,045,000
Welsh and Border Counties	717,000
Total England and Wales	10,793,000
Scotland	1,117,000
Northern Ireland	197,000
Grand Total	12,107,000

The above total includes 206,700 television licences. The total number of licences was 17,350 fewer than at the end of October, but there were 18,350 more television licences.

Television Exhibition for Birmingham

THE Radio Industry Council announces that a radio exhibition, with television as the main feature, is to be held at Castle Bromwich, Birmingham, in September next—the exact date to be announced later. As previously stated, there is to be no national radio exhibition in London this year.

Malin Head and Valentia Radio Stations

THE Postmaster-General announces that agreement has been reached on arrangements for the transfer to the Irish Republic of the Post Office short-range coastal radio stations at Malin Head and Valentia, which provide wireless services for ships at sea. Since the formation of the Irish Free State Government these two stations have been operated by the Irish Post Office on behalf of the British Post Office on an agency basis: they passed into the control of the administration of the Irish Republic on January 1st, 1950.

H. Leslie Dixon

CAPTAIN H. LESLIE DIXON, of Leslie Dixon and Co. and Electradix Radios, has just received honorary life membership

of the Institution of Electrical Engineers upon his having completed 50 years as a member. He sends his very best wishes to his numerous friends in the electrical profession.

B.I.R.E.

THE following meetings and lectures have been arranged:

London Section.—London School of Hygiene and Tropical Medicine, Keppel Street, W.C.1 (meetings commence at 6.30 p.m.). March 3rd, R. L. Kompfner: "Travelling Wave Tubes."

West Midlands Section.—Wolverhampton and Staffordshire Technical College, Wulfruna Street, Wolverhampton (meetings commence at 7 p.m.). February 22nd, H. W. Shipton (A-associate Member): "Electronics and the Brain."

North-eastern Section.—Neville Hall, Westgate Road, Newcastle-on-Tyne (meetings commence at 6 p.m.). February 15th, Major S. R. Rickman (Associate Member): "Single Sideband Systems Applied to Long-range Wireless."

S.O.S.

ON Christmas Eve two natives were severely mauled by a leopard in Bechuanaland Protectorate. Amateur station ZS9F, transmitting from a timber concession many miles from civilisation, tried to radio for help to Northern Rhodesia, but could not make contact. The message was picked up in Bordeaux. Bordeaux tried to pass on the message, also failed to contact Rhodesia, but



Mr. Clarricoats at his home station, G6CL.

was heard in Dakar, South-west Africa. From Dakar the S O S was again passed on, this time heard across the Atlantic in Massachusetts. And it was an American amateur who eventually spoke to a station in Northern Rhodesia. From there the S O S was passed on by telephone to Livingstone. An air ambulance took off the injured natives from the jungle. Later the leopard was killed and its skin is being sent to Bordeaux as a souvenir.

The story was told by Mr. John Clarricoats, secretary of the Radio Society of Great Britain, who heard the story from the Bechuanaland broadcaster himself. He picked him up at his own radio station in his home at Southgate, London.

International Telecommunications Union

A COMMITTEE consisting of the President of the U.I.R., and representatives of the B.B.C. and the Belgian, Dutch, Italian and French broadcasting organisations held a meeting in Paris in December last.

This committee decided to ask the B.B.C. to convene in Great Britain in February, 1950, a conference of all the broadcasting organisations belonging to countries of the European Zone which are members of the International Telecommunications Union. The object of this conference would be to form a new union. The draft statutes for this union have been prepared by the Preparatory Committee, and will be addressed to all those who are invited to the conference.

The committee has worked in the hope of achieving the unity of broadcasting in the European Zone, particularly with a view to obtaining the greatest possible co-ordination of the use of the allotted frequencies.

Bellahouston Park

IN December a new transmitting station in Bellahouston Park started radiating the Third Programme for Glasgow listeners. It takes over the service from the transmitter that was installed in Broadcasting House, Glasgow, as an emergency measure in 1940.

The new station, which is on a two and a half-acre site, has two transmitters, each capable of two kilowatts output power, and a T aerial, supported by a pair of tubular masts, 126ft. high. By having duplicate transmitters, a very reliable service is ensured.

The twofold increase in power and the more efficient aerial system at the new station will give listeners to the Third Programme a stronger signal in most parts of Glasgow.

Wireless Licences

NOTICES bearing the words "Warning! Is your wireless set licensed?" will shortly appear in all post offices.

The wireless combs have disclosed that many people failed to obtain the necessary broadcast receiving licence owing to misunderstanding of the regulations or forgetfulness. Under the regulations, each family using wireless apparatus in a house, part of a house, or flat should have a licence. A separate licence is necessary for a set fitted in a motor vehicle.

The new notice is designed to be a reminder to the forgetful, and it is hoped that it will also prompt others who are using wireless apparatus without a licence to inquire whether a licence is necessary in their case.

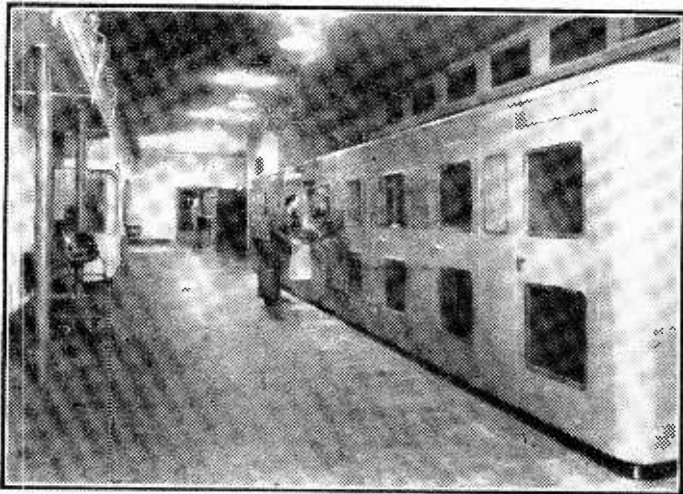

Main transmitter hall at Sutton Coldfield. The vision transmitter is in the foreground and the sound unit at the rear.

Marine Radio and Telephone

WE learn that the new Pye Marine Radio Telephone is now available for small craft enthusiasts. It costs 75 guineas (less crystals and aerials) and it will greatly enhance the pleasures of boating, apart from its life-saving significance. It is designed to a G.P.O. specification and consists of a combined transmitter and receiver covering up to eight frequency channels. These include those allocated for distress, ship-to-ship working, and calling coastal stations in the G.P.O. Marine Service. It is possible for small craft at sea to speak to any telephone subscriber ashore through the marine service or, alternatively, to receive or despatch radio-telegrams to any address.

The five-valve superheterodyne receiver gives ample coverage of these marine frequencies, as well as weather forecasts and gale warnings broadcast on the medium wave-band.

The set is self-contained, light in weight, simple to operate and needs little maintenance. Its power is derived from a 12- or 6-volt storage battery, and careful design ensures that it is extremely economical in operation. At 12 volts the receiver takes on 0.5 amp. from the battery.

Known as the type P.T.C. 110, it is 21in. high, 15in. wide, 9in. deep. A loudspeaker is incorporated for "listening out," and for two-way operation either a microphone or telephone handset can be used.

The Practical Wireless Television Receiver-4

Wiring Instructions and Coil Data

THE receiver is wired in two ways—certain components being fixed to the chassis and wired, and others being mounted on tag boards and interconnecting wires run from these to the chassis items. As with any receiver, it is essential that no leads are omitted or wrongly run, and therefore a careful check is necessary, and no doubt the most efficient way of wiring a receiver of this type is to take the theoretical circuit and as wires are put in position the equivalent wire on the theoretical circuit should be cancelled through with a coloured pencil. In view of the particular method of wiring this receiver it will be found very difficult to make alterations in certain positions so extra care should be taken. First of all, solder a vertical screen to each of six EF50 valvholders, soldering pins 5 and 6 to one side of the screen, and the spigot to the other side. If you have obtained the silver-plated valvholders you can clean a small space on opposite sides (near pins 4 and 8) to which points marked MC may be soldered, or alternatively, a soldering tag may be positioned over the screw-fixing hole and the various connections made to the tags. They may be held temporarily by a bolt which may then be removed whilst the valvholder is placed in position. On each of these valvholder assemblies wire up the resistors and condensers as seen in the wiring diagram. Arrange them neatly up against each side of the vertical plate, but make sure there are no short-circuits, and cut the wire ends of the components back to be as short as possible, leaving the ends no longer than is necessary to go between one point and another. The screens may be marked V1, etc., so that they may be identified afterwards, and they may be put on one side for the time being.

Mounting Order

Next mount on the chassis all remaining valvholders, the small tag-boards, the two output feed chokes, and the brackets carrying the two front controls. Fit a soldering tag beneath one of the screws showing the bracket which carries the volume control. Mount condenser C48 on its appropriate screening strip and the two oscillator transformers on each side of the time-base screen, making sure that they are on the right side as shown by the turned-over mounting edges.

Put in all the leads shown in the wiring diagram (Fig. 6) on the time-base side and any other leads on this diagram which are available, but do not touch the sound and vision sections yet. Note that the screened lead which runs from the volume control out to the power pack plug is anchored by being cut at the lower tag board so that the strain will not result in the wire being moved and thus introduce short-circuit. The two sections of screening braid should be bonded at the tag point. By this means both ends of the screened leads are earthed.

The next stage is to prepare the coils, if they have not been purchased ready-made, and to assemble the small tag boards. Full details of the coils are given in Fig. 7 and the wire used is No. 28 D.C.C. When wound the wire should be held in position with some form of cement, such as Denco, Belsol, etc. Small tag-rings are available from the makers of the coil formers and these clip on the reduced top of the coil former and are provided with four small soldering tags. The ends of the leads may be soldered to these, and the rings fit sufficiently tightly to enable fair tension to be put on the wire, but the cement is desirable to prevent the turns moving at some later date and necessitating retrimming.

The small video choke may be supported in the wiring, but for safety it is recommended that a short strip of $\frac{1}{8}$ in. by 1 1/16 in. brass be let into the lower edge and provided with a tapped hole through which a bolt may be passed to clamp the coil to the side runner of the chassis. An old Wearite "P" type coil may be dismantled and will provide the necessary former and tags. The two ends of the winding may then be brought up to the upper edge as shown in the wiring diagram, Fig. 6.

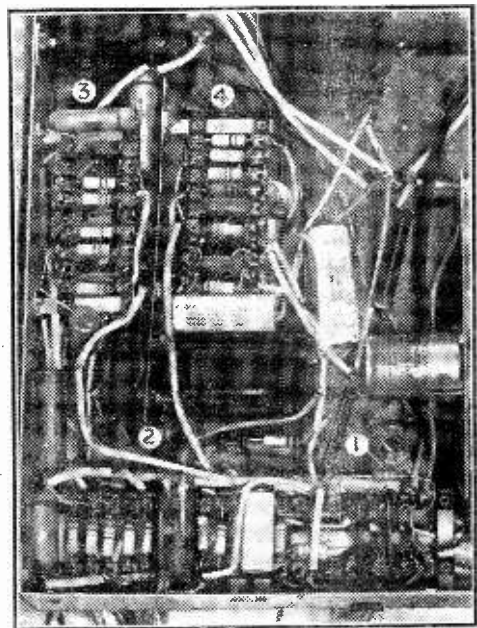

Fig. 1.—A corner of the chassis showing the tag boards—numbered 1 to 4. Wiring for these boards will be found on the facing page.

Tag Boards

Figs. 2 to 5 show the four tag-boards, and the components shown on them should be soldered to the tags, again cutting down the wire ends to the necessary minimum. Note that C55 on Board 3 is mounted on the *underside* of the board, as also are C49 and C51 on Board 4. On Board 1 C23 and 24 are also on the underside, whilst on Board 2 C40 is mounted on top of the two resistors R47 and 48. Make the interconnecting leads on each

running out toward the rear runner and then being bent towards the centre of the runner. The valveholders may now be dropped down into their positions in the sound and vision sections, making certain that you get the right holders in the right positions, and see that the screens attached to the valveholders do not come into contact with any bared leads. Standard insulated sleeving should, of

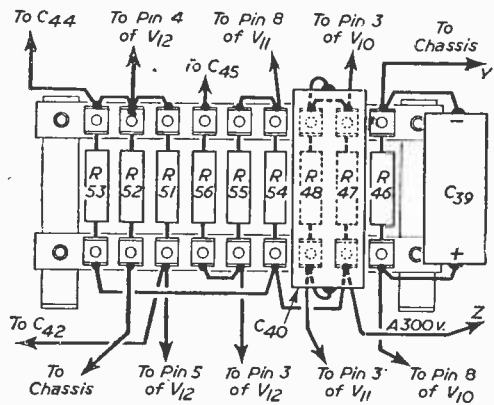

Fig. 2.—Tag board No. 2, which feeds the sync-circuits.

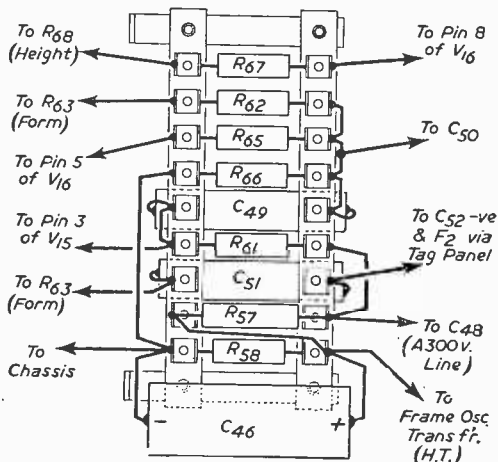

Fig. 3.—Tag board No. 4, which feeds the frame time-base.

board where indicated, but do not attach leads running off to the arrowed points.

Wiring

You are now in a position to complete the wiring. First, run the heater leads to the separate sections of the sound and vision receivers, taking a wire from V1 round past the contrast control to the rear chassis runner, and one from V6 to about the same position. Similarly, run a lead from V9 round to about the same position, these last two leads

course, be slipped over all leads to guard against short-circuits. Next drop the coil holders over the bolts which have been left projecting as described in last month's issue, and fit the necessary lock nuts to both coil formers and valveholders. Com-

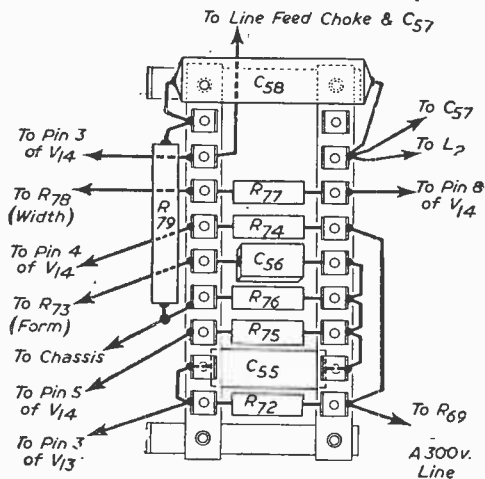

Fig. 4.—Tag board No. 3, which feeds the line time-base.

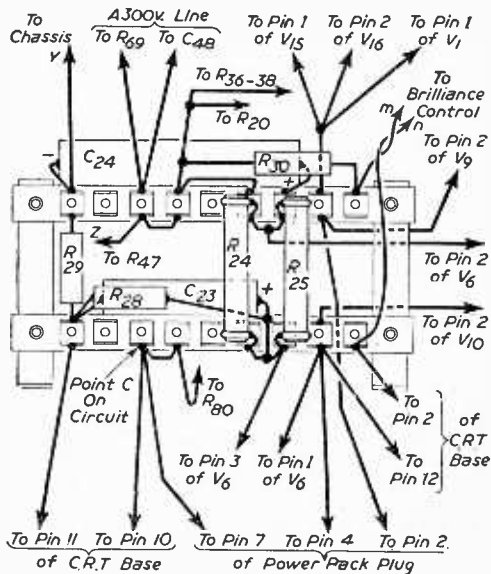

Fig. 5.—Tag board No. 1, which is the main power distribution point.

plete the wiring to these two sections and make a careful check. As the earth bonding relies upon actual contact between the valvholders and the chassis the adjacent surfaces should be thoroughly cleaned and the lock nuts well tightened. If a soldering tag has been used on the valvholders, make all other MC connections to the tags so that a common earthing point, in good contact with the chassis, is available at each MC point. When this

has been completed the two separating screens should be attached and the short length of screened (coaxial) lead attached through C10 to V3 and fed through the hole in the screen to the tag strip for subsequent connection to the input coil of the sound section. Cut the ends of C10 as short as possible and attach one end direct to the grid valve-socket of V3 and leave the smallest possible piece of lead showing from the short length of coaxial at

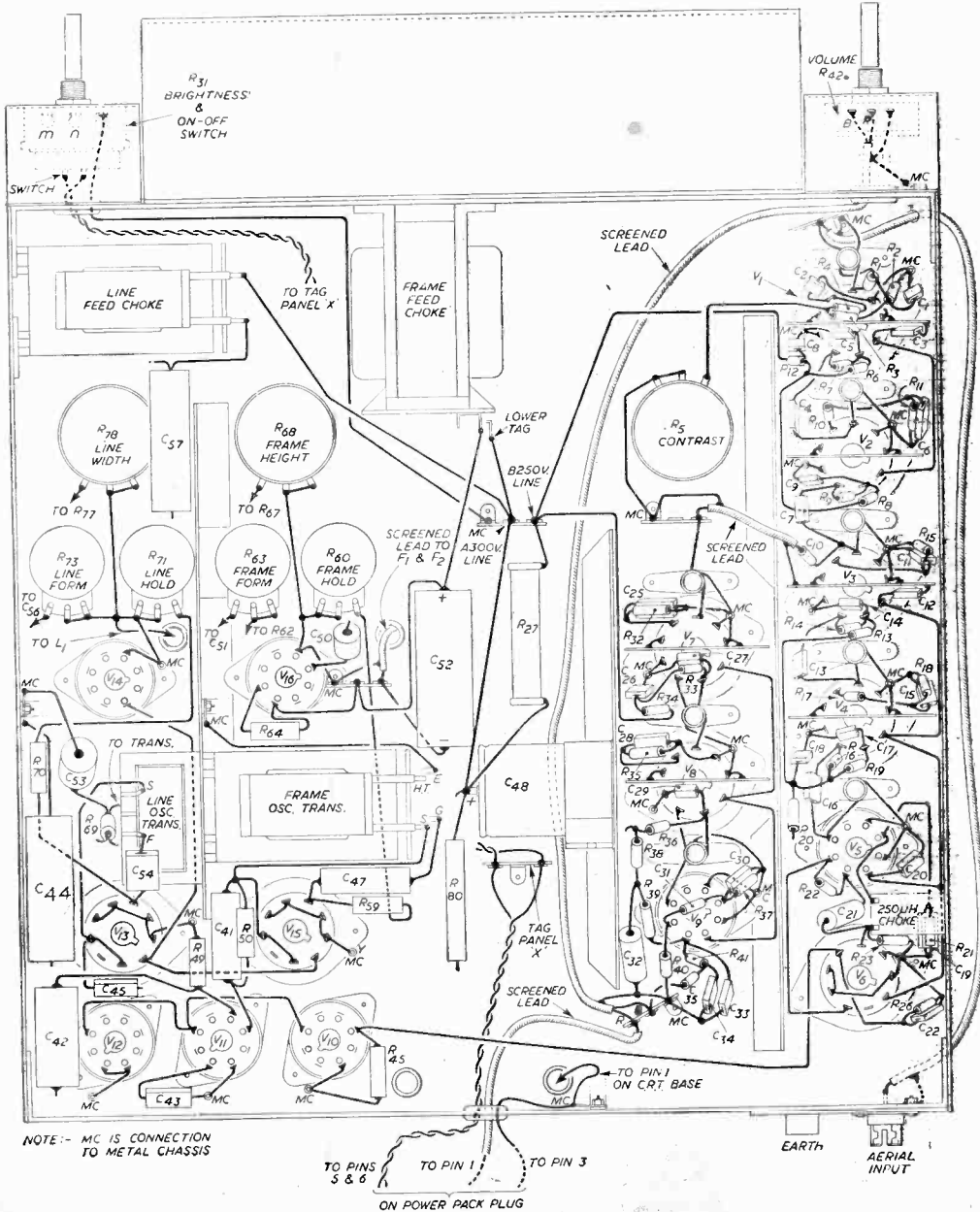

Fig. 6.—Main chassis wiring details.

each end. Excessive radiation from this lead may lead to instability.

Tag Board Connections

The leads from the components to the points on the tag boards are best attached to the chassis components and left rather long and projecting upwards. Taking tag board Nos. 1 and 2, place them in position roughly and snip off excessive lengths of the leads. Measure off suitable lengths of insulated sleeving, drop them down on the leads and, feeding them up as required, bolt both tag boards in position, noting that an earthing tag is attached at the outside bolts for these two boards, one being shown as the anchoring point for the lead to pin 1 on the C.R.T. base, and the other taking the lead from R52 on tag board 2. The inner upper connecting points on these two boards (marked "To Chassis Y") are joined together and connected to the earthing point on holder V15, immediately below them.

Next mount tag boards 3 and 4 on the metal screen carrying the two oscillator transformers, noting that board No. 4 is attached on the frame side and No. 3 on the line side (that is, the side nearest the side chassis runner). Put this screen gently into position, bringing up the various connecting wires, and slip lengths of insulated sleeving down as before. Note very carefully the connections to the two ends of C57 and also the two leads from R69. The other connections are more or less straightforward, but the usual care should be exercised to avoid short-circuits and mistaken connections.

Deflection Coil Leads

The leads which are taken up to the scanning coils are taken through rubber grommets, and for the line, ordinary twin flex (5 amp. type) may be used. One of these is taken to the chassis line and the other is brought down from tag board 4 (from C58). The frame leads consist of a few inches of ordinary single screened flex, the inner wire being taken to the small tag strip and C52, and the other braiding being connected to the earthed tag on the tag strip.

Points where it is possible to go wrong and give rise to difficulty are the respective positions of the

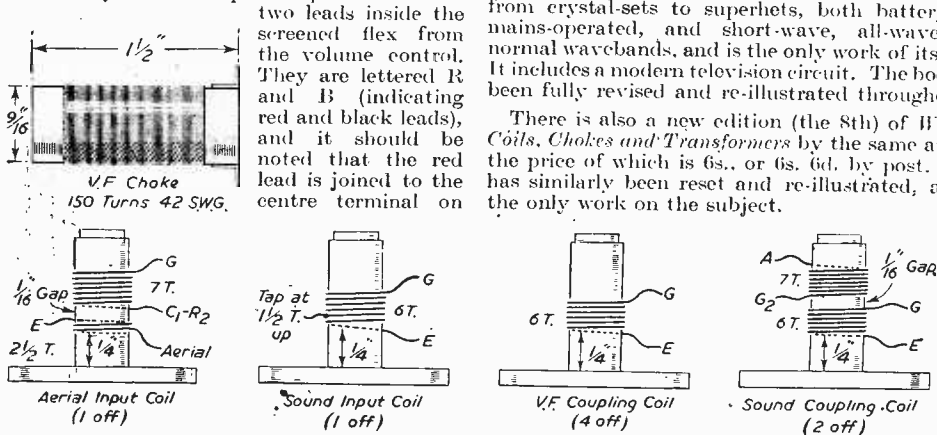

Fig. 7.—Details of the coils and the video corrector choke. The wire used for the coils is No. 28 D.C.C.

the control and to the outside tag on the tag strip. Similarly, the two essential points on the brightness control have been marked "m" and "n" and the respective positions of these should be noted on tag board 1. The twisted flex from the switch portion of this control (to tag panel "X" and on to the power pack plug) is not critical as it carries the incoming A.C. supply and the wires may be twisted at junction points without any ill effects.

When making all wiring endeavour where possible to keep H.T.— and low potential leads down near the surface of the chassis, whilst leads carrying H.F. or H.T. potentials should be kept as high from the chassis as possible. It will be found that the various essential items (C.48, for instance, and the tag board 1) have been designed to assist this end.

Note that the socket marked earth on the rear runner has no connection to it. It is merely a plain socket which makes direct contact with the small mounting strip and is thus in direct contact with the whole of the metal work and provides a separate earth connection instead of relying upon the outer shell of the coaxial aerial socket. This will be discussed when dealing with the setting up of the receiver.

Before passing on to the power unit the wiring should be very carefully checked, preferably with a meter and voltage source, checking from point to point and at the same time trying all screened leads to make quite certain that the screening has not come into contact with the inner screened wire.

Chassis Dimensions: a Correction.—In Fig. 2 on page 51 of our February issue, the two grummet holes at the top of the illustration were incorrectly positioned. The measurement of 1 3/4 in. is correct, but the holes should obviously be nearer the top of the illustration.

In Fig. 3, on page 52, the top left-hand measurement on the bottom separating screen should be 1 in. instead of 1 1/4 in.

Two New Editions

A new edition (the 15th) of *Practical Wireless Circuits*, by F. J. Camm, has just been published at 6s., or 6s. 6d. by post. This progressive guide covers the construction of all types of wireless receivers from crystal-sets to superhets, both battery and mains-operated, and short-wave, all-wave and normal wavebands, and is the only work of its type. It includes a modern television circuit. The book has been fully revised and re-illustrated throughout.

There is also a new edition (the 8th) of *Wireless Coils, Chokes and Transformers* by the same author, the price of which is 6s., or 6s. 6d. by post. This has similarly been reset and re-illustrated, and is the only work on the subject.

Simple Tone-control Circuits

The Design and Practice of Frequency Modifiers

By "EXPERIMENTER"

THERE are many occasions when modifications are necessary to the frequency-response of an amplifier; for example, an amplifier used for disc-recording usually includes a "bass cut" circuit and an amplifier used for disc reproduction employs a complementary "bass-lift" circuit. "Top cut" may be desirable to minimise surface noise when reproducing records or to minimise heterodyne whistles when listening on radio. "Bass-cut" is often employed in public address amplifiers to improve the intelligibility of speech reproduction. It is the purpose of this article to describe simple circuits consisting of resistance and capacitance only which can be used to give "top cut," "bass lift," etc., and to show how the component values can be calculated to give a wanted amount of control over a particular frequency range.

Possibly the simplest of all tone-control circuits is that shown in essentials in Fig. 1. It is a very familiar circuit for it occurs automatically in all R.C.-coupled amplifiers, C_1 being a coupling capacitor and R_1 a grid leak. This circuit gives "bass cut" and is obtained without the use of any additional components in the amplifier. For design purposes it is convenient to know that in this, as in many simple R.C. circuits, there is a loss of 3 db. at the frequency for which the reactance of C_1 equals R_1 . At half this frequency, i.e. one octave lower in pitch, the loss is 7.5 db., and if the frequency is halved again to give a pitch two octaves below the original the loss is 12.5 db. A further halving of frequency gives a loss of 18 db. and below this frequency the loss increases at a constant rate of 6 db. per octave. If frequency is increased above the value for which the reactance of C_1 equals R_1 the loss decreases, being 1 db., one octave above the original frequency, and is negligible at higher frequencies. The figures quoted for the losses at various frequencies, in order of descending frequency, are 1, 3, 7.5, 12.5 and 18; these are worth memorising, for they occur in all simple R.C. networks and enable the response curve to be drawn without calculations. These figures are listed in Table I, which is very useful for design purposes, and the following numerical example illustrates the method of preparing the frequency-response of Fig. 1.

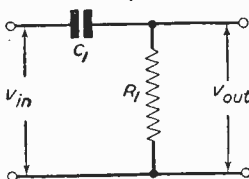

Fig. 1. — Fundamental circuit giving "bass cut."

Bass Cut

Suppose a "bass cut" circuit is required for a disc-recording amplifier and that the loss is required to be 12.5 db. at 50 c/s. If this "bass cut" is obtained from a simple circuit such as Fig. 1, the loss will be, from the table, 7.5 db. at 100 c/s, 3 db. at 200 c/s and 1 db. at 400 c/s. From these results the response curve of the network can be drawn immediately; it is given in Fig. 2. R_1 is a grid leak and its value is dictated by the design of the amplifier. Suppose it is 0.25 M Ω . The value of C_1 is required. From Fig. 2 or the table it is clear that the loss of the circuit is 3 db. at 200 c/s, and at this frequency the reactance of C_1 must equal R_1 . Thus the reactance of C_1 is 250,000 ohms at 200 c/s. From this the value of C_1 can be obtained by a simple calculation, or more conveniently from a reactance chart; the capacitance is 0.003 μ F. Sometimes it happens that the value of R_1 is not critical and may be given any value we please within certain limits; in designing such circuits it is useful to know that the frequency response of the network is unaltered by halving the capacitance of C_1 and doubling the resistance of R_1 . Thus a coupling capacitance of 0.0015 μ F and a grid leak of 0.5 M Ω have the response shown in Fig. 2. The same curve is also obtained from 0.006 μ F and 125 k Ω ; in fact, any combination of capacitance and resistance with a product of 0.00075 gives this particular response curve. Thus the actual values of C and R may be chosen to suit particular circuits and, provided the product CR has the right value, the frequency response will automatically be correct.

Top Cut

Fig. 3 shows the basic form of a circuit giving "top cut." This gives 3 db. loss at the frequency for which the reactance of C_1 equals R_1 , 7.5 db. loss one octave higher and 12.5 db. loss one octave higher still. If frequency is still further increased the loss ultimately becomes 6 db. per octave. It

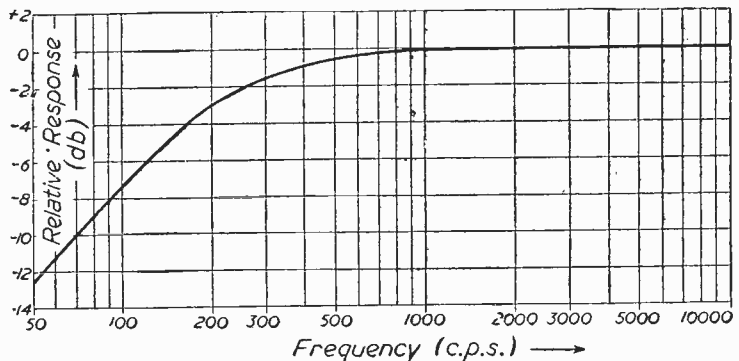

Fig. 2.—Response of the circuit of Fig. 1 when $R_1 = 0.25$ M Ω and $C_1 = 0.003$ μ F.

will be noticed that these are the same loss figures quoted for Fig. 1 and given in the table.

This network (Fig. 3) differs from Fig. 1 because to fit the "top cut" circuit to an existing amplifier C_1 and R_1 must be included as extra components. Fig. 4 shows how the top cut circuit may be embodied in an R.C.-coupling network. As a numerical example, suppose Fig. 4 is required to give a loss of 12.5 db. at 10,000 c/s. The loss of the circuit is 7.5 db. at 5,000 c/s and 3 db. at 2,500 c/s. From these values and others obtainable from the table, the frequency response curve for the tone-

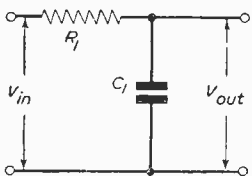

Fig. 3.—Fundamental circuit giving "top cut."

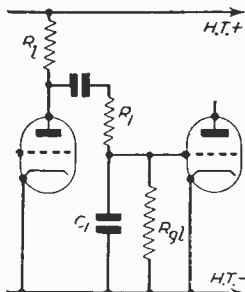

Fig. 4.—Fundamental circuit of Fig. 3 embodied in a practical circuit.

control circuit can be drawn; it is given in Fig. 5. The values of C_1 and R_1 necessary to give this curve are interdependent and one of them is usually determined by design considerations of that part of the amplifier into which the circuit is to be fitted. For example, in Fig. 4 R_1 should preferably not exceed about 100,000 ohms, otherwise the total grid-circuit resistance becomes excessive and C_1 becomes comparable with the input capacitance of the following valve. If R_1 is 100,000 ohms, C_1 must have a reactance of 100,000 ohms at 2,500 c/s.

From a reactance chart it is easily seen that C_1 must be 600 pF. Other R.C. combinations giving the same frequency response (Fig. 5) are 200,000 ohms and 300 pF, 50,000 ohms and 0.0012 μ F; in general any combination with an R.C.-product of 0.00006 gives the same curve.

The table can be used not only for determining the component values necessary to give a desired frequency response as already illustrated, but also to determine the shape of the frequency response curve obtained with a given set of component values. For example, the circuit of Fig. 3 is used universally for R.F. filtering in diode detectors and common values for high-quality medium-wave receivers are $R_1=50,000 \Omega$ and $C_1=100\mu$ F. What is the response curve of such a network and how much R.F. suppression is given at, say, 1 mc/s? The reactance chart shows that C_1 has a reactance of 50,000 Ω (equal to R_1) at 30 kc/s; there is thus a loss of 3 db. at 30 kc/s, 1 db. at 15 kc/s and negligible loss below this frequency. Thus the circuit can be said to give no loss over the audio-frequency band.

At radio frequencies the loss is 7.5 db. at 60 kc/s, 12.5 db. at 120 kc/s, 18db. at 240 kc/s, and increases at the rate of 6 db. per octave above this frequency. Thus the loss is greater than 30 db. at 1 mc/s and the circuit can be said to give considerable R.F. loss over the medium waveband.

Alternative Scheme

Another method of obtaining "top cut" is indicated in Fig. 6. It consists of connecting a capacitor C_1 across the anode load of an R.C.-coupled amplifier. This is a simpler method than that indicated in Fig. 4 because it involves the addition of only one component (C_1) to the amplifier. The figures in the table can be used to calculate the response curve of the circuit. For example there is a loss of 3 db. when the reactance of C_1 equals R_1 ; in this circuit R_1 is the resistance of r_a , R_1 and R_{g1} all connected in parallel. If the valve V is an R.F. pentode with a very high r_a and if R_{g1} is very much greater than R_1 (as it should be), R_1 is approximately equal to r_a . On the other hand if V is a triode and if R_{g1} is considerably greater than R_1 , R_1 is approximately equal to $r_a R_1 / (r_a + R_1)$.

As an example, suppose V is a pentode, R_1 is 100,000 Ω and a top cut of 7.5 db. is wanted at

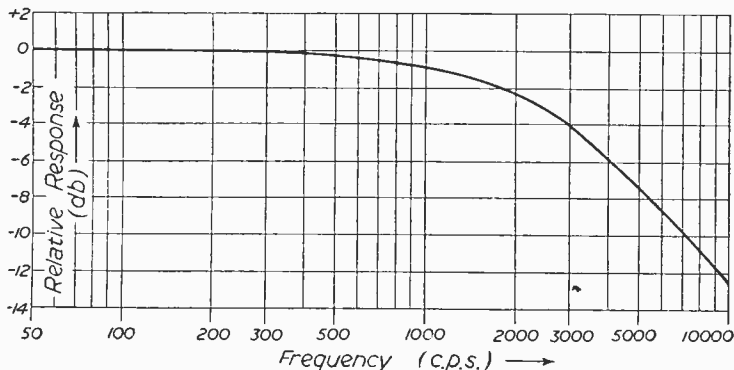

Fig. 5.—Response of the circuit of Fig. 3 when $R_1=0.1 M\Omega$ and $C_1=600 pF$.

10,000 c/s. What value of C_1 is wanted? From the table C_1 should have a reactance of 100,000 ohms at 5,000 c/s; C_1 is hence 300 pF.

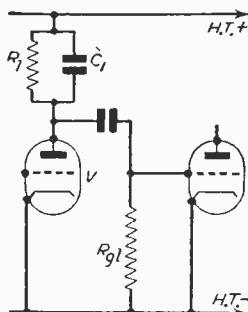

Fig. 6.—An alternative form of "top cut" circuit.

Top Lift

The simple circuit of Fig. 1 can be modified to give "top lift" by the inclusion of an additional

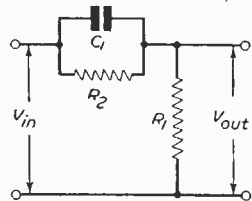

Fig. 7.—The circuit of Fig. 1 modified to give "top lift."

resistor R_2 in parallel with C_1 . This extra component slightly complicates the calculation of response curves and component values, but the following explanation and numerical example should make the method clear. The top lift circuit is shown in Fig. 7 from which it is clear that there is no loss at very high frequencies because the reactance of C_1 is very small and the capacitor short-circuits R_2 . On the other hand at very low frequencies the

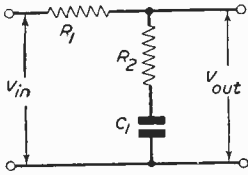

Fig. 8.—The circuit of Fig. 3 modified to give "bass lift."

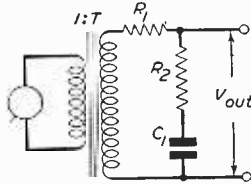

Fig. 9.—A practical form of Fig. 8.

reactance of C_1 is large and R_2 "short-circuits" the capacitor; the loss in the circuit is then given by—

$$\text{Loss in db.} = 20 \log_{10} \frac{R_1 + R_2}{R_1} \dots\dots\dots (1)$$

This expression gives the total number of decibels of "top-lift" available from the circuit and it is clear that this is decided by the ratio of $(R_1 + R_2)$ to R_1 . The capacitor value decides at what frequency the lift begins and as a rough approximation it may be assumed to begin when the reactance of C_1 equals R_2 .

As a numerical example suppose a lift of 10 db. is required between 1,000 c/s and 10,000 c/s. From the expression (1) R_2 must be roughly twice R_1 to give 10 db. lift, and provided this requirement is met, the actual values of R_1 and R_2 are unimportant. Generally however the constants of a tone-control network must have specific values in order to fit in with an existing amplifier; in other words the network must have a certain input or output impedance and the values of the components are thus fixed. In this example we will suppose that R_1 must be 100,000 Ω . R_2 is thus 200,000 Ω and C_1 must be 0.0008 μF . which has a reactance of 200,000 Ω at 1,000 c/s. Unfortunately there is no simple way of plotting the response curve of this circuit for the figures given in the decibel table apply only to circuits containing a single capacitor and resistor.

Bass Lift

The circuit of Fig. 3 can be modified to give "bass lift" by the inclusion of an additional resistor R_2 connected in series with C_1 as shown in Fig. 8. The calculation of frequency response curves and component values for this circuit can be made by methods very similar to those used with Fig. 7. At high frequencies the reactance of

C_1 is negligible and the network has a loss given by

$$\text{Loss in db.} = 20 \log_{10} \frac{R_1 + R_2}{R_2} \dots\dots\dots (2)$$

On the other hand at very low frequencies the reactance of C_1 is very large and there is practically no loss in the network. Thus expression (2) gives the total number of decibels of control available from the circuit. The reactance of C_1 decides at what frequency the loss begins. If C_1 is large, its reactance is small and the loss begins at a low frequency; the circuit then gives bass lift. If C_1 is small and its reactance large the loss begins at a high frequency; the circuit then gives "top cut." As a rough approximation it may be assumed that the loss begins when the reactance of C_1 equals R_2 .

Equalizer Circuit

As a numerical example, we will calculate the values of R_1 , R_2 and C_1 required in the gramophone pick-up equalizer shown in Fig. 9. The network must provide about 15 db. of "bass lift" at 50 c/s and the lift should begin at about 300 c/s. The pick-up is designed to work into a certain load and to satisfy this requirement we will assume that the load on the transformer secondary winding must be 100,000 Ω . From expression (2) R_1 must be four times R_2 to give 15 db. of "bass lift." Over most of the audio-frequency range the reactance of C_1 is small compared with R_1 and the secondary load may be taken as $(R_1 + R_2)$. This total must equal 100,000 Ω and the value of R_1 is 80,000 Ω and R_2 20,000 Ω . The bass boost is required to begin at 300 c/s and C_1 must have a reactance of 20,000 Ω at 300 c/s. From a reactance chart the necessary value of C_1 is 0.025 μF . There is no simple way of calculating the response curve given by this

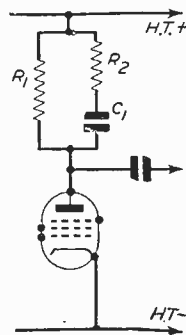

Fig. 11.—An alternative form of "bass lift" circuit.

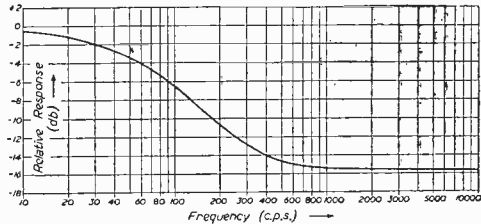

Fig. 10.—Frequency response obtained with the circuit of Fig. 9.

circuit and the figures given in the table do not apply. But as this circuit is extensively used in gramophone reproducing equipment the frequency response for the component values mentioned has been calculated and is given in Fig. 10.

An alternative bass-lift circuit is given in Fig. 11. This shows frequency correction carried out in the anode circuit of the gramophone pre-amplifier. Its operation may be explained in the following way. At very low frequencies the reactance of C_1 is very large and the anode load of the valve is nearly equal to R_1 ; at very high frequencies the reactance of C_1 is very small and the anode load is nearly equal to R_2 . R_2 is one-quarter of R_1 and the gain of the pentode tends to be directly proportional to the load resistance; thus the gain is greater at low frequencies than at high ones. This circuit has the advantage over that of Fig. 9

(Continued on page 129)

On your Wavelength

By THERMION

The Baird Imbrolio

IN last month's issue I dealt with a letter received from R. F. Tiltman, who wrote Baird's biography. You will remember that he disagreed with my statement, to which I rigidly adhere, and which I emphasise and underline, that Baird had little if anything to do with television as we know it to-day.

However, since writing that paragraph I have looked up Mr. Tiltman's book entitled "Television for the Home," published in 1927. In it he writes: "Television is not a probability of the future but a concrete fact of to-day."

Also: "There can be no question that Television Limited (Baird) have got the nucleus of really big business and there is no half measure about it—television is here. The television will be attached to the loudspeaker or output terminals of a powerful radio set, just as you now attach your loudspeaker. These pieces of apparatus will give you both sight and hearing." He considered it good advice to quote and endorse the statement: "In my opinion the ultimate television receiver will be a simple piece of apparatus fitting into the last stage of the audio-frequency amplifier of the present type radio set. It will cost less than £5." The amateur of the time was not misled by these statements and treated them with characteristic reserve.

Mr. Tiltman was not, as it has turned out, a good prognosticator. Let us all admit that Baird demonstrated the practicability of the principles of the scanning disc as laid down by Nipkow in 1856. I had as good results with a Baird disc machine as anybody and it was pretty foul, judged as a commercial device and not as a half-baked commercialised laboratory experiment. By the too early marketing of a television receiver, which Baird must have known would cause disappointment, he did immeasurable harm not only to himself and his company but also to television generally. When Baird first appealed on the Stock Exchange for £100,000 of public money on the specious promise that "real television is here," and that "television will be in every home by Christmas," he must have known both of those statements were untrue. The whole history of Baird's commercial enterprise is one of failure because he failed to keep the promises he made to those who backed him. In my view the Television Advisory Committee were generous in allowing Baird to have the first run of the B.B.C. high-definition programmes. It was his last chance to demonstrate the truth or the falsity of his claims. We all now know that at the end of the experimental period the B.B.C. changed over to the E.M.I. system.

It is only right that these matters should be set on record. It is only fair to say that I have received many letters in support of my views, including one from E. L. Haynes, of Haynes Radio Limited, who asks: "Who will write in defence of Mr. Tiltman? Certainly not the misguided public who subscribed to the Baird television flotation of the time."

I write this for the benefit of future historians. We do not want a repetition of the Alfred and the Cakes and the Bruce and the Spider rubbish. In these days when records are available, let historians be accurate. From this point of view biographies and autobiographies are not a good guide. The former tend to play up the good points of a man's life, to omit the bad, and to make the subject a sort of national hero, and as to the second there is always a tendency to egoism. The onlooker, it is said, sees the best of the game. I have been associated with radio and television as long as anyone in this country and certainly as long as Mr. Tiltman and my opinions therefore are at least as valuable as his. A biographer cannot be a disinterested party. I am entirely so.

I am not one of those who believe that intelligence and creative ability are indigenous to the soil of any part of Great Britain, and I deprecate these frequent attempts to corner the glory for one particular section of the English race. There are many people, whose praises go unsung, who have performed more for television than the late Mr. Baird, and whose inventions in connection with television are of the highest possible order. The publicity-seeking quack who batters on to other people's discoveries and claims them as his own should quite rightly be condemned.

And so, in the words of the editor, "this correspondence is now closed."

Delivery Delays

A CORRESPONDENT invites me "to have a bash" at what he considers to be inordinate delays in the delivery of wireless components. The cause of his wrath is that he has been kept waiting 10 days (I said 10 days!) for some components which were advertised in this journal. And, he goes on, this is not the first occasion; and what am I going to do about it? By the time the reader reads this he will of course have received his components and calmed down, so anything I could have done would be wasted effort anyhow. There are many reasons why readers should forbear in patience regarding the delivery of certain components. Most of our advertisers give a return-of-post service, but if they themselves are held up by the manufacturers they in turn must hold you up too. Another reason for delays is the terrific demand for certain components. An advertiser may lay in what he considers to be a supply of components adequate to meet an expected demand, only to find after his advertisement has appeared that his estimate was inadequate. On other occasions he is landed with a stock. Be patient, dear readers, and remember that 1949 is not 1939. You cannot buy what you like when you like nowadays, when our life is pretty well ordered for us. Incidentally, where is this increased standard of living about which people speak so freely?

Ex-W.D. Moving-coil Headphones

Converting a Headphone Unit into a Microphone

IT is possible nowadays to buy ex-W.D. moving-coil headphones at extremely reasonable prices. One postal firm, for instance, sells them at half-a-crown each.

Apart from their immediate use as headphones, these moving-coil units may be easily put to other purposes; in particular, they may be converted to microphones. In this case really good quality instruments can be obtained with a ridiculously small outlay in time and money. In fact, it is hardly stretching a point to state that a moving-coil microphone so constructed may be made for only a few shillings, and yet its performance would be comparable with commercial models, retailing at several pounds.

The Internal Construction

It would be well worth while at this stage to devote a few paragraphs to the internal construction of these headphones. This will help us to strip the units down for conversion and also give us an idea of their limitations.

Fig. 1 (a) shows a cross-section of a typical moving-coil unit. Beneath the screw-on cap and waxed-silk diaphragm (whose purpose is probably to prevent the ingress of moisture in atmospheres of high humidity), is found the cone. The cone and its surround are made from one piece of material. Presumably, the shape of the cone proper is sufficient to ensure good rigidity when compared with the flat surround. The coil is fixed to the

cone at its centre, a curved piece of material being mounted above it. There is no "spider," as would be found in a larger movement, the cone itself keeping the coil in the centre position. In practice, it will be found that the assembly holds the coil quite stiffly, and a relatively large amount

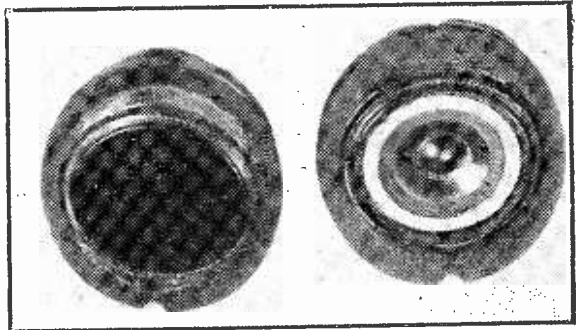

General view of the headphone with and without cap.

of force has to be applied to twist the coil former out of alignment with the magnet poles. This is an advantage, as will be seen later.

The movement of the cone is somewhat limited, since part of the black plastic mounting fits in closely underneath it. This, incidentally, precludes the use of the headphone as a miniature loud-speaker, as it would obviously be impossible to obtain any bass response with such a limited clearance.

The permanent magnet itself needs little explanation. The hole down the middle of the centre pole is presumably to prevent damping which might occur due to the small volume of air that would otherwise be trapped between the centre of the cone and the polepiece.

Fig. 1 (b) gives the more important dimensions of the headphone unit. These are shown to give an idea of the size of its component parts, and are approximate.

Conversion to Microphone

As it stands, the headphone will, of course, function fairly well as a microphone of sorts. However, owing to the small area of the cone the amount of pick-up is limited and the unit would be very insensitive.

Nevertheless, by the addition of a larger cone, an extremely useful microphone can be obtained. Fig. 2 shows the idea. The cap and waxed-silk diaphragm shown in Fig. 1 (a) are removed and an additional and much larger cone is mounted to the original one at the centre. The angle of the new cone is made slightly smaller than that of the original cone so that it will then clear the mounting at the surround. The original cone now acts as a spider. Owing to the rigidity of the suspension, the slight additional weight of the new cone has

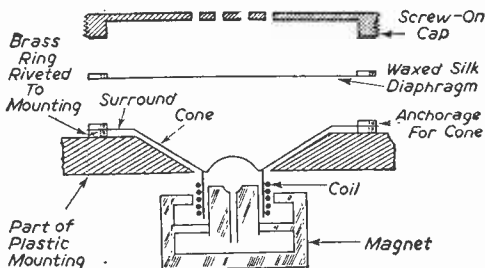

Fig. 1 (a).—Section of a typical unit.

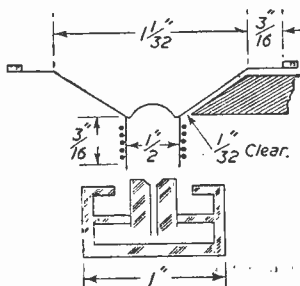

Fig. 1 (b).—The more important measurements of the units are shown in this illustration.

no obvious effect on the positioning of the coil in the magnet gap.

Dismantling the Headphone

The process of making and fitting the new cone is fairly simple. The hardest job is in getting the phone to pieces!

There appear to be two types of headphone offered on the "surplus" market. One type has a screw-on cap as shown in Fig. 3. This cap may be removed quite simply, whereupon the phone is immediately available for conversion. The two

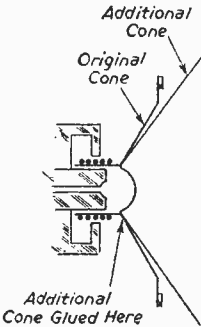

Fig. 2.—How to convert a standard receiver unit for use as a microphone.

terminals at the rear are useful for mounting purposes.

Unfortunately, this type of headphone does not appear to be readily available nowadays. The second and more commonly-met type is shown in

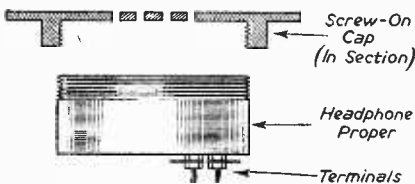

Fig. 3.—Screw-on type cap is shown here.

the photograph and has a cap similar to that illustrated in Fig. 1(a). Reference to the diagram and photograph, will show that there is no purchase anywhere available on the cap, should it be desired to unscrew it. When fitted, it lies almost flush with the rest of the case.

In addition, to make its removal more difficult, the threads of the cap are sealed during assembly with a fixing compound which it is practically impossible to shift. The writer has tried several different types of solvent in order to remove this fixative, but all attempts have proved unsuccessful. The best alternative course consists of breaking the cap away. This may be done by gently cracking the cap at the centre; then breaking off little pieces of the cap with a pair of long-nosed pliers until all but the outside has been removed. Care should be taken to see that the cone is not scratched or damaged during this operation. The result is a jagged edge which, although somewhat untidy, effectively clears the underside of the additional cone. The photograph illustrates the appearance of the unit before and after the cap has been removed.

Making and Fitting the Cone

The additional cone is made from light cartridge paper. Fig. 4 shows the dimensions before cutting and folding.

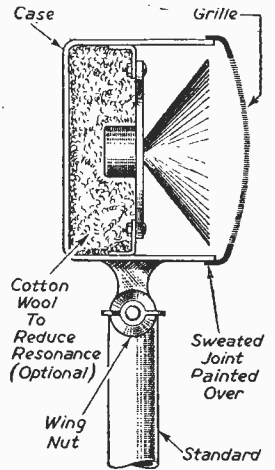

Fig. 6.—A finished microphone showing method of mounting in a case and packing to reduce resonance.

After marking, the paper may be cut out to shape, but it is advisable to leave the smaller hole at the centre until after the cone has been glued and set. This is because it is difficult to make the cone so that its apex is exactly at the centre point of the circle, the result of course, being an exaggerated dispositioning of the smaller hole.

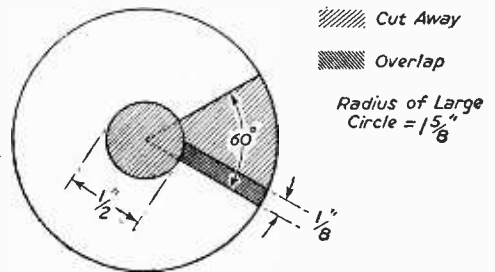

Fig. 4.—Simple method of cutting and making cone.

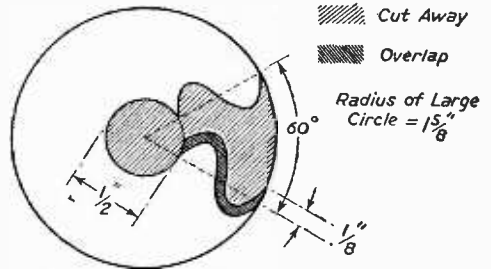

Fig. 5.—A more elaborate method of making a cone diaphragm.

When the cone has been cut and glued, the smaller circle which has been marked out may be used as a guide to cutting out the centre.

An alternative method of marking out the cone is shown in Fig. 5, where it may be seen that, instead of using a straight overlap, a curved line is used. This enables a stronger cone to be made.

Mounting the Microphone

An adhesive which does not set to a brittle hardness should be used for glueing the cone. The type of fixative sold in tubes is usually ideal for the purpose.

All that now remains is to mount the finished microphone in a case. Individual constructors will, of course, have their own ideas on the type of

case to be employed, but a general idea is shown in Fig. 6. Spring mounting of the case is not entirely essential, as the microphone does not respond unduly to chance knocks, etc.

The microphone, when finished, may be treated in just the same manner as a commercial moving-coil model. Its output is at low impedance, and relatively long leads may be employed between it and the amplifier. If care has been taken in the construction it should be capable of really good reproduction, and it will be found very useful for dance-band and similar P.A. work where a high degree of fidelity is needed.

Unlimited Ultrasonic Power

Details of the New Mullard Magnetostriction Generator

COMMERCIAL applications of ultrasonics to industrial processes may soon become a practical possibility through the use of a new low-frequency magnetostriction generator recently introduced by the Electronic Equipment Division of Mullard Electronic Products, Ltd. The first of its kind yet to be produced, this generator follows the success of Britain's first commercial high-frequency quartz crystal generator, which Mullard introduced earlier last year for laboratory use. Although this generator is proving of immense value in ultrasonic research, especially as applied to the treatment of extremely fine particles and bacteria, the limitation of its power to 500 watts means that it cannot be used successfully in production processes. In the new magnetostriction generator, however, this difficulty has been overcome.

Although the standard generators so far produced have powers of 1 kilowatt and less, and are intended primarily for experimental use, there appears to be no limitation to the ultrasonic power that may be produced by generators of this class.

In Two Parts

The Mullard low-frequency ultrasonic generator consists of two parts: the main unit comprising a driving oscillator, power amplifier and low-voltage D.C. power supply, together with necessary monitoring and check meters; and the transducer unit composed of a stack of nickel laminations wound with a common coil for excitation and polarisation. The amplifier which provides the source of power for the transducer is basically similar to a proved design of public address equipment, and delivers a maximum output of 1 kilowatt over a frequency range of 10 kc/s to 25 kc/s.

The almost unlimited field of applications of ultrasonics in industrial processes opened up by this generator are due almost entirely to the design of the magnetostriction transducer. This is composed of a stack of nickel laminations somewhat resembling a transformer core. The insulation of this unit is such that the complete transducer may be immersed in conductive liquids without fear of damage or electrical shock. In practice, the transducer can quite easily be clamped against the side of the treatment bath. Alternatively, it can be fitted in a pipe junction, thus enabling the liquid to

be treated as it flows over the actuating face. Besides being more compact and giving higher power outputs than previous transducers of the rod type, the new Mullard transducer has the advantage that it can quite easily be made to individual requirements. It can, for example, be provided with a curved actuating face. With simple cooling arrangements, a loading of about 5 watts per square centimetre can normally be used.

The maximum dimensional change, and therefore the maximum transfer of electric to ultrasonic energy, is obtained when the magnetostriction element is excited at its natural frequency. For this reason it is necessary to provide different transducers if the frequency of excitation is changed. The transducers at present available cover the standard frequencies 15 kc/s, 20 kc/s and 25 kc/s. Transducers covering other frequencies can be supplied to special order. The interchange of transducers for different frequencies can be easily and rapidly carried out.

Simplified Controls

The generator is rack-mounted for ease of service, and the controls are simplified for operation by semi-skilled labour. Continuous operation is possible at peak power over a frequency range of 10 kc/s to 25 kc/s. Equipment working at other frequencies may be supplied to special order.

Since the velocity of sound in nickel varies with the temperature and the magnetic field—and this in turn affects the natural frequency of the transducer—it is sometimes necessary to make a small adjustment to the generator frequency. For this reason a variable frequency source of power is provided.

Low-frequency ultrasonic waves have been used experimentally for many purposes, and applications can be found in a great number of industries. The robust design of the transducer employed in the new Mullard equipment offers scope for work in the metallurgical field in the mixing of powdered and molten metals in alloy production. It is possible that the equipment could also be used for speeding up the process of solidification in molten tin and aluminium, and for the tinning of aluminium and similar metals. Emulsification of a number of liquids, and the precipitation or dispersion of particles in suspension, are further possibilities of ultrasonics.

FOR THE UTMOST REALISM FROM RECORDS & RADIO

LISTEN-IT'S A GOOD SOUND JOB

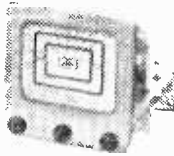

THE R.A. TUNING UNIT

A really fine design with lasting high performance. R.F. stage on all wavebands. High fidelity superhet or T.R.F. performance, at the turn of the switch. Suitable for any amplifier.

10 Gns. plus £2 : 6 : 8 tax
(2 years' guarantee)

(With escutcheon plate as shown 5/- extra)

THE K.I. AMPLIFIER KIT

The K.I. Kit is undoubtedly the best high fidelity amplifier kit available at the price. Absolutely complete, very simple to construct, the performance matches up to the high standard reached by moving coil pick-ups. We recommend either moving coil pick-ups or miniature moving iron types, such as the Connoisseur, which may be used without the transformer.

Price 13 Gns.

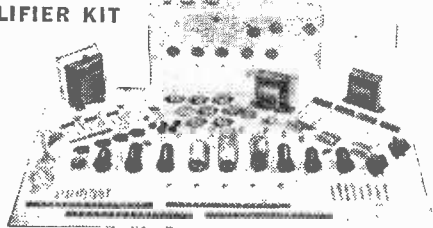

Write to-day for your copy of our fully illustrated catalogue.

Charles AMPLIFIERS

(Sales) LTD

181 Kensington High Street, London, W.8

Phone: WEStern 3350

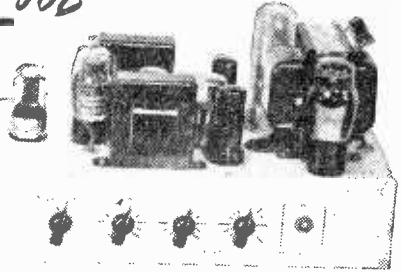

THE K.I. AMPLIFIER

This seven-valve amplifier, designed for the lightweight high fidelity type pick-up, is proving the real answer for the music-lover who seeks a high standard of reproduction at a moderate cost.

Independent bass and treble controls permit compensation for recording losses and reduce needle scratch. Tetrodes with negative feed-back ensure negligible distortion.

Price Complete 17 Gns.
Blueprint separately 2/6
(2 years' guarantee)

DEFERRED TERMS AVAILABLE

Our equipment can also be seen and heard at Webb's Radio, Soho Street, London, W.1 Signal Shop, 51, St. Mary Street, Bridgewater, Som.
Ernest Buchan, 28, Belmont St., Aberdeen
Farmer and Co., 83, George Street, Luton

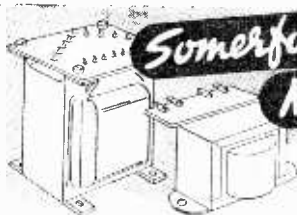

Somerford and Miniford

AUDIO OUTPUT TRANSFORMERS

CHARACTERISTIC CURVES

of Somerford Transformers showing frequency response between 20 cycles per second and 25,000 cycles per second are available upon request.

TRANSFORMERS

These two standard ranges of Output Transformers will meet all normal needs of the home constructor. They provide a degree of accuracy, quality and dependability which cannot be surpassed.

SOMERFORD.—A range of Output Transformers designed to ensure high quality and reliable performance. Suitable for single ended or push-pull circuits, covering the widest limits of the audio frequency band. May be used with confidence for the most exacting circuits.

MINIFORD.—A range of high quality transformers of economical design which provide excellent reproduction for domestic purposes, but over a more restricted range of audio frequencies than the Somerford Transformers. 2, 4 and 8 watt types suitable for all Outputs.

Write for our New Folder giving details of these two ranges.

GARDNERS RADIO Ltd

SOMERFORD CHRISTCHURCH HANTS
PHONE: CHRISTCHURCH 1025

£ LEARN MORE

FREE BOOKLET

giving details of home study and daytime courses —



HOME STUDY

- Practical Radio Receiver Servicing
- Basic Radio } for R.T.E.B. —
- Basic Television } "The practical man's diploma"

DAYTIME

- Principles and Practice of Radio — 1 year
- Telecom. Engineering — 2 years
- Electronics Engineering — 3 years (including 1 year in E.M.I. Factories)
- Marine and Air Radio Officers' Course (for P.M.G. Licence)

Write to Dept. 32:

E.M.I. INSTITUTES

10, Pembridge Sq., Notting Hill Gate, London, W.2

Associated with "H.M.V." MARCONIPHONE COLUMBIA ETC.



RESISTANCES. A parcel containing 100 popular assorted values for 1 watt type 6 or 1 watt 8/9.

COILS—Denco T.R.F. Matched pair Medium and Long Waves, 6/6 pair; Weymouth T.R.F. Matched pair M. and L. Waves, 9/6 pair. Superhet Matched pair S. M. and L. Waves, 8/9 or 11/6 3/- each, in stock. Weymouth Midget 11in. x 1/2in. dia. Iron Core, Aerial H.F. or Osc., 3/6 each, or Denco "Maxi Q." **OSMOR MIDGET COIL PACK.** Size 3 1/2in. x 2 1/2in. x 1 1/2in. covering S., M. and L. Waves. Coils wound on Polystyrene Formers with adjustable Iron Cores, ensures efficient performance. Factory wired and aligned. Price including full circuits for Superhet 465 k.c. Unit, 33/-; For T.R.F. circuit covering M. and L. Waves, 30/-.

THE OSMOR BATTERY PORTABLE SUPERHET PACK including ready wound Frame Aerial available at 37/6.

OUTPUT TRANSFORMER—Stern's, Midget 1 1/2in. x 1 1/2in. x 1 1/2in., ratio 60-1, 4/6 (or ratio 90-1, 4/6). Elston Multi-ratio (over 12 ratios, some C.T.), 5/6 watts, 7/6. Stern's Heavy Duty Multi-ratio, 2 C/Tapped, handles 13 watts and suits P.N.'s, 6L's, etc., 25/6.

L.F. CHOKES. Midget 10 Henry 250 ohm 40 m.A. 3/6; 15-20 Henry 250 ohm 60 m.A. 6/6; 20 Henry 300 ohm 100 m.A. 12/9; 5 Henry 50 ohm 250 m.A. 18/6; 20 Henry 250 ohm 120 m.A. 18/6; 9 Henry 250 ohm 120 m.A. 8/6.

ALUMINIUM CHASSIS. Substantially made of gauge 16 S.W.G. with four sides, 7in. x 4in. x 2in., 3 x 3; 9in. x 5in. x 2 1/2in., 4/-; 10in. x 6in. x 2 1/2in., 4/11; 10in. x 8in. x 2 1/2in., 5/6; 12in. x 9in. x 2 1/2in., 6/8; 14in. x 9in. x 2 1/2in., 6/11; 16in. x 9in. x 2 1/2in., 7/3; 16in. x 8in. x 2 1/2in., 8/6.

SELENIUM RECTIFIERS. H.T. H. Wave, 250 v. 50 m.A. 5/-; 200 v. 100 m.A. 5/9; 250 v. 100 m.A. 7/6. 12 v. 1 1/2 amp., 12/6. 12 v. 3 amp., 21/-; 12 v. 5 amp., 25/-; 24 v. 3 amp., 23/6.

CHARGER TRANSFORMER. Each has input of 230 volts, outputs 24 v. (tapped 15 v., 9 v. and 4 v.), 21/6; 30 v. (tapped 15 v. and 9 v.), 22/-; 15 v. (tapped 9 v.), 14/3; 15 v. (tapped 9 v.) 6 amps., 19/6; 16 v. 8 amps., 37/6.

FILAMENT TRANSFORMER. Input 230 volts, output 6.3 v. 1 1/2 amp., 7/6; 4 v. 1 1/2 amp., 7/6. Input 200/250 v.,

output 4 v. (C.T.) 1 1/2 amp., 1 v. 2 amp., 6.3 v. 2 amp., 17/6.

PRACTICAL WIRELESS "IMPROVED AUXILIARY" 3 VALVE (plus Rectifier) A.C. D.C. MAINS T.R.F. RECEIVER. We can supply all the components, including valves, drilled chassis and M coil speaker, to build this midset set, size 7in. x 4 1/2in., as specified in the November issue, at a total cost of £4 17/6. Reprint at a detailed assembly instructions (incl. practical layout) and circuit supplied separately for 9d.

STERN'S BATTERY PORTABLE "PERSONAL" KIT. A complete kit of parts to build a Midget 4-Valve All Dry "Personal" Set.

Consists of regenerative T.R.F. Circuit, employing Flat Tuned Frame Aerial with Denco Iron Dust Cored Coil, thereby ensuring maximum gain for Single Tuned Stage, covering Medium Waveband.

Valve Line-up: 1T4 (R.F. amp.), 1T4 (Detector), 1S5 (1st A.F.), and 354 (Output). Includes 3 1/2in. P.M. Speaker and with chassis already drilled and shaped.

Consumption of only 7 mA ensures long battery life.

The kit is designed for a cabinet, minimum size 8 1/2in. x 4 1/2in. x 3in. Detailed Building Instr. and circuit, including Practical Layout included with each Kit, make assembly very easy (supplied separately for 1/6).

PRICE FOR COMPLETE KIT, £3 18/9 (plus 16/7 P.T.). Suitable Unpolished Cabinet, 12/9; E. Ready B174 Battery, 9/7.

The MIDGET A.C. MAINS 2 VALVE RECEIVER. All the components to build this popular Set, as specified in a technical publication, can be supplied complete for £3. Reprint of detailed building instructions, giving practical layout and circuit, supplied separately for 9d.

A COMPLETE SET OF COMPONENTS to convert the Midget A.C. mains 2 valve to 3 valve set covering L. and M. waves is available for 33/-, reprint of assembly details available for 9d.

The 3 valve A.C. mains receiver circuit, as published in Wireless World. All the components to build this set, covering long and medium waves can be supplied for £4 7/6, including Drilled Chassis. Reprint of assembly instructions (supplied separately), 9d.

★ Send 2 1/2d. stamp for our Comprehensive Stock List. When ordering please cover packing and postage.

STERN RADIO LTD., 109 & -115, FLEET STREET, E.C.4.

Telephone: CENTral 5814 & 2280

CLYDESDALE
BARGAINS IN EX-SERVICE
ELECTRONIC EQUIPMENT

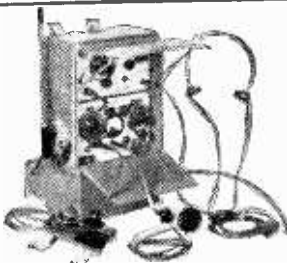

Brand New, in maker's original packing.

WIRELESS SET No. 48 MK.1 Transmitter/Receiver.

American version of the No. 18 Set, modified to U.S. Army requirements. Frequency coverage—6 to 9 mc/s. 33.3 to 50 metres. Complete equipment for "Phone" and C.W., comprising

TRANSMITTER with 1,000 kc. Xtal, 5 valves, 1A5, 2 1LD5's, etc. **RECEIVER**, with 6 valves, 2 1LD5's, 1LA6, 2 1LN5's, 1A5, etc. **HAND-DRIVE GENERATOR**, supplying

H.T. and L.T. plus 12 v. bias with switches for (S18) with operator's seat, etc. **AERIAL**, 10ft. Rod type (11 sections), ranges 5 miles R/T, 10 miles C.W., greater ranges can be obtained with a normal aerial. Plus cables and **INSTRUCTION BOOK**. This equipment can also be used with dry batteries (not supplied) as a **PORTABLE WALKIE-TALKIE**. Power requirements: H.T. 162 v. 60 m.A. L.T. 3.1V. 0.3A. Dimensions: Set and battery container: 11 1/2 x 10 1/2 x 17 1/2 ins.



CLYDESDALE'S PRICE ONLY **£14.10.0** Carriage Paid

NOW READY. New illustrated List No. 6 (152 pages), send 6d. to cover distribution cost. Please print name and address.

Phone: SOUTH 2706/9.

Order direct from: **CLYDESDALE SUPPLY** 2, Bridge Street, Glasgow, C.5. Visit our Branches in Scotland, England and N. Ireland.

PRATTS RADIO

1070, Harrow Road, London, N.W.10.
(N. Scrubs Lane). Tel.: LADbroke 1731

(N. Scrubs Lane). Tel.: LADbroke 1731

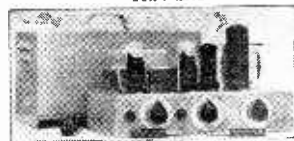

AMPLIFIERS.

Ready for use. **MODEL AC100** (as illustrated), 10-watt 4-valve unit. Neg. feedback. Separate mike stage and separate gram inputs. 2 faders and tone control. Input volts. mike .002 v., gram .21 v., output 181 watts, 6d.

MODEL AC18F. 6-valve push-pull unit. Output 181 watts. Separate mike stage and separate mike and gram inputs. 2 faders and tone control. Feedback over 3 stages; input volts. mike .003; gram. 3 v., £13 19s. 6d. **Model U10E.** 6-valve 10-watt unit for D.C./A.C. mains. Specification as AC18E, £11 11s. 0d. All above are complete with case and chrome handles. Inputs can be mixed and faded in or out as required. All match 3, 8 and 15 ohm speakers. Stamp for details of these and smaller units.

SPEAKERS. P.M. less transfr. Truvox 2 1/2in., 1 1/2; 5in., 10/-; 8in., 14/6; 10in., 18/6; 12in., 37/6. Plessey 15in., 8in., 11/9; 10in., 18/6; Rola, 6in., M.Eng., 700 ohm field, 10/-; 3 1/2in., Celestion, 10/6.

TRANSFORMERS. E.H.T. 2,500 v., 1 v., 4 v. C.T., 27/6; (suitable for VCR97) 2 x 350 v., 120 m.A., 6 v. 6 a.; 5 v. 4 a.; 4 v. 3 1/2 a.; 35/-; Speaker transfrs. pentode, 3/11; Ultra midget for S&A, 1C5, etc., 3/11; 5 watt, 6 ratio, 7/6; 30 watt, 10 ratio, 23/9; V.V.L.F.N.—Brand new 6K8, 6V6, 6K7, 6Q7, 5Z4, 6N7, 6J7, 6J9, 6C5, 6F6. All 6/- each. 1R5, 1C5, 1A7, 1S4. All 6/9 each.

VARIABLE CONDENSERS.—Long shaft and feet. Truoc .0005 mfd., 2 gang, 4/3; 3 gang, 6/9. Solid dielectrics, 0003, 3/4; .0005, 3/6. Presets, 50 pf., 4d., 100 and 500 pf., 1/3 each. C01S, etc.—Denco L. and M.W. with reaction, 6/6. Matched pr. Wearite "P" coils, all types, 3/- each. "Q" coil packs, 33/-; Wearite M400 I.P.'s, 10/6 each. Standard Wearite, 10/-; CONDENSERS.—Plessey midget, 16+8 x 450 v., 3/9; 8+8 x 450 v., 3/6; 3 mfd., 350 v., 1/11. T.M.C. 8 x 450 v., 2/9; 16+16 mfd., 350 v., 3/6. Dubilier 16 x 350 v., 1/11; Plessey 25 mfd., 25 v. 10d. Ditto T.C.C. 1/6. E.I. cardb'd 500/550 v., 8 mfd., 3/3; 16+8, 6/-; 8+8, 4/9; paper condensers, 00012/375 mfd., .01 x 1,000 v., .05 x 350 v.; .1 mfd., 350 v., 5 mfd., 350 v., 6d. each.

MISCELLANEOUS.—Octal bases, 4d.; 6 volt, valve droppers with feet and sliders, 2s., 1,000 ohms, 2s., 800 ohms, 4/6 each. Linecord, 3 a., 3-way, 60 ohms ft., 1/- yard. Volume controls, less s.w., 2/9; with s.w., 4/6. All valves, 5,000 to 2 megohms. Chokes, 60 m.A., 20 hy., 400 ohms, 6/6; 90 m.A., 10 hy., 10/6; 150 m.A., 10 hy., 14/3. Valve screens, complete, 1/3.

All goods new and unused. Post free over £1 C.W.O. of C.O.D.

The Band-searcher Tuning Unit-2

An Interesting Accessory for the Short-wave Enthusiast

By J. R. DAVIES

WE may now mount the tuning condenser to the plate A. If the maximum dimensions given above for this component were adhered to it may be mounted as shown in Fig. 4(a), i.e., with the main body of the condenser below the spindle. Practically all modern tuning condensers have a good selection of holes in the front plate and some of these may be utilised for mounting purposes. As these holes are not standard the constructor must mark them out for himself on the plate A. At least three mounting screws will be needed as the condenser must be attached to the front plate very firmly indeed. Attention must, of course, be paid to the exact centring of the spindle in the appropriate hole in the plate.

4. The various parts of the locating mechanism may now be attempted. Two further parts to mount to the circular disc B are manufactured. These are shown in Figs. 5 and 6. The semi-circular piece, part D, has all its measurements taken relative to a centre not actually on the finished piece of metal itself. When originally marked out, however, this centre may be marked by a light centre-punch on a slab of metal approximately 2 3/4 in. by 4 in. and all the dimensions scribed out before the required piece is cut out. A large amount of the metal inside the arc may be removed by criss-cross cutting with a hacksaw.

5. The parts B, C and D may now be fitted together as shown in Fig. 7. It will be seen that the two outer 6 B.A. screws holding C to D are short bolts, whereas the two inner screws not only have their heads on the inside of plate B, but also have their threaded portions projecting some considerable distance outwards. These screws are used to hold the cord drum for driving the tuning condenser (which will be described later), and their threaded portions should extend at least 3/4 in. from the surface of part C. The semi-circular slit between parts B and D must have a regular width along all its length. It should accommodate the shank of an 8 B.A. screw, which should be free to slide over the entire length of the slit. If the screw fits tightly at any points, any slight inaccuracies in the filing may now be carefully cleaned up. There will also be some slight degree of adjustment at the 6 B.A. mounting bolts which can be utilised to obtain satisfactory alignment of the various parts. When this is completed all the 6 B.A. bolts may be made really tight and will not require loosening again. (It will be seen that the difficult-to-make semi-circular slit of Fig. 2, has been made by using three separate pieces of material.)

6. The small locating "spikes" E may now be made. The number needed depends on how many bandset positions are required. The author used six, which should cover nearly all requirements. They are not so difficult to make as may be thought. After the first is made it may be used as a template for the others. It is advisable to drill the holes

before filing out the outline as it is a little more difficult to mark out the holes accurately after filing. Fig. 8 (a) gives the dimensions.

7. The spikes may now have their anchor nuts fixed and may be mounted on to the circular plate. The nuts are "anchored" to each other by soft solder.

To carry this out two brass 8 B.A. nuts are held to one of the spikes by two steel 8 B.A. screws. It will be found that in this position they almost touch each other. They are then soldered as shown

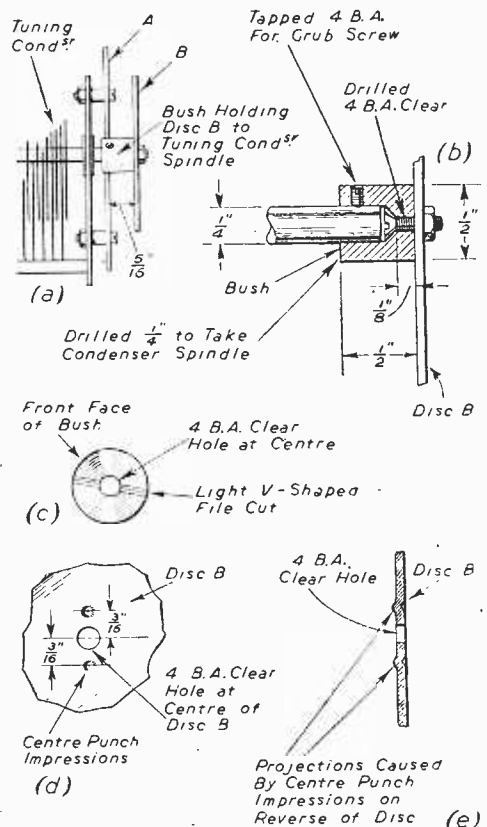

Fig. 4 (a).—The baudset tuning condenser attached to plate A (side view).

Fig. 4 (b).—The bush holding disc B to the tuning condenser spindle.

Fig. 4 (c).—The file cut across the face of the bush. Fig. 4 (d) and (e).—Detail of centre of disc B illustrating how centre-punch impressions cause swellings on underface of the disc, these locating with the V-shaped file cuts on the bush.

in Fig. 8 (b). It is necessary to use steel screws to hold the nuts during this operation so as to prevent the screws being soldered as well as the brass nuts. For this reason it is also advisable to use just sufficient flux to break down the oxides on the more-easily soldered brass. The solder should not "take" to the mild steel spike if care is taken.

The spike and its associated lock-nuts may now be mounted on to the circular plate as shown in Fig. 8 (c). The two 8 B.A. screw heads should be on the front side of the plate. When these screws are slightly loosened the spike should be free to move to any position along the periphery of the circle, the spike always pointing outwards at right angles to the tangent of the circle. On tightening the screws the spike should be held extremely rigidly. All the other locating spikes can now be mounted and the disc temporarily fixed to the tuning condenser spindle.

8. We may now proceed with the locating mechanism situated below the circular disc.

First of all we must fix a 2 B.A. screw to the

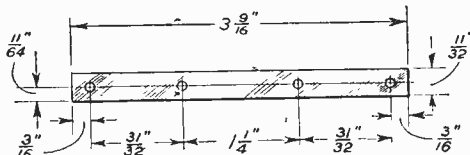

Fig. 5.—Another portion of the locating mechanism.

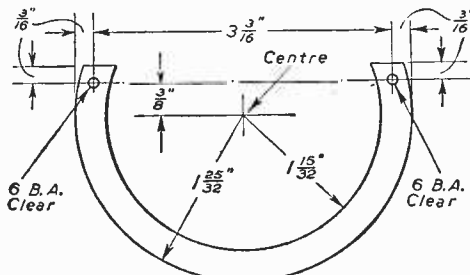

Fig. 6.—Semi-circular portion D.

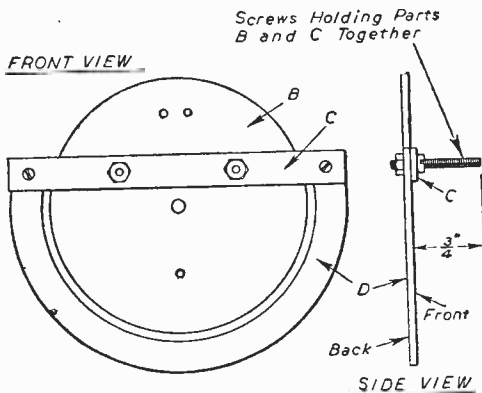

Fig. 7.—The method of mounting parts B, C and D together.

"2 B.A. clear" hole shown in Fig. 3 (a). The threaded part must project outwards from the plate, i.e., away from the tuning condenser side, for at least 1 1/6in. As it is the pivot for the locating lever it is best to use a steel screw. The nut holding the screw should not be thicker than 5/32in. If the tuning condenser is rotated, the ends of the locating spikes should just miss touching this screw.

9. The locating lever F may now be made. This consists of two pieces of metal cut out as shown in Fig. 9 (a). It will be noticed that the levers F and G each consist of two identical parts instead of one as shown in Fig. 2. This is because the mechanical strains are then equally balanced on either of the lever parts and they therefore require nothing but the simplest in the way of mountings and bearings. The two parts of lever F, for instance, come up on either side of the locating spike E. Incidentally, the shape of the levers is slightly different from the simplified versions shown in Fig. 2, but this is, of course, of small account.

When completed these may be bolted together. This is done by means of two 4 B.A. bolts in the two right-hand holes of fig. 9 (a). Fig. 9 (b) shows the general idea, whilst Fig. 9 (c) shows in detail the method of mounting the nuts and bolts. It is important to allow a space between the two inside nuts of the right-hand screw (Fig. 9 (e)), as a

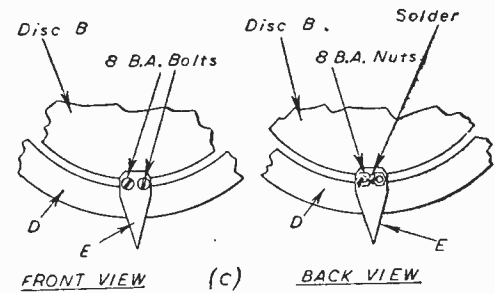
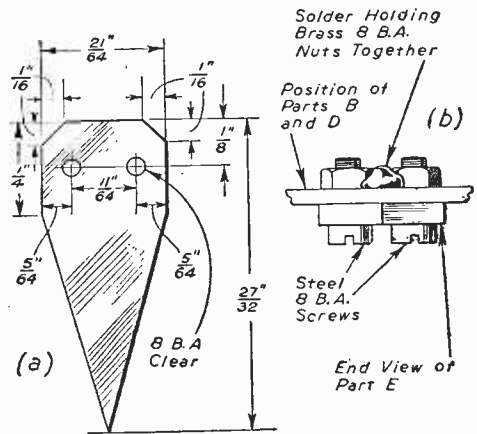

Fig. 8 (a).—Locating spindle E.
 Fig. 8 (b).—How the nuts for holding parts E are soldered together for anchoring purposes.
 Fig. 8 (c).—The method of fixing the locating spike E to the disc B.

spring has later to be hooked into this space. The two nuts (instead of one) on the outside of the left-hand screw are to provide a "stop." This stop serves the same purpose as that shown in Fig. 2 (d) although its position is somewhat changed.

When the two pieces have been bolted together the two "2 B.A. clear" holes should now lie directly above each other. Two cheese head (or round head) $\frac{1}{16}$ in. 2 B.A. steel screws may now be inserted as shown in Fig. 9 (d). These two screws take the place of the locating pegs shown in Fig. 2(a). They should be free to revolve in their holes if necessary. As there is not sufficient room between them to fit nuts at their ends they may be held in place by carefully fixing blobs of solder as shown in Fig. 9 (d).

The locating lever F may now be checked by

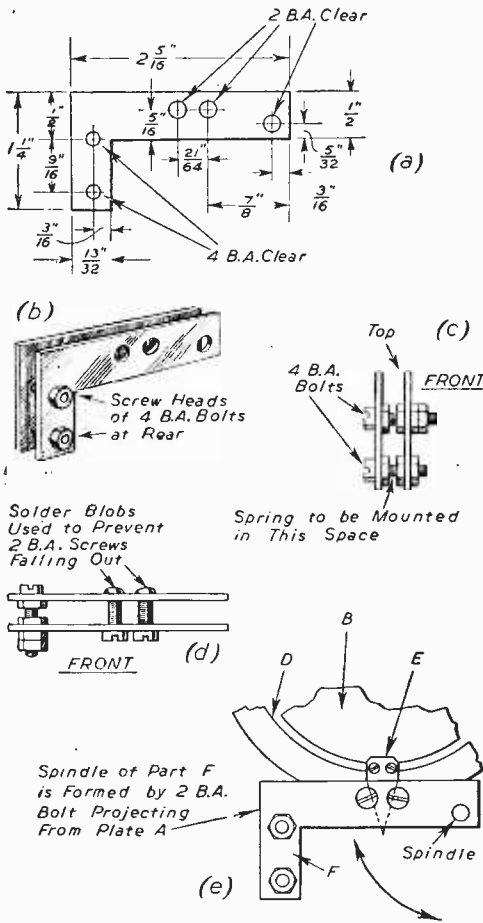

Fig. 9 (a).—Parts of the locating lever.
 Fig. 9 (b) and (c).—Showing how the two parts of lever F are fitted together.
 Fig. 9 (d).—View of top of lever F showing how the 2 B.A. steel screws acting as locating pegs are fitted. They should be free to rotate.
 Fig. 9 (e).—Experimentally checking the action of lever F.

temporarily mounting it by the two remaining "2 B.A. clear" holes on to the 2 B.A. steel screw projecting from the front of plate A. When the lever is pushed up by hand the two screws should

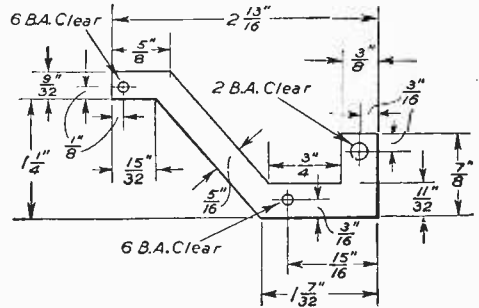

Fig. 10. (above)—Part 5 B.A. Clear of lever G.

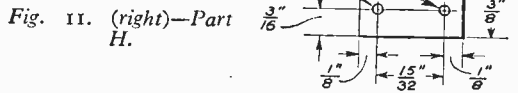

Fig. 11. (right)—Part H.

locate with whichever locating spike is selected and should hold the entire disc assembly rigid. The lever F should be approximately "horizontal" in this position and the locating screws should clear the periphery of part D by about $\frac{1}{16}$ in. See Fig. 9 (e).
 10. The two parts of lever G are next. Fig. 10 gives the dimensions.

11. Another small part II must be made before parts G can be assembled. Part H is shown in Fig. 11.

12. Parts G may now be assembled. (See Fig. 12). They are held together with one screw only, mounted through the central "6 B.A. clear" hole. Part H, it will be noticed, is pivoted at the centre of this mounting. It must be free to move around the 6 B.A. screw as axis. The 6 B.A. screw should have a 1 in. shank, that part projecting being used later to hold one end of the return spring.

(To be continued)

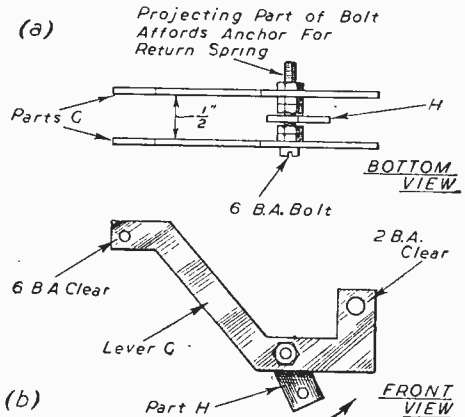

Fig. 12.—How the two parts of lever G are bolted together.

THE receiver circuit is shown in Fig. 3 and it will be seen that the arrangement is conventional apart from the heater supply method. V1 is the frequency changer, accepting signals from the aerial, mixing them with the local oscillations and passing on the I.F. signal to V2, the I.F. amplifier. A.V.C. is obtained from the anode of the I.F. stage which is coupled via C17 to one of the diodes of V3, the I.F. signal being passed to the other diode of V3 through a second I.F. transformer. V3 also gives the demodulated audio signal amplification before passing it on to V4, the output valve, whilst C23 and the grid stopper R16 filter out the last traces of I.F.

To prevent mainsborne interference the mains supply is filtered by a standard filter consisting of a suppressor choke in each mains lead, MSC, and a condenser, C29.

The heater supply condenser is C28, and it should be noted that this condenser, in the practical receiver circuit, is shunted by R18, a 1 megohm resistance. R18 plays no part in supplying the heater current, but it is a discharger to prevent C28's remaining charged when the receiver is switched off. If the throw of the switch coincides with a mains cycle peak quite a high charge can be held by C28, when

LIST OF COMPONENTS

- L1, Wearite PA2, 200-557 metres.
- L2, Wearite PA1, 700-2,000 metres.
- L3, Wearite PO2.
- L4, Wearite PO1.
- C1, C21, C24—0.01 μ F. 500 v.w. tubular : TCC 543.
- C2, C3, C12, C13—60 pF. trimmers : Walter Insts. MS70.
- C4, C6, C9, C15, C16, C18—0.1 μ F. 350 v.w. tubular : TCC 346.
- C5, C14—500 pF. double gang tuner : J.B. Type E.
- C7, C23—500 pF. mica. TCC CM20N.
- C8, C19, C20—100 pF. mica. TCC CM20N.
- C10, C11—double padder—220-480 pF., 100-240 pF. Walter Insts. 356.
- C17—50 pF. ceramic : TCC CC31y (cup).
- C22, C25—25 μ F. 12 v.w. electrolytic : TCC CE31B.
- C26, C27—16 plus 8 μ F. 450 v.w. electrolytic. (C26—16 μ F.): TCC CE28P, with clip H2.
- C28, 2.95—3 μ F. 500 or 1,000 v.w. paper. Built up as described, or use 2 μ F. and 1 μ F. in parallel : TCC Type 92.
- C29—0.001 μ F. mica. 750 v.w. : TCC M3U.
- R1, R4, R5, R14—47,000 ohms, $\frac{1}{2}$ watt.
- R2—220 ohms, $\frac{1}{2}$ watt.
- R3, R6—100,000 ohms, $\frac{1}{2}$ watt.
- R7—330 ohms, $\frac{1}{2}$ watt.
- R8—20,000 ohms, $\frac{1}{2}$ watt.
- R9—1 megohm variable, volume control, with double-pole switch.
- R10—47 $\frac{1}{2}$,000 ohms, $\frac{1}{2}$ watt.
- R11—1,200 ohms, $\frac{1}{2}$ watt.
- R12, R13, R18—1 megohm, $\frac{1}{2}$ watt.

Practical Series Heater

The Use of a Condenser in A.C. Receiver
By E. N.

a shock could be obtained from the mains plug or from the heater wiring if servicing or experimental work was to be performed.

The receiver circuit, Fig. 3, and the layout diagram, Fig. 4, should give the constructor all the necessary details to enable him to duplicate this receiver. Group board construction was not used; all components were mounted in the wiring

The receiver was intended for mounting in a midget set cabinet, and the tuning condenser drive was therefore made a drum and cord arrangement, with a pointer mounted at the end of the tuning

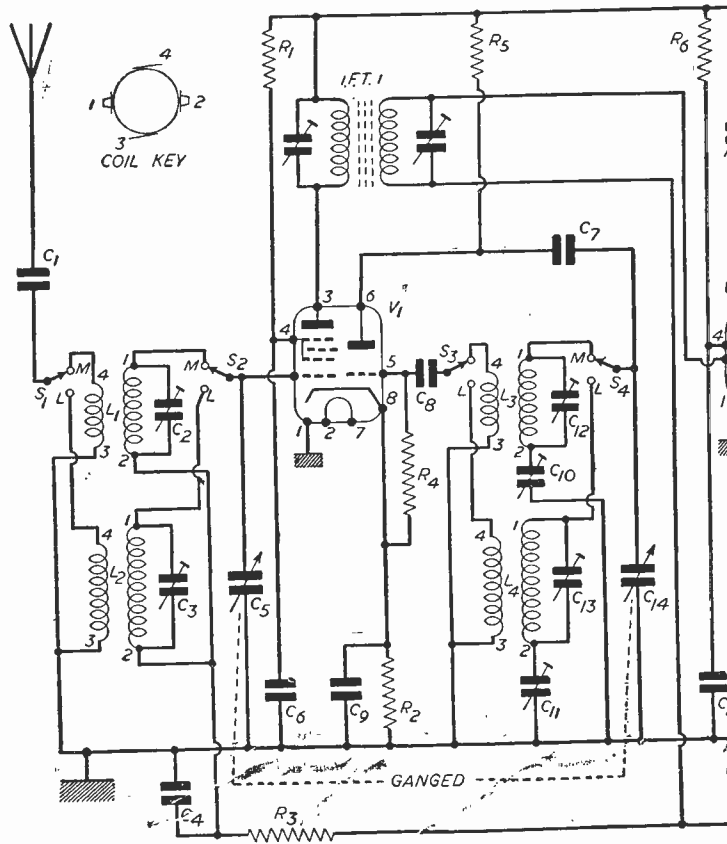

Fig. 3.—Circuit of a receiver incorporating the arrangement which has of this type

lead to the receiver chassis. Switch on the set and generator, and after allowing a five minutes warm-up period, trim the I.F. transformers, commencing with that feeding the diode detector, to 465 kc/s. reducing the generator output as far as possible when a rough trim is obtained, and continuing to trim on an output which just gives audibility.

With the I.F. stages trimmed, remove the 0.1 μ F. condenser from tag 5 of V1, replace the grid cap to V1, and feed the generator output to the aerial socket and the chassis of the set.

Switch the receiver to medium waves, tune both set and generator to 1,200 kc/s. (250 metres), and trim C12 to bring in the signal. Trim C2 for best volume. Tune the set and generator to 600 kc/s. (500 metres) and, rocking the tuning condenser of the set, pad C10 to bring in the signal.

Repeat the trimming and padding till one has no effect on the other.

Switch the receiver to long waves and tune both the set and the generator to 375 kc/s. (800 metres), then trim C13 to bring in the signal. Trim C3 for maximum volume.

Tune both set and generator to 200 kc/s. (1,500 metres) and, rocking the tuning condenser, pad C11 to bring in the signal.

Again repeat the trimming and padding until one setting fails to have any effect on the other. The two aerial trimmers, C2 and C3, should have a final adjustment with the receiver connected to its aerial. A small aerial should be found quite adequate for excellent reception in almost any area.

Remember that a direct earth may on no account be used with the receiver which is earthed via the mains supply; the chassis or receiver negative line should be connected to the neutral side of the mains. Connecting the mains plug to give least hum is generally sufficient indication of correct sense of connection.

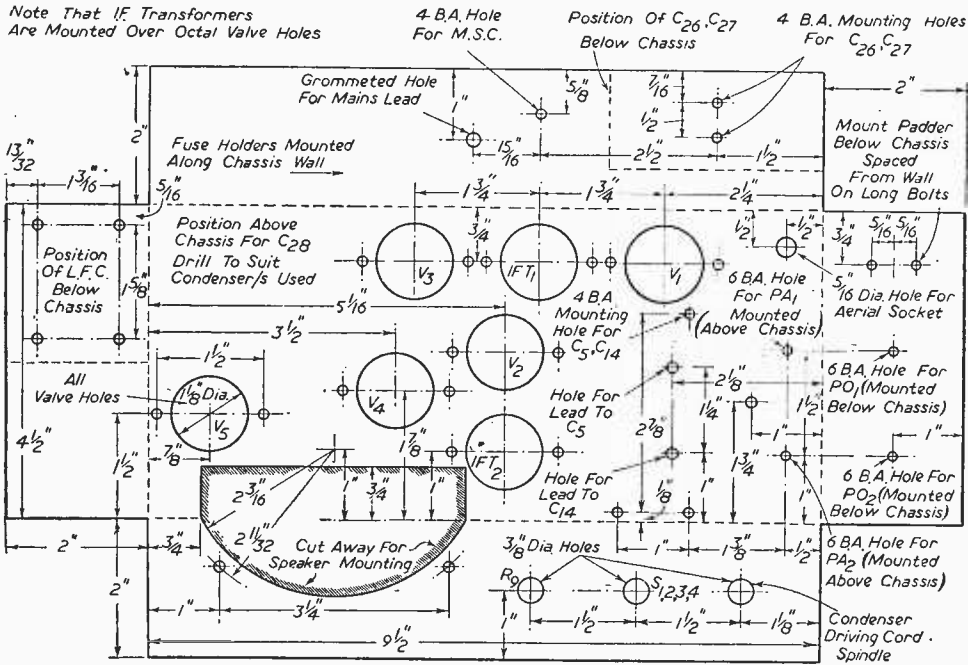

Fig. 4.—Chassis layout and drilling details for the receiver shown in Fig. 3.

Radio for Fleet of Dredgers

THE use of V.H.F. radio (supplied by the G.E.C.) to control a fleet of dredgers is a new application for this versatile communication system, and the Ribble Navigation Department of the County Borough of Preston has found that the ability to make a radio-telephone call to its dredgers is a valuable aid in keeping navigable the channel leading to the dock.

Normally every year about 1,000,000 cubic yards of sand and silt have to be dredged from the channel to maintain the necessary depth of water for navigation, and this was done by three sand

pump dredgers. With the deepening of the river which is now in progress, seven sand pumps are operating and are capable of working to a depth of 46ft. below the water level, and removing annually about 2,500,000 cubic yards.

The sand pump dredgers leave the Preston Dock each Monday and work in the river and estuary until the following Friday or Saturday. During this period the crew live on board. It is therefore important from the point of view of giving working instructions that there should be close contact between the masters of the vessels and the Dredging Superintendent who is responsible to the Harbour Engineer for the maintenance of the navigable channel.

Meter Problems

Reasons Underlying the Choice and Use of General-purpose Test Meters

By W. J. DELANEY (G2FMY)

WE are continually receiving letters from readers who have purchased ex-government meters of one kind or another and who ask for information for modifying the meter or adapting it for use as an all-purpose tester. In the majority of these cases the meter which has been obtained is useless for the purpose, and it does not seem to be realised that to be of any real use the meter movement in a multi-range tester must conform to certain stipulations—in other words, any old kind of meter movement will definitely not do. Before passing on to the reasons for selecting a particular type of meter there is one other point which should be mentioned here. In many cases the meters referred to have been removed from some ex-service equipment for which they were specially modified. This means that they may have inside the actual meter case one or more special shunts or other components, which in any case will have to be removed, and then the actual full-scale deflection and meter resistance will have to be found. As regular readers will have seen, the problem of finding meter resistance is not a simple one and considerable correspondence has been published on this question alone.

Meter Resistance

The main requirement of the meter movement used in a multi-test instrument is a high resistance, and it has been generally stated that the basis for such an instrument should be a resistance of 1,000 ohms per volt. A meter with a full-scale deflection of 1 mA. will be found satisfactory, although many modern test sets have meters of only 500 μ A., and at least one has a resistance of 20,000 ohms per volt. Why is it necessary to have a high resistance movement? A little application of Ohms Law will show the reason, and there is no need for the merest novice to worry about any difficulty as the calculations are not difficult and no advanced mathematics are called for. To make the scheme perfectly clear we will take the case of an amateur who wishes, for some reason or other, to measure the H.T. on the anode of a simple detector valve. Perhaps reaction is not working properly or some other fault is present which might be due to insufficient H.T. The circuit of the stage would probably be more or less as shown in Fig. 1. The valve may be battery or mains, but in either case it may be represented as a resistance, in which case the circuit may be redrawn as in Fig. 2, where R_a is the resistance equivalent to the valve, and in the case of a general purpose triode of the battery type would probably be about 15,000 or 20,000 ohms.

Applying Ohms Law

Now let us apply Ohms Law, and to make working easier certain round figures will be taken. The resistance of the transformer primary and H.F. choke will be very low and further to simplify matters will be regarded as negligible. There will

therefore be a voltage drop across the valve (R_a) the value of which will depend upon the total H.T. supply and the resistance. Remember that Ohms Law is as follows:

$$\text{Current} = \frac{\text{Voltage}}{\text{Resistance}}$$

and from this we get

$$\text{Resistance} = \frac{\text{Voltage}}{\text{Current}}$$

and

$$\text{Voltage} = \text{Current} \times \text{Resistance.}$$

It is necessary to remember that in this formula current is expressed in amps., voltage in volts and resistance in ohms, so here and there it will be necessary to convert current into milliamps, and this is probably most easily done by expressing the milliamps as a decimal value, 1 milliamp being written .001 amps. Alternatively one can divide by 1,000, but in any case it is necessary to remember the unit values in the formulae.

Now for our example. If we assume an H.T. value of 100 volts, and an equivalent valve resistance of 10,000 ohms, a current of 10 milliamps would be flowing ($\frac{100}{10,000} = .01 \text{ A.}$)

It is now necessary to bring in another mathematical calculation which should be familiar to all amateurs. It concerns the use of resistances in parallel. The formula for this is "the reciprocal of the total resistance is equal to the sum of the reciprocals of the individual resistances," which sounds very complicated. Fortunately, for the present case with which we are concerned it is possible greatly to simplify this. Where only two resistances are concerned, the formula may be simplified to:

$$R = \frac{R1 \times R2}{R1 + R2}$$

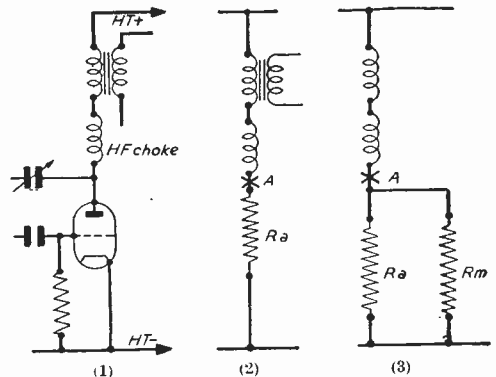

Fig. 1.—Detector stage.
Fig. 2.—Equivalent circuit.
Fig. 3.—Effect of meter in parallel.

When R_1 is the final value and R_1 and R_2 are respectively the two resistances which are in parallel with each other.

We now go back to Fig. 2 and see the result of connecting a low-resistance meter to the anode of the valve to find its voltage. (The normal method of testing would, of course, be to connect a meter from H.T.— or the earth line—to the anode.) The resultant circuit representation of the circuit would then be as shown in Fig. 3, where R_m is the equivalent resistance of the meter in use. In our example we considered a valve with an R_a of 10,000 ohms and to make the arrangement clear we will assume a meter with a resistance of only 500 ohms, and from the above formula it is found that the resistance between point A and H.T. is slightly under 500 ohms—actually about 476 ohms. It can now be seen how this will affect the reading on the meter. Without the meter in circuit there will be a current of 10 mA. flowing

but when the meter is connected across the valve the total current flowing would increase to $\frac{100}{500} = .2$ A. or 200 mA.! The additional drain will result in a reduction in the actual H.T. and the increased current flowing through the transformer primary—or what is more serious through a decoupling or coupling resistor will give a voltage drop so that the meter would indicate, for instance, that the anode voltage was about 10 volts, whereas in actual practice, with the meter disconnected there may be nearly 100 volts on the anode. The example taken is an extreme case, but should indicate the reason why it is necessary to use a meter having a high resistance. Summed up, the idea is only to use a meter which has a very high resistance so that it takes only a very small current and therefore will have an almost negligible effect upon any circuit across which it is connected.

Effective Tone-control Circuit

A Simple Circuit which may be Added to any Existing Battery or Mains Receiver or Amplifier

By F. G. RAYER

MOST simple tone-control circuits use a top-cut arrangement usually connected in parallel with the speaker, or at some earlier point in the A.F. circuit. This has its uses, but for more comprehensive tone-control the circuit shown below has been found very effective. This circuit may be added to any amplifier or receiver, point "A" being taken to the first valve anode where audio frequency signals are present, and point "B" to the grid of the valve following. A third lead, taken to Grid Bias in the case of battery-operated receivers, and the Earth or H.T. negative line with mains receivers, completes connections so that existing wiring need not be unduly disturbed. (Any coupling arrangement already present between the two valves should be removed, as the tone-control circuit replaces this.) The anode load of the first valve is left undisturbed.)

For ordinary response the two potentiometers should be set at approximately mid-way positions. With a full orchestra, the effect of adjusting either of the controls is very noticeable. With maximum treble and minimum bass only flutes, violins and similar high-toned instruments are audible, while

with maximum bass and minimum treble only the low-register instruments will be heard. Such extreme settings of the controls will not, of course, be used, but most recorded and orchestral programmes benefit considerably from a fair amount of boost to the lower register.

With some records and with certain types of interference (notably on short wave stations) the amplification of high register notes can be reduced a good deal with advantage, the resultant freedom from needle scratch or hiss and high-pitched interference being very noticeable in some circumstances.

The $.1 \mu\text{F}$ condenser should be a good-quality component, and a mica $.0001 \mu\text{F}$ condenser is recommended. All resistors can be of the usual $\frac{1}{2}$ watt carbon type.

IDEAL HOME EXHIBITION

A TELEVISION receiver which has special equipment for fringe-area reception will be seen at this year's *Daily Mail* Ideal Home Exhibition at Olympia. The set gives a 12in. by 10in. picture and also receives the B.B.C.'s experimental frequency modulation programmes. It will be shown by the English Electric Co., and is priced at £115 19s. 11d., including tax.

Decorative and with a pleasing tone, a new globular extension loudspeaker will be exhibited by C.M.C. (Switchmatic), Ltd. Other attractions include a combination table lamp-loudspeaker, the "Carlton" and the "Switchmatic" radio remote control unit. The "Conference" communication system, which is especially designed for smaller types of business houses, restaurants, hotels and private residences, will be demonstrated at this stand.

The latest models in television and radio receivers, radiograms and record reproducers will also be shown by H.M.V. and Alfred Inhof, Ltd.

The exhibition will be open from 9.30 a.m. to 9.30 p.m. on weekdays from March 7th to April 1st.

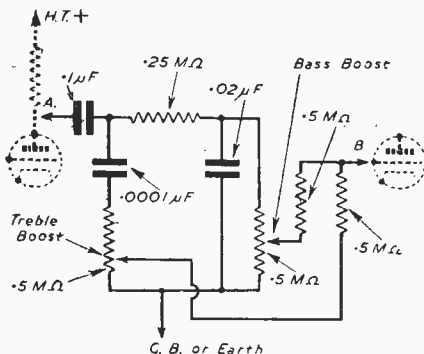

The tone control circuit.

TELEVISION PATTERN GENERATOR

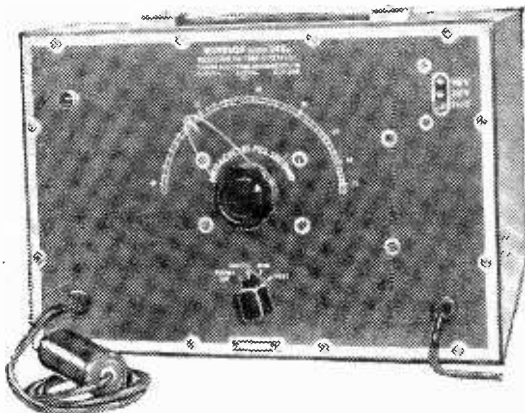

ALL WINDSOR & TAYLOR TEST EQUIPMENT IS AVAILABLE ON H.P. TERMS. SEND FOR DETAILS AND CATALOGUES

TAYLOR ELECTRICAL INSTRUMENTS LTD
419-424 MONTROSE AVENUE, SLOUGH, BUCKS. ENGLAND
Tel. SLOUGH 21381 (4 lines) • Grams & Cables TAYLINS, SLOUGH

MODEL 240A SPECIFICATION

FREQUENCY RANGE
40-70 Mc/s, directly calibrated.

OUTPUT VOLTAGES
Approx. 50 mV., 5 mV. and 500 μ V., at end of a 75 ohm co-axial cable.

MODULATION
Horizontal bars, vertical bars, unmodulated.

POWER SUPPLY
100-125 and 200-250 volts
40/100 c/s.

LIST PRICE £14.0.0
EARLY DELIVERY

other products include:

- Multirange A.C. D.C. Test Meters •
- Signal Generators • Valve Testers
- A.C. Bridges • Circuit Analysers
- Cathode Ray Oscillographs •
- High and Low Range Ohmmeters
- Output Meters • Insulation Testers •
- Moving Coil Instruments



PLAN YOUR CAREER

RADIO - TELEVISION
and other INDUSTRIAL
ELECTRONIC subjects

ELEMENTARY &
ADVANCED COURSES

DAYTIME

- Principles and Practice of Radio—1 year.
- Telecommunication Engineering—2 years.
- Electronic Engineering—3 years (including one year's practical training in E.M.I. Factories)—leading to C & G full Technological Certificate. (Next courses begin April 1950).
- Marine and Air Radio Officers' Course (for P.M.G. Licence),

also HOME STUDY

- Basic Radio • Basic Television • Industrial Electronics • Maths • Physics.

Write for FREE BOOKLET to Dept: 32

E.M.I. INSTITUTES

10 PEMBRIDGE SQUARE, NOTTING HILL GATE, LONDON, W.2.
Telephone: BAYSWATER 5131/2

NEW-TRUE FIDELITY by



The **G.P.20** MICROCELL PICK-UP establishes new standards in pick-up design. In addition to the features shown below and the availability of the interchangeable head for "long playing records" this instrument **REQUIRES NO EQUALISER.**

- Output $\frac{1}{2}$ v. at 1,000 cps—5 to 20 times greater than comparable magnetic types.
- Automatic bass-boost
- Negligible needle talk and motor rumble.
- Extremely low needle pressure (13 grams) virtually eliminates record wear.
- Unbreakable crystal element.
- No needle change.

The automatic bass-boost assures the finest possible reproduction of which your set is capable, without additional components.

Just connect up—that's all.

Heavy export commitments have severely curtailed supplies of the G.P.20 to the home market. Every effort is being made to increase production and in the meantime we ask your forbearance.

COSMOCORD • LTD • ENFIELD • MIDDX

HENRY'S

EX-GOVT. VALVES. The following brand new and guaranteed valves are in stock:

PEN 46, 6L6 metal at 10/- each. EF50, EF54, EF55, RL37, VU111, VU133, UB 5T4, 5R4GY, RL18, 6F7, 6AG5, PM22A, all at 7/6 each. 5Z4, MU14, 6K7GT, 6I1GT, 6K8GT, ML4, 12SR7, 12SJ7, 12SK7, 6SL7GT, 6SC7GT, 6C6, 6V6G or CT, 7C7, 7D4, 7S7, 7B3, 7C5, 12BR4, 9D2, VP23, P2, 12A6, 8D2, 15D2, EF36, EF39, EBC33, EK32, EL32, 6X5GT, 2X2, 6AC7, 6N7, 6SN7GT, 78, 9003, 1N5GT, 6J5GT, 6C5, KT61, KTW61, DH63, TDD2A, VP2B, all at 6/6 each. Also 9002 and 1N5GT, 6J6, 807, 7-, 4D1, 5-, EA50, SP61, 951, EB34, at 3/6 each. Di Diode at 2/6 only. And the midgeet range of 1.4 V. battery valves. 1T4 and 1S3 at 6/6 each. 1R5 and 1S1 at 7/6. 3S4 at 9/- each. Most of these valves are boxed. Please note for current popular circuits we also have in stock 1D8GT, at 15/3, and HIVAC XH at 10/6. Both these latter are new and boxed. In addition we have over 10,000 new boxed BVA valves in stock at current Board of Trade prices. Let us have your enquiries.

C/R TUBE VCR97. Each tube brand new, suspended in manufacturer's original packing case, guaranteed, complete with printed data sheet. Only 35/-. (Carriage and packing free.)

VCR139A C/R TUBES. Electrostatic 2in. tested and guaranteed O.K. Only 15/- each, plus 2/6 post and packing. Bases can be supplied at 2/- each.

SANGAMO-WESTON. Ex-Govt. 0.1 mA. M/C Meters. 2in. Panel-mounting. Absolutely brand new. 15/- each only.

RECEIVER TYPE 25. The receiver portion of the T/R 1196. Covers 4.3-6.7 Mc/s., and makes an ideal basis for an all-wave receiver, as per "Practical Wireless," August issue. Complete with valves types EF36 (2), EF39 (2), EK32 and EBC33. Supplied complete with necessary conversion data for home use. Only 22/6. Chassis only, 8/6.

IGRANIC MAINS TRANSFORMER. A special purchase enables us to offer the following:—250-0-250, 70 mA., 6.3V., 2 A., 2 A., half-shrouded, drop-through type, with voltage adjuster panel. Absolutely brand new and guaranteed. 15/- only, plus 3d. post.

5, HARROW ROAD, LONDON, W.2
PADDINGTON 1008/9

H.A.C.

Short-Wave Equipment

Noted for over 15 years for Short-Wave Receivers and Kits of quality

One Valve Kit, Model "C" .. Price 20/-
Two " " " "E" .. " 43/-

These kits are complete with all components, accessories, and full instructions. Before ordering send stamped, addressed envelope for descriptive catalogue.

"H.A.C." SHORT-WAVE PRODUCTS
(Dept. TH) 66 New Bond Street, London, W.1

COVENTRY RADIO

COMPONENT SPECIALISTS SINCE 1925

Television Components in stock for London and Midland version of **VIEW MASTER TELEVISOR**
Full instruction, circuit, plans, etc., 5/-

Electronic home-built Televisor components also in stock. SEND FOR LIST.

COVENTRY RADIO,

189, DUNSTABLE ROAD, LUTON, BEDS.

RL132A. 10 valve U.H.F. receiver, £4 (carr. 5/-). Power pack for same, £3 (carr. 5/-).

BC624A. 11 valve. 30/-, carr. paid.

SMOOTHING CHOKES. 30 mA., 3/6; 80 mA., 7/-; 120 mA., 9/-; 150 mA., 10/6.

INTERVALVE TRANSFORMERS. 3-1, 5-1, 2/6. Small Mic. Trans. 3/6.

METERS. 0.5 mA., 0-30 mA., 0-100 mA., 7/6; 0-2,000 V. Electrostatic, 21/-, 0-40 V., 7/6. 0-500 microammeter, 5/-. Boxed Standard 465 k/c I.F. Trans., 10/6. Var. Res., without switch, 5K, 20K, 25K, 50K, 100K, 2/6. 2 meg., 3/6; 10K min., 2/-; 50K, 5K, wire-wound, 3/6. 12 v. 1 amp. Rec., 7/6.

PANEL LIGHTS. one-hole fixing, 1/6. Pfs. 50 and 100, 3/1; each; 2,000 and 3,000, 6d. each; .0022 350 working, 4d. each; .1 mfd. 500 working, 6d. each; .01 mfd. 500 working, 6d. each.

TELEVISION. All parts for Birmingham. Wearite "P" coils. Aladdin formers in stock.

Let us have your requirements.

T.N.B. RADIO, 166a, Rookery Rd., Handsworth, Birmingham, 21.

CRYSTAL SET

incorporating the latest

CRYSTAL VALVE

as used in radar receivers.
Adjustable Iron Cored Coil

RECEPTION GUARANTEED

Polished wood cabinet. 15/- post 9d.

Send S.A.E. for lists of copper wires, screws, nuts, paxolin tubes, ebonite, tufnol rod and panels etc.

POST RADIO SUPPLIES

33, Bourne Gardens, London, E.4

INDUSTRIAL FINISHING CRACKLE

STOVE ENAMEL ALL COLOURS

Stoving ovens and spray service at your disposal. Prompt return after final inspection. Chassis, Panels, Cabinets, Photographic equipment, etc. Black 1/-. Colours 1/3 per sq. ft. (Flat surfaces—one side.) Carriage extra. Special quantity quotations. We make anything in metal to your requirements.

Full particulars on request.

Buccleuch Radio Manufacturers

6 Wheatfield St., Edinburgh, 11

'Grams: "Therm." 'Phone 64596

A FREE BOOK on Morse Code Training



There are Candler Morse Code Courses for **Beginners and Operators.**

Send for this Free "BOOK OF FACTS" It gives full details concerning all Courses

THE CANDLER SYSTEM CO. (S.L.O.)
121, Kingsway, London, W.C.2.

Candler System Co., Denver, Colorado, U.S.A.

BRAND NEW VALVES!

REAL bargains and RELIABLE valves. The following ex-Govt. valves are guaranteed to be BRAND NEW. They are NOT ex-equipment.

(1) Original Cartons as from manufacturer: 6H6, 1 6; VB54, 2-; 9006, 3/6; 9004, 4/-; 6C5, 6J5, 6J5GT/G, 6N7GT/G, 4/9; 6K7, 6AC7, 6SL7GT/G, 5/-; 6J7, 6SK7, 6Q7GT, 5/6; 6V6, 6P6, 2X2, 2C26, 6B8, 6-; 5U4G, 5Z4, 6K8, 6/3; 6F7, 6E5, 25L6GT, 7/-; 822A, 35/-; 813 (B.C.A. and Canadian Marconi), 37/6. (2) New and Boxed: 6H6, 6H6GT, 1/3; 6J5, 4/-; 6C5, 4/3; 6K7, 6AC7, 4/6; 6SJ7, 6J7, 4/9; 2C26, 6B8, 5/-; 6V6G (surplus), 4/-; 6X5GT/G, 6P6G, 5/6; 5R4G, 5U4G, KTW63, 5/9; 6F7, 6SA7, 6C4, 6C3, 6/6; 6AK5, 9/- (While they last!)

Orders over 15/- post free, otherwise please add 3d. per valve.

REED for SPEED and RELIABILITY!

DOUGLAS REED, 39, Burnley Rd., Southport.

DUNK & HEALEY

Brand New Valves in Original Boxes and Fully Guaranteed.

EF50, 7/6; 6V6G, 7/6; 5U4G, 8/6; 5Z4, 6/6 "Westalite" HT47 Metal Rectifiers, 250 v. 60 mA., 5/9. 40 v. 2 a. (230 v. 50 cps. Primary) Transformers, Heavy Cast Shrouds Terminal Block, 13/6.

Our range of Fine Chokes: 10 H. 80 mA., 5/9; 10 H. 120 mA., 6/9; 5 H. 200 mA., 8/6; 15 H. 250 mA., 12/9; 10 H., 300 mA., 12/6; 15 H. 100 mA., 8/6.

67, OSNABURGH STREET, LONDON, N.W.1.

Electromagnetic Tone Generator

Making the Essential Part of an Electronic Organ

By J. W. PANNELL, A.M.I.E.E.

AN electronic musical instrument requires some form of tone generator, the construction of which usually presents considerable difficulty.

The generator to be described can be easily made using a small lathe and the minimum of special tools.

The principle of operation is shown in Fig. 1, a voltage being induced in the coil due to the disturbing effect of the tone-wheel upon the magnetic field.

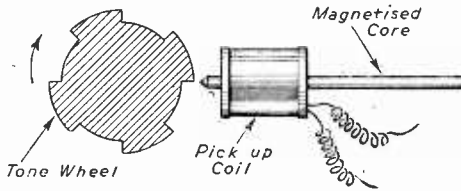

Fig. 1.—Single unit to illustrate method of operation.

The core of the pick-up coil is permanently magnetised.

There are 60 pick-up coils and magnets, each of which has its own tone-wheel. The frequency of any note is determined by the number of teeth on a tone-wheel and its speed of rotation.

These 60 wheels are arranged in 12 groups of five, each group being upon one spindle and corresponding to a note and its octaves (Fig. 2). Suitable pulleys enable each spindle to be driven at the correct speed. (Table 1.)

A countershaft 1.7 inches in diameter is driven direct from the shaft of a 50 c.p.s. ¼ h.p. induction

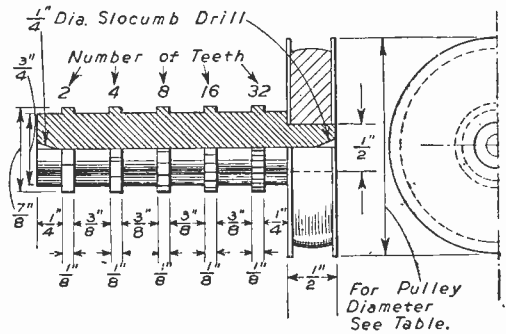

Fig. 2.—One of the groups of tone-wheels.

motor, giving an approximately constant speed of 1,420 r.p.m.

This countershaft is coupled by means of 12 plastic flat belts to the 12 spindles, and there should be at least 2ft. between the pulleys and the countershaft for satisfactory operation. The spindle pulleys are preferably domed in order to keep the belts clear of the flanges.

TABLE I.

Spindle	Pulley Diam. (mm.)	Spindle	Pulley Diam. (mm.)
C	31.3	F#	44.45
C#	29.6	G	41.9
D	27.9	G#	39.55
D#	26.3	A	37.3
E	24.82	A#	35.2
F	47.0	B	33.2

Spindles

These are machined between centres from mild steel bar, and the brass pulleys pressed on and finally turned to correct diameter.

The teeth, which should be as nearly as possible of the shape shown in Fig. 1, are ground or milled by means of an auxiliary motor clamped to the slide-rest, and indexed with a change wheel or marked disc.

Framework

The components shown in Fig. 4 are assembled and the spindles fitted to the pivots. A locknut

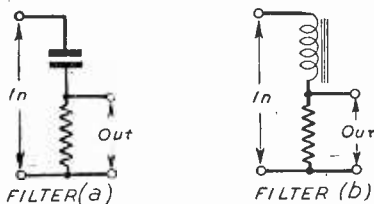
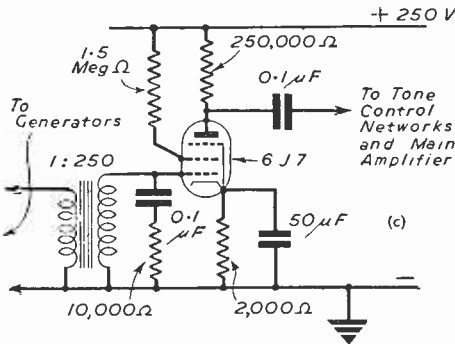

Fig. 3.—Filter circuits and a suitable pre-amplifier. Note that the screen-grid of the 6J7 should be connected to earth through a 0.1 microfarad condenser.

secures the pivot and allows for adjustment. It is advisable to grease the pivots at this stage. The spacers hold the side frames in correct position, using long 3/8 in. bolts.

Conclusion

These are wound with 10 layers 1/16 in. length of No. 36 s.w.g. d.c.e. copper wire on a 2 in. length of 3/32 in. diam. silver steel rod. The coil is 1/4 in. from one end, which has previously been made chisel edged in order to "scan" the tone-wheel.

Pick-up Coils

The generator terminals are connected to contacts on the keyboard, the common busbar of which is connected to a pre-amplifier incorporating a step-up transformer.

A tone control stage follows, and then a main amplifier controlled by a foot-operated volume control.

The tone control stage provides for a considerable amount of experiment, since it is here that the output tone quality is obtained. Typical filters

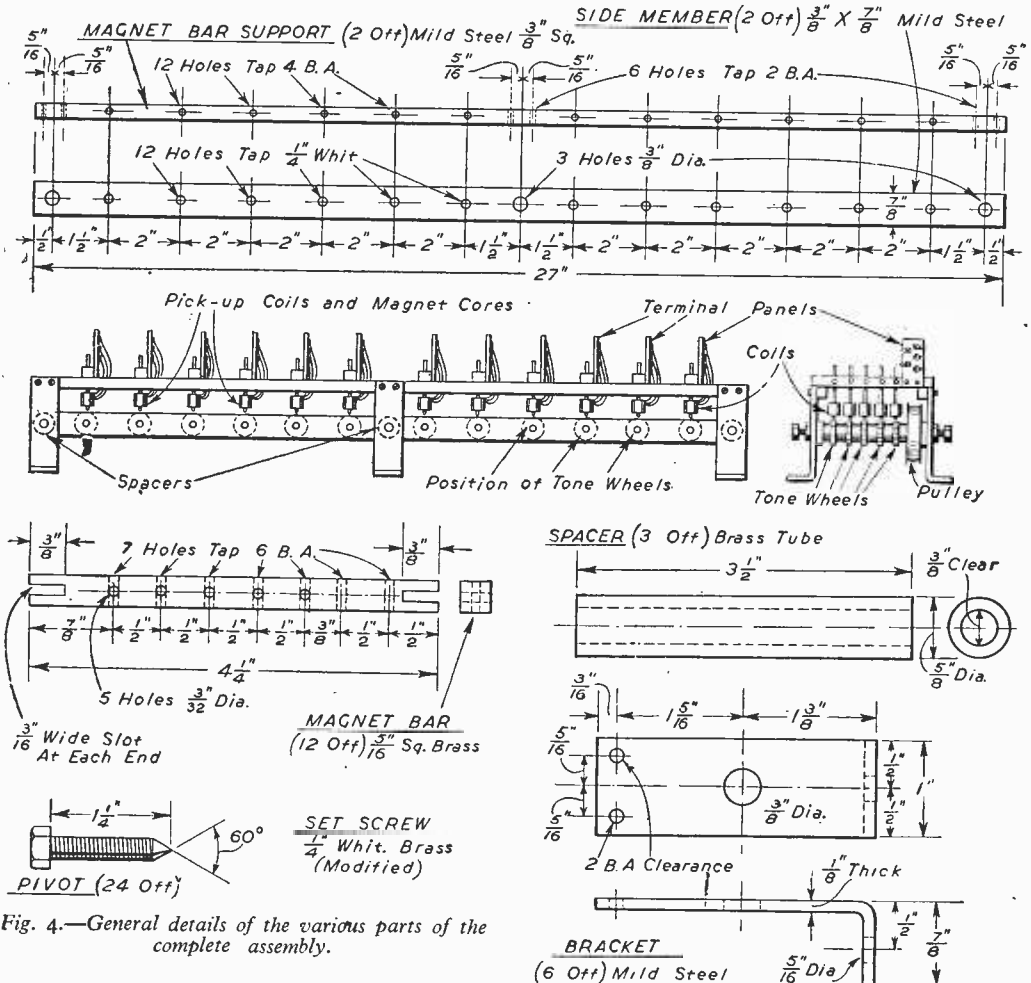

Fig. 4.—General details of the various parts of the complete assembly.

A 5-way terminal board is fitted to the magnet bar, and the pick-up magnets are held by means of 6B.A. screws.

The silver steel rods are magnetised by stroking with a permanent magnet.

Adjustment of output is possible by altering the distance of the pick-up magnet from the tone-wheel.

One end of each coil is soldered to the core, and the other end is connected to a terminal.

are shown in Fig. 3 (a) and (b), while a pre-amplifier is shown at (c).

It is advisable to include about 10 ohms resistance in each lead from coil to key contacts in order to avoid loss of output if several keys are operated at the same time.

WIRELESS COILS, CHOKES AND TRANSFORMERS
8th Edition now ready. Price 6/- by post 6/6d.

More Attractive Offers!

RECEIVER 25173. Now in stock again after a short interval when the consistently huge demand temporarily cleared our stocks. Valve line-up: two EF39, one EK32, one EBC33 and two EF36; and one pair of 460 Kc/s I.F. Transformers, resistors, condensers, etc. Easily and rapidly converted to an ordinary superhet receiver. Circuit and conversion data supplied. 22/6 post free.

RECEIVER 21. Receiver section of the Wireless Set 21. Operates as a superhet from 4.2-7.5 Mc/s and as a double superhet from 18-31 Mc/s. Complete with nine 2v. valves. Designed for 6v. L.T. input but can be modified for 2v. L.T. in a matter of minutes! Crash limiter and B.F.O. incorporated. Circuit diagram provided. 35/- post free.

RECEIVER TYPE 68. Battery superhet. Frequency coverage 3-5 Mc/s. Valve line-up: three ARP12 and one AR8; and 465 kc/s I.F. Transformers. New, but store soiled. 22/6 post free.

INDICATING UNIT TYPE 230. Operates from A.C. mains 110 or 230 v. 50 cycles. Contains a mains transformer giving 350-0-350 80 mA., two 6.3. windings, one 5v. 2 amp., and the following valves: one 5Z4, one Y63, one EA50, four EF50. Made by G.E.C. Housed in metal case and in good condition. 39/6 plus 3/6 carriage and packing.



Best Buy at Britain's CHARLES BRITAIN (RADIO) LTD.

11, Upper Saint Martin's Lane, London, W.C.2. TEM. 0545
Shop hours: 9-6 p.m. (9-1 p.m. Thursday)
OPEN ALL DAY SATURDAY

YOU can become a first-class RADIO ENGINEER

We are specialists in Home-study Tuition in Radio, Television and Mathematics. Post coupon now for free booklet and learn how you can qualify for well-paid employment or profitable spare-time work.

T. & C. RADIO COLLEGE

Post in unsealed envelope, 1d. postage.

To: R. Heath Bradley, T.C.R.C.,
50, Harland Road,
Southbourne, Bournemouth.

NAME
ADDRESS

P.104

GALPINS

ELECTRICAL STORES

408, HIGH STREET, LEWISHAM, LONDON, S.E.13.

Telephone: Lee Green 0309, Near Lewisham Hospital.

TERMS: CASH WITH ORDER. NO C.O.D.

THURSDAY EARLY CLOSING.

MAINS TRANSFORMERS, 200/250 v. Input in steps of 10 v., Output 350/0/350 v. 180 mA., 4 v. 4 a., 5 v. 3 a., 6.3 v. 4 a., 37/6 each; another 500/0/500 v. 150 mA., 4 v. 4 a., 6.3 v. 4 a., 5 v. 3 a., 42/6 each; another 350/0/350 v. 160 mA., 6.3 v. 8 a., 5 v. tapped 4 v. 3 a., 39/6.

MAINS VARIABLE RESISTANCES, slider type protected, 1,500 ohms carrying 0.45 a., 27/6 each; ditto, not protected, 14 ohms, 1 to 4 a., 15/- each; ditto, 60 ohms to carry 1 1/2 a., 15/- each; ditto, 5.7 ohms to carry 8 1/2 a., 17/6 each.

MAINS TRANSFORMERS, 200/250 v. Input in steps of 10 v., Output 500/0/500 v. 250 mA., 6.3 v. 8 a., 6.3 v. 8 a., 4 v. 4 a., 5 v. 4 a., 65/- each; ditto, 350/0/350 v. 300 mA., 5 v. 4 a., 6.3 v. 8 a., 6.3 v. 8 a., 4 v. 4 a., 62/6 each.

CHARGING SWITCHBOARDS, 1,250 Watts, 36 v. D.C. Containing all 5 Meters Amps/Volts and 5 Variable Resistances, slider type, also Cut-outs and Fuses, at 84 10s. each, carriage paid.

MAINS TRANSFORMERS, 200/250 v. Input in steps of 10 v., Output 350/0/350 v. 300 mA., 4 v. 8 a., 4 v. 4 a., 6.3 v. 6 a., 6.3v. tapped at 2 v. 2 a. (ELECTRONIC), 57/6 each; ditto, 425/0/425 v. 150 mA., 6.3 v. 3 a., 6.3 v. 3 a., 5 v. 3 a. (WILLIAMS AMPLIFIER), 39/6 each.

ELECTRIC LIGHT CHECK METERS, useful for Sub-letting, etc. All fully guaranteed electrically. All 200/250 v. 50 cycles 1 phase 2 1/2 a. load, 15/-; 5 a., 18/6; 10 amp., 21/-; 20 a., 25/-; 50 a., 35/- each; 100 a., 55/- each. (Please allow 2/- extra for carriage.)

MAINS TRANSFORMERS, 200/250 v. Input in steps of 10 v., Output tapped 0, 6, 12, 18 and 24 v. at 10/12 a., 47/- each; ditto, tapped 0, 6, 12 and 20 v. at 4/5 a., 29/-; ditto, tapped 0, 6, 12, 18, 24 volts at: 25/30 a., 68/6 each.

PRE-PAYMENT 11- SLOT METERS, 200/250 v. 50 cycles 1 phase. Electrically Guaranteed, 2 1/2 a. load, 27/6; 5 a. load, 37/6 each.

MAINS TRANSFORMERS, 200/250 v. Input in steps of 10 v., Output 500/350/0/350/500 v. 250 mA., 6.3 v. 6 a., 6.3 v. tapped 2 v. at 2 a., 5 v. tapped at 4 v. 4 a. twice 67/6 each; ditto, 450/0/450 v. 300 mA., 6.3 v. 8 a. twice, 4 v. 4 a., 5 v. 4 a., 62/6 each.

Ex-R.A.F. ROTARY CONVERTERS, 24 VOLTS D.C. INPUT 50 v. 50 CYCLE 1 PHASE A.C. OUTPUT at 450 Watts. Condition as new, 83 15s. each, carriage, 3/6
MAINS TRANSFORMER, 230 v. Input 150/0/150 v. 150 mA., 6.3 v. 8 a., 5 v. 3 a. Output (new, ex-Govt.), 15/- each.

METERS, all ex-Govt. new boxed, all first-grade moving coil, 2in. scale, 0 to 20 v., 6/6 each; 0 to 40 volts, 10/6 each; 0 to 10 a., 15/- each. 2 1/2in. scale, 0 to 10 mA., 12/6 each; 350/0/350 millivolts, 12/6 each; another 3 reading type 0 to 50 and 150 v. 0 to 15 a., 17/6 each; another 0 to 4 a., THERMO coupled, 2 1/2in. scale, 10/- each; another calibrated 50 cycles, 0 to 20 v., 12/6 each.

LARGE TYPE RECTIFIERS, Output 50 v. 1 a., D.C. input 70/75 v. A.C. Half wave type, 8/6 each, post 1/6. TANNYO P.M. SPEAKERS (Small Hailers), 4 ohm speech coil, complete in wooden case with output transformer, 15/- each, carriage 2/6.

It Pays to Purchase

ELECTRADIX BARGAINS

MOTOR BARGAINS. A.C. Motors. 1/2 H.P. 230 volts 50 cycles S.P. 1,425 r.p.m., new, 85/10.0. 1 1/3 H.P. 230 volts 50 cycles S.P. Capacitor Start, 1,425 r.p.m., 89/10.0, new. 200 volt 1/2 H.P. 50 cy. S.P., new, 1,425 r.p.m., 85/10.0. 3-phase Motors, 1/2 H.P. 440 volts 50 cy. 1,425 r.p.m., new, 87.

DYNAMOS, 12 volt 10 amp., totally enclosed, 1,400 r.p.m., 40/-. 30 volt 5 amp., 1,500 r.p.m., 35/-.

TELEPHONES. Ex G.P.O., wall type set of Constructor's parts: Bracket Mike, Mag. Bell, Transformer and Condenser, and connection strip in Polished wood box Bin. x 6in. x 3 1/2in. Hand Magneto Generators and single earphone, with wiring diagram, 35/-, carriage 5/-.

G.P.O. Magnet Bell in box, 5/-. G.P.O. Mike in Moulded bakelite case, 4/6. G.P.O. Mike insets, 2/6. Telephone connection strips, 2/6 dozen; postage 9d.

MAGNETS. Swift Levick instrument type, circular horseshoe 1 1/2in. dia. 1/2in. thick, 1/2in. polar gap drilled poles, weight 2 ozs., lift 3 lbs., 2/6 each, or 12/6 for six.

METERS. Hot wire Ammeters 0-1/2 amp. and 0-1/2 amp., panel type, 2/6 each, postage 1/-. Ammeters D.C. Moving Coil, 50-0-50 amps., 4/-. Voltmeters, D.C. Moving Coil panel, 0-30 volts, 4/-. Milli-ammeters, D.C., 0-1 2 1/2in. flush panel, 12/6.

ELECTRADIX RADIOS

214, Queenstown Road, London, S.W.8

Telephone: MACaulay 2159

SPARKS' DATA SHEETS

Clear full-size Constructional Prints of Tested and Guaranteed Designs. Used by Discriminating Radio Constructors in the FIVE CONTINENTS.

IMPORTANT ANNOUNCEMENT

Please note:

ON AND AFTER JANU-ARY 31st SPARKS' DATA SHEETS WILL BE OBTAIN-ABLE ONLY FROM MY NEW ADDRESS:

L. ORMOND SPARKS (P)
48A, HIGH STREET,
SWANAGE, DORSET.

OLD CLIENTS PLEASE NOTE. NEW CLIENTS PLEASE SEND STAMP FOR LIST.

Remember—when you want the finest and safest Data Sheet Designs, the only address is:

L. ORMOND SPARKS (P)
48A, HIGH STREET,
SWANAGE, DORSET.

CABINETS & COMPONENTS

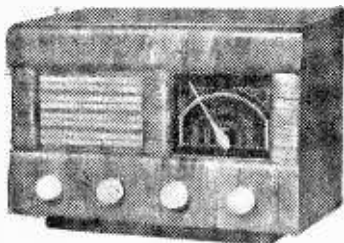

Walnut veneered cabinets 12 1/2 in. x 8 1/2 in. x 7 1/2 in. deep., 35/-.

ANY TYPE OR QUANTITY OF CABINETS MADE TO SPECIFICATION. (Send full details.)

All components to build a T.R.F. or Superhet Receiver in above cabinet are available.

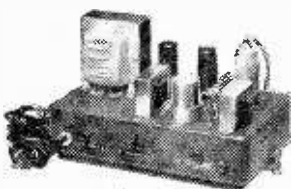

4 1/2 watt A.C. Quality amplifier with Neg. Feedback. From £5.4.7. 5 watt similar to above. From £3.16.2. 12 watt Universal Quality Amplifier. From £8.5.0. Full details on request.

LEWIS RADIO CO. (Dept. K2), 322, High Road, Wood Green, London, N.22. Phone: BOWes Park 5997

STOCKTAKING CLEARANCE

OFFER FOR 1 MONTH ONLY

- Single 50 mmfd. small tuning condenser (gangable) ... 6 for 5/-
- Single 30 mmfd. small tuning condenser... 6 for 5/-
- Two-gang 50 mmfd. small tuning condenser ... 6 for 7/6
- Two-gang 75 mmfd. small tuning condenser ... 6 for 7/6
- 2 1/2 in. Fluted knob black, 1/2 in. spindle 6 for 5/-
- Large brass terminals ... per doz. 2/6
- Medium size plated brass terminals ... per doz. 3/6
- Insulated terminals, Black and Red ... per doz. 3/-
- Slow-motion drives with scale for self-calibration ... each 3/6
- Ceramic stand-off insulators, ribbed, less screw lin. ... per doz. 5/-
- Ceramic stand-off insulators, ribbed, with screw lin. ... per doz. 6/6
- Ceramic stand-off insulators, ribbed, less screw 1/2 in. ... per doz. 5/-
- Claroostat mains dropping resistance plug in 445 ohms ... each 5/-
- Resistances 1/2-, 1- and 1-watt type, useful values ... (our choice) per 100 15/-
- Condensers, assorted mica, ceramic and paper tubular. ... 2/-

YOUR CHOICE:

- .001 mica, .001 ceramic, 10 pfd. mica, 10 pfd. ceramic, .01 mica, .01 tubular, .005 tubular, .0005 mica, .002 mica, 75 pfd. mica, etc. per assorted doz. 5/-
- Test prods with leads ... per pair 2/-
- Shakeproof washers 4Ba and 6Ba, assorted ... per gross 2/-

TELE-RADIO (1943) LTD.

177, Edgware Road, London, W.2. Telephone: AMB. 5393. PAD. 6116/5606

'VIEW' TV MASTER

the Television set anyone can build at home from standard parts. 9in. or 12in. Screen • 12 valves only • Magnetic focusing • Automatic interference Suppression • Easily aligned without instruments • Constructor envelopes containing 8 full-size stage by stage assembly drawings with full instructions and a 32 pp. book on construction, aerial systems, lining up faults and correction, simple non-technical explanation of how T.V. works. 6d. post.

We have also the necessary components and are listing a few only: W.B. Chassis and Speakers, etc., £6 5 0. T.C.C. Condensers, complete range for the V.M. £8 15 0.

WESTINGHOUSE Rectifiers, £3 2 6. **EDISWAN** Morganite Resistor Kit, £1 6 9.

EDISWAN Plessey Transformers, focus coils and other parts, £5 12 6.

CULVERN wire wound potentiometers (6), 19 9.

BULGIN Panels and Switches, 12 6.

WEARITE Coils and Choke, £1 2 0.

VALVES.—All available in reliable makes. The following are reduced in price:—

VALVES

AMERICAN TYPES

- OZ4, 7/6; 1C5, 8/8; 1LA4, 7/6; 1R5, 6/6; 1S5, 6/6; 1T4, 6/6; 1S4, 6/6; 2A3, 9/-; 2X2, 7/6; 5U4, 7/6; 5X4, 8/9; 5Z3, 13/6; 5Z4, 7/6; 6AC7, 6/6; 6AG5, 6/6; 6AG7, 6/6; 6B4, 7/6; 6B7, 10/2; 6B8, 6/-; 6C4, 6/6; 6C6, 7/6; 6C8, 8/6; 6D6, 7/6; 6F5, 6/6; 6F6, 7/6; 6E7, 6/6; 6G6G, 6/6; 6H5, 3/6; 6J5, 6/6; 6J6, 18/-; 6J7, 7/6; 6K6, 6/6; 6K7 MET, 7/6; 6K8, 7/6; 6L6G, 10/-; 6L7, 7/6; 6N7, 6/6; 6Q7, 6/6; 6SA7, 7/6; 6SQ7, 6/6; 6SH7, 6/6; 6SK7, 6/6; 6SL7, 8/6; 6SJ7, 6/6; 6SN7, 6/-; 6SQ7, 6/6; 6T7, 8/-; 6U7, 8/6; 6V6, 7/6; 6X3, 6/6; 7A7, 7/6; 7A8, 7/6; 7C7, 7/6; 12A4, 6/6; 12K7, 8/6; 12L8, 8/6; 12SH7, 7/6; 12SK7, 8/6; 12SQ7, 8/6; 12Q7, 7/6; 12SR7, 7/6; 14F6, 9/6; 18, 10/6; 19, 10/6; 25L6GT, 7/6; 25Y3, 10/-; 25Z4, 9/-; 25Z6GT, 7/6; 28D7, 8/6; 35Z4GT, 10/6; 39/44, 8/6; 39, 7/6; 4L, 7/6; 42, 10/6; 58, 7/6; 59, 10/-; 89, 8/-; 807, 7/6; 84/6Z4, 10/-; 9001, 6/6; 9002, 6/6; 954 acorn, 5/6; 955 acorn, 5/6; 886A acorn, 10/6.

BRITISH TYPES

- 210VPT, 8/6; SP2, 7/6; PM12, 8/6; 210LF, 5/8; TDD2, 7/6; PM1HF, 5/-; PM2A, 7/6; LP2, 4/6; QP21, 7/6; SP4, 5-pin, 8/6; 7-pin, 9/6; MS4, 10/4; MH41, 7/8; D4, 8/6; ML4, 8/6; MU12/14, 7/-; FW4/500, 7/6; VP13C, 10/4; SPI3C, 10/4; HL13, 7/8; UR3C, 9/-; FC13C, 8/6; FC13, 8/6; VP13, 8/6; TDD13, 8/6; AZ31, 9/-; CL33, 10/4; ECC31, 8/6; EP6, 10/4; EF3, 11/2; EF39, 7/6; EL32, 8/6; EL35, 14/3; EM34, 7/6; EL50, 7/6; CH35, 8/6; EK32, 7/6; HL23DD, 6/6; Pen 25, 6/6; TP25, 7/6; VP23, 6/6; U50, 7/6; KT51, 8/6; DE63, 7/6; KT61, 7/6; DA30, 17/8; KT68, 12/6; U52, 9/-; H63, 7/-; KT33C, 8/6; XH, 6/6; XP, 6/6; DET19, 21/-; 41MPT, 7/-; MHL4, 9/-; CL, 9/4; CIC, 9/4; PenDD2530, 10/6; KT32, 7/6; EL3, 8/6; WJ, 7/6; DL2, 7/6; DL35, 8/6, and many more.

IMPORTANT: Please include postage, 1/-.

EASY TERMS again on all TAYLOR meters. Please apply for illustrated catalogue and application form **P.F.P.C.O.** All-in-one Radiometers, A.C./D.C., 25/-.

EQUIVALENT BOOKS, 2/8. SERVICE SHEETS again available! One of your own choice (even some out of print) is included FREE in a dozen of sheets at 10/6.

STOP PRESS

AMERICAN SERVICE MANUALS. A bargain greatly reduced from 10/6 each to 12/6 for three different volumes. Not many left.

RADIO BULL VALVES
246 HIGH ST. WAREHOUSES LTD.

H. P. RADIO SERVICES LTD. OFFER

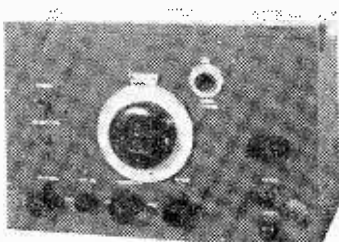

Brand New Ex-R.A.F. R1224a Battery Communication Receiver.

5 Valve Superhet of the Highest Class. 3 Wavebands: 33-70 metres, 70-150 metres, 150-300 metres. Valves, 2 VP23's, FC2A, HL2, PM2A, all included. Has R.F. stage, Muir-head dials, two Output Jacks. Air Ministry grey cabinet, 15ins. long, 10ins. high, 9ins. deep. Requires Aerial, 120v. H.T., 2v. L.T., 9v. G.B., and Loudspeaker or phones to put into immediate operation. All leads clearly marked.

Designed specially for long distance high quality reception. We have such a high opinion of these receivers that we unhesitatingly GUARANTEE Satisfaction or Money Returned within 7 days. Price £5 10s. Carefully packed. Carriage 5/- per Pass, Train, Instant Delivery.

H. P. RADIO SERVICES LTD.

Britain's Leading Radio Mail Order House
55 County Rd., Walton, Liverpool, 4
Tel: Aintree 1445 Estab. 1935

GREAT NEWS for Gramophone Enthusiasts

THE GOLDRING 'JUNIOR' HEADMASTER brings you the World's Finest Pick-up for only £2-4-0 (plus Purchase Tax, 19/-).

- Response 40-15,000 cycles without resonances.
- Interchangeable heads for all recordings.
- Negligible record-wear.
- "Floating-armature" design for perfect tracking—no distortion.
- Tonaliser: 3-point bass and treble equaliser for British and American records.

GOLDRING HEADMASTER with three heads, Tonaliser and Matching Transformer, £5-5-0 (plus 25/6 P.T.).

GOLDRING 'JUNIOR' HEADMASTER with two heads (for wide-range and pre-war recordings), £2-4-0 (plus 19/- P.T.).

Extra heads - 15/- (plus 6/6 P.T.)

Full technical information from

ERWIN SCHARF

49-51a, de Beauvoir Road, Kingsland Road, London, N.1

Programme Pointers

Some Recent Programmes are Reviewed in This Article by Our Music Critic,
MAURICE REEVE

THE B.B.C. has often been accused, and rightly. I think, of "playing down" to many of its audiences. There is an air of smugness, even of superciliousness, in the way some events are announced; very faint, perhaps, but there none the less. We are so frequently "told about" things, and have things "explained" to us, that we are willy nilly driven to the surmise that the powers that be must, more often than not, presume that we are more ignorant than we probably are. So much so that in their zeal for giving us the data and minutiae of a subject—more especially in music, to which I have already drawn attention—they lose count of the vast number of times they repeat themselves. Instead of presuming, as must undoubtedly be the case, that there is a "sucker born every minute," or, in more parliamentary language, that there is someone, somewhere, who is ignorant of the most widely known work and the facts relating to it, how refreshing and flattering it would be if they were to compliment the majority listening-in to a given subject by saying, metaphorically, "If any of you are ignorant of this, it's just too bad, but it can't be helped."

It must surely be the fact that the majority tuning-in to the broadcasts in specialist subjects must be reasonably educated and therefore well informed in them, and must resent, as I do, being addressed in an air that even minutely suggests "patronage" or the notion that "we hope these few facts will help you to 'comprehend'—vile word—the work about to be performed."

There seems to be this feeling that some good people at Broadcasting House, when they have selected plays for "Saturday Night Theatre" in recent weeks, must have been thinking to themselves, "they'll love that," or "they'll go for that every time, they always do," they being those who are presumed to prefer entertainment by means of musical rocking horses or dramatic puff-puffs, and who are far too scantily endowed with top-story matter to be allowed to do a little thinking for themselves. With a few exceptions, the titles chosen, and some of the acting served up, strongly savour of the "oh, Saturday night, they're mostly out at the pictures or elsewhere; I don't suppose there is much critical listening doing" attitude. The answer, maybe, is that the first-class stuff is put on in "World Theatre" and that "Saturday Night Theatre" is only meant for them." I won't answer my own supposition, but will only say that "plays" like "Marriage Aforethought," "Four Bays," "The Man with a Cloak Full of Holes," and "Home is Tomorrow"—the best, in my opinion, of this month's bunch—could easily have, along with "In Town Tonight" and "Music Hall," been specially picked for "them"!

Priestley's U.N.U.T.O.

J. B. PRIESTLEY'S "Home is Tomorrow," whilst not one of his best plays, is a sincere and interesting attempt to put before

the public perhaps the most urgent of all contemporary problems, that of peace through unity, or the Priestleyan UNUTO (United Nations Undeveloped Territories Organisation), wherein unselfish work for all takes the place of the bickerings and rivalries of national politics. That the scheme fails because of the old human failings of some of its leading protagonists doesn't necessarily cause us to despair of the not too distant future. The piece had an unmeritedly short run in the West End. Priestley's dialogue is always good forthright stuff, and it was well put over by Sebastian Shaw, Irene Worth, Cecil Trouncer and others.

"Have a Go"

I WONDER how much longer "Have a Go" will hold its present pre-eminent position. It is an extraordinary type of entertainment. I wonder if, say, twenty years ago, anyone imagined for one moment that, every week, millions of people would breathlessly listen to such an item as a lady publicly confess to them (A) that she had borne twenty-eight children (B) then listen to her try, and fail, to guess a single one of four simple questions put to her, but being awarded the prize for each, none the less, and (C) most amazing fact of all, derive huge pleasure and fun from it. But there we are, we do, and it's handed to us "on a plato" every week, or, in the words of the sub-title to the show, the people are brought to the people.

It has brought its leading personality, Wilfred Pickles, sufficient fame and renown to cause him to be given the leading rôle in a recent weekly Sunday serial, as well as that of elocutionist in a recent weekly poetry programme. In two or three instalments of the adaptation of Bennett's "The Card." I thought his very engaging and debonair personality came over extremely well.

"Music Magazine"

THREE talks in "Music Magazine," which promised to be unusually interesting and nostalgic—on Paderewski, Raff and Rubinstein—fell very flat because of the poverty of the musical illustrations. Mr. Thomas Johnson's playing of Raff and Rubinstein excerpts, especially the latter, were wholly inadequate, and completely nullified his attempts to resuscitate our interest in these two gentlemen. Paderewski, like all his generation, came too soon for adequate preservation by the gramophone companies. The discs selected were trifles made in the great man's dotage, and only served to mar, rather than enhance, the talk. Not a word about his supreme Chopin playing but the statement that he would best be remembered by his "Moonlight Sonata"—a sop, presumably, to the dreadful film of that name he made a few years before the war. Really!

Honnegger

HONNEGER'S "Joan of Arc at the Stake" is an impressive work which grows on one with each successive hearing. As regards the approach

to the subject of both the composer and the poet (Claude), I can only say that it strikes me as being wholly correct. Some have criticised both its excessive catholicity and some of its poetic imagery. But everything in it seems to be welded into a highly satisfactory and homogeneous work. Some of the musical illustrations are wonderfully descriptive and stimulating. A distinguished cast, with the B.B.C. Symphony Orchestra, under Basil Cameron, did the work full justice.

Bartók

I CANNOT enthuse over Bartók's music, which has been very fashionable since his death. I'd stake my wages to a trouser button that it won't live, in the generally accepted definition of that term. Max Rostal played the "Violin Concerto" with the B.B.C. Orchestra, under Sir Malcolm Sargent. That it is unfair always to expect music to be "easy on the ear," and of the old fashioned, heard daily,

idioms, easily comprehended and never taxing our brains unduly, is manifestly absurd. We should get nowhere under such conditions. But of those qualities which constitute "greatness" in music—whatever they may be—this example seems to me wholly to lack. The first symphony of Sibelius, in the same programme, swept us into an entirely different world and displayed all those qualities in their full majesty and panoply.

Sibelius

AFTERTHOUGHT. How strange that Sibelius should be totally unappreciated in France. Yet Sibelius himself, and the world in general, considered that great French violinist Ginette Neveu's rendering of his concerto the finest of all.

Bertrand Russell's series "Political and Cultural Influences of the U.S.A." confirms his supremacy as the best of all broadcast talkers.

News from the Clubs

THE GRAFTON RADIO SOCIETY

Hon Sec: W. H. C. Jennings, G2AHR.

THE Club meets every Monday, Wednesday and Friday evening at Grafton School, Eburne Road, Holloway, London, N.7, (one minute from the Nag's head, Holloway) at 7.30 p.m. Morse classes (beginners to advanced) are held at every meeting.

A large practical workshop offers excellent facilities for construction groups, with expert advice always on hand.

The main speciality of this club is the training and coaching of short-wave enthusiasts seriously interested in obtaining an amateur transmitting licence. Members receive practical coaching on the air, using the Club's transmitter (G3AFT) under qualified operators. Lectures and demonstrations covering a wide interest are always a regular feature.

A canteen provides light refreshments at popular prices, a useful service for those who travel straight from business. New members may be assured of a sincere welcome.

BRIGHTON AND DISTRICT RADIO CLUB

Hon Sec: L. Hobden, 17, Hartington Road, Brighton.

THE A.G.M. held in early January was very well attended.

Past activities were reviewed and the future planned. Several sub-committees were reformed. Extra interest in S.W.L. members as apart from the T.X. section is promised. Morse classes are still running and more of those wishing to learn are invited. Two first-class talks with demonstration of gear were given on sound recording. January programme included further Radio Servicing, Radio Control of Models and the Hon. Sec. discoursed at length on "Olde Tyme Radio."

WEST KENT RADIO SOCIETY

Sec: G. B. Brewer, G4LJ, 80, London Road, Southborough, Kent.

THE above Club is anxious to contact all those interested in radio in the area of Tunbridge Wells, Tonbridge, Sevenoaks, and Crowborough. Meetings are held on the second

and fourth Wednesday in the month at Culverden House, Culverden Park Road, Tunbridge Wells, and an interesting programme of lectures, etc., has been arranged.

(Edinburgh) THE LOTHIAN'S RADIO SOCIETY

Sec: I. Mackenzie, 41, Easter Drylaw Drive, Edinburgh, 4.

REGULAR fortnightly meetings continue to be held at 25, Charlotte Square, Edinburgh, on Thursday evenings at 7.30 p.m., the next meeting is February 16th. (Please note change to Thursdays: this will be permanent.)

At recent meetings talks have been given by A. Grainger, G3BQQ: "The Conversion of Type 24 Unit to a 10-Metre Converter"; and by K. Senior, who described the conversion of the SCR522 RX and TX for two metres.

The Society extends a cordial invitation to prospective members to attend these meetings or contact the secretary.

LEWES AMATEUR RADIO CLUB

Hon Sec: M. B. Beck, 5, Grange Road, Lewes, Sussex.

A RADIO Club has recently been formed in Lewes with a membership of 18 to date. Meetings are held every Friday evening at 7.30 in the Southover Grange, where Morse and the fundamentals of radio are dealt with by Mr. Toole. Enthusiasts in the district will be welcomed any Club night.

READING RADIO SOCIETY

Hon Sec: Frank Hill (G2FZ1), 907, Oxford Road, Tilehurst, Reading, Berks.

ON Saturday, 26th November, parties of official visitors were present from the local police, fire and ambulance services, for an operational demonstration of V.H.F. Mobile Radio Communication, by Mr. Bedwell, of Marconi's W.T. Co., when communication was set up from some of the worst radio localities on the outskirts of the borough, through mobile car and walkie-talkie sets.

Future programme is: Feb. 9th: Standard Frequency Measurement, by EKCO. Feb. 11th: Instructional Section. All meetings are held at Abbey Gateway, commencing at 7 p.m.

WHITTINGTON RADIO CLUB

Sec.: W. Watson, 44, Handby Road, New Whittington, Chesterfield.

A NEW club has recently been formed and meetings are held each Wednesday evening at 7 p.m. in the Angel Club Room, South Street, New Whittington, Chesterfield.

COVENTRY AMATEUR RADIO SOCIETY (G2ASF)

Hon. Sec.: K. G. Liles, 112, Shorncliffe Road, Coundon, Coventry.

ON January 16th a discussion on "Members' Problems" was the main topic, and on January 21st the club visited the Police Station, to see the V.H.F. radio gear.

On March 13th G2FTK (the club QSL manager) gives a talk on his work as manager, and brings some interesting cards along. Plans are well under way for the "Annual Dinner," to be held on March 31st.



Members of the Grafton Radio Society during an evening session

Ideal for conversion into TELEVISION RECEIVERS

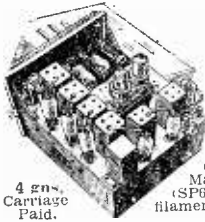

4 pin. Carriage Paid.

10 VALVE 1 1/2 METRE SUPER-HET
Ideal for conversion into Television Receivers. I.F. 12 Megs. Band width 4 megs. Co-axial input and output sockets. 10 Mazda Mains type VR65 (SP61) valves, 6.3 volt filaments.

Brand New WESTINGHOUSE 45 feet 10 sectional 2" DURAL MASTS

Complete with six guy ropes, picket posts. Packed in canvas bag. Each £4 10/-, plus 6/- carriage, or two of above in wooden transit case. £7/10/-, plus 12/6 carriage.

Send stamped addressed envelope for Bargain Lists.

WIRELESS INSTRUMENTS (LEEDS) LTD.

54-56 The Headrow, Leeds
Telephone: 22262

"YOU CAN RELY ON US" FOR CLEAN COMPONENTS AT COMPETITIVE PRICES

IMMEDIATE DISPATCH

LOOK—

JUST A FEW OF OUR LINES SPECIAL OFFER

VALVES.—6K8, 6Q7, 6K7, 6V8, 5Z4C, 5Z4 (Metal), 1C5gt, 6J7, RTW61, U50, DH63, 6SK7, 12J5, 6F6, VU11, each, 7/6; 359, 8/6; 154, 7/6; 1R5, 7/6; 155, 6/-; 1T4, 5/-; 6X5, 6D6, 6J5, 6B8, 77, 6J8, 6G6, 6/6; SP61 (Boxed), 3/6; EF36 (Boxed), 7/-; 6H6 (Boxed), 2/6.

BRAND NEW

FILAMENT TRANSFORMERS.—200 240 v. Primary, 6.3 v. 1.5 a. Secondary. Standard small Speaker trans. size, 8/6, 4 v. 3 a. Secondary, 12/6.

WAVE-CHANGE SWITCHES.—2 pole 2 way Midget Oak type, 2/6. 1 pole 3 way, 1/3. 4 pole 3 way, 3/6.

LOUDSPEAKERS.—2 1/2 in., 25/6; 3 1/2 in., 12/6; 5 in. with dust cover, 9/9; 6 1/2 in., 12/6; with Transformer, 17/6; R. & A. 8 in., 15/6; with Trans., 18/6. ALL BRAND NEW.

SPEAKER TRANS.—5 1/2 Pentode, 4/6; 4 Ratio, 6/6; Midget Mains Pentode, 3/9; Super Midget to match DL92, 354, 4/3.

COILS.—Wearite "P" 3. (Blueprint supplied); T.R.F. Saw LW pair, 7/6 (circuit).

FLEXTRAYTICS.—3 mfd. 450 v. Midget, 1 in. diam., 2/6; 16 mfd., 350 v., All, 2/6; 32 mfd. 350 v., All, 3/-; 16 mfd. plus 8 mfd., 450 v., All, 5/6; 24 mfd. plus 16 mfd., 350 v., All, 6/-.

RESISTANCE BOXES.—1 watt, 3d.; 1/2 watt, 4d.; 1 watt, 8d. Large Stock.

Write, Phone, or Call for:

RADIO SERVICING CO. 444, WANDSWORTH ROAD, CLAPHAM, LONDON, S.W.8.

Telephone: MACaulay 4155.
77. 77A Bus: 25, 28 Tram: S.R. Station, Wandsworth Road.

LONDON CENTRAL RADIO STORES

6 VALVE SUPERHET RECEIVING UNIT No. 25. Easily adapted for 5.V.V. reception for home use. Contains two EF36, two EF39, one EK32, one EBC33 valves, condensers, resistances, etc. Circuit diagram free with every set. 22/6.

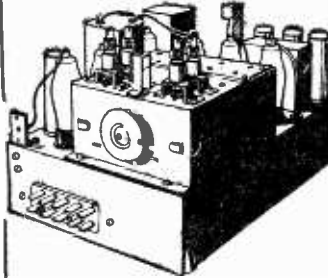

BRAND NEW 1/30 FRACTIONAL H.P. MOTORS, A.C./D.C., 3/16.

TELEPHONE LINE UNISELECTOR SWITCHES as new, 6 bank, 3/16.

MAGSLIPS (Receiver), 3 1/2" x 2 1/2," weight 1 1/2 lb., 10/6.

BLOWER MOTORS, 12-24 volts, 12/6.

NEW MILNES H.T. UNIT (Everlasting), 120 volts 600 mA. Charges from 6-volt accumulator, £3 7s. 6d.

HEADPHONES. Brand new U.S.A. 120 ohm, 5/6, with Aluminium Headbands.

BRAND NEW 2-VOLT VIBRATORS, 7-pin. Self rectifying, 200 volts 60 mA., 7/6.

NEW CARBON MIKE INSERTS, 2/6.

12 inch V.C.R. 140 TUBE. Blue Screen Magnetic deflect and magnetic focus MAX6K heater 4v. inter-octal standard connections American triode. £4 10s.

100ft. EX-GOVERNMENT COPPER AERIALS, with Insulators, 4/3.

12-VOLT VIBRATOR PACK, Admiralty Patt. W4760. New 21/6, 12 volt D.C. supply, 300 volt 100 mA.

WAVE FORM GENERATORS containing 13 Valves, 7 SP41, 3EF36, 1 EBC33, 2 EB34, 30/-.

METAL RECTIFIERS. Westinghouse, 80 volt 5 amp., 11 inches, 33 fins, 24/6.

EX-GOVERNMENT VALVES. Not new, but guaranteed. EF50, 5/- each; EA50, 2/6; SP61, 3/6; SP41, 3/6.

TELEPHONE HAND SETS, 10/6.

SET NO. 38 Mk. III WALKIE-TALKIE CHASSIS consisting 4 ARP12 valves (New) 3-gang condenser and all other components except valve ATP4, 25/-.

VALVE ARP12 new Ex-Government 5/6 each.

23, LISLE STREET, W.C.2.

Telephone: GERard 2969

R.F. E.H.T.

HIGH VOLTAGE SUPPLIES FOR TELEVISOR

type SH 17/50
2-5.5 K.V. £3.15.0

type SH 8/50
5-8 K.V. £4.15.0

Coils supplied separately

Trade supplied

HAZLEHURST DESIGNS LTD.

34, Pottery Lane, London, W.11.

MAINS TRANSFORMERS 16/6 POST PAID

NEW GOODS. NOT SURPLUS FULLY GUARANTEED

Primaries for 200 230 250v. Drop-through chassis type with top shroud. Interleaved and wax impregnated windings. Screened primary.

- (a) 250-0-250v. 60 mA., 6.3v. 3 A., 5v. 2 A., 16/6
- (b) 250-0-250v. 60 mA., 4v. 4 A., 4v. 2 A., 16/6
- Following Types have UNIVERSAL L.T. Windings, 0-4-6.3v. 4 A. C.T. 0-4-5v. 2 A. This means that either 4v. or 6.3v. valves may be used with either 4v. or 5v. rectifier.
- (c) 250-0-250v. 80 mA. 18/6
- (d) 300-0-300v. 80 mA. 18/6
- (e) 350-0-350v. 80 mA. 18/6
- (f) 250-0-250v. 100 mA. 20/6
- (g) 300-0-300v. 100 mA. 20/6
- (h) 350-0-350v. 100 mA. 20/6

Upright Types Fully Shrouded.

(i) 350-0-350v. 150 mA., 0-4-6.3v. 6 A. C.T. 0-4-5v. 3 A. 39/-

(j) 425-0-425v. 180 mA., 8.3v. 4 A. C.T. 6.3v. 4 A. C.T. 5v. 3 A. 42/6

10,000 VOLTS IN STOCK
Get the valve you want by return C.O.D. at standard B.O.T. prices.

MINE DETECTOR AMPLIFIERS
3 valve R.C. Midget Amplifiers with three IT4 valves in ceramic holders, 22/6.

3 AMP. LINE CORD
60/70 ohms per ft., 2-way, 1/6 yd.; 3-way, 1/9 yd.

ALUMINIUM CHASSIS, 3in. deep, 4 sides.
10in. x 6in., 10in. x 8in., 8/6; 12in. x 9in., 10/6;
14in. x 9in., 16in. x 8in., 11/6; 20in. x 8in., 12/6.

SMOOTHING CHOKES
40 mA., 5/-; 60 mA., 6/6; 90 mA., 7/-; 100 mA., 12/6; 200 mA., 21/-.

CARBON RESISTORS
1 watt, 4d.; 1 watt, 8d.; 2 watt, 1/3.

COULPHONE RADIO
"The Return of Post Mail Order Service."
53, Bursough Street, Ormskirk, Lancs.
Send 5d. stamps for 48-page catalogue.

HIGHSTONE UTILITIES

Crystal Sets, which are fitted with a permanent crystal detector. Why not have a set in your own room—9/6, post 6d. De Luxe receiver in polished oak cabinet, 1/8/6, post 1/-, Spare Permanent Detectors, 2/6, each. When ordered separately, 2/6. With clips and screws, 2/10, post 3d.

Headphones, in good order, 4/6 and 5/6, post 6d. (better quality, 7/6). New Headphones, 10/- a pair. Balanced armature type (very sensitive), 12/6 a pair, all post 6d. New Single Earpieces, 3/6. Bal. armature type, 4/6; ex-R.A.F. earpieces, 2/-, post 4d. All headphones listed are suitable for use with our crystal sets. Hand Microphones, with switch in handle, and lead, 4/-. Similar instrument moving coil, 7/6, post 6d.

Sparkling Plug Neon Testers, with vest-pocket clip, 3/3, and with gauge, 3/6, post 3d. **Soldering Irons**, Streamlined iron, with two interchangeable bits, one each straight and curved, 2/0/2/50 to 50/-, 9/-, standard iron with adjustable bit, 2/0/250 v., 60 w., 9/6. **Heavy Duty Iron**, 150 w., 12/6, all post 6d. **Neon Lamps**, for use on mains, showing 7 live 7 sid. of switches, etc., 3/6, post 4d. **Telephone Hand** (with switch in handle), 7/6, post 1/6, Bell, 4/6, post 6d.

Ex-R.A.F. 2-Valve (2-volt) Amplifiers, can be used to make up a deaf aid outfit, intercommunication system, or with crystal set, complete with valves, 20/-, post 1/6. Difeo, less valves, 10/-. Wooden box to hold amplifier, 2/- extra.

Meters, 10v., 2 1/2 in. Rectifier (a.c.), in wooden carrying case, 17/6; 15v., 2 1/2 in., m.c., 9/6; 150v., 2 1/2 in., m.c., 10/-; 300v., 2 1/2 in., m.c., 13/6; 3,500v., 3 1/2 in., m.c., 20/-; 6,000v., 3 1/2 in., m.c., 57/6; 15,600v., 2 1/2 in., m.c., double reading, 8/-; 100 ma. 2 1/2 in., m.c., 7/6; 35 amp. 2 1/2 in., T.C. 5/-; 4 amp., 2 1/2 in., T.C. in case with switch, 7/6; 20 amp., 2 1/2 in., m.c., 10/-. **A.C. Meters**, 2 1/2 in., size, with magnet and case, 1/00 microamp., 2/6. Units containing two. Money refunded if not completely satisfied.

HIGHSTONE UTILITIES, 58, New Watling Road, London, E.11. Letters only. New Illustrations sent on request with I.L. stamp and s.a.c.

RADIO ELECTRON

22, Frances Street, Scunthorpe, Lincs. New Goods Only.

CONDENSERS—Electrolytic 450v. wkg., 2 mfd., 2/6; 8, 3/-; 16, 4/-; 8-8, 4/8; 8-16, 5/7; 16-16, 6/2; 50, 5/9; 500v. wkg., 6 mfd., 3/6; 16, 4/7; 8-16, 6/1; 16-16, 8/11; 25 x 25v., 2/-; 25 x 50v., 2/3; 50 x 12v., 2/1; 50 x 50v., 2/6. Tubulars, 500v. wkg. up to .0005, 6d.; up to .005, 8d.; up to 1, 1/10d. Mica, up to .0003, 9d.; up to .002, 1/-; .003, 1/3; .005, 1/6; .01, 1/9. Sil. Mica, up to 175, 6d.; up to 300, 9d.; up to 800, 11d.; up to 4,500, 1/4. Tuning, .0005 mfd. per Sect., 1 gang, 3/6; 2 gangs, 8/3; 3 gangs, 8/6; Midg. 2 gang, 11/4.

VOLUME CONTROLS—Lg. Spds., all Values, 2/9; with SW, 4/6; with DP, S.W., 5/3.

RESISTORS—Carbon, all values, 1 watt, 4d.; 1 watt, 7d.; Wire Wound, 1 watt, 200 ohms to 1K., 10d.; 5 watt, 50 to 1.5K., 1/6; 3k. to 50k., 2/3; 10 watt, 50 ohms to 2K., 2/3; 20 watt, 150 ohms to 2K., 2/9; Mains Droppers with Ft. and 2 adj. taps, 2A., 4/3; 3A., 4/9.

LOUDSPEAKERS—P.M., 3in., 13/-; 6in., 14/6; 8in., 15/-; 10in., 21/-; Send 2id. Stamp for copy of our new list.

30-40

and watch our Ace service! Letters received daily praising the quality and performance of 30 & 40 Coil Packs and Tuning Units. Just look at the value-for-money you get.

"30" COIL PACK, 3 wave super., aligned and sealed for 465 kc/s. I.F., 24/- plus 3/9 P.T.

"40" COIL PACK, ditto (with R.F. stage), 47/- plus 7/6 P.T.

"M.M." I.F. TRANS., incored, aligned and sealed at 465 kc/s. 12/- pr.

"30" TUNING UNIT, comprising 30 coil pack, M.M. I.F.'s, 3in. x 6in. dial and 2-gang condenser. Aligned as a unit, 54/9.

"40" TUNING UNIT, comprising 40 coil pack, M.M. I.F. transformers, 8in. x 6in. dial and 3-gang condenser. Aligned as a unit, 86/3.

For further information, host of circuits, etc., let the "Home Constructor's Handbook" be your guide to radio realism-at-low-cost! Price 1/-, or FREE copy given with all orders over 1/.

ROBING LONDON FACTORIES (M.O. Dept.), 70, Lord Avenue, Ilford, Essex.



THE Preciton 5 VALVE RADIOGRAM CHASSIS

features include Triode output stage, three wavebands—16-59 (190-559) and 1,000-2,000 metres. Large floodlit Perspex scale. Radiogram switch brings p.u. into circuit. Volume and tone controls operate on both Radio and Gramo reproduction, £12 17s. 6d. Also Luxury 9 valve H.H. chassis, £21 8s. 6d. All guaranteed 12 months.

DATA SHEETS ON REQUEST

Aluminium chassis and panels. Any size, quick delivery. Holes punched for valveholders, plain or cellulose finish.



18, BROAD ROAD WILLINGDON, SUSSEX

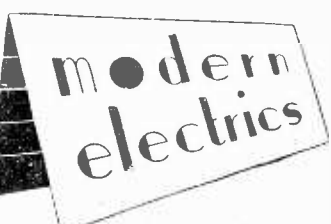

WE DON'T supply anything EX-Government ALL BRAND NEW GOODS Fully Guaranteed

We offer from stock the following Auto-Change Gram Units

- Garrard RC 65A. A.C./D.C. Mixed Records £30/15/0
- RC 65A. A.C. Mixed Records £15/13/6
- RC 70 A.C. NON MIX £10/9/1
- Collaro RC 500 A.C. NON MIX Crystal or HIPI P.U. £10/15/0

EMI A100M. A.C. NON MIX HIPI Pick-up Cabinets unpainted, for the above units, £3 10/0.

TAYLOR TEST EQUIPMENT The entire range of meters, oscillators and all other test gear is now available on Hire Purchase Terms. S.A.E. for Catalogue and terms.

Speakers by Famous Makers. 3in. 14/9; 5in. 11/6; 8in. 17/6; 10in. 21/-; 4 in. AVO MINOR. List price, 5 gu.; our Price, 4 gu.

Leather cases for Avo 7, £2/2/0. All items can be supplied C.O.D. up to 15lbs. in weight; otherwise Cash with order, please.

Special attention to Overseas orders which are free of purchase tax.

MODERN ELECTRICS, LTD., 164, CHARING CROSS ROAD, LONDON, W.C.2. Telephone: TEMPLE BAR 7587.

LYONS RADIO 3 GOLDHAWK RADIO, (Dept. M.P.) SHEPHERDS BUSH, LONDON, W.12

Telephone: SHEPHERDS Bush 1729

SIGNAL GENERATORS—Type B3-C. Manufactured by Advance Components Ltd., these precision Signal Generators have a frequency range of 100 kc/s to 30 Mc/s. Calibration accuracy is ± 1 per cent., output voltage is continuously variable from 1 microvolt to 100 millivolts and an output of 1 volt into 500 ohms is also available. Internal modulation is provided at the two levels of 10 per cent. and 30 per cent. at 400 c/s. External modulation requires 9 volts into an impedance of 10,000 ohms for 30 per cent. modulation, provision too has been made for an A.F. output of 0.9 v. at 400 c/s. with an output impedance of 10,000 ohms. R.F. leakage from the instrument has been reduced to a negligible amount by triple shielding of the oscillator. Operation is as new. Operation from 100-250 v. A.C. Normal list price is £30, but our special purchase enables us to offer a very limited quantity at only £18 10s. 0d.

WIRE-WOUND POTENTIOMETERS—Made by the famous Ohmite Co. of Chicago, in brand new condition: 500 ohms, 0.86 amp., insulated for 600 v., 5 1/2 in. diameter. Price 12/6 post free.

CALIBRATORS RANGE COILS—This unit contains a complete A.C. Power Pack comprising a transformer for 230 v. 50 c/s. input with outputs of 250-0-250 v. at 25 ma., 6.3 and 1 v. at 2 A., L.F. Choke rated at 50 H. at 25 ma. and rectifier valve type U5. Other useful gear fitted are 3 valves type ARP 30 (501), a 153 Ohm Kc. crystal, resistors, paper, metal-cased, smoothing condensers, etc., assembled on neat metal chassis and fitted in case approx. 10 1/2 x 7 1/2 x 9 in. In new condition. Price 32/6. Carriage 3/-.

SUPACOILS OFFER

- * MODEL 30 famous 3 waveband super-het Coil Packs. 2L1 (24-alignd), plus 3/9 P.T.
- * MODEL 40 Coil Packs—similar with R.F. stage, 42-47-alignd, plus 7/6 P.T.
- * MODEL 30 TUNING UNIT consisting of 30 Coil Pack, pair of "M.M." I.F. Transformers, matched 2-gang and attractive Dial. Components aligned together as a unit and sealed 54/9 inc.
- * MODEL 40 TUNING UNIT similar, with R.F. stage 86/3 inc.
- * COMPONENTS—Complete range of radio, television and gram components in stock at lowest prices.
- * FREE A copy of the Home Constructor's Handbook forwarded FREE with any of the above, or for 1/- from SUPACOILS, MAIL ORDER OFFICE, 98, Greenway Avenue, London, E.17

6 VALVE SHORT WAVE RECEIVER (TR.9), 31-80 Metres, complete with 6 Battery Operated Valves, VR21's (2), VR18's (2), VR22 or 118, in working order, 12/6 post 2/6.

BAND NEW VALVES—6V6, 6K7, 6J7, 6J5, 6K8, 6Q7, 6X5, 5Z4, 5U4, 5R4, 807, KTY4, 6/- each. Any 4 for 22/6, post 9d.

12 VALVES, 6SH7 (6), 6H6's (3), 7193's (3), for 11/6, post 10d. EF50's, EF35's, 3 for 10/6, post 9d. VR65's, 2/6, post 4d.

6 volt VIBRATOR UNITS, Output 200 volts at 80 ma. AS NEW, 16/6, post 1/9. **BLOWER MOTORS**, 80 volt A.C. or D.C., will run off 230 v. for short periods. 10/6, post 1/-.

DELCO MOTORS, 27 volt (5.400 r.p.m.), Will run off 6 volt, brand new, 7/6, post 9d. **MIXED POTS**, 6/- doz., post 6d.

5H CHOKES, 200 mA 3A 1/- each, post 10d. **3 VALVE BATTERY RECEIVERS** (Lifeboat), 470-530 kc/s., complete with headphones, 29/6, post 2/6.

SCREWDRIVERS, SLEEVE FIXING PLIERS, 1/6 pair, post 6d. **TENSION GAUGES**, 10-100 grms., 1/6, post 4d.

STAN WILLETTS, 43, SPON LANE, WEST BROMWICH, STAFFS.

OPEN TO DISCUSSION



The Editor does not necessarily agree with the opinions expressed by his correspondents. All letters must be accompanied by the name and address of the sender (not necessarily for publication).

Meter Resistance

SIR,—Since the article on measuring meter resistance was first published in the June, 1948, issue of your magazine, there has been a continual clash of opinions about the matter.

Of all the methods put forward by your readers, some ideas good, some bad, the best is that proposed by Mr. N. Mackinnon, but using the simplified equation

$$R_{m} = \frac{E(i_1 - i_2)}{i_1 \cdot i_2}$$

Where i_1 is the current *without* the unknown meter in circuit, and i_2 is the current *with* the unknown meter in circuit.

If the answer is to be obtained in ohms, then the currents *must* be given in amperes. I fail to see how Mr. Mackinnon's expression 1.45/1.3 can be made to equal 1115 ohms; rather, it should be 1.115 ohms. Actually, the expression should be 1.45/0.0013.

The accuracy of Mr. Mackinnon's method does not depend upon the instrument being tested. If access to a standard voltmeter and milliammeter can be obtained, then accuracies of a fraction of 1 per cent. should be quite attainable. However, even if one *does* know the resistance of the meter to the n th decimal place, I defy anyone without the most elaborate test equipment to wind a shunt of similar accuracy. For most purposes, passing F.S. current through the meter, then shunting it until it reads half-scale, then reading the value of the resistor with an ohmmeter, will be found sufficiently accurate.

It may be well to mention that most commercial grade meters have an accuracy not better than 1 per cent. at F.S.D. and probably worse than this at lower readings. Where then is the demand for super-accurate knowledge of the meter's internal resistance?—IAN B. WALL (South Australia).

[This correspondence is now closed—Ed.]

Focus Control

SIR,—I have built a televisior utilising a VCR157 tube. I have identical trouble to that of E. V. Ward with the focusing, but I have improved matters a little by winding a coil around the neck of the tube and wiring it in series with the supply to the focusing anode.

I also had a great deal of trouble to get a linear output from my Miller line time base, but I overcame this difficulty by replacing the essential resistors by potentiometers of about 500 ohms and adjusting them until I got a compromise between adequate amplitude and a linear output.

I would like to correspond with someone of my own age (15) who is interested in television.—K. BROWN, 41, Meadow Drive, Hendon, N.W.4.

SIR,—In reply to Mr. E. V. Ward's letter that appeared in the February issue may I submit the following?

I have had much experience with C.R.T's, both electrostatic and electromagnetic.

In the electrostatic tube, such as the VCR97, the focusing arrangement may be likened unto the focusing of light by lenses, i.e., the beam of electrons from the gun is focused by the three anodes on to a point at a certain distance from the anodes, in a similar way as light from the sun may be focused on to a piece of paper, making it catch fire.

It therefore follows that the distance from the anodes to the point at which the electrons are fully focused is a definite focal length: therefore, unless the screen of the tube describes a perfect part of a sphere with its radius being the focal length, i.e., radius = distance from screen to anodes, it will be impossible to have the entire screen in focus at any one time. This is the chief reason why electrostatic tubes are not used for T.V. nowadays as it is obvious that if the screen is to be reasonably flat, the length of the tube would have to be very great to give a good focus.

In electromagnetic tubes the action is entirely different, and the electrons spiral in the region of the focusing coils. They then make their way to the screen in a nearly parallel beam, and thus there is no definite focal length and good focusing is obtained over a large screen with a short-necked tube.

With the electrostatic tube of the VCR97 type it is unfortunate that the spot tends to be elongated either in the horizontal or vertical direction, according to the setting of the focusing control.

This effect is very difficult to overcome, but a great improvement occurs if the E.H.T. is increased. This will, of course, decrease the sensitivity of the tube, and a higher saw-tooth voltage may be required.

I have never seen a Miller time base which gives a pure saw tooth, and one cure, as Mr. Ward suggests, is to add a distorting amplifier to rectify the distortion or to use, as I prefer, a different time base, such as a thyratron, which I think, if properly designed, is far superior to the Miller. There are, of course, multi-valve time bases, giving superior results to either the Miller or thyratron.—BRIAN A. CURTIS (Hertford).

6K7 Pocket Receiver

SIR.—With reference to the letter of Mr. F. Lines (Stanmore) in the January issue on the subject of the 6K7 Pocket Receiver, I should like to mention that I have found the use of a Brimar 1C5 and a U2 cell a satisfactory answer to the problem. Results equal to that of the 6K7 have been obtained with the 9-volt H.T. battery, but the valve is pentode connected. Modifications are quite simple, and only four L.T. cells have been used in 10 months by my brother aged eight. The original H.T. battery is still in use. Incidentally, the receiver is working with low impedance balanced armature headphones.—D. W. MORRIS, G3AYJ (Aston, Birmingham).

R1224A

SIR.—Some time ago I purchased an R1224A battery superhet. Recently, however, I attempted to change range 1 to a new range of 30-10 metres, by replacing the existing coils with the appropriate Denco coils.

After aligning, the result was very disappointing: I could only get 5 or 6 very weak signals around 90° on the tuning dial, and nothing at all on either side.

Originally, I was assured by a radio dealer that the I.F. of the set was 465 kc/s. I am now wondering if his information was correct. A different one would, of course, be the cause of the trouble.

I should be very grateful if any of your readers could verify the I.F., and perhaps give me a few hints in connection with my problem.—P. R. MOTTERSHEAD, c/o Hill Farm Cottages, Southwick, Sussex.

"High Fidelity" Is It Worth It?

SIR.—May I please comment on Mr. Thomas Barker's letter in the January issue?

He evidently is learning the hard way, but one or two salient facts must be borne in mind when designing and building "Hi-Fi" apparatus in order to avoid subsequent disappointment.

First, amplifier design has outstripped recording technique; secondly, loudspeakers capable of giving high quality are still lamentably few in number, and even they need special housing to give of their best.

Mr. Baker need not despair; although many of the present B.B.C. transmissions are of poor quality, conditions must inevitably improve in time, and the possession of a really good amplifier and loudspeaker coupled to a suitably designed radio feeder will be a source of inestimable pleasure.—HAROLD STRIPE (New Malden).

A.C. Meter Ranges

SIR.—May I recommend a series condenser in the A.C. rectifier circuit of "Puzzled's" M.C. meter? The following notes enabled me to get satisfactorily accurate and nearly linear A.C. ranges on my own home-made meter. Incidentally, I use a 0.1 milliammeter myself, and I regard the basic consumption of "Puzzled's" meter, 0.10 milliamps, as rather large.

(1) Moving coil meters read average, not R.M.S. of A.C., so 1.11 times current will be needed to make meter read R.M.S., i.e., resistors must be 1.11 less than for D.C. For a 0-10 v. A.C. range,

total impedance must be 901Ω for a F.S.D. 10 milliammeter.

(2) Total impedance consists of reactance of series condenser + resistance of meter + resistance of rectifier at current passing.

However, the current passed by the condenser will be 90 deg. out of phase with current passed by the resistances of the meter and rectifier, and to find the reactance of the condenser, use must be made of the formula $Z = \sqrt{X^2 - R^2}$ where Z = reactance; x = total impedance; and R = total of resistances. Suppose $Z = \sqrt{901^2 - (\text{say}) 500^2} = 750\Omega$ approx.

Now at 50 ω , condenser reactance = $\frac{10^6}{2\pi fZ}$,

$$\text{i.e.,} = \frac{1,000,000}{2 \times 3.14 \times 50 \times 750} = 4\mu\text{F.}$$

Therefore a 4 μ F. 500 v. paper condenser will be made the start of operations.

(3) Next take a couple of mains transformers to the nearest service shop and bribe your friend behind the counter to put them on the mains and read off with his Avo the L.T., H.T. to C.T. and lowest to highest mains adjustment taps, noting the exact voltages. Note, also, the exact mains pressure, e.g., 237 v. What is needed are several 5 to 6 v. readings, a 40-60 v. reading, and the exact mains pressure. At home, put tranny across mains, set up circuit, across a 5 v. winding and measure D.C. output with meter.

If meter reads too high, put a small resistor in series—A.C. in D.C. side of rectifier; if meter reads too low, add a small condenser in parallel across large one, adjusting the current until the meter reads what you know it should. Check with other L.T. windings whose exact voltages are known. Meter deflection should be practically linear from 2-10 v.

(4) To calculate series resistor, R , for 100 v. range, use formula $R = \left(\frac{E}{I \times 1.11} \right) - x$, where E = volts, I = current, and x = total impedance, i.e., $R = \left[\left(\frac{100 \times 1,000}{10 \times 1.11} \right) - 901 \right] \Omega = 8,108\Omega$.

Tap off auto-wise 40 or 50 v. from mains adjustment (tappings of primary winding on transformer); put two 4,000 Ω 20 per cent. resistors in series with A.C. side of rectifier circuit and read D.C. current with meter. The reading must be adjusted by trying combinations of resistors. The calculation serves only as a reasonable starting point.

(5) Repeat for the 500 v. range, using the mains as a check point, or H.T. side to C.T. of the mains transformer.

Finally, the series condenser will protect the rectifier from burn-out should H.T. D.C. be applied accidentally to the A.C. input terminals. I hope that the need for brevity in these notes has not made them incomprehensible, and that they will be of help to others who feel the need, as "Puzzled" does, of A.C. ranges on his meter.—R. E. THOMAS (Tolworth).

OUR COVER SUBJECT

OUR cover illustration this month shows an engineer making adjustments to the radio waveform monitor at the new Sutton Coldfield transmitter.

Impressions on the Wax

Review of the Latest Gramophone Records

A JOSEF STRAUSS waltz magnificently played by the Vienna Philharmonic Orchestra, conducted by Herbert Von Karajan, on *Columbia LX1250* is one of the highlights of the recent releases. Josef has been named as "the Schubert of the Waltz," and this recording of "Spharanklange" is perfectly in the Viennese idiom.

Haydn's "Military" Symphony No. 100 in G has been recorded by the Liverpool Philharmonic Orchestra, conducted by Hugo Rignold, on *Columbia DX1623-5*. The instrumental layout is daring and original, and though the symphony takes its name of "Military" from the frank quotations of Austrian bugle-calls in the slow movement, the sound of this exposition of the opening subject has the taste of a super refined life band. In common with contemporary military usage, there are "Turkish" instrumentals catered for in the slow movement—not so slow, being marked *allegretto*—and in the finale. These instruments are the big drum, cymbals and triangle. They lend a certain colour to the movements concerned, but it is in the handling of the ordinary orchestral forces that the beauty of this symphony lies. The symphony is in five parts on the above three records and on the reverse side of *Columbia DX1625* is Gluck's "Dance of the Blessed Spirits," from "Orpheus."

Two guitar solos appear on *Columbia LX1248*—"Fandanguillo" and "Arada and Danza," played by the famous Spanish guitarist, Andres Segovia. An *arada*, as its name would suggest, is a ploughing song used in the country districts of Spain. It is followed by a typical country dance, and both pieces have been arranged for the guitar by the artist concerned. The guitar, with its keen, sharply-cut tones, records very well.

"The Twenty-four Preludes, Op. 28," by Chopin, have now been completed by Benno Moiseiwitsch (pianoforte). Nos. 1 to 14 have already been issued on *H.M.V. C3905-6* and this month Nos. 15 to 24 have been recorded on *H.M.V. C3907-8*. It will be noticed that the preludes in the major keys are in each case followed by those in the relative minor, ranging from the elaborate five-flat key signature of D flat major and B flat minor down to the single flat of F major and D minor.

The Bournemouth Municipal Orchestra has become a fine organisation under the conductorship of Rudolf Schwarz. "If I Were King" overture needs delicate handling; the Bournemouth musicians certainly give a most satisfactory performance in their recording on *H.M.V. C3945*.

Vocal

It is fitting to start off the vocal recordings with one by Gigli. In his latest recording, on *H.M.V. DB6995*, he sings in Italian. "Marcello" is a love song the gist of which is that the singer's "flame that consumes him will never be extinguished," and the feeling Gigli puts into that final "giammai s'estinguerà" is extremely impressive. Gigli's tone is still a marvel of richness in this song and in the song on the reverse side.

Elizabeth Schwarzkopf's previous records have set a high standard which leads one to expect something fine each time she comes into the lists. There will be no shadow of disappointment with her latest recording on *Columbia LX1249*. She sings two songs from Mozart's "Die Entführung aus dem Serail," Act 2.

Robert Wilson continues to make a speciality of Scottish ballads, and this month he sings a composition of his own, a cleverly conceived song which fits his style admirably. It is called "A Gordon for Me," which is partnered by a good, rich ballad, "When the Heather Gleams Like Stardust"—*H.M.V. B9864*.

Variety

Nobody needs to be told that Jack Train is one of Britain's brightest comedy stars. He has now been captured on *H.M.V.* records in two spirited comedy performances. "The Lord of the Blooming Manor" is a humorous number by British songwriter Michael Carr; the song on the reverse, built around the Colonel's famous interruptory remark, "I Don't Mind if I Do," was written by an old friend of Jack's, Carey Edwards—*H.M.V. B9865*.

Josef Locke's fine diction and controlled tenor voice have put him high among to-day's singing stars. His countless fans will welcome "In the Chapel in the Moonlight" and "We All Have a Song in Our Hearts," which he sings on *Columbia DB2636*.

Frank Sinatra returns to the Columbia lists with "That Lucky Old Sun" and "Let Her Go, Let Her Go, Let Her Go." Both of these songs, on *Columbia DB2630*, give Sinatra the chance to display his versatility, for neither is in the common run of hit numbers.

SIMPLE TONE-CONTROL CIRCUITS

(Continued from page 100)

that the correction is carried out at a high signal level and avoids feeding a very low signal to the valve; a low signal tends to give a poor signal-noise ratio. If the same component values are used, the frequency response given by the circuit of Fig. 11 is identical with that of Fig. 9.

Frequency	Loss in "top cut" circuit	Loss in "bass cut" circuit 6 db. per octave
1/16f	↑	24 db.
1/8f	↑	18 db.
1/4f	negligible	12.5 db.
1/2f	1 db.	7.5 db.
f	3 db.	3 db.
(when reactance of C ₁ equals R ₁)		
2 f	7.5 db.	1 db.
4 f	12.5 db.	negligible
8 f	18 db.	↓
16 f	24 db.	↓
	6 db. per octave	

"PERSONAL PORTABLES" is now receiving such comments as "highly interesting," "excellent," "best half-crown's worth," "most informative," etc. Get your copy of E. N. Bradley's latest book now, 2/8, post free, and build one of the several fully illustrated and described circuits for holiday use BRADDOCK'S, Sennen, Cornwall.

SHEET COILS, 3WB, 465KC with diagram, 2/6 pair; Kit of Parts for Midget Coil Pack L.M.S. (iron cored), 465KC, 9/6; IFT's, 6/- pair; EX-R.A.F. Output Trans., 9d.; 1.1.1, 3d.; Sleeving, 6d. doz. yds.; Amphenol Octal, 4/- doz.; .01 450v. Tub., 2/9 doz. Send for cheapest list in England. SUSSEX ELECTRONICS, LTD. (P), Riley Road, Brighton, 7.

97/6 CHARGING SWITCHBOARDS, 12.32v., 500 and 1,260 volts, amps., cut-outs, fuses, resistances, etc., 4 take-off superb unit, in case, 75/-; Dynamos, 24v., 1,000 w., 9in. x 7in., 3in. spindle, 75/-; Electric Motors, 230V/150 1/5 h.p. Incomp. 1,260cc. converter 58/-; Rotary Converters, from 1-12 kw., 110 and 220v. D.C. to 230v./150 A.C., from £15. Motor generators 1-6 kw., 110 and 220v. D.C. to 24/35v. D.C. £5-£59; 90/-, D.C. Consumption Meters, Ferranti, 210v. D.C. 5a. reading to 10,000 kw. hrs. Mains Transformers, 4-18 kva., all types. BENMOTORS, POWER SUPPLIES, Summerley St., Worsleyfield, London, S.W.18. WIM, 3833 100 yds. Sn. Electric Line, 10 mins. Waterloo.

COMPONENTS, etc., Ceramic V.H.'s, 59G, 3d.; loctal, 8d.; octal, 1/-; Fax., octal, 4d.; B7G, 6d.; VR92, 6d.; VF92 (cradle), 9d.; Xtal diodes, 2/9; Throat Mikes, 1/6; Mike Trans., 1/6; sel. Recls., 240 v., 40 ma, 3/3, 300 v., 80 ma, 3/6. Send stamp for lists, 6d. post orders under 10/-. C.W.O. ELDRIDGE, 254, Grove Green Rd., E.11. (LEY, 4986).

TR196 Receiver Units with 2—EF39, 2—EF36, EK32, and EBC33 Valves (guaranteed), etc., 22/6. Circuit and data for conversion to all wave superhet in "P.W." Aug., 49. Osmor Midget Coil Packs as specified, 33/-. All other components can be supplied. **TR196 Transmitter Units** with EF50, T11 and EL32 valves, 15/-. Type 165 Amplifier Units with 2—EF36, 2—EL32, EBC33 valves (guaranteed), etc., and circuit, 17/6. Small 2-Valve TX Chassis with 500 kc crystal, etc. (less valves), 8/6. Brown Bakelite Cabinets, 13in. x 7in. x 5 1/2in., 12/6. Extension Speakers, 5in. speaker in attractive moulded cabinet, 18/6. 465KC Iron-cored I.F. Transformers, (guaranteed), 4/- pr. 75 M.M.F.D. Air Spaced Ceramic Tuning Condensers (long spindle) 1/-. Ex-Govt. Microphone and Intervalve Transformers including LF type with C.T. secondary, 1/6. Push-Pull Output Transformers to match EL32, 6V6, etc. to 3 ohm speaker, 5/- each. New boxed Valves, 80/- 6KRM, 6V6GT, 6Z4M, 6F6GT, 6N7M, 6SN7GT, 6J7M, 6S7GT, 6SK7GT, 6S9GT, 6AG7M, 6SL7GT, 6U4, 6V6; 6J5GT, 6AC7M, 5/--. Unboxed, but guaranteed: EK32, EF39, EF36, EBC33, EL32, EF50, L63, KT61/3, VP23, HL23D, PEN25, TT11, 6J7, KT263, 4/-; 6V6, 504, 5R4GY, 9001, 9002, 9003, K78, DH63, X63, 5/-; X65, X66, 6/6. Everything post free. Send for free lists. **ELECTRAD RADIO, 64, Gt. Victoria St., Belfast.**

ALL-WAVE Batteryless Receivers—constructional gen. 17/6; all parts, 19/6. Matchbox size Receiver Kits, 3/3. List 1d. **ALEXTONE, Hillworth, Longdon, Glos.**

EVERYTHING for Radio Constructors. Condensers, Coils, Valves, Resistors, etc. Send stamp for list.—**SMITH, 98, West End Road, Morecambe. Quick service.**

NO. 19 TRANSMITTER—Receiver Units. Once again we have been fortunate to secure a limited number of these useful chassis. They were, in most cases, brand new, and of Canadian manufacture, but to conform to regulations were partially dismantled by the Ministry before release, and are sold by us for the many components, which include: one 4-gang, .0005 Tuning Condenser, 1 single .0005 Tuning Condenser, each fitted with slow motion dials, 3 I.F. Transformers, several, 15 Valve Holders, several, Pots, Xaxley Switches, Ceramic Trimmers and several dozen Condensers, Resistors, etc. Our special price is 12/6, carriage paid. We regret that when we last advertised these chassis the colossal demand exhausted all our stocks and we were forced to disappoint certain customers. If these customers will again apply, their orders will have preference. Power Unit for the above works direct from a 12 or 24 v. Battery and is actually 2 units in one (a rotary transformer and a vibrator unit), output 265 v. at 120 m.a. and 540 v. at 26 m.a.; brand new Canadian manufacture; also contain Fuses, Indicator Lamp, Change-over Switches, etc. A few only, at 49/6, carriage paid. We can also supply spare brand new valve type OZ4 and Rectifier Unit, Mallory type G634C, for 10/-. If ordered with this unit, Send S.A.E. for latest lists. **WALTON'S WIRELESS STORES, 203, Staveley Road, Wolverhampton (Mail orders); 48, Stafford Street, Wolverhampton (Callers only).**

DUST CORES, 10d. doz., .0001 Ceramic Trimmers, 3d.; 4 P., 2 w. Rotary with knobs, 9d.; Meter Jacks, Slydlock Fuse holders, 4 w. Jacks, Press Buttons, 6d.; 7 K.V. Rectifiers, 7 w. Pentodes, 5/10 w. Pentodes, 3/6; 210 LF, 2/- Post extra. Write for lists. **ANNAKIN, 2, Sunnydale Crescent, Otley, Yorks.**

MAINS TRANSFORMERS, fully interleaved and impregnated, 200-230-250 v. 50 c.p.s. Screened Primaries, midge type upright mounting, 3-24-3ins. 250-0-250 v. 60 m.a. 6.3 v. 1.5 a. 5 v. 2 a. 17/9. Standard Drop Through Types, 260-0-260 v. 60 m.a. 6.3 v. 3 a. 5 v. 2 a. 13/11; 350-0-350 v. 80 m.a. 6.3 v. 3 a. 5 v. 2 a. 16/9. Fully Shrouded Upright Mounting Types, 350-0-350 v. 120 m.a. 6.3 v. 3 a. 5 v. 2 a. 25/-; 250-0-250 v. 80 m.a. 6.3 v. 6 a. 5 v. 3 a. for 1355 conversion, 23/9; 350-0-350 v. 150 m.a. 6.3 v. 4 a. 5 v. 3 a. 27/9; 425-0-425 v. 200 m.a. 6.3 v. 4 v. C.T. 4 a. 6.3 v. 4 v. 4 a. C.T., 5 v. 4 v. 3 a. 41/6. Smoothing Chokes, 60 m.a. 12 h. 400 ohms, 4/3; 90 m.a. 10 h. Fully Shrouded, 4/11. Vibrator Transformers, 6 v. input, 300-0-300 v. 60 m.a. output, fully shrouded, 8/9. Oak 6 v. Vibrators 4-pin, 4/6. Receiver Chassis, undrilled, 16 s.w.g. aluminium, 10-51-2ins., 3/3; 11-6-2 1/2in., 3/9; 12-8-2 1/2in., 4/3; 16-8-2 1/2in., 5/3. Brand New ex-Govt. Valves: D1, EB34, 1/9; 8D2, 2/3; 6A7, 4/3; SP2, 6J5GT, 4/11; 6C5G, 6K7G, 4/9; KTW61, KTW62, 6C4, 6A5, 5/4G, 5Z4 Met, 5/9; 6V6C, 6J7G, 5/11; 6SN7GT, 6V6 Met, 6F6C, 6/6. Pvc co-axial Plugs and Sockets, 7/- doz. Mains Energised Speakers, 6in. Rola 2-3 ohms (field 750 ohms), 9/6. Celestion 2-3 ohms 8in. (field 1,000 ohms), 16/9. Electrolytics, 8 m.f.d. 275 v. tubular metal, 12/- doz.; 32 m.f.d. 350 v. Can, 1/9. Full list of bargains 24d. Special list for trade. C.W.O. or C.O.D. over £1. Postage extra under £2. **E. POWELL, 3, Rockingham Street, Leeds, 2. Callers: 15, Queen Square, Leeds, 2.**

"PRACTICAL WIRELESS," complete years 1943 to date (one number missing), good condition; Ekco Eliminator; offers, **HOGG, 91, Greenock Road, Paisley.**

R.1124, with 6 new 13 v. universal valves, 12/6, post 2/6. R.F. units, type 24 and 24 mod. 27 at 8/6, plus 1/3 post; type 25, 12/6; type 27, 22/6. No. 13 power units, tested O.K., £1 ea.; rotary only, 12 v., 275 v., 110 ma and 500 v. 50 m.a., 12/6. Mallory vibrator packs, 12 v., 150 v., 60 ma. with S.R. vibrator, 6/6, post 1/3. Ampmeters, 20-0-20, 4/6; 50-0-50, 4/6. Voltmeters, 0-40 or 0-20, 5/-; ma, 0-5, 6/-; 0-1, 12/6; 0-100, 200, 300, 500, 10/- ea., add postage. Liquid compasses for aerial setting, electrically illuminated with prismatic sighting, 35/-, 1b., 1/6. Coloured 6 pin 4/6; 9w, 1b., 1/6. Coloured knobs, 3/- doz, 18/- gr. STC rectifiers, 230 v., 60 ma, 3/9; 230 v., 250 ma, 10/-; 230 v., 1 1/2 a., 21/- ea. or 4 for £3/10/- (4 in bridge give 175 v., 5 a., from 230 v. direct). Telephone Sets, with dual handsets, 45/- per pair; Type F, £4 per pr.; ditto with amplifier, £3 ea. or £5/10/- per pair. Guarantee Valves, EF50, EF54, EF36, EF39, 9D2, 15D2, 8D2, 4D1, 6SH7 at 4/9, post 6d., 46/6, 10/-; VU39, 6V6; VU11, 8/6; VU120, 10/6; 6F6, 6V6, 6N7, 6SN7, VR150, 9001, 12A6, EBC33, 6/6, post 6d.; EA50, D1, 6H6, SP61, SP41, 2/6, p. 6d. 955, 6/-; 956, 9/-; 6AK5, 10/-; 807, 7/6; NR73, ECC31, 10/-; V761, 5/-; 6SL7, 8/-; ATP4, 8/-, Indicator units, Type L, with 97 and 7 valves, EF90, etc., brand new in cartons, £4/10/- ea., C.P. Type 182 with 917 and 8 valves, £35/5/- C.P. Make your own telescopes, binoculars, projectors, enlargers, etc., from ex-Gov. lens and prisms, our new booklet tells you how, price 2/6 ea. Optical lists free for your S.A.E. **H. ENGLISH, Rayleigh Rd., Hutton, Brentwood, Essex.**

5 CORE CABLE, rubber insulated, 9/012 colour coded, rubber covered, 35/-, 100 yards; 7 core ditto, but cellulose covered, 45/-, 100 yards; stamp samples, Belling Lee type 5 pin Plugs and Sockets, 80/- per 100; 7 pin ditto, 100/- per 100. High grade Panel Lights, frosted domed and glass crystal, plated bezel, M.B.C., 80/- per 100. £14 for 400. Ceramic EF. 50 Holders, 25/- per 100; V.C.R. 97 Holders, 18/- per dozen. Throat Mikes, 15/- per dozen. **A. McMILLAN, 5, Oakfield Road, Bristol, 8.**

DUKE AND CO. offer this lot for only 7/6: Condensers over 60; Resistors 50; R.F. Chokes; Meter Rectifiers; Transformers; Octal Valve Drivers; Valve Caps; Slow Motion Dials; Control Knobs; Spring-loaded Terminals; Switches; Xaxley Jack Plug Sockets; Variable Coil Variometer, including rev. counter coil and silver contacts, complete except for coil winding, plus rack chassis and case; this 22 set (Transmitter Receiver) is value for money. Send 7/6 and 2/- post and packing fee, takes one. Pre-U.H.F. Amplifier, takes one. E950 is ideal for television or short-wave gain stage, 2/6, post 6d. Condenser, .0005 mfd. slow motion dial, complete 3/-, post 6d.; .0005 single, 2/2; .0005 two gang, 4/6; 3 gang, 2/6. Crystal Sets, complete in bakelite cabinet, 7/6 each, post 6d. Valves: all types including X.W.D. at B.O.T. price. Television: 9in. white plastic escutcheons, 2/6, plus 9d. Headphones, new condition, low resistance, 2/6; high, 4/6. Induction Motors, 200/250 v. A.C., for milk snakes; complete with long spindle, runs smooth and silent, small, 17/6, plus post 1/-. New and improved Kit: a 3-valve T.R.F. 2-wave band receiver; all parts including a smart walnut, bakelite cabinet; complete kit £4/19/6; ivory cabinet available, 6/- extra. Telephones, complete, dial system, G.P.O. pattern, 15/- each, 25/- pair, plus 2/6 post. Send stamps only for lists. Trade enquiries invited, 219, Ilford Lane, Ilford, Essex. (ILF. 0295.) Export enquiries invited.

SIGNAL GENERATOR.—The now famous Homelab Signal Generator, moderately priced at £6/11/-, plus 5/- for postage and packing, has the refinements of an expensive instrument at a fraction of the cost. Check the specification:—1: Frequency coverage: 2: 100 kc/s to 130 Mc/s, q.c.s.y. Modulation 30% at 400 c.p.s. with provision for external modulation or unmodulated carrier; 3: Coarse and fine attenuator; 4: Output impedance 10 ohms; 5: Low leakage—R.F. oscillator double screened; 6: Very stable R.F. oscillator protected by buffer stage; 7: Accuracy of calibration 1% (operates from A.C. mains 200-250 volts); 8: Twelve months' guarantee. Do not be deceived by the very low price. This is really a first class instrument, and by dealing directly with the manufacturers you save approximately £8. The high standards of design and workmanship will satisfy the most critical. Send s.a.e. for full technical specification, enclosing P.O. for 2/6 if you want circuit diagram. Owing to the very large demand for the Homelab Signal Generator there is some delay in delivery, but all orders are being dealt with in strict rotation. This instrument can be seen at the following address: Homelab Instruments, 374, High Road, London, E.11. Orders and enquiries can only be accepted by post and these should be addressed to **HELY-MANN ELECTRONICS LABORATORIES**, 116, Grove Road, London, E.17.

REDUCTION DRIVES. 9d.; Sprague 801, 1,000 v.; Micamold, 1,350 v.; 3/6 doz.; 100 PF Ceramics, 2/6 doz. List from T. G. HOWELL & CO., 29, McWilliam Rd., Brighton, 7.

FRITH RADIOCRAFT, LTD. offer a full range of TV Components from stock—Morganite Resistors. "T" 20 per cent. 4d., 10 per cent. 6d.; "R" 20 per cent. 6d., 10 per cent. 9d.; "Q" pots 100k, 250k, 4/6. TCC Metalmlies .001 CP119W, 2/2; .002 CP32S, 1/9; .005 CP32S, 1/10; .01 CP32N, 1/8; .01 CP33S, 1/10; .015 CP33S, 2/-; .02 CP33N, 1/9; .05 CP3TS, 2/1; .1 CP3TN, 2/3. Paper Tubulars: .01 543, 11d.; 1/543, 1/3. Micadiscs, 500pF, 1/6. Mica .001 CM20, 1/9. Ceramics 2pF SCP4, 1/-; 15pF SCD3, 1/3; 40pF SCT1, 10 per cent., 2/6; 47pF SCT1, 1/9. Picopacks 10 350 CE30N, 2/150, CE30G, 20 12 CE30B, all at 2/6. Lectropacks 16 350 CE26L, 4/9; 30/350 CE29L, 6/6; 40 350 CE101, 7/6; 32+32E Television, 12/-; 100 350 CE10L, 13/6; 250 50 CE10DA, 10/-; 2500 3V CE25AA, 6/9. Reliance Controls T/1, 2, 21, 5, 10, 25, 50K, 4/6; 100K, 5/-; SG 150K, 2 meg, 5/-; Elac PM Focus Magnets R17, 21/-; R20, 22/6. Denco Scan Coils, 30/-; Screened Line OPT, 27/-; Combined Line OPT and EHT Unit with 2 EY51 valves, 86/-; BTH Crystal Diodes CG1C, 11/3. All "Viewmaster" parts from stock also "EE", "WW", "PW" for London or Midland. Books: "Viewmaster," 5/6; "Denco," 5/6; "EE," London, 2/6; "EE," Midland, 4/6; "WW" L M S'het, 5/6, post free. All goods post free over £1. Satisfaction guaranteed. **FRITH RADIOCRAFT, LTD.**, Church Gate, Leicester. (Phone: 58927.)

QUALITY ENTHUSIASTS! High Fidelity Tuners: No. 1 T.R.F., infinite impedance detector, M. & L. waves, excellent reports from "Williamson and Leak" 1/1 amplifier users, £5; complete kit, £4/10/-. New Quality Amplifiers: No. 1 4-watts undistorted output (3 ohms) 6V6 with special neg. feedback circuit, pickup and tuner inputs, £5/19/6; complete kit, £5/10/-. No. 2 12-watt Quality Amplifier, push-pull 6V6 output (3, 7 and 15 ohms), neg. feedback, gram., mike and tuner inputs; price 10 gns.; complete kit, £9/24/10/-. Radio Gram Equipment: Collaro RC49 Mixed Autochanger (8 records mixed) with crystal pick-up, £14/6/8. Marconi AC 100 Autochanger (9 records not mixed) with hi-fi lightweight pick-up and transformer, £10/10/7. Collaro AC504 Motor Pick-up Autostop Unit with magnetic pick-up, £5/3/2; Collaro AC47 centre drive motor, var. speed and non-magnetic turntable, £5 18/4. Viewmaster Television Components: WB Chassis and Speakers, etc., £6 5/-; Chassis Condensers, £6/15/-; Westinghouse Rectifiers, £3/2/6; Ediswan Morganite Resistors, £1/6/9; Ediswan Plessey Transformers; Focus Coils, etc., £5 12/6. Colvern Wire wound Potentiometers (6), 19 3; Bulgin Panels and Switches, 12/6; Wearite Coils and Chokes, £12/6; V M Cam structural Magnet 5/-; E.E. Television Birmingham edition, 5/-; full set of Coils and R.F. Chokes, 18/6. Terms C.W.O. or C.O.D. P.W. bargain list 2/6. **NORTHERN RADIO SERVICES**, 16, Kings College Rd., Swiss Cottage, London, N.W.3.

EX-GOV. SURPLUS.—Coaxial Wiring Cable with copperweld conductor, KS.8086, with single pin and casing connector, lengths: 13ft., 2/6; 20ft., 3/9; 22ft., 4/-; 27ft., 4/6; 200ft., 30/-. Radio Receiver, Type 76, freq. cov. 150-500 K cs., 3 valve calibrated tuning dial, desim trimmer, 15/-; Frequency Meter, 906, cov., 14-23 mc s, calibrated chart (new in case), 30/-. Signal Generator, 196, cov. I.F.P. range, 13/-; Radio Receiver, Type 78, 5 valve, crystal unit, freq. cov., 2.4-13 mc s, (new in case), 30/-; **SANMARK PRODUCTIONS**, Saint Marks Street, Bolton, Lancs. (Phone: 2632.)

P.M. SPEAKERS: 5in. Rola in case 8/11s. Goodman with transformer, handles 8 watts, 30/-; Condensers, under block type, 8 mid., 750 volts, 10/6; Co-axial Cable, 75 ohm, 10/6d. vd.; Valves: 6V6 7/6, 5U4G 7/6, SU2150A 12/6, EF50 5/-, 807 7/6, EA50 3/6, DI 1/9; Metal Rectifiers, 60 M.A. 230 volts, 3 wave, 3/-; Voltmeters, 0/200 A.C. moving iron, 23in. cov., 17/6, 31in. surface type, 22/6; 250 moving coil meter, pair of, 31in. fin., 30/-; **WILCO ELECTRONICS**, 204 Lower Addiscombe Road, Croydon.

D. COHEN, Radio and Television Components, 67, RALEIGH AVE., HAYES, MIDD., CONSTRUCTOR'S PARCEL (1) comprising miniature chassis, size 8 1/2 in x 3 1/2 in x 1 1/2 in, miniature twin ganc .0037", pair of miniature Wearite I.F.S. Type M400B, B7 V.H., frame aerial and medium wave osc. coil at £1 9 6. P. & P. 1.6. (2) Comprising chassis 10 1/2 in x 5 1/2 in x 2 1/2 in with speaker and V.H. cut-outs, Rola 5in. P.M. with trans., twin-ganc with trimmers, pair of 250v. coils, 4 V.H. and superchange switch, 17 6. P. & P. 1.6. **SUPERHET COIL KIT**, comprising long, medium and short-wave coils, twin-ganc, pair of 465 I.F.S. 4-pole 4 way switch, 4 trimmers, 2 trackers, 500v. superhet. chassis, IF and speaker cut-out and circuit, 14 6. plus 1-P. & P. **UNIVERSAL REPLACEMENT MAINS TRANSFORMER**, Input 200 250v., Sec. 280 250v. @ 60 mA. Gv. tapped 3 amp., 5v. tapped 4 v. 2 amp., Gv. 0.3 amp., 10 6., P. & P. 1-. **MAINS TRANSFORMER**, Input 200 250, Sec. 350 0.350v., 130 mA. 6 v. 5 amp., 5v. 3 amp., 19 6., P. & P. 1. **METAL RECTIFIERS**, 250v., 25 mA., 4 6. Post 4/6. 250v., 90 mA., 2 6. Post 6d., 24v. 4 amp., 18 6. Post 1/-; Send stamp for list.

PHOTO-ELECTRIC Exposure Meter Components.—Light Cell 6/6; Meter Movement, 10/6; Moulded Perspex Case, 9/-; Ivorine Conversion Dials, 5/6; Complete Assembly Instructions, 3/6. **G. R. PRODUCTS**, 78, Repton Road, Bristol, 4.

CONDENSER BARGAINS.—Oil-filled types, 4 m.F./200 v.w./2/6; 4 m.F./2,000 v.w./5/6; 2 m.F./500 v.w./6d.; 0.25 4 k.v./3/6. Tubular types, waxed, 0.1/300 A.C., 0.15/450 v.w., 0.01/3,000 v.w., all 3/- doz. Metal Cases, 0.002 Metalmlies, 0.01 750-1,000 v.w., 3/- doz., 0.5 Micamoulds, 3/6 doz., Electrolytics, 50 m.F., 20 v., 20 m.F./50 v., 7/6 doz.; 100 m.F. 50 v., 14 6. Ceramic, Silver and Standard Mica, many capacities, 2 Pf to 0.01 m.F., all at 2/3 doz. Wafer Switches, 2P 4W.4.B. 2/-. Include postage, excess refunded. **J. E. L. POSTAL SUPPLIES**, 133, St. James Rd., Blackburn.

VACUUM CLEANERS and Gram. Motors, repairs our speciality. Armature rewinds, new bearings and commutators fitted, also transformers rewound, speakers repaired, competitive prices. Trade enquiries invited. 2 to 5 days o.d. service. Write s.a.e. for price lists to: **A.D.S. CO. (V.E.M. Dept.)**, 261-3, Lichfield Road, Aston, Birmingham, 6. Est. 1935.

ONE-VALVE Loudspeaker Set. The "Eumomo" A.C. mins. Send 2/6 for Diagram and constructional notes to **DREW**, 126, Sidwell St., Exeter.

"TELEVISION SPECIAL!"—In response to 1,000!!! requests, we now offer the E.S.3 "Foundation Kit" which uses VCR 97 tube (not radar conversion). Send large S.A.E. for illustrated brochure. **Drpt. P.W. T.H. PRODUCTS**, 92, Leathway Rd., S.W.11.

WIRELESS WORLD Television, Deflector Coil Assembly 22/-; Focus Coil, 25/-; Block osc. Trans. 9/-; Superhet Coils, £2/12/6; Clauisss Kits, £6. "P.W." Television Components ready shortly. **R. P. SHILTON**, 19, Charendon Rd., Salisbury, Wilts.

MERCHANT NAVY AND AIR RADIO. Here is an opportunity to train as Radio Officer for merchant ships and the air. The big liners are open to you, but you must first qualify for the P.M.G. Certificate. Established 39 years. We can put you through in the minimum time. Day, evening and "Radioets" postal courses. Prospective Director. **THE WIRELESS SCHOOL**, 21 Manor Gardens, Holloway, London, N.7. ARC 3694.

TELEVISION.—The Gothic Television School specialises solely in training in television. Courses assume no previous television knowledge and provide guaranteed training for Brit.I.R.E., and R.T.E.B. examinations. All tutors possess university degrees and/or corporate membership of professional institutions and are appointed individually to postal course students to ensure complete and thorough training. Principals, M.B.E., B.Sc., M.Brit.I.R.E., education committee members, etc. Numerous well-known companies have adopted the School's Basic Television Course as standard television training for their staffs. Modern courses. Details from **GOTHIC TELEVISION SCHOOL**, 13, North Ave., London, W.13.

GLOBE JONRAD SHORT-WAVE KING RECORD
 The World at your fingertips! ★ Real LONG DISTANCE ★ Radio Reception
 SEND FOR FREE COPY OF CATALOGUE
 PROBABLY THE SMALLEST ONE VALVE SHORT-WAVE RADIO IN THE WORLD USING STANDARD TEST TUBES WITH BROADCAST TUNING BEVEL
 49/6
 SEND ON MONEY BACK GUARANTEE. APPROVAL CARD FOR 12 MONTHS.
JOHNSONS (Radio Specialists) CRESSHIRE (ENGLAND)

Autofeed SOLDERING IRON
 Simple self-feed speeds up soldering. Better work. Saves solder. Write for interesting leaflet 29 J
RUNBAKEN-MANCHESTER



ANNOUNCING THE £15 T/V FOR THE MIDLANDS

Constructors in the Midland T.V. Area will be pleased to learn that the Data for our Mk II Television for operation on the Sutton Coldfield Frequencies is now available. All constructors of this Television who have not yet received the information should write in quoting date of purchase and invoice number, when the full details will be supplied gratis.

This Television, many hundreds of which are in service, is designed round two Radar Units which cost only 45 sh. the pair. One unit is an Indicator containing a VCR97 C.R. Tube, and the majority of the valves and components, and the other unit is a ready-made Vision Receiver which only requires modification for the T.V. Frequencies. Use of this latter item, which was made regardless of cost to a planned layout, eliminates many of the headaches experienced by those who have attempted the construction of a Vision Receiver from scratch. The Constructional Data is most detailed, with photographs, parts lists, circuit diagrams, etc., and costs only 7/6, or is supplied gratis with the two Radar Units. Alternatively, it may be purchased, and the cost will be credited against the subsequent purchase of the Radar Units within 14 days. A fully detailed price list shows that the total cost is £15 4s. 9d. Please note that orders for the Radar Units should include an additional 12/6 carriage costs, plus 10/- deposit on packing case.

For Constructors embarking on other circuits we can supply a wide range of component parts, many of which are listed below.

R.F. UNITS TYPE 26 specified for inexpensive television are now all sold, but we can supply the R.F. Unit 27, with full details of modification to cover the T.V. Frequencies, simply by retrimming. **ONLY 35/-** (postage 1/6).

R.F. UNITS TYPE 25 specified for London Area Station, 177/6 (postage 1/6).

INDICATOR UNITS TYPE 6. The indicator unit specified for "Inexpensive Television" is being complete with the VCR97 Tube and valves. **BRAND NEW IN MAKER'S CRATES. ONLY 90/-** (carriage 7/6).

TRANSFORMERS for the above T/V have been specially made as follows: **Time Bases** and **Vision Transformer**, 350-0-350V, 160 ma., 5v. 8a., 6.3 v. 6a., 6.3 v. 3a. **ONLY 36/-** Sound Receiver C.W.O., please add postage where not stated on orders under £2. **Transformer**, 250-0-250 v. 100 ma., 5 v. 3a., 6.3 v. 6a. **ONLY 27/6**, EHT transformer for VCR97 Tube 2-0-2V, 1.1a., 2-0-2v. 2a. ETH at 5 ma.

MAGNETIC LENSES for 6in. CR. Tube. Brings up the picture size to approximately that given by a 9in. tube. **ONLY 25/-** (postage 1/6).

U.E.I. CORP., The Radio Corner, 138, Grays Inn Road, London, W.C.1. (Phone: TERminus 7937) Open until 1 p.m. Saturdays, we are two mins. from High Holborn, 5 mins. from King's X.

SPECIAL MARCH OFFERS

Brand New and Unused. In Maker's original carton. **EX-A.M. UNIT TYPE 567 C.W.W.** Containing 11 new valves: 2 5Z4G, 2 5U4G, 1 VU120, 1 6X5GT, 1 EF50, 1 EF55, 1 6V6G, 2 V570 (voltage stabilisers). Dozens of various components, including high voltage condensers, chokes, potentiometers, resistances, condensers (9 mid. 500 v.v.), etc. Totally enclosed in metal case size 12in. x 11 1/2in. x 6in. Weight 40 lbs.

LASKY'S PRICE 49/6 Carriage 5/- extra.

Brand New in maker's carton. **PACKARD-BELL PRE-AMPLIFIER.** Supplied complete with circuit. Contains 2 valves: 6SL7 twin triode and 2B7 with pentode. Also input and output transformers and many other components. Enclosed in lightweight metal case, size 4 1/2in. x 5 1/2in. x 4 1/2in. Weight 3 1/2 lbs.

LASKY'S PRICE 12/6 Post Free.

SPARE KIT OF VALVES FOR THE PACKARD-BELL PRE-AMPLIFIER. Consisting of one 6SL7 and one 2B7. Price only 7/- the pair. Post 9d. extra. Post free if purchased with the amplifier.

CATHODE RAY TUBES TYPE VCR97. Brand new ex-Government. Fully guaranteed. Supplied in sprung wood transit case. Characteristics: Heater 4 volts 1 amp. H.T. 2.5 kv. maximum. Tested before despatch.

LASKY'S PRICE 35/- Carriage Free.

I.F.F. RECEIVERS. Brand New and Unused. Supplied in maker's original cartons. Contains 8 new valves: 4 SP41, 1 EA50, 1 VR78, 2 CV6. Also hosts of components, coils, condensers, resistances, switches, etc. A motor generator with an input of 24 volts and output of 480 volts.

LASKY'S Special Clearance Price 19/11 Carriage 3/6 extra.

EX-A.M. RECEIVER TYPE 1155. Brand New in maker's original carton. Supplied with all valves, this excellent receiver requires no further description. Full details, however will be sent on request. Aerial tested before despatch. **LASKY'S PRICE £12.10.0.** Carriage 7/6 extra.

Send a 2d. stamp with your name and address (in block letters, please) for a copy of our current stock list of ex-Government equipment. The Lasky's Radio Bulletin.

LASKY'S RADIO

370, HARROW ROAD, PADDINGTON, LONDON, W.9.
Opposite Paddington Hospital.) Telephone: CUNningham 1979. Hours: Mon. to Sat. 9.30 a.m. to 6 p.m. Thurs. Half Day.

THE "RD JUNIOR" DE UXE

By popular demand the improved tone control circuit used in our Williamson pre-amplifier has now been incorporated in the RD Junior amplifier. This, together with increased N.F.B., low noise audio input stage (Mullard EF40), and other refinements, results in an amplifier which is by far the best available in its price class.

Performance Figures

- Frequency response: ± 2 DB 20-20,000 cps.
- Distortion: for 8 watts output, not exceeding .5 per cent. total harmonics at 100 and 1,000 cps.
- Sensitivity: Radio input, 2 v. R.M.S. for 10 watts output.
- P.U. input, 170 m.v. R.M.S. for 10 watts output (at 1,000 cps).
- Hum and Noise: With maximum gain, maximum bass boost, and open grid circuit. Gram position—85 DB or better.
- Bass and Treble controls: These are of the variable slope type, and give a range of ± 18 DB at 20 and 20,000 cps.
- Cross-over frequency 1,000 cps.
- Pick-up compensation: 6 DB per octave from 250 cps. to 20 cps.
- Degree of feed-back: 20 DB.
- Due to exceptionally low-phase shift the amplifier is unconditionally stable under all normal conditions.

PRICE: Completely wired and tested in chassis form—£22 10s. 0d.

The amplifier may be heard at our Hampstead premises. Demonstration Times: 10.30 a.m.—12.30 p.m., 1.30 p.m.—5.30 p.m. DAILY. Thursdays: 10.30 a.m.—12.30 p.m. Nearest Underground Station—Hampstead—Northern Line.

The amplifier may also be heard at:
The Gramophone Exchange, Shaftesbury Avenue, W.C.2.
Electro-Power Service Co., 390, High Road, Leytonstone, E.11.

ROGERS DEVELOPMENTS Co.,
106, Heath St., Hampstead, London, N.W.3.
HAMpstead 6901.

SOUTHERN RADIO'S WIRELESS BARGAINS

T.R. 1196. Six valve Super-hot Receivers. Complete with Circuit, 22/6.

CRYSTAL MONITORS. Complete in case, less Crystals, 6/-.

CRYSTALS. American and British 2-pin types from 2040 kc. to 38 mcs. 6/- each. Twelve assorted frequencies, 60/-.

SECTIONAL AERIALS. 8ft. interlocking, 3/6. Base for same, 2/6.

BENDIX COMMAND RECEIVERS. B.C. 454 (49-100 metres). B.C. 455 (33-49 metres). Complete with six valves, 35/-, plus 1/6 postage. A few only converted to 28-41 metres for television sound, 50/-.

CONTROL BOXES, for B.C. 453/4/5. Complete with slow motion dials. Volume Controls, etc., 13/6.

TRANSMITTER-RECEIVERS. Type 58, Mark I. Complete in original cartons with Vibrator Pack, Batteries, etc., £19.

R.A.F. BOMBIGHT COMPUTERS. Complete with Motors, Gears, Blowers, etc., etc., 55/-, plus 5/- carriage. The best component value ever offered.

INDICATOR UNITS. 829a. Complete with 7 valves C.R. Tube, 3BP1 and all components in metal case. Ideal for Oscilloscope conversion, 44/-, plus 5/- carriage.

CONTACTOR TIME SWITCHES, by Smith or Venner. 10-hour movement with thermostatic control. Complete in sound proof case, 10/-, plus 1/4.

RADIO COMPASS INDICATORS, with Selsyn motor, 3in. dial, 360 degrees, 13/6.

ROTOTHERM METERS. Chromium finish, 6/-.

BRAZING LAMPS. 5-pint size with extension hose and nozzle, 40/-.

ALDIS LAMPS. 6in. lens. Complete in transit case with spare bulbs, cable, etc., 40/-.

SMALLER size for signalling. Complete in metal case with taper, etc., 15/-.

DEF. (H) HAND GENERATORS. 6 volts at 4 amps. complete ready for use, 17/6.

LUCAS GENERATORS. 12 volt input to 480 volts D.C., 10/-.

SLEEVING. 1 mm. and 2 mm., 6/- gross yards. Minimum quantity one gross.

LABRA HOLE CUTTERS. Adjustable from 1/2in. to 3/4in. For use on wood, metal, plastic, etc., 5/6.

VECTECTORS Wx6 and W12. 6/4 per dozen.

Thousands of bargain lines for Callers. All goods unconditionally guaranteed. Please send 2d. for full publication list.

SOUTHERN RADIO SUPPLY LIMITED,

46, LISLE STREET, LONDON, W.C.

GERrard 6653

Practical Television

Vol. 2. No. 3

NEW SERIES

MARCH, 1950

Televiews

Programme Interchanges

NOW that Sutton Coldfield Station is in full swing the question of interchanging programmes with other countries is introduced. That time, however, is far distant, and certainly it will not happen for at least five years. Attention at present must be concentrated on providing a nation-wide coverage, and when that has happened it will be time enough to consider looking into the programmes radiated by other countries. The problem bristles with difficulties, not the least of which are the different standards of definition in their television systems.

The meeting of experts of the signatories of the Brussels Treaty, representing Belgium, France, Luxembourg, the Netherlands and the United Kingdom, recently examined a proposal submitted by the Belgian Government which draws the attention of the other four Powers to the difficulties caused by these different standards.

The experts recognise that although the exchanges of television programmes between the five countries could be effective without a common standard of definition, nevertheless, such a common standard would greatly facilitate the full development of these exchanges and would provide other advantages.

The present development of television in France, the Netherlands and Belgium is of such a nature that the difficulties to be overcome and the sacrifices to be made in order to reach agreement on common standards are bound to increase considerably during the coming months.

The French, Luxembourg and Netherlands experts recognise that the adoption by the continental powers of the Brussels Treaty, prompted by the concern expressed by the Belgian Government, of common standards of definition—standards the use of which could be extended to other

European countries—might justify the sacrifices which certain countries would have to make. The hope is expressed that the five countries of the Brussels Treaty will come to an agreement on common standards, but how this will be brought about is not suggested. Great Britain is tied to its present system and it can hardly change horses in the mid-stream of its own development, and we presume that is the position in other countries. It is upon this that we base our belief that programme interchange with other European countries is only a possibility of the remote future.

Standards of definition are already the subject of examination elsewhere, notably by the International Consultative Committee of Radio Diffusion. The meeting to which we have referred agrees that contacts established in London during the meeting ought to be maintained by further meetings.

These remarks are merely a criticism of our own Television Advisory Committee, whose recommendations have proved to be divorced from reality and requirement. This committee has considered television development mainly in this country alone and has scarcely examined continental systems or even the possibility of programme interchange. Little wonder that the trade has withdrawn its support from it. We repeat our advice of last month—the T.A.C. should be abolished. It has not performed and now cannot perform a useful function.

Sutton Coldfield Snags

AS was to be expected, the Sutton Coldfield Station has experienced certain teething troubles which revealed themselves to the looker-in as a series of breakdowns, including one of seventy minutes' duration. Some of the ill-informed critics who write notes for the provincial press have seized upon these breakdowns to express doubts as

to the reliability of television. We can reassure viewers on that point. The Sutton Coldfield station is the most powerful in the world, and it was not to be expected that it would start off from scratch without unexpected troubles. It is our view that the opening date, December 17th, was a little too early, but the B.B.C. did not break faith and opened on the appointed day. The announcement of the opening date was made during Radiolympia, no doubt with the idea of encouraging the sales of television receivers. Certainly the announcement had the desired effect, for the demand for television receivers in the service area of Sutton Coldfield has been truly remarkable.

Not all of the troubles are at the transmitting end. We understand that viewers are experiencing troubles, too, in that area; but then, so did viewers in the London area for a few months. The service engineers now are on top of the job and it is rare indeed that trouble is experienced once a receiver is installed.

Knob Twiddlers

AS in the early days of radio, so in these early days of television we have the knob twiddlers—not the genuine experimenter, who knows why he is twiddling and is able to assess the results of his twiddles, but those people proud of their new possession who think that by continuously turning the knobs they are going to achieve a better result. There are occasions when such knob-twiddling is due to trouble at the transmitting end and the looker-in has no means of knowing that it is not his set which is giving trouble. These viewers may not know that they may be causing interference on the television receiver owned by their neighbours. The test card put out by Alexandra Palace should enable the adjustments to be made before the programme starts and, but for a small adjustment to picture brilliance, the knobs should be left alone.

TELEVISION PICK-UPS AND REFLECTIONS

UNDERNEATH THE DIPOLE

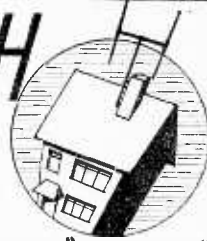

By "Scanner"

THE "Technical Hitch" has long been a cliché in the apologia of B.B.C. announcers. From the early days, openings of B.B.C. stations seem to have been afflicted by the inevitable teething troubles, which sometimes resulted in complete shut-downs for a few minutes or longer. Years ago, a new transmitter at Manchester failed to function at all on the opening night, and the original 2ZY Manchester Station had to carry on for the evening, putting on all the extra power possible in order not to disappoint listeners. At another opening, an engineer discovered a faulty joint at the very last moment and had to hold connections together with his hands for an agonising thirty minutes while the transmission proceeded smoothly. The Newcastle station opened with an "al fresco" studio rigged up in a furniture van in the yard of the transmitting station, with over-coated artistes singing into solid-back P.O. carbon microphones, and an upright piano tinkling in the background. True to the "technical hitch" tradition, the Midlands Television Transmitter commenced operations with a ten minute hold-up. The actual opening ceremony at Sutton Coldfield, as relayed back through the Alexandra Palace, seemed a little distorted and soft in focus compared with direct transmissions from the A.P., and the resultant pictures were rather unflattering both to the Marchioness of Reading, and to the Postmaster General, the Rt. Hon. Wilfred Paling, who seemed to glare at viewers as if they were "dirty dogs"! The speeches were brief and to the point, however, and gave the new station a good send off.

After the formal opening, viewers in London and the Midlands settled down to a most satisfying programme, including a star variety revue with Leslie Henson, Binnie Hale and Stanley Holloway; a first-rate newsreel—and, best of all, a most thrilling ice hockey match in which the Nottingham Panthers beat the Earls Court Rangers in the last

two minutes of the game. Such an opening must have given a tremendous fillip to television in the Midlands, and it certainly aroused great interest in the London area. I haven't yet seen the picture quality as radiated in the Sutton Coldfield area, but presume it is better than the "reversed relay" of the opening ceremony, as seen in London. Improved lighting of a temporary local "studio" may have presented the engineers with additional difficulties. The very-short-wave radio links between the London Museum exchange and Birmingham seemed to function very well indeed, and this development is in itself a fine achievement on the part of the G.P.O. Engineering Department. It will be interesting in due course to compare the results of the radio links with those obtained via the new co-axial cable, when that is completed.

Anyway, we all forgive the B.B.C. for the inevitable opening "hitch" and congratulate them on the quality, smoothness and high-entertainment value of all that followed.

Film Stand-by

IT is interesting to note that the B.B.C. have installed an E.M.I. tele-cine projector at Sutton Coldfield transmitter, for use in the event of a complete breakdown in the radio-links with the Alexandra Palace. Eventually, viewers will therefore be certain of some kind of transmission—barring a breakdown on the transmitter itself. There will be the radio-link, the co-axial link and the stand-by film machine. This, I expect, will be the pattern of things to come at the next provincial transmitters at Holme Moss, near Holmfirth, Yorkshire, and at the site between

Edinburgh and Glasgow. In the course of time, too, provincial studios will be added. As regards the local tele-cine equipment, there is always the possibility of this being used for film transmissions with additional copies of the same film that is being simultaneously transmitted from the Alexandra Palace, thus avoiding the use of the radio links. Whether or not there is sufficient difference in the quality of the results to justify the expense of making additional copies, remains to be seen. But there is no doubt at all that the general quality of film transmission from the Alexandra Palace is now very fine indeed, with all the old troubles of shading, grading and "tilt and bend" practically eliminated.

Recorded TV Programmes

MEANWHILE, the craze in U.S.A. for television has really taken hold, with sales of TV sets approaching the phenomenal figure of 400,000 per month. Transmitters are springing up everywhere, and in the New York area, viewers have a choice of no less than nine programmes. Latest information is that the general standard of programmes is not high, but that there are notable exceptions. It has been noted that cinema attendances fall noticeably on Tuesday nights, when the popular Milton Berle programme is transmitted, thus indicating clearly the adverse effect that good television programmes will have on the film business. Cost of the better programmes is mounting steadily and it seems that most of the programme sponsors still favour recording their expensive entertainment on 35 mm. or 16 mm. film and putting it out on tele-cine, copies being circulated to many TV transmitters simultaneously.

There is an enormous demand for films, and as in England, the banning by the trade of new film for use on television has resulted in the wholesale transmission of very old films from all possible sources. Many British films which could not be marketed

in the normal U.S.A. cinemas have been leased by the big television hook-ups, and these films include several which their British distributors will not allow to be televised in England. A number of the smaller film production companies in Hollywood and New York have turned over to making films specially for U.S. television, and no less than five companies are operating in England for the same market. The first film made at the recently-opened Paignton Studios, Devon, "Shadows of the Mind," was favourably received

in America and has resulted in a contract for another 50 special T.V. films, each of 30 minutes duration. The quality of this first Paignton film was said to be well above average, due to the special requirements of the new medium being carefully studied by the producer. The American specification called for: high-key lighting with low contrast; preponderance of close-ups and mid-shots; no important action, titles or properties to be located near the picture edges; low gamma processing; high quality

sound with good diction from the actors. This seems to me to be a sensible set of requirements, which might well be studied by the film people themselves, if they wish to keep in business. Bad diction and the throwing away of lines encouraged by stage and film directors in England is a result of striving for a so-called "natural" effect. I submit that most of us would prefer something that is somewhat sub-natural, if we are to be inflicted with slurred and slovenly speech, in the cause of high art.

Television Aerial Construction—3

This Month a Multiple Element Type Aerial is Described

By R. SHATWELL

ALTHOUGH the H-type aerial previously described is, without doubt, the most popular and generally useful type, occasionally the need for something slightly better is felt, either from the viewpoint of signal pick-up or, as in most cases, interference rejection.

The writer's set is operating in a neighbourhood where ignition and other interference is prolific, and experience has shown that although signal strength is such that nothing like full gain is needed to provide a good picture, the programme value suffered from this interference. Vision and sound limiters reduce the effect to negligible proportions in the case of sound, but cutting of whites and tearing of lines on vision made an alternative desirable. The H-type aerial previously described was therefore

converted to a triple array, with surprisingly effective results.

The addition does not necessitate any drastic alteration to the existing aerial and can be applied to any H-type with suitable connections for spacing of the elements. The 1½ in. mast was, however, found to be too flexible for the weight of the new array. If a wooden mast or stronger tube has been used, it is possible that no alterations will be needed even here, but if not, the expedient adopted by the writer and described later is quite satisfactory, can be carried out without dismantling, and results in a very strong assembly.

Design

This array has two additional elements spaced the same distance from the dipole as the original reflector and half that distance from the existing reflector. In other words, referring to Fig. 1 of the first article of this series, the three reflectors are each positioned on an arc, radius (c) centred about the dipole. The correct dimensions for the fitting of these can be determined mathematically, but a far simpler method of sufficient accuracy and more attractive to the non-mathematically minded is to make a scale-drawing of the assembly and take the required measurements from this. For 4ft. spacing between reflector and dipole this will show that the two additional reflectors should be 3ft. 11in. apart and 6½in. forward of the existing reflector.

Since it is impracticable to build a triple reflector A.P. aerial using quarter-wave spacing, i.e., 5ft. 6in. between dipole and reflector, it is necessary to use these dimensions for this array also.

Construction

Materials required for the addition are as follow (for Sutton Coldfield frequency):

One length ½ in. diameter aluminium or dural tube 3ft. 9½ in. long.

Two lengths ½ in. diameter aluminium or dural tube 7ft. 9in. long.

Two lengths ½ in. bar aluminium or dural tube (square or round).

½ in. paxolin or bakelised fabric sheet (4in. x 8in. approx.).

Mast (see text).

The two additional elements are plugged at each end and are fitted by paxolin insulators to the ½ in. crossbar, which is then bolted on top of the existing crossbar 6½ in. from the centre of the

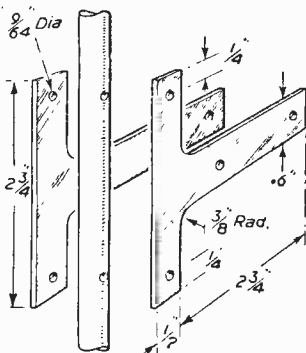

Fig. 10.—Details of the clamping pieces.

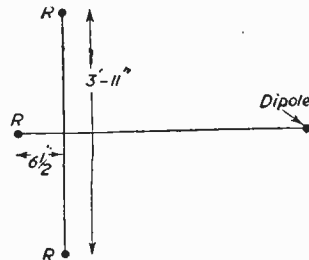

Fig. 9.—General arrangement of the complete aerial system.

reflector. The plan view in Fig. 9 makes this clear.

A simplified fitting for the reflectors of this array has been devised and can be used for the original reflector if desired, with a saving of both labour and weight. This fitting has functioned perfectly, even when snow-covered, and is thus quite as efficient as the one previously described. The dipole itself, of course, must be left as before. The exploded view in Fig. 10 explains the construction, whilst Fig. 11 gives additional information. As will be seen, the paxolin fastens inside the crossbar instead of outside as before, is only $\frac{1}{8}$ in. thick instead of $\frac{1}{4}$ in., and the packing between the element and this is dispensed with. Note (Fig. 11) that the edges of the paxolin are rounded to fit snugly into the crossbar.

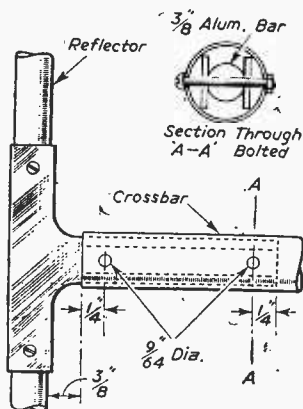

Fig. 11.—Assembly details for reflector support.

It is important that these fit tightly. Mechanical strength is ample for $\frac{1}{8}$ in. light alloy tubing.

The paxolin T-pieces should be fitted to the crossbar first, but not drilled or bolted. They should be tight enough to stay in position when the $\frac{1}{8}$ in. bar packing is in position between them. The elements can now be fitted to these T-pieces by the two 4 B.A. bolts, fitting one bolt before positioning the reflector exactly at right-angles to the crossbar and drilling the second fixing hole. Note that the T-pieces are *not central* but $\frac{1}{8}$ in. off centre, as the assembly lies above the existing $\frac{1}{8}$ in. crossbar.

This done, the T-pieces can be correctly positioned to give $\frac{1}{8}$ in. gap between reflector and the end of the crossbar and

drilled and bolted in position by 4 B.A. bolts, taking care when fixing the second that it is perfectly in line with the first. The fitting of this structure to the H array follows and is the most tricky part of the assembly, particularly where no bench drill is available. However, if the following procedure is followed, accuracy is ensured.

First drill a small hole ($\frac{1}{8}$ in. diameter is suitable) in the centre of the new crossbar in line with the reflectors and perfectly upright. Screwing the vice to a pair of step-ladders is a useful tip in view of the possibility of damage to the elements. A piece of $\frac{1}{8}$ in. rod inserted will enable the accuracy of drilling to be checked by set-square and sighting with the reflectors, and a small round file can correct errors in opening the hole to take a $\frac{1}{8}$ in. bolt 2 $\frac{1}{2}$ in. long. Similar accuracy and methods are necessary in drilling the H array $6\frac{1}{2}$ in. forward of the centre of the reflector.

The new assembly should then be bolted in position, the longer ends of the reflectors downwards, and the nut tightened just sufficiently to hold the assembly rigid. If its natural position is such that it tilts in any direction, correction is still possible. The $\frac{1}{8}$ in. bolt will be found to have a square on the underside of the head which must be accommodated, and the enlarging of the topmost hole to take this enables faults to be corrected.

Many methods will be obvious to prevent pivoting about this bolt, but surfaces for the wind to play upon should be avoided. Use is therefore made of two L-shaped steel plates from the local sixpenny store, arranged about the $\frac{1}{8}$ in. fixing bolt and between the two tubes, the ends being fixed by $\frac{3}{16}$ in. bolts with the two tubes at right-angles. Fig. 12 is an underside view of the junction.

Mast

The original mast is too flexible for the additional weight. Several alternatives are open: first, a larger diameter mast, about 2 in. should be sufficient, but this was not readily available. Second, a steel mast, which raises problems of weight and weather-proofing. The third alternative

of a wooden mast was also rejected from the angle of weight and less secure fixing points. The final alternative is the composite mast, which proved simple and strong as well as light.

Two additional tubes of light alloy $\frac{1}{8}$ in. in diameter and of the same length as the mast are bolted to the existing mast along its full length, cut away to fit close up to the mast fixing plates at the H crossbar and bolted with a $\frac{1}{8}$ in. bolt through both the fixing brackets and the $\frac{1}{8}$ in. tube. Fig. 13 shows the existing mast section (1) and the new tubes (2) and (3). Beginning at the bottom of the mast, these are bolted together by $\frac{1}{8}$ in. bolts in the following order: (2) to (3), (3) to (1), (1) to (2), and so on at 15 in. intervals. This assumes that the line of the aerial lies at

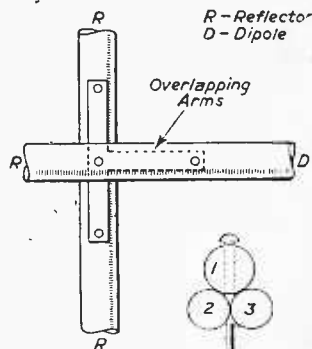

Figs. 12 and 13.—Underside view of the junction and mast strengthening arrangement.

right angles to the tangent to (2) and (3), or sufficiently so to enable slight packing to correct the lie of the array when bolted. If not, choose the tubes which are to lie against the chimney bracket and bolt these together first, continuing as before. With care in drilling the cable need not be withdrawn.

The existing chimney bracket, using a single band about the chimney, has proved quite sufficient to hold this assembly perfectly rigid, and the results have been surprisingly effective about a 50 per cent. increase in signal strength resulting, with sharp rejection of ignition behind the aerial over a wide angle. Using a VCR97, the 2 Mc/s bars are perfectly reproduced, and the 2.5 Mc/s with reduced intensity, bandwidth therefore being adequate.

Practical Wireless BLUEPRINT SERVICE

PRACTICAL WIRELESS

	<i>No. of Blueprint</i>
CRYSTAL SETS	
Blueprints, 1s. each.	
1937 Crystal Receiver ..	PW71*
The "Junior" Crystal Set ..	PW94*

STRAIGHT SETS	
Battery Operated	
One-Valve : Blueprints, 2s. each.	
Beginners' One-valver ..	PW85
The "Pyramid" One-valver (HF Pen) ..	PW93*
Two-valve : Blueprints, 2s.	
The Signet Two (D & LF) ..	PW76*
Three-valve : Blueprints, 2s. each.	
Selectone Battery Three (D, 2 LF (Trans)) ..	PW10
Summit Three (HF Pen, D, Pen) ..	PW37*
The "Rapide" Straight 3 (D, 2 LF (RC & Trans)) ..	PW82*
F. J. Camm's "Sprite" Three (HF, Pen, D, Tet) ..	PW87*
Four-valve : Blueprints, 2s. each.	
Fury Four Super (SG, SG, D, Pen) ..	PW34C*

Mains Operated	
Two-valve : Blueprints, 2s. each.	
Selectone A.C. Radiogram Two (D, Pow) ..	PW19*
Three-valve : Blueprints, 2s. each.	
Double - Diode - Triode Three (HF Pen, DDT, Pen) ..	PW23*
Four-valve : Blueprints, 2s. each.	
A.C. Fury Four (SG, SG, D, Pen) ..	PW20*
A.C. Hall-Mark (HF Pen, D, Push-Pull) ..	PW45*

SUPERHETS	
Battery Sets : Blueprints, 2s. each.	
F. J. Camm's 2-valve Superhet ..	PW52*
Mains Sets : Blueprints, 2s. each.	
F. J. Camm's Universal £4 Superhet 4 ..	PW60

SHORT-WAVE SETS	
Battery Operated	
One-valve : Blueprint, 2s.	
Simple S.W. One-valver ..	PW88*
Two-valve : Blueprints, 2s. each.	
Midget Short-wave Two (D, Pen) ..	PW38A*
Three-valve : Blueprints, 2s. each.	

	<i>No. of Blueprint</i>
Experimenter's Short-wave Three (SG, D, Pow) ..	PW30A*
The Perfect 3 (D, 2 LF (RC and Trans)) ..	PW63*
The Band-spread S.W. Three (HF Pen, D (Pen), Pen) ..	PW68*

PORTABLES	
Three-valve : Blueprints, 2s. each.	
F. J. Camm's ELF Three-valve Portable (HF Pen, D, Pen) ..	PW65
Parvo Flyweight Midget Portable (SG, D, Pen) ..	PW77
Four-valve : Blueprint, 2s.	
"Imp" Portable 4 (D, LF, LF, Pen) ..	PW86*

MISCELLANEOUS	
Blueprint, 2s.	
S.W. Converter-Adapter (1 valve) ..	PW48A*

AMATEUR WIRELESS AND WIRELESS MAGAZINE

CRYSTAL SETS	
Blueprints, 1s. each.	
1934 Crystal Set ..	AW44
150-mile Crystal Set ..	AW450

STRAIGHT SETS	
Battery Operated	
One-valve : Blueprint, 2s.	
B.B.C. Special One-valver ..	AW387*
Two-valve : Blueprints, 2s. each.	
A modern Two-valver ..	WM409*
Three-valve : Blueprints, 2s. each.	
Economy Pentode Three (SG, D, Pen) ..	WM337
PTP Three (Pen, D, Pen) ..	WM389

Mains Operated	
Two-valve : Blueprints, 2s. each.	
Consoelectric Two (D, Pen), A.C. ..	AW403
Economy A.C. Two (D, Trans), ..	WM286
Four-valve : Blueprints, 3s. each.	
All-Metal Four (2 SG, D, Pen) ..	WM329
Harris Jubilee Radiogram (HF, Pen, D, LF, P) ..	WM386

SUPERHETS	
Battery Set : Blueprints, 3s. each.	
"Varsity Four" ..	WM395*

SPECIAL NOTICE

THESE blueprints are drawn full size. The issues containing descriptions of these sets are out of print, but an asterisk beside the blueprint number denotes that constructional details are available, free with the blueprint. The index letters which precede the Blueprint Number indicate the periodical in which the description appears: Thus P.W. refers to PRACTICAL WIRELESS, A.W. to Amateur Wireless, W.M. to Wireless Magazine. Send (preferably) a postal order to cover the cost of the Blueprint (stamps over 6d. unacceptable) to PRACTICAL WIRELESS Blueprint Dept., George Newnes, Ltd., Tower House, Southampton Street, Strand, W.C.2.

	<i>No. of Blueprint</i>
PORTABLES	
Four-valve : Blueprints, 3s. each.	
Holiday Portable (SG, D, LF, Class B) ..	AW393

SHORT-WAVE SETS	
Battery Operated	
One-valve : Blueprints, 2s. each.	
S.W. One-valver for America ..	AW429*
Two-valve : Blueprints, 2s. each.	
Ultra-short Battery Two (SG, det Pen) ..	WM402*
Four-valve : Blueprints, 3s. each.	
A.W. Short-Wave World-beater (HF Pen, D, RC, Trans) ..	AW436*
Standard Four-valver Short-waver (SG, LF, P) ..	WM383*

Mains Operated	
Two-valve : Blueprints, 2s. each.	
Two-valve Mains Short-waver (D, Pen) ..	AW453
Four-valve : Blueprints, 3s.	
Standard Four-valve A.C. Short-waver (SG, D, RC, Trans) ..	WM391*

MISCELLANEOUS	
Enthusiast's Power Amplifier (10 Watts) (3/-)	WM387*
Listener's 5-watt A.C. Amplifier (3/-)	WM392
Harris Electrogram battery amplifier (2/-)	WM399*
De Luxe Concert A.C. Electrogram (2/-)	WM403*
New Style Short-wave Adapter (2/-) ..	WM388

HINTS COUPON

This coupon is available until March 6th, 1950, and must accompany all Practical Hints.
PRACTICAL WIRELESS MARCH 1950

Published on the 7th of each month by GEORGE NEWNES, LIMITED, Tower House, Southampton Street, Strand, London, W.C.2. and printed in England by W. SPENCER & SONS, LTD., Exmoor Street, London, W.10. Sole Agents for Australia and New Zealand: GORDON & GOTCH (A/SIA), LTD., South Africa: CENTRAL NEWS AGENCY, LTD. Subscription rate including postage, for one year: Inland and Abroad 10s. 6d. (Canada 10s.). Registered at the General Post Office for the Canadian Magazine Post. CONDITIONS OF SALE AND SUPPLY: This periodical is sold subject to the following conditions, namely, that it shall not, without the written consent of the publishers first given, be lent, re-sold, hired out or otherwise disposed of by way of Trade except at the full retail price of 9d.; and that it shall not be lent, re-sold, hired out or otherwise disposed of in a mutilated condition or in any unauthorised cover by way of Trade; or affixed to or as part of any publication or advertising, literary or pictorial matter, whatsoever.

M.O.S. BARGAINS!

REPEAT OFFER!

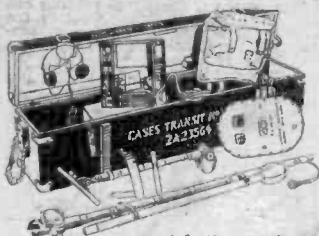

A further purchase of **NINE DETECTORS** enables us to repeat our offer of a complete unit, brand new at only **79/6** (Carry). Set of batteries available 22/6 extra. For detection of all types of METAL in timber, underground or water, etc., etc. In view of the demand for these detectors no correspondence can be exchanged concerning them.

Equipment: 3-valve battery amplifier in steel case, a shoulder haversack, two search coils with poles, junction boxes, headphones, 2 spare valves, circuit diagrams, log book, connecting cables and sensitivity measuring stick, operating instructions. Ready for use as soon as batteries are connected. Packed in robust transit case.

M.O.S. RADIO - ALARM KIT

A complete radio time switch in kit form which can be made in a few hours by anyone possessing the normal household tools.

We awakened to the strains of early morning music from your radio. Full wiring diagram and instructions included.

The KIT **12/6** (Post free).

£10,000 was spent to give you PERFECT SOLDERING!

For a limited period we are offering the already famous **BURGOYNE INSTANT HEAT SOLDERING GUN** (advertised and sold by the makers at 70/6) for ONLY **52/6**. We are setting a standard for value which we will find hard to beat. This offer has been possible only by an ACCIDENT—a blocked export shipment that missed the last boat to South Africa!

SAVE TIME ON SOLDERING!

Just press the button, count seven, and solder, and the bit will remain at soldering heat until you release the pressure, when it cools off instantly.

No waiting to warm up or cool down—No element to burn out—No mica to crack or splinter—No risk of shock. £10,000 was spent on the design of this famous tool originally! For A.C. mains, 200-250 v.

D.C. "Step-Up" Generator

A Universal Purpose Motor Generator, fully guaranteed, brand new and in original maker's cartons.

This unit can be driven on D.C. voltages of 2 v. to 14 v. and will give varying outputs according to the input voltage. For example:—

At 6 v. D.C. input, an output of about 230 v. 30 mA.

At 4 v. D.C. input, 180 v. 25 mA output.

At 12 v. D.C. input, 480 v. 40 mA output.

The motor will also provide sufficient power for use as a grinder, polisher, etc., as a spindle protrudes lin. from the casting face. Approximate r.p.m. at 12 v. D.C. input is 2,000 varying according to the applied voltage.

The cost of manufacturing these useful equipments was approximately £3 to £9.

OUR PRICE..... **8/11** (Post and 1/1).

Remember, each one carries full guarantee

2 VOLT VIBRATOR PORTABLE POWER SUPPLY



Now offered for the first time at only **35/-** (Postage and packing 2/6).

This well-known unit is also available complete with two 2 v. lead-acid accumulators and housed in a strong metal case for 50/- (Carriage and packing 5/-). Spare 2-volt synchronous vibrators, 9/8 (Post free). Circuit diagrams now available to all purchasers. Specification—

This unit is a source of H.T. and L.T. supply for portables, field day receivers, etc., etc., from 2 volt L.T. Outputs approximately 70-80 v. and 130-150 v. at 25 mA (according to load) and 1.5 v. L.P. Size of actual vibrator unit is 8 in. x 3 1/2 in. x 4 1/2 in.

As used on the famous "Walkie Talkie" 58 Set!

IVALEK De-Luxe CRYSTAL SET complete in attractive cream or brown plastic cabinet with tuning scale. Fully guaranteed. 15/- (Post free).

Terms: Cash with order

MAIL ORDER SUPPLY CO.

"THE RADIO CENTRE"

33 Tottenham Court Road,
London, W.1.

Tel.: Museum 6667-8-9



HOME STUDY

backs radio experience with sound technical knowledge

MANY men who wished to link their radio experience with a sound technological background have received successful instruction by means of an I.C.S. Course. Its value has been proved not only to amateurs but to men who already have a professional interest in radio and television engineering, including those taking qualifying examinations. It is invaluable, also, to students who wish to prepare themselves for a job in this field. Courses of Instruction covering radio and, if necessary, television including the following:

Complete Radio Engineering, Radio Service Engineers Radio Service and Sales, Advanced Short-Wave Radio Elementary Electronics, Radar, Radio, and Television Technology

And the following Radio Examinations:

British Institution of Radio Engineers
P.M.G. Certificates for Wireless Operators
City and Guilds Telecommunications

Write today for our FREE "Radio" booklet, which fully describes the above ICS Courses.

International
CORRESPONDENCE SCHOOLS

Dept. PW4, International Bldgs., Kingsway, London, W.C.2.

COMPONENTS FOR THE "VIEW-MASTER" TELEVISION RECEIVER

Sound/vision chassis VM100 complete with valveholders, 23/6d. Power pack/time base chassis VM102 complete with valveholders, 23/8d. Front, and rear tube supports 72007, 14/9d. Plessey scanning coil 72003, 28/3. Focus ring 72004, 20/3. Width control 72002, 0/8. Plessey boost choke 72005, 5/8d. Kit of five Westinghouse rectifiers, 23/3/8. Wearlite H.F. choke, 2/6d. Plessey frame transformer, 73002, 18/6d. Whiteley choke V 104, 18/3. Whiteley heater transformer VM103, 30/-.

Set of five Colvern potentiometers, 20/-. Set of Morganite variable resistors, type Q, 9/6d. Bulgin on/off switch Q257/1, 4/8d. Belling

Lee connector unit, complete with fuses (1707, 9/3d. G.E.G. neon lamp, type G. 3/-). Stentorian VM105 loudspeaker, 27/8. Complete set of T.C.C. capacitors, 23/16/9. Complete set of Morganite resistors, 26/3d. (All resistors and capacitors available separately.) Set of Bulgin terminal strips, 6/-). Bulgin plug & socket, P420/421, 2/6d. Bulgin P36 top cap connector, 1/4. Belling Lee L.355 feeder cable, 7/4. **STAGE BY STAGE CONSTRUCTION.** Complete sets of components & valves for all seven stages.

STAGE 1. £11.80.0. **STAGE 2.** £1.5.0d. **STAGE 3.** £3.3.0d. **STAGE 4.** 8/3d. **STAGE 5.** 20/- **STAGE 6.** each.

£4 12.0d. **STAGE 7.** Valves & cathode ray tubes, prices as below. **VALVES & O.R. TUBE.** EF50 or 63 SPT (five required), £1/4 (Ex WD 6/- each). EB91/6AL5 (one required), 9/2d. EBC33, DH67 or OM4 (one required), 11/7d. EL33 or KT61 (one required), 12/10d. or alternatively 6P26 at 15/10d. 6K25 (two required), 12/10d. 6P26 (one required), 12/4d. 6P25 (one required), 15/10d. or alternatively KT61 at 12/10d. 9in. Cathode-ray tubes, 9in. Mazda CRM92, Mullard MW22/14C. G.E.C. 6655, all £11.6.10 each. 12in. tubes, Mazda CRM121, Mullard MW31/14C, £15.2/5 each.

All prices, except valves, and cathode-ray tubes, are post free. When ordering cathode-ray tubes, please include 5/- extra to cover cost of cartage.

VALLANCE'S, Vallance & Davison
Ltd., Dept. P.W.

144, Briggate, Leeds 1. 'phone 29428/9.