

3-BAND SHORT-WAVE 3

Practical Wireless

9^D
EVERY
MONTH

Vol. 24. No. 506. ||

Editor: F. J. CAMM ||

SEPTEMBER, 1948

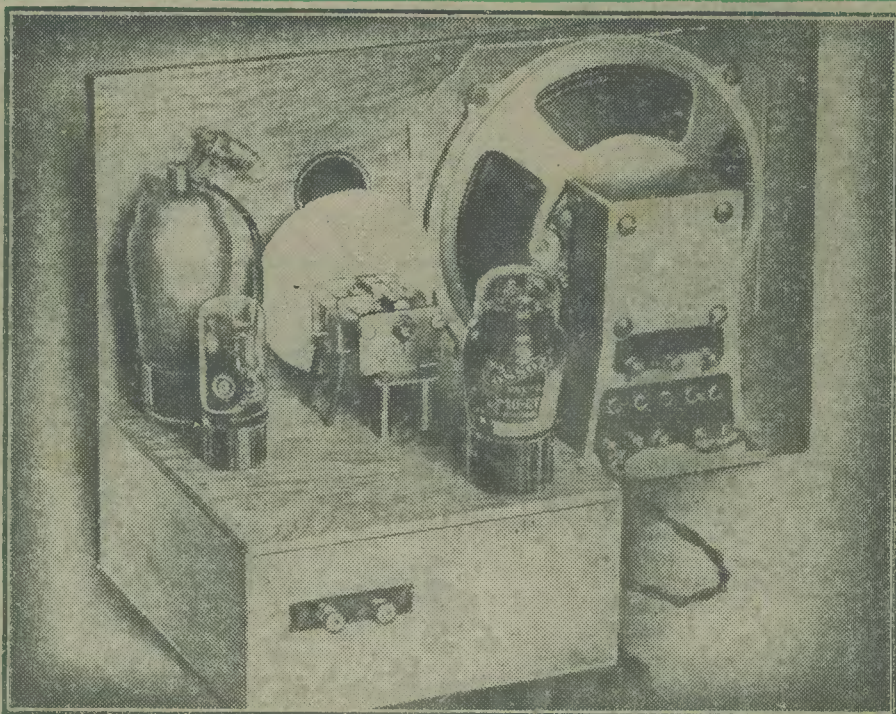

See Page 358

PRINCIPAL CONTENTS

Hi-Fidelity Radiogram
Couplings for Detectors
Build the Superscope
Loudspeaker Developments

||| Practical P.A. Working
Modulation
Home-Intercom. System
Television News

CLYDESDALE

The Radioman's Shop

For Bargains in ex-Services Electronic Equipment

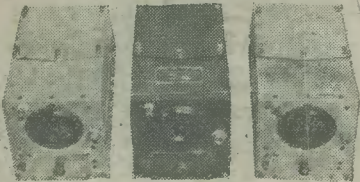

BRAND NEW EX. U.S. ARMY
COMMAND RADIO RECEIVER.

B.C. Series (Western Electric).
Each a Superhet, with 6 metal 12 v. Valves, 2/12SEK7's, 12K3,
12SR7, 12A6, in series/parallel for 24 v., less dynamotor in metal
case, length, base 10 1/2 in., top 7 1/2 in., height 5 1/2 in., width 4 1/2 in.

BC453. The "Q River".
199-530 kc/s.
I.F. 85 kc/s.

CLYDESDALE'S 50/- each. Post Paid.
PRICE ONLY

BC454. BC455.
3.0-6.0 mc/s. 6.0-9.0 mc/s.
I.F. 1,415 kc/s. I.F. 2,630 kc/s.

CLYDESDALE'S 30/- each. Post Paid.
PRICE ONLY
Set of CIRCUITS for COMMAND EQUIPMENT
BC453 A and B, BC454 A and B, BC455 A and B, BC946B. (M.W.)
Control Boxes, Transmitter and Modulator Unit, etc., with data.
CLYDESDALE'S 4/6 per set, Post Paid.
PRICE ONLY

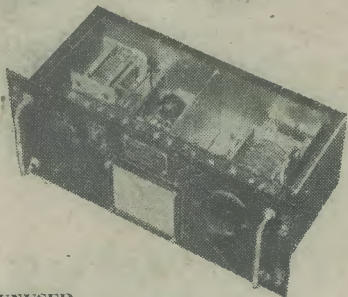

NEW—UNUSED

TRANSMITTER TUNING UNITS

For that "Transiron V.F.O. Unit".
Each having Vernier tuning dial, Variable capacitors, Tank
coil unit on Ceramic Former, Ceramic Switch, R.F. Chokes,
etc., in metal cabinet, 17 1/2 in. x 7 1/2 in. x 8 in., finish black.

TU5B. 1,500-3,000 kc/s. TU6B. 3,000-4,500 kc/s.
CLYDESDALE'S 25/- each Carriage Paid.
PRICE ONLY
TU8B. 6,200-7,700 kc/s. TU9B. 7,700-10,600 kc/s.
TU26B. 200-500 kc/s.

CLYDESDALE'S 19/6 each. Carriage Paid.
PRICE ONLY

BRAND NEW, in maker's carton EX-R.A.F.
5 and 6 METRE OPERATION.

THE FAMOUS
R.F. UNIT TYPE 26.
Variable tuned from 65-50 mc/s. 5-6 metres.

R.F. UNIT 27.
Variable tuned from 85-65 mc/s. 3.5-5 metres.
These units enable any mains set that tunes to 40 metres
(7 mc/s.) to be simply converted to a 5 and 6 metre receiver.
See S.W. Mag. for May. S.W. Listener for July.
With three valves, 2 VR126 (EF54), VR137 (EC52) S.M. Drive,
Condensers, etc., in metal case, 9 1/2 in. x 7 1/2 in. x 4 1/2 in.
Power supplies required H.T. 250 v. L.T. 6.3 v.

CLYDESDALE'S 35/- each. Post Paid.
PRICE ONLY
JFS6E. 6-way Jones' type socket with cable entry cover.
For R.F. Units, 24, 25, 26, 27, R1481, R1132, etc.

CLYDESDALE'S 3/6 each. Post Paid.
PRICE ONLY
6 for 17/6. 12 for 30/-.

Send now for new illustrated list, write name and address in Block
Letters Please.

CLYDESDALE SUPPLY CO., LTD.
2, BRIDGE STREET, GLASGOW, C.5.

Phone: South 2706/9

Visit our branches in Scotland, England and Northern Ireland

Southern Radio's Wireless Bargains

RADIO PUBLICATIONS:—RADIO VALVE MANUAL,
British and American Alternatives and Equivalents, 3/6.
post 3d. All publications previously advertised still available,
send 2/6 for complete list.

A.C. MOTORS.—200/250 volts, one-eighth h.p., 2,600 r.p.m.
Ideal for light work, 55/- carriage 5/- extra.

R.A.F. BOMBSIGHT COMPUTERS.—Brand New, with
Sperry gyro, 2-28 volt motors, gearing, counters and hundreds
of other components, 23 carriage paid.

R.A.F. I/T TESTERS.—2,500-6,700 kc/s. 45-120 metres. Two
valves. In metal carrying case with leather handles, 16 in. x
10 in. x 6 in. 20/- carriage paid.

TELEPHONE LINE UNITS.—In polished wood box, com-
prising rectifiers, relays, etc., 5/-.

INPUT TRANSFORMERS.—50 : 1 or 7 : 1 mu metal, 5/- each.
Dipole Aerials, V.H.F., 4/6.

LUBBRA HOLE CUTTERS.—Adjustable, for use on wood,
metal or plastic, 5/6.

75 pf MIDGET CONDENSERS.—Twin gang, 5/-; single gang,
2/6, post 6d.

THROAT MICROPHONES.—With 3ft. lead and jack plug, 5/-.
PERMANENT CRYSTAL DETECTORS.—2/6, post 4d.

WESTECTORS.—W.X.6 and W.112, 1/- each, 9/- per dozen,
post 6d.

M.C.R.I. Batteries—90 volt h.t. and 7 1/2 volt l.t., 6/6 each,
post 9d.

OIL-FILLED CONDENSERS.—0.1 mfd, 7,500 volt D.C. and
0.5 mfd, 7,000 volt D.C. 7/6 each, post 9d.

Tannoy Carbon Mike Inserts—2/6 each, post 3d.

MOVING COIL METERS—0.5 m.a. and 0-5 amps., 2 1/2 in. dia.,
9/- each.

R.A.F. Morse Keys—2/6 each, post 4d.

Double sided Recording Blanks—5 1/2 in. dia., 1/- each, 10/6
per dozen.

Inspection Lamps with 3ft. lead and plug, 3/6.

OSCILLOSCOPE TRANSFORMERS—Ratio 1 : 1. Brand
New, boxed, 2/6, post 9d.

SPECIAL OFFER—COLLARO GRAM MOTORS—(A.C.)
with turntable, auto-stop and Collaro swivel head mag-
netic pick-up. Complete with speed regulator, 100-250 volts,
50 c.p.s., 29 carriage paid.

VALVES S.P. 41 and E.F. 8 (Side contact), 5/- each, brand new.

SOUTHERN RADIO SUPPLY LIMITED

46 LISLE STREET, LONDON, W.C.2. GERrard 6653

Connoisseur



At last a gramophone motor to match the performance
of the famous Connoisseur Pick-up. Voltage: 220-250
volts A.C., 50 cycles. Rim drive with speed variation.
No governors and no gearing. Heavy non-ferrous turn-
table, machined to run dead true, fly-wheel action—
no "WOW". Main turntable spindle hardened, ground
and lapped to mirror finish, running in special phosphor
bronze bearings. Motor runs in needle-point, self-adjust-
ing bearing. Motor Board in plastic. Pressure on
Drive-wheel released when not in use, to obviate forming
flats and noisy action.

Apply to

A. R. Sugden & Co. (Engineers) Ltd.

Made by

A. R. Sugden & Co. (Engineers) Ltd., Brighouse, Yks.



*Products of
Quality & Reliability*

MAINS TRANSFORMERS
A. F. TRANSFORMERS
SMOOTHING CHOKES
**THERMAL
DELAY SWITCHES**
POWER RESISTANCES

Made by

OLIVER PELL CONTROL LTD

Telephone - WOOLWICH 1422
CAMBRIDGE ROW - WOOLWICH S.E.18



A Growing Audience

MORE AND MORE people are enjoying good radio entertainment through the smooth power provided by Pertrix accumulators. Every Pertrix product gives a consistently high performance—just a little more than the promise. For trouble-free listening choose the accumulator in the red and yellow pack. Most good dealers stock them.

HOLSUN BATTERIES LIMITED

137 Victoria Street London S.W.1

PII

HENRY'S

B.C. 221 FREQUENCY METER. American, crystal-controlled, 2 6SJ7, 6K8, plus complete set spare valves. Coverage 125-20,000 Kc/s. Calibrated charts and instruction booklet supplied. Battery operation 130 v. H.T., 6 v. L.T. Ample space available for easily constructed mains pack. New, £15 only.

TELEVISION COMPONENTS BY "SCANCO." High-grade tested components. Standard fitting. Guaranteed 100%. Focus Coil 37/6. Scanning Coils, 35/-; Line Transformer, 30/-; E.H.T. Transformer, 4,000 v. with 4 v. and 2 v. heaters, 59/6 only. Suitable for "Electronic Engineering" designs.

R 1626 EX. A.M. RECEIVER. Comprising 10 valves E.F.50, 2 EB 34, 24 volt Rotary Generator, relays, and hundreds of resistors and condensers, complete in metal case. Brand New, 75/- only.

THE E.T.A. FOUR STATION SUPERHET TUNER. Completely self-contained Tuner, may be set to select any three medium and one long wave stations. No tuning condenser required. Four position switch. Tuning by high permeability dust cores. Litz wound coils. Once set requires no further adjustment. The station you want at a flick of a switch. Size 2 1/2 in. high by 3 in. x 3 in. Complete with full aligning instructions and suitable A.C. and A.C./D.C. circuit. Only 33/-.

"QUALRAD" TOOL TRIMMER KIT. Our price for this well-known essential is 30/- only. Comprising 1, 2, 4, 5, 6, 8 B.A. box spanners, trimming tools, feeler gauge, four small spanners, screwdrivers, etc. Attractively finished in white ivory. The whole enclosed in compact crackle-finish box. Note the price, 30/-.

MILLIAMMETERS. 0-5 m.a. moving coil, 2 1/2 in. scale. Two mounted on panels, 15/- the pair only.

MICRO-AMMETERS. 3 1/2 in. scale, graduated 0-100. Moving Coil, F.S.D. 375 micro-amps. Brand new, 35/- only.

ELECTROSTATIC VOLTMETERS. 0-5,000 volts, 3 1/2 in. scale. Panel mounting, 65/- only.

TERMINAL BLOCKS. Black moulded, small, "Grecco," 6-way, 2/-; 10-way, 2/6 only.

COLLARO GRAM MOTORS. Still a few at the old price. A.C. 110-250 volts. Auto stop and start, speed regulator, 12 in. turntable, magnetic pick-up. Inc. tax, 49 only.

DENCO. Please note that we are appointed stockists of Denco products.

In addition to the above few items, we have probably the most up-to-date stock of Radio Components in the trade. Also over 10,000 valves in stock.

TRADE SUPPLIED.

Send stamp for Latest Comprehensive Component List.

HENRY'S, 5, Harrow Road, W.1 PADDINGTON 1008/9.

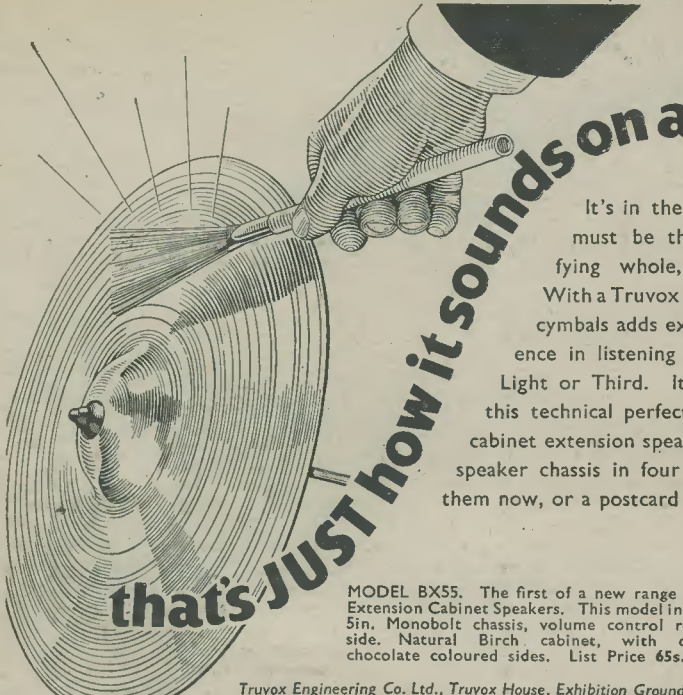

TRUVOX

that's JUST how it sounds on a

It's in the score, it's in the performance—it must be there in your room to make a satisfying whole, whether symphony or swing. With a Truvox speaker, faultless reproduction of the cymbals adds extra realism that makes all the difference in listening to a favourite programme—Home, Light or Third. It has taken us 18 years to achieve this technical perfection . . . it's yours today. Three cabinet extension speakers are in the shops, "Monobolt" speaker chassis in four sizes are there too—you can hear them now, or a postcard will bring you full details.

MODEL BX55. The first of a new range of Truvox Extension Cabinet Speakers. This model incorporates 5in. Monobolt chassis, volume control recessed in side. Natural Birch cabinet, with contrasting chocolate coloured sides. List Price 65s.

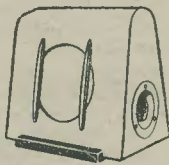

Truvox Engineering Co. Ltd., Truvox House, Exhibition Grounds, Wembley, Middx.

TX33A

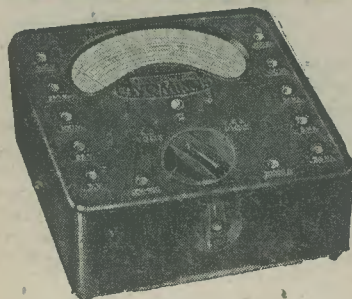

'AVO' Precision ELECTRICAL TESTING INSTRUMENTS

Registered Trade Mark.

A dependably accurate instrument for testing and fault location is indispensable to the amateur who builds or services his own set. Stocks are now available of these two famous "Avo" Instruments. If you have any difficulty in obtaining one locally, please send us the name and address of your nearest Radio Dealer.

The UNIVERSAL AVOMINOR

(as illustrated) is a highly accurate moving-coil instrument, conveniently compact, for measuring A.C. and D.C. voltage, D.C. current, and also resistance; 22 ranges of readings on a 3-inch scale. Total resistance 200,000 ohms.

Size: 4½ins. x 3½ins. x 1½ins.

Net weight: 18 ozs.

Price: £8: 10: 0

Complete with leads, interchangeable prods and crocodile clips, and instruction book.

The D.C. AVOMINOR

is a 2½-inch moving coil meter providing 14 ranges of readings of D.C. voltage, current and resistance up to 600 volts, 120 milliamps, and 3 megohms respectively. Total resistance 100,000 ohms.

Size: 4½ins. x 3½ins. x 1½ins.

Net weight: 12 ozs.

Complete as above.

Price: £4: 4: 0

D.C. Voltage

0—75 millivolts
0—5 volts
0—25 "
0—100 "
0—250 "
0—500 "

A.C. Voltage

0—5 volts
0—25 "
0—100 "
0—250 "
0—500 "

D.C. Current

0—2.5 milliamps
0—5 "
0—25 "
0—100 "
0—500 "

Resistance

0—20,000 ohms
0—100,000 "
0—500,000 "
0—2 megohms
0—5 "
0—10 "

GUARANTEE: The registered Trade Mark "Avo" is in itself a guarantee of high accuracy and superiority of design and craftsmanship. Every new Avominor is guaranteed by the Manufacturers against the remote possibility of defective materials or workmanship.

Sole Proprietors and Manufacturers:—

AUTOMATIC COIL WINDER & ELECTRICAL EQUIPMENT CO., LTD.
Winder House, Douglas Street, London, S.W.1

Phone: VICTORIA 3404-9

Practical Wireless

16th YEAR
OF ISSUE

and PRACTICAL TELEVISION

EVERY MONTH
VOL. XXIV, No. 506 SEPTEMBER, 1948

Editor F. J. CAMM

COMMENTS OF THE MONTH

BY THE EDITOR

Campaign for Better Listening

TO replace the Radiolympia Exhibition this year plans have been made for a Radio Fortnight, and it will take the form of a Better Listening Campaign. The dates fixed are September 26th to October 9th, and it is to cover the whole of Great Britain and Ireland. It is being organised by the British Radio Equipment Manufacturers' Association.

About 15,000 radio retailers are being asked to co-operate in what may prove to be the largest drive to increase radio sales ever undertaken.

The main object is to persuade listeners either to replace their old receivers or to augment those already in use. Additionally, there will be a drive in the London area to push the sale of television receivers, the supply of which continues to improve. This campaign is the result of the joint efforts of a committee consisting of publicity and sales managers who are members of the B.R.E.M.A. and of the Radio Industry Council.

The opening stage of the campaign will be a series of functions to enable members of the national and provincial Press to meet members of the industry, the retailers' and wholesalers' organisations, and the B.B.C. These functions are planned to take place in London and the various centres based on the B.B.C. regions—Newcastle, Leeds, Manchester, Bristol, Birmingham, Glasgow, Belfast, Cardiff and Edinburgh.

The B.B.C. have promised to co-operate and is considering the methods it can employ to encourage the public to give greater time to listen during the course of the campaign. Retailers during the fortnight will demonstrate the quality of the new receivers and endeavour to stress that it is better to buy than to repair. Every form of publicity method is to be employed, including window displays, notices on cinema screens, on the curtains of local theatres, and notices in hotels and other public places.

Local exhibitions will be organised by groups of radio dealers. Advertisements are to be placed in the national Press, as well as in the provincial. Indeed, over 1,000 newspapers and periodicals in Great Britain and Northern Ireland will carry advertisements designed to stimulate public industry.

The B.R.E.M.A. will supply display material, including crown posters with B.B.C. programmes during the fortnight and carrying also the theme of the campaign. There has recently been issued a television poster listing sporting events which are to be televised this summer.

This is a campaign worthy of the support of everyone interested in selling or using radio equipment. We are glad to notice that the B.B.C. intend to put on some special programmes during the run of the campaign because we think this will do more than anything else to encourage sales. It must be admitted that the programme mixture at present is not likely to persuade many new customers to buy a radio receiver.

There is far too much dance music, too many talks, and too few plays. As far as dancing is concerned, perhaps the musicians themselves have provided the solution by striking. We do not think that listeners generally care very much whether dance bands broadcast or not. Some of the programmes, indeed, are hopelessly childish, and we hope that they will be dropped.

Another point arises. Does the B.B.C. admit, by promising to put out special programmes, that its present programmes are in need of improvement? Suppose as a result of the campaign sales go up. Will the B.B.C. model their future programmes on those found successful during the fortnight? And assume that sales remain static. What then? The inevitable conclusion must be reached that prices are still too high or that the market has reached absorption point.

We think that there is room in every home for at least another radio receiver. There should be one in every bedroom. The B.B.C. could help by having later programmes and by cutting out a large number of silly talks.

However, we invite our readers to make suggestions for the radio fortnight, and any which we feel may be of assistance to the Radio Equipment Manufacturers' Association will be forwarded on to them.

There can be no doubt that the trade at present has struck a slump, and the campaign should do a great deal to find the reason for it.

Editorial and Advertisement Offices:
"Practical Wireless," George Newnes, Ltd.,
Tower House, Southampton Street, Strand,
W.C.2. Phone: Temple Bar 4363.
Telegrams: Newnes, Rand, London.
Registered at the G.P.O. for transmission by
Canadian Magazine Post.

The Editor will be pleased to consider articles of a practical nature suitable for publication in "Practical Wireless." Such articles should be written on one side of the paper only, and should contain the name and address of the sender. Whilst the Editor does not hold himself responsible for manuscripts, every effort will be made to return them if a stamped and addressed envelope is enclosed. All correspondence intended for the Editor should be addressed: The Editor, "Practical Wireless," George Newnes, Ltd., Tower House, Southampton Street, Strand, W.C.2.

Owing to the rapid progress in the design of wireless apparatus and to our efforts to keep our readers in touch with the latest developments, we give no warranty that apparatus described in our columns is not the subject of letters patent.

Copyright in all drawings, photographs and articles published in "Practical Wireless" is specifically reserved throughout the countries signatory to the Berne Convention and the U.S.A. Reproductions or imitations of any of these are therefore expressly forbidden. "Practical Wireless" incorporates "Amateur Wireless."

ROUND THE WORLD OF WIRELESS

Broadcast Receiving Licences

THE following statement shows the approximate numbers of licences issued during the year ending May 31st, 1948.

Region	Number
London Postal	2,092,000
Home Counties	1,471,000
Midland	1,600,000
North Eastern	1,736,000
North Western	1,469,000
South Western	975,000
Welsh and Border	650,000
<i>Total England and Wales</i>	<i>9,993,000</i>
Scotland	1,058,000
Northern Ireland	185,000
<i>Grand Total</i>	<i>11,236,000</i>

This number includes 52,500 television licences, an increase of 3,300 over the previous month. Prosecutions in May for operating wireless receiving apparatus without a licence numbered 590.

Two-way R.T. in 24-hour Race

GIVEN a "dress rehearsal" at the Isle of Man, recently, the two-way radio telephony system of Pye Telecommunications, Ltd., received a searching trial at Spa, Belgium, in July, when pits-to-car R.T. had its first test in a race of long duration. The H.R.G. team captained by Peter Clark, consisting of three cars and six drivers, were "on the air" to the pits for the whole 24 hours of the Spa-Francorchamps race.



A hitherto unpublished picture of Mr. Goldup (right) taken during a recent visit of Royal Corps of Signals officers to the Mullard Research and Factory Establishments.

Racing on an undulating course which contains the longest and fastest straight in Europe, it is hoped to analyse the effect of constant radio communication on drivers submitted to intense strain by both day and night. Each driver completes in turn 30 laps of the triangular course, taking about three hours, during which he would ordinarily be out of touch with everyone except by means of hand signals.

The mobile radio which was used is exactly the same as that employed extensively in taxis and industry, and by the *Daily Express* to transmit news and pictures. It is an amplitude-modulated set operating on fixed frequencies between 27 and 125 Mc/s. Drivers use earphones and throat mike in place of the ordinary loudspeaker and hand mike.

Radio-picture Service

CABLE AND WIRELESS announce that a radio-picture service between London and the company's station at Salisbury, Southern Rhodesia, is now open. The charges for radio-pictures from London to Salisbury are at the minimum rate of £5 for 150 square centimetres. The minimum press rate is £3.

Princess Portable on Show

EKCO'S new Princess portable—styled by Wells Coates R.D.I.—was chosen by the Council of Industrial Design for inclusion in the Manchester Design Week and was exhibited in the town's art gallery.

This is the fourth exhibition sponsored by the Council which has honoured E. K. Cole's carefully developed reputation for good design.

The makers also recently heard from their distributors in Cairo that one of these sets has been sold for two thousand Egyptian pounds. This is not the normal export price, but a special bid at a charity fete, when King Farouk himself handed the model over in aid of the Soldiers Welfare Fund!

Big Reductions in Radio Set Prices

ALREADY one well-known radio manufacturer has met the Chancellor half-way in an effort to get more modern radio sets into people's homes.

Following on Sir Stafford Cripps' announcement of a reduction in Purchase Tax from 66½ per cent. to 33½ per cent., the Philco Radio and Television Corporation of Great Britain, Ltd., are making reductions in selling price which will have the effect of reducing the total selling price by about 25 per cent.

The total cost of a five-valve

receiver in the medium price class is now £21 13s. 4d., as against £28 9s. 8d. before the Chancellor acted. A car radio set previously selling at £35 6s. 1d., now costs £27 2s. 11d.

Radio for Road Safety?

LONG-DISTANCE cold storage lorries used for daily deliveries of ice cream to the big provincial centres have been fitted with radio receivers—as a safety measure.

Walls' Ice Cream installed experimental receivers in the drivers' cabins as part of a policy aimed at relieving the monotony and strain of long hauls, many of them at night, and because the perishable nature of the product made rapid and uninterrupted journeys essential.

The experiment proved so successful that every long-distance vehicle leaving the main factory at Acton, W., will soon be equipped with a push-button receiver which can be used to tune in any one of four programmes instantaneously.

On a recent visit to Walls' factory, Mr. G. Searle, Director of Transport, Ministry of Food, asked one of the drivers whether he thought there was any truth in the suggestion that radio was a distracting influence. The driver, Mr. W. T. Dracott, replied: "Oh, no. The hum of an engine gets terribly monotonous, and with nothing to do but watch the road it's hard to keep yourself from nodding. The radio gets rid of the monotony. You don't feel tired and, what's more, the journey doesn't seem to take so long. I'm all for it, especially at night."

The Radiomobile receivers on Walls' vehicles are supplied and installed by Messrs. Boon & Porter, of Castelnau, Barnes, S.W.

Mullard-Hallcrafters Trade Agreement

THE Mullard Electronic Products, Limited, have concluded an agreement with Hallcrafters, Incorporated, of Chicago, the well-known amateur communications receiver and transmitter designers, whereby Mullards have the right to manufacture to all Hallcrafters communication designs. In addition, Mullards will be responsible for the representation of Hallcrafters in the U.K., Eire, and Australasia, this being separate from their world sales, rights as Mullards. This supersedes the previous McElroy-Adams/Hallcrafters arrangement. One of the first models that will be released will be the Hallcrafters SX 42 Communication Receiver, which gives coverage from 0.5 to 110 Mc/s. with frequency-modulated reception from 50 to 110 Mc/s.

Inquiries should be addressed to the Communications Division of Mullard Electronic Products, Ltd., pending announcement of distribution arrangements outside the U.K. In the U.K. (but not for Government and marine business) arrangements are in hand for the distribution of Hallcrafters-marked equipment to be handled by Mr. Reg Adams of the McElroy Adams Group, Ltd.

Palestine Communications

CABLE & WIRELESS announce that their Haifa office has been informed by the local post and telegraph authorities that they are able

to accept cables to and from the Jewish sections of Jerusalem.

A direct wireless circuit with London—in the homeward direction only—has been opened by the company's station at Tel Aviv. Two-way working will be opened shortly.

Mullard Losses

MULLARD ELECTRONIC PRODUCTS, LTD., regret to announce the death of two employees who have given many years of service to the company.

At the age of 56, Mr. A. T. Halstead, of Halifax,

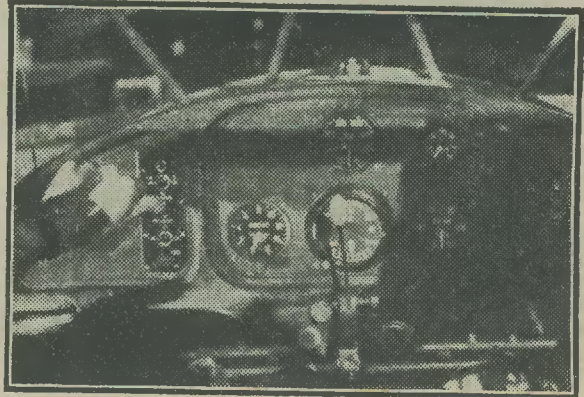

The easily-accessible selector switch control unit of the Ekco light aircraft communication system.

a representative of Mullard radio receivers and valves in Yorkshire for 21 years, died after a brief illness at the Halifax General Hospital on June 19th, 1948. He was best known in the territories of the West Riding, Westmorland and Cumberland.

Mr. Halstead became a member nearly two years ago of the Institute of Practical Radio Engineers, of which he was elected chairman of the Leeds Section. So active was he in this field that the I.P.R.E. recently showed their appreciation by appointing him to a Fellowship.

Mr. H. S. Robertson, of Nottingham, a representative of Mullard radio receivers and valves since 1928, died suddenly at his home on June 23rd, 1948.

Mr. Robertson was well known in the counties of Derby, Nottingham, Lincoln, Leicester and Northampton, in which areas he has been very active over a number of years.

Their colleagues at Mullards extend their sympathy to the widows and families of both deceased.

Television at the Science Museum

A TELEVISION receiver has now been installed at the Science Museum, South Kensington, and demonstrations are being given every afternoon. The demonstrations generally take place from 3.4 p.m., but vary occasionally in accordance with the times of the B.B.C. programme, details of which appear in the *Radio Times* and in the daily press.

The Science Museum is open daily from 10 a.m.-6 p.m., Sundays 2.30-6 p.m. Admission free.

3-band Short-wave 3

A Battery-operated Self-contained Set with Home-made Coils

By F. G. R.

MANY interesting programmes are available on short wavelengths and this receiver is intended specially for their reception. For maximum convenience wave-change switching is used, three ranges enabling the most-used frequencies to be tuned. Because the gang condenser is of a more suitable capacity than the $.0005 \mu\text{F}$ component usual in all-wave sets, tuning is made much easier. To complete the receiver the loud speaker is mounted on the panel as shown, so that the set is compact and self-contained. When inserted in a tasteful cabinet the whole receiver is a useful and efficient one for general short-wave reception.

With a fair aerial, good speaker reproduction will be obtained on many stations. For occasional long-distance reception of weaker stations, or for amateur band operation, headphones may be plugged in. The speaker is then silenced, but its transformer primary is kept in circuit, the phones being fed through a condenser.

Chassis and Panel

The panel should be drilled and cut to the dimensions shown in Fig. 2. The three small controls will require $\frac{3}{16}$ in. diameter holes. Many different types of single and dual-ratio tuning drives and dials are available and the panel should be marked out to fit the one it is intended to use. When fitting the gang condenser, this can be raised to bring its spindle to the required height.

The panel should be sandpapered and varnished. The chassis, with three 1 in. diameter valve-holder holes ready drilled, is then screwed securely to it. The size and position of the chassis will be seen from Fig. 6.

Wiring and Circuit Details

As the speaker is rather heavy it should be left off until last, but the tuning condenser and dial can be added, and the valve-holders, which are screwed on the underside of the chassis.

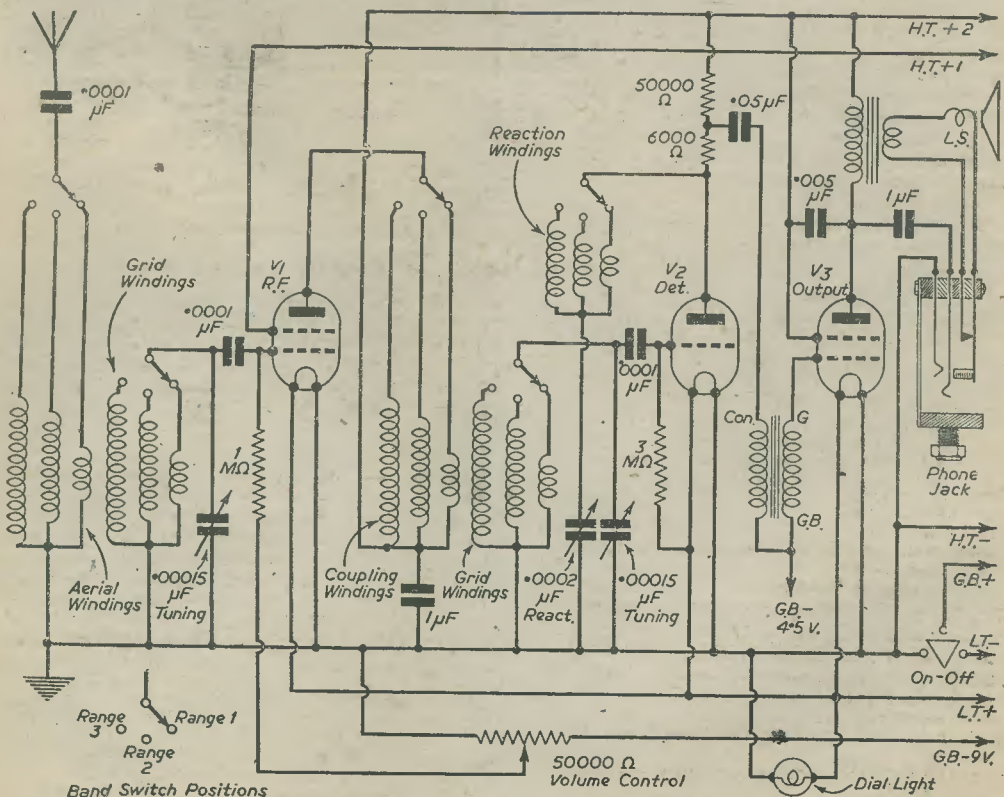

Fig. 1.—Theoretical circuit of the 3-Band Short-wave 3.

From the circuit it will be seen that separate cores are used for each range. The chassis is deep enough for these and they are mounted at right angles as illustrated in Fig. 3. H.F. transformers are

Switch Connections

All these are shown in Fig. 4. Wiring will be simplified if short lengths of tinned copper wire are soldered to the contacts before the switch is mounted in position. By using a component with two separate wafers, R.F. and detector wiring can be kept all apart.

When fixing the switch, earth the securing bush, as in Fig. 3. The five leads which go to the fixed condensers and other components can then be soldered on, keeping them as short as possible. One lead will pass through the chassis to the R.F. valve anode, and 20 s.w.g. insulated solid wire can be used here also.

It is then only necessary to add the tuning coils. It is suggested these be added in pairs, commencing with the

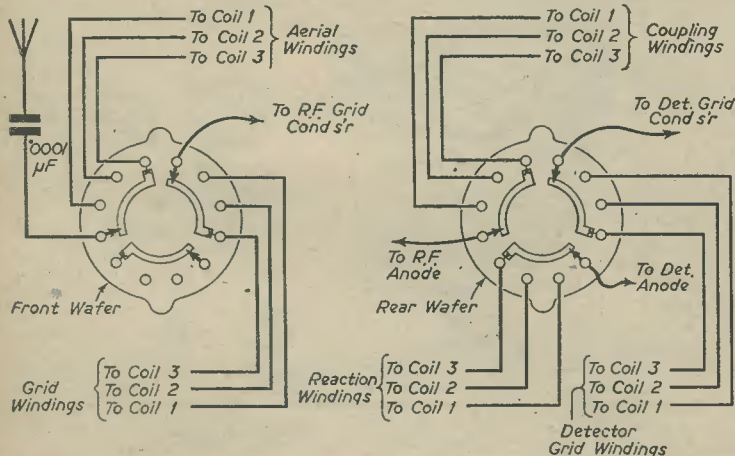

Fig. 4.—Connections to the switch sections.

used to provide a most suitable degree of coupling for each range.

The wiring associated with the valve-holders (Fig. 3) can most conveniently be carried out before adding the switch and coils. Short connections made from 20 s.w.g. insulated wire are recommended. Only three leads pass through the chassis, and these are shown.

Flex is used for the battery leads. Flex leads about 9in. long should also be soldered to the screen grid and anode tags of the output valve-holder; these pass through a hole in side runner and are afterwards joined on to the speaker transformer.

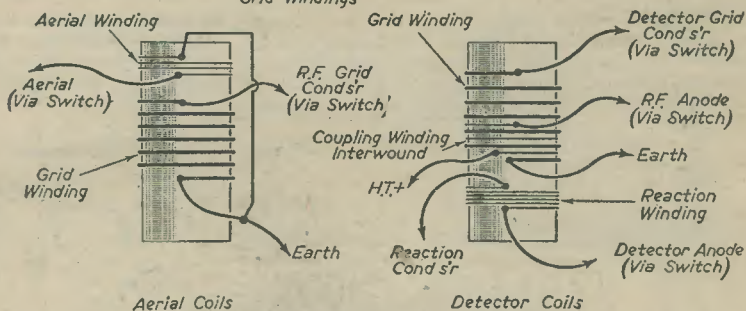

Fig. 5.—Details of coil winding and connections.

two coils used for Range 1 (lowest wavelengths). Provided Fig. 4 is examined, no difficulty should arise. Keep all grid and anode leads well apart. There is no need for any of the detector coil leads to come near or cross over the leads going to the R.F. coils.

Tuning Coils

Wearite Type P coils are available in various inductances and three to tune from 12 to 100 metres will enable all the most-used frequencies to be covered. It is also possible to wind coils which will give satisfactory results and if this is done the connections shown in Fig. 5 should be followed.

When winding, take care to get exactly the same

The number of turns used can be as follows:—

Pair of Coils No. 1	Aerial	Reaction	Coupling
Both Grid Windings			
7 turns 20 s.w.g.	3	5	2
Pair of Coils No. 2			
14 turns 22 s.w.g.	6	9	6
Pair of Coils No. 3			
28 turns 24 s.w.g.	10	17	11

COMPONENT LIST

- Two 4-pin, one 5-pin chassis valve-holders.
- Three .0001 μ F. fixed condensers.
- One .05 μ F. do.
- One .005 μ F. do.
- Two 1 μ F. do.
- 2-gang .00015 μ F. tuning condenser with reduction drive and trimmers.
- .0002 μ F. reaction condenser.
- Resistors: One each of 3 megohm, 1 megohm, 50,000 ohms, and 6,000 ohms.
- One 50,000 ohm potentiometer with 3-point switch.
- L.F. parafeed transformer, ratio about 1:4.
- 6-pole, 3-way rotary switch (5 poles only required).
- Dial light and holder.
- Coils (see text).
- 6in. moving coil speaker with transformer for pentode.
- Jack with OFF-ON switching. (Similar to Bulgin Type J. 18.)
- Plug for same.
- "Aerial" and "Earth" sockets or terminals, battery connectors, etc.

trimming are necessary. To do this, open both trimmers completely. Then tune to a high frequency with coils No. 1 and adjust whichever trimmer is necessary until

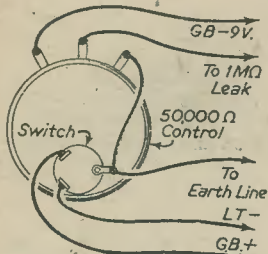

Fig. 7.—Connections to the control and switch.

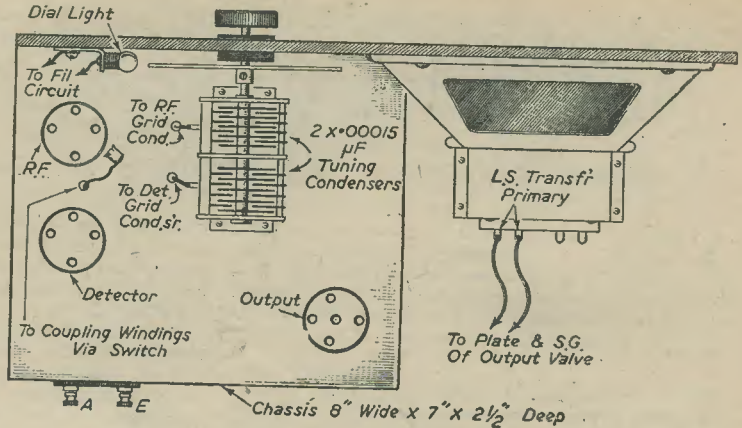

Fig. 6.—Layout of the complete receiver.

this trimmer is peaked for maximum volume. Slightly re-tune while adjusting the trimmer, and leave one trimmer completely open.

The refinement of connecting a separate trimmer in parallel with each grid winding can be tried, but is scarcely necessary.

6K7 Pocket Receiver

Some Additional Notes Concerning the Receiver Described in Our July Issue

As with all straight receivers used to pick up weak signals, it must be possible to bring the receiver right up to the point of oscillation. When using a short aerial this is essential, as signals which would otherwise be almost inaudible can be increased to satisfactory 'phone strength. With some tuning coils it may be necessary to increase the number of turns on the reaction coil, or place this winding closer to the grid coil, as mentioned in the constructional notes. It is also necessary, of course, that the coil be connected in the right sense, otherwise no reaction will be obtained.

It must be noted that the valve-holder wiring shown is for the top of the holder, as mentioned. If screen grid or suppressor is left disconnected reception will be weakened.

Three or four yards of wire as a throw-out aerial generally seem best. A very long wire will prevent oscillation.

It will be found that the valve oscillates more readily with the grid condenser and leak short-circuited; however, this reduces volume and should in no case be necessary, though it may be tried as an experiment to ensure the circuit is functioning. The receiver will give greater volume with a higher battery voltage, of course, but the single 4.5-volt dry battery is quite sufficient for satisfactory earphoné reception under normal conditions.

It should not be overlooked that the valve takes a short time to reach operating temperature. A valve in ordinary good condition should be used. It is quite possible that some of the ex-service valves now being offered cheaply have seen many hours of service and their emission may have dropped. If so, they will operate less effectively than a comparatively new valve.

Attention to these points should give satisfactory results. Do not use one of the low-resistance ex-service earphones cheaply offered, as they are useless without a matching transformer. It is also necessary to see that the tuning coil is not very close to the metal envelope of the valve. If using a commercial coil, where the original primary winding is now used for reaction, the wave band covered by the coil will be raised somewhat. To reduce it, to enable certain stations to be received at the lower end of the band, a small pre-set condenser should be included in the aerial lead. A maximum value of about 100 pF should prove satisfactory.

BOOK RECEIVED

"**RADIO Laboratory Handbook**," by M. G. Scroggie, B.Sc., M.I.E.E. Published by Iliffe & Sons, Ltd. Size 7 by 4 1/2 (F8vo), 430 pages. Illustrated with 170 diagrams and 46 photographs. Cloth bound with jacket. Price, 12s. 6d.

In this handbook the author, who has a long and varied professional experience of radio, shows the methods available for carrying out tests, and measurements, either with commercial instruments or with improvised equipment.

The subject-matter covers not only the principle sources of power and signals, types of indicators, comparison methods of measurement such as bridges and their application in measurements on components and on complete amplifiers and receivers, but there is much useful advice on the plotting and interpretation of results.

The fourth edition has been revised and extended.

High-fidelity Radiogram-3

This Month, C. W. HAGE Gives Details of the Power Pack, Construction and Adjustment

ANYONE who desires to be more careful than usual with his 807s should consider the use of a 60 mA. fuse bulb in the main lead to the screen grids (shown dotted in the diagram). This prevents overload of the screens if there is any break in the anode circuit.

Output Transformer

The transformer used was home made on an old Ferranti bobbin and laminations of the largest type. This was used for the famous 1:6 and 1:1½ A.F. transformers (not the AF3 or AF5), and has two bobbin sleeves. On the inner sleeve was wound 3,000 turns of wire (28 enamel). This was carefully centre tapped, keeping the primary winding balanced both physically and electrically about the centre tap. This winding was covered with insulation tape and then with two-layers of good quality Empire cloth. Directly on top of this was wound the secondary of 105 turns of 18 enamelled wire tapped at 36 turns (2 ohms), 46 turns (3 ohms), 60 turns (5 ohms), 77 turns (8 ohms), 85 turns (10 ohms) and full winding for 15 ohms. (Note this is for two speakers.) When winding is complete and after tapping wires have been well sleeved, the complete winding is covered with more Empire tape tied down with thread. Laminations are then replaced. The original case can be used, but sides covering ends of bobbin must be removed at side where secondary leads are brought out. An additional pair of legs were mounted on the top to act as support for a strip of Bakelite on which the secondary tags are mounted. Tags for the primary can be similarly mounted.

From data charts the inductance of the primary was worked out to be 40 Henries at no D.C., giving a primary impedance of 6,200 ohms at 27 cycles. Slight out-of-balance of anode currents would reduce inductance—but not seriously so long as it is not more than 5 mA.—but care should be taken to reduce this to the lowest possible amount if the finest bass response is desired.

Incidentally, it has not been found difficult to keep anode currents within 1 mA. over periods of weeks. In case other types of cores and windings are used it should be pointed out that a similar type of sectionalised winding should be adopted and care taken to balance the windings, to keep primary self capacity low and coupling between primary and secondary as high as possible; as the combination of self capacity and leakage inductance is the factor which determines high-note response, the point at which the two resonate gives the point to which high-note response will be good. Higher up, response falls rapidly. Many commercial types fail here, the response peaking at 4-5,000 cycles and falling rapidly beyond. With the type given frequency response is adequate up to highest levels on test records

used and no difficulty is found in hearing quite high 8-9 k/cs. heterodyne whistles between stations, embarrassing at times when it is found necessary to cut high-note response on most B.B.C. stations after dark.

Speakers Used

Two speakers are used—a large 12in. type coming from an American radiogram and a smaller Ferranti of about 6in. diameter. Both are not commonly available types, and no purpose would be served in giving fuller details. It is suggested, however, that two speakers be used, one of 12in. diameter and with the best bass response possible. It should not have a rigid spider of ¼in. fibre, however, as is often used, as cone movement must be free if good bass response is required, and the cone should be able to move ¼-½in. in each direction. Some commercial types are considerably improved if the stiff spiders used are removed and new ones of thinner flexible material are fitted. (I have found stout linen-surfaced playing cards, shellac varnished and mounted with Durofix quite good.) Certain commercial types, e.g. the Epoch series, would also be found O.K. for this position.

The smaller speaker is intended to give good reproduction of the higher notes, and many smaller types are quite good if they have a cone of light material. Here, again, results have been improved in some cases by making up new cones of drawing paper. No splitting of the A.F. range between the speakers has been used (e.g., by filter networks), as it has been found, if the speakers are mounted close together on the same baffle and connections to the moving coil of one speaker changed over if necessary until both are in phase, that the two speakers reinforce one another and give a much better "spread over" effect, reducing the focusing of high notes to some extent and lessening the effect of the sound coming from one small area. Obviously the two speakers must not have resonances near the same points, but this may have to be determined by experiment.

Decoupling

Both speakers used are energised, and a separate power pack is used for this purpose. This allows for adjustment and modification and keeps the various sections independent. While it is not quite so essential that the smaller speaker be an energised type, it has been found that normally an energised speaker, well energised, gives a far better bass response and much better "attack." The large 12in. type used is allowed about 20 watts for the field, which runs just warm after some time, and works much better at this than at the 10-12 watts normally used. The smaller speaker is marked 200-250 volt, but is given 350 volts and gives a far finer result.

A large measure of decoupling and smoothing is used, especially with the gramophone input valve and the mixer valve. This is used with the double purpose of obtaining the highest possible stability and the lowest possible hum level. It should be noted that efficient decoupling is particularly important in view of the high gain available.

Power Pack

This is mounted on a large wooden chassis accommodated in the lower part of the cabinet behind the speakers. Starting from the mains input it will be seen that a double-pole switch is used to break both mains leads, disconnecting the whole of the apparatus, except for a small inspection lamp on a piece of cable which has its own switch in the lead to it (this has been found very useful for adjustments). Then the mains pass through a pair of 2-ampere fuses. A screened lead is here taken off to the mains input of the gram. motor. Mains to the power pack proper then pass through a pair of heavy duty mains R.F. chokes, which with the four .001 μ F 1,000-volt working mica condensers form an efficient filter to mains borne R.F. Mains now pass to the four mains transformers—one in the R.F. power pack is not shown in this diagram.

Field Power Pack

The transformer gives 350-0-350 volts at 250 mA., and 5 volts 3 amps, which is used with a U52 (=5U4G) to give about 340 volts at 133 mA. This is smoothed by a heavy duty choke of uncertain inductance, but probably 10-15 Henries, used with two 16 μ F electrolytic condensers. A 250 mA. fuse bulb direct to the rectifier filament protects the rectifier against shorts or condenser breakdown. The 1,300 ohm 10-watt resistor shown is to cut down the consumption of the lower resistance field which requires 200 volts at 100 mA.

Two other secondaries, each of 2.5 volts 6 amps., are connected in series and used to heat the filaments of the two 5U4Gs used in the A.F. power pack.

A.F. Power Pack

The transformer used gives 425-0-425 volts at 250 mA., also 6.3 volts 3.5 amps. and 6.3 volts 7 amps. (A fourth, 5 volt.2 amp., winding not used.)

Two 5U4Gs are used each connected as a half-wave rectifier, i.e., both anodes together. The total load of about 180 mA is well within output of one 5U4G, but two are used (a) to reduce internal resistance of rectifier and thus keep output voltage

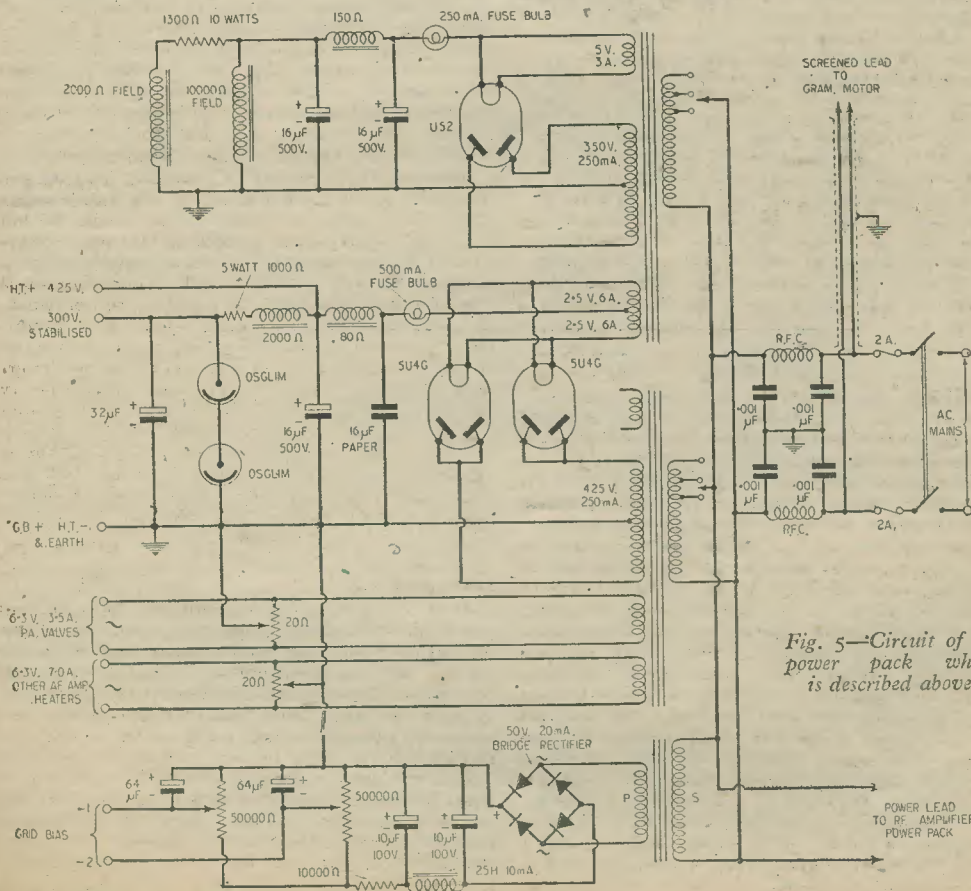

Fig. 5—Circuit of the power pack which is described above.

steadier and (b) because I have found that heavy loading of rectifiers, especially when used with condenser input, does not give long life and trouble-free service.

A 500 mA. fuse bulb is used direct to rectifier output for safety's sake, although the first smoothing condenser is a 16 μF paper (actually two 8 μF 750 volt-working condensers in parallel). The first choke is a low-resistance gapped type of about three Henries. Supply to output valve anodes is taken off here.

A further 16 μF condenser and a 2,000 ohm choke of about 20 Henries and a 1,000 ohm 5-watt resistance give additional smoothing for the A.F. valves, and stabilisation of output voltage is obtained by using two deapped Osglim neon lamps in series. These are standard 5-watt types which have had bases removed by unsoldering wires at base and soaking off base with methylated spirits and, if necessary, strong soda solution. A resistance will be found inside base and must be removed. Two longer wires were then soldered on—well sleeved and cemented on an old four-pin valve base, the leads being taken to "grid" and "anode" pins. When lit, the neons should glow on the beehive, not on the plate. The new base was secured to the bulb with Durofix adhesive.

The 300-volt output is decoupled by means of a 32 μF electrolytic condenser.

Both 6.3-volt heater circuits are centre tapped by means of 20-ohm miniature potentiometers, adjusted for minimum hum.

Bias Pack

A large old-type A.F. transformer is used here with secondary winding to mains, and gives about 50 volts A.C. to a small metal bridge rectifier. This can be quite small, as only about 10 mA. is required. Two 10 μF electrolytic condensers (100 volt) and a 25 Henries 10 mA. choke smooth the output. This is passed to two 50,000 ohm potentiometers which should be wire wound. Maximum voltage across potentiometers is about

40 volts. The moving arm of each potentiometer is decoupled to earth by a 64 μF condenser. (Value not critical, 50-100 μF , but should be at least 50 volt working.) Note that the positive side is earthed. This pack gives two individually adjusted bias voltages for the two 807 valves.

Adjustment of Amplifier and Bias

Before switching on, put both bias adjustments at maximum negative bias. Switch on and insert meter plug in PP 1+2 jack. Adjust both bias potentiometers together until meter reads 60-80 mA. Then plug into PP1 and adjust the bias potentiometer of this valve until meter reads 40 mA. (Class AB₁) or 65-70 mA. for Class A. Then plug into PP2 socket and adjust to same current. It will be necessary to check and adjust each anode's current several times as adjustment of one upsets the other slightly. When adjusted to the same current, check other sockets. AF₁ should be about 15 mA. and AF₂ about 10 mA.

Now with some input signal plug a pair of phones into socket AF₂ and adjust balance potentiometer in inter P.P. stage for minimum signal in the phones. Balance point is not sharp and is easily obtained.

Construction

An aluminium chassis was used of same size as R.F. amplifier, and again has internal screens and a base-plate. Volume and tone controls are mounted at panel end with gram. input valve and mixer. Phase connector and inter push-pull valves occupy next compartment, and then the two 807s, with the output transformer at back of the top.

The large decoupling condensers are mounted at the side of the chassis and smaller condensers internally. Lead from pick-up plugs into chassis at front near input transformer. Leads are taken from the back to power pack and two sockets are provided for the speaker fields and A.F. supply.

Layout is not so critical as in R.F. amplifier, but leads should be kept short, especially grid leads.

Frequency Spectrum Chart

A COMPREHENSIVE reference chart, measuring 4ft. 6in., by 2ft. 6in., has been designed and printed by the Projects Department of Mullard Electronic Products, Ltd.

Based on the decisions of the International Telecommunications Union Conference, 1947, at Atlantic City, this chart has been executed in sixteen colours and shows at a glance the allocation of frequencies over the entire telecommunication spectrum—that is, between 10 kc/s and 10,500 mc/s.

The chart is first divided into 18 broad vertical columns which are each sub-divided into three sections, headed "Region 1," "Region 2," and "Region 3." These are the zones into which the world was sectionalised by agreement at the Conference, and they are defined at the foot of the chart.

A "key" panel over the chart indicates the colour which has been selected to illustrate the various media of radio-communication—for example, "Aero Fixed" is black; "Amateur," blue; "Broadcasting," pink; "Meteorological" is green.

Commencing at the top left-hand corner, and reading downward, the frequencies are indicated at intervals beside the broad columns (the coverage

of the first column being 10 kc/s to 2,300 kc/s), and horizontal lines show the limits of allocated frequency bands. Each of the broad columns is thus divided into sections in terms of frequency, and the vertical sub-sections, or "Regional" columns are coloured according to the medium appropriate to the frequency band.

This is the first chart of its kind to be designed in this country since the Atlantic City Conference, and it will supply a means of rapid and easy reference which will be of great value to all who are interested in frequency allocations; for instance, designers of communications equipment, and those concerned with navigational problems for ships and aircraft. Radio amateurs will also find it a useful guide.

A smaller chart is envisaged, which will be equally comprehensive, but confined to six colours instead of 16.

Copies of the chart are available as follows: Sixteen-colour version, price 30s., on application to Communications Division, Mullard Electronic Products, Ltd., Century House, Shaftesbury Avenue, London, W.C.2.

* Six-colour version will be available later.



ON YOUR WAVELENGTH

By THERMION

Producers and Pronunciations

SOME years ago the B.B.C. appointed a committee to decide on the correct pronunciation of the English language. For this purpose I believe they appointed a committee led by a Welshman and backed by Scotsmen as well as Englishmen. Presumably, they reached certain conclusions, and I want to know what steps have since been taken to ensure that producers are adequately instructed in those pronunciations, and to see that they pass them along to those taking part in the programmes they produce.

During the course of my listening last month I came across the following real gems of mispronunciation:

Gels (girls)
Tords (towards)
Tard (tired)
Owers (hours)
Yers (Years)
Da' (day)
Garntee (guarantee).

These are but a few of the offensive pronunciations which B.B.C. producers regularly pass by. Surely the producers have qualifications regarding diction, enunciation and pronunciation? I am sure they do not wish to be thought:

*Empty shells from eight till ten,
Filled with the wit of other men.*

There is a tendency for members of B.B.C. programmes to "drawing-room" their pronunciations with the evident idea of giving the impression of college education and erudition.

I understand that there is a school for producers within the B.B.C. organisation, and it is time that some of the producers went back to that school and learned the King's English.

Tyres and Car Radio.

OWNERS of car radio receivers may be unaware that tyres can generate considerable static electricity and give rise to interference.

The new Dunlop tyre eliminates this. The composition is such that it dissipates, as soon as it is formed, any static electricity generated while running. Static interference is thus got rid of, and tests show a marked improvement in reception, particularly in dry weather. Non-static tyres have been used on aircraft for many years.

My own car-radio, which is a Radiomobile made by H.M.V., is certainly the best car radio receiver I have ever possessed. It really is quite interference-proof, and it brings in as many stations as a receiver installed in my home. It has push-button tuning as well as manual control, and it is a receiver I can thoroughly recommend to car-owners.

When I had mine fitted I drove my car to the depot in the morning and had it back the same evening.

Electronics Exhibition

THE Electronics Exhibition, which took place at Manchester during July, provided several interesting examples with the use of batteries. The examples chosen, which were loaned by various manufacturers, carried out their usual service duties operated by battery power.

Among the equipment exhibited was a ship's lifeboat radio-transmitter working in conjunction with the patented Exide self-priming battery; deaf-aid apparatus, incorporating lead-acid L.T. and dry H.T. batteries; a battery-operated portable oscilloscope; gas-detector units; and batteries, and "Keopalite" emergency lighting equipment.

Interesting novel batteries were shown, among them the prototype miniature H.T. and L.T. battery for use with Radio Sonde apparatus in meteorological balloons, as well as a battery for operating in an oilwell bore-hole.

Other items of general interest included an Exide-Ironclad bus-lighting battery; Exide wireless H.T. and L.T. batteries; Exide low-loss cells for operating electric impulse clocks; Exide aircraft batteries for commercial planes; and Drydex and Drymax batteries for radio, hearing aids, etc.

Radio Telegrams to Tel Aviv

CABLE AND WIRELESS announce that telegrams may now be sent by direct wireless service from London to their station at Tel Aviv. This service supplements the London-Haifa cable route via Alexandria.

Two-way service with Palestine is also available between London and the Jewish quarter of Jerusalem via Haifa.

All telegrams are subject to censorship in Palestine and to senders' risks. Letter telegrams are not admitted, but there are no restrictions on code telegrams.

Television Receivers

MORE and more television receivers are coming on the market and prices, I see, are coming down. I propose to test all of those on the market and to report upon them in this journal. Notwithstanding the reduction in purchase tax, I understand that sales of radio and television receivers have not increased and the shops are still full. What a paradox it is that when there is a demand there is no supply, and when there is a supply there is little demand! All this talk of another war is not helping trade.

New Season's Models

Details of Some New Receivers from Ace Radio, Mullard and Philips

Philips' Battery Model 474B

THIS is a new six-valve, three wave-band superheterodyne battery-operated receiver of a very advanced design, and gives a much better performance than any previous battery set.

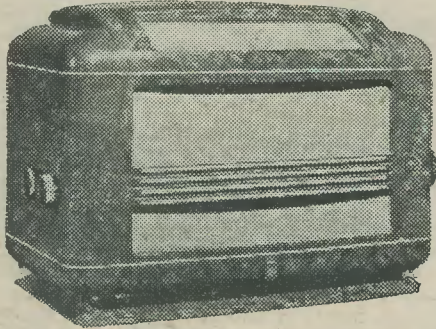

Philips new battery receiver with Q.P.P. output.

The very high efficiency of coil design and the incorporation of two L.F. stages result in a high order of sensitivity.

The quietest push-pull output stage and specially designed high sensitivity 8in. speaker provide generous volume with low harmonic distortion and exceptionally fine quality. Sockets are provided for an extension speaker and for gramophone pick-up.

The price of this receiver (without batteries) is £18 18s., plus purchase tax £4 0s. 11c.

Ace Model 600

This is a highly sensitive A.C. mains superheterodyne radio, designed for overseas customers who require a first-class short-wave receiver which could be relied on for the reception of European and American programmes in any part of the world.

The circuit incorporates bandspreading, and signals are easily tuned in on the large, clearly marked dial.

In addition a radio frequency stage is included to increase the strength of incoming signals relative to background noises, and variable selectivity, which by means of a switch gives either high-fidelity reception and reproduction of local transmissions or lessens the background noise which accompanies distant broadcasts.

To ensure the best possible reproduction, Model 600 incorporates a high-quality amplifier fitted with negative feedback, a 10in. specially matched permanent magnet moving-coil loudspeaker mounted on a large area baffle, and is housed in a cabinet specially designed for its acoustic properties.

Model 600's 10-watt power output is sufficient to feed a number of extension loudspeakers which can be permanently connected. Both internal and external speakers are controlled from a switch on the front control panel. The receiver is available

to the home market. Price, £45 (purchase tax, £9 12s. 6d.).

Mullard Model MAS 221

This is an A.C. mains counterpart of the MUS 221, the A.C./D.C. receiver which was released towards the end of last year.

The MAS 221 is a five-valve superheterodyne designed to operate from 100-250 volts A.C. mains supply, at 50-100 cycles.

There are three wavebands: Short, medium and long. The set is fitted with a three-position tone-control switch, and

efficient delayed automatic volume control is incorporated. Sockets are provided for an extension loudspeaker of 5-7 ohms, and for a gramophone pick-up. An internal plate aerial permits the reception of local stations without the use of an

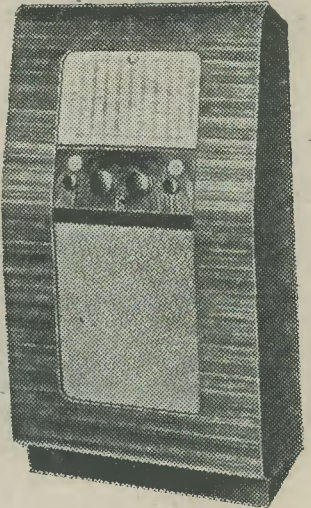

The Ace model 600, which incorporates bandspread tuning by iron-cores on short waves.

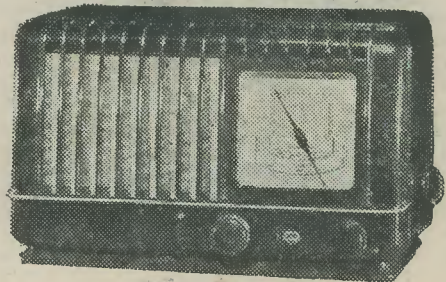

The new Mullard model MAS 221.

outdoor aerial, which can, however, be connected if required. Mains consumption is 51 watts at 220 volts.

The price of the MAS 221 is £20 7s. 11d., including purchase tax of £3 11s. 11d.

DUSTBIN MENACE

Waste Paper thrown out as rubbish means dollars lost to Britain so save every scrap.

Loudspeaker Developments

A Review of Some of the Latest Single Units Designed for High-fidelity Reproduction

By W. J. DELANEY (G2FMY)

ABOUT a year ago we discussed in these pages the developments which were taking place in the design of cabinet loudspeakers of the acoustic labyrinth and similar types. It appeared at that time that manufacturers were going to concentrate on that particular line of development, but there are still several firms concentrating on the speaker unit design, as distinct from the cabinet. Amplifier design has progressed, and there is no doubt whatsoever now that the weak link is definitely the loudspeaker. How have manufacturers attempted to improve speaker design? It is obviously impossible to deal with every speaker in an article such as this, but I have selected those which show most interesting lines of development, some of which I have had an opportunity of testing. Those to be discussed range from a speaker unit costing £9, to a corner cabinet model, which costs 98 guineas. It should be mentioned that the popular loudspeaker manufacturers have also attacked the question of improving performance, although in most cases the improvements are merely along standard lines, such as cone material, magnet shape, etc.

The Hartley

The first model to be dealt with is the latest

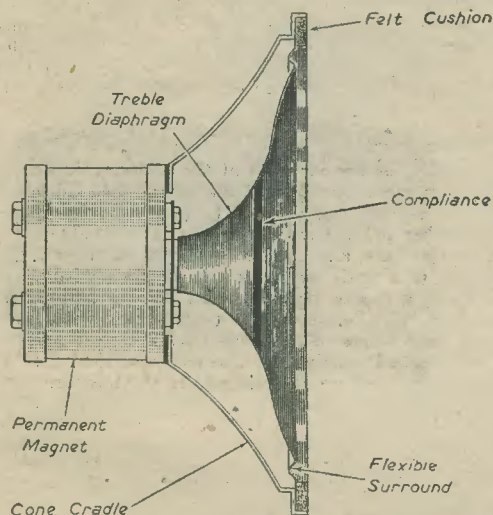

Fig. 1.—Constructional features of the Hartley loudspeaker with the diaphragm curves slightly exaggerated.

Hartley, Model 125, which costs £9. Resembling a normal speaker, the main feature of this model is the diaphragm, which may be roughly described as a standard pattern, cut round half way between apex and front edge, with the two pieces rejoined with a

flexible joint. Fig. 1 gives some idea of the scheme. Actually, the cone has a sort of double curve in section and is made from special material. The main feature of this model is the practical removal of cone resonance, although as with all moving-coil loudspeakers, some sort of cabinet is essential for proper bass response. The maker claims a response curve from approximately 50 to 10,000 cycles.

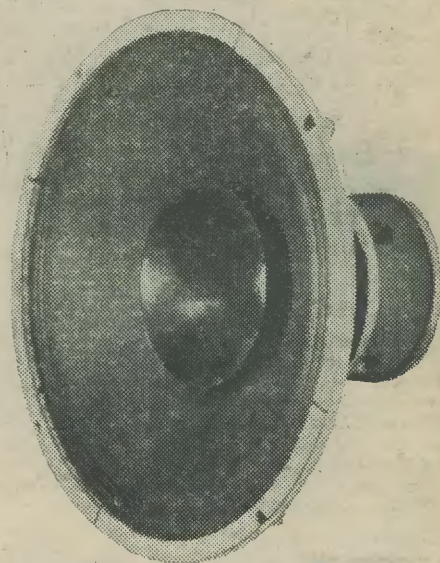

Fig. 2.—The new Goodman double-cone speaker. The large diaphragm is exponential in section.

Magnetic Damping

It should be mentioned here that for good transient response high magnetic damping is called for, and the measure of this is seen from the flux density in the gap. The Hartley claims from 11,000 to 12,000 lines per sq. cm., and if a speaker with such high density is simply connected to an amplifier in place of an old speaker with very low damping the effect will be noticed at once in the "sharpness" of items such as cymbals, etc. They seem "chopped off" by comparison with the weak magnet types of speaker. The baffle is critical with the Hartley and the maker recommends two types, one having internal screens to break up the contained air column, and the other filled with a granular material for the same purpose. (As distinct from those makers who recommend a resonant air column.) The speaker cone diameter in this model is 9in.

Goodman "Axiom Twelve."

In the Goodman range a new model recently introduced is known as the "Axiom Twelve."

This has a 12in. diaphragm, exponential in shape rather than straight-sided, with an internal narrow-angle cone attached at the apex. The two cones are not rigidly joined, but have a flexible joint. In this model flux density is rated at 13,000, frequency response from 40 to 15,000 cycles, with a fundamental resonance of 55 cycles. For this model the makers recommend a resonant type of box baffle, something on the lines of an acoustic labyrinth. The upper frequency response of this model is remarkable after ordinary types of speaker, although if the amplifier and associated equipment produces very good "top" it may be found a little harsh to some tastes. Even without the proper baffle the bass response is very "clean," the 12in. diameter cone no doubt playing a big part in this. This model costs 9 guineas.

The Barker

An entirely new type of coil unit is the principal feature of the Barker speaker. This has an 11in.

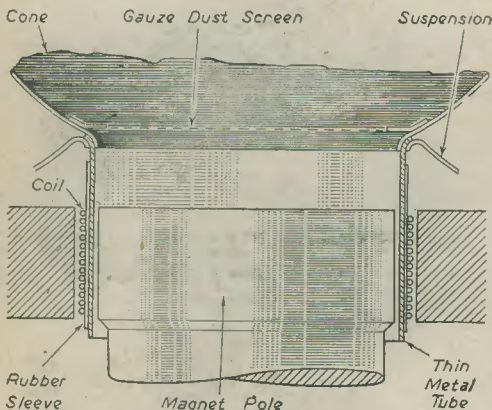

Fig. 3.—A sectional view of the speech-coil arrangement of the Barker loudspeaker.

cone, a magnet rated at 12,000 lines and a frequency response from 25 to 15,000 cycles. In this model the speech coil is wound on an aluminium former, with a layer of soft rubber between former and coil. It is claimed that the aluminium former acts as a single turn coil at high frequencies, and the speech coil is free to "float" over the rubber separator so that there is, in effect, a frequency cross-over without any electrical filter circuit. Again, the maker draws particular attention to the baffle cabinet in which the speaker should be mounted to ensure good bass response. We have not had an opportunity of testing this model, which costs 15 guineas.

The Lowther

At the extreme end of the scale is the Lowther in which many interesting features are found. Firstly, the cone is only 6in. in diameter and the magnetic flux is claimed to be over 19,000 lines. Obviously, with this type of diaphragm the speaker is intended for use in a properly-designed cabinet incorporating a bass chamber of some sort, together with "horn loading." A corner model is available from the makers at £24. The speaker unit alone costs £32. The combination of this speaker and

cabinet gives a response down to below 50 cycles, but no claims are made so far as the upper range goes, although with the special diaphragm and reflector cabinet this should be at least right up to the 15,000 cycle mark.

Cabinet Models

In the range of special cabinet designs, employing single speakers, as distinct from "woofer" and "tweeter" models with cross-over networks, there are the "Endsleigh" at one end of the scale, costing £42 15s., and the "Mordaunt" at the other end, costing 98 guineas. The Endsleigh is a corner model, carrying a special Wharfedale speaker with 10in. diaphragm. A quadrant exponential horn is built into the cabinet, together with an infinite box baffle, giving the entire unit a frequency response from about 30 cycles up to 15,000 or so.

It is interesting perhaps at this point to explain that most loudspeakers can be improved, so far as their overall performance is concerned, if they are put into a corner cabinet in which either horn loading or reflector arrangements are incorporated for high note effects, and some form of vented enclosure for the lower part to assist in the low-note response. Such cabinets are available without loudspeakers from certain firms, such as Lowther-Voigt, Rogers Development, etc. It is generally desirable, however, to follow the makers' recommendations concerning the type of cabinet, and with most of the firms mentioned special details of this type are supplied. For instance, the Goodman recommendation is for a box 30in. high by 14in. deep and 22½in. wide, with a rectangular opening 15in. by 6in. immediately underneath the speaker opening, which is centred 12in. below the cabinet top. The vent in this case is "framed" inside to a depth of 6in. all round, thus breaking up the lower part of the cabinet. The whole is lined with lin. felt.

The Mordaunt

Finally, as an example of the extreme in design mention must be made of the Mordaunt. This is a corner cabinet standing 5ft. 5in. in height and projecting 28½in. from the corner. It consists of two separate bass and treble sections, in which the former is a multiple taper folded horn with 12in. speaker, and the treble section having a separate speaker with exponential twin cone, with low-frequency filters of the cross-over network pattern mounted in the cabinet. The inside of the reflector and horn surfaces is finished in matt cream and concealed amber-tinted lamps illuminate the surface when the apparatus is working. Obviously, with such an elaborate design, every attention has been paid to detail, both as regards finish and performance, and the cost of this reproducer is 98 guineas.

SAVE THAT CARTON

Every empty breakfast-food, sugar, cigarette, soapflake packet is urgently needed for salvage.

CLIX

LOCTAL VALVEHOLDERS

FOR LOCK-IN TYPE VALVES EBL21, ECH21, 7A7E, 7B8, etc.

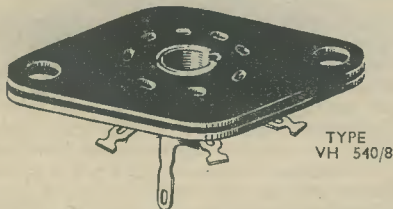

A double-plate laminated valveholder designed with 8 special sockets and centre spigot socket meeting the requirements of the B8G and B8B range of Loctal Valves.

THE GENERAL ACCESSORIES CO. LTD.

21 Bruton Street, London, W.1 Tel. MAYfair 5543
FOREMOST IN VALVEHOLDER DESIGN

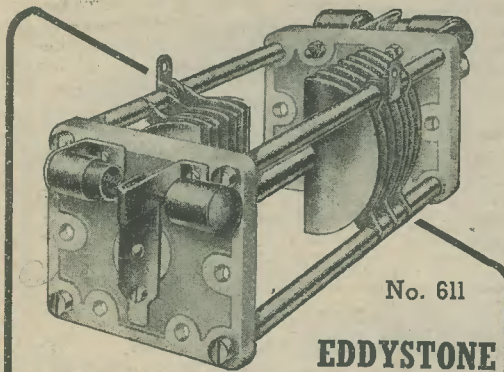

No. 611

EDDYSTONE TRANSMITTING CONDENSERS

A range of Eddystone transmitting condensers is now available for immediate delivery. A standard type of construction is employed in all three, the ceramic end plates being 2 1/2 in. square. Losses are extremely small. The metal mounting plates supplied provide alternative methods of fitting—either directly to a metal chassis or on small stand-off insulators.

All three are of split stator type, and are therefore suitable for balanced and push-pull circuits. By strapping the stator plates together, additional capacity values are available for use in single-ended or aerial tuning circuits.

Cat. No.	Cap. per Section	Effective cap. as Split Stator	As Single ended
611	25pF	12.5pF	50pF at 39/6
612	50pF	25pF	100pF at 32/6
614	100pF	50pF	200pF at 36/6

Order from your Eddystone retailer. We do not supply direct.
STRATTON & CO. LTD., WEST HEATH, BIRMINGHAM, 31

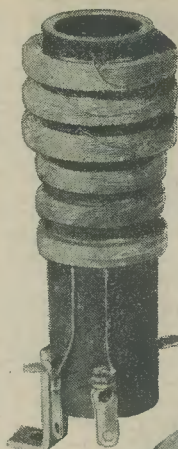

RM

HIGH Q. T.R.F. COILS TYPE 34/5

The choice of coils decides the performance of a T.R.F. Receiver. Users of these R.M. Coils acclaim them as the finest available. Try them yourself.

15/- PER PAIR

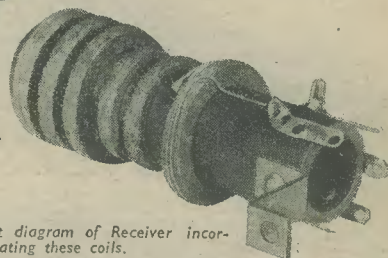

Send for circuit diagram of Receiver incorporating these coils.

R. M. ELECTRIC LTD. TEAM VALLEY, GATESHEAD, 11

COMMUNICATIONS RECEIVER TYPE R1132A

This is specially directed at you—U.H.F. enthusiasts!

A 10-valve receiver covering 100-124 Mc/s., complete with "S" meter—AGC—attenuator control,

etc., etc. Brand new in padded transit case, and specially treated to withstand extremes of climatic conditions. A dial you can really see! Valve line-up P41, EB34, 7475, EF32, 6J5G, two of SP41, three of EF39.

In addition we have a separate power supply to operate from 200-250 v. A.C. mains, which was designed for the R1132A. Brand new, and also in padded transit case, a switch gives choice different input voltages. Outputs: 220 v., 70 m/a D.C., 6.3 v. 4-5 amps A.C. Panel size 19in. x 7in., 0-300 v. and 0-150 m/a metres incorporated, for output readings. Rectifier type V439.

The pair of units, all complete, £7/19/6 (carr. and pkg., £1). R1132A only, £4 19/6 (carr. and pkg., 10/-). Power unit No. 3 only, £3 10/- (carr. and pkg., 10/-). Transit cases returnable, but may be retained upon payment of 10/-.

BC433G RADIO COMPASS UNITS.—A sensitive and selective 15-valve superhet receiver, easily modified from this U.S.A.A.F. navigational equipment. Complete with 15 brand new valves types: 6K7(4), 6N7, 6SC7, 6L7, 6J5, 5Z4, 6F6(2), 2051(2), 6B8(2). Power supply 115 v. 400 c/s incorporated. Weight 47 lbs. Size 20in. x 12in. x 8in. Frequency coverage, 200-1,750 kc/s. A bargain at £5/10/- (carr. and pkg., 10/-).

Post orders to 3, Robert Street, Hampstead Road, London, N.W.1

M.O.S. MAIL ORDER SUPPLY CO. (Dept. PW)

24, New Road, London, E.1
Stepney Green 2760-3906

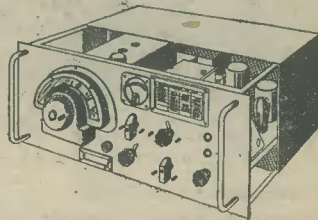

Charger Transf.
Input 200-230-250
v., outputs 4 v.,
8 v., 15 v. and 24
v., at 3 amp.,
27/6.

Ex-Govt. T.M.C.
Reed-type Head-
phones, 70 ohms,
1/8 each (3/6 pair
with leads).
Ultra Midget
O'put Transf.,
22-1, and Para-
feed Tr., 4-1,
both 1in. x 1in., 3/- each. P/Pull Inter valve, 2.5-1 each
half, and O'put Tr. 60-1, both 1 1/2in. x 1 1/2in., 3/- each.
Tannoy Transverse Carbon Mike Inset, 3/-, L.F. Choke 15
Hny. 300 ohms, 175 m/a, 12/6. M/Coil Mike, 2/6. I.F.
Transf. *6.8 m/6, 6/6 pr. Mu-Metal Intervalve Transf. 3-1,
5-1 or 10-1, 3/9 each.

Coils, T.R.F. Matched pair, M. L., 6/9. Weymouth ditto,
9/6 pair. S/Het. matched, S.M. & L., 8/9; 10/6 and 11/6
pair. All Wearite "P" Coils, 3/- each.

I.F. Transf. 465 kc/s, Wearite Midget Iron Core, 21/- pair.
Weymouth Midget Iron Core, 18/9 pair. Service, Cap. Tuned,
110 kc/s, 15/- pr. Mfrs' Surplus, new, High Q., 465 kc/s, Iron
Core, 10/- pr.

Potentiometers. Centralab. 5K, 10K, 25K, 50K, 100K, 1, 1, 1
and 2 Meg., less Switch, 4/3. With Switch, 6/-, Midget with
switch, 1 and 1 Meg., 6/-. Special 75 meg., with switch, 4/9.

Electrolytics. E.E.C. Midget, 3-3 mid. 450 v., 1 1/2in. x 1in., 5/6,
and 32 mid. 350 v., 1 1/2in. x 1in., 5/-, T.C.C. 16 mid. 150 v., 2 1/2in.
x 1in., 3/3. Dubilier 8 mid. 500 v., 2 1/2in. x 1in., 4/-. And all
makes and types.

L.F. Chokes. Porthminster 20 Hny. 300 ohms 60 m/a, 6/6 ;
20 Hny. 350 ohms, 100 m/a, 12/9 ; 20 Hny. 185 ohms, 250 m/a,
30/- ; 50 Hny. 1,000 ohms, 60 m/a, 12/9.

Meter Rectifiers. Westinghouse; 0.5 m/a, 3/11 ; 0-10 m/a,
7/6 ; 0-1 m/a, 10/6.

Selenium Rectifiers. H.T., h/wave : 250 v. 50 m/a, 5/9 ;
200 v. 100 m/a, 5/9 ; 250 v. 100 m/a, 7/6. Bridge Rect. : 6 v.
1 amp., 6/3 ; 12 v. 1 amp., 12/6 ; 12 v. 3 amp., 24/- ; 12 v.
6 a., 37/6 ; 36 v. 1 a., 23/6 ; 70 v. 1 a., 37/6. Also L.T. 2 1/4 v.
1 a., h/wave, 3/6.

Television Transf. I.I.L.T. 4,000 v. 3 m/a, 2 v. 1 1/2 amp., 45/- ;
500-0-500 v. 250 m/a, 4 v. 5 a., 6.3 v. 8 a., 75/- ; 350-0-350 v.
250 m/a, 6.3 v. 6 a., 4 v. 8 a., 4 v. 3 a., 6.3 v. (tapped 2 v.), 2a., 72/6.

★ Send 2d. stamp for very full Stock Lists. When ordering
please cover packing and postage.
STERN RADIO LTD., 109 & 115, Fleet Street, E.C.4
Telephone : CENtral 5814 and 2280.

You're SURE to get it at

STERN'S

ESTABLISHED 25 YEARS

QUALIFY FOR a BETTER POST

-by Post!

Let the most progressive, most successful College
in the world coach you by correspondence.
Choose your career or be advised by us. We
take a personal interest in all our students and
provide the friendly individual training that quickly
leads to success. Make the first move NOW
—write for free particulars.

CHOOSE YOUR CAREER WE WILL TRAIN YOU QUICKLY

- | | |
|---|---|
| Accountancy Exams. | Municipal and County
Engineers |
| Advertising and Sales
Management | Naval Architecture |
| Agriculture | Novel Writing |
| A.M.I. Fire E. Exams. | Plastics |
| Applied Mechanics | Play Writing |
| Auctioneers and Estate
Agents | Plumbing |
| Aviation (Engineering
and Wireless) | Police, Special Course |
| Banking | Preceptors, College of
Press Tool Work |
| Blue Prints, Boilers | Production Engineering |
| Book-keeping, Account-
ancy and Modern
Business Methods | Pumps and Pumping
Machinery |
| Building, Architecture
and Clerk of Works. | Quantity Surveying—
Inst. of Quantity
Surveyors' Exams. |
| Builders' Quantities | Radio Service |
| Cambridge Senior
School Certificate | Engineering |
| Carpentry and Joinery | Radio Short Wave |
| Chemistry | Road Making and
Maintenance |
| Civil Engineering | Salesmanship, I.S.M.A. |
| Civil Service | Sanitation |
| All Commercial Subjects | School Attendance Officer |
| Commercial Art | Secretarial Exams. |
| Common Profim. E.T.E.B. | Sheet Metal Work |
| Concrete & Structural
Engineering | Shorthand |
| Draughtsmanship. All
Branches | Shorthand (Pitman's)
Short-story Writing |
| Engineering. All branches,
subjects and exams. | Social Welfare |
| General Education | Speaking in Public |
| G.P.O. Eng. Dept. | Structural Engineering |
| Heating and Ventilating | Surveying |
| Institute of Housing | Teachers of Handicrafts |
| Journalism. Languages | Telecommunications
(City and Guilds) |
| Mathematics | Television |
| Matriculation | Transport Inst. Exams. |
| Metalurgy | Viewers, Gaugers,
Inspectors |
| Mining. All subjects | Weights and Measures
Inspector |
| Mining, Electrical
Engineering | Welding |
| Motor Engineering | Wireless Telegraphy
and Telephony |

If you do not see your own requirements above, write to
us on any subject. Full particulars free.

COUPON—CUT THIS OUT



To DEPT. 104, THE BENNETT COLLEGE,
LTD., SHEFFIELD.
Please send me (free of charge)

Particulars of..... (Cross out line
Your private advice..... which does
about..... not apply.)

PLEASE WRITE IN BLOCK LETTERS

Name.....

Address.....

4 - VALVE SUPERHET RECEIVER

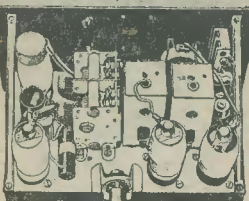

for short waves, complete,
as illustrated. Needs only
batteries and phones. 29/6
Pkg. and Ins. 2/6.

Suitable H.T. Battery 9/-
Matched Phones, pr. 9/-

MAINSTRANS. Drop-
through type. Primary
200-250 volts, Secondary
350-0-350 80 mA, 5 volts
2 amps, 6.3 volts, £1
3 amps. Post paid

EX-RAF AMPLIFIER
1134. Ideal for use with
a microphone, or can be
used as an amplifier with-
out modification. Com-
plete with wooden tran-
sit case. 17/6

Post free
**NUTS, BOLTS,
WASHERS.** Small
sizes for model making,
3 gross, 7/6

assorted.
SCREENED FLEX.
Suitable for
mikes, 100ft. 10/-

28 VOLT MOTORS
(new). Can be run off
lower voltages but at
reduced speeds. 7/6

Post free.
**MULTIRANGE TEST
METER.** 17 range ;
AC/DC, 24, milliamp
and resistance. Guar-
anteed Brand new £7

BC348, as new. 28
volt. Plus 10/- packing. £18/10/-

Fitted internal AC Power Pack.
200-250 volts. Plus
10/- packing. £22/10/-

**2 1/2" FLUSH MOUNTING
MILLIAMMETER.** Moving coil,
Bakelite case, 0-1 FSD.
Brand new. Post free 13/6

**2 1/2" FLUSH MOVING
COIL AMMETER** 0-25 7/6
Post free

**12 ASSORTED MAGNETIC
RELAYS** for experimental
purposes. Post free 12/9

PHOTO-ELECTRIC CELL.
Dozens of applications, e.g., burglar
alarms, counting, door-
opening, etc. 14/6

Light Operated Kit for
above cell. 57/6

NO C.O.D. ORDERS OVER £1.

Write to Dept. "R"

INSTRUMENT CO.
24 HARRŌW ROAD,
LONDON, W.2. Cun. 0508

Couplings for Detectors

Some Unusual Schemes for Reacting Detector Stages.

By "EXPERIMENTER"

MOST of the receivers constructed at home by radio enthusiasts are of the "straight" or "T.R.F." type. One of the reasons for this is undoubtedly that such receivers can give better quality of reproduction than home-constructed superhets, but possibly the most obvious reason is that T.R.F. receivers can be satisfactorily built and aligned at home without the aid of expensive signal generators and test equipment. Such receivers have, however, a small number of tuned circuits (seldom more than three and usually two) and the selectivity is limited and often insufficient to permit satisfactory reception of signals on the crowded medium wave-band. Practically the only way of improving the selectivity is by the use of reaction, and the circuit of a detector stage typical of those used in T.R.F. receivers is given in Fig. 1.

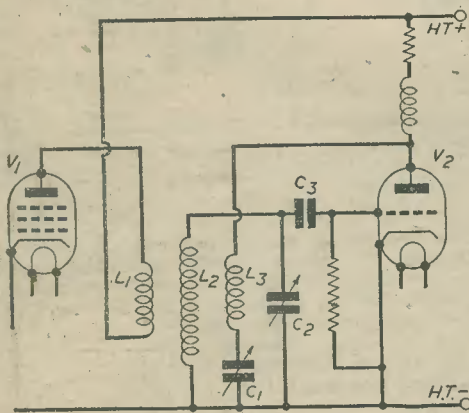

Fig. 1.—Typical R.F. coupling used in T.R.F. receivers.

The R.F. transformer illustrated here and situated between the R.F. amplifier stage and the detector has three windings: a coupling coil or primary winding, L1, carrying the anode current of V1; a secondary winding, L2, which is tuned by the variable capacitor, C2, and feeds the detector, V2; and a tertiary winding, L3, providing reaction, the degree of which is controlled by the variable capacitor, C1. It should be noted that the moving vanes of both variable capacitors may be earthed, a convenience in mounting them. Few three-winding R.F. transformers are manufactured to-day and such components are difficult and laborious to construct at home because three separate windings are required for each band to be covered. If there are any ways of reducing the number of windings required to two, or better, to one, without impairing the results obtained from the circuit, these would be welcome not only because they enable many types of commercial coil-packs to be used, but also because they reduce the labour

involved in winding the transformers. Various methods of reducing the number of windings will now be described. Although there is no sacrifice in performance, it is to be expected that the economies in windings about to be described can be obtained only by making sacrifices in other directions or by the use of additional components. These will be pointed out for each circuit described; generally the sacrifices are worth making in view of the simplification of the transformer design.

Choke-capacity Coupling

One well-known method of avoiding the use of L1 is to use choke-capacitance coupling between V1 and V2, as shown in Fig. 2. This circuit involves the use of an additional R.F. choke, which is moderately expensive, will probably require screening and occupies some space, and for these reasons the circuit is not recommended. A better method of avoiding the use of L1 is shown in Fig. 3. In this circuit the lower end of L2 is disconnected from earth and is joined to H.T. positive, a low impedance path to earth being provided by a fixed 0.1 μF or 0.05 μF capacitor, C4. The upper end of L2 is connected to the anode of V1. This circuit has the disadvantage that the full value of the H.T. supply is applied to the fixed plates of the tuning capacitor, C2, and there is thus a possibility of obtaining shocks if this component is touched, or of a direct short-circuit of the H.T.

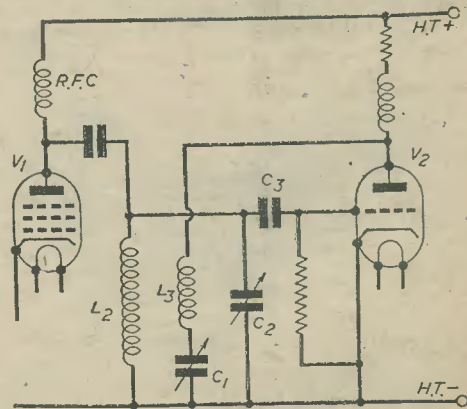

Fig. 2.—One method of dispensing with L1—by choke-capacitance.

supply if any conductor comes into contact with C2. To avoid this, a blocking capacitor C5 of not less than 0.05 μF capacitance can be connected in series with the tuning capacitor, as shown by the dotted lines in Fig. 3. As C4 and C5 have all to withstand continuously the full value of the H.T. supply they should be good quality components. Another property of the circuit, though

it is not a serious disadvantage, is that the output capacitance of V1, possibly about 15 μF , is connected directly in parallel with L2 and therefore will slightly upset the ganging of C2 with other tuning capacitors if used. This can be corrected by reducing the capacitance of the trimmer on C2 or increasing the capacitance of the trimmers on

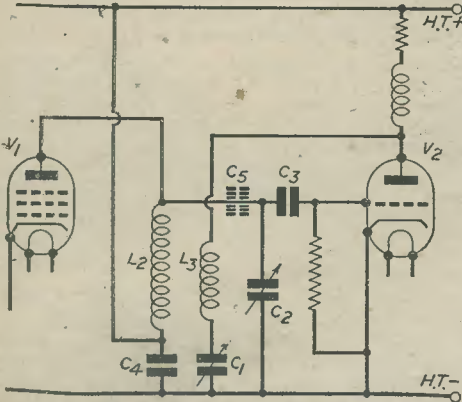

Fig. 3.—A second method of doing away with L1—by using L2 as a coupling coil.

all the other tuning capacitors by a suitable amount. This circuit may give greater gain than those using a separate coupling coil (Fig. 1) and the danger of R.F. instability is greater, so that more care is needed in layout and screening. The selectivity of this circuit arrangement is, however, in no way inferior to that obtained from other circuits.

Alternative Scheme

Another method of dispensing with L1 is illustrated in Fig. 4. In this circuit the anode current of V1 is passed through L3 instead of through L2

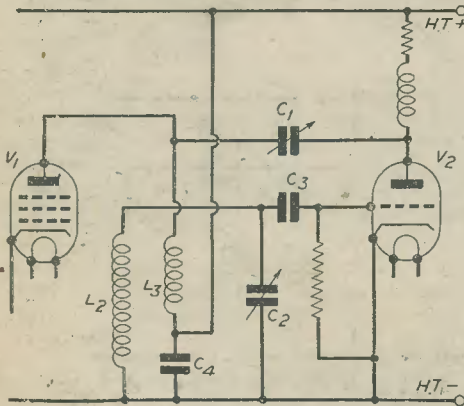

Fig. 4.—A third arrangement where L3 is used as the coupling coil.

(as in Fig. 3). In order that one end of L3 may be earthed the positions of L3 and C1 are interchanged from those shown in Fig. 1. The lower end of L3 is connected to H.T. positive and is earthed to R.F. currents by the inclusion of the 0.1 μF or 0.05 μF capacitor C4. The upper end of L3 is

connected to the anode of V1. A disadvantage of this circuit is that both the moving and fixed vanes of the reaction capacitor C1 are at R.F. potential with respect to earth. A second disadvantage is that the number of turns on L3 and its relative position with respect to L1 must be chosen to give satisfactory control of reaction. For this purpose L3 should contain about one-third or one quarter the number of turns on L1 and the coupling should be very close; it is best, in fact, to wind L3 on top of the earthy end of L1. Such an arrangement does not give satisfactory coupling between V1 and V2 and the R.F. gain obtained from the circuit of Fig. 4 will be less than that given by other circuits described.

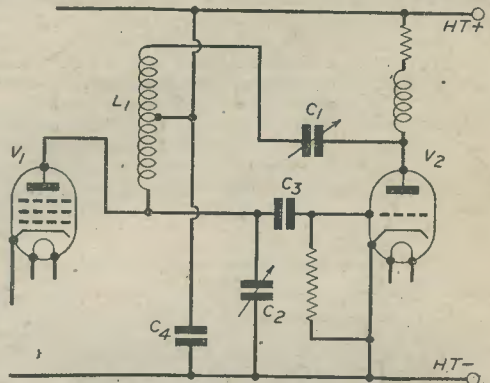

Fig. 5.—A single tapped winding performing all the functions of L1, L2 and L3 in Fig. 1.

Tapped Coil

This process of making one coil do the work of two can be continued further, and it is possible, as in the circuit of Fig. 5, to use one tapped coil to perform all the functions of L1, L2 and L3 in Fig. 1. The tapping point should be about one-quarter to one-third the way down the coil, the upper part of the coil being used to give reaction and the lower half being tuned by C2 and also carrying the anode current of V1.

A low impedance path to earth is provided by C4, which should be a good quality component of not less than 0.05 μF capacitance. The anode of V1 may be connected to either end of L1, but the connection illustrated gives most gain from V1.

This circuit has the disadvantage that both "sides" of the reaction capacitor are at R.F. potential with respect to earth. Full winding details of a suitable coil for use with this circuit on the medium waveband are given in Fig. 6. The tuned part of the winding has an inductance of 157 μH , which is a value used with tuning capacitors of 500 μF maximum capacitance, to cover the frequency range 550 1,500 kc/s.

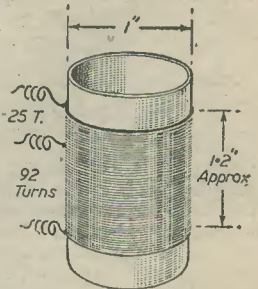

Fig. 6.—A suitable coil for the Fig. 5 arrangement. The wire is No. 36 D.S.C.

Build the "Superscope"

A Cheaply Built Oscilloscope Incorporating Single Valve Sensitivity, Deflection Amplifier

By E. SOWDEN

Of all the instruments used by the radio experimenter, the cathode ray oscilloscope is probably the most versatile, and from the amateur's point of view it is one of the most suitable to build, because, unlike signal generators, etc., it does not require special calibration before it can be put into use.

For the benefit of readers who are not acquainted with the uses of the oscilloscope and who for this reason have not already built one, a brief description of some of its applications will not be out of place. The basic principles of operation were described by Mr. Tooke in the April issue and his article will be very suitable for reference.

It was seen that a voltage applied to the deflector plates produces a deflection of the spot, the first most obvious use for the tube, therefore, is as a voltmeter, and used thus it will measure voltages from zero frequency up to radio frequency with little or no effect on the circuit being investigated, due to the high input impedance of the tube.

The addition of the time base makes it possible to examine the "shape" (i.e., the way in which it varies with respect to time) of the applied signal and its frequency, if the frequency of the time base is known; it is very often convenient to use the 50c controlled mains voltage as a time base for calibrating oscillators. This method has the advantage over beat frequency methods in that the presence of harmonics in the oscillator output causes no confusion.

Other uses of interest to the amateur are the projection of valve characteristic and receiver response curves on to the screen, thus eliminating much laborious plotting of graphs; the study of A.F. amplifier characteristics, and for the transmitting amateur the determination of modulation depth and quality.

The list could be extended *ad infinitum*, for its uses are legion, but space forbids and the reader is referred to the many publications on the subject at present on the market.

Cost

Although it contains features which are normally only found in the more expensive type of commercial instrument, the 'scope to be described can be built for about £10 if advantage is taken of the cheap market in Government surplus components; it was, in fact, designed so that most of the components used in its construction could be obtained in this way.

The valves and tube are all ex-Service, and suitable switches, potentiometers, smoothing chokes, etc., are to be found in various items of surplus gear, or can be bought separately at cheap rates.

Power Pack

The circuit diagram is shown in Fig. 1 and from this it will be seen that the tube, amplifier and time base supplies are all derived from one transformer

which feeds two half-wave rectifiers. Half-wave rectification was found to be quite adequate for supplying the time base and amplifier, instead of the full-wave arrangement which is usually used for this purpose.

There are many alternative arrangements for the power supplies which can be used, employing 350-0-350 volt transformers with voltage doubling to obtain the necessary volts for the tube, which should be in the region of 700, and the reader will no doubt have his own ideas; but one point should be borne in mind; it is often stated that very little smoothing is required for the tube supplies because only a small current is being taken. This is quite true, but it is essential that the smoothing be adequate, because any ripple on the tube supply will be developed across R20, as the grid of the tube is being fed from the time base which has one side earthed.

The effect of the ripple will be to cause a recurring blacking out of the trace.

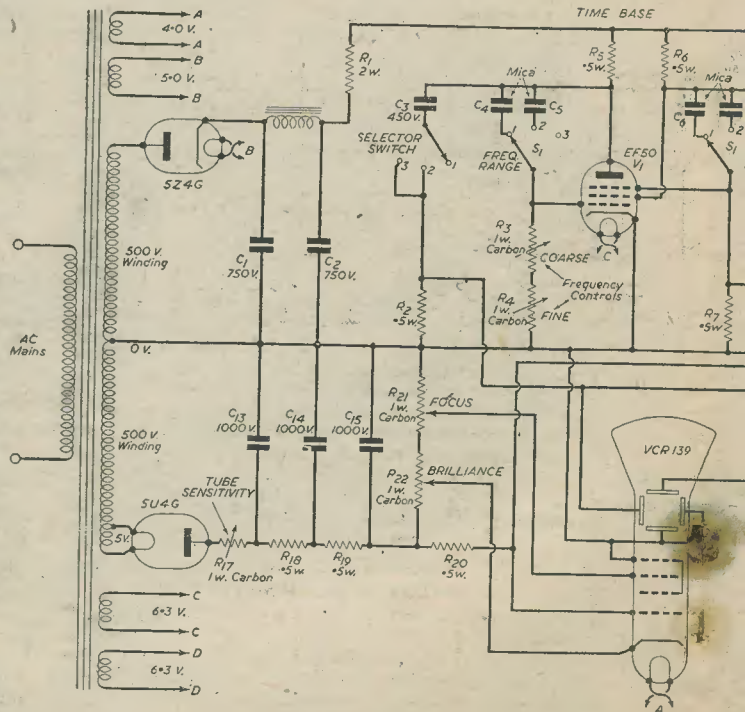

Fig. 1.—Theoretical circuit of the Superscope with ratings of condensers and

Superscope

Valve Time Base, Automatic Sync., Variable Tube and Fly-back Suppression

OWDON

It is unlikely that a transformer will be obtained having all the L.T. windings required—in this case two 6.3 v., two 5 v. and one 4 v. It will therefore be necessary to add the extra windings, and this is quite a simple matter. The turns-per-volt ratio for the transformer is first of all established by measuring the voltage of an existing L.T. winding, counting the turns which comprise it and dividing the number of turns by the voltage; i.e., if number of turns $N=16$ and volts $E=4$, then

$$\frac{N}{E} = \frac{16}{4} = 4$$

turns per volt = 4, and the number of turns required for 6.3 volt winding is $6.3 \times 4 = 25.2$ turns, and for 5 v. winding $5 \times 4 = 20$ turns.

The 4-volt tube heater winding and the 5-volt rectifier windings should be well insulated from each other and from the core.

The variable resistance R17 controls the tube sensitivity by reducing the voltage on the anodes, thus reducing the acceleration of the electron beam and allowing the signal on the deflector plates

to exercise greater control over it. There is, of course, a decrease in brilliance, but this is no great disadvantage, as the picture is still quite clear at greatly increased tube sensitivity, especially if a hood is fitted over the screen to exclude external light.

R21 and R22 are the brilliance and focus controls. No provision has been made for X or Y shift, as the writer has found no great use for them; they can easily be included if desired.

Time Base

The time base is a self-running Miller, working on the transitron principle, and has been modified slightly from the normal arrangement, inasmuch as the control grid is taken to earth through resistors instead of being taken to the H.T. positive line.

The Miller time base was developed during the war for use on radar and is hard to beat for cheapness and efficiency, requiring only one valve (V1) and capable of working from frequencies of a few cycles per second right up to radio frequencies. In this respect it is far superior to the Thyatron time base, its only other rival for cheapness.

At the higher time base frequencies the ratio of forward-stroke time to fly-back time becomes rather small, and the waveform under examination shows upon the fly back nearly as brightly as on the forward stroke. It is therefore an advantage to black out the fly-back, and this is accomplished by feeding the screen pulse via a squaring diode V2 to the grid of the C.R.T.

R3 is the coarse frequency control and R4 the fine control. S1 controls the range.

Automatic Sync.

V3 is the automatic synchronising valve and is a Class C limiting amplifier, another circuit which found similar uses on wartime radar; it is biased back to Class C conditions by grid current flowing on the positive half cycles of the applied signal which is taken from the Y plate, and charging up C1 which can discharge only very slowly through the 40 megohm grid leak R16.

With no signal input the bias is zero, hence the high wattage dropping resistors R11 and R13.

Only the tips of the applied signal are amplified and the output volts at the anode remain constant over a large range of input volts; the output is taken to the suppressor of the time base valve.

Note that the screen is maintained at only 30 volts, and it is important that it should not exceed this figure by any great amount.

This form of sync. control is very useful when dealing with waveforms of fixed frequency but of varying amplitude, or where the amplitude has to be varied as part of an experiment. The time base remains locked and does not require continual adjustment, and, in addition, the high input impedance of the amplifier does not load the circuit under investigation as would a manual control.

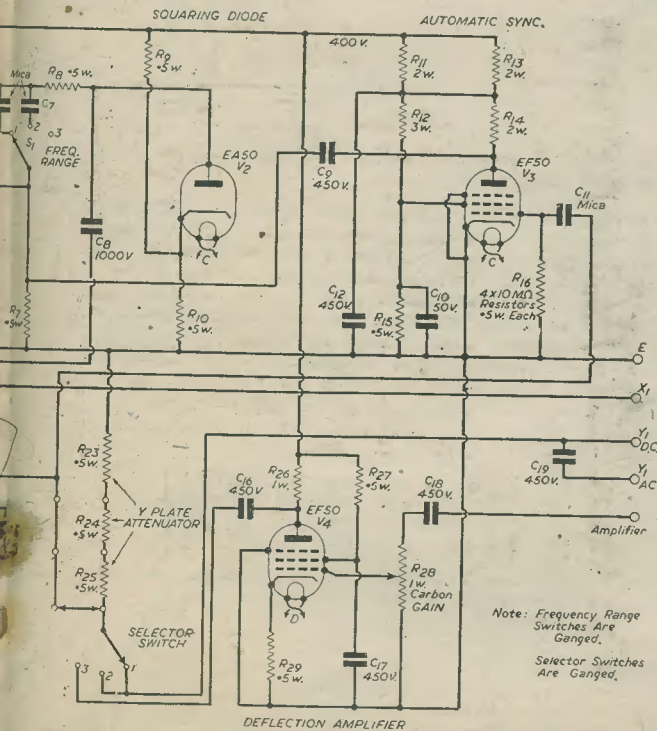

and resistors marked. A list of these will be found on page 376.

Deflection Amplifier

This is a simple single-stage amplifier which will, in conjunction with the variable tube sensitivity, give sufficient gain for most purposes.

Switching

- Position 1.—No time base or amplifier in circuit.
 Position 2.—Time base, but no amplifier.
 Position 3.—Time base and amplifier.

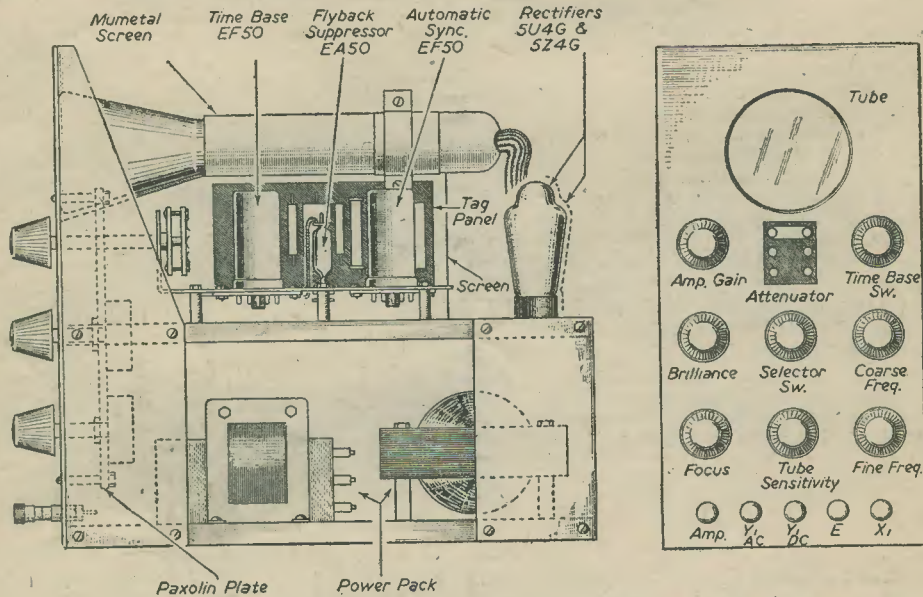

Fig. 2.—The left-hand illustration shows a plan view of instrument, and on the right the control panel layout panel is shown.

Construction

The outward form of the finished instrument will depend on three factors, (1) What can be obtained in the way of material? A factor to be reckoned with in these days. (2) What is there to hand in the way of suitable chassis or boxes? (3) The constructor's personal taste.

For these reasons no detailed building instructions have been given, but a few hints and tips are set out below.

First, unless a mumetal screen can be obtained, there is no use considering building the instrument in the compact form illustrated in Fig. 2, because the tube will almost certainly be in the field of the mains transformer with resultant 50 ω interference; but if size is no object, a longer chassis could be employed, and the transformer situated directly behind the tube at a distance determined by experiment. The transformer should be tried in various positions to determine the position of minimum pick-up. This form of interference may be detected by applying A.C. first to the Y₁ plate then the X₁ plate; the plate not being used is taken to chassis. A straight line should result in each case, but if interference is present, then an ellipse will appear in one axis or the other.

If interference is being picked up by the leads, then earthing the X and Y plates will cause it to

disappear; the trouble will be cured by changing the positions of the leads.

The alternative method of construction is to build the power pack separately from the rest of the 'scope, and this is probably the most economical from the amateur's point of view, for then the power pack may be used for other work, and the question of interference does not arise.

Whatever type of construction is adopted,

remember that the voltages are higher than those normally used in standard broadcast receivers and adequate insulation should be provided for all high-potential wires and components. This applies to the potentiometers used in the H.T. supply for the tube, and these should be fixed to paxolin plates mounted on spacers on the front panel as in Fig. 2, making sure, of course, that the spindles clear the holes in the panel.

(Concluded on page 382.)

COMPONENT VALUES

R1	3.5k Ω	R17	500k Ω	C4	.001 μ F
R2	6.8M Ω	R18	10k Ω	C5	50pF
R3	1.0M Ω	R19	10k Ω	C6	.001 μ F
R4	10k Ω	R20	100k Ω	C7	250pF
R5	100k Ω	R21	1M Ω	C8	.25 μ F
R6	68k Ω	R22	10k Ω	C9	.25 μ F
R7	100k Ω	R23	2M Ω	C10	8 μ F
R8	330k Ω	R24	2M Ω	C11	.0001 μ F
R9	150k Ω	R25	2M Ω	C12	8.0 μ F
R10	40k Ω	R26	100k Ω	C13	0.5 μ F
R11	22k Ω	R27	150k Ω	C14	0.5 μ F
R12	22k Ω	R28	500k Ω	C15	0.5 μ F
R13	22k Ω	R29	220 Ω	C16	.25 μ F
R14	10k Ω	C1	8.0 μ F	C17	.25 μ F
R15	3k Ω	C2	16.0 μ F	C18	.25 μ F
R16	40M Ω	C3	0.25 μ F		

A Home Intercom.-2

A Room-to-room Telephone of the Loudspeaking Type

By E. N. BRADLEY

ANOTHER "Master-slave" network is shown in Fig. 4, this circuit allowing station A to contact any of three other stations. The main control is now a two-pole six-way switch, A once again having full control of the whole system. The switch positions should be coded thus—

- Position 1. A transmits to B.
- " 2. A receives from B.
- " 3. A transmits to C.
- " 4. A receives from C.
- " 5. A transmits to D.
- " 6. A receives from D.

A set of contacts from an old change-over relay, with a push-button turned from ebonite rod, could also be used successfully.

Double Station Control

The two circuits of Figs. 3 and 4 by no means exhaust the possibilities of the "Master-slave" arrangement, but very often something more flexible is needed. A two-way circuit with control from either station is shown in Fig. 5.

It will immediately be seen that the wiring is a good deal more complicated, and that five wires

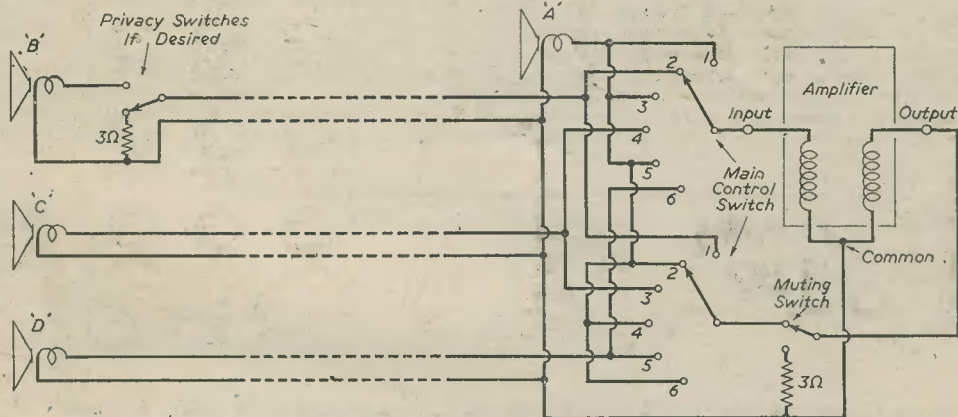

Fig. 4.—A four-station system, with Master and three slaves.

It will be seen that in addition to the main switch, there is a second single-pole two-way switch under the control of A termed a "Muting switch." If A is set to receive from B—that is, at position 2—and wishes to contact station D by switching to position 5, there will be a click at station C as he switches through position 3, and C may think he is being called. To prevent this A throws over the muting switch which temporarily connects a dummy 3 ohms load across the output line and disconnects the system from the output of the amplifier. When the main switch is at position 5 A then throws back the muting switch and proceeds with the call.

The muting switch is most easily operated if a simple push-button switch is adapted to the job. With the button in its up position the circuit is normal; depressing the button disconnects the output line until the button is released.

between the two stations are needed in place of the simple two-way cable of the first arrangement. As a result line losses increase, although the amplifier has sufficient gain to make up for quite heavy

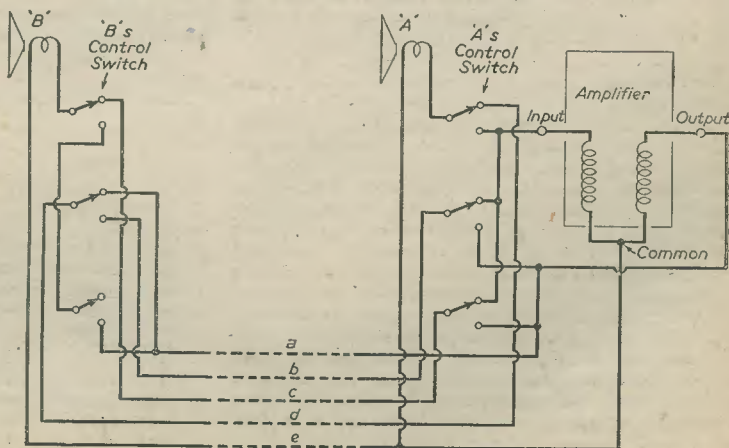

Fig. 5.—This circuit shows a double control system.

losses. Another factor enters into the consideration, however, the factor of feedback and instability.

Consider first the manner in which the circuit works.

Each station has a three-pole two-way switch and the arrangement operates as follows.

With both switches A and B up, B transmits to A. If A wishes to interrupt he has only to depress his switch, when he breaks the line to B and can talk in his turn.

Supposing, however, that A is busy—developing in the darkroom or cooking in the kitchen, for example—and cannot depress his switch, B, on finishing his conversation, has only to depress his own switch to allow A to reply.

With both switches up again, now suppose that it is B who is busy. After speaking to A he informs him of this fact, and now it is once again A's turn to take control by depressing his switch.

The chance of instability arises from the fact that both input and output currents are flowing in the five wires making up the whole cable system. Reversing the connections to either transformer to change the phase is no solution, for then the feedback is merely transferred from one switch position to another. The only way out of the diffi-

culty is to separate the cables, using two pairs and a single line, and, using the small letters in the diagram, the wires are separated so that—

b and e form one pair,

a and e form the other pair, and

d is a single wire.

It may have occurred to some readers that since in each wiring system shown one line is common to output and input and to the amplifier chassis, this wire may be omitted and the speakers earthed, instead, to some convenient earth point near each station—a hot-water system, for example. It must be remembered that the amplifier is designed to work from A.C./D.C. mains, and that therefore such an arrangement might prove very dangerous. Apart from the possibility of a direct short across the mains, should the mains plug be inserted incorrectly, there is also the chance that the mains earth is not perfect so that a potential gradient could exist between points. A common, insulated wire should be used for these connections.

Similarly, the amplifier must not be directly earthed; if an earth connection is required it must be made through a $0.1 \mu\text{F}$ 750 v.w. capacitor. The mains plus is inserted to give least hum.

Practical P.A. Working—3

This Month R. SELBY Goes Into the Question of Power Supplies and Other Problems

AS anyone who has experimented with Tetrodes and Pentodes will confirm, there are difficulties. These come under two headings, viz., voltage regulation and self-oscillation.

In order to obtain maximum output and minimum distortion, anode and screen voltages must be maintained as nearly constant as possible in spite of the fluctuations in current drawn, due to the varying signal level.

Power Supply

The first thing to do is to consult the maker's data and pick the operating conditions which will give minimum current variation. The H.T. power supply should then be designed with as good regulation as possible, i.e., by using a good mains transformer and choke, the D.C. resistances of which are low, and by using a rectifying valve or valves with low internal resistance. A choke input filter helps greatly, but has the disadvantage previously mentioned. However, assuming we have dealt with this, there remains another problem, i.e., the voltage regulation of the screen supply. In the case of the EL37, which operates with 400 volts on both anode and screen, the difficulty will not arise, but in all the other cases the screen voltage must be at least 100 volts lower than that of the anode. Moreover, the screen current fluctuates much more widely, proportionately, than the anode current. Obviously, a series

dropping resistor cannot be used. A number of methods have been devised to overcome this difficulty, amongst which are the following:

1. Separate rectifying valve and power supply for the screens.
2. Use of a heavy bleeder resistance drawing some 70 or 80 mA. permanently from the H.T.
3. Use of neon voltage stabilisers.
4. The cathode follower voltage regulator patented by Partridge.
5. The use of silicon-carbide non-ohmic dropping resistors.

The disadvantages of the first three methods are fairly obvious, but the fourth system is very effective and calls for only one extra valve. The use of silicon carbide resistors is a very recent development which has not yet been fully explored. These are not yet on the retail market, but, by the courtesy of one of the leading electrical manufacturers, the writer has been able to conduct some experiments with sample resistors. These promise well, providing that the voltage and current to be controlled fall within certain limits, and it is considered that much more will be heard of them.

Coming now to the other snag with these valves—oscillation—no hard and fast rules can be laid down. The usual parasitic stoppers in grid, screen and anode leads should, of course, be fitted, but are often ineffective in preventing supersonic oscillations brought about in the negative feedback circuits. The only thing to do is to take feedback

over the minimum number of stages and limit its amount. Judicious experiment with small condensers of the order of $.0001 \mu\text{F}$. sometimes helps. If feedback is taken from the secondary of the output transformer, the latter should be of the best design obtainable. It is necessary to check for the presence of oscillation by an oscillograph or an A.C. voltmeter connected across the loud-speaker, since it is often not apparent by any other audible or visible test. Moreover, it is necessary to test under actual working conditions and not rely on a bench test. The writer had one amplifier which operated satisfactorily on the bench, but when taken to a job where long loud-

type gramophone motor may be used. A little consideration will, however, show that it is very extravagant in battery requirements. The efficiency of the rotary converter will be about 50 per cent., and, taking the average power required by a medium-sized amplifier as 150 watts, plus 20 watts for a gramophone motor, this means that the batteries must supply 340 watts, i.e., about 14 amperes for a 24-volt battery. The minimum capacity of the battery must therefore be 140 ampere-hours at a 10 hour discharge rate. Batteries are often rated on a 20 hour discharge basis, and the above capacity corresponds to one of about 165 ampere-hours at the 20 hour rate. When

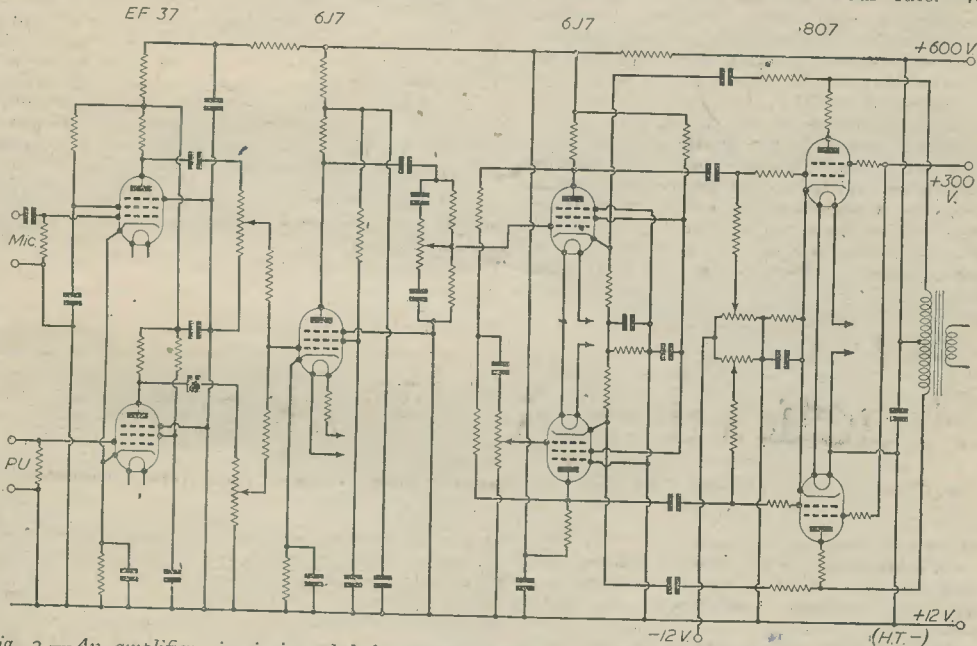

Fig. 2.—An amplifier circuit intended for operation from A.C. mains or 12-volt supply (with rotary converter).

speaker and microphone leads were in use, it went into supersonic oscillation, which could only be stopped by cutting out the negative feedback circuits as a temporary emergency measure.

Battery Operation

It may be as well now to touch upon the question of battery operation for mobile use and in situations where mains are not readily available. Even where mains are accessible, there is very often a considerable saving of labour and time in installation by using battery equipment. In fact, for a couple of years the writer used no mains driven equipment at all at sports meetings and other outdoor jobs.

In addition to the usual problems of design we now have another formidable difficulty to cope with, i.e., current consumption.

One obvious method of operation is to supply A.C. to a mains amplifier from a rotary converter, powered by accumulators. This is simple, effective, and possesses the advantage that a normal induction

purchasing batteries it is advisable to ascertain on which rate the quoted capacity is based. Reputable makers usually give both figures. Such a battery will cost to-day something in the region of £35 to £40, so more than ever is it desirable to explore other possibilities.

The most effective economy is to use a D.C. to D.C. rotary transformer for supplying H.T. and to operate the valve heaters direct from the battery, connecting them in series-parallel as necessary. In this way battery power required may be cut by nearly one half, and the amplifier much simplified, since no mains transformer, rectifier or smoothing circuits are needed. In the case of medium and low gain amplifiers up to about 15 watts output, a non-synchronous vibrator unit may be used in place of a rotary transformer with some gain in efficiency. The synchronous self-rectifying type is useless for P.A. amplifiers since it is impossible to eliminate the hum which is induced in the microphone input valve via the heater circuits.

Where possible, the writer recommends the rotary transformer in preference to the vibrator, but the supply position is, of course, difficult. Fortunately, there is a fairly wide range of Government surplus machines on the market at present, and it is often possible to find a suitable one. Judicious selection is, however, necessary, since the ratings given by some dealers can lead one astray. For example, rotaries are sometimes quoted as 6 to 12 volts or 12 to 20 volts input. A machine can only run efficiently at its designed voltage and load, and under other conditions the input/output efficiency will drop to perhaps 20 per cent., causing an unexpectedly heavy consumption. Machines with several outputs are also best avoided unless one intends to make use of all the outputs. The point is that even under optimum conditions the efficiency of these small machines averages only 45 per cent. (rarely reaching 50 per cent.), so that one cannot tolerate any further losses.

One other difficulty which arises with battery-operated equipment is the restriction of having one common source of heater supply. This rules out phase-splitting and screen voltage control circuits, where valve cathodes operate at a considerable potential above earth, as the heater-cathode insulation would soon break down.

As an example of circuit design, Fig. 2 shows an amplifier which the writer has used successfully for some time. Equipped with alternative power packs, it allows operation from A.C. mains or 12 volt battery as required, and gives an output of approximately 40 watts. It is not claimed that this represents ideal design by any means, since it was built around the only rotary transformer available, the output of which was not the optimum desirable. Space does not permit a detailed description, but most readers will be able to arrive at component values and modifications in the light of their own particular requirements. A few points may be mentioned briefly, however.

The H.T. supply is 600 volts, derived from a normal power pack for A.C. working, and from an ex-Army rotary when operating on batteries. The rating of this rotary, which is fan-cooled, is—input 11.5 volts, output 600 volts 250 mA. It actually operates at about half load, although the current varies with signal strength between 100 and 160 mA., but, being compound wound, the voltage regulation is good, better, in fact, than that of the A.C. power unit.

Much experiment showed that the easiest and most satisfactory method of obtaining a stable 300 volts screen supply was by fitting a third brush to the H.T. commutator. This was accomplished without a great deal of difficulty. It should be pointed out that this third brush must be as narrow as possible to minimise the short-circuiting of adjacent commutator segments, otherwise serious sparking will take place and the windings and commutator damaged. A small range of adjustment in a rotary direction is desirable for voltage adjustment. When operating on A.C., the Partridge control circuit is used to stabilise the screen supply.

It will be noted that bias to the output valves is partly automatic and partly fixed, 12 volts being derived from the battery or from a half-wave metal rectifier, the remainder being developed across the 200-ohm cathode resistor. Individual adjustment for balancing the output valves is provided.

The writer does not particularly care for the method of phase-splitting adopted, but there is little choice of circuits available, and it works quite well in practice.

The gain is sufficient for operating from a light-weight moving-iron pickup without transformer, and using bass compensation, giving 20 decibels loss. Microphone input is for a sound-cell crystal type, and gain is sufficient for loud speech close to the microphone, but otherwise a pre-amplifier is necessary. For a moving coil instrument the gain is far more than necessary.

The Pickup

Turning now to the accessories required in a P.A. system, it is necessary to decide what type of pickup is to be used—crystal, moving-coil, light-weight moving-iron or the older balanced-armature.

The crystal pickup has found great favour until recently owing to its high output and better response than earlier types. It is, however, a delicate article, the crystal being easily broken. Some will not hold the groove of a constant-frequency record at anything below 100 c.p.s. without extra weight being added, whilst surface scratch is unduly emphasised.

The better-class older balanced-armature pickups are robust and give reasonably good reproduction, and are probably most suitable where carelessness or ham-fisted operators will use the equipment.

The writer's preference is for the most modern developments, the moving-coil and the light-weight moving-iron types. A bass compensation circuit and at least one extra stage of amplification are necessary, but this is a small price to pay for the improved reproduction and reduced record wear gained. Some care is, of course, necessary in handling, as they are precision-made instruments. A suitable bass compensation circuit for a modern moving-iron pickup will be illustrated next month. It should be realised that this decreases the average output by about 20 DB, i.e., to one tenth of the original voltage, so extra gain will be required. These pickups use special miniature needles which are rather expensive, but fortunately one needle will play a minimum of 10 sides.

Microphones

When we come to the question of microphones, the choice is not so easy. The transverse carbon type, pre-eminent in its day, has been superseded by the ribbon, the moving-coil and the crystal, but which one of these to adopt is a problem, influenced by many conflicting factors.

The moving-coil is probably the most common, because its low impedance and fairly high output make it easy to use, and because many cheap models are available. It is robust and reliable and a good specimen in the medium-price class can give quite reasonable results. Most suffer from some resonances and from some loss of high frequencies, so that speech lacks a certain crispness. Reproduction is affected by variation in the distance and direction of the sound source to a greater extent than with some types. Of course, matters are different when we come to really first-class instruments, costing in the region of £20.

(To be Continued)

Modulation-2

This Month, Sidebands and Similar Factors are Dealt With by "DYNATRON".

IN Fig. 5 we have a fundamental and a strong second harmonic combining (i.e., adding) to give the resultant distorted waveform shown. But this "complex waveform" is nothing of the nature of a modulated wave.

The fundamental and harmonic remain entirely separated, and could be separately extracted by filters or tuned circuits, without any necessity for rectifying.

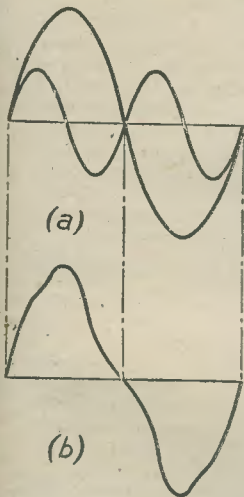

Fig. 5.—Simplest case of A.C. superposition: a fundamental and second harmonic giving rise to the resultant waveform (b). This is not modulation, in any sense, since the frequency components in the complex wave are completely separated.

Every complex waveform, the resultant of any number of harmonics, should be similarly regarded, and so should the complex waves resulting from

speech or music—always with the proviso that the circuit is linear, and that we neglect "beats" ("combination tones").

The resultant wave due to all the instruments in an orchestra is exceedingly complex, and, moreover, is changing at every instant. It is said a trained musician can hear each separate instrument—though the resultant wave is complex, each frequency remains completely distinct.

Modulation implies that a wave can interact upon another, to vary its amplitude (or frequency in F.M.), e.g., by utilising the modulating voltage to vary the resistance of a circuit, or some valve parameter.

Superposition of H.F. and A.F.

Figure 6 shows the meaning of superimposing H.F. and A.F.

There is no modulation. A tuned circuit would extract the H.F. at constant amplitude Fig. 6(b), whilst an A.F. transformer would pick out the low-frequency component, 6(c).

Compare Fig. 6(a) with Fig. 1(b), where a rectifier would have to be employed to give us the A.F. component.

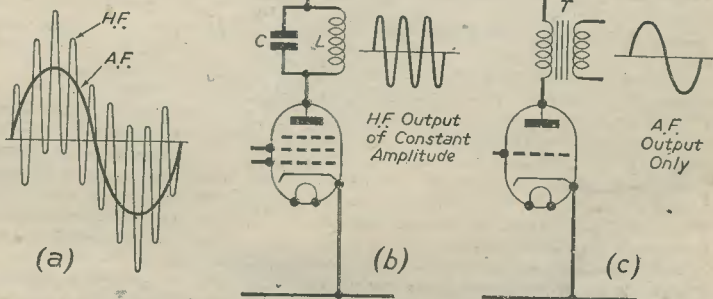

Fig. 6.—"Superimposing," without modulating: the A.F. and H.F. components exist independently, and appropriate amplifiers would respond to the separate components without any necessity for rectifying, as in (b) and (c).

We need a non-linear circuit element to cause the A.F. to amplitude-modulate the H.F. as in 1(b). That is another way of stating that the A.F. voltage must operate upon some independent "circuit parameter" as just suggested.

But we can obtain D.C./A.C. modulation, 4(b), without any non-linear element. True, speech impressed upon a carbon microphone varies the resistance, and the relation between "Current" and "Resistance" is a non-linear one ($I \propto 1/R$).

That has nothing whatever to do with the case under consideration, for we might equally cause the D.C. to vary by using a moving-coil microphone to induce alternating E.M.F.s in the secondary of a transformer—with an amplifier, if necessary.

The alternating voltages will add to and subtract from the battery voltage, so varying the line current at audio frequencies.

Similarly, no rectifier would be essential to give rise to audible sounds in a telephone receiver. The alternating component can operate the diaphragm directly. If for any reason filtering should be required, a condenser or transformer will effectively block D.C.

It seems, therefore, this is a case where modulation and superposition mean the same, which partly accounts for the fact that modulated H.F. tends to be similarly regarded.

H.F. Sidebands

From a more advanced mathematical viewpoint, A.M. is a case of superimposing three radio-frequency waves, namely, an H.F. carrier and two sidebands (a pair for each modulating frequency).

If 1,500 kc/s is modulated by one single tone at 1,000 c/s, there is radiated from the transmitter: (a) a carrier at 1,500 kc/s; (b) an upper sideband at 1,501 kc/s; and (c) a lower sideband at 1,499 kc/s.

All these are radio frequencies. They "beat" to produce the amplitude-modulated resultant of Fig. 1(b). Let us consider this point.

Suppressing the Carrier

Suppose that after generating sidebands the 1,500 kc/s carrier is removed.

This can be done in transmitting by the use of a push-pull circuit called a "Balanced Modulator." The sidebands are two H.F. currents of equal

Showing "Beats" by Vectors

It is important to understand that the effect shown in Fig. 1(a) requires no "modulating" or "non-linear" devices.

We have already said in connection with Fig. 3 that beats result merely from combining two H.F. voltages in a tuned circuit, afterwards rectifying to extract the (beat) modulation exactly as with any other modulated wave.

A beat, pure and simple, is a mechanical effect. If two vibrating systems have slightly different "periods," they will be vibrating in step, then 180 deg. out of step, at regular intervals. If mutual interference takes place, the resultant complex vibration will be of the type shown in Fig. 1(a).

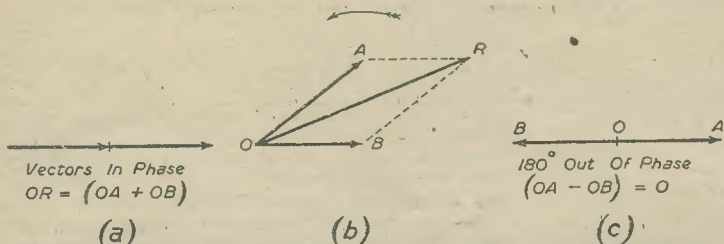

Fig. 7.—Vector representation of a simple beat between two alternating quantities of small frequency-difference. OA gains slowly (at the difference-frequency) on OB, and the resultant vector OR will be rotating, also at the difference-frequency, and varying in length between O and $2OA = 2OB$.

amplitudes, frequencies 1,501 kc/s, and 1,499 kc/s. Two "waves" will be radiated having a frequency-difference of $(1,501 - 1,499) = 2$ kc/s = twice the modulating frequency.

What will happen if we "mix," and rectify, any two alternating voltages having a small frequency-difference?

One wave—the one of higher frequency—will constantly gain in its "phase" on the other. At times, the two will be exactly in phase, adding to give a maximum resultant amplitude; at other equal intervals they will be diametrically opposite, annulling one another, and giving zero resultant.

We have briefly outlined a simple "beat" between two waves. Fig. 1(a) shows the resultant effect if the beating waves are of equal amplitudes.

It is thus seen that a simple beat is a form of amplitude modulation—a resultant "beat wave" whose amplitude varies as in 1(a). It can be shown mathematically that the resultant high frequency is the arithmetical average of the two beating frequencies; in this case, $\frac{1}{2}(1,501 + 1,499) = 1,500$ kc/s—simply the original carrier-frequency. The amplitude varies at the frequency-difference of 2 kc/s.

Clearly, after rectifying, we would not get a sine wave, but a pulsating current at 2 kc/s, at twice the original 1 kc/s used for modulating. The predominant note heard would be at 2,000 c/s, and not at 1,000 c/s.

The heterodyne principle just outlined is the same in all cases.

If in a superheterodyne we beat 1,000 kc/s with 1,465 kc/s, we shall get, after rectifying, the beat-difference at 465 kc/s. If the beating oscillations are of equal amplitudes, the resultant H.F. would also be at $\frac{1}{2}(1,000 + 1,465) = 1,232.5$ kc/s.

In rectifying, a strong second harmonic of this average frequency of 1,232.5 kc/s will be present, which explains how we would also find a "sum frequency" of 2,465 kc/s.

The principle is equally true of audible beats produced by mixing and rectifying inaudible H.F. waves. Things are somewhat complicated when the beating waves are of unequal amplitudes, though a sum frequency, as well as the difference, will always be found in the output of a detector.

Many mechanical or acoustical examples might be given. The "throb" between aero engines, or between tuning-forks or strings of slightly different periods, are familiar phenomena.

Electrically, vectors can give a useful picture.

In Fig. 7(b) the vector OA is rotating anti-clockwise at a slightly faster rate than OB. After every revolution, OA will have gained on OB by a certain angle. If they started in phase, as in 7(a), they will ultimately move 180 deg. out of phase as in (c), then again moving gradually into phase, and so forth.

Evidently, if representing two alternating voltages acting together in the same circuit, the resultant OR is a vector whose length will be changing. This length will be $(OA + OB)$ in (a), and $(OA - OB)$ in (c). Also, OR will be revolving slowly, because its position depends upon the rate at which OA is gaining upon OB.

A little consideration will show that OR revolves at the "difference-frequency," or has an angular velocity " ωt " which is the difference of the angular velocities of OA and OB.

(To be continued.)

BUILD THE SUPERSCOPE

(Continued from page 376)

The deflection amplifier should be screened from the time base and power supplies, and the input lead to the amplifier will probably also require to be screened.

From Fig. 2 it will be seen that the time base chassis consists only of a straight plate, bent at right angles to take the switch, the whole being spaced from the top deck by spacers made from brass tube. A paxolin tag board is fixed at right-angles to the plate behind the valves, and all the resistors and condensers, with the exception of grid components which are below the chassis, are mounted on it.

The amplifier was built in the same way, and is placed on the other side of the screen shown in Fig. 2. This type of construction is simple, neat and makes it easy to change components for experimental purposes.

Underneath the Dipole

Television Pick-ups and Reflections. By "THE SCANNER"

EXPANSION of accommodation at the Alexandra Palace is long overdue. It is a constant source of wonder to me how the service is maintained at such a high standard under the present cramped conditions. From time to time, additional studios are talked about but come to nought, and it is generally assumed that building licence difficulties are the principal snag—not finance. Yet many of the film studios seem to be able to obtain licences to construct extensions, and, what is more surprising in these "enlightened" days, do actually succeed in building them. Possibly this may be due to the fact that films are an exportable product and, therefore, such applications receive support from the Board of Trade, whose new minister is surprisingly businesslike. On the other hand, the B.B.C. engineers may be inexperienced or lacking in "imagination" when it comes to the filling up of the dozens of application forms (in triplicate) which seem to govern one's every little movement. A lucrative profession has arisen in connection with the horrors of income tax, and now one can visualise the evolution of similar form-filling experts for dealing with building licences and applications. Industry is meeting a slow death by strangulation with red tape!

More Television Studios?

American television leaps ahead, unfettered. British television has to carry on with practically the same accommodation and facilities it had over 10 years ago. If the B.B.C. could establish, say, three first-class television studio-stages in the West End, plus, say, a couple more stages at the Alexandra Palace, their hard-worked producers would be able to hold more rehearsals under transmission conditions, with Emitron cameras and closed-circuit viewing. As things are at present, this facility is rarely available for more than one rehearsal.

Experience at the Alexandra Palace during the last couple of years has, of course, influenced the design of new television studios, and the plans and technical layouts so optimistically worked out when television recommenced, will by now have been scrapped or considerably modified. Progress with equipment in both television and film fields has been rapid, and the growing sensitivity of super-Emitron cameras together with various developments in lighting (including the appearance of the high-pressure mercury "compact light source" lamp) must have simplified the problems of ventilation and of power for lights. Much less power is required with the newest television cameras, compared with the huge banks of light-(and heat-) producing tungstens formerly necessary.

Remote Control Lighting

In the future, lighting for television will probably be carried out with about the same number of lights as before, but with most of them of a much lower

power. The principal "key" lighting will possibly be provided with the cool-running compact light source lamp, consuming about 5 kW. Variations in the lighting during actual transmission will be carried out by remote control, a system which is just beginning to be introduced in the film studios. Two methods are used; variable series resistances for tungsten incandescent lighting, and venetian blind fittings for arc lights and mercury lights. The venetian blinds or shutters, attached in front of the lamps, are actuated by tiny Selsyn motors which are interlocked with transmitter motor control knobs situated on a desk near the camera. In film studios, especially when contemplating the shooting of film scenes of considerable length, the object is to provide the lighting cameraman with a means of silently varying the lighting intensity of individual lamps or of groups of lamps during the progress of a scene. The normal rather rough-and-ready method is for the electricians to interrupt the rays at the appropriate moments with opaque material, gauzes on frames, or filters of gelatine. With the remote control of lamps, however, the human element is confined to the lighting cameraman only, who sits at a kind of miniature Wurlitzer console near his camera. Advanced film workers feel that in the course of time, this console will be fitted with a television screen, upon which the cameraman will view an exact replica of the film scene being shot in the camera. The "television viewfinder" is not a wild dream of the future; it is a device which is now in existence and upon which preliminary tests have already been made. Remote control of lighting lends itself even more readily to television, which has no breaks between shots, and in this case the lighting expert can sit in front of a normal television receiver situated outside the studio stage, if necessary, controlling his lights on a console, provided he has a plan of the set marked with the positions of the various lamps.

Other possible refinements include provision for the back projection of moving or static backgrounds, such as the travelling view seen from a railway compartment window or a car, and for a turntable stage, upon which several small sets can be erected to take their turn before the television cameras. Already, the Alexandra Palace technicians have achieved a high standard with the handling of the cameras, panning, tilting and "tracking" them with great skill, though sometimes with an accompaniment of creaks and heavy footsteps. And that reminds me—hob-nailed boots might be banned from the studios!

Politics and Television

The Republican Convention in Philadelphia focussed the attention of Americans upon television in no uncertain manner. The 1,100 delegates who attended the convention and the many thousands of supporters and opponents who crowded into the

city were met by batteries of lights and cameras, both film and television, and speakers had to decide whether they would be made-up and "beautified" for television, at the risk of losing a little dignity in the actual auditorium. Later reports of the convention indicate that dignity was forgotten in a spate of ballyhoo, but that the forceful oratory of Mr. Dewey gained considerably when reinforced by the sight of his dramatic gestures and photogenic features. The politician who nervously fumbles with his written notes as he reads his address, may nevertheless "put it across" on the sound radio—but not so on television. I wonder just how long several of our own cabinet ministers would survive the ordeal by television, which appears to magnify every little fault of public speaking. Harold Wilson, President of the Board of Trade, appeared immaculately dressed and made an extremely good speech of a non-political character on the occasion of the presentation of the British

equivalent of the "Oscar" to Margaret Lockwood and John Mills. On the other hand, the television film of Aneurin Bevan walking around an exhibition with Royalty, gave him the appearance of a down-at-heel actor-laddie from the provinces. From the Opposition benches, Harold Macmillan is a little too forceful to be effective in a close-up interview, but Churchill's magnetic personality always holds the attention of viewers of all political shades. On the whole, I am glad that the B.B.C. keep politics off television to a greater degree than on the sound radio. The appearance of the majority of politicians in real life can scarcely be said to be inspiring; on the screen, and especially on television, they seem to take on every aspect of cinema villains or gangster spivs. Fortunately, they can spare very little time off from Parliament, where they are busy producing new acts as quickly (and as badly) as the film producers made "Quota Quickies" in the bad old days of British films!

Trade Notes

Burgoyne Soldering Gun

THIS device is intended to replace the standard soldering iron for such purposes as wiring-up components, receiver repairs, etc. A short hairpin-

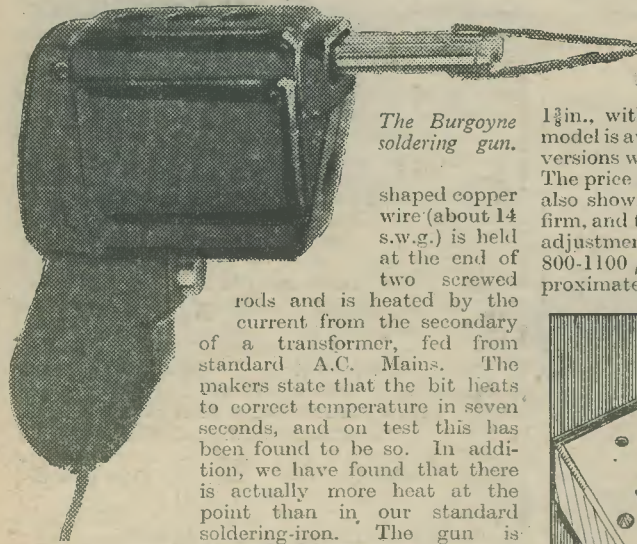

The Burgoyne soldering gun.

shaped copper wire (about 14 s.w.g.) is held at the end of two screwed

rods and is heated by the current from the secondary of a transformer, fed from standard A.C. Mains. The makers state that the bit heats to correct temperature in seven seconds, and on test this has been found to be so. In addition, we have found that there is actually more heat at the point than in our standard soldering-iron. The gun is brought into use by pressure

on a button below the main body and conveniently situated on the pistol grip. It thus may be put down without risk of damaging the bench, as it cools off almost instantly. The mains consumption is just over 100 watts, and the device will be found of great value to experimenters and servicemen. The price is £3 19s. 6d. (with three spare bits), and the makers Burgoyne Engineering Co., 1-3, Robert Street, Hampstead Road, London, N.W.1.

Weymouth Coil Pack

THE new Weymouth Coil pack is totally enclosed, with easily reached trimmer screws. The wave-band coverage is 16-50, 200-55 and 800-2000 metres, with 365 pF tuning condenser. The I.F. is 465 kc/s. Adjustable iron dust cored coils and ceramic trimmers are used and the padding condensers are of the close tolerance silver-mica type. The overall dimensions are 3½ in. by 2½ in. by 1½ in., with a switch projection of 1½ in. A similar model is available for 483 pF condenser and two other versions with slightly different wave-band coverages. The price is 35s. In the accompanying illustration are also shown two new I.F. transformers by the same firm, and these are only 2 in. by 1 in. by 1 in. The core adjustment gives an inductance change of approx. 800-1100 μH. "Q" is 110, and the band-width approximately 9 kc/s. at ±6db. The price is 7s. 6d. each.

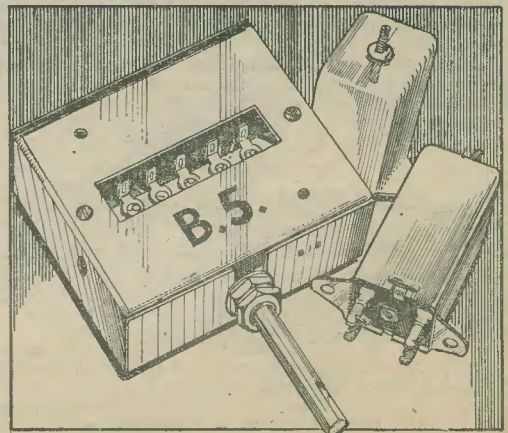

The new Weymouth Coil Pack and I.F. Transformers.

REMARKABLE OFFER!

BC-348's at £15-10-0

CARRIAGE PAID

"A Special Buy" of a quantity of BC-348's enables us to offer you this first-class communication receiver at the remarkably low price of **£15.10.0**—complete for 28-volt operation—or for **£20.10.0**—modified for A.C. mains and complete with power pack. Packing and carriage paid. **£2.0.0** case charge returnable.

This American receiver is one of the finest released to date by the Ministry. Built to stringent U.S. Army specifications, constructed of first-grade components. It is extremely sensitive and easy to operate.

Offering this receiver at this price will quickly drain the stocks available, so be sure to order **NOW**.

Vallante's purchase only surplus gear that is useful for the "Ham" and at the right price, too! Please inform us of your requirements.

VALLANCE & DAVISON LTD.

144 BRIGGATE, LEEDS, 1. Tel.: 29428/9

Staff call signs: G2HHV, G8SX, G3ABD, G3AHV.

Manufacturers
SPECIFY IT BECAUSE IT IS
THE FINEST CORED SOLDER
IN THE WORLD

MULTICORE SOLDER
CONTAINS 3 CORES OF FLUX
NO EXTRA FLUX REQUIRED

You
WILL PREFER TO USE
IT BECAUSE IT MAKES
PRECISION SOLDERING
SO SIMPLE

SPECIAL HANDY CARTON
6^D
ENOUGH FOR
100 AVERAGE
JOINTS

MULTICORE SOLDERS LTD., MELLIER HOUSE, ALBEMARLE STREET, LONDON, W.1

VALUE! MATT has it

Order with confidence.
Full satisfaction assured.

SPECIAL OFFERS

HEADPHONES.—W/lead and Jack Plug, 3/11 pair (Boxed 2 pairs), 4/- doz. pairs.
LINE CORD.—3 amp. 60 ohms, per ft. 2-way, 1/6 yd., 3-way, 2/- yd.
TUNING CONDENSERS.—0005 Polar Midget, 11/6; .0005 Standard, 5/6.
CONDENSERS.—002, 2/6 doz.; .006, 3/- doz.; .1 .01, 9/- doz.; .16 mfd./500v, canned, 3/6; 8 mfd./350v, midgets, 3/-; 8 mfd./450 v., 4/-; 4+4 block, 3/-.
SPEAKERS.—P.M. (less trans.), 5in., 12/6; 6in., 24/-; Limited quantity 8in. TRUVOX P.M. SPEAKERS, 16/6.
Trans. to match, 5/6. Multi Ratio Do. 7/6.
VOL. CONTROLS.—All values (Centralab). L/S, 3/6. W/S, 4/9.

Postage extra.
Let us have your enquiries for all Radio Components. Competitive prices.

MATT RADIO SERVICE
Kingston 8353
29, Castle Street, Kingston-on-Thames, Surrey.

M. & J. PEARSON, 373, Eglinton St. Glasgow, C.5.

Special Offers

CONDENSERS
Block type 1 plus 1 mfd., 3,000 volt, 2/6 each; 800 mfd., 12 volt, 2/- each; 8 mfd., G.E.C., 600 volt, in boxes of two, 6/6 box; 4 mfd., 1,500 volt, 4/- each; 4 mfd., 450 volt, 2/6 each.
ELECTROLYTICS
4 mfd., 450 volt, metal, 25 mfd., 25 volt, cardboard, 75 mfd., 50 volt, Bakelite, all 10/- half dozen; 24 10s. half gross, £8 per gross. These will be mixed as ordered.
TUBULAR.—1 350 volt, 5/- doz., 20/- per half gross, 35/- per gross; 1 mfd., 1,000 volt, 9/- doz.; 25 mfd., 350 volt,

5/- doz.; .1 mfd., 450 volt, 8/8 doz.

METERS

FERRANTI—0-500 micro-ammeters, grade 1, moving coil, 2 1/2 in. flush mounting, new and boxed, 16/6 each. 0-100 micro-ammeters, 2 1/2 in. flush mounting, calibrated 0-1,500 yds., new and boxed, 20/- each. 0-300 volts A.C. 2 1/2 in. flush, moving iron type, new and boxed, 8/6 each.

TERMS: We pay all Carriage (Gt. Britain only) and Cash With Order Please. No Lists issued.

H.A.C.

Short-Wave Equipment

Noted for over 15 years for Short-Wave Receivers and Kits of quality

One Valve Kit, Model "C" .. Price 20/-
Two " " " " "E" .. " 43/-

These kits are complete with all components, accessories, and full instructions. Before ordering send stamped, addressed envelope for descriptive catalogue.

Note new sole address:—

"H.A.C." SHORT-WAVE PRODUCTS
(Dept. TH) 66 New Bond Street, London, W.1

MIDCO RADIO

Shortly available 6 band super communications coil pack for 160 pf. tuning and 1.6 mcs lf. Provisional details. Coverage 21-190 m., R.F. stage, including decoupling components, etc. Price £4. The Mk 5 chassis, rust-proof steel chassis with all holes, for 5 v. 5/ht. Fitted 5 Amphenol Octal valveholders and PU/AE strip. Price 12/6.
We can supply this chassis fitted 10in. x 4 1/2 in. horizontal type dial. 1Fs and 2 gang at 5/6, or fitted 5 1/2 in. square dial, e.c., at 4/6. Both include blueprints for an economical receiver, which can be completed, less cabinet, for £10.
Components. 1Fs 465 perm tuned, 151/- pr. Coils 12-2,000 m., 2/9. Horizontal dial as above, 2/16, square dial, 7/6. Amplifiers from 10 watts at £10.

Send 3d. stamp for full lists.

MIDLAND RADIO COIL PRODUCTS
19, Newcomen Road, Wellingborough

Programme Pointers

This Month Our Music Critic, MAURICE REEVE, Discusses

Noises, and in Particular the Accordion

"NOISES off" has been a stage direction ever since language was used for the theatrical representation of human actions. It might apply to the necessity of accompanying the spoken dialogue with thunder, wind or the rolling sea, a dog's bark, shots or screams; in fact, anything from the whole gamut of human or terrestrial "noise" which it was either not seemly or practicable for the actors to make themselves, except in pantomime, farce or general clowning. Rather than see our favourite actor, when the lightning flashes outside, wave his arms about and make fantastic noises of shouting and 'oooh' etc., sheets of tin are rattled and buckets of stones tipped in and out in imitation of the thunder. Instead of letting him go "honk honk" to denote the arrival of visitors outside in a motor-car, in full view of the audience, a "supernumerary" is employed "off stage" to perform on that instrument, whose name I need not mention, out of sight.

But seldom if ever is the language itself distorted, violated, not to say prostituted, for these purposes. True, it would very seldom be a suitable medium for the purpose, even the human voice uncontrolled or undisciplined and just allowed to yell or bawl at will.

Music is Different

With the language of music, however, all is different. Although even more susceptible to impurities in execution and coarseness in the instrument itself than the spoken word (after all, "we was two quid aht" means exactly the same as "our total losses amounted to exactly two pounds," though it may not sound so nice; whereas Schubert's songs played on an accordion or a cinema organ neither mean the same nor sound so well), no compunction is any longer felt as to the how, when or where of its presentation or performance. A Schubert song, for instance, is deemed to be a melody which people want to hear through any medium that any given lady or gentleman may find it most convenient to use. If his, or her, "instrument," q.v., happens to be the accordion being played at a troops' concert, then the Serenade is a "good thing to give them" ("they like that sort of thing"). If, on the other hand, it should be a cinema organ, on which a virtuoso usually flourishes for a quarter of an hour or so between programmes, "they" are still "given" it. "They still like to hear it"! Whilst gentlemen who supplement their incomes outside pubs of an evening "give" it even there; even they like it!

"Noises On" ?

As to the "noises off" of the theatre, these, augmented, implemented and elaborated, have become, or are made "noises on," "performed" by highly paid "artists" who, together with their "instruments" (of torture), are in full view of the I deeply regret to say, admiring and excited

audience. If it is desired to imitate the noises of a dog being run over by a taxicab, the cab's hooter, brakes, etc., together with the dog's moans, they are all there; stops to the right of him, stops to the left of him, a hundred and fifty or so different stops for a hundred and fifty or so different effects. If the baby finds his bath water, too hot or the old boy falls asleep after dinner and snores, something is stuffed in the bassoon or the saxophone, or the stops are only half or a quarter depressed or the key holes or vents a half or a quarter, as the case may be, covered, and the baby screams or the old man snores and the house roars.

All this is very well and not to be deprecated as "effects." My point is that, in taking them out of their proper sphere, whether Schubert's songs or the baby being bathed in too hot water, and giving them for performance before a vast public, music is committing slow but sure hari-kari.

A correspondent recently asked of me whether I thought (a) the accordion was an instrument suitable for the playing of good music, and (b) whether it was one that repaid intensive study. As the brevity of my answer was governed by the exigencies of a short letter, I can enlarge on it here.

To (a), most emphatically "no." I cannot conceive three more hideous, crude or blatantly vulgar rows than those produced by the aforesaid instrument, a cinema organ and a jazz band in full cry (there are many others nearly as bad, especially crooning, but space forbids their analysis. In any case, the crooner has his own specialist's repertoire). As with all forms of musical reproduction, the skill of the executant can make all the difference between sheer "nudity" and the best of a bad job. But when the fundamental principles and origin of a thing are bad, little can be done except, as I said, ameliorate its worst effects.

Its Origin

Like much of the world's worst music, the prototype concertina came from Germany. There seems to be some doubt as to whether the begetter of this pest was one Damian of Vienna, 1829, or one Buschmann, of Berlin, 1822. It was made tolerable to sensitive ears, though barely so, by Bourton's (Paris, 1852) introduction of the keyboard in lieu of stops. Hence the modern nomenclature "piano accordion." The modern "Steinway grand" used by our piano accordion. Paderewskis has a keyboard of three and a half octaves, whilst the left hand operates the bellows and buttons that produce an accompaniment of major and minor common chords, with which every note of the diatonic scale may be harmonised, as well as the chords of the dominant and diminished seventh! Truly a hell's kitchen or Babel's tower of misproduced and distorted sound. No wonder William Told the

Poet and Peasant that Tosca was, the Last Rose of Summer!

In spite of all these gadgets, enabling the performer to produce a considerable portion of the harmonic world from an instrument capable of being for long periods hung round the back of the neck, nothing can compensate for the dreary monotony of the reed tone, coming out at you in rushes and receding with equal abruptness when played by the average player. Nor can the eternal scale and chord or arpeggio padding, everlastingly and unavoidably used to cover up what would otherwise be the appalling thinness of the musical texture, be anything but a curse and a bane to anyone in the least bit used to the never-ending changes of tone colour and timbre constantly welling from a symphony orchestra or even a well-played piano.

One-track Mind

Tone, or lack of ability to produce any variety or make any deviation from its own native qualities, coupled with the fact that it is far too overpowering and "self-assertive" to work in successful co-operation with any other solo instrument or body of instruments, is the reason why, in my opinion, it is not a suitable medium for a musician's serious consideration. As we have seen, it can make a considerable harmonic display and can play harmony up to a high degree of involvement: the essential quality for a first class composition as we saw in a recent article. But its utter one-track mind in performance, as with all the family of freak instruments, precludes it from ever entering the musical hierarchy of the classic instruments as employed by the masters in the symphony orchestra.

News from the Clubs

NOTTINGHAM SHORT WAVE CLUB

Hon. Sec.: J. Rowbottom, 9, Mansfield St., Sherwood, Nottingham.

THE annual field-day was held recently by the above club. The winning team was Messrs. D. C. Johnson (leader), R. Peatman and R. Woodward, 1,316½ points; 2nd team, led by A. Johnson, 609½ points; and the 3rd team, led by A. Sissons (G3CKV) with 516½ points. The two latter teams each had four members. The points are awarded on the stations' DX value and the band in use, the L.F. bands receive points in proportion. The winning team received 713 different amateur stations in 80 countries in the 24 hours. All teams used the same type of receiver, namely, a two-valve set using a six-volt car battery, which also supplied the night lighting, and a standard H.T. battery. The winners owe their success to the fact that although they only had three members to the other teams' four, two were proficient Morse readers. It is expected that the club's Morse class will be receiving more attention in the future. An anonymous friend of the club has donated a trophy to be used with the field-day event. A talk was given recently by Mr. D. C. Johnson on "Variable Frequency Oscillators" and proved very useful.

STOKE-ON-TRENT AMATEUR RADIO SOCIETY

Hon. Sec.: D. Poole (G3AQW), 13, Oldfield Avenue, Norton-le-Moors, Stoke-on-Trent, Staffs.

THE first field-day of the club was held recently, and although the weather wasn't too good, the members attended in fine style. Quite a number of contacts were made even though the power was only five watts and from batteries. Beginners took advantage of this day and plenty of home-constructed equipment was in evidence. Five-metre signals were heard from Stoke by 2FXK and SSE, but no incoming signals could be heard.

The following lectures took place at the town lecture room: "Power Packs," by Ken Parkes; "Doubler Units," by 3ALP; and Jim Roberts well explained VHF receivers and converters. The last week of the month was taken up with a "Junk Sale" ably assisted by "Col. Bandsread," who nearly sold his "Beer detector."

Arrangements are on the way for a field-day in conjunction with Leek and District Radio Society.

WIRRAL AMATEUR RADIO SOCIETY

Hon. Sec.: J. O'Brien (G2AMY), 26, Coombe Road, Irby, Heswall, Cheshire.

THIS society continues activity with 72 (actual paid up) members. Meetings are held twice a month at the Y.M.C.A., Whetstone Lane, Birkenhead.

Many of our members participated in N.E.D. recently and had a good time in spite of the weather.

Prospective members will be welcomed at meetings or may obtain full particulars from our Hon. Sec., address above.

THE WEST MIDDLESEX AMATEUR RADIO CLUB

Hon. Sec.: C. Alabaster, 34, Lothian Avenue, Hayes, Middlesex.

RECENT meetings were devoted to lectures given by Mr. R. H. C. Bostock (G3BWC) on "Portable Operation" and Mr. H. D. Branwell (G2RF), who described an interesting H.F. Generator and Grid Dip Meter he had designed and constructed. The last meeting was devoted to the club group leaders leading a discussion on the future practical work of the club.

Meetings continue to be held at the Labour Hall, Uxbridge

Road, Southall, on the second and fourth Wednesdays of every month, at 7.30 p.m. New faces are always welcome.

BURTON AND DISTRICT RADIO SOCIETY

Hon. Sec.: E. B. Hardy (G8L), Hill Cottage, Dunstall, nr. Burton-on-Trent.

THE society was re-formed just after the war to cater for all interested in the science of radio and all forms of electronic activity.

The number of members is between 50 and 60, and good attendances are the rule at meetings. The membership includes about 25 licensed hams, but the society definitely tries to present a balanced programme to cover all interests in radio.

Meetings are held monthly, usually in the evening on the third Wednesday in the month, at the local Education Buildings, Guild Street, Burton. These meetings are advertised in the local press.

New members are always welcome, and further details can be obtained from the secretary. The subscription is 5s. a year; 2s. 6d. for junior members.

STOURBRIDGE AND DISTRICT AMATEUR RADIO SOCIETY.

Hon. Sec.: W. A. Higgins, 35, John Street, Brierley Hill, Staffs.

A MEETING of the above society was held in the Science Block of King Edward's School, Stourbridge recently. The secretary, Mr. W. A. Higgins, gave a resume of the society's activities during June: these included a National Field Day Contest, a visit to Droitwich B.B.C. Station and a Joint Committee Meeting of all the West Midland societies; and indicated that there was much more of interest to members for the ensuing year.

The main event of the evening was a talk on "The Design and Use of Cathode Ray Oscilloscopes," by W. H. Rigg, Esq., A.M.I.Mech.E., A.M.Inst. Fuel, of Lydiate Ash Laboratories, Bromsgrove. Mr. Rigg described some very interesting circuits of amplifiers, time bases and multi-vibrators. Owing to lack of time the talk was not concluded and Mr. Rigg will continue at the next meeting, on Tuesday, August 10th, at 7.45 p.m.

Anyone wishing to join the society should contact the secretary at the above address.

BRENTFORD EVENING INSTITUTE RADIO AMATEURS' EXAMINATION

A COURSE covering the syllabus of the Radio Amateurs' Examination of the City and Guilds of London Institute will be held during the 1948-49 session at the Brentford Evening Institute. The institute is situated in Boston Manor Road at the rear of Brentford Library and is on the 97 bus and 653 trolleybus routes.

Classes commence in the week beginning September 20th, but the enrolment week begins on September 13th when, from Monday to Friday, 7 to 8.30, the head of the institute and his staff will be present to advise and enrol intending students.

The course will continue up to the date of the examination (which is probably in May, 1949) and the fees are, students under 16 years of age, 2s. 6d.; students over 16 years of age, 5s. Full details of this and other technical courses may be obtained from the prospectus which is available on application to the Principal, Chiswick Polytechnic, Bath Road, Bedford Park, London, W.4.

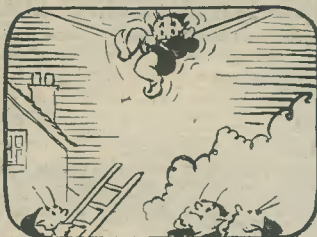

The "Fluxite Quins" at Work
Cried Ol, "Cut the cackles, you three, it's rescue I need. Can't you see!
I'll crash down in two shakes
If this aerial breaks."
"It won't. It's FLUXITED," grinned EE.

See that FLUXITE is always by you—in the house—garage—workshop—wherever speedy soldering is needed. Used for over 40 years in government works and by the leading engineers and manufacturers. Of all ironmongers—in tins, 10d., 1/6 and 3/-.

To CYCLISTS: For stronger wheels that will remain round and true, there's a time tested tip. Tie the spokes where the cross with fine wire and SOLDER. It's simple—with FLUXITE—but IMPORTANT.

The FLUXITE GUN puts FLUXITE where you want it by a simple pressure. Price 1/6, or filled, 2/6.



ALL MECHANICS WILL HAVE

FLUXITE

IT SIMPLIFIES ALL SOLDERING

Write for Book on the ART OF "SOFT" SOLDERING and for leaflets on CASE-HARDENING STEEL and TEMPERING TOOLS with FLUXITE, also on "WIPED JOINTS." Price 1d. EACH.

FLUXITE LTD. (DEPT. W.P.),
BERMONDSEY ST., S.E.1.

COULPHONE RADIO

"THE RETURN OF POST MAIL ORDER SERVICE"

58, Derby Street, Ormskirck, Lancs.

New Goods Only—C.O.D. or cash with order. All orders over 5/- post free. A few of our lines are listed below. Send 2d. stamp for entirely new 32 page catalogue and valve list.

Valves.—All B.V.A. and Tunstam, including American. Reduced Prices. Eddystone short wave gear. S.W. Manual, 2/6. Bernards Radio Books. Mains Transformers.—Interleaved and Impregnated. For 200/250 v. mains, with 4 v. or 6.3 v. and 5 v. L.T.s. 250 v. 100 mA., 25/-; 300 v. 100 mA., 27/6; 350 v. 100 mA., 28/6; 450 v. 200 mA., 45/-.

Smoothering Chokes.—40 mA., 5/-; 60 mA., 6/6; 90 mA., 7/-; 100 mA., 13/6; 200 mA., 22/6.

Speaker Transformers.—Midget Power/Pen. 40 mA., 5/6. Std. size Push-Pull Universal, 60 mA., 7/6; Heavy Duty P.-P., 22/6. Extra H.D. 100 mA., 37/6.

Mains Dropper Resistors, with feet and two sliders, .2 amp., 4/6; .3 amp., 5/-; Resistors 1w., 6d.; 1w., 9d.

Loud Speakers P.M., 21/2; 31in., 29/6; 5in., 20/6; 8in., 23/6; 10in., 35/-; With Trans., 8in., 29/6; 10in., 42/6.

Weymouth Tuning Coil Pack.—Completely wired. Short, Medium and Long Wave Superhet type for 465 kc/s. L.F., 38/6. Midget L.T.3, 18/9.

Line Cord, 60/70 ohms per foot. 3 amp. 2-way, 1/6; 3-way, 1/9. 14/36 flex. 6d.; 23/36, 9d.; Slewing, 3d. yd.

Tuning Condensers.—Small 2-gang .005 with 2-speed drive, 16/6. L.D.R., 10/6.

Undrilled Polished Aluminium Chassis, 3in. deep, 10in. x 6in., 10in. x 8in., 8/6; 12in. x 9in., 10/6; 14in. x 9in. and 16in. x 8in., 11/6; 20in. x 8in., 12/6.

EXCLUSIVELY MAIL ORDER

THIS MONTH'S SPECIALS

AMERICAN RADIO RECEIVER, TYPE C/543 AAY (ABKL).—This receiver is built in two units of the double plug type, which are connected together by a 7-way plug and socket. RECEIVER UNIT. Built on chassis size 12in. x 7in. x 2in. Containing 10 valves: 6 6SH7, 2 6H6, 2 7193, 2 relays, dozens of other components.

POWER UNIT. Chassis size 12in. x 7in. x 2in. Containing dynamotor, input 18 volts at 3 amps., output 450 volts at 60 m/a. Carbon pile regulator and numerous other components. The generator in this unit can easily be converted into a handy motor suitable for running a small drill unit, in metal case, black crackle finished. Overall dimensions: 12in. high, 12in. wide, 8in. long. Weight 25 lbs.

LASKY'S PRICE 22/6d. (carriage 2/6d. ex.)

EX-R.A.F. RADAR RECEIVER, TYPE R3095. Containing 23 valves: 15 EF50, 1 high voltage rectifier type HVR2, 1 rectifier type R3, 2 EA50, 2 CV66, 1 RL37, 1 VR53. Hundreds of resistances, condensers, coils and other components. Also transformer, 2 metal rectifiers, etc. Built on strong metal chassis size 20in. long, 12in. wide, 7in. deep. Weight 40 lbs. Grey finish with black control panel.

THIS RECEIVER IS UNUSED AND A GREAT BARGAIN IDEAL FOR THE TELEVISION CONSTRUCTOR.

LASKY'S PRICE 95/- (Carriage 5/- extra)

EX-A.M. ROTARY CONVERTERS. BRAND NEW AND UNUSED. POWER UNIT TYPE 105. Input 24 volts D.C. Output 230 volts 50 c.p.s. In smart grey enamelled metal box with hinged lid, leather carrying handle. Complete with all cables and plugs. Size: 12in. x 12in. x 8in. Weight 35 lbs. A bargain not to be missed.

LASKY'S PRICE 59/6d. (Carriage 5/- ex.)

Why not get your name on our mailing list and have advance information regarding our ex-Government bargains? Send 1d. stamp with your name and address in block letters please.

LASKY'S RADIO,
370, Harrow Road, Paddington, London, W.9. (opposite Paddington Hospital).
Telephone: CUNningham 1979.
We are open all day Saturday.



New
1948

CATALOGUE

now available

Contains a wealth of information on both complete apparatus and components for home construction.

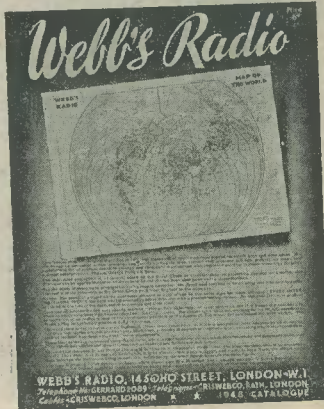

Price 6d. to callers
or 7½d. post free.

Webb's Radio

14, SOHO ST., OXFORD ST., LONDON, W.1.

Note our SHOP HOURS: 9 a.m. to 5.30 p.m.
Sats. 9 a.m. to 1 p.m.
Telephone: GERard 2089

SPARKS' DATA SHEETS

Provide detailed Instructions with Easy-to-follow Full-size Constructional Prints of Tested and Guaranteed Designs.

THE "CRUISER"

An All-dry High Efficiency 3-valve T.R.F. Circuit.
Three Pentodes. Fine range, power and quality. Low cost. Wide selection of stations on M/L waves with short aerial. Specially designed for those wanting a compact, all-dry, trouble free design for the home, caravan, camping, yachting, etc.
Data Sheet 2/6

THE "OLD FOLK'S TWO"

An A.C./D.C. 2-Valve plus Rect. for those who cannot be bothered with tuning. 3 Station Selection by Switch. L/M Waves. 2/9

THE "CUB." A Fine little A.C./D.C. 2-Valve, plus Rect. M/L Wave receiver. Powerful, Inexpensive and Simple to Build 2/6

THE "CADET" A.C./D.C. AMPLIFIER. A full 3 $\frac{1}{2}$ Watts Output. Vol. and Tone Controls. Good Quality. Ideal for P.U. 2/6

THE "CHALLENGER" PORTABLE. An amazing A.C./D.C. Portable. 3-Valve plus Rect. M/L Waves. Power and Quality 2/9

MANY OTHER DESIGNS for Sets and Amplifiers available. Send S.A.E. for latest List and please include stamp with order. Prompt Service. Components supplied.

L. ORMOND SPARKS (P),
9, PHOEBETH ROAD,
BROCKLEY, S.E.4.
(Nearest Station: Ladywell, S.R.)
Telephone: Lee Green 0220

DUNK & HEALEY

EF50.—Brand new in original manufacturer's cartons, 7/6.
S. G. Brown.—5,000 ohm Head-phones, 12/6.
6V6G.—Brand new, guaranteed, 7/6.
40v.2a.—Transformer, 230v. 50 cys. primary. Fully shrouded. Fitted Terminal Block. Ideal for charging room, on bobbin; enables any secondary winding up to 100 watts to be added easily, 16/-.
SMOOTHING CHOKES.—10H 80m/a., 5/6; 10H 120m/a., 6/9; 10H 300m/a., 12/6 (as previously advertised). Add 8d. for postage.
67, OSNABURGH STREET,
LONDON, N.W.1

VALVES

British and U.S.A. types
C.W.O. or C.O.D.

J. RYDING

41, Green Lane, Horwich, Lancs.

METAL RECTIFIERS

12 volts 1 amp., 6/6 each.
12 volts 1 $\frac{1}{2}$ amps., 8/5 each.
24 volts 1 $\frac{1}{2}$ amps., 8/5 each.
All continuous rating D.C. output. New lists with hundreds of interesting electrical bargains ready. Send 2d. stamp NOW.

A. McMILLAN
5, Oakfield Road, Bristol, 8.

Most People Stop

at PALACE GATE!

Most people, on buying an Amplifier make a tour from manufacturer to manufacturer. But most people stop at Palace Gate where the Concerto and the Kl are demonstrated. There must be a reason! Write today for illustrated leaflet and interesting information on Amplifiers and Tuning Units, in kits or complete.

Charles
AMPLIFIERS
LTD
1e PALACE GATE,
KENSINGTON, W. 8

YOU can become a first-class RADIO ENGINEER

We are specialists in Home-Study Tuition in Radio, Television and Mathematics. Post coupon now for free booklet and learn how you can qualify for well-paid employment or profitable spare-time work.

T. & C. RADIO COLLEGE
KING EDWARD AVE., AYLESBURY.

Post in unsealed envelope 1d. postage.
Please send me free details of your Home-Study Mathematics and Radio Courses.
NAME
ADDRESS.....
P. 92

ALEC DAVIS Supplies LTD.

18, Tottenham Court Road, London, W.1.
Tel.: MUSEum 4539. Tel.: MUSEum 2453

Our new range of high Q Permeability Tuned Coils is now available from stock for Long, Medium or Short Wave operation. Each range available in three types, Aerial, I.F. or Oscillator (465 Kcs.). Every coil is boxed with circuit enclosed. Price, all at 2/6 each, plus 3d. carriage.

Iron-cored I.F. Transformers, with high quality ceramic tuning condensers available for 465 Kcs., 1.6 or 10.6 Mc/s. operation. Size 1 $\frac{1}{2}$ in. square x 3 $\frac{1}{2}$ in. high. Price per pair 15/-, plus carriage 6d.

Centre-tapped 465 Kcs. I.F. Transformers, otherwise as above. Price 8/- each, plus carriage 4d.

Variable selectivity 465 Kcs. I.F. Transformers, with two additional windings for use with a two-pole multi-way switch. Circuit included. Otherwise as above: Price per pair 18/6, plus carriage 6d.

ENQUIRIES ARE ALSO INVITED FOR 90 Mc/s. F.M. COILS now being developed. **SPECIAL SURPLUS LINES (Limited Stock only).**

The well known Ex-11 A.F. Heavy Brass Key, Type D, complete with moulded cover. Size of base 7in. x 4in., only 3/6 each, plus carriage 9d.

New and unused 1 mfd. 2 per cent. 350 v.d.c. wkg. Paper condenser. Light grey finish. Ideal for bridge construction, price 3/6 each, plus carriage 3d.

Celestion 2 $\frac{1}{2}$ in. Speaker, new and boxed, price 17/6, plus 9d. carriage. Standard single circuit closed jack-midset type, price 1/8, plus 3d. carriage.

OUR LATEST TELEVISOR LIST IS NOW AVAILABLE
Send stamped and addressed envelope for copy.

STOCKISTS OF VALVES, BATTERIES, TEST EQUIPMENT (Hire purchase facilities available) and RADIO COMPONENTS OF ALL TYPES.

ATTENTION, PLEASE!

A really SOUND Amplifier Case

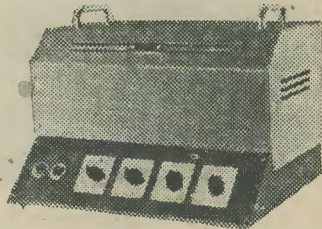

Two Colour Crackle finish. 15" x 10" x 9"
£3-15-0. Trade enquiries invited. Detailed leaflet from

BUCLEUTH RADIO Manufacturers,
Melville Terrace, Edinburgh, 9

HIGH "Q" IRON CORED COILS

of Unsurpassed Quality for Discerning Amateurs

AERIAL, I.F. OR OSCILLATOR, short, medium or long wave, size of former 1 $\frac{1}{2}$ in. x 4in., 3/9 each.
INPUT FILTER, 465 Kcs., parallel or series tuned, 3/9 each.

I.F. TRANSFORMERS, 465 Kcs./midset, permeability tuned, size 1 $\frac{1}{2}$ in. diam. x 1 $\frac{1}{2}$ in. high, 2/6 each.

I.F. TRANSFORMERS, standard, 465 Kcs., permeability tuned, size 1 $\frac{1}{2}$ in. square x 3 $\frac{1}{2}$ in. high, 8/6 each.

All coils fitted with adjustable iron cores, and supplied with circuit diagrams.

TERMS: Cash with order or C.O.D. on orders over £1.

TRADE INQUIRIES INVITED
MONOCHORD RADIO
(Established 1929)

17, Streatham Hill, London, S.W.2
Phone: Tulse Hill 1051.

Impressions on the Wax

Review of the Latest Gramophone Records

AMONG the artists to appear at the London Musical Festival at Harringay was Lily Pons, one of the most talented operatic and lyric sopranos active to-day.

This month, partnered by her husband, Andre Kostelanetz, a conductor, whose services are in constant demand all over the United States, she gives a vocal version of Johann Strauss' famous waltz, "Voices of Spring" on *Columbia LX 1087*. This double-sided record is sung in French and the flute obbligato is by Julius Baker.

George Weldon is one of the most versatile of our conductors and conducting the City of Birmingham Orchestra he has recorded the "Raymond Overture" on *Columbia DX1493*. Ambroise Thomas' overture to his opera "Raymond" is quite as fine a piece of workmanship as the more famous "Mignon," and Weldon presents it with great spirit.

For lovers of the pianoforte there is a recording by Malczuzynski of Chopin's "Scherzo No. 2 in B Flat Minor," on both sides of *Columbia LX1086*. This is the second of the four famous independent scherzi that Chopin wrote at fairly regular intervals in his life; independent because they stand in their own right and are not contained in sonatas. Chopin was not greatly interested in form for its own sake and for these works he is content to use the classical scherzo-trio-scherzo as his ground plan.

Another superb performance of a first rate symphony has been made available in the H.M.V. plum label category. It is a recording of Mendelssohn's Italian Symphony by the Hallé Orchestra, conducted by John Barbirolli on *H.M.V. C3758-60*. In these three records John Barbirolli shows the measure of his power as a conductor. In a score as nicely adjusted as this, great attention to detail is needed, and where that is the case he is one of the best men to turn to.

One of the highlights of the recent releases is the recording by Gabriella Gatti (Soprano) and Nancy Evans (contralto) of "Othello, Act 4, Scene 2," on *H.M.V. DB6712-3*. They are accompanied by the London Symphony Orchestra, conducted by Vincenzo Bellezza. These two records are important operatic issues. They give a large slice of the fourth act of "Othello," the episode in Desdemona's bedroom, prior to the entry of Othello, and the strangling scene.

Light Music

George Melachrino has distinguished himself in the varied spheres of classical, light and dance music and as a composer and arranger has few equals. "Kiss me Again" and "By the Sleepy Lagoon" are beautifully scored and played on *H.M.V. B9658*, and both need no recommendation to those who are already familiar with the performances given by the Melachrino Strings. "Kiss me Again" is one of the most popular ballad waltzes, by Victor Herbert, while "By the Sleepy Lagoon" is numbered among the most popular works to come from the prolific pen of Eric Coates.

Sidney Torch with his Concert Orchestra has

recorded another of his compositions, an intriguing waltz melody, coupled with a Torch arrangement of Jacob Gade's "Jealousy," on *Parlophone R3114*. "My Waltz for You" is a lovely tune, lavishly scored and executed. "Jealousy," which was written in 1926, and re-released five years ago, is here given brilliant concert treatment which enhances the dramatic quality of the tango.

Variety

Popular star of C. B. Cochran's "Bless the Bride," Georges Guetary, has left the cast of this musical show in order to fulfil film commitments signed up last year. For his latest recording on *Columbia DB2427* he sings "She's Got that Look in her Eyes" and "To-night."

Steve Conway adds two more representative titles to the many recordings he has made during the past year with Billy Reid's "After All," which is sung in fine style to Peter Yorke's Orchestra, and "Would you Believe Me," which conjures up welcome memories of the entertaining Hollywood musical "Love and Learn." The number of this record is *Columbia FB3405*.

The Queen's Hall Light Orchestra, conducted by Sidney Torch, have now made a re-recording of "The Boulevardier," coupled with "Jamaican Rumba," on *Columbia DB2421*. "The Boulevardier," written by Curson in 1941, captures the carefree atmosphere of the Paris of the gay 'nineties, and the orchestra, under Torch's able direction, carries out the composer's intentions admirably.

All the latest dance tune hits have been recorded including "Laroo Laroo Lilli Bolero" and "After All," by Geraldo and his Orchestra on *Parlophone F2301*, "My Girl's an Irish Girl" and "Down by the Old Mill Stream," by Oscar Rabin and his Band on *Parlophone F2302*, "Galway Bay" and "Only Passing Clouds," by Jack Simpson and his Sextet on *Parlophone F2299*, and "Don't Call it Love" and "After All," by Lou Preager and his Orchestra on *Columbia FB3408*. For jazz fans there is "At the Jazz Band Ball" and "Clarinet Blues," by Harry Parry and his Radio Sextet on *Parlophone 3119*.

A NEW VEST POCKET BOOK

JUST PUBLISHED

NEWNES METRIC &
DECIMAL TABLES

By F. J. CAMM

3/6 or 3/9 by post from

Geo. Newnes, Ltd., Tower House,
Southampton St., Strand, W.C.2.

O. GREENLICK, LTD.

TELEVISION COMPONENTS.—For E.E. circuits, Scanning coil units, 30/-; Line transformers, 30/-; Vision chassis, assembled with coil formers, valveholders, 22/6. Sound chassis, ditto, 18/6. Focus coil, 35/-. Rubber mask for 8in. tube, 15/-; E.E. Manual, "The Home Television," 2/6. **TEST PRODS.**—Polished ebonite prods, metal tipped, 5ins. long on flexible leads, with plugs, 4s.

CONDENSERS.—Ultra midget 2-gang condenser, as used for Personal portables, 10/-; standard ditto, 0.0005 mfd., 8/6; with trimmers, 10/-; Electrolytics, 8 mfd., 450 v., 2/6; 8 plus 16, 450 v., 5/6. Paper, 0.01 and 0.5 mfd., 6/- dozen; 4 mfd., 100 v., 9d. each.

DIALS/DRIVES.—Glass S.M.L. dial, 6in. by 8in., 4/6. Pan, 4/6. Escutcheon, 5/6. Full Vision Drive assembly, with glass escutcheon, etc., 7in. by 4in., 12/6; ditto, Square Plane, M.L.4 by 3in., 11/6. Dials, S.M.L.4 by 3in., 1/-; ditto, 5in. by 5in., 1/8. Drum drive (drum, pulley, springs), 3/-; epicycloid drive, 2/-.

RESISTANCES.—Mains droppers, 500 ohms, 0.3 and 1.00 ohms, 2, 4/- each. Heavy duty variable resistance, 300 ohms 1 amp., 15/-.

CABINETS.—Table Model, walnut veneered, 21in. by 10in. by 7in., 40/-.

TRIMMER KITS.—In smart metal case, comprising 17 tools, for the service engineer, "Quadrad" product, 45/-.

SPEAKERS.—P.M., less trans., 8in., 17/6. 6in. P.M. with trans., 22/6. 5in. less trans., 15/-.

ROTARY TRANSFORMERS. In 612 v., out 200/220 v., 50 m.a., or as small motors, D.C. Mains, 15/-.

VIBRATORS.—Non Synchronous, 6 volt, 4-pin, 8/-.

SWITCHES.—Yaxley type, 3-pole, 2-way, 2/-; 4-pole, 3-way, 3/-; 4-pole, 4-way, 3/6; midget ditto, 2-pole, 2-way, 3/-; 4-pole, 3-way, 3/-; 14-pole, 3-way, 7 banks, 7/6.

Our list at 21d. gives full details of all stocks.

17, Whitechapel Met. Station, 255, Whitechapel Rd., London, E.1.

Phone: B15 5079.

BULGIN

A Name
famous
in Radio

★

A. F. BULGIN & CO., LTD.

Bye Pass Road, Barking, Essex

Tel: Rippleway 3474 (5 lines).

RADIOLETRON

22, Frances St., Scunthorpe, Lincs.
New Goods Only.

SUPERHET TUNING HEARTS. S. M. and L. Waves, with 2-gang tuning condenser and drive, tuning coils, 1.5 coils, 465 kc/s, wave-change sw., dial, two valve-holders for 6K8 and 6K7, all mounted on chassis completely wired and aligned, complete with cir. diagram, 109/-.

S.H.E.T RADIO ASSEMBLYS. 2 S. M. and L. waves, with 2-gang tuning condenser, drive, tuning coils, wave-change sw., dial, 5 valve-holders for 6K8, 6K7, 6Q7, 6V6, 5Z4, all mounted on chassis, 10in. by 7in. by 2 1/2in., complete with cir. diagram, 95/-.

SUPERHET COIL PACKS. S. M. and L. waves, completely wired on sub-chassis, with trimmers, padders, wave-change sw., complete with cir. diagram, 34/-.

P.M. LOUDSPEAKERS. 5in. 18/-; 8in. 20/-; 10in. 27/-; **VOLUME CONTROLS.** 3/6; with sw. 5/3.

PICO ALL-IN-ONE RADIOMETERS. 25/-; **WESTINGHOUSE** 1 m.a. Bridge Meter Rectifiers, 10/6.

Terms: Cash with order, post free over 10/-, and add 4d. C.O.D. extra. A 21d. stamp will bring you a copy of our latest list.

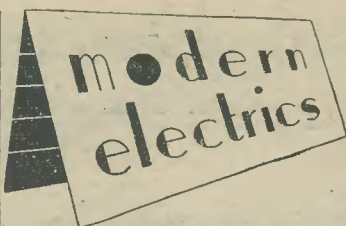

WE GUARANTEE IMMEDIATE DELIVERY. Collaro Gram-unit chassis, with magnetic pick-up and auto-stop, 49/12/6. Synchronous motor and turntable without pick-up, 44/12/6. C.W.O. please.

TEST INSTRUMENTS. The entire range of Taylor Instruments now available on Hire Purchase. S.A.E. for Catalogue and Terms.

AVO. Entire Avo range of test equipment can now be delivered from stock. Write for catalogue.

VALVES. Huge stocks of English and American valves, including U403, PX4, KT33C, PenB4, FC4, CL4, CL33, 75, 35Z4GT, 25A8, 18, 6A7, 6B9, 3Q5, 1A7GT, 1N5GT, 1N5GT, Miniatures: 1T4, 1R5, 1S4, 1S5, 354, and many others.

STROBOSCOPES. Single speed, 78 r.p.m., 50 cycles, 6d. each; 81d. post free.

SPECIAL OFFER OF ELECTROLYTICS, not Ex-Government, TMC 32 mfd., 5.9, 16 & 8 mfd., 6/6, 16 mfd., 4/-, 8 mfd., 4/-.

SPEAKERS. Unrepeatable offer, 6in. Celestion P.M., less-transformer. New, boxed, guaranteed, 12/6.

CONDENSERS. 2-gang, suitable for miniature sets, 350 pf. Size 1 1/2 x 1 1/2, 9/- each. Under 20/- C.W.O. only; C.O.D. or C.W.O. over 20/-. When ordering C.W.O. please allow sufficient for packing and postage.

MODERN ELECTRICS LTD.

164 Charing Cross Road, London, W.C.2

Tel: TEMple Bar 7587.

L-R'S IN STOCK**CASH or EASY TERMS**

Goodmans "Axiom Twelve" Speaker Unit. One of the finest quality speakers available to-day. Cash price £8 8 0

Avo Model 7 Cash price £19 10 0

Valve Tester, complete £16 10 0

And practically the whole AVO range.

Avo Wide Range Signal Generator

An R.F. Generator of remarkably wide range and accuracy of performance. Cash price £18

Specifications of the above on request.

We can supply on convenient terms much of the Radio and Electrical Equipment at present available, all transactions being strictly between customers and ourselves. Please let us know your requirements.

THE LONDON RADIO SUPPLY CO.

(Est. 1925)

BALCOMBE, SUSSEX

HIGHSTONE UTILITIES

Crystal Sets.—Our latest Model is a real radio receiver, which is fitted with a permanent crystal detector. Why not have a set in your own room 9/6, post 6d. De Luxe Receiver in polished oak cabinet, 18/6, post 1/-.

Spare Permanent Detectors. 2/- each. When ordered separately, 2/6, post 3d. **Headphones,** reconditioned and in good order, 5/6, post 6d. (better quality, 7/6).

New Headphones. 10/- a pair, post 6d. Balanced armature type (very sensitive, and very suitable for use with crystal sets), 12/6 a pair, post 6d. **New Single Earpieces,** 3/6. Bal. armature type, 4/6; ex-P.A.F. earpiece, 2/-, post 4d. **Headphones** with moving coil mike, 15/-.

Similar phones with throat mikes, 12/6, post 8d. **Headphone Cords,** 1/3 a pair, post 3d. **Replacement Bands,** 1/3, post 4d. **Wire Bands,** 6d.

Hand Microphones, with switch in handle and lead, 4/-; similar instrument moving coil, 7/6, post 6d.

Spark Plug Neon Testers with vest pocket clip, 3/3, and with gauge, 3/6, post 3d. **Telephone Sets,** with ringing hand generator, twin bells and C.P.O. type handcom, 30/- each, carr. 2/6. 5/7/6 pair, carr. 3/6.

New handcom sets, 7/6, post 6d. **Telephone hand generator** with handle, 9/6, post 1/6. Bell, 4/6, post 6d.

Ex-R.A.F. 2-Valve (2-volt) Amplifiers, can be used to make up a deaf-aid outfit, intercommunication system, or with crystal set, complete with valves, 20/-, post 1/6. Ditto, less valves, 10/-.

Meters. All brand new, 0-1 m.a. 2in. m/c, 10/-; 3.5 amp. 2in. T.C., 7/-; 4 amp. 2in. thermo coupled in case with switch, 7/6. 600 m.a., 3in. m/c, 15/-; Double reading 40/120 m.a. 2in. m/c, 8/-; 20 amp. 2in. m/c, 9/6; 15 volt 2in. m/c, 9/6; 50 amp., 6in. m.a. Switchboard mounting, 35/-; 6,000 v., 3in. m/c, 5/7/6. Post Extra. Money refunded if not completely satisfied.

HIGHSTONE UTILITIES, 58, New Wansted, London, E.11.

Letters only. New Illustrated List of above and other Lines enclosed with all orders on request, with 1d. stamp.

MORTONS

1948 CATALOGUE of 50 modern Radio

Books, Manuals and Circuits, now ready.

Send 21d. stamp for your copy.

RADIO CABINETS. Moulded bakelite.

Size: 11in. x 6in. x 5in. Supplied with

ready drilled Chassis, 5in. Loudspeaker,

Dial and Drive, £3 complete.

MOVING COIL MICROPHONES, in

bakelite case with built-in switch. For

serious work or home entertainment.

Splendid value, 6/-.

WIRE-WOUND RESISTORS. 5 watt,

50Ω to 2,500Ω, 1/16 each; 3,000Ω to

50,000Ω, 2/-; 10 watt type, 50Ω to 2,500Ω,

2/- each; 3,000Ω to 50,000Ω, 2/6.

MAINS DROPPERS. Type A, 1,000Ω,

.2a., 600Ω .3a., 4/9; 1,500Ω 1.5a, 5/-; Type B,

2 adjustable clips, 1,000Ω .2a., 600Ω .3a.,

750Ω .3a., 5/-; 1,500Ω 1.5a., 5/6 each.

Trade supplied.

13, CAMDEN ROAD, WALTHAMSTOW, LONDON, E.17.

WE OFFER

A large range of used and new Test Equipment, Converters, Recorders, Amplifiers, Motors, Transformers, etc.

All guaranteed and at very attractive prices.

We buy good modern used equipment of all types for spot cash.

UNIVERSITY RADIO LTD.

22 LISLE STREET, LONDON, W.C.2

Tel.: GER 4447 and GER 8582

Open to Discussion

The Editor does not necessarily agree with the opinions expressed by his correspondents. All letters must be accompanied by the name and address of the sender (not necessarily for publication).

Car Radio Problem

SIR,—With reference to the letter (p. 366, July, 1948, issue) from J. Perry, Woking, it is often unsatisfactory to operate vibrators, made for a particular voltage, with series resistance and a higher voltage. Since the vibrator is, basically, only an automatic change-over switch, the voltage across its contact-pairs will rise to that of the supply upon breaking circuit (a series resistor will only drop voltage when current flows). Hence it is to be expected that sparking will increase and—consequently—contacts will wear. In absence of direct viewing of this (often not desirable, since the cover-plus-damping affects the operating frequency), the depth of the interference represents a measure of the magnitude of the sparking. It is also likely that the operating frequency is changed because of the different supply voltage which the vibrator receives at parts of its cycle-of-operation, and hence—any tuned spark-suppressor circuit may now be wrong.

This all adds up to an expectation of shorter life for Mr. Perry's vibrator.

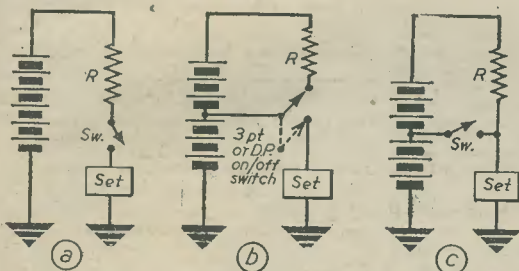

On the left at (a) is Mr. Perry's arrangement. A preferable scheme is shown at (b), and (c) should not be used as an alternative.

As he is now dropping 6 volts in a series resistor, so dissipating, therein, watts equal to those taken by the vibrator and valves of the set, he might just as well tap the battery at 6 volts up from chassis with a switched lead to set, and use the resistor as a load from set (6 volts above chassis) to the 12 volt terminals. This discharges the battery fairly evenly, as an ammeter will show, and dissipates no extra energy than at present, and preserves both vibrator and low-level interference.

—H. T. STOTT (Chadwell Heath).

[Several other correspondents have written on similar lines to the above, pointing out the danger of damaging the vibrator—Ed.]

Television Interference

SIR,—I can sympathise with your correspondent, Mr. W. J. Cox, of Colindale, who, in your July issue, complains of interference with television caused by aircraft.

It would be interesting to know what type of aerial he uses, its position relative to the local

aerodrome and Alexandra Palace respectively, and its height.

My home is situated near an aerodrome. Northolt is about a mile due south in the front of my house, whilst Alexandra Palace is about twelve miles in a north-easterly direction at the back.

I have a simple dipole aerial without reflector, situated at the back of the house. The centre of this is at eaves level, with the result that the top is well below the apex of the roof.

Now when a plane makes a wide circuit of the aerodrome, either in landing or taking off, and it flies round the back of the house, then the picture "fluctuates." As the plane approaches the effect is rapid, like flickering, but it slows down and becomes more pronounced when the plane is directly between the aerial and Alexandra Palace. (At its worst the picture varies between total blackness and over-brilliance, the variations being of about one second duration. Sound waves seem to be also affected as there is a corresponding fluctuation in background noise.) As the plane proceeds on its circuit the effect again speeds up and disappears.

When the plane is again in the front of the house, as it were, there is no bad effect unless it is at a great height.

Of course, as your correspondent says, it is very difficult to observe the airplane and picture at the same time, but the above is my general impression and the conclusion would appear to be that a house can screen an aerial from reflections of the signal from an airplane.

Therefore, I suggest that your correspondent considers very carefully whether he can improve the position of his aerial. He is quite near Alexandra Palace, and height, therefore, is not essential.

If he can place his aerial below the height of the roof so that it is on the Alexandra Palace side of his house and the aerodrome is on the opposite side, he would probably be relieved of as much as 75 per cent. of the interference.

Finally, there is one very interesting point. So far as I have been able to observe, a jet plane making the circuit, as above, does not appear to cause any fading at all. Presumably this is due to its greater speed in relation to the frequency of the synchronising pulses and/or the carrier frequency.—A. MELVILL ELLIOTT (Harrow).

Experimenter's Results

SIR,—Being a student for electro-technical engineer at the University of Ghent, I am very interested in experimental radio. I am, since our liberation, a regular reader of your magazine. Well, it's really grand! You give in it all those little hints and experiments you can find nowhere else, but which have such a great value for the practice of engineering.

So I have built, for example, your VHF adapter, as described in your July, 1948, issue for the 5 m. band. Reception is splendid. Local stations are.

of course, R9, ++ but I have also logged some real 5 m. DXs: G6DH (or BH), PAΦAD (100 miles), PAΦJW. Last, but not least, I am receiving here regularly the sound of Philips' experimental television, broadcast from the Dutch works at Eindhoven (50 miles), at a frequency of 67.75 Mc/s in FM. Reception is R9 on only a Hertz indoor aerial without any reflector!

I am now building a real FM receiver—also for the reception of the FM transmitter at Brussels (100.1 Mc/s). Plans are prepared for the building of a picture receiver. I have again a real help by the "Analysis of a Television Receiver" you published a year or so ago.

I hope your magazine will keep on publishing regularly such interesting articles. KAREL Z. KIESEL (Antwerp).

Radio-controlled Models

SIR,—I would like to correspond with readers on radio control of models, with a view to exchanging notes and ideas to our mutual benefit.

The frequency I am particularly interested in for this work is 450 Mc/s.—LESLIE HARRIS, 93, Long Lane, Hillingdon, Middlesex.

Home-made Television Receiver

SIR,—With reference to the article "Home-made Television Receiver," published in your June issue, I would like to make the following comments.

I bought a 6A vision unit with a V.C.R. 97 tube and connected it to my 1,000 volt power supply, recommended by Mr. Etherden. (By the way, 1,000 volts can be obtained from most commercial mains transformers by utilising the 700 volts A.C. which appears across the secondary winding. As it is known from the theory of rectification the D.C. produced = 1.41 × the available A.C.; therefore, the 700 volts A.C. will yield 987 D.C., which is near enough to 1,000.) I found, however, that with a single time base working I could only obtain a faint line though the brightness control was turned to the maximum, while with both time bases on I got no visible results at all. This, of course, is due to the fact that the energy which was hardly sufficient to produce a single line was now asked to produce 405 lines.

I got into touch with Mullards and was told that 2,000 volts are needed with this tube to produce a raster of sufficient brilliance.

I think this information may be useful to any disheartened owner of a V.C.R. 97.—PAUL TELCO (Jnr.) (N.W.3).

Correspondents Wanted

SIR,—I am anxious to correspond with a boy of my own age (16 to 17 years) who lives near a Government radio surplus sale, and who is interested in the building of radio sets and amplifiers.—C. A. ROND (4, Rickhayes, Wincanton, Somerset).

SIR,—I only recently (about six months ago) became interested in amateur radio, but now, seeing its endless possibilities and interests, I am extremely keen.

My knowledge of radio is not very great; I know enough to get my transmitting licence. I would, therefore, like to correspond with others

of my own age (16 years), preferably in the Southampton area or abroad, but anybody would be welcome.

I would be very grateful if somebody could send me any data or circuits on the following sets: Tx and Rx Type 18, R107, Tx and Rx Type 38. Any printed matter and books I will take great care of and return at the earliest possible moment, if desired.

May I take this opportunity of thanking you for a very fine magazine and an invaluable aid to the amateur like myself.—G. GAUGHAN (11, Cliffe Avenue, Hamble, Hants.).

A Reader's Thanks

SIR,—Please allow me to tender my very sincere thanks to all your readers who so readily responded to my letter in the July, 1948, PRACTICAL WIRELESS and came to my assistance.

It makes me very happy to see such a widespread friendship between all true radio constructors; I would like to reply to all the readers who sent me their letters and back numbers containing the wartime midget A.C./D.C. receiver, but I am sure this letter will be read by all those concerned.—D. M. SMITH (Cheltenham).

Another Problem

SIR,—A rather peculiar problem has come my way during the last few days, and I would be obliged if a solution could be found through the medium of your excellent paper. Perhaps some of your readers may be able to help.

An all-mains set works perfectly normally on all wavebands except that the Light Programme on the medium band is very low in volume. The only way to bring up this station in strength is to switch on an immersion heater in the next room when the station is received perfectly.

A local "ham" has suggested using a pair of such heaters in push-pull as a power amplifier, and is considering experimenting on these lines!—P. LUMB (Knaresborough).

Set No. 18 (Mk. III)

SIR,—The following information regarding the No. 18 Mk. III "Walkie Talkie" might be of use to some readers:

The set is a four-valve short-wave superhet consisting of an R.F. amplifier, frequency-changer, one-stage of I.F. amplification, and a combined signal detector, A.V.C. and A.F. stage.

The A.F. stage acts as a B.F.O. for C.W.

The power plug, which comes out at the front, is coded as follows:

Red H.T. + * White H.T. — L.T. — G.B. +
Green L.T. + Yellow G.B. — 1½

Blue Aerial Input.

* White is, in some cases, not earthed to the chassis but goes to the top cap of the first valve via a condenser, and Blue is earthed to the chassis; you then reverse the leads.

The receiver was originally designed as a "Walkie Talkie" with separate sender and receiver. The range covered is approximately 30-54 metres.—L. G. MOORE (S.E.11).

CLASSIFIED ADVERTISEMENTS

RATES: 3/- per line or part thereof, average five words to line, minimum 2 lines. Box No. 6d. extra. Advertisements must be prepaid and addressed to Advertisement Manager, "Practical Wireless," Tower House, Southampton St., Strand, London, W.C.2.

R.S.G.B. TECHNICAL PUBLICATIONS. The following are of special interest to transmitting amateurs and short-wave enthusiasts.

VALVE TECHNIQUE. Presents the calculations associated with the application of thermionic valves. 104 pages. Fully illustrated, 3/9 post free.

V.I.F. TECHNIQUE. Comprehensive account of techniques employed for generation, propagation and reception of frequency between 30 and 300 Mc/s. 93 pages. Fully illustrated, 3/9 post free.

MICROWAVE TECHNIQUE. Describes theory and practice of microwave technique. 68 pages. Fully illustrated, 2/3 post free.

SEVICE VALVE EQUIVALENTS. Third edition. Lists commercial equivalents of Service and CV valves, also Cathode Ray Tubes. 36 pages, 1/- post free.

THE TRANSMITTING LICENCE. Second edition. How to obtain an amateur licence. 32 pages, 1/- post free.

R.S.G.B. BULLETIN. Monthly publication of R.S.G.B. 1/6 post free. (Free to Members.)

THE RADIO SOCIETY OF GREAT BRITAIN.

28, Little Russell Street, London, W.C.1.

EDDYSTONE Short Wave Radio. Stratton and Co., Ltd., are now in a position to register applications for a limited number of registered dealerships in areas not already covered. Applications are invited from expert and enthusiastic Shortwave specialists at home and abroad. Write Stratton and Co., Ltd., Eddystone Works, Alvechurch Road, West Heath, Birmingham, 31.

RADIO Constructor's Catalogue. 20-page Catalogue, packed with hundreds of items of interest to the constructor, service engineer and experimenter, plus details of our Technical Query Service. Price 4d., post free.—Cussins and Light, Ltd., The North's Leading Radio Engineers, King's Square, York.

RECEIVERS & COMPONENTS

HUGE PURCHASE enables us to offer: New condensers, best make, 4 m.f.d., 2,000 v.w. Price 12/6 each. Post and packing 1/6. Ex-Radar receivers in metal cases. Sold for components. Contain approx. six 7-pin valve holders; 3 coils; 2 transformers; 2 Westectors; 25 condensers; 25 resistors, all useful sizes; sockets, etc. Price 12/6. Post and Packing 1/6.—30, St. Matthew's Street, Ipswich.

KITS of Radio Receivers. Electric and Battery. New materials. Table and Mains-midget models. Cabinets. Latest kit, Wylwyn Star, 3 wave, connections for gram, pick-up; ext. speaker. A.V.C. All kits have illustrated descriptive constructional details. Lists Radio components, gram, turntables, motors, pickups, C.W.O. or C.O.D. Amateurs' queries welcomed. Good stocks Valves, Cathode ray equipment.—Isherwoods, Reme House, 81, Fulington Road, Preston, Lancs. Tel. 3598. Est. 1936.

TESTED COMPONENTS.—8 mF., 425 v., 2.5, 36 mF., 500 v., 4.3, 2 mF., 2 v., 1.8, 10 mF., 500 v. papers; 2.6 Silver mica; 2.5 paper tubular up to 1 mF., 6d. 5 mF., 1. Volume controls, 1/6. Complete range of goods at right prices. List, 21d. Carter's, 67, Bell Lane, Marston Green, Birmingham.

RADIO CONSTRUCTORS. Special Clearance Bargains of Mail Order Lines. Must have room for New Stock. 30 Brand New 1155 Receivers, £11/10/-; 46 good condition used 1155 Receivers, £7/10/-; 17 B.C. 243 Receivers, new or as new, £16/0/-; 29 1224 A Receivers, £4/10/-; 38 Beam Approach 5-valve Receivers, 35/-; 24 A.B.K. Receivers, 35/-; 39 1/5 H.P. A.C. Single-phase Motors, £12/6; 1,250 pairs brand new 120 ohms Headphones, 3/9 p. (37.6 doz. each); 170 T.U.5B Units (super FVO), 17/6. No Lists. First Come, First Served.—Radio Constructors, 23, Spital Hill, Sheffield, 4.

CLEARANCE SALE. Smashing reductions. BC 455 6 Valve Superhets. Short Wave, 45/-, BC357 2 Valve "Marker Beacon" receivers with relay. Circuit diagram included. 15/-, Motors, 230 Volt A.C., approx. 1 h.p., with fan on shaft end (3000 r.p.m. 4000 r.p.m.). Will drive small drill or grinder, 20 lbs. wt. 30/-. All Carr. Paid.—Surplus Store, 63, Liverpool Road, St. Helens.

ALUMINIUM CHASSIS and panels from stock or quickly made to your special size. Holes punched. Also tuning units and many other components. Estimates and lists free. READ, 13 Bence Lane, Darton, Barnsley.

STEEL CHASSIS. 1 1/2 in. x 1 1/2 in. x 2 in., 4 sided. Almost undrilled, 3/6 ea., post free.—W. Cooper, 71, Forest Rd., Quinton, Birmingham, 32.

MAINS TRANS., 16/6. Coil Packs LMS, S.H. 465 k/c., 17/6. L.F. Trans., 465 k/c., 10/- pair, 36 Condensers, each, 10/6; 48 Resistances, 12/-. Voltage Droppers, 2/9. Send for cheapest list in England.—Sussex Electronics, Ltd., 4 Upper Bevendean Ave., Brighton. Tel. 4446.

LEFT-RIGHT D.F. Indicators, as used for High Impedance Radios, tuning indicator, new, 6/-, post 9d.—Surpluses, 8, Shanklin Drive, Filton, Bristol.

WANTED.—Heaverber W.31 Transformer, Eddystone Coil Unit 960 or 961, two Hivac ACHL (4v.). State price.—254, Princes Avenue, Kingsbury, N.W.5.

UNWANTED GIFT. De Luxe trimmer kit cost 45/- will accept 25/-.—E. Vernon, 444, 7th Ave., Dagenham, Essex.

SALE. "P.W." 1939 onwards. Two volumes bound.—Elworthy, 2, Review Rd., Dagenham, Essex.

SALE. Newnes "Complete Electrical Engineering," 48 parts (unsold). W.B. Midget Loudspeaker. Ditto Extension Loudspeaker. Valves: 210HL; AS412; 10A. Price Box No. 161.

97.6 CHARGING SWITCHBOARDS. 12v./32v., 500 and 1,200 watts, volts, amps, cut-outs, fuses, resistances, etc., 4 take-offs, superb unit, in case; or send £5 carriage paid.

75/- DYNAMOS. 24 volts, 1,000 watts, 9in. by 7in., 4in. spindle, or send 80/- carriage paid.

75/- 230v. 11v. 1/5 h.p. ELECTRIC MOTORS, incorporating 1,260 cycle converter, or send 80/- carriage paid.

58/- MAINS TRANSFORMER SWITCH-BOARD. 230v. A.C. to 12v. 5 separate take-offs, complete distribution panel, all switches, fuses, amps., etc., brand new, or send 60/- carriage paid.

55/- ELECTRIC MOTORS, 12v. and 24v., 1 1/4 p., 4in. by 4in., with 1in. spindle for drive, beautiful job, or send 60/- carriage paid.

45/- DYNAMOTOR UNITS, containing 12v., 24v., 130v. and 300v. D.C. dynamo, or suitable as 6v., 12v., or 24v. motor, approx. 1 1/2 in. by 5in., with spindle to take small grindstone, mop, etc., also contain adjustable 24v. cut-out, 12v. automatic voltage control, smoothing condenser, resistances, and many other extremely useful fittings, beautifully made, or send 50/- carriage paid.

38/- RADIO WAVEMETERS, adjustment dial, 350-370 Mc/s., beautiful instrument in case, or send 40/- carriage paid.

Host other valuable equipment. Lists free. 14, St. James's Sumner Street, Earlsfield, S.W.18. WIM 3833. (100 yds. S. Ry. Electric Line: 10 minutes Waterloo.)

FRITH RADIOCRAFT, LTD., LEICESTER.—Our new lists give details of over 100 items of ex-Govt components and assemblies, offered at only 1/- each, or any 3/- items for 42/-, including: 300 W. Rotary converters, 24v. D.C. to 200v. 50 mA. D.C., 5/- plus 1/6 post; Slewing, 72yds. asstd., 5/-; 50 asstd. new condensers and resistors, 10/-; 200: 1 Slow-motion dials with logging device reading to 3 decimal places, 5/- plus 9d. post; Meters 0-2A, D.C., 0-5, 0-3, 0-6 amps. R.F., all at 5/- plus 9d. post; 0-300, 0-500 mA. D.C. at 7/6 plus 9d. post; 0-3,500 volt D.C./mcoil, 31in., 21/- each.

D.C./A.C. Rotary converters, input 24v. 9 a., output 230v. 50 cycles, 100 watts, brand new in carrying case, present cost over £90, or price, £3/15/-, carriage paid. C.R. indicator units, type 182A, complete with 6in. C.R. tube, 4 SP613, 3 EF508, etc., condition sealed but otherwise as new, 35/- plus 4/6 carriage. Latest lists free. Trade supplied. Satisfaction guaranteed or money refunded without question.—Frith Radiocraft, Ltd., Leicester. (Phone 58927).

"SPECIAL THIS MONTH!" N.R.S. "Fidelity" 5v., Med. and Shortwave A.C./D.C. Superhet receiver, wonderful tone and range, attractive plastic two-colour cabinet; complete 91 tubes, incl. tax and carriage. Postage for illustrated leaflets and bargain list, EXHAUSTIVE CONSTRUCTIONAL MANUAL, enabling even beginners to build a powerful professional standard 5-valve all-wave A.C. Superhet of exceptional range; price 5/-, parts available incl. figured walnut cabinets. COMPONENTS: 2A3A2; Metal rectifiers 250v., 45mA, 5/- (4/-), 350v., 70 mA, 8/6 (7/-). Heater Transformers 6.3 v., 1.5 a., 12/6 (11/-). Universal type, tapped at 4v., 5v. and 6.3 v. at 3 amps each, 16/6. Autotransformer 115-230v., 65 watt, 19/6; 100 watt, 32/6. Iron-cored I.P.C.'s 465 kc/s standard or midget, 18/6 pair (12/6). OSMOR Coil Pack, iron-cored, L.M. and S-wave with full circuit, 33/-. WEARITE (ditto, L.M. and S. or Med. and 2 short, 40/6). 4000 r.p.m. 4000 r.p.m. 4000 r.p.m. VALVES guaranteed: 6AT2, 6J5, 6L6, 6BC33, 5/6 (5/-). BRAND NEW VALVES: best makes only: guaranteed: EF39, EF36, EL32, ECH35, EF50, 6J7, 8/- (7/-); 6G6, 6K7G, 6Y7G, 6V6G, 6F6G, 6Z4C, 6N7, ECC83, 6SN7GT, K12, K13C, 15D2, 15D4, 5X4, U2, MUI4, FW4/500, 51AU, U18/20, 10/- (9/-); 6L6G, 11/6, 23/- matched pair, PX25, 16/-, 30/- matched pair. GRAMOPHONE EQUIPMENT: A.C. 200-250v. gram. motors, fixed 78 r.p.m., 9in. turntable 99/6; COLLARO ditto, 230 v., 12in. table 118/4; COLLARO Combined Unit—Motor Pick-up/Autostop, latest de luxe model £9, carr. 5/-. We specialise in INSTRUMENTS by Mail Order—Immediate, safe delivery, all A.V.C. and BULLIN models, literature available 2/-, TERMS: any order c.o.d. or c.w.o. (above bracketed prices for lots of three). Postage extra under £5. Northern Radio Services, 102, Barkhill Road, London, N.W.2. Tele. 6 GUYVER 1453.

HALLICRAFT RECEIVER, 27-145 mc/s., 14 valve, built-in S. Meter, A.M., F.M., B.F.O., etc., less power supply, £30. Valves, 6SN7, 6AC7, VR150/30, 7/6 each.—Box No. 162.

U.H.F. & S.W. COMPONENTS.—Split-stator condensers, silver-plated coils, stand-off inductors, ceramic flexible couplers, low-loss valveholders, special U.H.F. and S.W. valves, slow motion dials and drives, co-axial connectors, circuits, manuals. Every-thing for the Enthusiast. Valves, most types in stock, 6A7, 6AG8, 6AG6, 6BT, 6C8, 6C9G, 6F7, 6G6, 6G7, 6G8, 6SA7, 6SJ7, 6T7G, 6U7G, 12K6GT, 12K6GT, 12Q7GT, 12SA7, 12SR7, 25A6G, 35L6GT, etc. Send 21d. stamp for Components and Valves lists. Inquire for whatever you want. Something new in the U.H.F. and S.W. each our lists, for further announcements.—Eddy Stone Stockists.—City & Rural Radio, 101, High Street, Swansea, Glam. (Phone: 4677).

R.A.E. SURPLUS RADIO. 18 valve receivers with valves, for salvage, guaranteed 75 per cent. sound, 39/6 C.P. Ferranti N.C. Transformer, 11-13 Brand New, 7/6 ea. Set of 3 S.W. dust tuned coils, 7/6 tuning condensers 2g., 0003, 3/9. 3g., 00015, 4/6. B.F.O. Units, 465, 3/- ea. Rotors 12v. D.C., 27v., 110 and 500v., 50 ma., 15/-, C.P. Vibrator Packs, 12v., 150v., 100 ma., 15/-, complete. 6v., 200v., 60 ma., A.C. output, 27/6. Fuse holders, 5 way in, 2/6 8c. fuses to fit 5 amp., 2/- doz. Coloured knobs 1in. shaft. Brand new, 2/- doz. 5 amp., 230v. Mains A.C. meters, 12/6 ea. Self energised magnetic mikes, 2/6 ea. Phones L.R., 4/6 ea. Bell Arm, 3 set, M.C. with 120, 12/6. 0-20 and 0-40 volt meters, 5/- ea. 0-100 ma., 12/6. 60 ma., 230v. Metal recs., 3/9 ea. Phone adaptors, High to low res., 3/6 ea. VCR37 tubes, 55/- ea., guaranteed. TFF transceivers 10 valves, 25/-; 12 valves, 30/-; American type 35/- Transformers and Rectifiers to charge at 12v. 1 amp. from 230v. A.C., £1. Midget W.M. coils. D. Tuned, 1/3 ea., 12/- doz. Assorted condensers 36 for 10/-, Assorted resistors 100 for 8/6. Coax cable 30ft. with connector, 6/6 ea. Telescopic masts, 33ft., 50/-, 22ft., 30/-, 9ft., 10/-, Most types ex-govern, valves available at lowest current prices, also Lens, Prisms, H.V. and H.C. condensers, electrolyzers, magnicons, Hicid Radio Receivers, 30ft. with connector, gyroscopes, computers, auto-pilots, H.F. dynamos, signal gennys and wave-meters, amplifiers, small motors and blowers, A.C. motors, D.C. motors petrol generating sets, and Radio Receivers of all types, including H.R.O. Hallicraft, R.C.A. Eddystone, A.S.A.E. for our lists will save you pounds, H. English, The Maitings, Rayleigh Rd., Hutton, Brentwood, Essex.

CHARLES BRITAIN (RADIO), LTD.
AMPLIFIER TYPE 1134 (Inter Com.)
for battery operation, complete with 2 valves, QF21, 210L, packed in wooden transit case. Price 12/6, post free.
1124 RECEIVER, range 30 to 40 mc/s. contains six new valves, 3. 9D2, 1. 8D2, 1. 15D2 (Frequency Changer), 1. 4D1, 24 Ceramic trimmers, 6. Ceramic valveholders, 6 valve screening cans, 30 resistors, 3 pot meters, mica and tubular condensers, ceramic coil formers, 5-way 4-bank switch with long spindle, and IF transformers, etc., a real buy at only 19/6, plus 2/6 carriage.

BARGAIN OFFER BC454 Western Electric Radio Receiver, frequency coverage 3 to 6 mc/s. Contains 3. 12SK7, 1. 12K6, 1. 12SR7, 1. 12A6, plug in I.F.s 21 volt dynamotor. Used, but in good condition, complete in metal case. Price 37/6 each, 2/6 carriage and packing.

TEST SET 74. The ideal unit for a scope. It works straight off the mains and we can supply detailed instructions for making a good 'scope. Details as follows. Size of case, 18in. x 12in. x 9in. Contains 3in. tube VC139A; 2 VC139A; 5. SP611; 1. CW6; 1. 607; 1. 635; 1. EAC3; 1. 5Z4. Complete with the necessary mains supply and smoothing, etc. All instruments tested before despatch. Price, with full instructions, 15/6 10s., or less instructions, 15/6 10s., plus 15s. carriage.
INDICATOR UNIT TYPE 182A.—Contains 6in. CRT VC8517 which has the same beam connections as the VC897. Also 8 valves, 3. EF50, 1. 5U4G, 4. SP61, 13 volume controls, etc., etc. The tube, although slightly persistent, is O.K. for Television or scope. Amazing bargain at 39/6 plus 15s. carriage. All CRTs will be demonstrated to callers.

R1155—Tested and complete with all valves in good condition, price 18/8s., plus 10s. carriage and packing.

SPECIAL ANNOUNCEMENT.—We are shortly moving to more conveniently situated premises. Full details will be given in the next issue.

CHARLES BRITAIN (RADIO), LTD.
Radio House, 2, Wilson St., London, E.C.2. Tel. B15, 2966.

MAINS TRANSFORMERS. super quality 350-0-350v. 80 m.a., 6.3 v. 3 amp. 5/2 amp. Semi shrouded, 22/6 each. Output Transformers, multi ratio, 5 w. Class B. Push-Pull, 5/6 each. Midget Pentode, 35 m.a., primary current, 40 : 1, 3/3 each, 30/- doz. Selenium Rectifiers, 250 v. 60 ma. half wave or voltage doubler, 3/- 1/2 in. 4/- each, 36/- doz. 250 v. 80 m.a. 4-1/2 in. 4/6 each, 48/- doz. 250 v. 100 m.a., 5/6 each, 60/- doz. Malloy Vibrators, 12 v., 4 pin. 3/6 each, 36/- doz. Vibrator Transformers, 12 v. input, 240 v. output, 6/6 each. Bias Electrolytics, Micro pack 12 mfd. 50 v., 11/8 doz., 1/- each. Chassis, 16 gauge aluminium, 10-1/2 in., 3/6 each; 11-6 2 1/2 in., 3/11; 13-8 2 1/2 in., 4/6; 16-3 2 1/2 in., 6/3; 20-8 2 1/2 in., 7/6. Dial and Drives, Full vision type, complete with attractive dial, 10/- each. Station named ivorine dial (3 waveband), handsome bronze escutcheon, 8-5 1/2 in., slow motion drive, pointer, and glass, 10/6 each. Electrolytics, unused Gov. surplus, 8-8-8 mfd. 500 v. blocks, 3/6 each, 36/- doz. Tuning condensers, 0.005 mfd. 2-gang midget with feet, 8/6 each. Satisfaction Guaranteed or money refunded, C.W.O. or C.O.D. over 1/1. Lists 2nd. Trade supplied.

E. POWELL, 19, Lidcot Hill, Pudsey, Leeds.

SPECIAL OFFER.—New RCA valves, 25L6 GT limited quantity, 1/9, post 3d. RF Unit 28 w/2 RL7 (EF54) and RL6 (E652), vari. SM tuning (3 gang) 50-80 mc. 19/11, post 1/3. Precision Hand Compass mounted on No. 8 torch base w/brism viewer, 12/6, post 1/3. Metal Case tubular 1 mfd. lots of 9 doz. at 6/11, post 1/4. Yankee New amplifier chassis, A5, 4 valve (less 1.0 v.s.), at only 9/11, post 1/3. A snip! C.W.O. or callers. Tiny For Radio, 36a, Dalston Lane, London, E.8.

G200, Power Supply Unit No. 4, 12 v. D.C. input vibrator, 1.1 amp. 250 v. electrolytics, 4 metal rectifiers, etc. Ideal for car radio, a must at 19/6 each. Condensers, 3-30 pF air trimmers, 6d. each. 1 mF. paper, 2/- doz. 1, 2, 33, 47 pF, ceramic, 3/6 doz., 470 pF, 5/- doz. Mica, 0.005, 0.01, 0.047, 0.0022 mF, 4/- doz.; .005, 4/6 doz. 100 assorted, 30/- Valves, 2 v. triodes, 3/6 each, HL23DD, 5/6; 6K7, 6K3 (metal), 9/6 each. Button base, 6AG5, 6J6, 12B6, 9/6 each. 6C4, PT15 (transmitting tube), 15/6 each. Octal bases, 4/6 doz. A. C. Hoile, Loose Village, Maldstone.

HARRY JAMES PRODUCTIONS,
270, Leith Walk, Edinburgh 6. Mail Order Specialists, C.O.D. or Cash with Order. Electrolytics, new not W.D. surplus. B.I. Hunts, etc., 3 mfd.s., 3/2; 16 mfd.s., 5/3; 16+8 mfd.s., 6/3; 8-8 mfd.s., 6/-; 4 mfd.s., 2/9; 25 mfd.s., 25 v., 2/-; 50 mfd.s., 50 v., 2/9. T.R.F. Chassis, 3.6. T.R.F. Coils, M. & L., 7.9 pair. Condensers, 0.1, 0.01, 0.05, 500 v., 8d. each. Variable 2 gang, 0.0015, 12/- with Trimmers, 13.6. Loudspeakers, 5in. P.M. 19.6; 6 1/2 in. energised 1,000 ohms, 29.6. 8in. P.M. 25/- Volume Controls, Long Spindle, W.S., 5/6; L/S, 3.6. Mains Transformers, 350-0-350, 6.3 v. and 5 v. or 4 v. Heaters, 30/- Output, Multi Ratio, 9/- Valve Holders 5 pin. 7d. and octal, 7d. each. Amphenol type, 9d. each. Voltage Droppers, 0.2 amp. 1,000 ohms, 3/9; 0.3 amp. 800 ohms, 4/9. Line cord, best quality, 0.8 amp. 3 core, 9d. per ft. Special Offer, 0.1 milliamperes metres, suitable for multi meters, etc., price 12/6. Valves C.O.D. Large stocks of British and American types. Enquire for anything in Radio. S.A.E. for lists.

COPPER Wires, enamelled, tinned, Litz, cotton, silk covered. All gauges. B.A. screws, nuts, washers, soldering tags, eyelets. Ebonite and laminated bakelite panels, tubes, coil formers. Tufnol rod, Flexes, crystals, permanent detectors, headphones, etc. List S.A.E. Trade supplied.—Post Radio Supplies, 33, Bourne Gardens, London, E.4.

MAINS TRANSFORMERS.—A limited number of Ex-Government Trans. Pri. 0, 210, 220, 250, Secs. 315-0-315 at 70 m.a., 6.3 and 5.0 v. All are unused and boxed, and supplied under money back guarantee. Price 25/-. Available from: Radio Companies, East Street, Darlington.

PORTABLE RECEIVER.—Complete kit instructions, etc., includes matched frame aerial, smart rexine case all components, 19/18, 6d., inc. tax. Stamp to Radio Development Co., Moretonhampstead, Devon.

TEST EQUIPMENT CONSTRUCTION.—Complete kits for home construction professional signal generator 100 kc/s. to 50 mc/s. direct calibration, 19/18, 6d., stamp for details.—Radio Development Co., Moretonhampstead, Devon.

EVERYTHING for the wireless constructor. Send stamp for price list.—H. Tabner, 118, Nightingale Road, Hitchin, Herts.

QUALITY SPEAKERS.—New Rola G12 plus, 16/10/-, Goodmans 12in. 18/15/-, Goodmans Atom 28/8/-, Rola 6 Elia, 10in. 30/-, 8in. 23/6. Mains transformers, 350-0-350v. 85 ma., 6.3 and 5v., 28/6; ditto, but 4v. and 4v., 28/6. Pifco Radiometers, 0-5v., 0-240v., 0-30ma., A.C. or D.C. and circuit test, 25/-, Avinor D.C., 24/6. Goodman A.C.D.C. 28/10/-, Taylor 120A (1,000 op), 28/8/-, Electrolytics, best makes only, 8 m.f., 4/-; 8-8, 6/6; 16-8, 8/6. Many other lines, all brand new stock of best quality. Send S.A.E. for list. C.W.O. or C.O.D. C.W.O. only for 12in. speakers, too heavy for C.O.D.). Carriage paid over 1/1.—Homer and Newey (Radio), Ltd., Dept. F, 211, Queens Road, Smeethwick, Staffs.

M.C.R.1, with coils and speaker, 90/-; D. Skinner, Bolingbroke, Spilsby, Lincs.

WANTED, books on radio, second hand, clean. Send by post, cash offer by return.—Bulls (F.W.), 246, High St., Harlesden, N.W.10.

WANTED. "Ferrocart" extractor coil (S.T.600).—Adams, 27x, 10th Ave., Blyth, Northumberland.

VERSATILE TRANSFORMER. Another Oldchurch Laboratories Special. This is the most universally useful component yet offered to the Home. It has four separate windings, impregnated in screened container. Weight 4lbs. These are some of its uses: Modulation choke with 3 taps, modulation transformer with ratios of 3, 2 and 1 to 1, driver transformer, auto coupling transformer, mains, 100, 200, 300 and 400 v. step up or down transformer. Carries 50 w./Inst.uction leaflet and diagram with each. You cannot afford to be without one. Brand new ex-Govt. Price 7/6 each. Trade for 2/1 (plus post). E.P. 50 valves. Emission tested. No cracked bases, 83 per doz. New Arrival, 1.155 Receivers, complete, in excellent condition. Very limited number. Each 29 (plus 1/1 deposit on case, returnable, plus 15s. carriage).—J. L. Dismore, 52c, Oldchurch Rd., Chingford, E.4.

SHOP BY POST.—All our goods are carriage paid to any address in Great Britain. You pay no fancy prices. We are actual buyers direct from the Ministry of Supply. Here are a few examples of the value obtainable to-day: Modulator unit Type 208 contains 5-KT44 output pentodes, 2-U17 rectifiers, 1-MH41 triode, switches, transformers, chokes, resistances, etc., etc., only 59/6. Receiver type B 3087 contains 10 useful valves, 2-6J5C, 2-CU5, 2-D1, 1-EB34 and 4-SP61, 12 volt Rotary transformer, and a host of condensers, resistances, etc., the scrap value of this unit is over 110. Our price, 49/6. Exide 10 volt 500 m.a. H.P. accumulators, 5/- per unit. Teak case free with each 8 units, 2 volt 20 amp. unspillable accumulators, 10/- Complete Aircraft Aerials, Stainless Steel Wire Insulators, etc. 1/11 each. Single Flex in 12yd. coils, 1/3 coil. Twin Tuff Rubber Covered Cable, 5/- per doz. yds. Co-ax Cable, 6/- doz. yds. 1200 yd. coil. Items advertised last month still available except receivers. Send S.A.E. to-day for our latest lists.

WALTONS WIRELESS STORES, 203, Waterloo Rd., Wolverhampton, or call on only 48, Stafford St., Wolverhampton.

1154 TRANSMITTERS, 18. BC 603 10 valve receivers, 17/10/- 30ft. sectional masts, 25/- H.R. headphones, 3/6. Agents for all makes, orders post free by return of post, 10 page catalogue free, or buy by Electric 43, Collyer Ed. Park, Portbury.

KIT SETS WIRED.—Apparatus constructed to your design. Any receiver serviced. Send diagram or set for quotation, to F.A. Sharp & Sons, 53, Weedington Road, Kentish Town, N.W.5. Phone: GUL 1759.

REPAIRS to loud-speakers. Cones, coils fitted. Fields altered, rewound. Input transformers, chassis coils. No claims accepted. Prices quoted. Satisfaction guaranteed.—L. S. Repair Service, 49, Trinity Rd., Upper Tooting, S.W.17. Closed Saturdays. Phone: Balham 2359.

REWIND SERVICE.—Armatures, Gram. motors, Vacuum Cleaners, Drill and all small motor transformers.—Fields Pick-ups, Speakers—New Cones and Speech Coils fitted—New Vac. Cleaners supplied. All work guaranteed and promptly executed. Special terms to the Trade. Send S.A.E. for Price List and Radio Spares.—A. S. Co., 261-1/2, Lichfield Road, Aston, Birmingham 6.

TUITION

RADIO AND RADAR.—Training for a career in Air or Marine Services as Radio Officer, Radio Officer, Technician, Electrical, Radio, Residential and non-residential Courses at the Radio and Radar School of Britain's Air University. Enquiries to the Commandant, Air Service Training, Hamble, Southampton. Telephone, Hamble 2185.

A.M.I.E.E., A.M.I.E.E., City and Guilds, etc., or No 80 Victoria, London, Ours 300 successes. For details of Exams. and courses in all branches of Engineering, Building, etc., write for 108-page Handbook—Free.—B.I.E.T. (Dept. 2423), 17, Stratford Place, London, W.1.

THE INSTITUTE of Practical Radio Engineers have available Home Study Courses covering elementary, theoretical, mathematical, practical and laboratory tuition in radio and television engineering; the text is suitable coaching matter for I.P.R.E., Service entry and progressive exams; arbitrary fees at pre-war rates are moderate. The Syllabus of Instructional Text may be obtained, post free, from the Secretary, Fairfield Road, Crouch End, N.8.

WIRELESS (sea and air) TELEVISION, Broadcasting, Radar, etc., offer tremendous opportunities. Students, both to sexes, age 14 upwards, trained for appointments in all branches of Radio. Low fees, boarders accepted. 2d. stamp for pros.—Wireless College, Colwyn Bay.

THE BRITISH NATIONAL RADIO SCHOOL (Estd. 1940) for New World Ideas covers Old World Ideas, both to sexes, and the Knowledge How! Home Study Specialists with the Personal Touch. Radio, Radar, Maths, Physics. The B.N.R.S. Four Year Plan covers the full syllabus of A.M.I.E.E., A.M.I.E.E., and City and Guilds Radio and Telecommunications Exams. Six months' trial period without obligation to continue. Day classes in all subjects, including P.M.G., recommending shortly. Send for free booklet to 7—Studies Director, British National Radio School, 68, Addiscombe Road, Croydon. (Phone: Addiscombe 3341.)

Practical Wireless BLUEPRINT SERVICE

SPECIAL NOTICE

THESE blueprints are drawn full size. The issues containing descriptions of these sets are now out of print, but an asterisk beside the blueprint number denotes that constructional details are available, free with the blueprint.

The index letters which precede the Blueprint Number indicate the periodical in which the description appears: thus P.W. refers to PRACTICAL WIRELESS, A.W. to Amateur Wireless, W.M. to Wireless Magazine.

Send (preferably) a postal order to cover the cost of the Blueprint (stamps over 6d. unacceptable) to PRACTICAL WIRELESS, Blueprint Dept., George Newnes, Ltd., Tower House, Southampton Street, Strand, W.C.2.

PRACTICAL WIRELESS No. of Blueprint.

F. J. Camm's A.C. Superhet 4 .. -- PW59
F. J. Camm's Universal 44 Superhet 4 .. -- PW60
"Qualitone" Universal Four .. -- PW73

CRYSTAL SETS

Blueprints, 1s. each. *
1937 Crystal Receiver .. -- PW71*
The "Junior" Crystal Set .. -- PW94*

STRAIGHT SETS. Battery Operated

One-Valve: Blueprints, 2s. each.
All-Wave Unipen (Pentode) .. -- PW81A
Regiment One-valver .. -- PW85
The "Pyramid" One-valver (HF Pen) .. -- PW93*
Two-valve: Blueprints, 2s.
The Signet Two (D & I F) .. -- PW76*

SHORT-WAVE SETS. Battery Operated

One-valve: Blueprint, 2s.
Simple S.W. One-valver .. -- PW88*
Two-valve: Blueprints, 2s. each.
Midget Short-wave Two (D, Pen) .. -- PW38A*
The "Fleet" Short-wave Two (D (HF Pen), Pen) .. -- PW91*
Three-valve: Blueprints, 2s. each.
Experimenter's Short-wave Three (SG, D, Pen) .. -- PW30A*
The Prefect 3 (D, 2 LF (RC and Trans)) .. -- PW63*
The Band-spread S.W. Three (HF Pen, D (Pen), Pen) .. -- PW68*

PORTABLES

Three-valve: Blueprints, 2s. each.
F. J. Camm's ELF Three-valve Portable (HF Pen, D, Pen) .. -- PW65
Parvo Lightweight Midget Portable (SG, D, Pen) .. -- PW77
Four-valve: Blueprint, 2s.
"Imp" Portable 4 (D, LF, LF, Pen) .. -- PW86*

MISCELLANEOUS

Blueprint, 2s.
S.W. Converter-Adapter (1 valve) .. -- PW48A*

AMATEUR WIRELESS AND WIRELESS MAGAZINE CRYSTAL SETS

Blueprints, 1s. each.
Burslem Crystal Set .. -- AW427
Lucerne Tuning Coil for AW427 1s. .. -- AW444
1934 Crystal Set .. -- AW440
150-mile Crystal Set .. -- AW450

STRAIGHT SETS. Battery Operated.

One-valve: Blueprint, 2s.
B.B.C. Special One-valver .. -- AW387*
Two-valve: Blueprints, 2s. each.
Full-volume Two (SG det, Pen) .. -- AV392
A modern Two-valver .. -- WM409*
Three-valve: Blueprints, 2s. each.
45 5a. S.G. 3 (SG, D, Trans) .. -- AV442*
Lucerne Ranger (SG, D, Trans) .. -- AW422*
43 5a. Three De Luxe Version (SG, D, Trans) .. -- AW435
Transportable Three (SG, D, Pen) .. -- WM271

Three-valve: Blueprints, 2s. each.
Selectone Battery Three (3, 2 LF (Trans)) .. -- PW10
Summit Three (HF Pen, D, Pen) .. -- PW37*
Hall-Mark Cadet (D, LF, Pen (RC)) .. -- PW48*
F. J. Camm's Silver Souvenir (HF Pen, D (Pen), Pen) (All-Wave Three) .. -- PW49*
Capeo Midget Three (D, 2 LF (Trans)) .. -- PW51*
1936 Sonotone Three-Four (HF Pen, HF Pen, Westector, Pen) .. -- PW63*
Battery All-Wave Three (D, 2 LF (RC)) .. -- PW55*
The Monitor (HF Pen, D, Pen) .. -- PW61*

The "Colt" All-Wave Three (D, 2 LF (RC & Trans)) .. -- PW72*
The "Rapide" Straight 3 (D, 2 LF (RC & Trans)) .. -- PW82*
F. J. Camm's Oracle All-Wave Three (HF, D, Pen) .. -- FW78
1938 "Triband" All-Wave Three (HF Pen, D, Pen) .. -- FW84*
F. J. Camm's "Sprite" Three (HF, Pen, D, Tel) .. -- PW87*
The "Hurricane" All-Wave Three (SGD, Pen, Pen) .. -- PW69*
F. J. Camm's "Push-Button" Three (HF Pen, D (Pen), Tel) .. -- PW92*
Four-valve: Blueprints, 2s. each
Beta Universal Four (SG, D, LF, Cl, B) .. -- FW17*

Nucleon Class B Four (SG, D (SG), LF, Cl, B) .. -- PW34B
Fury Four Super (SG, SG, D, Pen) .. -- PW34C
Battery Hall-Mark 4 (HF Pen, D, Push-Pull) .. -- PW46*
"Acme" All-Wave 4 (HF Pen, D (Pen), LF, Cl, B) .. -- PW53*
The "Admiral" Four (HF Pen, HF Pen, D, Pen (RC)) .. -- PW90*

Mains Operated

Two-valve: Blueprints, 2s. each.
Selectone A.C. Radiogram Two (D, Pow) .. -- PW19*
Three-valve: Blueprints, 2s. each.
Double-Diode-Triode Three (HF Pen, DDT, Pen) .. -- PW23*
D.C. Ace (SG, D, Pen) .. -- PW25*
A.C. Three (SG, D, Pen) .. -- PW29*
A.C. Leader (HF Pen, D, Pow) .. -- PW35C*
A.C. Premier (HF Pen, D, Pen) .. -- PW35B*
Ubique (HF Pen, D (Pen), Pen) .. -- PW30A*
F. J. Camm's A.C. All-Wave Silver Souvenir Three (HF Pen, D, Pen) "All-Wave" A.C. Three (D, 2 LF (RC)) .. -- PW50
A.C. 1936 Sonotone (HF Pen, HF Pen, Westector, Pen) .. -- PW56*
Mains Record All-Wave 3 (HF Pen, D, Pen) .. -- FW70*
Four-valve: Blueprints, 2s. each.
A.C. Fury Four (SG, SG, D, Pen) .. -- PW20*
A.C. Fury Four Super (SG, SG, D, Pen) .. -- PW34D
A.C. Hall-Mark (HF Pen, D, Push-Pull) .. -- PW45*
Universal Hall-Mark (HF Pen, D, Push-Pull) .. -- PW47*

SUPERHETS

Battery Sets: Blueprints, 2s. each.
45 Superhet (Three-valve) .. -- PW40
F. J. Camm's 2-valve Superhet .. -- PW52*
Mains Sets: Blueprints, 2s. each.
A.C. 45 Superhet (Three-valve) .. -- PW43
D.C. 45 Superhet (Three-valve) .. -- PW42*

Battery Sets: Blueprints, 3s. each.
"Varsity Four" .. -- WM355*
The Request All-Waver .. -- WM407
Mains Sets: Blueprints, 2s. each.
Heptode Super Three A.C. .. -- WM359*

PORTABLES

Four-valve: Blueprints, 3s. each.
Holiday Portable (SG, D, LF, Class B) .. -- AW393*
Family Portable (HF, D, RC, Trans) .. -- AW447*
Tyers Portable (SG, D, 2 Trans) .. -- WM327*

SHORT-WAVE SETS. Battery Operated

One-valve: Blueprints, 2s. each.
S.W. One-valver for America .. -- AW429*
Roma Short-waver .. -- AW452*
Two-valve: Blueprints, 2s. each.
Ultra-short Battery Two (SG, det, Pen) .. -- WM402*
Home-made Coll Two (D, Pen) .. -- AW440
Three-valve: Blueprints, 2s. each.
Experimenter's 5-metre Set (D, Trans, Super-regen) .. -- AW435
The Carrier Short-waver (SG, D, E) .. -- WM390

Four-valve: Blueprints, 3s. each.
A.W. Short-wave World-beater (HF Pen, D, RC, Trans) .. -- AW436*
Standard Four-valve Short-waver (SG, D, LF, P) .. -- WM383*
Superhet: Blueprint, 3s.
Simplified Short-wave Super .. -- WM307*

Mains Operated

Two-valve: Blueprint, 2s. each.
Two-valve Mains Short-waver (D, Pen), A.C. .. -- AW453
Four-valve: Blueprints, 3s.
Standard Four-valve A.C. Short-waver (SG, D, RC, Trans) .. -- WM391*

MISCELLANEOUS

S.W. 1-valve Converter (Price 1s.) .. -- AW329
Enthusiast's Power Amplifier (10 "Watts") (3/4) .. -- WM387*
Listener's 5-watt A.C. Amplifier (3/4) .. -- WM392*
Radio Unit (2v.) for WM392 (2/-) .. -- WM392*
Harris Electrogram battery amplifier (2/-) .. -- WM390*
De Luxe Concert A.C. Electrogram (2/-) .. -- WM403*
New style Short-wave Adapter (2/-) .. -- WM388
B.L.D.L.C. Short-wave Converter (2/-) .. -- WM405*
Wilson Tone Master (2/-) .. -- WM406
The W.M. A.C. Short-wave Converter (2/-) .. -- WM408*

HINTS COUPON

This coupon is available until Sept. 6th, 1943, and must accompany all Practical Hints. PRACTICAL WIRELESS, SEPT., 1943.

Published on the 7th of each month by GEORGE NEWNES, LIMITED, Tower House, Southampton Street, Strand, London, W.C.2, and printed in England by W. SPEAIGHT & SONS, LTD., Exmoor Street, London, W.10. Sole Agents for Australia and New Zealand are GORDON & GOTCH (A)SIA), LTD. South Africa: CENTRAL NEWS AGENCY, LTD. Subscription rates including postage: Inland 10s. 6d. per annum; Abroad 10s. per annum. Registered at the General Post Office for the Canadian Magazine Post. CONDITIONS OF SALE AND SUPPLY: This periodical is sold subject to the following conditions, namely, that it shall not, without the written consent of the publishers first given in writing, be re-sold, hired out or otherwise disposed of by way of trade except at the full retail price of 6d., and that it shall not be lent, re-sold, hired out or otherwise disposed of in a mutilated condition or in any unauthorised cover by way of Trade, or affixed to or as part of any publication or advertising, literary or pictorial matter, whatsoever.

*We can now put our
best FOOT forward*

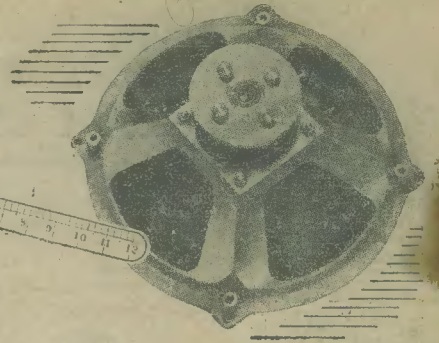

12" SPEAKER CHASSIS Type SI2135

It may be news to you that we make a chassis of this size, and we admit that we've kept rather quiet about it until now. The reason?—simply that our output has been fully taken up by Public and Educational Authorities. Now, re-organisation of our manufacturing programme enables us to offer this magnificent example of Whiteley skill to a wider field of users.



Stentorian

**LOUDSPEAKERS AND
RADIO EQUIPMENT**

WHITELEY ELECTRICAL RADIO CO. LTD. MANSFIELD. NOTTS

Highest distortion-free performance—accurate reproduction over widest possible audio-frequency range. Magnet of "Alcomax," the most efficient anisotropic alloy. Die-cast chassis. Flux density: 13,500 gauss. Total flux: 106,000 gauss. Speech coil impedance: 15 ohms. Handling capacity: 15 watts.

PRICE £6.6.0 (without transformer)
£7.7.0 (with transformer)

The NEW Taylor (Pocket Size) Industrial AC/DC Test Meter

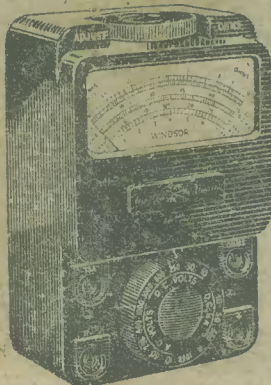

MODEL 125 A

17 ranges specially designed for TELEPHONE AND ELECTRICAL ENGINEER'S Requirements.

Features

- | | |
|---------------------------|--|
| A.C./D.C. VOLTS | 0-7.5v. to 0-750v. |
| D.C. CURRENT | 0-3mA to 0-15A |
| RESISTANCE | 0.2-100,000 ohms
(with internal battery) |
| ROBUST METER | Fitted with instantaneous
OVERLOAD PROTECTION |
| SHOCK-PROOF MOULDED CASE | |

PRICE £8 - 8 - 0

H.P. TERMS: £0.16.3 deposit and
11 monthly payments of £0.16.1



TAYLOR PRODUCTS INCLUDE: MULTIRANGE A.C./D.C. TEST METERS ● SIGNAL GENERATORS ● VALVE TESTERS ● A.C. BRIDGES ● CIRCUIT ANALYSERS ● CATHODE RAY OSCILLOGRAPHS ● HIGH AND LOW RANGE OHMMETERS ● OUTPUT METERS ● INSULATION TESTERS ● MOVING COIL INSTRUMENTS

TAYLOR ELECTRICAL INSTRUMENTS LTD
419-424 MONTROSE AVENUE, SLOUGH, BUCKS, ENGLAND

Telephone SLOUGH 21381 (4 lines)
Grams & Cables "TAYLORS" SLOUGH