

BUILD OUR 2½-WATT TRANSMITTER— SEE PAGE 496

Practical and Amateur Wireless

3^D
EVERY
WEDNESDAY

Edited by F.J. CAMM

a GEORGE
NEWNES
Publication

Vol. 9. No. 224.
January 2, 1937.

AND PRACTICAL TELEVISION

The Trend of **CIRCUIT DESIGN**

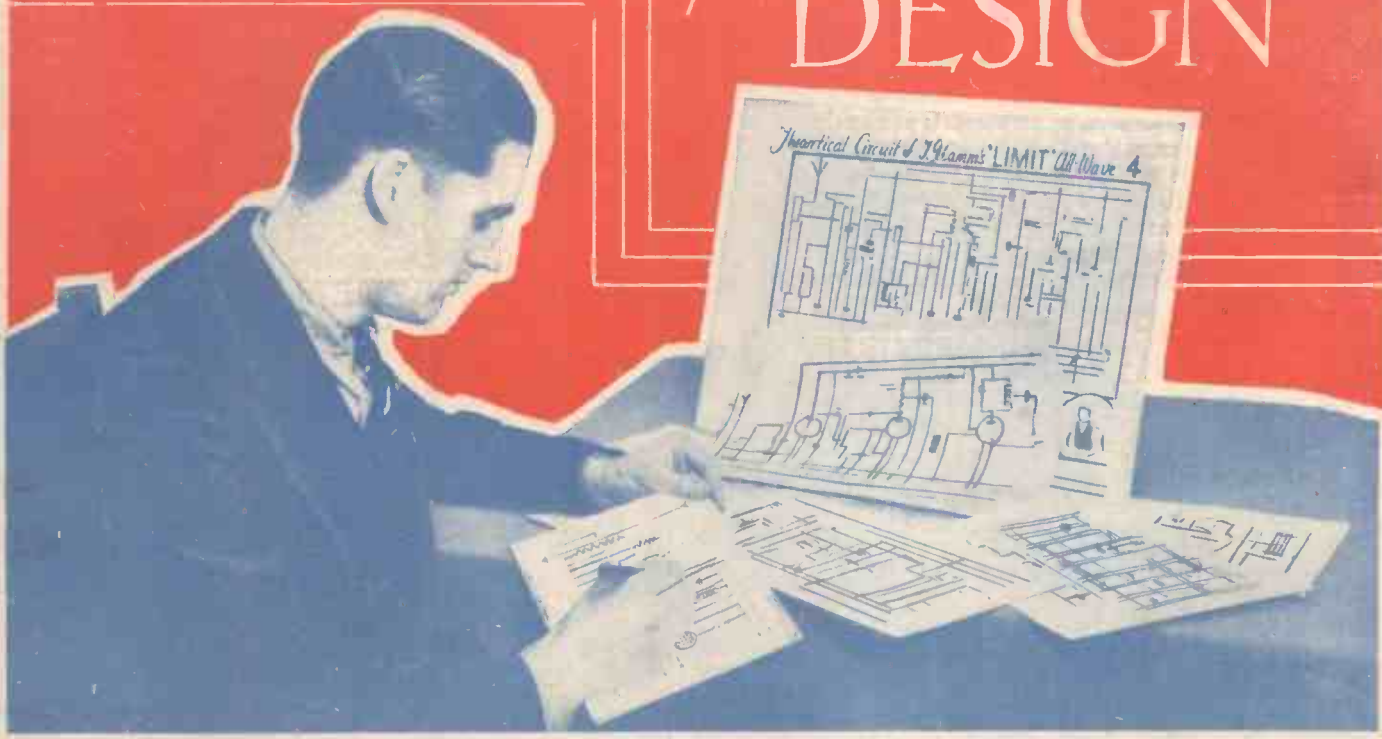

EVERYMAN'S WIRELESS BOOK

BY F. J. CAMM (Editor of "Practical and Amateur Wireless," etc.)

A Radio Consultant for the Listener, Expert and Amateur Constructor, explaining the Operation, Upkeep and Overhaul of all Types of Wireless Receivers, with Special Chapters on the principles of Radio Telephony Installation, and Systematic Fault-finding.

From all Booksellers only 3/6 net. or 3/9 post free from

GEORGE NEWNES, LIMITED, Tower House, Southampton St., LONDON, W.C.2.

With
200

Illustrations



FLYING THRILLS!



"POPULAR FLYING," The National Aviation Magazine, takes you on aerial adventures with our air aces, and transports you on daring flights across desert, ocean and vast continents with the world's greatest flyers. And every issue tells you all about the latest aircraft and new air inventions. "POPULAR FLYING" is profusely illustrated. The January Number contains amongst other Special Features:

NAVAL EIGHT (The history of a famous British fighting unit); **INLAND AIR LINES** By William Courtenay; **HOW TO JOIN THE R.A.F. RESERVE**; **AIRMINDED RUSSIA** (Aviation in the U.S.S.R. to-day); **MOOSE GLUE PROP** (An amazing true story from Canada of how an aeroplane was flown with a home-made propeller).

THE JANUARY POPULAR FLYING

Of all Newsagents and Bookstalls, or by post
7d. from The Publisher, C. Arthur Pearson,
Ltd., Tower House, Southampton St., London,
W.C.2.

6^{d.}

C. Arthur Pearson Ltd.

NEWNES BOOKS on WIRELESS

A New Year Offer

THE WIRELESS CONSTRUCTOR'S ENCYCLOPAEDIA

By F. J. GAMM

Wireless terms and definitions, stated and explained in concise, clear language by one of the best-known and most popular designers and writers on the practical side of wireless construction. Profusely illustrated. A veritable treasure of wireless knowledge.

5/- net

(5/3 post free)

FIFTY TESTED WIRELESS CIRCUITS

By F. J. GAMM

Modern circuits of practically every type from crystal to superhet. Diagrams and instructions for assembling and wiring. Details of components and notes on operation.

2/6 net

(2/10 post free)

THE OUTLINE OF WIRELESS

By RALPH STRANGER

Here is a book which covers the theory and practice of Wireless Reception from A to Z, and makes everything plain even to the most "non-technical" reader.

WORLD-RADIO: "Step by step, line upon line, precept upon precept, it teaches you everything you want to know about wireless."

816 pages: Lavishly Illustrated.

8/6 net

(9/- post free)

THE MATHEMATICS OF WIRELESS

By RALPH STRANGER

This brilliant and experienced writer on Wireless has a happy knack of making even the driest and most abstruse topic interesting—and amusing! He has a characteristic way of handling mathematics which appeals irresistibly to those to whom previously the subject has seemed both difficult and dull.

5/- net

(5/5 post free)

FREE In order to introduce our wireless books to the greatest possible market and to encourage the buying of technical books generally, we recently offered a free copy of the famous wireless text book "Wireless for the Man in the Moon" (2s. 6d. net) to all purchasers of wireless books from our list to the value of not less than 5s. So many people have written to us making application for this book since our offer was closed, that in fairness to all kind enough to be interested we are repeating the offer as a New Year Greeting to our many book-buying friends. Order now from the above list and make sure of this delightful volume. Mark your envelope "Wireless Books Offer."

Book Dept., 8-11, Southampton Street, Strand, London, W.C.2.

NEWNES : LONDON

RECEIVER FAULTS REVEALED—See Page 488



Practical and Amateur Wireless

Edited by F. J. CAMM

Technical Staff:
W. J. Delaney, H. J. Barton Chaplin, Wh.Sch., B.Sc., A.M.I.E.E., Frank Preston.

VOL. IX. No. 224. January 2nd, 1937.

ROUND *the* WORLD of WIRELESS

Improving Your Set

HUNDREDS of listeners are intrigued by the possibilities of the superhet, but hesitate to scrap their present set and build a new one. There is, however, no need to take such a drastic step, and on page 487 of this issue you can read how to make up a simple unit which will enable you to convert your present set into a modern superhet arrangement, and thus give you all the advantages of this modern type of circuit. The main feature of such a unit is that it may be disconnected when the locals are required, or when other experiments are being carried out, and the old set thus reverts to normal.

Princess Juliana's Wedding

THE B.B.C. announces that on the occasion of the wedding of Princess Juliana and Prince Bernhard of Lippe-Biesterfeld, on January 7th, the religious ceremony will be relayed from The Hague to the transmitters in this country. A brief commentary in English will precede and follow the service.

Radio on "The Girl Pat"

THE famous trawler *The Girl Pat*, which recently made the adventurous voyage across the Atlantic, is to be brought home soon from Georgetown. The Marconi International Marine Communication Company have built a wireless telephony installation for this vessel, and the captain and crew recently left Dover, taking with them the Marconi installation. This will enable them to keep in touch with other ships and shore stations. She is expected home early in the spring.

Havana Calls Britain

PROGRAMMES featuring typical Cuban music, with announcements in English, German, French and Spanish, are now being broadcast between 10 and 11 p.m. (Greenwich Time), from Havana, station COCD (250 watts, 48.92 metres, 6,130 kilocycles).

As this station has a comparatively low transmission power, it would be interesting to know if many listeners are able to pick it up.

New London Announcer

THE new Announcer recently heard on the London Regional is Mr. D. Grinnell-Milne. After a distinguished War

service, during which he was captured in 1915 and escaped from Germany in 1918, Mr. Grinnell-Milne was granted a permanent commission in the R.A.F. Between 1919 and 1926, when he was placed on the Retired List at his own request, Mr. Grinnell-Milne served in Egypt, Sudan, Palestine, Syria, and as Assistant Air Attaché at the British Embassy, Paris. For the past six years he has lived mainly abroad, writing on international affairs. Mr. Grinnell-Milne was one of two successful candidates for the post of announcer which

Pantomimes by Air

THIS is the time of year when pantomime holds sway, and many extracts will be included in the B.B.C. programmes. Next week (January 8th) Midland listeners will hear excerpts from "Dick Whittington" from the Theatre Royal, Birmingham. This particular pantomime keeps closer to tradition than most, and in this particular instance the knighting of Dick by Richard II is included. George Formby and Jack Williams are the chief comedians.

More Windmills

WE recently mentioned the use of windmill generators in the U.S.A., and we now learn that the scheme is also to be given a trial in Estonia. Over 120 such generators have been distributed in various parts of that country and by means of the network it is intended to operate an accumulator charging service for listeners in isolated parts of the country. The experiment is being undertaken by the broadcasting authorities.

High-power Station for Tunis

A 100 kW station is contemplated for Tunis, according to Mr. Guillon, the Resident-General, and the cost of the transmitter is to be met by the French Government, whilst the installation is to be met by the dependency. M. Guillon stated that the expense could be covered by the receipts from wireless taxation and publicity, but the latter would appear to be contrary to the policy of the French Government, which has decided against advertising from official stations.

ON OTHER PAGES

	Page
Converting to Superhet	487
Receiver Faults Revealed	488
Trend of Circuit Design	489
On Your Wavelength	491
Readers' Wrinkles	493
1936 in Retrospect	494
Latest Television News	495
Building a Transmitter	496
New G.E.C. Laboratories	499
Short Wave Section	500
British Long Distance Listeners' Club ..	501
New Components Reviewed	504
Readers' Letters	505
Queries Asked and Answered	507

produced about a thousand applications when recently advertised.

Croydon's Radio Beacons

A NEW system of radio beacons has been installed at Croydon airport to avoid risks to aircraft during bad visibility. A main beacon, working on 9 metres, gives a defined path of approach to the aerodrome from a distance of ten to fifteen miles. A "distant" or "outer" beacon, on 7.89 metres, throws up a vertical fan-shaped screen across the main approach path, about one and a half to two miles from the aerodrome, and an "inner" marker beacon on a similar wavelength throws up a similar screen about 300 yards from the edge of the aerodrome. Standard Telephones and Cables, Ltd., supplied the Lorenz pattern beacon in one case, whilst the Plessey Company supplied a similar type of beacon for a different avenue of approach. The third is a Marconi installation.

"Twelfth tide"

"TWELFTH TIDE" will be the subject of the next West Country Calendar broadcast on January 4th. It will take the form of a composite sound picture of some of the customs still surviving in the West Country during the twelve days of Christmas. These have been gathered by the Mobile Recording Unit and the programme will include: Christmas Morning, Ottery St. Mary; The Bilbye Handbell Ringers, Chew Stoke; Carols from Somerset, Dorset and Cornwall; and performances in whole or in part of The Madron Guise Dancing; The Marshfield "Paper Boys" Mumming Play; the Battle of Waterloo, by the Dorchester Mummings, and "Crimea" by the Evershot Mummings.

ROUND the WORLD of WIRELESS (Continued)

More Radio Licences

IT is reported that the number of wireless receiving licences issued by the Post Office during November totalled 962,125. This represents a net increase of 44,349 in the number of licence holders during the month, after making allowance for expired licences and renewals.

Windjammers

LISTENERS will remember some months ago some talks by Captain Davis on windjammers and timber vessels of the old days which sailed out of Belfast. Captain Davis will give another talk on this fascinating subject on January 1st in the Northern Ireland programme.

Regional Director at the Microphone

THE "Brief Chronicles" talk which is to be broadcast on January 1st will take the form of a New Year message to Northern listeners from the North Regional Director, Mr. E. G. D. Liveing.

The Phantom Five

THIS popular quintet, directed by Edgar Hawke, will give their third broadcast in the Western programme on January 5th.

INTERESTING and TOPICAL NEWS and NOTES

relay service established in the Gold Coast Colony. It is for an extension of the system to Koforidua, and the equipment com-

casting on January 7th are the Beethoven quartet in B flat and Mozart's No. 14 in G.

Song Recital

MIRIAM LICETTE, who on January 3rd will sing German songs by Wolf, French songs by Fauré, and English songs by Hinchliffe and Rubbra, is the well-known operatic soprano who sang in the Beecham Opera Company.



Some of the guests who were present at Jack Hylton's party recently at the "His Master's Voice" Recording Studios. In this picture can be seen (left to right) Jack Hylton's Swing Quintet, Tommy Handley, Tom Webster, Freddie Fox, Jack Barty, Nelson Keys, Peggy Dell, Hilda Mundy, Billy Caryll, Jack Hylton. The party was recorded on "H.M.V." C2883.

Valve-making Substances

A RECENTLY issued American valve catalogue reveals the interesting fact that in an ordinary mains valve there are actually sixty-eight separate substances employed in its manufacture.

New Cossor Universal Receiver

WE hear that the Cossor Company have just introduced a new low-priced D.C./A.C. mains receiver, with two pentode and one super-power valve. It sells for seven guineas.

Concert Party from Hull

DURING the summer there are Arcadian Follies concert parties in Blackpool, Morecambe, Colwyn Bay, and Fleetwood. Three of these have broadcast regularly in the Northern programmes. In the winter an Arcadian Follies concert party, comprising members of the other four parties, goes on tour, and this is to broadcast from the Alexandra Theatre, Hull, on January 7th.

prises two special short-wave receivers with associated power amplifiers for direct operation on the 230 D.C. supply available. Line material and loudspeakers for an initial load of 300 subscribers has been supplied.

A Rough Test

DURING one of the recent gales a small fishing smack was wrecked off the coast of Largs, Ayrshire, the crew being forced to abandon the boat and swim ashore. All their personal belongings were left aboard the vessel—including an Ever Ready 5010 portable receiver.

This receiver was subsequently recovered, and was found to be in perfect working order.



The complete B.B.C. Cardiff transmitter has been purchased by McMichael Radio for exhibition by their agents. The illustration shows it being inspected at Davies' Radio Stores at Southend.

British Radio Relay Equipment for Overseas

WE are informed that the General Electric Co., Ltd., has received an order for a complete radio relay equipment from the Crown Agents for the Colonies in connection with the broadcast

The Catterall Quartet

THIS popular quartet has been a favourite with Midland music-lovers for many years. Its personnel now is Arthur Catterall and T. Petre (violins), William Primrose (viola), and Johan Hock (cello). The works chosen for broad-

SOLVE THIS!

PROBLEM No. 224.

Clark built a three-pentode battery receiver using resistance-capacity coupling between the detector and output valves, with 72 volts on the screens of the H.F. pentodes and 120 volts on the screen of the L.F. pentode. Why were results unsatisfactory? Three books will be awarded for the first three correct solutions opened. Address your solutions to the Editor, PRACTICAL AND AMATEUR WIRELESS, George Newnes, Ltd., Tower House, Southampton Street, Strand, London, W.C.2. Envelopes must be marked Problem No. 224 in the top left-hand corner, and must be posted to reach this office not later than the first post on Monday, January 4th, 1937.

Solution to Problem No. 223.

A delay voltage could be obtained by connecting the cathode of the diode to the cathode of the output pentode.

The following three readers successfully solved Problem No. 222, and books are accordingly being forwarded to them: H. L. Clarke, Oakleigh, Healing, Lincs.; W. Ferris, 63, Defoe Road, Tooting, S.W.17; R. W. Holt, Kingston Maurward, Dorchester, Dorset.

CONVERTING TO SUPERHET

Details for the Construction and Use of a Superhet Converter which Can be Employed in Conjunction with a "Straight" H.F.-Det.-P. Receiver

IT has come to be recognised that the superhet is the most selective circuit arrangement which can be used in a reasonably simple type of receiver. There are some who say that the superhet is the only circuit that can possibly provide the degree of selectivity required in present-day conditions. That is probably not quite true, but a super-selective "straight" set generally provides many difficulties, both in design and operation.

length to which the existing set will tune on medium waves is about 550 metres (about 545 kc/s). In any case, the intermediate frequency can be chosen so that interference is not experienced, and can be altered in a moment simply by adjusting the tuning condenser on the set and varying the setting of the oscillator tuner.

The coils chosen for the superhet converter can be of any good make, and should be a matched pair intended for 465 kc/s use. It should be noticed that the aerial-tuning condenser has a capacity of .0005-mfd., and the oscillator condenser a capacity of only .0002 mfd.; with these values it will be found that the two can be kept reasonably well "in step," since the frequency range to be covered by the oscillator tuner is narrower than that which has to be covered by the aerial-tuning circuit.

Modifications for 465 Kc/s

By using a converter of the type described it will be an easy matter at any time to disconnect it and use the "straight" set alone—when local station reception only is required, for instance. On the other hand, if it is proposed to use the receiver permanently as a superhet it will be worth while to modify the original receiver so that it will tune to 465 kc/s (approximately 650 metres) by connecting a fixed condenser of .0005-mfd. capacity in parallel with each section of the gang-tuning condenser. The normal tuning knob will then be used simply as an I.F. trimmer.

In order to ensure that the various tuning circuits of the set are properly matched when the .0005-mfd. fixed condensers are added, and as a check on the accuracy of capacity of the additional condensers, the receiver should first be used as a "straight" set and tuned to a signal near the bottom of the medium-wave tuning scale. The trimming screws on the gang condenser can then be adjusted for maximum strength. After that the converter can be added and the receiver tuning condenser set to about its midway position. When a station has been received the oscillator trimmer should be adjusted, and then the receiver tuning condenser turned to the position at which maximum signal strength is obtained. Afterwards, this condenser should not be altered, all tuning being carried out with the two-gang condenser on the converter.

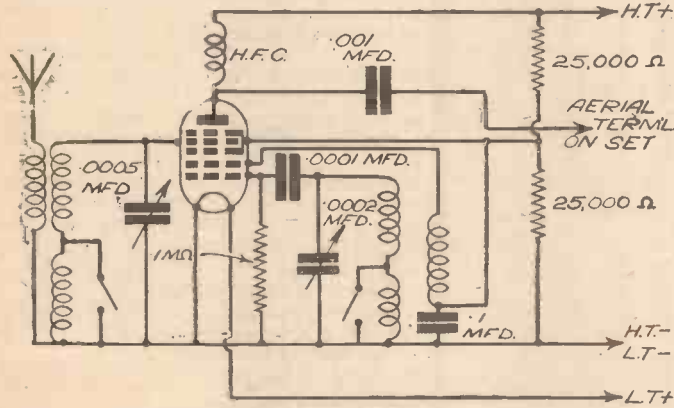

Fig. 1.—A simple superhet converter circuit employing 465 kc/s coils and separate tuning condensers.

As selectivity is more important during the winter months than at any other time of the year—due to the fact that reception conditions are ideal, and that there is a large number of transmissions within range—there might be many readers who would like to modify their existing "straight" sets to incorporate superhet principles. Generally speaking, however, a cheaper method than rebuilding the set in modified form is to add a superhet unit to it. This is frequently done to permit of short-wave reception, of course, but the matter is by no means as simple where broadcast reception is concerned. For one thing, a simple autodyne oscillator is useless for frequency-changing on the medium- and long-waves, and for another, care must be taken to ensure that the oscillations of the frequency changer are not radiated.

A Simple Circuit

A simple and satisfactory circuit for a pentagrid superhet unit is given in Fig. 1, where it can be seen that separate tuning condensers are used for the input and oscillator tuning circuits. This arrangement is not ideal, since it renders tuning rather more difficult. But it is certainly the simplest, because if a gang condenser were used it would be necessary to operate on an intermediate frequency of either 110 kc/s or 465 kc/s; this might necessitate a modification of the tuning system used in the set, as will be described later.

Another objection to the general idea of the circuit shown in Fig. 1 is that the intermediate frequency employed would have to be one which is covered by the tuning coils. This means that there would always be a danger of interference from stations operating on the corresponding wavelength. This need not prove to be a serious matter, however, provided that the highest wave-

Connecting the Converter

To use the converter it is necessary only to transfer the aerial lead to the appropriate terminal on the converter, connect the L.T. leads to the corresponding terminals on one of the valveholders in the set, plug the H.T.+ lead into a socket on the H.T. battery, and join the lead from the anode circuit of the pentagrid to the aerial terminal on the set.

By using these connections the converter will be switched on and off along with the set, so avoiding the need for a separate switch on the converter. As to the method of using the complete instrument, it is necessary first of all to adjust the tuning of the "straight" set to the top of the medium-wave band, and then carry out all tuning operations on the converter. It will be found quite an easy matter to find the local station by carefully tuning the oscillator condenser; signals can then be brought up to full strength by adjusting the aerial condenser. Other stations can then be found by slowly moving the knobs of both condensers together. A certain amount of practice will be required before stations can be tuned in quickly, but the more experienced reader will not find very much difficulty.

Oscillator Tuning

As most readers will be aware, there are slightly different tuning circuits for the oscillator section of a 465 kc/s frequency changer, and those shown in Fig. 2 apply

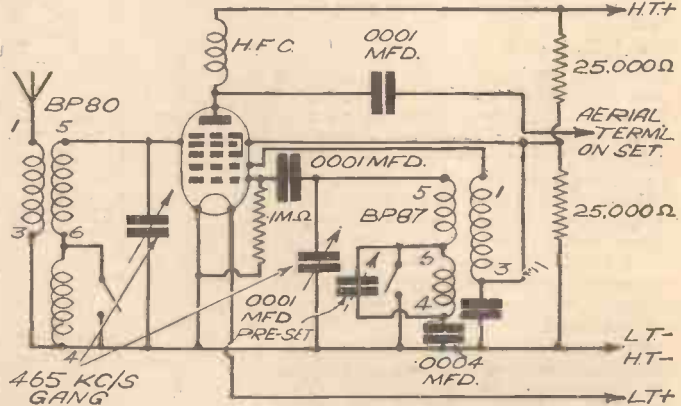

Fig. 2.—Circuit corresponding to that in Fig. 1, but using a gang condenser and Varley BP80 and BP87 coils.

when using the Varley coils—types BP80 and BP87—specified for the "£4 Superhet." If other coils are employed it will be necessary in most cases slightly to modify the tracking system according to the connections given by the makers.

It has not been mentioned before, because it is generally known that a superhet converter of the type described can be used only in conjunction with a receiver having an H.F. stage—which acts as the normal I.F. amplifier when the converter is attached.

Receiver Faults Revealed

How the Cathode-ray Tube Reveals Faults in Low-frequency Amplification

AS the input impedance of a cathode-ray oscillograph is extremely high, and as its addition to an electrical circuit causes practically no alteration to the operating conditions, the wave trace seen on the fluorescent screen can be regarded as a good indication of what is actually occurring in any particular circuit. Accordingly, if we connect the cathode tube to an amplifier stage, it is possible to see exactly what is taking place.

The most general of all the troubles met with in a low-frequency amplifier is that due to the incorrect operation of the valve, which, in turn, is frequently due to incorrect bias.

In Figs 1 and 2 we have the familiar grid-voltage anode-current characteristic of an ordinary triode. It is obvious by mere inspection that in order to obtain linear or distortionless amplification, we must only operate the valve on the straight portion of the curve. Theoretically, therefore, the valve should be operated in the region of the mid point.

In Fig. 1 the A.C. voltage is applied so that it operates about a point which will give linear amplification. Of course, if the applied voltage is quite small, we can still operate the valve either above or below the mid point without running into the curved portion at either end.

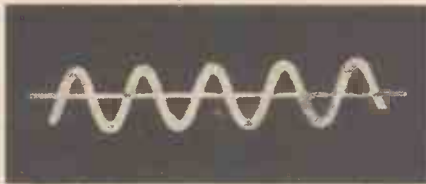

Fig. 3.—An oscillogram showing the wave-form applied to a valve as mentioned in this article.

The Effect of Bias

Now the operating point on the curve is controlled by the steady bias on the grid. Obviously, if this voltage is made too large or too small, the peaks of our applied voltage will sweep the anode current on to the curved portion of the characteristic. If the applied voltage is too high, it is easy to see that we shall be working into the lower bend, and in this case it is the peaks of our applied voltage which will be affected. Accordingly, they will not be amplified in their true proportion. In other words, they will tend to flatten.

Examination of the oscillograms shows that this actually takes place. Fig. 3 shows the wave form of the applied voltage. This voltage is clearly shown in Figs. 1 and 2. It has a regular wave form consisting of peaks of sine formation, having the same intensity or value on either side of the datum line. The height of the peaks above the line is a direct measure of the applied voltage, and so long as this voltage does not sweep the anode current off the straight part of the curve, as shown by the characteristic of Fig. 1, we should expect to obtain an identical wave form for the current in the output or anode circuit.

True and Flattened Peaks

For the benefit of those who are not familiar with alternating current wave

form, the abscissa or datum or zero line has been drawn on the oscillograms. This, it is thought, will help to show more readily the difference between a true and flattened peak. It should be pointed out that in the oscillogram records the wave shape is a function of the amplitude or height. The

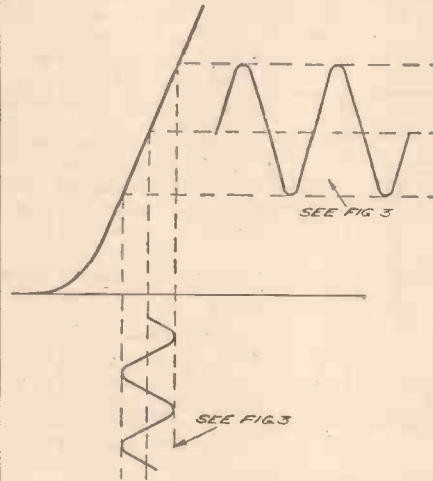
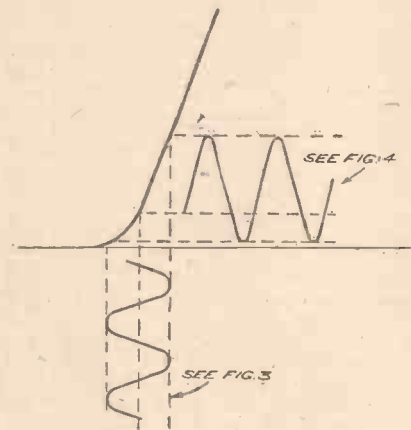

Fig. 1 (above).—Characteristic curves of triode operating on the straight portion of its anode-volts anode-current curve, and Fig. 2 (below) the effect when the curved portion is used.



shape actually depends upon the number of peaks which are formed in a given length or time interval on the screen. If six or eight peaks had been shown instead of

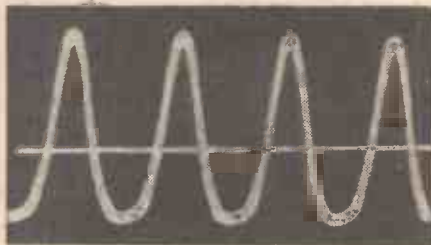

Fig. 5.—In this oscillogram the distortion caused by excessive grid bias is shown by the flattening of the lower portion of the curves

three or four, they would obviously be much steeper. This is just a property of the time base circuit used on the cathode tube for obtaining a steady or repeating picture.

The amplified voltage produced across a load in the anode circuit of a valve operating as in Fig. 1 is shown in Fig. 4. Here it is seen that it is exactly proportional to the input, and, accordingly, we are obtaining distortionless amplification.

Let us now examine what happens when a valve is over-biased so that it operates at the point shown in Fig. 2. We have now moved the operating point lower down on the curve by increasing the bias very considerably. We should now expect the positive half cycles to be amplified without distortion. Obviously, however, the negative half cycles must be affected because the change in anode current with respect to grid voltage is not a linear function. The operating conditions of Fig. 2 are shown more clearly by the oscillogram of Fig. 5. Here the positive half cycles are properly amplified, while the negative half cycles are almost perfect near the abscissa or datum line, but the tops are very seriously flattened.

Effect of Overbias

It is a little difficult to appreciate just what this means to the ear, but everyone is, no doubt, familiar with the scraping or

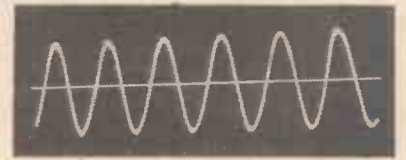

Fig. 4.—The amplified form of Fig. 3.

grating noise which is produced by an over-biased valve.

It is easy to see that if we bring the operating point right down to the curve there will then be practically no amplification of the negative half cycles, and we shall obtain what is in effect rectification, or the complete cutting off of one half of the cycle. A valve used under these conditions is frequently referred to as a bottom-bend rectifier.

Apart from the theoretical consideration of Fig. 1, the series of oscillograms shows very clearly that it is most essential to operate our amplifying valves so that the peaks do not tend to run into the curved portion of the characteristic, particularly if the valve has a very sharp curve. Slight distortion, due to the peaks just running into a gradual curve, is not sufficiently marked to produce any noticeable aural distortion.

No trouble is likely to arise due to incorrect operation if the valve manufacturers' ratings are strictly observed. The effect of insufficient high-tension voltage due to a partially discharged battery, and the result of applying too large a voltage to the grid circuit of the valve, can also be deduced from the anode-current grid-voltage curve, and these defects will be illustrated in a subsequent article.

The Trend of Circuit Design

In this Article Modern Technical Refinements in Radio Receivers are Discussed. By G. V. COLLE

TO the commercial radio technician a circuit diagram is a piece of machinery the mechanism and operation of which can be estimated to a fine degree.

Whereas a plan or practical wiring diagram allows constructors to make faithful copies of a receiver design, a circuit sets out the function, which it is not otherwise possible to show except under actual test. Mention is made of these facts because the literal translation of a theoretical circuit possesses a peculiar fascination of its own, being equivalent to the

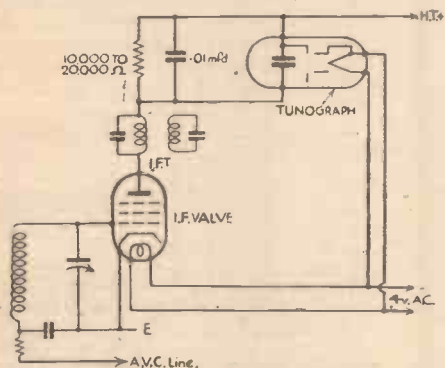

Fig. 1.—A circuit diagram incorporating a micro-mesh tunograph or modified cathode-ray tube.

blueprint plans of a completely assembled engine.

There are few receivers now made which are not the result of circuit research, resulting as it does in the blending of various features into a fundamental framework or circuit nucleus. Most designers set out to produce at least one original feature in each circuit diagram, and the numerous patents granted purely for novel circuits during recent years bear testimony to the importance attached by manufacturers to their technical designs departments.

For the most part the trend of circuit design at the present time shows no marked tendencies in any particular branch. The ultimate cost of a set seems to be the only real limiting factor for technical ingenuity, since, if one is prepared to spend a matter of one hundred pounds or so, a radiogram incorporating nearly every known technical refinement can be obtained in a number of makes.

Last season every attempt was made to include expensive receiver features in popular-priced versions by employing multi-electrode valves. This phase is now disappearing, because valve charges have been reduced, and it is possible for designers to allow for special schemes operated by separate valves which superficially appear to provide superior results.

Modern Improvements

It is possible to enumerate most of the

improvements which have been made recently, although no claim is made that the list is entirely comprehensive. Ranking in approximate order of importance, provision is now made for:

- (1) Short-wave reception on two or three bands.
- (2) Visual indicator methods of tuning.
- (3) Pre-detector H.F. amplification.
- (4) Optional Q.A.V.C. (quiet automatic volume control).
- (5) Variable selectivity, usually in I.F. stages.
- (6) Filters for second channel whistle suppression.
- (7) Automatic input limiting schemes for L.F. stages.

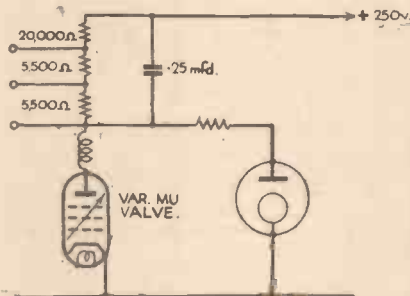

Fig. 2.—Connections for the G.E.C. button "Tuneon" which resembles a small flash-lamp bulb.

- (8) Wider and more scientific methods of A.V.C. to allow for input variations as great as 15,000 to 1.
- (9) Improved tone and/or contrast control.
- (10) Aerial connections suitable for ordinary or matched feeder cable.
- (11) Mains filters.
- (12) Various patented circuit schemes covering L.F. feedback, etc., etc.

The inclusion of short-wave features particularly has resulted in more simple tuning arrangements. Owing to the neces-

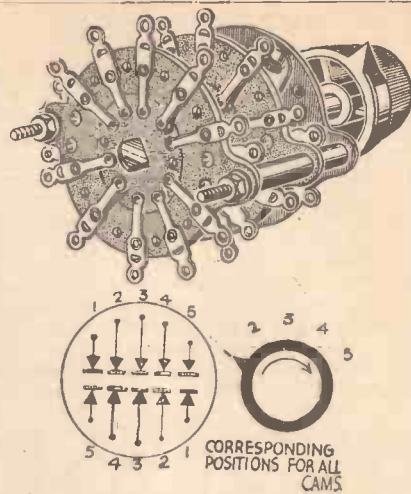

Fig. 3.—A modern rotary multi-contact switch, showing the method of cross-connection in pairs.

sity for short wiring, the avoidance of stray couplings and undesirable capacity effects, as well as difficulties of ganging, it has been found necessary to limit the tuned circuits and accompanying switches.

Special low-capacity disc type switches have, of course, been developed for use in the signal-tuned circuits, but it is not so equally well known that, owing to the restricted number of coils, those intended for medium and long waves have had to be improved in efficiency to allow for adequate selectivity. Some of the very latest set designs do not admit of short-wave ganging difficulties and incorporate a full set of coils on each waveband, usually three in number. Mis-matching to a large extent is avoided by making all circuits other than the oscillator (these remarks refer substantially to all-wave superhets) rather flatly tuned, but, even so, the provision of ganged short-wave circuits is a comparatively new innovation, and represents, from the mass production viewpoint, a considerable advance in technique.

Tuning S.W. Coils

Methods of tuning short-wave coils differ according to the particular circuits employed. With those arranged for choke or aperiodic signal-tuned circuits, the oscillator frequency is sometimes adjusted by the usual .0005 mfd. variable condenser, the effective capacity of which is reduced by a series of fixed capacity introduced by switching. Some designers, on the other hand, provide a special variable capacity of .00015 to .00025 mfd. which, in addition to possessing a low minimum capacity, is

(Continued overleaf)

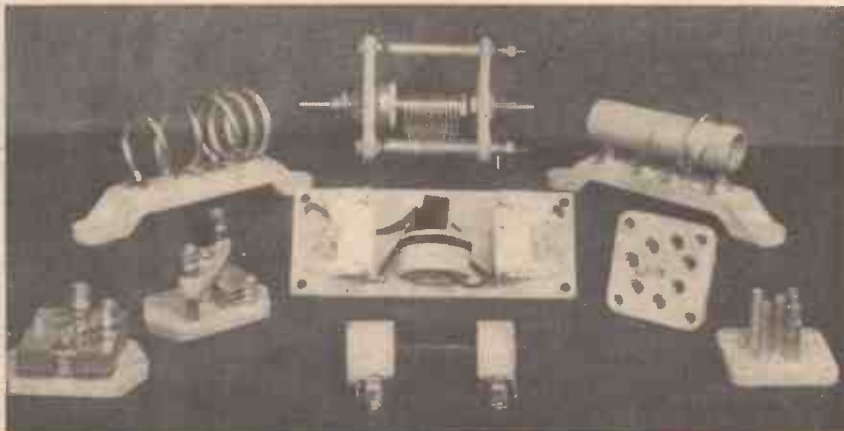

Fig. 4.—A group of B.T.S. low-loss short-wave components with ceramic material for insulation purposes.

THE TREND OF CIRCUIT DESIGN
(Continued from previous page)

either linked mechanically to the usual gang unit or is an integral part of the latter. In multi-coil receivers the usual short-wave practice is to insert fixed condensers in series with each section of the ganged variable unit. Operation is by a 10 to 1 reduction drive and a vernier 10 to 1 (giving 100 to 1) for short wavelengths. Incidentally, on account of their low losses, it will be found that ceramic (porcelain or Steatite) materials are being extensively used for the variable condenser insulation. coil formers, valveholders, and similar parts in the signal and oscillator circuits.

There are innumerable multi-range tuning schemes in use at the present time, but

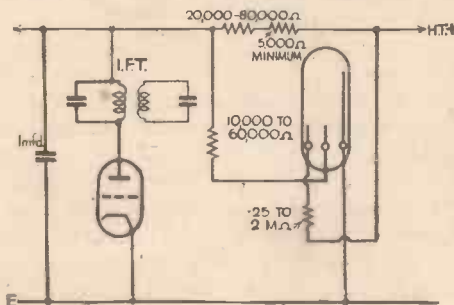

Fig. 5.—Connections for a G.E.C. "Tuncon" indicator.

designers appear to have adopted certain standard practices, such as short-circuiting those coils not in use "out of circuit," and separate padding or trimming condensers across individual coils. A further propensity is to make each coil independent of associated units. In other words, there is a tendency to dispense with the usual series connections, such as is usual with medium- and long-wave inductances. With the new system, each coil is made to an inductance value which will resonate over the required frequency band without the loading effect of earlier and lower value inductances.

The main advantages briefly are as follows: (a) each circuit is balanced on the merits of the coils matching in that particular range and no other, (b) simplified switching, (c) independent coil construction not dependent on critical couplings for correct inductance matching, (d) allows for unit construction where so desired and without losses, (e) easier construction and independent trimming.

Tuning Indicator

Most receivers of recent design and incorporating A.V.C. are fitted with tuning indicators. They are particularly valuable where a variable selectivity control is provided, since it is often difficult to ascertain the exact resonance point for a received transmission where the control is adjusted for maximum frequency response, or low selectivity. It may be argued that in the interests of accurate tuning the operator should set this control for maximum or sharp selectivity before readjusting the tuning knob when "searching," but the fact remains that very few listeners do this, and hence by turning the tuning control to its approximate setting and then watching the tuning indicator the desired transmission is accurately received. There are a number of indicators available ranging from the meter type, which is usually a 0.6 milliammeter marked with an arbitrary scale, to the neon glow tube of the special focusing beam type acting on the cathode-ray principle with a fluorescent screen. In the case of the meter, it is merely con-

nected in series with one or more of the anode H.T. supplies to the controlled valves. Neon and cathode-ray indicators necessitate a proper bridge arrangement across the H.T. supply, as shown in Figs. 1, 2 and 5. Those readers desiring further detailed particulars of the operation of these devices can obtain them from the valve makers' lists.

The H.F. Stage

H.F. amplification by a screen-grid variable-mu H.F. pentode or simple S.G. valve preceding the first detector in superhet designs provides a circuit arrangement which is becoming universally popular. The idea, of course, dates back to the very earliest times when H.F. valves were introduced, although the reasons for reintroducing this stage are now somewhat different.

Whereas the Heptode and Octode frequency-changer valves have proved to have ample sensitivity for medium and long waves, their efficiency factors have been found wanting an ultra-short wavelengths. No doubt the high internal capacities of these valves have been partly responsible for their inability to deal with the short-wave requirements of all-wave sets, and without apportioning the blame, assuming they can be made to function correctly at high radio frequencies, H.F. amplification

Rapid A.V.C.

Mention is made in (c), above, of an instantaneous action for the A.V.C., because an all-wave circuit must deal with the rapid fading encountered on the short waves. This brings us to a point which has arisen before; namely, the need for an automatic change-over by switching for an A.V.C. action with a time lag for broadcast wavelengths. Where the rapid A.V.C. is employed on all wavebands it will be found that the receiver is particularly noisy on medium and long waves, especially during the process of tuning. To the knowledge of the writer there are very few receivers which incorporate the refinement described. There is no doubt that the provision of A.V.C., instantaneous for short waves, and with the time lag for wavelengths above 200 metres, would do much to improve all-wave sets.

Many receivers in the eighteen to twenty guinea class include quiet automatic-volume control in addition to A.V.C. It is normally made optional by the turn of a separate and inconspicuous switch, or similarly by means of a small control at the back of the chassis. A control, usually a variable resistance or potentiometer, for

Q.A.V.C. allows stations above a predetermined noise level only to be received. Where this control is not augmented by a switch, it is so arranged that at one end position the full sensitivity of the set is available, corresponding to the prevailing noise level, and reducible by rotation, as explained, to an arbitrary lower level to suit individual needs. Generally speaking, Q.A.V.C. requires a separate valve for its operation, as shown in Figs. 6 and 7, but modified forms

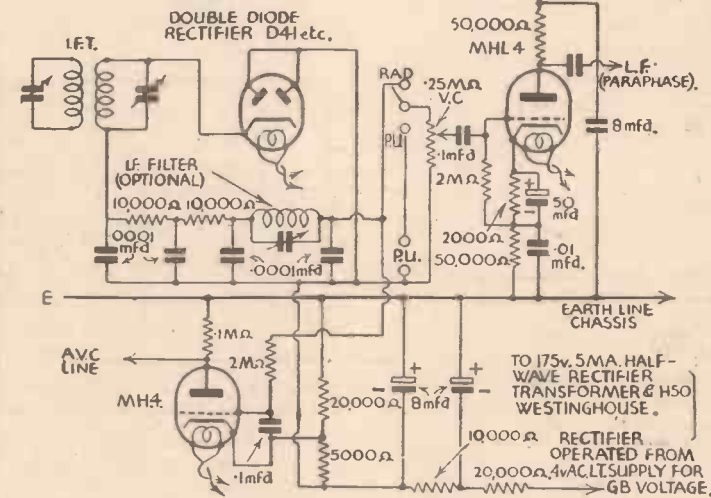

Fig. 6.—Amplified A.V.C. system fitted to a phase-changing valve as first link in a paraphase amplifier (not shown).

at the signal frequency offers these advantages: (a) it provides a better signal-to-noise ratio due to the larger overall signal amplification, and resulting in lower I.F. gain due to the A.V.C. action; (b) the pre-detector amplification allows for reception of very minute transmission currents which would otherwise remain unheard; (c) an improved high-speed A.V.C. is obtained to counteract fading on short waves; (d) the additional signal-tuned circuits required avoid image points and reduce second channel whistles, and (e) greater selectivity on all wavebands.

have recently been patented whereby the second detector, a double-diode or double-diode-triode, is used for the purpose, in addition to its usual functions, including A.V.C.

The objection to rapid A.V.C. on all wavebands logically can be overcome by Q.A.V.C., although in actual fact Q.A.V.C.,

(Continued on page 498)

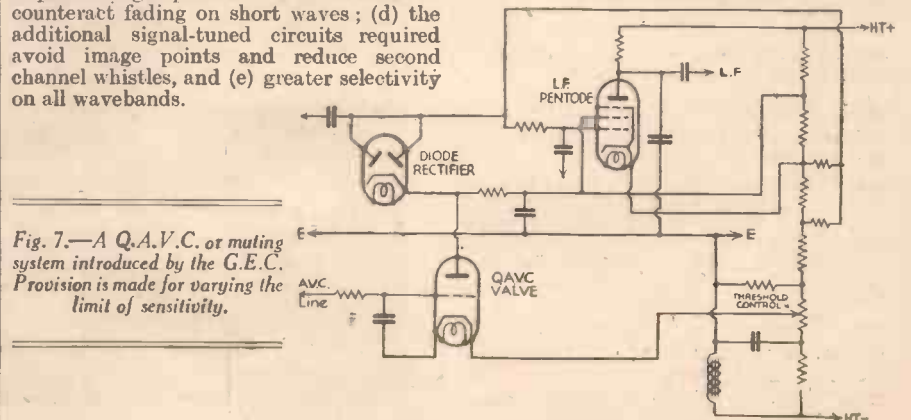

Fig. 7.—A Q.A.V.C. or muting system introduced by the G.E.C. Provision is made for varying the limit of sensitivity.



On Your Wavelength

By **TAERMION**

three other letters, asking in somewhat similar terms the same question. These three letters

A Reader's Curious Mentality

ALTHOUGH we handle some thousands of letters from readers in the course of a year, we do not relax vigilance in efforts to spot letters which, innocuous in themselves, are for one reason or another tainted, and therefore suspect. Quite often, "a regular reader from No. 1" will ask a question which has been the subject of an article only the week before. We are, of course, well

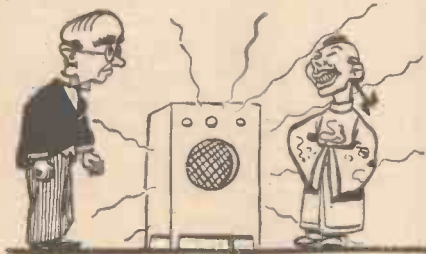

Chinee likee noise muchee plenee.

aware of the "reader" who apologises for the fact that he cannot enclose the coupon "because he has lent his copy to a friend." Then there is the mean creature who tries to win half-a-guinea by copying his hints from other periodicals. All this is a preamble to a wad of four letters which reached me last week from Paisley, Scotland. The letter was as follows: "I have heard so much about this short-wave listening that I would like to have a shot at it. The little short-waver called The Simplest Short-wave Set would suit me, so please let me know through your answers to correspondents if you have a back number describing it." The letter came from W. E., or W. M., of Gallowhill Estate, Paisley, Scotland. Now that letter on its own would have been answered in the ordinary course of events, except for the astonishing fact that by the same post, and written on notepaper cut from the same sheet, arrived

came from one Angus Cameron, 14, Love Street, Paisley, Scotland; James Marshall, 35, Andrew Street, Paisley, Scotland; and J. Kerr, 10, Hunter Street, Paisley, Scotland. These readers were written to, but the letters were returned to us marked "Not Known."

I thought I would draw the attention of the reader, or readers, concerned to the fact that neither he nor they will get a reply until they have explained this extraordinary state of affairs. I am told that a brief reply appears in this week's issue, drawing their attention to this matter in case they are not "regular readers." Thus, when he or they visit the local library to read their favourite weekly journal, they will know that whatever joke they wished to perpetrate has not been consummated. Perhaps some of my other Paisley readers can explain the extraordinary mentality which will cause someone to waste a saxpence in the form of four three-halfpenny stamps; none of the letters, of course, contained Query Coupons. Is this an old Scottish custom?

An Interesting Analysis

ACCORDING to a recent analysis of the L.T. consumption of 280 modern battery sets, which was undertaken by Exide Batteries, of Clifton Junction, the following result was obtained:

- 0.7 per cent. with L.T. consumption under 0.3 amperes.
- 7.1 per cent. with L.T. consumption of 0.3 to 0.4 amperes.
- 67.3 per cent. with L.T. consumption of 0.4 to 0.6 amperes.
- 22.3 per cent. with L.T. consumption of 0.6 to 1.0 amperes.
- 2.6 per cent. with L.T. consumption over 1.0 amperes.

Thus, over 90 per cent. consume .4 amperes or more. It indicates

more than this: it shows that modern battery sets consume more current, no doubt, owing to the use of a greater number of valves and illuminated dials. The manufacturers raise a most important point in asking whether you are using an old accumulator to operate a modern set. The popular, thick plate type of accumulator is excellent for small sets, but is not suitable for the majority of modern sets. This type of battery, as they rightly point out, is designed for slow discharge and infrequent recharging, and if it has to be recharged more frequently than once a fortnight, its life will be shortened. It will not give the most economical service, as its full-rated capacity will not be obtained. To meet these changed conditions, Exide have produced a new type of multi-plate battery called the Hycap, which gives its full-rated capacity at comparatively high discharge rates, and so lasts longer on each charge. Listeners obtain from 35 per cent. to 90 per cent. more listening hours

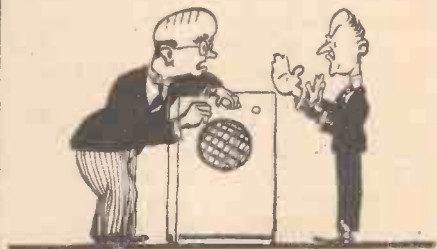

No wireless on Sunday in Wales.

on each charge, and the reduction in the frequency of charging added to the robust nature of the multi-plate assembly, considerably improves the durability. Incidentally, it can be recharged in half the time required for thick plate batteries. The Hycap has, of course, the invaluable indicator.

A New Landmark

SOUTHEND recently gained a new landmark in the form of a 120ft. aerial mast which is adjacent to the Ekco factory.

The mast, at the western end of the main office block, consists of one hundred feet of slender steel tubing, capped by a reinforced ash pole and finally by a television dipole aerial. From the top of the tubing section of the mast a span stretches across to the central office building. This span is to carry twenty-four smaller aerials leading down through tubes built into the walls of the various laboratories of the research building.

The new aerial gives excellent reception of the B.B.C. television programmes at Ekco Works, which

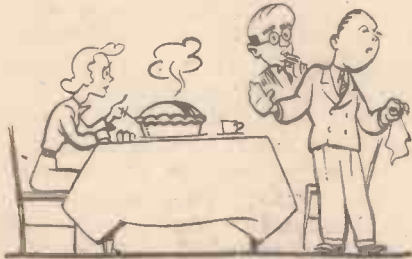

'No' meat pie after hearing Sweeney Todd.

are roughly forty miles from Alexandra Palace, or fifteen miles outside the official service area.

By Its Noise

I LEARN that the sale of wireless sets is soaring in the salubrious district of British Malaya. The United States Department of Commerce has handed to certain radio manufacturers a statement informing them that the Chinese like radio because it makes a noise, and they judge a set not by the tone, but by the amount of noise it will make. Then, indeed, should certain English manufacturers increase their sales in British Malaya. Me no likee noisee. No can stop the makee of noisee settees, but velly much doubttee whether Chineee knows the difference.

Those Sunday Broadcasts

THE Aberystwyth Free Church Council decided to send a resolution to the Free Church Council headquarters in London criticising Sunday broadcasting. At the meeting Mr. David Phillips said: "We in Wales regard that as sacrilege and something which jars on the ears of Welshmen on a Sunday which day should be kept solely for spiritual purposes." Their objection was particularly to the gardening talks. Now, I dislike the Sunday programmes as much as anyone, but I dislike them, unlike these Taffies, because even though they are supposed to have been brightened up, they are still too spiritual for me. Let us be frank about it. We are living in 1936, not in 1836, and we must admit that

religion has long ceased to be the basis of civilisation or of the English home life on Sunday. Make no mistake about that. Do you, dear reader, go to church on Christmas Day or Good Friday, or Easter Sunday, or Whit Sunday? Do you regularly go to church at all? Do many Welshmen, Scotsmen, or Irishmen? Of course not. It is not my purpose to seek the reason, but we must remember that the world has grown more intelligent. Many do not need the services of a parson to preach at us, and to explain what the Bible means. There are intelligent people who cannot understand the contradictions of Religion, and therefore refuse to accept it at all. We certainly do not wish to have the church controlling broadcasting, and moreover, we shall not have it. It is a great pity indeed that the B.B.C. does not take a census of the number of listeners who draw their Sunday radio entertainment from foreign stations, who are years ahead of us in broadmindedness on the question of Sunday entertainment. As a nation we are narrow minded, and we like flummery and panoply.

We like to be hoodwinked and to deceive ourselves. The world is a far, far better place to-day with less church going than it was in the disgusting Victorian era, with its secret Sunday entertainment after going to church to satisfy the conscience and the local parson. Fortunately, the latter individual has long ceased to exercise control over the amusements of his local flock. If Welshmen are so religious that they take offence at the B.B.C. Sunday programmes, they should not listen in at all. Are they

The following apology to the Editor and readers of P. & A. W. has been received from the Thornton Heath Short-wave Radio and Television Society.

IT has been brought to the notice of the Editorial Committee of the Thornton Heath Short-wave Radio and Television Society that paragraphs appearing on pages 1 and 3 of the November issue of "Carrier Wave" are offensive to the Editor and readers of PRACTICAL AND AMATEUR WIRELESS. The Editorial Committee wish to make it quite clear that no slur was intended, and they very much regret that they permitted to be inserted the paragraphs in question which are considered derogatory to that journal, its Editor and its readers.

It is regrettable that any comment written by the contributor and editor of "Carrier Wave" should have occasioned a breach in the friendly relationship which has hitherto existed between PRACTICAL AND AMATEUR WIRELESS and this Society, and the Committee take this early opportunity of apologising for any annoyance or inconvenience caused to that journal."

too lazy to go to church? Those who profess to be deeply religious should remember that a good case can be made out for not listening in at all on Sunday. You cannot combine entertainment and religion. If a Welshman wishes to listen in to be entertained he should not be so hypocritical as to think that it ceases to be entertainment because they play a Bach's fugue. Most religion is a miserable affair, and I, for one, refuse to be miserable. I know that I am a voice, crying out in the wilderness.

Sweeney Todd

IT was most apt of the B.B.C. to broadcast the old myth entitled "Sweeney Todd." Particularly as *Tod Slaughter* was associated with it. You all remember the Demon Barber of Fleet Street who cut up the bodies of his customers to make meat pies. A firm of meat pie manufacturers has complained that following the broadcast the sale of their meat pies fell enormously. If that is so let us go on broadcasting plays such as "A Royal Divorce" in the hope that it will reduce divorce. Let us broadcast "Paradise Lost" in the hope that we may regain it. And, by the same argument, let us broadcast "At Trinity Church I Met my Doom" as a warning to young men, whilst the robust strains of "Beer, Beer, Glorious Beer," should be good for the brewery trade.

A Listeners' Union

IN the United States, radio listeners have formed a union, which claims to have members in twenty-two States and hopes shortly to have 30,000,000 members. They hope to co-operate with radio stations and advertise them. If they fail to co-operate they threaten to call a listeners' strike.



A listeners' strike.

They accuse broadcasters with the transmitting of dirty jokes and glorifying crime even in high class programmes. Is there such a thing as a high class programme in America? And why don't the broadcasters form a union, and refuse to broadcast unless the union members co-operate? Such a threat would bring them to heel. Such a crazy notion as a listeners' union is truly Amurrican.

A PAGE OF PRACTICAL HINTS

SUBMIT YOUR IDEA

READERS WRINKLES

THE HALF-GUINEA PAGE

A Transformer Mounting

THE accompanying sketch shows a neat method adopted to mount a stripped transformer which was obtained from an old eliminator. Two small wood blocks about $\frac{1}{4}$ in. thick were first cut to

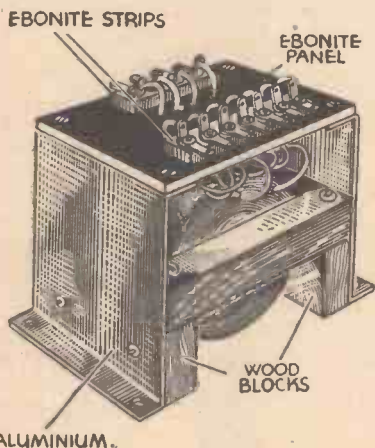

A neat method of mounting a stripped transformer.

the width of the transformer laminations, and the core was then clamped to those blocks, with four long wood screws. Two aluminium end pieces were cut from an old set panel, and bent, as shown, the flanges being $\frac{1}{4}$ in. wide, and fastened to the wood blocks with small wood screws. A piece of ebonite, cut to the required size, was then bolted to the aluminium end plates to

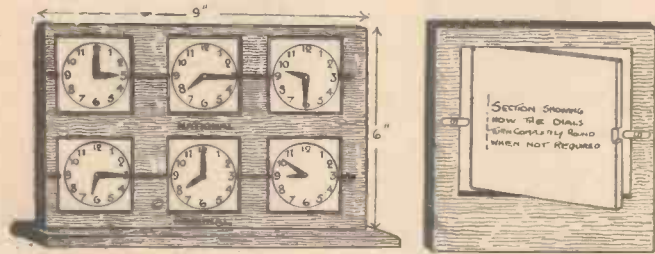

A novel programme indicator.

form the terminal board. The terminals or tags were of the double-ended type, and were fastened to the ebonite top with 6B.A. brass screws and nuts, a small strip of ebonite about $\frac{1}{4}$ in. wide being interposed between the tags and ebonite top. The wires from the transformer were extended with rubber-covered flex, and taken through holes drilled behind their respective tags, and then soldered to the latter. Small nickel-plated terminals could replace the tags if desired. No actual sizes are given, since the particulars depend upon the size of the transformer used, but the above methods may be employed with any small transformer or choke.—JOHN HADDON (Glasgow).

THAT DODGE OF YOURS!

Every Reader of "PRACTICAL AND AMATEUR WIRELESS" must have originated some little dodge which would interest other readers. Why not pass it on to us? We pay £1-10-0 for the best wrinkle submitted, and for every other item published on this page we will pay half-a-guinea. Turn that idea of yours to account by sending it in to us addressed to the Editor, "PRACTICAL AND AMATEUR WIRELESS," George Newnes, Ltd., Tower House, Southampton Street, Strand, W.C.2. Put your name and address on every item. Please note that every notion sent in must be original. Mark envelopes "Radio Wrinkles." Do NOT enclose Queries with your Wrinkle.

A Programme Indicator

WHEN you read through the morning paper, pick out the radio programmes which you wish to listen to during the day, and mark off the times of your selected items on the "Programme Indicator," herein described. This will save you the trouble of constantly referring to your newspaper, and will save you the annoyance of missing altogether a certain item. This indicator, of course, can be made larger, so as to incorporate the additional B.B.C. stations. It is advisable to use five-ply for the main part and three-ply for the clock dials. The squares are cut out by fretsaw, and the dial squares cut, allowing about $\frac{1}{4}$ in. all round. These are fixed by panel pins, top and bottom, enabling them to swivel right round; this is in case you do not require all of the dials and also after a certain item is concluded. The slot cut out of one side and the small brass plates, allow the dial to swivel round to a stop. The fingers are cut out of thin sheet brass, and fixed with a small brass screw and washers, allowing them to turn easily. The dials are made of light-coloured birch, three-ply, and are well sand-papered and given a thin coat of brush french polish. It is quite simple to write the necessary figures without the ink running.—B. A. HENTON (Wim-

borne, Dorset).

A Novel Choke

A PROBLEM met with in the average household is how to dispose of old (used) razor blades, and the accompanying illustrations show how I solved this problem and at the same time provided myself with a very efficient L.F. choke. The blades are employed as a core, approximately 100 being used in the component which I constructed. Two lengths of 4 B.A. studding were locked into position on a base made from a piece of scrap metal, the spacing holes being first marked by using a blade as template. A former was constructed from scrap pieces of paxolin,

although ordinary waxed cardboard could be used, and a winding of 40 s.w.g. enamelled wire was put on. I used approximately 2,000 turns, and calculate the inductance to be about 20 henries. Small bolts and soldering tags from an old rheostat were fitted to one edge of the paxolin former, and the ends of the wire

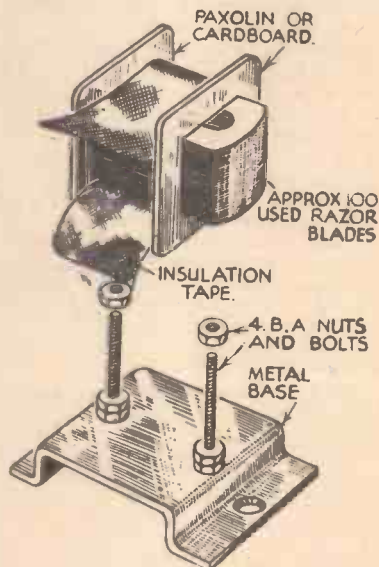

A method of making a choke with old razor blades for the stampings

anchored there, short lengths of fine flex being first soldered to the inner edge to guard against breaking the fine wire. The blades were then slipped into the former, slipped over the bolts, and the top nut placed on and locked up. It is used as an output filter in the standard circuit shown below.—A. W. WARD (Edgware).

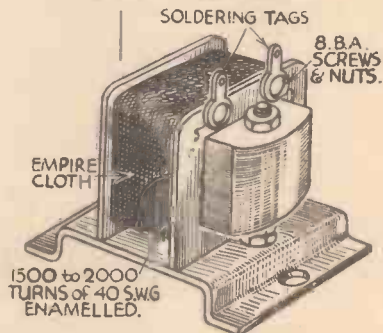
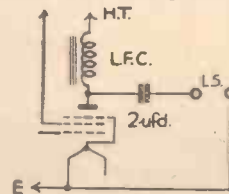

Circuit diagram showing the wiring and a view of the completed choke.

1936 In Retrospect

A Brief Account of the Developments of the Past Year, and a Forecast of Some of the Things which May be Expected This Year By W. J. DELANEY

THE past year has been singularly free from outstanding inventions in the ordinary wireless sphere, although there have been some remarkable general developments. No doubt the biggest change in the general technique has been the increased use of all-wave circuits and the general exodus to the lower wavelengths. This has resulted in many new commercial receivers being introduced for all-wave reception, and we, also, have produced some interesting receivers of this type. Of these no doubt the Record has the greatest appeal owing to the simplicity of construction and the fact that a special ganged all-wave coil unit is employed. As a direct result of this tendency to add the short-wave ranges to the broadcast receiver there has arisen a demand for special aerial systems which will enable the highest efficiency to be obtained on each range. In the direction of reproduction there has been a general improvement in the quality demanded by the ordinary listener, and thus the modern set will be found to offer a much improved quality, with which the loudspeaker also must be associated. The improvement has not been in the low-note response, but in the reproduction of the higher frequencies, and this has removed a great deal of the "boom" or "wooden" effect which seemed to attract so much attention in previous years.

Valve Changes

The increased use of the superhet, which lends itself so admirably to all-wave reception, has led the valve manufacturers

to improve valve construction and valve performance, and the special frequency-changing valves represent the most important change in this direction. The triode combined with another multi-electrode valve in one glass envelope is now steadily replacing the simple pentagrid, and there is the triode-pentode, as well as the triode-heptode, to be found in this particular direction. One or two special valves have been developed for television, but these will be dealt with under the television section. A change in mechanical construction is noticed in the modern valve, and the general system now is to ensure rigidity of the electrode system by anchoring the electrodes to a mica disc or other shape held in position at the top of the glass bulb, which is accordingly provided with a smaller top. This arrangement has practically removed microphony and ensures a longer life for the valve, as it is mechanically stronger.

Television

Undoubtedly the development of the high-definition television system is the greatest advance to be noted at this period. Regular transmissions have commenced from the Alexandra Palace and although at the moment only two one-hour periods per day are given, there is every possibility of an increase at the earliest possible moment, and no doubt before this year is out the present periods will be increased to bring them into line with the present broadcast programmes. In view of the use of the ultra-short wavelengths special aerial systems have been introduced to the listener, and these are now offering scope for experiment. The television receiver has been developed by a number of firms, but the high initial cost no doubt keeps many listeners from sampling the pleasure of the television programme. So far, we have not described a complete television equipment, although certain individual parts have been described. Our

experiments are, however, nearing finality, and we hope to publish full constructional details in the very near future.

The television receiver offers a completely new field of experiment to the home-constructor, and it will be found that this is even more interesting than the ordinary broadcast equipment. In the early days of broadcasting the builder of a receiver was a man to be envied, but the task of

building such a receiver is a very simple matter compared with the modern television receiver. There are many points to be considered in the design, and, in view of the very high voltages, especial care is necessary both in designing and in using the equipment. The Mazda company have produced some interesting valves for the television receiver, and these include special H.F. pentodes for use in the intermediate-frequency stages of the superhet, together

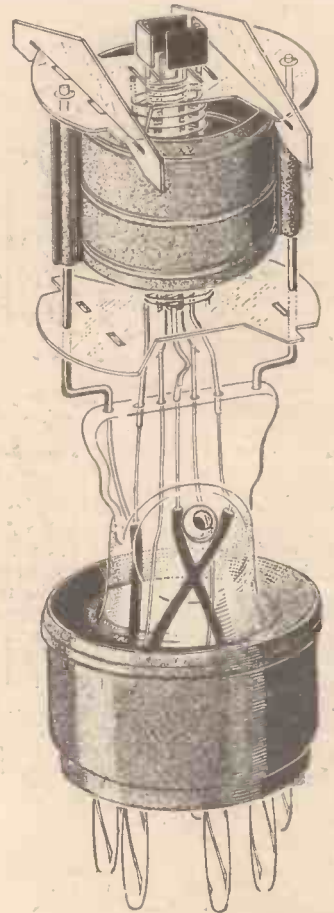

A popular Hivac valve which shows the mica supporting strips which are now generally employed.

with a special double-diode for the second-detector stage. The cathode-ray tube also has been developed, and, apart from an increase in overall dimensions, the fluorescent screen has been improved, and now brilliant black-and-white pictures may be obtained with ease.

As the quality obtainable from the sound section of the television programmes is much higher than on the ordinary broadcast wavelengths, the Edison Swan Company have also developed two new loudspeakers which provide a greater frequency range, and very high quality is obtainable. The demonstration which we recently attended at the research laboratories of this company showed that

(Continued on page 504)



A popular all-wave receiver described by us recently. This also shows the manner in which the valve bulb is now being modified.

Practical Television

January 2nd, 1937. Vol. 3. No. 31.

Making a Début

THE artist who makes his début on the film, stage or concert platform is conscious of his audience, and realises that if he or she makes good, then other engagements are sure to follow as a matter of course. With television, however, conditions differ somewhat. The extent of the viewing audience is unknown, and with the fading-in of many close-ups the artist realises that his characteristic gestures and facial play are reinforcing his act, yet he cannot secure any hints from his audience as to the manner in which the turn is being accepted by those in possession of television receivers. It is interesting to record, therefore, that quite recently, a conjurer who was making his first appearance in the Baird intermediate film studio to be televised was watched in the offices of a theatrical agency some miles away. So good was his turn that the received television picture was instrumental in securing him several other engagements through the agency. As far as is known, this is the first case on record of such a happening, and should be an incentive for all artists to ensure that their television act is rehearsed carefully with a full realisation of further possible developments occurring as a consequence of the programme quality of his received picture.



One of the latest Ferranti cathode-ray tubes intended for use in Ferranti television receivers.

Films and Television

A COMMITTEE set up by the Board of Trade to consider the position of British films and the act of 1927, recently issued its report. On the subject of television the committee state that it was suggested to them in evidence that in view of the possibilities of the televising of cinematograph films from a central broadcasting station, a recommendation should be made to cover the televising of such films for the purpose of public exhibition. The committee then went on to report that no concrete proposals were put before them in this connection, and having regard to the present position of television they did not think it necessary to deal with it in their recommendations. This is all the more remarkable when it is known that in each day's B.B.C. transmission films are included as part of the normal programme. Again, cinema television has been brought very much to the fore of late, especially in view of Mr. Baird's demonstration of pictures 8ft. by 6ft. 6in. at the Dominion Theatre, London. The definition in this case was one of 120 lines interlaced by a new method to such effect that flicker was negligible. (Details of this demonstration and of the methods used were given in

our issue dated December 19 last). Perhaps the committee did not realise the significance of these developments, but it is certain that they will assume a high degree of importance in the very near future.

Transatlantic Television

DURING the course of a recent remarkable four-way short-wave broadcast linking Washington, New York, Niagara Falls, and the Mediterranean, Marconi made several interesting observations. He was speaking from his famous yacht, the *Elettra*, cruising off Genoa, to the president of the R.C.A. in his New York office. Marconi stated that television will soon span the Atlantic. How, and by what method, was not disclosed, but with ultra-short waves performing peculiar feats on the question of range when high powers are employed, anything is possible. It must not be forgotten, also, that in the middle of 1928 trans-Atlantic television was accomplished on short waves. This achievement was all the more remarkable when it is remembered that the radio equipment then available was of a much lower grade than that now in use, while television itself was only just emerging from the laboratory stage in rather crude, low-definition form. Perhaps the reception of B.B.C. television signals in South Africa has altered the view of experts on propagation characteristics.

Looking Ahead

THE next Olympic Games are not to be held till 1940, the scene on this occasion being Tokyo. In spite of the long period ahead, plans are already being drawn up for televising the games. Readers will remember that at this year's Berlin games, certain events were televised by suitably positioned electron cameras and intermediate film equipment vans, the results towards the end being particularly good. With the lapse of about three and a half years before this world's athletic event takes place again, it is difficult even to conjecture to what degree of perfection the scanners and transmitters will be brought. It seems certain that by that time all traces of picture flicker will have disappeared, the definition will be increased, while larger pictures with a very wide range of contrast will be seen in the home. Even with the B.B.C. service, which has only been in official operation a few weeks marked improvements in picture quality and studio technique have been noticed. The full standard of picture definition of which the complete Alexandra Palace equipment is capable has not yet been reached.



The first outdoor night television transmission took place recently at the Alexandra Palace, where a mock "air raid" was staged. The illustration shows the searchlight and television cameras in action.

I HAVE recently been carrying out some very interesting tests with the One-Valve 'Phone Transmitter now being described, and it has proved to be very satisfactory in every way. Whether it is for use with an A.A. or Full Licence, it is capable of providing endless enjoyment and unlimited scope for instructive experiments, but may I remind you to be sure and obtain your licence before operating the outfit. The sketches in last week's issue gave a general idea of the construction.

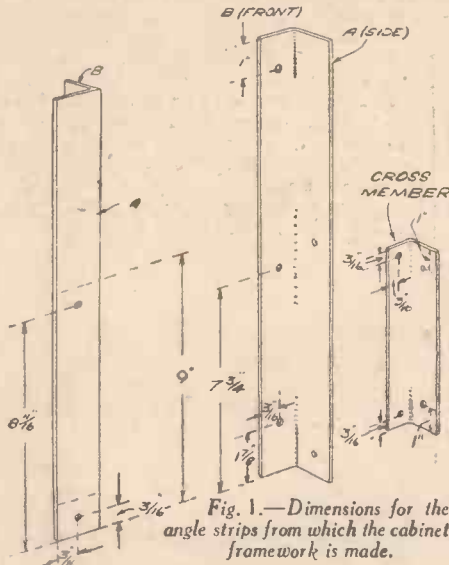

Fig. 1.—Dimensions for the angle strips from which the cabinet framework is made.

The "rack" method of assembly is used, as it enables a self-contained job to be made, and eliminates bits and pieces and batteries from the bench or table, apart from cutting out long and untidy leads.

Constructional Details of Rack

It is possible to buy all the parts for the "rack" ready drilled and cut to the right lengths, but for those who wish to buy the raw material and make it up themselves, a few more details will be helpful. Four



Fig. 2.—The transmitter in its present form, ready for use.

16in. and four 9in. lengths of 3/4in. angle aluminium will be required, 6 BA clearance holes being drilled in the positions shown in Fig. 1.

Do not start bolting these together until the perforated zinc sides are cut and fitted into the 16in. angle pieces. The zinc sides, of which there are two, are 16ins. by 9ins., and it is essential for care to be taken in cutting them. Be sure that the long edges are parallel with each other and at right

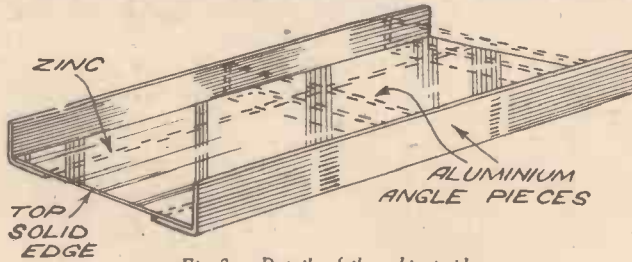

Fig. 3.—Details of the cabinet sides.

angles to the top and bottom, otherwise the whole structure will be thrown out of square.

If the two sides are cut from a roll of material obtainable from one of the cheap stores, it will be possible to have a finished or solid edge for the top of the sides, thus making a much neater job.

Each zinc side must be framed by two 16in. lengths of angle metal as shown in Fig. 2, after which the cross members can be bolted in position. The cross member fitted to the extreme ends forms the support for the floor of the rack, therefore see that the solid end of the zinc sheets are at the other end, that is, the top. When the side sections have been completed, the bottom front ply panel can be placed in position inside the angle aluminium and made secure by four bolts. Again, it is necessary to check the whole thing up for "squareness," although the remaining parts will eventually lock everything up shipshape.

After this, the bottom floor can be considered, but remember, when cutting, that it is not 9ins. square; it is 9ins. by 9ins. less the thickness of the bottom front panel. The floor butts up against the panel, not under it.



Further Constructional Details of transmitter are given in This

Panel and Baseboard

The panel is cut from sheet ebonite, its size being 9ins. by 7ins. by 1/8 in. or 1/4 in. thick, and it is fastened to the baseboard by means of two aluminium brackets.

Use a little care in fixing these, or else the appearance of the panel can be spoiled and the essential rigidity lost.

Before fixing the panel, remember to drill the two holes for the variable condenser and on/off switch, the condenser being mounted in the dead centre, and the switch in the mid position between edge of dial and baseboard. The simplicity of controls will be evident.

The Valve Mounting

It should be noted that a chassis type of valve-holder is used, employing ceramic insulation material, therefore it is necessary to provide the platform shown in Fig. 4, which also allows short connecting leads to be used.

The brackets are made from aluminium, the dimensions being given in the diagram. They are quite easy to make but, if the

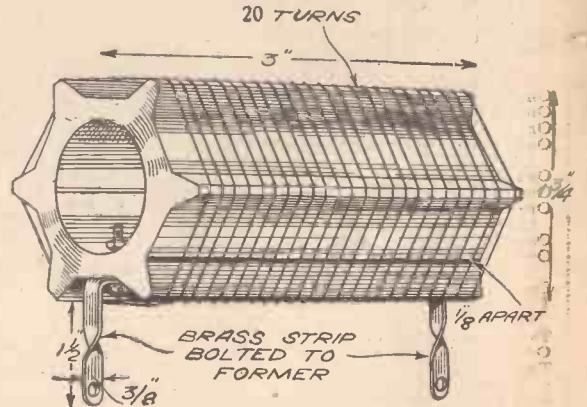

Fig. 5.—The coil is made up as shown here. 18 S.W.G. tinned copper wire is used.

Amateur Wiring

of a Single-valve 'Phone Trans-
Sixth Article of the Series

constructor is not too keen on metal work, neat hard wood blocks could be used.
The platform itself is cut from bakelite or ebonite sheet, the circular hole being 1.2ins. in diameter or, if a compass is not handy, scribe round a penny, cutting just inside of the line. A word of warning is necessary about the valve-holder. When fastening the holding bolts, be very careful not to exert too much pressure, otherwise there is a risk of cracking the ceramic material.

Bolt the aluminium brackets to the platform but, before screwing the assembly to the baseboard, connect to each required valve pin, except one filament, a piece of tinned copper wire about 9ins. long. I would strongly advise the use, if possible,

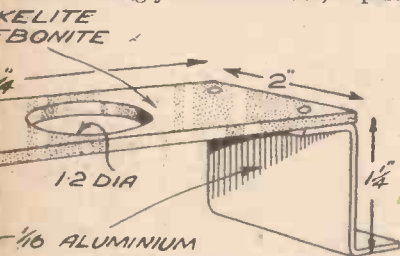

Fig 4.—Mounting for the valveholder.

of solder to eliminate the fracture or breaking of wires by the locking screws in the valve pins. To the one filament pin left vacant, the red lead of a 12in. length of red and black twin flex must be connected, the remaining black lead being taken to one side of the on/off switch on the panel.

Connecting the Components

The crystal holder, L.F. choke, and microphone transformer can now be

LIST OF COMPONENTS FOR ONE-VALVE PHONE TRANSMITTER

- One ebonite panel, 9in. by 7in. by 3/16in.
- One valve—Cossor 240B.
- One variable condenser—B.T.S. .000067 type. Ceramic.
- One fixed condenser, .001 mfd.
- One H.F.C.—short-wave—Eddystone.
- One L.F. choke—Varley.
- One microphone transformer—Bulgin, type L.F.35.
- One dial—Bulgin, type I.P.8.
- One knob, Bulgin, type K.58.
- One terminal block, and two insulated-head terminals.
- One Erie resistance, 30,000.
- One Quartz Crystal and holder. Frequency 7 M.c. (Quartz Crystal Co.).
- Coil to specification (see text).
- Two push-pull switches—Bulgin, type S.38 or S.22.
- Two panel brackets—Bulgin type P.B.3.
- One valveholder—B.T.S. U.H.7.
- Two brackets.
- One strip bakelite.
- Four 16in. lengths 3/16in. angle aluminium.
- Four 9in. lengths 3/16in. angle aluminium.
- Bolts (6BA), nuts, 2 spade ends, 2 H.T. plugs.

mounted on the baseboard, and the connections made according to plan. Be careful with the two anode/grid circuits. Don't connect Anode 2 to the point where Anode 1 is shown, and vice versa.

Three holes must be drilled through the baseboard to allow the battery leads to pass down into the battery compartment. The microphone terminal block should be
(Continued overleaf)

WIRING DIAGRAM FOR THE SINGLE-VALVE TRANSMITTER

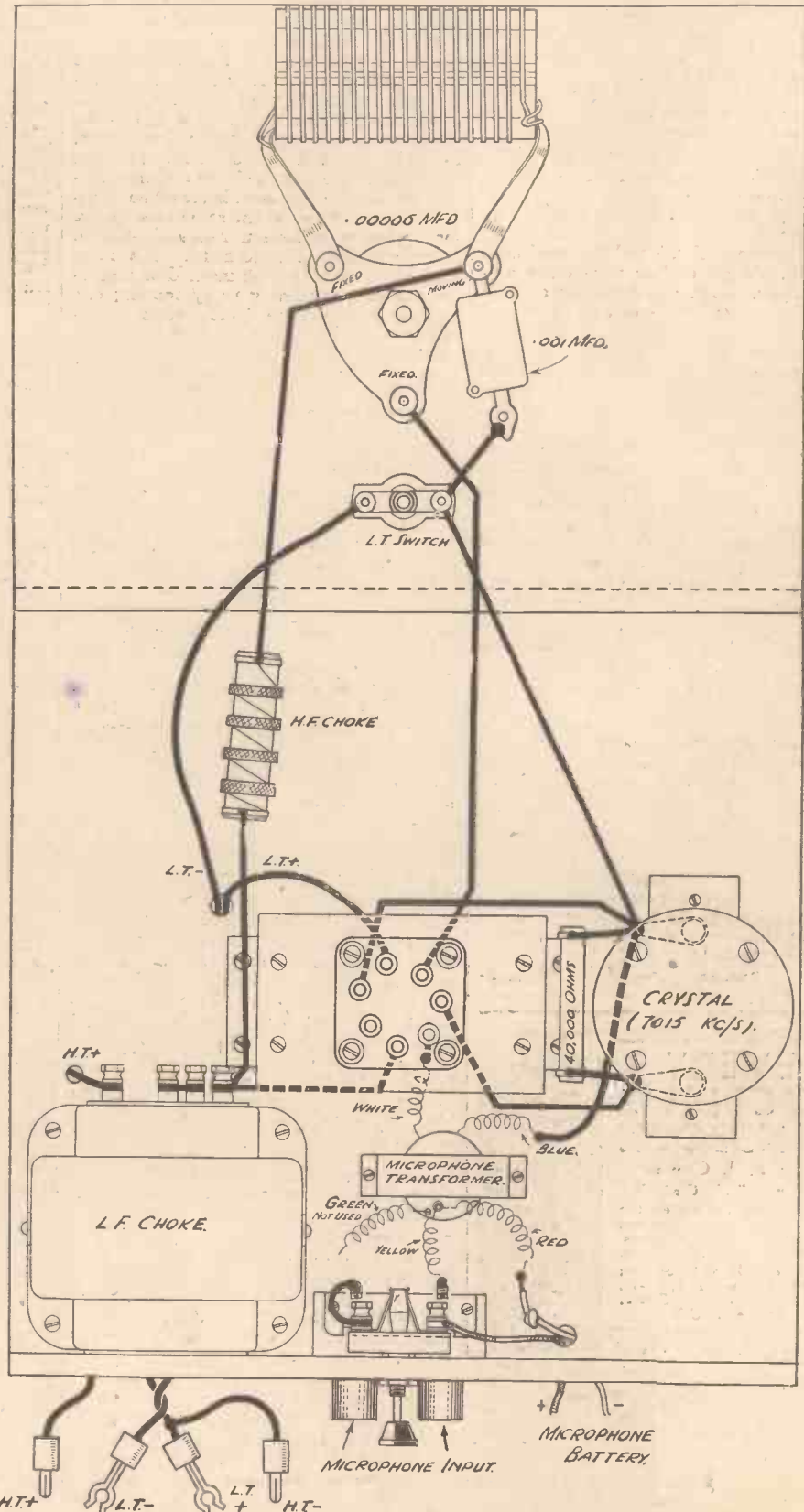

H.T.+ L.T.- L.T.+ H.T.-

AMATEUR TRANSMITTING

(Continued from previous page)

dealt with next, one terminal being connected to one side of the primary of the mike transformer, and the other fitted with a 4in. length of flex to go to the on/off switch on rear panel. The centre-tap or the other side of the primary, according to the microphone in use, is joined to one of the flex leads from the mike battery.

The H.F. choke and .001 mfd. by-pass condenser should now be mounted, leaving the anode coil to the last.

The use of two switches and a terminal block may cause some comment. I purposely used these components as they are more convenient, from the experimenter's point of view, than a dual-purpose switch, and a plug and jack.

The Coil

This is shown in Fig. 5 and is wound with 18 S.W.G. tinned copper wire on a six-ribbed, 1½ins. diam. good quality ebonite former or, better still, one of the special low-loss formers obtainable from Messrs. Peto-Scott or B.T.S. There are twenty turns, each turn being spaced ½in. and wound on as tightly as possible, each end being anchored through a small hole to their respective mounting strips. The brass strips, Fig. 5, are so arranged that they fasten direct on to the terminals of the fixed and moving vanes of the anode variable condenser, the coil being arranged just above the condenser. Before winding the coil, unwind about 5yds. of the wire and stretch it until all unevenness is removed. It will be noted that no tapping points, which are essential for use with a radiating aerial, are shown. They will be mentioned later on, as it is first intended to consider the transmitter with an artificial aerial, which will be described in detail in the next article.

When all wiring is completed, the apparatus can be fitted into the rack, and the back panel mounted, the microphone on/off switch having been mounted just above the terminal block cut-out.

It will be found that the panels keep the perforated zinc tight against the corner pieces, and make the whole structure quite rigid and firm. In this respect, it is advisable to bolt the ebonite panel to the angle aluminium by one bolt, each side, about 1in. from the top edge. For a permanent job, the baseboard should be bolted to the side cross pieces, as all such fixing strengthens the whole assembly.

THE TREND OF CIRCUIT DESIGN

(Continued from page 490)

like the distance-getting properties of a powerful set, is often overlooked owing to the latter being tuned to the "locals" for 75 per cent. of its working life!

Variable Selectivity

Variable selectivity, which allows for maximum-frequency response, and hence the best possible reproduction under the reception conditions pertaining to any particular transmission, is mentioned here for several reasons. It is no new innovation, having been in use for some years, but it takes on a new significance due to its adoption in even popular-priced receivers. A control which will allow for the reception of a station free from whistles and monkey-chatter (adjacent channel heterodyne interference), and which at the same time allows for the best reproduction from each station, is an excellent advancement. The most simple and more popular method of achieving variable selectivity is by moving one coil on one or more I.F.T. units (intermediate-frequency transformers) relative to fixed coils. An alternative arrangement is to interpose a third winding between two fixed ones and control the amount of absorption of the H.F. field by means of a variable resistance control. To the knowledge of the writer it has rarely been explained why the I.F. stages of a superhet are chosen for the purpose instead of the signal-tuned circuits. The reason is that an I.F. stage has fixed tuning where variation of coupling between the windings merely produces changes in bandwidth. With signal circuits, it is possible to achieve a similar effect, although not without a tendency to upset the ganging. Circuit designers are quite content if they can design signal coils and constants which allow the full frequency spectrum to be maintained evenly over each waveband, a desirability rarely attained in practice.

Second-Channel Interference

The presence of second-channel inter-

ferences, peculiar to superhet circuits, are now considered to be proof of poor design. They are normally avoided by feeding back part of the energy developed in the cathode or grid circuit of the frequency-changer to the tuned-aerial system. A further precaution is to screen certain vital leads to the second detector valve. Where an H.F. stage precedes the frequency-changer the practice of providing a feed-back coil is not always followed.

A list of circuit arrangements, given earlier in this article, mentions automatic input-limiting schemes (7) and scientific methods of A.V.C. (8).

By employing amplified A.V.C., the improvement described in (7) is obtained. The theory underlying both ideas is to maintain a constant signal input at the second detector on received transmissions which vary as much as 15,000 to 1. Briefly, the circuit is provided with a large negative grid-bias source which can be automatically fed to the H.F. valves for reducing their magnification progressively with increase of signal developed in the second detector and to operate from a defined maximum. The grid-bias is derived from a separate low-current rectifier or by robbing the H.T. supply to the extent of the G.B. voltage required. Full sensitivity is assured by arranging the diode second detector with a delay action, whereby the H.F. stages assume full amplification when a weak or no carrier wave is received.

When the detector is adjusted to accept a prearranged signal and no more, it is easy to see that the L.F. stages following can be designed not to overload with the volume control full out. Nevertheless, because true perfection has not yet been reached in this system, some reserve of L.F. power is provided to ensure full volume from those stations which do not properly load the diode. Amplified A.V.C. unquestionably "levels up" all stations and enhances reproduction from powerful locals on receivers designed with "DX" properties.

RELIABLE STOP WATCHES

STOP watches are so useful in almost every sphere of activity—wireless, motoring, flying, metal turning, racing—that it is a wonder that more people do not own them. If you develop the stop-watch habit you will increase your knowledge, and can give reliable information about speeds and times instead of making wild guesses. The speedometer is not the most reliable means of testing accurately the speed of a car, the distance it takes to pull up, its rate of acceleration, but a stop watch is infallible. Because of this we should like to draw the reader's attention to the fact that A. Arnold & Co., 19, Clerkenwell Road, London, E.C.1, are specialists in stop watches of all types, sizes, and prices, from a few shillings to several pounds, in chrome, nickel, silver, and gold—for the wrist or the pocket, and in a variety of case styles.

It is always wise to deal with a specialist. You cannot expect to buy a reliable stop watch at a general stores. The firm mentioned have been specialists for many years, in all types of timers, from the simple stop watch with or without fly-back, to complicated split

seconds chronographs, with Kew A certificates, costing several pounds. They supply a variety of dials for various purposes, sports, mechanical, dog racing, medical, etc., accurately calibrated for the purpose required. Whatever stop watch you require A. Arnold & Co. have it. Drop them a line at the address given and explain your requirements. They will send you illustrated lists and a quotation by return.

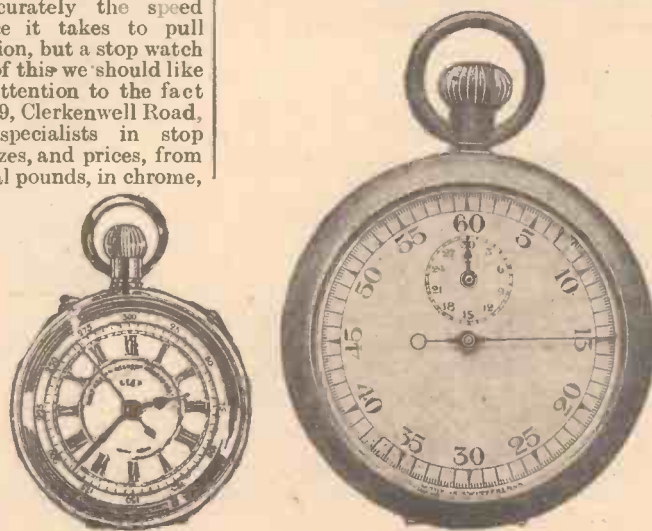

Two of the interesting Arnold Stop Watches.

EVERY CYCLIST'S HANDBOOK

By F. J. Camm

(Editor of "The Cyclist")

The Standard Work on the Bicycle . . . on the road and in the workshop. 200 pages. Fully illustrated throughout.

3/6 net or 3/10 post free from George Newnes, Ltd., 8-11, Southampton Street, Strand, London, W.C.2.

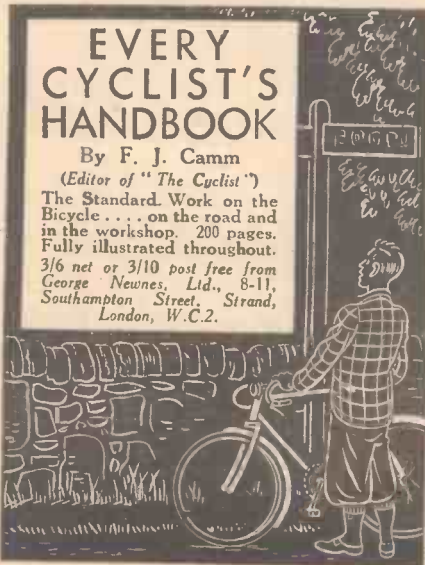

New G.E.C. Research Laboratory

A Brief Account of How the G.E.C. Tackles the Problems Associated with High-class Radio Apparatus at their New Laboratories at Coventry

SINCE the advent of broadcasting in 1922, steady progress has been made in the scope and quality of wireless transmission. In order that the receiving end should not lag behind, much research work has been necessary on the part of manufacturers, and the rapid climb to the present-day peak of achievement in radio reception is a matter of history.

This successful result has, however, not been reached without considerable forethought and planning, particularly by the larger radio manufacturers like The General Electric Co., Ltd., which turns out complete receivers in tens of thousands annually. Two centres of radio investigation are maintained by the G.E.C.: one for research proper at the Wembley Research Laboratories, and the other for works development at the Coventry Radio Works. At the Wembley establishment, which is, of course, solely devoted to research of one kind or another, ample accommodation is available, and the whole radio industry is covered—from receiving valves and sets to the large transmitting valves used in broadcasting

for acoustic, electrical, mechanical, and circuit development respectively.

Speaker Development

For speaker development the laboratory work proper is supplemented by the final listening tests on speakers and complete receivers. Owing to the difficulty of reproducing domestic conditions artificially, these tests are carried out in a "living-room," in which the constructional details, furniture, walls, hangings, and so on are similar to those of a normal domestic interior. The only essential difference from the living-room of an average house is the provision of a test bench on which half-a-dozen receivers at a time can be tested and compared, relay devices with remote control push button switches being installed for rapidly changing from one receiver to another.

In the electrical development of receivers one of the main requirements is the provision of working space so that each worker is reasonably free from the acoustic and electrical disturbances caused by his fellows,



One of the small laboratories, fitted with a wide range of testing instruments.

stations. At Coventry, however, the growth of manufacturing activities and the additional room required for the commercial production of television receivers meant that the space available for experimental investigation was becoming congested. It was therefore decided early in the year to erect a new building where the works development of receivers could be carried out under scientific conditions, while at the same time close contact could be maintained with all sections of the factory.

The new G.E.C. Radio Laboratory at Coventry is situated near to, but separate from, the manufacturing shops. It is divided into about twenty-four separate offices and laboratories and it has been built in two floors, enabling the ground-floor rooms to be made reasonably sound-proof for work requiring silence and freedom from mutual interferences. The work of the laboratory is divided into four sections

consequently a number of small laboratories, one of which is shown in the illustration above, each suitable for one or two engineers and an assistant, have, therefore, been provided on the ground floor of the building. Each of these laboratories is provided with signal generators and standard testing equipment, while special equipment (e.g., radio-frequency bridges) that is not so frequently employed is installed in two further rooms for use when required.

Work requiring the total elimination of electrical interference is carried out in a "screened" room, which was designed after investigations extending over several months. This room is fully screened, and special arrangements are made to prevent interference being brought in from the mains; so effectively has this been carried out that it is impossible to receive from even the most powerful transmitting station or from locally generated interference unless there is an aerial outside the room.

PETO-SCOTT

RECORD BATTERY ALL-WAVE 3

KIT "A." Authors kit of first specified parts, less valves, cabinet and speaker. CASH OR C.O.D. Carriage Paid 4/2/6, or 12 monthly payments of 7/8. With 3 specified valves. Cash or C.O.D. Carriage Paid: 25/9/3, or 12 monthly payments of 10/-.

MAKES YOUR SET an ALL-WAVE!

B.T.S. ADAPTOR

HEAR AMERICA DIRECT with this famous unit.

12-47 METRES



Simply plugs into your battery or A.C. Mains set. The only adaptor at the price with 100-1 ratio aerial tuning and slow-motion reaction: for use either as Plug-in or Superhet Adaptor. Walnut finished Cabinet (111 u.s. traded). With 2 plug-in coils, 12-26, 22-47 metres. Ready assembled.

CASH OR C.O.D. Carriage Paid 2/6

2/6 DOWN

Extra. coils, 41-94 and balance in metres, 2/9; 76-170 12 monthly payments of 4/9.



1937 SPEAKERS

SPECIFIED FOR THE COLT AND RECORD RECEIVERS

MODEL 378. Amazing reproduction provided by new magnet and exponential moulded cone. (Micro-iodide matching device. Cash or C.O.D. Carr. Paid 2/2/0. Or 2/6

2/6 DOWN

down and 11 monthly payments of 4/-.

MODEL 377. Matches any receiver as principal or extra speaker. Cash or C.O.D. Carriage Paid, 2/12/6. Or 2/6 down and 11 monthly payments of 3/-.

PETO-SCOTT Co., Ltd., 77 (Pr. W.15), City Road, London, E.C.1. Telephone: Glosold 9875. West End: G2 (Pr. W.15), High Holborn, London, W.C.1. EST. 1919

A Radio mechanic named Hyde
For a "fault-finder's" job once applied.
"I'll be all right," he mused;
"Where no FLUXITE'S been used
I could always find fault if I tried."



See that FLUXITE is always by you—in the house—garage—workshop—wherever speedy soldering is needed. Used for 30 years in government works and by leading engineers and manufacturers. Of Ironmongers—in tins, 4d., 8d., 1/4 and 2/8.
Ask to see the FLUXITE SMALL-SPACE SOLDERING SET—compact but substantial—complete with full instructions, 7/6.
Write for Free Book on the art of "soft" soldering and ask for Leaflet on CASE-HARDENING STEEL and TEMPERING TOOLS with FLUXITE.

TO CYCLISTS! Your wheels will NOT keep round and true, unless the spokes are tied with the fine wire at the crossings AND SOLDERED. This makes a much stronger wheel. It's simple—with FLUXITE—but IMPORTANT.

THE FLUXITE GUN

is always ready to put Fluxite on the soldering job instantly. A little pressure places the right quantity on the right spot and one charging lasts for ages.
Price 1/6.



ALL MECHANICS WILL HAVE

FLUXITE

IT SIMPLIFIES ALL SOLDERING

FLUXITE LTD. (Dept. W.P.) DRAGON WORKS, BERMONDSEY STREET, S.E.1.

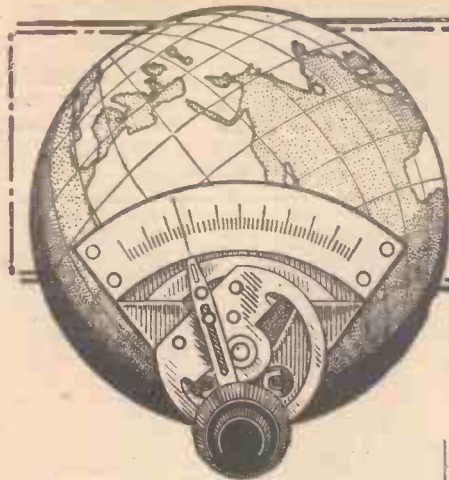

SHORT WAVE SECTION

THE TUNED H.F. STAGE VERSUS THE SUPERHET

The Possibilities of the T.R.F. Receiver are Discussed in this Article
By A. W. MANN

A NOTICEABLE thing relative to short-wave circuits and receivers is that the individual types have a definite following amongst enthusiasts. Financial status, together with variations in the standards of constructional and operating skill, is undoubtedly responsible for such diversity of tastes, and whilst everyone desires the best type of receiver obtainable, the majority must compromise and build the best they can afford.

The experimenter of long standing more or less takes everything in his stride. Consequently some favour the superhet, others the T.R.F. receiver, and regard short-wave reception via the loudspeaker as the only means worthy of consideration. Such ideas are, of course, erroneous. We must take a broad view and remember that the headphone-type receiver meets the individual requirements of some, if not of others.

The most satisfactory receiver is that which enables one to obtain results which are equal or surpass those which may reasonably be expected at the price. Sponsored designs are, therefore, a sound investment.

Selectivity and sensitivity are factors of vital importance, and the superhet is undoubtedly the most selective and sensitive type of short-wave receiver available, and, in addition, the colossal stage gain of this type of receiver cannot be disregarded.

Superheterodynes, however, have their disadvantages, some of which can be overcome if one is prepared to pay the price.

Many, however, cannot afford to do so, yet desire short-wave reception via the loudspeaker, and consequently the T.R.F. receiver still enjoys a measure of popularity. If carefully designed and used in conjunction with a suitable aerial and earthing system, a reasonable degree of selectivity and sensitivity is obtainable. Selectivity and sensitivity, however, are much below superhet standards, although some improvement is noticeable when modern coils and H.F. pentodes are employed.

Tuned and Untuned H.F. Stages

It is, however, generally realised that in order to obtain the maximum of H.F. amplification the H.F. stages should be tuned. This, however, does not mean that untuned H.F. stages are absolutely useless. An untuned stage of H.F. has limitations, and so long as such are realised and definitely understood, can be used to serve a purpose within those limitations. Usually, untuned H.F. stages are associated as buffers between the aerial and the detector stage.

A receiver in which two tuned H.F. stages are used requires very accurate coil matching and condenser ganging, in order to obtain maximum sensitivity, selectivity and volume. To achieve all this is by no means a simple matter.

The degree of effective H.F. amplification obtained on the higher frequencies falls a long way below broadcast standards, and whilst two tuned stages will obviously prove to be better than one, comparative tests have shown that the difference between a tuned H.F. stage, followed by an untuned H.F. stage as an alternative to the use of two tuned stages, is in many instances not sufficiently marked to justify the extra controls and coil-matching procedure.

Thus it will be appreciated that the use of a tuned H.F. stage, followed by an intermediate untuned stage is, in the circumstances, worthy of consideration, as the loss in selectivity and sensitivity are very slight indeed.

If, however, controlled oscillation or, to be correct, controlled regeneration in the H.F. stage, could be introduced, both sensitivity and selectivity would be considerably improved.

Whilst an attractive proposition, it is by no means a simple one, because the application of reaction during operation to one stage would throw the other into oscillation.

The regenerative stages must, therefore, be effectively isolated, and the inclusion of an untuned intermediate H.F. stage would accomplish this successfully, because whilst allowing signals to pass through the set in the normal way, it would prevent feed-back between the detector and regenerative H.F. stage. The complete screening of each stage and separate control of each reaction circuit would be necessary, although there appears to be no reason why the tuned circuits should not be ganged, and a drum-type dial used.

Experiments along the lines suggested

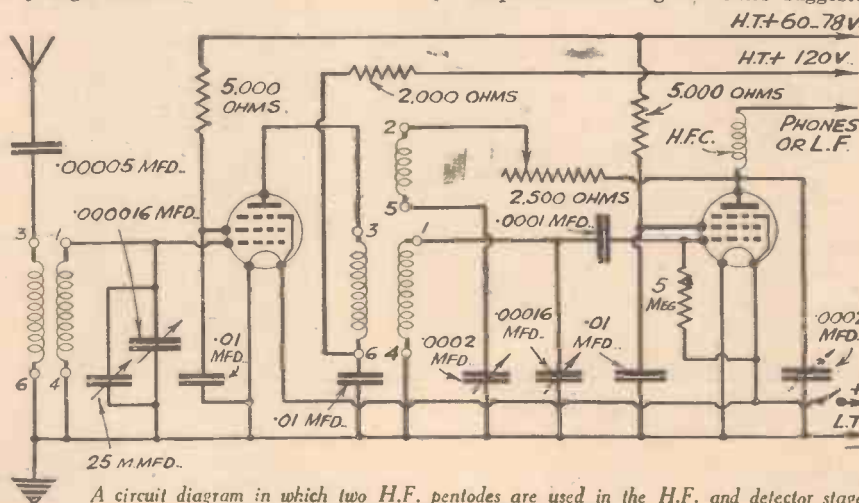

A circuit diagram in which two H.F. pentodes are used in the H.F. and detector stages, and a rather complex reaction system is employed.

An Experimental Receiver

Whilst tuned and untuned H.F. amplification is under discussion, further applications of the latter might form a basis for useful experiment. For example: a carefully-designed receiver, employing one or two tuned H.F. stages, is usually comparatively trouble free, and simple to operate, especially when ganged tuning is incorporated.

Experimental models, however, sometimes behave in quite a different manner, and one of the most common symptoms experienced is instability due to self-oscillation in the H.F. amplifiers, over which the operator has no control, and a definite cure must be found before any useful work can be done.

cannot be regarded as straightforward, due to the fact that the method adopted in order to overcome one snag may create others. One fact, however, must be borne in mind, namely, that whilst some means of increasing the selectivity and sensitivity of the T.R.F. receiver is desirable, simplicity of control must not be sacrificed.

Providing, however, that the application of high-frequency regeneration can be applied, and simplicity of control retained, there is no reason why the T.R.F. receiver should not regain the popularity lost to the benefit of the superheterodyne.

Taking into consideration the ability and adaptability of British research workers, such developments are within the bounds of possibility.

BRITISH LONG DISTANCE LISTENERS' CLUB

Local Branch Formation

MR. A. ANDERSON, of 12, Goodyear Terrace, West Thurrock, Grays, Essex, would like to get into touch with any members, handy to Grays, who would like to form a branch there. He says that he has found that some of his best reception has been on moonlight nights. He also says, "if I do not get very good reception and have a lot of crackle to contend with, it is nearly certain to be rough weather the next day. In fact, so regular has this become that the chaps at work now ask me what sort of day we are likely to have."

Station Identification

MR. J. S. PARKER, of Worcester, has heard two transmissions which he cannot identify, and would like to know whether any member can let him have details, particularly the country of origin and the QRA, of the following two stations:

(a) GF9A, heard on December 7th on 14 mc/s, at 15.05 G.M.T. approx., using C.W.

(b) FS5AZ, heard December 14th, 14 mc/s, at 17.15 G.M.T., using C.W., and sending CQJ.

Both calls were checked several times. Have these call signs been heard by any other listeners?

Station Reports

WITH regard to the various correspondents who complain about not receiving cards in return for their reports, G6GA says that unless one replies to a card as soon as it arrives it gets mixed up with the rest and is very easily forgotten, though he does try to reply to all the reports he receives.

He says: "When it comes to the value of the reports, I think that the standard of the British listeners is comparatively high compared with the ones I receive from other countries, especially U.S.A."

"I would like to quote from one received from a S.W.L. in Ohio; it seems that he heard me talking to a certain station in Dominica. He writes: 'I heard you at twenty minutes till eleven p.m. your time; you were beautiful; you sound as if you were using about 70 watts.' I must say that I have never received one like that from a British S.W.L. Another writes: 'I am five feet ten and one half inches tall, and weigh one hundred and fifty-five pounds. I am very interested in radio.' I ask you, what has it all got to do with radio?"

A Novel Aerial

MR. LEIGH writes regarding the aerial system recently described:—"I would like to add to my recent letter about aerials that if any of your readers are interested I will make some regular tests, say, every day at 2.30 a.m., 6.0 a.m., 1.0 p.m., 6.0 p.m., for a month on the 20 m. band and will let you have a full report for publication. The tests would simply be comparing signals, first on a 66ft. aerial, second on [a Dipole aerial, for a period of about fifteen minutes. Weather report, temperature, etc. "Perhaps a member of the B.L.D.L.C. in some other district would compare results."

IMPRESSIONS ON THE WAX

Vocal Gems

THE Light Opera Company adds to its series of Vocal Gems with a tuneful medley, "Memories of Lehar," on *H.M.V. C 2878* and Janet Lind and Webster Booth are the soloists in "This Year of Theatreland, 1936" on *H.M.V. C 2867*, which introduces some of the most tuneful songs of the year. John Watt compères an assembly of "Stars in Top Liners of Variety" on *H.M.V. C 2886*, and also the world's six best dance bands playing "Eight Hits of 1936" on *H.M.V. C 2887*. Ray Noble on *H.M.V. C 2872* and Roy Fox on *H.M.V. C 2875* both contribute medleys of the favourite successes, and Jack Hylton throws a party to which he asks Tommy Handley, Tom Webster, Nelson Keys, Jack Barty, and a host of other celebrities on *H.M.V. C 2883*.

There are some tuneful light orchestral records—Marek Weber's orchestra in "Durand's Waltz" and "Tiny Tot" on *H.M.V. B 8507*, Barnabas von Geczy and his Orchestra in "Pony" and "Ragamuffin" on *H.M.V. B 8510* and Jack Hylton's Orchestra in "Bolero" and "Vienna, City of my Dreams" on *H.M.V. BD 393*. Alfredo Campoli with his Orchestra plays a "Christmas Fantasy" on *H.M.V. BD 381*, and there is a fine medley of Strauss waltzes played by the Viennese Waltz Orchestra on *H.M.V. C 2882*.

For the Children

THE children are well catered for. Peter Dawson has a "Children's Party" on *H.M.V. B 8509*, and there is a pantomime, "Little Red Riding Hood" on *H.M.V. BD 384*, and a "Toyland Medley" by Anton and the Paramount Theatre Orchestra on *H.M.V. BD 392*. Parents who wish to be popular should make a special note of the Mickey Mouse Album, to hold six records made from the actual film sounds of the "Mickey Mouse and Silly Symphony Series." The newest records include the "Orphans' Benefit" and "Mickey's Grand Opera"—*H.M.V. BD 382*, "The Grasshopper and the Ants" and "Mickey's Moving Day"—*H.M.V. BD 386* and "Three Little Wolves" and "Three Little Pigs" on *H.M.V. BD 387*. These, with the three records already issued, can be purchased in a delightful album for 10s. 6d.

Dancing Time

THERE is, of course, a good list of the latest dance hits, including "Just say 'Aloha,'" and "I'm in a Dancing Mood," played by Jack Hylton and his Orchestra with vocal refrain by Bert Yarlett on *H.M.V. BD 5136*, and "Did Your Mother Come from Ireland?" and "The Miller's Daughter Marianne," played by Roy Fox and his Orchestra. "Fats" Waller and his Rhythm contribute "I'm at the Mercy of Love" and "Copper Coloured Gal" on *H.M.V. BD 5133* and "S'posin'" coupled with "Sing an old-Fashioned Song" on *H.M.V. BD 5135*.

BUY
"THE CYCLIST,"
2d. Every Wednesday.

ELECTRADIX BARGAINS



TRANSmitters, MORSE AND SIGNAL KEYS, Royal Air Force model, balanced action, all solid brass bar, tungstic contacts, indicator lamp. Type KHS1, a guinea key for 7/6. Other keys from 4/6 to 30/-. Learner's outfit complete. 4/9. Ask for

special illustrated Key List. Send 1/6.
ALL-WAVE CRYSTAL SETS with plug-in coils, 2 tuning condensers, semi-perm. detector, 7/6.
HEADPHONES—Sullivan 120 ohms, 2/9. Ericsson, Lissen and others, 2,000 and 4,000 ohms, 4/6. Single high res. ear-pieces, 2/6.

HOME RECORDING is great fun, and cheap. Record your voice with any gram. on the MIVOICE Acoustic Recorders. De Luxe model in presentation carton. Two-cases model, 18/6. Speakasie gram set, 10/6. Junior ditto, 5/6. Spare blank records, 4/- doz. **MICROPHONES**—We are makers and carry the largest and most varied stock in London. Prices are low and these are models for all purposes.

Table Model "W.W.11." For home broadcasting. Bakelite square body on bronze base, containing transformer, switch and plugs, is a marvellous production at a low price. Worth 2 guineas. Only 15/-.
Lesdix No. 10B Pedestal, 10in. high, 12/6. Lesdix Superior No. 12B Ring, 14in. pedestal, 18/6. Hand mikes in 2-in. case, No. 1 at 5/6. Superior type, No. 11a, 7/6. Home microphone No. 11 is a solo general-purpose robust mike with solid bakelite body, back terminals, front metal grille, hand or sling design, 5/6.

COILS—Short-wave coils, plug-in type, 1/6 each; Ribbed low-loss formers, 9d.; Long-wave 2-pin coils, 1/-; Reaction tuners, 9d.; Mains interference, H.F. twin chokes, 2/-; SOLENOIDS for model or relay operation, 6-v. or 12-v., with jin. 1oz. iron travel, 2/6.
SMALL MOTORS—D.C. 6-v., 12/6; 50-v., 14/-; 110-v., 15/-; 220-v., 18/-; Home Cinema type, D.C. or A.C., 18/6. A.C. 230-v. induction enclosed, 1/10 h.p., 35/-; A.C. electric drills, ditto to jin., with chuck and flex, 69/6. Universal type motors, 1/16 h.p., 35/-; 1/4 h.p., 45/-; 1 h.p. induction, A.C., 49/-; Large sizes stocked.

COMMUTATORS—For dynamos, motors, interruptors and multi-switches. Engine built, 24 copper segments, mica insul., finely finished, 2/- worth 7/6.
ROTARY CONVERTERS, small size, 220-v. D.C. to 15-v. 1 amp. A.C. for transforming to any voltage, ball bearings, laminated acid, silent, 65/-; 50 watts, 2/6.

COIL TURN COUNTERS for checking the number of turns up to 9,999 on dial. Soiled, 1/3 each.

BELL SETS. Best British Trembler, 2/2/- each. Porcelain super-grade. Pushes, bankrupt 2/6 line for 6d. Flat Brass, 1/6. Door Barrel, all brass, 2/6. Twin lead-covered bell wire, 1d. per yd. Indoor bell wire, single, 100 yds., 1/6; twin, 3/-; Transformers for ringing 100-v. A.C., 2/6; 200/40 A.C., 3/9. Indoor Aerials, 1/-.
SPARK COILS—jin., jin. and jin. gap, with condensers. Large coils, 2in. to 7in. dia., 23/-; Short wave spark transmitters for boat model control, 17/-; **SPEAKERS AND MIKES** cheap.

1,000 gifts in our latest Bargain List "N.", free.

ELECTRADIX RADIOS
218, Upper Thames Street, London, E.C.4.
Phone: Central 4611

Convert your receiver into an ALL WAVE with a—

"RIDCO"

SHORT WAVE UNIT

"RANGER" MODEL 15-85 metres. Suitable for any type of A.C. Mains or Battery receiver.

AMERICAN RECEPTION GUARANTEED ON ANY RECEIVER.

Price 27/8 (less valve)
Price 37/6 (with valve)
Post Free.

"CUB" MODEL 19-50 metres. Suitable for A.C. Mains. Superhets only. Price 9/6 ready for reception. Post Free.

RIDCO UNITS ARE RECOMMENDED BY "PRACTICAL AND AMATEUR WIRELESS."

Send for illustrated catalogue.

RADIO INDUSTRIES DEVELOPMENT CO.,
Birch St., Hanley, Stoke-on-Trent

Let Us Send You This 40-Page Booklet—Free



It gives full information regarding various I.C.S. Courses of Instruction in Radio work. The Radio industry is progressing with amazing rapidity. Only by knowing thoroughly the basic principles can pace be kept with it. I.C.S. Instruction includes American broadcasting as well as British wireless practice. It is a modern education, covering every department of the industry.

OUR COURSES

Included in the I.C.S. range are Courses dealing with the Installing of radio sets and, in particular, with their Servicing, which to-day intimately concerns every wireless dealer and his employees. The Equipment Course gives sound instruction in radio principles and practice.

There is also a Course for the Wireless Salesman. This, in addition to inculcating the art of salesmanship, provides that knowledge which enables the salesman to hold his own with the most technical of his customers.

Then there are the Preparatory Courses for the City and Guilds and I.W.T. Exams.

We will be pleased to send you details and free advice on any or all of these subjects. Just fill in, and post the coupon, or write in any other way.

International Correspondence Schools, Ltd.,
Dept. 94, International Buildings,
Kingsway, London, W.C.2.

Without cost, or obligation, please send me your "Radio" booklet of information about the Courses I have marked X

- COMPLETE RADIO
- RADIO SERVICING
- RADIO EQUIPMENT
- RADIO SERVICING AND SALESMANSHIP
- WIRELESS ENGINEERING
- EXAMINATION (state which)

Name Age

Address

.....

RADIO CLUBS AND SOCIETIES

Club Reports should not exceed 200 words in length and should be received First Post each Monday morning for publication in the following week's issue.

Radio, Physical and Television Society

AT the Society's last meeting of 1936, which was held on Friday, December 11th, a representative of Messrs. Milnes Distributors, Ltd., lectured on "Wet H.T. Accumulators." After summing-up the relative advantages and disadvantages of the lead-acid accumulator the lecturer explained how most of its disadvantages are overcome by the use of nickel-cadmium cells. The latter is, of course, open to certain disadvantages, the most important being its comparatively low E.M.F., the affinity of the caustic-potash electrolyte for carbon-dioxide and, above all, its higher cost. The lecturer claimed, however, that these disadvantages were outweighed by the advantages, as the very action of the lead-acid battery must tend to wear it out, whereas in the case of the nickel-cadmium cell the electrolyte does not attack the materials of which the cell is constructed.

The Society proposes to begin the year 1937 with an informal social evening to be held at the Society's headquarters on January 1st. Meetings of the Society are held at 72a, North End Road, West Kensington, W.14, every Friday evening at 8 o'clock. Readers requiring further particulars are invited to write to the Hon. Secretary, Mr. V. R. Walker, 49, Fitz-James Avenue, West Kensington, W.14.

Newbury and District Short-Wave Club

THE above Club have now a good club-room at No. 12, Northfield Avenue, Newbury. The clubroom is open day and night to members. A modern four-valve short-wave receiver has been installed for the use of all members, also a morse key outfit for those who wish to learn the morse code. The clubroom is also fitted with a work bench for those who wish to make their receivers there. More keen members are needed and will be welcome. Particulars from Hon. Sec., Mr. L. B. King, 12, Northfield Avenue, Newbury.

Radio and Television Society (Merchant Taylor's School, Northwood)

A RECENT meeting of this Society commenced with a short lecture on "Microphones," by the Hon. Sec., R. B. Gardner. He illustrated the various types of microphones in use, elaborating more particularly on the microphones at the B.B.C., when at Savoy Hill, and those at present in use at Broadcasting House. He then showed the members the sensitivity of certain types of microphone. Hon. Sec., R. B. Gardner, 91, Clarence Gate Gardens, London, N.W.1.

Wellingborough and District Radio Society

THE fortnightly meeting of this Society was held on Wednesday, December 16th, in the Midland Hotel, Wellingborough, when a lecture was given by the Hon. Sec., Mr. L. F. Parker, G5LP, on "Transmitting for the Amateur."

In reviewing the qualifications necessary for an amateur to hold a transmitting licence, Mr. Parker explained

that it was not at all necessary that the applicant should be an expert in theory, and all that was really required was a keen interest in radio and at least a year's experience of short-wave listening on the amateur bands coupled with as much practical experience as could be obtained in the construction of short-wave receiving apparatus. Books dealing with the various aspects of the theory of radio could quite easily be obtained from the local library, and although short-wave literature was rather rare at such places, the fundamental laws of electricity, magnetism and induction were quite easily obtained, and should be studied by all those who aspired to become the future owner of an active transmitting station.

At this point, special mention was made of the valuable help that PRACTICAL AND AMATEUR WIRELESS was to the beginner, and stress was paid upon the new series of articles appearing in that paper and dealing with the transmission side from the viewpoint of the beginner.

Mr. Parker then went on to describe in detail the various transmitting circuits which were mostly used by amateurs in this country, and lantern slides depicting the circuits were shown on the screen.

Hon. Sec., L. F. Parker, 127, Jubilee Crescent, Wellingborough.

Swindon and District Short-Wave Society

ON Thursday, December 10th, Mr. E. W. Mortimer (2BMM) gave a very instructive lecture on "Fixed Condensers." A large number of condensers, kindly loaned by Messrs. Dubilier were on view. The construction of the club's short-wave receiver was begun, Mr. E. W. Mortimer being in charge of the work. He stressed the need of careful layout in short-wave gear, and explained the functions of the various components. His work and advice were followed with keen interest, particularly by the junior members. The membership still continues to swell, and all members are looking forward to the granting of a transmitting licence and the construction of a transmitter for the Society. There are now six A.A. licenses held by members, and they are carrying out experiments with American 59's and 53's as oscillators and other experimental work. We need more members and further particulars can be obtained from Hon. Sec., W. C. Barnes (2BWR), 7, Surrey Road, Swindon, Wilts.

Exeter and District Wireless Society

AT a meeting of the above Society held recently at No. 3 Dix's Field, Exeter, a large and enthusiastic audience listened to a most interesting talk on amateur radio given by Mr. H. A. Bartlett, Radio G5QA, of Exeter. The speaker briefly sketched the history of the amateur movement right from pre-war days, and illustrated his talk with many pieces of apparatus both old and new.

The next meeting will not be held until February 8th, 1937, when members are to visit the station belonging to Mr. Ware, of Woodbury, near Exeter, where a demonstration of high-definition television is to be given. Intending members should get in touch with the Secretary, W. J. Ching, Esq., 9, Sivell Place, Heavitree, Exeter.

TELEVISION AND SHORT-WAVE HANDBOOK

By F. J. CANN

3/6 or 3/10 by post from
George Newnes, Ltd., Tower House,
Southampton St., Strand, W.C.2.

REPLIES IN BRIEF

The following replies to queries are given in abbreviated form either because of non-compliance with our rules, or because the point raised is not of general interest.

R. G. L. (Walthamstow). We regret that we have no blueprint using the coils referred to. They could, of course, be incorporated in any H.F. or Detector-I.F. circuit, and the only thing we can suggest is that you try and get hold of an old Colvern catalogue, in which a suitable circuit will be found.

M. H. (Exeter). The unit may be suitable, but any slight residual hum left after smoothing would give rise to trouble on the short-wave bands.

A. J. L. (Redcar). Quite good 'phone results should be obtained with the receiver mentioned under the conditions set out in your letter. We thank you for your sentiments.

C. (W.14). Can you let us have further details? Is there nothing in our Blueprint list which appears to be suitable?

M. S. L. (Kingsland). We think the most suitable set in your case would be the Twenty-station Loud-speaker One-valver, blueprint No. AV440.

A. M. (Blackpool). No doubt your mains unit will need modification, or the circuits will have to be altered, and we therefore suggest that you try the receiver with a dry battery before going any further.

C. A. L. (Brownhills). Perhaps your meter is unsuitable for measuring the voltage in this particular case. Use it as a milliammeter and ascertain whether any current is being passed in that valve. If not, then there must be some interruption in the H.T. and it should not be difficult to find it in this particular case.

M. C. N. (Dromod). What details do you require? We give the prices of components and full instructions for building our receivers as they are published.

F. P. (Dublin). The ordinary type of valve should not be microphonic in the sense mentioned and perhaps, therefore, the valve is faulty. Try a substitute. If the trouble still persists, it may be due to vibration carried to it from a transformer or choke with loose laminations; these could be tightened or the component mounted on rubber. If it is due to sound waves from the loudspeaker, the valve will have to be enclosed, but adequate ventilation must be provided for it.

C. P. D. (Chislehurst). Each valve must be given individual treatment, and you will find that some voltage between 45 and 66 volts will prove suitable. Adjust it for the best control.

W. W. (Crewe). We cannot trace any details of the coil in question.

R. G. T. (East Talbot). We have not described the method of adding full A.V.C. to this receiver. A meter for tuning should be included in the anode circuit of the I.F. valve.

R. J. P. (S.E.21). The H.T. applied from your mains unit may be unsuitable, or your aerial-earth system may require modification. Try a series aerial condenser of the variable type and adjust this with a view to overcoming the difficulty. If this proves unsuccessful, try an ordinary dry battery with the set with a view to finding the best working voltage.

E. M. (Chalfont St. Peter). There is no coil on the market exactly like the one described, but you could, of course, use a standard six-pin short-wave coil from the B.T.S., Eddystone or Raymart range.

K. P. (Nottingham). Whilst 60 volts could be employed, the results would be very poor and the volume would not be satisfactory. We therefore suggest that you obtain the correct cabinet and use the maximum H.T.

W. F. C. (Gallowhill). We are not familiar with the service difficulties of individual commercial receivers and therefore suggest that you get into touch with the makers or their nearest local service agent.

G. W. (Methil, Fife). The receiver may be too old to warrant the inclusion of modern coils. You should obtain better results than those outlined in your letter, even with old coils, and we suggest that you have the set overhauled first.

W. E. or W. M., Angus Cameron, James Marshall, and J. Kerr (Paisley, Scotland). Letters were sent to you, but were returned marked "Not Known." You all ask the same query, and we await your explanation for this extraordinary conduct. The next time you write, please do not forget the Query Coupon.

WHY TRUST TO LUCK?

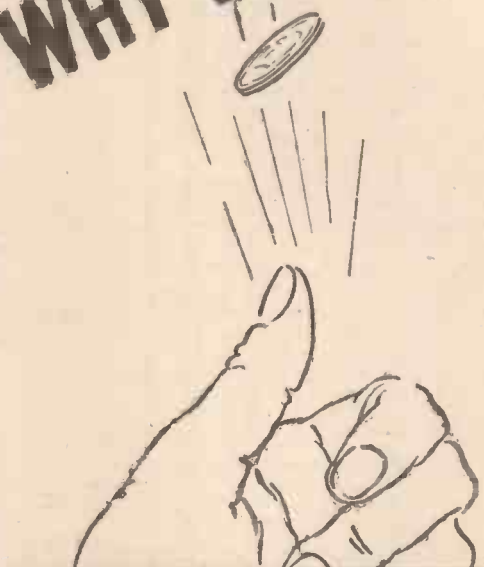

WHEN T.C.C. HAVE MADE CONDENSERS AND NOTHING BUT CONDENSERS FOR OVER 28 YEARS



T.C.C.
ALL-BRITISH
CONDENSERS

Join Newnes' Practical Group!

PRACTICAL MOTORIST

The owner-driver's journal which tells you how to repair, overhaul, and obtain the best performance from your car.

3d.—Every Friday.

PRACTICAL MECHANICS

The only English journal of its type. It deals with every branch of Science, Mechanics, Invention, Model-making, Chemistry, Astronomy, Photography, Television.

6d.—Every Month.

THE CYCLIST

The leading weekly for every Cyclist, Clubman, Utility Cyclist or Tourist.

Join "The Cyclist" Road Club and enjoy FREE Insurance

2d.—Every Wednesday.

THE TELEGRAPH CONDENSER COMPANY LIMITED.
WALES FARM ROAD - N. ACTON - LONDON W. 3

Facts and Figures

COMPONENTS TESTED IN OUR NEW LABORATORY

Bulgin Shaft Couplings

IN many modern receivers it is the custom to mount controls on a horizontal motor-board whilst the receiver is placed below, and although this may be carried out by suspending the chassis, it is easier to place the chassis in the usual horizontal position and use flexible drives to the control panel. In many cases the provision of a coupling is not a simple matter, as any slight deviation from the correct direction results in a stiffness in the controls at that point, or even in twisting of the controlled component, and thus a flexible form of coupling is desirable. Two such couplings are shown in the attached sketch, one being provided additionally with a porcelain insulator, thus rendering it suitable for use in high-voltage apparatus such as may be met with in a television

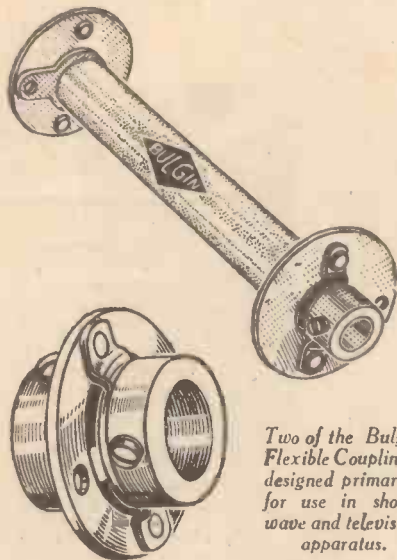

Two of the Bulgin Flexible Couplings, designed primarily for use in short-wave and television apparatus.

equipment. The couplings consist of short bosses with $\frac{1}{4}$ in. holes, connected with each other by means of short bridge pieces joined to a disc of a flexible nature. A steel grub-screw is fitted in each boss. In the small coupling it is possible to obtain two different patterns, one with the metal disc, at a cost of 9d., and one with an insulated disc costing 1s.; the larger models are provided with porcelain rods between the two discs and these are obtainable in two different lengths, one of 1in. and one 2 $\frac{1}{2}$ in. long. The former costs 1s. 9d. and the latter 2s. 3d. To couple these units to a control knob, Messrs. Bulgin can supply round brass shaft rod in $\frac{1}{4}$ in. diameter at various lengths, the standard stock consisting of 6in., 9in., and 12in. lengths at 3d., 4d. and 5d. per length respectively. Special panel bushes for use with the rod may also be obtained from the same firm for 3d. each.

New Marconiphone H.T. Battery

A NEW 120-volt H.T. battery is announced by Marconiphone, designed for a high discharge rate. The type number is B25 and the price is 10s. 6d. This par-

ticular battery is actually a larger version of the well-known B601 which is used in a number of popular receivers.

Morse Key

IN view of the fact that we are now describing transmitting apparatus, some readers will no doubt require a good morse key in order to carry out practice in the morse code, and also for subsequent inclusion in the complete apparatus. A very good range of keys is to be found in the Electradix catalogue, and one is illustrated below. This is built on a mahogany base measuring 5in. by 2 $\frac{1}{2}$ in. and all metal parts are lacquered. This is of the pattern known as the "Official type" and has large contacts with adjustable spring tension and adjustable back contact. A refinement to be found on this particular key (not shown in the sketch) is the provision of a pair of terminals and a pealamp holder on the side of the base. By connecting a suitable battery to these terminals the lamp will flash as the key is manipulated, and thus the operator will be able to see as he sends whether he makes any faults or mistakes. This particular key may be obtained for 7s. 6d.

Mazda TH.2320

THE Mazda TH.2320 has had its filament characteristics revised, and the rating is now 23 volts .2 amps. instead of 26 volts .2 amps. The valve will, therefore, be known in future as the TH.2320 in accordance with the Mazda code, which indicates the heater voltage and current in the title of the valve. It is important to note that the alteration in the heater voltage will necessitate an extra 15 ohms in the series resistance on AC/DC mains. This particular valve is, of course, a triode-hexode designed for use with an anode voltage for the hexode portion of 250 maximum, and grid voltage of 100 max. The grid bias is -3 volts and the anode current 3mA with 6 mA screen current. The triode portion of the valve is designed to operate at 100 volts maximum H.T., at which the anode current is 4 mA. The price is 15s.

New Eddystone Tropical Receiver

MESSRS. STRATTON & COMPANY have produced a novel new receiver designed especially for use in the tropics. It is an 8-valve battery-operated superhet incorporated in a solid cast aluminium chassis, and cabinet built in such a manner that they cannot come apart and will withstand the roughest handling. The highest degree of screening is provided for each circuit, and every component part is designed to withstand equally the tropical climate of the Equator or the extreme cold of the Arctic. A dual-ratio drive is fitted, and the complete receiver covers three wave ranges, namely from 22.3 to 8.66 mc/s (13.44 to 34.6 metres), 11.04 to 4.34 mc/s (27.15 to 69.2 metres) and 1,250 to 523

kc/s (240 to 573 metres). The price is £27 10s. Additional inductance units are available to cover the long broadcast range and from 63.2 to 287.5 metres.

New Ostar Ganz Set

A NOVELTY is introduced into a new receiver of the superhet type just announced by the Universal High Voltage Radio Company. This receiver is designed primarily round the Ostar Ganz high-voltage mains valves, but in the circuit arrangements have been incorporated so that ordinary battery valves may be used without undue loss of efficiency. The battery valves are manufactured by the Tungstram Company, and in addition to inserting these in place of the mains valves a special switch is operated and the receiver is then instantly converted into a battery set. The circuit embodies a frequency-changer, I.F. amplifier, double-diode-triode and pentode output valve, and in addition to the normal broadcast wavelengths a short-wave band from 16.6 to 53 metres is included. Refine-

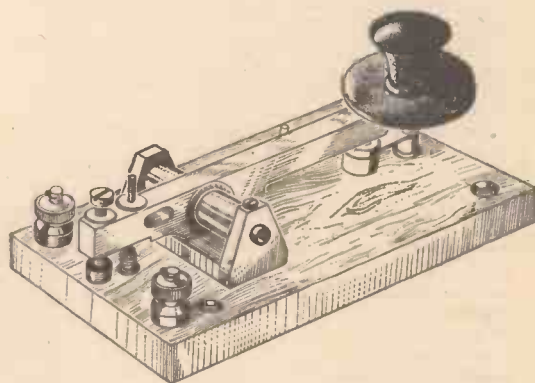

For morse practice, or for inclusion in a complete transmitter. This key may be obtained for 7s. 6d. from Electradix Radios.

ments include provision for a gramophone pick-up and an extension speaker.

1936 IN RETROSPECT

(Continued from page 494)

some very interesting developments will be forthcoming this year, and there is not the slightest doubt that these will also affect the standard broadcast receiver. So far, the mechanical television receiving systems are shrouded in mystery and thus there is no possibility of forecasting the future in this direction.

Destruction of Crystal Palace

The last month of the year opened with the news of the destruction of the Crystal Palace, which was associated with the development of the high-definition television systems, and the famous landmark which had stood for so long was reduced to a smouldering heap of ruins in a very few hours. With it, perished many valuable pieces of apparatus in the Baird laboratories, and no doubt this tragedy will remain for many years to come as the most important feature of the year 1936.

It is never safe to forecast, and we thus hesitate to suggest what 1937 offers for the home-constructor, but it is an undoubted fact that the keen amateur will find in television a re-awakening of the interests which he had in the early days of broadcasting, and apart from the fascination of building the much larger equipment which is required, the results when finished, will afford to him, as well as to his family circle, a much wider field of entertainment and enjoyment.

LETTERS FROM READERS

The Editor does not necessarily agree with opinions expressed by his correspondents



All letters must be accompanied by the name and address of the sender (not necessarily for publication.)

Correspondents Wanted

SIR,—I am writing you for some help in establishing a correspondence with fellows in the British Isles (England, Wales, Ireland, Scotland) and in Bermuda. I would like to correspond with anyone interested in short-wave radio in either of these countries. I live just forty miles from the Pacific Ocean, away out west in Oregon. I do a good deal of DX'ing on the short waves.

For your information: There is a new station in Colombia. The call is HJ4ABH, short wave and HJ4ABA, long wave. They are on 9,520 kc/s, and sign off at 6.45 p.m. P.S.T. daily. The location is Armenia, Caldas. They use the "Indian Love Call" as a theme in signing off.

PLX is a new station in Bandoeng, Java. They are on 14,480 kc/s irregular between 6 and 11 a.m. P.S.T.

Wishing you and your magazine the best of success and a Merry Christmas.—Lyle Nelson (Yamhill, Oregon, U.S.A.)

SIR,—I feel that I should like to express my pleasure upon seeing letters from two readers "across the ditch." I also note that they both come from Wisconsin—are we to believe that PRACTICAL AND AMATEUR WIRELESS is only read in Wisconsin? I am sure that this is not so, and I should be pleased to hear from any reader from any country in the British Empire or America.

I agree with the opinion expressed in a letter recently published in your columns with regard to the apparent lack of interest in Ultra-H.F. reception. If anyone interested should read this I shall be very pleased to correspond with him.—FRANK C. GABELL, 64, Arnos Villas, Bowes Road, Southgate, N.11.

W9XAZ and W2XEN

SIR,—I herewith report reception on several occasions of the short-wave broadcasting station W9XAZ, owned by The Milwaukee Wisconsin Journal, and operating on 26.4 mc/s between 16.10 and 18.00 G.M.T.

Also of W2XEN, Hartford Police, and other U.S.A. police stations on 9-10 metres.

The above were heard on a four-year-old S.W. converter with two turns taken off the fixed coil (13-85 metres) to get down to 10 metres, etc.—R. D. Everard (Sawbridge-worth, Herts.).

QSL Cards and Reports

SIR,—An examination of the Short-Wave Listeners' Review reveals the fact that Mr. Everard's club relies entirely on the QSL card for its existence and leaves no doubt in my mind that that is the reason for his attitude. Suppress the QSL card and the *raison d'être* for his club vanishes. He may tell his 350 members what he likes, but they do not constitute the whole of the short-wave listening fraternity.

It would have been better if, instead of publishing an imposing list of his QSL cards, and thereby confirming my previous remark on "personal glory," he had given a good, substantial reason why transmitters should continue to waste both their time and

money replying to the thousands of fictitious and exaggerated reports which are being circulated over the world.

Whether Mr. Everard likes it, or whether he does not, the fact remains that short-wave listeners have themselves killed the "Goose that laid the golden eggs," and neither his sarcasm nor his black list is likely to revive it.—J. W. ISMAY (G6JI) (Walthamstow).

This Short-wave Business!

SIR,—I should like to ask what there really is in this short-wave business from the listeners' point of view? I see in your paper nearly every week of amateurs with 2- or 3-valve sets logging many stations from all parts of the globe, quite a number being at good loudspeaker strength. I should like to know if with a good 2- or 3-valver they get real entertainment? I mean do they get music (without "mush") as well as "Calling all cars"? In your issue dated November 7th a Mr. Leigh says that he logged 344 stations on the 20 m. band in a couple of months or so, and that it was a 2-valver! In "Leaves from a Short-Wave Log" of the same issue it states that "stations which were a mere whisper a month ago are now coming in at good readable strength." Am I to infer that short-wave fans sit at their sets with ears pointed, twiddling the controls, very, very carefully, of course, and listening—listening, and then saying "Did I hear it?" and on getting the call sign by fair means or foul, logging it in the good old log book?

It would be interesting to know a short-wave fan's programme for one night; how many stations are received at good strength and entertainment value plus clarity, say on a 2- or 3-valve good short-wave set. I might say that a fellow here has a 6-valver, supposed to be all-wave, but all he can receive decently are short-wave stations, the Empire, Java, and a German station being very well received and at good volume, all others are too weak to be of any use. One or two amateurs are sometimes picked up speaking to each other: "What is my modulation like, etc." I have been reading your paper for a year now and I still eagerly await each issue. I would like to start dabbling with short-wave apparatus in a small way but something seems to say "don't waste your money." So I must go on reading about it in your interesting paper and hoping for more light on the subject.

Wishing you all the best for the New Year.—"GRAMOPHILE" (Jubbulpore, India).

LATHE-WORK FOR AMATEURS

by
F. J. CAMM

1/- or 1/2 by post from

George Neunes, Ltd., Tower House, Southampton Street, Strand, W.C.2.

Back Numbers Wanted

A READER urgently requires copies of PRACTICAL AND AMATEUR WIRELESS dated November 24th, 1934, and February 8th, 1936. We shall be glad if any reader having these issues to spare will kindly send them along to this office.

SIR,—I am very anxious to obtain a copy of *Amateur Wireless* dated October 29th, 1932, in which was described the "New Century Super." If any of your readers has a copy or a blueprint of the above set that they would loan me I would be very grateful. Needless to say, any postage or expense incurred would be refunded.—J. E. HAWKINS (Liverpool).

A Strange Transmission

SIR,—I recently noticed in a back issue of your journal that you were wanting to know about the strange transmissions on the 40-metre band.

I have been hearing these "transmissions," which sound almost like Duplex working on one wavelength which now seems to be about 49 metres, but varies. I have never found what it is. The woman mentioned usually keeps saying "Pronto Tripoli," which I suppose means "Get ready, or stand by, Tripoli." No actual transmission ever seems to take place, it is always "Pronto. Pronto Tripoli." I think the station may be Asmara (in Eritrea) or possibly Coltano, which works with Tripoli (and ships).

This strange transmission still goes on, as you may have heard yourself. The language is Italian all right.—D. SHERLEY-PRICE (Bournemouth).

Reports Wanted

SIR,—May I, through the columns of your paper, request reports on my 5- and 10-metre transmissions (phone and c.w.)? If persons interested would send me their addresses, also details of their receivers and aerials, I would post them a schedule of test transmitting times.—A. G. HILL (G2KG), 58, Sandford Road, Chelmsford, Essex.

CUT THIS OUT EACH WEEK

Do you know

—THAT special valves have now been developed especially for use in television circuits.

—THAT in designing a combined vision and sound receiver it is essential to prevent interference between the two sections.

—THAT a sectional-wound H.F. choke avoids losses due to self-capacity.

—THAT in some parts of a modern receiver it is quite permissible to use a wire-wound (or inductive) resistor.

—THAT the inductance of the ordinary type of L.F. transformer primary varies according to the current flowing through it.

—THAT H.F. chokes in a mains lead will not always prevent instability due to mains interference.

—THAT the ordinary type of H.F. choke is unsuitable for use in mains leads for interference prevention.

The Editor will be pleased to consider articles of a practical nature suitable for publication in PRACTICAL AND AMATEUR WIRELESS. Such articles should be written on one side of the paper only, and should contain the name and address of the sender. Whilst the Editor does not hold himself responsible for manuscripts, every effort will be made to return them if a stamped and addressed envelope is enclosed. All correspondence intended for the Editor should be addressed: The Editor, PRACTICAL AND AMATEUR WIRELESS, Geo. Neunes, Ltd., Tower House, Southampton Street, Strand, W.C.2. Owing to the rapid progress in the design of wireless apparatus and to our efforts to keep our readers in touch with the latest developments, we give no warranty that apparatus described in our columns is not the subject of letters patent.

Practical and Amateur Wireless BLUEPRINT SERVICE

These blueprints are drawn full size. Copies of appropriate issues containing descriptions of these sets can in some cases be supplied at the following prices, which are additional to the cost of the blueprint. A dash before the Blueprint Number indicates that the issue is out of print.

Issues of Practical Wireless .. 4d. Post paid
 " " Amateur Wireless .. 4d. " "
 " " Practical Mechanics .. 7d. " "
 " " Wireless Magazine .. 1/3 " "

The index letters which precede the Blueprint Number. Indicate the periodical in which the description appears thus, PW refers to PRACTICAL WIRELESS, AW to Amateur Wireless, PM to Practical Mechanics, WM to Wireless Magazine. Send (preferably) a postal order to cover the cost of the blueprint and the issue (stamps over 6d. unacceptable), to PRACTICAL AND AMATEUR WIRELESS Blueprint Dept., Geo. Newnes, Ltd., Tower House, Southampton Street, Strand, W.C.2.

PRACTICAL WIRELESS

STRAIGHT SETS. Battery Operated.

One-valve : Blueprint, 1s.	Date of Issue.	No. of Blueprint
All-wave Unipen (Pentode) ..	—	PW31A
Two-valve : Blueprint, 1s.		
Four-range Super Mag Two (D, Pen) ..	11.8.34	PW30B
Three-valve : Blueprints, 1s. each.		
Selectone Battery Three (D, 2 LF (Trans)) ..	—	PW10
Sixty Shilling Three (D, 2 LF (RC & Trans)) ..	—	PW34A
Leader Three (SG, D, Pow) ..	—	PW35
Summit Three (HF Pen, D, Pen) ..	8.8.34	PW37
All Pentode Three (HF Pen, D (Pen), Pen) ..	22.9.34	PW39
Hall-Mark Three (SG, D, Pow) ..	—	PW41
Hall-Mark Cadet (D, LF, Pen. (RC)) ..	16.3.35	PW48
F. J. Camm's Silver Souvenir (HF Pen, D (Pen), Pen) (All-Wave Three) ..	13.4.35	PW49
Genet Midget (D, 2 LF (Trans)) ..	June '35	PM2
Cameo Midget Three (D, 2 LF (Trans)) ..	8.6.35	PW51
1936 Sonotone Three-Four (HF Pen, HF Pen, Westector, Pen) ..	17.8.35	PW53
Battery All-Wave Three (D, 2 LF (RC)) ..	—	PW55
The Monitor (HF Pen, D, Pen) ..	—	PW61
The Tutor Three (HF Pen, D, Pen) ..	21.3.36	PW62
The Centaur Three (SG, D, P) ..	—	PW64
The Gladiator All-Wave Three ..	29.8.36	PW66
F. J. Camm's Record All-Wave Three (HF Pen, D, Pen) ..	31.10.36	PW69
Four-valve : Blueprints, 1s. each.		
Fury Four (2 SG, D, Pen) ..	—	PW11
Beta Universal Four (SG, D, LF, Cl. B) ..	—	PW17
Nucleon Class B Four (SG, D (SG) LF, Cl. B) ..	6.1.34	PW34B
Fury Four Super (SG, SG, D, Pen) ..	—	PW34C
Battery Hall-Mark 4 (HF Pen, D, Push-Pull) ..	—	PW46
F. J. Camm's "Limit" All-Wave Four (HF Pen, D, LF, P) ..	26.9.36	PW67
Mains Operated.		
Two-valve : Blueprints, 1s. each.		
A.C. Twin (D (Pen), Pen) ..	—	PW18
A.C.-D.C. Two (SG, Pow) ..	7.10.36	PW31
Selectone A.C. Radiogram Two (D, Pow) ..	—	PW19
Three-valve : Blueprints, 1s. each.		
Double-Diode-Triode Three (HF Pen, DDT, Pen) ..	10.6.33	PW23
D.C. Ace (SG, D, Pen) ..	—	PW25
A.C. Three (SG, D, Pen) ..	—	PW29
A.C. Leader (HF Pen, D, Pow) ..	7.4.34	PW35C
D.C. Premier (HF Pen, D, Pen) ..	31.3.34	PW35B
Ubique (HF Pen, D (Pen), Pen) ..	28.7.34	PW36A
Armada Mains Three (HF Pen, D, Pen) ..	18.8.34	PW38
F. J. Camm's A.C. All-Wave Silver Souvenir Three (HF Pen, D, Pen) ..	11.5.35	PW50
"All-Wave" A.C. Three (D, 2 LF (RC)) ..	17.8.35	PW54
A.C. 1936 Sonotone (HF Pen, HF Pen, Westector, Pen) ..	—	PW56
Four-valve : Blueprints, 1s. each.		
A.C. Fury Four (SG, SG, D, Pen) ..	—	PW20
A.C. Fury Four Super (SG, GS, D, Pen) ..	—	PW34D
A.C. Hall-Mark (HF Pen, D, Push-Pull) ..	—	PW45
Universal Hall-Mark (HF, Pen, D, Push-Pull) ..	9.2.35	PW47
SUPERHETS.		
Battery Sets : Blueprints, 1s. each.		
£5 Superhet (Three-valve) ..	—	PW40
F. J. Camm's 2-valve Superhet (Two-valve) ..	13.7.35	PW52
F. J. Camm's £4 Superhet ..	—	PW58
Mains Sets : Blueprints, 1s. each.		
A.C. £5 Superhet (Three-valve) ..	—	PW43
D.C. £5 Superhet (Three-valve) ..	1.12.34	PW42
Universal £5 Superhet (Three-valve) ..	—	PW44
F. J. Camm's A.C. £4 Superhet 4 ..	—	PW59
F. J. Camm's Universal £4 Superhet 4 ..	11.1.36	PW60
SHORT-WAVE SETS.		
Two-valve : Blueprint, 1s.		
Midget Short-Wave Two (D, Pen) ..	15.9.34	PW38A
Three-valve : Blueprints, 1s. each.		
Experimenter's Short-Wave Three (SG, D, Pow) ..	—	PW30A
The Prefect 3 (D, 2 LF (RC and Trans)) ..	—	PW63
The Bandspread S.W. Three (HF Pen, D (Pen), Pen) ..	29.8.36	PW68

PORTABLES.

Three-valve : Blueprint, 1s.		
F. J. Camm's ELF Three-valve Portable (HF Pen, D, Pen) ..	16.5.36	PW65
Four-valve : Blueprint, 1s.		
Featherweight Portable Four (SG, D, LF, Cl. B) ..	—	PW12

MISCELLANEOUS.

S.W. Converter-Adapter (1 valve) ..	—	PW48A
AMATEUR WIRELESS AND WIRELESS MAGAZINE CRYSTAL SETS.		
Blueprints, 6d. each.		
Four-station Crystal Set ..	12.12.36	AW427
1934 Crystal Set ..	—	AW444
150-mile Crystal Set ..	—	AW450

STRAIGHT SETS. Battery Operated.

One-valve : Blueprint, 1s. each.		
B.B.C. Special One-valver ..	—	AW387
Twenty-station Loudspeaker One-valver (Class B) ..	—	AW449
Two-valve : Blueprints, 1s. each.		
Melody Ranger Two (D, Trans) ..	—	AW388
Full-volume Two (SG det. Pen) ..	—	AW392
B.B.C. National Two with Lucerne Coil (D, Trans) ..	—	AW377A
Big-power Melody Two with Lucerne Coil (SG, Trans) ..	—	AW338A
Lucerne Minor (D, Pen) ..	—	AW426
A Modern Two-valver ..	July '36	WM409

Three-valve : Blueprints, 1s. each.

Class B Three (D, Trans, Class B) ..	22.4.33	AW386
New Britain's Favourite Three (D, Trans, Class B) ..	15.7.33	AW394
Home-built Coll Three (SG, D, Trans) ..	—	AW404
Fan and Family Three (D, Trans, Class B) ..	25.11.33	AW410
£5 5s. S.G.3 (SG, D, Trans) ..	2.12.33	AW412
1934 Ether Searcher : Baseboard Model (SG, D, Pen) ..	20.1.34	AW417
1934 Ether Searcher : Chassis Model (SG, D, Pen) ..	—	AW419
Lucerne Ranger (SG, D, Trans) ..	—	AW422
Coosor Melody Maker with Lucerne Colls ..	—	AW423
Mullard Master Three with Lucerne Coils ..	—	AW424
£5 5s. Three : De Luxe Version (SG, D, Trans) ..	19.5.34	AW435
Lucerne Straight Three (D, RC, Trans) ..	—	AW437
All-Britain Three (HF Pen, D, Pen) "Wireless League" Three (HF Pen, D, Pen) ..	3.11.34	AW451
Transportable Three (SG, D, Pen) ..	—	WM271
£6 6s. Radiogram (D, RC, Trans) ..	—	WM318
Simple-tune Three (SG, D, Pen) ..	June '33	WM327
Economy-pentode Three (SG, D, Pen) ..	Oct. '33	WM337
"W.M." 1934 Standard Three (SG, D, Pen) ..	—	WM351
£3 3s. Three (SG, D, Trans) ..	Mar. '34	WM354
Iron-Core Band-pass Three (SG, D, QP 21) ..	June '34	WM362
1935 £6 6s. Battery Three (SG, D, Pen) ..	—	WM371
PTP Three (Pen, D, Pen) ..	June '35	WM389
Certainty Three (SG, D, Pen) ..	Sept. '35	WM393
Minutube Three (SG, D, Trans) ..	Oct. '35	WM396
All-wave Winning Three (SG, D, Pen) ..	Dec. '35	WM400

Four-valve : Blueprints, 1s. 6d. each.

65s. Four (SG, D, RC, Trans) ..	—	AW370
"A.W." Ideal Four (2 SG, D, Pen) ..	16.9.33	AW402
2 H.F. Four (2 SG, D, Pen) ..	—	AW421
Crusaders' A.V.C. 4 (2 HF, D, QP 21) ..	18.8.34	AW445
(Pentode and Class B Outputs for above : Blueprints, 6d. each) ..	25.8.34	AW445A
Self-contained Four (SG, D, LF, Class B) ..	Aug. '33	WM331
Lucerne Straight Four (SG, D, LF, Trans) ..	—	WM350
£5 5s. Battery Four (HF, D, 2 LF) ..	Feb. '35	WM381
The H. K. Four (HF Pen, HF Pen, D, Pen) ..	Mar. '35	WM384
The Auto Straight Four (HF Pen, HF Pen, DDT, Pen) ..	April '36	WM404
Five-valve : Blueprints, 1s. 6d. each.		
Super-quality Five (2 HF, D, RC, Trans) ..	May '33	WM320
Class B Quadradyne (2 SG, D, LF, Class B) ..	Dec. '33	WM344

Mains Operated.

Two-valve : Blueprints, 1s. each.		
Consoelectric Two (D, Pen) A.C. ..	—	AW403
Economy A.C. Two (D, Trans) A.C. ..	—	WM286
Unicorn A.C./D.C. Two (D, Pen) ..	Sept. '35	WM394
Three-valve : Blueprints, 1s. each.		
Home-Lover's New All-electric Three (SG, D, Trans) A.C. ..	—	AW383

Three-valve : Blueprints, 1s. each (contd.)

S.G. Three (SG, D, Pen) A.C. ..	—	AW390
A.C. Triodyne (SG, D, Pen) A.C. ..	19.8.33	AW399
A.C. Pentaquester (HF Pen, D, Pen) A.C. ..	23.6.34	AW439
Mantovani A.C. Three (HF, Pen, D, Pen) A.C. ..	—	WM374
£15 15s. 1936 A.C. Radiogram (HF, D, Pen) ..	Jan. '36	WM401
Four-valve : Blueprints, 1s. 6d. each.		
All Metal Four (2 SG, D, Pen) ..	July '33	WM326
Harris Jubilee Radiogram (HF Pen, D, LF, P) ..	May '35	WM386

SUPERHETS.

Battery Sets : Blueprints, 1s. 6d. each.		
Modern Super Senior ..	—	WM375
Varsity Four ..	Oct. '35	WM395
The Request All-Waver ..	June '36	WM407
1935 Super Five Battery (Superhet) ..	—	WM379
Mains Sets : Blueprints, 1s. 6d. each.		
1934 A.C. Century Super A.C. ..	—	AW425
Heptode Super Three A.C. ..	May '34	WM359
"W.M." Radiogram Super A.C. ..	—	WM366
1935 A.C. Stenode ..	Apl. '34	WM385

PORTABLES.

Four-valve : Blueprints, 1s. 6d. each.		
Midget Class B Portable (SG, D, LF, Class B) ..	20.5.33	AW389
Holiday Portable (SG, D, LF, Class B) ..	1.7.33	AW393
Family Portable (HF, D, RC, Trans) ..	22.9.34	AW447
TWO H.F. Portable (2 SG, D, QP21) ..	June '34	WM363
Tyers Portable (SG, D, 2 Trans) ..	—	WM367
Five-valve : Blueprint, 1s. 6d.		
New Class-B Five (2 SG, D, LF, Class B) ..	Nor. '33	WM340

SHORT-WAVE SETS—Battery Operated.

One-valve : Blueprints, 1s. each.		
S.W. One-valve converter (Price 6d.) ..	—	AW320
S.W. One-valve for America ..	—	AW429
Rome Short-Waver ..	—	AW452
Two-valve : Blueprints, 1s. each.		
Ultra-short Battery Two (SG det. Pen) ..	Feb. '36	WM402
Home-made Coll Two (D, Pen) ..	—	AW440
Three-valve : Blueprints, 1s. each.		
World-ranger Short-wave 3 (D, RC, Trans) ..	—	AW355
Experimenter's 5-metre Set (D, Trans, Super-gen) ..	30.6.34	AW438
Experimenter's Short-waver (SG, D, Pen) ..	Jan. 19, '35	AW463
The Carrier Short-waver (SG, D, P) ..	July '35	WM390
Four-valve : Blueprints, 1s. 6d. each.		
A. W. Short-wave World Beater (HF, Pen, D, RC, Trans) ..	—	AW436
Empire Short-waver (SG, D, RC, Trans) ..	—	WM313
Standard Four-valver Short-waver (SG, D, LF, P) ..	Mar. '35	WM383
Superhet : Blueprint, 1s. 6d.		
Simplified Short-wave Super ..	Nov. '35	WM397

Mains Operated.

Two-valve : Blueprints, 1s. each.		
Two-valve Mains short-waver (D, Pen) A.C. ..	—	AW453
"W.M." Band-spread Short-waver (D, Pen) A.C./D.C. ..	—	WM368
"W.M." Long-wave Converter ..	—	WM380
Three-valve : Blueprint, 1s.		
Emigrator (SG, D, Pen) A.C. ..	—	WM352
Four-valve : Blueprint, 1s. 6d.		
Standard Four-valve A.C. Short-waver (SG, D, RC, Trans) ..	Aug. '35	WM391

MISCELLANEOUS.

Enthusiast's Power Amplifier (1/6) ..	June '35	WM387
Listener's 5-watt A.C. Amplifier (1/6) ..	Sept. '35	WM392
Radio Unit (2v.) for WM392 (1/-) ..	Nov. '35	WM398
Harris Electrogram (battery amplifier) (1/-) ..	Dec. '35	WM399
De-Luxe Concert A.C. Electrogram ..	Mar. '36	WM403
New Style Short-waver Adapter (1/-) ..	Jan. '35	WM388
Trickle Charger (6d.) ..	Jan. 5, '35	AW462
Short-wave Adapter (1/-) ..	Dec. 1, '34	AW456
Superhet Converter (1/-) ..	Dec. 1, '34	AW457
B.L.D.L.C. Short-Wave Converter (1/-) ..	May '36	WM405
Wilson Tone Master (1/-) ..	June '36	WM406
The W.M. A.C. Short-Wave Converter (1/-) ..	July '36	WM403

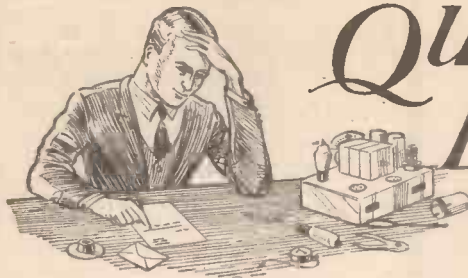

QUERIES and ENQUIRIES

Component Unobtainable

"I am building a set in which you specified a 10/1 coupling unit, but I am informed that this is now unobtainable. Will you please advise me as to the best component to substitute in this case? Would an ordinary transformer of high ratio do, please?"—A. L. (S.W.2.)

THE component in question was simply a parallel-fed L.F. transformer of high ratio, and thus you could use any similar alternative. Unfortunately, however, the highest transformer ratio now obtainable is 7 to 1 (in the Ferranti range), or a standard Q.P.P. transformer which may be obtained with a 9 to 1 ratio. Either of these could be employed, and by connecting the primary and secondary windings to form an auto-transformer it is possible to obtain an increase of 1 in the ratio. For this purpose the primary and secondary are connected in series (and in the same sense electrically) and the connection from the coupling condenser is taken to the junction of the two windings. The other end of the primary is joined to earth (or grid bias) and the other end of the secondary to the grid. It is necessary, when using such a high gain, to guard against overloading in the output stage.

A Baffle Horn

"I am thinking of constructing the horizontal baffle horn as described by you recently for a small public-address outfit. Before doing so would you kindly inform me if it will reproduce the bass register as well as a flat baffle, in view of the fact that it is only made of 3-ply. I intend using the Universal Hall Mark receiver with it."—G. P. (Sydenham).

GENERALLY, the horn in question will not give the same bass response as a correctly designed flat baffle employed with a good moving-coil speaker. It is possible to obtain with a horn just as good a bass output as a large square baffle and a good moving coil, but the design of such a horn is quite complicated and an unduly large horn is required. Such a unit may be seen at the Science Museum, Kensington, and the output may be compared with the standard flat baffle and well-designed speaker there, operating from the same amplifier. However, as you intend to use the Hall Mark amplifier, the quality and range of frequencies handled by the output stage would be such that there would be no object in building such a horn, and the reproduction from the horizontal baffle horn referred to would be practically indistinguishable from that given by a three-foot square flat baffle and ordinary moving-coil speaker.

Using Headphones

"What value resistance should be placed in the leads when connecting two pairs of 2,000 ohm headphones to the L.S. extension terminals of a five-valve superhet commercial receiver giving an output of about 3 watts—D.C. mains? How and where should this resistance be placed, and are

any precautionary measures necessary against shocks?"—T. N. (Hanley Castle).

WE are not quite clear concerning the point which is troubling you. Firstly, the impedance of the phones will more or less match the ordinary output valve, and thus no matching difficulty arises. Secondly, no current should flow through the extension point and thus no limiting resistance is needed. Therefore, the only point is that concerning a volume control to prevent an excessive signal from causing distress when tuning with the 'phones. This can be arranged by a parallel resistor, although the ordinary volume control fitted to the receiver should be quite sufficient. As the receiver is operated from the mains it is necessary to isolate the headphones in case of shocks, and a large capacity fixed condenser should be

RULES

We wish to draw the reader's attention to the fact that the Queries Service is intended only for the solution of problems or difficulties arising from the construction of receivers described in our pages, from articles appearing in our pages, or on general wireless matters. We regret that we cannot, for obvious reasons—

- (1) Supply circuit diagrams to complete multi-valve receivers.
- (2) Suggest alterations or modifications of receivers described in our contemporaries.
- (3) Suggest alterations or modifications to commercial receivers.
- (4) Answer queries over the telephone.
- (5) Grant interviews to querists.

Please note also, that queries must be limited to two per reader, and all sketches and drawings which are sent to us should bear the name and address of the sender. Requests for Blueprints must not be enclosed with queries, as they are dealt with by a different department.

If a postal reply is desired a stamped addressed envelope must be enclosed. Send your queries to the Editor, PRACTICAL AND AMATEUR WIRELESS, George Newnes, Ltd., Tower House, Southampton Street, Strand, London, W.C.2.

The Coupon must be enclosed with every query.

included in each 'phone lead. There is no doubt already one included in the extension circuit, but to avoid all risks one should be used in each lead.

Wireless Control

"I wish to experiment with wireless controlled boats. I understand that a small transmitter is necessary. Do I require a transmitting licence for this?"

NEWNES (Illustrated) TELEVISION and SHORT-WAVE HANDBOOK

by F. J. CAMM
(Editor "Practical Television," "Practical and Amateur Wireless," etc.)

EVERYTHING ABOUT—
Drums, Mirror Screws, Scanning Discs and other Scanning Systems, Neon Lamps, the Cathode-Ray Oscillograph. How to build Short-Wave Receivers; How to build Ultra-Short Wave Receivers, straight and superhet types.

280 pages Only 3/6 net

or 4/- post free from—
GEORGE NEWNES, LIMITED
Tower House, Southampton Street,
Strand, W.C.2

If so, could you please give me details?"—H. C. (H.M.S. "Dispatch").

A SIMPLE transmitter will be needed for the purpose and a licence must first be obtained. Write to the Engineer-in-Chief, Radio Section, G.P.O. Armour House, London, E.C.1.

Simplest One-Valver

"I am about to build the one-valve short-wave set described on December 12th, but I do not know exactly what the dotted lines mean. Does the wire from "Earth" go to the top of the aerial tapping on the coil, or to the bottom tapping of the grid. If it goes to the latter, why the dotted line? I also understand that the wire from "Moving" of the tuning condenser goes to the filament of the valve. Is this correct? Is a blueprint obtainable for this set?"—G. I. C. (Canvey).

THE dotted lines indicate the additional connections when it is desired to use the apparatus as a short-wave adapter. The lead connected to the earth terminal is joined to the junction of the bottom of the grid winding and the top of the aerial coil, and in this case the dotted line shows the wire running inside the coil. You will note that the two wires are twisted together outside the coil and then joined to earth. The moving vanes of the tuning condenser and reaction condenser are joined to the filament terminal which is also earthed, and in this case part of the wire is shown dotted as it passes behind the coil. We regret there is no blueprint for this particular set.

Using a Pentode

"Wishing to obtain more volume from my home-made Det. L.F. Power set, I fitted a pentode, but am now troubled by the high-pitched tone. Also, I thought the volume would be much more than it is. Will you kindly examine the enclosed circuit and advise me on the best course to adopt?"—H. G. (Blackpool).

THE circuit is quite correctly wired and consists of a perfectly standard arrangement. The high-pitched tone is always experienced when using an uncorrected output circuit with a pentode, and you should fit a tone corrector across the loud-speaker terminals. The usual .01 mfd. fixed condenser, in series with a 10,000 ohm variable resistor, will be found satisfactory. Furthermore, your loud-speaker may not be matched to the pentode, and this point must receive attention, as a much higher impedance is required than was formerly needed for the power valve. There is a possibility that the additional anode current required for the pentode is resulting in overloading of your mains unit, and this point also should be checked.

S. W. Adaptor

"I am thinking of building your converter adaptor, P.W.48A, but before doing so I should like to know the cost of the parts for this."—K. O. (Balham).

KIT A, that is, all parts including 2 B.T.S. short-wave coils for 13 to 52 metres, but less valve and cabinet, costs £2 13s. 6d. The cabinet costs 10s. 6d. If desired, the complete instrument, ready assembled, may be obtained from Messrs. Peto Scott for £3 15s.

The coupon on page iii of cover must be attached to every query.

Miscellaneous Advertisements

Advertisements are accepted for these columns at the rate of 3d. per word. Words in black face and/or capitals are charged double this rate (minimum charge 3/- per paragraph). Display lines are charged at 6/- per line. All advertisements must be prepaid. All communications should be addressed to the Advertisement Manager, "Practical and Amateur Wireless," 8, Southampton Street, Strand, London.

RECEIVERS, COMPONENTS AND ACCESSORIES
Surplus, Clearance or Secondhand, etc.

RADIOMART
SHORT-WAVE SPECIALISTS
Announce 1937

SHORT-WAVE MANUAL

Packed with short-wave information and circuits of mains and battery receivers, including straight, superhet and 5-metre transmitters, modulators, etc. Information on transmitting licences, aerials, Class B amplifications, neutralization, superhet alignment, etc. The most comprehensive manual published, written by practical engineers, price 6d., post free 7d., including catalogue.

1937 Catalogue only (3 times enlarged) price 1½d. post free.

TELSEN screened dual range coils, 2/6. Pair, 4/6. Milliammeters, 25 ma. upwards, 5/9. Super, 6/9. **M**ERICAN mains transformers 230v. fully shrouded, 350/350. 6.3v., 5v., 6/11. Majestic 250/250. 2.5v., 5v., 4/11. **H**EAVY DUTY mains transformer worth 35/- 350/350. 150 ma.; 4v. 2.5ACT., 4v. GACT., 12/6. KC/S., IF transformers, 2/11. Telsen Ace, 1/11. RG4, Radio grands, 2/9. 2mf. 300v., 9d. **U**TILITY straight line wavelength dials, 3/11. Telsen H.F. chokes, 1/11. **U**TILITY 2-gang unknob and dial, 3/11; 1,500-volt tubular condensers, all sizes, 6d. **L**ECTROLYTICS 500-volt 5mf., 1/6; 4 mf., 1/6; 4 x 4, 1/11; 8 x 8, 3/6; 25 mf. 25v., 1/-, etc. **M**OOthing chokes, 20 by. 120 ma., 3/11; 100 ma., 2/11; 40 ma., 1/11. **P**USHBACK wire, 6 yds., 6d.; heavy, 9d.; 2 gross solder tags, 6d.; resin-cored solder, 9ft., 6d. **C**ENTRALAB pots, all sizes, 1/6; switched, 2/-; tubular glass fuses, 2d. **J**ENSON PM speakers, 12/6. Varley Iron core coils, 2/6; matched pair, 4/6. **P**ECIAL OFFER Class B valve, driver transformer and valveholder, new, lot 5/-.
ISSEN 3-gang bandpass, 3-gang superhet, 2-gang all-wave coils, any set, price 7/6.
TRADERS' monster bargain parcels, value £4/10/-, for 10/-; also 5/- parcels.
FAMOUS Continental A.C. valves, 4/6; American Duotron, etc., all types, 3/6; battery from 2/3. **U**TILITY 3/6, microdisc dials, 3/11; Radiophone, 0.00016 short-wave condensers, 3/6; series gap, twin, 3/9. **C**ERAMIC all brass microvariables, 15 mmfd., 1/4; 40 mmfd., 1/7; 100 mmfd., 1/10; short-wave H.F.C., 9d. **C**LEARANCE catalogue 1½d. Goods over 5/- post free. All enquirers must send stamp. Branches: 19, John Bright St., 44, Dale End, Mail Orders, 44, Holloway Head, Birmingham. Telephone, MID 3254.

CONVERSION UNITS for operating D.C. Receivers from A.C. Mains, improved type, 120 watts output, at £2/10/0. Send for our comprehensive list of speakers, Resistances and other components. **W**ARD, 46, Farringdon Street, London, E.C.4. Telephone: Holborn 9703.

ALL goods previously advertised are standard lines, still available. Post card for list free. **V**AUXILIARY UTILITIES, 163a, Strand, W.C.2. Over Denny's the Booksellers, Temple Bar 9388.

RADIO CLEARANCE, 63, HIGH HOLBORN, W.C.1. Tel.: Holborn 4631. **A**LL GOODS AS ADVERTISED LAST WEEK STILL AVAILABLE.

BANKRUPT Bargains. List free. Steady advertiser since 1929. All new goods. Battery all-wave sets complete with valves, HF pentode, detector and pentode and moving coil speaker, 16-2,000 metres, £3/19/6. Halcayon AC superhets, AC5, £6; AC7, 7 gns. Ormond AC superhets, £3. Ormond battery 3v. transportables with MC and three valves. HF pentode detector and pentode 57/6. Lotus 4v. A.C./D.C. midgets, £3. Pilot, Ferguson and Truphonic All-wavers, British 5v. superhets from £7/10/0. All-wave superhets £7/17/6. Large stock components right prices.—Butlin, 6, Stanford Avenue, Brighton. Preston 4030.

PREMIER SUPPLY STORES

Get our quotation for your Short-Wave and Television Gear

Offer the following Set Manufacturers' Brand New Surplus Goods at a Fraction of the Original Cost; all goods guaranteed perfect; carr. paid over 5/-; under 5/- postage 6d. extra. Orders under 5/- cannot be sent C.O.D.

ALL POST ORDERS TO JUBILEE WORKS, 167, LOWER CLAPTON RD., LONDON, E.5
CALLERS, AS USUAL, TO 20-22 HIGH ST., CLAPHAM, S.W.4 (Macaulay 2381). 'Phone: Amherst 4723
And 165 & 165a, FLEET ST., E.C.4 (Next door to Anderton's Hotel.) Central 2833.

MAINS VALVES

MAINS VALVES, famous Europa 4 v. A.C. types, 4/6 each. HL, L, S.G., Var.-Mu-S.G., H.F.-Pens., Var.-Mu-H.F. Pens., 1, 3 and 4-watt A.C. directly-heated output Pentodes. Full-wave rectifiers, 250 v. 60 ma. A.C./D.C. types. 20-volt. 18 amp. S.G., Var.-Mu-S.G., H., HL, Power. Following types all 5/6 each. Full-wave rectifiers, 350 v. 120 ma. and 500 v. 120 ma. 2½ watt indirectly-heated Pentodes, Frequency Changers, Octodes and Heptodes. **BATTERY VALVES.** 2 volts, H.F., L.F., 2/3. Power, Super-Power, 2/9. S.G., Var.-Mu-S.G., 4- or 5-pin Pentodes, H.F. Pens., Y.-Mu-H.F. Pens. 5/-, Class B, 3/6. **AMERICAN TRIAD VALVES.** Genuine American MYTRON and TRIAD first-grade Valves. 3 months' guarantee. All types in stock, 5/6 each. 210 and 250, 8/6 each. New Metal-Glass Valves, all types, 6/6 each. Genuine American **DUOTRON** Valves, all types, 3/6 each. Valve holders for all above types, 6d. each, Metal bases, 9d. each.

SHORT WAVES

SHORT-WAVE COILS, 4- and 6-pin types, 13.5v., 227/7, 41-94, 78-170 metres, 1/9 each, with circuit. Special set of 3 4-pin S.W. Coils, 14-150 metres, 4/- set, with circuit. Premier 3-band S.W. Coil, 11-25, 19-43, 38-86 metres. Simplifies S.W. receiver construction, suitable any type circuit, 2/6. **COIL FORMERS**, in finest plastic material, 1½in. low-loss ribbed, 4- or 6-pin, 1/- each. **SUPER CERAMIC CONDENSERS**, S.I.F. .00016, .0001, 2/9 each; double-spaced, .00005, .000025, .000015, 3/- each. All brass with integral slow motion, .00015 tuning, 3/9; .00015 reaction, 2/9. British Radiophone 2-gang .00016, 5/6. **H.F. CHOKES**, S.W. 10-200 metres, 9d.; S.W. screened, 1/6; standard screened 180-2,000 metres, 1/6. **CERAMIC S.W. VALVE HOLDERS**, 4-, 5- or 7-pin. Chassis types, 6d.; B.B. type, 8d. **GLASS AERIAL INSULATORS**, 4d. each. **BEEHIVE STAND-OFF**, 6d. each. **SCREENED FLEX**, single, 3d. yd.; twin, 4d. yd.

PREMIER AMPLIFIER KITS

3-WATT A.C. AMPLIFIER, 2-stage, for mike or pick-up. Complete kit of parts with 3 valves, 40/-. **7-WATT A.C./D.C. AMPLIFIER**, 3-stage, high-gain, push-pull input. Complete kit of parts with 5 specially matched valves, £4 4s. **10-WATT 3-stage A.C. Amplifier Kit** with 5 valves, £5 6s. **20-WATT 3-stage A.C. Amplifier Kit** with 5 valves, £8 8s. **ELECTROLYTICS**, U.S.A., 4, 8 or 12 mfd. 530 v. peak 1/9 each. Dutilleul, 4 or 8 mfd. 500 v. 3/-; 50 mfd. 50 v., 1/9; 12 mfd. 20 v., 6d.; 25 mfd. 25 v., 1/-; T.O.C. 4 or 8 mfd. 650 v., 4/-; 15 mfd. 50 or 100 v., 1/-; 50 mfd. 12 v., 1/-; Paper Condensers, W.E. 250 v. working 4 mf., 2/-; 2 mf., 1/-; 1 mf., 6d.; 350 v. working 4 mf., 2/6; 2 mf., 1/6. Dutilleul 500 v. working 4 mf., 4/-; 800 v. 4 mf., 6/-. **Wago 450 v. working 1 mf., 1/-; 2 mf. 1/9, 4 mf., 3/-; 700 v. working 2 mf., 2/-; 4 mf. 3/6. COSMOCOD PICK-UPS**, with tonearm and volume control, 10/6 each. **PICK-UP HEADS** only, 4/6 each.

MAINS TRANSFORMERS

PREMIER wire-ent type with screened primaries, tapped 200-250 v. Centre-tapped Filaments. Guaranteed one year. H.T. 8 & 9 or H.T. 10 with 4 v. 4 a. C.T. and 4 v. 1 a. C.T., 8/6. 250-250 v. 60 ma., 4 v. 1 a., 4 v. 2 a. and 4 v. 4 a., all C.T., 8/6. 350-350 v. 120 ma., 4 v. 1 a., 4 v. 2 a. and 4 v. 4 a., all O.T., 10/6. Any of these transformers with engraved panel and N.F. terminals, 1/6 extra. 500-500 v. 150 ma., 4 v. 2-3 a., 4 v. 2-3 a., 4 v. 2-3 a., 4 v. 2-3 a., all O.T., 17/6. Super Model, 19/6. **AUTO-T R A N S F O R M E R S**, step up or down, 50 watts, 7/6; 100 watts, 10/- **FILAMENT TRANSFORMERS**, Tapped Primaries, 200-250 v. All secondaries O.T. 4 v. 3 a., 7/6; 4 v. 5 a., 8/6; 7.5 v. 3 a., 7/6; 6 v. 3 a., 7/6; 2.5 v. 8 a., 7/6; 6.3 v. 3 a., 7/6; 5 v. 3 a., 7/6. **SMOOTHING CHOKES**, 25 ma., 2/9; 40 ma., 4/-; 60 ma., 5/6; 150 ma., 10/6. 2,500 ohms, 60 ma. Speaker Replacement Chokes, 5/6. **MILLIAMMETERS**, moving-iron, flush 2½in., all ranges from 0-10 ma., 5/9. Visual tuning, 6 or 12 ma., 5/9. Moving-coil meters, 2½in. 0-1 ma., 18/6; 3½in. 0-1 ma., 22/6. Multipliers, 1/- each.

AMPMETERS, all ranges, from 0.1 amp. 5/9. **T R A N S F O R M E R S**, latest type Telsen H.G.4 (list 12/6), 2/9. Lisson Hypernik Q.P.P. (list 12/6), 3/6. **O U T P U T T R A N S F O R M E R S** for Power, Pentode and Push-Pull, 2/6; Multi-Ratio, 4/6; Push-Pull Input Transformers by prominent manufacturer, 4/6 each. **E L I M I N A T O R K I T S**, for A.C. mains. 120 v. 20 ma., or 150 v. 25 ma., 15/-, tapped S.G., det. and output. Complete Kit with long-life valve rectifier (replacement cost only 2/-). **P R E M I E R L. T. C H A R G E R K I T S** for A.C. mains, including Westinghouse Rectifier and Tapped Mains Transformers. 8 volts at 4 amp., 14/6; 8 volts 1 a., 17/6; 15 volts 1 a., 19/-; 15-15 volts 1 a., 37/6; 15-15-15 volts 1 a., 50/-; 8 volts 2 a., 29/6. **T E L S E N** iron-cored screened coils, W.349, 4/- each. **E L E C T R I C S O L D E R I N G I R O N S**, 200-250 v., A.C./D.C., 2/3. **L O T U S J A C K S** (and Jack-switches), all types, 1/- each. Lotus Plugs, 1/- each. **P R E M I E R H. T. K I T S**, all with Westinghouse rectifiers; tapped transformers and adequate smoothing. All Kits absolutely complete. 120 v. 20 ma., 20/-; with 1 a. L.T. Charger, 28/-; 150 v. 30 ma., 25/-; with 1 a. L.T. Charger, 31/-; 250 v. 60 ma., with 4 v. 3 a. C.T., 30/-.

SHORT WAVE KITS

SHORT-WAVE KIT for 1-valve receiver or adaptor, complete with chassis, 4 coils, 14-150 metres, condensers, circuit and all parts, 12/6. **V A L V E G I V E N F R E E I D E L U X E M O D E L**, 17/6. **S U P E R H E T C O N V E R T E R K I T**, 3/6. **S. W. S U P E R H E T C O N V E R T E R**, for A.C. Mains Receivers, 20/- **A. C. Valve given FREE!** **2-VALVE S.W. KIT**, 19/6. **V A L V E S G I V E N F R E E!** **3-VALVE S.W. KIT**, S.G. Det. and Pen., 42/- **V A L V E S G I V E N F R E E!** **A L L - W A V E A L L - W O R L D R A N G E** 3-valve Kit, 12-2,000 metres in 4 wavebands without coil changing, complete kit of parts with 3 valves, S.G., H.F., S.G. det. and pentode (2 volts); 50/- **Q. P. P. Model**, 6/6 extra. **BAND-PASS TUNING PACK**, comprising set of Telsen 3-gang iron-cored coils with switching, mounted on steel chassis with 3-gang condenser, illuminated disc-drive and 4 valve holders. 25/- the lot. All Mains or Battery circuit. **F R E E I L I S S E N A L L - W A V E C O I L S**, 12-2,000 metres, complete with switching and wiring diagram, 12/6. **3-VALVE BAND-PASS KIT**, 200-2,000 metres. Complete kit of parts, including chassis, all components, valves, M.C. speaker and wiring diagram. Battery Model 50/- **A. C. Mains Model**, 70/-.

MOVING COIL SPEAKERS

MA G N A V O X. Mains energised. 154, 7in. cone, 2,500-ohms 4 watts, 12/6; "152", 9in. cone, 2,500 ohms, 17/6; 152 "Magna" 9in. cone, 2,500 ohms, 6 watts, 37/6. Magnavox P.M.S. "254", 7in. cone, 16/6; "252", 9in. cone, 22/6. Reliable P.M.S., 10/6. **R O L A** latest type P.M.S. 18/6. KE 7in. mains energised, 1,500 or 2,500 ohms, 7/9. **G O O D M A N S'** 8in. mains energised, 1,000 ohms field, 10/6 each. **J E N S E N P. M. S.** 11/6. **D I A L S**—Clarion Illuminated S.W. slow-motion Dial with 2½in. knob, 2/- **P r e m i e r A l l - W a v e** 2-speed Dial, full vision straight-line, dual ratios 10-1 and 150-1 6/6, with escutcheon. **P o t e n t i o m e t e r s** by well-known makers. All values up to 1 meg., 2/-; with switch, 2/6. **G R A M O P H O N E M O T O R S**—Collaro Gramophone Unit consisting of A.C. motor, 100-250 v. high quality pick-up and volume control, 45/-; Collaro motor only, 30/-; Collaro Universal Gramophone Motor, 100-250 v. A.C./D.C., with high quality pick-up and volume control, 67/6; Collaro Universal Motor only, 49/6. Edison Bell double-spring motors, including turntable and all fittings, 15/- **C o s m o c o d** Gramo unit, comprising A.C. motor, pick-up and volume control (list 55/-), 35/9. **T U B U L A R C O N D E N S E R S**, non-inductive, all values up to 5 mfd. 6d. each. **W i r e - e n t R E S I S T O R S**, any value, 1 watt, 6d.; 4 watts, 1/-; 8 watts, 1/6; 15 watts, 2/-; 25 watts, 2/6 each. **R e l i a b l e M O R S E K E Y S** with Morse Code engraved on bakelite base, 2/- each. Bakelite case BUZZERS, 1/6. Walnut Case "Loud-tone," 2/6 each. **S u p e r Q u a l i t y l i g h t w e i g h t H E A D P H O N E S**, 3/9 pair.

PREMIER (Réisz Pattern) Transverse-current MIKE, High Output, Straight Line Response, 30/- Transformer, 5/- Table Stand, 7/6. Adjustable Floor Stand, 22/6

HAVE YOU HAD OUR LATEST GIANT ILLUSTRATED CATALOGUE AND VALVE LIST? IF NOT, SEND 4d. IN STAMPS FOR THIS AMAZING LIST OF BARGAINS!

RECEIVERS, COMPONENTS AND ACCESSORIES
Surplus, Clearance or Secondhand, etc.

SALE OF NEW SURPLUS RECEIVERS, Etc.—G.E.C. BC/3480, 8-V. AC. Superhets, £7-15-0. Listed 21 gns. 3435/MV, 6-V. AC. Superhets £6-15-0. Listed £14-14-0. DC/AC. Models £6-15-0. 5-V. Models £5-19-6. 4-V. Models £4-19-6. 6-V. AC. 3550/RG. Radiograms £14. Listed 24gns. Lampex 4-V. AC Receivers £3-15-0. 3-V. 55/-. DC. 45/-. Marconi 248, 2-V. Battery Sets 35/-. 3-V. 70/-. Ready Radio Meteor SG-3 Kit Sets £1. Magnavox 236, PM, MC Speakers 10/-. Celestion "Soundex" 10/-. AC. Eliminators £1, DC, 10/-. 3-Gang Condensers 4/6, etc. Trade Supplied.—Collins, Riversley Road, Nuneaton.

HEADPHONES, Brown, G.E.C., B.T.H., Nesper, Sterling, Ericsson, Marconiphone, Telefunken etc., from 2/6 pair. Postage 6d. List free. **CRYSTAL SETS.** Complete, Guaranteed, Burne-Jones, 5/6. Ditto, double circuit, 8/-. Large P.O. type, 10/-. Crystal detector. Complete parts, 1/-. Sensitive permanent detector, 1/6.—Post Radio, 183, Caledonian Road, London, N.1.

WE BUY for cash, all types of Modern Second-hand Radio Sets, Accessories, etc. Unbeatable Part-exchange allowances for new goods. Bring, send or write.

UNIVERSITY RADIO LTD., 82, Hampstead Road, London, N.W.1. Phone: Euston 3810.

SHORT WAVES

SHORT WAVE on a crystal set. Full building instruction and crystal, 1/2 post paid.—Badiomail, Tanworth-in-Arden, Warwickshire.

LOUDSPEAKER REPAIRS

REPAIRS to Moving Coil Speakers, Cones and Coils fitted or rewound. Fields altered. Prices Quoted including Eliminators, Loud-speakers Repaired, 4/-. LF. and Speech Transformers, 4/ post free. Trade invited. Guaranteed. Satisfaction. Prompt Service. Estimates Free. L.S. Repair Service, 5, Balham Grove, London, S.W.12. Battersea 1321.

VALVES

NOTHING better available. **SIX MONTHS' GUARANTEE**, complete range of **BATTERY, A.C. MAINS, RECTIFIERS** always in stock. 2 volt Det., H.F., L.F., 2/3, POWER 2/0, SCREEN GRID, PENTODE, H.F. PENTODE 5/-. American types, fully guaranteed, 5/6 each, Nos. 80, 42, 43, 57, 58, 77, 78, 606, 6D6, 25Y5, 25Z5. Write for other prices to Dulci Electrical Co., Ltd., Devonshire Works, Dukas Avenue, Chiswick, W.4.

MISCELLANEOUS

WESTERN ELECTRIC Microphones, 1/6 each, post free; Transformers to match, 1/3; 500 clearance lines, catalogues 3d. each.—J. Bearfield, 105, Upper Street, London, N.1.

RADIO BARGAINS.

AMAZING prices. I lead, others follow. All-wave A.C./D.C. Table models, £6/15/0; Halcyon A.C.7, £7/7/0; Halcyon, A.C./D.C., Listed 14 gns., £7/7/0; Austin twin Rola speakers, Listed 15 gns., £7/7/0; A.C./D.C. Compacts, 65/-. Other Mains receivers, £5. Stamp for list. Speakers, Components, English, American Valve replacements. Full stock of the amazing All-wave Ferguson models. Trade supplied. State requirements.—Fitter, The Midland Dealer, 2, Barras Lane, Coventry.

WANTED Modern used Radio sets, short-wave parts and adaptors. Speakers, Eliminators, Meters, Motors and Pick-ups. Spot cash paid. Bring or send.—University Radio, Ltd., 82, Hampstead Road, London, N.W.1.

WANTED—ambitious young men to prepare for well paid posts in TELEVISION, the great career of the future. Apply for free booklet from **BRITISH INSTITUTE OF ENGINEERING TECHNOLOGY**, 15P, Shakespeare House, 17-19, Stratford Place, London, W.1.

FREE ADVICE BUREAU COUPON

This coupon is available until January 9th, 1937, and must be attached to all letters containing queries.

PRACTICAL AND AMATEUR WIRELESS, 2/1/37.



£7 6 VALVE ALL-WAVE SUPERHET

(Complete with B.V.A. Valves)
Improved all-wave superheterodyne for A.C. or D.C. mains. High sensitivity on all three wave-bands (16.5-50 metres, 200-550 metres, 800-2,000 metres). Many interesting features, including:— Illuminated "Airplane" dial with station names. Special "squelch" valve for inter-station noise suppression, with manual muting control. Octode frequency changer. 8 stages, 7 tuned circuits. Iron Cored I.F. Coils. Delayed A.V.C. 3.5 watts output. Extra heavy Cadmium-plated steel chassis.

£7 cash complete with valves, knobs, pilot lamps, mains cable and plug, etc. Deferred terms from London Radio Supply Co., 11, Oat Lane, E.C.2. 12 months' guarantee. Suitable loudspeakers, cabinets, etc., in stock. McCarthy Chassis from £4 5s. to £12. Write for illustrated catalogue.

MCCARTHY RADIO LTD.
44a, Westbourne Grove, London, W.2.
Telephone: Bayswater 3201.

DANGER FROM LIGHTNING
GET A **GARD**
LIGHTNING ARRESTER
WITH THE GUARANTEE 2/- OF £200

Act now! Don't run risks. Lightning may ruin your set, your home, your very life. Forget these dangers with a GARD, from all dealers or post free from:

GRAHAM FARISH LIMITED,
Masons Hill, Bromley, Kent.

MCCARTHY 6-VALVE A.W. CHASSIS

27/- DOWN. Complete receiver chassis, with all B.V.A. Valves, etc., ready for fitting in your own cabinet: £8/10/0 Cash or C.O.D. or 27/- down and 10 monthly payments of 16/-.
W.B. STENTORIAN SPEAKERS

2/6 DOWN. 37S: Cash or C.O.D. 42/-. or 2/6 down and 11 monthly payments of 4/-. 37J: Cash or C.O.D. 32/6, or 2/6 down and 11 monthly payments of 3/-.
CASH or C.O.D. Orders—DELIVERY BY RETURN.

THE LONDON RADIO SUPPLY CO., LTD.,
11, Oat Lane, Noble Street, London, E.C.2.

ADVERTISEMENT INDEX

	Page
Electradix Radios	501
Fluxite, Ltd.	499
Graham Farish, Ltd.	Inside Back Cover
International Correspondence Schools	502
London Radio Supply Co., Ltd.	Inside Back Cover
McCarthy Radio, Ltd.	Inside Back Cover
Peto-Scott Co., Ltd.	499
Radio Development	501
Telegraph Condenser Co., Ltd.	503

RECEIVERS, COMPONENTS AND ACCESSORIES
Surplus, Clearance or Secondhand, etc.

SOUTHERN RADIO'S Wireless Bargains; all goods guaranteed and sent post paid.

G.E.C. 8-valve Battery Sets, "Battery Compact Three," with 3 Osram valves, moving coil speaker in beautiful bakelite cabinet, brand new, in sealed cartons, fully guaranteed; 50/- each (list 55/10).

SPEAKERS—Celestion Soundex permanent magnet 5 10/-; Telsen permanent magnet, with 10-ratio transformer to suit any receiver, 12/6; Telsen loud-speaker units, 2/3; all brand new and in sealed cartons.

COILS—Telsen, iron core, W349, Midgot size, 4/-; Type W478 (twin), 9/- pair; W477 (triple), 14/- set; Type W476 (triple superhet selector and oscillator) 16/- set, all ganged coils complete on base with switch; Telsen I.F. transformer coils, W482, 5/-; Telsen dual range aerial coils, with aerial series condenser incorporated; W76, 4/-; Telsen aerial series condensers with shorting switch, 2/-; Telsen I.F. transformers, Type R.G.4 (4 to 1), 3/-; all brand new, in sealed cartons.

MICROPHONES—Ace (P.O.) microphones, complete with transformer, ready for use with any receiver, 4/6 each.

RESISTANCES—Tru-ohm 1-watt, colour coded and marked, 36 assorted capacities on card; 6/- per card.

POTENTIAL Dividers—Lissen wire wound, 3-section, 60-watt, 4,500 ohms, 3,000 ohms, and 2,000 ohms; 3-section, 5 watts, 20,000, 20,000 and 20,000 ohms; 2-section, 5 watt, 50,000 and 30,000 ohms; 1-section, 5 watt, 8,000 ohms, all at 1/3 each; brand new and guaranteed.

AMERICAN Valves—A full range of valves for all American receivers; 6/- each.

HEADPHONES—Lightweight headphones, double pole type, 4,000 ohms, each ear piece; 3/- pair.

REPAIRS—Any type of receivers. American, British, etc., repaired by expert staff.

WE Have Purchased the Complete Component Stock of a Well-known Radio Dealer and Manufacturer, and we are offering the complete stock in parcel lots as under:—

5/- Parcel, containing components to the value of at least 20/-, comprising chokes, resistances, coils, switches, condensers, wire and circuits, 5/- per parcel.

10/- Parcel, containing components to value of at least 45/-, comprising variable condensers, screened chokes, switches, resistances, screened coils, wire, circuits, etc., etc.; 10/- per parcel.

ALL Articles Included in These Parcels are Brand New and Modern.

SOUTHERN RADIO—Branches at 271-275, High Rd., Willesden Green, N.W.10; 46, Lisle St., London, W.C.2. All mail orders to 323, Euston Rd., London, N.W.1.

SOUTHERN RADIO, 323, Euston Rd., London, N.W.1 (near Warren Street Tube). Phone: Euston 3775.

MISCELLANEOUS

£3 BUYS the swellest compact on the market—4 valves, A.C./D.C., M.C. speaker—Smart fabric covered case. Good quality—reproduction plenty of stations.

£5.19.6 6-valve, all wave superhet, A.C./D.C. National Union valves, 17 1/2, 650 metres.

£9.9.0 7-valve all-wave super, with cathode ray tuning eye, mono-vision dial, marvellous performance.

£10.10.0 all-wave superhet, 1937 model, with R.F. stage. Universal transformer, 100-250 volts A.C.

£13.13.0 8-valve 4-band superhet, 12 1/2, 2,050 metres, 8 watts output. Every modern refinement. Available in A.C. and A.C./D.C.

ALL sets 100 per cent. guarantee. Set 12 months. Valves 6 months. Carriage free. Satisfaction or money refunded.

RADIOGRAPHIC, LTD., 66, Osborne Street, Glasgow, C.1.

"WIRELESS FOR THE MAN-IN-THE-MOON" by Columbus and Decibel, 2s. 6d. net.—Writing about the book the "Midland Daily Telegraph" says: "It is both good fun and sound theory."—At all Booksellers and Libraries, or from George Newnes, Ltd., 8-11, Southampton Street, Strand, London, W.C.2.

MORE THRILLING THAN FICTION—Newnes Wide World Library contains the finest true-life travel and adventure books, great literature and exhilarating reading. Each 2s. 6d. net from all Booksellers.—George Newnes, Ltd., 8-11, Southampton Street, Strand, London, W.C.2.

"WORKING MODELS and How to Make Them" Edited by F. J. Camm, 3s. 6d.—This Book will appeal to all who are handy with tools. Contains complete instructions for the making of every kind of working model. Each model has been actually constructed in accordance with the details given and subjected to stringent tests. The instructions and diagrams are so clear that even the most elaborate model can be built without fear of failure. Obtainable at all Booksellers and Newsagents.—Geo. Newnes, Ltd., 8-11, Southampton Street, Strand, London, W.C.2.

Rockets

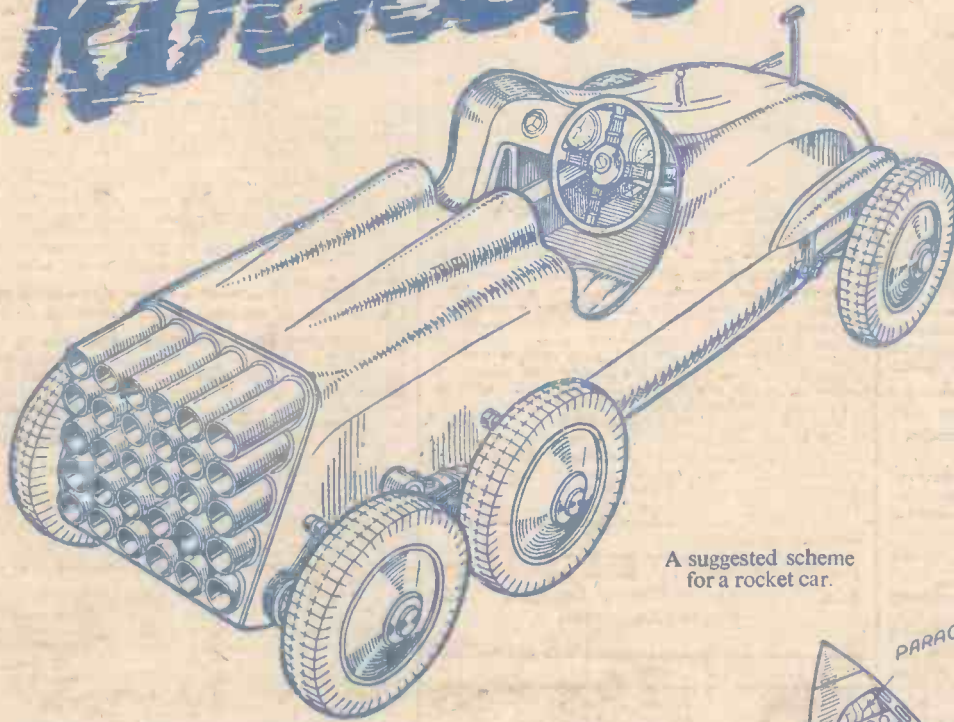

A suggested scheme
for a rocket car.

THE POWER OF THE FUTURE

PRACTICAL limits appear to have been reached in the speeds of Cars, Aeroplanes and Steam Ships. So now comes Rocket Power! In the January "PRACTICAL MECHANICS" F. J. Camm shows in a most interesting and well-illustrated article the vast strides that have been made in rocket propulsion. And you will discover how this wonderful new power is to be harnessed in the future.

Other Special Contents of the January
"PRACTICAL MECHANICS" include:

- The Chemistry of "Cold Light."
- How to build a Model Super-Duration Biplane.
- The World's First Theatres.
- The Canal-ways of England.
- Television Topics.
- Sectional Illustration of an Empire Flying Boat.
- Rewinding an Armature, etc., etc.

THE JANUARY PRACTICAL MECHANICS

On sale Thursday, Dec. 31st, at all Newsagents and Bookstalls, or by post 7½d. from The Publisher, George Newnes, Ltd., Tower House, Southampton Street, London, W.C.2.

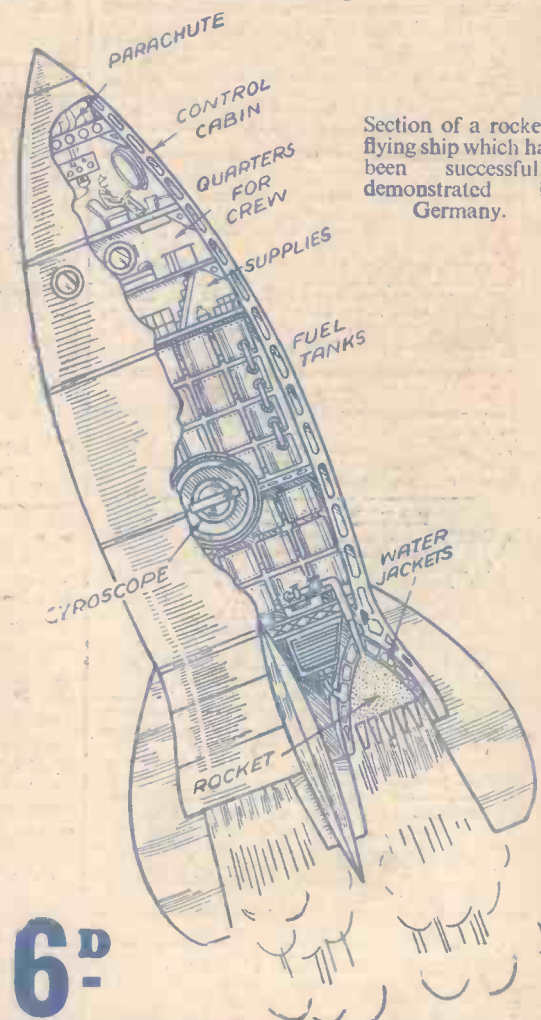

Section of a rocket-flying ship which has been successfully demonstrated in Germany.

6^d

AN AUTOMATIC TWO-VALVER—See Page 511.

Practical and Amateur Wireless

3^D
EVERY
WEDNESDAY

Edited by F.J. CAMM

a GEORGE
NEWNES
Publication

Vol. 9 No. 225,
January 9, 1937.

AND PRACTICAL TELEVISION



NEWNES TELEVISION AND SHORT-WAVE HANDBOOK

By F. J. CAMM (Editor, Practical and Amateur Wireless)

Fully
Illustrated

EVERYTHING ABOUT—Drums, Mirror Screws, Scanning Discs and other Scanning Systems, Neon Lamps, the Cathode-Ray Oscillograph. How to build Short-Wave Receivers; How to build Ultra-Short-Wave Receivers, straight and Superhet types.

FROM ALL BOOKSELLERS

NEWNES or 4/- post free from Tower House, Southampton Street, Strand, W.C.2, LONDON

only
3/6
net

THE OUTSTANDING WORK FOR ALL ELECTRICAL AND WIRELESS ENGINEERS

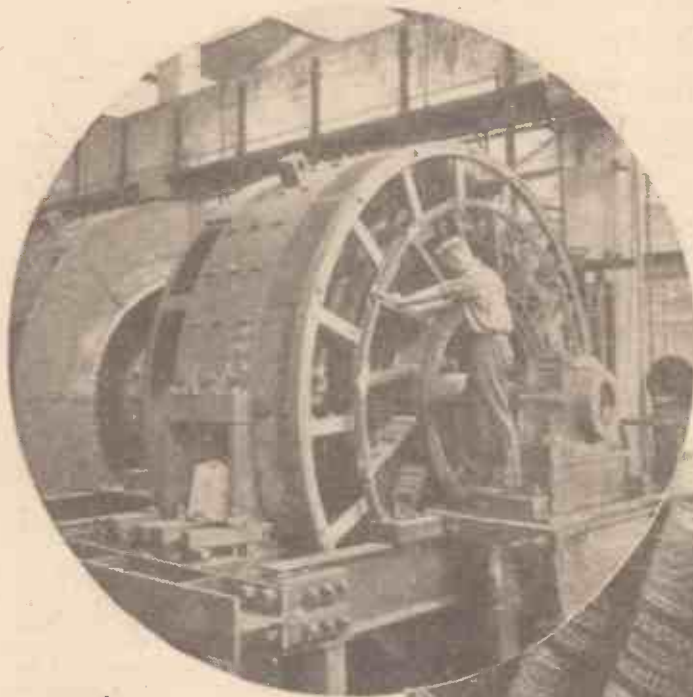

" PRACTICAL ELECTRICAL ENGINEERING "

IN Electrical Engineering, advancement and success come to the man who is best equipped to tackle and understand the multifarious jobs and problems he may encounter. This new and up-to-date work will help you to acquire the necessary combination of theoretical and practical knowledge. It is invaluable alike to the Student and to the practising engineer. It shows the approved methods of dealing with every type of work, from the installation, erection, wiring and maintenance of an electrical plant for a small house to that of a large factory replete with the most up-to-date equipment.

In addition, the most modern applications of electricity, including sound - film reproduction, wireless, etc., are fully dealt with and the work contains a great deal of most valuable data which cannot be found in any other handbook.

Send for the illustrated prospectus — and judge for yourself.

Complete in
5 Handy
Volumes

Bound in full Blue Moroquette. This strong binding is oil- and water-proof so that the books may be used freely in the Workshop, etc., without risk of damage.

A few of the
important subjects :

- WIRELESS AND GRAMOPHONES.
- ELECTRICAL MACHINERY.
- GENERATION AND DISTRIBUTION.
- INSTRUMENTS AND METERS.
- WIRES AND CABLES.
- LIGHTING AND ILLUMINATION.
- INSTALLATION WORK.
- OPERATION AND MAINTENANCE WORK.
- INDUSTRIAL USES OF ELECTRICITY.
- THEATRE AND CINEMA WORK.
- TELEGRAPHY AND TELEPHONY.
- ELECTRIC TRACTION.

POST THIS 
COUPON TO-DAY

We will send you full details of this most valuable reference work



OVER
30 SPECIALIST CONTRIBUTORS
MORE THAN
1,000
ILLUSTRATIONS
2 FOLDING PLATES
SECTIONAL MODELS
IN FULL COLOURS
OVER 1,900 PAGES

To The HOME LIBRARY BOOK COMPANY
(George Newnes, Ltd.)
TOWER HOUSE, SOUTHAMPTON ST., LONDON, W.C.2

Please send me, without any obligation to purchase, full particulars of PRACTICAL ELECTRICAL ENGINEERING and details of your scheme of Easy Payments with immediate delivery.

Name

Address

.....PRAC. W. 9137

If you do not wish to cut your copy, send post card mentioning "Practical Wireless" to address above.

SOME NEW VALVES—See page 518



Practical

and Amateur

Wireless

Edited by F. J. C. AMM

Technical Staff:
W. J. Delaney, H. J. Barton Chapple, Wh.Sc.,
B.Sc., A.M.I.E.E., Frank Preston.



VOL. IX. No. 225. January 9th, 1937.

ROUND *the* WORLD of WIRELESS

Super-regenerative Circuits

THE increasing popularity of short-wave reception has led to a reawakening of interest in circuit arrangements which were very popular in the early days of broadcasting, but which have since been forgotten by many constructors owing to the interest devoted to quality circuits and other arrangements. The short waves definitely require individual treatment, and many of the arrangements which were at one time so popular will be found to be of greater value for short-wave reception than some of the circuits which are now in common use. Of these, the super-regenerative receiver is undoubtedly one of the most efficient, and in view of the increased interest in this arrangement we give on page 523 an informative article on the subject, with various circuits embodying the super-regenerative principle. The subject is also dealt with in the column devoted to the British Long Distance Listeners' Club.

Croydon's Beacons

THE new radio beacons mentioned in last week's issue have already proved their worth. Towards the end of the year a dense fog descended on Croydon airport and all outgoing planes were cancelled. Two planes from the Continent, however, were warned by radio of the conditions and advised to land at the coast. They were fitted with the Lorenz apparatus, and decided to continue the journey. The first machine, a Swiss, picked up the radiation from the beacon and landed successfully, to the surprise of the officials, whose first intimation was the appearance of the machine taxi-ing along the ground towards the control tower, the landing having been invisible owing to the dense fog. The second machine also landed successfully and without difficulty.

Westinghouse on the Air

A SERIES of short-wave programmes has been arranged by the makers of the Westinghouse Refrigerators, through the American station W8XK, on wavelengths of 13.91 metres (21,540 kc/s), 19.71 metres (15,210 kc/s), 25.25 metres (11,870 kc/s), and 48.83 metres (6,140 kc/s). This station, which is owned by the Westinghouse Electric and Manufacturing Company, is located at Pittsburgh, Pennsylvania,

and any reader who wishes to receive advance details of the programmes may obtain copies on application to the British distributors for this company, the Lightfoot Refrigeration Company, Ltd., Bush House, Strand, London, W.C.2.

Chocolate Manufacture

MANY people are puzzled as to the manner in which the cream is placed inside a chocolate, or how the liquid is put in the popular liqueur chocolates. The art of chocolate making is a fascinating one, and many problems will be explained for the layman in a broadcast from the

and finally placed on the Durie where it is allowed to burn for a certain time. The burning embers are then scattered and eagerly picked up by the natives. In the old days these embers were thought to bring good luck to the household that obtained them.

New B.B.C. Stations

THIS year will see some interesting additions to the B.B.C. range of transmitters, and a high-power transmitter at Stagshaw, west of Newcastle, should be ready before the end of the year. A new medium-power transmitter at Beaumaris, in Anglesey, will be put into service early in the spring, and will work on the same wavelength as the present West Regional transmitter. At Daventry, three transmitters of considerably higher power than those now in operation have been ordered, and it is hoped that all three will be in operation by the early summer. Eight additional masts are being erected to support an improved aerial system.

Pick-up Regulates Watches

IN America the crystal pick-up is employed for the regulation of watches. Recently a design had to be perfected for the regulation of a miniature wrist-watch, measuring only one inch [by three-eighths of an inch, and a beat-frequency oscillator was employed to measure the range of frequencies produced by the "tick." This was found to extend from 60 to 17,000 c.p.s., with the most prominent vibration at 3,000 cycles per second. The tick from the watch is conveyed to the pick-up and passed through an amplifier, and then compared with a standard produced by synchronous machinery.

B.B.C. Letter Bag

DURING 1936 approximately 160,000 letters from listeners on the programmes were dealt with by the B.B.C. An analysis showed that roughly 80 per cent. were appreciative, and more letters of appreciation were received for talks than for any other type of programme; religion, variety and children's hour broadcasts coming next in order of preference. Amongst the peculiar requests received from listeners were those asking the B.B.C. to give hints on keeping bulldogs, and to say what kind of work Shakespeare would be writing if he were alive to-day.

ON OTHER PAGES

	Page
An Automatic Two-valver	511
Amateur Transmitting ...	513
On Your Wavelength ...	515
Practical Television ...	517
New Osram Valves ...	518
Readers' Wrinkles ...	519
1937 Crystal Set ...	520
Short Wave Section ...	523
Blueprint Service ...	530
Queries and Enquiries	531

Midland transmitter on January 16th, when a talk, illustrated by sound recordings from a well-known chocolate factory in the Midlands, will be given by Mr. A. R. Taylor.

Burning the Clavie

THERE are still many interesting superstitious rites observed in various parts of the country, and the old and the new will be united on January 12th at Burghhead, the site of the most up-to-date transmitter in Europe. Here, under the shadow of this B.B.C. transmitter, the clavie will be burnt. It consists of a barrel filled with chips of wood and tar, and having been set on fire it is carried in triumph through the village

ROUND the WORLD of WIRELESS (Continued)

King George Memorial Fund

A SPECIAL broadcast appeal is being made this month for the "odd shillings and pence" in everyone's savings to be given to the King George Memorial Fund. The sum thus collected will be devoted to the provision throughout the country of playing-fields, to be called King George's Fields. Further information in connection with this fund can be obtained from R. S. Forman, The King George Memorial Fund, 101, St. Martin's Lane, W.C.1.

Controlling Britain's Radio Traffic.

APPARATUS is shortly to be installed at the new wireless building at Baldock which will police the wireless traffic of Britain. At present it is at the experimental station at Dollis Hill. The job of the station is to see that the wireless "roads" are each kept clear for their particular form of traffic and that one station does not interfere with the transmissions of another. The staff are constantly getting complaints of "jamming" owing to one station or another having moved off its correct wavelength. When "jamming" occurs, the wavelength of the offending station is measured on a special instrument, and if the offender is off his own "road" an instruction is at once sent for the fault to be corrected.

"Up in London"

THIS is the title of an interesting talk designed to portray a discursive personal, and not too weighty, account of some of the sights a West Country man has observed there recently. The talk will be broadcast on January 7th, in the Western programme, and the speaker will be Reginald Arkell.



Radiograms were largely used to provide the music for New Year's parties, as this illustration shows, the instrument in this case being one of the latest Cossor radiograms.

INTERESTING and TOPICAL NEWS and NOTES

Revue Orchestra

PROGRAMMES of light music by the Midland Revue Orchestra, conducted by Reginald Burston, and led by Norris Stanley, have become popular. In the programme to be broadcast on January 10th the vocalist will be Alex Penney, the Derby

listeners, will give a concert from the Studio on January 10th. The leader of the sextet is Norman Brooks, who has also been heard as a soloist.

Rugby Running Commentary

COMMANDER C. A. KERSHAW, the famous Rugby international, will give a running commentary on the match between Gloucester and Leicester at the Kingsholme Ground, Gloucester, on January 9th, in the Midland Regional programme.



In the wireless traffic control experimental station at Dollis Hill. The operator is at work on a siphon recorder for precise measurements.

soprano. Miss Penney first broadcast in 1928 and has appeared in a number of musical shows and also as a soloist. Besides being a singer, she is an accomplished pianist and water-colour painter.

A Novel Broadcast

VICTOR SMYTHE will present on January 7th, in the Northern programme, another "Outside Broadcast Cameo." This time he will take listeners on a tour of the L.N.E.R. automatic marshalling yard at Hull. This is one of three yards in this country where traffic is handled automatically, being controlled from an electric switchboard in a tower overlooking the yard. In the broadcast an attempt will be made to give listeners a snapshot picture of the work that goes on in the yard. The sound of the trains, of the switching gear and so forth will be broadcast. The principal commentator will be L. S. Harper, the District Goods Manager.

A Famous German Soprano

ON January 8th Anita Oberlander will sing with the B.B.C. Midland Orchestra, conducted by Leslie Heward. Miss Oberlander was formerly leading lyric-dramatic soprano at the Stuttgart Opera and went on to the Berlin State Opera.

Lockier Grosvenor Sextet

THIS popular sextet, whose broadcasts are well known to Western

Variety from Birkenhead

AN excerpt from the Variety bill will be broadcast from the Argyle Theatre, Birkenhead, on January 13th, in the Northern programme.

SOLVE THIS!

PROBLEM No. 225.

Bristow's superhet worked satisfactorily on the medium waveband, but no signals could be heard on the long waveband. When current tests were made it was noted that consumption increased by about 3 mA when the wavechange switch was changed over from the medium-wave to the long-wave position. What was the fault? Three books will be awarded for the first three correct solutions opened. Address your solutions to the Editor, PRACTICAL AND AMATEUR WIRELESS, Geo. Newnes, Ltd., Tower House, Southampton Street, Strand, London, W.C.2. Envelopes must be marked Problem No. 225 in the top left-hand corner, and must be posted to reach this office not later than the first post on Monday, January 11th, 1937.

Solution to Problem No. 224.

Excessive voltage was being applied to the screen of the pentode detector. This screen should have approximately 30 volts.

Only two readers successfully solved Problem No. 223, and books are accordingly being forwarded to them: R. Stickler, 105, Partridge Road, Llwynypia, Glam., S. Wales; A. Sloan, 136, Blenheim Road, Harrow, Middlesex.

An Automatic Two-valver

Constructional Details of a Simple Two-valve, Two-station Receiver which is Suitable for Use as a Stand-by Set, or by Old People By FRANK PRESTON

THE idea of a receiver which can be tuned automatically to one of two transmissions by the operation of a change-over switch is by no means new, but it is carried a stage further than is usual in the circuit given in Fig. 1. Usually, two pre-set condensers only are used, these being arranged so that either can be placed in parallel with the tuning coil as required. One is adjusted so that, in conjunction with the coil, it tunes to the Regional

of interest. For example, there is no H.F. choke, a fixed 20,000-ohm metallised resistance replacing this; resistances are generally more trouble-free and foolproof than chokes. Additionally, it will be seen that automatic grid-bias is used. This saves the necessity for a separate grid-bias battery, and also regulates the G.B. voltage according to the condition of the high-tension battery. This, in turn, prevents the distortion which normally be-

factory to use a transformer of the pattern normally intended for resistance-feed connection. Adequate decoupling is provided for the detector, whilst the resistance used in place of an H.F. choke acts as an effective, though inexpensive, barrier to high-frequency currents.

No Battery Leads

As the receiver is intended to be foolproof and ultra-simple, and as it will probably be made in many cases for use by elderly people, it is best to avoid the need for battery leads and connections of the usual kind. For this reason it is suggested that the components be mounted on a base-board, underneath which can be fitted a 120-volt H.T. battery of the type with spring-tab connections (similar to those on flash-lamp batteries). Such batteries are made by most of the battery manufacturers for use in portable sets. The battery can be placed in a suitable compartment beneath the baseboard, contact being obtained by means of two round-headed brass wood screws, from which leads can be taken to the components in the set. It is also suggested that space be left on the baseboard for a small two-volt accumulator. Connection to this can easily be made, as shown in Fig. 2, by means of two tinplate strips with slotted ends. These are best mounted on an upright piece of wood, and arranged so that they fit exactly on to the accumulator terminals. It is not proposed to give dimensions, since these must of necessity be governed by the particular types and makes of batteries

(Continued overleaf)

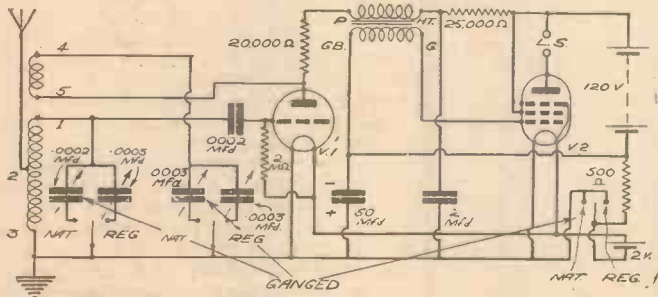

Fig. 1.—Theoretical circuit diagram of the "Automatic Two."

transmitter, while the other is adjusted for the National. A rather serious objection to this simple scheme in the case of a low-powered set is that there must also be a reaction control, or else reaction must be so adjusted that a "compromise" setting is obtained, which will provide reasonably satisfactory reception on either of the two wavelengths.

Critical Reaction Control

The drawback with this system is that the maximum sensitivity of the set can be obtained on only one of the two transmissions. As is well-known by constructors a fairly critical adjustment of the reaction condenser is necessary if the best possible results are to be obtained. This is necessary not only in the interests of volume of reproduction, but also because a fairly high degree of selectivity—fairly high, that is, for a simple tuning circuit—is required if complete freedom from interference is to be ensured.

Even when using the arrangement just described, it is generally necessary to employ an on-off switch in addition to that used for wave-changing. It will be seen from Fig. 1 that there are actually three change-over switches, although these are all ganged together, and all are of the type which provides a central off position. The first of these is for bringing one of two pre-set tuning condensers into circuit, the second is for achieving a similar result with two pre-set reaction condensers, whilst the third is for switching on and off the battery current. In practice, a single three-point change-over switch of the Wearite three-way rotary type is employed. By this means, the receiver can be turned off by setting the switch to its central position, on and tuned to the National transmitter by turning the knob to the left, and on and to the Regional transmitter by turning the knob to the right.

Automatic Grid-bias

The rest of the circuit is fairly straightforward, although there are a few points

comes apparent when the H.T. begins to run down and the G.B. voltage is not altered accordingly.

The first valve is of the H.F. type, which requires a very small amount of high-tension current, and the second is a high-efficiency pentode. Suitable valves for the two positions are Cossor 210 H.F. and Cossor 220 H.P.T. By using a detector valve such as the H.F., it is possible to employ a small, inexpensive transformer, due to the low current passed through the primary winding. It is, in fact, satis-

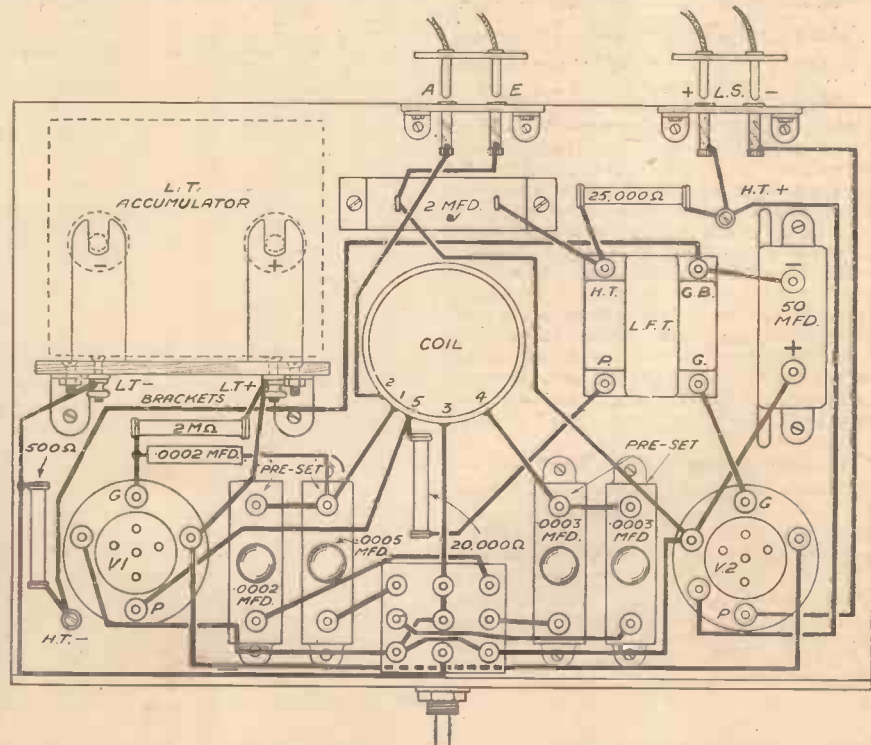

Fig. 2.—This is the wiring plan corresponding to the theoretical circuit in Fig. 1.

AN AUTOMATIC TWO-VALVER

(Continued from previous page)

chosen. In any case, the constructor will not experience any difficulty in modifying the details to suit his own convenience.

Components and Lay-out

Terminal-socket strips should be used for loudspeaker, aerial and earth connections, these being mounted on small metal angle brackets attached to the baseboard. Wander plugs could be used for external connections, but a better method is to use double plugs, such as are made by Clix, to fit the terminal-socket strips; this simplifies the small task of connecting-up.

Fig. 2 also gives an idea of a suitable component lay-out, although this is certainly not critical. If the general arrangement is followed as shown, however, the wiring will not present any problems—due to the use of short and direct leads. Additionally, the symmetrical arrangement shown gives a better appearance. It should be noticed that the pre-set condensers used for tuning are not both of the same capacity, one being of .0002-mfd. and the other .0005-mfd.; the reason for this is that a lower capacity is required for tuning to the National transmitter than to the Regional, and the minimum capacity of a .0005-mfd. might not be sufficiently low. Another practical point which should not be overlooked is that the value of the automatic bias resistance is correct only for the valves mentioned above. If different valves were used, a different value of resistance might be required.

The choice of components is not critical, but the following notes should prove helpful. All resistances may be of the $\frac{1}{2}$ -watt or 1-watt metallised or composition type; the 2-mfd. condenser can be an ordinary "paper" one; the 50-mfd. condenser is an electrolytic with a working voltage of 12 or less (T.C.C. type 501 is a typical example); the coil can be of any standard type or may be home-made.

Making the Coil

Since the coil has to tune only to the

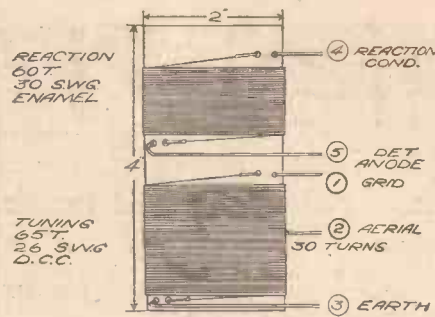

Fig. 3.—Constructional details of coil.

medium-wave band, it seems rather wasteful to employ a ready-made one with double-waveband windings, and so the constructor will probably prefer to make his own. This can be done by using a 4in. length of cardboard or paxolin tube 2in. in diameter. The tuning winding should consist of 65

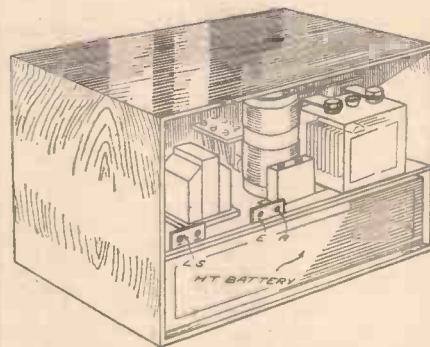

Fig. 4.—This shows how the batteries are placed, and a type of containing cabinet which is suitable. The H.T. battery has spring-leaf contacts with which connection is made by means of screws on the underside of the baseboard.

turns of 26 s.w.g. cotton-covered wire placed near one end of the tube. After leaving a space of $\frac{1}{4}$ in., the reaction winding can be placed alongside, this consisting of

60 turns of 30-gauge enamelled wire. Both windings should be wound in the same direction, when the connections will be as shown in Fig. 3.

It is best and simplest to solder short lengths of single flex to the ends of the windings, this being used for making the necessary connections. A tapping is taken from the 30th turn from the aerial end of the tuning winding, and this can be done by making a small loop in the wire when this number of turns has been reached, baring the wire and soldering on the length of flex. By tapping at this point a fairly high degree of selectivity will be obtained.

Condenser Adjustment

When the parts have been assembled, it will be necessary to adjust the various pre-set condensers. First turn the switch to the left (National), unscrew both reaction controls, and then tune in the National transmitter by turning the adjusting nut of the .0002-mfd. condenser. Next increase signal strength by means of the corresponding reaction condenser. This should be set so that signal strength is at a maximum, but also so that the deflector valve is not too close to the oscillation point. It should be remembered that slight readjustments of the tuning condenser will have to be made as reaction is advanced.

Next turn the switch over to the Regional position, and repeat the adjustments just described. Once the correct settings have been obtained, tighten the locking-nuts on the pre-sets so that the condenser capacities cannot alter due to vibration. When this has been done the set will not require any further adjustment unless and until the wavelength of one of the stations is altered.

With regard to the probable range of this set, it should be possible to obtain really good speaker strength for a small room up to thirty miles, although a greater range is possible if a lower volume level is not objected to. At ranges up to twenty miles, full loudspeaker strength (judged by battery-set standards) can be expected if a short outdoor or good indoor aerial is used.

Valves and Filaments

It is not generally known that the so-called "dull" emitter is older than the bright emitter. The very early valves used a flat platinum filament, sometimes bent along its length to form a shallow trough with a deposit of lime. This filament was intended to burn at a relatively low temperature, the filament temperature being extremely critical, as a few milliamps. change would take the valve from deadness, to a point where the lime was burnt away. The bright emitter valve was introduced later, only to give place in due course to the low-temperature valve, as it is known to-day, the platinum having been replaced by tungsten or nickel, and coated with various secret mixtures, the bases of which are strontium and barium.

Communication with Mars!

It has been proved that one of the difficulties in sending a wireless message to Mars (to say nothing of an incredible number of other difficulties) is the presence of the Heaviside and Appleton layers. These, of course, reflect between them almost every frequency available for such a purpose. Assuming that Mars is equipped with one or more layers of this description, the point arises that they will present a convex surface to energy radiated from the earth, whereas, of course, at our end our layers present a concave surface. For true

ITEMS OF INTEREST

reflection, of course, the circle is so big that curvature is unimportant, but there is no knowing the effect of any possible refraction of a wave capable of penetrating it.

A Renovation Hint

WHEN renovating a cracked cabinet, it is infinitely easier to use the coloured plastic wood now obtainable, rather than to attempt to use the ordinary white plastic wood, and colour afterwards.

Colour High-definition Television

SO far, little has been said about the question of colour high-definition television. One basic method of achieving this object would be a spinning disc in front of the cathode-ray tube suitably divided into the three primary colours, the arrangement being in effect that each picture is framed in each colour in turn, the transmission being so controlled that the "light" portions of each picture are controlled by the colour value of the object or scene to be transmitted. In actual

practice, of course, the three primary colours would have to be modified, as the source of light (the cathode-ray spot) is not truly white. There is, however, little likelihood of such an arrangement being adopted for many years to come, and it is also questionable whether the present technique of transmission allows for a sufficiently steady picture to be broadcast to enable the colour to be obtained by, say, green being obtainable by two succeeding pictures, yellow and blue, as should the smallest movement of the picture take place, a green object would have a yellow fringe on one side, and a blue fringe the other.

Cathode-ray Tube Screens

It is not generally known that the screen of a cathode-ray tube becomes very much more sensitive when subjected to bright light; consequently when a television receiver is correctly adjusted, and the light is switched on, it will often be found on switching off that the picture appears too bright, but it will return to normal in a second or so.

Reception on a Cossor Television Receiver

WE understand that the Cossor television receiver is giving satisfactory service at Sevenoaks, although at a distance of thirty-five miles it is well outside the service area.

AMATEUR TRANSMITTING

(Continued from previous page)

looking for the indicator, so I would suggest that a neon bulb or low-wattage mains lamp is wired in circuit with the supply.

Fuses should always be embodied between the double-pole mains switch and the primary of the mains transformer, when on A.C., and between switch and smoothing arrangements on D.C. As is usual with D.C. circuits, the earth connection must not be taken direct to the common negative side of the circuit; a reliable make of fixed condenser of, say, .05 mfd., should always be in series with the earth lead.

There is one other very satisfactory source of H.T. supply if mains are not available, and that is accumulator H.T. cells. These are capable of supplying a very steady current, free from any trace of hum and chemical noises, while they will stand up to a much heavier current drain than the usual dry H.T. battery and, of course, after the initial outlay, they are more economical.

Modulation

So far no mention has been made about modulating the oscillations produced in the crystal circuit of the 240B, therefore, just a few words about suitable microphones and their operation.

With the microphone transformer specified and with the amplification available, it is necessary to use a fairly sensitive "mike," otherwise satisfactory modulation of the signal will not be obtained.

There are many carbon "mikes" on the market, ranging from simple button affairs to elaborate transverse current jobs, so consideration must be given to the selection of a suitable instrument. I have had the opportunity of testing many makes and types, and I would strongly advise all those really interested in transmitting to invest in a decent transverse current model. Bearing in mind quality of reproduction, sensitivity and price, the "Midget" transverse current microphone produced by the Aintree Production Company was found to be most satisfactory, as ample output was obtained, with 4½ volts energising current, fully to modulate the oscillator section. If price is not a vital consideration, and if one is contemplating going in for a "Full Licence," then the Q.S.M. Model is well worth its extra cost.

The "mike" is connected to the two terminals provided on the back panel of the rack by a length of ordinary twin flex, and placed in a position most convenient to the operator.

Either ratio of the Bulgin microphone transformer can be used, the higher giving

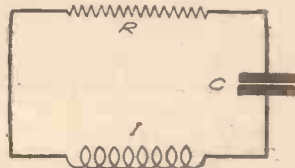

Fig. 6.—Theoretical representation of an artificial aerial system.

greater output but not quite such good quality.

When modulating with speech, don't speak into the "mike," place the mouth fairly close to the microphone, say, 9ins., and speak, clearly, across the metal grille.

Gramophone records can be used either by reproducing them through the "mike" or by using a pick-up, the P.U. leads being connected across the secondary of the microphone transformer. If so desired,

both the "mike" and P.U. can be used at the same time, thus allowing details to be given of any adjustments made during the transmission of the record. In the case of a single operator, the P.U. will be found most useful, as the test receiver can be

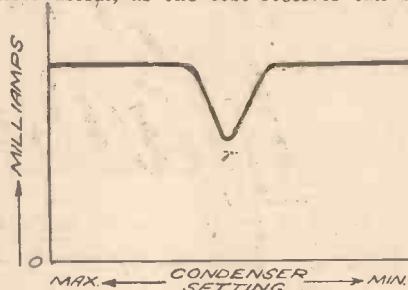

Fig. 4.—Curve showing the resonant point.

placed in some remote part of the house, and the transmission checked while the gramophone continues to modulate the signal.

Operation of the Transmitter

With all batteries connected, but without any aerial or earth, and the milliammeter in the positive H.T. supply, switch on and watch the meter. The variable condenser should be closed, i.e., maximum capacity.

When the needle has reached the end

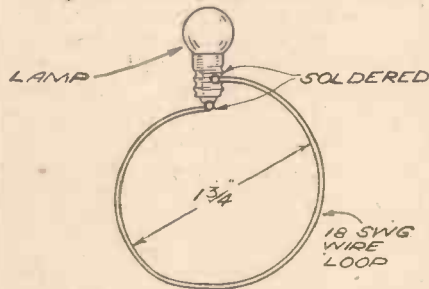

Fig. 5.—The "looped-lamp" circuit indicator.

of its travel, the exact setting depending on the value of H.T. and grid leak, slowly rotate the condenser towards minimum, and still watch the meter.

What should happen is this. A setting of the condenser will be reached where the current will take a sudden dip downwards, and then, as the condenser capacity is still further reduced, the needle will commence to swing back again towards its original position.

If the current readings are plotted against condenser settings, a curve like that shown in Fig 4 will be obtained if all is well.

At the point "T," i.e., minimum current reading, the anode tank coil circuit is tuned to resonance with the grid circuit, or in other words, the transmitter is producing the required oscillations, and, when the needle swings upwards, oscillations cease. More will be said about these effects later on.

If the microphone is then switched on, it will be possible to see minute variations in the current reading when the "mike" is flicked with the finger (the case not the diaphragm), providing the oscillator and modulator sections are working properly.

If a test receiver is handy, which it should be, it will be found that the signals can be picked up if the receiver is tuned to the transmitter frequency.

Loop-lamp Test

There is another very simple yet instructive way of checking up the transmitter

adjustments, which does not require the use of a meter. It is the "looped-lamp" method, which employs an ordinary low consumption—in this instance, pocket lamp—bulb, the contacts of which are soldered to the ends of a loop of, say, 18 S.W.G. tinned copper wire which is bent to form a loop or circle having a diameter approximately equal to that of the tank coil. Fig. 5.

The loop should be held near, but not touching, the end turns of the tank coil, and if 200 or more volts are being applied on the H.T. side, it will be possible to make the lamp glow. When the maximum output is being given, the lamp will give the brightest light.

The same effect can be produced with lower H.T. voltages, depending on the type or current consumption of the lamp. It must be remembered that the average 4½-volt pocket lamp takes .3 amp., i.e., 300 mA., while some of the 8-volt type only take .2 amp. The properly rated fuse bulbs produced by Messrs. Bulgin are most useful, as they can be obtained for very low current readings.

Artificial Aerial

As explained in the first article of this series, it is necessary, with an Artificial Aerial Licence, to employ some form of dummy aerial which will absorb, so to speak, the output of the transmitter, thus preventing radiation over distances beyond the immediate vicinity of the apparatus.

The theoretical diagram is shown in Fig. 6, where it will be seen that very few parts are required. The average aerial has inductance, resistance and capacity, so the same qualities are embodied in the dummy or artificial arrangement, the coil L providing the inductance; C, a condenser, the capacity, and R the resistance.

For the present purpose it is advisable to make the A.A. so that it can be tuned, and provide it with some means of indicating the effectiveness of the transmitter. To do this, the condenser C is made variable and the resistance R is replaced with a small lamp.

The construction is quite simple, the illustration showing the position of all parts, and the three wires connecting them. The coil can be made identical to the anode tank coil, or a more simple and flexible way is to use a B.T.S. plug-in 24-52 metre coil, which was the method I adopted.

(Continued on page 522)

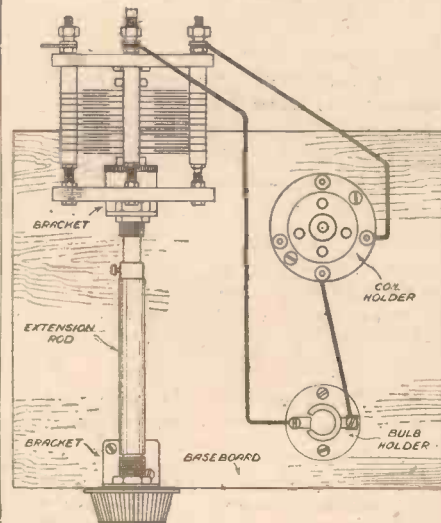

Fig. 7.—Layout and wiring of the artificial aerial for use with the transmitter.



On Your Wavelength

By THERMION

When a particular club got annoyed because they thought more matter

terrible disease among the entertaining profession known as crooning. If you know any new words, do please send them on to me.

Club Life

I HAVE had a considerable amount of correspondence from readers of my recent notes about Wireless Clubs, and I feel that I ought to amplify them.

In the first place there is always the tendency for members of a club to think that they represent the entire circulation of the paper, and it is quite a common experience for them to write to the editors of papers saying: "Unless you drop such and such a feature our members are going to cease taking your journal," or "Unless you publish the design we want, we shall cease taking your paper."

Such letters leave editors, as well as your present scribe, quite cold. If the continuation of your subscription to a journal depends upon every view expressed in it coinciding with yours, I am prepared to bow to the inevitable and lose a reader, or readers. I, for one, refuse to be threatened. You buy a journal because you like it, and it is inevitable that you will disagree with something which appears in it at some time or another. The average clubmen's outlook is parochial and he cannot perceive that there are any other readers outside his own circle. The sort of reader or clubman who writes on the lines I have indicated is wasting his time, and I, for one, would prefer that he adopted a more reasonable attitude. You cannot expect a journal to kow-tow to threats. We like to be on the friendliest of terms with readers, but we do not permit them to be offensive or impertinent. It is not alone in the wireless game that club members adopt (fortunately not in every case), a pugnacious and dictatorial attitude. A well-known editor once told me that clubs were a darned nuisance to him, and his journal did not deal with radio.

should be published dealing with the particular subject, they inevitably wrote in saying that they were not going to take the paper in future "and will persuade all their friends to act similarly." No club represents more than a small tithe of the circulation of a paper, and such an attitude is not only a waste of time and impertinent, but makes the club itself appear very small beer. Additionally it displays extreme lack of intelligence. The correct function of a newspaper is to criticise, using fair words, but without fear or favour. That function this journal and I, as its servant, will continue to discharge fearlessly.

Crooners Again

HERE is a letter I have received from J. G. B., of Ingleton:

"Dear 'Thermion,'

"Although you, in your office in London, are to me and the rest of the boys, anonymous and impregnable, I feel I must have a gentle prod at you, *re* your repeated onslaughts against 'crooners.' Why must you keep on each week referring to their 'larynx, epiglottos, gurgles and plonks'? Think of the sets you have no doubt built in your time, and how they used to rattle the larynx and make queer gurgling noises.

"Come now, 'Thermion,' listen to the pure and beautifully modulated voices of Bing Crosby, Brian Lawrance, Sam Brown, or Ann Lenner, who make our listening worth while, and I think you will agree with me, there are some 'crooners' undeserving of your comments.

"Wishing you, and PRACTICAL AND AMATEUR WIRELESS, all the best for the New Year."

I have used all of the expletives and oburgations within the ambit of my vocabulary in decrying the

How Many Clubs?

YOU will remember that I questioned whether a certain individual could recite off-hand thirty clubs as he claimed to be able to do. I have been to a lot of trouble searching up records and past issues and can find the appended. Here are forty, and I am indebted to a correspondent for sending me a similar list. I reproduce the names of these clubs for the benefit of other readers.

Anglo-American Radio and Television Short-Wave Club, Uxbridge.
 Bideford and District Short-Wave Club.
 Bristol Radio Club.
 Blackpool Short-Wave Club.
 Blackwood Radio and Television Club.
 Bradford Short-Wave Club.
 Cardiff and District Short-Wave Club.
 City of Belfast Y.M.C.A. Radio Club.
 City and Guilds (ENG) College Radio Society.
 Coventry Short-Wave Club.
 Eastbourne and District Radio Society.
 Hastings and St. Leonards Radio Society.
 International Short-Wave Club, London.
 International Short-Wave Club, St. Peter Port.
 International Short-Wave Club, Brighton.
 International Short-Wave Club, Manchester.
 Leicester Amateur Short-Wave Society.
 Leeds Radio Society.
 Medway Amateur Transmitters Society.
 Midland Amateur Radio Society.
 North Manchester Radio Society.
 Nelson and District Radio Club.
 Newport and District Radio Club.
 Peterborough Short-Wave Club.
 Radio, Physical and Television Society.
 Radio Transmitters Union, N. Ireland.
 Reading Short-Wave Club.
 Salisbury and District Short-Wave Club.
 Scottish Short-Wave Radio and Television League.
 Sheffield Short-Wave Club.
 Southend and District Radio and Scientific Society.
 South Hants Radio and Television Society.
 South London Transmitters Society.
 S.T.C. Radio Experimental Society.
 Surrey Radio Contact Club.
 Sutton-in-Ashfield Radio Society.
 Swindon and District Short-Wave Club.
 Thames Valley Amateur Radio and Television Society.
 Tottenham Short-Wave Club.
 Wirral Amateur Transmitter and Short-Wave Club.

Thanks

MY thanks to the numerous readers who sent me Christmas cards and letters of good will. I had no idea I had so many friends,

for each year the number of such messages and tokens increases in volume. They come from all over the world, which means in some cases posting a letter to me three weeks before the 25th arrives. Once again, my thanks.

The Past Year

AT the end of a year it is nice to look back as well as forward. In 1936 all-wave receivers showed an astonishing increase in sales and the television service commenced. The Crystal Palace was burnt down, and many of the old hands who helped to make radio history have ascended into the empyrean on an unknown wavelength. Probably the last show to be held at Olympia was held in August, and gives rise to the pretty problem of what title will supersede Radiolympia. Otherwise the year 1936 was uneventful. Notwithstanding the competition of commercial receivers it is astonishing to note the loyalty of our readers as indicated by our circulation, and my best wishes go out to every reader for a healthy and prosperous time in 1937.

Television Programmes

I AM glad to note that the B.B.C. is now asking listeners to make known their likes and dislikes concerning the television programmes. I know that many readers are not yet in possession of a television receiver, but you can do a lot towards ensuring that you will get a programme which will meet your requirements when you do make up one of these receivers by letting the B.B.C. know the type of programme which interests you. If you have not yet looked in at a modern transmission, I advise you to take the earliest opportunity of visiting one of the many shops or stores where demonstrations are now given. You can then see what is being done and let the B.B.C. have your criticisms. They are, of course, working against tremendous odds at the moment, and the new field requires careful exploration before the best use can be made of it, and it is better that you should make your comments now than to wait until you have a set and then grumble if things are not to your liking. There are dozens of opportunities of seeing television, and I understand that a list of places where the demonstrations may be seen will be given in these pages shortly.

Volume Controls

I HAVE previously complained of my bad luck with volume controls, but it does not appear to have



Notes from the Test Bench

Delayed A.V.C.

IF a modern diode valve is used, it is possible to obtain a useful A.V.C. effect, provided that the diode is preceded by two or more valves. In a superhet one of these will be the intermediate-frequency amplifier and the other the frequency changer, and in a straight set they will both be high-frequency amplifiers. Both valves must, of course, have variable mu characteristics. The A.V.C. circuit originally used was of what is now known as the "simple" type. With this method, weak signals were controlled as well as strong signals from the local station, thus resulting in a general reduction of sensitivity. Circuits have since been evolved which effectively control the strength of the local stations without materially affecting weak signals. This effect is produced by biasing the A.V.C. anode of the diode so that no control occurs until the input signal reaches a certain level. The diode anode is connected to the negative line through its load resistance, and the cathode is joined to a point a few volts positive with respect to the negative line. The diode anode is then negative with respect to the cathode, and until the input to the diode reaches the value of this negative voltage no control takes place.

A.C. Record

SOME readers have queried the necessity for resistance R_{13} in the A.C. Record Three. This resistance is connected across the smoothing condenser and its function is to safeguard the other components against voltage surge when the receiver is switched on. During the heating up period the current taken from the rectifier is very low and therefore the output voltage is abnormally high unless a limiting resistance is used. The wet electrolytic condenser across which the resistance is connected also acts as a voltage regulator. When the rectifier output voltage reaches a higher value than the rated working voltage of the condenser, the latter will not break down, but will pass a higher current, thereby producing a drop in the voltage.

Wet Electrolytic Condensers

THIS type of condenser is also very suitable for use in receivers employing a high voltage output valve. In such sets a high resistance must be joined in the anode lead to the valves preceding the output valve, and a wet electrolytic connected between the anode side of this resistance and H.T.—will limit the anode voltage during the heating-up period.

changed. Each time I build a new receiver the trouble reappears. With my last set I fitted no less than five different makes of 5,000 ohm variable-mu volume controls before finding one which operated smoothly and silently. Even then, my trouble was not over, for after the component had been in use for four days it again became excessively noisy.

The complaint is not confined to components for home construction, for I learned from a manufacturer the other day that he had precisely the same difficulty. Besides, it is apparent when using commercial receivers. It is very difficult to imagine why the design of such an apparently simple component should present so many obstacles. When an appreciable amount of current has to be carried the matter is more understandable, but when a 250,000 ohm potentiometer is used for L.F. volume control—so that no D.C. current is normally passed through it—the element cannot be overloaded and the only strain is that due to mechanical friction, which is slight. Once more I appeal to manufacturers: Will you not do something about it? In 1937?

A Dust-proof Room

I LEARN that in the television section of the G.E.C. research laboratories at Wembley, Middlesex, is what is claimed to be the most dust-proof room in the world. Here a white-coated girl scientist spends her day conducting one of the most delicate operations in the manufacture of a television set—making the screen. Even the smallest particle of dust would be enough to distort the picture on it. So the room in which she works has to be free, not only from the kind of dust that can be seen, but dust so minute that only the most powerful scientific instruments can detect it.

The television screen consists of a special powder coated on to the flat surface inside the glass cathode-ray tube. When this powder is bombarded with electrons it lights up, giving the picture. This layer of powder must be absolutely even, and that is why there must not be even a speck of dust in the room. The thickness of the coating is so slight that it has to be measured by weight in grammes after application.

The powder used by the G.E.C. is zinc sulphide with other chemicals, the nature of which is not divulged. These must be added with an accuracy of within a thousandth of one per cent. This television "screen" of powder has to be able to withstand a terrific strain, as it is bombarded by electrons travelling at 70,000,000 miles an hour.

Practical Television

January 9th, 1937. Vol. 3. No. 32.

Television Monopoly

THE subject of television monopoly is one of the questions which the Postmaster-General will have to answer in Parliament shortly. In view of the rapid advance in television which has taken place in this country since the Ullswater Committee on broadcasting took evidence and reported, coupled with the extensive developments in prospect during the new ten-year period of the B.B.C.'s charter, one M.P. intends to raise an interesting point. He desires to know whether the P.M.G. can give an assurance that safeguards will be incorporated, both in the charter and the licence, to protect those entertainment interests which may be adversely affected by the monopoly of visual as well as sound broadcasting which the Corporation will enjoy in this country. The charter draft which has now been published reveals only slight changes from its 1926 prototype, but for the first time there is a clause in the agreement between the Postmaster-General and the Corporation which makes provision for the P.M.G. to approve finally any of the B.B.C.'s operations in the television service. This form of control is essential, but it is confidently anticipated that the television service under the jurisdiction of Gerald Cock will not be unduly fettered, but rather given considerable scope to expand in its own particular way, quite distinct from anything which may happen in aural broadcasting.

An Interesting Question

DURING the course of a recent television address to an assembly of doctors, several very interesting questions were raised, particularly in connection with television's possible relation to the medical profession. One of the members of the audience, however, brought up the subject of his own pet hobby, which was astronomy. He was anxious to know whether the exploration of the heavens, more especially with reference to discovering the nature of certain planets, could be assisted by electron scanners and multiplier cells. It was pointed out that in any television system the light waves at one end were converted, for transmission purposes, into electrical impulses, which then passed through equipment capable of producing an enormous degree of amplification. Finally, the signal was reconverted into light waves to give a replica of the scene originally televised by the camera. Strictly speaking, therefore, this degree of magnification exceeded considerably anything which could be achieved by a telescope with optical lens magnification. It seems certain that once the electron camera with its associated photo-electric device for light wave to electric impulse conversion was improved, coupled with an increase in efficiency of the multiplier cells or cold cathode valves which depend for their action on controlled secondary emission, then astronomers will be provided with apparatus which will reveal many of the stars' secrets that now

remain hidden. Lenses of high quality will form the planet's image in part, or in sections, on to the cathode surface, scanning will then be effected, and, finally, the generated signal, after amplification, will be converted to a picture on a large screen.

A Theatrical Suggestion

ALTHOUGH it was pointed out during the recent demonstration of Mr. Baird's multi-mesh large screen at the Dominion Theatre that the viewing device was for the specific purpose of public addresses or for private programmes, the idea has already brought forward several interesting suggestions. Realising that the screen as shown was confined primarily to close-ups, since the fire at the Crystal Palace had destroyed the ultra-short-wave radio transmitter which was to provide the link between the distant studio and the theatre, from one source comes the proposed scheme for harnessing a device of this character as an aid to the theatre. So often has television been regarded as a menace to the stage or cinema screen that a change of front, if only in a small way, is a welcome fact. It is stated that owing to competition from the cinema some provincial theatres have had to close their doors. To accommodate in complete comfort those patrons who are prepared to pay the higher theatre prices, it is suggested that these empty buildings be altered so that the performance can not only be seen directly by the assembled audience, but, in addition, some, or even the whole, of the turns or plays could be transmitted by wire or wireless to neighbouring cinemas. The extra income derived from these "relays" would meet the cost of providing the salaries of really first-class companies and entertainers, and in this way theatre, cinema and public would reap the benefit of a co-operative effort. The idea is one which merits a very close examination, for it may provide a solution to this "menace" attitude which crops up with unfailling regularity every few weeks in some quarter or another.

TELEVISION NOTES

the wrong colour of fluorescence. Again, problems of signal distribution are acute, owing to the size of the country, coupled with the very high buildings in all large cities, producing unpleasant reflections or ghost images. The co-axial cable, while a promising means of interlinking stations, has yet to be proved quite satisfactory, and directional radio links have not yet been established in the country on any large scale.

A Conservative Policy

ALTHOUGH it is claimed quite frequently that television development in America has reached the same degree of technical efficiency as in this country, there still seems little prospect of a public service in the States. With marked frequency elaborately arranged Press demonstrations are staged by one or other of the big companies interested in television, and this is followed by a spate of television news in the Press, but nothing concrete materialises. This may be due to a variety of causes, but nearly all the Press criticism is directed towards the smallness of the image seen on the cathode-ray tube receivers and



The International Short-Wave Club (London Chapter) are holding regular meetings on Television, and the illustration shows members interested in the latest television transmissions.

Rehearsals and Transmitting Times

THE question of increased hours of transmission is still being discussed in many quarters, and one section of the Press went so far as to suggest that the Alexandra Palace officials are sufficiently ambitious to hope for an eventual nine-hour programme daily. This is largely the outcome of the high quality of the technical results achieved, which side of the service is undoubtedly well ahead of the programme material so far provided. The biggest stumbling-block is associated with rehearsals, since it is so essential to have every detail right before any act is televised. Lack of studio space is being felt very acutely, but this has been offset partially by the acquisition of the Alexandra Palace Theatre. Here it has been possible to stage replicas of the Baird and E.M.I. television studios by outlining on the floor items of furniture and fittings employed in the studio proper. All the preliminary work can thus be undertaken in the theatre, and final dress rehearsals confined to the transmitting studios to secure the correct lighting, etc., and observe the pictures on the pilot television receivers. Time is a big factor, which has to be studied carefully in all television productions, and this contrasts in a very marked degree with film production, which can be spread over days and weeks with retakes, cutting and editing undertaken in a relatively slow manner.

New Osram Valves

WITH the ever-increasing valve slopes and widening range of multiple valves which have been the vogue for the past few years, it is interesting to turn to a new range of valves now marketed by the General Electric Co., Ltd., in which an entirely new note in design is struck.

These valves, which are additions to the range of Osram 4-volt indirectly-heated A.C. mains types, are at present available in five varieties which, with the addition of an existing A.C. rectifier, are adequate to design a complete A.C. receiver giving an extremely high order of reliability and modern characteristics.

Several new features have been incorporated in these valves, some of which are:—

(1) Improved methods of manufacture adopted with this range, involving exceedingly close inspection and special precautions in handling between each stage, which render possible closer manufacturing tolerances. Thus a very high degree of consistency is realised with these valves.

(2) A materially reduced heater wattage, with the exception of the output pentode where adequate reserve of electron emission is essential. The heater current in these valves has been reduced from the standard figure of 1.0 amp. to 0.6 amp., maintaining a voltage rating of 4 volts. This means that economies can be effected in the mains transformer design and there is less liability of voltage drop in the heater leads.

(3) Each of the valves in the range, with the exception of the output pentode, has the grid connection brought to a top cap on the bulb. While for purely technical reasons it is possibly difficult to argue as to whether the grid or anode top cap connection is better, there are undoubtedly reasons of lay-out in the actual circuit which favour the grid top cap connection and which will ultimately lead to simplicity and economy in the set design. Another advantage of this is the lower value of grid-cathode, or input capacity, which is permissible, thus extending the tuning range for a given value of tuning condenser. A particular feature of interest is the grid top connection to the triode in the range, which is an innovation in regard to valves of this class.

Types

Dealing with the types separately, we have first the W42. This is a variable- μ H.F. screen pentode, the general uses to which it is adaptable being: As an H.F. amplifier, or in a T.R.F. receiver, and as an intermediate-frequency amplifier in a superheterodyne receiver.

The valve operates with a screen voltage of 100 and with a minimum grid bias of 3 volts. At these figures, and assuming an anode voltage of 250, the anode current is of the order of 7.6 mA with a screen current of 1.9 mA.

As in other valves in this range, no attempt is made to secure a high value of mutual conductance, the aim being maximum stage gain with complete stability and a very high order of consistency between valves. The mutual conductance is therefore rated at the moderate value of 1.5 mA/v., but bearing in mind that this is

Details of a Range of 4-Volt A.C. Mains Valves with Simplified Characteristics for Economy in Circuit Design and Operation

measured at -3 grid volts, the actual stage gain with suitable coil design is as great as many valves showing a much higher paper value of slope.

Type X42 is a variable- μ heptode frequency changer which differs from earlier forms of heptodes on the market by reason of its lower inter-electrode capacities and more economical operation. This is on account of the short electrode assembly which is employed and results in the ability to operate successfully down to short wavelengths of the order of 15 metres.

In common with the W42, the valve operates with a screen voltage of 100 and



Two of the new valves; on the left the H42 and on the right the N42

a minimum grid voltage of -3 . The conventional type of tuned grid oscillator circuit is recommended with the X42, precautions being taken by means of damping in the oscillator anode circuit, and the maintenance of a constant screen voltage by means of suitable potentiometer network being advisable.

A New Triode

Type H42 is a high amplification factor triode designed for use in the early stages of an audio-frequency amplifier. Due to its high amplification factor it is particularly suitable for use in a resistance-coupled circuit.

The features of interest in this type are the low value of grid-cathode capacity by reason of the grid being taken to the top cap, which prevents severe attenuation of the higher frequencies; and the non-microphonic construction which renders the valve particularly applicable as the first stage of an amplifier with reasonably high gain. A very low grid bias is necessary, which could be suitably supplied by grid bias cells of permanent type instead of a cathode bias resistance, if desired.

The H42 is capable of loading fully a PX4 operating at its maximum working conditions; thus an output in excess of 4 watts may be obtained from an input of about 0.5 volt with a total harmonic distortion of less than 5 per cent.

The heater current of the H42 is 0.6 amp. and the valve has an amplification factor of 100 for a mutual conductance of 1.5 mA/volt when measured at anode volts 250 and grid volts -2 . With an anode load resistance of 250,000 ohms the stage gain is greater than fifty times.

Type DH42 is a multiple valve of the double diode triode type, consisting of two diodes electrostatically screened from the triode section on a common cathode. The cathode is heated by a 4 volt 2.4 watt filament of special construction to reduce magnetic hum. The operation of such a valve depends largely on the particular requirements of the user, and the normal use is with the diodes connected to the tuned circuit of the I.F. transformer, the audio component being taken via a condenser and a potentiometer to the triode grid.

For small inputs of say, 0.2 volt R.M.S. a bias of -1.2 at 350 volts H.T., and -1 volt at 250 volts H.T. is suitable. The bias may be supplied by a resistance in the negative H.T. lead.

As the type is designed for use in conjunction with the output pentode N42 (described below), it has a somewhat higher amplification factor than similar valves at present available, this being a value of 70 for a mutual conductance of 1.2 mA/volt measured at anode volts 250, grid volts -3 . A suitable value of anode load resistance is 200,000 ohms, and the stage gain of the triode section is of the order of 32.

Output Pentode

Type N42 is a power amplifying pentode with indirectly-heated cathode for use in the output stage, and has a heater rating of 4 volts 1 ampere. The N42 can be either transformer or resistance coupled to the previous stage and with the latter it is possible to use the high "m" type such as the H42 or DH42. When employed as a single output stage in a Class "A" amplifier the order of power output is 3 watts for a total harmonic distortion of 7 per cent. This is obtained with a grid input peak voltage of 16.5 and a load resistance of 7,000 ohms. The valve will therefore be seen to have a considerable undistorted power output, and it is also possible to employ two such valves in Class "A-B" push-pull where an output of the order of 5.5 watts is obtainable with a total harmonic distortion of 4 per cent., using automatic grid bias.

To operate in conjunction with the above series of valves an existing rectifier—Osram U12—is recommended. This is a well-tried directly-heated full-wave rectifier rated for an output of 120 milliamps at 350+350 volts.

All the above types are fitted with the standard 7-pin base, with the exception of the U12, and may of course be operated in conjunction with any of the existing valves, if desired, such as the high-slope output pentode N41 in conjunction with a diode D41, in place of the combination N42—DH42; or with a triode output of the PX4 type.

A PAGE OF PRACTICAL HINTS

SUBMIT YOUR IDEA

READERS WRINKLES

THE HALF-GUINEA PAGE

A Reduction Drive and Indicator

THE accompanying illustrations show a simple and effective reduction drive and indicator for tuning purposes.

As my set is an eight-valve superhet, a good dial and drive is essential for easy and accurate tuning, and the one described

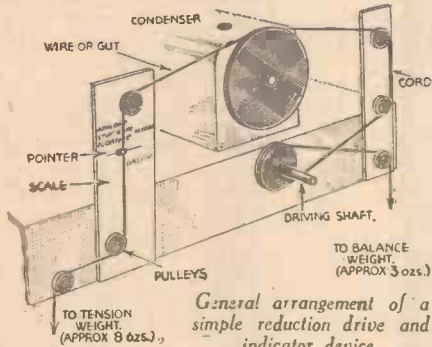

General arrangement of a simple reduction drive and indicator device.

herein has proved quite satisfactory. The arrangement possesses the following advantages: First, ease of construction, from an amateur point of view; second, positive and non-slipping drive; third, easily adaptable for any lay-out, condensers either parallel or at right-angles to panel; fourth, with the usual log-law type of gang condenser now common, the lower wavelengths are unduly crowded, and by a suitably arranged cam-wheel in the proposed drive an even frequency scale

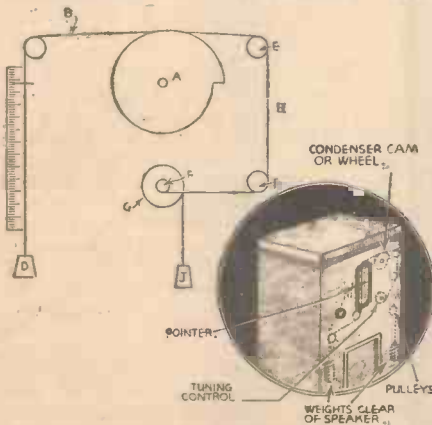

The arrangement of pulleys and (inset) showing the weight drive fitted in a radiogram cabinet.

may be readily obtained; and, fifth, the only force required to operate the drive is that required to overcome the frictional resistance of the small pulleys and condenser spindle, which together are extremely small.

The cam-wheel A is secured to the condenser spindle, and its shape depends on type of scale divisions required (open scale at lower end to convert log-law condensers to S.L.F. readings). A plain diametrical pulley may be used if desired,

THAT DODGE OF YOURS!

Every Reader of "PRACTICAL AND AMATEUR WIRELESS" must have originated some little dodge which would interest other readers. Why not pass it on to us? We pay £1-10-0 for the best wrinkle submitted, and for every other item published on this page we will pay half-a-guinea. Turn that idea of yours to account by sending it in to us addressed to the Editor, "PRACTICAL AND AMATEUR WIRELESS," George Newnes, Ltd., Tower House, Southampton Street, Strand, W.C.2. Put your name and address on every item. Please note that every notion sent in must be original. Mark envelopes "Radio Wrinkles." Do NOT enclose Queries with your Wrinkle.

the scale being then divided according to type of condenser used. A weight (D) exerts a steady pull on the condenser pulley A through a wire (B). This pull is balanced by weight J acting through shaft F, pulley G and cord H, which is secured to pulley A. The dial reading of the condenser is indicated on a scale by a pointer fitted to wire B. Pulleys E allow for any relative positions of condenser and scale. The ratio of F to A is the reduction ratio of the drive.—L. BOOTH (Sheffield).

A Soldering Dodge

WHEN soldering, the problem often crops up as to what to do with the solder when you have the iron in one hand

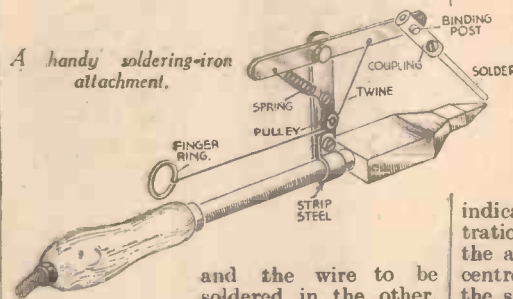

and the wire to be soldered in the other. The accompanying sketch shows a simple device which solves the problem. When the ring is pulled the solder touches the point of the iron, thus melting a sufficient quantity of the solder. It is best to use steel strip for the construction, as it does not conduct heat as readily as copper or brass.—R. WILLIAMS (Flixton).

Tapping a Coil

IT is very often found that for experimental purposes a coil has to be tapped and the best position has to be found by

trial. A good way of doing this is to wind the coil with D.C.C. wire in the usual way, ignoring allappings. When completed, the lead which has to be tapped to the coil is threaded through the eye of a large darning needle, and the end of the needle wrapped with insulation tape. It may then be pushed through the cotton covering of the wire at various points without damaging the coil winding, and a good electrical connection made as the needle will pierce the actual copper wire. When the best point has been found the point of a penknife should be slipped between the two turns and the required turn carefully prised upwards, when the copper wire will stretch just enough to permit of a match-stick being slipped under the wire. The cotton may then be scraped away and a soldered joint made.—E. WARRE (Hendon).

A Range Indicator

ON most receivers in which a coil with self-contained switch is employed, the only indication as to which range is in use is a dot or mark on the control knob, and this is often difficult to discern. To the rotating arm a brass collar is locked, and to this a short brass arm is soldered. To the end of this arm a strip of thin metal is pivoted, and the shape of this may be seen in the illustration below. The wide portion at the top should be covered by ordinary white paper upon which the wave-ranges may be written in coloured ink. Two small guides are then attached on the inside of the panel and the slide thereby kept in position. The collar is locked into position so that the correct range is indicated, and to ensure an accurate registration the names should be written on after the arm is fixed. As an alternative, the centre may be cut out of the wide part of the slide and ivorine stuck on, with the name illuminated from the rear, and it is obvious that coloured lights may be switched in and out by the moving slide.—J. McLELLAND (Walton, Liverpool, 4).

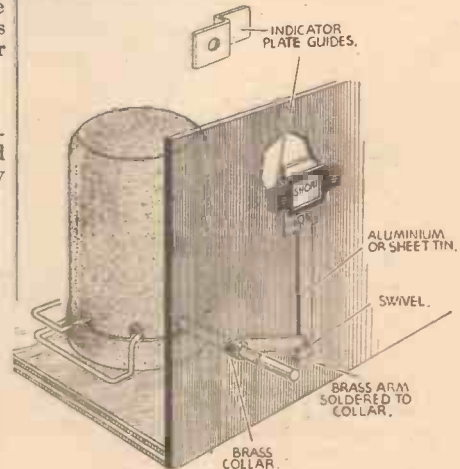

A wave switch indicator.

NEWNES' TELEVISION AND SHORT-WAVE HANDBOOK

2nd Edition

By F. J. GAMM.

Price 3/6 or 3/10 by post from the Publishing Dept., George Newnes, Ltd., Tower House, Southampton St., Strand, London, W.C.2.

THE 1937 CRYSTAL

Details of a Simple Crystal Set Designed to Meet and which may be Modified to include Several

Full-size Blueprint

ALTHOUGH the crystal receiver is often regarded with scorn by the listener with a powerful field-valve receiver, it has a definite field of utility, and, in fact, to many listeners it offers the only form of providing entertainment from the broadcast programmes. But it may also be used by the listener as a stand-by apparatus, for use, for instance, whilst an accumulator is being charged, or whilst a receiver is being modified. Further, it is the most satisfactory receiver to be constructed by the beginner, as it will lead the way to larger receivers and enables all of the elementary principles to be grasped slowly. The old tag concerning the necessity of learning to walk before you try to run is very applicable to radio, and many constructors fail to make a satisfactory job of constructing a large receiver, simply because they have not commenced in a simple way. Primarily, the crystal set is a very simple piece of apparatus, consisting merely of a tuned circuit and a crystal detector, the latter being joined in series with a pair of 'phones across the tuned circuit. But in such a form several difficulties would arise under modern conditions. The high power of the modern B.B.C. stations, coupled with the fact that there are, in most districts, two such stations, renders it necessary to provide a fair degree of selectivity, but as is now well known, as soon as selectivity is introduced sensitivity automatically disappears.

The Circuit

Consequently, a compromise has to be adopted, and in a simple set such as a crystal receiver it is rather difficult to introduce such a compromise. After considering the results obtained with ordinary receivers in various districts, and analysing the various requirements of listeners as given in their published correspondence, I decided that a form of "adaptable" circuit would provide the most satisfactory

solution to the crystal set problem. It is not satisfactory to design a standard arrangement and say that it will suit every listener in the country. Reception conditions vary in every locality, and there are no benefits such as reaction which we can include in the circuit to make up for losses or to sharpen up the tuning. The circuit finally adopted is shown in Fig. 1, and it will be noted that two of the components are shown in dotted lines. The reason for this will be given later, but it will be noted that a coil made up of three separate windings is employed, and that a tuning condenser is joined right across it. The crystal is tapped to a point a short distance from the high-potential end of the coil, and this has the effect of removing the damping exerted on the circuit and gives a slight increase in the sharpness of tuning. The wave-change switch is of the double-pole double-throw type, and carries out two functions.

The Wave-change Switch

In the simplest form all that is necessary to change from medium to long waves is to short-circuit part of the tuning coil, but

connection when changing wavelengths. It will be seen in this circuit that when in the medium-wave position the aerial is joined direct to the top or high-potential end of the coil (ignoring the dotted condenser), whereas when switched over to long waves, the aerial is transferred to a point much lower down on the coil. If any doubt exists as to the advantage of this, the aerial should be removed from the aerial socket and connected direct to the top of the coil in the long-wave position! It will be noted that a coil is

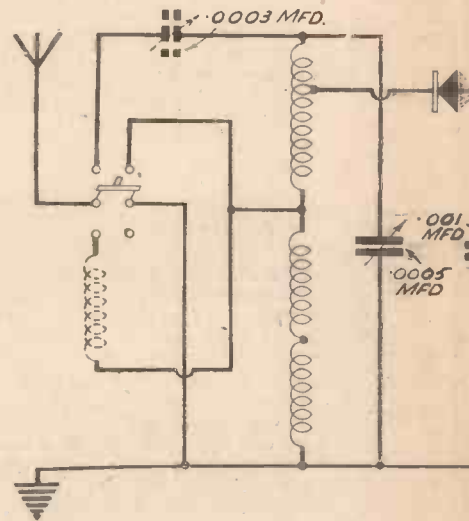

Fig. 1.—Circuit employed in the 1937 Crystal

shown in dotted lines joined between the aerial contact for the long-wave position and the tapping on the coil, and this is a special anti-breakthrough choke which will be found invaluable to those listeners who are situated close to a medium-wave broadcast station.

The condenser shown in dotted lines is also of value to listeners in a similar position as it may be adjusted to separate the two local stations, when a large aerial is employed. Therefore, the receiver should be first made up, ignoring these two components, and if it is found in your particular case that the two locals are heard together, the pre-set condenser should be included between the switch and the top of the coil. Similarly, if when switched over to long waves the medium-wave station can be heard in the background, the special choke should be placed in circuit as shown in the wiring diagram.

Constructing the Receiver

The construction is exceedingly simple, and the components have been selected so that no soldering is called for, and thus



Fig. 3.—A three-quarter rear view of the receiver, showing the simple construction and wiring.

the same degree of selectivity is not required on the long waves as is needed on the medium waves, and thus it is an advantage to be able to modify the aerial

TAL RECEIVER

et Every Requirement of the Modern Listener
 at Refinements - - - By W. J. DELANEY
 Costs Sixpence.

the set may be made up with only a penknife and screwdriver. The panel and baseboard both measure 6in. by 6in. and the former is of paxolin. Ordinary three-ply wood may be used for the baseboard, but a thickness of about $\frac{3}{8}$ in. is desirable in order that the panel may be firmly screwed to the front edge. The panel may be drilled by following the measurements and details given in Fig. 2, and the switch and terminal sockets should be

down. Follow the maker's instructions regarding the mounting of the special slow-motion drive and scale.

Winding the Coil

The coil is wound on a length of paxolin tubing measuring $2\frac{1}{2}$ in. in diameter and 4in. in length. Two small holes should be pierced at the upper edge and the end of

Wiring the Receiver

Now note carefully, when ends of the coils are connected to the respective points, and if the condenser and choke are to be left out, the end of the first coil and the commencement of the first of the two pile windings should be twisted together and taken to the switch. If the choke is to be included, it should be joined between the two switch contacts as shown. Note that the end of the complete coil is joined both to the variable condenser and to the switch, and the one length of wire may be used, scraping away the cotton covering for the purpose. The small fixed condenser is joined across the 'phone terminals, and the crystal detector mounted on the component-mounting bracket. The loop of wire in the first part of the coil should be scraped and passed over the end of the detector and locked beneath the terminal nut, whilst the lead from the detector to the 'phone terminals is anchored between the component-mounting bracket and the locking nut on the detector.

The Special Choke

If the anti-breakthrough choke is found necessary, it may easily be constructed from the same wire as is used for winding the coil. Cut a disc of plywood about $\frac{1}{4}$ in. thick and about 1in. in diameter, and two discs of similar wood $1\frac{1}{2}$ in. in diameter. Screw these together to form a spool and drill a hole through one disc near the edge of the centre piece. Anchor the wire in this hole and wind 150 turns of wire in the spool, afterwards anchoring the end of the wire through a further hole or by wrapping a piece of ordinary tape round the coil of wire and tying a knot.

The aerial should be provided with a plug and inserted into the aerial terminals, whilst the earth should similarly be connected. The 'phones are plugged into the right-hand pair of sockets. The condenser

(Continued overleaf)

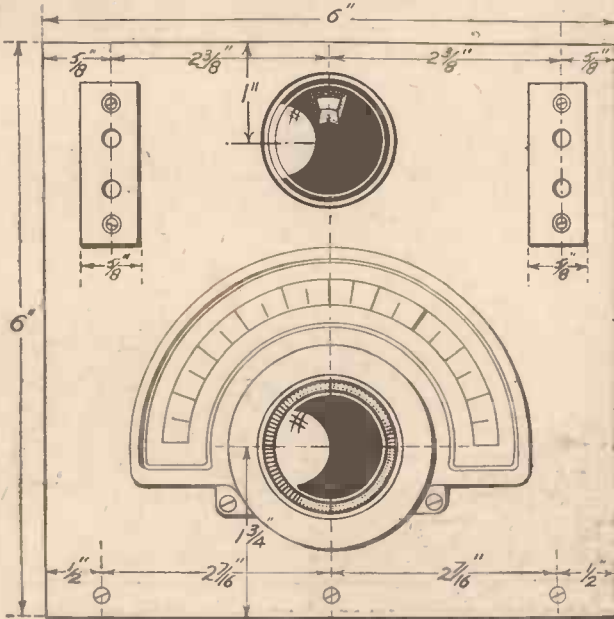

Fig. 2.—Drilling Diagram for the Panel of the Receiver.



Set.
 attached. The variable condenser is screwed to the baseboard, and the correct position may be marked off from the wiring diagram, or it may be placed upon the baseboard and the panel held in position whilst the condenser is slid forward until the mounting bush comes into the correct position. The holes should then be marked with a pencil and the panel removed whilst the condenser is screwed

the wire passed through, leaving a length of 5in. projecting for connection to the variable condenser. Wind on 8 turns and then make a large loop—about 2ins. in length; and in the position shown in the diagram of the coil. Continue the winding for another 32 turns, and cut the wire so that when passed through a further pair of holes there will be approximately 5in. left. About $\frac{1}{4}$ in. from this end of the coil make another pair of holes and pass the end of the wire through again, leaving a further 5in. for connection, and then wind on the wire, hank fashion, for 80 turns, after which let the wire pass across the former for a quarter of an inch or so and wind a similar hank winding of the same number of turns. This will give you a grand total of 200 turns of wire, the lower two piles forming the long-wave loading coil. The coil is mounted by screwing a strip of wood inside the lower end. Alternatively, a disc may be cut from plywood for the purpose.

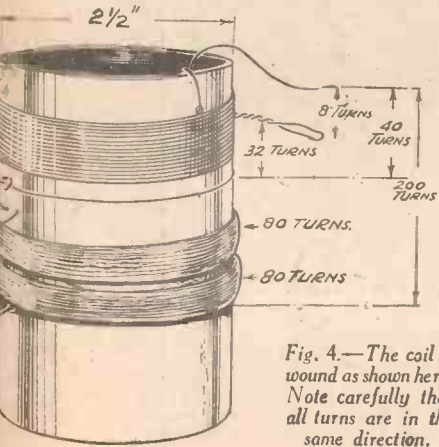

Fig. 4.—The coil is wound as shown here. Note carefully that all turns are in the same direction.

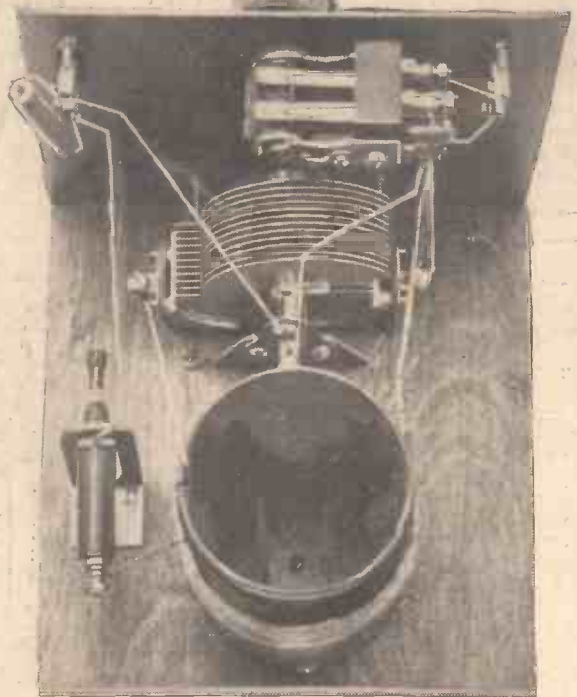

Fig. 5.—A plan view of the finished receiver, to assist in wiring.

1937 CRYSTAL RECEIVER

(Continued from previous page)

dial should be turned to tune in the desired station, and the small control knob on the detector should be pulled out, turned and gently released when adjusting the detector. On no account turn this without pulling it out, as by so doing you will spoil the surface of the detector and it will soon need replacing. The particular type of detector used will be found sensitive in practically every position, although it is worth while trying to find the most sensitive spot.

The aerial should, of course, be as efficient as possible, and in this connection height is

**1937 CRYSTAL RECEIVER.
LIST OF COMPONENTS.**

- One paxolin panel, 6in. by 6in. (Peto-Scott).
- One wooden baseboard, 6in. by 6in. by 3/4in. (Peto-Scott).
- One paxolin former, 2 1/2in. by 4in. (Peto-Scott).
- One Formo slow-motion condenser with Mystic dial, type SU.5 (Formo Products, Ltd.).
- One Red-Diamond crystal detector (Jewel Pen Company).
- One component-mounting bracket (B.T.S.).
- One double-pole change-over switch, type L23 (Wright and Weaire).
- Two terminal socket strips (Belling-Lee).
- One .001 mfd. tubular condenser (T.C.C.).
- Quantity 22 D.C.C. wire, screws, four 4BA bolts and nuts.
- The following additional components are required in some districts, as mentioned in the text:
- One .0002 mfd. preset condenser (Formo Products, Ltd.).
- One anti-breakthrough choke (constructional details given in the text).

the most important factor. The insulation of each end should be carefully carried out, by using two or three of the egg-type insulators, and the leading-in wire should be brought down well clear of the house walls, guttering, pipes, and other earthed bodies. Similarly, the earth should be as efficient as possible, and a good sound connection to a main water-pipe, through the medium of a standard type earth clip, will be found as good as any. A buried plate or connection to one of the proprietary earths such as the Graham Farish "Flit" may also be highly recommended.

For the Beginner

If this is your first receiver, it is worth while examining the arrangement of the parts and studying the relation between the theoretical symbols in the circuit diagram and the practical interpretation in the wiring diagram. The fact that so

(Continued at top of next column)

AMATEUR TRANSMITTING

(Continued from page 514)

The extension rod (Bulgin) is essential, as it allows accurate adjustment to be made without any capacity effects from the hand. The variable condenser is of the S.W. type and has a capacity of .00016 mfd. or .0002 mfd.

The lamp calls for particular attention and, maybe, a little experiment before a suitable one is found, owing to the variation in current consumption of different types. I found that it is best to use, on limited H.T. voltages, low-consumption fuse bulbs, but these, unless reliable ones like Bulgins are used, are also liable to vary widely as regards actual current. With H.T. voltages of 200 and over, no trouble is experienced, in fact, as the power of the transmitter increases so must the wattage of the lamps, otherwise frequent replacements are necessary.

Next week I will describe coupling the A.A. to the transmitter, so until then, get busy with the constructional work, and the Morse Code.

few components are employed enables you to do this without confusion, and you can then carry this a step farther by obtaining a copy of our "Wireless Constructor's Encyclopædia," in which a full table of the wireless symbols is given. "In Fifty Tested Wireless Circuits," some simple one-valve receivers will be found and these may be the subject of your next construc-

tional venture. You will also find in that book a suitable design for a low-frequency amplifier which may be added to this receiver in order to obtain loudspeaker reception if the local is fairly close to you, or which will give you louder headphone signals. "Everyman's Wireless Book" deals with first principles, faults and remedies, etc.

Wiring Diagram of the 1937 Crystal Set

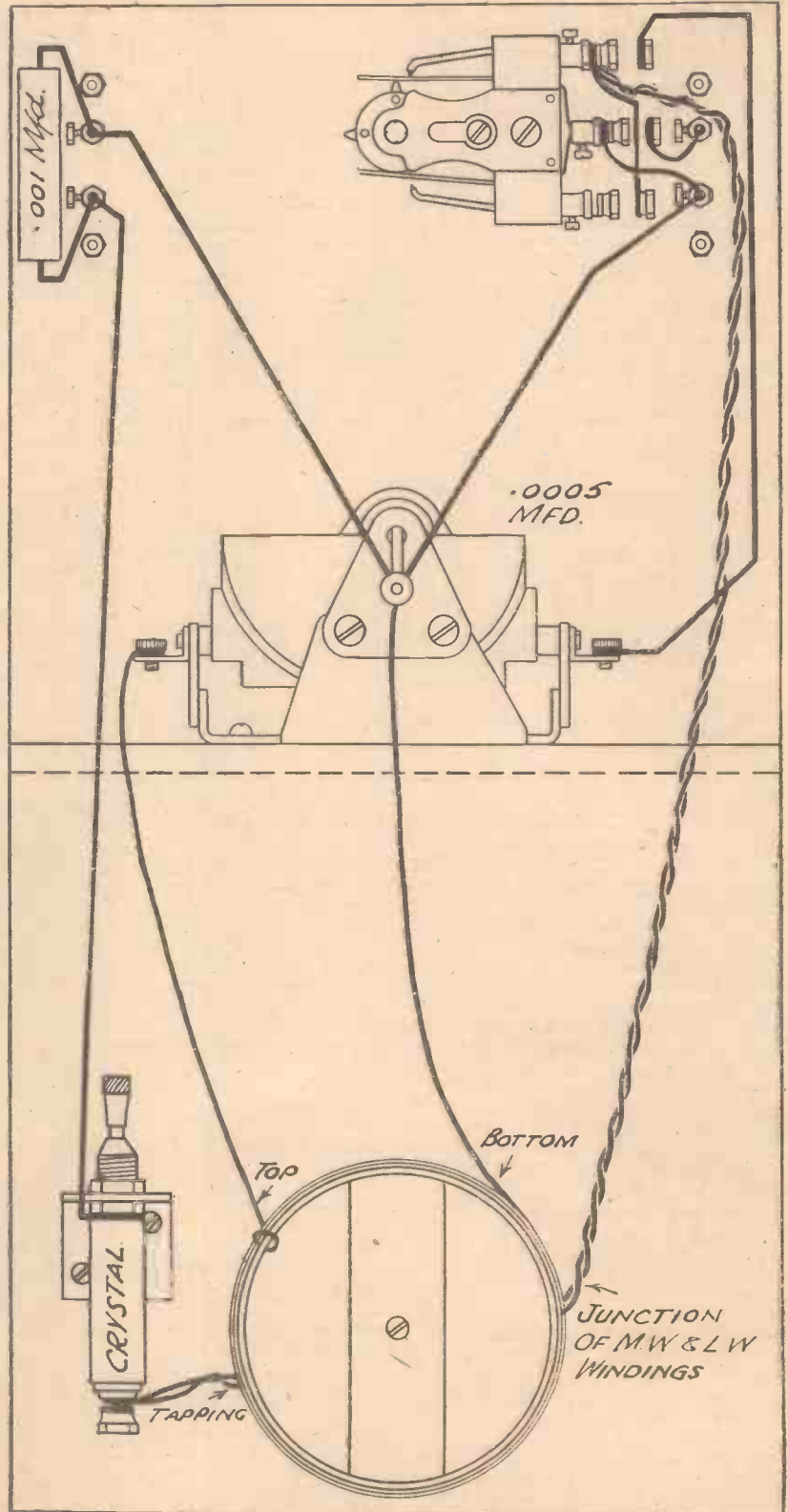



SHORT WAVE SECTION

SUPER-REGENERATION

In This Article Super-sensitivity in Ultra-short-wave Receivers is Dealt With By AUSTIN FORSYTH

THE Alexandra Park transmissions on 7 metres have given a new interest to reception experiments on the ultra-short-wave bands, and in this article it is proposed to deal briefly with the principle and application of super-regeneration, a means of increasing considerably receiver sensitivity at high frequencies. Let it be said right away, however, that super-regeneration is *not* recommended for reception of television broadcasts, either sound or vision, where they can already be strongly received on a straight set. The reason for this will be made clear

AERIAL, EARTH OR DOUBLET.

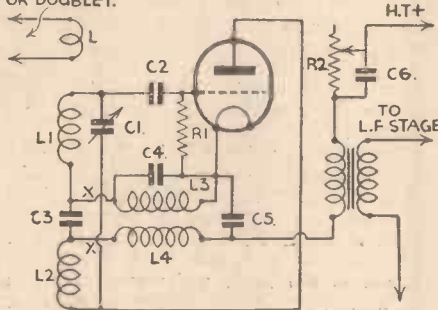

Fig. 1.—SELF-QUENCHING DETECTOR.

L1—1 turn 18g. enamelled, 3/16 in. diam.
L1-L2—3 turns 18g. enamelled, 3/16 in. diam., turns slightly spaced.
L3, L4—Quenching coils. See text.
C1—Three-plate midget variable condenser.
C2, C3, C5—.0001 mfd. C4—.002 mfd. C6—1 mfd.
R1—3 megohm leak. R2—50,000 ohm 2-watt quench control resistor.
(Try U.S.W. RF chokes at X,X.)

later. Rather, the system has its application as a means of increasing sensitivity on the 5- and 2½-metre amateur bands, the former of which is showing such interesting possibilities at the present time.

The action of a super-regenerative circuit is that oscillations of a much lower frequency than that to which the detector is tuned are superimposed on its grid circuit; these oscillations are generated either by the detector valve itself or by a separate "quenching" valve. The effect of these low-frequency oscillations on the detector is to allow the reaction limit to be increased considerably. It is well known that the result of increasing reaction is to go on cancelling circuit losses till the valve goes into oscillation; when this starts, reaction has to be decreased till the valve is just about to oscillate, this adjustment then giving maximum sensitivity for the reception of modulated signals. With super-regeneration, the L.F. oscillations imposed on the detector stop and start ("chop") the H.F. oscillation so that the valve never reaches the stage

where reaction has to be slacked back. The result is that sensitivity becomes considerably greater, as the detector is operated well beyond the point at which oscillation would normally start and hence the amplification due to reaction is increased enormously.

A secondary effect due to super-regeneration is that the selectivity of the detector circuit is very much reduced which, in one respect, is an added advantage in that tuning becomes much easier, while instability at the transmitting end becomes less noticeable.

Quench Frequency

In passing, it might be asked why super-regeneration is not used at lower, and even broadcast frequencies. The fact mentioned above is one reason, while another is that the gain would not be so great as circuit losses become less as the frequency gets lower (wavelength higher); thirdly, the difference between the detector frequency and the "quench" (super-regeneration) frequency would begin to get smaller as the wavelength was increased, and hence the action would not be so

pronounced. The quench frequency has to be chosen so that the oscillations are above audibility but low enough to give the fullest "chopping" effect to the detector.

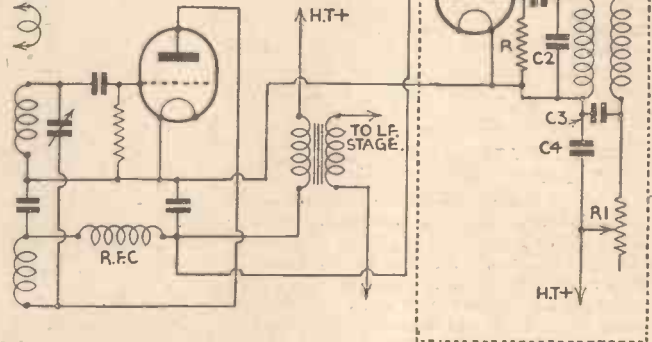

FIG. 2.—U.S.W. DETECTOR WITH SEPARATE QUENCH.

(Section enclosed by dotted lines can be made up as quench unit.)

Cf—Quench feed condenser, .002 mfd.
C1—.0005 mfd. C2—.002 mfd. C3—.002 mfd. C4—1 mfd.
R—50,000 ohm leak. R1—50,000 ohm 2-watt quench control resistor.
L3, L4—Quench coils. See text.
RfC—U.S.W. RF choke. For construction, see text. All other values as in Fig. 1.

Obviously, these conditions become harder to meet as the received wavelength is increased. Further, the action of super-regeneration causes a loud hissing in the receiver.

The latter effect is a disadvantage from (Continued overleaf)

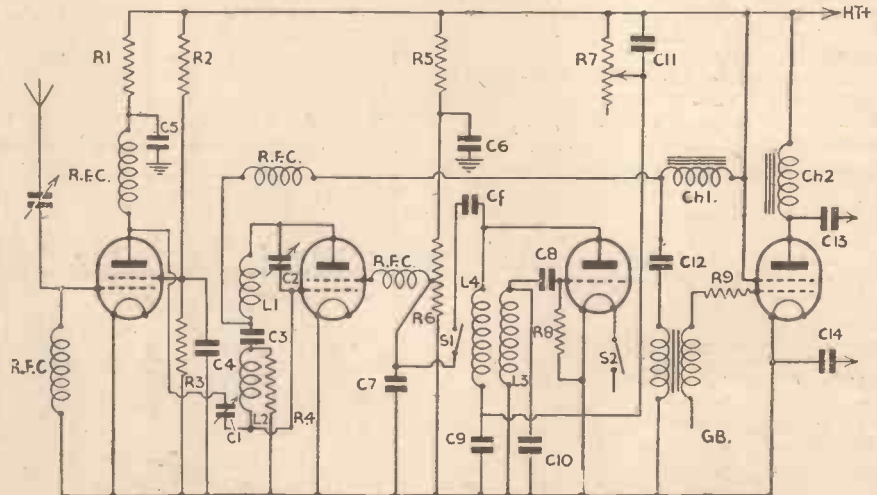

FIG. 3.—THREE-STAGE U.S.W. RECEIVER WITH OPTIONAL QUENCH.

L1, L2—As in Fig. 1. L3, L4 (see text). R.F.C.—(See text).
C1—Variable coupling condenser, 3-plate midget. C2, C3—see Fig. 1. C4, C5, C6, C7—.0003 mfd. C8—.0005 mfd. C9, C10, C11—.002 mfd. C12—1 mfd. C13, C14—2 mfd. R1, R5—10,000 ohms. R2—40,000 ohms. R3, R8, R9—50,000 ohms. R4—3 megohm leak. R6, R7—50,000 ohm 2-watt resistors, R6 potentiometer.
Ch.1—High inductance coupling choke. Ch.2—Output choke.
S1, S2—D.P.S.T. switch.

SHORT WAVE SECTION

(Continued from previous page)

all points of view, but can be considerably minimised by proper design. Also, it tends to cease as a signal is tuned in, and a strong signal will take out the quench noise completely. Another disadvantage is that if the receiver is a simple two-stage affair, either with or without a separate quench valve, a modulated signal is radiated from the receiving aerial. Therefore, using a re-radiating super-regenerative receiver on the vision wavelength would produce some remarkable effects on the screens of neighbouring vision receivers! On the sound wavelength, the result would be a continuous musical note of low pitch.

Here again, the trouble can be minimised if not completely cured by using an H.F. stage in front of the detector. This would not give any amplification, but the receiver would be more stable and re-radiation would be prevented.

Turning now to the application of super-regeneration to ultra-short-wave reception, it will be seen from the arguments above that the system is of the greatest use at the highest frequencies; at the moment, this means five metres and below, and for experimental reception of the television transmissions at abnormal distances where they are not expected to be received even on a powerful straight set.

Circuit Arrangements

Fig. 1 shows a circuit-diagram incorporating a self-quenching detector valve, and Fig. 2 the same with a separate quenching valve. Fig. 3 is a more ambitious arrangement with an HF stage, detector with separate quench which can be cut in and out, and pentode output. It will be noted that a SG valve is used as detector, and the quench frequency applied to the screen-grid. This makes for better stability and higher efficiency, as comparing the circuit of Fig. 1, it will be seen that the quench control is by variation of the detector plate voltage, which reduces the detector sensitivity when the plate voltage has to be set below the optimum to quieten the quench. With a separate quenching valve, this does not occur. The general efficiency is increased by using a screen-grid valve as in Fig. 3. In this circuit, either the new "acorn" valves could be used, or the midget type for the H.F. and detector stages, though quite good results will be obtained with ordinary valves of the SG215 and HL210 type in any of these circuits.

Suitable values are given under each circuit, and it is not proposed to try within the limits of the space here available to go

deeply into the construction of any of them, the idea being rather to give the experimenter a few pointers in the use of this type of receiver. All H.F. leads should be kept short and direct and the detector stage completely screened. In the case of the receiver in Fig. 3, the three R.F. stages should be in separate screening boxes, though all the circuits will perform without any screening at all.

Quench Coil Construction

It may be helpful, however, to describe the construction of the quench coils, a dimensioned sketch of one being given in Fig. 4. The writer finds that the assembly suggested is very useful in experimental work as they are always in one handy unit. Any other form of construction would, of course, be equally effective.

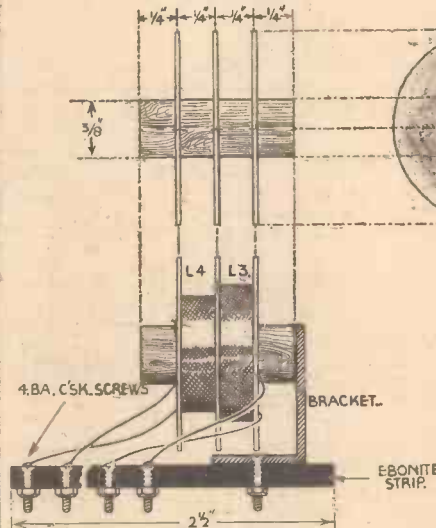

Fig. 4.—Details of quench coil assembly.

The former consists of a 3/16 in. diam. wooden dowel about 1 in. long on which are mounted three cardboard cheeks 1 1/2 in. diam. and spaced 1/4 in. These are fixed in position with sealing wax. One section L3 is wound with 1400 turns of No. 40 enameled wire, and the other section L4 with 900 turns. Less than 1/2 oz. of wire is needed. The windings can be put on quite quickly and easily by mounting the former in the chuck of a breast-drill, which is then fixed horizontally in the vice. The turns are run on from a bobbin of wire set up so that it is free to rotate. One hand is used for operating the drill handle and the other for guiding the wire. Meticulous precision

is not at all necessary, but the layers should be put on as evenly as is reasonably possible. Find out how many revolutions of the chuck go to one turn of the drill handle and divide this into 1400 and 900 respectively. This will give the number of handle revolutions required. The ends of the windings are brought out through small holes in the cardboard cheeks, and a piece of insulated sleeving slipped over them. These leads are then spotted to the terminals on the strip, to which the heavier circuit connections can be taken without risk of breaking the leads. The former should be varnished before being mounted to finish the job.

The various U.S.W. chokes required can be made up very easily by putting about 50 turns of 40 g. enameled wire, slightly spaced, on a 3/16 in. diam. former.

It will be readily apparent that an existing straight U.S.W. receiver can be made super-regenerative simply by introducing the quench coils L3 and L4 in the grid and plate circuits respectively, following Fig. 1. Alternatively, a

quench unit can be built up consisting of the portion of circuit Fig. 2 enclosed by the dotted lines. Super-regeneration can then be applied to any receiver simply by connecting the feed condenser Cf to the HT end of the RF choke in the plate circuit of the detector valve, using a common battery supply. A point to notice is that if, with either circuit arrangement, the quench effect is not obtained, one of the coils L3 or L4 should have its connections reversed.

The quench noise will be found to be almost unbearable at the maximum, but when searching for signals, it should be kept low, and then adjusted for maximum signal strength when something is heard. Weak signals will not be found if the quench is too loud, while strong signals like a strong quench to bring the strength up.

DX Reception

As to what can be done with a super-regenerative receiver it may be mentioned that up till quite recently, it was laid down that waves below about 8 metres were "quasi-optical" in that they were unreceivable beyond visual range. Evidence is piling up that this is far from being the case, and some phenomenal results have been obtained.

MOST short-wave listeners will have noticed to what extent the bands now reveal Spanish-speaking studios. What with the Colombian, Venezuelan, Cuban, Argentinian and Spanish official—and non-official—stations found on the air nightly, it is difficult to keep pace with the new arrivals. Of these those nearer home are the most persistent.

EAQ, Madrid

Regular listening during the last few days has confirmed the closing down of EAQ, Madrid (30.43 m.—9,860 kc/s), which is not surprising considering that the transmitter was situated at some 28 miles south of the capital at Aranjuez, which is now in the hands of the Nationalists. On the other hand, Vallecas, the site of another bunch of wireless transmitters, about 5 miles north of Madrid, is still in the possession of the "Red" Government, and

LEAVES FROM A SHORT-WAVE LOG

EDZ-EAH, on 31.65 m. (9,480 kc/s), now announcing itself as Madrid UGT, has taken over the duties of EAQ; it works daily at about noon and at G.M.T. 21.00. Barcelona, EAX, on 31.60 m. (9,495 kc/s), may also be heard frequently communicating with the U.S.S.R. and other foreign countries. Another station in the same city, ECNI, on 41.55 m. (7,220 kc/s), broadcasts war news every Tuesday, Thursday and Saturday at G.M.T. 21.00, and on Sundays at G.M.T. 22.00 in various European languages. The Nationalists, or Anti-Reds, in their turn continue to use EHZ, el Tablero (Canary Isles), on 28.93 m. (10,370 kc/s), for which the times were

published on page 344 of PRACTICAL AND AMATEUR WIRELESS dated November 28th. You will also pick up Spanish and other transmissions relative to the civil war from EAIAZ, La Coruna (Corunna), on 41.96 m. (7,150 kc/s); EA9AH, Ceuta (Spanish Morocco), and EAIBT, Lugo, both on 42.25 m. (7,100 kc/s), as well as from a station giving the call EA1CH, on 41.67 m. (7,200 kc/s), and of which I have not yet managed to secure the location.

Experimental Transmitters

Note that these were originally experimental transmitters, and are working in the amateur band. Identification of the various transmitters is proving difficult owing to the fact that in the course of the later evening hours bulletins concerning the Spanish front are also given in detail

(Continued on facing page)

LEAVES FROM A SHORT-WAVE LOG

(Continued from facing page)

by most of the Cuban and South American stations.

Climatic Changes

We have now reached a period of the year when the strongest telephony signals are heard in the higher portion of the short-wave band, and more time should now be devoted to listening to broadcasts on the 31- and 40-metre bands. You will notice that towards dusk transmissions on and around 20 metres suffer from fading, and are subject to interference from parasitic, and other noises, but at this time of the evening signals on the 31-metre band begin to come in well. After midnight it is a wise precaution to switch over to 46 metres, and above, when it will be found that background noises noted in the earlier evening hours are prone to disappear and listening becomes a pleasure.

A Powerful Cuban Station

One of the strongest signals now heard nightly—it is possible to pick it up from about G.M.T. 21.00—emanates from COCH, Havana, on 31.28 m. (9.43 mc/s), as it is now using a 10-kilowatt transmitter for its broadcasts. Although English announcements would only appear to be made in special programmes, taking place between roughly midnight and G.M.T. 04.00, it is an easy matter to identify the station. The call is: *Aqui estacion de onda corta COCH*, and many references are made to the *General Electric Company of Cuba*. As an interval signal it uses three chimes, but the broadcasts open with a variety of sounds, namely, the crowing of a cockerel, a bugle call, or a noise reminiscent of waves breaking on a pebbly beach. You will also hear occasionally a clock with chimes somewhat similar to those of Big Ben. COKG, Santiago (Cuba), formerly on 48.78 m. (6.15 mc/s), is now on 48.38 m. (6.203 mc/s), and is another easy station to log between G.M.T. 22.00-02.00. Other broadcasts are carried out daily between G.M.T. 13.00-14.00 and 16.00-19.00, but the channel is an unfavourable one for the former period, and, so far, barely recognisable signals have been picked up by the writer before G.M.T. 22.00. The call: *Santiago de Cuba* is given out every fifteen minutes. Four chimes have been registered as interval signal.

What would seem to be a new transmitter is COCE, La Corona, Havana, which relays the medium-waver CMCE, on 34 m. (8823.5 kc/s), and also sometimes on 24.49 m. (12.250 mc/s). Immediately before the call three single chimes and a double one are struck, and a railway whistle is blown after the announcement. The station was logged on two successive mornings between G.M.T. 04.00-06.00.

English Talks from Colombia

HJ4ABB, Manizales (Colombia), which has recently slightly altered its wavelength to 49.15 m. (6.103 mc/s), and which is quickly identified by its four chimes (*soldo-mi-soh*) is on the air every Sunday morning from G.M.T. 03.00-04.00 with an interesting talk in the English language. From this studio the announcer does not always give out the call-letters, but refers more frequently to *Radio Manizales* or *La Voz de Caldas*. The airline distance from London is roughly 4,600 miles, but as the station boasts of a 3.5-kilowatt transmitter the signals, when captured, will be found very hefty.

NEW McMICHAEL ALL-WAVE CONSOLE

THE excellent performance of the McMichael 362 All-wave Superhet has resulted in a large number of requests from listeners for an all-wave console of similar efficiency. To meet this demand, McMichael Radio have now produced a new A.C. mains All-wave Console (Model 362) at 17½ guineas.

This fine receiver incorporates the 5-valve 8-stage A.C. chassis as used in the existing table model, with pre-detector H.F. amplification, a separate "band-spread" S.W. pointer, and energised M.C. speaker with 2 watts output. The wavebands covered are from 18.6 to 51, 200-550, and 900-2,000 metres, whilst provision is made for a gramophone pick-up and extra speakers with full



Note the novel cabinet design incorporated in this new McMichael Console.

switching control; the general technical specification is identical with the table model.

The cabinet of the 362 console is very solidly built from figured and inlaid walnut with a speaker surround of oxidised copper. A modern style is employed for the whole design, with a heavy piano-hinged lid enclosing all controls. The cabinet is polished to the high piano-finish which is used for all 1937 McMichael models.

For A.C. Mains, 200-255 volts, 40-100 cycles. H.P. terms 3ls. 9d. deposit, and 12 monthly payments of 3ls. 9d., or 23s. deposit, and 18 monthly payments of 23s.

PETO-SCOTT

COLT ALL-WAVE 3 KIT "A" CASH or C.O.D. CARRIAGE PAID £3:2:6

Or 5/- down and balance in 11 monthly payments of 5/9.

Author's kit of first specified parts, including plywood base-board, less valves, cabinet and speaker.

3 specified valves 12/3

KIT "B" WITH VALVES ONLY or 12 monthly payments of 6/9 £3:14:9

KIT "C" WITH VALVES AND CABINET or 12 monthly payments of 8/9. £4:14:3



PETO-SCOTT 1937 SHORT-WAVE ADAPTOR - CONVERTER KIT

13-74 METRES



Convert your existing Battery or A.C. set for operation on the short waves with this up-to-the-minute unit. No alterations to your set whatsoever. Two hours to build—a lifetime of world-wide entertainment.

- No coil changing.
- Ready drilled enamelled steel chassis.
- Ready drilled black crystalline finish steel panel.

KIT "A" 29/6

Cash or C.O.D. Carr. Paid. Or 2/6 down and 10 monthly payments of 3/-.

Comprise all parts for building, with diagram, assembly and operating instructions, less cabinet.

Fully described in Booklet "B."



B.T.S. 1937 SHORT-WAVE ADAPTOR

MAKE YOUR SET an ALL-WAVER! HEAR AMERICA DIRECT with this famous unit.

12-47 METRES

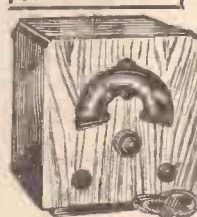

Simply plugs into your battery or A.C. Mains set. The only adaptor at the price with 100-1 ratio aerial tuning and slow-motion reaction; for use either as Plug-in or Superhet Adaptor. Walnut finished Cabinet (illustrated). With 2 plug-in coils, 12-26, 22-47 metres. Ready assembled.

CASH OR C.O.D.

Carriage Paid

£2:12:6

or 2/6 down

and balance in 12 monthly payments of 4/9.

Extra coils, 41-94 and 76-170 metres, 2/9; 76-170 metres, 3/-.



W.B. 1937 SPEAKERS



MODEL 375. Amazing reproduction provided by new magnet and exponential moulded cone. Microdome matching device. Cash or C.O.D. Carr. Paid. £2/2/0. Or 2/6 down and 11 monthly payments of 4/-.

MODEL 373. Matches any receiver as principal or extra speaker.

Cash or C.O.D. Carriage Paid. £1/12/6. Or 2/6 down and 11 monthly payments of 3/-.



RADIO for 5/- DOWN DIRECT to YOU

SPECIAL OFFER BRAND NEW LAST SEASON'S Peto-Scott

S.G.3 TYPE "H" BATTERY RECEIVERS

LIST PRICE £6:12:6 CLEARANCE PRICE £4:4:0

Gives a wide choice of foreign stations with amazing perfection of tone and volume. Built with all high quality components, including Peto-Scott Moving-Coil Speaker, SCREENED COILS, high efficiency S.G. Detector and Pentode output valves. Low H.T. consumption. Full-vision scale. Modern Walnut Cabinet. British Valves of guaranteed life. Ready to play. Complete with Oldham Accumulator and H.T. Batteries. Cash or C.O.D. Carriage Paid. £4/4/0, or 5/- down and 11 monthly payments of 8/-.

PETO-SCOTT Co., Ltd., 77 (Pr. W.16), City Road, London, E.C.1.

West End: 62 (Pr. W.16), High Holborn, London, W.C.1. EST.1919. Telephone: Gipsoid 9875

ELECTRADIX BARGAINS

ROTARIES, D.C.-A.C. Type P.M., 7 watts 50 v. D.C., 75 v. A.C., 45/-; 15 watts 220 D.C. to 12 v. 1 1/2 amp. A.C. or 220 v. A.C., with transformer, 65/-; 50 watts, 220/220 v., 25/. Other sizes up to 1 kW.

MOTOR-GENERATORS, A.C.-D.C. and D.C.-D.C. Cheap. **MOTORS, DYNAMOS, ALTERNATORS, SWITCHBOARDS, PUMPS, BLOWERS, AMP-LIFIERS and RELAYS, CONTACTORS and CIRCUIT TRIPS, AEC LAMPS and H.T. TRANSFORMERS.**

A BARGAIN IN DYNAMOS. Type "C." Our latest for Bungalow, Yacht or Cell Charging. 140-watt Enclosed Dynamo, 12/20 v., 12 amps. Ball Bearings. See Pulley, 25/-. Marine Type Switchboard with Ammeter, maximum and minimum Auto Cut-out Mains Switch and Fuses, Field Regulator, 25/- or 47/6 the pair (as illustrated).

DOUBLE CURRENT GENERATORS, D.C.: 600 volts/100 m/a., and 6 volts/3 amps. 32/6. Direct-coupled Electric Water Pumps, A.C. or D.C., 120 g.p.h., 67/6. Motor Blowers, 63/-. Electric Drills, 63/-.

MOTORS. MOTORS. MOTORS. Tiny, Small and Medium. A large stock of really fractional horse-power motors have been released at bargain prices. 6 volts, 12/6; 50 volts, 14/-. A.C. MAINS MOTORS.—Enclosed, self-start on load.

A.C. repulsion, 1/60 h.p. with pulley, Type 36, 1,500 revs., 18/6. Ditto, 1/16 h.p., O.E.O., 3,500 revs., 27/6. Induction, 1/10 h.p., 2,500 revs., 35/-. 1 h.p., 1,425 revs., 49/-. D.C. MAINS MOTORS.—1/40 h.p., 110 v. or 220 v., K.B. series, 1,750 revs., 15/-. Ditto, 1/40 h.p., G.E.C., 230 v. series, 2,000 revs., 18/-. Ditto 1/12 h.p., Croydon 110 and 230 v. shunt, 1,700 revs., 30/-. M.G. for A.C. 220 v. to 100 v., 1 amp. D.C., 60/-.

TELEPHONES.—House, office, and garage, wall and table phone sets, 27/6 pair. Portable Army Field phones, 60/- each. Headphones, 120-ohm Sullivan, 2/9. High Res. best British for short wave, 4/6. Lightweight, 4/9.

LIGHT AND RAY CELLS.—Selenium Raycraft, 22/-; Kingston, 15/-. Raycraft outfit with relay and amplifier, 45/-. Photo-Cells, for Sound-on-Film, Television and Ray work, B.T.P., 15/-; R.C.A., 25/-; Beck Angle Prisms, mounted in carrier, 5/8. X-Ray Tubes, 25/- line for 10/-.

CELL OR MIKE AMPLIFIERS.—Single-stage pre-amplifiers, walnut cabinet, 8 x 9 x 6, fitted switch output transformer, terminals, valve-holder and leads, space for batteries. For mikes, sound heads or as an extra L.F. stage, 12/6; all new.

CRYSTAL SETS.—Still the best Radio Receiver. Quiet and efficient reception. 500 solited sets cheap. 7/6 each

ELECTRADIX RADIOS
218, Upper Thames Street, London, E.C.4.
Phone: Central 4611



47/6 (as illus.)



A NEW AEROPLANE AERIAL

A SUITABLE transmitting aerial for aeroplanes has been the subject of much consideration and research. There are three main types of aerial—the fixed type, fixed trailing wire, and reel type weighted trailing wire. The fixed type, owing to its short length, its low effective height and its high capacity, is relatively inefficient and used only on aircraft where limited range or extremely high-frequency transmission is desired.

Most air lines have found it advisable to use a fixed trailing wire type of aerial. However, the disadvantage of this type is that constant whipping and abrasion shorten the length and they require frequent replacement. The necessity for replacement is so prevalent that a well-known American company has developed an auxiliary aerial which can be released by remote control when the main trailing wire aerial becomes broken or lost.

The reel type weighted trailing wire aerial has proved to be very reliable and considerably more efficient than the other two types, which, reduced to simple language, means greater transmitting range

and the fairlead protruding from it arranged to emerge directly below and out of the fuselage of the plane. This practically eliminates radiation losses within the plane and makes the whole length of aerial effective for transmission.

The rated power of a transmitter means very little. The amount of power in the aerial means a great deal. The Motoreel allows accurate matching of the aerial load to the output impedance of the transmitter, which ensures radiation of practically all the power the transmitter is able to deliver. In many cases 50-watt transmitters are delivering only 5 watts to the aerial because of mismatching. It is obvious that in these cases it would be far better to have a 10-watt transmitter putting 10 watts actually into the aerial, which would result in greater transmitting range and considerable saving in weight and payload, not to mention decreased battery drain and lower first and operating costs.

One of the greatest advantages of the Learadio Motoreel is that it allows the pilot to match properly his aerial for a

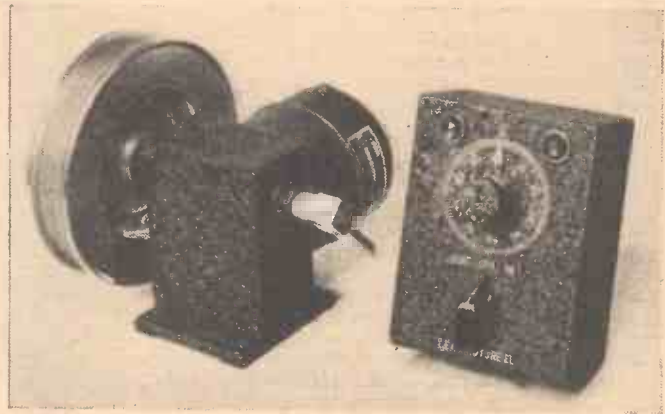

A view of the aerial reel, motor, and the remote control panel.

for a given transmitter output. However, it also has certain disadvantages, the main one being that the hand reel upon which the wire is wound must be placed in a position where the pilot can operate it. In most cases the transmitter has to be located in the back of the aeroplane, which necessitates running a connection from the hand reel back to the transmitter. The disadvantage in this is that there is always considerable loss due to radiation within the frame of the plane from this long wire. There is also the disadvantage that it requires considerable physical effort on the part of the pilot to reel the aerial in and out and it is difficult for him to judge exactly the length of wire he has extended. In an emergency it is sometimes necessary to land the plane promptly, in which case there is no time for the pilot to reach over and reel in the extended aerial, should it be out at the time.

A New Idea

For the private, as well as for the airline pilot, the problem of satisfactory transmitting aeriels has been solved by the new Learadio Motoreel, which provides a variable length weighted trailing wire aerial, with all of the advantages of all three type aeriels mentioned above and none of their disadvantages. The reel itself may be located alongside the transmitter

number of different transmitting frequencies. Pilots are more and more realising the necessity for multiple frequency transmission. The engineering problem involved in matching a given length of aerial to various frequencies is quite difficult to solve. Being able to vary the length of the aerial to get maximum radiation eliminates this problem and ensures putting all of the transmitter's power to work without waste.

With the Learadio Motoreel it is possible to pre-select any given length of aerial, turn the "operate" switch to the "out" position, and the Motoreel will automatically reel out the length of aerial selected and stop. Warning lights on the remote control indicate when the aerial is extended. These lights remain on until the aerial has been retracted. They are a constant warning to the pilot when the aerial is out. Complete retraction of the aerial is obtained by turning the control handle on the remote unit to the "in" position. When the aerial is all the way in and the weighted swivel fish is in its proper position against the fairlead, the warning lights go out.

The use of an aerial current meter in conjunction with the remote control unit enables the pilot to select a length of aerial giving maximum current circulation. It is only necessary for him to note that length and reset the aerial accordingly each time he wishes to use his transmitter.

Engineers' Guide

containing the widest choice of engineering courses in the world

Outlines The F.I.G.B.'s up-to-date home-study Courses in Wireless, Electrical and Mechanical Engineering, etc. Shows how to become A.M.I.E.E., A.M.I.W.T., A.Rad.A., etc., and how to qualify for a well-paid post. Training until successful guaranteed.

WRITE NOW for Free Guide.
THE TECHNOLOGICAL INSTITUTE OF GREAT BRITAIN,
42, Temple Bar House, London, E.C.4. (Founded 1917. 19,000 Successors.)



To Success

SHORT WAVES FIT A FILTER PERCOLATIVE EARTH



The only direct contact to the station is through the earth. When signals are weak, your earth is a vital link. Fit a Filter. From all dealers or post free from:

GRAHAM FARISH Ltd.
Masons Hill, Bromley, Kent.

BRITISH LONG DISTANCE LISTENERS' CLUB

Super-regenerative Receivers

MR. E. DE COTTIGNIES sends us the following letter, accompanied by the three diagrams shown, and in view of the interest in this type of receiver, we give his remarks in full. We are also giving this week a long article on the subject of super-regenerative receivers in our short-wave section on page 523. "One subject that is worthy of a little attention is one which is left severely alone—namely, that of super-regenerative receivers. These much maligned receivers actually are

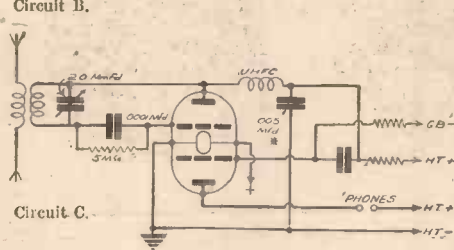
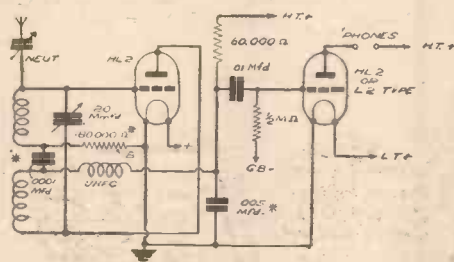
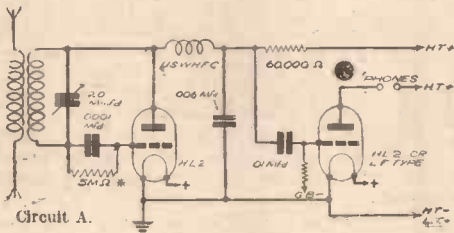

Three of the circuits referred to in Mr. Cottignies letter.

extremely simple to handle and give surprising results. Might I therefore be allowed to say a few words about three simple receivers of this variety with which I have been experimenting during the past few weeks? They are easy to make and operate and I would be interested to hear results obtained by readers.

"Each of the three that I propose to comment on uses a self-quenching detector and one stage of L.F. Each enables one, with different coils, to cover various wavelengths from 2 metres to 12 metres. Circuit A is very simple and uses one coil only; made of No. 16 tinned copper, 3/4 in. in diameter, it has 4 turns (to tune from 4 to 6 metres).

"Components marked * are of a critical value. Circuit B, a little more complicated, has two coils (actually one split in the middle). These are of equal size, each the same as the one used in circuit A. The critical component here is resistance B—values from 30,000 to 150,000 ohms must be tried until smooth regeneration is obtained. Ideally, H.T. to the detector anode should

be potentiometer controlled, but this is not essential.

"Circuit C is interesting in that it can be made up in such a small space—it uses a Cossor 220B class B valve, one half as a self-quench detector, the other half as an L.F. amplifier.

"Naturally, in all three circuits various methods of L.F. coupling can be tried, such as: straight transformer, parallel fed transformer, or R.C.C. On such receivers as these I have heard 'Hams' on 10 m., American experimentals on 9.5 m., American police on 9 m., the television on 7.2 and 6.6 m., 'Hams' on 5 m., and 'ump-teen' harmonics all over the place. P.S.—Various forms of antennae can be tried. Dipole, capacity fed, etc."

RADIO CLUBS AND SOCIETIES

Club Reports should not exceed 200 words in length and should be received First Post each Monday morning for publication in the following week's issue.

Bideford and District Short-wave Society

THIS society, with a live membership of about thirty, has been making excellent progress. Premises have been obtained for a permanent club-room, and apparatus is being installed for power supply, reception, and receiver testing. Two more "A.A." call-signs have been issued to members, and, ultimately, it is hoped to obtain a transmitting licence for the society. The Secretary, Mr. E. K. Jensen, 5, Furzebeam Terrace, Bideford, will be pleased to hear from prospective members and to give them all information.

The Croydon Radio Society

ALL tastes were provided for in the Croydon Radio Society's musical programme on records in St. Peter's Hall, S. Croydon, on Tuesday, December 15th. It was arranged by the hon. secretary, Mr. H. G. Salter, with his own radiogramophone. A British composer, Eric Coates, opened proceedings with his "London Again" suite, and after some Albert Sandler minuets, a legendary figure of the British Music-hall appeared. It was none other than Harry Tate, and he told the society how to run an office. Becoming bolder, Mr. Salter contrasted two modern composers: Honegger, with his "Pacific 231," and Lotter's "Moto Perpetuo." Eileen Joyce's piano solo proved very acceptable, and, indeed, for as long as time permitted did the hon. secretary vary his repertoire from symphony down to jazz. The chairman took the opportunity of reminding members that the session's second half began on Tuesday, January 5th, with a demonstration of Brunswick receivers and records. Usual good things like loudspeaker nights, set demonstrations, technical talks, follow, and a demonstration of television is being arranged. New members are welcome, and can now enrol for a reduced subscription for a half session.

Hon. Pub. Sec.: E. L. Cumbers, Maycourt, Campden Road, S. Croydon.

FREE ADVICE BUREAU COUPON

This coupon is available until January 16th, 1937, and must be attached to all letters containing queries.
PRACTICAL AND AMATEUR WIRELESS,
9/1/37.

Let Us Send You This 40-Page Booklet—Free



It gives full information regarding various I.C.S. Courses of Instruction in Radio work.

The Radio industry is progressing with amazing rapidity. Only by knowing thoroughly the basic principles can pace be kept with it. I.C.S. Instruction includes American broadcasting as well as British wireless practice. It is a modern education, covering every department of the industry.

OUR COURSES

Included in the I.C.S. range are Courses dealing with the Installing of radio sets and, in particular, with their Servicing, which to-day intimately concerns every wireless dealer and his employees. The Equipment Course gives sound instruction in radio principles and practice.

There is also a Course for the Wireless Salesman. This, in addition to inculcating the art of salesmanship, provides that knowledge which enables the salesman to hold his own with the most technical of his customers.

Then there are the Preparatory Courses for the City and Guilds and I.W.T. Exams.

We will be pleased to send you details and free advice on any or all of these subjects. Just fill in, and post the coupon, or write in any other way.

International Correspondence Schools, Ltd.,
Dept. 94, International Buildings,
Kingsway, London, W.C.2.

Without cost, or obligation, please send me your "Radio" booklet of information about the Courses I have marked X

- COMPLETE RADIO
- RADIO SERVICING
- RADIO EQUIPMENT
- RADIO SERVICING AND SALESMANSHIP
- WIRELESS ENGINEERING
- EXAMINATION (state which)

Name Age

Address



THIS BOOK will answer your *Queries*

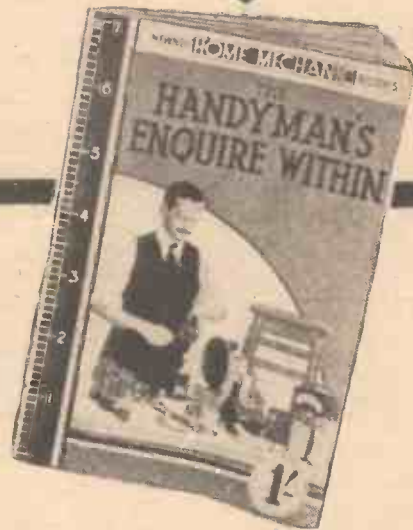

THE HANDYMAN'S ENQUIRE WITHIN costs only a shilling, but it may save you pounds in time and material. In 96 lavishly illustrated pages it gives a representative selection of all those hints and tips which have been proved after years and years of use. All of them represent information in common demand arranged for immediate reference at the precise moment the information is required. Owners of the book also have the benefit of a correspondence service for handymen, if any particular specialised information is unavailable in the book. It is only one of the famous Newnes Home Mechanic Series. All are equally practical, equally inexpensive, equally handy and essential to the modern man who makes things.

Here are some others in the series

- THE HOME WOODWORKER**
- MODEL BOAT BUILDING**
- TOY MAKING FOR AMATEURS**
- 25 SIMPLE WORKING MODELS**
- MOTOR CAR OVERHAUL AND UPKEEP**

- ACCUMULATORS—CAR AND WIRELESS**
- MODEL AEROPLANES AND AIRSHIPS**
- POWER-DRIVEN MODEL AIRCRAFT**
- SIMPLE ELECTRICAL APPARATUS**
- LATHE WORK FOR AMATEURS**

Newnes' HOME MECHANIC BOOKS



*Make Leisure hours
PLEASURE hours*

Each 1/- net.
From all booksellers, bookstalls and newsagents—or 1/2 each post free, from George Newnes, Limited, Tower House, Southampton St., Strand, London, W.C.2.

LETTERS FROM READERS

The Editor does not necessarily agree with opinions expressed by his correspondents



All letters must be accompanied by the name and address of the sender (not necessarily for publication.)

Correspondent Wanted

SIR,—I should like to express my appreciation of the excellent articles you are publishing at present on "Amateur Transmitting" and it is good to see PRACTICAL AND AMATEUR WIRELESS leading again, being the only weekly journal to cover this subject. Incidentally, if there is any reader in my immediate vicinity who is interested in morse code and transmission, I shall be very pleased to hear from him. I would also like to correspond with an amateur transmitter in Great Britain. Wishing your journal continued success.—W. FLINTOFF (2BNZ), 27, Eden Street, Saltburn-by-Sea, Yorkshire.

Delay in Delivering Components

SIR,—I have followed your remarks regarding the constructor's difficulties with intense interest, and although my theoretical knowledge is not as profound as I could wish, yet I have derived hours and hours of happiness and pleasure in the past in constructing sets, chiefly from published designs.

I shall never purchase a manufactured article, as I like to know its construction in case of repairs. During the past couple of years or so, it seems obvious that the set-builder has served his purpose, and is no longer needed by either dealer or manufacturer.

The purchaser of sets does not change about, as the constructor is able to do and who, in my opinion, has, in a great measure, been the means of establishing the great popularity of wireless.

I, for one, am fed-up, and possibly hundreds of others have come to the same decision, to sacrifice efficiency rather than be subjected to the annoyance of delay.

Many of us feel the need of an absorbing hobby and we shall seek it outside the realms of wireless construction in the future.

Some weeks back I decided to build your 4-valve quality set, published in July of last year under the title "Sets that Readers Ask For." Six weeks ago I gave the order to my dealer for the specified components. I have waited three weeks, a month, for some, five weeks for the volume control, and the L.F. choke I am still waiting for. I phoned up one firm and received the reply, "Awfully busy, will send one this afternoon."

This is an example that disgusts the enthusiast and nothing kills a keen interest more quickly than delay.

Some may, as you say, be driven to the junk shops, but anyone with experience of these will avoid them at all costs where reliability is concerned.

The perusal of PRACTICAL AND AMATEUR WIRELESS provides me with endless pleasure, for its articles are so helpful, clear, and practical, and I shall continue to greedily absorb its interesting articles.—ROBERT COOMBS (Hayes, Middlesex).

Still Going Strong!

SIR,—The last report of The Croydon Radio Society for the first half of the session heads a very successful period since October. Enquiries re membership have been coming in very satisfactorily and I

must really thank PRACTICAL AND AMATEUR WIRELESS for this.

It is said that the societies are dying. Some, I suppose, are, but facts and figures show that the Croydon Radio Society is as strong as ever, and likely to be more so in the future. All this is no idle boast, it is merely a shout of satisfaction.

The Society sends its New Year greetings to you, and hopes and expects that 1937 will bring continued prosperity to PRACTICAL AND AMATEUR WIRELESS.—E. L. CUMBERS (Hon. Pub. Sec.), 14, Campden Road, South Croydon.

Reception of W2XFA

SIR,—Yet another letter has reached me verifying the reception of an American police transmitter, this time W2XFA, of Jersey City, heard on 9 metres. In this letter they said it was just as thrilling for them to learn of the reception of their signals in far off Aberdeen, as it was for me to hear them. Their transmitter is crystal-controlled and capable of 200 watts, although operated at 100 watts. In the output circuit two 838 tubes are used. Antenna used, 170ft. vertical atop Police H.Q. and radio room is 75ft. from the ground (which is a vast difference from the last one I reported to you). With this letter was received a log-sheet which will be prized along with the verification received. This slip is an actual copy of the "radio message" (giving time received, sent by which officer, etc.) that was transmitted and which I received. It might amuse your readers to know what the message was. Here it is: "216 Wegman Parkway. Get the name of owner of dog which bit a child and give same to fifth precinct."—JOHN C. BARRON (Aberdeen).

CUT THIS OUT EACH WEEK.

Do you know

—THAT the pick-up may be connected on the "earth" side of the detector grid circuit when an anode-bend detector is employed.

—THAT for good power-grid detection a high anode load should be employed, as well as a high anode voltage.

—THAT automatic grid bias for the L.F. stages of a battery receiver in which a variable- μ H.F. valve is employed is not very satisfactory.

—THAT poor high-note response may often be traced to an incorrect choice of de-coupling and by-pass condensers in the H.F. stages of a receiver.

—THAT a simple way of avoiding difficulty in regard to extension speakers is to fit a universal output transformer and arrange to connect any speaker to the secondary.

—THAT in the above case it is preferable to use low-resistance speakers.

The Editor will be pleased to consider articles of a practical nature suitable for publication in PRACTICAL AND AMATEUR WIRELESS. Such articles should be written on one side of the paper only, and should contain the name and address of the sender. Whilst the Editor does not hold himself responsible for manuscripts, every effort will be made to return them if a stamped and addressed envelope is enclosed. All correspondence intended for the Editor should be addressed: The Editor, PRACTICAL AND AMATEUR WIRELESS, George Newnes, Ltd., Tower House, Southampton Street, Strand, W.C.2. Owing to the rapid progress in the design of wireless apparatus and to our efforts to keep our readers in touch with the latest developments, we give no warranty that apparatus described in our columns is not the subject of letters patent.

REPLIES IN BRIEF

The following replies to queries are given in abbreviated form either because of non-compliance with our rules, or because the point raised is not of general interest.

R. J. W. (W.6). In view of the failure to obtain results on all wavebands, the circuit must be wrongly wired or a valve must be faulty. Check each stage with a milliammeter in the usual way.

F. R. B. (Aylesbury). The trouble is often experienced, and is generally found to be due to the slight residual A.C. ripple being modulated by the carrier-wave. More extensive smoothing and H.F. filtering is called for.

J. McD. (Bradford). We are not familiar with the unit and connector which is provided and therefore suggest you communicate direct with the makers.

G. T. (Horsforth). Neither of the receivers mentioned employs the 4-pin plug-in coil. For a one-valve it would be preferable to use the 6-pin type of coil as this enables an aerial coupling coil to be employed. The Prefect would be the nearest receiver, and you could no doubt arrange to build this without the L.F. stages for the time being.

B. J. W. (Barnwood). No suggestions can be made until it is known what type of interference exists. Is it mains borne, or picked up by the aerial or earth leads? In each case separate treatment will be necessary.

J. E. M. (Hackney). The coil is a reaction coil, but the arrangement is not too good. The two-valve circuit shown would be better if the reaction coil were included in the anode circuit of the detector valve. The circuit will probably be very unstable as at present shown, and the moment the anode circuit is tuned to resonance with the grid circuit, it will undoubtedly oscillate, and be difficult to stabilise.

F. A. S. (W.12). We cannot send blueprints C.O.D. You give no indication of the type of circuit you require. Do you need range, or volume? You can have, for instance, two H.F. stages with a detector and output stage, or one H.F. stage, detector, and two L.F. stages.

R. A. (W.2). If a rectifier is connected in circuit, there should be no risk of the back E.M.F., but it should be a simple matter to fit a four-pole switch (such as the Bulgin S.80), to avoid your difficulty.

S. A. L. (Hounslow). Some slight loss is to be expected, but it should not be serious, and unless you are out to get the very last ounce from the set it is not worth attempting to make any alteration to the aerial system. From your description it would be very difficult to arrange an alternative.

R. F. L. (Gorleston-on-Sea). We have no circuit of the type mentioned, and the nearest we can recommend is the special unit described in our issue dated October 10th last.

H. M. (Balsall Heath). No blueprint is available as yet for the receiver in question. A full wiring diagram is given in our issue dated December 5th last.

J. S. (Huyton). So far as we are aware there is no age limit. Our Television and Short-Wave Handbook is about the best we can recommend in your particular case, although it does not run through the subject in the manner outlined.

F. H. A. (Leyburn). There are no receivers in our blueprint list of the type mentioned, but the Prefect S.W. Three can be recommended, and we advise this rather than the type outlined in your letter.

L. F. (Intake, Sheffield). The receiver is not one of our designs, and the blueprint was supplied by Messrs. Lissen. We suggest you communicate with them. We have no data sheet for this set.

R. B. C. (Tonbridge). The valves referred to are quite in order. We cannot check grid-bias as you give no valve references, and the bias depends, of course, upon the particular valve and H.T. employed. The anode resistor in the third stage could be increased in value up to 10,000 ohms. The H.F. pentode will require bias if it is of the variable- μ type.

H. J. B. (Ashford). The trouble is probably due to H.F. instability, and we suggest that you check the H.T. applied to the first stage. We do not think any additional screening is called for, but simply a modification of the voltage on the oscillator anode or screen.

A. N. (Jarrow). As the trouble has only arisen recently, and both the short and medium-waves are still O.K., we suspect a fault in the coil switching, and advise you to have this examined.

W. H. (Blairgowrie). The voltage may be correct, as your meter may not be suitable for measuring the voltage at this particular point. A good high-resistance meter must be used, and a value of 1,000 ohms per volt should be considered the minimum for this type of measurement.

F. R. (Longdon). A 20 henry choke should be quite satisfactory, and the condenser may be either 2 mfd. or 4 mfd. The speaker will match quite satisfactorily owing to the inductance of the choke. Prices vary from 10s. or 12s. for the choke and from 3s. for the condenser.

M. B. (Newcastle-on-Tyne). The blanks may be obtained from Electradix Radios, whose advertisement appears in each issue of this paper. Both kinds of blanks may be obtained from this firm. There is no book on the subject so far as we are aware.

G. W. (Manchester). If you obtain a set of all-range coils, such as the Bulgin or B.T.S., you will be able to use them with a suitable ganged condenser.

J. S. (Peterhead). A possible solution is that the valve acts as a capacity and coupling thus takes place between one stage and the next through the capacity of the valve.

NEW YEAR BARGAINS

COLT ALL-WAVE 3 KIT "A" CASH or C.O.D. CARRIAGE PAID **47/6**
Or 5/- down and balance in 11 monthly payments of 4/3.

Comprising N.T.S. Kit of matched components, including exclusively specified Bulgin Coil, Cix S.W. Valveholders, Peto-Scott Baseboard and Peto-Scott Component Brackets, less Valves, Cabinet and Speaker. **3 specified valves 12/3 extra**

5/- DOWN

RECORD ALL-WAVE 3 KIT "A" CASH or C.O.D. CARRIAGE PAID **63/-**

Comprising N.T.S. Kit of matched components, including exclusively specified B.T.S. ALL WAVE COIL UNIT, H.B. 3-GANG TUNING CONDENSER and DRIVE and PETO-SCOTT METAPLEX BASEBOARD, less valves, cabinet and speaker. Cash or C.O.D. £3 3 0. Send 5/- only. Balances in 11 monthly payments of 5/8.

KIT "B" As for Kit "A," but including 3 specified valves, less cabinet and speaker. Cash or C.O.D. Carriage Paid, 24/9/3, or 12 monthly payments of 8/3.

KIT "C" As for Kit "A," but including valves and specified cabinet, less speaker. Cash or C.O.D. Carriage Paid, 28/4/9, or 12 monthly payments of 11/6.

SEND 5/- ONLY

N.T.S. S.W. ADAPTOR 12-94 METRES



Hear America and all the World DIRECT on your present set, for only 17/6. Complete Kit of parts to build a reliable short-wave adaptor for use with any BATTERY receiver.

Kit comprises all parts for instant assembly, including metal-sprayed base-board, 2 variable condensers, .0016, .001 MFD., 2 base-board mounting 4-pin holders, short-wave H.F. choke, grid leak, fixed condenser, adaptor plug, terminal mount, two terminals, 3 4-pin plug-in coils, 12/26, 22/47, and 41/94 metres, 1 component bracket, slow-motion drive, trimming condenser, connecting wire and wiring diagram. Built in one evening. Cash or C.O.D. Carriage Paid 17/6 or 2/6 down and 7 monthly payments of 2/6.

2/6 DOWN

TWO Guinea S.G.3 CHASSIS

Each chassis brand new and tested on British and Foreign Broadcasts before dispatched to you. **CIRCUIT COMPLETES:** Screened Grid H.F., Detector and Pentode Output Valves, Screened wave-wound coils, 2-Gang Air Dielectric Condenser, Metal Chassis. Only 9 main H.T. consumption. Illuminated and Wavelength Calibrated Dial. Wave range 200-2,100 metres.

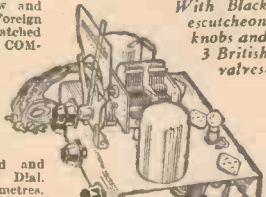

With Black escutcheon knobs and 3 British valves.

LIST PRICE £5/6 BARGAIN £2/-

or 2/3 down, and 12 monthly payments of 4/- Recommended P.M. Moving Coil Speaker, 15/- Walnut finished Console Cabinet, 10/- COMPLETE RECEIVER comprising above chassis housed in walnut-finished Console Cabinet with valves and P.M. speaker, less batteries. Cash or C.O.D. Carriage Paid £3 7 6 or 5/- down and 12 monthly payments of 5/9.

ONLY 2/6 DOWN

BATTERY CLASS B4

INCLUDES 4 BRITISH VALVES
Amazing purity of tone and volume rivalling that of powerful all-mains models. Wide choice of foreign stations. The perfect mains quality Battery receiver. Four matched British valves of guaranteed life. Moving-Coil Speaker. Single knob slow-motion tuning, bronzed escutcheon, illuminated circular aeroplane dial. New type switch. Combined volume control and on-off switch. Sensitivity and graded volume control. Wave-lengths 200-550 and 900-2,100 metres. Oldham Long-Life 120-volt H.T. and 2-volt L.T. Accumulator and G.B. Batteries. Output 11 watts at 120 volts. Exquisite Walnut Veneered Cabinet illustrated above. Absolutely complete with aerial equipment ready to play.

List Price £8 8 0 BARGAIN £4 19 6

5/- DOWN

Cash or C.O.D. Carriage Paid. and 12 monthly payments of 8/9.

Practical and Amateur Wireless BLUEPRINT SERVICE

PRACTICAL WIRELESS			PORTABLES.		
CRYSTAL SET.	Date of Issue.	No. of Blueprint	Three-valve : Blueprint, 1s.		
1937 Crystal Receiver	9.1.37	PW71	F. J. Camm's ELF Three-valve Portable (HF Pen, D, Pen)	16.5.36	PW65
STRAIGHT SETS. Battery Operated.			Four-valve : Blueprint, 1s.		
One-valve : Blueprints, 1s.			Featherweight Portable Four (SG, D, LF, Cl. B)		PW12
All-wave Unipen (Pentode)		PW31A	MISCELLANEOUS.		
Two-valve : Blueprint, 1s.			S.W. Converter-Adapter (1 valve)		PW48A
Four-range Super Mag Two (D Pen)	11.8.34	PW36B	AMATEUR WIRELESS AND WIRELESS MAGAZINE CRYSTAL SETS.		
Three-valve : Blueprints, 1s. each.			Blueprints, 6d. each.		
Selectone Battery Three (D, 2 LF (Trans))		PW10	Four-station Crystal Set	12.12.36	AW427
Sixty Shilling Three (D, 2 LF (RC & Trans))		PW34A	1934 Crystal Set		AW444
Leader Three (SG, D, Pow)		PW35	150-mile Crystal Set		AW450
Summit Three (HF Pen, D, Pen)	8.8.34	PW37	STRAIGHT SETS. Battery Operated.		
All Pentode Three (HF, Pen, D (Pen), Pen)	22.0.34	PW39	One-valve : Blueprints, 1s. each.		
Hall-Mark Three (SG, D, Pow)		PW41	B.B.C. Special One-valver		AW387
Hall-Mark Cadet (D, LF, Pen, (RC))	16.3.35	PW48	Twenty-station Loudspeaker One-valver (Class B)		AW449
F. J. Camm's Silver Souvenir (HF Pen, D (Pen), Pen) (All-Wave Three)	13.4.35	PW49	Two-valve : Blueprints, 1s. each.		
Genet Midget (D, 2 LF (Trans))	June '35	PM2	Melody Ranger Two (D, Trans)		AW388
Cameo Midget Three (D, 2 LF (Trans))	8.6.35	PW51	Full-volume Two (SG det. Pen)		AW392
1936 Sonotone Three-Four (HF Pen, HF Pen, Westector, Pen)	17.8.35	PW53	B.B.C. National Two with Lucerne Coil (D, Trans)		AW377A
Battery All-Wave Three (D, 2 LF (RC))		PW55	Big-power Melody Two with Lucerne Coil (SG, Trans)		AW338A
The Monitor (HF Pen, D, Pen)		PW61	Lucerne Minor (D, Pen)		AW426
The Tutor Three (HF Pen, D, Pen)	21.3.36	PW62	A Modern Two-valver	July '36	WM409
The Centaur Three (SG, D, P)		PW64	Three-valve : Blueprints, 1s. each.		
The Gladiator All-Wave Three	29.8.36	PW66	Class B Three (D, Trans, Class B)	22.4.33	AW386
F. J. Camm's Record All-Wave Three (HF Pen, D, Pen)	31.10.36	PW69	New Britain's Favourite Three (D, Trans, Class B)	15.7.33	AW394
Four-valve : Blueprints, 1s. each.			Home-built Coil Three (SG, D, Trans)		AW404
Fury Four (2 SG, D, Pen)		PW11	Fan and Family Three (D, Trans, Class B)	25.11.33	AW410
Beta Universal Four (SG, D, LF, Cl. B)		PW17	£5 5s. 8.G.3 (SG, D, Trans)	2.12.33	AW412
Nucleon Class B Four (SG, D (SG) LF, Cl. B)	6.1.31	PW34B	1934 Ether Searcher : Baseboard Model (SG, D, Pen)	20.1.34	AW417
Fury Four Super (SG, SG, D, Pen)		PW34C	1934 Ether Searcher : Chassis Model (SG, D, Pen)		AW419
Battery Hall-Mark 4 (HF, Pen, D, Push-Pull)		PW46	Lucerne Ranger (SG, D, Trans)		AW422
F. J. Camm's "Limit" All-Wave Four (HF Pen, D, LF, P)	26.9.36	PW67	Cosser Melody Maker with Lucerne Coils		AW423
Mains Operated.			Mullard Master Three with Lucerne Coils		AW424
Two-valve : Blueprints, 1s. each.			£5 5s. Three : De Luxe Version (SG, D, Trans)	10.5.34	AW435
A.C. Twin (D (Pen), Pen)		PW18	Lucerne Straight Three (D, RC, Trans)		AW437
A.C. D.C. Two (SG, Pow)	7.10.33	PW31	All-Britain Three (HF Pen, D, Pen)		AW448
Selectone A.C. Radiogram Two (D, Pow)		PW19	"Wireless League" Three (HF Pen, D, Pen)	3.11.34	AW451
Three-valve : Blueprints, 1s. each.			Transportable Three (SG, D, Pen)		WM271
Double-Diode-Triode Three (HF Pen, DDT, Pen)	10.6.33	PW23	£6 6s. Radiogram (D, RC, Trans)		WM318
D.C. Ace (SG, D, Pen)		PW25	Simple-tune Three (SG, D, Pen)	June '33	WM327
A.C. Three (SG, D, Pen)		PW29	Economy-Pentode Three (SG, D, Pen)	Oct. '33	WM337
A.C. Leader (HF Pen, D, Pow)	7.4.34	PW35C	"W.M." 1934 Standard Three (SG, D, Pen)		WM351
D.C. Premier (HF Pen, D, Pen)	31.3.34	PW35B	£3 3s. Three (SG, D, Trans)	Mar. '34	WM354
Ubique (HF Pen, D (Pen), Pen)	23.7.34	PW36A	Iron-core Band-pass Three (SG, D, QP 21)	June '34	WM362
Armada Mains Three (HF, Pen, D, Pen)	18.8.34	PW38	1935 £6 6s. Battery Three (SG, D, Pen)		WM371
F. J. Camm's A.C. All-Wave Silver Souvenir Three (HF Pen, D, Pen)	11.5.35	PW50	PTP Three (Pen, D, Pen)	June '35	WM389
"All-Wave" A.C. Three (D, 2 LF R.C.)	17.8.35	PW54	Certainty Three (SG, D, Pen)	Sept. '35	WM398
A.C. 1936 Sonotone (HF Pen, HF Pen, Westector, Pen)		PW56	Minute Three (SG, D, Trans)	Oct. '35	WM396
Four-valve : Blueprints, 1s. each.			All-wave Winning Three (SG, D, Pen)	Dec. '35	WM400
A.C. Fury Four (SG, SG, D, Pen)		PW20	Five-valve : Blueprints, 1s. 6d. each.		
A.C. Fury Four Super (SG, SG, D, Pen)		PW34D	Super-quality Five (2 HF, D, RC, Trans)	May '33	WM329
A.C. Hall-Mark (HF Pen, D, Push-Pull)		PW45	Class B Quadradyne (2 SG, D, LF, Class B)	Dec. '33	WM344
Universal Hall-Mark (HF, Pen, D, Push-Pull)	9.2.35	PW47	Mains Operated.		
SUPERHETS.			Two-valve : Blueprint, 1s. each.		
Battery Sets : Blueprints, 1s. each.			Consoelectric Two (D, Pen) A.C.		AW403
£5 Superhet (Three-Valve)		PW40	Economy A.C. Two (D, Trans) A.C.		WM286
F. J. Camm's 2-valve Superhet (Two-Valve)	13.7.35	PW52	Unicorn A.C./D.C. Two (D, Pen)	Sept. '35	WM394
F. J. Camm's £4 Superhet		PW58	Three-valve : Blueprints, 1s. each.		
Mains Sets : Blueprints, 1s. each.			Home-Lover's New All-electric Three (SG, D, Trans) A.C.		AW383
A.C. £5 Superhet (Three-valve)		PW43	These blueprints are drawn full size.		
D.C. £5 Superhet (Three-valve)	1.12.34	PW42	Copies of appropriate issues containing descriptions of these sets can in some cases be supplied at the following prices, which are additional to the cost of the blueprint. A dash before the Blueprint Number indicates that the issue is out of print.		
Universal £5 Superhet (Three-valve)		PW44	Issues of Practical Wireless	4d	Post paid
F. J. Camm's A.C. £4 Superhet 4		PW59	" " Amateur Wireless	4d.	"
F. J. Camm's Universal £4 Superhet 4	11.1.36	PW60	" " Practical Mechanics	7jd.	"
SHORT-WAVE SETS.			" " Wireless Magazine	3/3	"
Two-valve : Blueprint, 1s.			The index letters which precede the Blueprint Number indicate the periodical in which the description appears: thus, PW refers to PRACTICAL WIRELESS, WM to Wireless Magazine, PM to Practical Mechanics, AW to Wireless Magazine. Send (preferably) a postal order to cover the cost of the blueprint and the issue (stamps over 6d. unacceptable), to PRACTICAL AND AMATEUR WIRELESS Blueprint Dept., Geo. Newnes, Ltd., Tower House, Southampton Street, Strand, W.C.2.		
Midget Short-Wave Two (D, Pen)	15.9.34	PW38A			
Three-valve : Blueprints, 1s. each.					
Experimenter's Short-Wave Three (SG, D, Pow)		PW30A			
The Prefect 3 (D, 2 LF (RC and Trans))		PW63			
The Bandsread S.W. Three (HF Pen, D (Pen), Pen)	20.3.36	PW68			

New Times Sales Co. 56 (PR.W.3.) Ludgate Hill, London, E.C.4. Est. 1924.



QUERIES and ENQUIRIES

to fit switching of this type in a modern receiver, and, if so, could you give me any complete constructional data?"—H. C. (Bath).

Radio Abbreviations

"I am a newcomer to short-wave wireless, which greatly appeals to me, and I am now a regular reader of your interesting publication. I have learnt a good deal from this, but I find that there are several abbreviations which I do not understand. A few of these are—C.W., Q.S.B., Q.R.M., S.W.L., G.R.A., D.X.'ers, Q.S.A.5, etc. This list is not meant to be exhaustive, but I should be very grateful for a list of these abbreviations together with their full meanings."—A. W. B. (Wisbech).

YOU will note that among the abbreviations there are several which commence with the letter "Q," and consequently these are known as the "Q Code." A full list of the abbreviations in this code will be given shortly in connection with our transmitting articles, but in the meantime we may mention that Q.R.A. is the address of a transmitter, Q.R.M. refers to interference, and so on. D.X. is a standard radio abbreviation for distance, and thus a D.X.'er is a long-distance listener. C.W. is a form of signalling in which the transmitter generates a continuous wave, and the two letters are the initials of this form of transmission. I.C.W. means interrupted continuous wave. You will find all of these terms in our Wireless Constructors' Encyclopaedia.

Mains Record All-wave 3

"Would you tell me the name of the makers of the condenser C.19 in the Mains 'Record' All-wave 3? Also if a dry electrolytic condenser of 8 mfd. could be used instead of the wet one specified in the same receiver."—A. H. (Southampton).

CONDENSER C.19 is a differential reaction condenser of the Litlos type manufactured by the Graham Farish Company. You could use the dry electrolytic condenser without any ill effects, but we would remind you that we cannot agree to the use of alternative components in our Guaranteed receivers.

Oil-immersed Condensers

"I have noted in recent advertisements and in specifications for television apparatus that 'oil-immersed' condensers are specified. From an illustration these appear to be very large and I am interested to know how these are made. Are they of the type used in old-fashioned tuning condensers, with free oil as the dielectric? If so, surely there must be some leakage and messiness when these are in use."—T. W. A. (W. Norwood).

THE condensers in question are of the ordinary multiple paper dielectric type, each of which is impregnated and oil-immersed by a patented process. There is no fear of any leakage, as the condenser cases are hermetically sealed.

Automatic Tuning

"I remember reading some time ago how to fit a switch so that tuning could be dispensed with. I believe a pre-set condenser was used, but I am not clear of the complete arrangement. Is it practicable

WE are giving in this issue an article describing the construction of an automatic two-valve receiver on the lines mentioned, and you will find in that all the necessary details for a completely automatic receiver. Although the scheme therein detailed permits of only two stations, it

RULES

We wish to draw the reader's attention to the fact that the Queries Service is intended only for the solution of problems or difficulties arising from the construction of receivers described in our pages, from articles appearing in our pages, or on general wireless matters. We regret that we cannot, for obvious reasons—

- (1) Supply circuit diagrams of complete multi-valve receivers.
- (2) Suggest alterations or modifications of receivers described in our contemporaries.
- (3) Suggest alterations or modifications to commercial receivers.
- (4) Answer queries over the telephone.
- (5) Grant interviews to querists.

Please note also, that queries must be limited to two per reader, and all sketches and drawings which are sent to us should bear the name and address of the sender. Requests for Blueprints must not be enclosed with queries as they are dealt with by a different department.

If a postal reply is desired, a stamped addressed envelope must be enclosed. Send your queries to the Editor, PRACTICAL AND AMATEUR WIRELESS, George Newnes, Ltd., Tower House, Southampton Street, Strand, London, W.C.2.

The Coupon must be enclosed with every query.

is possible, by adopting a switch with many more contacts, and by including more pre-set condensers, to make the receiver tune to any desired number of stations, but in such a case it will be found preferable to use a reaction condenser mounted on the panel for "vernier control."

Visual Tuning Indicator

"I am interested in the electric eyes and similar devices which are fitted to many new commercial sets, and as I am using a modified form of your £4 Superhet, with signal H.F. stage and two intermediate-frequency stages, I should like to fit some similar device. I have read about the indicator as fitted to your Superhet unit for the Paraphase amplifier, but this seems complicated to fit up. Also the Ekco and Philco indicators are not too easy to connect. Is there no simpler arrangement, in which, perhaps, I could use a flash-lamp bulb to give a similar effect. I do not want an ordinary meter."—S. T. H. (Amersham).

THERE is now available a simplified form of neon indicator which should meet your requirements. This consists of a very small device, not unlike an ordinary

flash-lamp bulb, approximately one inch in length, and this is connected in the anode circuit of the intermediate-frequency stage—in your case in the second stage. One side of the indicator is joined to the chassis, via the metal screw-holder, and the other side is joined to the anode circuit of the I.F. valve via a resistance, which must be of such a value that the indicator just glows when no signal is received. The correct tuning point is shown by the degree of brightness, and thus you should mount the indicator in a short length of tubing, blackened on the inside and so arranged on the panel that it is clearly seen, even when daylight falls direct on the front of the panel. The indicator is made by the G.E.C. and costs only 2s. 6d. You could no doubt devise a suitable surround for the mount to resemble an eye.

Oscillator Coils

"I am building a short-wave superhet, but am rather in a difficulty concerning the frequency-changer. I have decided to use a pentagrid, but require the set to be adjustable so that when desired I can use it for broadcast reception on the ordinary wavelengths. Do you agree that an intermediate frequency of 465 kc/s is best, and what type of coil should I construct for the oscillator stage?"—E. Q. S. (Plymouth).

ALTHOUGH a separate oscillator tuning condenser would be of great value, you could use a ganged unit, but to cover the ordinary wavelengths in addition to the short waves you may find ganging problems will arise—especially if you make your own coils. However, we refer you to the article on the construction of oscillator coils in our issue dated October 17th last, and you will see there that the oscillator coil is practically identical with a normal tuning coil, except for the size of the winding, and that the ordinary reaction winding may be employed. By making this in the form of a six-pin plug-in coil on a standard short-wave coil former, you could experiment to find the best arrangement for your particular circuit.

Fading Signals

"A fault has arisen in my set which takes the form of a gradual fading away of the signal. If I switch off the mains and then switch on again the signals are restored. Can you offer any suggestion? I have replaced all the valves without this having any effect."—F. P. (S.W.4).

AS the trouble has only risen recently, it indicates a component or valve fault, and the replacement of valves eliminates these from your trouble tracking. The simplest way to locate a fault of this nature is to include a milliammeter in each anode circuit in turn, and when the signals cease the current will probably drop to zero. As the switching off of the set for the purpose of including the meter may restore signals, we suggest that the meter is included in the first anode circuit with a switch across it, and when signals cease the switch may be operated to bring the meter into circuit. This can be done with successive stages until the fault is localised. If no change in current is shown, a grid coupling may be suspected. The inclusion of headphones in the detector anode circuit, and each L.F. circuit in turn may also prove a simple way to locate the faulty stage, whilst the aerial may be joined to the detector circuit to eliminate the H.F. stage or stages.

LATHE-WORK FOR AMATEURS

by
F. J. CAMM

1/- or 1/2 by post from

George Newnes, Ltd., Tower House, Southampton Street, Strand, London, W.C.2.

The coupon on page 527 must be attached to every query.

Miscellaneous Advertisements

Advertisements are accepted for these columns at the rate of 3d. per word. Words in black face and/or capitals are charged double this rate (minimum charge 3/- per paragraph). Display lines are charged at 6/- per line. All advertisements must be prepaid. All communications should be addressed to the Advertisement Manager, "Practical and Amateur Wireless," Southampton Street, Strand, London.

RECEIVERS, COMPONENTS AND ACCESSORIES
Surplus, Clearance or Secondhand, etc.

RADIOMART
SHORT-WAVE SPECIALISTS
Announce 1937

SHORT-WAVE MANUAL

Packed with short-wave information and circuits of mains and battery receivers, including straight, superhet and 6-metre transmitters, modulators, etc. Information on transmitting licences, aerials, Class B amplifications, neutralization, superhet alignment, etc. The most comprehensive manual published, written by practical engineers, price 6d., post free 7d., including catalogue. 1937 Catalogue only (3 times enlarged) price 1½d. post free.

TELSEN screened dual range coils, 2/6. Pair, 4/6. Milliammeters, 25 ma. upwards, 5/9. Super, 6/9. MERICAN mains transformers 230v. fully shrouded, 350/350, 6.3v., 5v., 6/11. Majestic 250/250, 2.5v., 5v., 4/11.
HEAVY DUTY mains transformer worth 35/-, 350/350, 150 ma.; 4v. 2.5ACT, 4v. 6ACT, 12/6. 5 KC/S., IF transformers, 2/11. Telsen Ace, 465 1/11. RG4, Radio grands, 2/9, 2mf. 300v., 9d. UTILITY straight line wavelength dials, 3/11. Telsen H.F. chokes, 1/11. UTILITY 2-gang unknob and dial, 3/11; 1,500-volt tubular condensers, all sizes, 6d. ELECTROLYTICS 500-volt 8 mf., 1/6; 4 mf., 1/6; 4 x 4, 1/11; 8 x 8, 3/6; 25 mf. 25v., 1/- each. SMOOTHING chokes, 20 hy. 120 ma., 3/11; 100 ma., 2/11; 40 ma., 1/11. PUSHBACK wire, 6 yds., 6d.; heavy, 9d.; 2 gross solder tags, 6d.; resin-cored solder, 0ft., 6d. CENTRALAB pots, all sizes, 1/6; switched, 2/-; tubular glass fuses, 2d. JENSON PM speakers, 12/6. Varley Iron core coils, 2/6; matched pair, 4/6. SPECIAL OFFER Class B valve, driver transformer and valveholder, new, lot 5/-. ISSEN 3-gang bandpass, 3-gang superhet, 2-gang all-wave coils, any set, price 7/6. RADERS' monster bargain parcels, value £4/10/-, for 10/-; also 5/- parcels. AMOUX Continental A.C. valves, 4/6; American Duotron, etc., all types, 3/6; battery from 2/3. UTILITY 8/6, microdisc dials, 3/11; Radiophone, 0.00016 short-wave condensers, 3/6; series gap, twin, 3/9. ERAMIC all brass microvariables, 15 mmfd., 1/4; 40 mmfd., 1/7; 100 mmfd., 1/10; short-wave H.F.C., 9d. CLEARANCE catalogue 1½d. Goods over 5/- post free. All enquirers must send stamp. Branches: 19, John Bright St., 44, Dale End. Mail Orders, 44, Holloway Head, Birmingham. Telephone, MID 3254.

MISCELLANEOUS

ALCO ELIMINATORS AND CHARGERS. 4 H.T. taps, 18/- . With ½ amp. charger, 25/- . Charger alone, 7/6. ½ amp., 11/- complete. Year's guarantee. Details free. P. & D. Radio, 1, Gooding Road, N.7.

RADIO BARGAINS

WANTED Modern used Radio sets, short-wave parts and adaptors. Speakers, Eliminators, Meters, Motors and Pick-ups. Spot cash paid. Bring or send.—University Radio, Ltd., 82, Hampstead Road, London, N.W.1.

WANTED—ambitious young men to prepare for well paid posts in TELEVISION, the great career of the future. Apply for free booklet from BRITISH INSTITUTE OF ENGINEERING TECHNOLOGY, 18F, Shakespeare House, 17-19, Stratford Place, London, W.1.

VALVES

NOTHING better available. SIX MONTHS' GUARANTEE, complete range of BATTERY, A.C. MAINS, RECTIFIERS always in stock. 21 Grid Det., H.F., L.F., 2/3, POWER, 2/9, SCREEN GRID, PENTODE, H.F. PENTODE 5/- . American types, fully guaranteed, 5/6 each, Nos. 80, 42, 43, 57, 58, 77, 78, 6C6, 6D6, 25Y5, 25Z5. Write for other prices to Dulci Electrical Co., Ltd., Devonshire Works, Dukas Avenue, Chiswick, W.4.

PREMIER SUPPLY STORES

Get our quotation for your Short-Wave and Television Gear

Offer the following Set Manufacturers' Brand New Surplus Goods at a Fraction of the Original Cost; all goods guaranteed perfect; carr. paid over 5/-; under 5/- postage 6d. extra. Orders under 5/- cannot be sent C.O.D.

ALL POSTORDERS TO JUBILEE WORKS, 167, LOWER CLAPTON RD., LONDON, E.5
CALLERS, A3 USUAL, TO 20-22 HIGH ST., CLAPHAM, S.W.4 (Macaulay 2381). 'Phone: Amherst 4723
And 165 & 165A, FLEET ST., E.C.4 (Next door to Anderson's Hotel.) Central 2833.

MAINS VALVES

MAINS VALVES, famous Europa 4 v. A.C. types, 4/6 each. HL., L., S.G. Var.-Mu-S.G., L.F. Pens., Var.-Mu-H.F. Pens., 3 and 4-watt A.C. directly heated output Pentodes. Full-wave rectifiers, 250 v. 60 ma. A.C./D.C. types. 20-volt. 18 amp. S.G., Var.-Mu-S.G., H., HL., Power. Following Types all 5/6 each. Full-wave rectifiers, 350 v. 120 m.a. and 500 v. 120 m.a. 2½ wait indirectly heated Pentodes, Frequency Changers, Octodes and Heptodes. **BATTERY VALVES**, 2 volts, H.F., L.F., 2/3. Power, Super-Power, 2/9. S.G., Var.-Mu-S.G., 4- or 5-pin Pentodes, H.F. Pens., V.-Mu-H.F. Pens. 5/-, Class B, 3/6. **AMERICAN VALVES**, Genuine American HYTRON and TRIAD first-grade Valves, 3 months' guarantee. All types in stock, 5/6 each. 210 and 250, 8/6 each. New Metal-Glass Valves, all types, 6/6 each. Genuine American DUOTRON Valves, all types, 3/6 each. Valve holders for all above types, 6d. each. Metal bases, 9d. each.

SHORT WAVES

SHORT-WAVE COILS, 4- and 6-pin types, 8.25, 22.47, 41.9, 78.170, 179, each, with circuit. Special set of 3 4-pin S.W. Coils, 14-150 metres, 4/- set, with circuit. Premier 3-band S.W. Coil, 11-25, 19.43, 38-86 metres. Simplified S.W. receiver construction, suitable any type circuit, 2/6. **COIL FORMERS**, in finest plastic material, 1½in. low-loss ribbed, 4- or 6-pin, 1/- each. **SUPER CERAMIC CONDENSERS**, S.L.F. .00016, .0001, 2/9 each; double-spaced, .00005, .000025, .000015, 3/- each. All brass with integral slow motion, .00015 tuning, 3/9; .00015 reaction, 2/9. British Radiophone 2-gang .00016, 5/6. **H.F. CHOKES**, 2 v., 120 ma., 2d.; 8 v., S.W. screened, 1/6; standard screened 180-2,000 metres, 1/6. **CERAMIC S.W. VALVE HOLDERS**, 4-, 5- or 7-pin. Chassis types, 6d.; B.B. type, 8d. **GLASS AERIAL INSULATORS**, 4d. each. **BEEHIVE STAND-OFF**, 6d. each. **SCREENED FLEX**, single, 3d. yd.; twin, 4d. yd.

PREMIER AMPLIFIER KITS

3-WATT A.C. AMPLIFIER, 2-stage, for mike or pick-up. Complete kit of parts with 3 valves, 40/-.
7-WATT A.C./D.C. AMPLIFIER, 3-stage, high-gain, push-pull output. Complete kit of parts with 5 specially matched valves, £4 4s.
10-WATT 3-stage A.C. Amplifier Kit with 5 valves, £5 5s.
20-WATT 3-stage A.C. Amplifier Kit with 5 valves, £8 8s.
ELECTROLYTICS, U.S.A. 4, 8 or 12 mfd. 50 v. peak, 1/9 each. Dubilier, 4 or 8 mfd. 500 v., 3/-; 50 mfd. 50 v., 1/9; 12 mfd. 20 v., 6d.; 25 mfd. 25 v., 1/-; T.C.O. 4 or 8 mfd. 650 v., 4/-; 15 mfd. 50 or 100 v., 1/-; 50 mfd. 12 v., 1/- . Paper Condensers, W.E., 250 v. working 4 mf., 2/-; 2 mf., 1/-; 1 mf., 6d.; 350 v. working 4 mf., 2/6; 2 mf., 1/6. Dubilier 500 v. working 4 mf. 4/-; 800 v. 4 mf., 6/-. Wego 400 v. working 1 mf., 1/-; 2 mf. 1/9, 4 mf., 3/-; 750 v. working 2 mf., 2/-; 4 mf. 3/8. **COSMOCORD PICK-UPS**, with tonearm and volume control, 10/6 each. **PICK-UP HEADS** only, 4/6 each.

MAINS TRANSFORMERS

PREMIER wire-end type with screened primaries, tapped 200-250 v. Centre-tapped Filaments. Guaranteed one year. H.T. 8 & 9 or H.T. 10 with 4 v. 4 a. C.T. and 4 v. 1 a. C.T., 8/6. 250-250 v. 60 ma., 4 v. 1 a., 4 v. 2 a. and 4 v. 4 a., all O.T., 8/6. 350-350 v. 120 m.a., 4 v. 1 a., 4 v. 2 a. and 4 v. 4 a., all O.T., 10/6. Any of these transformers with engraved panel and N.P. terminals, 1/6 extra. 500-500 v. 150 m.a., 4 v. 2 a., 4 v. 2 a., 4 v. 2 a., 4 v. 2 a., 4 v. 2 a., 4 v. 2 a., all O.T., 17/6. Super Model, 19/6. **AUTO TRANSFORMERS**, step up or down, 60 watts, 7/6; 100 watts, 10/-. **FILAMENT TRANSFORMERS**, Tapped Primaries, 200-250 v. Secondary Chokes, 5/6. 4 v. 3 a., 7/6; 4 v. 5 a., 8/6; 7.5 v. 3 a., 7/6; 6 v. 3 a., 7/6; 2.5 v. 8 a., 7/6; 6.3 v. 3 a., 7/6; 5 v. 3 a., 7/8. **SMOOTHING CHOKES**, 25 m.a., 2/9; 40 m.a., 4/-; 60 m.a., 5/6; 150 m.a., 10/6. 2,500 ohms, 60 m. Speaker Replacement Chokes, 5/6. **MILLIAMMETERS**, moving-iron, flush 2½in., all ranges from 0-10 m.a., 5/9. Visual tuning, 6 or 12 m.a., 5/9. Moving-coil meters, 2½in. 0-1 m.a., 18/6; 3½in. 0-1 m.a., 22/6. Multipliers, 1/- each.

AMPMETERS, all ranges, from 0-1 amp., 5/9. **TRANSFORMERS**, latest type Telsen R.G.4 (list 12/6), 2/9. Lissen Hypernik Q.P.P. (list 12/6), 3/6. **OUTPUT TRANSFORMERS** for Power, Pentode and Push-Pull, 2/6; Multi-Plate, 4/6; Push-Pull Input Transformers by prominent manufacturer, 4/6 each.

ELIMINATOR KITS, for A.C. mains, 120 v. 20 m.a., or 150 v. 25 m.a., 15/-, tapped S.G., det. and output. Complete Kit with long-life valve rectifier (replacement cost only 2/-).

PREMIER I.T. CHARGER KITS for A.O. mains, including Westinghouse Rectifiers and Tapped Mains Transformers, 8 volts at 1 amp., 14/6; 8 volts 1 a., 17/6; 15 volts 1 a., 19/-; 15+15 volts 1 a., 37/6; 15+15+15 volts 1 a., 50/-; 8 volts 2 a., 29/6.

TELSEN iron-cored screened coils, W.349, 4/- each. **Electric SOLDERING IRONS**, 200-250 v., A.O./D.C., 2/3.

LOTUS JACKS (and Jack-switches), all types, 1/- each. Lotus Plugs, 1/- each.

PREMIER H.T. KITS, all with Westinghouse rectifiers; tapped transformers and adequate smoothing. All Kits absolutely complete, 120 v. 20 m.a., 20/-; with ½ a. L.T. Charger, 28/-; 150 v. 30 m.a., 29/-; with ½ a. L.T. Charger, 31/6; 250 v. 60 m.a., with 4 v. 3 a. C.T., 30/-.

SHORT WAVE KITS

NEW 1937 SHORT-WAVE KIT for 1 valve Receiver or Adaptor, 13-86 metres, 12/6. **VALVE GIVEN FREE! DE LUXE MODEL**, 17/6. **SUPERHET CONVERTER KIT**, 13/6. **S.W. SUPERHET CONVERTER**, for A.O. Mains Receivers, 20/- . A.O. Valve given FREE! **2-V ALVE S.W. KIT**, 19/6. **VALVES GIVEN FREE! 3-VALVE S.W. KIT**, S.G. Det. and Pen., 42/- . **VALVES GIVEN FREE!** **BAND-PASS TUNING PACK**, comprising set of Telsen 3-gang iron-cored coils with switching, mounted on steel chassis with 3-gang condenser, illuminated disc-drive and 4 valve holders, 25/- the lot. All Mains or Battery circuit. **FREE!** **SPECIAL OFFER, LISSEN 2-GANG ALL-WAVE COILS**, 12-2,000 metres, with switching and circuit diagram, 6/11 set. **3-VALVE BAND-PASS KIT**, 200-2,000 metres. Complete kit of parts, including chassis, all components, valves, M.O. speaker and wiring diagram. Battery Model 50/- . A.C. Mains Model, 70/- .

MOVING COIL SPEAKERS

MAGNAVOX, Mains energised, 154, 7½in. cone, 2,500 ohms, 4 watts, 12/6; "152", 5½in. cone, 2,500 ohms, 17/6; 152 "Magnavox" 9½in. cone, 2,500 ohms, 6 watts, 37/6. **Magnavox P.M.s.**—254", 7½in. cone, 16/6; "252", 9½in. cone, 22/6. **Reliable P.M.s.**, 10/6. **ROLA** latest type P.M.s. 18/6. **KB** 7½in. mains energised, 1,500 or 2,500 ohms, 7/9. **GOODMANS'** 8½in. mains energised, 1,000 ohms field, 10/6 each. **JENSEN P.M.s.**, 11/6. **DIALS**—Clarion Illuminated S.W. slow-motion Dial with 2½in. knob, 2/- . Premier All-Wave 2-speed Dial, full vision straight-line, dual ratios 10-1 and 150-1, 6/6, with escutcheon. **Potentiometers** by well-known makers. All values up to 1 meg., 2/-; with switch, 2/6. **GRAMOPHONE MOTORS**, Collaro Gramophone Motor, pick-up and volume control, 45/-; Collaro motor only, 30/-; Collaro Universal Gramophone Motor, 100-250 v. A.C./D.C., with high quality pick-up and volume control, 67/6; Collaro Universal Motor only, 49/6. Edison Bell double-spring motor, including turntable and all fittings, 15/- . Cosmocord Gramo unit, comprising A.O. motor, pick-up and volume control (list 55/-), 35/9.

TUBULAR CONDENSERS, non-inductive, all values up to 5 mfd., 6d. each. **Wire-end RESISTORS**, any value, 1 watt, 6d.; 4 watts, 1/-; 8 watts, 1/6; 15 watts, 2/-; 25 watts, 2/6 each. **Reliable MORSE KEYS** with Morse Code engraved on bakelite base, 2/- each. Bakelite case **BUZZERS**, 1/6. Walnut Case "Loud-tone", 2/6 each. **Super Quality lightweight HEADPHONES**, 3/9 pair.

PREMIER (Reisz Pattern) Transverse-current MIKE, High Output, Straight Line Response, 30/- . Transformer, 5/- . Table Stand, 7/6. Adjustable Floor Stand, 22/6

HAVE YOU HAD OUR LATEST GIANT ILLUSTRATED CATALOGUE AND VALVE LIST? IF NOT, SEND 4d. IN STAMPS FOR THIS AMAZING LIST OF BARGAINS!

RECEIVERS, COMPONENTS AND ACCESSORIES

Surplus, Clearance or Secondhand, etc.

SOUTHERN RADIO'S Wireless Bargains; all goods guaranteed and sent post paid.

G.E.C. 3-valve Battery Sets. "Battery Compact Three," with 3 Osram valves, moving coil speaker in beautiful bakelite cabinet, brand new, in sealed cartons, fully guaranteed; 50/- each (list £5/10).

SPEAKERS—Celestion Soundex permanent magnet 10/-; Telsens permanent magnet, with 10-ratio transformer to suit any receiver, 12/6; Telsens loud-speaker units, 2/6; all brand new and in sealed cartons.

COILS—Telsens, iron core, W349, Midget size, 4/-; Type W473 (twin), 9/- pair; W477 (triple), 13/- set; Type W476 (triple superhet selector and oscillator) 16/- set, all ganged coils complete on base with switch; Telsens I.F. transformer coils, W482, 5/-; Telsens dual range aerial coils, with aerial series condenser incorporated; W76, 4/-; Telsens aerial series condensers with shorting switch, 2/-; Telsens L.F. transformers. Type R.G.4 (4 to 1), 3/-; all brand new, in sealed cartons.

MICROPHONES—Ace (P.O.) microphones, complete with transformer, ready for use with any receiver, 4/6 each.

RESISTANCES.—Tru-ohm 1-watt, colour coded and marked, 36 assorted capacities on card; 6/- per card.

POTENTIAL Dividers.—Lissen wire wound, 3-section, 60-watt, 4,500 ohms, 3,000 ohms, and 2,000 ohms; 3-section, 5 watts, 20,000, 20,000 and 20,000 ohms; 2-section, 5 watt, 50,000 and 30,000 ohms; 1-section, 5 watt, 8,000 ohms, all at 1/3 each; brand new and guaranteed.

AMERICAN Valves.—A full range of valves for all American receivers; 6/- each.

HEADPHONES.—Lightweight headphones, double pole type, 4,000 ohms, each car piece; 3/- pair.

REPAIRS.—Any type of receivers, American, British, etc., repaired by expert staff.

WE Have Purchased the Complete Component Stock of a Well-known Radio Dealer and Manufacturer, and we are offering the complete stock in parcel lots as under:—

5/- Parcel, containing components to the value of at least 20/-, comprising chokes, resistances, coils, switches, condensers, wire and circuits, 5/- per parcel.

10/- Parcel, containing components to value of at least 45/-, comprising variable condensers, screened chokes, switches, resistances, screened coils, wire, circuits, etc., etc.; 10/- per parcel.

ALL Articles Included in These Parcels are Brand New and Modern.

SOUTHERN RADIO.—Branches at 271-275, Ilgh Rd., Willesden Green, N.W.10; 46, Lisle St., London, W.C.2. All mail orders to 323, Euston Rd., London, N.W.1.

SOUTHERN RADIO, 323, Euston Rd., London, N.W.1 (near Warren Street Tube). Phone; Euston 3775.

ALL goods previously advertised are standard lines, still available. Post card for list free.

VAUXHALL UTILITIES, 163a, Strand, W.C.2. Over Denny's the Booksellers. Temple Bar 9338.

CONVERSION UNITS for operating D.C. Receivers from A.C. Mains, improved type, 120 watts output, at £2/10/0. Send for our comprehensive list of speakers, resistances and other components.

WARD, 46, Farringdon Street, London, E.C.4. Telephone: Hoborn 9703.

SALE OF NEW SURPLUS RECEIVERS, Etc.—G.E.C. BC/3480, 8-V, AC, Superhets, £7-15-0. Listed 21 gns. 3435/MV, 6-V, AC, Superhets £6-15-0. Listed £14-14-0. DC/AC, Models £6-15-0. 5-V, Models £5-10-6. 4-V Models £1-19-6. 6-V, AC, 3550/RG, Radiograms £14, Listed 24gns. Lampex 4-V, AC Receivers £3-15-0. 3-V, 55/- DC, 45/- Marconi 243, 2-V Battery Sets 35/- 3-V, 70/- Ready Radio Meteor 50-3 Kit Sets £1. Magnavox 236, PM, MC Speakers 10/- Celestion "Soundex" 10/- AC, Eliminators £1, DC, 10/- 3-Gang Condensers 4/6, etc. Trade Supplied.—Collins, Riversley Road, Nuneaton.

HEADPHONES, Brown, G.E.C., B.T.H., Nesper, Sterling, Ericsson, Marconiphone, Telefunken, etc., from 2/6 pair. Postage 6d. List free. CRYSTAL SETS. Complete, Guaranteed, Burne-Jones, 5/6. Ditto, double circuit, 8/- Large P.O. type, 10/- Crystal detector. Complete parts, 1/- Sensitive permanent detector, 1/6.—Post Radio, 183, Caledonian Road, London, N.1.

EXPERIMENTERS' OPPORTUNITY. Parcels containing Wireless Components 40/- value for 5/6. Carriage 1/- Taylors, Radio House, Macaulay Street, Huddersfield.



6 VALVE ALL-WAVE SUPERHET

(Complete with B.V.A. Valves)

Improved all-wave superheterodyne for A.C. or D.C. mains. High sensitivity on all three wave-bands (16.5-50 metres, 200-550 metres, 800-2,000 metres). Many interesting features, including:— Illuminated "Airplane" dial with station names. Special "squelch" valve for inter-station noise suppression, with manual muting control. Octode frequency changer. 8 stages, 7 tuned circuits Iron Cored I.F. Coils. Delayed A.V.C. 3.5 watts o tput. Extra heavy Cadmium-plated steel chassis.

£7 cash complete with valves, knobs, pilot lamps, mains cable and plug, etc. Deferred terms from London Radio Supply Co., 11, Oat Lane, E.C.2. 12 months' guarantee. Suitable loudspeakers, cabinets, etc., in stock.

McCarthy Chassis from £4 5s. to £12. Write for illustrated catalogue.

MCCARTHY RADIO LTD. 44a, Westbourne Grove, London, W.2. Telephone: Bayswater 3201.

MCCARTHY 6-VALVE A.W. CHASSIS

27/- Complete receiver chassis, with all B.V.A. Valves, etc., ready for fitting in your own cabinet! £8/10/0 Cash or C.O.D. or 27/- down and 10' monthly payments of 16/-.

W.B. STENTORIAN SPEAKERS 2/6 373: Cash or C.O.D. 42/-, or 2/6 down and 11' monthly payments of 4/-.

373: Cash or C.O.D. 32/6, or 2/6 down and 11' monthly payments of 3/-.

CASH or C.O.D. Orders—DELIVERY BY RETURN.

THE LONDON RADIO SUPPLY CO., LTD., 11, Oat Lane, Noble Street, London, E.C.2.

RADIO CLEARANCE

63, HIGH HOLBORN, W.C.1

TEL. : HOLBORN 4631.

8-VALVE A.C. MAINS SUPERHET RECEIVER, by well-known manufacture, incorporating many refinements, visual tuning, illuminated colour-coded volume control, local distance switch, etc., fitted in handsome bird's-eye maple cabinet, size 16" wide, 12" deep and 23" high. Comprising the following Valves: AC/VP1, FC4, AC/VP1, AC/VP1, AC/HLDD, V914, AC2, Pen, IW3, Pre H.F. Stage, 2 I.F. Stages, full A.V.C., etc. Limited quantity. £7 15s.

GRYCE MAINS TRANSFORMERS AND CHOKES, standard for the season, finest made, British and guaranteed.

250-0-250, 80 m.a., 2-0-2 volts, 2.5 amp, 2-0-2 volts, 4 amp, 8/6.

350-0-350, 120 m.a., 2-0-2 volts, 2.5 amp, 2-0-2 volts, 4 amp, 10/6.

350-0-350, 150 m.a., 2-0-2 volts, 2.5 amp, 2-0-2 volts, 4 amp, 2-0-2 volts, 2 amp, 12/6.

500-0-500, 130 m.a., 2-0-2 volts, 2.5 amp, 2-0-2 volts, 6 amp, 2-0-2 volts, 2 amp, 2-0-2 volts, 2 amp, 17/6.

H.T.8 TRANSFORMER, 250 volts, 60 m.a., 2-0-2 volts, 4 amp, 8/6. Ditto with H.T.8. Metal Rectifier, 17/6.

All Transformers are fully shrouded.

GRYCE MAIN CHOKES.

40 m.a. 30 Hys., 500 Ohms, 4/6; 60 m.a. 40 Hys., 500 Ohms, 6/-; 150 m.a. 40 Hys., 200 Ohms, 10/6; 250 m.a. 15 Hys., 200 Ohms, 21/-; 60 m.a. 80 Hys., 2,500 Ohms for Speaker replacement, etc., 6/-.

CENTRALAB VOLUME CONTROL with switch, 5,000, 10,000, 25,000, 50,000, 2/6 each.

LISSEN ALL-WAVE COILS, complete with circuit switching, etc. Sent out in matched pairs, covering 2 short bands, 1 medium and 1 long, 8/-.

Ditto Single Coils, 4/6 each.

8 mfd. 500 volt, working 550 volt surge, heavy duty electrolytic condenser, by well-known manufacture, 2/11.

8 mfd. and 4 mfd. Electrolytics, 450 volt working, 500 volt peak, 2/6.

LISSEN CLASS B 1—1 HYPERNIK TRANSFORMER. Boxed, brand new as from makers, 2/6.

Enquiries, 13d. stamp if reply expected.

Hours of business 9 a.m. to 7 p.m. Saturdays, 9 a.m. to 1 p.m.

All orders value 5/- and over, Post Free. Orders under 5/- must be accompanied by a reasonable amount for postage.

C.O.D. orders under 5/- cannot be executed.

LOUDSPEAKER REPAIRS

REPAIRS to Moving Coil Speakers, Cones and Coils fitted or rewound. Fields altered. Prices Quoted including Eliminators, Loud-speakers Repaired, 4/- LF. and Speech Transformers, 4/- post free. Trade invited. Guaranteed. Satisfaction. Prompt Service. Estimates Free. L.S. Repair Service 5, Balham Grove, London, S.W.12. Battersea 1321.

MISCELLANEOUS

BANKRUPT Bargains. List free. Best wishes for the New Year to all my customers. Always a good stock of receivers, valves and components in stock. Let me know your requirements.—Butlin, 6, Stanford Avenue, Brighton.

RADIO BARGAINS

AMAZING prices. I lead, others follow. All-wave A.C./D.C. Table models, £6/15/0; Halcyon A.C.7, £7/7/0; Halcyon, A.C./D.C., Listed 14 gns., £7/7/0; Austin twin Rola speakers, Listed 15 gns., £7/7/0; A.C./D.C. Compacts, 65/- Other Mains receivers, £5. Stamp for list. Speakers, Components, English, American Valve replacements. Full stock the amazing All-wave Ferguson models. Trade supplied. State requirements.—Littler, The Midland Dealer, 2, Barras Lane, Coventry.

RECORD The quality valve in the COMPLETE range RECORD RADIO LTD., 2/3, Eldon Street, E.C.2

CIVIL SERVICE VACANCIES

AGE LIMITS 15-26, EITHER SEX Excellent Commencing Pay NO EXPERIENCE REQUIRED WANTED

Numerous vacancies are now existing for keen applicants. For details of these vacancies, and of Age Limits, Pay, Promotion, and Entrance Requirements for all branches of the Service (Taxes, Customs, Post Office, Clerical, Engineering, L.C.C., Municipal, etc.), you are advised to apply for free copy of the 1937 Edition of Civil Service Handbook. FREE and post free on request.



B.T.I. (Dept. 113), 356, Oxford Street, W.1.

PATENTS AND TRADEMARKS.

KINGS PATENT AGENCY (Director: B. T. King, Patent Agent) Advice, Handbook and Consultations free.—146A, Queen Victoria Street, E.C.4. Phone: City 6161.

Varley NICORE COIL UNITS Four NEW CIRCUITS. We have recently published four new circuits which are giving excellent results with our new ganged units. No. 1 (BP 111) Mains Superhet for 110 k/c No. 2 (BP 112) Battery Superhet for 465 k.c. No. 3 (BP 113) Three-valve mains receiver with band-pass tuners. No. 4 (BP 114) S.C. Battery Three with Pentode. Blueprints now ready, 6d. each (BP 114 is 3d) Post Free OLIVER PELL CONTROL, LTD., BLOOMFIELD ROAD, WOOLWICH, S.E.18 WOOLWICH 2345

FREE!



This IMPORTANT GUIDE to SUCCESSFUL ENGINEERING CAREERS

After months of intensive effort and research, we are pleased to announce that the 1937 edition of our Handbook, "ENGINEERING OPPORTUNITIES," is now out of the publishers' hands and ready for free distribution. Containing 268 pages of practical guidance, this book is, beyond argument, the finest and most complete handbook on Successful Engineering Careers ever compiled. It is a book that should be on the bookshelf of every person interested in engineering, whatever his age, position, or experience.

The Handbook contains, among other intensely interesting matter, details of **B.Sc., A.M.I.C.E., A.M.I.Mech.E., A.M.I.E.E., A.M.I.A.E., A.M.I.W.T., A.M.I.R.E., CIVIL SERVICE,** and other important Engineering Examinations: outlines courses in all branches of **CIVIL, MECHANICAL, ELECTRICAL, AUTOMOBILE, RADIO, TELEVISION** and **AERONAUTICAL ENGINEERING, BUILDING, GOVERNMENT EMPLOYMENT,** etc., and outlines the unique advantages of our Employment Department.

WE DEFINITELY GUARANTEE "NO PASS—NO FEE"

If you are earning less than £10 per week you cannot afford to miss reading "ENGINEERING OPPORTUNITIES." In your own interests we advise you to send for your copy of this enlightening guide to well-paid posts by filling in and posting the coupon Now.

There is no cost or obligation of any kind.

BRITISH INSTITUTE OF ENGINEERING TECHNOLOGY
409A, SHAKESPEARE HOUSE
17, 18 & 19, STRATFORD PLACE, LONDON, W.1



-----TEAR OFF HERE-----
FREE COUPON
BRITISH INSTITUTE OF ENGINEERING TECHNOLOGY,
409a, Shakespeare House, 17-19 Stratford Place, W.1.
Please forward Free of cost or obligation of any kind, your 268 page Handbook "ENGINEERING OPPORTUNITIES."
NAME
ADDRESS
.....
.....

POWER SUPPLY FOR MAINS SETS—See Page 535.

Practical and Amateur Wireless

3^d
EVERY
WEDNESDAY

Edited by F.J. CAMM

a GEORGE
NEWNES
Publication

Vol. 9. No. 226.
January 16th, 1937.

AND PRACTICAL TELEVISION

Building the **“QUALITONE
UNIVERSAL
Four”**

NEWNES TELEVISION AND SHORT-WAVE HANDBOOK

By F. J. CAMM (Editor, Practical and Amateur Wireless)

EVERYTHING ABOUT—Drums, Mirror Screws, Scanning Discs and other Scanning Systems, Neon Lamps, the Cathode-Ray Oscillograph. How to build Short-Wave Receivers; How to build Ultra-Short-Wave Receivers, straight and Superhet types.

FROM ALL BOOKSELLERS

NEWNES or 4/- post free from Tower House, Southampton Street, Strand, W.C.2. **LONDON**

Fully
Illustrated

only
3/6
net

NEWNES' HOME MECHANIC

WILL SAVE HUNDREDS OF POUNDS

A Practical Work for the Practical Man



NEWNES' HOME MECHANIC is produced for the man who wants to do things for himself and to do them correctly. It gives just those practical tips which are known to the professional craftsman and which make all the difference between merely doing a thing and doing it well.

It enables the handyman or woman to beautify or renovate any part of the house, to repair fittings, and to make hundreds of useful articles.

Particular attention has been devoted to the subject of wood-working tools and methods, and an interesting series of articles, each illustrated by action photographs, is included.

Valuable Contents Include:—

The House.—Deals with Wet and Dry Rot, Fencing Repairs, Concrete, Distemping, Painting (inside and out), Repairing and Laying Floors, Papering Walls, Pointing, Glazing, Defective Plaster, Sash Cords, Electric Burglar - alarms, Locks, Smoky Chimneys, Heating and Lighting, Electricity in the Home, Cisterns, Pipes, Water Supply, etc.

Home Hobbies.—Maintenance of Gramophones, Wireless, Pianos, Pianolas, Motors, Cycles, Metalwork, Photography, Rugmaking, Soldering, Boot and Shoe Repairs, Pressing and Cleaning Suits, Sewing-machine Repairs, Picture-framing, Dyeing, Bookbinding, Garden Tools and Mower Repair, Stencilling, Beadwork, Leatherwork, etc.

How To Make : Shelves, Folding Chest, Steps, Sheds, Lawn, Garden Seat, Concrete Path, Pergola, Dog's Kennel, Tent, Tree Seat, Rockery, Tables, Clothes Airing, Kitchen Cabinet, Plate Rack, Egg Stand, Ironing Board, Ice Box, Tea Wagon, Lady's Work Table, Table Lamp, Bookshelf, Panelling, Modern Furniture, Window Seat, Pelmets, Barometer, Miniature Grandfather Clock, Baby's High Chair, Boot Rack, Child's Desk, Play Pen, Many Toys, etc.

BIG RECIPE AND METALWORK SECTIONS. HOW-TO-REPAIR-FURNITURE SECTION. HOME LEGAL AIDS.

WONDERFUL SERIES OF CHARTS!

Each chart explains how to make some useful piece of furniture, or valuable appliance for the home. Amongst the charts are: GATE LEG TABLE, COMBINED BATHROOM STOOL AND LINEN LOCKER, SMALL REVOLVING BOOKSTAND, ELECTRIC CLOCK, SIDEBBOARD, MODEL ELECTRIC LOCOMOTIVE, etc.

Complete in 4 Handsome Volumes

20 Specialist Contributors

POST THIS COUPON TO-DAY FOR PARTICULARS

**TO THE HOME LIBRARY BOOK CO.,
Tower House, Southampton Street, Strand, London, W.C.2.**

Please send me, FREE of all cost and without obligation, the folder describing Newnes' HOME MECHANIC and particulars of the scheme whereby I shall be able to have the immediate use of the four volumes at an outlay of a few shillings per month.

Name

Address

(Prac.W. 16137)

If you do not wish to cut your copy, send a postcard mentioning "Practical Wireless" to the address above.

A HETERODYNE FREQUENCY METER SEE PAGE 547



Practical

and Amateur

Wireless

Edited by F. J. CAMM

Technical Staff:
W. J. Delaney, H. J. Barton Chapple, Wh.Sc.,
B.Sc., A.M.I.E.E., Frank Preston.



VOL. IX. No. 226. January 16th, 1937.

ROUND *the* WORLD of WIRELESS

The "Qualitone" Receiver

THERE is little doubt that many constructors hesitate to make or buy a mains receiver as they are at present on D.C. supplies and do not know when this will be changed over to A.C. Such hesitation can be understood in some cases as it may mean that a receiver will have to be scrapped or some additional parts obtained to feed it, and then perhaps not with the same satisfactory results as were formerly obtained. A receiver of the Universal or A.C./D.C. type can, however, be designed to function exactly in the same manner on either A.C. or D.C. mains and no alterations have to be made to the circuit. In many cases, however, the results are not comparable with those obtained with a highly efficient A.C. receiver, but we are describing this week a receiver which has been designed for the listener who wants something above the average in the way of a Universal set. This is a superhet, and embodies all of the most desirable features such as delayed A.V.C., but without the complication of additional controls. This receiver will provide entertainment of high quality from dozens of stations and will be found to be perfectly hum-free on either A.C. or D.C. supplies. The quality of reproduction will be found to be higher than that usually associated with a receiver of this type. Turn to page 544 for full details of this new receiver.

Radio for Strome Island

THE County Council of Caithness recently received a petition from the inhabitants of Strome Island in the Pentland Firth regarding the supply of a radio service. During rough weather this island is completely cut off from the mainland, and there is no means of communication. The County Council have now decided that radio would enable them to keep in touch, and accordingly plans are being prepared for the installation of a transmitter and receiver.

Radio Pioneer Stamps

PHILATELISTS, as well as radio fans, will be interested in the announcement that the French Postmaster General is considering the issue of a series of postage stamps bearing the heads of General Ferrie and Edward Branly, French radio pioneers.

Assistant Stage Manager for Television

THE B.B.C. have added another member to the Television staff, and have again drawn upon the experience gained on the stage and in the film industry. The new member is Mr. R. Smith and the appointment is as Assistant Stage Manager. Mr. Smith was educated at Clifton College and Merton College, Oxford, and on leaving the University in 1923 he joined the Oxford Repertory Theatre, and has been in the theatrical profession ever since.

8.30, entitled "The 100,000th Radio Licence," produced by Desmond Bell.

G.E.C. Research Laboratories

THE HON. WALTER NASH, Minister of Finance and Customs of New Zealand, accompanied by members of his staff, recently paid a visit of inspection to the General Electric Company's Lamp Works and Research Laboratories at Wembley. It will be remembered that at Wembley the television research department is situated, and no doubt the visitors were impressed by the remarkable apparatus which is installed at this factory.

Sealing Sets

TO avoid difficulties which arise through users tampering with trimming adjustments and other parts of commercial receivers, a dealer is advocating in a Trade paper that all receivers should be sealed in the same manner as electric meters. It would render the guarantee void if the seal were broken and would no doubt save a lot of unnecessary trouble caused by unnecessary adjustments.

G.E.C. High-definition

TO augment the research apparatus used at the G.E.C. laboratories, a new high-definition transmitter has now been installed. This provides a definition of 400 lines and will assist in the design of many pieces of apparatus, including special co-axial cables. It is stated that special types of this cable are being tried out for use as television lead-in wires.

Shepherds' "Meet"

IN the Lake District the fells are not fenced or divided up into fields, and hence the sheep which graze on them are liable to stray and get lost. When a shepherd in this district finds a strange sheep he takes it in and keeps it until the next "meet." These meets are held twice a year, when sheep are brought to the meet and all the Fell men attend to identify their missing animals. If a man is not present to identify his sheep he is fined half a crown. Naturally the meet is also an occasion for conviviality, at which the men partake of dinner and afterwards join in song and story. Part of the proceedings of this interesting event will be relayed from the Northern station on January 22nd.

ON OTHER PAGES

	Page
Power Supply for Mains Receivers	535
Amateur Transmitting	537
Practical Television	540
On Your Wavelength	541
Readers' Wrinkles	543
The "Qualitone" Universal Four	544
Short-wave Section	547
British Long Distance Listeners' Club	549
The "W.B." Long-arm	550
Clubs and Societies	551
Facts and Figures	552
Letters from Readers	553
Blueprint Service	554
Queries Asked and Answered	555

Variety in Miniature

FROM the Midland transmitter on January 19th a novel variety programme bearing the above title will be relayed. It will include only half an hour's broadcast of a swing quartet, a new Hawaiian quartet, one or two Yorkshire stories and two sketches. Some of the artists in this programme will be broadcasting for the first time.

Irish Listeners

BY the time this issue is on sale the number of licences taken out in Ireland should reach the 100,000 mark. To commemorate the event a programme is being broadcast on January 15th at

ROUND the WORLD of WIRELESS (Continued)

Dr. Adrian Boulton

THE B.B.C. announces that Dr. Adrian Boulton will conduct the concert at Queen's Hall on Wednesday, January 20th. Sir Hamilton Harty, originally engaged for this date, is unfortunately prevented from directing the programme owing to illness.

The Runaways

THE first microphone production of Eden Phillpotts' three-act Devonshire comedy, "The Runaways," will be heard in the Western programme on January 18th. Cyril Wood, who has adapted the comedy as a radio play, will be the producer.

A Miniature Transmitter

IT is reported that the N.B.C. of America have perfected a miniature transmitter for use in relaying outdoor events. The entire instrument is contained in a small



Dr. Adrian Boulton, who will conduct the Queen's Hall concert on January 20th.

case no larger than a 3in. cube, and two 10in. rods are used for the aerial. Acorn valves are used, and it weighs less than 1lb. Successful relays have been carried out over distances of four miles.

Organ Recital

THE first organ broadcast from the New Savoy Cinema, Exeter, will be given by Harold Stringer, in the Western programme, on January 19th. This will be Mr. Stringer's first broadcast as an organist, but he has previously broadcast from the Midland Regional as a pianist.

Swedish Short-wave Station

ACCORDING to a recent report, Sweden has at last decided to make an official entry into the realm of short-wave broadcasting, and it is expected that a transmitter will be erected in the vicinity of Motala. Hitherto, the rôle of national short-wave broadcaster has been undertaken by an amateur, Dr. Siljeholm, who has been working on the 40-metre band.

British Orchestral Works

ON January 16th, in the National programme, three new orchestral works by British composers will be broad-

INTERESTING and TOPICAL NEWS and NOTES

cast for the first time, under the direction of Joseph Lewis. One of these is a "Saxo-rhapsody" by Eric Coates, which will be played by Sigurd Rascher (saxophone) and conducted by the composer; and the other two are William Lovelock's "Second Suite for Orchestra" and Benjamin Britten's "Soirées Musicales," a suite of movements on themes by Rossini.

Variety from Bristol

VARIETY from the Colston Hall, Bristol, will be broadcast on January 20th when items by the Gordon Ray Girls (the Radiolympia troupe), Nat Gonella and his Georgians, Phyllis Robins, Freddie Bamberger, and Lockier's Variety Orchestra will be heard.

Pantomime Excerpts

LISTENERS to the Midland Regional programmes who like pantomime excerpts will enjoy an hour which will be allotted on January 13th to a double bill representing two Midland pantomimes—one at Nottingham and one at Oxford. The former is "The Sleeping Beauty," presented by Tom Arnold (for Julian Wylie Productions, Ltd.) at the Theatre Royal,



Mantovani and his Tipica Orchestra are well known to listeners, and he is here seen with Evelyn Dall and Brian Lawrence in a scene from "Calling All Stars," the latest Joe Rock production, under the direction of Mr. Redd Davis.

Nottingham. The cast includes Helene Cooney as the Prince, Eleanor Fayre as Beauty, Ernest Lester and Hugh Rene as King and Queen respectively, and Frank Attree as the witch. The Oxford pantomime is "Cinderella," presented at the New Theatre, by arrangement with Bertram Montague, and produced by Lewis Marks. Heather Gayle takes the name-part, Cecile Benson is the Prince Charming, Dan Leno the dame, and Joan Brett, Dandini.



Twenty-five years ago, Backhaus made the first grand piano records for the gramophone. Here he is seen listening in the "His Master's Voice" studios, recently, to the records played on a machine of that period, and comparing them with recordings he has made by modern electrical methods.

Dance Music from the Midlands

"DANCING TIME" is the title of a new series of programmes of dance music without frills to be given by various bands in the region. Harry Pell, who founded the Lido Revellers, is conductor of the Birmingham Hippodrome Orchestra which is often "on the air."

Concert from Torquay

THE popular Torquay Municipal Orchestra will broadcast from the Pavilion, Torquay, on January 19th, when the soloist will be Olive Sturgess (soprano).

SOLVE THIS!

PROBLEM No. 226.

Taylor's home-constructed three-valve, having transformer coupling in the H.F. and L.F. stages, stopped functioning. When tests were made it was found that the H.T. current consumption of the S.G. valve was zero. The valve was tried in another set, and functioned satisfactorily. What was the trouble? Three books will be awarded for the first three correct solutions opened. Address your solutions to the Editor, PRACTICAL AND AMATEUR WIRELESS, Geo. Newnes, Ltd., Tower House, Southampton Street, Strand, London, W.C.2. Envelopes must be marked Problem No. 226 in the top left-hand corner, and must be posted to reach this office not later than the first post on Monday, January 18th, 1937.

Solution to Problem No. 225.

The fault in Bristow's receiver was a broken long-wave winding in the oscillator-tuned circuit. The following three readers successfully solved Problem No. 224 and books are accordingly being forwarded to them: T. Phelan, 23, Congo Road, Plumstead, London, S.E.18; J. D. James, 139, Redhill Drive, Moordown, Bournemouth; H. N. Caley, 38, Dornton Road, Balham, London, S.W.12.

Power Supply for Mains Receivers

This is the First of Two Articles Dealing with the Design of the Mains Section of A.C. and Universal Receivers. By FRANK PRESTON

IT is nearly always desirable that the power pack or supply unit of a mains set should be designed alongside the receiver itself. This is because the two are largely interdependent; neither can operate properly if the other is unsuitable. Nevertheless, the constructor often wishes to arrange and make the power-supply section of a set for which he has a circuit diagram concerning the receiver portion only. In the same manner, it might be desired to modify the design of a battery receiver for mains use.

In these cases a knowledge of the main points in the design of the high- and low-tension systems is essential. In the first

to feed the output valve, due to its directly-heated filament. In other words, two transformer windings, each to give 4 volts, 2 amps., are required for low-tension.

Dealing with the H.T. current at maximum voltages of 200 for the first two valves and 250 for the third, we find that the first valve requires an anode current of 7 mA. and a screen current of 1.5 mA.; the second valve needs 3 mA.; and the output valve, 30 mA. for the anode and 6 mA. for the screen. Taking the total of these figures we find that the current required by all the valves together is 47.5 mA. We have not, however, reckoned the current passed by the potentiometer used to

words, the total output voltage required from the rectifier would be 287.5.

If we were to use an A-type valve rectifier of the full-wave type, the available voltage would in most cases be rather less than the maximum desired, since these generally provide an unsmoothed output of rather more than 250 volts at 60 mA. It must be remembered, however, that the voltage actually obtained increases as the "load" is reduced below 60 mA. In consequence, there would not be a very appreciable loss in volume by using a valve of this type fed from a transformer giving an output of 250 volts to each of the anodes. In fact, we find from an examination of various

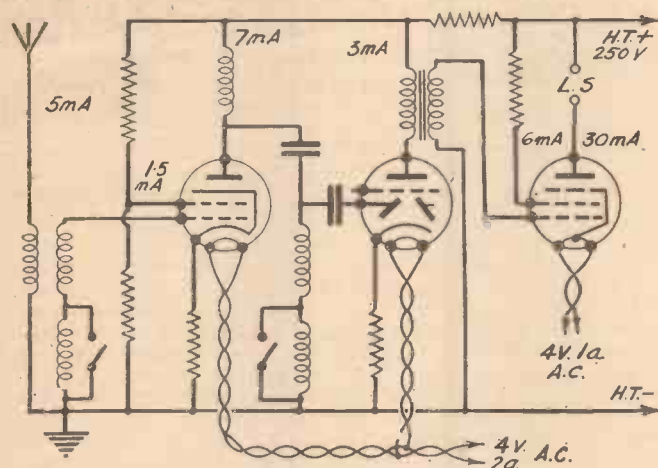

Fig. 1.—Skeleton circuit of a simple three-valve "quality" set, showing the H.T. and L.T. currents and voltages.

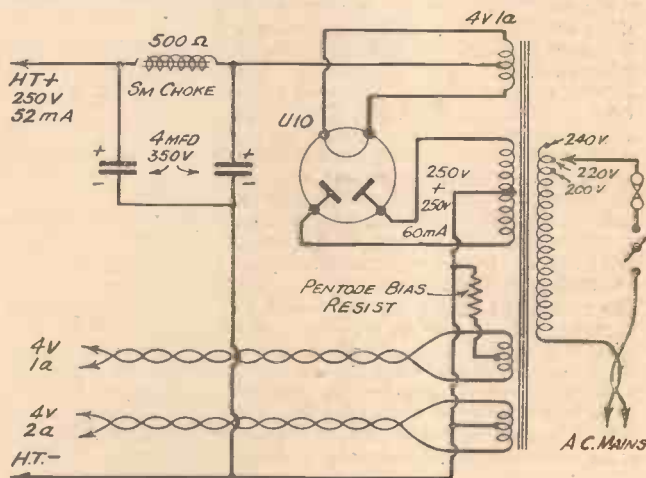

Fig. 2.—Power supply circuit for Fig. 1, using full-wave valve rectifier. H.F. output shown is approximate when using the components indicated.

place it is wise to make a list of the various H.T. and L.T. current requirements of the various valves. That makes it possible to complete the specification for the mains transformer and/or rectifier. When this has been done, it might prove better slightly to modify the receiver in some small details in order to render it suitable for use with a standard transformer or rectifier.

An Example

The idea will more readily be understood by referring to the simple skeleton receiver circuit in Fig. 1. This is for a perfectly straightforward "quality" receiver having H.F., double-diode triode and pentode valves. For purposes of explanation the pentode is shown as being of the directly-heated-filament type. If we deal first with the L.T. or heater circuit we find that the first valve requires 4 volts at 1 amp., the second also requires 4 volts, 1 amp., and it can be assumed that a valve such as the Cossor P.T.41 is to be used in the output stage. Thus, the total low-tension current required, at 4 volts, is 4 amp., but a separate source of supply (separate secondary winding on the transformer) is required

feed the screen of the H.F. valve. Assuming that the total resistance of this is 40,000 ohms, the current passed (at 200 volts) will be 5 mA., thus bringing the total consumption of H.T. to 52.5 mA.

In reckoning the above figures, average currents have been taken for the valves, although in practice the constructor would take the figures given by the makers of the particular valves which it was proposed to use. Generally, they would approximate very closely to those employed.

Choice of Rectifier

We have now found that a maximum of 250 volts and 52.5 mA. is required to feed the valves in the set. The next step is to decide on the type of rectifier which will prove most suitable. In this respect, however, it must be remembered that additional voltage is required to provide automatic grid bias for the output valve, and that there must inevitably be a voltage drop across the smoothing choke. The bias needed by the output valve mentioned is 12.5 volts, and if a 500-ohm smoothing choke were used, this would account for a loss of approximately 25 volts. In other

makers' catalogues that the Osram U 10 rectifier gives a maximum output of 260 volts at 60 mA., or of rather more than 270 volts at 50 mA. (this is found from the output curve). Thus, a valve of this type could be used satisfactorily, by employing the circuit shown in Fig. 2. It can be seen from this that a third L.T. winding is required to heat the filament of the rectifying valve. Consequently, the mains transformer employed should have secondaries for 4 volts, 2 amp.; 4 volts, 1 amp.; 4 volts, 1 amp.; and 250 + 250 volts, 60 mA.

It has been shown that the maximum anode voltage for the output valve would not be obtained from this arrangement, although this would not normally be an important matter. The loss would, nevertheless, be still greater if the primary winding of the speaker transformer had a fairly high resistance—which has not so far been taken into consideration.

Metal Rectification

Bearing these points in mind, and when the greatest possible output is required from the receiver, it would clearly be better to employ a rectifier giving a higher output.

There is no standard valve rectifier to comply with this requirement, because the B-type provides an output of approximately 350 volts at 120 mA, which is a good deal higher than is necessary. There is, however, a metal rectifier—the Westinghouse H.T.8—which would suit the purpose admirably. This has a smoothed output (through a 500-ohm choke) of nearly 300 volts at 52.5 mA, and a maximum current output of 60 mA. The H.T.8 would exactly meet with our requirements if a 1,000-ohm smoothing choke were employed in the voltage-doubler circuit shown in Fig. 3.

Fig. 3 also shows the specification for the mains transformer; and it can be seen that the H.T. winding is rated at 200 volts, 200 mA. The latter figure might appear much too high at first, but it must be remembered that the voltage is increased by the so-called voltage-doubler circuit, and therefore the current must be reduced at the same time.

Other Points

The above are typical examples which show some of the points to be observed in designing the power-supply section. There are many others, but these can be considered separately. For example, it might be preferred to use an indirectly-heated output pentode, in which case a single transformer winding could be employed for the heaters of all three valves; this would require to provide an output of 4 volts, 3 amp. This leads us to another point, which is that most standard transformers have an L.T. winding which will give a maximum of 5 amp. Does this mean that such transformers would not be suitable for our present requirements? The answer is that a transformer of that type could be used in any of the instances dealt with above, provided that it were a well-made component of reputable manufacture.

The reason is that currents of less than the maximum can be obtained without causing any appreciable rise in voltage, as long as the transformer has a good "regulation curve"; in other words, provided that the component has a massive core and is soundly designed. This is an

important point which often leads to confusion.

Indirectly-heated Rectifiers

Another point which arises when using an indirectly-heated output valve is that an advantage can be secured by using a valve rectifier of the indirectly-heated type, such as the Mullard "I.W." series, the Hivac "U.U." patterns, or the Mazda "U.U.3," for example. The heaters of these valves warm up at the same rate as the heaters of the receiving valves, so that their output gradually rises from zero to the maximum as the receiving valves are capable of passing the anode current. This means that there is no voltage surge, such as must occur when using a metal or directly-heated valve rectifier in con-

junction with an output valve of the indirectly-heated type. As a result, there is less strain on the smoothing condensers, and on the valves themselves. On the other hand, when the output valve is directly-heated, this prevents anything more than a slight voltage surge when using a directly-heated or metal rectifier, because it passes its normal anode current almost as soon as the set is switched on.

Smoothing Condensers

It will also be observed that electrolytic condensers are shown in some cases. These are to be preferred as providing a better degree of smoothing, but they can, if desired, be replaced by others of ordinary type and correct capacity and working

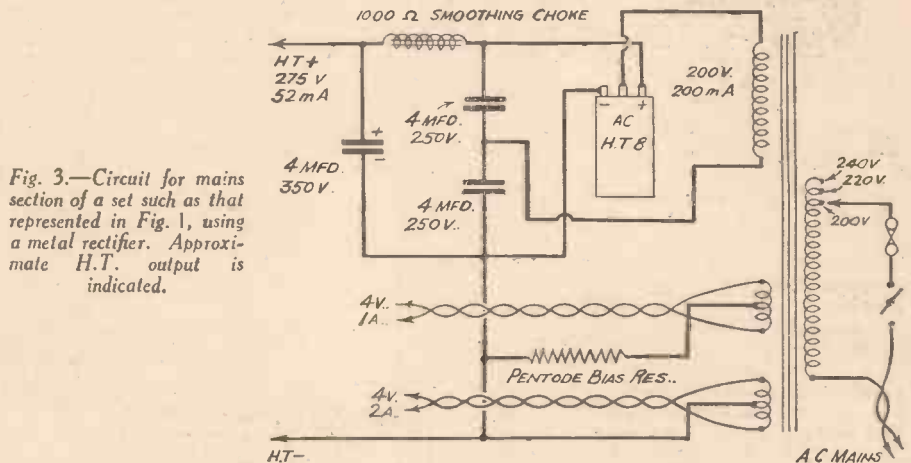

Fig. 3.—Circuit for mains section of a set such as that represented in Fig. 1, using a metal rectifier. Approximate H.T. output is indicated.

In the power-supply circuits shown in

voltage. Another point which is worthy of note is that if a metal rectifier or directly-heated valve rectifier were to be used in conjunction with an indirectly-heated output valve it would be desirable to use smoothing condensers with working voltages about 100 volts higher than those indicated.

In the next article further examples will be given of more unusual cases, and the power-supply section of universal receivers will be considered.

TELEVISION NOTES

Single Sideband Transmission

MANY discussions have arisen concerning single sideband transmission for radiating aural signals, but we are still using the ordinary double sideband modulated waves. Hopes are now being expressed that satisfactory methods will be devised whereby single sideband transmissions in the ultra-high-frequency band can be undertaken. One of the main difficulties of any high-definition television service is the extremely high frequencies involved in the picture signal when it is desired to transmit a flickerless picture with considerable detail. This will become more noticeable at the receiving end as picture sizes increase, and any scheme whereby an economy in ether space can be accomplished without in any way mutilating the signal will be welcome. Already certain "subterfuges" are being tried with this end in view, and in America it is learned that attempts at better definition have been made by tuning the receiver and transmitter to one sideband. It is hoped that this will bring about sufficient reduction in the undesired sideband to allow the separate television and sound carriers to be spaced

closer than at present. In this country the separation is 3.5 megacycles, but any further increase in the number of pictures transmitted per second, or in the number of lines into which the picture is dissected, will necessitate a wider frequency channel and possibly an increased separation. When other stations are erected the question will have to be studied with the greatest care for, in spite of the range limitation encountered with these short wavelengths, anyone residing on the border line of the service areas of two or more stations may experience interference which can mar completely the pictures seen in the receiving set.

American Standards

WHEREAS in this country we have two standards of high-definition television radiated from the Alexandra Palace, the Radio Manufacturers' Association of America has recommended to the Federal Communications Commission of that country that one single standard be chosen for the use of all companies when the inauguration of any American service is contemplated. The definition is to be one

of 441 lines with a total of thirty complete pictures per second interlaced to give sixty frames per second. The figure of sixty has been chosen since this is the most common alternating current mains frequency throughout the American continent. The relation between picture width and height is given as four to three, while a minimum of 20 per cent. of the maximum carrier amplitude is to be devoted to synchronising pulses. Each television channel is to be six megacycles wide with suitable separating bands between to prevent inter-station interference, while the total band asked for the nation-wide service is 42 to 90 megacycles. In each particular station channel the sound carrier will have a higher frequency than the vision signal channel, while the actual picture transmission will be of the negative type, that is to say a decrease in light in the picture scanning analysis will bring about an increase in radiated power. With the B.B.C. transmission an increase in carrier modulation amplitude is synonymous with an increase in light. It is said that these standards have been drawn up with due regard to the possibility of single sideband transmission, since in the ideal case a given television picture can be radiated in exactly one-half the band width used for the more usual double sideband scheme, such as is now being employed in England.



NEW SERIES

Amateur Transmitting

Inductive Coupling, Coil Construction, and Operation, are Dealt with in this Eighth Article of the Series. By L. O. SPARKS

AS soon as the Artificial Aerial unit is completed, tests can be commenced to determine the most satisfactory form of coupling between the transmitter and the A.A., and, when that has been done, to secure maximum output from the 240B valve. There are several ways of coupling the A.A.; for example, it is possible to connect the anode tank coil circuit to the A.A. coil by means of a very small fixed or variable condenser, but such an arrangement, while being quite satisfactory in many respects, introduces one or two undesirable features, so it is best to consider other methods. The tank coil and the A.A. coil can be inductively coupled, such a method approaching the ideal, but the trouble in this case is that it is not always convenient or practicable to arrange the necessary coupling, either by reason of space or coil construction.

"Link" Coupling

It is possible, however, to make use of a modified form of inductive coupling which, while allowing the power or energy in the tank coil to be transferred to the A.A., also allows the two coils to be separated from each other by a convenient distance, according to operating requirements.

Such an arrangement is known as "link" coupling, and I would advise the beginner to give the method some consideration as it is used quite a lot with transmitting apparatus. The theoretical circuit of the form under consideration is shown in

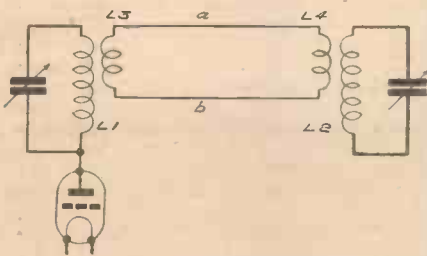
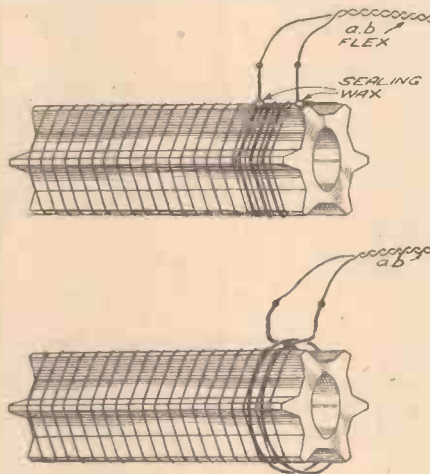

Fig. 1.—A link coupling for connecting the transmitter to the artificial aerial.

Fig. 1, where L1 and L2 represent the tank and A.A. coils, and L3 L4, together with the connecting leads ab, the "link" coupling.

It will be noted that as L1 and L2 are separated from each other, no mutual inductive coupling can take place, while the possibility of capacity coupling, due to the distributed capacity of the windings, is reduced to a minimum.

It is not possible to tie down the exact number of turns of the coils L3, L4 or their exact positions in relation to the other coils, but it can be taken that 1/10th of the number of turns on the main coils will be a satisfactory basis for the number to be used for the coupling coils. As regards their position on L1 and L2, that is best determined by experiment, commencing from the low H.F. potential end of the tank coil, i.e., end remote from anode, and adjusting them until the maximum power is transferred.



Figs. 2 and 3.—Alternative methods of affixing a coupling coil to the tank coil.

Coil Construction

The construction is quite simple, in fact, it lends itself to the skill or ideas of the constructor, as the formation of the coupling coils and the degree of coupling can be obtained in so many ways. Figs. 2, 3 and 4, show three methods, each of which allows the degree of coupling and the position of the coupling coil to be varied. I would like to mention that while this part of the experiments may seem rather tiresome, don't gloss over it, and assume that all is well with the first arrangement; try several positions, and vary the number of turns and note the results obtained with each attempt.

The connecting leads a and b are called "feeders" and should consist of spaced wires or twisted twin flex, thus forming what is known as a "low impedance" line. The length is not critical, in fact, it can be anything from a few inches to several feet, although, in this instance, it is not necessary to make it longer than that required to allow the A.A. to be placed alongside the transmitter.

If a plug-in coil is used in the A.A. unit,

there is no harm in trying the reaction winding as a coupling coil, providing 200 volts or over are being used on the transmitter, otherwise the coupling may be too loose for the power available.

Operation

With the transmitter switched on, and the feeder line broken, adjust the tank coil circuit variable condenser until the maximum dip is indicated by the milliammeter needle. Now complete the feeder or link circuit and note the rise in current, that is, if all is well with the adjustment of the oscillator. The tank tuning condenser must now be adjusted to produce, again, the greatest dip of the meter needle, and, when that state is reached, the A.A. circuit is pulling or receiving the maximum output. It is at this stage that experiments should be made with the position of the coupling coils, and the degree of coupling.

Unless, by chance, the A.A. happens to be tuned to the exact frequency of the transmitter, it will, of course, be necessary to tune that circuit as well until the brightest glow is produced in the lamp. It will be found that the tuning is rather critical, and unless high H.T. is used on the 240B valve the glow will, at first, be very faint. Remember that it is essential to use a low consumption lamp.

The Grid Leak

I mentioned last week about using a variable resistance in place of the fixed grid resistance, for experimental purposes, and those who have taken the tip will soon appreciate how the value of the grid resistance can affect the operation of the oscillator.

It will be possible to set the variable resistance to a fairly low value and secure quite a bright light from the lamp in the A.A. circuit, and, on the other hand, make the resistance too high and not secure any visible effects.

Don't fall into the trap that the low value, and bright light, indicates that all is well.

(Continued overleaf)

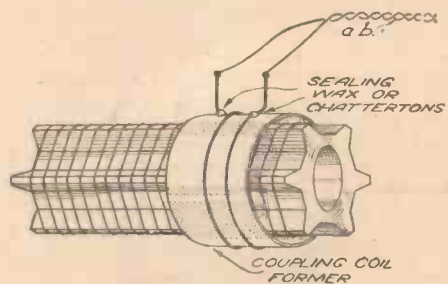

Fig. 4.—Another, and simpler, method of arranging for the coupling coil.

AMATEUR TRANSMITTING

(Continued from previous page)

Just revert to the milliammeter and see what is happening. The following effect can be produced: starting from maximum capacity of the tank tuning condenser and slowly opening the vanes, the needle will give an upward kick, when oscillations commence, before taking the downward dip described last week. When such indications are noted, and they must be watched for, it is pretty safe to assume that the grid resistance is *too small*, and that a higher value is required. By careful adjustment of the resistance, it is possible to arrive at a point where the maximum output will be given and the meter needle will perform in the proper manner, i.e., a sudden dip as oscillations start, and then a rise as the resonant point is passed. Stating the requirements rather boldly, the circuit should always be tuned for the maximum dip or minimum reading.

Modulating

After having adjusted the circuits to utmost efficiency, switch the microphone into circuit and test for visible indication, by the meter or lamp, that it is modulating

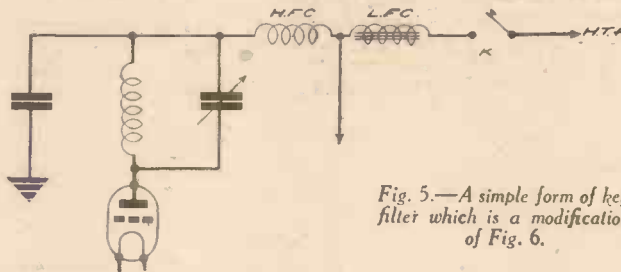

Fig. 5.—A simple form of key filter which is a modification of Fig. 6.

meter needle should fluctuate, and the intensity of the glow of the lamp vary.

As previously mentioned, a fairly sensitive microphone is necessary, but remember that sensitivity without quality or reproduction is useless. Keep the microphone to one side of the transmitter rack, and the A.A. unit to the other; if a gramophone pick-up is used, keep that also on the same side as the microphone.

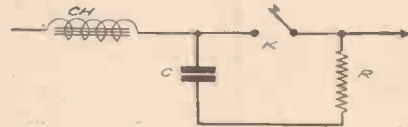

Fig. 6.—The simplest form of key filter to avoid interference.

Keying

To enable the Morse Code to be transmitted, it is necessary to provide some means which will interrupt, in an easily controlled manner, the continuous oscillations. Fig. 3 shows the method adopted in this instance, K being a Morse key of reliable make, such as that obtainable from Electradix Radios. The one reviewed in our issue of January 2nd, 1937, is quite

to nearby receivers, owing to its effect on the oscillator circuit, and the resultant waveform of the signals; therefore, it is absolutely necessary to embody some form of key-filter which eliminates this possibility.

A usual form of filter is shown in Fig. 6, where Ch is a low-frequency choke, C a fixed condenser and R a resistance. The condenser prevents an immediate breaking of the circuit when the key is open, while the resistance helps to stop any sparking at the key contacts when the circuit is closed.

With the circuit in question, use can be made of the L.F. choke already embodied in the H.T. supply, so the filter becomes as shown in Fig. 7, where the values of the two additional components are given. The value of R is not critical, in fact, the values of both have fairly wide limits and are best selected by experiments, checks being carried out on a "monitor" or stand-by receiver. It should be noted that interference can be introduced into receivers which are operating on a wave-band quite remote from that of the transmitter, so every precaution must be taken to see that the filter is effective.

Other keying systems will be described at a later date, but the arrangement given here is quite satisfactory for the low-

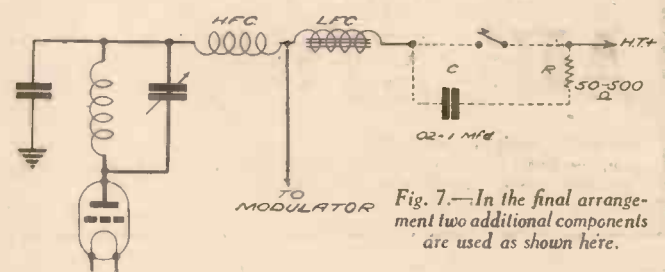

Fig. 7.—In the final arrangement two additional components are used as shown here.

the oscillator output, when, of course, sound is directed into the mike or the case flicked with the finger. If all is well, the

satisfactory. When a key is employed in a circuit of this type, it is possible for its operation to cause interference

power transmitter being dealt with, but it should not be overlooked that it is connected in the maximum positive H.T. supply.

G.E.C. Amplifier Equipment in a Mosque

FROM the other side of the world comes news of an installation of G.E.C. sound reproduction equipment of a very interesting nature. It is an installation which has been carried out by the General Electric Company's branch at Singapore for the Masjid Sultan Mosque, the largest of its kind in the country. Two projector speakers have been mounted in the body of the mosque for amplifying the services and lectures, and their output will serve comfortably for an audience of 4,000 to 5,000 people. Two similar speakers, mounted in two of the minarets, are used to call the faithful to prayer before the services. The equipment, incidentally, has a range of about a mile, and the first call from the minaret is made at half-past four in the morning!

Radio Relay in Cinemas.

WE understand that there has lately been an increasing demand on the part of cinema exhibitors for facilities to relay broadcasts of events of national importance to their patrons over the cinema amplifiers and speakers, and many requests have been made to radio relay-service operators for the connection of their services to cinema sound-reproducing systems. Some exhibitors have attempted to connect up ordinary commercial radio receivers, but results have generally been unsatis-

ITEMS OF INTEREST

factory; in addition, very bad electrical interference is often encountered.

Negotiations have been proceeding for some time between the Relay Services Association of Great Britain and Western Electric Company, Limited, and an agreement has now been reached under which members of the Association are granted the right, subject to certain conditions, permanently to connect their services to Western Electric sound equipment when requested by the exhibitor.

Relay Services engineers have, in conjunction with Western Electric, designed protective apparatus for insertion between the relay service cables and the sound equipment, which has successfully overcome the technical difficulties of bringing speech

circuits of anything up to 50 volts into cinema operating boxes without the risk of pick-up or cross-talk in the sound equipment, and of feeding into the amplifiers in a satisfactory manner. The protective and control apparatus consists of two separate units, both of which are located in the operating box, but which are separated by a distance of two feet.

The first unit contains a relay programme selector switch, an isolating step-down transformer electrostatically screened between windings, and attenuator pads which may be switched in and out of the circuit as required. A single earpiece monitoring headphone is provided, permitting the theatre operator to select the desired radio programme while the sound-film equipment is still in use.

The second unit controls the input to the main amplifiers, and consists of a film/radio key and a volume-control potentiometer. Experiments have proved that extremely satisfactory sound reproduction can be obtained in theatres by this equipment, and exhibitors taking advantage of this new arrangement will be enabled to relay practically all broadcasts, with the exception of news items, running commentaries, and certain other items for which the B.B.C. do not give permission for public broadcasting. Western Electric equipment is installed in nearly 2,000 cinemas in this country, and it is estimated that between 600 and 700 of these will be able to connect up to a radio relay service if desired.

LATHE-WORK FOR AMATEURS

by **F. J. CAMM**

1/- or 1/2 by post from

George Newnes, Ltd., Tower House, Southampton Street, Strand, London, W.C.2.

WAR IN THE AIR!

12

EXCITING STORIES OF AERIAL ADVENTURE, AND SPECIAL AIR FEATURES in the February "AIR STORIES." Including "The Bridegroom of Death," "The Phantom Fokker," "Falcons of France," "Decoy for Dolphins," etc.

Also All About New and Model Aircraft

In The February

AIR STORIES

Of all Newsagents and Bookstalls, or by post 9d. from the Publisher, Geo. Newnes, Ltd., Tower House, Southampton Street, Strand, London, W.C.2.

7^{D.}

George Newnes, Ltd.

POLAR

SPECIFIED

for the

A.C./D.C. SUPERHET 4

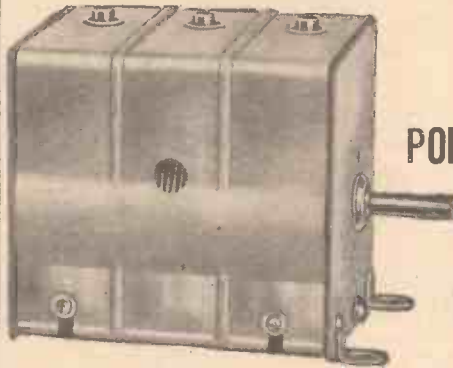

POLAR 'MIDGET'
3-GANG
SUPERHET
CONDENSER
(for 110 Kc. I.F.)

Steel frame, aluminium vanes, ball bearing shaft, trimmers operated from top, small overall dimensions.

Also made in:

- Two-Gang (2 x .0005) or Superhet Type .. Price 11s. 0d.
- Three-gang (3 x .0005) .. 16s. 6d.
- Four-gang (4 x .0005) or Superhet Type .. 22s. 0d.

Price 16s. 6d.

To maintain Good Reception

To trace faults it is essential to have an accurate meter. The AvoMinor enables you to service your set efficiently and speedily. With either of these accurate combination meters you can track down trouble quickly and make every test to valves, circuits, components, batteries and power units. Each model of the AvoMinor covers a wide field of measurement and provides testing facilities unrivalled by any other meters near their prices.

The Universal AVOMINOR

A smaller brother of the Universal Avometer. Gives 22 ranges of readings (A.C. and D.C.), in current, voltage and resistance. Total resistance 200,000 ohms. Complete with instruction book, leads, interchangeable testing prods and omnidial clips. Price **£5** Leather Case 10/-



The D.C. AvoMinor
Current
0-8 m/amps.
0-20 "
0-120 "
Voltage
0-6 volts 0-240 volts
0-12 volts 0-300 volts
0-120 volts 0-600 volts
Resistance
0-10,000 ohms
0-50,000 "
0-1,300,000 "
0-3 megohms

Price 40/-

Deferred Terms if desired.
Descriptive pamphlets post free from:
THE AUTOMATIC COIL WINDER & ELECTRICAL EQUIPMENT CO., LTD.,
Winder House, Douglas St., London, S.W.1.
Telephone: Victoria 3404/7.

The POLAR V.P. HORIZONTAL DRIVE

Slow motion with vertical moving pointer. Scale calibrated in wavelengths. Moulded escutcheon, Lamp-holders.

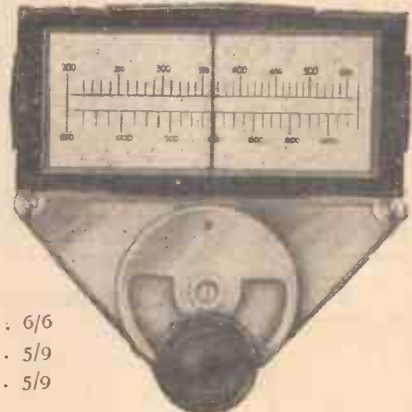

PRICE 6/6

Other Polar Drives include:—

- Vertical C.K. Drive .. 6/6
- Arcuate Drive .. 5/9
- Semi-Circular Drive .. 5/9

Send for fully illustrated Catalogue of Polar and N.S.F. Components.

WINGROVE & ROGERS, Ltd.

188/189, Strand, London, W.C.2

Phone: Temple Bar 2244.

Works: Old Swan, Liverpool.

The AVOMINOR

BRITISH MADE

Regd. Trade Mark.

Obtainable at all good Radio Shops

Practical Television

January 16th, 1937. Vol. 3. No. 33.

Cinema Television for New Year

PLANS have now been completed for introducing the Baird large screen into the daily programmes at the Dominion Theatre, London. The recent demonstration showed quite clearly the potentialities of this new device, which the size and brightness of the screen enabled it to be seen in every part of the cinema. Famous stage and film stars are to take part in the programmes, and each performance will last approximately ten minutes. They will be supplementary to the ordinary film programme and quite self-contained, for at present no attempt will be made to reproduce any of the B.B.C. programmes. For the time being both the scanning transmitter and receiver will be located in the Dominion Theatre itself, as the ultra-short-wave radio transmitter, which had been used for all the trials, now lies buried under the debris of the Crystal Palace fire. This will, however, in no way destroy the novelty appeal of this new device, and is the forerunner of other installations of a similar type, but with a variety of applied purposes to show the versatility of the equipment.

Gale Damage

THE recent gales were responsible for the loss of a full day's television programme from the Alexandra Palace. The double sound and vision aerial arrays at the top of the 220ft. mast were badly damaged, and the engineers who climbed the mast reported that a short circuit had occurred. No announcement could be made on the television sound wavelength, and people who switched on their receivers were puzzled to find the screens quite blank and the loudspeaker silent. Strenuous efforts were made to repair the damage, but the conditions were too bad to enable the work to be completed in time for the 9 p.m. programme. By noon the next day, however, both sound and vision signals were radiated satisfactorily, and it is confidently anticipated that future storms will not cause similar troubles.

New Soviet Television Receivers

AN ultra-short-wave television centre is being built in Moscow and will be put into operation some time during the present year. The new centre will be able to transmit images over the radio not only from the studio but from the streets and squares of the capital. It is planned to televise the procession in the Red Square on the twentieth anniversary of the Revolution, which takes place in November next. The Kaganovich Works in Leningrad is undertaking the production of 200 television receivers to work on 33.40 valves, the screens of which will be 15 centimetres in diameter.

Appeal To Owners of Television Sets

AS mentioned in our last issue the B.B.C. invite owners of television sets to co-operate with the Corporation in an investigation into reception conditions and the quality of programmes. As a first step a preliminary announcement was made in the television transmissions recently asking set owners to send their

names and addresses to the B.B.C. on a postcard. The B.B.C. will then from time to time write to them asking various questions about reception and programmes.

The B.B.C. feels that invaluable practical help in this pioneer stage of the television service can be given if those who have sets will lend their assistance by way of comment and criticism, as the successful development of the television service depends a good deal on the voluntary help of viewers. This applies to public viewing rooms as well as to private houses. The sort of questions that will be asked are as follows:—

What items in recent programmes did you and your friends like or dislike?

What difference (if any) are you meet-



"Looking-in" with a Cossor television receiver. The instrument seen in the illustration is model 137T.

Postcards should not be sent to the Alexandra Palace, but to the B.B.C., Portland Place, W.1, and marked "Viewer" above the address.

ing over reception (a) for sound, (b) for vision?

Suggestions for future programmes are also invited.

TELEVISION DEMONSTRATIONS

IN addition to the large stores, such as Selfridges, Whiteleys, Gamage, etc., many smaller shops and stores are now giving regular demonstrations of television receivers. For the benefit of those readers who have not yet seen a demonstration and who wish to avail themselves of the opportunities offered by these firms, we give below a list of some of the larger places where the different

makes of receiver are demonstrated. We include the names of the receivers which may be seen, so far as our information permits. We have already announced that a Cossor receiver is installed at the Science Museum, South Kensington, and a Baird receiver at Waterloo Station. At the latter place, the demonstration is only available to travellers who are holders of tickets issued by the Southern Railway.

FIRM.	Receivers Demonstrated.
Arding & Hobbs, Clapham Junction, S.W.4	G.E.C.
Army & Navy Stores, Ltd., 105, Victoria Street, S.W.1	Baird, Cossor
Barker, John & Co., Ltd., High Street, Kensington, W.8	Cossor, Pye
Bentalls, Kingston-on-Thames	Pye
Gamages, A. W., Ltd., Holborn, E.C.1	Baird, Cossor, G.E.C.
Hampton & Sons, Ltd., Pall Mall East, S.W.1	Marconiphone
Harrods, Ltd., Brompton Road, S.W.1	Baird, Cossor
A. Imhof, Ltd., Imhof House, New Oxford Street, W.C.1	Cossor, Pye
Keith Prowse & Co., Ltd., 159, New Bond Street, W.1 (and certain branches)	Baird, Pye
Kennards, Ltd., North End, Croydon	G.E.C.

FIRM.	Receivers Demonstrated.
Murdoch, Murdoch & Co., 463, Oxford Street, W.1	Baird, Cossor, G.E.C.
Royal Arsenal Co-operative Society, Ltd., at various branches in South London	G.E.C.
Selfridge & Co., Ltd., Oxford Street, W., and also the Selfridge Provincial Group at:	
Bon Marche of Brixton	Baird, Cossor, Pye
Holdrons of Peckham	
John Barnes of Hampstead	
Trewins of Watford	
Jones Bros. of Holloway	
Pratts of Streatham	
Quin & Axtens of Brixton	
J. & M. Stone, Ltd., at various branches throughout London	G.E.C.
Wallis, T., & Co., Ltd., Holborn	G.E.C.
Circus, E.C.1	G.E.C.
Whitley, Wm., Queen's Road, Bayswater, W.2	Baird, Cossor



On Your Wavelength

By THERMION

Club Activities

IT has become almost impossible to read all of the letters which have reached me concerning club activities, but it seems that there are still many clubs whose activities are really on the lines of those which should be fulfilled by a Radio Club. The dissemination of knowledge is not alone the prime factor, but the good will which should exist amongst members, and the actual practice which may be obtained in construction and other branches of the radio hobby, render the particular sphere completely different from that covered by, say, a Bridge Club. Well then, club members, I am glad to note that an extremely large proportion are in full agreement with all of my previous remarks and I can only say that I wish you continued success during the present year. By the way, a reader in Cheltenham, wishes to start a local society and has asked for my advice on the matter. I wish him luck and trust that he will be able to obtain sufficient members in the district to form a really active society, and with a view to assisting him in the formation of this society I am giving his name and address here. His name is A. E. Mayers, and the address, 53, Rodney Road, Cheltenham. Will those readers in the district who are anxious to see a flourishing society in the neighbourhood please get into touch with Mr. Mayers.

Cycle Radio

FROM time to time enthusiasts send in accounts of their experiments, and although it often appears that little sound knowledge is possessed before experiments are undertaken, it is surprising sometimes what results are obtained. I recently mentioned cycle radio, and I have received a letter from a reader at

been remarkably fortunate in his results, and in view of the interest taken in this particular field, I am giving you his remarks in full:—
“Thermion. In answer to your questions about cycle radio, I should like to state that I have had a radio on my cycle intermittently for the last four months. The whole set, batteries and frame aerial, is gins. by 4ins. by 6ins. Since funds at this end were low, I decided to experiment on standard valves that would oscillate at low voltages; I eventually found that a P.M.2DX would operate (though not loudly) on $4\frac{1}{2}$ v. I therefore built a set around two of these valves (Det.-L.F.) to operate off of 2 G.B. batteries. Finding this quite successful, I incorporated a frame aerial and, to my genuine amazement, I found I could get an R7 strength from a set working with 18v. H.T. and frame aerial gins. by 6ins. from R. Normandie (which is just opposite us here). After polishing things up a bit and jellifying a small 20 A.H. accumulator (as described in ‘Wireless Constructor’s Encyclopædia’) I fitted the set to my cycle and now I can have music as I go along without any inconvenience whatsoever. It is rather against good wireless policy not to include an H.F. stage in the portable, but as the set works well as it is I see no reason to alter it. You see, then, I was able to make a small cycle set from ordinary standard parts.”—J. BLITZ.

Good luck, Mr. Blitz!

Jazz Again

THERE are many interesting things in the dance world, and I have roused storms of antagonism by my remarks anent crooning. Swing Music now seems to be a standard term in this field, but it appears that even musicians do not

know what Swing Music is. I am told that one musical paper offered a cash prize to anyone who could describe it! Further than this, musical clubs throughout the country have had debates to try to define it. Can this be *music* that musicians cannot explain what it is? I know I shall only be again rousing the wrath of those who are “dance fans,” but I cannot refrain from giving a few terms which have just been pointed out to me in connection with jazz. It appears that the performers in a jazz band do not refer to each other as pianist, guitarists, etc., but have a language all their own. Have you ever heard of a “Crapso-diser”? That is the term for a saxophone player. A Larynx Libeller is a crooner; an Ivory-rattler is a pianist; Gobsticks are clarinets; Egg-boxes are guitars; and the double-bass is known as a Dog-kennel. After that can you blame me for hating jazz? A Mr. Magnus-Osborn, of Rustington, is also a musician, and he recently sent me this interesting epistle: “This is the first time that I have written to you—and not being an expert at the job, I’m not quite sure how I should begin; however, I suppose I should begin by saying that I have been having PRACTICAL AND AMATEUR WIRELESS ever since its amalgamation, and that I turn to your page first, and that I eagerly look forward to the delivery on Wednesday morn? Whether or no, I do, and have!!

“I read your criticisms and ‘shop’ with interest, and usually, though by no means always, agree with you. With regard to crooners and jazz—I’m afraid that I cannot find words fit to describe them; even if I could, I am far too much a gentleman to use them.

“A correspondent recently rather gave himself away—long before he told his age (18 years) I guessed it. For, dear Thermion, I think that most youths of eighteen share his opinion of jazz—don’t you think so? Later on, when they

have sobered down, they begin to think that 'Classical music, which gives me a pain in the neck,' is not so bad. It seems perfectly obvious to me that there is no sobriety about jazz. When I hear people say that pieces such as the Prize Song from the Mastersingers give them 'pains in the neck' I feel like saying—'they know not what they do' (or say). I read your 'article' on Dr. Thatcher (I believe that is the name) with delight and interest—I have often been present at recitals by him, as I used to go to Orley Farm (prep. school at Harrow) and he frequently came to that school. But I haven't noticed the change at the B.B.C. yet.

"You said a few weeks ago that now practically anyone can receive U.S.A. on the medium waves at about 2.30 a.m. Could you let me (and I expect the other readers of PRACTICAL AND AMATEUR WIRELESS would welcome this information, too) have the wavelengths of a few of the more powerful American stations? I have tried various ways and means to obtain this information, but have failed, so I now turn to you!"

American Broadcasts

I HAVE spoken to the editor concerning the American stations, but he does not think that many readers would be interested in a list of these stations. There are so many of them, and the times of transmission vary so much, that it is not a simple matter, apparently, to pick out the most important. One good tip, which is worth passing on, is that by tuning to the Midland Regional, and leaving the set tuned to that point, it is often possible to switch on in the early hours of the morning and hear an American. There is, of course, a thrill in tuning in a station from the other side of the Atlantic, and although it is interesting to get these stations on the medium waves, I think that it is far more interesting to use the short and ultra-short wavelengths. Down there you will find a much greater kick and it is a far better test of the construction of your set. For my part, I do not like the hustle of the American programme nor the advertisements which are interspersed. I see enough of these when I try to read my morning paper, and I like to rely upon my receiver to provide me with entertainment—but then I have told you all this before. But, as a matter of interest, has any reader yet succeeded in picking up a short-wave television transmission from the U.S.A.? The Alexandra Palace has already been



Short-wave Coil

MANY readers have written to ask whether they can use a commercial coil in place of the home-constructed type used in the one-valve short-waver described in the issue dated December 12th. The construction of the coil is a very simple matter, but anyone wishing to use a commercial component will find the six-pin type quite suitable. It will then be necessary to fit a six-pin base, of course, and the wiring to the terminals of this should be made in the manner suggested by the coil manufacturers; a leaflet showing the connections accompanies coils of reliable manufacture. One big advantage in using a plug-in coil in place of the home-made type indicated in the diagram is that several sizes can be obtained to cover all the wavebands between 13 and 2,000 metres.

L.F. Volume Controls

L.F. volume controls are used in most superhet receivers nowadays, H.F. control being effected by the A.V.C. voltage. The L.F. control generally takes the form of a variable potentiometer having a value of between 250,000 ohms and 1 megohm. Its end terminals are joined to the earth line, and the coupling condenser respectively, and its moving arm to the grid of the output valve. This arrangement works quite satisfactorily until the volume control develops a bad contact. When this happens, however, serious trouble can ensue.

Safeguarding Output Valve

IF contact between the moving arm and the elements is broken when the set is in operation the grid of the output valve becomes free and no bias voltage will be applied. If this is allowed to continue for even a short length of time the valve will be damaged. The high current passing through the speaker-transformer winding and the bias resistance due to the loss of contact can also damage these components. To avoid damage due to this fault it is advisable to connect a high resistance between the centre tag of the volume control and the earth line. This will not materially affect results, but will ensure the application of a bias voltage to the output valve even if contact is broken inside the volume control.

TELEVISION AND SHORT-WAVE HANDBOOK

By F. J. CAMM

3/6 or 3/10 by post from

George Newnes, Ltd., Tower House,
Southampton Street, Strand, London, W.C.2.

received in South Africa, and therefore although it is contrary to the present accepted theory, there seems some possibility of the American television signals being heard in this country.

Telling the World

HAVE you seen the largest electrical advertising sign in London? This is erected in Trafalgar Square, on top of the Grand Building, and is also claimed to be the second largest in the British Empire. It was erected for the Philco company and is in neon tubing. The overall size is 73ft. long and 40ft. high, and it announces that "Philco is the World's largest Makers of Radio Sets, a Musical Instrument of Quality." The manufacturers of the sign claim that it may be seen for a distance of three miles, and it is controlled by photo-electric cells which switch on the power when daylight falls to a certain point. When the light increases to a certain value it is extinguished. It will be interesting to observe the effects of this sign during a real London fog, as there appears to be a remarkable penetrating power to the neon glow.

Car Interference

I RECENTLY witnessed an interesting demonstration of the far-reaching effects of interference from an ordinary motor-car. This was driven round a factory in which television research was being undertaken, and the cathode-ray tube gave a most remarkable display of the interference radiated by the car. There is no doubt that a lot of the noise now heard on ordinary broadcast receivers is due to machinery of this type which is not fitted with suppressing devices, but I wonder if it will ever be proved that our more sensitive nerves are affected by such radiations? I agree with many of those responsible people who maintain that it should now be made illegal to install electrical machinery which is capable of radiating interference. The onus of preventing the trouble should not rest with the user of a radio receiver or similar piece of apparatus, but upon the user of the motor or other device.

Crooning Note

TOO much crooning might give anyone the desire to commit suicide," said Mr. Percy Macbeth, the Salford Stipendiary Magistrate. He advised a youth who came before him to find a better job. The youth had been earning a living by crooning in public-houses. That is the proper place for crooning if we must have it.

A PAGE OF PRACTICAL HINTS

SUBMIT YOUR IDEA

READERS WRINKLES

THE HALF-GUINEA PAGE

Positive Contact for Temporary Tests
 BY means of this dodge, the temporary inclusion of resistances or condensers for test purposes is facilitated, and, as will

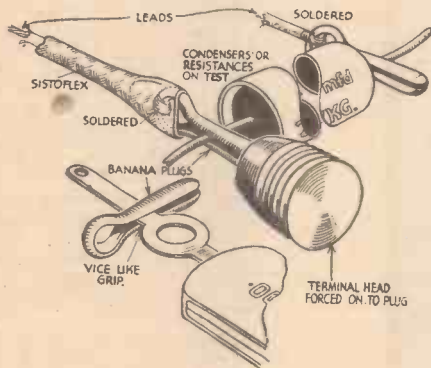

A handy method of making temporary connections.

be seen by the illustration, the split plugs effect a vice-like grip when the terminal heads are worked into position.

I have found that bad contacts are minimised and, in fact, the idea is even more effective than some crocodile clips, the contact area being definitely more positive.—L. FREEMAN (London, S.W.).

A Handy Cabinet Fitment

FOR those who use accumulators for L.T. here is a novel fitment, the inclusion of which will facilitate the removal

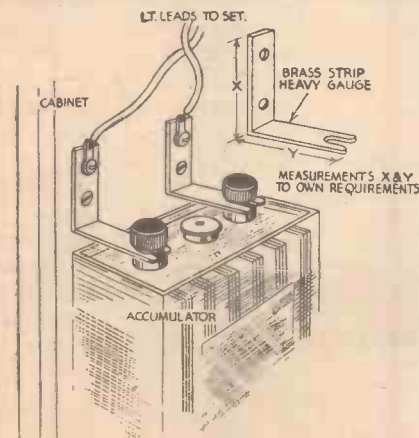

A dodge for facilitating the removal of accumulators from cabinets.

or connecting of one's accumulator, and make it easier for the collector when he calls for same to be charged. A neat appearance is given to the inside of the cabinet since excess wiring is obviated. The contact ends should be vaselined to prevent corrosion, also, the contacts to the leads should be made by solder tags.—E. T. TRAVERS (Birmingham).

THAT DODGE OF YOURS!

Every Reader of "PRACTICAL AND AMATEUR WIRELESS" must have originated some little dodge which would interest other readers. Why not pass it on to us? We pay £1-10-0 for the best wrinkle submitted, and for every other item published on this page we will pay half-a-guinea. Turn that idea of yours to account by sending it in to us addressed to the Editor, "PRACTICAL AND AMATEUR WIRELESS," George Newnes, Ltd., Tower House, Southampton Street, Strand, W.C.2. Put your name and address on every item. Please note that every notion sent in must be original. Mark envelopes "Radio Wrinkles." Do NOT enclose Queries with your Wrinkle.

A Flashlamp Walking-stick

THE illustration shows in part-section a walking-stick which has been adapted to carry a small battery and flashlamp bulb. It may be switched on and off by means of the small switch whilst in normal use, and will be found extremely useful to those who reside in unlighted streets. It will be seen that the stick has a screw-thread cut in its straight portion. The upper part is hollowed out to receive a pencil battery. A small frame is fitted to the front of the stick, and the connections are made as shown. A small spring is placed beneath the bottom of the battery to force it into contact with the electrical connection. No doubt many readers will be able to find from odd electrical apparatus the pieces necessary to adapt the stick in the manner here detailed, but in case they cannot, it is worth mentioning that small sockets complete with reflectors and lenses suitable for the purpose are obtainable from most electricians. The idea may also be adapted for other items of personal use, such as

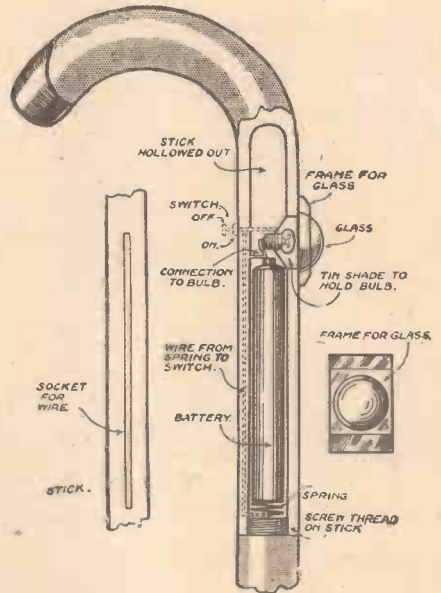

Sectional view of the walking-stick showing the battery and lamp in position.

attaché cases, handbags, and so on. The diagram clearly shows all the connections.—R. PALMER (Uxbridge).

Neat Improvised Connectors

THE accompanying sketch shows a neat terminal strip that can be made with a strip of paxolin or ebonite, aided by the brass connections from a number of unwanted electric light roses. With the two fixing bolts, or one with adequate spacing, there is no risk of shorting. The lower sketch shows how the connectors can be arranged to form a neat junction for a number of common connections.—S. EMERY (London, W.).

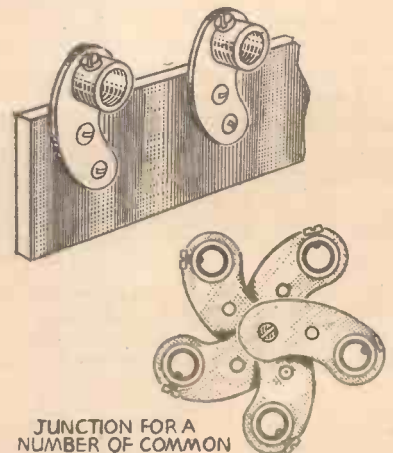

Improvised connectors made from small electric light fittings.

Of Special Interest to Every Reader

- Automatic Cylinder Lubrication
- Winter Garage Accessories
- Road Test of the Wolseley "Ten-Forty"
- Cause and Effect of Engine Vibration
- Scene of the Red Barn Murder
- Increasing Braking Efficiency

These are a few of the Articles which appear in that famous journal PRACTICAL MOTORIST dated January 9th, now on Sale. Price 3d. Every Friday from your usual Newsagent or Bookseller.

DURING the past eighteen months great improvements have been made in the design of valves and components for use in A.C./D.C. receivers. These have been mainly due to the fact that manufacturers have, at last, realised that a large proportion of the public prefers a universal receiver to the A.C. type, even though an A.C. supply is available. This cautiousness has probably been engendered by the delay in changing over the local supplies from D.C. to A.C. Consumers on D.C. are beginning to wonder whether their supplies will ever be changed over to A.C., and many of those on A.C., on the other hand, are not at all certain whether to believe that their supplies will not be changed to D.C. at some future date. Provided that the receiver is capable of giving as good a performance on A.C. as

THE "QUALITONE"

Circuit and Constructional Details of an A.C./D.C. Receiver with a Delayed A.V.C. and Providing Three Wavebands

years ago was mainly due to the use of unsuitable valves and to I.F. and L.F. instability. By careful choice of valves and decoupling components, however, it has been possible to eliminate all traces of instability in the present design, with the consequence that quality of reproduction is really good.

Circuit Arrangement

A study of the theoretical diagram will indicate that the receiver employs a pentagrid frequency-changer, an H.F. pentode as I.F. amplifier, a diode detector, and a high-efficiency power pentode output valve. An intermediate frequency of 110 kc/s has been chosen as this provides a higher degree of selectivity and sensitivity than 465 kc/s. It is true that there is freedom from image interference on the medium waveband when a high frequency is used, but serious interference can occur on the long waveband. If efficient bandpass coupling precedes the frequency-changer, image interference is negligible with 110-kc/s components in use, and there is a definite improvement in selectivity as compared with 465-kc/s sets, especially on the long waveband. One or two whistles will probably be

experienced on the medium waveband in most localities, due to interference from the strong local transmitters. In the London locality the only pronounced whistle is on a wavelength of approximately 450 metres, but this does not interfere with reception of the two adjacent transmissions and therefore the addition of complicated suppression circuits was not deemed advisable.

The Frequency-changer

Some readers may wonder why a triode-hexode was not used as frequency-changer. This type of valve was tried, however, and in this design its performance was found to be slightly inferior to that of the specified pentagrid. The screen and oscillator anode voltages for this valve have been carefully chosen and it will be noted that the oscillator anode circuit is very effectively decoupled. The I.F. stage follows standard

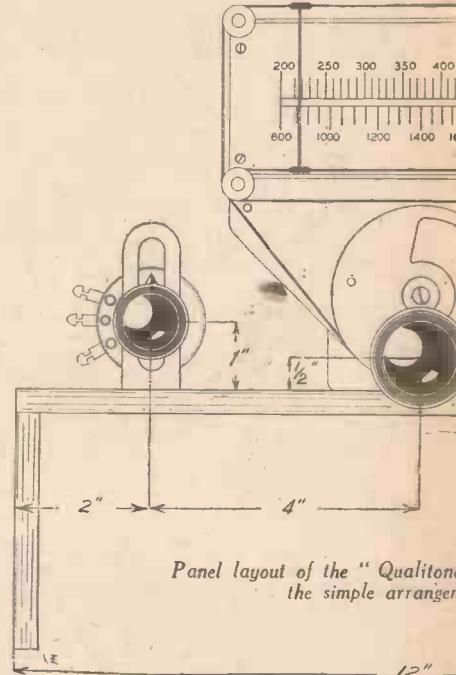

Panel layout of the "Qualitone" receiver showing the simple arrangement.

practice, using variable selectivity iron-core I.F. transformers and a high-efficiency H.F. pentode valve. The second transformer is fed into a diode detector, the centre tap on the secondary winding being used in order to reduce damping.

The Detector and Output Stages

It is still difficult to obtain an output of more than 7 watts with A.C./D.C. valves in use, but this wattage is greatly in excess of the requirements of the average listener—a modest 1 watt is sufficient for most living-rooms. When designing the A.C./D.C.4,

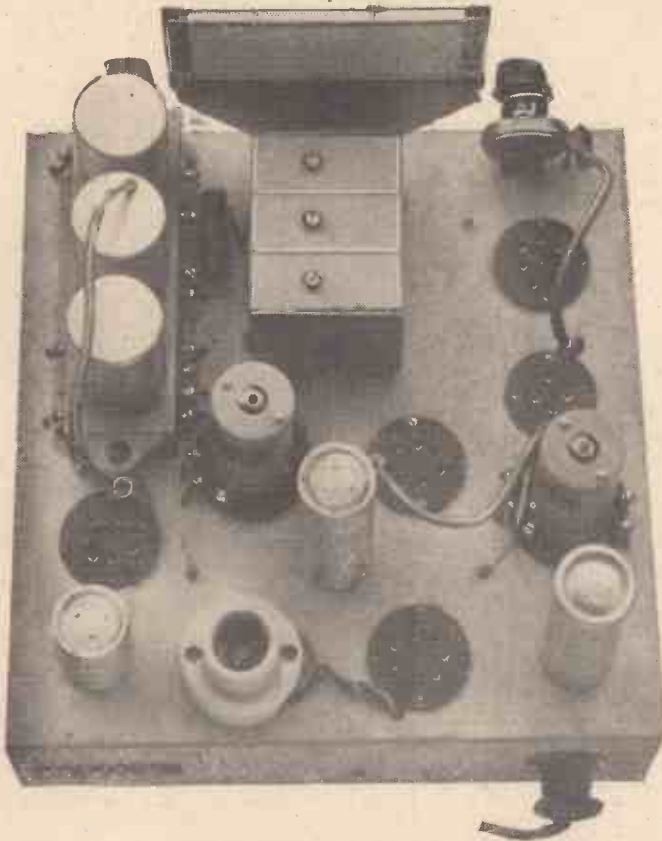

This view shows the careful layout which has been adopted in the "Qualitone" receiver.

on D.C., one is certainly justified in obtaining a universal receiver for operation on A.C. mains. Care must be exercised in choosing such a set, however, as many commercial A.C./D.C. receivers have a pronounced hum on A.C. Constructors can rest assured that the A.C./D.C.4 has been thoroughly tested on both types of supply, however, with good results; hum is negligible if the set is built to specification.

Superhet versus Straight

After careful comparative tests had been conducted, it was found that greater sensitivity and selectivity could be obtained from the superhet than from a straight set using the same number of valves. The quality of reproduction obtainable from a well-designed superhet was also found to be up to the standard of that of the straight set. The bad quality which was characteristic of the superhet two or three

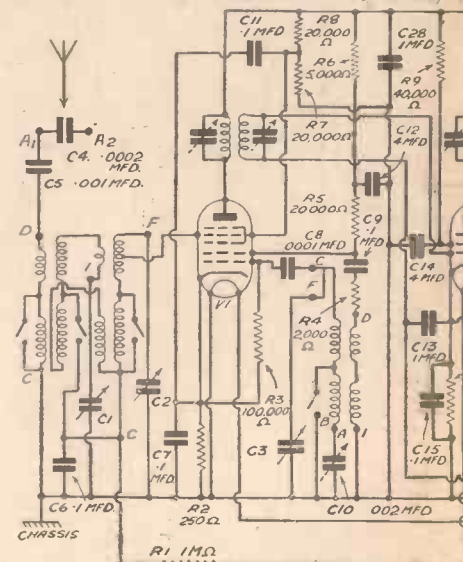

Theoretical circuit diagram of the receiver.

UNIVERSAL FOUR

A.C./D.C. Four-valve Superhet Incorporating
 Undistorted Output By IDRIS EVANS

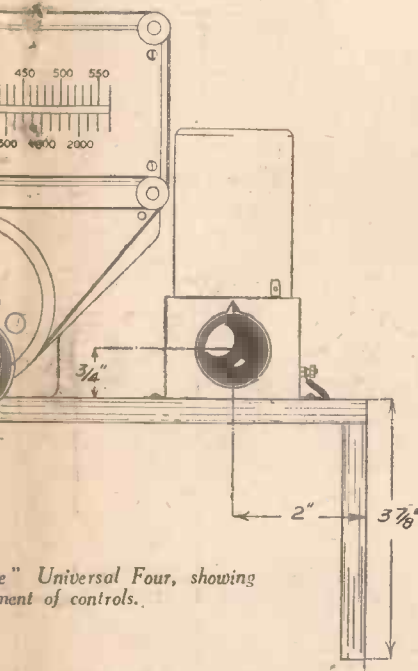

"Universal Four, showing
 arrangement of controls.

however, an output of approximately 3 watts was aimed at so as to avoid the possibility of transient distortion. The use of a well-designed diode detector circuit practically eliminates detector distortion. As the diode valve is fed directly into the output pentode it can be given a heavy input voltage, which is the ideal condition for a detector of this type. The output pentode, on the other hand, is capable of providing maximum undistorted output with a comparatively low input voltage owing to its high mutual conductance. The combination of diode and

pentode is therefore very suitable, provided that the correct values of coupling components are used.

The A.V.C. Circuit

The A.V.C. diode is fed from the anode of the I.F. valve through a .0001 mfd. condenser, and the A.V.C. voltage developed across the two 500,000-ohm resistances is fed back to the grid of the frequency-changer. It was found in practice, however, that for optimum results the I.F. valve did not require as much negative bias as the first valve and therefore the A.V.C. feed for the second valve is taken from the junction of the two 500,000-ohm resistances. Simple A.V.C. would be obtained by connecting the cathode of the diode valve to the H.T.—line, but this would materially reduce the sensitivity of the set. It was therefore decided to provide a delay voltage, this being done by connecting the cathode to the junction of the 5,000 and 75,000-ohm resistances. This point is positive with respect to H.T.—, and therefore the A.V.C. anode of the diode valve is biased negatively with respect to the cathode, and effective delayed automatic control is thereby provided.

The Smoothing Circuit

The mains voltage is applied through the barretter to the heater circuit and also direct to the anodes of the rectifier. This valve operates on the half-wave principle, its cathodes being joined together and connected to the smoothing choke and thence to the valve anodes. Two electrolytic condensers are used for smoothing, one of these having a very high capacity. A.C. ripple is thereby eliminated, and provided that the receiver layout and wiring is in order, freedom from hum is ensured.

Construction

A metallised chassis has been used in preference to the metal type as wood is much easier to work, and by using a heavy gauge tinned copper connector on the underside of the chassis for the negative line connections satisfactory contact is ensured. This thick connector must not be omitted,

as the metallised surface of the chassis cannot be relied upon to carry heavy currents. A 1/4 in. drill should be used for the 7-pin valve-holders and a 1 in. for the 5-pin type, care being taken to centralise the sockets so that they are quite clear of the metallised surface. Washers should be placed underneath the heads of the M.B. bolts in order to ensure good contact with the metallising, and soldering tags underneath the nuts for connection to the thick wire connector. It is also advisable to scrape off the metallising around the terminal-strip holes.

After the valve-holder sockets have been mounted the components underneath the chassis may be fixed. All connections to the sockets should be soldered in order to ensure rigidity and perfect contact. If the constructor cannot solder very efficiently, he should have his work inspected by a competent mechanic before testing the receiver—poor reception from home-constructed receivers is very often due to bad soldered joints.

Coil Connections

Before mounting the coil unit, three slight alterations should be made to the internal wiring. It is necessary to keep the leads to the fixed vanes of the tuning condenser sections as short as possible, and as the fixed-vane terminals of the condenser

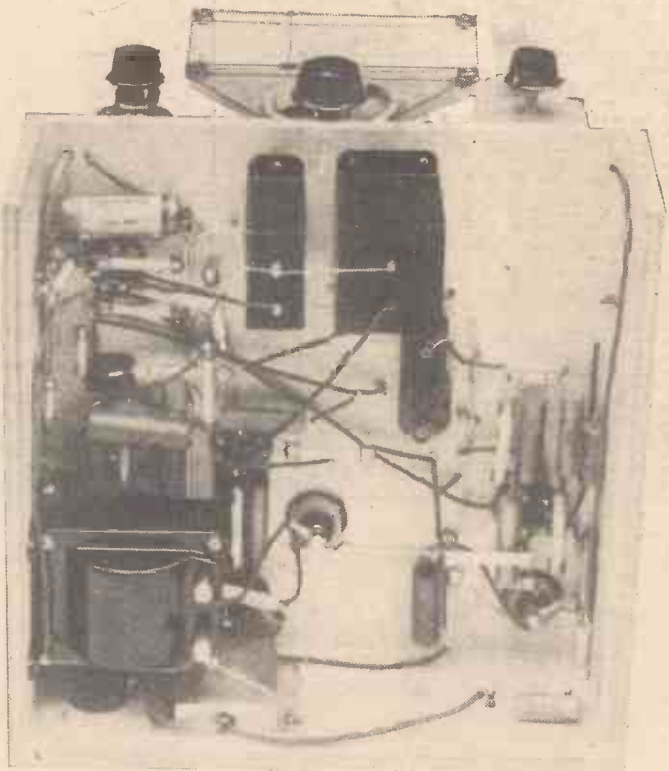

In this illustration the heavy earth return leads may be seen.

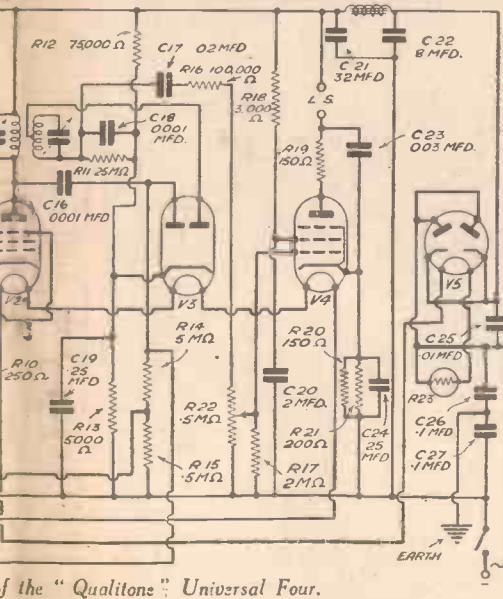

of the "Qualitone" Universal Four.

are a good distance from the coil terminals to which they should be connected, it was thought advisable to transfer terminals I and F of the first two coils to the side of the coil unit nearest the gang condenser. Terminal D has also been transferred to the side of the coil unit remote from the gang condenser. To summarise, the leads from the aerial series-condenser, the fixed-vane terminal of C1, and the fixed-vane terminal of C2 should be joined to terminals D, I, and

(Continued on next page)

THE "QUALITONE" UNIVERSAL FOUR

(Continued from previous page)

WIRING DIAGRAMS OF THE

"QUALITONE" UNIVERSAL FOUR.

Of the first two coils respectively, after the latter have been transferred to the opposite side of the coil unit. No trouble should be experienced in mounting any of the other components, but in order to ensure good contact between the cans of the electrolytic condensers and the negative line connector the wire from the latter should be passed through the fixing hole in the wooden chassis and its free end clamped underneath the condenser can on the surface of the chassis.

LIST OF COMPONENTS FOR THE "QUALITONE" UNIVERSAL FOUR

- One coil unit—BP 111—Varley.
- One 3-gang condenser—Midget 110 kc. (C1, C2, C3)—Polar.
- One tuning drive—V.P. horizontal—Polar.
- Two I.F. transformers—BP84—Varley.
- Seventeen fixed condensers, tubular type: Three .0001 mfd. (C8, C16, C18); .0002 mfd. (C4); .001 mfd. (C5); .003 mfd. (C23); .01 mfd. (C25); .02 mfd. (C17); seven .1 mfd. (C6, C7, C9, C11, C13, C15, C28); .25 mfd. (C19); 25 mfd./25v. electrolytic (C24)—Dubilier.
- Five fixed condensers: 2 mfd. (type 84) (C20); 4 mfd. (type 65) (C14); 4 mfd. (type 812) (C12); 8 mfd. (type 802) (C22); 32 mfd. (type 809) (C21)—T.C.C.
- Twenty-one fixed resistances: 1 meg. (R1); two 500,000 ohms (R14, R15); 250,000 ohms (R11); 2 meg. (R17); two 100,000 ohms (R3, R16); 2,000 ohms (R4) (type F1); 75,000 ohms (R12); 40,000 ohms (R9); three 20,000 ohms (R7, R8, R5); two 5,000 ohms (R6, R13); 3,000 ohms (R18); two 250 ohms (R2, R10); 200 ohms (R21); two 150 ohms (type F1) (R19, R20)—Dubilier.
- One volume control, 500,000 ohms (R22)—Erie.
- One L.F. choke—20H/60 mA/500 ohms—B1—Ferranti.
- Five valveholders: Four 7-pin; one 5-pin, chassis mounting without terminals—Clix.
- Two socket strips: A1, A2, E, and L.S.—Clix.
- Loudspeaker control panel—Clix.
- One preset condenser—.002 mfd. max. (C10)—Ward and Goldstone.
- One anti-interference condenser unit—A.20 (C26, C27)—Bulgin.
- Two screened valve-cap connectors—P64—Bulgin.
- One standard connector—P 41—Bulgin.
- Two feet screened flex wire—Bulgin.
- One 2-pin mains plug and socket—P74—Bulgin.
- One on-off switch—S80—Bulgin.
- One component bracket—Peto-Scott.
- One Metaplex chassis, 12in. by 12in. by 3½in.—Peto-Scott.
- Three feet 14 S.W.G. T/C wire for earth connections—Peto-Scott.
- Quantity 20 S.W.G. T/C wire and sleeving for wiring—Peto-Scott.
- Two ft. ¼in. sleeving for screened leads—Peto-Scott.
- Five valves: X32 (metallised); W31 (metallised); D41 (clear); N31 (carbonised); U30 (clear)—Osram.
- One barretter with porcelain holder—type 304 (R23)—Osram.
- One speaker—Stentorian Senior—W.B.

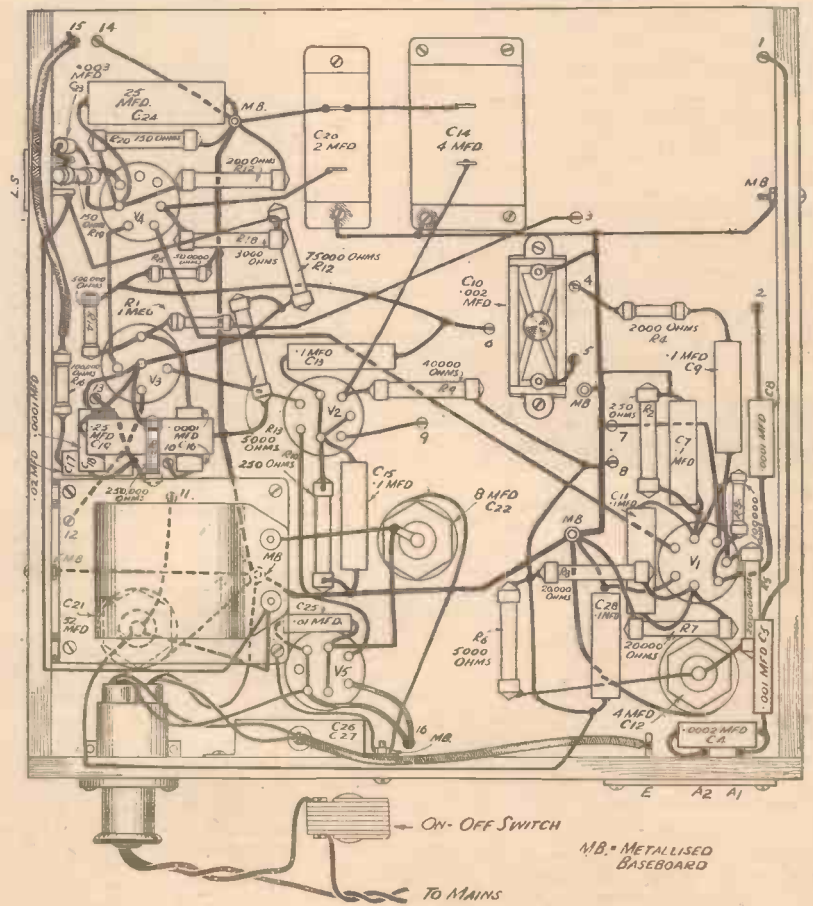
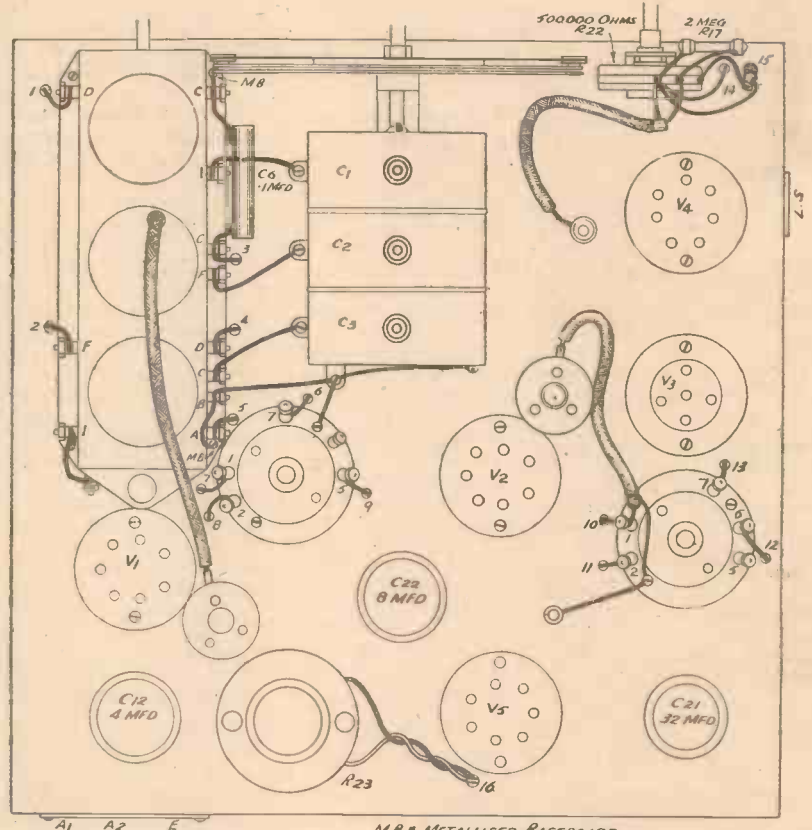

FOR CYCLISTS

Every wireless enthusiast who is interested in cycling should make sure of obtaining a copy of *The Cyclist*. The issue now on sale (2d. of all newsagents), contains a number of special features, including an investigation into the causes of mud-throwing and a suggestion for improved mudguarding; a characteristic essay by "Wayfarer" on the simple joys of cycle-touring; a photographic description of some amazing relics of barbarian England, and some trenchant comments on the latest developments in the sporting and cyclo-political world. *The Cyclist*, published by George Newnes, Ltd., is the authority of the cycling movement, and the only journal that appeals to every class of cycle-user.

SHORT WAVE SECTION

A Heterodyne Frequency Meter

Full Particulars Concerning the Construction and Calibration of a Useful Instrument for the Amateur are Given in this Article. By AUSTIN FORSYTH

shows the amateur bands, and it will be seen that they are in approximate "harmonic relation" with one family of frequencies—the shaded sections—in true harmonic relation. Now, it is well known that an oscillating valve generates harmonics; if they are sufficiently strong, they can be detected right down to the fourth and fifth, even with simple apparatus. Therefore, if a valve frequency meter is set oscillating at, say, 3,582 kc/s in the 80-m. amateur band, harmonics will appear at 7,164 kc/s in the 40-m. band, 14,328 kc/s in the 20-metre, and so on. Similarly, an "overtone" (or second harmonic beat from the receiver's detector valve) will be heard at 1,791 kc/s in the 160-m. band. This illustrates the most valuable

and five-metre region, but this cannot be taken too far or instability will result.

Considerations of Design

Turning now to the design of a suitable instrument, it can be shown that if the proper precautions are taken, the accuracy obtainable with any one of the circuits previously mentioned is much the same, but there are advantages and disadvantages with each. The dynatron, a very simple circuit using a screen-grid valve, suffers from the fact that it cannot conveniently be used as a listening monitor, i.e., to listen to one's own transmission; also, a separate L.T. supply is essential and, for reasonable accuracy, an 0.5 mA meter is needed in the circuit. The electron-coupled oscillator, also using an S.G. valve, can be operated as a monitor, but is somewhat complicated from the constructional point of view, as filament chokes must be used under certain conditions. Both circuits require modification depending upon whether mains or battery values are used.

In Fig. 2 is shown the third type of circuit, the triode oscillator, which, in the writer's experience, is the most suitable for all-round use. It is simple to construct and either mains or battery valves can be employed; if calibrated to a good degree of accuracy, it will maintain this for long periods; it is equally effective as a listening monitor and generates strong harmonics. The condensers C4, C5 and C6 should be noted. While helping to increase harmonic output, they are also "swamp capacities" across grid-filament, grid-plate, and plate-filament, the idea being that after calibration small changes in the coils

(Continued overleaf)

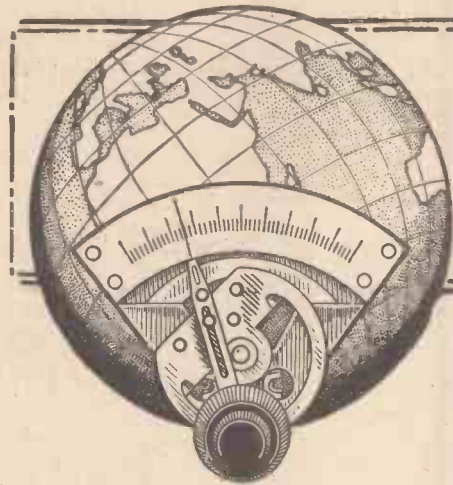

A FREQUENCY meter of some sort is one of the most important pieces of equipment on the experimenter's bench, and those who possess one are not only able to do all kinds of useful and interesting work with it, but can also save themselves a lot of unnecessary trouble in, say, the calibration of a new receiver, to mention only one of the possibilities. Further, if the intention is eventually to go in for amateur transmission, a frequency meter is virtually a necessity, even if finally used only as a listening monitor. Actually, a heterodyne frequency meter of the type to be described has a number of

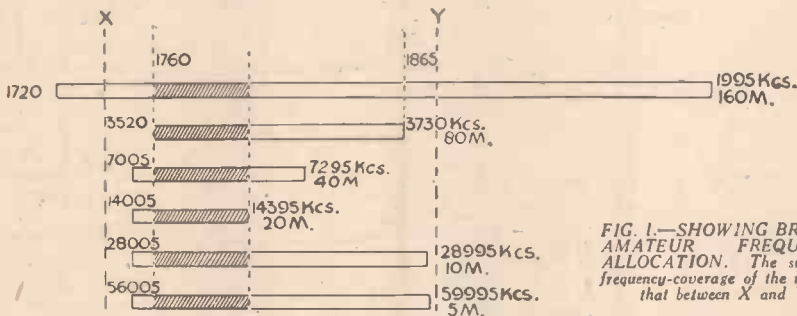

FIG. 1.—SHOWING BRITISH AMATEUR FREQUENCY ALLOCATION. The suggested frequency-coverage of the meter is that between X and Y.

applications—apart from the obvious one of measuring and checking frequencies—which make it extremely useful in any station, whether transmitting or receiving. Frequency meters vary from the complicated laboratory design to the most elementary form of measuring instrument—the absorption wavemeter, consisting simply of a coil and condenser, with perhaps a coupled circuit for sharper tuning. A meter of this kind can do no more than give an indication of wavelength (frequency), and there its functions end, though a well-designed instrument can be made very accurate over a limited range of frequencies. For amateur work there are several simple types of valve frequency meter which can maintain, through fairly wide supply voltage variations, a degree of accuracy quite high enough for practical purposes. They are all single-valve oscillators, depend on the harmonic principle to cover a wide frequency range, and use either the dynatron circuit, the electron-coupled arrangement or the ordinary triode oscillator. This last-named is of course the same thing as the reacting detector valve in a receiver.

Harmonic Operation

To explain the point about harmonic operation, consider Fig. 1, taken from an earlier article by the writer, and now revised and brought up to date. This diagram

property of a valve frequency meter. The instrument can be built and calibrated to cover one particular band of frequencies and, providing the harmonic output is sufficiently rich, it is equally effective, within practical limits, on any other band above or below.

From a further consideration of Fig. 1 it will be apparent that there is actually a difficulty in this owing to the relative "widths" of the bands. If the meter is designed to cover the 160-m. band, it will automatically cover all others, but the calibration for 20 metres will be too close for convenience, and it is on the high-frequency bands that the best accuracy is usually required. This difficulty is overcome by a compromise which takes into account the practical aspects of the matter. 160 metres is, comparatively speaking, not much used and most stations operate between the frequencies 1,760 and 1,865 kc/s, as shown in Fig. 1, so as to be able to "double" from their crystals. Hence, by arranging that the 80-m. band is fully covered—between the dotted lines X and Y in the diagram—the useful part of 160 metres is brought in and the best possible spread obtained on the high-frequency bands. A further point here is that the nearer the fundamental of the frequency meter is brought to the H.F. bands, the stronger will be the harmonics in the ten-

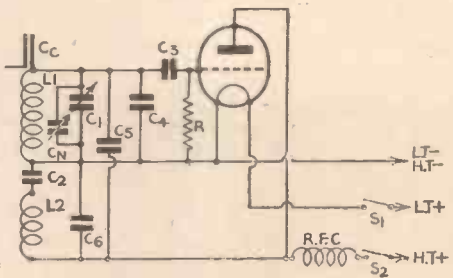

FIG. 2.—SHOWING THE TRIODE OSCILLATOR IN THE HETERODYNE FREQUENCY METER CIRCUIT.

- L1—42 turns No. 32 enamelled close wound on 1 in. diameter former.
- L2—14 turns do. do. do. do. do. (same former).
- RFC—Sec Text.
- Cc—Sec Text. Cn—"J.B." Neutralising condenser, see Text.
- C1—.0002 mfd. SLF. "J.B." Short-Wave Special.
- C2—.005 mfd C3, C4, C5, C6—.0001 mfd.
- R—3 megohm grid-leak.
- S1, S2—D.P.S.T. switch.
- "J.B." Short-wave slow-motion dial, 0-100 in 200 divisions

SHORT-WAVE SECTION.

(Continued from previous page)

L1 and L2, or within the valve itself, will not materially affect the calibration of the meter since these changes will necessarily be minute compared with the condenser capacities, which will thus swamp them.

Layout and Connections

The condenser C1, the tuning capacity, is most important and should be of good manufacture, fitted with a positive clear-reading slow-motion dial. The parallel variable condenser Cn is a very small one, of the neutralising variety, for trimming purposes only, and its function will be explained later. RFC can be a standard short-wave choke with a broadcast choke in series, or an S.W. choke can be made up by putting three sections of 75, 50 and 100 turns of No. 32 enamelled wire on a lin. diameter former, spacing the sections about 1/4 in. Any available broadcast choke can be put in series with this. The coils L1 and L2 are important, and the values, given with the other circuit data in Fig. 2, cannot be definitely stated, as variations in the layout and the oscillator valve used will affect them to a certain extent. With a valve of the HL210 class (anything similar which may be to hand will do) the turns data given should bring the frequency range between X and Y in Fig. 1. It is, however, necessary to be prepared for a certain amount of adjusting. The condenser Cc is for coupling the output of the meter into the receiver. It is a very small

ample—which can then be put into a screening box.

Method of Calibration

Before commencing the calibration, make sure the required frequency-coverage is being obtained by checking against the receiver, and also that there is a good pick-up on 20 metres. This will, of course, be an audible beat-note which will be heard in the receiver with the detector just oscillating as the meter dial is swung through its tuning range. The effect is exactly similar to tuning in a station, and the meter is nothing more than a very low-power transmitter local to the receiver to which it is coupled. If a good pick-up is not at first obtained, adjust the loose lead attached to Cc in Fig. 2, as previously explained, till a comfortable beat-note is heard, and then fix the lead down in that position.

For the best results, the meter should be calibrated in the condition under which it will normally be operated; that is, with the valve always to be used and in the position on the bench it will ordinarily occupy.

If the experimenter can read sufficient morse to identify the various commercial stations at the ends of the amateur bands, which will be covered by the meter, a skeleton curve can easily be drawn. And here another point comes up for explanation. It is convenient to base the curve on the 80-metre band, but this does not mean that only stations in or near that band can be used for calibration. A little

to 3,692.5 kc/s on 80 metres; and to 1,846.25 kc/s on 160 metres.

To help in this calibration process, a short list of those stations likely to be heard, with their frequencies, is given herewith. A lot more will be receivable, but it is either not possible to get their exact frequencies or else they are unreliable.

To get points for the portion of the curve which actually passes through the amateur bands, and on which there are no commercial stations, the best thing to do is to rely on amateur transmitters' crystal frequencies. Tune in a station to which a report would be sent in the ordinary way. Set the frequency meter and adjust to zero beat, as before. Make a careful note of the dial setting, and when sending the amateur his report, ask specifically for his crystal frequency, and explain that this is being requested for calibration purposes. A 1d. stamp will help a quick reply! In this way, a curve can be built up quite quickly and accurately, but it pays to take time and trouble in the work, and to make sure that reliable stations only are selected.

Plotting the Curve

Before drawing the final curve, which will be of the shape shown in Fig. 3, a few "roughs" are necessary. Try to get centimetre-squared paper rather than the ordinary inch-squares divided in tenths, as the former allows of greater accuracy. Then plot the points just as they come, and draw a smooth curve through as many as possible. One or two will probably be wildly out, due either to inaccurate logging or the station being off frequency. These should be rejected, as it is, of course, on the neatness and accuracy with which the final curve is produced that the usefulness of the meter ultimately depends. All four communication bands can be marked, with their limits shown, so that whatever band the receiver may be on, a required frequency can be "shot" right away.

Periodically, the calibration should be checked on the original stations, or from other standard frequency transmissions. The use of the small parallel condenser Cn across C1 now becomes clear. This, which should be set in the mid-way position before

(Continued on page 552)

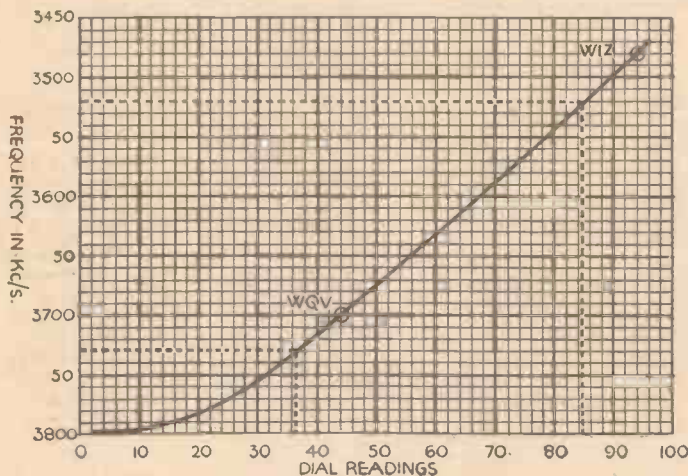

FIG. 3.—The curve obtained with the circuit shown in Fig. 2. In this example, the calibration spread is 5 kc/s per dial division, which could easily be improved upon. WIZ (6,965 kc/s) and WQV on 14,800 kc/s are possible marker stations. The dotted lines show the limits of the 80-metre amateur band. Readings below 30 degrees would be unreliable owing to flattening of the curve due to the lumped capacity in the circuit.

capacity consisting simply of two pieces of aluminium or thin brass, 1in. long by 1/4 in. wide, each bent at right angles in the middle, the two sections then being mounted on a strip of ebonite so that they are 1/4 in. apart. One side is connected to the grid of the meter valve, as shown, and to the other side is taken an insulated lead which can either be clipped to the aerial terminal of the receiver if it has an H.F. stage, or brought near (but not actually connected to) the receiver grid coil if the set is a detector-L.F. arrangement. This serves to increase pick-up from the meter, though it may not be necessary in some instances. In any case, the pick-up will be quite good on the 160, 80 and 40-metre bands if a common battery supply is used. This is the simplest and most economical method of coupling the meter to the receiver.

The construction of the instrument does not call for much comment, as it will be a matter of individual preference. It is essential, however, that it should be solidly constructed as one unit, preferably on an aluminium chassis—base 5in. square by 1 1/2 in. deep, with a panel 7in. high, will be

thought will show that all signals heard within the range of the meter, provided their frequencies are known with certainty, can be referred to the 80-metre band for calibration purposes. Remembering the harmonic principle, it follows that it is only necessary to make a simple calculation to put a frequency near, say, 20 metres on its correct spot on the 80-metre curve. For instance, suppose one evening WKP on 6,950 kc/s is heard at the top of the 40-metre band. He will probably be sending "VVV de WKP." Tune this on the receiver and adjust to zero beat ("silent point"). Tune the frequency meter till its beat-note is heard on the receiver and also adjust it to zero beat. Then, receiver and frequency meter will both be tuned to WKP on 6,950 kc/s. Suppose the meter dial reading is 94 degrees. This will correspond to frequencies of 1,737.5, 3,475, 6,950, 13,900 kc/s., in or near the 160, 80, 40 and 20-metre bands respectively. Similarly, WEB can often be heard on 14,770 kc/s, below the 20-metre band. This frequency corresponds to 7,385 kc/s, just outside the H.F. end of 40 metres;

HETERODYNE METER TABLE OF CALIBRATION FREQUENCIES.

Call-Sign	Frequency
KEN	6,845
WKP	6,950
WIZ	6,965
DHE	7,324
WEG	7,410
DIY	7,537
XGO	7,580
WQU	13,855
WEB	14,770
WQV	14,800
WKU	14,830
WAZ	14,920

In addition to the above, W6XX and W9XAN make standard frequency transmissions on a schedule announced a month in advance. The frequencies used are at intervals of 100 kc/s in the 80 and 40-metre bands, and are receivable in this country. The schedule is obtainable through this paper.

Call-Sign	Frequency
G5ZJ	1,732
G5BM	1,760
G2WO	1,766
G5KT	1,775
G5JU	1,794
G5KG	1,830
G6FO	1,850
G2PL	1,870
G6GM	1,900

The amateur frequencies above should be verified by reference to the station concerned before being taken as definite.

BRITISH LONG DISTANCE LISTENERS' CLUB

Veri Cards

THE recent correspondence on the subject of acknowledgements of reports has brought the following letter from a member, Mr. L. J. Marsh, of Fratton. He says: "As a member of several wireless clubs and societies, including BSWL, I must protest against G6JI's statements. The object of organisation is to gain scientific knowledge, and this is the primary object of BSWL. Concerning the QSL business, many members had a lot of cards before BSWL came into being, and I consider that this interesting part of short-wave listening is nearly played out. But BSWL will even then continue to grow. Were I to send reports to every TX I hear, I should spend more than I earn on postage, etc. The trouble with G6JI seems to be that he wishes to be a personality and not part of an organisation, but I must call his attention to the fact that 'Without another interested person his TX would be of little use.'

"Even Marconi had to have a listening post to conduct his experiments. Had the TX's of this country combined with Mr. Rowden in his recent scheme to keep the 7 mc/s band clear, this band would be good now and a lot of knowledge would have been gained, but the TX's preferred to use their apparatus to have a bit of fun with, instead of using it for scientific investigation. I have submitted a good many reports, but I have only once asked for a card, and then only for sentimental reasons. When I received this card, the gentleman who sent it me wrote: 'I do not QSL European or GSWL's, but you have won one O.M.

for your reports over more than eighteen months.' I trust he received my letter of thanks. Concerning Gramophile's letter on this short-wave business. His quip on Mr. Leigh's 344 stations on 20 metres in a couple of months is out of place, as Mr. Leigh's statement was only a matter of interest, not a boast. I happen to know it to be true, and, incidentally, Mr. Leigh (an A.A. man) is interested in all the aspects of radio, and is trying to gain and give knowledge from and to anyone, and he certainly does not try to make fun of anyone's efforts to interest his fellow man.

"And now may I say to those fellows who send logs from their districts: One logging with details is better than a long list of call-signs unless, of course, it happens to be a really DX list, which is generally not the case. In conclusion, may I say to SWL's, TX's and all interested. Get together to find out things and don't worry about pulling the other fellow to pieces; it is only wasting part of your three score years and ten."—BLDLC 173.

Morse Practice

MR. D. R. WARREN, writing from Bournemouth, says: "As is well known, conditions on the 10-metre band are good at the present time. I have had very much pleasure in talking to several American 'phone stations on this band through the British amateur station G6LK.

"On December 26th conditions were very good, and after a test call, no fewer than five stations were heard answering. Of these we selected W9BHT, who was putting in an R9+ signal, and had a very fine 100 per cent. QSO. In all, eight stations were worked in forty-five minutes.

"I hope this will be of interest to members of the BLDLC. I myself am a member, and would be pleased to be put in touch with any member near Cranleigh who would like to hold morse practice."

THE 'RANGER' S. W. CONVERTER

EVERY user of a standard broadcast receiver can now take advantage of the short-wave transmissions, simply by using one of the many adapters or converters which are now available. One of the latest of these units to be brought to our notice is the "Ranger," manufactured by the Radio Industries Development Co., of Stoke-on-Trent. The cabinet in which this is housed consists of a sheet of aluminium bent and bolted to form the four sides, with thin ebonite top and bottom panels, the whole being held together with long lengths of 2BA studding passed from one panel to the other. Terminal heads at the lower end serve for feet upon which the cabinet stands.

The Circuit

The circuit consists of a more or less standard frequency-changer arrangement in which one of the special octode valves has to be employed, the recommendation of the makers being for a Mullard FC2 or FC4. A 7-pin valveholder is fitted and is held in position towards the bottom of the cabinet by means of lengths of metal studding, so that the valve top projects through the upper panel. A plug-top connector is provided for connection purposes. The coils provided cover two separate ranges, controlled by a switch on the panel. In one position the range is from 15 to 35 metres, and in the other position from 33 to 85 metres. The leads from the unit are fitted with a 7-pin adapter plug for insertion into the valveholder for the output pentode stage in a

standard broadcast receiver. This ensures the maximum H.T. voltage and avoids certain forms of H.F. instability. To enable the unit to be used in cases where a four-pin or five-pin valve is employed, a 5-pin adapter is supplied with the unit and may be attached to the leads in place of the adapter which is fitted.

Test Result

The unit is used in the usual way, the receiver being tuned to the long waves, the most satisfactory wavelength being somewhere between 1,500 and 2,200 metres. It is necessary to try one or two different settings in the tuning of the broadcast receiver, not only to obtain maximum volume but also to avoid interference from long-wave stations. The most efficient point is easily observed, by switching on and setting the tuning dial on the unit to a point where no signal (or a very weak signal) is obtained, and then turning the broadcast receiver control until the background noise appears at its loudest. When a signal is located, it may then be found desirable to make a very slight adjustment on one side or another of this preliminary setting. The unit was tested with two or three standard broadcast receivers and proved very efficient and simple to handle. The slow-motion drive which is fitted, coupled with the screening which is incorporated, enabled many stations to be tuned in easily without hand-capacity effects or other erratic tuning points. The price of this unit is 27s. 6d. without valve or 37s. 6d. with valve.

PETO-SCOTT

DO YOU KNOW?

Do you know that you can obtain all your radio requirements from us either for CASH, C.O.D. or under our famous Easyway system? No matter whether you require complete Kits, or Loudspeakers, eliminators, pick-ups, or a selection of special components for a set you intend to build, we will be pleased to quote you our EASY TERMS without obligation. We are the oldest Radio by Mail House in the country and have been established since 1919, so you can order with confidence.

RECORD ALL WAVE 3 KIT "A" CASH OR C.O.D. £4.26

or 12 monthly payments of 7/6. Author's Kit of first specified parts, less valves, cabinet and speaker. KIT "B" As for Kit "A," but including specified valves only. Cash or C.O.D. Carriage Paid £5.93. Or 12 monthly payments of 10/-. KIT "C" As for Kit "A," but including valves and specified cabinet only. Cash or C.O.D. Carriage Paid £7.43. Or 12 monthly payments of 13/3.

Peto-Scott 1937 SUPER SENSITIVE S.G.3 KIT

A NEW VERSION of AN OLD SUCCESS

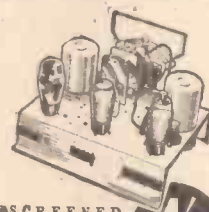

Without a doubt the very last word in sensitive and selective Kits, capable of providing real entertainment from numerous British and Foreign stations. Screened grid detector. Harries Pentode Output valves.

- SCREENED WAVE - WOUND AIR CORE COILS.
- DRILLED GREY ENAMELLED STEEL CHASSIS.
- PICK-UP CONNECTIONS.
- FULL INSTRUCTIONS WITH EVERY KIT.

4 DOWN

And 11 monthly payments of 4/6.

KIT "A" 47/6

Cash or C.O.D. Carriage Paid Complete kit of parts including ready-drilled enamelled steel chassis less valves, cabinet and speaker.

Fully described in Booklet "B"

THE NEW W.B. STENTORIAN IMMEDIATE DELIVERY YOURS FOR 2/6 DOWN

MODEL 37S. Amazing reproduction provided by new magnet and exponential moulded cone. Microtone matching device. Perfectly matches any receiver as principal or extra speaker. Cash or C.O.D. Carr. Paid, £2/2/0, or 2/6 down and 11 monthly payments of 4/-. MODEL 37L. Wonderful improvement in volume and realism of reproduction. Cash or C.O.D. Carr. Paid, £1/12/6, or 2/6 down and 11 monthly payments of 3/-. Any W.B. Chassis or Cabinet model available on attractive Easy Terms.



H.T. for 1d. per WEEK!

Peto-Scott H.T. ELIMINATORS Cost only 1d. a week to run!



Model A.C.12 Eliminator— Suitable for sets operating on an output of up to 12 m/A. A.C. 200/150-v., 40/100 cycles. Output 120-v. at 12 m/A. 4 t a p p l i e s. 60-v., 75-v., 90-v., and 120-v. Cash or C.O.D. Carriage Paid, 20/-, or 2/6 down and 10 monthly payments of 3/-. MODEL MA 10-30 Eliminator and TRICKLE CHARGER, £2/10/6, or 5/- down and 11 monthly payments of 5/6.

2/6 DOWN

Fully described in Booklet "B"

FREE TO READERS

Send for our beautiful Art Brochure "All-Wave Radio for the Millions," and also for our 40-page 2-colour catalogue which fully describes 36 Peto-Scott All-Wave Broadcast, Battery and Mains Receivers. Every Peto-Scott Radio Set is amazingly reliable, extremely efficient, and is outstanding value for money. Models from £4/10/6. Cash or C.O.D., or from 5/- down. Peto-Scott have specialised in Radio since 1919, and that is why we give you the best Radio at prices that defy competition.

PETO-SCOTT Co., Ltd., 77 (Pt. W. 17), City Road, London, E.C.1. Telephone: Clissold 9875 EST. 1919 West End: 62 (Pt. W. 17), High Holborn, London, W.C.1.

A Radio mechanic named Hyde

For a "faul-finder's" job once applied.

"I'll be all right," he mused;

"Where no FLUXITE'S been used

I could always find fault if I tried."



See that FLUXITE is always by you—in the house—garage—workshop—wherever speedy soldering is needed. Used for 30 years in government works and by leading engineers and manufacturers. Of Ironmongers—in tins, 4d., 8d., 1/4 and 2/8.

Ask to see the FLUXITE SMALL-SPACE SOLDERING SET—compact but substantial—complete with full instructions, 7/6.

Write for Free Book on the art of "soft" soldering and ask for Leaflet on CASE-HARDENING STEEL and TEMPERING TOOLS with FLUXITE.

TO CYCLISTS! Your wheels will NOT keep round and true, unless the spokes are tied with the fine wire at the crossings AND SOLDERED. This makes a much stronger wheel. It's simple—with FLUXITE—but IMPORTANT.

THE FLUXITE GUN

is always ready to put Fluxite on the soldering job instantly. A little pressure places the right quantity on the right spot and one charging lasts for ages. Price 1/6.



ALL MECHANICS WILL HAVE

FLUXITE

IT SIMPLIFIES ALL SOLDERING

FLUXITE LTD. (Dept. W.P.) DRAGON WORKS, BERMONDSEY STREET, S.E.1.

HOME CHARGING!

The new Heyberd "MIDGET" Battery Charger incorporates a METAL RECTIFIER and will charge a 2-volt accumulator at 1/2 amp., for LESS THAN 1d. PER WEEK. Simply connect the output terminals of the charger to the battery, and insert the mains lead into the nearest power point. Home Charging ensures that the accumulator is always "well up" when required.

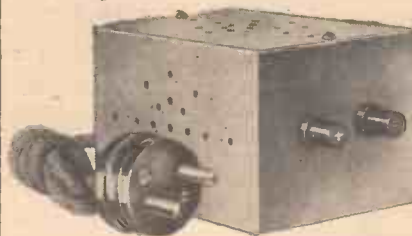

Complete with Mains Lead and Adaptor.

SEND NOW FOR FULL DETAILS OF THIS REMARKABLE MIDGET BATTERY CHARGER.

12/6

F. C. HEYBERD & Co. 10, FINSBURY STREET, LONDON - E.C.2

FIRST TELEVISION SCHOOL

Full Radio Television courses for degrees of this Society, A.M.I.R.E. or A.M.I.T.E.

Full details from—
INSTITUTION OF TELEVISION ENGINEERS, (Limited by guarantee)
65, Lichfield Street, Wolverhampton.

THE "W.B." Long-arm

PRACTICALLY every listener now employs an extension speaker, and although this gives a considerable increase in the amount of entertainment which is provided by the radio receiver (due to the additional listening point without which it might be difficult or inconvenient to listen at some particular moment) this may be considerably improved upon if the receiver may be controlled from that point. In the ordinary way, it is necessary to go into the room where the receiver is installed in order to switch it on or off, and a common method of using the extension speaker is in a bedroom, and for listening late at night, for instance, it would not be convenient to go downstairs in order to switch off. Remote controls of various types have been designed from time to time, and in its simplest form this consists of a simple solenoid which is connected to a local battery supply. When

which is designed for use in conjunction with the W.B. Extension loudspeaker.

How It Works

We have received a set of the various essentials for the equipment of a remote listening point, consisting of a speaker, long-arm, volume control, and length of three-core cable. The volume control is of the wire-wound type, with tappings brought out to contact studs, and the contact arm is drilled through to carry a thin metal plunger. At the end this may be brought into contact with another short metal arm, which in turn will short-circuit two thin springy contact arms fitted to the bakelite moulding carrying the control. This is fitted with a transparent cover to prevent the entry of dust and thus ensures noiseless working. Four flexible leads are attached to this, and two are intended for connection to a pair of terminals provided on the W.B. Stentorian loudspeakers.

Connections

There are five terminals on the long-arm unit, two of which are joined to the speaker terminals on the receiver, and the remaining three to the three terminals on the extension speaker, or special volume control. Two leads from the long-arm are connected to the accumulator for the L.T. supply, and the L.T. leads on the receiver are joined to a plug for insertion into the unit. Thus, when the button on the extension speaker is pressed in, the L.T. supply

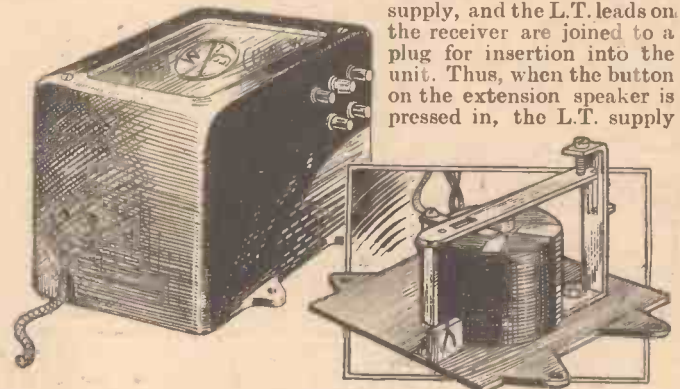

This is the Long-arm Unit showing the internal construction

the solenoid is energised the movement of a core operates a suitable switch, and this is in effect the basis of the W.B. Long-arm device. But the makers have considered the subject more thoroughly than merely from the switching point of view, and the result is the production of a combination device

from the accumulator via the long-arm unit is interrupted. The arrangement was tried out and found to function in a very efficient manner. The long-arm unit costs 15s. 6d. and the volume control 3s. The three-way cable may be obtained from most good electrical dealers.

REPLIES IN BRIEF

The following replies to queries are given in abbreviated form either because of non-compliance with our rules, or because the point raised is not of general interest.

H. L. T. (Dartmouth). The diagram is rather confused, but appears in order. Your receiver may be unsuitable for use with this particular unit and you should consult the makers with regard to this point.

F. C. (Dungannon). Constructional details are given each week about some feature or another. In addition, the various receivers described are dealt with clearly from the constructional point of view, as well as the operating details. Perhaps you could let us know what further information you require.

K. D. (North Lowestoft). The various bands adjoin one another, and we presume you refer to the amateur bands. The allocations are made by the P.M.G.

J. W. W. (Coalville). We regret that we are not familiar with the servicing difficulties of commercial receivers and suggest that you communicate with the makers or their nearest local service agent.

R. C. (Birmingham 18). We regret that we cannot trace the component in our records and accordingly are unable to give you the appropriate connections.

G. R. (Drem, E. Lothian). A faulty volume control could give rise to the trouble, as also could the wrong type of H.F. valve. Perhaps you could check both of these points.

J. W. D. (Nottingham). The coil in question could be used without difficulty. The aerial should be joined as shown in your sketch, and the plate connection should go to the junction of the anode and H.F. choke.

W. A. (Northampton). An unsuitable H.F. choke,

wrong H.T. voltage, and too large an aerial can give rise to the difficulties mentioned. Try a pre-set or small variable condenser in the aerial lead, and adjust the H.T. voltage with a view to overcoming the trouble. We cannot give the capacity of the condenser as it varies according to the spacing and shape, and the number of vanes is no indication.

E. J. W. (Wigan). The crystal does not produce the voltage, but it is ground to oscillate at one particular frequency. The power is the anode dissipation of the valve. Two PX.4's could be used.

A. J. W. (Chester). The valve you mention could be used, but is not so efficient for this particular circuit as the specified valve.

P. S. W. (S.E.3). One of the valves may be of the multi-electrode type, such as a double-diode-triode, and this accounts for the small number. Alternatively, there may be one or more Westectors (or cold valves) hidden away under the chassis.

L. M. (Dublin). It is a matter of opinion, and one listener prefers one whilst the other prefers the second form of output. Hear them both so that you can judge which suits your ear best. The output in the second case mentioned would be 1/2 watts with 5 per cent. second harmonic distortion, and the total anode current 16 mA.

W. O. (Hoxton, N.1). Kit A for the receiver in question costs £1 17s. 6d., from Peto-Scott.

R. I. W. (Kintbury). The condenser costs 7s. 6d., and the crystal complete with holder costs £1 3s. 6d.

F. K. W. (Ponders End). It would be best to use the S.G. valve without bias, although this would increase the H.T. consumption. You cannot use the variable volume characteristic in the circuit referred to, and it would really be preferable to obtain a power or small power valve and use the triode as detector.

G. W. (S. Shields). The Morse Code was published in our issue dated November 28th, last.

RADIO CLUBS AND SOCIETIES

Club Reports should not exceed 200 words in length and should be received First Post each Monday morning for publication in the following week's issue.

Newtownards Amateur Radio Club (Northern Ireland)

THIS newly formed club, the first of its kind in Northern Ireland, has had a good send off. The official inauguration took place at a meeting which was held in the Good Templar Hall, Newtownards, on Thursday evening, December 3rd, the chair being occupied by Mr. M'Gavock.

It was arranged that the yearly subscription would be 2s. 6d., to be paid on or before January 1st of each year, and that members should pay 1s. per month. It was further resolved that meetings of the club will be held on the first Thursday in each month at 8 o'clock p.m. (G.M.T.), the place of meeting to be previously arranged by the committee. T. L. Kirk, Hon. Sec., Chapel View, Newtownards, Co. Down, Ulster, N. Ireland.

Halifax Experimental Radio Society

THE above newly formed society welcomes any readers to their meetings, which are held at the Friendly and Trades Club Room, No. 13, St. James Road, Halifax, at 7 p.m. every Thursday. Entrance fee 1s. All details at meetings or from the Hon. Sec., W. Milner, "Ryburn Radio," Sowerby Bridge, Nr. Halifax.

The Croydon Radio Society

THE Croydon Radio Society's second half of the session is now in full swing, and the following is a list of some forthcoming events:—

January 19th: "Modern Sound Film Technique." Lecture by the chairman, Mr. W. J. Bird.

January 26th: "Components of Modern Types and their Uses." Descriptive demonstration by A. F. Bulgin and Co.

February 2nd: Loudspeaker Night.

February 9th: A members talk on: "Sound and its Reproduction."

February 16th: Visit to the Short-Wave Radio and Television Society of Thornton Heath.

February 23rd: Demonstration and lecture by Mr. P. K. Turner, of Hartley Turner Radio, Ltd.

Full details of programmes are in the new fixture card up to April, and PRACTICAL AND AMATEUR WIRELESS readers are invited to any meeting. The half session subscription is now in operation. Hon. Pub. Sec., E. L. Cumbers, Maycourt, Campden Road, S. Croydon.

Cardiff and District Short-wave Club

DURING the last few weeks there has been great activity in the lecture and demonstration side of the club.

Mr. Phillips, 2BQB, continues his series of lectures on "Transmitting for the Beginner," and so far the following subjects have been dealt with:—

"Reinartz and Armstrong Circuits."

"Simple Crystal Controlled Circuits."

On February 4th, 1937, a supper will be held at the Barry's Commercial Hotel, St. Mary Street, Cardiff, at 7.30 p.m. (tickets 1s. 9d.), and members of the public, especially readers of PRACTICAL AND AMATEUR WIRELESS, are invited to attend. Reservations should be made to the Secretary before January 26th. Hon. Sec., H. H. Phillips, 132, Clare Road, Cardiff.

CLIX



V.5.

CLIX VALVEHOLDERS

Four 7-pin 11d. each
One 5-pin 8d.

(Without Terminals)

As specified for the "AC/DC Superhet 4"

Yours faithfully
LECTRO LINX LIMITED

79 ROCHESTER ROW, LONDON S.W.1

LOUD SPEAKER CONTROL PANEL

"A useful device and a valuable safeguard."

Vide: "Practical & Amateur Wireless," Sept. 12th, 1936

"A useful device for fitting to a receiver so that an external loud speaker may be used in conjunction with the internal one, or without it, or the internal loud speaker used alone."

Vide: "The Wireless World," Nov. 27th, 1936.

Specified for the
"AC/DC SUPERHET 4"

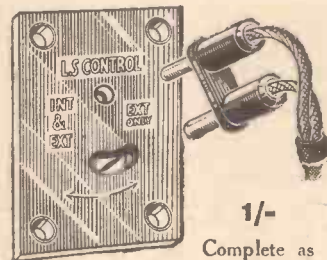

1/-

Complete as illustrated.

AC/DC SUPERHET 4

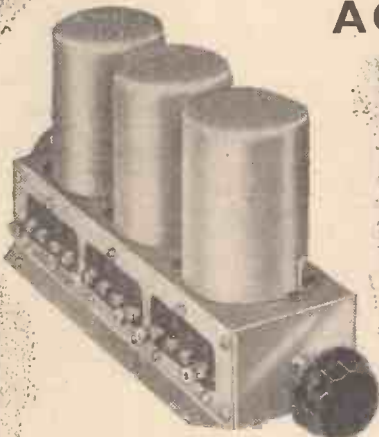

When building the AC/DC SUPERHET 4, follow the designer's advice. Use a Varley BP.111 3-gang unit, also two I.F. Transformers BP.84 and the results are bound to please you.

Varley components have again been specified because of their supreme accuracy, resulting from the wide experience of their makers.

LIST NO.	PRICE
BP.111. 3-Gang for Superhet	£1 1 0
Sets	
BP.84. Intermediate Frequency Transformer 110 kc.	8 6
BP.112. 2-Gang for Superhet	13 6
Sets	
BP.113. 3-Gang for Straight	£1 1 0
Sets	
BP.114. 2-Gang for Straight	13 6
Sets	

We have recently published four brand new circuit blueprints, which are giving excellent results with our new ganged units. No. 1 (BP.111) Mains Superhet for 110 kc. No. 2 (BP.112) Battery Superhet for 465 kc. No. 3 (BP.113) Three valve mains receiver with band pass tuners. No. 4 (BP.114) Screened-grid Battery Three with Pentode. You can have one of these blueprints (and they're really worth having) for 6d. (BP.111, BP.112, BP.113), or the BP.114 for 3d. The postage is free.

Varley

TO VARLEY (OLIVER PELL CONTROL LTD.), BLOOMFIELD RD., WOOLWICH, S.E.18.
Please send me, Post Free, the following blueprint(s). (Put List No. here) I enclose 6d. in stamps for either the B.P. 111, B.P.112, or the B.P.113, or 3d. in stamps for the BP.114.

NAME

ADDRESS PRAC. 16/1/37.

Facts and Figures

COMPONENTS TESTED IN OUR NEW LABORATORY

Garrard Gramophone Motors

THERE is a wide range of motors suitable for use with a radiogram, and these include both clockwork and electric models. For the listener who has no electric mains facilities, a clockwork model has to be employed and in general it is preferable to select one with as large a spring as possible. This is not entirely to prevent the trouble of winding between each record, but the reserve power which is available ensures that a 12in. disc will be turned at a constant speed right to the end of the record, no matter how loud the recording. Such a motor is shown at the foot of this page, and is the Garrard model No. 30. This is supplied with a 12in. plush-covered turntable, brake, speed indicator with top speed adjuster for mounting on the motor-board, regulating lever, patent winding crank, escutcheon with fibre bush, screws, rubber and steel washers, and will, if desired, play both sides of a 12in. record at one winding. The price of this model is 25s., and the rubber washers supplied will ensure that the slight vibration which results from the mechanism will not have any effect on a radio receiver which may be mounted on the same motor-board.

The other model illustrated is an induction motor from the Garrard range, No. AC4. This also is complete with a 12in. plush-covered turntable, and is ready mounted on a Florentine bronze motor plate, with speed indicator and a fully automatic starting and stopping switch. The price of this model is 42s. 6d.

G.E.C. P.M. Loudspeakers

THERE is a growing tendency, for technical reasons, to use public address loudspeakers of a high impedance line type when they are situated at some distance from an amplifier.

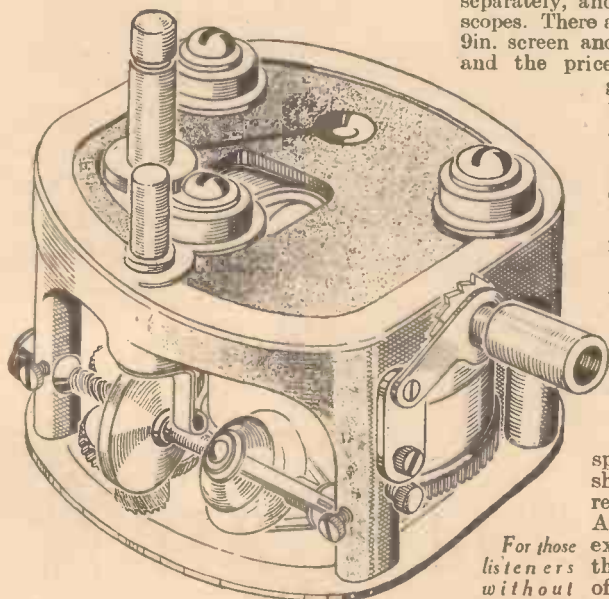

For those listeners without mains facilities, this Garrard clockwork motor will be found very useful when constructing a radiogram. It costs 25s. and will play two sides of a 12in. record with one winding.

The General Electric Co., Ltd., have therefore, introduced a modification to the moving-coil loudspeakers available in chassis and cabinet form and previously known as the BCS.3170 and BCS.3175 respectively. These units now have a 5,000 ohm primary speech transformer fitted to them, although connections direct to the 5-ohm speech coil can still be easily made. The catalogue numbers assigned to these units are BCS.3171 (high impedance) P.M. moving-coil loudspeaker chassis, and BCS.3176 (high impedance) P.M. moving-coil cabinet loudspeaker. Supplies are now available.

Cathode-ray Tubes

A NEW high-vacuum cathode-ray tube of the double-electrostatic type is now available in the Mullard range. This is designed primarily for use as an indicator or measuring instrument for test apparatus, and has a 7 cm. screen of the green type. The heater is of the indirectly-heated type rated at 4 volts 1 amp. and the second anode is designed for a maximum working-voltage of 800. The type number is E40-G3 and the price £4-15-0.

The Marconiphone Company now announce that their cathode-ray tubes for television receivers are available for sale separately, and are to be known as Emiscopes. There are two types, one having a 9in. screen and the other a 12in. screen, and the prices are 11 guineas and 15 guineas respectively. Full technical details will be given in a later issue.

Ever-Ready Dial Lamp

THE importance of using the correct type of lamp for dial illumination cannot be too strongly emphasised, and we have several times discussed this problem in these pages. In a simple battery receiver, the ordinary flash-lamp type of bulb is rather too heavy on current to be economical in use and a special low-consumption bulb should be used. On mains receivers operated from an A.C. supply many listeners experience difficulty due to the use of a flash-lamp bulb of 3.5 or 4 volt rating, and this is joined to the nearest heater terminals on a valve-holder in the receiver. As, however, the heater supply

is 4 volts A.C. the bulb is seriously over-run, and although it gives a brilliant light it very soon burns out. A bulb of 6-volt type should be used, and will give ample illumination as well as a long life. The Ever Ready Company have now introduced a new type of bulb for the purpose, rated at 6.3 volts .15 amp. and this is of the 15mm. type, with a bayonet cap. It gives much better illumination, which is especially desirable with a large scale of the "airplane" or full-vision type, and the bayonet holder simplifies replacement and enables a more positive electrical connection to be obtained, with a consequent reduction in the risk of noises due to poor contact. The price is 9d.

Ferranti Service Kits

THE service engineer who is called to visit a receiver in a listener's house needs to carry a fair number of components for replacement purposes, but it is generally found that in the majority

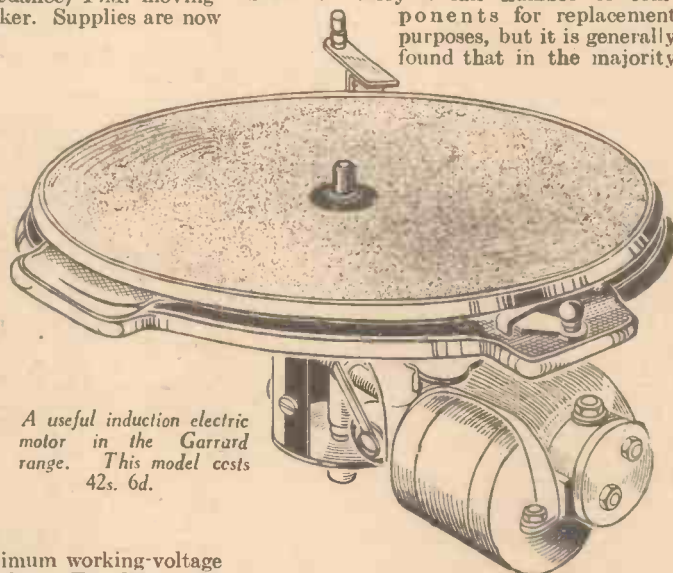

A useful induction electric motor in the Garrard range. This model costs 42s. 6d.

of cases the faulty part is a condenser or resistor. A new kit of such parts is now included in the Ferranti range of service apparatus and it includes 23 half-watt resistors, 21 one-watt, 3 two-watt, and 22 condensers. A second kit (known as Kit B) includes 53 half-watt resistors, 41 one-watt, 6 two-watt, 39 condensers, and 4 volume controls. The condensers which are included embrace ordinary small fixed types as well as low and high-voltage electrolytics. The smaller kit costs 25s. and the larger one £3.

S.W. SECTION

(Continued from page 548)

calibration, can always be used to bring the frequency "back on the curve" if any wandering is experienced. Thus, supposing WKP, originally at 94 degrees, is found to be on 95.5 degrees, and other stations are similarly affected, it is only necessary to set the frequency-meter dial at 94, the correct reading, and then to adjust condenser Cn till the meter beat-note is again heard on WKP in the receiver, thereby correcting the meter for the change which has taken place.

Such an instrument as that described will maintain its calibration for long periods; the writer used one exactly similar for over four years without detecting any appreciable change within the calibration limits, though it was in operation practically daily, and gave an accuracy of plus or minus 2 kc/s on 40 metres.

LETTERS FROM READERS

The Editor does not necessarily agree with opinions expressed by his correspondents.



All letters must be accompanied by the name and address of the sender (not necessarily for publication.)

An All-wave Mains Set!

SIR,—With reference to the correspondence in your paper about an all-wave mains set, I should like to support the suggestions made by Mr. J. D. Morris, of Stockport. I think such a set with three or four valves (excluding rectifier) would make a great appeal to your readers. It should contain all the features outlined by Mr. Morris, and should have really good selectivity besides, as he says, being reasonable in price.—R. BUCKLEY (Grimsby).

Soldered Contacts!

SIR,—It is a long time since I read anything so funny as the query on page 483 of your current issue, under the heading of "Soldered Contacts." Your querist, "B. W.," has evidently been to the local cheap stores for his "cold solder" and has obtained the usual mixture of celluloid, amyl acetate, and aluminium dust!

"Soldered" contacts! My Gawd!—H. J. LAYZELL (Canterbury).

[We indicated in our reply the essence of the remarks contained in the above letter.—ED.]

Our One-valve Transmitter: Reports Wanted

SIR,—I wish to say a few words about the one-valve transmitter, particulars of which you have just published. I have built the transmitter and have tried it out, and have had some very good reports—5R., 5S., 9T—from G stations on C.W. I have also worked a G station on phone.

I made an improvement to the transmitter by using it as a C.O. stage and coupling it to a P.A. stage, and just using the same method of modulation I was able to get a much stronger signal. I also found that a 10,000 ohms resistance across the crystal was better, and that the 24B valve was able to stand up to 220 volts D.C. mains without any heating.

Hong Kong S.W. Station

SIR,—With reference to Mr. Reed's letter in PRACTICAL AND AMATEUR WIRELESS dated October 31st, 1936, regarding the Hong Kong short-wave station, it seems that the transmission he logged was apparently H.K. ZCK on 31.47 m. Experiments having been carried out on the following frequencies: 49.18 m., 34.29 m., 31.49 m., 19.75 m., and 16.90 m.

Below are given the times of transmission from Hong Kong on 31.49 m., 9.52 mc/s, which will, no doubt, be of interest to other readers.

Sat., 02.30-06.15, 08.00-11.00*, 11.00-16.00. Sun., 04.30-06.15, 08.00-11.00* 11.00-15.00. Mon., 02.00-06.15, 09.00-12.00, 12.00-15.00*. Tues., 02.00-06.15, 08.00-11.00*, 11.00-15.00. Wed., 02.00-06.15, 08.00-11.00*, 11.00-15.00. Thurs., 02.00-06.15, 09.00-12.00, 12.00-15.00*. Fri., 02.00-06.15, 08.00-11.00*, 11.00-15.00. All times are G.M.T. * Denotes Chinese programme.

Announcements are in English by male or female announcer. Time signal at 12.00, also at 14.00 by Big Ben.

Reports to Hong Kong Broadcasting Station, P.O. Box 200, Hong Kong, China.—F. FREEMAN (Hong Kong).

REALISM—NOT JUST 'TONE'



Taken from a user's letter, the words above have an important meaning for you.

During 1937, will you be satisfied with "just tone" or will you let this new marvel of speaker efficiency bring you that vivid "life" which makes all the difference to radio listening?

To thousands, the new features of the 1937 Stentorian will bring a fresh radio enjoyment during the New Year. How about you?

Above is the 1937 Stentorian Senior Chassis, at 42/-. Incorporating an entirely new exponential moulded cone (manufactured from an exclusive material at Mansfield) it gives a width of response and freedom from resonances that must be heard to be believed. The enormous flux strength, original speech-coil construction, and re-designed matching system make possible a new sensitivity and brilliant "attack." It will make all the difference to your set.

Other models from 23/6. Ask your dealer.

Again Mr. Camm selects a Stentorian—this time for the AC/DC Super-het 4. Hear one, and you'll know why!



1937 STENTORIAN

THE NEW SPEAKER WITH THE NEW REALISM

WHITELEY ELECTRICAL RADIO CO., LTD. (Technical Dept.), MANSFIELD, NOTTS.

NORTHERN IRELAND

G i 8 G K

BRITISH AMATEUR RADIO STATION

TO RADIO

CONFIRMING OUR QSO ON

AT BST-GMT. UR SIGS WERE

RST. QSB. TO MOD. %

TX RX QRG K/C

ANTENNA INPUT WATTS

REMARKS

ORA. 11 SALISBURY GARDENS, BELFAST.

PSE/TRX QSL/O.M. VY. 73 DE S. R. WATSON.

I intend to try out a number of experiments with the one-valve transmitter to see what really can be done with it.

In conclusion, I shall be glad to have reports on my C.W. and phone tests (7,040 kc/s), and all reports will be acknowledged. Reports to be sent to Radio Society of Northern Ireland, Y.M.C.A., Wellington Place, Belfast.—S. R. WATSON (Belfast).

[A reproduction is given above of Mr. Watson's QSL card, a copy of which will be sent to all readers who report on his C.W. or phone tests.—ED.]

ELECTRADIX BARGAINS HOME RECORDING



Our machine-made, accuracy-cut Trackers are the cheapest on the market. Centre-drive or for 10in. Disc. Complete Tracker Sets, gear drive with cutter head, diamond needle and blanks. Bradford Model, 37/6. Felsh Model, 27/6. Blank Records, 4/- doz. Diamond Cutters, fit any pick-up, 7/6. Illustrated List "N."

WIRE-WOUND POWER RESISTANCES 5 watt 8,000 ohms, 10 m.a., 10d. 5-watt Potential Dividers, tapped 50,000 ohms, 1/8. Spaghetti Resistances, 3d. ca. **MORSE AND SIGNAL KEYS**, 5/-, 7/6, 18/6 and 25/-. **BUZZERS**, 1/6, 3/6 and 5/-. **SOUNDERS**, 5/-. 7/6 and 10/-. Morse Practice Sets complete, 4/9. **BELLS**, circular Desk vibrator in gong, 2/-. Wall Bell Pushes, Porcelain, 2/3. Gd. or 5/- doz. Brass pushes, 6d., 1/6 and 2/6. Pendant Pushes, 6d. Bakelite Fuse Carriers, 3d. Telsen Terminal Blocks, 3d. Black and Red Insulated Terminals, 2d. each, 1/9 dozen. Hydrometers, 3d. each. **MICROPHONES**. We are makers and carry the largest and most varied stock in London. Prices are low and there are models for all purposes. Our Public Address Elisel-Reiss Transverse Current Microphones are far superior and all the best judges use them. Only **55/-** High-grade Stand as illustrated, 15/- extra.

TABLE MODEL "W.N.11" For Home Broadcasting, containing transformer, switch and plugs; is a marvellous production at a low price. Bakelite square body on bronze base. Worth 2 guineas. Only 15/-. For other models, from 1/- to £10, see list "N."

TELEPHONES, House and Portable Inter-comm. and Telephones of various types cheap. Kindly specify wants. 120 ohm Sullyan Headphones, W.D. model. Aluminium body and headbands. Maker's price to-day, 15/-. Our price 2/9 per pair. 3d. postage.

METERS, 2,000 in stock, all sizes and ranges. 2" Special line of Megger milliammeters, thistle shape. 0-20 m/a, 12/6. Model 301, Weston 30 m/a, 15/-. 100 m/a, 17/6. Charge Pole-testers, 2/6. A.C./D.C. meters, 20 volts, 5/6; 50 volts, 5/6; 100 volts, 5/9. And 2,000 others up to 6,000 v.

MICRO-AMMETERS for small current Valve Voltmeters, etc. Sensitivity. 0 to 50 microamps full scale, moving coil, panel type, 2 1/2 in. dial. Reads direct your signal strength on a crystal set. 1,000 ohmores, 50mV. def. Cheap. 40/-.

1,000 other Bargains in New Sale List "N." Post Free.

ELECTRADIX RADIOS

218, Upper Thames Street, London, E.C.4
Phone: Central 4611

SHORT WAVES SLIP A SLOT AERIAL FILTER



Essential for all-wave sets. Makes your aerial adjustable at the turn of a knob. Complete with cut-out switch, from all dealers or post free from:

GRAHAM FARISH, LIMITED,
Masons Hill, Bromley, Kent.

W.B. STENTORIAN SPEAKERS

The Finest Permanent Magnet Loudspeakers on the market, supplied on lowest terms:—

37S: Cash or C.O.D. 42/-, or 2/6 down and 11 monthly payments of 4/-.

PROMPT DELIVERY.
Anything and everything Radio supplied on lowest terms.

The London Radio Supply Co., Ltd.,
11, Oct Lane, Noble Street, London, E.C.2.

Add 50/- WEEKLY to your earnings

Charge accumulators in your spare time. Complete Charger, incorporating Westinghouse Metal Rectifiers. Will charge 84 accumulators weekly. Price £4.4.0 or 8/- monthly. Send for full particulars.

M.P.R. ELECTRICAL CO., 252, Victoria Road, Romford, Essex.



Practical and Amateur Wireless BLUEPRINT SERVICE

PRACTICAL WIRELESS.		Date of Issur. No. of		PORTABLES.	
CRYSTAL SETS.		Blueprint		Three-valve: Blueprint, 1s.	
Blueprints, 6d. each.				F. J. Camm's ELF Three-valve	16.5.33 PW65
1937 Crystal Receiver	0.1.37	PW71		Portable (HF Pen, D, Pen)	
STRAIGHT SETS. Battery Operated.				Four-valve: Blueprint, 1s.	
One-valve: Blueprint, 1s.				Featherweight Portable Four (SG, D, LF, Cl. B)	PW12
All-wave Unipen (Pentode)	—	PW31A		MISCELLANEOUS.	
Two-valve: Blueprint, 1s.				S.W. Converter-Adapter (1 valve)	
Four-range Super Mag Two (D, Pen)	11.8.34	PW36B		AMATEUR WIRELESS AND WIRELESS MAGAZINE	
Three-valve: Blueprints, 1s. each.				CRYSTAL SETS.	
Selectone Battery Three (D, 2 LF (Trans))	—	PW10		Blueprints, 6d. each	
Sixty Shilling Three (D, 2LF (RC & Trans))	—	PW34A		Four-station Crystal Set	12.12.36 AW427
Leader Three (SG, D, Pow)	—	PW35		1934 Crystal Set	— AW444
Summit Three (HF Pen, D, Pen)	8.8.34	PW37		150-mile Crystal Set	— AW450
All Pentode Three (HF Pen, D (Pen), Pen)	22.9.34	PW39		STRAIGHT SETS. Battery Operated.	
Hall-Mark Three (SG, D, Pow)	—	PW41		One-valve: Blueprints, 1s. each.	
Hall-Mark Cadet (D, LF, Pen, (RC))	16.3.36	PW48		B.B.C. Special One-valver	
F. J. Camm's Silver Souvenir (HF Pen, D (Pen), Pen) (All-Wave Three)	13.4.35	PW49		Twenty-station Loudspeaker	
Genet Midget (D, 2 LF (Trans))	June '35	PM2		One-valver (Class B)	
Cameo Midget Three (D, 2 LF (Trans))	8.6.35	PW51		Two-valve: Blueprints, 1s. each.	
1936 Sonotone Three-Four (HF Pen, HF Pen, Westector, Pen)	17.8.35	PW53		Melody Ranger Two (D, Trans)	
Battery All-Wave Three (D, 2 LF (RC))	—	PW55		Full-volume Two (SG det. Pen)	
The Monitor (HF Pen, D, Pen)	—	PW61		B.B.C. National Two with Lucerne Coil (D, Trans)	
The Tutor Three (HF Pen, D, Pen)	21.3.36	PW62		Big-power Melody Two with Lucerne Coil (SG, Trans)	
The Centaur Three (SG, D, P)	—	PW64		Lucerne Minor (D, Pen)	
The Gladiator All-Wave Three	29.8.36	PW66		A Modern Two-valver	
F. J. Camm's Record All-Wave Three (HF Pen, D, Pen)	31.10.36	PW69		Three-valve: Blueprints, 1s. each.	
Four-valve: Blueprints, 1s. each.				Class B Three (D, Trans, Class B)	
Fury Four (2 SG, D, Pen)	—	PW11		New Britain's Favourite Three (D, Trans, Class B)	
Beta Universal Four (SG, D, LF, Cl. B)	—	PW17		Home-built Coil Three (SG, D, Trans)	
Nucleon Class B Four (SG, D (SG) LF, Cl. B)	6.1.34	PW34B		Fan and Family Three (D, Trans, Class B)	
Fury Four Super (SG, SG, D, Pen)	—	PW34C		£5 6s. S.G.3 (SG, D, Trans)	
Battery Hall-Mark 4 (HF, Pen, D, Push-Pull)	—	PW46		1934 Ether Searcher: Baseboard Model (SG, D, Pen)	
F. J. Camm's "Limit" All-Wave Four (HF Pen, D, LF, P)	26.9.36	PW67		1934 Ether Searcher: Chassis Model (SG, D, Pen)	
Mains Operated.				Lucerne Ranger (SG, D, Trans)	
Two-valve: Blueprints, 1s. each.				Cosor Melody Maker with Lucerne Coils	
A.C. Twin (D (Pen), Pen)	—	PW18		Mullard Master Three with Lucerne Coils	
A.C.-D.C. Two (SG, Pow)	7.10.33	PW31		£5 5s. Three: De Luxe Version (SG, D, Trans)	
Selectone A.C. Radiogram Two (D, Pow)	—	PW19		Lucerne Straight Three (D, RC, Trans)	
Three-valve: Blueprints, 1s. each.				All-Britain Three (HF Pen, D, Pen)	
Double-Diode-Triode Three (HF Pen, DDT, Pen)	10.6.33	PW23		"Wireless League" Three (HF Pen, D, Pen)	
D.C. Ace (SG, D, Pen)	—	PW25		Transportable Three (SG, D, Pen)	
A.C. Three (SG, D, Pen)	—	PW29		£6 6s. Radiogram (D, RC, Trans)	
A.C. Leader (HF Pen, D, Pow)	7.4.34	PW35C		Simple-tune Three (SG, D, Pen)	
D.C. Premier (HF Pen, D, Pen)	31.3.34	PW35B		Economy-Pentode Three (SG, D, Pen)	
Ubique (HF Pen, D (Pen), Pen)	28.7.34	PW36A		"W.M." 1934 Standard Three (SG, D, Pen)	
Armada Mains Three (HF Pen, D, Pen)	18.8.34	PW38		£3 3s. Three (SG, D, Trans)	
F. J. Camm's A.C. All-Wave Silver Souvenir Three (HF Pen, D, Pen)	11.5.35	PW50		Iron-core Band-pass Three (SG, D, QP 21)	
"All-Wave" A.C. Three (D, 2 LF (R.C.))	17.8.35	PW54		1935 £6 6s. Battery Three (SG, D, Pen)	
A.C. 1936 Sonotone (HF Pen, HF Pen, Westector, Pen)	—	PW56		PTP Three (Pen, D, Pen)	
Four-valve: Blueprints, 1s. each.				Certainty Three (SG, D, Pen)	
A.C. Fury Four (SG, SG, D, Pen)	—	PW20		Minutube Three (SG, D, Trans)	
A.C. Fury Four Super (SG, SG, D, Pen)	—	PW31D		All-wave Winning Three (SG, D, Pen)	
A.C. Hall-Mark (HF Pen, D, Push-Pull)	—	PW45		Five-valve: Blueprints, 1s. 6d. each.	
Universal Hall-Mark (HF, Pen, D, Push-Pull)	9.2.35	PW47		Super-quality Five (2 HF, D, RC, Trans)	
SUPERHETS.				Class B Quadrydne (2 SG, D, LF, Class B)	
Battery Sets: Blueprints, 1s. each.				Mains Operated.	
£5 Superhet (Three-Valve)	—	PW40		Two-valve: Blueprints, 1s. each.	
F. J. Camm's 2-valve Superhet (Two-Valve)	13.7.35	PW52		Consoelectric Two (D, Pen) A.C.	
F. J. Camm's £4 Superhet	—	PW58		Economy A.C. Two (D, Trans) A.C.	
Mains Sets: Blueprints, 1s. each.				Unicorn A.C./D.C. Two (D, Pen)	
A.C. £5 Superhet (Three-valve)	—	PW43		Three-valve: Blueprints, 1s. each.	
D.C. £5 Superhet (Three-valve)	1.12.34	PW42		Home-Lover's New All-electric Three (SG, D, Trans) A.C.	
Universal £5 Superhet (Three-valve)	—	PW44			
F. J. Camm's A.C. £4 Superhet 4	—	PW59			
F. J. Camm's Universal £4 Superhet 4	11.1.36	PW60			
SHORT-WAVE SETS.					
Two-valve: Blueprint, 1s.					
Midget Short-Wave Two (D, Pen)	15.9.34	PW33A			
Three-valve: Blueprints, 1s. each.					
Experimenter's Short-Wave Three (SG, D, Pow)	—	PW30A			
The Prefect 3 (D, 2 LF (RC and Trans))	—	PW63			
The Bandsread S.W. Three (HF Pen, D (Pen), Pen)	20.8.36	PW68			

These blueprints are drawn full size. Copies of appropriate issues containing descriptions of these sets can in some cases be supplied at the following prices, which are additional to the cost of the blueprint. A dash before the Blueprint Number indicates that the issue is out of print.

Issues of Practical Wireless	—	4d. Post paid
" " Amateur Wireless	—	4d. " "
" " Practical Mechanics	—	7d. " "
" " Wireless Magazine	—	1/3 " "

The index letters which precede the Blueprint Number indicate the periodical in which the description appears: thus, PW refers to Practical Wireless, AW to Amateur Wireless, PM to Practical Mechanics, WM to Wireless Magazine. Send (preferably) a postal order to cover the cost of the blueprint and the issue (stamps over 6d. unacceptable), to PRACTICAL AND AMATEUR WIRELESS Blueprint Dept., Geo. Newnes, Ltd., Tower House, Southampton Street, Strand, W.C.2.



QUERIES and ENQUIRIES

Twenty Station One-valver

"With reference to the blueprint of the battery-operated Twenty Station one-valve set, can you inform me as to the make, type and number of the valve required for this set?"—M. R. G. (Hornchurch).

THE valve used in this receiver is manufactured by the High Vacuum Valve company, and there is no alternative on the market. It consists of a combined Class B and driver valve enclosed in one glass bulb, and the type number is DB240. The valve has a 7-pin base and a top cap connection. The price of this valve is 15s. 6d.

L.F. Coupling

"I am anxious to make up a three-valver in which I have only a small H.T. supply.

RULES

We wish to draw the reader's attention to the fact that the Queries Service is intended only for the solution of problems or difficulties arising from the construction of receivers described in our pages, from articles appearing in our pages, or on general wireless matters. We regret that we cannot, for obvious reasons—

- (1) Supply circuit diagrams of complete multi-valve receivers.
- (2) Suggest alterations or modifications of receivers described in our contemporaries.
- (3) Suggest alterations or modifications to commercial receivers.
- (4) Answer queries over the telephone.
- (5) Grant interviews to querists.

Please note also, that queries must be limited to two per reader, and all sketches and drawings which are sent to us should bear the name and address of the sender.

Requests for Blueprints must not be enclosed with queries as they are dealt with by a different department.

If a postal reply is desired, a stamped addressed envelope must be enclosed. Send your queries to the Editor, PRACTICAL AND AMATEUR WIRELESS, George Newnes, Ltd., Tower House, Southampton Street, Strand, London, W.C.2.

The Coupon must be enclosed with every query.

This is obtained from a small mains unit and the total voltage is just 100. I am anxious to get the maximum gain from the L.F. valve and I am desirous of using R.C. coupling in the interests of quality. I believe it is possible to use an L.F. choke in place of the usual resistance in order to obtain quality, and if this is so I should be glad of details of a suitable choke."—F. I. (Dartford).

THE arrangement is certainly in order, and it is even possible to use a choke in place of the usual grid-leak in an R.C. stage, as well as for the anode load. A good L.F. choke of standard pattern may be employed, with an inductance of from 20 to 50 henries, and naturally you will obtain one with as low a D.C. resistance as possible. If the choke is to follow the detector, you may find it desirable to use one of the special chokes having an inductance of 200 or 300 henries. If you wish to retain a resistance as the anode load, and at the same time wish to add a decoupling circuit without voltage loss, you could use the choke for a decoupling component.

Igranitor Coils

"Can you supply me with the connections for the Igranitor coil, Type S.W., and let me know what condensers I need for tuning and reaction? The numbers on the coil are 1, 2, 3, 4."—W. W. (Crewe).

THIS coil was employed in conjunction with an Igranitor broadcast coil in

our All-wave Two receiver. Terminals 1 and 2 are connected to the reaction winding terminal 2 being joined to the anode and terminal 1 to the reaction condenser. This should have a maximum capacity of .0002 mfd. The aerial should be joined through a pre-set condenser to terminal 3, and terminal 4 is joined to earth. The condenser for tuning should have a maximum capacity of .0002 mfd. You could use a .0005 mfd. tuning condenser, and in that case the two ranges covered by the coil would be from 15 to 30 and from 28 to 80 metres.

The 2½-Watt Transmitter

"Can you give me the type number and the makers and price of the variable condenser which you specified for the transmitter recently described?"—T. C. (Poole).

THE condenser specified is manufactured by British Television Supplies, Ltd., and is the type number UVC/67. The metal parts of this particular component are silver plated and the dielectric material is reduced to a minimum. The price is 7s. 6d. The crystal, complete with holder, for this transmitter costs £1 3s. 6d., from the Quartz Crystal Company.

The coupon on Cover iii must be attached to every query.

Quartz Crystals

"I would be pleased if you could tell me where I could get quartz crystals for the transmitting circuits described in your issue dated December 26th last, and the prices. Have you any back numbers on learning the Morse Code? I am very interested in the new Amateur Transmitting series and am following them up every week."—K. B. (Earlsdon).

THERE are several firms who can supply quartz crystals, either complete and mounted for various frequencies or for final adjustment and mounting by the user. The crystal specified for our 2½-watt transmitter is supplied by the Quartz Crystal Company of 71, Kingston Road, New Malden. The first of the series on Transmitting gave the Morse Code in full and details of an oscillator suitable for learning the code. This was in our issue dated November 28th last.

A Service Oscillator

"As a regular reader of 'Practical and Amateur Wireless' I appreciate the information given, as I am a service man. I would like you to recommend an oscillator, preferably one-valve with modulation, suitable for use with batteries. I should like something to carry about conveniently."—R. B. (Hazel Grove, Nr. Southport).

WE have not described an instrument which would meet your requirements as set out in your letter. If you intend to take the instrument about with you, you obviously require it to carry out the maximum amount of work, and an all-wave oscillator would obviously be desirable to-day. With regard to the voltage supply problem, we would remind you that batteries are heavy, and a simple mains instrument can be constructed in a very much lighter form, especially if the "universal mains" arrangement is incorporated, as this excludes a mains transformer. In the circumstances we suggest you consider the construction of the Bulgin Modulated All-wave A.C./D.C. Oscillator, a Kit of Parts for which may be obtained from Messrs. Bulgin for £5. You may have quite a number of the necessary components already to hand, and the constructional details of this instrument will be found in the Bulgin publication *Radio Progress*, price 1s.

Amateur Addresses

"Will you please explain Q. R. M., Q.S.O., etc., and also let me know where I could obtain station addresses?"—K. B. (Bristol 3).

AS mentioned last week, the abbreviations are taken from what is known as the "Q" code and we shall give this in full shortly in our Transmitting series. Addresses of many amateurs in all parts of the world may be found in the publication entitled the *Radio Amateur Call Book*, published in America and obtainable in this country from F. L. Postlethwaite, 41, Kinfauns Road, Goodmayes, Ilford, Essex, price 5s. 3d. post free.

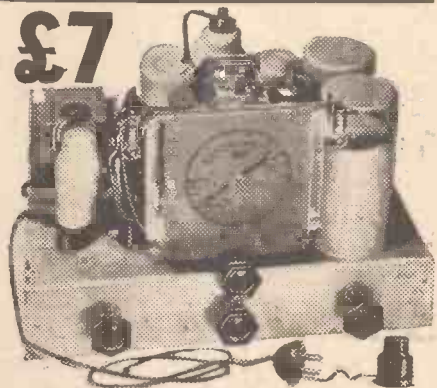

6 VALVE ALL-WAVE SUPERHET

(Complete with B.V.A. Valves)

Improved all-wave superheterodyne for A.C. or D.C. mains. High sensitivity on all three wave-bands (16.5-50 metres, 200-550 metres, 800-2,000 metres). Many interesting features, including:— Illuminated "Airplane" dial with station names. Special "squell" valve for inter-station noise suppression, with manual muting control. Octode frequency changer. 8 stages, 7 tuned circuits. Iron Cored I.F. Coils. Delayed A.V.C. 3.5 watts output. Extra heavy Cadmium-plated steel chassis.

£7 cash complete with valves, knobs, pilot lamps, mains cable and plug, etc. Deferred terms from London Radio Supply Co., 11, Oat Lane, E.C.2. 12 months' guarantee. Suitable loudspeakers, cabinets, etc., in stock.

McCarthy Chassis from £4 5s. to £12. Write for illustrated catalogue.

MCCARTHY RADIO LTD.

44a, Westbourne Grove, London, W.2.

Telephone: Bayswater 3201.

ENGINEERS! ARE YOU EARNING LESS THAN £10 PER WEEK?

If so, you cannot afford to carry on without reading our 268-page Handbook. The book explains clearly and definitely many ways of carving out a successful career. Among other things it explains the Services of our unique Appointments Department, outlines Home-study Courses in all branches of Civil, Mechanical, Electrical, Motor, Aero, Wireless, "Talkie," Engineering, Building, Govt. Employment, etc., and gives details of B.Sc., A.M.I.C.E., A.M.I.E.E., A.M.I.Mech.E., A.M.I.A.E., A.M.I.W.T., A.M.I.R.E., G.P.O., MATRIC, and all Exams. We Guarantee—"NO PASS—NO FEE." Whether you be an old hand or a budding apprentice, get this book to-day—FREE and POST FREE, BRITISH INSTITUTE OF ENGINEERING TECHNOLOGY, 409, Shakespeare House, 17/19, Stratford Place, London, W.1.



Miscellaneous Advertisements

Advertisements are accepted for these columns at the rate of 3d. per word. Words in black face and/or capitals are charged double this rate (minimum charge 3/- per paragraph). Display lines are charged at 6/- per line. All advertisements must be prepaid. All communications should be addressed to the Advertisement Manager, "Practical and Amateur Wireless," Southampton Street, Strand, London.

RECEIVERS, COMPONENTS AND ACCESSORIES
Surplus, Clearance or Secondhand, etc.

RADIOMART
SHORT-WAVE SPECIALISTS

SHORT-WAVE MANUAL

Packed with short-wave information and circuits of mains and battery receivers, including straight, superhet and 5-metre transmitters, modulators, etc. Information on transmitting licences, aerials, Class B amplifications, neutralization, superhet alignment, etc. The most comprehensive manual published, written by practical engineers, price 6d., post free 7½d., including catalogue.

1937 Catalogue only (3 times enlarged) price 1½d. post free.

TELSEN screened dual range coils, 2/6. Pair, 4/6. Milliammeters, 25 ma. upwards, 5/9. Super, 6/9. **A**MERICAN mains transformers 230v. fully shrouded, 350/350, 6.3v., 5v., 6/11. Majestic 250/250, 2.5v., 5v., 4/11.

HEAVY DUTY mains transformer worth 35/-, 350/350, 150 ma.; 4v. 2.5ACT, 4v. GACT, 12/6.

465 KC/S. IF transformers, 2/11. Telsen Ace, 2/9. 1/11. RG4. Radio grands, 2/0. 2mf. 300v., 9d.

UTILITY straight line wavelength dials, 3/11. Telsen H.F. chokes, 1/11.

UTILITY 2-gang uniknob and dial, 3/11; 1,500-volt tubular condensers, all sizes, 6d.

ELECTROLYTICS 500-volt 8 mfd., 1/6; 4 mf., 1/6; 4 x 4, 1/11; 8 x 8, 3/6; 25 mf., 25v., 1/-, etc.

SMOOTHING chokes, 20 hy. 120 ma., 3/11; 100 ma., 2/11; 40 ma., 1/11.

PUSHBACK wire, 6 yds., 6d.; heavy 9d.; 2 gross solder tags, 6d.; resin-coated solder, 9ft., 6d.

CENTRALAB pots, all sizes, 1/6; switched, 2/-; tubular glass fuses, 2d.

JENSON PM speakers, 12/6. Varley Iron core coils, 2/6; matched pair, 4/6.

SPECIAL OFFER Class B valve, driver transformer and valveholder, new, lot 5/-.

LISEN 3-gang bandpass, 3-gang superhet, 2-gang all-wave coils, any set, price 7/6.

TRADERS' monster bargain parcels, value £4/10/-, for 10/-; also 5/- parcels.

FAMOUS Continental A.C. valves, 4/6; American Dnutron, etc., all types, 3/6; battery from 2/3.

UTILITY 8/6, microdisc dials, 3/11; Radiophone, 0.00016 short-wave condensers, 3/6; series gap, 3/9.

CERAMIC all brass microvariables, 15 mmfd., 1/4; 40 mmfd., 1/7; 100 mmfd., 1/10; short-wave H.F.C., 9d.

CLEARANCE catalogue 1½d. Goods over 5/- post free. All enquirers must send stamp.

Branches: 19, John Bright St., 44, Dale Rd. Mail Orders, 44, Holloway Head, Birmingham. Telephone, MID 3254.

CONVERSION UNITS for operating D.C. Receivers from A.C. Mains, improved type, 120 watts output, at £2/10/0. Send for our comprehensive list of speakers, resistances and other components.

WARD, 46, Farringdon Street, London, E.C.4. Telephone: Holborn 9703.

EXPERIMENTERS' OPPORTUNITY. Parcels containing Wireless Components 40/- value for 5/6. Carriage 1/- Taylors, Radio House, Macaulay Street, Huddersfield.

MISCELLANEOUS

DO YOU WANT A PROFITABLE BUSINESS OF YOUR OWN? We show you exactly how to start and run a business with little capital from your own address. No office, shop or experience is necessary. You receive working details of 201 profit-earning businesses from which to make an immediate start. No risks. No waiting. Results are sure. Just send a p.c. to-day—NOW—for fully descriptive book to Business Service Institute (Dept. 121W), 6, Carmelite Street, London, E.C.4.

WANTED—ambitious young men to prepare for well paid posts in TELEVISION, the great career of the future. Apply for free booklet from BRITISH INSTITUTE OF ENGINEERING TECHNOLOGY, 18P, Shakespeare House, 17-19, Stratford Place, London, W 1.

PREMIER SUPPLY STORES

Get our quotation for your Short-Wave and Television Gear

Offer the following Set Manufacturers' Brand New Surplus Goods at a Fraction of the Original Cost; all goods guaranteed perfect; carr. paid over 5/-; under 5/- postage 6d. extra. Orders under 5/- cannot be sent C.O.D.

ALL POST ORDERS TO JUBILEE WORKS, 167, LOWER CLAPTON RD., LONDON, E.5
CALLERS, AS USUAL TO 20-22 HIGH ST., CLAPHAM, S.W.4 (Macaulay 2381). 'Phone: Amherst 4723
And 165 & 1652, FLEET ST., E.C.4 (Next door to Anderson's Hotel.) Central 2833.

MAINS VALVES

MAINS VALVES, famous Europa 4 v. A.O. types, 4/6 each. HL. L., S.G., Var.-Mu-S.G., H.F. Pens., Var.-Mu-H.F. Pens. 1, 3 and 4-watt A.C. directly-heated output Pentodes. Full-wave rectifiers, 250 v. 50 ma. A.C./D.C. types. 20-volt. 18 amp. S.G., Var.-Mu-S.G., H., HL., Power.

Following Types all 5/8 each. Full-wave rectifiers, 350 v. 120 ma. and 500 v. 120 ma. 2½ watt indirectly-heated Pentodes, Frequency Changers, Octodes and Heptodes.

BATTERY VALVES, 2 volts, H.F., L.F., 2/3. Power, Super-Power, 2/9. S.G., Var.-Mu-S.G., 4- or 5-pin Pentodes, H.F. Pens., V.-Mu-H.F. Pens. 5/-, Class B, 3/6.

AMERICAN VALVES, Genuine American HYTRON and TRIAD first-grade Valves, 3 months' guarantee. All types in stock, 5/8 each. 210 and 250, 3/6 each. New Metal-Glass Valves, all types, 6/6 each. Genuine American DUOTRON Valves, all types, 3/6 each. Valve holders for all above types, 6d. each. Metal bases, 9d. each.

SHORT WAVES

SHORT-WAVE COILS, 4. and 6-pin types, 13-26, 22-47, 41-94, 73-170 metres, 1/9 each, with circuit. Special set of 3*4-pin S.W. Coils, 14-150 metres, 4/- set, with circuit. Premier 3-band S.W. Coil, 11-25, 19-43, 38-86 metres. Simplified S.W. receiver construction, suitable any type circuit, 2/6.

COIL FORMERS, in finest plastic material, 1½in. low-loss ribbed, 4 or 6-pin, 1/- each.

SUPER CERAMIC CONDENSERS, S.L.F., .00016, .0001, 2/9 each; double-spaced, .00005, .000025, .000015, 3/- each. All brass with integral slow motion, .00015 tuning, 3/9; .00015 reaction, 2/9. British Radiophone coils, .00016, 5/6.

H.F. CHOKES, 8 and 10,000 metres, 6d.; S.W. screened, 1/6; standard screened 180-2,000 metres, 1/6.

CERAMIC S.W. VALVE HOLDERS, 4-, 5- or 7-pin. Chassis types, 6d.; B.B. type, 8d. **GLASS AERIAL INSULATORS**, 4d. each. **BEEHIVE STAND-ONE**, 6d. each. **SCREENED FLEK**, single, 3d. yd.; twin, 4d. yd.

PREMIER AMPLIFIER KITS

3-WATT A.C. AMPLIFIER, 2-stage, for mike or pick-up. Complete kit of parts with 3 valves, 40/-.

7-WATT A.C./D.C. AMPLIFIER, 3-stage, high-gain, push-pull output. Complete kit of parts with 5 specially matched valves, £4 4s.

10-WATT 3-stage A.C. Amplifier Kit with 5 valves, £5 5s.

20-WATT 3-stage A.C. Amplifier Kit with 5 valves, £8 8s.

ELECTROLYTICS, U.S.A. Electrolytics, 500 v. working Aqueous, 4, 8 and 16 mf., 1/9 each. Dry, 500 v., 10 mf., 1/9. Philips Aqueous, 8+8 mf., 320 v. working 380 v. Peak, 2/-; U.S.A. 8+8 mf. dry 500 v., 2/6. Dubilier, 4 or 8 mfd. 500 v., 3/-; 50 mfd. 50 v., 1/9; 10 mfd. 50 v., 6d.; 25 mfd. 25 v., 1/-; T.C.O. 4 or 8 mfd. 650 v., 4/-; 15 mfd. 50 or 100 v., 1/-; 50 mfd. 12 v., 1/-. Paper Condensers, W.B.L. 250 v. working 4 mf., 2/6; 2 mf., 1/-; 1 mf., 6d.; 350 v. working 4 mf., 2/6; 2 mf., 1/6.

Dubilier 500 v. working 4 mf., 4/-; 800 v. 4 mf., 6/-.

COSMOCORD PICK-UPS, with tonearm and volume control, 10/6 each.

PICK-UP HEADS only, 4/6 each.

MAINS TRANSFORMERS

PREMIER wire-end type with screened primaries, tapped 200-250 v. Centre-tapped Filaments. Guaranteed one year. H.T. 3 & 9 or H.T. 10 with 4 v. 4 a.c.t. and 4 v. 1 a.c.t., 8/6. 250-250 v. 60 ma., 4 v. 1 a., 4 v. 2 a. and 4 v. 4 a., all O.T. 8/6. 350-350 v. 120 ma., 4 v. 1 a., 4 v. 2 a. and 4 v. 4 a., all O.T., 10/6. Any of these transformers with engraved panel and N.P. terminals, 1/6 extra.

500-500 v. 150 ma., 4 v. 2-3 a., 4 v. 2-3 a., 4 v. 2-3 a., all O.T., 17/6. Super Model, 19/6. **AUTO-TRANSFORMERS**, step up or down, 60 watts, 7/6; 100 watts, 10/-.

SMOOTHING CHOKES, 25 ma., 2/9; 40 ma., 4/-; 60 ma., 5/6; 150 ma., 10/6. 2,500 ohms, 60 ma. Speaker Replacement Chokes, 5/6.

MILLIAMMETERS, moving-iron, flush 2½in. all ranges from 0-10 m.a., 5/9. Visual tuning, 6 or 12 m.a., 5/9. Moving-coil meters, 2½in. 0-1 m.a., 18/6; 3½in. 0-1 m.a., 22/6. Multipliers, 1/- each.

AMP METERS, all ranges, from 0-1 amp., 5/9. **TRANSFORMERS**, latest type Telsen R.G.4 (list 12/6), 2/9. Lissen Hypernik Q.P.P. (list 12/6), 3/6.

OUTPUT TRANSFORMERS for Power, Pentode and Push-Pull, 2/6; Multi-Ratio, 4/6; Push-Pull Input Transformers by prominent manufacturer, 4/6 each.

ELIMINATOR KITS, for A.C. mains, 120 v. 20 ma., or 150 v. 25 ma., 15/-, tapped S.G., det. and output. Complete Kit with long-life valve rectifier (replacement cost only 2/-).

PREMIER L.T. CHARGER KITS for A.O. mains, including Westinghouse Rectifiers and Tapped Mains Transformers, 8 volts at 1 amp., 14/6; 8 volts 1 a., 17/6; 15 volts 1 a., 19/-; 15+15; 8 volts 1 a., 37/6; 15+15+15 volts 1 a., 50/-; 8 volts 2 a., 29/6.

TELSEN iron-cored screened coils, W.349, 4/- each.

ELECTRO SOLDERING IRONS, 200-250 v., A.O./D.C. 2/3.

LOTUS JACKS (and Jack-switches), all types, 1/- each. Lotus Plugs, 1/- each.

PREMIER H.T. KITS, all with Westinghouse rectifiers; tapped transformers and adequate smoothing. All Kits absolutely complete, 120 v. 20 ma., 20/-; with 1 a. L.T. Charger, 29/-; 150 v. 30 ma., 25/-; with 1 a. L.T. Charger, 31/6; 250 v. 60 ma., with 4 v. 3 a. O.T., 30/-.

SHORT WAVE KITS

1937 SHORT-WAVE KITS. NEW 1937 **SHORT-WAVE 1-VALVE RECEIVER OR ADAPTOR KIT**, 13-86 metres, without coil changing! Complete Kit of Parts, with wiring diagram, 12/6. **VALVE GIVEN FREE!**

SUPER-HET CONVERTER KIT for Battery Sets, 13/6.

1937 DE LUXE 1-VALVE SHORT-WAVE KIT, 14-150 metres. Complete Kit of Parts, including All-metal Chassis, 4 coils, and all components, with wiring diagram, 17/6. **VALVE GIVEN FREE!**

1937 2-VALVE SHORT-WAVE KIT, 13-86 metres, without coil changing! Complete Kit of Parts, with wiring diagram, 19/6. **VALVES GIVEN FREE!**

1937 DE LUXE 2-VALVE SHORT-WAVE KIT, 14-150 metres. Complete Kit of Parts, including All-metal Chassis, 4 coils, all components and wiring diagram, 25/- **VALVES GIVEN FREE!**

S.W. SUPERHET CONVERTER for A.C. Receivers, 20/-; A.C. VALVE GIVEN FREE!

3-VALVE S.W. KIT, S.G. Det. and Pen., 42/- **VALVES GIVEN FREE!**

BAND-PASS TUNING PACK, comprising set of Telsen 3-gang iron-cored coils with switching, mounted on steel chassis with 3-gang condenser, illuminated disc-drive and 8 valve holders, 25/- the lot. All Mains or Battery circuit. **FREE!**

SPECIAL OFFER, LISEN 2-GANG ALL-WAVE COILS, 12-2,000 metres, with switching and circuit diagram, 6/11 set.

3-VALVE BAND-PASS KIT, 200-2,000 metres. Complete kit of parts, including chassis, all components, valves, M.C. speaker and wiring diagram. Battery Model 50/-; A.C. Mains Model, 70/-.

MOVING COIL SPEAKERS

MAGNAVOX. Mains energized, 154, 7½in. cone, 2,500 ohms 4 watts, 12/6; "152", 9½in. cone, 2,500 ohms, 17/6; 152 "Magna" 9½in. cone, 2,500 ohms, 6/-; 6 watts, "Clarion" Magnavox P.M.S. "254", 7½in. cone, 16/6; "252", 9½in. cone, 22/6. Reliable P.M.S. 10/6.

ROLA, latest type P.M.S., 18/6. **GOODMANS** 8in. mains energized, 1,000 ohms field, 10/6 each.

JENSEN P.M.S., 11/6.

DIALS—Clarion Illuminated S.W. slow-motion Dial with 2½in. knob, 2/-. Premier All-Wave 2-speed Dial, full vision straight-line, dual ratios 10-1 and 150-1, 6/6, with esutechon.

Potentiometers by well-known makers. All values up to 10 meg., 2/-; with switch, 2/6.

GRAMOPHONE MOTORS. Clarion Gramophone Unit consisting of A.C. motor, 100-250 v. high quality pick-up and volume control, 45/-; Collaro motor only, 30/-; Collaro Universal Gramophone Motor, 100-250 v. A.O./D.C., with high quality pick-up and volume control, 67/6; Collaro Universal Motor only, 49/6. Edison Bell double-spring motor, including turntable and all fittings, 15/-; CosmoCORD Gramo unit, comprising A.C. motor, pick-up and volume control (list 55/-), 35/9.

TUBULAR CONDENSERS, non-inductive, all values up to 5 mfd., 6d. each.

Wire-end RESISTORS, any value, 1 watt, 6d.; 4 watts, 1/-; 8 watts, 1/6; 15 watts, 2/-; 25 watts, 2/6 each.

Reliable MORSE KEYS with Morse Code engraved on bakelite base, 2/- each.

Bakelite case BUZZERS, 1/6, Walnut Case "Loud-tone", 2/6 each.

Super Quality lightweight HEADPHONES, 3/9 pair.

PREMIER (Reisz Pattern) Transverse-Current MIKE, High Output, Straight Line Response, 30/-. Transformer, 5/-.

Table Stand, 7/6. Adjustable Floor Stand, 22/6

HAVE YOU HAD OUR LATEST GIANT ILLUSTRATED CATALOGUE AND VALVE LIST? IF NOT, SEND 4d. IN STAMPS FOR THIS AMAZING LIST OF BARGAINS!

RECEIVERS, COMPONENTS AND ACCESSORIES

Surplus, Clearance or Secondhand, etc.

RADIO CLEARANCE

63, HIGH HOLBORN, W.C.1

TEL.: HOLBORN 4631.

3-VALVE A.C. MAINS SUPERHET RECEIVER by well-known manufacture...

LISSEN 4-valve Universal A.C./D.C. receiver, fitted in handsome upright walnut cabinet...

BRUCE MAINS TRANSFORMERS AND CHOKES, standard for the season, finest made...

350-0-350, 120 m.a., 2-0-2 volts, 2.5 amp, 2-0-2 volts, 4 amp, 10/6.

350-0-350, 150 m.a., 2-0-2 volts, 2.5 amp, 2-0-2 volts, 4 amp, 12/6.

40 m.a. 30 Hys., 500 Ohms, 4/6; 60 m.a. 40 Hys., 500 Ohms, 6/-; 150 m.a. 40 Hys., 200 Ohms, 10/6.

LISSEN ALL-WAVE COILS, complete with circuit switching, etc. Sent out in matched pairs...

8 mfd. 500 volt working, 550 volt surge, heavy duty electrolytic condenser...

LISSEN CLASS B 1-1 HYPERNIK TRANSFORMER. Boxed, brand new as from makers...

Hours of business 9 a.m. to 7 p.m. Saturdays, 9 a.m. to 1 p.m.

All orders value 5/- and over, Post Free. Orders under 5/- must be accompanied by a reasonable amount for postage.

VAUXHALL—Polar Midget 3-gang condensers, straight or superhet, 8/9; Polar full vision horizontal or Arcuate dial and drive, 5/-.

VAUXHALL—Flat, sheet aluminium, hard rolled 18-gauge, 12in. x 12in., 3/-; 18 x 18, 5/6; other sizes proportionate.

VAUXHALL—Polar station-named scales, for horizontal dials, latest settings; 1/9 each.

VAUXHALL—Hivac valves, mains or battery, all types. Usual discounts from new prices.

VAUXHALL—T.C.C. electrolytic condensers, 8 mfd. and 4 mfd., 550 volt, 3/-; 500 volt, 2/6; 200 mfd., 10 volt, 2/6.

VAUXHALL—T.C.C. condensers, tubular, non-inductive, 0.1 6d.; 50 mfd., 50v. working, 1/6; 50 mfd., 12v., 1/3; 0.05, 6d.; 0.002, 0.0002, 0.001, 0.0001, 4d. each.

VAUXHALL—T.C.C. mica 0.002, 2,000 volt test, 1/-; 0.0001, 4d.; 0.001, 0.01, 1/-; 1 mfd. Mansbridge, 1/3; 2 mfd., 1/8.

VAUXHALL—Resistances by well-known manufacturers, 1-watt type, 6d. each; all values.

VAUXHALL—Set manufacturers' surplus, skeleton type Westinghouse rectifiers, H.T. 8, 9/6; H.T. 9, H.T. 10, 10/-; complete with fixing brackets.

VAUXHALL—Chix valveholders, terminals, 5-pin, 7d.; 7-pin, 9d.; baseboard mounting, 5-pin, 43d., 7-pin, 1/-.

VAUXHALL—Pushback wire, four colours, 6 yds., 6d. 6BA screws or nuts, 4d. doz.

VAUXHALL UTILITIES, 169a, Strand, W.C.2, over Denny's, the Booksellers, Temple Bar 9338. Send postcard for lists free. Post paid 2/6 or over, or c.o.d.

HEADPHONES.—5,000 guaranteed pairs to be cleared. Brown, G.E.C., B.T.H., Ericsson, Nesper, Western Electric, Siemens, Brandes, Sterling, etc., 2,000 ohms, 2/6, 4,000 ohms, 5/-. Postage 6d.

BANKRUPT Bargains. List free. All-wave 3v battery sets, 16-2,000 metres, with H.F. pentode detector and pentode valves...

MISCELLANEOUS

DETECTION. New theory, system, circuits, book, post free 1s. 1d.—D'Arcy Ford, Gaudy Street, Exeter.

NEW Kit. Limit Allwave 4. Cost 96/-. Sell 60/-. C.O.D. Approval.—355, St. Anne's Road, Blackpool.

ALCO ELIMINATORS AND CHARGERS.—4 H.T. taps, 120v/150v, 20/30 m.a., 18/-; with 1 amp. charger 25/-. Charger alone 7/6; 1 amp. 11/-.

LOUDSPEAKER REPAIRS

REPAIRS to Moving Coil Speakers, Cones and Coils fitted or rewound. Fields altered. Prices Quoted including Eliminators...

SITUATIONS VACANT

YOU CAN USE YOUR SPARE TIME to Start a Mail Order Business that quickly brings you a full time income. Follow the lead of others who are averaging £12 per week net profits.

VALVES

NOTHING better available. SIX MONTHS GUARANTEE, complete range of BATTERY, A.C. MAINS, RECTIFIERS always in stock.

FREE ADVICE BUREAU COUPON

This coupon is available until January 23rd, 1937; and must be attached to all letters containing queries.

ADVERTISEMENT INDEX

Table listing various companies and their page numbers: Automatic Coil Winder & Electrical Equipment Co., Ltd. 539; British Institute of Engineering Technology 555; Electradix Radios 554; Fluxite, Ltd. 550; General Electric Co., Ltd. Back Cover; Graham Farish, Ltd. 554; Heyberd, F. C., & Co. 550; Institution of Television Engineers 550; Lectro Linx, Ltd. 551; London Radio Supply Co. 554; M.P.R. Electrical Co. 554; McCarthy Radio 555; Peto-Scott Co., Ltd. 549; Varley 551; Whiteley Electrical Radio Co., Ltd. 553; Wingrove and Rogers 539.

RECEIVERS, COMPONENTS AND ACCESSORIES

Surplus, Clearance or Secondhand, etc

SOUTHERN RADIO'S Wireless Bargains; all goods guaranteed and sent post paid.

G.E.C. 3-valve Battery Sets, "Battery Compact Three," with 3 Osram valves, moving coil speaker in beautiful bakelite cabinet...

SPEAKERS—Celestion Soundex permanent magnet 10/-; Telsen permanent magnet, with 10-ratio transformer to suit any receiver, 12/6; Telsen, loud-speaker units, 2/6; all brand new and in sealed cartons.

COILS—Telsen, iron core, W349, Midget size, 4/-; Type W478 (twin), 9/- pair; W477 (triple), 16/- set; Type W476 (triple superhet selector and oscillator) 16/- set, all ganged coils complete on base with switch; Telsen I.F. transformer coils, W482, 5/-; Telsen dual range aerial coils, with aerial series condenser incorporated; W70, 3/-; Telsen aerial series condensers with shorting switch, 2/-; Telsen L.F. transformers, Type R.G.4 (4 to 1), 3/-; all brand new, in sealed cartons.

MICROPHONES—Ace (P.O.) microphones, complete with transformer, ready for use with any receiver, 4/6 each.

RESISTANCES.—Tru-ohm 1-watt, colour coded and marked, 36 assorted capacities on card; 6/- per card.

POTENTIAL Dividers.—Lissen wire wound, 3-section, 60-watt, 4,500 ohms, 2,000 ohms, and 2,000 ohms; 3-section, 5 watts, 20,000, 20,000 and 20,000 ohms; 2-section, 5 watt, 50,000 and 30,000 ohms; 1-section, 5 watt, 8,000 ohms, all at 1/3 each; brand new and guaranteed.

AMERICAN Valves.—A full range of valves for all American receivers; 6/- each.

HEADPHONES.—Lightweight headphones, double pole type, 4,000 ohms, each ear piece; 3/- pair.

REPAIRS.—Any type of receivers. American, British, etc., repaired by expert staff.

WE Have Purchased the Complete Component Stock of a Well-known Radio Dealer and Manufacturer, and we are offering the complete stock in parcel lots as under:—

5/- Parcel, containing components to the value of at least 20/-, comprising chokes, resistances, coils, switches, condensers, wire and circuits, 5/- per parcel.

10/- Parcel, containing components to value of at least 45/-, comprising variable condensers, screened chokes, switches, resistances, screened coils, wire, circuits, etc., etc.; 10/- per parcel.

ALL Articles Included in These Parcels are Brand New and Modern.

SOUTHERN RADIO.—Branches at, 271-275, High Rd., Willesden Green, N.W.10; 46, Lisle St., London, W.C.2. All mail orders to 323, Euston Rd., London, N.W.1.

SOUTHERN RADIO, 323, Euston Rd., London, N.W.1 (near Warren Street Tube). Phone: Euston 3775.

RADIO BARGAINS

AMAZING prices. I lead, others follow. All-wave A.C./D.C. Table models, £6/15/0; Halcynon A.C.7, £7/7/0; Halcynon, A.C./D.C., Listed 14 gns., £7/7/0; Austin twin Rola speakers, Listed 15 gns., £7/7/0; A.C./D.C. Compacts, 65/-. Other Mains receivers, £5. Stamp for list. Speakers, Components, English, American Valve replacements. Full stock the amazing All-wave Ferguson models. Trade supplied. State requirements.—Littler, The Midland Dealer, 2, Barras Lane, Coventry.

SHORT WAVES

SHORT WAVE on a crystal set. Full building instruction and crystal, 1/2 post paid.—Radonath, Tanworth-in-Arden, Warwickshire.

NEW RECEIVERS, COMPONENTS, AND ACCESSORIES

YOU WANT SOMETHING COMPLETELY DIFFERENT. If you have a nicely furnished home and the stereotyped models you see on every street corner do not appeal to you, you will delight in our superb range of exclusive quality models. We have Radiograms with and without Auto Record Changers, A.C. and A.C./D.C., which are a complete breakaway from the usual stuff in the local shops. If you prefer good furniture to boxes, if you want outstanding shortwave performance, and above all if you appreciate true quality of reproduction when you hear it, we have what you are looking for. Come and see. Come and listen. You will be agreeably surprised, not only to find that such splendid models exist, but that they can be sold at such very reasonable prices.—WIRELESS SUPPLIES UNLIMITED, 278-280-282, High Street, Stratford, E.15. Maryland 3191.

OURS is now the only store in London handling a complete and comprehensive range of high grade Components and Accessories as distinct from clearance and surplus stuff. Everything from the smallest plug to the complete Auto Changer Unit; finest makes, really keen prices, and personal and efficient service unobtainable from chain stores, clearance houses, department stores or by mail. Come and see.—WIRELESS SUPPLIES UNLIMITED, 278-280-282, High Street, Stratford, E.15. Maryland 3191.

OF TECHNICAL IMPORTANCE

NEGATIVE FEED-BACK AMPLIFICATION FOR D.C.-A.C. CIRCUITS

Osram Valves

MADE IN ENGLAND

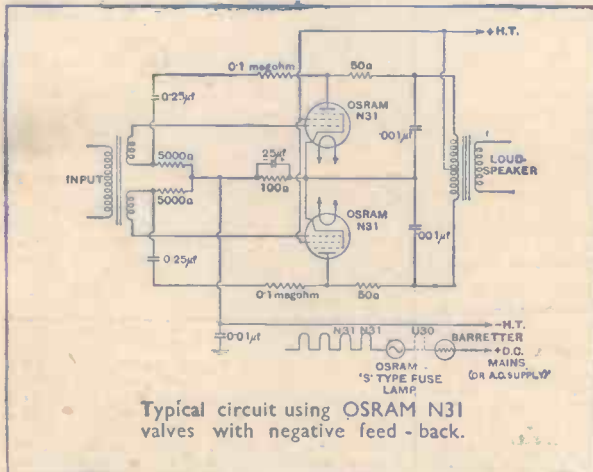

TYPE N31 HIGH SENSITIVITY OUTPUT PENTODE

"The development of the negative feed-back principle has made it economically possible to build a D.C. Mains Amplifier which is strictly comparable from the point of view of quality with the best A.C. apparatus"

"The chief advantage of the arrangement is to give a pentode performance which approaches that of a triode as regards quality of amplification."

The ideal valve for negative feed-back circuits is the OSRAM N31.

CHARACTERISTIC OF TYPE N31.

Heater Current	0.3 amp. or 0.6 amp.
Heater Volts	26.0 or 13.0
Anode Volts	200 max.
Screen Volts	180 max.
Mutual Conductance	10.0 mA/volt
Anode Current average	40 mA
Screen Current average	10.6 mA
Anode Dissipation	8 watts
Normal Grid Bias	-4.4 volts
Automatic Bias Resistance: each valve	87 ohms
Optimum Load (single valve)	5,500 ohms
Optimum Load (anode to anode, Low Loading Push-Pull)	7,000 ohms

Price each : 13/6

OTHER OSRAM 0.3 AMP. SERIES — RUN VALVES TO OPERATE WITH THE N31 ARE —

TYPE W31	Vari-mu Screen Pentode	12/6
TYPE X31	Triode-Hexode Frequency changer	15/-
TYPE H30	High 'mu' Triode	9/6
TYPE D41	Double diode	5/6
TYPE DH30	Double-diode-Triode	12/6
TYPE U30	Rectifier	15/-

Technical data on application.

OSRAM VALVES—DESIGNED TO ASSIST THE DESIGNER

Advt. of The General Electric Co., Ltd., Magnet House, Kingsway, London, W.C.2.

A ONE-VALVER FOR AMERICA—See Page 572.

Practical and Amateur Wireless

3^d
EVERY
WEDNESDAY

Edited by F.J. CAMM

a GEORGE
NEWNES
Publication

Vol. 9. No. 227.
January 23rd, 1937.

AND PRACTICAL TELEVISION

ADJUSTING & TUNING THE

Qualitone
Universal
Four

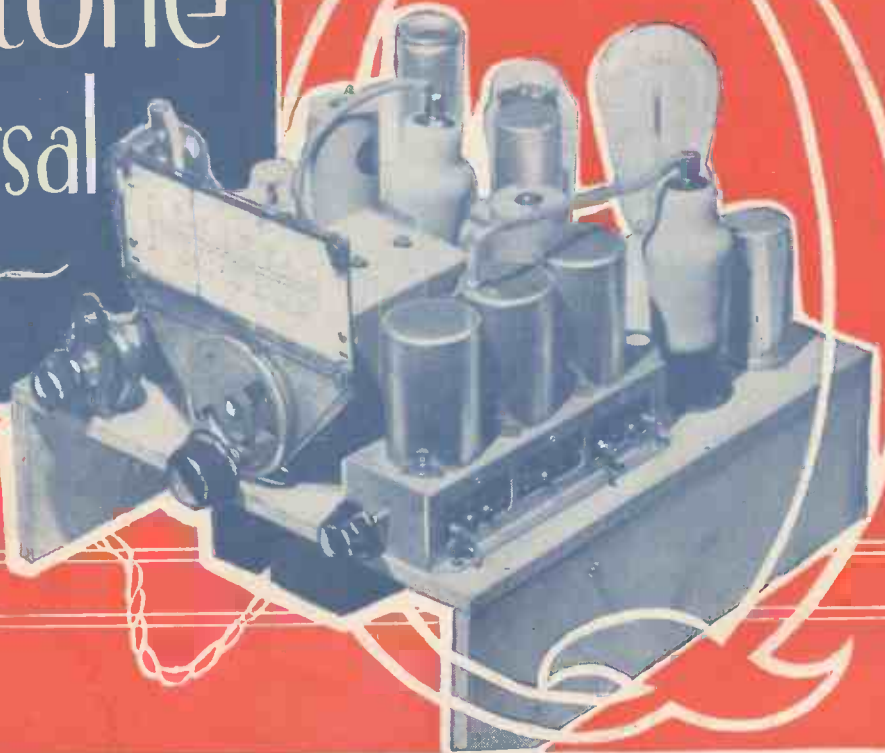

AC
DC

The KING-HALL SURVEY of 1936

JUST
PUBLISHED
ILLUSTRATED

By Stephen King-Hall

A "personally conducted tour" through the chaos of home and foreign news during one of the most gripping and dramatic years in World history. With over 200 brilliant photographs.
NEWNES FROM ALL BOOKSELLERS or 6/6 post free from George Newnes, Ltd., Tower House, Southampton St., Strand, W.C.2.

LONDON

Only

6/- net
ADVT.

ALL YOU WANT TO KNOW ABOUT A.C. MAINS RADIO, DETECTION & A.V.C.

THE COMPLETE CIRCUIT

Having dealt with each section of the eliminator circuit, an examination of the typical circuits below will show how these sections are inter-connected to form the complete circuit. These circuits may be taken as the basis of any other arrangement, and together with the information given in this book will be sufficient to enable the constructor to build an eliminator suitable for any type of receiver.

GENERAL NOTES ON ELI

It is essential to use a mains transformer which is rated in terms of power in order to ensure that the back from the supply mains. If a transformer is a possibility of the "live" side of the receiver and rectifier.

A fuse must be used in the receiver and rectifier.

Apparatus from that circuit, in three stages at six times the normal frequency for the full-wave circuit, or three stages for the half-wave circuit.

Resistor Condensers of the type used, as otherwise the output would be increased for decreased load. Capacities recommended are 100 microfarads for filter condenser and 25 microfarads for cycle supply. Values of resistor and capacitor of the cycle supply should be checked in order that sufficient current is carried in this circuit.

Resistor must have sufficient current capacity. Rectifier must be of the horizontal, i.e., in the direction of an open free current of an open circuit. Alternatively, a diode may be used. This depends on the type of the receiver used in the circuit. Specific details for each part should be given carefully, there are no exceptions or to prepare in the same manner as the principal pages, etc.

FIG. 7—Circuit and type of layout of an eliminator for a small transformer receiver, comprising screen grid, detector and power valves. Maximum output, 1.25 to 30 watts.

FIG. 8—Eliminator circuit for all-electric thermionic receiver with A.C. input, values and automatic control lines.

NOTE—We regret that we are unable to supply circuit diagrams of special eliminators and receiver circuits for building eliminators. We publish complete instructions for building eliminators designed for use with special receiver circuits published in the technical press. Particulars are advertised in the journals concerned.

"The All-Metal Way, 1937," is more than a catalogue of Westinghouse Metal Rectifiers—it's a text book on A.C. mains radio, distortionless detection and automatic volume control. Every constructor will find it of great use . . . and it costs only 3d. post free. Get a copy to-day.

WESTINGHOUSE METAL RECTIFIERS

COUPON

WESTINGHOUSE BRAKE & SIGNAL CO. LTD.,
82, York Road, King's Cross, London, N.1.

Please send me "THE ALL-METAL WAY, 1937" for which I enclose 3d. in stamps.

NAME.....

ADDRESS.....

P.P.A.W. 23/1/37

Why do many smokers prefer a MIXTURE?

Your smoker of Mixture is firmly convinced that no other form brings out so well the quality in a tobacco. If he smokes Airmen he is quite likely to be right.

PLAYER'S AIRMAN MIXTURE

ALSO OBTAINABLE IN FLAKE OR NAVY CUT

10d
PER OZ
NAVY CUT DE LUXE III

P.A. 51E.

ALL COMPLETE STORIES

THE GRAND

12
COMPLETE STORIES

Authors include:

DOROTHY BLACK, H. de VERE STACPOOLE, PHYLLIS HAMBLEDON, WALTER DURANTY, I. A. R. WYLIE, DENNIS WHEATLEY, VERE DUNNE, JACLAND MARMUR

IN THE FEBRUARY

GRAND

MAGAZINE **7d.**

Of all Newsagents and Bookstalls, or by post 9d. from the Publisher, George Newnes, Ltd., Tower House, Southampton Street, Strand, London, W.C.2

POWER SUPPLY FOR MAINS SETS—See Page 568

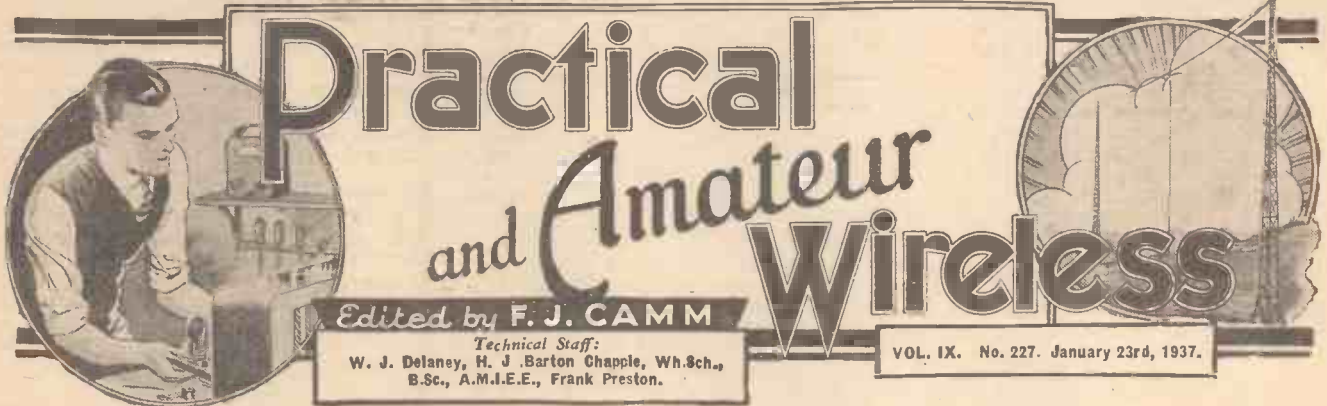

Practical and Amateur Wireless

Edited by F. J. CAMM

Technical Staff:
W. J. Delaney, H. J. Barton Chapple, Wh.Sch.,
B.Sc., A.M.I.E.E., Frank Preston.

VOL. IX. No. 227. January 23rd, 1937.

ROUND *the* WORLD of WIRELESS

America on One Valve

AT one time it was necessary to use a multi-valve receiver in order to hear signals from across the herring pond, but in the hands of a careful operator a one-valver can produce some remarkable long-distance results. Several one-valve designs which have appeared in these pages have produced prodigious logs, many of which we have published. The thrills of such reception are enhanced, however, when most of the parts in the receiver are home made, and the one-valver for America which was described in 1934 is a receiver of this type. The demand for blueprints of this receiver has been so great that all of the issues of the paper in which the constructional details were given have been sold out, and in response to the demand for these details we are reprinting the salient points on page 572 of this week's issue. Make up this little set as a stand-by, and with a good pair of 'phones you will be surprised at the results which are obtainable.

Telephone Loudspeaker

THE Moscow Province Post Office Administration have designed a loudspeaker telephone installation which enables several persons to take part in a telephone conversation. In place of the customary mouthpiece a loudspeaker and microphone is employed and the latter is placed three feet or more from the persons taking part in the conversation. Several telephone lines can be connected with the apparatus at the same time. Thirty of these outfits have already been installed.

Birmingham Pantomime

THOSE listeners who heard the relay from the Prince of Wales Theatre, Birmingham, during the rehearsal of the pantomime "Humpty Dumpty" will be interested in hearing more of it. On January 29th a forty-minute extract will be broadcast from the Midland transmitter. Gene Gerrard, Bobbie Comber, June and Helen Gilliland are among the well-known members of the cast, which includes a parrot named Pippelwhistle and a dog named Mr. Peppermint.

Radio Statistics

AT this time of the year manufacturers produce for their own information all sorts of statistics on the year's business.

One of the most interesting facts that arises from this data is that, although sets are cheaper this year than ever before, the average selling price of receivers is actually 8s. up per set, due to the tendency of the public to buy more expensive sets. The superhet has become even more popular, so have ultra short-wave sets and radio gramophones. Another interesting statistic is that approximately 66 per cent. of valves manufactured have top terminals.

Other popular items in the schools broadcasts are Nature Study, Regional Geography, British History and World History.

Welsh Witches

DID you know there are still witches in Wales? Listen to the broadcast from the Welsh Regional on January 25th, when this subject will be dealt with, amongst others, including the queer country remedies which are claimed to cure where doctors have failed; how people lived and reared families in the bleak limestone caves of the north coast, and how they beat the bounds at an old estate in Anglesey with bread, beer and cheese!

Fishy

IF you can tune in to Northern Ireland, you should make a point of hearing the broadcast on January 29th on the subject of Fish. This will take the form of a discussion between a fisherman, a fish merchant, a fishmonger and a housewife, on the subject of fishing and the distribution and sale of fish. As might be expected one of the principal bones (of contention in this case) to be picked will be that of price, and each participant will state his or her individual problems. The fisherman will show how he is dependent on the weather, and how precarious is his means of livelihood. The fish merchant and the fishmonger will deal with the economic aspect of things, and the housewife will point out her difficulties in obtaining the kind of fish she wants at the price she is able to pay.

"Wait for Me"

THE author of this new radio drama is Philip Wade, and the play entitled "Wait for Me" is his seventh. Too much of the plot must not be revealed, as there is in it a strong element of surprise. The exigencies of what at first will seem a simple plot allow of many changes of scene, and there will be "sound shots" of a hunt ball, an artist's studio in Chelsea, and a West End theatre during a first-night performance. The production will be in the hands of Barbara Burnham.

This broadcast will be given in the Regional programme on February 8th, and from the National on February 9th.

A VALUABLE TECHNICAL LIBRARY!

WIRELESS CONSTRUCTOR'S ENCYCLOPÆDIA

5/-, or 5/6 by post.

EVERYMAN'S WIRELESS BOOK

3/6, or 4/- by post.

TELEVISION & SHORT-WAVE HANDBOOK

3/6, or 3/10 by post.

THE HOME MECHANIC ENCYCLOPÆDIA

3/6, or 4/- by post.

All obtainable from GEORGE NEWNES, LTD.

Broadcasting in Time of War

ELABORATE arrangements are being made for the running of the B.B.C. in the event of a war. An official has been appointed to evolve an emergency plan, and it is stated that bomb-proof studios and gas-proof shelters are being planned, together with arrangements for the dissemination of news in the event of a situation demanding emergency measures.

Broadcasts for Schools

THE B.B.C. Travel Talks for schools are still the most popular items amongst the children. It is stated that there are now 3,120 schools listening regularly to these travel talks, exactly 1,000 more than at this time a year ago.

ROUND the WORLD of WIRELESS (Continued)

Ghosts of London

ON January 31st Mark Lubbock and Rooke Ley combine to present another of their interesting programmes, "Ghosts of London." In these programmes music and dialogue are used to recall famous occasions in London's musical history. Famous visitors to the metropolis whose works will be heard will include Wagner, Chopin, and Berlioz.

Sealed Orders

KENNETH ADAM will be the speaker in the series of Midland surprise items entitled "Sealed Orders." The broadcast last month was a recorded impression of his visit to all-night cafés for lorry-drivers on Watling Street. The subtitle of the broadcast on January 27th is "Night Out."

Dance Cabaret

IN the Western programme, on January 28th, a Dance Cabaret will be broadcast from the Marine Spa Ballroom, Torquay, when Walter Snelling's Dance Orchestra will be heard for the first time.

Symphony Concert

PART of the symphony concert by the City of Birmingham Orchestra will be heard from the Town Hall, Birmingham, on January 21st. The conductor will be Leslie Heward. The performances to be broadcast will be Brahms' Tragic Overture and Rachmaninoff's Pianoforte Concerto No. 2, with Solomon as solo pianist.

Concert from Glasgow

FLORENCE AUSTRAL, the well-known soprano, will broadcast with the Scottish Orchestra from St. Andrew's Hall, Glasgow, on January 23rd. She will sing in "Isolde's Liebestod" ("Tristan and Isolde"), by Wagner. Other items in the concert will be the overture to "Der Freischütz," by Weber, and Symphony No. 2 in D, by Brahms. The orchestra will be conducted by John Barbirolli.

Reappointment of B.B.C. General Advisory Council

THE General Advisory Council of the B.B.C., formed two years ago for an



The Rev. Leslie Weatherhead, Minister of the City Temple, listening to the heart beats of Mr. R. H. Dent, Managing Director of Ardenite Deaf Aids and P.A. Apparatus.

INTERESTING and TOPICAL NEWS and NOTES

experimental period now ended, is to be reappointed for a further period of three years. To the Corporation's regret, His Grace the Archbishop of York, who has presided over the Council since its formation, has intimated that he can no longer continue to serve. The B.B.C. announces that the Rt. Hon. the Lord Macmillan, who has throughout been a member of the



Noel Coward recording for "His Master's Voice" some new songs written by himself. He broadcast these in a recent Henry Hall Guest Night. Carroll Gibbons is directing the orchestra.

Council, has accepted an invitation to succeed the Archbishop of York as Chairman. The Council's functions are, briefly, to advise the B.B.C. on any matter relating to its programmes, its publications, and its general policy, and to promote among listeners a fuller interest in and understanding of the constitutional problems, policy, and practice of the B.B.C.

The Air-Do-Wells

THIS popular concert party broadcast another programme on January 21st. Max Kester, who is again producing, is trying to gather together as many of the original Air-do-Wells as are available. Among the boys and girls of the old brigade who have promised to be present are Marjorie Stedford, Doris Palmer, Ronnie Hill, Hindle Edgar, and Arthur Askey.

Gypsy Orchestra

ALFREDO and his popular Gypsy Orchestra will broadcast in the Northern Ireland programme on January 29th, when they take part in the Ideal Homes Exhibition, at the King's Hall, Balmoral, Belfast.

Ice Hockey Match

BERNARD TAYLOR will give a commentary on the ice hockey Trial Match between Dark Blues and Light Blues, on January 29th, in the Western programme. This is the second of the series of trial games to choose a team for the newly formed club.

Sonata Recital

THELMA REISS (violin) and John Hunt (pianoforte) will give a sonata recital on January 21st. Although both these artists have been heard on many occasions in the Western programme as soloists, this is the first time they have given a combined broadcast.

B.B.C. Theatre Orchestra

FROM Vienna on January 24th comes Robert Stoltz to conduct the B.B.C. Theatre Orchestra in a programme of his own works. He is well known as the composer of "Wild Violets," "Rise and Shine," and other light operatic successes. Maria Elsner and Jan van der Gucht, both well-tried

broadcasting favourites, will be the principal vocalists.

Weston Municipal Orchestra

ANOTHER concert by the Weston Municipal Orchestra, conducted by H. C. Burgess, will be broadcast from the Winter Gardens Pavilion, Weston-super-Mare, on January 24th. Although the orchestra has been heard many times in the programmes, this will be its first Sunday broadcast.

SOLVE THIS!

Problem No. 227

Wood had a short-wave receiver having resistance coupling between the detector and the output valve. The triode detector anode was joined to the end of the anode resistance and the coupling condenser, the other end of this condenser being connected via a stopper resistance to the output valve grid. He decided to use straight transformer coupling in place of the resistance coupling, but was disappointed to find that results were then very poor. Why was this? Three books will be awarded for the first three correct solutions opened. Address your solutions to the Editor, PRACTICAL AND AMATEUR WIRELESS, Geo. Newnes, Ltd., Tower House, Southampton Street, Strand, London, W.C.2. Envelopes must be marked Problem No. 227 in the top left-hand corner, and must be posted to reach this office not later than the first post on Monday, January 25th, 1937.

Solution to Problem No. 226

The lack of current was due to a break in the primary winding of the H.F. transformer.

The following three readers successfully solved Problem No. 223 and books are accordingly being forwarded to them: A. Burton, 25, Newmarket Rd., Cambridge; J. Evans, 36, Hythe Rd., West Worthing, Sussex; C. J. Leach, 52, Hamstead Rd., Catford, S.E.6.

The "Qualitone" Universal Four

Further Constructional Details, Together with Adjusting and Operating Instructions are Given This Week - - - - By IDRIS EVANS

THE circuit and constructional details of this efficient four-valve superhet were given last week, but there are a few special points in connection with the constructional work which should be carefully noted. These will therefore be dealt with before giving the adjusting and operating instructions.

M.B. Contacts

The points marked M.B. on the wiring diagram are those which should be in contact with the upper metallised surface of the chassis. It will be noted that the thick wire negative connector underneath the chassis is marked M.B. at several points and, therefore, care should be taken to ensure good contact between the connector and metallised surface at these points. In order to improve the screening the metallised surface of the side runners is also connected by means of M.B. bolts to the connector, and leads are joined from the casings of the choke, smoothing condensers, and interference suppressor to the M.B. connector. It was mentioned last week that the cans of the large electrolytic condensers should be joined to the connector by means of thin wires, and it should be noted that the negative end (—) of the 25 mfd./25v. condenser must be connected to M.B. and the positive end to the valve cathode—reversal of this condenser can cause damage to its associated valve and to other components.

Volume Control

A 2 meg. resistance has been joined across the moving arm and earth tag of the volume control in order to avoid damage to the output valve should the moving arm not make good contact with the resistance element. The spindle of the specified control is insulated from the moving arm, but all volume controls are not insulated in this manner and, therefore, if a substitute is used the metallised surface of the chassis should be scraped off underneath the component bracket. In the wiring diagram the lead from the control to the 100,000-ohms resistance is shown passing over the

L.S. sockets, for clarity. This lead should pass underneath the sockets, about $\frac{1}{16}$ in. from the baseboard, the socket strip being mounted approximately 2 in. from the baseboard. The leads to the control and the valve caps are of the screened type, the screening cover being joined to M.B. The specified thick tubing should be passed over the screening cover to avoid crackling noises due to the metal screening coming

in contact with component casings. Great care must, of course, be taken to keep the metal screening clear of the lead passing through it.

Gang Condenser and Coil Unit

It should be carefully ascertained that the gang condenser is of the 110 kc/s type, having the oscillator section at the back. This section is marked C3 and can be

recognised by its fixed vanes which are smaller than those of sections C1 and C2. The instructions given last week concerning the coil connections should be carefully followed.

Mains Connections

The mains switch could have been mounted on the volume control or the coil chassis, but this might produce hum in some cases. It is therefore suggested that the switch be mounted at the most convenient point on the side of the cabinet, care being taken to keep the switch and its leads clear of the valves and wiring. With this method of connection it will only be necessary to

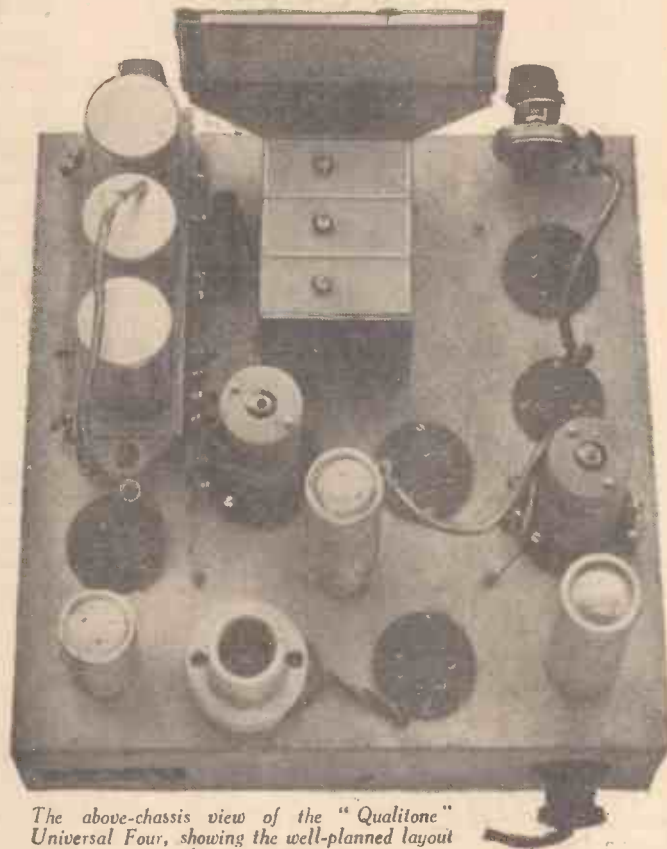

The above-chassis view of the "Qualitone" Universal Four, showing the well-planned layout of components.

LIST OF COMPONENTS FOR THE "QUALITONE" UNIVERSAL FOUR

One coil unit—BP 111—Varley.
One 3-gang condenser—Midget 110 kc. (C1, C2, C3)—Polar.
One tuning drive—V.P. horizontal—Polar.
Two I.F. transformers—BP84—Varley.
Seventeen fixed condensers, tubular type: Three .0001 mfd. (C8, C16, C18); .0002 mfd. (C4); .001 mfd. (C5); .003 mfd. (C23); .01 mfd. (C25); .02 mfd. (C17); seven .1 mfd. (C6, C7, C9, C11, C13, C15, C28); .25 mfd. (C19); 25 mfd./25v. electrolytic (C24)—Dubilier.
Five fixed condensers: 2 mfd. (type 84) (C20); 4 mfd. (type 65) (C14); 4 mfd. (type 812) (C12); 8 mfd. (type 802) (C22); 32 mfd. (type 809) (C21)—T.C.C.
Twenty-one fixed resistances: 1 meg. (R1); two 500,000 ohms (R14, R15); 250,000 ohms (R11); 2 meg. (R17); two 100,000 ohms (R3, R16);

2,000 ohms (R4) (type F1); 75,000 ohms (R12); 40,000 ohms (R9); three 20,000 ohms (R7, R8, R5); two 5,000 ohms (R6, R13); 3,000 ohms (R18); two 250 ohms (R2, R10); 200 ohms (R21); two 150 ohms (type F1) (R19, R20)—Dubilier.
One volume control, 500,000 ohms (R22)—Eric.
One L.F. choke—20H/60/500 ohms—B1—Ferranti.
Five valveholders: Four 7-pin; one 5-pin, chassis mounting, without terminals—Clix.
Two socket strips: A1, A2, E, and L.S.—Clix.
Loudspeaker control panel—Clix.
One preset condenser—.002 mfd. max. (C10)—Ward and Goldstone.
One anti-interference condenser unit—A.20 (C26, C27)—Bulgin.
Two screened valve-cap connectors—P64—Bulgin.
One standard connector—P41—Bulgin.

Two feet screened flex wire—Bulgin.
One 2-pin mains plug and socket—P74—Bulgin.
One on-off switch—S80—Bulgin.
One component bracket—Peto-Scott.
One Metaplex chassis, 12 in. by 12 in. by 3 $\frac{1}{2}$ in.—Peto-Scott.
Three feet 14 S.W.G. T/C wire for earth connections—Peto-Scott.
Quantity 20 S.W.G. T/C wire and sleeving for wiring—Peto-Scott.
Two ft. $\frac{1}{8}$ in. sleeving for screened leads—Peto-Scott.
Five valves: X32 (metallised); W31 (metallised); D41 (clear); N31 (carbonised); U30 (clear)—Osram.
One barretter with porcelain holder—type 304 (R23)—Osram.
One speaker—Stentorian Senior—W.B.

THE "QUALITONE" UNIVERSAL FOUR

(Continued from previous page)

remove the mains plug at the back of the chassis when it is necessary to remove the latter. In some commercial receivers H.F. chokes are connected between the mains leads and the receiver, but these were not found necessary in the Qualitone. If they are added they should be of the mains H.F. type, capable of carrying 400 mA., and one choke should be connected in each mains lead. If there is any doubt concerning the effectiveness of the house supply fuses, the plug connecting the free ends of the mains leads to the mains socket can be of the type having enclosed 1 amp. fuses.

Adjusting

After the wiring has been carefully checked and the speaker connected, the set may be switched on—connection of the speaker is very important as the output valve may be damaged if this has not been done. If the supply is D.C. the mains plug must be inserted the correct way round otherwise voltage will not be applied to the valve anodes. When the aerial and earth leads are joined and the volume control rotated to its maximum setting (maximum clockwise rotation), signals from local stations should be picked up, and these may be used for adjusting the receiver. The trimmers of the I.F. transformers will be at approximately the correct setting when received, and therefore it should only be necessary slightly to readjust these until maximum volume is obtained from the local stations. C3 trimmer should then be adjusted until these stations tune in at the

correct setting on the tuning dial, and C1 and C2 adjusted afterwards for maximum volume. If it is found that stations do not tune in at the correct setting at the upper and lower ends of the scale, readjustment of the I.F. transformer trimmers will be indicated. These adjustments should be made with the wave-change switch attached to the coil unit in the medium-wave position (centre setting). After satisfactory reception has been obtained on this band the switch control should be rotated in a clockwise direction for long-wave reception, and the preset condenser adjusted for optimum results. If the efficiency of the preset is in doubt it may be replaced by a .002 mfd. fixed condenser.

Test Voltages

Constructors possessing meters will prob-

ably be anxious to check the voltages at the valve electrodes. The readings will, of course, vary with different supply voltages, but taking a 240-volt A.C. supply as an example a reading of approximately 75 volts should be obtained at the screens of the first and second valves, and 125 volts at the oscillator anode of the first valve. The anodes of the first and second valves should show a reading of approximately 220 volts and the output valve anode 210 with 185 on its screen. A slight voltage drop is to be expected across the rectifier if the supply is D.C.

The 200 ohms resistance attached to V4 cathode is R21, as indicated in the component list and theoretical diagram. This has been incorrectly marked R12 on the wiring diagram.

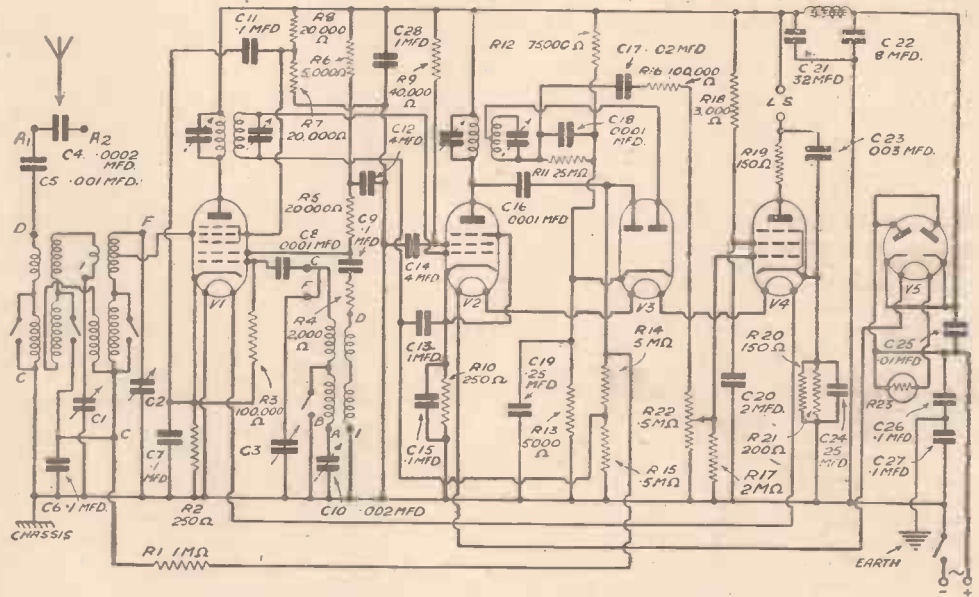

Theoretical circuit diagram of the "Qualitone" Universal Four.

Price of Television

Components

WHEN radio was first introduced, prices of sets ranged anywhere between £30 and £50, only to fall in a few years to single figures, due to the rapid decline in the price of components. The same events will not overtake television, as, with the exception of the cathode-ray tube, practically all the parts are radio components, the prices of which have reached a low level.

Death of Marconi's Collaborator

THE death was announced recently of Colonel Henry Jameson Davis, J.P., D.L., at the age of eighty-two. Colonel Davis collaborated with his first-cousin, Marconi, in organising the original Marconi's Wireless Telegraph Co., and was its first managing director. The Company, which at the present time employs thousands of people all over the world, was founded in 1897 in Colonel Davis's small office in Mark Lane.

A Cause of Interference

IT is quite common with a television receiver suddenly to get a terrific increase in the interference from motor-cars, and from other similar sources. This is almost certain to be caused by a break in one half of the feeder leading from the dipole. This is caused by the remaining unbroken feeder wire acting as

ITEMS OF INTEREST

an aerial and picking up the interference which would be cancelled out by the other feeder wire if it were intact.

Paper Condensers

ALTHOUGH the modern paper condensers of the one or two mfd. type have very long lives, the same cannot be said for all those manufactured several years ago. There has been a perfect epidemic of receivers becoming faulty due to the breakdown of old paper condensers. A case came to our notice the other day, where the condenser of this type was causing a serious short-circuit when subjected to a potential of 120 volts in the set, but when tested at a lower voltage proved to be perfectly O.K. Such faults are obviously very difficult to trace unless tests are carried out under working conditions.

A Peculiarity of Sound

ONE has become so accustomed to the idea that sound is produced by, say, a loudspeaker or a gun, that it is generally accepted as a fact, whereas it is a fallacy. To take an example, if a gun is fired in the middle of the Sahara Desert, the explosion will set up a train of vibrations

in the air, which, impinging on the ear drum of a human being or animal, will result in the phenomenon known as "sound." If, on the other hand, there is no living creature in hearing distance of the gun, the gun does not make any sound. Admittedly, it sets up a train of air waves, but sound is created in the ear, and if there is no ear to receive the air waves, no sound results.

Reaction Control

SOME receivers suffer from undue influence of the tuning range over reaction control. To make the set oscillate at 200 metres calls for only a degree or so of reaction, whereas, to reach a similar state at, say, 400 metres, the reaction control has to be turned almost to maximum. Such a state of affairs makes searching extremely difficult, but fortunately, it is very simple to overcome. A resistance of a few thousand ohms in series with the reaction condenser will greatly improve matters, while in particularly serious cases an additional resistance in parallel with the reaction coil will materially assist, as also will a change in aerial coupling. A common cause of this trouble is an aerial coil of unsuitable size compared to the grid coil, or too close to it. Where it is difficult for mechanical reasons to slacken the coupling, it is often possible to short a portion by taking a wire from the earth or the aerial end, whichever is the most convenient, and soldering it to a convenient turn which has been carefully bared for the purpose.

Economy with Efficiency

There are Many Ways in which Certain Substantial Economies can be Effected without Loss of Efficiency, and this Article Deals with Some of the More Important Ones

By H. J. BARTON CHAPPLE, B.Sc.

BY paying a sufficiently high price, one can always obtain the very best, but it is equally true that there are often ways and means whereby money can be saved without in any way sacrificing either quality or efficiency in radio engineering.

First of all, it is necessary to point out that economies are possible in two directions, namely in the first cost of the receiver, also in the cost of operating it. With regard to the first class, these can be again separated into economies due to the use of more efficient circuit arrangements, and those effected by substituting the skill and labour of the home constructor for that of the manufacturer—in other words, they result from the amateur making certain of the components for himself instead of purchasing them from a shop.

Running Costs

Initially, we will deal with economies in running costs because these, being recurring charges, are usually more vexatious than the original cost of the set. There is little chance of reducing the operating cost of a mains receiver, and in view of the fact that in very few cases does the consumption exceed 60 watts or so—about the amount taken by a single electric lamp—and also in view of the fact that energy is, in most districts, very cheap, there is small temptation to do so. In fact, any attempt to reduce the current consumption of a mains set would result in so small a diminution of the electricity bill that it would not be worth while, and the deterioration in performance would more than outweigh the monetary advantage.

But in the case of a battery set the position is very different. It can be shown, for example, that if the fee for charging a 2-volt 25 amp.-hr. accumulator is 4d., this is equivalent to paying 6s. 8d. per unit for the low-tension energy—and mains current seldom costs more than 6d. per unit, and usually very much less. Now for a given performance it is not possible to reduce the L.T. consumption of a battery set. Each valve takes its own toll from the L.T. battery, and the number of valves and their types is almost unalterably fixed by the performance required from the set. But economy in L.T. consumption can be effected, where electricity mains are available, by constructing a home charging plant. On D.C. systems this can take the form of a pair of terminals in series with one of the lighting circuits to which the spare

L.T. battery can be connected for a steady, slow charge. This is more economical than using a lamp or resistance on a separate charging board, and the small drop in voltage at the lamp due to the accumulator makes no appreciable difference to the light.

On A.C. systems some form of rectifier must be used in the home charger, either a valve or metal rectifier being quite suitable. The amateur who takes pride in his apparatus would no doubt construct a conventional trickle-charger, but quite good work can be done with a cruder apparatus using an old receiving valve, such as a mains type output triode or pentode with anode and grids strapped together, as the rectifier.

H.T. Consumption

Turning to H.T. supply, it is difficult to estimate the total cost per unit for current from a dry H.T. battery, as this depends upon the extent to which the battery is used, the maximum drain taken, and the quality of the battery itself. But records taken on a number of H.T. batteries under varying conditions of service during the past few years suggest that somewhere between ten shillings and a pound can be considered as the average cost of 1,000 watt-hours of dry H.T. supply. The case for an H.T. battery eliminator is at once made out, for such a unit can be constructed at home at a cost no greater than one year's expenditure on new H.T. batteries. Of course, the whole question of the running costs of a battery set can be settled at once where mains current is available, by suggesting that the listener should use a mains set.

But there are many listeners who have electric light and yet prefer to use their existing battery sets because they are still in good condition, or because for the moment they do not wish to incur the cost of a new set.

Of circuit devices for reducing the consumption of H.T. current, a certain number merit more attention from the amateur than is usually accorded them. First and foremost, it must be remembered that the bulk of the H.T. consumption occurs in the output stage. The drain in this stage can, of course, be reduced by the use of valves of the Q.P.P. and Class "B" types and, properly applied, these devices can produce substantial economies without loss of efficiency. But improperly applied—and in all too many instances they are improperly applied—quality suffers severely, and it is probably for this reason that Q.P.P. and Class "B" have never become really popular with some amateurs.

Output Pentodes

The best solution, according to the most recent practice, is to employ one of the new high-slope output pentodes in the last stage—valves which normally operate at 5 mA anode current and a screen current of less than 1 mA, yet give an output in the region of 300 milli-watts with less than 10 per cent. total harmonic distortion. Moreover, these valves require a grid signal of only 1.75 volts, which means that they can be driven comfortably from a diode detector. Thus, for a given output, they consume less H.T. themselves than a comparable output stage using earlier type valves, and in addition eliminate the H.T. consumption of the detector stage.

Then something may be done by way of minimising the H.T. consumption throughout the set. The anode current con.

(Continued overleaf)

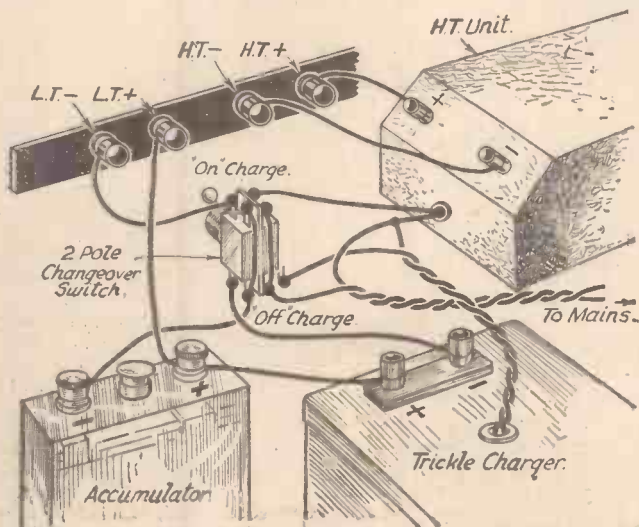
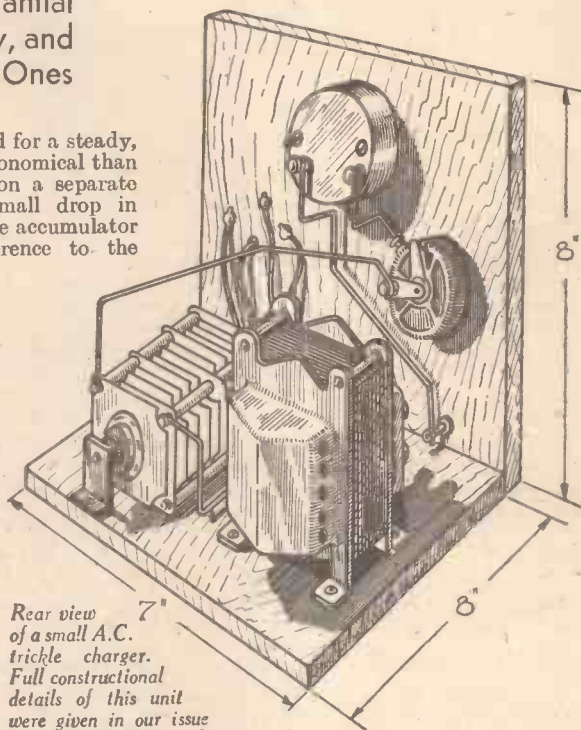

A pictorial diagram showing the arrangement for obtaining all-mains operation with an ordinary battery receiver.

ECONOMY WITH EFFICIENCY

(Continued from previous page)

sumption of an amplifying valve depends largely upon the bias voltage and upon the value of the applied H.T. voltage. The negative bias in every case is required to ensure that each valve operates on a part of its characteristic curve, at which the anode current swings do not exceed the straight part of the curve, and the grid bias values recommended in makers' catalogues are average values giving a good factor of safety. In many cases, however, a higher grid bias can be used without introducing distortion—it all depends upon the signal voltages the valve is called upon to handle. The amateur who possesses a good sensitive milliammeter is recommended to insert it in the anode circuit of each valve in turn, and to adjust the grid bias to the maximum amount which will give a steady anode current reading without the kicks which indicate distortion. Each valve will then be operating at the minimum permissible anode current, and although only a milliamp or so may be saved in all, a whole milliamp may well represent 10 per cent. of the total

H.T. drain, and prove to be a valuable economy.

Where a leaky grid detector valve is used the H.T. voltage should also be reduced to the lowest value which gives adequate signal-handling power, and here again the gain of a fraction of a milliamp. will be worth while. Also, in designing a set it is wise, in the interest of economy, to select a combination which will do what is required for minimum H.T. expenditure. For example, sets which normally would use a double-diode-triode followed by an output valve can be converted, with considerable economy, by using a simple double-diode and high-slope output pentode, providing always that an efficient aerial is available.

Other Economies

We can now turn to directions in which economy in first cost can be made without affecting the overall efficiency of the set. According to many radio engineers we have, during the past year or so, tended to be too liberal in the use of decoupling components; more especially in mains sets. Usually it is false economy, from the efficiency point

of view, to cut down the decoupling in grid circuits too drastically, but anode decoupling can sometimes be reduced, or even omitted altogether, without risk. No definite advice on this point can be given, but if the amateur is anxious to build a set on extremely economical lines he can design it with a minimum of decoupling and try it out, adding further decoupling as and when found desirable.

Certain economies can be effected by the amateur making a few of his components. It is, of course, in the simpler types of set that the greatest economies can be effected, since the designs of complex circuits usually call for more exact adherence to specification and critical calculation of values. No one would suggest, for instance, that complicated multi-stage wave-change switches should be home-made, but all the switching for a simple two-circuit receiver can usually be done with home-made switches. Valvoholders, we know, cost only a few pence apiece, but even these may be dispensed with and the valves supported by a simple mechanical device, the connections being soldered to the valve pins.

Frequency Drift in Receivers

FADING of radio signals on short waves has ever been a sore point and, despite the numerous methods devised to counteract the effect, listeners have been forced to accept it as a necessary evil. This for the most part is necessarily and unfortunately true, but the ever-increasing number of S.W. superheterodyne receivers used by listeners has brought to the fore a type of fading which can, to a great extent, be overcome. It is to the results of an investigation of this so-called "fading" that the following notes refer.

On a number of receivers examined because of complaints of bad fading, it was found that signals tuned in at good strength disappeared completely after the set had been on for anything from ten to thirty minutes, and although they could be brought back by a slight variation of tuning, they disappeared again a little later, necessitating further tuning adjustment. This disturbing effect continued throughout the listening period. Investigation proved the trouble to be due to temperature changes inside the receiving set affecting components in the oscillator circuit, with consequent slight variation or "drift" in oscillator frequency. It may at first sight seem unlikely that these slight changes in frequency would be sufficient to cause serious fading, but that this can be so is clearly shown in the following numerical example.

Assume that it is desired to receive an unvarying signal of 5,000 kc/s on a superhet with an intermediate frequency of 465 kc/s. To achieve this result it will be necessary to tune the oscillator to a frequency of 5,465 kc/s. Now if, for any reason, the oscillator frequency changes by, say, 1 per cent., i.e., to 5,465+54.65 kc/s, it is obvious that the intermediate-frequency circuits will be out of tune to the extent of 54.65 kc/s, or roughly 12 per cent. This, in a receiver of reasonable selectivity, is not sufficient to cause a complete fade of the signal, will, at least, result in a serious drop in level.

Lack of Stability

Now, lack of stability in an oscillator may be, among other things, due to a

A Common Cause of Fading on the Short Waves, and Methods of Effecting a Cure are Discussed in this Article

poor valve (with unstable values of the constants t_a and g_m), poor design and faulty or unsuitable grid and anode condensers and resistances. In the instruments examined, compact design was the chief cause of the trouble, inasmuch as the proximity of the valves to oscillator components was, by the effect of dissipated heat, sufficient to cause frequency changes. In the majority of cases investigated there was sufficient heat to cause expansion of the oscillator tuning condenser plates, with consequent detuning. In these cases a complete cure was impossible without changing the design of the set, so a compromise was effected by adjusting the oscillator and intermediate frequency cir-

cuits for maximum performance after the set had reached its normal working temperature. This resulted in stable operation after the initial warming-up period.

Faulty Fixed Condensers

In two other cases the trouble was due to an "oil-can" effect in small "stamp" type fixed condensers. The plates were apparently not securely clamped together, and the valve heat caused expansion and bulging of the outer plates, which, from then onwards being in a state of mechanical strain, spasmodically varied their location, with consequent variation in capacity and, therefore, oscillator frequency. Replacement of the faulty condenser effected a permanent cure.

As it is certain that numerous readers will be experiencing this so-called "fading" produced by oscillator frequency drift, it is hoped that the foregoing notes will give them a line to work on, and help them to effect some improvement.

N. C. E.

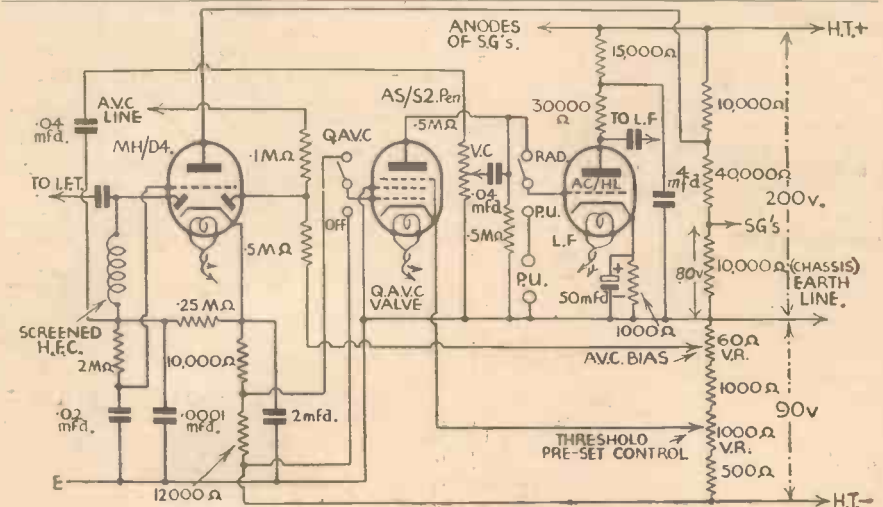

An interesting superhet arrangement showing a Q.A.V.C. valve. This circuit should be considered in conjunction with the article on "The Trend of Circuit Design," recently published.

A PAGE OF PRACTICAL HINTS

SUBMIT YOUR IDEA

READERS WRINKLES

THE HALF-GUINEA PAGE

A Neat Key Switch

MOST key switches necessitate the boring of large holes in the front panel. I have worked out one which needs only a hole large enough to take the shank of a pin terminal.

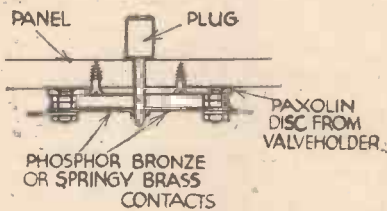
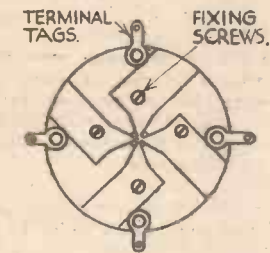

Details of the contact pieces for a simple key switch.

The base consists of a Paxolin disc from an old valveholder, and four pieces of springy brass for contacts (cut to shape, as illustrated). Some odd nuts act as spacers to keep the contacts away from the base to allow resilience, the whole assembly being bolted together, incorporating small soldering tags for connections.

When this switch is in position a pin terminal, when pushed home, contacts with

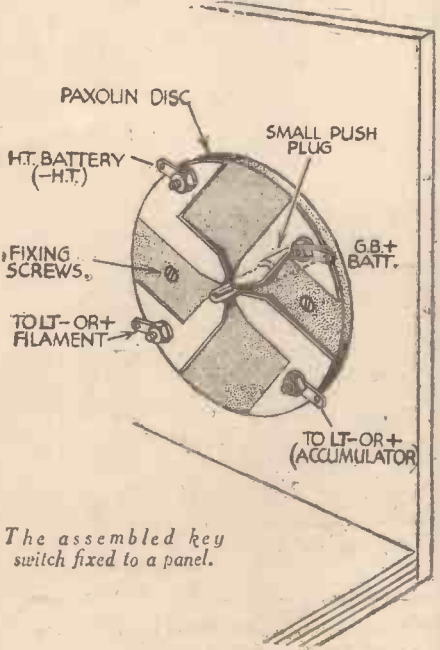

The assembled key switch fixed to a panel.

THAT DODGE OF YOURS!

Every Reader of "PRACTICAL AND AMATEUR WIRELESS" must have originated some little dodge which would interest other readers. Why not pass it on to us? We pay £1-10-0 for the best wrinkle submitted, and for every other item published on this page we will pay half-a-guinea. Turn that idea of yours to account by sending it in to us addressed to the Editor, "PRACTICAL AND AMATEUR WIRELESS," George Newnes, Ltd., Tower House, Southampton Street, Strand, W.C.2. Put your name and address on every item. Please note that every notion sent in must be original. Mark envelopes "Radio Wrinkles." Do NOT enclose Queries with your Wrinkle.

each of the four strips of brass, thus completing the high- and low-tension circuits. On removal of the pin terminal the set is "dead."—A. T. WARD, (Edgware).

An L.T. Indicator Pilot Light

FOR this indicator, shown in the accompanying sketch, I have used a 2.5v bulb to run in series with a rheostat from the accumulator. The bulb is to be fitted behind the tuning dial and used as a pilot light if

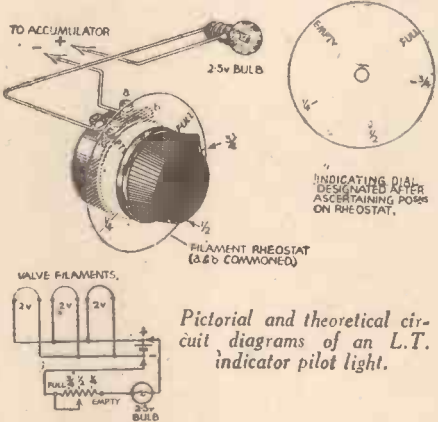

required. When putting on a fully-charged accumulator the moving arm of the rheostat is rotated until the pilot light is extinguished; this should cover the whole of the resistance. The dial can be marked full at whatever point on the resistance the light goes out; the rest of the resistance can then be marked off into $\frac{3}{4}$, $\frac{1}{2}$, $\frac{1}{4}$ charge and empty by dividing equally the remaining distance left on the resistance. Whenever it is required to find the state of the accumulator it is only necessary to rotate the knob until the bulb lights, and note on the dial the state of charge. This arrangement also makes a handy pilot light and should be extinguished after the station is found, to save consumption.—F. W. VINCENT (Norwich).

A Novel Calculator

ALTHOUGH it is a simple matter to calculate the value of a given resistance by the colour code system, and to ascertain the rating of coded fuses by referring to one's diary, I have found that the calculator as illustrated was well worth constructing. The only real accuracy required is that occasioned by the designations and divisions, and the following method of perfecting same will no doubt be of assistance:—

A piece of notepaper or cartridge paper is cut into a disc, and a few pencil lines having been scribed by the aid of compasses, the ten colour divisions are marked off through 180° of the disc. These divisions are then halved by short lines (up to and including the blue division); the pointer "X" should always be set on these lines.

The next designations are the cipher numbers 0 to 0⁶, for example,

0⁶ equals 00000
0 " none
0² " 0.

These are equally spaced in order that when pointer "X" is on the required colour, "Y" is on the correct cipher.

Example:—

A resistance with the following colouring is taken:—

- Body colour — Brown,
- Tips — Black,
- Dot — Orange.

Calculation.

1st movement: Pointer "X" turned to Brown 1!
2nd " " " "X" " " Black 0:
3rd " " " "X" " " Orange—

Examples:—

Pointer "X"	For Fuses	Pointer "Y"
Coded Black	60 mA.	
" Brown	250 mA.	
" Purple	2 A.	
" (D) Dark Blue	1 A.	
" (L) Light Blue	1.5 A.	
" B. & W.	6 A.	

—P. CLAUDE (London, W.C.2).

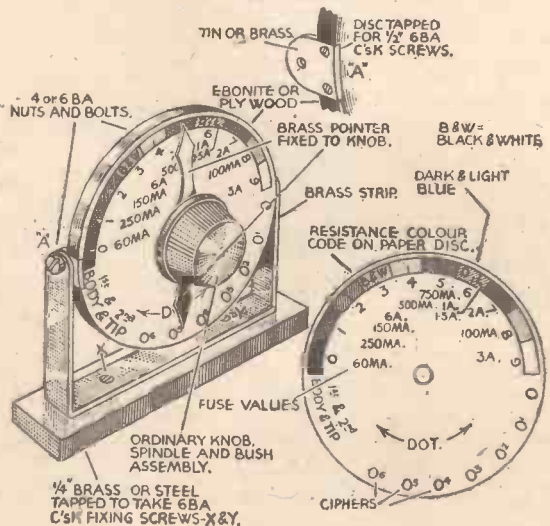

The neat appearance of this novel calculator is evident from the illustration.

Practical Television

January 23rd, 1937. Vol. 3. No. 34.

TELEVISION RECEIVER DESIGN

Details of Some of the Problems, and New Components which Are Now Obtainable.
By W. J. DELANEY.

THERE is a considerable difference in the design of the modern broadcast receiver and the modern television receiver. In the latter we have both the sound and the vision wireless sections, to which are added the time-base units for both vertical and horizontal scanning movements. Thus there must be three separate supplies of voltage (both H.T. and L.T.), as it is essential to avoid interference between any one of these sections and another. Slight interference which might be present in a sound receiver, and which would be masked by the received music, would, in a picture receiver, betray its presence by either distortion of the picture, or by an accompaniment of lines, spots, or flashes. This means that the vision receiver must be designed on very efficient lines, and considerable care has to be paid to the screening and avoidance of losses. Interference in the time-base will also give rise to various forms of distortion, and therefore it is preferable, when designing the television receiver, to arrange for completely separate mains sections. These may each be built on a separate chassis, or all made up together on one chassis, the latter arrangement being preferable as it enables the high-voltage A.C. leads to be kept in the lower part of a cabinet, and only D.C. leads and the low-voltage heater A.C. leads have to be run from one section to another.

Combined or Separate Receivers ?

As it is necessary to tune both sound and vision, a further problem concerns the design of the wireless section, as distinct from the time-base and its associated circuits. One method now being favoured by many manufacturers is to adopt a single frequency-changing stage, to which the sound and vision signals are fed by using a flatly-tuned input circuit. Separate I.F. circuits can then be used to "tap off" the resultant two beats which are produced by the two signals in the single mixer stage, and each circuit may feed I.F. stages in the usual way, all tuning then being carried out by the oscillator trimmer. Obviously, for this to produce good results, the I.F. tuners must be correctly designed, but it enables the vision signal to be accurately tuned, as the ear decides the exact tuning point. By turning the volume control down until the signal is barely audible the exact point is easily located, and the picture is then correctly tuned. A standard super-het arrangement is adopted in this case for the sound receiver, but in the vision receiver there are several alternatives. For high-quality pictures a bandwidth of at least 2 megacycles should be aimed at, and this may be obtained by flatly-tuned I.F. transformers or choke-coupling. The former may be obtained by winding the transformer with resistance wire, or shunting a transformer with an ordinary resistor of suitable value. In the second case, in order to obtain a satisfactory bandwidth and good amplification in each stage, the design of the choke must be carefully considered.

Components

In view of the very high voltages which are present in a television receiver, certain standard broadcast components are not suitable for use. For interconnection between the various chassis, multi-cables may be employed, but in certain cases the insulation between adjacent leads may prove inadequate unless special cables are employed, and in view of the number of leads multi-contact plugs and sockets will have to be employed. Messrs. Bulgin are producing a special plug and socket for such cases, in which twelve contacts are provided and these are available for circuits carrying up to 7,000 volts. Messrs. Belling-Lee also manufacture multi-contact plugs having five or ten contacts, and these are provided with an extended bakelite boss which must first be inserted in the correct position before any of the pins or sockets make contact, and this prevents damage due to a wrong connection.

The insulation in the mains transformer may also have to receive a considerable amount of attention, but this will depend upon the circuit employed with the cathode-ray tube. In the circuits at present being developed it is possible to earth either the anode or the cathode, and less smoothing is required if the cathode is earthed. Expense can also be saved in certain cases by using components connected in series, thus avoiding the high wattage rating of a single component, which would be dearer than the two smaller components. Messrs. Haynes Radio have designed mains transformers specially for television receivers, in which high insulation is provided, and both Dubilier and T.C.C. can supply condensers designed to operate up to 3,000 volts or so. In the Dubilier components oil is employed for increasing the insulation, whilst in the T.C.C. components petroleum jelly is employed for a similar purpose.

Special Valves

The Mazda Company have produced special H.F. valves for use in the intermediate-frequency stages of the vision receiver, whilst special double-diodes are also being produced for the second detector, as it is the output from this which feeds the tube. For the high voltage for the tube special rectifiers are also employed, these being of the half-wave type, with the anode brought out to the top of the valve to avoid the cathode being destroyed by the powerful field which would be created. As connection has to be made to the top cap and the associated condensers may hold their charge at a dangerous potential for several days (due to the high insulation), special insulated cap-top connections are desirable, and these also are produced by the Bulgin Company.

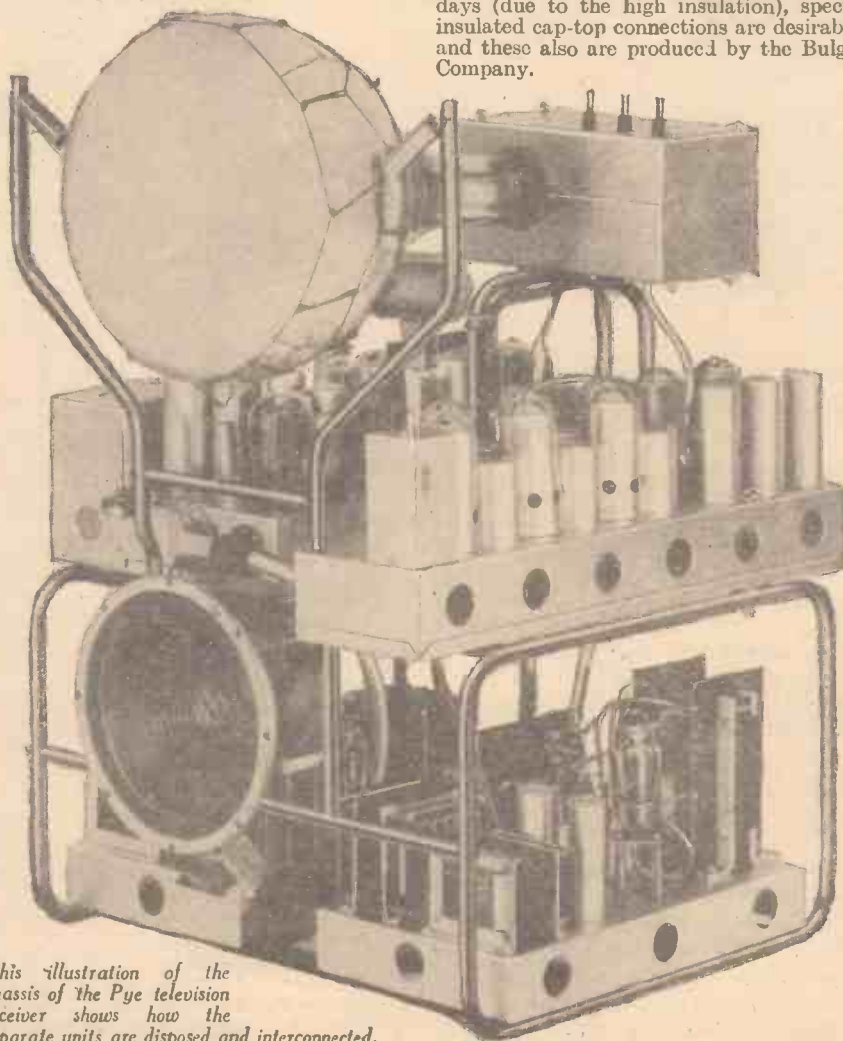

This illustration of the chassis of the Pye television receiver shows how the separate units are disposed and interconnected.



On Your Wavelength

BY THERMION

Knobs

IN an imperfect world the most we can do is to strive for perfection—the unattainable ideal. Perfection is a two-edged sword, and the desire is to combine nicety of appearance with scientific efficiency. A wireless receiver functioning perfectly lacks something if it is housed in a bloater box. Its builder may think it perfect; another receiver of poor performance can be snugly accommodated in a beautiful cabinet. In the one case, the man is satisfied by performance, and in the other by appearance. The constructor who is an aesthete will not be satisfied until he has the best possible receiver in the nicest possible cabinet. Even then, when it is finished the lady of the house may think it a dreadful piece of work which clashes with the curtains, the style of the furniture, or the latest colour of her hair. This preamble is to introduce a subject which has been hotly debated and the source of extreme annoyance to constructors from the earliest days of the hobby. I refer to knobs. When you build a receiver you buy a tuning condenser, a tuning coil, a volume control, switches, and other components which need to have an extremity with a knob on it; and constructors find that the knobs do not match. They are thus put to the additional expense as well as the inconvenience of hunting around trying to match up the knobs. Even when they succeed they find that the holes in the knobs are too large or too small for the spindles. Some makers supply black knobs, others mottled knobs, chocolate-coloured knobs, brown knobs, and chromium knobs. What a mixture!

There is a standardisation committee of the Radio Component Manufacturers' Federation which ought to "sit" on this problem at

form, and the hole dimensions, both as to diameter and depth, providing reasonable alternatives in colour to match the cabinet. This would rid us of one of our most frequent complaints: "I bought a kit of parts for the Lorlavit Three, and the knobs do not match." One manufacturer does supply knobs separately, but quite often these will not fit, even though brass bushes are



The singing mouse.

supplied. *Verb sap.* No accent on the sap.

Clubs

ON page 515 of our issue dated January 9th I gave a short list of Radio Clubs. Here are a few more to add to it.

Exeter and District Wireless Society.
Folkestone and District Wireless Club.
Croydon Radio Society.
Golders Green and Hendon Radio Scientific Society.
Newbury and District Short-Wave Club.
West London Radio Society.
Newark News Radio Club.
Portsmouth and District Wireless and Television Society.
Wellingboro' and District Wireless and Television Society.
Ipswich and District Amateur Radio Society.
British Short-Wave League.
Radio Society of Northern Ireland.
Slade Radio, Birmingham.
The Harco Radio Club of Greenwich.

Thanks to one or two readers who have drawn my attention to the omissions.

Lay It With Music

A WIRELESS fan who also owns an egg farm at Crawley is trying the experiment of coaxing

the eggs by means of loudspeakers. Four loudspeakers have been fixed in one of the hen houses. It is stated that when the music plays the hens rouse themselves. When it is switched off they become subdued again. Some of the programme material is enough to rouse any self-respecting hen, and I should think that some of the programmes would cause the eggs to be added or hard boiled.

The Noisy Bagpipes

IT is often said that very few good things come out of Scotland, and remembering that the population of London is greater than the population of Scotland, perhaps there is a sub-stratum of truth in it. Two of the bad things which have come from Scotland are haggis and the daft ceremony of piping it in, and the bagpipes, which are far worse than the crudest instrument used by the most aboriginal aborigine. No one can convince me that music is possible with the bagpipes. It is worse than any jazz band, and ought to be banned from England. I am reminded of this by a paragraph which appeared in one of the daily papers referring to a case in which a name-proud Scot was summoned for "using a noisy instrument, to wit, bagpipes, for the purpose of obtaining money or alms." The magistrate said that it was a good thing that citizens of Scotland were not present in large numbers. He thought the music would be appreciated in Scotland, but it is not appreciated in the streets of London, especially at night. The Scots are reputed to know very little about music, and this would account for the fact that they have never progressed beyond bagpipes.

The Singing Mouse

I READ that an enterprising person with an eye to business has discovered a mouse which sings each night for a piece of cheese. It was suggested that it should be captured and its "song" broadcast. I hope the B.B.C. will do nothing of the sort.

It should not continue to waste its surplus cash on darn silly things like the song of the nightingale, the noise of a mine lift, or the sound of a train entering a tunnel. The song of the nightingale, in my opinion, is no better than the chirrup of a sparrow, and it is pathetic to think that the British Broadcasting Corporation cannot among its personnel collect sufficient of the grey matter to think of something better. I should very much like to meet the individual at the B.B.C. who has these brilliant flashes about broadcasting songs of nightingales, the scratching of a rat, etc., etc. I am sure he or they must be curious to gaze upon. But then, I understand that the B.B.C. is run on the lines of one gigantic tea party, where the staff managers meet to discuss the important problems of programme material. There is something highly amusing in an enormous organisation like the B.B.C. spending hundreds of pounds each year broadcasting the inane song of an inconsequential bird.

How about broadcasting the sound of a man having a tooth pulled out, paying his Income Tax, arguing with the telephone operator, striking a match, or the noise of a Jew treating a Scotsman?

Unions and Strikes

A SUNDAY paper informs me that composers and authors threaten a strike against the B.B.C. They want 1s. out of the 10s. licence fee to be paid as royalties to the Performing Rights Society. The P.R.S. threaten to withdraw from the B.B.C. permission to broadcast the work of any member unless their wishes are granted. At present the B.B.C. pays £115,000 a year in this way—roughly 3 per cent. of the licence revenue. The sum now asked represents about 10 per cent. of the licence revenue. If I were the B.B.C. I should let the P.R.S. get on with it. A large amount of the material is not worth broadcasting at all, and a fair amount isn't worth more than a few shillings royalty a year. I should tell the Lews, Als, Eds, Joes, Jacks, Sids, Toms, Dicks and Harrys that they are being grossly overpaid for their trifling work as it is. The B.B.C. can easily create its own composers at a tenth of the price, and such can only have beneficial results on the programmes. There are thousands of struggling composers who turn out decent work but cannot get a chance. Here is their chance. You must remember that with broadcast material fame does not come as a result of merit, but by consistent plugging. The mediocrities who call



Notes from the Nest Bench

Speaker Connection

MOST commercial receivers have a permanently connected speaker mounted inside the cabinet, but home-constructed sets have a separate speaker so that it can easily be detached. If a pentode is used in the output stage it can be damaged by disconnecting the speaker with the set switched on, as voltage will then be applied to the screen but not to the anode. Great care should therefore be taken to see that the set is switched off before the speaker is disconnected. In some cases an extension speaker is used as well as the one in the set and a switch is used for changing over from one to the other. Unless the set is switched off before changing over, the switch should be of such a type that contact is not broken at the set speaker before the extension comes into circuit.

Removing Mains Valves

APART from the disconnection of the speaker, removal of the valves in a mains receiver when the switch is on is dangerous. If the output valve is removed the current passing through the speaker field winding or choke will be greatly reduced and excessive voltage will be applied to the other valves. This may cause damage to the valves and also to the smoothing and by-pass condensers. Removal of the valves preceding the output valve is not likely to cause any damage, provided that they are removed in turn and replaced before a second one is removed. Removal of all the valves except the last one is likely to cause damage for the same reason as the removal of the output valve, however, and if the receiver is supplied from A.C. through a transformer the voltage applied to the heater or filament of the output valve is also likely to rise excessively and cause damage. When handling a mains receiver it is therefore safer to switch off before disconnecting any component.

Record Three

SOME readers have written to complain that they cannot obtain reaction on the lowest range of the Record Three. This can be caused by a faulty short-wave coil in the unit, but as the coils are carefully tested this fault is not likely to occur. In most cases lack of reaction is due to low voltage at the anode of V₂. Plug H.T.2 should therefore be tried in a higher socket of the H.T. battery and if this does not provide a remedy the 15,000 ohm resistance and valve V₂ should be tested.

themselves composers have had their names bruited about the ether, and are enjoying spurious reputations. Merit and ability should count for something at some time in the world's history, and here is the opportunity to send a junta of so-called musicians and entertainers about their business, whatever that may be. It certainly isn't music or entertainment.

S.P.R.P.

WHEN I was at school we formed a secret society which operated under the cryptic initials N.T.B.R.: Any member uttering these mystic symbols was sacrosanct, for among the inner circle they meant "Not to be ragged." If a member was submitted to this indignity, the words when uttered by him meant also "Now to be rescued." I mention this because the S.P.R.P. has been formed in the Manchester district. They do not mean at the end of a letter "So please reply promptly." No! They are the initials of The Society for the Protection of Radio Programmes. The sponsors are certain people in the Manchester district and I hope that it manages to achieve something. I suggest that the movement ought to develop in every district, for it is worthy of support. I understand that leaflets are being printed and distributed in the Manchester district.

Are They Your Views?

MR. G. BLANEY, of Barlow Moor Road, West Didsbury, Manchester, says: "I have read with interest your weekly article since its first appearance in PRACTICAL AND AMATEUR WIRELESS, and feel that I have been reading my own thoughts regarding things that really matter. Good luck to you, Thermion. Without further palaver I shall be pleased if you will allow me to endorse your remarks on Sunday programmes."

Volume Controls

I REPEATED my grouse about the lack of a good volume control in a recent issue, and must apologise for the fact that I had overlooked the claim of the Polar N.S.F. Volume Controls, one of which I tried some months ago, testing it for a period of three months. At the end of that time it was as good, as silent, and as even in its action as when I first fitted it. Unfortunately, I loaned it to a friend who was suffering from trouble with volume controls. He has not returned it, and I have heard no further complaint from him. He evidently knows a good thing when he sees it, and tries it!



NEW SERIES

Amateur Transmitting

Various Types of Aerials are Discussed in This Ninth Article of the Series - - - - By L. ORMOND SPARKS

Types of Aerials

While, as previously stated, there are many types of aerials or radiating systems, it will be seen that, fundamentally, they are modifications of two distinct systems, namely Marconi and Hertz. The difference between these two methods—and it is advisable to make special note of this for future reference—is as follows. With the Marconi system the aerial is tuned, and the circuit completed by means of an earth or counterpoise arrangement. It is not necessary to calculate exactly the length of wire or, in other words, an indefinite length of aerial can be used, the whole being brought into tune by means of a coil, or coil and condenser in series.

point is likely to be affected by surroundings.

The length required for any frequency can be determined by the formula

$$\text{Length (feet)} = \frac{492,000}{F}$$

where F is the

frequency of transmission. There are, however, other factors which affect the figure, and it is usual to include in the formula "K," which takes into account the physical properties of the aerial system. For example, on wavelengths between 10 and 80 metres, with wire up to 12 S.W.G. in use for the aerial, and with all earthed objects at least half a wavelength away, K can be taken as 0.95. Thus the formula becomes: $\text{Length (feet)} = \frac{492,000}{F} \times 0.95$.

The most simple form of Hertz aerial, and the one most suited to beginners, is known as the "End-on" Hertz, which is shown in Fig. 2, the aerial being excited by tapping it on to the tank coil of the output valve of the transmitter.

THE question of aerials for transmitting is one which has to receive reasonable consideration and, unlike receiving installations, it cannot be disposed of with the "that's good enough" attitude. In fact, it would be quite true to say that unless careful attention is paid

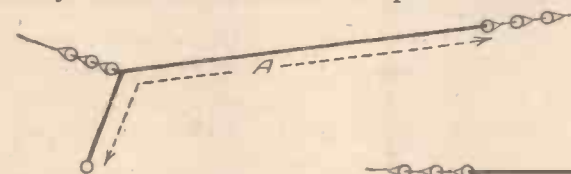

Fig. 1.—This is the popular Marconi aerial.

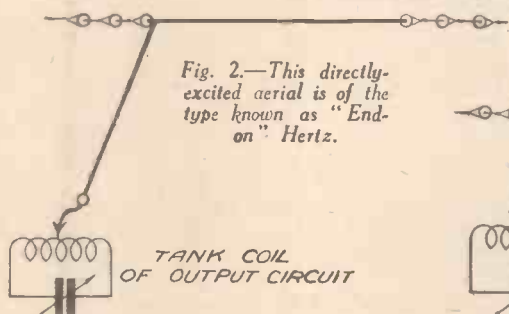

Fig. 2.—This directly-excited aerial is of the type known as "End-on" Hertz.

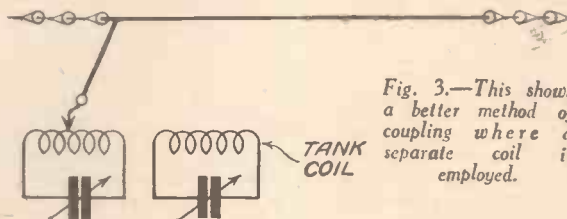

Fig. 3.—This shows a better method of coupling where a separate coil is employed.

to the design and construction of the radiating portion of a transmitter, the results will be most disappointing and, possibly, a continual source of perplexity. The types of aerials are many and varied, and the beginner will do well to select the most simple, according to local conditions and transmissions concerned, and investigate the properties of the more elaborate forms as he progresses with the subject. There are one or two points which must be noted when selecting the site, and when erecting the aerial, and if it is remembered that one is dealing with the radiation of a very low-powered signal, and not the reception of a transmission several times as strong, the transmitter output will stand a much better chance of "getting over."

Firstly, height is an all-important factor; every foot helps, so give that item some little thought, and get the suspension points as high as conditions will allow.

Secondly, select a site which will enable the aerial to be as far away as possible from all earthed objects, by which is meant houses, trees, telephone lines and cables and roofs.

Thirdly, see that the use of insulators is not skipped and that all joints, if any, and connections are soldered, while the suspension is such that the whole rig is reasonably taut and not liable to sway about, particularly if earthed objects are near.

As an earth or counterpoise is necessary, it is usual to consider the lengths A and E (Fig. 1) when referring to the length of aerial with this system.

The Marconi aerial is not greatly favoured by amateur stations, except where space is a vital consideration, as it radiates less of its input than the Hertz type.

Hertz Aerial

With this type of aerial the length is carefully calculated so that its natural frequency or wavelength will correspond to that of the transmitter and/or its harmonics. No form of earth connection is employed, the system being based on the principle that the wavelength to which a wire will tune depends directly upon its length, ignoring, for the moment, certain limitations or secondary factors.

The approximate natural wavelength of

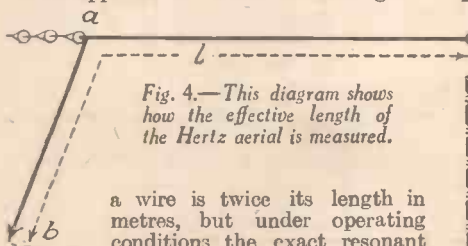

Fig. 4.—This diagram shows how the effective length of the Hertz aerial is measured.

a wire is twice its length in metres, but under operating conditions the exact resonant

A rather better method of coupling is shown in Fig. 3, where it will be seen that the aerial is tapped on to a tuned circuit, which is inductively coupled to the tank coil.

It must be appreciated that it is possible for a given aerial to be half-wave system on one band, a full-wave on the next higher frequency band, i.e., second harmonic, and so on, but it is not advisable to consider quarter-wave as a loss of radiation efficiency is likely to be experienced. In fact, the most satisfactory results are usually obtained with aerial lengths which are multiples of half-waves, preferably an uneven number.

When considering the length of a Hertz aerial, the full length "L," Fig. 4, must be taken, and when erecting such a system the section a, b should be kept as clear as possible from earthed objects, otherwise losses due to absorption will be introduced.

50 Tested Wireless Circuits

By F. J. CAMM

(Editor of "Practical and Amateur Wireless")

Obtainable at all Bookstalls, or by post, 2/6
2/10 from George Newnes, Ltd., Tower
House, Southampton Street, Strand, London, W.C.2

MAINS RECEIVERS

Gives Further Examples in Connection with A.C. Concerning the Power Supply in Universal Sets.

PRESTON

indicated. The first point of importance is that all of the valves should be of types taking the same heater current—in our example, .2 amp.

It will be seen that a simple double-

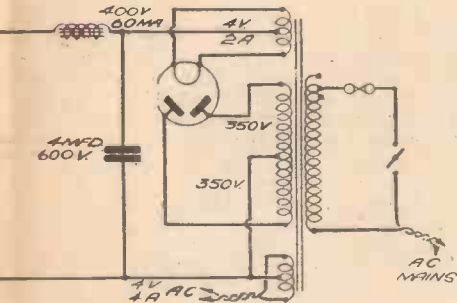

diode is used for second detection, since the output valve is a high-efficiency pentode, which would be loaded satisfactorily by the diode. The total heater voltage (found by adding together the voltages of all receiver and rectifier valves) is 119 volts. The mains voltage would generally be from 200 to 250 volts, so that a voltage drop of about 80 to 130 is required. This can best be arranged for by using a barretter, and the Philips type C1 provides a voltage drop of 90 to 230 at .2 amp., and is thus as suitable. The barretter would ensure that the heaters received the correct voltage when the mains voltage was anything between 200 and 319, although the difference in results when using an input voltage of 200 would be too small to be worth considering.

The High Tension

So much for the low-tension circuit. What about the H.T.? Again we must take representative figures, and it can be assumed that average valves of the types required would pass currents as follow: frequency-changer, 10 mA; I.F., 10 mA; double-diode, nil; output pentode, 45 mA; in addition, the potentiometer would pass, say, 5 mA. Thus, we have a total of 70 mA, and we know that most of the half-wave A.C.-D.C. rectifiers provide an output of about 220 volts at 75 mA. In consequence, the anode voltage of 150 to 200 taken by most universal valves could be obtained when using a smoothing choke of any resistance between 500 and 1,000 ohms, and when allowing for the bias voltage.

The example which we have just taken works out very conveniently, but there are often cases where this is not quite so

however, a very simple arrangement would be to use a 6,500-ohm mains-energised speaker with the field winding connected in parallel with the output from the rectifier between the points marked X in Fig. 3. This would pass about 30 mA at rectified voltages between 200 and 250, and would thus bring the total load just up to maximum output current provided by the rectifier.

Half-load

Alternatively, the rectifier could be operated at half load, when the voltage would be increased to a value of about 275. Use could then be made of a higher-resistance smoothing choke, or a fixed resistance could be connected in series with the choke, in the same manner as previously discussed. The same general rules would apply when using alternative rectifiers of either the valve or metal-oxide type, and the several variations mentioned in connection with A.C. receivers could be applied.

In some instances it would be possible to use an A.C.-type energised speaker in series with the H.T. supply, but this is not generally possible in a universal receiver,

Fig. 3.—Power supply details for a typical universal four-valve superhet.

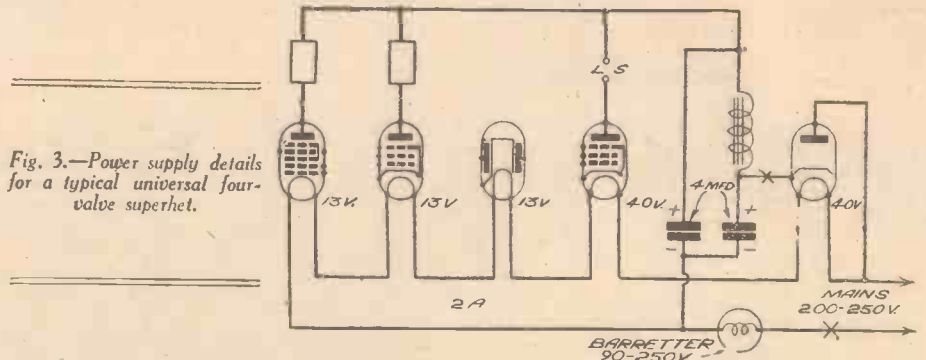

straightforward. For example, if the total anode-current consumption of the set were only about 35 mA. In such an instance,

due to the lack of "spare" H.T. voltage. Nevertheless, the idea would be perfectly satisfactory when using a voltage-doubler rectifier, such as the Tungram PV 3018, which provides a maximum output of 240 volts, 100 mA, or of 260 volts, 50 mA. Thus, when using the Tungram PP 4118 output pentode, which takes a maximum anode current of 35 mA and a screen current of 7 mA in conjunction with other valves taking 8 mA between them, there would be an available "surplus" voltage of 80 (the PP 4118 takes a normal anode voltage of 180). At 50 mA, a 2,500-ohm speaker field would drop 125 volts, which is too much, but a speaker with a 1,500-ohm field would drop only 75 volts, which would leave nearly 180 volts after allowing for the grid bias.

Of course, it must be remembered that the maximum rectified outputs are those obtained when the mains input voltage is 250, and that there is a corresponding drop when using a lower mains voltage. But in any event the universal receiver can be a compromise only, due to the possible variations in mains input voltage, and the valves are not very susceptible to reasonable variations in anode voltage.

It should be understood that all of the figures given above in relation to valves, voltages, and currents are only average ones, and in working out the details reference should be made to the data supplied by the makers of the valves which it is proposed to employ.

NOTES



Broadcasting Company, New York, and the RCA Circ. State Building, during a test broadcast.

to these there was an added attraction which was of especial interest to the press and art folk who came along, since The General Electric Company, Ltd., had installed for the occasion a high-definition television receiver. The suggestion for its installation had, as a matter of fact, only been made twenty-four hours prior to the party, but a complete installation with a dipole aerial on the roof leading down to the studio in the basement, had been made by G.E.C. engineers before the first guest had arrived.

Electron Multiplication

THE principles of secondary emission governing the action of electron multipliers are now well known, but so far the powers dissipated in such devices have been of a relatively low order. It is now learned that a Californian professor of physics has devised a piece of equipment which develops ultra-high-frequency oscillations for controlling the electron movement. The essential vacuum tubes are housed in a large copper shell of drum shape, and apart from the high efficiency attained there is no external radiating field. Oscillators or electron accelerators of this type will prove of extreme value for transmitter work.

Confessions of a Constructor

THE joke about making and breaking New Year resolutions is an old one, and I must confess that I have been as prolific in promises and as remiss in carrying them out as any other man. Never before, however, have I brought radio within the ambit of my good resolutions, but this year I have resolved to become, as far as in me lies, a model radio amateur.

First of all, I have resolved to be an active and consistent constructor this year. Radio, to me, is enthralling, but not all-enthralling; I have other interests—my garden; home decoration; occasional visits to the cinema; country excursions. In the past, enthusiasm has jumped from one to the other in an erratic manner, and often radio has been neglected for weeks or even months; and my own room even now contains the relics of several constructional enterprises, commenced in the full flush of enthusiasm, but later abandoned, half completed. In future I shall construct to a programme. One task at a time shall be my motto—a job carefully selected for its interest and “worth-whileness,” and carried out to its full completion before another is started.

The First Task

My first job will be to see that the domestic radio installation is as perfect as is reasonably possible, and then to keep it so. It is truly astounding that often those homes which can boast of at least one member of the family possessing something like expert radio knowledge have radio installations far less satisfactory than homes where no one knows the first thing about wireless, and the set is an ordinary commercial model, installed by the local dealer.

In my case, the “family” set is, in fact, a good class commercial radio-gram—an early 1936 model and fully capable of all that the family require, and more. The set itself is in excellent condition, but the installation is certainly not a credit. Among the jobs to be done are, first, a proper plug point and switch near the set to avoid the present straggly flexible lead. Second, the aerial and earth system must be overhauled, and particularly the lead-in, which is very unsightly and, probably, highly inefficient. Third, performance is at present marred by a considerable amount of electrical interference—a little due to outside sources, but most of it home-grown, and due to various causes such as the vacuum cleaner, hairdrier and so forth, but still more to faulty switches and wiring in the lighting circuit. It shall be one of my first jobs to track down all these sources of interference and to remedy them, so far as is possible, by replacing bad switches, checking the continuity and earthing of the conduit, installing suppressors where needed and, if necessary, providing a new aerial in a more satisfactory position, with a non-pick-up transmission line between aerial and set.

A Few New Year Resolutions which All Readers would do Well to Emulate

My next efforts will be directed to exploit to the full the possibilities of the family set by way of loudspeaker extensions. The set has a speaker extension socket but, apart from a permanent line from the lounge to the dining-room, proper advantage has never been made of the extension circuit, and on those occasions where listening in other rooms has been needed, untidy temporary leads have been used. Prosaic as the job seems, I am going to install permanent extension wiring to all the bedrooms and to the kitchen. More interesting, however, will be my attempts to devise some simple yet novel arrangement for the remote control of the set from each speaker position—a job which should provide several evenings' amusement.

Experimenting

When I have completed the house installation, my conscience will allow me to proceed with more serious experimental work. Here I shall be embarrassed by the wide field of opportunities. What shall it be—quality reproduction? Short-wave reception? or ultra-short-wave work?

Frankly, I have not made up my mind for the moment, but I am determined to make a definite choice—to set down in black and white what I intend to do, and what results I am aiming at; and to plan and to experiment until those results are achieved. In this way I shall secure tangible results for my labours, and shall have made a definite contribution to my knowledge and experience.

So much, at least for the present, for my practical programme this year. But there are other sides to my radio activities which must be properly organised. For example, I plan to devote a definite amount of time each week to serious radio study in order to keep my technical knowledge up-to-date with the latest developments. In the past I have often been unduly baffled for a time by a technical problem which, had I but known it, had already been dealt with in the technical press. My resolve, therefore, is to read PRACTICAL AND AMATEUR WIRELESS from cover to cover each week, and to file my copies carefully so that I can turn up any desired reference at any time.

Getting Things Ready

Next, and before commencing any practical work, I am going to spring-clean my own room at the first opportunity.

(Continued on opposite page)

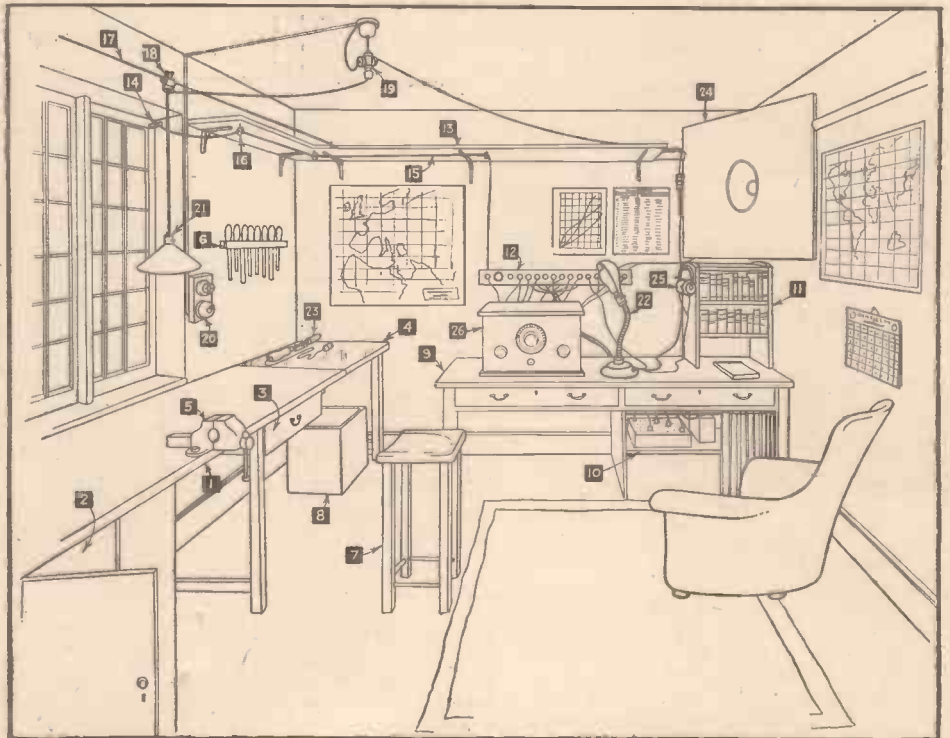

A suggested design for a radio workshop, in which there is a place for everything. Note the general tidiness, which should be a sine qua non in every constructor's den.

- Item No. 1.—The work bench.
 “ 2.—A useful cupboard.
 “ 3.—The tool drawer.
 “ 4.—Sheet of zinc.
 “ 5.—The vice.
 “ 6.—The tool rack.
 “ 7.—The bench stool.
 “ 8.—The scrap box.
 “ 9.—The testing bench.

- Item No. 10.—The battery compartment.
 “ 11.—Bookshelf.
 “ 12.—Universal terminal strip.
 “ 13.—Shelf.
 “ 14.—Lead-in tube.
 “ 15.—Aerial lead-in.
 “ 16.—Insulated hook.
 “ 17.—Stout galvanized wire.
 “ 18.—Sliding Clip.

- Item No. 19.—Three-way adapter.
 “ 20.—Wall-plug and switch.
 “ 21.—Light plug and switch.
 “ 22.—Adjustable lamp.
 “ 23.—Electric soldering iron.
 “ 24.—Loudspeaker mounted on baffle-board.
 “ 25.—Headphones.
 “ 26.—A set under test.

CONFESSIONS OF A CONSTRUCTOR
(Continued from facing page)

What a muddle it is in at present! Piles of papers on the floor, and on the desk! Tools scattered over the bench and elsewhere! Components lying about in a hopeless state of confusion; abandoned, partly constructed and partly taken down receivers on bench and shelves, and two junk boxes overflowing with "bits and pieces." An almost hopeless task to tackle—but it must be done.

All papers and catalogues shall be gone through and either filed away neatly or consigned to the garden incinerator according to their age and interest. My kit of tools shall be retrieved from the bench, shelves, drawers and cupboards among which they are at present distributed. They shall be overhauled, cleaned, sharpened or repaired as may be necessary, and where too badly damaged they shall be replaced. I hope to set aside a few shillings for new tools, but these shall be selected with more care than in the past. I shall buy a very limited number of high-quality implements because I have learned from experience that far better work can be done with a few good tools than with an extensive assortment of badly-made ones.

Test Equipment

Finally, I am going to devote a few evenings to my test equipment. I happen to be the fortunate possessor of a few quite good instruments—millimeters, a couple of high-resistance voltmeters, a calibrated oscillator, and so on. However untidy and haphazard I may be with regard to other things, I have always treated my instruments with the respect due to them. But there is a certain amount of work in connection with them which I want to do before starting on my constructional programme. There are test leads to be overhauled and a few new ones prepared, with various kinds of connectors—plugs, spades, and the adaptable "crocodiles." I also intend to refresh my memory concerning a number of useful testing hook-ups and will jot down in my note-book the appropriate circuits and connections so that no time need be lost in looking up details if I want to do a special test in a hurry. And while I am about it I think I will borrow from a friend a really good and accurate combined test set in order to check over the calibrations of my own instruments.

There is one other thing which I intend to do in connection with my New Year resolutions. It is, to institute a laboratory note-book. It will not be an elaborate affair—just a good thick exercise book which will always be found on my bench. In it I shall jot down brief details of what I do and the results which I obtain; diagrams of any new circuits I use, any changes I make, reception logs with times and dates for verifying long distance and short-wave reception; test readings, and any other matters which appear worth recording.

I believe this book will be exceedingly useful. In the past I have often wanted to repeat a certain experiment or to reproduce certain conditions, but have been unable to do so because I have modified my apparatus and have forgotten exactly what circuit or what conditions I was using before. With the aid of my notes it should be possible to turn up previous experiments and to find out exactly how certain results were obtained.

Now I have detailed my intentions for 1937. I hope to be able to report from time to time the extent to which I have been successful, for the benefit of fellow constructors.

PETO-SCOTT EVERYTHING RADIO—CASH C.O.D. or EASY TERMS

DO YOU KNOW?

Do you know that you can obtain all your radio requirements from us either for CASH, C.O.D. or under our famous Easyway system? No matter whether you require complete Kits, or Loudspeakers, eliminators, pick-ups, or a selection of special components for a set you intend to build, we will be pleased to quote you our EASY TERMS without obligation. We are the oldest Radio by Mail House in the country and have been established since 1919, so you can order with confidence.

1937 CRYSTAL SET

KIT "A" Cash or C.O.D. 22/- or yours 2/6 down and 11 monthly payments of 2/-
Comprises all components as specified in the Jan. 19th issue of PRACTICAL WIRELESS, including ready drilled paxolin panel and material for making coil.
● If B.T.S. Super Sensitive lightweight headphones required with Kit, add 8d. to deposit and each monthly payment.

ONE VALVE TRANSMITTER

KIT "A" Cash or C.O.D. 87/- yours 12/6 and 11 monthly payments of 7/6
Comprising every single component exactly as specified in Jan. 2nd issue of PRACTICAL WIRELESS. With all screws and wire, and aluminium angle pieces, panel and bakelite strip, ready drilled.
KIT "B" exactly as KIT "A," but including specified 240 B valve. Cash or C.O.D. £4 18 0, or deposit of 15/3 and 11 monthly payments of 3/6

B.T.S. ANTI-NOISE AERIAL



Cuts Out Noise and Increases Efficiency on Every Waveband. Improves Every All-wave Set.

Abolish man-made static, with this amazing new All-British Aerial Outfit. 90% of the trouble experienced in all-wave reception is NOISE, which the B.T.S. Anti-Noise Aerial efficiently suppresses, vastly improving your radio reception on ALL wavebands. In addition to an aerial transformer, the outfit includes a special set transformer, fitted with switch for reception on ALL WAVEBANDS. This EXTRA component will improve the sensitivity and selectivity of your receiver. Suitable for all sets, A.C. Battery and D.C. and ALL WAVEBANDS.

Complete Outfit, ready for instant erection. 25/- Cash or C.O.D. or 2/6 down and 8 monthly payments of 3/3.

2/6 DOWN.

NEW AND DIFFERENT! PETO-SCOTT 1937 SHORT WAVE ADAPTOR - CONVERTER KIT

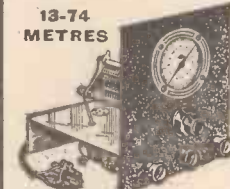

Convert your existing Battery or A.C. set for operation on the short waves with this up-to-the-minute unit. No alterations to your set whatsoever. Two hours to build—a lifetime of world-wide entertainment.

- No coil changing.
- Drilled steel chassis.
- Drilled steel panel.

KIT "A" 29/6
Cash or C.O.D. Carriage Paid.
Or 2/6 down and 10 monthly payments of 3/-
Comprises all parts for building, with diagram, assembly, and operating instructions, less cabinet.
Fully described in Booklet "B."

2/6 DOWN

Peto-Scott 1937 SUPER SENSITIVE S.G.3 KIT

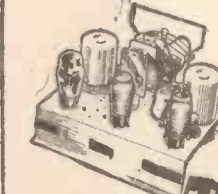

A NEW VERSION OF AN OLD SUCCESS

Without a doubt the very last word in sensitive and selective Kits, capable of providing real enjoyment from numerous British and Foreign stations. Screened grid detector Harries Pentode Output valves.

- SCREENED WAVE - WOUND AIR CORE COILS.
- DRILLED GREY ENAMELLED STEEL CHASSIS.
- PICK-UP CONNECTIONS.
- FULL INSTRUCTIONS WITH EVERY KIT.

KIT "A" 47/6
Cash or C.O.D. Carriage Paid
Complete kit of parts, including ready-drilled enamelled steel chassis, iess valves, cabinet and speaker.
Fully described in Booklet "B."

4/- DOWN

SELECTION OF POPULAR EASYWAY LINES

GARRARD A.C. Induction ELECTRIC MOTOR. A.C. mains. 100/250-v., 50-60 cycles. 12" turntable mounted on motor plate, with fully automatic start and stop. Cash or C.O.D. Carriage Paid, £2/2/6. Send 2/6 only. Balance in 11 monthly payments of 4/-.

GARRARD AUTOMATIC RECORD CHANGER. Type RC4. A.C. mains 200/250 volts, 50/60 cycles. Mounted on Unit Plate, including pick-up, ready for fitting. Cash or C.O.D. Carriage Paid, £7/10/0. Send 13/- only. Balance in 11 monthly payments of 13/6.

PETO-SCOTT MODEL MA 10/30 Eliminator and TRICKLE CHARGER. L.T. Output 0.5 amp, H.T. 20 M/A at 120 volts. Tappings for Screen, Det. Med. Power, High Power. Cash or C.O.D. Carriage Paid, £2/19/6, or 5/- Send down and 11 monthly payments of 5/6. For A.C. Mains 200-250 volts, 40/50 cycles.

B.T.S. NEW MINOR (UNIVERSAL) PICK-UP. Send with self-contained volume control. Cash or C.O.D. Carriage Paid, 17/6. Balance in 7 monthly payments of 2/6.

A VOMINOR D.C. MAINS & BATTERY TEST METER. 10 ranges. Supplied in velvet lined case with leads, dials and prods. Cash or C.O.D. Carriage Paid, £2/0/0. Balance in 10 monthly payments of 4/3.

Peto-Scott PORTABLE 5-metre TRANSMITS and RECEIVES TRANSCEIVER KIT



What a thrill! What a hobby! What a pastime! Imagine the delight in establishing radio communication with your friends—there's tremendous fun and entertainment in it. Start building your Transceiver NOW. Full Building and Operating Instructions with every kit.

- SENSITIVE MICROPHONE in spring mounting.
- TELEPHONE JACK
- SPECIALLY DESIGNED TRANSFORMERS for 5-metre band.
- ENTIRELY SELF-CONTAINED (except aerial.)

KIT "A" £2:12:6
Cash or C.O.D. Carriage Paid. Or 5/- down and 11 monthly payments of 4/10.
Comprising drilled steel chassis and black panel, all necessary parts, including microphone, less valves, cabinet and batteries.

W.B. 1937 SPEAKERS



MODEL 37S. Amazing reproduction provided by new magnet and exponential moulded cone. Microlode matching device. Cash or C.O.D. Carr. Paid, £2/2/0. Or 2/6 down and 11 monthly payments of 4/-.
MODEL 37J. Perfectly matches any receiver as principal or extra speaker. Cash or C.O.D. Carriage Paid, £1/12/6. Or 2/6 down and 11 monthly payments of 3/-.



MODEL 37SC A Cabinet instrument giving superb reproduction, with power handling capacity of up to 10 watts undistorted. The turn of a switch adjusts it to match any set made. With volume control. Cash or C.O.D. Carriage Paid, £2/3/0. Or 3/- down and 11 monthly payments of 5/9.

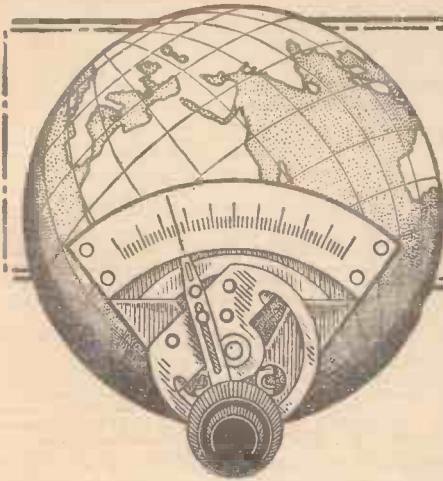

SHORT WAVE SECTION

THE "ONE-VALVER" FOR AMERICA

This Receiver was Originally Described in "Amateur Wireless" dated March 31st, 1934

AS quite a number of constructors who require a simple but yet effective one-valve S.W. receiver, not costing too much to build, are turning their attention to the above receiver, we are giving the details of the coil and S.W. H.F. choke, as these were intended for home construction, and it is no longer possible to obtain copies of the issue describing them.

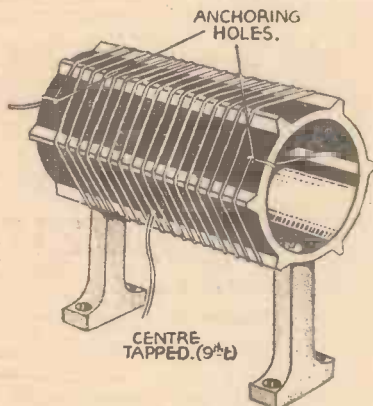

Fig. 1.—The finished coil, showing the method of mounting.

Making the Coil

For this component, a 4in. length of six-ribbed ebonite former, having a diameter of 3in., is required, together with about 1/4lb. of 20 S.W.G. tinned copper wire.

A small hole is made at each end of the former, sufficiently large to take the 20 gauge wire, and to anchor each end of the coil. The detail shown in Fig. 1 is self-explanatory; one end of the wire is made fast through one anchor hole, and then sixteen turns are wound on the former, care being taken to keep the wire really taut, and each turn spaced from its neighbour by 1/8 in. When the winding is completed, clip off any surplus and make the end fast through the remaining anchoring hole.

The completed coil is then mounted on two Bulgin coil supports (type S.W.49) so that it stands clear of the baseboard.

Connections

The fixed vanes of the aerial tuning condenser, one side of the grid condenser, and one side of the aerial series condenser are connected to the coil by means of a short length of flexible insulated wire, which is fitted with a crocodile clip. The earth side of the reaction condenser, i.e., moving vanes, is also connected to the opposite end of the coil in a similar manner,

this method being adopted to allow different wavebands to be received.

It is now necessary to make a connection to the centre of the coil winding, i.e., the 8th turn from either end, and this is best done by soldering another length of 20-gauge tinned copper wire to that point, or by using another crocodile clip, though soldering is by far the better.

This centre connection is wire No. 9 on the blueprint, and forms the earth connection to the coil.

The maximum wavelength, with the specified tuning condenser, .0002 mfd., is approximately 60 metres, but 20 metres can be received if the crocodile clips are fastened, say, two turns each side of the centre or earth connection. As the clips are moved further from the centre, especially the one connected to the tuning condenser, so will the wave-range increase.

Use of Plug-in Coils

If it is desired to use modern plug-in coils, such as those produced by Eddystone, B.T.S., Premier Supply Stores, and other producers of S.W. products, a suitable valve-holder can be fitted in place of the specified coil assembly, and different plug-in coils used to cover a much wider band of wavelengths.

The wires No. 9 and 18 should be connected to the grid winding, and No. 19 to one side of the reaction winding, the other side of which can be connected to the terminal holding wire No. 9.

High-frequency Choke

The specified choke is made in the following manner. A glass test tube, 1/2 in.

diameter, should be obtained from a chemist, and on it is wound 255 turns of 36 S.W.G. D.S.C. wire. It is rather difficult to count the turns, in this case; therefore, it will be sufficiently accurate to wind until 2 1/2 in. of the tube is covered, each end being made fast by means of a small blob of sealing-wax or Chatterton's compound, as indicated in Fig. 2. Care should be taken to leave ends long enough to make the connections to the anode of the valve-holder, and one terminal on the 'phone block. The H.F.C. thus formed is held in position by screwing a cork, which will fit the test tube tightly, to the baseboard, and then gently forcing on the tube, so that it stands vertically. To enable those constructors who have the blueprint to secure the specified parts, we append a copy of the original component list.

USING A HETERODYNE FREQUENCY METER

THE following notes are given concerning the frequency meter described in the last issue. Apart from its function and usefulness in checking and measuring frequencies and calibrating receivers, it can be used as a separate heterodyne for CW recep-

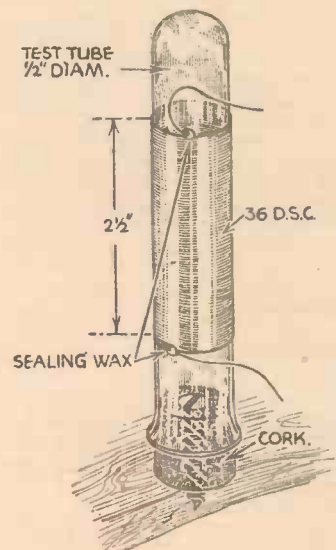

Fig. 2.—The simple H.F. choke.

tion through heavy interference. The required CW signal is tuned in as closely as possible on the receiver and the reaction backed off as for 'phone reception; the meter note will then beat with the incoming CW signal, giving greatly increased selectivity on that particular signal.

COMPONENTS REQUIRED FOR THE ONE-VALVER FOR AMERICA.

- Baseboard, Ply, 10 x 9 inches.
- Fixed Condensers.
 - One .0001 mfd.
 - One .0002 mfd.
- Variable Condensers.
 - One .0002 mfd. air dielectric with 4in. dial.
 - One .0005 mfd. solid dielectric.
 - One .00002 mfd. Jackson Bros. (Neutralising).
- Valve-holder. One 4-pin.
- Plugs, Terminals, etc.
 - Two Wander Plugs, H.T. +, H.T. —
 - Two Spade Terminals, L.T. +, L.T. —
 - Two Terminal Blocks—Belling-Lee.
- Resistance, Fixed.
 - One 3-megohm—Erie.
- Sundries.
 - One ebonite former, 3in. dia. by 4in. long, six ribs.
 - Two Bulgin coil supports (type S.W.49).
 - 20 S.W.G. tinned copper wire.
 - Insulated Slewing
 - One component mounting bracket.
 - Two crocodile clips.
 - 2yds. rubber-covered flex.
 - 12yds. 36 S.W.G. D.S.C. wire.
 - One Test Tube, 1/2 in. diameter.
 - Valve. Cossor 210 Det.

THE BRITISH LONG DISTANCE LISTENERS' CLUB

THE recent reference to old-time circuits such as the super-regenerative has led to a crop of inquiries concerning other features which were at one time popular but which have now ceased to exist. For short-wave reception the old arrangements such as the Flewelling, etc., will not be found so valuable as the super-regenerative. Even the latter is inferior to a well-designed superhet, but in the latter case, of course, more valves are required. The circuits which we gave recently of one-valve super circuits may be found of great value in obtaining improved results in short-wave receivers, but there is always an element of luck in getting these to function efficiently. Reflex circuits also seem to be doubtful in their results. One reader has had phenomenal results with a two-valve reflex in which a Class B valve performed three separate functions, but in a hook-up which we tried, round the same circuit, the results were very poor indeed. Individual valves will, in fact, be found to vary to quite a considerable extent when employed in these "stunt" circuits, and therefore one should be prepared to spend some time in getting the arrangement working.

Mr. Cottignies, who supplied the super-regenerative details in a recent issue, has sent a diagram of a straight three with which he has had splendid results. He says

that it is delightfully easy to handle on any frequency from 1.5 mc/s to 70 mc/s. This employs a simple band-spread arrangement with R.-C. coupling to the first stage and parallel-fed transformer coupling to the output valve. He uses a dipole for 56 mc/s.

Station W4XE

FROM Mr. Cottignies, the following details of the New Florida station have been received: "It may be of general interest that station W4XE, an experimental station at Gainesville, Florida, is being well heard down here. It works on 31.5 megacycles, or 9.5 (approx.) metres, and is heard around 14.30 G.M.T. With a two-tube straight receiver conditions on December 12th, 1936, at 14.30, were R5 to 6, QSA 4 to 5, with slight shallow QSB.

"I wish to thank your correspondents for their kind help in elucidating the harmonic problem.

"If I may, for a moment, refer back to the old, old subject of QSL's, I would just like to say that I received, a few days back, a card from SUI5G, which I find pleasing to the eye, owing to the pictures of Sphinx and Pyramid of Gizeh. It also has a charming message on it thanking me for F.B. reports at various dates (last one sent four months ago!).

"May I take this opportunity of wishing the good old PRACTICAL AND AMATEUR WIRELESS and its staff all the prosperity going in 1937, not forgetting all my fellow-readers wherever they may be."

A.E.L. Certificate

Several readers have written concerning the qualifications required for the All Empire Listener's Certificate. To obtain this you must send verifications of reception in respect of five continents. Upon receipt of these verifications, which will be returned to you, the certificate will be prepared.

Directional Aerials

Very little appears to have been done by the amateur in the way of experimenting with directional aerials. The effects of reflector-aerials are too well known to need emphasising, and by using such a device in conjunction with a moving reflector it is possible to obtain long-distance reception under conditions which would normally be impossible. In this connection we may mention that at Southend a listener is regularly receiving the television pictures from Alexandra Palace, and these are unobtainable at this particular spot without the reflector. Mr. A. W. Mann, of Middlesbrough, whose short-wave articles are well known to readers of this paper, has developed an aerial of the uni-directional type and this is now on the market. It enables the aerial system to be rotated from inside the house and in addition to giving directional reception, a device of this nature also reduces atmospheric background noises to a remarkable extent. Have any other members experimented in this direction with any degree of success?

RADIO CLUBS AND SOCIETIES

Club Reports should not exceed 200 words in length and should be received First Post each Monday morning for publication in the following week's issue.

Radio, Physical and Television Society
THE first lecture of the second half of the 1936-37 season was given by Mr. J. G. Hobbs on Friday, January 8th, the subject being "Short-wave Converters and Superhets." After dealing with the disadvantages of the T.R.F. receiver Mr. Hobbs explained how a great number of these disadvantages may be overcome by causing the incoming signal to beat with a local oscillation and effecting the major part of the amplification at one frequency. The most usual frequency-changing arrangements were explained and instructions given for making a short-wave converter enabling one to use a broadcast receiver for short-wave work.

The lecture was rendered exceptionally interesting thanks to Messrs. Burgoyne, Ltd., who were kind enough to loan the Society a five-valve A.C. all-wave receiver. Mr. Hobbs explained briefly the circuit employed in the receiver, which was afterwards demonstrated, and in spite of the exceptionally poor local conditions and inefficient aerial many short-wave stations were received.

Meetings of the Society are held at 72a, North End Road, West Kensington, W.14, every Friday evening during the winter months at 8 p.m., when lectures are given on various Radio and Physical subjects. Morse instruction and assistance is given to members wishing to obtain transmitting licences. Readers interested in the Society

are invited to communicate with the Hon. Sec., Mr. V. R. Walker, 49, Fitz-James Avenue, London, W.14.

The Cardiff and District Short-wave Club

THE above club has just completed a very successful first year, and wishes to send to all its members—readers of PRACTICAL AND AMATEUR WIRELESS—its best wishes for a prosperous New Year. These wishes are also extended to all readers of this paper, and the committee of the above club hope to have the pleasure of meeting many of them at any of the meetings.

Meetings are being held weekly at the clubrooms in City Road, Cardiff, and the Secretary would be only too pleased to give any information to any person writing him, at 132, Clare Road, Cardiff. On February 4th the Club are holding their Annual Supper at the Barry's Hotel, St. Mary Street, Cardiff, and any person wishing to be present should write to the Secretary, H. H. Phillips, reserving a ticket. The charge will be 1s. 9d.

Harco Radio Club (Greenwich)

THE membership of our club is increasing rapidly. Up to the present most evenings have been in general discussions on amateur radio, learning the morse code and testing members' receivers.

On January 26th, 1937, there is to be a demonstration and lecture given by Mr. E. Cholot, of Lissen Ltd. All readers of PRACTICAL AND AMATEUR WIRELESS are welcome to attend any of our meetings, which are held every Tuesday at 8 o'clock.

Hon. Sec.: C. W. Kemp, Dept. (HRC), 124, River Way, Greenwich, S.E.10.

OUR FREE CATALOGUE SERVICE

To save readers trouble, we undertake to send on catalogues of any of our advertisers. Merely state, on a postcard, the names of the firms from whom you require catalogues, and address it to "Catalogue," PRACTICAL AND AMATEUR WIRELESS, Geo. Neumes, Ltd., Tower House, Southampton St., Strand, London, W.C.2. Where advertisers make a charge, or require postage, this should be enclosed with applications for catalogues. No other correspondence whatsoever should be enclosed.

Eddystone Short-wave Components

A WIDE range of short-wave components, including several new lines, are listed in the latest catalogue issued by Stratton and Co., Ltd., of Birmingham, who are well known amongst the short-wave fraternity for the quality and high-class workmanship of their products. Among the new components listed are a split-stator condenser, for which many uses as a tuning element will be found; a full vision dual-speed dial and precision slow-motion dial, with a particularly smooth action and a 100-1 ratio; an iron-cored filament choke, hand microtelephone, and a welded steel cabinet provided with ventilating louvres. In addition, the popular Eddystone standard lines are listed, including four- and six-pin coils, ultra-short-wave interchangeable coils, I.F. transformers, chokes, condensers, valveholders, aerial equipment, transmitting inductances, quench-coil unit, and transmitting racks. There is a price reduction on interchangeable four- and six-pin coils, and also the Litz-wound air-tuned intermediate-frequency transformer, which is now listed at 10s. 6d.

Let Us Send You This 40-Page Booklet—Free



It gives full information regarding various I.C.S. Courses of Instruction in Radio work.

The Radio industry is progressing with amazing rapidity. Only by knowing thoroughly the basic principles can pace be kept with it. I.C.S. Instruction includes American broadcasting as well as British wireless practice. It is a modern education, covering every department of the industry.

OUR COURSES

Included in the I.C.S. range are Courses dealing with the Installing of radio sets and, in particular, with their Servicing, which to-day intimately concerns every wireless dealer and his employees. The Equipment Course gives sound instruction in radio principles and practice.

There is also a Course for the Wireless Salesman. This, in addition to inculcating the art of salesmanship, provides that knowledge which enables the salesman to hold his own with the most technical of his customers.

Then there are the Preparatory Courses for the City and Guilds and I.W.T. Exams.

We will be pleased to send you details and free advice on any or all of these subjects. Just fill in, and post the coupon, or write in any other way.

International Correspondence Schools, Ltd.,
Dept. 94, International Buildings,
Kingsway, London, W.C.2.

Without cost, or obligation, please send me your "Radio" booklet of information about the Courses I have marked X

- COMPLETE RADIO
- RADIO SERVICING
- RADIO EQUIPMENT
- RADIO SERVICING AND SALESMANSHIP
- WIRELESS ENGINEERING
- EXAMINATION (state which)

Name Age

Address

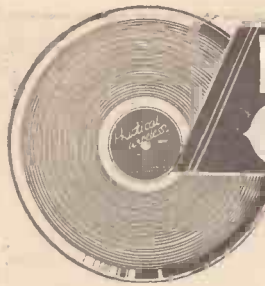

IMPRESSIONS ON THE WAX

By
T. O'nearn

Columbia Records

PARTICULARLY recommended for all who like waltzes, either for listening or dancing to, is a Columbia record entitled "Waltzing to the Guitar." Leñ Fillis on a Hawaiian guitar plays a lot of old favourites, including "Destiny" and "Alice Blue Gown," and mention must be made of the piano accompaniment by Scott Wood. The number of the record is *Columbia FB 1544*.

Albert Sandler also appears in this list, and we have him playing a medley of popular "Sandler Minuets" on *Columbia DX 759*. He has also made another record of "Estudiantina" and "Dolores," both of which are waltzes, on *Columbia FB 1537*. Quentin Maclean, on the Trocadero organ, revives Ketelbey's most popular work, "In a Monastery Garden," on *Columbia FB 1534*.

A Popular Tune

If a song is in public favour, depend upon it that Turner Layton will record it. A tune in popular favour at the moment is "When the Poppies Bloom Again," and he has recorded this ballad, coupled with "I want the whole world to love you," on *Columbia FB 1564*. He has also made another popular record this month of "Miracles sometimes happen" and "Cabin on the hilltop" on *Columbia FB 1565*.

A Fine Orchestration

THE great element of enjoyment inseparable from a Drury Lane show is its music, and "Careless Rapture" is certainly a notable example. Ivor Novello's catchy tunes are woven into an excellent selection, played by the popular wireless "Orchestre Raymonde" under its talented leader-arranger, G. Walter. The number of this record is *Columbia DB 1658*.

A request record this month is issued featuring Flanagan and Allen in a half-dozen of their own hits. Among them are "Underneath the arches," "Where the arches used to be," and "Dreaming." The title of the record is "Memories," and its number is *Columbia FB 1558*.

Fireside Variety

THERE are some excellent records in the latest Columbia list with which one can spend many a happy evening. Carroll Gibbons and his Savoy Hotel Orpheans have recorded "The Song is Ended" and "Serenade" on *Columbia DX 762*, and the famous radio song "Audrey, Little Audrey" (she laughed and laughed) is sung by the composers, Davy Burnaby and Michael North, with a burlesque on Flotsam and Jetsam on the reverse side—*Columbia FB 1539*.

Will Hay and His Scholars, issued for the first time on 1s. 6d. records, enact their episode in the "Fourth Form at St. Michael's"—*Columbia FB 1540*; Louis Levy and his Gaumont British Symphony have done their popular "Music from the Movies" selection, which includes their

famous march signature tune—*Columbia FB 1545*; something new in xylophone records comes from Harry Robbins and His Redbreasts playing "Chicken Reel" and "I'm Just Wild About Harry"—both in the Red Norvo style on *Columbia FB 1555*; and Les Allen sings the sentimental hits, "When Old Friends Meet Again" and "Don't Kiss Me Good-night," on *Columbia FB 1563*.

The new cowboy song "I'm An Old Cowhand" has its ideal exponents in the Rocky Mountaineers on *Columbia FB 1562*, and a magnificent "Mikado" selection is furnished by Debroy Somers band on *Columbia FB 1535*. Clapham and Dwyer have also done their funny radio skit "Another Day's Broadcasting" on *Columbia FB 1536*.

An All-star Record

A RECORD which I specially recommend is "Carroll Gibbons' Birthday Party," on both sides of *Columbia DX 760*. The guests who appear on this record are Stanley Holloway, Flanagan and Allen, Albert Sandler, Turner Layton, Norman Long, Mario Lorenzi, Raymond Newell, and Scott Wood and his Six Swingers.

The ringleader is Stanley Holloway, whose comic song about Mr. and Mrs. Ramsbottom on a bicycle made for two sets everybody in a good humour. Albert Sandler contributes a fine violin solo, Raymond Newell obliges with a shanty, Scott Wood and his Six Swingers troop in playing "For He's a Jolly Good Fellow," and all the other artists add to the fun of the party.

Decca Records

A FEW weeks ago the B.B.C. presented a vaudeville programme in which there appeared a number of artists generally unfamiliar to listeners and in this interesting broadcast Cecil Johnson appeared. As his broadcast turn was considered to be unique, he has recorded it for the Decca Company. The records are "A Running Commentary on the Annual Dinner of the Slate Club Secretaries," on *Decca F 6236*, and "A Running Commentary on a Bargain Sale," on *Decca F 6237*.

The Street Singer has made a new record this month of "The Way You Look To-night" and "I'll Sing You a Thousand Love Songs," on *Decca F 6235*.

Dancing Time

AMBROSE and his orchestra have made three popular records in the new Decca list. They are "I've Got You Under My Skin" and "Easy to Love," both of which are from the film, "Born to Dance"—*Decca F 6240*, "Have You Forgotten So Soon?" and "To You, Sweetheart"—*Decca F 6227*, and "Memories of the Mayfair," on *Decca F 6239*.

TELEVISION AND SHORT-WAVE HANDBOOK

By F. J. CAMM

3/6 or 3/10 by post from

George Newnes, Ltd., Tower House,

Southampton Street, Strand, London, W.C.2.

REPLIES IN BRIEF

The following replies to queries are given in abbreviated form either because of non-compliance with our rules, or because the point raised is not of general interest.

W. G. (Portadown). The full address was given in the issue at the end of the writer's letter. No further address is required.

G. P. M. (Edinburgh). There is no complete list. The Radio Amateur Call Book gives many amateurs in various countries in the world, but not all of them. Threshold howl may be responsible for the trouble. Try different values of grid leak and a different H.F. choke.

F. S. D. (Hillingdon). We regret that the issue is now out of print, and we did not take over copies dating back to the time mentioned. Consequently, we are unable to give you any information regarding the set.

I. F. A. (Southgate, N.14). We refer you to the list of blueprints which appears in each issue. Perhaps you can select a suitable set from this list.

J. L. W. (Sydenham). We regret that the unit was only used in one of our receivers, and this was a D.C. mains set.

G. E. S. (Marchwood). Your information does not enable us to identify the set as one of our designs, and accordingly we are unable to recommend one of our blueprints.

H. J. C. (S.W.3). We have no blueprint of a short-wave receiver of the type mentioned, but the Prefect S.W. Three could be used by employing different coils. We would not recommend it for the ultra-short waves down to 5 metres, however, in view of the length of some of the leads in the tuning circuit.

H. C. S. (Harrow Weald). We are not familiar with the circuit arrangements of the commercial receiver referred to, and suggest that you communicate direct with the manufacturers.

S. F. (Lozells). The £4 Superhet 4 or the £5 Superhet 3 are the best receivers to suit your requirements.

A. W. B. (Swindon). An ordinary L.F. transformer and valveholder are required. The P. and H.T. terminals on the transformer are joined to the L.S. terminals on your present set and the remaining connections are as in the L.F. stage you are now using.

J. W. (Hednesford). You can add a simple L.F. stage and the remarks above apply also in your case. Alternatively, you could extract the L.F. stage from any circuit published in our pages. It should be possible to work a loudspeaker satisfactorily with the complete receiver.

J. R. (Warrington). The coils were designed by another publication and we have not used them in any of our receivers. Consequently, we cannot recommend any of our blueprints.

E. R. B. (Barking). Your idea seems quite sound, but we do not think many readers would consider the expense justified, and would prefer a superhet. with the same number of valves.

A. H. (Gleckheaton). If the unit is a straight one (and not a superhet pack), it would be similar to that used in our Radiopak Class B 4 receiver, but no further blueprints of this are available, as the pack has not been on the market for some considerable time.

M. W. (Boscombe, E.). No further details of the amplifier are available. It should not be difficult to construct it from the details given in the issue.

W. J. (Higham Ferrers). We are sorry that we cannot give any further details on the article in question. We shall, no doubt, add to the beginners' articles you refer to.

A. L. W. (Barking). It would appear that either the coil or the switch is faulty. You should certainly not get new valves until you have got this part of the set to work properly.

J. S. (Hull). It should not be necessary to clean out the acid. We suggest you take it to a good Exide service agent and have it examined. Perhaps it requires a slow charge, or some other special treatment.

E. H. (Windsor). We have no blueprint which uses exactly the parts mentioned in your letter. You could, of course, substitute your coil and valves for those specified for any of our receivers, but we could not give you any information for making this change and only guarantee our receivers when the parts specified by us are employed.

E. T. (S.W.2). You do not give the H.F. circuits or other details, and as the current of these valves will pass through the chokes we cannot give you the values of the resistors, etc., nor the H.T. voltages at the points mentioned.

N. H. (Belfast). We have no blueprint or constructional details of a receiver of the type mentioned in your letter. We may be describing such a set in the near future.

G. E. C. (East Ham). The wiring is carried out with 22 D.C.C. wire as mentioned. The books referred to can be purchased from this office.

NEW YEAR BARGAINS

2 GUINEA S.G.3. CHASSIS

COMPLETE with S.G., DET. and PENTODE VALVES

BRAND NEW!

LIST PRICE £4:4:0 BARGAIN 42/-



Complete with 3 British Valve of Guaranteed Life.

Opportunity with a capital "O"! Build a set with a capital performance at a quarter the usual price! We offer you this marvellous, modern Screened Grid 3 Chassis, complete with valves, black escutcheon and knobs, for a couple of guineas only! Part of a famous manufacturer's stock, each chassis is brand new and tested on British and Foreign stations before dispatch. A typical N.T.S. BIG BARGAIN! Secure yours now. Recommended P.M. Moving Coil Speaker, 15/- extra. Walnut Finished Console Cabinet, 10/- extra.

- Screened Grid H.F. Detector and Pentode Output Valves.
- Screened wave-wound coils.
- 2-gang Air Dielectric Condenser.
- Metal Chassis.
- Only 9 m.a. H.T. consumption.
- Illuminated and Wavelength Calibrated Dial.
- Wave range 200 - 2,100 metres.

CASH or C.O.D. Carriage Paid £2:2:0

2/6 DOWN

Or 2/6 down and 12 monthly payments of 4/-

COMPLETE RECEIVER, comprising above Chassis in walnut finished Console Cabinet, with Valves and P.M. Speaker, less batteries. Cash or C.O.D. Carriage Paid £3/7/6, or 5/- down and 12 monthly payments of 5/6.

ALL WAVE 6-VALVE A.C. CHASSIS

A.C. MAINS 200-250 volts 40-80 cycles.

LIST PRICE £8:10:0

BARGAIN £4:15



Complete with 6 valves

- Octode Frequency Changer circuit employing 6 Valves
- Automatic Volume Control
- Celestion M.C. Speaker
- Illuminated air-plane dial
- Waverange 17-2,000 metres.

This wonderful triple-range set is as simple to operate and as economical to run as an ordinary 2-band receiver, and covers all three wavebands, long, medium, short, bringing you music and entertainment from every part of the world, in addition to the usual English and Continental broadcasts. Cash or C.O.D. Carriage Paid £4/15/0 or 5/- down and 11 monthly payments of 9/-. Everised Speaker 21/- extra or add 2/- to deposit and monthly payments.

5/- DOWN

N.T.S. Moving Coil SPEAKERS

LIST PRICE 27/6

BARGAIN 10/- OR

High fidelity permanent magnet Moving Coil speakers, slightly shop soiled only. Power, Super Power or Pentode. (State which when ordering.) Cash or C.O.D. Carriage Paid 10/- or 2/6 down and 4 monthly payments of 2/6.

2/6 DOWN

N.T.S. 1-valve SHORT WAVE KIT

Complete Kit of parts to build an efficient experimental short-wave covering 12/94 metres. Comprises Metaplex baseboard, variable and fixed condensers, switch, valve, and coil holders, H.F. choke, terminals, slow motion drive, short-wave coils, connecting wire, and FULL WIRING DIAGRAM. Less valve. Every part for immediate assembly. Cash or C.O.D. Carriage Paid 19/6, or 2/6 down and 3 monthly payments of 2/6. N.T.S. Lightweight headphones 7/6 pr. extra.

2/6 DOWN

N.T.S. SHORT WAVE 2

12-94

Metres



With a remarkable range that will give you hours of fascinating short-wave entertainment. Kit comprises all components including metal-sprayed baseboard, 3 variable condensers, .0001, .0002 and .00016 MFD. on/off switch, L.F. Transformer, 3 baseboard mounting four-pin holders, short-wave H.F. choke, 2 terminal mounts, 4 terminals, 3 fixed condensers, slow-motion drive, grid leak, connecting wire, 3 4-pin short-wave coils, 12/26, 22/47, and 41/94 metres, 2 component brackets and wiring diagram. Cash or C.O.D. Carriage Paid 27/6, or 2/6 down and 11 monthly payments of 2/6.

2/6 DOWN

N.T.S. S.W. ADAPTOR

12-94

Metres



America and all the World DIRECT on your present set, for only 17/6. Build this reliable short-wave adaptor for use with any BATTERY receiver. Kit comprises all parts, including metal-sprayed baseboard, 2 variable condensers, .00016, .0001 MFD., 2 baseboard mounting 4-pin holders, short-wave H.F. choke, grid leak, fixed condenser, adaptor plug terminal mount, 2 terminals, 3 4-pin plug-in coils, 12/26, 22/47, and 41/94 metres, 1 component bracket, slow-motion drive, trimming condenser, connecting wire and wiring diagram. Built in one evening. Cash or C.O.D. Carriage Paid 17/6, or 2/6 down and 7 monthly payments of 2/6.

2/6 DOWN

BARGAIN CLASS "B" 4 KIT

4-VALVE KIT

7 TIMES THE VOLUME of the ordinary Battery Set!

LIST PRICE £4:4:0

BARGAIN



45/- Cash or C.O.D. Carr. Paid. OR YOURS FOR

2/6 DOWN

● Latest Class "B" Circuit built on METAPLEX. ● 4 Stages. ● Variable Mu. Screened Grid high-frequency detector. Class "B" Driver and Class "B" Output Valves. ● Shielded Coils. ● Twin gang Air Dielectric Condenser. ● Range 200-550 and 1,000-2,000 metres. Working Drawings and instructions with each kit.

KIT "A" All parts, less valves, cabinet, speaker. Cash or C.O.D. Carriage Paid £2 5s. or 2/6 down and 11 monthly payments 4/3.
KIT "B" with valves. £3:13:6 or 12 monthly payments 6/9.
KIT "CS" with valves, walnut finished console cabinet, and N.T.S. Class "B" M.C. Speaker £5 15s. 6d. or 10/- down and 11 monthly payments 10/6.

B.T.S. ADABAND BARGAINS

LIST PRICE £6:12:6

BARGAIN

£4:19:6

BRINGS AMERICA to your present set! Simply stands beneath and plugs into your existing receiver, of almost any kind. Walnut veneered cabinet. Single tuning control. Long, medium or short-wave reception on one switch without disconnecting. Waverange 13-74 metres. A.C./D.C. MAINS MODEL. List Price £6/12/6. Bargain £4/19/6. Cash or C.O.D. Carriage Paid or 5/- down and 11 monthly payments of 9/6. BATTERY MODEL. List Price £5/5/0. Bargain £3/19/6, or 5/- down and 11 monthly payments of 7/6.

5/- DOWN

MORE SET BARGAINS

In addition to the bargains appearing in this advertisement we have a large number of battery and A.C. mains receivers of all types, and they are offered at ridiculously low prices that cannot possibly be repeated. Send for comprehensive list of these bargain receivers NOW.

Engineers' Guide

containing the widest choice of engineering courses in the world

Outlines The T.I.G.E.'s up-to-date home-study Courses in Wireless, Electrical and Mechanical Engineering, etc. Shows how to become A.M.I.E.E. A.M.I.W.T., A.Rad.A., etc., and how to qualify for a well-paid post. Training until Successful Guaranteed. WRITE NOW for Free Guide. THE TECHNOLOGICAL INSTITUTE OF GREAT BRITAIN, 42, Temple Bar House, London, E.C.4. (Founded 1917. 19,000 Successes.)



To Success

DANGER FROM LIGHTNING
GET A GARD
LIGHTNING ARRESTER
 WITH THE GUARANTEE 2/- OF £200

Act now! Don't run risks. Lightning may ruin your set, your home, your very life. Forget these dangers with a GARD, from all dealers or post free from:

GRAHAM FARISH LIMITED,
 Masons Hill, Bromley, Kent.

EASY PAYMENTS
 "THERE'S NO PLACE LIKE HOLMES." Monthly

	Deposit	Payments	of	
W.B. 37 J	32/6	3/7	9	3/7
ROLA. F720 P.M. .. .	36/-	3/10	9	3/10
ROLA. G.12 P.M. .. .	£5 5s.	9/7	11	9/7

ANY MAKE OF SPEAKER SUPPLIED.
 B.T.H. PIEZO-ELECTRIC .. . 35/- 3/10 9 of 3/10
 PICK-UP .. . 40/- 4/5 9 of 4/5
 AVOMINOR .. . 50/- 4/7 11 of 4/7
 GRAHAM-FARISH SENSITIVITY .. .
 SUPER .. .
 GRAHAM-FARISH ALL-WAVE KITS .. . 57/6 5/3 11 of 5/3

Valves, Battery and Mains Valves supplied on H.P. PARTS FOR ANY SET. ANY MAKE OF SPEAKER. New goods obtained for every order.

Send us a list of parts or valves you require or any speaker or set you may select and we will forward you a definite quotation. Ten years' advertiser in the Wireless Press. Thousands of satisfied customers

H. W. HOLMES,
 New Address:—333, EUSTON ROAD, LONDON, N.W.1.
 Phone: Euston 1414.

W.B. STENTORIAN SPEAKERS
 The Finest Permanent Magnet Loudspeakers on the market, supplied on lowest terms:— 37/5 Cash or C.O.D. 42/- or 2/6 down and 11 monthly payments of 4/-. PROMPT DELIVERY. Anything and everything Radio supplied on lowest terms. The London Radio Supply Co., Ltd., 11, Oct Lane, Noble Street, London, E.C.2.

RECORD
 The quality valve in the COMPLETE range
 RECORD RADIO LTD., 2/3, Eldon Street, E.C.2

Add 50/- WEEKLY to your earnings

Charge accumulators in your spare time. Complete Charger, incorporating Westinghouse Metal Rectifiers. Will charge 84 accumulators weekly. Price £4.4.0 or 8/- monthly. Send for full particulars. M.P.R. ELECTRICAL CO., 252, Victoria Road, Romford, Essex.

Facts and Figures

COMPONENTS TESTED IN OUR NEW LABORATORY

Lissen Hi-Q Components

AMONG the many special components designed by the Lissen company for short-wave and ultra-short-wave use, are the condenser and choke illustrated on this page. The condenser is of special low-loss construction, having a minimum capacity of only 5 m.mfd., the end plate being of ceramic material. It is available in two values, one with a maximum capacity of 20 m.mfd. and one of 160 m.mfd., the prices being 5s. 6d. and 7s. 6d. respectively. The rotor section turns smoothly and noiselessly even on 5 metres, and the mounting is such that there is no risk of short-circuits due to side-play. Terminal connections are provided and these are of the type in which the connecting wire is locked in a special nut and cannot come loose or be pulled away. The choke shown

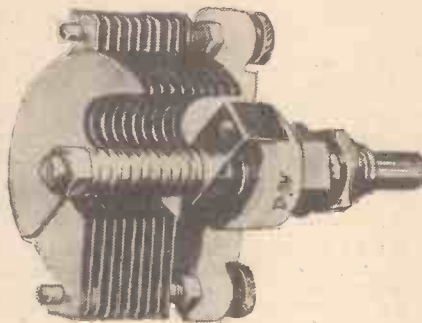

The low-loss condenser to be found in the Lissen Hi-Q range, and reviewed on this page.

is of the type designed for inclusion in the filament circuit for the prevention of instability and other defects usually present in short-wave and ultra-short-wave receivers and transmitters, and accordingly it is wound with a very low resistance value. It is double-wound so that an equivalent value is included in each filament lead, and the total D.C. resistance of each choke is less than .05 ohms. The price of this component is 2s. 6d.

A New Time Switch

THE Nivex Instrument and Gauge Company, of Exmouth House, 3-11, Pine Street, E.C.1, announce a new time switch which will be found of extreme interest to the broadcast listener. This is of the clockwork-operated type with a high-grade Swiss movement, and the electrical section is tested at 2,000 volts suitable for working on standard mains up to 250 volts at 5 amps. A.C. and 2 amps. D.C. It is neat and compact, the overall diameter being slightly less than a standard 15 amp. electric-lighting switch. It is provided with sockets for connection to any standard electrical apparatus, such as a wireless receiver, water-heater, shop or room lights, etc., and the hand is set by means of a small projecting knob. With this the switch is wound as in the case of an ordinary watch, and the knob is then

pressed down and the pointer moved round to indicate the period of time which must elapse before the apparatus is switched on. The dial reads from 1 to zero (equivalent to a period of 11 hours), and any period of time from 7½ minutes may be selected. It is therefore necessary to calculate the period of time which is to elapse before the apparatus is set, and the pointer slowly travels backwards for this period, bringing the switch into operation when the zero mark is reached. The mechanism stops when the switch is closed. A bayonet holder may be used so that the switch may be plugged into a standard lighting socket. The price is 19s. 6d., with an additional 2s. 6d. for an adaptor set for lamp holders and 3s. 6d. for a wall switch with socket.

Belling-Lee Suppressor

MESSRS. BELLING AND LEE announce that the special suppressor, type 1256, for inclusion in the leads to a wireless receiver, has been discontinued. This unit was designed for interference suppression on the medium and long-waves, but in view of the increased use of all-wave receivers a new model has been introduced for suppression on the short waves down to 10 metres. The fact that the earth lead is filtered makes it a better suppressor on all waves up to 2,000 metres. Tests have shown that, although only designed for use down to 10 metres, it is quite effective in clearing up the miniature snow-storm which sometimes appears on a television screen, due to local interference. The new suppressor, type No. 300, now becomes the standard Belling-Lee lead suppressor and costs 21s.

It is also announced that the increase in the price of raw materials has resulted in an increase in the price of the shielded "Eliminoise" cable, No. 1,221. The new price is 10d. per yard. The rather large increase is due to the fact that the cable has copper screening and there is thus a rather larger proportion of copper than usual in a cable of this type.

Chloride at the B.I.F.

AT the British Industries Fair, in Birmingham from the 17th to the 28th February, the Chloride Electrical Storage Co., Ltd., will be showing a comprehensive selection of batteries for all purposes. These include the open-type, semi-enclosed and fully-enclosed chloride batteries for various purposes, as well as the special emergency lighting systems which have been developed for use in cinema safety units. The Exide accumulators for radio receivers are already well known, and the ingenious self-indicating device renders all testing or guesswork unnecessary. You can see at a glance just when it needs re-charging.

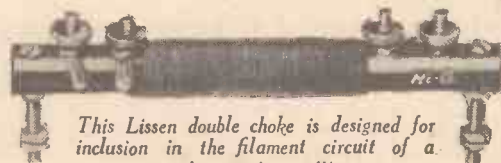

This Lissen double choke is designed for inclusion in the filament circuit of a receiver or transmitter.

LETTERS FROM READERS

The Editor does not necessarily agree with opinions expressed by his correspondents.



All letters must be accompanied by the name and address of the sender (not necessarily for publication.)

Back Numbers from Guernsey: Supply Exhausted

SIR,—I seem to be still in demand for back copies, etc., as I am still receiving requests mentioning my letter to you last March and have written to-night in reply to a letter from S. Africa.

I would be grateful if you would make it known that owing to my moving home shortly, I cannot now supply back copies as I have given them all away.

Passing on to other things, that's a curious business about those three phantom Scots. Maybe you'll hear some more from them, but I hardly think that they are worth that half-inch of space you gave them.

I fully agree with Thermion in regard to the Sunday broadcasts, but I disagree very much when he throws doubt on there being any high-class stuff on the U.S. radio. Possibly he hasn't heard the Pittsburgh Symphony Orchestra, or Rubinoff, or Nelson Eddy, and many others.—E. WEBSTER (Guernsey, C.I.).

QSL Cards and Reports

SIR,—May I, as co-Founder, Editor and Secretary of the British Short-wave League, be permitted to reply to the letter of your correspondent, J. W. Ismay, G6JI, published in your issue of January 2nd?

Mr. Ismay wrongly states that our organisation exists merely for the stimulation of QSL card collecting, but if he cares to "examine" our publication again, he will find that we not only describe QSL cards, but also devote much space to the publication of Short-wave (B.C.) News; Ten-metre reception articles; Readers' DX lists; News of the World Friendship Society of Radio Amateurs; and so on. The reason for our description of QSL cards is because the great majority of our members collect cards from DX stations, both amateur and broadcast, and that these articles have proved immensely popular. We respond to demand; if the interest in the collecting of verifications ever ceases, then we will devote the space to some other subject.

Transmitting stations are not obliged to answer listeners' requests for verification, and if the S.W.L. is becoming a nuisance it is only because the owner of the transmitter is partly to blame. There is one remedy, and that is for the transmitting man to ignore all but useful reports or DX reports.

Your correspondent is apparently endeavouring to show that listeners' reports are not appreciated by any amateur station, and that the S.W.L. is both wasting the time and money of the transmitting man. A further perusal of our "Review" will prove that this is not the case, for many well-known stations have often been known to request further reports. Amongst these I can number W2IXY, W4UP, TI4NRH, HKIABM, W6ITH, W7ALZ, CO2HY, W4ZF, etc. etc. Some, including W4UP, W2IXY, SU1KG, etc., have even joined the B.S.W.L., the listeners' organisation which even dares to "blacklist" the tin-god amateur stations!

But, happily enough, there are still a few stations left that do not share the views of

G6JI. I have evidence that W3MR, W1CCZ and W4DRD, which are all well received in Great Britain, actually return reply coupons sent to them from this country accompanied by a QSL card, and a message something like this: "The courtesy of your report deserves an answer at my expense, and I am therefore returning your coupon." The surprising thing is that there is a vast difference between the sender of this courteous communication (W1CCZ) and G6JI, in that the former is particularly well heard all over the world and is likely to be inundated with reports, whereas the latter is practically unknown, and has never been mentioned in any of the numerous DX reports which I am constantly receiving from Australia and the U.S.A.

Mr. Ismay also refers to our Blacklist, and as there appears to be considerable misunderstanding as to its functions I would like to point out that it is not concerned with British transmissions, but exists to prevent members from wasting their time and coupons on DX stations that habitually ignore all reports. Incidentally, I would like to make it clear that our League is not interested in the reception of British, or non-DX amateur stations, and that we do not recommend our members to report on these transmissions.

In conclusion, I would like to thank G2UV for his excellent letter defending the collecting of QSL cards, published in your issue of December 26th.—F. A. BEANE (Ridgewell, Essex).

Proposed Club for Deal

SIR,—I shall be very glad to get in touch with any radio enthusiasts in this district who might be keen enough to start a club of some description. Two, I believe, already exist at Tankerton and Folkestone, but both, unfortunately, are rather far away. The locality itself is productive of excellent DX results, and the nearby Kingsdown cliffs promise a remarkably good vantage point for 56 m.c. work.—IAN MURFITT, Sutherland House, London Road, Deal, Kent.

R.A.F. Wireless School

THE Annual Re-union Dinner of the Past and Present Officers of the Electrical and Wireless School, Royal Air Force, Cranwell (one time Farnborough and Worthydown), is to be held at 7.0 for 7.30 p.m., on January 23rd, 1937, at the R.A.F. Club, Piccadilly.

Particulars may be obtained from the Hon. Secretary, F./Lt. F. S. Wainscot, Electrical and Wireless School, Cranwell, Lincs.

The Editor will be pleased to consider articles of a practical nature suitable for publication in PRACTICAL AND AMATEUR WIRELESS. Such articles should be written on one side of the paper only, and should contain the name and address of the sender. Whilst the Editor does not hold himself responsible for manuscripts, every effort will be made to return them if a stamped and addressed envelope is enclosed. All correspondence intended for the Editor should be addressed: The Editor, PRACTICAL AND AMATEUR WIRELESS, George Newman Ltd., Tower House, Southampton Street, Strand, W.C.2.

Owing to the rapid progress in the design of wireless apparatus and to our efforts to keep our readers in touch with the latest developments, we give no warranty that apparatus described in our columns is not the subject of letters patent.

ELECTRADIX

HOME RECORDING



37/6

Felgh Model, 27/6. Blank records, 4/- doz. Diamonds, fit any pick-up, 7/6. Sapphires, 3/6.

MICROPHONES, No. 11 TABLE MIKE.—Illustrated is a splendid Microphone for speech and music. The bakelite case, containing a 2in. mike and transformer, is on a bronze pedestal, detachable for slinging. Switch and plug fitted. Unrivalled for quality and price, 15/-. Adaptor and long lead to set, 3/-.
Lesdix No. 10B Pedestal, 10in. high, 12/6; Lesdix Superior No. 12BB Ring, 14in. Pedestal, 18/6. Hand Mikes in 2in. case No. 11 at 5/6; Superior type No. 11A, 7/6. Etched public address and loud Mike (Reisz principle), 55/-. Ask for Illustrated Mike List of 25 models for all uses. Our famous parts for making your own mike. Carbon Granules in glass capsule: No. 2, 1/-; No. 3, fine, 1/6; No. 4, extra fine, 2/6; Carbon Blocks, 4d.; Diaphragms, 6d.; Button in 1 1/2in. hard wood case with 2in. mica diaph., 2/6; Ditto, mounted on pedestal, 3/6. NRS MIKE AMPLIFIERS.—Single-stage pre-amplifiers walnut cabinet 8 x 9 x 6, fitted switch output transformer, terminals, valve holder and leads, space for batteries. For mikes, oscillators or as an extra L.F. stage, 12/6; all new.



LIGHT AND RAY CELLS.—Selenium Raycraft, 21/-; Kinoston, 15/-. Raycraft outfit with relay and amplifier, 45/-. Photo-cells for Sound-on-Film, Television and Ray Work, B.T.P., 15/-; R.C.A. 25/-; G.E.C. 25/- to 33 10s. Beck Angle Prisms, mounted in carrier, 5/6. Micrometer adjusters for lens, 1/-; Eyepieces with prism and lenses for photo-cell inspection, 12/6. Five-guinea X-ray valves, new, 10/- only. Special packing, 2/6.

MIRRORS.—5 1/2in. dia. Hello or Television, 1/6. Parabolic Concave, 10in., 20/-; 20in., 25/-; 24in., 30/-. Carr. fwd. Neon Lamps, 2/6 and 3/- each, with holder. Miniature Neons, 2/6.

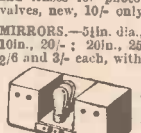

PUBLIC ADDRESS.—We can supply from stock a range of Portable and Fixed D.C. and A.C. Amplifiers for Dance Band, P.A. and Talkies, from 3 wats to 100 wats, at bargain prices. All new 1936 models.

1,000 Switchboard Service and Panel Meters in stock, lowest prices. MOTORS, MOTORS. MOTORS. Tiny, Small and Medium. A large stock of really fractional horse-power motors have been released at bargain prices. 300 at 21s for immediate delivery.

A.C. MAINS MOTORS.—Enclosed, self-start on load. A.C. repulsion, 1/60 h.p. with pulley, Type 40, 1.500 revs., 18/6. Type 36, Ditto, 1.25 h.p., G.E.C., 3,500 revs., 27/6. Induction 1/10 h.p., 2,500 revs., 35/-; 1 h.p., self-starting, 1,425 revs., 48/-.

D.C. MAINS MOTORS.—1/40 h.p., Type 60, 220 v., K.B. series, 1,750 revs., 15/-. Ditto, 1/40 h.p., G.E.C., 230 v. series, 2,000 revs., 16/-. Ditto, 1/12 h.p., Croxford 110 and 230 v. shunt, 1,700 revs., 30/-. M.G. for A.C., 220 v., to 100 v. 1 amp. D.C., 60/-; 100 v., 15/-. All fully guaranteed.

DOUBLE CURRENT DYNAMOS.—D.C. 600 volts 100 m.a., 32/6. ROTARY CONVERTORS for A.O. sets on D.C. mains. 7-watt P.M. model, 35/-; 15 watt 220 D.C./220 A.C. ball bearings, lam. field, silent running, 65/-.

M.G. Sets with filter, 6 v. to 170 v. 25 ma., for H.T., 65/-. Dynamo and Switchboard, 12 v. 12 amps., 47/6.

AUTOMATIC MAGNETIC SWITCHES.—Overload, No-load, Convertors.

OVERLOAD BREAKERS replace fuses now. Magnetic Trip, 2 to 4 amps., 7/6; 6 amps., 10/-; 10 amps., 12/-; 15 amps., 14/-.

TELEPHONES, House and Portable Inter-comm. and Telephones of various types cheap. Pair of Wall Sets, 25/-. 120 ohm Sullivan Headphones, W.D. Aluminium body and bands, 2/3. Lissen Brown, Ericsson, etc., 2,000 and 4,000 ohms, 4/9.

TIME SWITCHES, CLOCKDRIVE.—Switch on-off any time, 6 amps., 35/-; 10 amps., 40/-.

SWITCHGEAR, DIMMERS, CHARGERS.

METERS.—We carry large stocks of Meters, all ranges and sizes, from 2 1/2in. dia., to 6in., Laboratory apparatus, a speciality.

Send for "Radio Electrical" Scientific Illus. List "N" Free.

ELECTRADIX RADIOS
218, Upper Thames Street, E.C.4

Phone: Central 4611

"ENGINEERING OPPORTUNITIES" FREE!

This unique Hand-book shows the easy way to secure

A.M.I.C.E., A.M.I.Mech.E., A.M.I.E.E., A.M.I.A.E., A.M.I.W.T., A.M.R.E., and similar qualifications.

WE GUARANTEE— "NO PASS—NO FEE."

Details are given of over 150 Diploma Courses in all branches of Civil, Mech., Elec., Motor, Aero, Radio and Television Engineering, Building, Government Employment, etc.

Write for this enlightening Hand-book to-day FREE and post free. British Institute of Engineering Technology, 409, Shakespeare House, 17, 18, 19, Stratford Place, W.1.

PATENTS AND TRADEMARKS.
KINGS PATENT AGENCY (Director: B. T. King, Patent Agent). Advice, Handbook and Consultations free.—146A, Queen Victoria Street, E.C.4. Phone: City 6161.

RADIO PROGRESS

1/-

each



10 TESTED CIRCUITS.

Presenting in attractive and simple form complete data for building ten of the world's most modern A.C. D.C. Battery and All-Wave receivers. Fully illustrated with scale drawings and simple explanatory text. A Station Chart given with each copy.

To A. F. Bulgin & Co., Ltd.,
Abbey Road, Barking, Essex.

Please forward me a copy of your RADIO PROGRESS MAGAZINE, No. 2, for which I enclose P.O. value 1 shilling.

Name

Address

N

£7

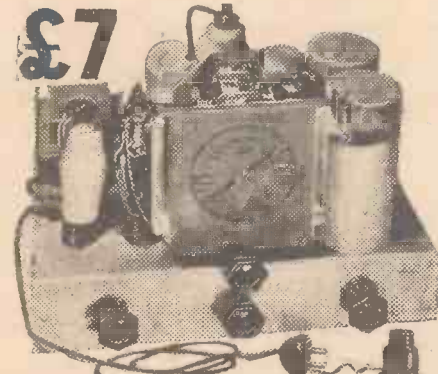

6 VALVE ALL-WAVE SUPERHET

(Complete with B.V.A. Valves)

Improved all-wave superheterodyne for A.C. or D.C. mains. High sensitivity on all three wave-bands (16.5-50 metres, 200-550 metres, 800-2,000 metres). Many interesting features, including:—
Illuminated "Airplane" dial with station names.
Special "squelch" valve for inter-station noise suppression, with manual muting control.
Octode frequency changer. 8 stages, 7 tuned circuits.
Iron Cored I.F. Coils. Delayed A.V.C. 3.5 watts output.
Extra heavy Cadmium-plated steel chassis.

£7 cash complete with valves, knobs, pilot lamps, mains cable and plug, etc. Deferred terms from London Radio Supply Co., 11, Oat Lane, E.C.2. 12 months' guarantee. Suitable loudspeakers, cabinets, etc., in stock. McCarthy Chassis from £4 5s. to £12. Write for illustrated catalogue.

MCCARTHY RADIO LTD.
44a, Westbourne Grove, London, W.2.
Telephone: Baywater 3201.

Practical and Amateur Wireless BLUEPRINT SERVICE

PRACTICAL WIRELESS.		PORTABLES.	
CRYSTAL SETS.	Date of Issue.	No. of Blueprint	
Blueprints, 6d. each.			
1937 Crystal Receiver ..	9.1.37	PW71	
STRAIGHT SETS. Battery Operated.			
One-valve: Blueprint, 1s.			
All-wave Unipen (Pentode) ..	—	PW31A	
Two-valve: Blueprint, 1s.			
Four-range Super Mag Two (D, Pen) ..	11.8.34	PW36B	
Three-valve: Blueprints, 1s. each.			
Selectone Battery Three (D, 2 LF (Trans)) ..	—	PW10	
Sixty Shilling Three (D, 2 LF (RC & Trans)) ..	—	PW34A	
Leader Three (SG, D, Pow) ..	—	PW35	
Summit Three (HF Pen, D, Pen) ..	8.8.34	PW37	
All Pentode Three (HF Pen, D (Pen), Pen) ..	22.9.34	PW39	
Hall-Mark Three (SG, D, Pow) ..	—	PW41	
Hall-Mark Cadet (D, LF, Pen, (RC)) ..	16.3.35	PW48	
F. J. Camm's Silver Souvenir (HF Pen, D (Pen), Pen) (All-Wave Three) ..	13.4.35	PW49	
Genet Midget (D, 2 LF (Trans)) ..	June '35	PM2	
Cameo Midget Three (D, 2 LF (Trans)) ..	8.0.35	PW51	
1936 Sonotone Three-Four (HF Pen, HF Pen, Westector, Pen) ..	17.8.35	PW53	
Battery All-Wave Three (D, 2 LF (RC)) ..	—	PW55	
The Monitor (HF Pen, D, Pen) ..	—	PW61	
The Tutor Three (HF Pen, D, Pen) ..	21.3.36	PW62	
The Centaur Three (SG, D, P) ..	—	PW64	
The Gladiator All-Wave Three (HF Pen, D (Pen), Pen) ..	29.8.36	PW66	
F. J. Camm's Record All-Wave Three (HF Pen, D, Pen) ..	31.10.36	PW69	
The "Colt" All-Wave Three (D, 2 LF (RC & Trans)) ..	5.12.36	PW72	
Four-valve: Blueprints, 1s. each.			
Fury Four (2 SG, D, Pen) ..	—	PW11	
Beta Universal Four (SG, D, LF, Cl. B) ..	—	PW17	
Nucleon Class B Four (SG, D (SG) LF, Cl. B) ..	6.1.34	PW34B	
Fury Four Super (SG, SG, D, Pen) ..	—	PW34C	
Battery Hall-Mark 4 (HF, Pen, D, Push-Pull) ..	—	PW46	
F. J. Camm's "Limit" All-Wave Four (HF Pen, D, LF, P) ..	26.9.36	PW67	
Mains Operated.			
Two-valve: Blueprints, 1s. each.			
A.C. Twin (D (Pen), Pen) ..	—	PW18	
A.C. D.C. Two (SG, Pow) ..	7.10.33	PW31	
Selectone A.C. Radiogram Two (D, Pow) ..	—	PW19	
Three-valve: Blueprints, 1s. each.			
Double-Diode-Triode Three (HF Pen, DDT, Pen) ..	10.6.33	PW23	
D.C. Acc (SG, D, Pen) ..	—	PW25	
A.C. Three (SG, D, Pen) ..	—	PW29	
A.C. Leader (HF Pen, D, Pow) ..	7.4.34	PW35C	
D.C. Premier (HF Pen, D, Pen) ..	31.3.34	PW35B	
Ubique (HF Pen, D (Pen), Pen) ..	28.7.34	PW36A	
Arnada Mains Three (HF Pen, D, Pen) ..	18.8.34	PW38	
F. J. Camm's A.C. All-Wave Silver Souvenir Three (HF Pen, D, Pen) ..	11.5.35	PW50	
"All-Wave" A.C. Three (D, 2 LF (R.C.)) ..	17.8.35	PW54	
A.C. 1936 Sonotone (HF Pen, HF Pen, Westector, Pen) ..	—	PW56	
Four-valve: Blueprints, 1s. each.			
A.C. Fury Four (SG, SG, D, Pen) ..	—	PW20	
A.C. Fury Four Super (SG, SG, D, Pen) ..	—	PW34D	
A.C. Hall-Mark (HF Pen, D, Push-Pull) ..	—	PW45	
Universal Hall-Mark (HF, Pen, D, Push-Pull) ..	9.2.35	PW47	
SUPERHETS.			
Battery Sets: Blueprints, 1s. each.			
£5 Superhet (Three-Valve) ..	—	PW40	
F. J. Camm's 2-valve Superhet (Two-Valve) ..	13.7.35	PW52	
F. J. Camm's £4 Superhet ..	—	PW58	
Mains Sets: Blueprints, 1s. each.			
A.C. £5 Superhet (Three-Valve) ..	—	PW43	
D.C. £5 Superhet (Three-Valve) ..	1.12.34	PW42	
Universal £5 Superhet (Three-Valve) ..	—	PW44	
F. J. Camm's A.C. £4 Superhet 4 ..	—	PW59	
F. J. Camm's Universal £4 Superhet 4 ..	11.1.36	PW60	
SHORT-WAVE SETS.			
Two-valve: Blueprint, 1s.			
Midget Short-Wave Two (D, Pen) ..	15.9.34	PW38A	
Three-valve: Blueprints, 1s. each.			
Experimenter's Short-Wave Three (SG, D, Pow) ..	—	PW30A	
The Prefect 3 (D, 2 LF (RC and Trans)) ..	—	PW63	
The Bandspread S.W. Three (HF Pen, D (Pen), Pen) ..	29.3.36	PW63	
Three-valve: Blueprint, 1s.			
E. J. Camm's L.F. Three-valve Portable (HF Pen, D, Pen) ..	16.5.36	PW05	
Four-valve: Blueprint, 1s.			
Featherweight Portable Four (SG, D, LF, Cl. B) ..	—	PW12	
MISCELLANEOUS.			
S.W. Converter-Adapter (1 valve) ..	—	PW48A	
AMATEUR WIRELESS AND WIRELESS MAGAZINE CRYSTAL SETS.			
Blueprints, 6d. each.			
Four-station Crystal Set ..	12.12.36	AW427	
1934 Crystal Set ..	—	AW444	
150-mile Crystal Set ..	—	AW450	
STRAIGHT SETS. Battery Operated.			
One-valve: Blueprints, 1s. each.			
B.B.C. Special One-valver ..	—	AW387	
Twenty-station Loudspeaker One-valver (Class B) ..	—	AW440	
Two-valve: Blueprints, 1s. each.			
Melody Ranger Two (D, Trans) ..	—	AW388	
Full-volume Two (SG def. Pen) ..	—	AW392	
B.B.C. National Two with Lucerne Coil (D, Trans) ..	—	AW377A	
Big-power Melody Two with Lucerne Coil (SG, Trans) ..	—	AW388A	
Lucerne Minor (D, Pen) ..	—	AW426	
A Modern Two-valver ..	July '36	WM409	
Three-valve: Blueprints, 1s. each.			
Class B Three (D, Trans, Class B) ..	22.4.33	AW386	
New Britain's Favourite Three (D, Trans, Class B) ..	15.7.33	AW394	
Home-built Coil Three (SG, D, Trans) ..	—	AW404	
Fan and Family Three (D, Trans, Class B) ..	25.11.33	AW410	
£5 5s. S.G.3 (SG, D, Trans) ..	2.12.33	AW412	
1934 Ether Searcher: Baseboard Model (SG, D, Pen) ..	20.1.34	AW417	
1934 Ether Searcher: Chassis Model (SG, D, Pen) ..	—	AW419	
Lucerne Ranger (SG, D, Trans) ..	—	AW422	
Coscor Melody Maker with Lucerne Coils ..	—	AW423	
Mullard Master Three with Lucerne Coils ..	—	AW424	
£5 5s. Three: De Luxe Version (SG, D, Trans) ..	19.5.34	AW435	
Lucerne Straight Three (D, RC, Trans) ..	—	AW437	
All-Britain Three (HF Pen, D, Pen) ..	—	AW448	
"Wireless League" Three (HF Pen, D, Pen) ..	3.11.34	AW451	
Transportable Three (SG, D, Pen) ..	—	WM271	
£6 6s. Radiogram (D, RC, Trans) ..	—	WM318	
Simple-tune Three (SG, D, Pen) ..	June '37	WM327	
Economy-Pentode Three (SG, D, Pen) ..	Oct. '33	WM337	
"W.M." 1934 Standard Three (SG, D, Pen) ..	—	WM351	
£3 3s. Three (SG, D, Trans) ..	Mar. '34	WM354	
Iron-core Band-pass Three (SG, D, QP 21) ..	June	WM362	
1935 £6 6s. Battery Three (SG, D, Pen) ..	—	WM371	
PTP Three (Pen, D, Pen) ..	June '35	WM389	
Certainty Three (SG, D, Pen) ..	Sept. '35	WM393	
Minutube Three (SG, D, Trans) ..	Oct. '35	WM396	
All-wave Winning Three (SG, D, Pen) ..	Dec. '35	WM400	
Five-valve: Blueprints, 1s. 6d. each.			
Super-quality Five (2 HF, D, RC, Trans) ..	—	WM329	
Class B Quadracyc (2 SG, D, LF, Class B) ..	Dec. '33	WM344	
Mains Operated.			
Two-valve: Blueprints, 1s. each.			
Consoelectric Two (D, Pen) A.C. ..	—	AW403	
Economy A.C. Two (D, Trans) A.C. ..	—	WM286	
Unicorn A.C./D.C. Two (D, Pen) ..	Sept. '35	WM394	
Three-valve: Blueprints, 1s. each.			
Home-Lover's New All-electric Three (SG, D, Trans) A.C. ..	—	AW383	

These blueprints are drawn full size. Copies of appropriate issues containing descriptions of these sets can in some cases be supplied at the following prices, which are additional to the cost of the blueprint. A dash before the Blueprint Number indicates that the issue is out of print.

Issues of Practical Wireless ..	4d. Post paid
" " Amateur Wireless ..	4d. " "
" " Practical Mechanics ..	7d. " "
" " Wireless Magazine ..	1/3 " "

The index letters which precede the Blueprint Number indicate the periodical in which the description appears: thus; PW refers to PRACTICAL WIRELESS, AW to Amateur Wireless, PM to Practical Mechanics, WM to Wireless Magazine.

Send (preferably) a postal order to cover the cost of the blueprint and the issue (stamps over 6d. unacceptable), to PRACTICAL AND AMATEUR WIRELESS BLUEPRINT, Dept., Geo. Newnes, Ltd., Tower House, Southampton Street, Strand, W.C.2.



QUERIES and ENQUIRIES

Address of COCO

"I am anxious to report reception of a transmission from COCO, Havana, and should be glad if you could supply me with the address of this station. I have not seen this in your pages."—A. T. (Rossendale, Lancs).

VERIFICATIONS for this station should be addressed to Señor Luis Casas, P.O. Box 98, Havana, Cuba. The stamped envelope which you enclosed with your letter has been redirected to this station, and we make no charge for this service.

Reading a Circuit Diagram

"I have been a reader of your paper for the past few years and have always found some valuable information, but there is one thing that I could never understand, and that is the Theoretical Circuit Diagram. I could never follow it and I think if you were to put in the plain wiring diagram with the proper wiring of the components they would be understood by more readers. I enclose a cutting of the sort of diagram I refer to."—A. R. (Perth).

THE diagram which you enclose is merely the Practical Wiring Diagram, exactly identical with our standard Blueprints. With every receiver which we describe in these pages we publish the theoretical circuit and also a wiring plan, which is actually a miniature reproduction of the full size Blueprint. If you examine the wiring diagram in conjunction with the theoretical circuit you will soon be able to read a circuit diagram. The full list of theoretical symbols has been given in these pages several times, and is included in the Wireless Constructor's Encyclopædia.

Curing Breakthrough

"I have recently fitted a small iron-cored dual-range coil to a straight-three valve set, but am puzzled by the way in which the Midland Regional breaks through when the wave-change switch is in the long-wave position. In fact, by having the switch in the 'long' position, and rotating the condenser to the lower end of the scale, the Regional comes in almost as well as when switched over on to the medium band. The coil is screened and the switch is an ordinary on-off type. The aerial is in the form of an open 'loop' wound round under the joists in the attic and is plain bell wire. Is it

possible that this has a natural wavelength of such pronounced definition as to cause this effect?"—L. du P. (Quinton, Birmingham).

WE think the trouble is due partly to the aerial and partly to the fact that you are situated so close to the Midland Regional transmitter. This form of interference is commonly referred to as "break-through," and it may be prevented by including a special choke in series with the aerial, or by fitting a wave-trap in the aerial circuit. In the latter case an ordinary medium-wave coil with parallel condenser is joined between the aerial lead and the aerial terminal on your set and when switched to long waves the condenser is

RULES

We wish to draw the reader's attention to the fact that the Queries Service is intended only for the solution of problems or difficulties arising from the construction of receivers described in our pages, from articles appearing in our pages, or on general wireless matters. We regret that we cannot, for obvious reasons—

- (1) Supply circuit diagrams of complete multi-valve receivers.
- (2) Suggest alterations or modifications of receivers described in our contemporaries.
- (3) Suggest alterations or modifications to commercial receivers.
- (4) Answer queries over the telephone.
- (5) Grant interviews to querists.

Please note also, that queries must be limited to two per reader, and all sketches and drawings which are sent to us should bear the name and address of the sender.

Requests for Blueprints must not be enclosed with queries, as they are dealt with by a different department.

If a postal reply is desired a stamped addressed envelope must be enclosed. Send your queries to the Editor, PRACTICAL AND AMATEUR WIRELESS, George Newnes, Ltd., Tower House, Southampton Street, Strand, London, W.C.2.

The Coupon must be enclosed with every query.

adjusted until the medium-wave station is eliminated. Naturally the wave-trap must be short-circuited on medium waves unless you find it useful in cutting out the local whilst searching for long-distance stations in a wavelength close to it. A special anti-breakthrough choke should be obtainable from your local radio dealer.

D.C. Charging

"I have recently made a trickle charger for my S.G., Det. Power receiver, but find I have to keep it switched on every night for about nine hours to keep my accumulator charged. I am using a 60-watt lamp, and with current at 5jd. unit this appears to be costing me 1s. 5d. a week. This seems rather an expensive idea. Is there any way I can cut it down a little?"—J. S. (Horsham).

THE trouble mentioned is one of the drawbacks to charging from D.C., but you may avoid the additional expense

by charging the accumulator during the evening, connecting it in series with a table lamp used for the normal room illumination. In this way the light is utilised, although you will be paying for more electricity than is normally required for the illumination of the lamp. This arrangement is preferable to that of charging whilst you are asleep, as then the light is wasted. You can reduce the charging period, by using a larger lamp, say, 100 watts, in the same scheme, or if your accumulator is designed for a fairly high charging rate it may be joined in series with a domestic iron, or small bowl fire, for instance. You must, of course, calculate the charging rate when using these devices and make quite certain that the makers' recommendations are not exceeded.

Obtaining a Transmitting Licence

"What do I do to obtain a transmitting licence, and what is the difference between an A.A. and full licence. What is the difference in the price of these two licences?"—G. H. (Marlow-on-Thames).

ALL applications for a licence must be made to the Engineer-in-Chief, Radio Section, G.P.O., Armour House, London, E.C.1. For the Artificial Aerial licence a brief description of the transmitter must be given and no Morse test has to be passed. The cost of this licence is 10s. per annum. The full licence enables you to erect an aerial and connect the transmitter to this, but a Morse test at which you must transmit and receive at 12 words per minute for five minutes has to be passed. This licence costs 30s. for the first year, and £1 for each succeeding year.

Using Headphones

"I wish to use headphones in conjunction with the Hall-Mark Four which I have in regular use. I have tried to use these by connecting the 'phone leads through two 4 mfd. fixed condensers to the anodes of the output valve, but the volume is very weak. Can you suggest how to improve on the volume as I wish to use the 'phones for a person who is slightly deaf?"—F. H. (Darwen).

THE trouble may be that the 'phones are defective or of an unsuitable resistance value. As you are connecting them in parallel with the loudspeaker primary you may be unbalancing the output, but if the 'phones are of high resistance you may find that results will be quite satisfactory if you include them in the anode circuit of the penultimate stage. The primary of the transformer is already connected to the anode in this case, and a 2 mfd. condenser may be joined to the anode of the valve and then to the 'phones, the other side of the 'phones being joined to earth. In this way the 'phones will be parallel-fed, the L.F. transformer primary acting as an L.F. choke.

The coupon on page iii of cover must be attached to every query.



AT LAST THE TRULY UNIVERSAL RADIO SET IS HERE!
The set which can be Used Anywhere and under any conditions—safe against mains breakdowns.

The Hyvoltstar Universal All-Waves, A.C., D.C. and Combined Battery Receiver
REVOLUTIONARY IN EVERY WAY!

The only set of its kind in the world. Can be used on any mains, on its own batteries, in your own home, or friend's, car, boat, or on safari, and be sure of peak results. **PORTABLE—TRANSPORTABLE.**

Hyvoltstar offers the fullest range of 4, 5, 6, 7, 8, 9, 10-valve Universal All-Wave Supers and Radiograms, which enable you to tune in to any part of the world from any part of the world, at full loudspeaker strength.

UNIVERSAL HIGH VOLTAGE RADIO Ltd.
28-29, Southampton St., Strand, London, W.C.2
Telephone: TEMple Bar 4985, 8608.

SPECIAL OFFER FOR THE NEW YEAR

NEW KITS FOR OLD AND NEW VALVES FOR OLD

We suggest that Constructors seize the opportunity of trying out the Famous OSTAR-GANZ UNIVERSAL HIGH VOLTAGE VALVES, which are rapidly conquering the market. The advantages of using these valves will be proved soon after you accept our part exchange offer which we are backing with a six-months' guarantee, compared with the usual guarantee of three months, with 20% P.X. allowance. The same applies to our full range of Universal ALL-WAVE RECEIVERS, AMPLIFIERS, RADIOGRAMS AND TRANSMITTER KITS. Apply to:

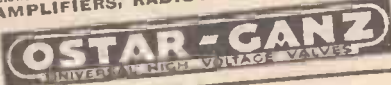

EUGEN J. FORBAT,
28-29, Southampton St.,
Strand, London, W.C.2.
Temple Bar 8608-4985.

Miscellaneous Advertisements

Advertisements are accepted for these columns at the rate of 3d. per word. Words in black face and/or capitals are charged double this rate (minimum charge 3/- per paragraph). Display lines are charged at 6/- per line. All advertisements must be prepaid. All communications should be addressed to the Advertisement Manager, "Practical and Amateur Wireless," Southampton Street, Strand, London.

RECEIVERS, COMPONENTS AND ACCESSORIES
Surplus, Clearance or Secondhand, etc.

RADIOMART
SHORT-WAVE SPECIALISTS
Announce 1937
SHORT-WAVE MANUAL

Packed with short-wave information and circuits of mains and battery receivers, including straight, superhet and 5-metre transmitters, modulators, etc. Information on transmitting licences, aeriels, Class B amplifications, neutralization, superhet alignment, etc. The most comprehensive manual published, written by practical engineers, price 6d., post free 7½d., including catalogue.

1937 Catalogue only (3 times enlarged) price 1½d. post free.

TEISEN screened dual range coils, switched, 2/11 each. Pair 5/3. Milliammeters, 25 ma. upwards, 5/9. Super, 6/9.

AMERICAN mains transformers 230v. fully shrouded, 350/350, 6.3v. 5v., 6/11. Majestic 250/250, 2.5v., 5v., 4/11.

HEAVY DUTY mains transformer worth 35/-, 350/350. 150 ma.; 4v. 2.5ACT, 4v. GACT, 12/6. KC/8, IF transformers, 2/11. Telsen Acc. 1/11. RG4 Radiogram, 2/9. 2mf. 300v., 9d.

UTILITY straight line wavlength dials, 3/11. Telsen H.F. chokes, 1/11.

UTILITY 2-gang unknob and dial, 3/11; 1,500-volt tubular condensers, all sizes, 6d.

ELECTROLYTICS 500-volt 8 mf., 1/6; 4 mf., 1/6; 4 x 4, 1/11; 8 x 8, 3/6; 25 mf. 25v., 1/-, etc.

SMOOTHING chokes, 20 hy. 120 ma., 3/11; 100 ma., 2/11; 40 ma., 1/11.

SOLDER wire, 6 yds., 6d.; heavy 9d.; 2 gross solder tags, 6d.; resin-cored solder, 9ft., 6d.

CENTRALAB pots, all sizes, 1/6; switched, 2/-; tubular glass fuses, 2d.

ENSON PM speakers, 12/6. Varley Iron core coils, 2/6; matched pair, 4/6.

SPECIAL OFFER Class B valve, driver transformer and valveholder, new, lot 5/-.

TRADERS' monster bargain parcels, value £4/10/-, for 10/-; also 5/- parcels.

FAMOUS Continental A.C. valves, 4/6; American Duotron, etc., all types, 3/6; battery from 2/3.

UTILITY 8/6, microdisc dials, 3/11; Radiophone, 0.00016 short-wave condensers, 3/6; series gap, twin, 3/9.

CERAMIC all brass microvariables, 15 mmfd., 1/4; 40 mmfd., 1/2; 100 mmfd., 1/10; short-wave H.P.C., 9d.

CLEARANCE catalogue 1½d. Goods over 5/- post free. All enquirers must send stamp.

Branches: 15, John Bright St., 44, Dale End. Mail Orders, 44, Holloway Head, Birmingham. Telephone, MID 3254.

CONVERSION UNITS for operating D.C. Receivers from A.C. Mains, improved type, 120 watts output, at £2/10/0. Send for our comprehensive list of speakers, resistances and other components.

WARD, 46, Farringdon Street, London, E.C.4. Telephone: Holborn 9703.

NEW RECEIVERS, COMPONENTS, AND ACCESSORIES

YOU WANT SOMETHING COMPLETELY DIFFERENT. If you have a nicely furnished home and the stereotyped models you see on every street corner do not appeal to you, you will delight in our superb range of exclusive quality models. We have Radiograms with and without Auto Record Changers, A.C. and A.C./D.C., which are a complete breakaway from the usual stuff in the local shops. If you prefer good furniture to boxes, if you want outstanding shortwave performance, and above all if you appreciate true quality of reproduction when you hear it, we have what you are looking for. Come and see. Come and listen. You will be agreeably surprised, not only to find that such splendid models exist, but that they can be sold at such very reasonable prices.—**WIRELESS SUPPLIES UNLIMITED**, 278-280-282, High Street, Stratford, E.15. Maryland 3191.

PREMIER SUPPLY STORES

Offer the following Set Manufacturers' Brand New Surplus Goods at a Fraction of the Original Cost; all goods guaranteed perfect; carr. paid over 5/-; under 5/- postage 6d. extra. Orders under 5/- cannot be sent C.O.D.

ALL POST ORDERS TO JUBILEE WORKS, 167, LOWER CLAPTON RD., LONDON, E.5
CALLERS, AS USUAL, TO 20-22 HIGH ST., CLAPHAM, S.W.4 (Macaulay, 2381). 'Phone: Amherst 4723
And 165 & 165a, FLEET ST., E.C.4 (Next door to Anderton's Hotel). Central 2833.

MAINS VALVES, famous Europa 4 v. A.C. types, 4/6 each. HL, L, S.G., Var.-Mu-S.G., H.F.-Pens., Var.-Mu-H.F. Pens. 1, 3 and 4-watt A.C. directly heated output Pentodes. Full-wave rectifiers, 250 v. 60 m.a. A.C./D.C. types. 20-volt. 18 amp. S.G., Var.-Mu-S.G., H, HL, Power.

Following types all 8/6 each. Full-wave rectifiers, 350 v. 120 m.a. and 500 v. 120 m.a. 2) watt indirectly heated Pentodes, Frequency Changers, Octodes and Heptodes.

BATTERY VALVES, 2 volts, H.F. L.F. 2/3. Power, Super-Power, 2/9. S.G., Var.-Mu-S.G., 4- or 5-pin Pentodes, H.F. Pens., V.-Mu-H.F. Pens., 5/- Class B, 3/6.

AMERICAN VALVES. Genuine American HYTRON and TRIAD first-grade Valves. 3 months' guarantee. All types in stock, 5/6 each. 210 and 250, 8/6 each. New Metal-Glass Valves, all types, 6/6 each. Genuine American DUOTRON Valves, all types, 3/6 each. Valve holders for all above types, 6d. each. Metal bases, 9d. each.

SHORT WAVES

SHORT-WAVE COILS, 4- and 6-pin types, 13-26, 22-47, 41-94, 78-170 metres, 1/9 each, with circuit. Special set of 3 4-pin S.W. Coils, 14-150 metres, 4/- set, with circuit. Premier 3-band S.W. Coils, 11-25, 19-42, 38-86 metres. Simplified S.W. receiver construction, suitable any type circuit, 2/6.

COIL FORMERS, in finest plastic material, 1½in. low-loss ribbed, 4- or 6-pin, 1/- each.

SUPER CERAMIC CONDENSERS, S.L.F. .00016, .0001, 2/9 each; double-spaced, .00005, .000025, .000015, 3/- each. All brass with integral slow motion, .00015 tuning, 3/9; .00015 reaction, 2/9. British Radiophone 2-gang .00016, 5/6.

H.F. CHOKES, S.W. 10-200 metres, 9d.; S.W. screened, 1/6; standard screened 180-2,000 metres, 1/6. Telsen 200-2,000 Binocular H.F. Chokes, 1/6.

CERAMIC S.W. VALVE HOLDERS, 4, 5- or 7-pin. Chassis types, 6d.; B.B. type, 8d. GLASS

AERIAL INSULATORS, 4d. each. **BEEHIVE STAND-OFF**, 6d. each. **SCREENED FLEX**, single, 3d. yd.; twin, 4d. yd.

NEW 1937 SHORT-WAVE KIT for 1 valve Receiver or Adaptor, 13-86 metres, 12/6. VALVE GIVEN FREE! DE LUXE MODEL, 17/6. SUPERHET CONVERTER KIT, 13/6. SUPERHET CONVERTER, for A.C. Mains Receivers, 20/-. A.C. Valve given FREE!

2-VALVE S.W. KIT, 19/6. VALVES GIVEN FREE! 3-VALVE S.W. KIT, 5/6. Det. and Pen., 42/-. VALVES GIVEN FREE!

BAND-PASS TUNING PACK, comprising set of Telsen 5-gang iron-cored coils with switching, mounted on steel chassis with 3-gang condenser. Illuminated disc-dial and 4 valve holders, 25/- the lot. All Mains or Battery circuit. **FREE!**

SPECIAL OFFER, LISSEN 2-GANG ALL-WAVE COILS, 12-2,000 metres, with switching and circuit diagram, 6/11 set.

3-VALVE BAND-PASS KIT, 200-2,000 metres. Complete kit of parts, including chassis, all components, valves, M.O. speaker and wiring diagram. Battery Model 50/-. A.C. Mains Model, 70/-.

3-WATT A.C. AMPLIFIER, 2-stage, for mike or pick-up. Complete kit of parts with 3 valves, 40/-.

7-WATT A.C./D.C. AMPLIFIER, 3-stage, high-gain, push-pull output. Complete kit of parts with 5 specially matched valves, £4.4s.

PREMIER MAINS TRANSFORMERS

Wire-end type with screened Primaries, tapped 200-250 v. All Filaments C.T. Guaranteed One Year. H.T. 8 and 9 or H.T. 10 with 4 v. 4 a. O.T. and 4 v. 1 a. O.T., 8/6. 250-250 v. or 300-300 v. 60 m.a. 40 v. 1 a. 4 v. 2 a. and 4 v. 4 a., all O.T., 8/6. 350-350 v. 120 m.a. 4 v. 1 a., 4 v. 2 a., and 4 v. 4 a. all O.T. Any of these transformers with engraved panels and N.P. terminals, 1/6 extra. 500-500 v. 150 m.a. 4 v. 2.3 a., 4 v. 2.3 a., 4 v. 2.3 a., 4 v. 2.3 a., 4 v. 3.4 a., all O.T., 17/6. Super Model, 19/6.

Auto transformers, step up or down. 60 watts, 7/6; 100 watts, 10/-.

SPECIAL OFFER PLESSEY mfg. type transformer, 350-350 v. 120 m.a. 4 v. 2 a., 4 v. 3.5 a., 8/6.

U.S.A. mains transformer, 300-300 v. 90 m.a. 5 v. 2 a. and 6.3 v. 1.3 a., 6/11.

SMOOTHING CHOKES, 25 m.a., 2/9; 40 m.a., 4/- 60 m.a., 5/6; 150 m.a., 10/6. 2,500 ohms. 60 m.a. Speaker Replacement Chokes, 5/6.

MILLIAMMETERS, moving-iron, flush 2½in., all ranges from 0-10 m.a., 5/9. Visual tuning, 6 or 12 m.a., 5/9. Moving-coil meters, 2½in. 0-1 m.a., 18/8; 3½in. 0-1 m.a., 22/6. Multipliers, 1/- each.

PREMIER (REISZ PATTERN) Transverse current MIKE, High Output, Straight Line Response, 30/-.

TRANSFORMERS, latest type Telsen E.G.4 (list 12/6), 2/9. Lissen Hypernik Q.P.P. (list 12/6), 3/6.

ORMOND Midget Parafed transformer, manufacturer's type, 2/-.

OUTPUT TRANSFORMERS, Power or Pentode, 2/6; Multi-Ratio, 4/6; Push-Pull Input Transformers by prominent manufacturer, 4/6 each.

ELIMINATOR KITS, for A.C. mains, 120 v. 20 m.a., or 150 v. 25 m.a., 15/-, tapped S.G., det. and output. Complete Kit with long-life valve rectifier (replacement cost only 2/-).

PREMIER I.T. CHARGER KITS for A.C. mains, including Westinghouse Rectifiers and Tapped Mains Transformers, 8 volts at ½ amp., 14/6; 8 volts 1 a., 17/6; 15 volts 1 a., 19/-; 8 volts 2 a., 29/6.

TELSEN iron-cored screened coils, W.349, 4/- each. Electric **SOLDERING IRONS**, 200-250 v., A.C./D.C., 2/3.

PREMIER H.T. KITS, all with Westinghouse rectifiers, tapped transformers and adequate smoothing. All Kits absolutely complete, 120 v. 20 m.a., 20/-; with ½ a. L.T. Charger, 25/-; 150 v. 30 m.a., 25/-; with ½ a. L.T. Charger, 31/6; 250 v. 60 m.a., with 4 v. 3 a. C.T., 30/-.

MOVING COIL SPEAKERS

MAGNAVOX. Mains energised, 154, 7in. cone, 2,500 ohms 4 watts, 12/6; "152," 9in. cone, 2,500 ohms, 17/6; 152 "Magna," 9in. cone, 2,500 ohms, 6 watts, 37/6. **Magnavox P.M.s.** "254," 7in. cone, 16/6; "252," 9in. cone, 22/6. Reliable P.M.s.

ROLA latest type P.M.s., 18/6. **GOODMANS** 8in. mains energised, 1,000 ohms field, 10/6 each. **JENSEN P.M.s.**, 10/-.

DIALS—Clarion Illuminated S.W. slow-motion Dial with 2½in. knob, 2/-.

Premier All-Wave 2-speed Dial, full vision straight-line, dual ratios 10-1 and 150-1, 6/6, with escutcheon.

Potentiometers by well-known makers. All values up to 1 meg., 2/-; with switch, 2/6.

GRAMOPHONE MOTORS. Collaro Gramophone Unit consisting of A.C. motor, 100-250 v. high quality pick-up and volume control, 45/-; Collaro Motor only, 30/-.

Collaro Universal Gramophone Motor, 100-250 v. A.C./D.C. with high quality pick-up and volume control, 67/6; Collaro Universal Motor only, 49/6. Edison Bell double-spring motors, including turntable and all fittings, 15/-.

Cosmocord Gramo unit, comprising A.C. motor, pick-up and volume control (list 55/-), 35/9.

COSMOCORD PICK-UPS, with tonarm and volume control, 10/6 each.

PICK-UP HEADS only, 4/6 each.

TUBULAR CONDENSERS, non-inductive, all values up to 5 mf., 6d. each.

Wire-end **RESISTORS**, any value, 1 watt, 6d.; 3 watts, 1/-; 8 watts, 1/6; 15 watts, 2/-; 25 watts, 2/6 each.

Reliable **MORSE KEYS** with Morse Code engraved on bakelite base, 2/- each.

Bokelite case **BUZZERS**, 1/6. Walnut Case "Loud-tone," 2/6 each.

Super Quality lightweight **HEADPHONES**, 3/9 pair.

HIGH-GRADE I.F. TRANSFORMERS, 465 kc. Ceramic trimmers, 5/6.

1936 TELSEN Iron-cored 3-Gang Band-Pass Coils with integral switching, 200-2,000 metres, 12/6 set, with instruction Booklet.

U.S.A. MIDGET 2-Gang (2 x .0005) condenser, with trimmers, 3/11. (3½in. wide, 2½in. long; 1in. spindle, ½in. long.)

ELECTROLYTICS. U.S.A. 4, 8 or 16 mf. 530 v. peak, 1/9 each. Dubilier, 4 or 8 mf. 500 v. 3/-; 50 mf. 50 v., 1/9; 10 mf. 50 v., 6d.; 25 mf. 25 v., 1/-.

T.O.O. 4 or 8 mf. 650 v., 4/-; 15 mf. 50 or 100 v., 1/-; 50 mf., 12 v., 1/-.

Paper Condensers. W.E. 250 v. working 4 mf. 2/-; 2 mf., 1/-; 1 mf., 6d.; 350 v. working 4 mf. 2/6; 2 mf., 1/6. Dubilier 500 v. working 4 mf., 4/-; 800 v. 4 mf., 6/-.

MALLORY 5-VALVE MIDGET RECEIVERS, A.C. or D.C., 200-250 v. (can be adapted to 100 v.), moving-coil speaker. Full-size performance, 69/6.

HAVE YOU HAD OUR GIANT ILLUSTRATED CATALOGUE AND VALVE LIST? IF NOT, SEND 4d. IN STAMPS FOR THIS AMAZING LIST OF BARGAINS!

RADIO CLEARANCE

63, HIGH HOLBORN, W.C.1

TEL.: HOLBORN 4631.

Special Clearance Sale now taking place at our London Premises. The following bargains are offered to enable our Mail Order Customers to participate in this eagerly awaited annual event.

8-VALVE A.C. MAINS SUPERHET by well-known manufacturer. Fitted Visual Tuning, Volume Control, Tone Control, etc. Handsome Bird's-eye Maple Cabinet, size 16" wide, 12" deep, 23" high. Valves as follows: AC/VPI, FC4, AC/VPI, AC/VPI, AC/HLDD, V014, AC-2 Pen. 1W3. Pro H.F. Stage, 2 I.F. Stages, full A.V.C. A super bargain at £6 19s. 6d.

LISSEN 4-VALVE UNIVERSAL A.C./D.C. RECEIVER, fitted in handsome dark finish Walnut Cabinet of upright design. Clock-face tuning, Volume Control, Reaction Control, etc. A really fine receiver, £4 15s.

Exclusive British Rights held by us for **AMERICAN CONSTRUCTRAD KITS**. During the Sale, these Kits are offered as follows:

- 1-Valve Battery Kit, complete with valve, 21/-
 - 2-Valve Battery Kit, complete with valves, 25/-
 - 1-Valve A.C./D.C. Kit, complete with valve, 29 6.
 - 2-Valve A.C./D.C. Kit, complete with valves, 32 6.
- These are complete Sets (not converters), covering a waveband of 15 to 600 metres by means of 5 interchangeable plug-in coils.

8-VALVE A.C. SUPERHET Chassis, complete with valves, details as above, £6 7s. 6d.

ROLA 9" ENERGISED TYPE MOVING-COIL SPEAKERS, 600 ohms or 1,000 Ohms Field, less transformer, 4/11 each.

10,000 Ohm 7 1/2" Cone, complete with transformer, pentode type, 4/11 each.

LISSEN ALL-WAVE COILS, complete with circuit, switching, etc., in matched pairs, 3/- per pair.

LISSEN 126 I.F. TRANSFORMERS, fully screened, 1/3.

G.E.C. 110 I.F. TRANSFORMERS, Midget type, complete with trimmers, 1/3.

WEARITE 2 MEG. VOLUME CONTROLS, with switch, 1/- each.

CENTRALAB VOLUME CONTROLS with switch, 5,000, 10,000, 25,000, 50,000, 2/3.

SPECIAL !! SPECIAL !! SPECIAL !!!

JENSEN 7 1/2" 2,500 Field Pentode type Moving Coil Speakers, 5/9 each. Few only.

HANDSOME Straight line Slow Motion Dial, complete with escutcheon, 2/3 each.

THE FOLLOWING CONDENSERS BY WELL-KNOWN MANUFACTURER.

8 plus 8 plus 4 Electrolytics, Wire End type, Metal Cases, 3/-.

14 plus 8 Electrolytics, Wire End type, Metal Cases, 2/-

8 plus 8 Electrolytics, Wire End type, Cardboard cases, 3/-.

8 mfd., 550 surge, 500 v. working, metal can, 1 hole fixing, 2/11.

8 mfd., 500 surge, 450 v. working, metal can, 1 hole fixing, 2/6.

TUBULAR CONDENSERS, paper type, all sizes up to 1, 6d. each.

50 mfd. 50 v. working condensers, well-known manufacture, 1/6.

50 mfd., 25 v. working condensers, well-known manufacture, 1/3.

25 mfd., 50 v. working condensers, well-known manufacture, 1/-.

50 mfd., 12 v. working condensers, well-known manufacture, 1/-.

UTILITY 3 Gang Condenser, superhet. type, 2.0005 sections, 1 1/10 k/c section, fully screened with top trimmers, 2/6.

AMERICAN VALVES, Special clearance, 3 types only. 12Z3, 6B7, 6A7, 1/9 each.

American Valves*, First-class brand, Triad. Following types, 34, 33, 47, 42, 43, 49, 6B7, 50, 53, 55, 6A7, 80, 75, 43, 41, 5Z3, 2A3, 12Z3, 45, 6C6, 6D6, 6E7, 30, 59, 4/6 each.

*All these valves carry a 90-day guarantee, and free replacement, provided that the filament or heater is intact and the glass not broken when returned to us.

LISSEN CLASS B DRIVER TRANSFORMERS—ratio 1—1, brand new, boxed, 1/9 each.

LISSEN INTERVALVE CHOKES, brand new, boxed, 1/-.

DRYCE MAINS TRANSFORMERS AND CHOKES, standard for the season, British and guaranteed. 250-0-250, 80 m.a., 2-0-2 volts, 2.5 amp., 2-0-2 volts, 4 amp., 8/6.

350-0-350, 120 m.a., 2-0-2 volts, 2.5 amp., 2-0-2 volts, 4 amp., 10/6.

NEW RECEIVERS, COMPONENTS, AND ACCESSORIES

OURS is now the only store in London handling a complete and comprehensive range of high grade Components and Accessories as distinct from clearance and surplus stuff. Everything from the smallest plug to the complete Auto Changer Unit; finest makes, really keen prices, and personal and efficient service unobtainable from chain stores, clearance houses, department stores or by mail. Come and see.—**WIRELESS SUPPLIES LIMITED**, 275-280-282, High Street, Stratford, E.15. Maryland 3101.

RADIO BARGAINS

AMAZING prices. I lead, others follow. All-wave A.C./D.C. Table models, £6/15/0; Halcyon A.C.7, £7/7/0; Halcyon, A.C./D.C., Listed 14 gns., £7/7/0; Austin twin Rola speakers, Listed 15 gns., £7/7/0; A.C./D.C. Compacts, 65/-; Other Mains receivers, £5. Stamp for list. Speakers, Components, English, American Valve replacements. Full stock the amazing All-wave Ferguson models. Trade supplied. State requirements.—Littler, The Midland Dealer, 2, Barras Lane, Coventry.

LOUDSPEAKER REPAIRS

REPAIRS to Moving Coil Speakers, Cones and Coils—dotted or rewound. Fields altered. Prices Quoted including Eliminators. Loudspeakers Repaired, 4/-; L.F. and Speech Transformers, 4/- post free. Trade invited. Guaranteed. Satisfaction. Prompt Service. Estimates Free. L.S. Repair Service, 5, Balham Grove, London, S.W.12. Battersea 1321.

VALVES

NOTHING better available. **SIX MONTHS' GUARANTEE**, complete range of BATTERY, A.C. MAINS, RECTIFIERS always in stock. 2 volt Det., H.F., L.F., 2/3. POWER 2/9, SCREEN GRID, PENTODE, H.F. PENTODE 5/-. American types, fully guaranteed, 5/6 each, Nos. 18, 24A, 35, 42, 43, 45, 47, 56, 57, 58, 75, 77, 78, 80, 2A5, 2A6, 2A7, 6A7, 2B7, 6B7, 6C6, 6D6, 25Z5, 25Y5. Write for other prices to Dulci Electrical Co., Ltd., Devonshire Works, Duke's Avenue, Chiswick, W.4.

SHORT WAVES

SHORT WAVE on a crystal set. Full building instruction and crystal 1/2 post paid.—Radiomail, Tanworth-in-Arden, Warwickshire.

HEADPHONES.—5,000 guaranteed pairs to be cleared. Brown, G.E.C., B.T.H., Ericsson, Nesper, Western Electric, Siemens, Brandes, Sterling, etc. 2,000 ohms, 2/6. 4,000 ohms, 5/-. Postage 6d. **SPECIAL**. Telefunken, adjustable, lightweight, 2,000, 4,000 ohms, 7/6. **CRYSTAL SETS**. Burne-Jones. Complete. Guaranteed. 5/6. Ditto, double circuit, 8/-. With permanent detector, 1/- extra. Sensitive permanent detectors, 1 6. Crystal detectors, complete parts, 1/-. Crystals 6d.—Post Radio, 183, Caledonian Road, London, N.1

FREE ADVICE BUREAU COUPON

This coupon is available until January 30th, 1937, and must be attached to all letters containing queries.

PRACTICAL AND AMATEUR WIRELESS, 23/1/37.

ADVERTISEMENT INDEX

	Page
British Institute of Engineering Technology	577
Bulgin, A. F. & Co., Ltd.	578
Chloride Electrical Storage Co., Ltd.	Back Cover
Electradix Radios	577
Eugen Forbat	579
Graham Farish, Ltd.	576
Holmes, H. W.	576
International Correspondence Schools, Ltd.	574
Kings Patent Agency	577
London Radio Supply Co., Ltd.	576
M.P.R. Electrical Co.	576
McCarthy Radio, Ltd.	578
New Times Sales Co.	575
Peto-Scott Co., Ltd.	571
Player's Airman Tobacco	Inside Front Cover
Premier Supply Stores	580
Record Radio, Ltd.	576
Technological Institute of Great Britain	576
Westinghouse Brake and Signal Co., Ltd.	576

RECEIVERS, COMPONENTS AND ACCESSORIES

Surplus, Clearance or Secondhand, etc.

SOUTHERN RADIO'S Wireless Bargains.—All goods guaranteed and sent post paid.

BELMONT 6-valve Superhet. Receivers, complete in handsome cabinet for use on any mains, A.C./D.C., 110-250 volts, with moving coil speaker and 6 valves, ready to plug in; £4 each.

GRAMOPHONE Motors.—Garrard type "B" radiogram unit, consisting of A.C. motor, 100-250 volts, and pick-up, 43/-; Garrard motor, less pick-up, 30/-; in original sealed cartons.

RECORD Changers.—Garrard model R.C.3, plays automatically and changes 8 10 in. or 12 in. records of any kind, sealed cartons, £6.

SPEAKERS.—Celestion Soundex permanent magnet, 10/-; Telsen permanent magnet, with 10-ratio transformer to suit any receiver, 12/6; Telsen loud-speaker units, 2/6; all brand new and in sealed cartons.

COILS.—Telsen, iron core, W349, Midget size, 4/-; type W478 (twin), 9/- pair; W477 (triple), 10/- set; type W170 (triple superhet. selector and oscillator), 10/- set, all ganged coils complete on base with switch; Telsen I.F. transformer coils, W482, 5/-; Telsen dual range aerial coils, with aerial series condenser incorporated, W76, 4/-; Telsen aerial series condensers with shorting switch, 2/-; all brand new, in sealed cartons.

MICROPHONES.—Ace (P.O.) microphones, complete with transformer, ready for use with any receiver, 4/6 each.

RESISTANCES.—Tru-ohm 1-watt, colour coded and marked, 36 assorted capacities on card; 6/- per card.

AMEERICAN Valves.—A full range of valves for all American receivers, 6/- each.

HEADPHONES.—Lightweight headphones, double pole type, 4,000 ohms each earpiece, 3/- pair.

TEISEN A.C./D.C. Multimeters, tests anything radio or electrical, 8/6.

CAR Radio Aerials.—Ekco copper mast aerials can be used on roof or floor of car; size 36 in. x 20 in. 4/- each, 36 in x 26 in. 5/- each.

SOUTHERN RADIO.—Branches at 271-275, High Road, Willesden Green, N.W.10; 46, Lisle Street, London, W.C.2. All mail orders to 323, Euston Road, London, N.W.1.

SOUTHERN Radio, 323, Euston Road, London, N.W.1 (near Warren Street Tube). 'Phone: Euston 3775.

MISCELLANEOUS

WANTED.—ambitious young men to prepare for well paid posts in TELEVISION, the great career of the future. Apply for free booklet from **BRITISH INSTITUTE OF ENGINEERING TECHNOLOGY**, 18P, Shakespeare House, 17-10, Stratford Place, London, W.1.

SINCLAIR SPEAKERS Have Quantity New Speakers, P.M. and energised, 8 and 10 inch, also P.A. 10 watt; to clear from 8/6 each; all guaranteed.—Alma Grove, Copenhagen St., London, N.1. Tel. 4355.

RECEIVERS, COMPONENTS AND ACCESSORIES

ALCO ELIMINATORS AND CHARGERS. 5 H.T. taps, 120/150 v., 20/30 ma., 18/-. With 1 amp. charger, 25/-. Charger, 7/6. 1 amp., 11/-. Year's guarantee. Details free.—P. & D. Radio, 1, Gooding Rd., N.7.

BANKRUPT Bargains. List-free. All-wave battery, 3v. H.F. pentode sets, complete valves and M.C. speakers, 16-2,000 metres, 79/6. British made 1937 5v. superhets, complete, £7. All-wave models, £7/10/0. Halcyon A.C.7 superhets, 7 gns. Ormond A.C. superhets, £6. Halcyon 4v. A.C./D.C., 85/0. Telsen 6v. A.C. superhets, £5/17/6. Ormond, 3v. A.C./D.C., 59/6. Ormond battery, 3v. H.F. pentode, detector and pentode, M.C. speaker and valves, 59/6. Ferguson, Pilot and Truphone, 1937 models, trade supplied. Serialite S.W. converters, 29/6. Regentone A.C. eliminators with charger, 82/6. M.C. speakers from 10/0. Most popular type American valves, 3/0. Europa valves, most types, 3/0. Battery valves from 1/0. Volume controls, 2/6, with switch 3/0. Dual coils, 1/1. Telsen transformers, 2/6. Crystal sets, complete, 4/6. Phones 3/6 pair. Full stock condensers, resistances, all types valves and components at low prices. Morse signal sets, buzzer, lamp and key, 4/6. Any type of repair at keen price. Only new goods offered above. Secondhand sets. 3v S.G. M.C. speaker, D.C. mains, 40/0. Pye D.C. transportable, 45/0. Ace 4v. A.C./D.C., 50/0. All in good order.—Bulgin, 6, Stanford Avenue, Brighton, Sussex. Preston: 4030.

ALL goods previously advertised are standard lines, still available. Post card for list free.

VAUXHALL UTILITIES, 163a, Strand, W.C.2. Over Denny's the Booksellers, Temple Bar.

THE TENDENCY IN BATTERY SETS

What analysis shows

A recent analysis of the L.T. consumption of 280 present-day battery sets shows this result :—

0.7% with L.T. consumption under 0.3 amperes
 7.1% with L.T. consumption of 0.3 to 0.4 amperes
 67.3% with L.T. consumption of 0.4 to 0.6 amperes
 22.3% with L.T. consumption of 0.6 to 1.0 amperes
 2.6% with L.T. consumption over 1.0 amperes

It will be seen that over 90% consume 0.4 amperes or more. It shows that modern battery sets consume more L.T. current. This is owing to the use of more valves and of illuminated dials. That fact is highly important. It means that the popular thick-plate type of battery, while being excellent for small sets, is not suitable for the majority of modern sets.

This type of battery is designed for slow discharge and infrequent recharging, and if it has to be recharged more frequently than once a fortnight its life will be shortened.

Moreover, it will not give the most economical service, as its full rated capacity will not be obtained.

To meet these changed conditions Exide have produced a new type of multi-plate battery called the Exide 'Hycap' which gives its full rated capacity at comparatively

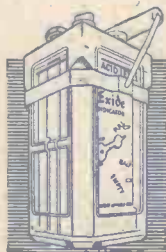

high discharge rates and so lasts longer on each charge. Listeners obtain from 35% to 90% more listening hours on each charge, and this reduction in the frequency of charging, allied to the robust nature of the multi-plate assembly, considerably improves the durability of the battery. Incidentally, it can be recharged in half the time required for thick plate batteries.

Operated under the conditions for which it was designed, it will be obvious that the Exide 'Hycap' effects considerable economies in the cost of listening.

Like the Exide 'D' type battery, it has the invaluable Exide Indicator, which tells you in time when to recharge.

Sizes and Prices of Exide 'Hycap' Batteries

Type	Voltage	Capacity in ampere hours at the 20 hr. rate	Price (uncharged)
OCG3 - C	2	15	8/6
GFG4 - C	2	24	10/6
GKGS - C	2	36	12/6
CZG6 - C	2	60	15/6

Obtainable from all reputable dealers or Exide Service Stations.

EXIDE BATTERIES • EXIDE WORKS • CLIFTON JUNCTION • NEAR MANCHESTER ALSO AT LONDON
 MANCHESTER • BIRMINGHAM • BRISTOL • GLASGOW • DUBLIN AND BELFAST

R.175

BUILD OUR LATEST MULTI-RANGE S-WAVER

Practical and Amateur Wireless



Edited by F.J. CAMM

a GEORGE
NEWNES
Publication

Vol. 9. No. 228.
January 30th, 1937

AND PRACTICAL TELEVISION

HOW TO MAKE

The Beginner's

"TELE-CENT" 3



4.8 to 100 metres without Coil Changing

EVERYMAN'S WIRELESS BOOK

BY F. J. CAMM (Editor of "Practical and Amateur Wireless," etc.)

A Radio Consultant for the Listener, Expert and Amateur Constructor, explaining the Operation, Upkeep and Overhaul of all Types of Wireless Receivers, with Special Chapters on the principles of Radio Telephony Installation, and Systematic Fault-finding.

From all Booksellers only 3/6 net, or 4/- post free from

GEORGE NEWNES, LIMITED, Tower House, Southampton St., LONDON, W.C.2.

With

200

Illustrations



ADVT.

Specified for the TELECENT

THE NEW PRECISION DESIGNED

LISSEN Hi-Q

COMPONENTS

Specified for the Telecent

HI-Q ROTARY COIL UNIT

4.8-91 metres by a turn of the knob!
(Hi-Q 5649) 15/6

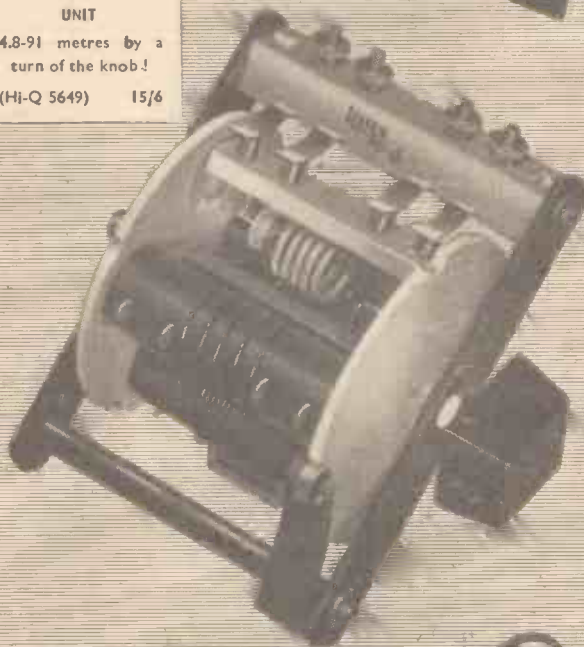

Specified for the Telecent

HI-Q ULTRA SHORT AND SHORT-WAVE CHOKES
(Above) standard type. (Hi-Q 5656)—2/-
(Below) double wound filament type (Hi-Q 5645)—2/6

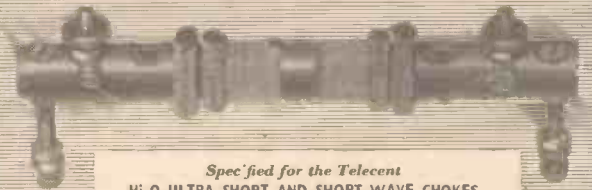

HI-Q I.F. UNIT
Tuned anode coupling unit (50 k.c.) for use with Hi-Q rotary coil unit. (Hi-Q 5654) 7/-



HI-Q LOW-LOSS CONDENSERS
Minimum capacity—5 mmfd. Absolutely noiseless in action even at 5 metres, 160 mmfd.—(Hi-Q 5652)—7/6
20 mmfd.—(Hi-Q 5653)—5/6



HI-Q DECIMAL DIAL AND SLOW-MOTION DRIVE
1,000 divisions for accurate calibration! (Hi-Q 5655) — 12/6

HI-Q VALVE HOLDERS
Low-loss ceramic. 7-pin (Hi-Q 5651) — 2/3
5-pin (Hi-Q 5650) — 1/9.



36 PAGES ALL ABOUT THE ULTRA SHORT AND SHORT WAVEBANDS!

Post this coupon for a copy of **SHORT WAVE NO. 3** containing complete instructions for building two wonderful ultra short and short-wave receivers, a converter and a transmitter.

Messrs Lissen Ltd. (Dept. P.W.), 113-117, Charing Cross Road, W.C.2.
Please send me a copy of Short Wave No. 3 for which I enclose 3d. In stamps.
Please send me **FREE** copy of the Hi-Q catalogue.

Name

Address

The Lissen Hi-Q range consists of 26 Precision-designed Components.

A WAVEMETER FOR 5 METRES —See Page 603



Practical and Amateur Wireless

Edited by F. J. CAMM

Technical Staff:
 W. J. Delaney, H. J. Barton Chapple, Wh.Sch., B.Sc., A.M.I.E.E., Frank Preston.

VOL. IX. No. 228. January 30th, 1937.

ROUND *the* WORLD of WIRELESS

The Tele-Cent Three

IN view of the great popularity of the short waves, many listeners are now building short-wave receivers, or modifying their existing apparatus to take in the short waves. The average all-wave receiver, however, fails to go down sufficiently low to enable the present television transmissions to be heard, and usually ends at about 50 or 60 metres, leaving a gap from there to the lower part of the medium-wave range. In the special Beginner's receiver published this week we present a new type of receiver, one which might well be termed a Super Short-wave set. This embraces not only the usual short-wave ranges upon which amateurs and broadcasting stations from all parts of the world may be heard, but takes in the television signals and goes even lower down to the 5-metre amateur band. The upper ranges are also extended, and take in wavelengths right up to 100 metres, thus providing the listener with an unusual range of programmes embracing amateurs, broadcasting stations, American and English Police Radio, Special Weather Reports, News Reports, and many other interesting broadcasts. The most important feature about this receiver is that all of these signals may be heard without coil-changing, a new and novel coil unit designed by Messrs. Lissen forming the nucleus round which the receiver has been designed. Full constructional details will be found on page 594.

New B.B.C. Stations

IT is hoped that the new Empire Daventry station will be completed in time for the Coronation ceremonies in May. Three 50-watt transmitters are being built, and two are partially installed. The new power house is ready for the gear, and eight new masts have been erected. When completed, there will be 24 special aerial arrays designed to cover, by means of directional beams, all parts of the Empire.

"Over She Goes"

IN the outside broadcast included in the National programme on February 5th, listeners will hear Stanley Lupino getting the audience to whistle in the number "Yes, No." The broadcast begins with part of the music of the interval overture and then to Act 2, which opens with a

song, "We Police," featuring Sid Walker and Richard Murdock. Laddie Cliff is also in the cast.

Television Cable

IT is announced that a special co-axial cable is being laid down to connect St. George's Hall with the Alexandra Palace. This will enable the usual Saturday evening Music Hall programmes, as well as other items, to be radiated on the television wavelengths, and will help to solve some of the B.B.C. television programme problems.

ingenious ideas which have been put forward to remove the risk of a pilot losing his way when flying over strange country or when the ground is obscured from his view.

"Sniper of the Ether"

THE above title, together with others, such as "Master of Short-wave Connections," is to be conferred by the Government of the U.S.S.R. on certain amateur transmitters. The first title goes to the amateur who establishes two-way communication with all continents and with all regions of the U.S.S.R. Those who have worked for not less than five years in the field of long-distance communication, and who also obtain the above qualification, will receive the second title.

ON OTHER PAGES

	Page
The "Experimenters" Discuss Old Times ...	583
It Does Not Happen Now	585
G.E.C. Service Depot ...	586
Wrinkles	590
Practical Television ...	591
The Beginner's Tele-Cent Three	594
Switch Scheme for Plug-in Coils	600
Transmitting	601
Short Wave Section ...	603
Readers' Letters	608
Queries and Enquiries ...	611

Car Radio in U.S.A.

IT appears that car radio is very much more popular in the U.S.A. than it is in this country. General Motors recently sent out 1,000,000 questionnaire forms to United States motorists in which one of the questions was about car radio, and the result was that 71.8 per cent. of the replies stated what radio equipment was wanted. This is a very good response and shows the interest in the subject, although it does not necessarily indicate that that number of users of cars had radio fitted.

Boxing at Harringay

IN the broadcast on February 1st (Regional) of the Petersen-Neusel match, the usual arrangements will be followed by the B.B.C. This is to divide the task into three sections, Lionel Seacombe concentrating on the boxing, an assistant filling in between the rounds with a description of the scene and personalities present, whilst an expert from the ringside periodically visits the microphone to give his opinion on the progress of the fight.

Motor-cycle Trial

MIDLAND listeners will hear the Colmore Cup Trial for motor-cycles on February 6th. The R.A.C.'s district manager for Birmingham will describe this trial in the series of Midland Sports programmes.

Guiding Aircraft

A SYSTEM of high-frequency radiations from cables buried in the earth has been suggested for ensuring that aircraft can keep to an allotted course during fog or darkness. This is only one of the many

Electron Speed

THE speed of the electrons in a television tube is little less than 100,000,000 miles per hour. An object travelling at this speed could journey to Mars in twenty-three minutes, or to the sun in an hour.

ROUND the WORLD of WIRELESS (Continued)

In Arctic Siberia

ONE usually pictures Siberia as a land of the lost, but Mr. H. P. Smolka recently visited the Polar station in Arctic Siberia and in place of an icy waste, a land of white death, he found a thriving and comfortable community. He visited towns with newspaper offices, factories, cinemas, theatres, schools, hospitals, mines and airports, and watched a football match. Dickson Island has 200 inhabitants and six radio transmitters, as it is an important radio centre for the Polish region.

Concert from Malvern

PART of the concert by the City of Birmingham Orchestra, at the Winter Gardens, Malvern, will be broadcast on January 30th. Leslie Heward is to be the conductor, and Gwendoline Parke the pianist for the Schumann A minor Concerto.

Fifty Years in Electrical Industry

SIR FELIX POLE, Chairman of the Associated Electrical Industries, Ltd., which includes the Edison Swan Electric Co., Ltd., the British Thomson-Houston Co., Ltd., etc., recently made presentations to three members of the Ediswan staff at Ponders End, Middlesex, who had completed over fifty years' service with the Company. These men were:

Mr. Jack Wade of the lamp factory, sixty-seven years old, who completed his fifty years' service on December 31st, 1935. He was presented with a canteen of cutlery.

Mr. W. Stokes, a glass-blower in the lamp factory, sixty-four years old, who completed his fifty years' service on January 7th, 1937. He received a gold watch.

Mr. William Hutt, who has now completed fifty-four years' service, starting from 1882, sixty-seven years old. He also received a gold watch.

It is interesting to note that Mr. Hutt, whose job is the exhausting of large rectifier valves for television, actually exhausted the first vacuum flask ever made. They were then known as Dewar flasks, after the inventor, and were made at the Ediswan Works, which were then at Benwell, Newcastle, under the direction of Sir Joseph Swan, the famous electric-lamp pioneer.



Few people know that Nomo King's name was derived from the words "No smoking," seen in an hotel lobby, and that he is a well-known Radio personality under his real name. The Cossor Radio people took this picture of him without his droll black-face make-up. Can you recognise him?

INTERESTING and TOPICAL NEWS and NOTES

A Mozart Programme

ON February 6th Leslie Heward is to conduct the City of Birmingham Orchestra in a Mozart programme in which the chief work is Symphony No. 40 in G minor. Joseph Farrington, well-known bass, is to sing two arias from the operas.

Dance Orchestra, directed by Henry Hall, will broadcast regularly on Saturdays on the Regional wavelength from 11.45 a.m. to 12.15 p.m. This day-time session is additional to the Friday day-time broadcasts by the B.B.C. Dance Orchestra (National, from 12.30 to 1.15 p.m.) which will continue as at present.

New B.B.C. Appointment

WE understand that Mr. Leslie Baily has entered into a programme



This illustration shows the modern lines of the new Broadcasting Station at Dairen, Manchuria.

Clifton Light Orchestra

ALEXANDER HENDERSON (bass) will be the soloist in a concert by the Clifton Light Orchestra, conducted by J. L. Bridgmont, to be broadcast on January 31st in the Western Regional programme.

Orchestral Concert from Edinburgh

AN hour of the concert to be given by the Reid Symphony Orchestra in the Usher Hall, Edinburgh, will be broadcast on January 28th. The orchestra will be conducted by Sir Donald F. Tovey. The broadcast portion includes "Symphony in C" by Mozart and a "Violin Concerto" by Sibelius, in which Ernest Whitfield will play solo violin. The broadcast portion will conclude with "Hungarian Capriccio" by Zador.

More Broadcasts by B.B.C. Dance Orchestra

FROM January 30th, the B.B.C.

contract with the B.B.C., and will take up work as an Assistant in the Variety Department in the near future. Mr. Baily was the originator and author of "Scrapbooks," and has written many feature programmes, plays and sketches.

SOLVE THIS!

Problem No. 228

When testing his faulty three-valve mains set, Jones found that excessive voltage was being applied to all the valve anodes and excessive H.T. current was being passed. This current was measured by connecting a milliammeter in series with the 2,500-ohm field winding of the speaker connected in the common anode lead. The valves were tested and found to be in order. What was the fault? Three books will be awarded for the first three correct solutions opened. Address your solutions to the Editor, PRACTICAL AND AMATEUR WIRELESS, Geo. Newnes, Ltd., Tower House, Southampton Street, Strand, London, W.C.2. Envelopes must be marked Problem No. 228 in the top left-hand corner, and must be posted to reach this office not later than the first post on Monday, February 1st, 1937.

Solution to Problem No. 227

When R.C. coupling was used, the grid-leak and stopper-resistance of the output valve acted as effective H.F. stoppers, but when the transformer was substituted the primary winding by-passed the detector H.F. component and no reaction was obtainable. The following three readers successfully solved Problem No. 226 and books are accordingly being forwarded to them: R. J. Cox, 14, Gyllyngdune Gardens, Seven Kings, Ilford; B. Walker, 43, Pepys Road, Wimbledon, S.W.20; W. D. John, Brookville, Pembrey, Carmarthen.

The "Experimenters" Discuss Old Times

After Their "Hibernation" Your Old Friends Have an Argument and Compare Notes Made in Their Log Books During the Early Twenties

WE are flattered to learn from the Editor that readers have been writing to bemoan the fact that our usual notes have been absent from these pages for quite a long time. Apologies to those who have been disappointed; think of the others who have been pleased to have better material than ours.

Quite frankly, though, although we have been rather lazy for some weeks, it has been our purpose to write only when some particularly interesting experiment was in hand, or had been concluded. As we have not carried out any startling experiments just recently we thought it better to keep quiet. It is not that any of us has deserted his hobby, for it so happens that we have each made up a new receiver during the past couple of months. These new sets are really responsible for this outburst.

A New Set—

It is like this; soon after 1937 had started we met to celebrate the New Year, and to talk about old times. We started by discussing our new receivers. One of our number is a DX fiend, and has made a six-valve superhet, with pre-frequency-changer H.F. pentagrid, I.F. stage, double-diode detector, L.F. and push-pull output. This, he claims, is the "last word," particularly so since the set covers short waves as well as medium and long. He claims remarkable results, and it transpired during our chat that he can receive every main British transmitter at full speaker strength, and without very much serious fading. This does not mean that the set will not "reach out;" every experimenter knows that there are dozens and dozens of foreigners which can be received more easily in the South of England than can, say, the Scottish Regional.

Anyhow, he wished to prove the high efficiency of the set by guaranteeing to

receive any British station (barring those on common wavelengths, of course) at any time of day. This immediately roused another of our company, who raised the question of why it is far more difficult to receive long-distance stations to-day than it was a dozen or so years ago. Two of the party said that surely this was not the case, although they were not speaking from personal experience, due to the fact that they were too young to be "knob twiddlers" so long ago. The "old man" then went on to describe his experiences from 1922 (when first B.B.C. was a *Company*) onward.

by The Experimenters

—And an Old One

He explained how, in 1922, '23, and '24, he was able to receive every B.B.C. transmitter as it came into operation on a single-valve set of the simplest possible type. It transpired that this set used a Dutch valve—the very "soft" type, which emitted a blue glow when the anode voltage exceeded about 30 — in conjunction with home-made basket coils. The basket coils were wound on shellacked cardboard and were mounted on home-made ebonite plugs fitted with a pair of valve pins. These were fitted into a two-way coil holder, in which one coil could be moved angularly in respect of the other. Aerial tuning was by means of a .0005-mfd. (so-called, but not guaranteed) variable condenser connected in series with the aerial lead-in.

The valve was supposed to take 4 volts, but it was generally necessary to turn down the filament rheostat when using

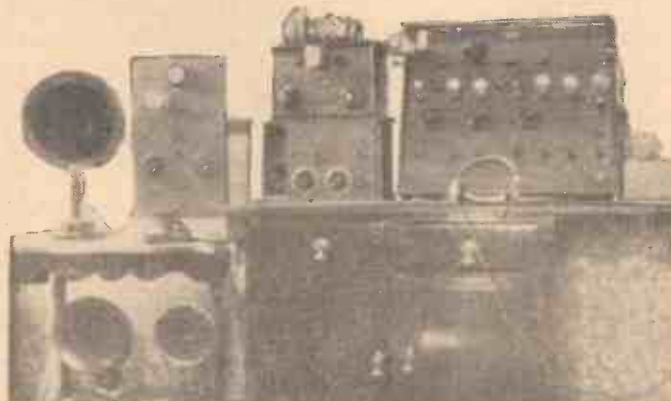

This picture was not taken recently, as can be understood. It actually shows the eight-valve receiver referred to by the "Experimenters" on this page. Also shown are a three-valve "straight" set, a short-waver and a low-power transmitter—not to mention the loudspeakers.

a four-volt accumulator for fear of burning out the filament. Reaction was controlled by means of the swinging coil; the grid leak was continuously variable from .5 to 5 megohms, and a pair of Brown A-type 'phones of 8,000 ohms resistance (costing over three pounds as far as he could remember), were included between the end of the reaction coil and H.T.+

The main point about this outfit was that every British station could be heard at good 'phone strength, whilst stations like Paris P.T.T., Brussels, and Eiffel Tower provided excellent signals in reasonably good conditions. Our colleague also boasted that with this simple arrangement he could claim to have received American medium-wave broadcasts during more than one of his all-night sittings.

What is the Reason?

These remarks called forth the question; could such reception be obtained to-day when using the far superior valves and components? Alternatively, were present-day receivers inferior to the old ones, or were reception conditions much worse? Another point which was raised was that transmitters in the early 'twenties rarely used more than about 1½ kilowatts, compared with figures running into hundreds of kilowatts to-day. It was definitely concluded that reception similar to that described was now out of the question. But why? Receivers are definitely better than they were then, so conditions must be worse.

And this aroused a somewhat bearded argument. Do receivers act on wireless waves in a similar manner to a sponge on water? If sufficient receivers were in use would it be possible to "absorb" all the radiated energy, so that if just one more set were switched on none of the sets could obtain sufficient "pick-up" to enable them to reproduce the transmitted signals? This argument almost resulted in strained friendship, for so many points were made both for and against.

What Do You Think?

Nevertheless, it was fairly generally agreed in the end that such a state of affairs must exist. Not that receivers could not be made so sensitive that they would respond to the smallest fraction of

(Continued overleaf)



The "station" of one of the Experimenters, as it was in 1925. Note the changes in design since the time of the receivers shown in the illustration at the head of this page.

THE EXPERIMENTERS DISCUSS OLD TIMES

(Continued from previous page)

a microvolt, but that if they were so designed signals could not be heard for the tremendous amount of interference which would be picked up and amplified. In the end, we agreed that each receiver in use did actually "absorb" a percentage of the radiated signal energy; but if any reader can advance an argument against this theory, at least one of our number would like to hear of it, because he cannot agree, but is unable to offer proof against the theory. Perhaps somebody will take up the cudgels on his behalf. Come along, you technicians!

Proving His Status

From this argument—which was dropped to avoid frayed tempers—we went on to discuss our old log books. It appears that very few of the present generation of amateurs keep a log book, which is simply a day-by-day record of reception conditions, stations received, and tests carried out. In the "old days," no amateur could claim to be an experimenter unless he could produce a well-kept log book as proof. One of our "gang" recalled an early entry in his log book—made in 1919—which was a report of the first wireless reception he had ever heard. This was of a time signal in morse from the Eiffel Tower. He was so excited at the reception that he pulled the complete receiver off the table in his haste to run into the next room to tell the other members

of his family—without first removing the phones. As a result, his painstaking adjustment of the crystal detector was ruined, so that no further reception was possible for two whole days. And every spare hour during those days was spent in attempting to find what appeared to be the only sensitive spot on the crystal.

R.C.—Transformer in 1923

Another member of our "select circle" recalled an entry in his log book which appeared to prove that he was the first person to use a resistance-fed transformer—without knowing it! As well as he could remember, the entry read: "Good idea. Resistance-capacity coupling provides good quality; transformer coupling gives inferior quality but far better amplification. Why not combine them by connecting a primary of the transformer in parallel with the anode resistance, breaking one of the leads with a fixed condenser? Try it." The following entry gave the result of the experiment: "Connected transformer in parallel with resistance, using a .006-mfd. condenser in series. Results better even than expected." That entry, if his memory serves him well, was made about June, 1923. It was many years later that resistance-fed-transformer coupling was generally known. The only difference between our friend's system and that used widely to-day was that one end of the transformer primary was joined to H.T.+, instead of to earth. Anyway, the principle is the same, and the results almost identical. We now wonder if one of our members is cleverer than we had imagined.

Eight-valve "Straight"

The same "experimenter" told of his results with an eight-valve "straight" receiver which he built towards the end of 1923. This had four H.F. stages, a detector, and three L.F. stages. There was a separate filament rheostat for each valve, and a system of plugs and sockets was provided for cutting out each of the valves in turn. When using up to four valves (H.F., Det., and two L.F.), the set worked fairly well, but additional H.F. stages merely caused instability; even this arose only after spending a good deal of time bringing each of the separate tuning condensers "into line." After weeks of useless experiment trying to make all four H.F. stages operate together, he hit upon the idea of using three semi-aperiodic stages. That is, the normal plug-in coils were replaced by tapped coils wound with resistance wire. With this arrangement the set appeared to work very well—until two of the H.F. stages were cut out without there being any appreciable difference in reception! In the end the set was rebuilt as a six-valver with two tuned-anode H.F. stages, detector and three stages of resistance-coupled L.F. That proved very satisfactory and gave a considerable amount of pleasure (?), chiefly because there were three tuning condensers to be operated almost simultaneously. Two of these were eventually "ganged" by fitting a rubber band round the pair of tuning knobs.

But enough of reminiscences; we must get down to some more experimental work of a more modern nature.

Reception of British Guiana

STATIONS have been coming over exceptionally well on the short waveband lately, but of all the stations that have surpassed themselves, first prize must be given to Georgetown, British Guiana, which, working with a power of only 0.15 kW, has been received regularly from midnight onwards at tremendous volume. In South London, using a five-valve superhet, this station was received every night during Christmas week on a 5ft. aerial at sufficient volume to overload the output stage, while reports from readers, on the excellent conditions that have been prevailing, make mention of this station more than any other.

Radio Advertising

WHAT is said to be the largest electric advertising sign in London, and the second largest in the British Empire, was put into service last month. The sign was built for the Philco Radio and Television Corporation of Great Britain, Ltd., and is placed on the face of the Grand Building on the east side of Trafalgar Square, at the intersection of Northumberland Avenue.

The over-all size of the sign is 73ft. long by 40ft. high. When lighted, it flashes the message: "Philco, World's Largest Makers of Radio Sets, a Musical Instrument of Quality." It can be seen for a distance of three miles, according to its makers, Claude-General Neon Lights, Ltd., of Pitman House. The lighting of the sign is automatic, being actuated by a photo-electric cell which turns on the power when natural daylight decreases to a certain point. It is extinguished automatically when daylight increases sufficiently for the cell to break the electric circuit.

Eliminating Interference from Television Transmissions

REPORTS reach us of interference from the television transmission on the broadcast waveband. It has been sug-

ITEMS OF INTEREST

gested in other directions that a tuned wave-trap in the aerial will overcome the trouble. Whilst this is undeniably true, it is in our opinion an unnecessarily expensive method, except, perhaps, in very extreme cases, as we have found by experiment that a short-wave choke, consisting of thirty turns of wire (anywhere between 16 and 22 S.W.G.) wound on a round former 1in. diameter, with turns spaced one-sixteenth of an inch apart, completely eliminates this form of

interference without affecting the normal broadcast wavebands.

Call to Prayer by Loudspeaker

THE Prophet's injunction of the call to prayer has been brought up to date in a mosque in Singapore, by the introduction of a loudspeaker.

Hitherto the call of the muezzin of the Masjid Sultan Mosque in Singapore has barely reached the ground. This is not surprising, since the minarets are 90ft. high and the mosque stands in a busy quarter of the city.

Now the call to prayer travels a quarter of a mile when the traffic is at its height. In the early morning it can be heard over a mile away.



This unusual view of Trafalgar Square shows some of the night lights around the famous statue of Lord Nelson. The Philco Radio sign in the background is the largest Neon sign in London and one of the largest in the British Isles. It was first put into operation on December 28th, 1936. It is 76ft. long and 40ft. high.

IT DOES NOT HAPPEN NOW

It is Interesting to Recall what Effects Were Experienced by Early Amateurs and to See How They are Now Non-existent - - - By H. J. BARTON CHAPPLE, B.Sc.

TO the experimenter who has interested himself in radio since pre-broadcasting days, one of the most notable features of present-day practice is the comparative freedom from many of the trials and troubles which afflicted early receiving sets. In the hope that it will interest newcomers it is proposed to describe some of the ways in which the listener of 1937, and particularly the constructor of 1937, is in a far happier position than the amateur of ten to fourteen years ago.

We will deal first with technical problems, serious in those bygone days, but which have now been entirely or almost eliminated.

Instability

The first of these is circuit instability, with its accompanying practical annoyances. One reason for the prevalence of circuit instability in the old days was that transmitters were of such low power, and receiving circuits so comparatively inefficient, that it was essential to employ reaction, and often critical reaction, if any but the local programme was to be received, and even for local reception in a very large number of cases. Reaction in the early days was a tricky thing, depending for its trouble-free functioning on the somewhat critical adjustment of detector high-tension voltage (and often detector low-tension current via a filament rheostat) and the manipulation of a swinging reaction coil. Moreover, as plug-in coils were commonly used, the size of the reaction coil selected also affected the smoothness of the reaction effect. With all these variables, and also taking into consideration the somewhat crude mechanical features of much of the apparatus available at the time, it required considerable skill and experience to design and to operate a set in a way which would ensure stable circuit conditions. Even when better reaction circuits became

available, adjustment and operation remained fairly critical.

Apart from the weird noises generated in one's own set, instability also caused re-radiation, so that in addition to home-made howlings, the listener had to cope with those produced in his neighbours' sets. Even the improvements in methods of applying reaction, and a growing knowledge of how to use it intelligently did not result in the complete disappearance of the trouble. To-day, however, thanks to more powerful stations, highly efficient amplifying valves and circuits, reaction is quite unnecessary as a sensitivity control for normal broadcast reception, its only use at the present being a somewhat crude form of selectivity control in sets of the simpler sort.

Instability, however, was not entirely due to the use or misuse of normal detector reaction. The high inter-electrode capacities of the then existing types of high-frequency valves produced unwanted reaction effects in such high-frequency amplifying stages as were used, and in addition to giving rise to all the ill effects of misapplied detector reaction, usually at erratic and unexpected moments, prevented circuits from being worked to the limit of their theoretical efficiency, and thus reduced the overall sensitivity of the set. This trouble was heightened by the fact that the desirability of screening high-frequency circuits from each other was not always recognised, and that efficient means for doing so were not readily available. To-day, screened tetrode and pentode high-frequency valves, screened components of high efficiency, metal chassis, and a far higher standard of technical knowledge among both constructors and manufacturers, make it a comparatively simple matter to design, construct and operate receivers in which perfect stability can be ensured from the outset.

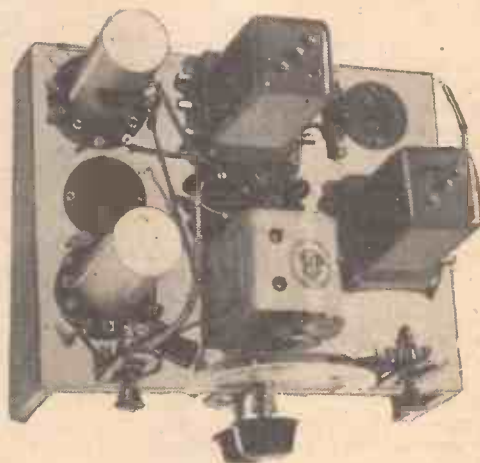

A typical modern receiver in which only two valves are used, but the full superhet feature is incorporated.

Sensitivity

We can now consider two other properties of a radio receiver, namely, sensitivity and selectivity. Owing, as has been already suggested, to the weak powers of broadcasting stations, a far greater degree of sensitivity was required in those early days. But valves were comparatively insensitive, radio-frequency losses in circuits and components were comparatively high and, as we have already seen, considerations of stability further limited the degree of sensitivity which could be usefully employed. So that, even with a set having two or three high-frequency stages and detection with reaction, results, so far as the number of stations receivable was concerned, were far inferior to those obtainable to-day with a simple straight three-valve set.

It is, of course, true that early superhets, in skilled hands, gave remarkable results, but only a very few expert amateurs could construct and operate sets of this type with any hope of success. Even so, they were of erratic behaviour, prone to re-radiation troubles, and the quality of reproduction was far from satisfactory. The modern superhet, in quite unskilled hands, can be relied upon to provide an overall performance of which no one need be ashamed.

Selectivity

Selectivity, which did not trouble the listener in the earliest days, loomed large in the requirements of the constructor when the number of broadcasting stations multiplied. But a high degree of selectivity was difficult to achieve. In the first place, many of the selectivity-inducing devices, such as loosely-coupled circuits, resulted in such a diminution of signal strength that most of the weaker stations were unreceivable. Then, the addition of further tuned high-frequency stages did not improve selectivity to the degree which might have been expected, because of the comparative inefficiency of the components and circuits, resulting in damping and consequent flatness of tuning. And, as has been seen, the third possible method of improving selec-

(Continued overleaf)



An early design, using four valves, which may be compared with the illustration above. This is the famous Fury Four receiver.

IT DOES NOT HAPPEN NOW

(Continued from previous page)

tivity, namely by reaction, had to be used with great caution, or instability resulted. Thus was set up a vicious circle which severely limited set performance with regard to both sensitivity and selectivity.

Simplicity of operation, another noteworthy feature of the modern set, was practically unknown in the early and middle days of broadcasting. To begin with, each of the very few essential controls found on the modern set was multiplied many times in the early receivers. To-day, we may have a single switch controlling the mains (or battery supply) and also the wave-change and gramophone features. In the early days, however, there was one battery switch, and often a separate filament rheostat for each valve and, until dual-wave coils were introduced, wave-changing was obtained by pulling out one set of coils and inserting others—and in a multi-stage set this might mean the changing of five or six coils. Even when dual-range coils were used, there often had to be a separate wave-change switch for each coil—possibly four—while the connection of a gramophone pick-up was frequently effected by pulling out the detector valve, inserting a special adaptor, and then replacing the valve.

Next, the modern set has one simple volume control. But in the old days volume was adjusted by the simultaneous use of the reaction control, filament rheostats and, perhaps, a potentiometer in one of the low-frequency circuits.

Tuning

Then, tuning in the modern set consists in adjusting a single ganged condenser which brings all the tuned circuits into resonance simultaneously—a matter of turning one knob and watching an illuminated dial with station names already printed on it with, possibly, a tuning indicator to give additional accuracy. A set made in 1924, or even later, might have three variable condensers with scales marked in numbers—1 to 100—all of which had to be adjusted in step and frequently without the aid of a slow-motion drive. Moreover, these condensers were seldom identical, so that the correct scale readings on the three were also not identical; in addition, each main condenser might have an individual "vernier" adjustment for final critical tuning. Also, any variation of the reaction setting usually altered the tuning setting of at least one of the tuned circuits. Add to all this a variable grid leak, variable detector bias by means of a potentiometer across the low-tension battery, and possibly one or two neutralising condensers to be adjusted, and it will be seen that tuning in, now a simple one-finger control, then called for both hands, bated breath, patience and considerable luck.

Tonal quality, by which is meant faithful reproduction of the programme from a musical point of view, was almost impossible of achievement in the old days, and this in spite of the fact that one of the biggest obstacles to high fidelity, namely the need of super-selectivity, did not then exist. The reasons for poor quality in the old days were, first, the poor acoustic qualities of

early types of loudspeaker (it was not until the moving-coil instrument came into use that efficient bass reproduction was possible); second, distortion introduced by such causes as reaction, the inability of existing valve types to handle large signal voltages without overloading, and the overloading of early types of low-frequency transformers; and finally, the limitation of the output from the set imposed by the necessity of using dry high-tension batteries.

To-day, ample incoming signal strength is available from all the main stations; amplifying circuits are correctly designed and there need be no overloading in any stage. Valves have better characteristics, and linear amplification can be achieved, or corrected circuits employed, to compensate for possible distortion. Modern speakers have excellent overall frequency response, and with mains sets ample power is available without excessive expense.

Finally, mention must be made of fading—a great bugbear once upon a time, and now largely mitigated. In this connection it is interesting to note that although fading, has obviously always existed from the earliest days, it was quite a long time before it was recognised as being a phenomenon due to causes outside human control. The rising and falling of the strength of distant signals was originally considered, by most amateurs, as part of the generally erratic behaviour of radio sets. Even when the phenomenon was scientifically investigated there seemed no way of overcoming the difficulty until, after the development of the variable-mu valve, the automatic volume control circuit presented a very satisfactory solution to the problem.

The G.E.C. Radio Service Depot

THE G.E.C. Radio Service Depot at Greycoat Street, London, S.W.1, is the headquarters for the network of radio service departments operating at home and overseas branches of The General Electric Co., Ltd. Radio service in all its aspects is planned and guided at this Depot, in co-operation with the Company's works at Coventry and Hammersmith. Incidentally, such repair work as is required by their customers in the London area is dealt with in a fully-equipped workshop, run on up-to-date lines, and catering for every class of repair or adjustment likely to crop up during the life of any G.E.C. radio product.

The Depot is a combination under one roof of a number of sections, each of which specialises in one or more of the after-sales requirements incidental to the marketing and maintenance of radio and television receivers and public-address equipment. We had the opportunity recently to survey this Radio Service Depot, and found it extremely interesting. Before making a tour of the premises we had an informal chat with Mr. D. F. Carter, the Manager of the Depot. He gave us a brief outline of the purpose of his organisation. "The complexity of the radio business," he said, "is to-day such that the G.E.C., as one of the leading radio manufacturers, desires to make available to its dealers every possible facility in order to cope with problems which crop up in the course of their business. We co-operate with them in schemes for anti-interference devices, television installations, and any special problems which may arise after our sales representatives have sold the goods.

Spare Parts

"There is a constant demand for spare parts for old types of sets going back many years, and, in addition, each week sees the return of a number of old sets requiring repairs on the premises.

"A comprehensive stock of spare parts for old and new sets is always available. Our workshop is run on lines similar to that of our production factory at Coventry. Every article undergoes at least three tests in addition to the usual routine tests during the actual repairs. All sets and loudspeakers have to pass a final inspection and test in specially equipped sound-proof rooms."

The Main Workshop

The main workshop is fitted up with a large variety of apparatus and instruments, and the staff is clearly competent to handle all the often intricate service work it is called upon to perform. Every receiver, or component, which passes into this shop is registered before it is sub-

jected to examination, and the scrupulous care with which such examination is carried through is typical of the efficiency which marks everything in the Depot. Each stage is proceeded with in a systematic manner, so that all faults can be traced and remedied.

The test work is also very thoroughly done. When a receiver is passed from the main workshop as satisfactorily repaired, it is submitted to a number of stringent tests by skilled supervisors in rooms expressly set aside for this purpose. Apparently nothing is left to chance. Every valve in each receiver is separately tested in another room for its characteristics, so that a receiver may be returned as mechanically and electrically satisfactory.



The repair workshop in the G.E.C. Service Depot, showing the stores on the left.

On Your Wavelength

By THERMION



Comic Names

I AM compiling a list of the names of dance band conductors. I know that Nosmo King derives his from "No Smoking," and I expect a number of others have derived their *noms-de-guerre*, pseudonyms, or appellations in a somewhat similar way. That is not the sort of directory I wish to compile. I have long been of the opinion that the names of dance band leaders are adjusted to suit the publics for which they cater, much in the same way that it would not do for a prize fighter to have such a name as W. H. Jones, E. J. Brown, or P. S. Smith. No! You must become Bill Jones, Ted Brown, or Percy Smith. On no account must you surround your cognomen with dignity. It is one of the curious aspects of life that those engaged in the professions are vain people. You cannot accuse me of that, for I hide my identity behind a pen name. The sort of list I wish to compile is of the Christian names, for as yet I have been unable to identify any band leader who merely uses his

the world that you are an extremely popular fellow. Thank goodness that the band leaders have not yet descended to that lowest form of conceit—the double-barrelled name. A man who is not satisfied

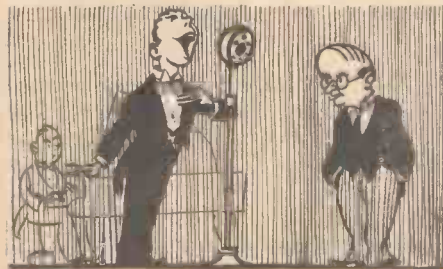

Crooners can sing in the dark.

with the name of Jones, or Smith, or Robinson, or Brown, will usually try to hyphenate it to give you the impression that he is no ordinary brand of Smith, Jones, Robinson, or Brown. The names of some dance band leaders do not lead you to suppose that they are very intelligent fellows; they could not be and still deal in such tripe.

How to Show Your Appreciation

I LEARN that Paris listeners are being asked to switch on an extra light for one minute when they enjoy any particular item or entertainer. This increased use of electricity will be registered at the Power Station who, in turn, will pass on the good news to the radio station. The increase in units will thus show the applause. Likewise, if they do not enjoy the item, they can sit in the dark, and that also will be registered. In this country it is conceivable that listeners would sit in the dark for at least two hours each evening. The trouble is that crooners can still croon in the dark. One of these days we shall have some means in this country of answering back, although we must confess that our programmes are

vastly superior, except on Sundays, to those of any other nation.

Badly Balanced Transmissions

THERE has been a large number of badly balanced transmissions recently. In a great number of programmes, especially those from the North of England, it sounds as if the piano is being accompanied by a singer instead of vice versa. In the case of some of the singers perhaps it is just as well.

Loudspeaker Annoyance

A BY-LAW has been passed at Kingston-on-Thames making it an offence punishable by a fine to cause annoyance by too loud a loudspeaker. The point now arises as to when a loudspeaker is too noisy, a problem which has been troubling the minds of motorists in connection with their exhausts for many years. It is so much a question of district. You cannot penalise a man because a set or a motor-car which is quiet in one district is noisy in another. You cannot penalise a man because his neighbours are sensitive people, and we all know how cantankerous some neighbours can be. If your neighbour is not particularly well disposed towards you, he is going to frame you



A piano accompanied by a singer.

initials. They all proudly convey to the world their Christian names, or their popular corruptions such as Bill, Ed, Lew, Joe, etc., etc. I don't want to know their Christian names, and perhaps some reader can offer an explanation as to why they do it. The only reason which occurs to me



A too loudspeaker.

by complaining to the police that your wireless set annoys him. Then again, he may stick up a high fence which will cause the set to suddenly become apparently noisy. Someone will use his garden fence as a baffle-board in order to annoy an unfriendly neighbour. It is a complex problem,

and although we have the phon and the decibel as units of noise, you cannot expect local magistrates to listen to technical evidence of this sort.

School for Announcers

ANOTHER 11,000 golden quidlets are to be spent by the B.B.C. this year on a school for announcers. They are to be taught B.B.C. English and how to become an aunt, even though they have not a brother or a sister. This raises some interesting questions. How far are the B.B.C. to be permitted to play fast and loose with the English language? What is the percentage of the various nations employed by the B.B.C. and by its Committees? In the B.B.C. you will find Scotsmen (plenty of them!), Englishmen, Irishmen, Welshmen, and those of foreign extraction, all excellent fellows, no doubt, but each probably feeling that his own particular branch of the Tower of Babel speaks the best English. The dictionaries are supposed to define pronunciation, although many of them disagree on the matter. As I have said before, the production of a dictionary should be a national concern. At present anyone can compile



A school for announcers.

a dictionary and make up his own pronunciation and derivations. I do not think the B.B.C. is the best body to decide, as its constitution is far too cosmopolitan. Let us imagine, for a moment (mind you it is purely supposition), that by some means or another the Scots Nationalist League managed to get a lot of its members important posts in the B.B.C. We should find, I have no doubt, that words would be given Scottish pronunciations. This is an important matter, and the Government should do something about it before the B.B.C. gets too strong a hold.

I am aware that it has a committee which decides pronunciations, and I should very much like to know the nationality of each member. Such a committee should be composed chiefly of Englishmen, as English is the Mother tongue. As an Englishman it is unpalatable to me to feel that I am being



Screening Coils

MOST receivers of the straight type having the detector as first valve use an unshielded coil. When it is desired to increase the range of a set of this type the addition of an H.F. stage is the most effective procedure. This addition is likely to cause H.F. instability unless the existing coil is screened, however, and therefore it is advisable to enclose the unshielded coil in a copper or aluminium can. There should be a clearance of approximately $\frac{1}{2}$ in. between the can and the coil winding and the can must be fitted centrally over the winding. In some cases sufficient screening can be obtained by separating the two coils by means of an aluminium or copper sheet, but this method of screening is seldom sufficiently effective when modern high-efficiency valves are used.

Resistance Wattage

SPACE and money are often wasted by using resistances having an unnecessarily high wattage rating. It is better, however, to use a resistance having too high a rating than the reverse. If the resistance rating is too low excessive heat will be generated and the resistance will eventually burn out, thereby causing damage to associated components and valves. A knowledge of Ohm's Law is necessary in order accurately to calculate the required rating. The approximate current which the resistance will be required to pass is generally known. This current, in amperes, multiplied by the resistance, in ohms, will give the voltage which will be dropped across the resistance. The voltage drop, in volts, multiplied by the current, in amperes, will then give the wattage dissipation, and a resistance having a wattage rating slightly higher than the dissipation value should be chosen.

Record Three Volume Control

SOME readers have complained that the volume control on their Record Three does not function. In most cases it will be found that this is due to the spindle being in contact with the centre tag; if a metallised baseboard is used this tag will then be connected to earth. The remedy for this fault is to scrape off the metallising underneath the component bracket supporting the control.

THE BEST WEEKLY FOR CYCLISTS
THE CYCLIST
2d. — WEEKLY

told what to do by Scotsmen, Welshmen, Irishmen, and the Cosmopolitans.

Another Bright Idea

ANOTHER bright idea of the B.B.C., I understand, is to stick a pin in the telephone directory, to ring up the number so stuck, and ask the person who answers what is their favourite book, play, or film, and to request them to come along to Broadcasting House and tell listeners all about it. This is really an absurd idea, for very few people have anything to say on anything which is worth listening to, and there are fewer people still who can make their views entertaining. In any case I do not want to listen to the views of some denizen of suburbia who probably hasn't the power of thought anyway. It would be rather unfortunate if the person concerned had a great interest in pornographic literature, or was interested in books on nudism!

Local Clubs

F. N. SHELLEY, of 54, Avon Road, Bitterne Park, Southampton, writes as follows: "With regard to your reader's suggestion



His favourite book.

that the PRACTICAL AND AMATEUR WIRELESS should form clubs in various districts, I think this a great idea if it could be made possible. I feel sure there are many amateurs in Southampton who, like myself, would welcome the formation of such a club (i.e. 'Short Wave Club' or 'Amateur Radio Club'). I am only a beginner myself as regards DX on short waves, and I am afraid my knowledge is rather limited at present as regards the technical side of radio, of which I should like to know more. I do not get a lot of spare time myself, but I am willing to do what I can to help, if you think that a club could be formed in Southampton. I should also like to take this opportunity of wishing you and PRACTICAL AND AMATEUR WIRELESS every success in the coming year."

Perhaps local readers will communicate with Mr. Shelley.

★ Incorporates the Best
in **DIAL**
DESIGN
for **MODERN**
Short Wave
TUNING!

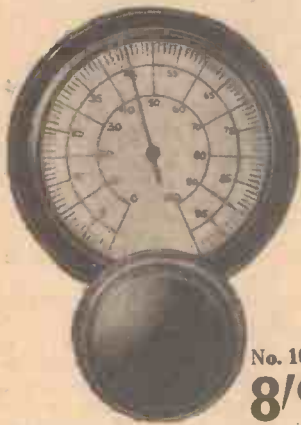

No. 1070

8/9

The movement can be mounted from panel or baseboard.

The dial is noiseless in operation even on the highest frequencies.

The open vision scale is clearly readable and divided in a new attractive manner into 100 divisions so that the indicating pointer has ample space for accurate settings.

The readings are arranged to increase as the frequency increases, which is in keeping with modern practice.

The movement is superbly smooth in action, without backlash on both the 20-1 and the 100-1 speeds.

The dial face fits on the front of the panel so that no large panel gap has to be cut unless it is desired to illuminate the scale from the back.

The dial can be used on panels up to 1" thick and takes the standard 1" spindle.

The escutcheon has a simple dignified appearance and is beautifully finished in oxidised silver relief.

EDDYSTONE FULL VISION
DUAL SPEED DIAL

Sole Manufacturers: STRATON & CO., LTD., Eddystone Works, Birmingham
London Service Depot: Webb's Radio, 14, Soho Street, Oxford Street, W.1

By Request!



Folder "N" gives details of Hivac special short-wave valves.

AT the request of leading short-wave experts and many enthusiastic amateurs three Hivac valves were specially designed for short-wave work. Each valve has the grid connection brought out at the top and the bases are made of frequentite.

Mr. F. J. Camm

is using two of these

SHORT-WAVE VALVES

and a Hivac Harries

FOR THE

"TELE-CENT"

described in this issue.

Two SG 220. SW. 12/6 ea.
One Y.220 9/6

From all dealers or direct.



BRITISH MADE

High Vacuum Valve Co., Ltd., 111-117, Farringdon Rd., London, E.C.1



"I can tell it's a
Wills' Gold Flake
... it's such a
CLEAN SMOKE"

CLEAN AND SMOOTH TO THE PALATE

A PAGE OF PRACTICAL HINTS

SUBMIT YOUR IDEA

READERS WRINKLES

THE HALF-GUINEA PAGE

An Accumulator Indicator

ALTHOUGH some modern accumulators are fitted with an automatic indicator to show the condition of the acid, it is possible to arrange a simple indicator on the panel which will give you an indication automatically of the condition of the battery. A small bell movement or similar relay with a low-resistance winding is wired as shown in the accompanying illustration, the make-and-break contacts being wired, via one part of a double-pole on/off switch, to a dial lamp and flash-lamp battery. The other contacts of the switch are connected to the accumulator and filament circuit of the valves through the relay winding. Thus when the set is switched on by means of this switch, the L.T. current flows through the relay winding and this attracts the armature, thus

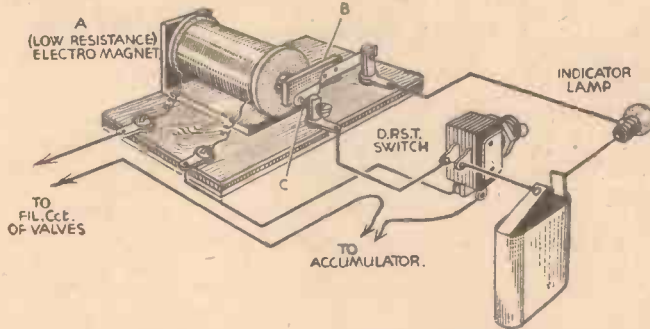

General arrangement of an automatic accumulator indicator.

breaking the circuit to the indication lamp, which is, of course, mounted in a convenient position on the control panel. As the accumulator runs down the current will fall, and a point will be reached where the resultant magnetism of the relay will fail to hold open the contacts. Consequently, at this stage, the indicating lamp circuit will be closed and the lamp will light. The contacts must, of course, be adjusted so that the lamp will light before the accumulator has run down too low. It will be noted that no current flows through the indicating lamp circuit until the accumulator has become more or less discharged.—W. E. JOHNSON (Sowerby Bridge)

A Double-acting Eliminator Switch

THIS switch enables the low-tension supply to be switched on first, and the high-tension off first, by simply moving the switch in and out, an operation which is essential for battery sets having an eliminator.

A piece of 3/16 in. wide stout sheet brass, A, is bent to the form shown, having a 1/16 in. hole at one end for the screw of the push-pull switch to go through, and three small holes at the other end, two to fasten the toggle switch on to the bracket, and one to fasten the bracket to the back of the panel.

B is a piece of sheet brass 1 in. by 3/16 in.

THAT DODGE OF YOURS!

Every Reader of "PRACTICAL AND AMATEUR WIRELESS" must have originated some little dodge which would interest other readers. Why not pass it on to us? We pay £1-10-0 for the best wrinkle submitted, and for every other item published on this page we will pay half-a-guinea. Turn that idea of yours to account by sending it in to us addressed to the Editor, "PRACTICAL AND AMATEUR WIRELESS," George Newnes, Ltd., Tower House, Southampton Street, Strand, W.C.2. Put your name and address on every item. Please note that every notion sent in must be original. Mark envelopes "Radio Wrinkles." Do NOT enclose Queries with your Wrinkle.

cut to the shape shown, bent U-shape in the centre at the large end (as shown partly in section in position), and riveted together with a 1-16 in. rivet which operates the toggle. This part B is fastened by two nuts on the lengthened spindle of the push-pull switch, which also has on it an extra piece of brass E. This enables the low tension to be connected while the high-tension switch is being operated, and the two grooves shown allow a momentary pause before the switch is finally pushed in or pulled out.

I have had a switch of this type in use for about two years and it has proved to be entirely satisfactory throughout the whole of this period.—A. J. WEBBER (Sidecup).

Novel Plug-in Coils

NOW that the short-wave band is being explored more, I think this quick-

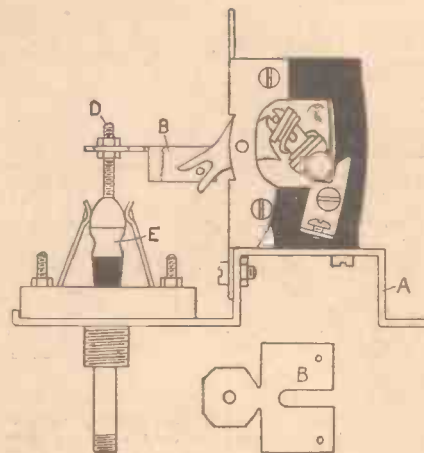

A dual-purpose switch for use with an eliminator.

change coil dodge will come in handy to many readers.

All that is needed is an old coil former, five strips of metal, and some cardboard for the formers. The cardboard type are made large enough to enable them to slide over the old former. I used an old Lucerne coil former, as indicated in the sketch, but any other is equally

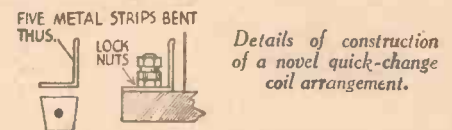
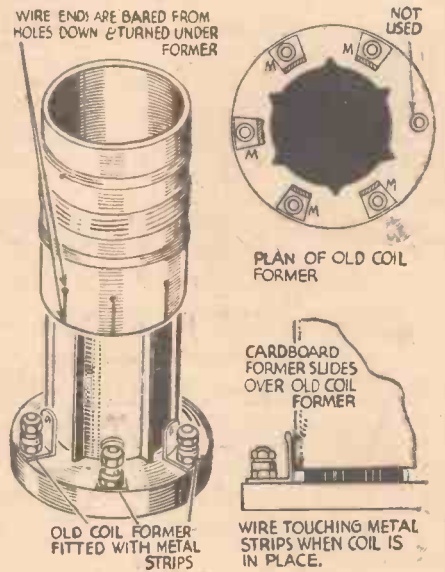

Details of construction of a novel quick-change coil arrangement.

suitable. The metal should not be too thick, and when finished, one strip should be fixed under each of the terminals.

The wire is bared at the ends so that it touches metal strips, and the former is then pushed into place.—R. D. PATE (Liverpool).

THE WIRELESS CONSTRUCTOR'S ENCYCLOPAEDIA

By F. J. GAMM 4th Edition 5/- net.

Wireless Construction, Terms, and Definitions explained and illustrated in concise, clear language.

From all Booksellers, or by post 5/6 from George Newnes, Ltd., Tower House, Southampton Street, Strand, London, W.C.2.

Practical Television

January 30th, 1937. Vol. 3. No. 35.

SOLVING THE MAINS PROBLEM

How to Obtain the Various Voltages Required in a Modern Television Receiver

By W. J. DELANEY

LAST week we discussed in broad detail the problem of the design of the modern television receiver, and we can now pass to the individual sections and find the best method of attacking the various problems and so designing an efficient receiver. It is logical to start with the mains supply voltages, as these apply to every section of the complete receiver and all of the valves must receive H.T. and L.T. voltages. In addition the cathode-ray tube has its own H.T. and L.T. to obtain, and thus we find to commence with

section, provided that interaction is avoided. This would enable the complete mains section to utilise only two rectifiers, and the saving in expense is not offset by any additional components or condensers of high-voltage test. There is a further advantage in this method of construction, in that it becomes easier to arrange that no H.T. shall be applied to the time base until the heater supplies have been switched on, and a single switch may be employed for on-off switching. If the separate transformer and rectifier arrangement is adopted, we shall require a transformer for the "wireless" (sound and vision) section giving 4 volts at about 18 or 20 amps. (according to the design of the combined sound and vision receivers), with a 500-volt H.T. output and an associated rectifier. In this respect the arrangement will be perfectly standard radio practice, and the usual H.T. chokes and filter condensers will be fitted. The combined receivers would be built on a single chassis with the mains section arranged at one end in the usual manner, but would have to be carefully screened to avoid the external field from the mains transformers affecting the C.R. tube, as it would be assumed that the receiver would be so placed that the controls were easily handled, and thus would be in close proximity to the C.R. tube which must also be in a similar position to enable the picture to be viewed comfortably.

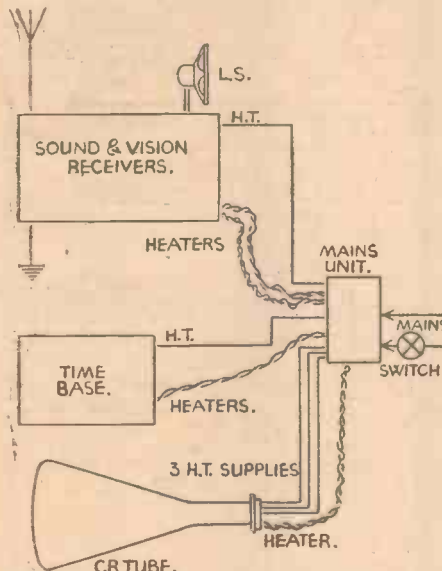

A diagrammatic representation of the arrangement for feeding the various sections of the television equipment.

that we must obtain about 24 or 25 amps at 4 volts for the various valve heaters, plus 4,000 or more volts at a few milliamps for the cathode-ray tube H.T., plus the heater supply for the latter. To these outputs must be added the supplies for the valve rectifiers. It is obviously impossible to arrange for all of these windings on one transformer, not only on account of the physical consideration, but in order to maintain the necessary high degree of insulation between certain windings and in order to prevent interaction. The vision and sound receivers each require H.T., as also does the time base, and thus we can use three separate transformers and rectifiers, obtaining each supply individually. Small mains transformers would suffice in this case, and standard types of rectifiers could be employed. To maintain a high degree of efficiency in the time base, however, we require a high voltage source so that there is some margin with which to play.

Separate Rectifiers

We may, therefore, tap off part of the H.T. supply for the C.R. tube to supply the time base, and in addition make use of some of the surplus from the wireless

and to avoid interaction, a good scheme is to have the transformer for this part of the outfit made as a completely separate unit. We may then use one mains transformer for the supply of all the voltages to the vision and sound sections, and another transformer for the time-base supply, thus reducing the mains equipment to a fairly economical value, and greatly simplifying the construction. As mentioned last week, to avoid the running of mains supply leads all round the back of the cabinet, the mains section is preferably built as a single unit, in which case there will be simply the three transformers and associated rectifiers, with the various smoothing chokes. The speaker field may be included in the smoothing supply as an additional point of economy, and these sections may be separated on the chassis, to facilitate testing and to avoid interaction. The radio section should occupy one side of the chassis, and the time base and C.R. tube sections may be grouped on the other side. Multi-contact plugs and sockets will enable the supplies to be conveyed to the radio and time-base chassis, but to carry the very high heater current double leads will have to be fitted, and even so these will have to be of the heaviest flex. The type known as 76-30 should be employed, and in the radio chassis, the double leads should be separated to feed individual valves to avoid heating of the flex, and the avoidance of voltage loss through it. The primaries of the mains transformers may then all be joined to a common switch, with due provision for insulation and the avoidance of heat.

(Continued overleaf)

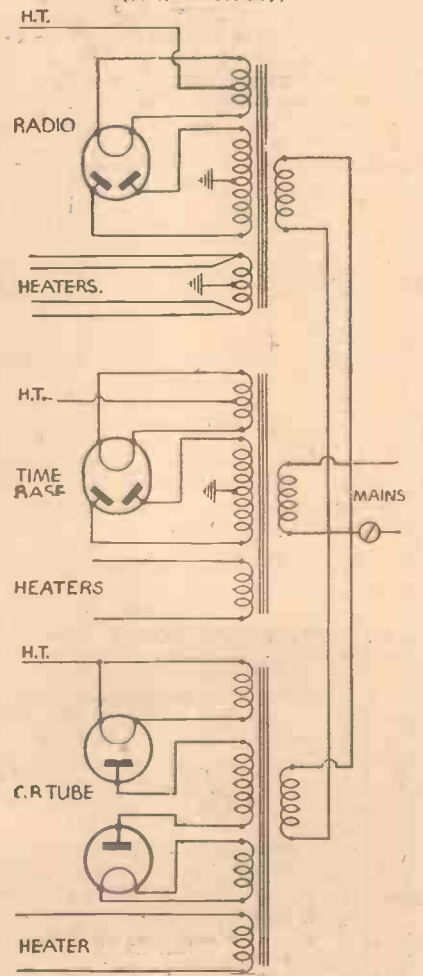

How each mains transformer is wired up to carry out the arrangement mentioned in this article.

PRACTICAL TELEVISION
(Continued from previous page)

Separate Sound Section

One scheme which may appeal to some listeners is the building of the sound section as a completely individual unit, so

that it may be used when no television programmes are being transmitted. In such a case, of course, the standard radio scheme may be incorporated, and a separate mains on-off switch fitted to this section. This will add one more control to the complete outfit, and may result in some diffi-

culty when no sound is heard accompanying a picture, and with the multiplicity of controls there is a possibility of it being overlooked that the appropriate switch has not been operated, and some delay would accordingly be experienced whilst a non-existent fault is being looked for.

Widening the Broadcast Range

SO far all the open-air television broadcasts have been confined to a radius of 1,000 ft. from Alexandra Palace, this being the length of co-axial feeder cable in the hands of the B.B.C. It is now suggested, however, that the Post Office may be prepared to lay a special television cable round London so that when the television van becomes available it can "tap" into this at selected points and so feed the signals to the Alexandra Palace for broadcast purposes. The first big experiment will coincide with the Coronation, but subsequent to this it seems certain that big sporting events so dear to the hearts of the British public will be featured. This will undoubtedly add very considerably to the programme value of the B.B.C. service and, coupled with other promised improvements, will help to meet the criticisms which have been so far levelled at the programme quality. The B.B.C. are to be congratulated on the step they have taken to ask all those who look in to give a candid expression of their opinions on programme matters. The collation of data of this nature will be invaluable to the producers, and it seems quite logical to go a step farther and secure as much technical information on reception conditions. This could be analysed and then circulated to manufacturers and technical journals, and so assist in the design and installation of receivers. Everything will depend on the nature of the public response to such a request. A previous attempt of a similar character in the days of the low-definition service failed lamentably owing to the paucity of the replies. It would be a good scheme if all the big stores and dealers who give daily television demonstrations were to secure supplies of the questionnaire form, so that anyone who sees a transmission, whether an actual or prospective purchaser, could voice an opinion, especially if it was of a constructive nature. One national press writer sees in this B.B.C. effort a heralding of far-reaching developments for the New Year, especially with a view to increasing the length of programme times. This is questionable, however, until there is more space available for additional studios and extra rehearsal facilities.

An Interesting Experiment

IN an effort to acquire the appropriate "atmosphere" an interesting experiment was undertaken recently. The occasion was the television broadcast of excerpts from the play "Murder in the Cathedral," by T. S. Eliot. Television receivers were installed against the footlights and stall seats of the Duchess Theatre, and an assembled audience of about two hundred people watched parts of a stage play in a full-sized theatre but on miniature screens. Each picture was 10ins. by 8 ins., a size which hardly did justice to a play of this nature. It was, however, most impressive to watch how ghost effects were superimposed on actual scenes, a technique which can be exploited to marked effect with the electron cameras now in use at Alexandra Palace. Apart from one or two minor defects the reception was quite

Television Notes

satisfactory, and in some quarters is looked upon as a portent of things to come when the public are entertained with a mixed fare instead of being limited to films or a stage play alone.

Unification ?

IT is being mentioned quite freely that the Television Advisory Committee are engaged on the question of decisions regarding the use of a single standard for the television broadcasting from Alexandra Palace. The systems will in no way be affected; that is to say, both companies will still operate, but one standard of definition, pictures per second, picture proportions and synchronising to video signal ratio

will be arrived at. This would do much towards simplifying the controls and reducing the cost of receivers, as well as removing the tendency to invite comparisons between the respective systems, when the aim of dealer and manufacturer alike should be towards popularising television as a service. One rather sweeping suggestion was to the effect that there is a probability of one system being in operation for a long period, while the other is devoted to carrying out intensive experiments for research and *vice versa*. In any case, vital decisions will have to be made soon for the provinces are jealous of London's position in regard to television, and are anxious to have their own stations working. This will at once establish a first-class industry, one which has had a long struggle and spent thousands of pounds to establish itself in the face of continued opposition from nearly every quarter.

CATHODE-RAY TUBES

Maker.	Type.	Heater volts.	Heater-amps.	Max. anode volts.	Screen dia. mm.	System of Deflection.	
Cossor	3232	0.6	1.25	3,000	133	Double electrostatic	
	3233	0.6	1.25	3,000	133	Do.	
	3236	0.6	1.25	3,000	133	Do. Split deflector plates.	
	3234	0.6	1.25	1,500	100	Single electrostatic with one split deflector plate.	
	3237	0.6	1.25	1,500	100	Double electrostatic with one X and one Y plate split.	
	3271	0.6	1.25	3,000	150	Double electrostatic.	
	3276	0.6	1.25	3,000	150	Do.	
	3274	0.6	1.25	4,000	240	Do.	
	3272	0.6	1.25	4,500	325	Do.	
	3273	0.6	1.25	6,000	133	Single electrostatic.	
	Mazda	5H	2.0	1.0	1,000	140	Double electrostatic.
		7H	2.0	1.0	3,500	170	Do.
10H		2.0	1.3	3,500	250	Do.	
12H		2.0	1.5	4,000	300	Do.	
Mullard	6001	4.0	1.0	6,000	220	Double electrostatic.	
	4002	4.0	1.0	1,000	95	Do.	
	4002A	4.0	1.0	1,000	95	Do.	
	4001	4.0	1.0	2,000	160	Do.	
	4001A	4.0	1.0	2,000	160	Do.	
	E42/G6	4.0	1.0	2,000	160	Do.	
	E42/B6	4.0	1.0	2,000	160	Do.	
	E46/12	4.0	1.0	6,000	300	Do.	
E40/G3	4.0	1.0	800	70	Do.		
Philips	3957	4.0	1.0	1,000	95	Double electrostatic.	
	3958	4.0	1.0	1,000	95	Do.	
	3951	4.0	1.0	2,000	160	Do.	
	3952	4.0	1.0	2,000	160	Do.	
	3953	2.5	2.1	1,000	80	Do.	
	3954	2.5	2.1	1,000	80	Do.	
	3962	4.0	1.0	6,000	220	Do.	
	3955	2.5	2.1	4,600	130	Single electrostatic.	
	3966	2.5	2.1	7,000	230	Double magnetic.	
	Standard	4050AG	0.75	.85-1.1	1,000	100	Double electrostatic
4050AB		0.75	.85-1.1	1,000	100	Do.	
4050AD		0.75	.85-1.1	1,000	100	Do.	
4050BG		0.75	.85-1.1	1,000	175	Do.	
4050BB		0.75	.85-1.1	1,000	175	Do.	
4050BD		0.75	.85-1.1	1,000	175	Do.	

GAS-FILLED RELAYS

Maker.	Type.	Heater volts.	Heater amps.	Anode volts.	Anode current.
Cossor	GDT4	4.0	1.5	500	20 mA
Marconi	GT1	4.0	1.3	1,000	.3 amp.
	GT1A	4.0	1.3	300	.2 amp.
Mazda	T11	4.0	1.2	700	.3 amp.
	T21	4.0	1.2	200	.3 amp.
	T31	4.0	1.5	400	.3 amp.
Osram	GT1	4.0	1.3	1,000	.3 amp.
	GT1A	4.0	1.3	300	.2 amp.
	GT1B	4.0	1.35	120	2 mA
Standard	4039A	4.0	1.0	500	.1 amp.

MORE NEW YEAR BARGAINS

NEW TIMES SALES
Postal Orders must be crossed and made payable to New Times Sales Co. Currency must be registered.

N.T.S. BARGAIN S.G.3 KIT

LIST £3 : 0 : 0 BARGAIN 32/6

Newly-developed circuit, modern to the minute and using tested and matched components. Kit includes 2-gang air-spaced condenser, slow Motion Dial, wave-wound coils, super L.F. Transformer, solid dielectric reaction condenser, complete with ready-drilled chassis and all necessary valveholders, condensers

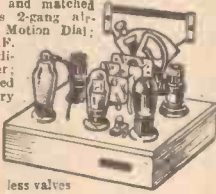

2/6 DOWN

How to Build the Marconi S.G.3 supplied FREE with each Kit. Cash or C.O.D. Carriage Paid £1/12/6, or 2/6 down and 8 monthly payments of 4/3.

BATTERY CLASS B4

INCLUDES 4 BRITISH VALVES

Amazing purity of tone and volume rivaling that of powerful all-mains models. Wide choice of foreign stations. The perfect main quality battery receiver. Four matched British valves of guaranteed life. Moving-Coil Speaker. Single knob slow-motion tuning, browned escutcheon, illuminated circular aeroplane dial. New type switch. Combined volume control and on-off switch. Sensitivity and graded volume control. Wave-lengths 200-550 and 900-2,100 metres. Oilham Long-Life 120 volt H.T. and 2-volt L.T. Accumulator and O.B. Batteries. Output 11 watts at 130 volts. Exquisite Walnut Veneered Cabinet, illustrated above. Absolutely complete with aerial equipment ready to play.



5/- DOWN

List Price £8 : 8 : 0 and 12 monthly payments of 8/9. Cash or C.O.D. Carriage Paid. BARGAIN £4:19:6

BARGAIN 1-valve S.W. KIT

LIST PRICE 35/- BARGAIN 19/6

12-94 METRES



2/6 DOWN

Complete Kit of parts comprises Metal-plex baseboard, variable and fixed condensers, switch, valve- and coil-holders, H.F. choke, terminals, slow-motion drive, 3 short-wave coils; connecting wire, and FULL WIRING DIAGRAM. Less valve. Cash or C.O.D. Carriage Paid 19/6, or 2/6 down and 8 monthly payments of 2/6. N.T.S. Lightweight headphones 7/6 pr. extra.

W.B. 1937 SPEAKERS



MODEL 373. Amazing reproduction provided by new magnet and exponential moulded cone. Microtone matching device. Cash or C.O.D. Carr. Paid, £2/2/0. Or 2/6 down and 11 monthly payments of 4/-.
MODEL 371. Perfectly matches any receiver as principal or extra speaker. Cash or C.O.D. Carriage Paid, £1/12/6. Or 2/6 down and 11 monthly payments of 3/-.
2/6 DOWN

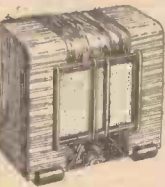

MODEL 375C A Cabinet instrument giving superb reproduction, with power handling capacity of up to 5 watts undistorted. The turn of a switch adjusts it to match any set made. With volume control. Cash or C.O.D. Carriage Paid, £3/3/0, or 5/- down and 11 monthly payments of 5/6. Complete with W.B. "Long Arm" Remoja Control. Cash or C.O.D. Carriage Paid, £3/15/6, or 12 monthly payments of 7/3.

AMAZING BARGAIN

2 GUINEA S.G.3 CHASSIS

including 3 British Valves

Each chassis brand new and tested on British and foreign stations before dispatch. Circuit Comprises: Screened Grid H.P. Detector and Pentode Output Valves, Screened wave-wound coils, 2-gang Air Dielectric Condenser, Metal Chassis. Only 9 m.a. H.T. consumption. Illuminated and Wavelength Calibrated Dial. Wave range 200-2,100 metres.

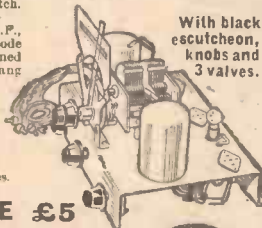

With black escutcheon, knobs and 3 valves.

LIST PRICE £5 BARGAIN 42/- LIMITED SUPPLY ONLY FEW LEFT

2/6 DOWN

Cash or C.O.D. Carriage Paid. Or 2/6 down and 12 monthly payments of 4/- Recommended P.M. Moving-Coil Speaker, 15/- Walnut finished Console Cabinet, 10/-.

COMPLETE RECEIVER, comprising above Chassis, in walnut finished Console Cabinet, with Valves and P.M. Speaker, less batteries. Cash or C.O.D. Carriage Paid £27/6, or 5/- down and 12 monthly payments of 5/9

BELMONT AC/DC 4

LIST PRICE £7/10/0 Bargain Price £4/19/6

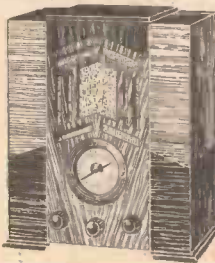

5/- DOWN and 12 monthly payments of 8/9.

- For A.C. or D.C. Mains, 200-260 v.
- Wavelengths 195-580 and 800-2,100 metres.
- Illuminated airplane dial.
- Moving Coil Speaker.
- NO EARTH REQUIRED.

A Wonderful bargain! A remarkably efficient 4-Valve receiver, having an extremely attractive appearance, enormously reduced in price. Housed in a modernistic walnut cabinet of pleasing design. Simple to control, quiet in operation, and possessing a most mellow and powerful tone. Perfect reception of a number of British and foreign programmes. Cash or C.O.D. 4/19/6, or 5/- down and 12 monthly payments of 8/9.

N.T.S. SHORT WAVE 2

12-94 Metres



With a remarkable range that will give you hours of fascinating short-wave entertainment. Kit comprises all components including metal-sprayed baseboard, 3 variable condensers, .0001, .0002 and .00016 MFD., on/off switch, L.F. Transformer, 3 baseboard mounting four-pin holders, short-wave H.F. choke, 2 terminal mounts, 4 terminals, 3 fixed condensers, slow-motion drive, grid leak, connecting wire, 3 4-pin short-wave coils, 12/25, 22/47, and 41/94 metres, 2 component brackets and wiring diagram. Cash or C.O.D. Carriage Paid 27/6, or 2/6 down and 11 monthly payments of 2/6.

2/6 DOWN

N.T.S. Moving Coil SPEAKERS

LIST PRICE 27/6 BARGAIN 10/- OR High fidelity permanent magnet Moving Coil speakers, slightly shop soiled only. Power, Super Power or Pentode. (State which when ordering). Cash or C.O.D. Carriage Paid 10/-, or 2/6 down and 4 monthly payments of 2/6.

2/6 DOWN

STRAIGHT 3v. BATTERY RECEIVER

INCLUDES 3 BRITISH VALVES



A wonderful opportunity. New type highly selective circuit. Slow-motion illuminated dial. Pick-up sockets. Metal chassis. Low H.T. consumption. Complete in cabinet as illustrated, with valves and speaker, less batteries.

LIST PRICE £4 : 19 : 6 BARGAIN 35/-

2/6 DOWN

Cash or C.O.D. Carriage Paid. Or 2/6 down and 9 monthly payments of 4/-.

N.T.S. SCREENED - GRID 3



List price £6 : 6 : 0

BARGAIN PRICE £3:19:6

OR 5/- DOWN

and 11 monthly payments of 7/6.

Incorporates: British long-life Screened Grid Valve for range, detector and high-efficiency Pentode for power and low H.T. consumption. Metal Chassis. N.T.S. Matched Pentode Moving Coil Speaker, Wave-wound Screened Coils. Full vision illuminated Wavelength Scale. Only 9 m/a H.T. consumption. Wave-range 200-550 and 900-2,100 metres. Complete with valves, and exquisite Walnut veneered Cabinet (illustrated). With full aerial equipment. Overall dimensions: 19 1/2 ins. high, 14 ins. wide, 10 ins. deep.

N.T.S. S.W. ADAPTOR

12-94 Metres



America and all the World DIRECT on your present set, for only 17/6. Build this reliable short-wave adaptor for use with any BATTERY receiver. Kit comprises all parts, including metal-sprayed baseboard, 2 variable condensers, .00016, .00016 MFD., 2 baseboard mounting 4-pin holders, short wave H.F. choke, grid leak, fixed condenser, adaptor plug terminal mount, 2 terminals, 3 4-pin plug-in coils, 12/25, 22/47, and 41/94 metres, 1 component bracket, slow-motion drive, trimming condenser, connecting wire and wiring diagram. Built in one evening. Cash or C.O.D. Carriage Paid 17/6, or 2/6 down and 7 monthly payments of 2/6.

2/6 DOWN

BARGAIN SHORT WAVE ADAPTOR

13-52 METRES



Ready built and tested LIST PRICE

£3 : 0 : 0

BARGAIN only a few 37/6 available

Cash or C.O.D. Carr. Pd.

Make your set an all-wave set, with this wonderfully efficient, inexpensive unit, the latest up-to-the-minute design of the foremost short-wave experts. Simply plugs into your A.C. or battery receiver. Incorporates 100:1 ratio aerial tuning and slow-motion reaction. Ready assembled on aluminium chassis complete with aluminium panel (as illustrated) and 2 coils, covering 13-26 and 24-92 metres. Or 2/6 down and 11 monthly payments of 3/6.

2/6 DOWN

NEW TIMES SALES CO., 56 (Pr.W.5), Ludgate Hill, London, E.C.4.

The Beginners' Tele-Cent Three

By F. J. CAMM

An Ideal Receiver for all Programmes from 4.8 Metres to 91 Metres—No Coil Changing—Only One Tuning Circuit—Specially Designed for Beginners

EVER since the introduction of the television programmes there has been a consistent demand for a practical and simple receiver by means of which listeners could tap not only the sound portion of the television programmes but also that land of strange delights, comprised of the transmissions radiated on various wavelengths between 5 and 91 metres.

It is a comparatively simple matter to make an ultra-short-wave receiver which will pick up the television programmes, and it is also a simple matter to design a receiver which will cover the normal short-wave bands. To encompass the whole of the range without coil changing, however, is a problem which few designers have hitherto tackled.

An additional problem has been, even with coil changing, the multiplicity of controls and the complicated switching arrangements, which have made the set anything but easy to build and to operate.

The Tele-Cent, as its name implies, embraces the television transmissions, and those up to approximately 100 metres. The latter part of its title might also truthfully describe the number of stations it will receive.

Some excellent material is being radiated on the television wavelength, and although you will not be able to enjoy the vision part of the programme, they are, none the less, even more interesting than the normal broadcast programmes. The Tele-Cent thus not only enlarges the ambit of your listening domain but it also provides a valuable means of getting you acquainted with the particular requirements of ultra-short-wave

receiver operation, and, moreover, it does this without adding to the number of controls, without a considerable outlay for components, and without adding complications. The Tele-Cent, as the illustrations adequately indicate, is even simpler to build than an ordinary broadcast receiver, and it is with every confidence, the confidence which

WIRING DIAGRAM

Page 598

LIST OF COMPONENTS

Page 596

THEORETICAL CIRCUIT OF THE BEGINNERS' TELE-CENT 3

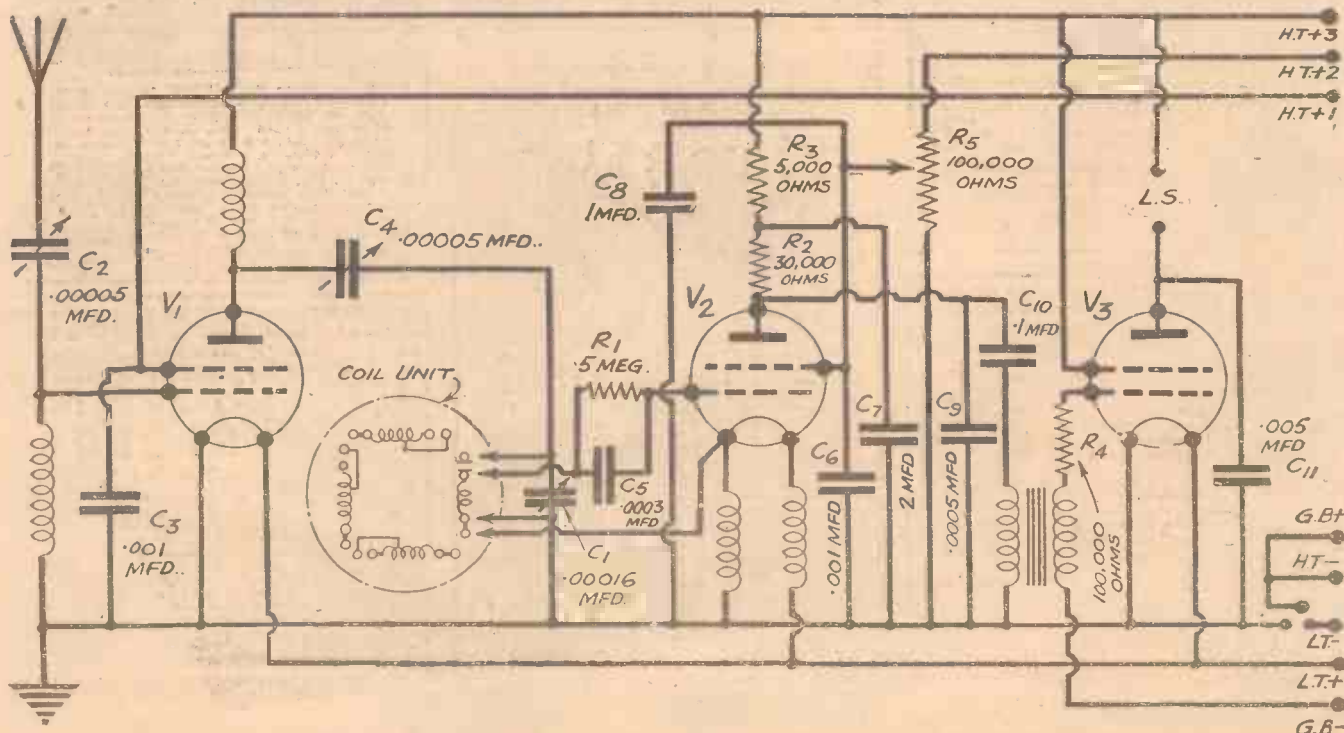

4.8 to 91 Metres Without Coil Changing!

comes from satisfactory achievement, that I place the design before my readers. There is no need to remind them that my usual guarantee applies.

Simplicity of Control

The first thing that you will notice is that there is only one tuning circuit, but, notwithstanding this, the selectivity is adequate. The special tuning unit, as I have said before, covers a band from 4.8 to 91 metres, without coil changing, and almost equally important, without noises due to poor switch contacts, a trouble which we must admit has been only too prevalent in many previous assemblies of this sort.

Thus, we have one-knob tuning, rendered even simpler by means of the very latest pattern slow-motion dial with which the tuning control is operated. This dial is ingeniously designed and has a glass front and a cork gasket which enables it to be mounted on the panel so that all dust is excluded. Dust cannot, therefore, enter and give rise to noises.

Another important point is that regeneration is resistance controlled, an arrangement which provides for smoother reaction effects than with a condenser. The special chokes used in the detector stage, in conjunction with the new design of coils incorporated, provide vastly superior results to those obtained from the orthodox reacting detector stage.

What You Will Hear

In order that you may

extract the last ounce from the receiver, pre-set aerial and H.F. coupling condensers are incorporated, together with separate H.T. leads, so that niceties of adjustment can be carried out at every point, and these are dealt with more fully later. I have no need to dwell upon the large range of broadcasts which are available on the bands covered, for I have dealt in previous articles with the fascination of the short- and ultra-short-wave bands. It is sufficient to say that these include the

intriguing amateur transmissions, police radio, both in America and this country, special weather reports, news bulletins, and, of course, the television programmes. The Tele-Cent,

even if you are out of range of the television programmes, provides you with an instrument for interesting experiment with directional aerials, bearing in mind that the television programmes have been picked up in South Africa, and that the American television signals on a wavelength identical with those radiated from the Alexandra Palace have been heard in this country.

High quality of reproduction is assured by the use of resistance-fed transformer coupling, and a refinement

SIMPLE TO BUILD—EASY TO OPERATE
AND TROUBLE-FREE IN OPERATION

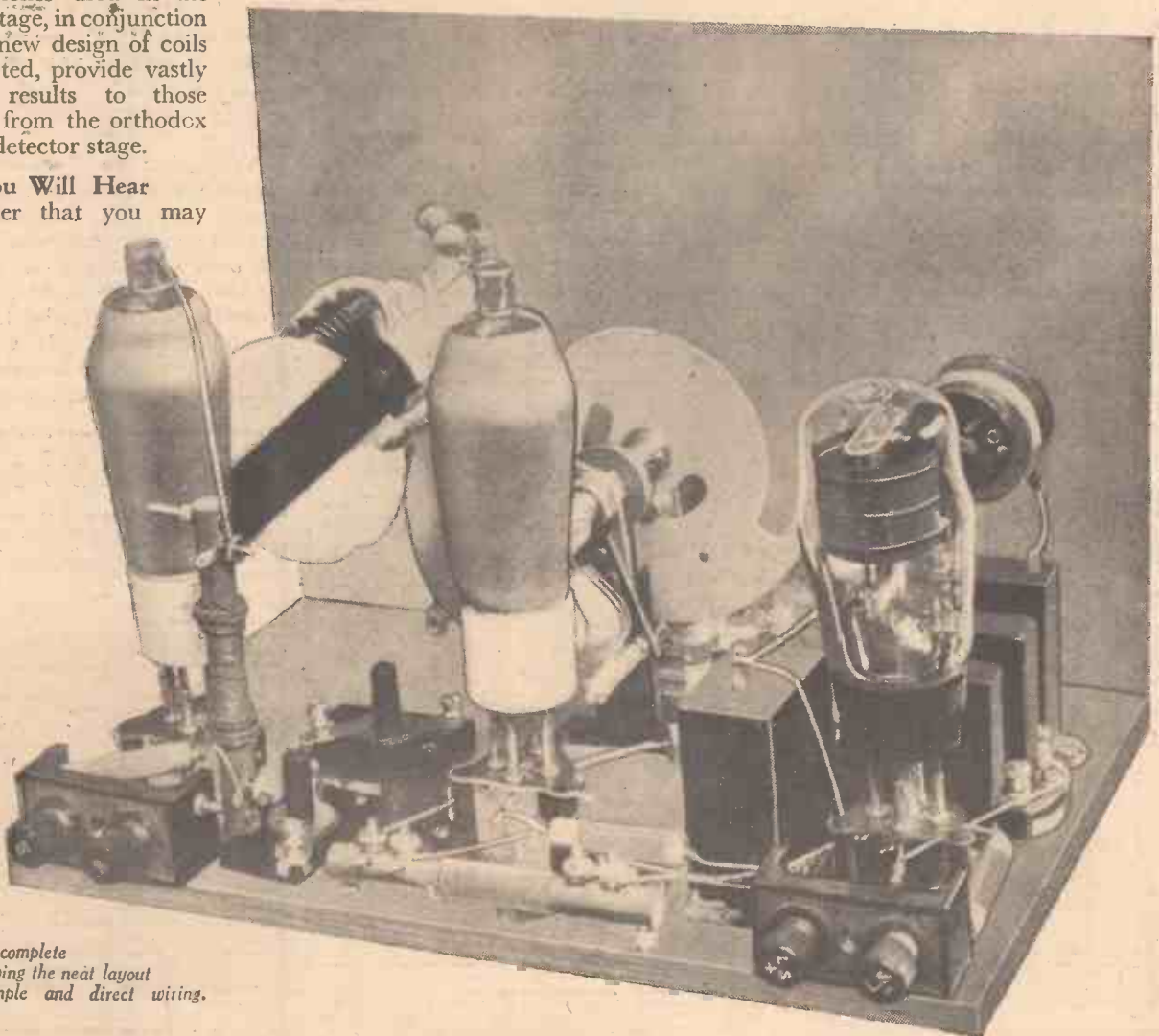

Here is the complete receiver, showing the neat layout and the simple and direct wiring.

The Tele-Cent for the Television and all Short Wave

is the fitting of the special Clix panel which enables the loudspeaker or the 'phones to be used without having to fiddle about with the leads. This strip is accommodated at the back of the cabinet, and will be explained in greater detail later on. Let us now go through the circuit in more detail.

The Circuit

An examination of the circuit of the receiver, which is printed on page 594, will show that the minimum of

THE IDEAL RECEIVER FOR THE BEGINNER, AND AN INVALUABLE ADDITION TO THE BROADCAST LISTENER'S EQUIPMENT

three valves has been arranged in the most efficient and practical manner. A detector and 2 L.F. stages will, of course, give splendid results on the short waves, but there often arise some difficulties due mainly to the effects of the aerial and earth system. These are chiefly experienced as "dead spots"—places on the tuning dial where no station can be tuned—or erratic reaction effects. By using a choke-coupled H.F. stage, however, the effects of the aerial and earth may be counterbalanced, and the improvement of this arrangement may be even more enhanced if certain additional schemes are incorporated. Thus, it will be noted that the aerial is fed to the grid circuit of the H.F. pentode through a pre-set condenser, and this enables the actual loading effect of the aerial to be altered to suit various conditions. In addition, the condenser used to feed the detector grid circuit from the H.F. anode is also made in the form

of a pre-set, again enabling the user to adjust the capacity for the best operating conditions.

L.F. Efficiency

Bearing in mind that this receiver is designed for the beginner, as well as the advanced experimenter, other parts of the circuit are also made variable, and thus the voltage for the screening grid of the H.F. valve is brought out to a separate battery tapping. It should not be thought that the additional connections which are required will lead to complications, but it will definitely be found that no difficulty will arise in obtaining some sort of result when the set is first put into use, whilst when the adjustment of the tuning condenser and reaction potentiometer have been mastered, the improvements effected by the use of the additional adjustments will be found of great value.

Coupling between the detector and L.F. stage is by means of a resistance-fed L.F. transformer, giving good quality and thereby making the best use of the present television sound signals.

The Layout

The illustrations show that an "all-metal" layout had been adopted although in the case of the baseboard this consists of a metal layer upon ordinary plywood, giving increased strength and easier working, as ordinary wood-screws may be used for holding down the various components. The panel is of metal, and is connected to earth, thus removing hand-capacity tuning difficulties. It will be noted that there are only three controls fitted to the panel, the centre being a two-

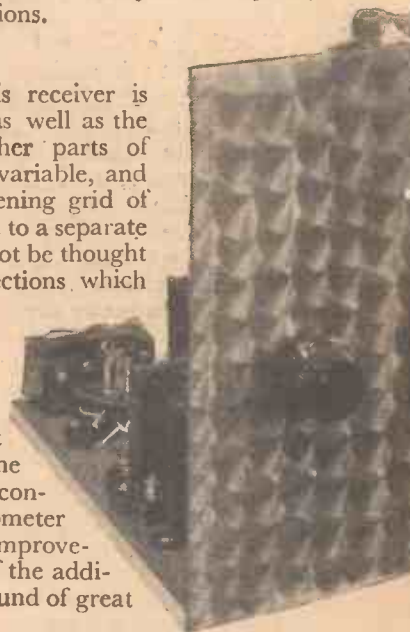

Panel Drilling Diagram

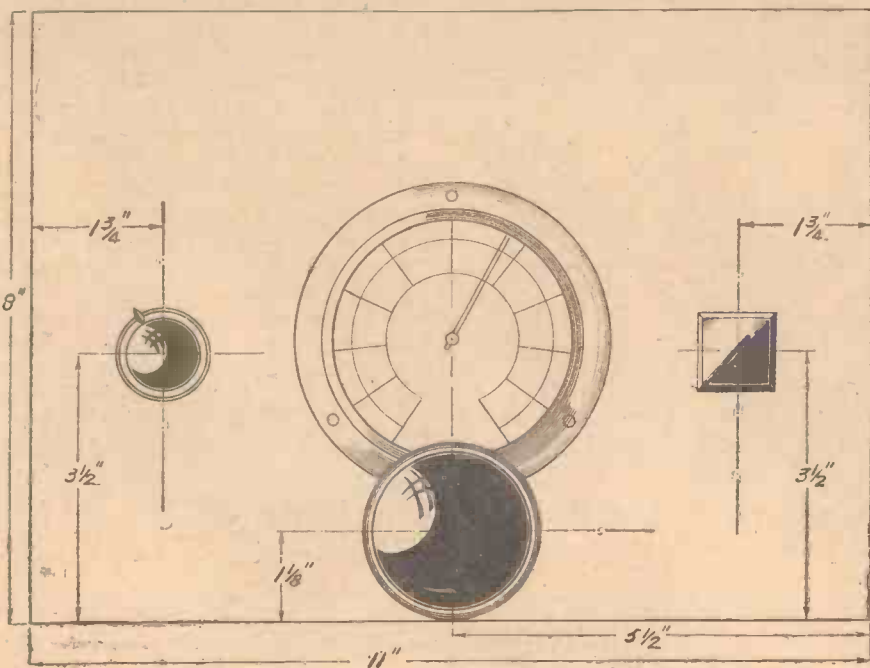

PRICE LIST OF COMPONENTS

- One rotary coil unit (type Hi-Q 5649)
- One tuning condenser, 160 mmfd. (C1) (type 922)
- One slow-motion drive, No. 1070
- One mounting bracket (type 1007)
- Three H.F. chokes—one Hi-Q 5645 (2s. 6d.), two Hi-Q 5656 (2s. 6d.)
- One L.F. transformer, ratio 3 : 1
- One potentiometer with 3-pt. switch, 100,000 ohms (R5) (type VM)
- Eight fixed condensers: 2 mfd. (C7), 1 mfd. (C8) (type 65), 1 mfd. (C11), two .001 mfd. (C3, C6), .0005 mfd. (C9), .0003 mfd. (C5)
- Two pre-set condensers, .00005 mfd. (C2, C4) (type No. 1087)
- Three valveholders, two 4-pin and one 5-pin (baseboard S.W. type)
- Four fixed resistors: 5,000 ohms (R3) and 30,000 ohms (R2) (type R1) and 100,000 ohms (R4) (type F1)
- Two terminal mounting blocks
- Four type R terminals, L.S., L.S., A. and E.
- Six plugs, H.T.—, H.T.1, H.T.2, H.T.3, G.B.—, G.B.—
- Two spades, L.T.—, L.T.+
- One Plymax baseboard, 11in. by 7in.
- One 16 S.W.G. aluminium panel, drilled, polished, 11in. by 8in.
- Two panel brackets
- Quantity of 18-gauge tinned copper connecting wire, two lengths

ACCESSORIES

- Three valves: two SG220SW, one Y220
- One pair headphones
- One 120-volt H.T. battery
- One 9-volt G.B. battery
- One 2-volt L.T. accumulator
- One Stentorian Junior loudspeaker
- One L.S. control panel
- One All-wave Aerial Kit

Short-wave Programmes up to 91 Metres



Here is another view of the complete receiver.

ratio tuning control of the latest pattern, and the right-hand one the range-selector switch fitted to the coil unit. The left-hand control is the screening-grid potential selector on the detector valve and controls the reaction effects. This is combined with the on-off switch and thus has to be turned to its maximum position in an anti-clockwise direction each time in order to switch the receiver off. This does, however, avoid the necessity of mounting another component on the panel, and it is a simple matter to mark the panel if necessary to

be experienced if care is taken. Before commencing to fix the drive holes for the coil-unit and volume-control spindles should be drilled, and also the small holes for the bracket-fixing screws. The hole for the coil-unit spindle should be $\frac{3}{16}$ in. in diameter, but a larger hole will be necessary for the volume control, as it is essential to insulate the spindle of this component from the panel. The insulated bushes supplied with the control require a $\frac{1}{2}$ in. fixing hole. After the volume control and coil unit have been securely mounted, the supporting feet of the tuning drive may be screwed to the baseboard in the position indicated on the diagram, and the panel pushed into

A FULL-SIZE BLUEPRINT MAY BE OBTAINED FOR THIS RECEIVER
PRICE - - 1/-

find a pre-arranged setting. The wiring diagram, in conjunction with the various photographic illustrations, makes all the remaining constructional and layout details quite clear, and we may therefore proceed to the actual work of building the receiver.

position and secured. Panel brackets are not essential provided that three wood-screws are used to fasten the panel to the edge of the baseboard; but to ensure rigidity their use is advised. It will be noted that the tuning drive has two sets of supporting legs. One set should be screwed to the metal surface of the baseboard at a distance of $\frac{3}{16}$ in. from the front edge of the latter. The other set of legs should then be fastened to the panel by means of the two bolts provided with the drive.

Construction

It is advisable to mount the components on the panel and baseboard separately. The panel will probably be received ready drilled, but if this is not the case the template enclosed with the tuning drive should be used when drilling the necessary holes for fixing this component. Mounting the drive is the most difficult job in the constructional work, but no trouble should

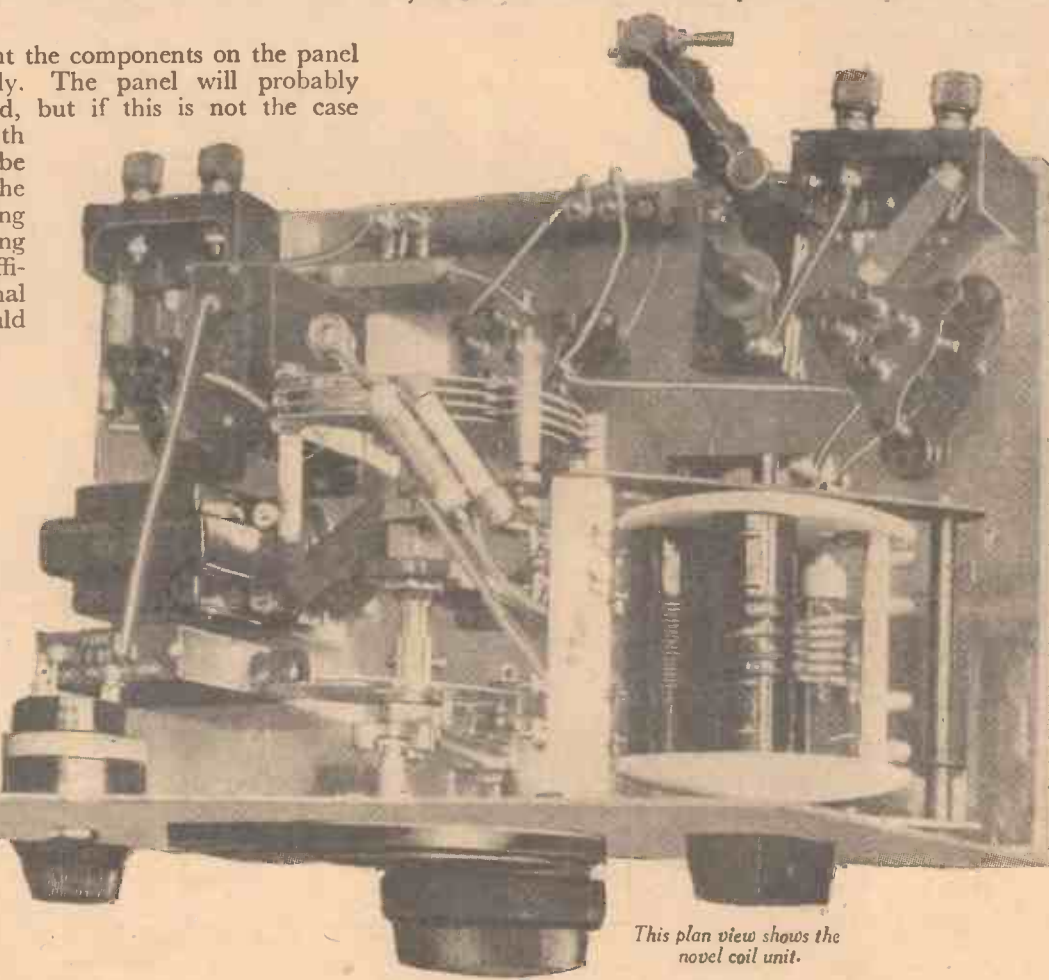

This plan view shows the novel coil unit.

COMPONENTS

..	Lissen	..	15	6
..	Eddystone	..	8	6
..	Eddystone	..	8	9
..	Eddystone	..	1	6
(ach)	Lissen	..	6	6
..	B.T.S.	..	4	6
(.61)	Bulgin	..	5	6
(C10), .005 mfd.	T.C.C.	..	11	0
all tubular	J.B.	..	2	0
(.8)	Clix	..	5	6
(1) and .5 meg.	Dubilier	..	3	0
..	Belling and Lee	..	1	0
..	Belling and Lee	..	1	0
..	Belling and Lee	..	1	0
..	Belling and Lee	..	6	6
..	Peto-Scott	..	4	9
..	Peto-Scott	..	5	0
..	Peto-Scott	..	1	0
of insulated-sleeving, and screws				
..	Hivac			
..	B.T.S.			
..	Drydex			
..	Drydex			
..	Exide			
..	W.B.			
..	Clix			
..	B.T.S.			

The Tele-Cent is Guaranteed!

These will ensure good contact between panel and baseboard and will also make the panel more rigid.

Mounting Baseboard Components

After the panel components have been carefully mounted and the panel has been securely fastened to the baseboard the remaining components may be fixed. Perhaps it will be best to commence by attaching the tuning condenser to the drive. The condenser supporting bracket should be screwed to the baseboard at a distance of 2 3/8 ins. from the baseboard edge. A word of warning should prove helpful here. In order to avoid breaking the wood-screws it is advisable to drill through the aluminium by means of a 1/8 in. drill before attempting to tighten the screws. Although steel screws are harder than the aluminium covering, it will be found that they are liable to break, or the head stripped, if they are screwed through the aluminium. The tuning condenser can now be locked to the supporting bracket after ascertaining that the fixed vane terminal of the condenser is as near as possible to terminal 2 of the coil unit. As the terminal end of the fixed vane supporting bolt will then be approximately 1 1/2 ins. from terminal 2, it will be advisable to shorten the distance between the coil terminal and the condenser vanes by attaching a tag to the other end of the fixed vane bolt, and then using this for the connecting lead.

Attaching H.F. Chokes

The H.F. chokes have 1 in. supporting bolts, and it will be found that these can conveniently be used for securing the chokes to the baseboard. The filament choke and the S.G. anode choke are fastened in this manner, care being taken to keep the windings clear of the metal surface. The aerial circuit choke is mounted in an upright position with one of its supporting bolts secured to the side of the Aerial and Earth terminal block. This method of mounting eliminates interaction between the two chokes incorporated in the H.F. stage, and also brings the grid end of the aerial circuit choke near the grid of the H.F. valve. The mounting of the other baseboard components should present no difficulty, but they must, of course, be fixed in the positions indicated on the wiring diagram.

Wiring

It will be advisable to use fairly thick tinned-copper wire for the connecting leads, especially between the coil unit and tuning condenser; 16 or 18 s.w.g. wire will be suitable. This is easy to solder and can be insulated where necessary by means of sleeving. Soldered joints are essential on the type 65 condensers and the volume control, and it is also advisable

to solder the leads to the valveholders. This should only be done if the constructor is a good solderer, however, as a well-secured pressure joint is always more effective than a poor soldered joint. If bare wire is used it must, of course, be kept well clear of the metal surface of the baseboard, and the same precaution must be taken in connection with the bare ends of the resistors. Half-watt resistors may be used in positions R1 and R4, as these do not have to pass direct current.

Speaker Control Panel

It will be noted that the leads coming from the L.S. terminals are marked "to speaker control panel." Connection may be made direct from the L.S. terminals to the 'phones or loudspeaker, of course, but the addition of a control panel is recommended. This enables the listener to use either headphones or speaker without unscrewing the L.S. terminals.

WIRING DIAGRAM OF THE TELE-CENT 3

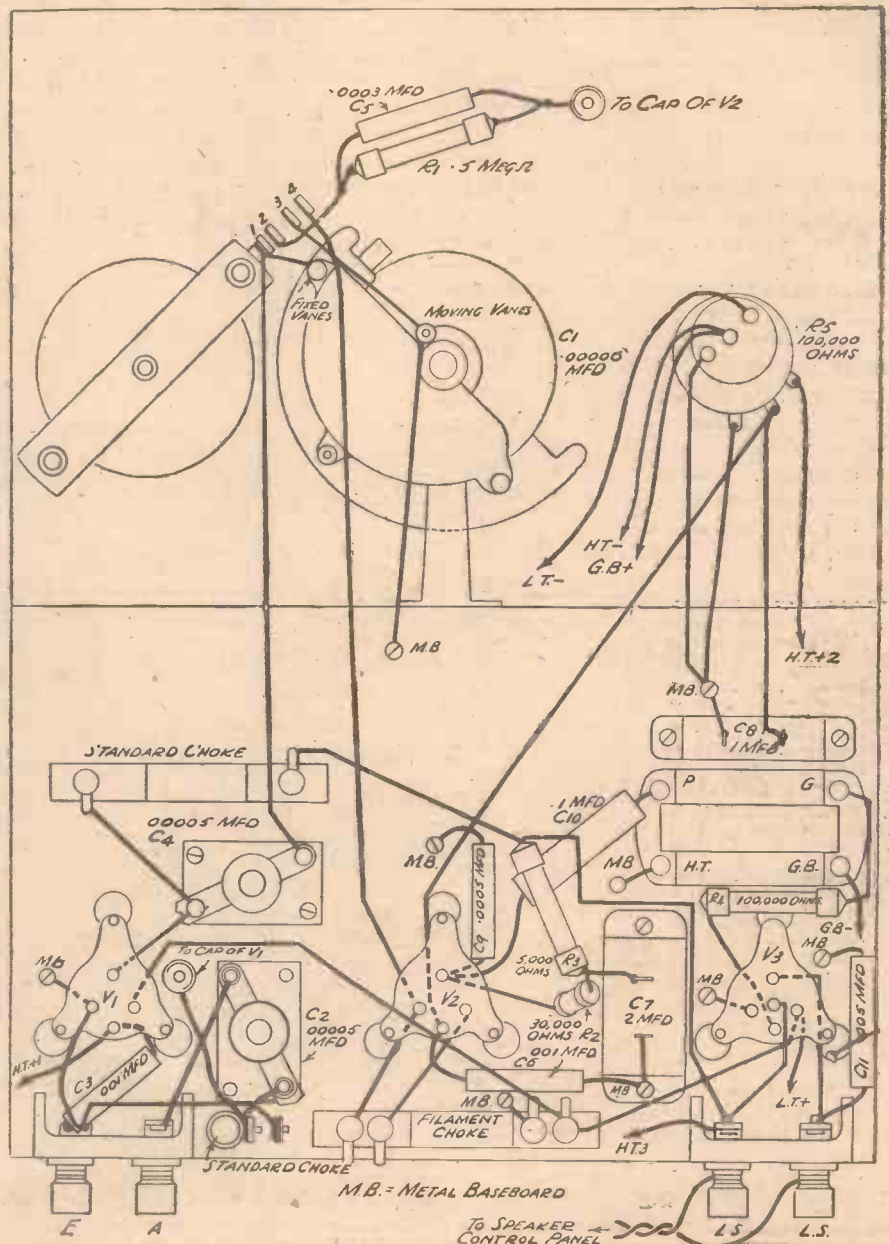

PETO-SCOTT EVERYTHING RADIO - CASH C.O.D. or EASY TERMS

Peto-Scott 1937 ALL-WAVE BATTERY S.G.3
 4 Wavebands, 14-31, 28-82, 400-550, and 800-2,100 metres. Variable-Mu. H.F. Pentode, High Efficiency Detector, Harries High Efficiency Distortionless Output Pentode Valves, Double Ratio, slow-motion self-indicating colour code Airplane Dial, 81u. Tone Corrected M.O. Speaker, Latest type low-capacity switch with replated self-cleaning contacts, 3 gang Ball-bearing Shielded Condenser, Combined Volume Control, On-Off Switch, H.T. Consumption 10 mA.



5/- DOWN
 COMPLETE with H.T., L.T. and G.B. Batteries. Walnut veneered cabinet (illustrated). Aerial equipment. **READY TO PLAY.**
 Cash or C.O.D.
 Carr. Paid, **£7/15/0**
 Or 5/- down and 18 monthly payments of 9/9.

FREE TO "P.W." READERS
 Send for our beautiful Art Brochure, "All-Wave Radio for the Millions," and also for our 40-page 2-colour catalogue which fully describes 36 Peto-Scott All-Wave Broadcast Battery and Mains Receivers. Every Peto-Scott Radio Set is amazingly reliable, extremely efficient, and is outstanding value for money. Models from **£4/19/6**. Cash or C.O.D., or from 5/- down.

Peto-Scott SHORT-WAVE 4 KIT 7 TO 77 METRES



Entirely new design in Battery Short and Ultra S.W. Kits. Just what the keen DX man has been waiting for. Provides for the reception of all Short-Wave Stations, and also covers the Television sound channel. Stove enamelled steel chassis and screens. With eight 9-pin coils.

5/- DOWN
 4 Valves, Pentode Output.
 ● Dual Ratio S.M. Airplane Dial.
 ● Low and 11 monthly payments of 5/9
 ● Slow Motion Reaction Cond.
 ● Combined V.C. and Switch.

KIT A 63/-
 Cash or C.O.D. Carriage Paid
 Complete Kit of components less valves and cabinet. 4 valves **£18/6** ex. Described in Booklet "B"

BEAUTIFUL WALNUT VENEER CABINETS
 by Peto-Scott
RADIO CONSOLE



At last the Constructor is able to buy a console cabinet worthy of his receiver. This latest Peto-Scott production is not only an outstanding example of the best cabinet craftsmanship, but is offered at a price that would be impossible but for our huge production and policy of selling direct to the Public. The extreme beauty of this cabinet must be seen to be appreciated. . . . The illustration herewith can give but a poor idea of the truly lovely appearance of this exquisite cabinet. The cross banded and contrasting inlaid walnut veneered panels are relieved by narrow ebony inlays. Every cabinet is hand French polished; it is supplied complete with shelf for receiver, and loudspeaker baffle board. The Cabinet is supplied undrilled. Drilling quoted extra. Cash or C.O.D. Carriage Paid. **57/6**
 Or 5/- down and 11 monthly payments of 5/8.

RADIOGRAM CABINET

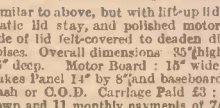

Similar to above, but with lift-up lid, with automatic lid stay, and polished motor board. Inside of lid felt-covered to deaden direct pick-up noises. Overall dimensions 85" high; 18" wide; 16" deep. Motor Board: 15" wide, 12" deep. Takes Panel 14" by 8" and baseboard 14" by 14".
 Cash or C.O.D. Carriage Paid **£3 : 17 : 6** or 7/6 down and 11 monthly payments of 7/-.

5/- DOWN

Carriage and Packing on each of the above Cabinets 2/8 extra.
REMITTANCES
 All Postal Orders must be crossed and made payable to Peto-Scott Co., Ltd. Currency must be restated.

DO YOU KNOW? Do you know that you can obtain all your radio requirements from us either for CASH, C.O.D. or under our famous Easyway system? No matter whether you require complete Kits, or Loudspeakers, eliminators, pick-ups, or a selection of special components for a set you intend to build, we will be pleased to quote you our EASY TERMS without obligation. We are the oldest Radio by Mail House in the country and have been established since 1918 so you can order with confidence.

TELE-CENT SHORT WAVE S.G.3 KIT "A" CASH or C.O.D. **£4:8:9** OR YOURS FOR **7/6** and 11 monthly payments of 8/3
 Complete Kit "A" comprises all necessary parts exactly as specified with both aluminium panel and plymax baseboard ready drilled but less valves and cabinet.

KIT "B" yours for **11/3** and 11 monthly payments of 11/3
 As for Kit "A," but including 3 specified valves, less cabinet. Cash or C.O.D. Carriage Paid **£6 : 2 : 9**.

KIT "C" yours for **13/1** and 11 monthly payments of 13/1
 As for Kit "A," but including 3 specified Valves and Peto-Scott Fitzall Cabinet, less accessories. Cash or C.O.D. Carriage Paid, **£7 : 2 : 3**.

- If W.B. 37J Speaker required with KIT "C" add 3/- to deposit and to each monthly payment.
- B.T.S. Anti-Noise Aerial is available with the above kits. If required, add 2/6 to deposit and 2/3 to each monthly payment.
- If H.T., L.T. and G.B. Batteries are required, add 2/- to deposit and to each monthly payment.

DETAILED PRICE LIST OF SPECIFIED PARTS FREE ON REQUEST

RECORD ALL-WAVE 3 KIT "A" CASH or C.O.D. **£4:2:6** Or 12 monthly payments of 7/6
 Author's Kit of First Specified parts, less valves, cabinet and speaker. Set of 3 valves if required 26/9 extra.

B.T.S. 5-Valve SHORT-WAVE SUPERHET KIT
 12-80 Metres



COMPLETE KIT "A" 7/6 DOWN
£3:19:6
 or 7/6 and 11 monthly payments of 7/6.
 Complete set of parts with drilled chassis and panel, less valves.

- ENAMELLED STEEL CHASSIS.
- B.V.A. VALVES.
- 3-range COIL UNIT operated by B.T.S. ROTARY SWITCH.
- SLOW MOTION DRIVE.

Described in B.T.S. "SHORT-WAVE CONSTRUCTOR No. 2." Post free, 3d.

CONNECT THIS Peto-Scott SHORTWAVE A.C./D.C. PRE-SELECTOR



9/- DOWN
 TO YOUR EXISTING SET and tune in to America and the whole World on Short Waves. Only a few simple connections necessary and NO ALTERATIONS to your receiver. Incorporates special coil unit covering 13 to 74 metres, and is equipped with an arrangement whereby just a turn of the switch by-passes the Pre-Selector so that your set is then available for reception on normal broadcast wavelengths. **SUITABLE FOR ALL RECEIVERS, A.C. OR BATTERY,** providing mains supply is available.

COMPLETE UNIT
 with valves and cabinet illustrated **£4:17:6**
 Cash or C.O.D. Carriage Paid.

- ABSOLUTELY READY FOR USE.
- DUAL RATIO SLOW-MOTION DIAL (8-1,100-1)
- WAVELENGTH-CALIBRATED SCALE.
- B.V.A. VALVES

W.B. 1937 SPEAKERS



Model 37S. Amazing reproduction provided by new magnet and exponential moulded cone. Microtone matching device. Cash or C.O.D. Carr. Paid **£2:2/0**. Or 2/8 down and 11 monthly payments of 4/6.

Model 37J. Matches any receiver as principal or extra speaker. Cash or C.O.D. Carr. Paid **£1:12/6**. Or 2/6 down and 11 monthly payments of 3/6.

37SC. Cabinet Model. Highly efficient for use with any set. Cash or C.O.D. Carr. Paid **£3:3/0**, or 5/- down and 11 monthly payments of 5/9.

2/6 DOWN

Peto-Scott BANDSPREAD SHORT-WAVE SUPER 3
 COVERING 12-94 METRES



KIT "A" 7/6 DOWN
£2:5:0

- Maximum volume and efficiency. Detector and 2 L.F. Circuit.
- Slow-Motion Reaction-Condenser.
- Dual Ratio Slow-Motion Dial.
- Matched and Tested Components.

A simple-to-build and highly efficient short-wave 3 that will give you hours of thrilling entertainment on the short-wave band. Simple but efficient circuit comprising Det. and 2 L.F. valves, dry drilled and enamelled chassis.

2/6 DOWN
 Bandsread tuning simplifies station finding.

KIT "A" Complete kit of parts including 3 coils, 12-94 metres, building instructions and wiring diagram, less valves, speaker and cabinet. Cash or C.O.D. **£2:5/0**, or 2/6 down and 11 monthly payments of 4/3.

Peto-Scott 1937 ALL-WAVE S.G.3 KIT
 16-2100 METRES NO COIL CHANGING



World-wide programmes on all wavelengths. Every constructor should build his own all-wave set and enjoy the thrill of All-Wave listening that will bring programmes from all over the world. Peto-Scott offer you a Kit which, in the words of a famous designer, "An amazingly efficient yet simple to build Kit set."

- NO COIL CHANGING.
- LOW LOSS ROTARY SWITCH.
- PRESSED STEEL DRILLED CHASSIS.
- S.G., DETECTOR and PENTODE CIRCUIT.
- FULL INSTRUCTIONS AND DIAGRAMS.

KIT "A" 7/6 DOWN
 Complete Kit of components, less valves and cabinet. and 11 monthly payments of 7/-
 Cash or C.O.D. Carriage Paid **£3. 17. 6**

KIT "B" As for Kit "A," but with 3 recommended Htrac valves. Cash or C.O.D. Carriage Paid, **£5:9/3**, or 9/- deposit and 11 monthly payments of 8/3.

PETO-SCOTT CO. LTD. Head Office : 77 (Pr. W.19.), City Rd., London, E.C.1. Telephone : Clissold 9875/6.
 West End Showrooms : 62 (Pr. W.19.), High Holborn, London, W.C.1. Holborn 3248.

A Switch Scheme for Plug-in Coils

Constructional Details of a Novel Method of Wave-change Switching - - By G. BIRRELL

CONSTRUCTORS who possess a set of three or four short-wave plug-in coils which they are loath to scrap, but who yearn for the switch-method of wave-range selection, may find the scheme described herein of some use.

position 1 of the switch brings it into action. The order is then in increasing range towards the back of the coil support.

Indicator Dials

The indications can be inked on to small pieces of white card glued to the knob in the four quarter-positions, or they may be marked on a circular piece of card glued to the panel, and used in conjunction with a knob and pointer. The advantage of mounting the switch-base on small pillars is to allow the contacts to be brought very near to the sockets, and virtually on a level with them, so that only very short wiring is necessary. Insulated wire is used and either soldered or screw-fixed according to the type of coil-holder in use. Any connections to the valve or other components which have

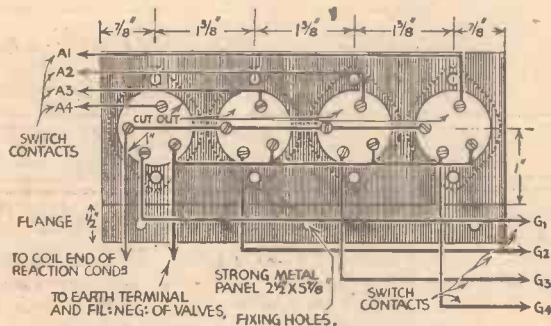

Fig. 1.—Coil-holder base, showing positions of ceramic coil-holders, and connections.

The scheme, as illustrated, is applied to four short-wave coils covering the usual ranges of 13-26 metres, 26-42 metres, 41-94 metres, and 90-160 metres. The low-loss ceramic chassis-type S.W. coil-holders are, as shown in Fig. 1, mounted by small bolts and nuts on a sheet of either brass or aluminium of stout gauge. Circular pieces 1in. in diameter are cut where shown from the sheet to allow the coil-holder sockets to protrude. The support is fixed to the chassis or baseboard by small screws through the flange shown. It might be advisable to remove any metallising below the flange in case of possible capacity losses to earth. If desired, thin metal screens can be placed between the coils and secured to the base-board.

Connections

Two sets of four each of the coil-holder sockets are connected, these being the four to which the earth-ends of the grid windings are attached, and the four which are the terminals of the condenser-ends of the reaction windings. Besides being connected these sets of four are permanently joined to the earth terminal of the set and to filament negative in the one case, and to the fixed vanes of the reaction condenser in the other case. Hence to place any coil into operation only its two remaining sockets have to be brought into circuit. This is accomplished by a rotary switch, details of which are shown in Figs. 2 to 6. It is very simple in design consisting merely of springy brass strips secured to an ebonite base, and closed or opened by the pressure of the small screws in the switch-roller (Fig. 5). In any one position of the switch only two of the eight pairs of the contacts are closed—namely, those which are wired to the grid socket and the anode socket of the plug-in coil covering the corresponding range. The normal order for the coils will be to have the 13-26 metres coil in the holder on the left of Fig. 1, in which case

to cross the switch are taken underneath its base.

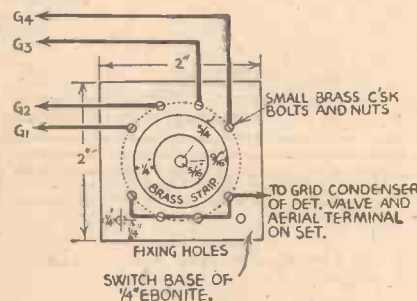

Figs. 7, 8 and 9.—Grid and anode switch units, showing connections, and detail of switch arm.

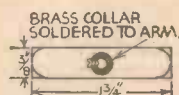

A THIN WOODEN DRIVES SPINDLE MAY BE USED OR A METAL SPINDLE MADE TO FIT COLLARS BY THE AID OF SMALL LENGTHS OF SLEEVING.

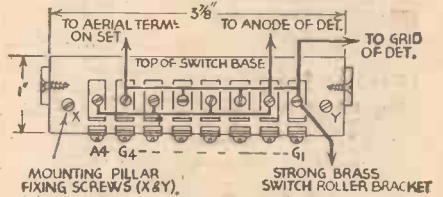
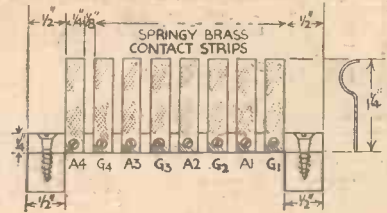

Figs. 2 and 3.—Side and plan views of contact strips.

An Alternative Switch

A flat rotary switch, instead of the one just described, is shown in Figs. 7 to 9, and one of the 2-pole 5-way commercial switches might be used. This switch, by the employment of a third unit, enables the low-tension switching to be accomplished at the same time as the wave-changing. The first contacts of all three units are unused and the remaining ones of units 1 and 2 are wired as shown in Figs. 7 and 8, whilst the four top contacts of unit 3 are joined together and wired to filament + of the valve or valves, the bottom four corresponding contacts being also inter-connected and wired to L.T.+ of the accumulator. As

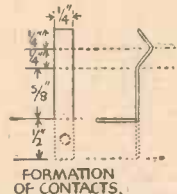
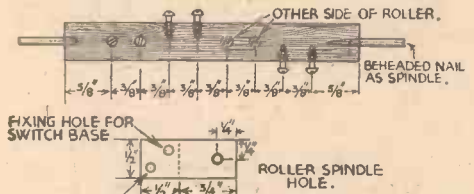

Fig. 4.—Showing how the contact strips are bent to shape.



Figs. 5 and 6.—Details of switch roller and bearing bracket.

against this added function of the flat switch, the original switch of Figs. 2 and 3 permits all-wave operation to be carried out by increasing the length of the coil support (Fig. 1) and mounting on it two more holders to take plug-in coils for the medium and long-wave broadcast bands! To correspond with these, four more pairs of contacts must be mounted on a longer switch-base, each of the two pairs being wired to the grid and anode sockets of the added holders. The length of the switch-base will now be 6 ins. The commercial 5-way 2-pole switches will only allow all-wave operation by sacrificing the short-wave coil covering 90-160 metres, since there are only five contacts on the unit and in this case no L.T. switching is possible.

Full All-wave Switching

Home-made rotary switches with seven contacts on each semi-circle of the units will allow full all-wave switching, and also filament switching, the first contacts on all units being unused, being the OFF position of the switch. Instead of the six all-wave coils, four 6-pin coils can be used in 6-pin holders, and wired to the extended switch with its twelve contacts. In this case the earth-ends of the aerial-windings are wired on the holders to the earth-ends of the grid-windings, and the aerial-ends of the windings are taken to contacts on the side of the switch-base, the top-of-base contacts corresponding to these being wired together.

NEW SERIES

T Amateur Transmitting

Modulating Systems are Discussed in this Tenth Article of the Series

By L. ORMOND SPARKS



BEFORE proceeding with the construction of the A.C. operated transmitter, which I propose describing in this series, the question of "modulation" must be considered.

varied in such a manner that they convey the signal to be transmitted. Without some form of modulation, the carrier waves would be absolutely useless, so far as conveying any intelligence from one station to another.

The carrier waves can be modulated by (a) varying their frequency or (b) by varying their amplitude, and it is proposed to consider the latter, as it is the only

the amplitude has been varied according to the wave-form of Fig. 2, or, in other words, one would say that the carrier is modulated, so that it is conveying the single-tone sound.

The new shape—dotted outline—is called the "modulation envelope," and it will be noticed that it extends beyond the original limits—amplitude—of the carrier, but the frequency has not been changed in any way.

When the carrier is modulated or, rather, when its amplitude is varied, additional frequencies are produced which are known as "side bands." These are equal to the sum of the frequency of the carrier and the modulation frequency, and the difference between them. This may sound rather confusing, but it is an item which must be appreciated, as the following will show. When, say, the voice is being transmitted, the modulation frequencies can range as high as 2,500 cycles per second, approximately, which means that wave or frequency band covered by such a transmission would occupy 5,000 cycles, i.e., 5 kc/s.

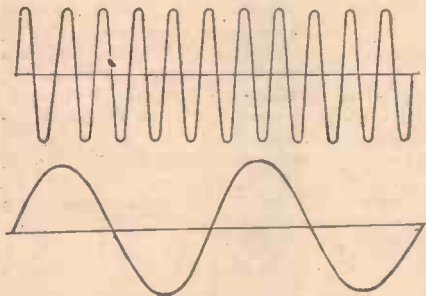

Figs. 1 and 2.—The constant carrier, and, below, the applied L.F. oscillation.

I have already explained that the oscillator valve in a transmitter is solely concerned with the generation of radio-frequency

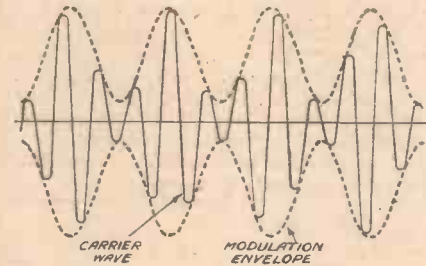

Fig. 3.—The result of combining the two impulses shown at Figs. 1 and 2.

satisfactory method so far as the amateur is concerned.

An imaginary radio-frequency wave is depicted, graphically, in Fig. 1, the waves

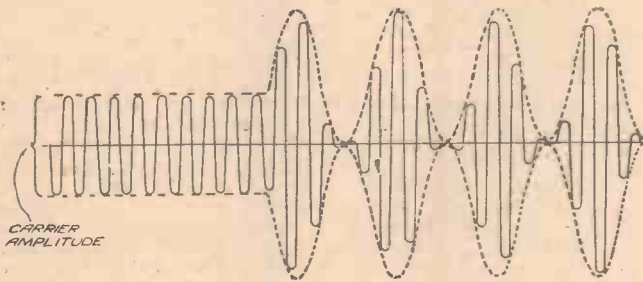
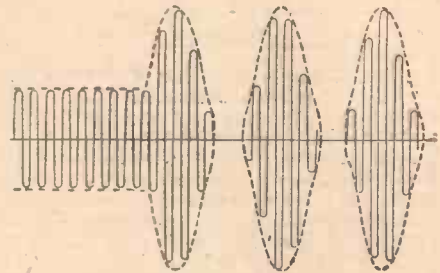

Fig. 4 (left). — A carrier with 100% modulation

Fig 6 (right).—In this diagram the modulation is over 100%. Note the breaks in envelope.



oscillations at a predetermined and constant frequency. Such oscillations are responsible for the production of what might be termed a steady train of waves from the radiating system, the amplitude and frequency of which are maintained within definite close limits.

It is usual to refer to the waves thus produced as "continuous waves" or "C.W.," but when telephony is being considered they are more often spoken of as the "carrier waves," the reason for which will be apparent in the next few paragraphs.

Modulation

Modulation can be thought of as the means or process whereby the radio frequency oscillations (carrier waves) are

having constant amplitude, while Fig. 2 represents a single tone sound. If the carrier is now modulated by the electrical equivalent of the sound, Fig. 1 becomes that shown in Fig. 3, where it will be seen that

usual to express the amount as a percentage, the formula being thus:—

$$\frac{\text{Maximum modulated amplitude} - \text{carrier}}{\text{carrier amplitude}} \times 100\%$$

A carrier, modulated 100 per cent., is shown

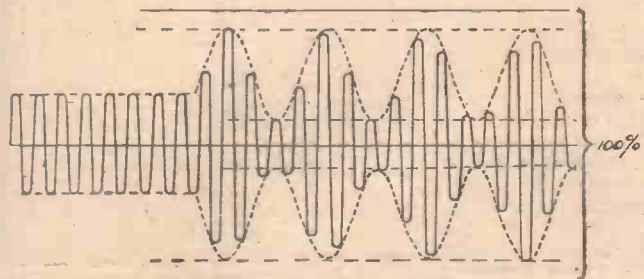

Fig. 5.—In this diagram the effects of modulation lower than 100% are shown.

AMATEUR TRANSMITTING.

(Continued from previous page)

in Fig. 4, and it should be noted that under such conditions, the carrier amplitude is increased to twice its normal amount, and reduced to zero. With a lower value, the graph would be similar to Fig. 5, while a higher percentage would produce Fig. 6, which indicates the state of over modulation.

Such conditions are *not good*; the modulation envelope becomes distorted, and the quality of transmission is seriously affected, while—due to the production of additional side bands—the transmission channel becomes broader which, in turn, can cause unnecessary interference to local listeners.

Modulating Systems

Except in the case of a low-powered single-valve outfit, such as the model recently described, it is not usual to apply modulation direct to the oscillator circuit as such methods are likely to cause frequency variation which, in this instance, is to be avoided.

It is more general, therefore, to modulate the driven R.F. power amplifying stages as the following diagrams indicate.

Choke System

This arrangement, also known as the Heising or "constant current" method of

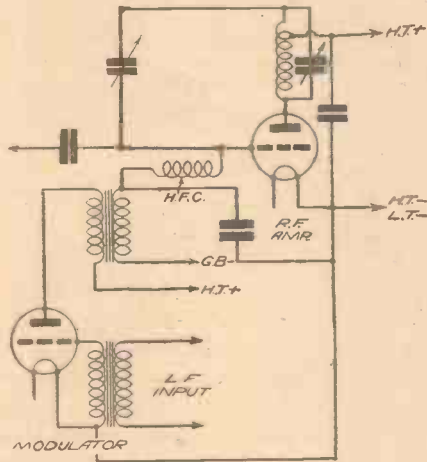

Fig. 8.—This circuit shows the arrangement for grid-bias modulation.

plate modulation, is shown in Fig. 7. The H.T. supply for the modulator and R.F. amplifier is supplied from a source common to both anodes, and through the L.F. Choke Ch. which has, naturally, a very high impedance to low frequencies.

The low-frequency input is fed to the grid of the modulator, which operates as an ordinary L.F. amplifier, the anode circuit of the R.F. amplifier acting as its anode load. Under operating conditions, the low-frequency output of the modulator is superimposed on the D.C. supply of the R.F. amplifier whose radio-frequency output is modulated accordingly.

If the circuit of the 2½-Watt Transmitter is examined, it will be noticed that this form of modulation is used, but in its most simple state.

To obtain satisfactory operating conditions with this system, it is necessary for the R.F. amplifier to be at a lower plate D.C. voltage than the modulator, so the resistance R is embodied, an L.F. by-pass being provided by the condenser C.

Grid-bias Modulation

This system is shown in Fig. 8, where it will be seen that the secondary of an

L.F. output transformer is in series with the bias supply to the R.F. amplifier. Actually, the method is not recommended for beginners, as more attention has to be paid to the R.F. amplifier to make up for a loss of modulated output, which is one

of microphone has to be employed, and too much care cannot be devoted to this section of the transmitter, as good quality is of vital importance.

The type of microphone most favoured is the simple carbon pattern, on account,

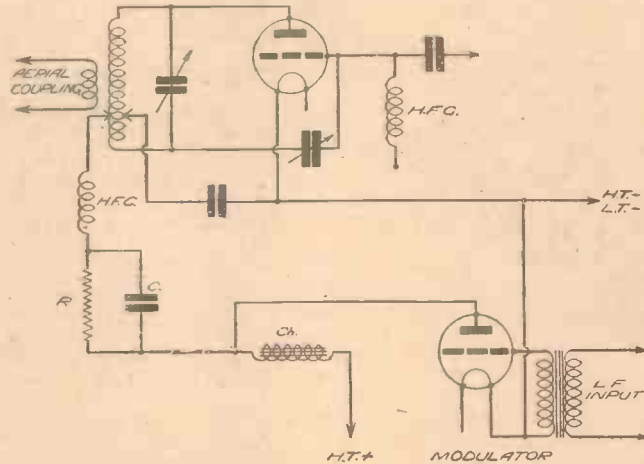

Fig. 7.—This is the choke, Heising, or constant plate-current modulation circuit.

of the disadvantages of the system.

The primary of the L.F. transformer is in the anode circuit of the modulator, and, during operation, the bias of the R.F. amplifier is varied at modulation frequencies which directly affect the radio-frequency output. Less low-frequency power is required to obtain full modulation, thus reducing the amount of gear necessary, but it must be remembered that the modulated carrier is also reduced, for given conditions, compared to the plate modulating systems.

no doubt, of its low cost and high sensitivity. A "transverse current" model is strongly advisable, as that combines quite good quality with a very reasonable degree of sensitivity, though, of course, it must be appreciated that these vary, therefore, careful selection is necessary.

A good microphone transformer is employed to connect the mike to its associated amplifier, Fig. 10, a ratio of between 15:1 and 50:1 (step-up) is usually required, while the energising voltage may be anything from 3 volts to

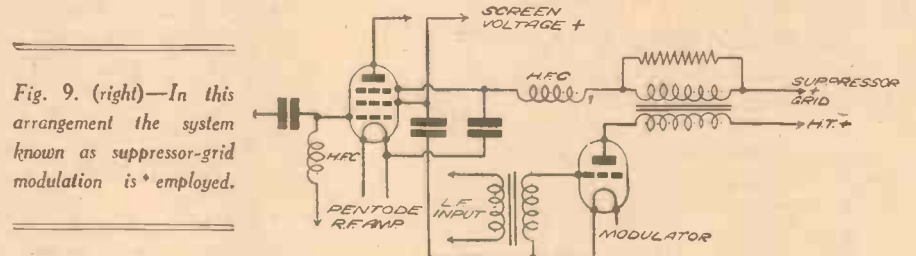

Fig. 9. (right)—In this arrangement the system known as suppressor-grid modulation is employed.

Suppressor-grid Modulation

A method which is becoming very popular is the use of pentodes in the R.F. amplifier, and obtaining modulation by variation of the suppressor-grid potential.

Such valves have very high efficiency, and quite small low-frequency power is sufficient to modulate large radio-frequency outputs, as a very small change in the suppressor-grid voltage produces a much greater change in the radio-frequency output.

A typical circuit is shown in Fig. 9.

Microphone Input Circuits

To convert the sounds to be transmitted into their electrical equivalent, some form

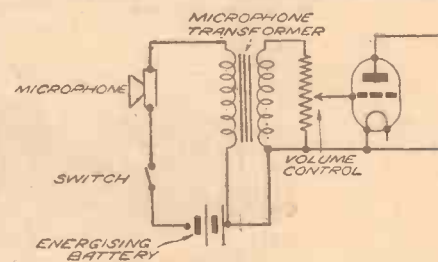

Fig. 10.—The best method of connecting the microphone is shown here.

9 volts, according to the model in use.

The volume control should be fitted in the microphone stage or, at least, in the first stages of any subsequent amplification, so that satisfactory control can be maintained.

It may be necessary to use an amplifier between the microphone circuit and the modulator, to obtain sufficient drive, and it will be appreciated that every care must be taken to see that the amplifier is capable of giving faithful response, otherwise serious distortion will be introduced.

The layout of the transmitter should be such that the microphone amplifier is well screened and remote from the remainder of the assembly, otherwise R.F. currents will be introduced into the L.F. circuits with dire effects.

The design of suitable amplifiers will be dealt with at a later date; in fact, the A.C. operated transmitter, mentioned in the first paragraph, employs a separate unit.

LATHE WORK FOR AMATEURS

by F. J. CAMM

1/- or 1/2 by post from

George Neumes, Ltd., Tower House, Southampton Street, Strand, London, W.C.2.

SHORT WAVE SECTION

FINDING FIVE METRES

Constructional Details of a Ready-calibrated Absorption Wavemeter are Given in this Article.
By AUSTIN FORSYTH

band had been by counting harmonics. Starting at the lowest known harmonic (in wavelength) they were carefully traced down through the waverange of two receivers till the neighbourhood of five metres was reached. This is where the mistake arose, as the oscillator, being in the 80-metre amateur band, was giving harmonics very close together in the five-metre region. It only needed a miscount to throw the results right out, and this is what had actually happened.

be used—though this does not mean that other makes of condensers will not work, but only that as the model has been calibrated with the condenser specified, the use of another make will obviously affect the calibration seriously. Similarly, the coil described must be reproduced as accurately as possible. In practice, all this will be found quite easy, as the apparatus required is readily obtainable and construction is simplicity itself.

For the benefit of those who may question



It is more than likely that a number of experimenters, in making their initial efforts to get results on five metres, have had considerable difficulty in "finding the band." It is also very probable that a number of receivers, though built strictly to specification, are not covering the

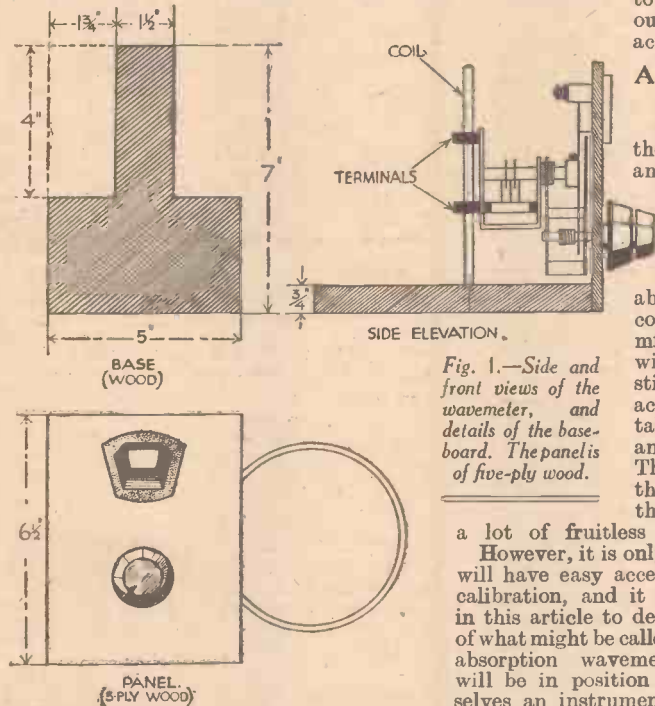

Fig. 1.—Side and front views of the wavemeter, and details of the base-board. The panel is of five-ply wood.

a lot of fruitless endeavour.

However, it is only a small minority who will have easy access to such a source of calibration, and it is, therefore, intended in this article to describe the construction of what might be called a "ready-calibrated" absorption wavemeter, so that readers will be in position to produce for themselves an instrument sufficiently accurate for practical purposes simply by making up the one described hereunder.

It follows from this that it is essential to work *exactly* to the specification; no other condenser than that given can

A Question of Calibration

At the present time there are a number of amateur stations on five metres, and the experimenter starting on that band would be well advised to make up a simple absorption wavemeter, consisting of a .00005 mfd. variable condenser with a single turn of stiff wire 3in. in diameter across its terminals, and take it to the nearest amateur for calibration. This will then ensure that the receiver is in the band, and will save

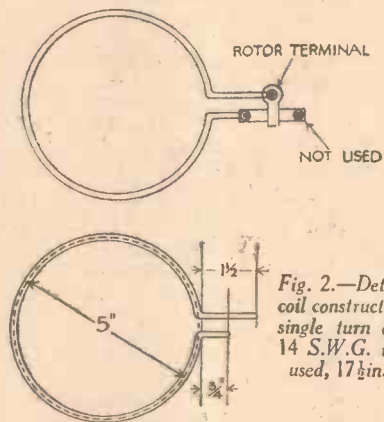

Fig. 2.—Details of coil construction. A single turn of No. 14 S.W.G. wire is used, 17 1/2 in. long.

the accuracy of such a wavemeter, it may be said that the calibration has been made against a commercial G.R.-Lyons Standard Five-metre instrument, and it is a matter of interest to add that not only are a large number of amateur transmitters actually "tied" to this particular meter, but its accuracy has been independently checked by reference to the standards obtained by other groups of amateurs from different sources and methods.

Constructional Details

Turning now to the constructional details of the model, the fundamental circuit consists simply of a coil and condenser. All the necessary information is given in Figs. 1 and 2, which show the constructional features; a plan view of the base, a front elevation, a side view, and the details of the coil-condenser assembly. The peculiar base shape with the handle has been adopted to enable the meter to be used without actually having to touch the coil and condenser. The details should be

followed exactly as given. When clamping the dial, make sure the moving vanes are all in. The wire for the single turn coil consists of 17 1/2 ins. of No. 14 bare copper, which can be polished before fixing and lacquered afterwards. A suitable lacquer can usually be obtained at an ironmonger's store.

In Fig. 4 the full line shows the actual

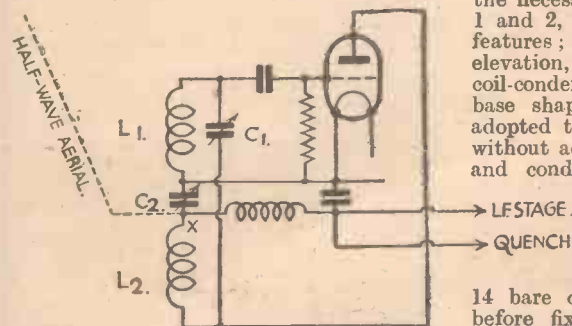

Fig. 3.—Theoretical circuit diagram of the absorption wavemeter described in the text.

5-metre band at all—not because of any fault in the design followed, but due to those individual differences in interpretation which mean so much on the high frequencies.

For in truth it is often very difficult on a home-built set to find even 20 metres, let alone 10 and 5, and on the latter band experienced transmitters have gone sadly astray when using self-excited oscillators for the first time. A classic instance of this occurred some years ago in the West of England when two groups of amateur transmitters, though they had been conducting tests practically in sight of one another for months, yet failed to get contact. After consultation, it was somewhat belatedly decided to check wavelength, and it was then found that one group's "standard" wavemeter had been calibrated not to five, but to six metres! When the necessary adjustment had been made, QSO was immediately obtained.

In this case, the method of finding the

calibration curve obtained with the model as described. The dotted curves A and B above and below are the possible limits which may be obtained in individual instances. From experiment, it has been found that these represent a degree of error which only careless work can produce. Therefore, it follows that by taking the limits of the band as lying between 53 and 66 degrees, it is practically certain that the instrument made up by you, as a particular reader, will cover the five-metre band with a degree of accuracy ample for ordinary purposes.

Using the Wavemeter

In practice, the best way to use it is to set the u-s-w receiver in operation with the quench comfortably audible. The wavemeter is then held within two or three inches of the coils L1 and L2 in Fig. 3, and the meter-tuning condenser adjusted till the quench noise is taken out. The tuning will be found fairly sharp (it flattens as the coupling is increased) and the point at which the quench is inaudible or at a minimum is, of course, the wavelength to which the receiver is tuned, which can be read off from the curve. If the receiver does not respond the first time, try a different setting of the tuning condenser C1, and swing through the meter-tuning range again. When the upper limit, say, of the band has been found, the lower can be ascertained in the same way and the receiver will be calibrated.

Two further points in connection with any super-regenerative receiver of the type shown in Fig. 3 are worth mentioning here. The first is that the waveband to which the receiver will tune is somewhat

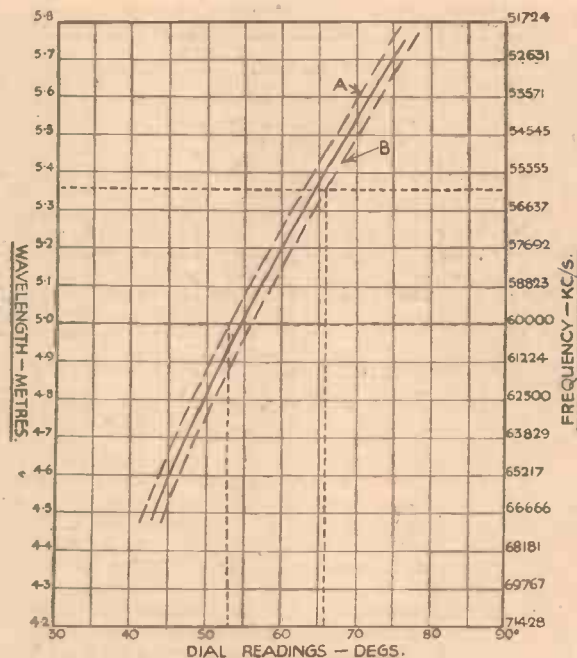

Fig. 4.—The full line is the actual curve obtained for the wavemeter, as described; dotted curves A and B are positive and negative limits, explained in text. Horizontal and vertical dotted lines show limits of the 5-metre amateur band in terms of wavelength (5.00-5.36 metres), frequency (56005-59995 kc.), and dial reading (53-66 degrees).

This diagram can be cut out and pasted on a board under a sheet of celluloid, or the curves can be reproduced on graph paper. An accurate curve for any particular meter can be made by logging a station on a definitely known frequency, plotting this point, and drawing a parallel curve through it.

affected by the value of C2' the coupling condenser, which can therefore be made a .00005 mfd. midget variable instead of the fixed condenser usually specified. This helps considerably in adjusting the waverange of the receiver, which may be found from the wavemeter to be either above or below the band. A simple waverange adjustment can also be made by squeezing in or spreading out the coils L1 and L2, as may be required.

The second point is that it is worth trying a half-wave semi-vertical aerial tapped direct to the point X in Fig. 3. This will often result in a big increase in signal strength, even if the aerial is indoors, as it would usually have to be under these conditions. For the five-metre band, a half-wave wire is 8ft. long, and for outside portable work try a quarter-wave wire 4ft. long tapped to the "cold" end of the plate coil in the same way.

COMPONENTS REQUIRED:

- "J.B." .000025 mfd. midget u-s-w condenser.
 - "J.B." Short-Wave Slow-Motion Dial.
- (The above fit together so that no special condenser mounting is required.)

THE short-wave listener has no cause to grumble at the conditions which have prevailed during the past month, as although the weather has proved unpleasant on most nights to the general community, it has been specially favourable for the reception of DX signals. Wet and windy forecasts may not appeal to many, but there seems little doubt that such conditions approach the ideal for the stay-at-homes who possess a radio set. It will be noticed that when sharp frosts obtain to the accompaniment of cold and dry easterly winds, signals from the more distant stations do not attain full strength, and when the barometer is unsteady, fading effects are specially noticeable. On the other hand, a bright moonlight night usually spells good listening. Give me, for an enjoyable evening with my wireless receiver, a boisterous night with a falling barometer, and all signs of a squally and rainy morn!

A Station, with Many Channels

*W2XE, Wayne (N.J.), U.S.A., the main short-wave outlet of the Columbia Broadcasting System, uses a number of frequencies for its daily transmissions. The 13.94 m. (21.52 mc/s) channel is an experimental one, but carries a programme daily from G.M.T. 12.30-18.00. On 16.89 m. (17.76 mc/s) broadcasts are less regular, but it is scheduled from G.M.T. 17.00-17.45; at 18.00, W2XE comes on the air on 19.646 m. (15.27 mc/s), and works until 22.00, when the frequency changes over to 11.83 mc/s (25.36 m.), and work is carried on until 03.00. On 49.02 m. (6.12 mc/s), the programme is a short one lasting only one hour, namely, from 03.00-04.00. For further experimental transmissions the Columbia system uses the call-sign W2XDV, to which the following channels have been

LEAVES FROM A SHORT-WAVE LOG

allotted: 9.5 m. (31.6 mc/s); 8.43 m. (35.6 mc/s); 7.78 m. (38.6 mc/s); and 7.32 m. (41 mc/s). On 35.6 mc/s you may pick up the relay of the WABC, New York, programme simultaneously broadcast between G.M.T. 22.00-03.00; on 31.6 mc/s, tests are being carried out on Saturdays between G.M.T. 18.30-23.00; on Mondays, from midnight to 03.00; and on other days between 23.00-04.00. All announcements from W2XE in programmes destined to overseas listeners are given out in English, French, German, and Spanish. The call is: *This is station W2XE, an International broadcasting station of the Columbia Broadcasting System in the city of New York, United States of America. The studio regularly closes down with an orchestral rendering of the "Star-Spangled Banner."*

Broadcasts from Spanish Morocco

Nightly, towards G.M.T. 21.00, if you tune in to 43.04 m. (6.97 mc/s), you will hear a Spanish call: *Aqui estacion del Administracion de Postas y Telegraficos de la Guardia Civil, Radio Tetuan.* This is the 5-kilowatt transmitter which, I believe, is situated at Melilla, and which has been taken over by the rebel authorities in Spanish Morocco; the station is run by the Civic Guard at Tetuan. From G.M.T. 22.00 the broadcast consists of short news items interspersed with songs in Arabic to the accompaniment of native stringed instruments. The casual capture of this transmission might mislead the listener to believe that he is hearing the Oriental

programme from Radio Maroc (Rabat), on the medium-wave band.

More U.S.S.R. Short-wave Stations

In addition to the broadcasts on the 50 m. (6 mc/s) channel from Moscow, the Soviet authorities have recently brought into operation several other stations; in particular, for the relay of political speeches and news bulletins in connection with the Spanish Civil War. The channels used are: RAN, 31.25 m. (9.6 mc/s); RBO, 36.1 m. (8.31 mc/s); RPK, 40.43 m. (7.42 mc/s); RKA, 43.1 m. (6.96 mc/s); and RYS, 44.44 m. (6.75 mc/s). All these stations are not on the air nightly, but RAN has taken over the broadcasts between G.M.T. 23.00-24.00 which were previously made on 31.51 m. (9.52 mc/s).

Pernambuco Closes Down

PRA8, on 49.76 m. (6.028 mc/s), which transmitted programmes sponsored by the Radio Club de Pernambuco (Brazil), is said to have suspended its broadcasts. At present the only programmes available from that country are those from PRF5, Rio de Janeiro, on 31.53 m. (9.5 mc/s). This station, which is on the ether every day from G.M.T. 21.15-23.00, strikes a three-note gong as an interval signal, and gives out a call every fifteen minutes: (phon.) *Pay air effay sinko, La Voz do Brasil.* This is station PRF5, short-wave station of the Government of Brazil. As a rule, a talk in a foreign language other than Portuguese is transmitted nightly; in English on Mondays. The studio closes down with a bi-lingual announcement; in English you will hear: *You have been listening to PRF5, Rio de Janeiro, Brazil. We thank you for your attention and wish you a good night wherever you may be.* The final musical strains picked up are those of the National Anthem.

BRITISH LONG DISTANCE LISTENERS' CLUB

Station Reports

WE regret that the scheme inaugurated by Mr. E. A. J. Barrs has had to be terminated. This information has just come to hand in the following letter received from this member: "Re the reporting scheme that I have tried to make a success. I am very sorry to say that it has proved a failure, due to lack of reports from SWL's. It also seems that this type of reporting is not in favour with W2XE, as I have just received a letter from them thanking SWL's for the data, but they don't want it published. I would be obliged if you would kindly publish the new time schedule of W2XE, and also mention the increase in power."

"Well, re LRU and W3MD, I have not had two reports yet, so this is the finale of the scheme, I'm afraid. I thank all those SWL's who very kindly helped in the scheme."

We regret that Mr. Barrs' efforts have met with failure, but hope that he will not be disheartened in his attempts to help in collating data which may be of assistance to transmitters.

344 Stations on Two Valves

MR. LEIGH replies to "Gramophile" in the following terms: "I read with interest 'Gramophile's' letter in your issue dated January 2nd, 1937, on 'This Short-wave Business.' As he mentions my name I would like to reply from my point of view."

"It might further interest 'Gramophile' to know that the two-valve set on which I logged the 344 stations was built from 'junk' at a cost including 'phones and valves, but excluding batteries, of 15s."

"Most of the stations logged were coming through about 2.30 a.m. At the time I was preparing a lecture on 'Short Waves,' and I wanted to see how many stations could be received on an average two-valve set. Every report I sent out was verified, although some were very late."

"In contrast to this, at the present moment (2.30 a.m.) out of eleven days' listening, only three stations have been logged. Most mornings there was not a single signal on the 20-metre band, while from 12.30 p.m. until early evening dozens can be logged."

"If 'Gramophile' wants good, consistent music, then a two-valve or three-valve is no use to him in India. Recently I made up a three-valve set for a friend in Ceylon, and although here it would receive Sydney and the principal American stations on speaker, at Ceylon, Daventry could only just be heard on headphones."

"If 'Gramophile' wants good music I should advise him to go in for a multi-valve job, and even then it is not certain."

"If he wants to join the ranks of that world-wide friendship 'the radio amateur,' let him construct his own set and have the thrill and satisfaction of hearing, not the powerful broadcasting stations, but the amateur at the other end of the earth using a few watts power. A report sent probably leads to correspondence and friendship, and broadens one's mind. There would be much less chance of war if there was more of the 'radio amateur spirit.'"

"Try it, 'Gramophile,' and let me know how you go on; the money will not be wasted. I shall be pleased to hear from you."—HAROLD LEIGH (2BBG).

REPLIES IN BRIEF

The following replies to queries are given in abbreviated form either because of non-compliance with our rules, or because the point raised is not of general interest.

W. B. W. (Rotherham). We regret that we have no blue print of the type referred to.

A. E. C. (Bude). The valve in question is a multi-valve made by the Loewe Company. It consists of a detector and two L.F. stages, and is complete with the valve elements of those three stages as well as the inter-coupling condensers and resistors. (N.F. is the German for Low-frequency.) The two L.F. stages are R.C. coupled, and there was a partner valve obtainable consisting of 2 H.F. stages. We cannot give you the price or other details.

E. R. G. (Wolverhampton). There is no need to do anything with the other winding, as it will not be harmed. A ballast resistor should be used to prevent the voltage rise on the winding in use.

F. H. (Wattford West). The circuit may need slight alteration, but before doing this we advise you to communicate with the makers of your receiver and obtain their sanction.

J. L. W. (Sydenham, S.E.). We have only used the tuning pack once, in a D.C. receiver. You may be passing too much H.T. through the chokes and should check this point.

P. R. (Thornton Heath).—There is no special system, but you simply send a report of the reception, and in most cases a QSL card is sent back to you as acknowledgment. We refer you to the recent correspondence on this subject in our Practical Letters and B.L.D.L.C. columns.

G. T. K. (Middlesbrough). The Television and Short Wave Handbook, obtainable for 3s. 6d., should meet your requirements. The price by post is 4s., and this gives a number of short-wave circuits and other interesting short-wave data.

R. H. H. (Bishop Auckland). The voltage on the detector could certainly be increased. In view of the high tuning point of the London Regional, we suspect wrong connections to the coil. It should be tuned much lower on the dial, and you should unscrew the trimmers on the condenser before making any further tests.

G. R. W. (Sunderland). We have no blueprint which uses the coil mentioned. Three of these coils were employed in a set designed three years ago, but back numbers of the issue are no longer obtainable and we think you would find difficulty in obtaining the extra coils to make up this receiver.

REALISM—NOT JUST 'TONE'



Above is the 1937 Stentorian Senior Chassis, at 42/-. Incorporating an entirely new exponential moulded cone (manufactured from an exclusive material at Mansfield) it gives a width of response and freedom from resonances that must be heard to be believed! The enormous flux strength, original speech-coil construction, and re-designed matching system make possible a new sensitivity and brilliant "attack." It will make all the difference to your set. Other models from 23/6. Ask your dealer.

Taken from a user's letter, the words above have an important meaning for you.

During 1937, will you be satisfied with "just tone" or will you let this new marvel of speaker efficiency bring you that vivid "life" which makes all the difference to radio listening?

To thousands, the new features of the 1937 Stentorian will bring a fresh radio enjoyment during the New Year. How about you?

A Stentorian is exclusively specified by Mr. Camm for the "Telecent." Hear one, and you'll know why!

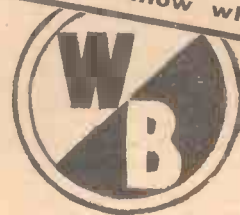

1937 STENTORIAN

THE NEW SPEAKER WITH THE NEW REALISM

WHITELEY ELECTRICAL RADIO CO., LTD. (Technical Dept.), MANSFIELD, NOTTS.

FOR LESS THAN 1/2d PER WEEK!

The new HEAYBERD "MIDGET" Battery Charger incorporates a METAL RECTIFIER, and will charge a 2-volt accumulator at 1 amp. FOR LESS THAN 1/2d PER WEEK. By charging your batteries at home, time and money is saved, and the life of the battery considerably lengthened.

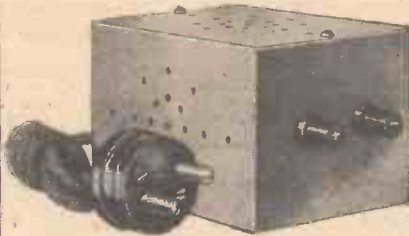

SEND NOW FOR FULL DETAILS OF THIS RE-MARKABLE "MIDGET" BATTERY CHARGER.

Complete with mains lead and adaptor.

The full range of HEAYBERD Chargers may be seen at our new Showrooms.

12/6

F. C. HEAYBERD & Co. 10, FINSBURY STREET, LONDON - E.C.2

ENGINEERS! ARE YOU EARNING LESS THAN £10 PER WEEK?

If so, you cannot afford to carry on without reading our 268-page Handbook. The book explains clearly and definitely many ways of carving out a successful career. Among other things it explains the Services of our unique Appointments Department, outlines Home-study Courses in all branches of Civil, Mechanical, Electrical, Motor, Aero, Wireless, "Talkie," Engineering, Building, Govt. Employment, etc., and gives details of B.Sc., A.M.I.C.E., A.M.I.E.E., A.M.I.Mech.E., A.M.I.A.E., A.M.I.W.T., A.M.I.E.S., G.P.O., MATRIC, and all Exams. We Guarantee—"NO PASS—NO FEE."

Whether you be an old hand or a budding apprentice, get this book to-day—FREE and POST FREE, BRITISH INSTITUTE OF ENGINEERING TECHNOLOGY,

405, Shakespeare House, 17/19, Stratford Place, London, W.1.



SHORT WAVES FIT A FILT PERCOLATIVE EARTH



The only direct contact to the station is through the earth. When signals are weak, your earth is a vital link. Fit a FilT. From all dealers or post free from:

2/6
GRAHAM FARISH Ltd.
Masons Hill, Bromley, Kent.

EARN EXTRA MONEY by hiring out the M.P.R. 7 Watt Amplifier to dances, socials, etc. Complete with Four Valves. Speaker, and Volume Control. Push-Pull output. Will reproduce Gramophone Recordings or Radio at full Band strength. Supplied ready for connecting to pick-up or microphone. For AC mains only. Price 45-5-0 net, or 10/- monthly. Send for full particulars. Phone: Romford 338. M.P.R. Electrical Co., 252, Victoria Road, Romford, Essex.



COMPONENTS TESTED IN OUR NEW LABORATORY

Exide Wet H.T. Batteries

THE makers of Exide batteries announce that in future the Wet H.T. blocks will be supplied with a novel form of Leakage Current Shield. This will be fitted round each of the battery terminals, with an air gap between the terminal and the shield. The advantage of this shield is that it reduces the current leakage across the top of the battery from one terminal to another. When the battery is charged in an atmosphere containing a fine acid spray (such as normally obtains when a large number of batteries are being charged simultaneously) some of the spray settles on the top of the battery, and as the water in this fine film evaporates a layer of concentrated acid is left covering the battery top. This provides, between the two 10-volt terminals, a leakage path for current which, although small in amount, is continuous.

As these H.T. batteries are usually only charged at infrequent intervals, the loss in current constitutes a serious shortening of the useful working capacity of the battery. The introduction of the two porcelain collars, one embracing each terminal post, breaks this leakage path, and extended tests in the Exide laboratories have proved most conclusively that batteries equipped with these shields have a longer useful working life than similar batteries not so equipped. The accompanying illustration shows one of the new H.T. batteries with the shields fitted.

"Avo" Instruments Price Increase

OWING to the increased cost of certain raw materials, the Automatic Coil Winder and Electrical Equipment Company have had to increase the price of some of the popular Avo instruments. Some of the revised prices are as follow:—

	£	s.	d.
AvòMinor, Universal Model..	5	10	0
AvòMinor, D.C. Model ..	2	5	0
Avometer, Model 7 ..	16	16	0
Avometer, D.C. Model ..	9	9	0
Avometer, Universal Model..	13	13	0
Avo Capacity Meter ..	23	0	0
Avo Valve Tester ..	11	11	0
AvoDapter ..	1	7	0

For Service Engineers

SOME interesting new lines are announced for the use of service engineers and those engaged in testing and repairing receivers. The E.M.I. Service Company have produced a set of test leads designed to speed up testing operations. These are fitted with plug clips which facilitate contact with practically any socket, wire, terminal or plug and cut out the time which is normally wasted in cutting odd lengths of lead and fitting appropriate

sockets or plugs to the ends. The price of the set is 17s. 6d. The same company have also produced a bench lamp with a universal action so that the light may be directed in any direction. This costs £1 17s. 6d.

The Wharfedale Wireless Works have produced an output transformer of the universal type designed primarily for replacement purposes. It has a stalloy core and a primary winding designed to carry 50 mA. This is centre tapped. The price is 6s.

Exide Deaf-aid Cell

A NEW small 2-volt cell has been produced by Exide for incorporation in deaf aids. Designed primarily for the Aurophone device, this cell measures 2 3/16in. wide, 1 1/4in. long and 2 1/4in. high. The capacity, at the 20-hour rate, is 1.6 amps, and the type number is AU2. The price, uncharged, is 6s.

New Pilot Radiograms

PILOT RADIO announce two new radiograms to be added to the range of receivers now in production. One is a four-valve (plus rectifier) A.C. superhet with the chassis as fitted to type U.355, recently reviewed in these pages. This includes the short-wave band from 16 to 52 metres in addition to the normal broadcast wavebands. The price of this model is 22 guineas. The second new model is type RU.225, and incorporates the chassis as fitted to model U.225. It is a five-valve (plus rectifier) A.C./D.C. superhet covering the same short-wave band as above mentioned. In both of these receivers A.V.C., variable tone-control, two-speed tuning dial and full-vision dial with separate illumination for each band is provided, and the electric gramophone motor is provided with an automatic stop and start device.

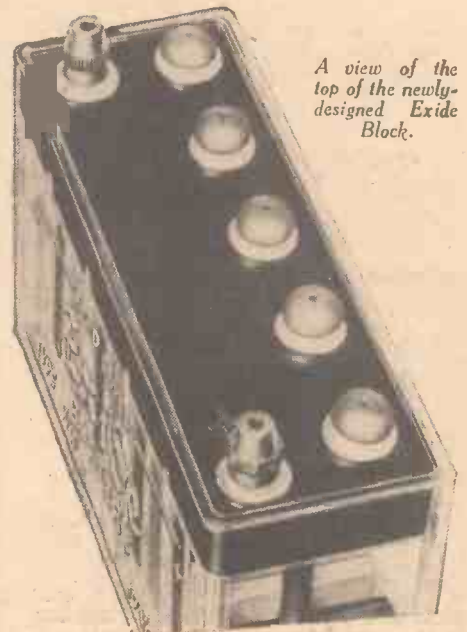

A view of the top of the newly-designed Exide Block.

Ideal for the Beginner F. J. CAMM'S EVERYMAN'S WIRELESS BOOK 2nd Edition.

238 Pages and over 200 Illustrations. Now 3/6, or 4/- by post, from George Newnes, Ltd., Tower House, Southampton St., Strand, London, W.C.2.

RADIO CLUBS AND SOCIETIES

Club Reports should not exceed 200 words in length and should be received First Post each Monday morning for publication in the following week's issue.

Bradford Short-wave Club

ON December 11th Mr. G. A. Briggs, of Wharfedale Wireless Works, gave us a very interesting lecture and demonstration, the title of which was "How to Judge a Loudspeaker."

The Morse instruction class is being carried on under the guidance of G8JD, who will welcome any newcomers to this side of amateur radio.

Progress is being made with a new club receiver, and it is hoped that the club will shortly own its own transmitter. Meetings are now held at Bradford Moor Council School, Leeds Road, Bradford, every Friday evening from 7.30 to 11 p.m. Further information will be gladly furnished by the secretary, G. Walker (2AWR), 33, Napier Road, Thornbury, Bradford, Yorks.

International Short-wave Club (London)

THE London Chapter meets at 80, Theobalds Road, W.C.1, every Friday evening, at which all readers are welcome. Every attention is given to those interested in amateur radio, short-wave work and television. We now have a permanent club-room for the members.

A copy of the *News Letter*, the official organ of the I.S.W.C., will be sent to any reader on receipt of a postcard.—Arthur E. Bear, 100, Adams Gardens Estate, London, S.E.16.

Leeds and District Radio Society

THIS society has moved to more central headquarters in the Y.W.C.A. Building, Cookridge. The main interest lies in the Morse classes, lectures, demonstrations, and the club receiver which is in course of construction.

The society is having a members' trip to the North Regional station and other outings are planned for the near future. Anyone interested in radio is invited to write for particulars to the secretary, J. Kavanagh, 63, Dawlish Avenue, Leeds 9.

Swindon and District Short-wave Society

A MEETING of this society was held on January 7th. The construction of the society's short-wave receiver was continued, and Morse practice was also taken by the members. Points relating to the coming contest for the Swindon and District Short-wave Society's QRK cup were discussed. This cup is given by Mr. E. W. Mortimer (2BMM), the chairman, for competition among the members. The short-wave receivers are to be home-constructed, and points will be awarded for sensitivity, bandspread, layout, frequency drift, and performance. The contest takes place in February, and it is hoped to obtain the services of Mr. R. A. Hiscocks (G6LM) as judge. There is great activity among the members preparing their receivers for the contest. Six A.A. transmitting licenses are now held by various members, who are now very active experimenting with various types of gear. Mr. P. Bailey has recently obtained his A.A. license, and has the call 2CGN. It is hoped to arrange field days, D.F. contests and visits to various s.-w. stations in the near future. The hon. secretary is

W. C. Barnes (2BWR), 7, Surrey Road, Swindon.

Halifax Experimental Radio Society

THE above society spent a very interesting evening on Thursday, January 7th, listening to a talk on the "Growth of Amateur Radio," given by Mr. J. H. Bateman (G6BX), of Bradford. In his talk he described his own experiences of the pre-war period, when amateurs had to make most of their components, and their receivers employed crystal detectors. To transmit over a distance of ten miles at that time, on the allotted wavelength of 1,000 metres, required 1/4 kW of power from a spark transmitter. Then came the war, after which was the amateur post-war period, which saw great developments in the science by the advent of the valve. Mr. Bateman then described how they tackled their new difficulties, and concluded his very interesting lecture by describing a

modern use for the old "R" valve, namely an oscillator for a wavelength of 1 metre.

The membership of this newly formed society is increasing rapidly, and meetings are held every Thursday evening at 7.30 in Room 13; Friendly and Trades Club, Halifax. We welcome all who are interested in amateur radio.—J. B. Bedford, Hon. Sec., Oak House, Triangle, Nr. Halifax, Yorkshire.

Proposed Club for Swansea

IT is hoped to form a short-wave club in Swansea, and interested readers residing in the district are invited to communicate with Mr. R. F. Armstrong, "Blairgowrie," Caswell Road, Bishopston, Swansea, Glam.

THE PRACTICAL MOTORIST
3d. Every Friday

YOU HAVE BEEN WARNED BY RADIO—

Professor Hilton of the B.B.C. on November 19 broadcast a warning to all intending students concerning correspondence colleges. The warning was to the effect that while there are many good and reliable colleges teaching by correspondence, there are many others that are merely colleges by name only. He specially warned intending students against these so-called colleges who rented a couple of rooms in a large building in a well-known street, who made great promises that they did not intend to fulfil, and claimed success as they could not prove, and who used the names of prominent men who were in no way connected or working with the college.

NOTICE.

The accompanying picture is taken from a photograph of The Bennett College, which has been established over 30 years. We have a permanent staff of over 190 people on the College premises. Our Professional Staff have all passed their examinations, and our tutors are all experts in their own specialised work. We do not send out any homework to be corrected by tired, spare-time tutors. All students' homework is corrected on the College premises the same day that it arrives and is returned by evening post. This College is Technical, General and Commercial, thus enabling us to cater for all requirements.

This is an entirely British College. Most of our text-books are written on the College premises by our own professional staff, especially for tutorial purposes. Our tutors specialise in teaching students for the examinations they themselves have already passed.

THERE IS NO OTHER COLLEGE IN THIS KINGDOM THAT CAN CLAIM ALL THE ABOVE ADVANTAGES.

We have seating accommodation for over 10,000, but it is not necessary for students to attend the College; we can send exactly the same tuition to you by post for a reasonable fee payable monthly.

Anyone who reads the journals knows that there are many things advertised that one can study, and any kind of study is good. It is training for the brain, but the best thing to study, surely, is a course specially prepared to teach your own vocation, or prepare you for the examination which you have in view.

Knowing that you are master of your job gives you self-confidence and personality, but a Diploma from a College is absolute proof of your efficiency. We have agencies in all English-speaking corners of the world. The nature of our business makes us keep in touch with employment requirements in all parts of the world, therefore we specialise in preparing students for the good positions which we know exist, and for all the worth-while examinations.

THE ABOVE VAST ORGANISATION CAN HAVE BEEN CREATED ONLY BY THE SUCCESS OF OUR STUDENTS.

There is a tide in the affairs of man which, if taken at the flood, leads on to fortune and success. There are three things which come not back, the spoken word, the spoken word, and the lost opportunity.

This is your opportunity. If it is your desire to make progress and establish yourself in a good career, write to us for free particulars on any subject which interests you, or if your career is not decided, write and tell us of your likes and dislikes, and we will give you practical advice as to the possibilities of a vocation and how to succeed in it. You will be under no obligation whatever. It is our pleasure to help. We never take students for courses suitable.

Do not forget that success is not our experience of over 30 years achieves more than outstanding



the prerogative of the brilliant. proves that the will to succeed brilliancy.

LET ME BE YOUR FATHER

Let me tell you how to make a success of your career. If your future is undecided or appears unsatisfactory, let us talk it over together. I want to help, and it will cost you nothing to get my help, you will be under no obligation whatever.

We are prepared to produce, on demand, over 10,000 unsolicited testimonials from successful students, or in default we will hand over £100 to charity.

A STAFF OF 197 are in daily attendance at this College at your service.

YOUNG MEN

Young men physically fit and whose careers are not definitely fixed should join the Police Force. We have Special Courses for Entrance and Promotion. 1/- per week brings success. Full particulars Free. Address: POLICE DEPT. 104.



THE MOST SUCCESSFUL AND MOST PROGRESSIVE COLLEGE IN THE WORLD.

ENGINEERS

Engineers, now is your chance to dig yourselves into a Key position and make your future solid. It needs Technical Training; we can give you that by post. Full particulars Free. Dept. 104

DEPT. 104, THE BENNETT COLLEGE LTD., SHEFFIELD

£7



6 VALVE ALL-WAVE SUPERHET

(Complete with B.V.A. Valves)

Improved all-wave superheterodyne for A.C. or D.C. mains. High sensitivity on all three wave-bands (16.5-50 metres, 200-550 metres, 800-2,000 metres). Many interesting features, including:— Illuminated "Airplane" dial with station names. Special "squell" valve for inter-station noise suppression, with manual muting control. Octode frequency changer. 8 stages of 7 tuned circuits. Iron Coiled I.F. Coils. Delayed A.V.C. 3.5 watts output. Extra heavy Cadmium-plated steel chassis.

£7 cash complete with valves, knobs, pilot lamps, mains cable and plug, etc. Deferred terms from London Radio Supply Co., 11, Oat Lane, E.C.2. 12 months' guarantee. Suitable loudspeakers, cabinets, etc., in stock. McCarty Chassis from £4 5s. to £12. Write for illustrated catalogue.

MCCARTHY RADIO LTD.

44a, Westbourne Grove, London, W.2.

Telephone: Bayswater 3201.

ELECTRADIX BARGAINS

TRANSMIT VALVES. NEW VT13B. A fine 30-watt 0-v. 11-amp. anode 1,500-v. imp. 35 thou. mag. 35. Less than half price, 25/- AT50 5-Guinea line. 7-v. 24-a., 1,500-v., mag. 30. as new, 25/- Big Rectifiers, NU2, 5-v. 24-a., 250 watts up to 20,000-v., 45/-; 10,000 volts 2 m.a., 35/-, 100-watt TST2A, 45/-. Also a few 1kw. Bottles cheap.

THE SUPERSEDER makes H.T. from your L.T. 2-volt battery, rectified and smoothed. Three tappings. Lasts indefinitely. A boon. List £3 15s. New guaranteed, 37/6. TELEPHONES. The cheapest is a pair of 2/9 Sullivan phones. Brown's "A" reed for short-wave sets, 1,500 ohms, 21/6, 120 ohms, 17/6, Western Elec., 2,000 ohms, 4/3 pair, 4,000 ohms, T lightweight, 4/6. Single high res. earpieces, 2/6. Wall or Table Housephones, 25/-. DOUBLE CURRENT DYNAMOS. D.O. 600 volts, 100 m.a. and 6 volts 3 amps., 32/6. COMPASSES. Boat Binnacle Mariners' 610. Boat Compass, floating gimbal glass case, 35/-. Magnetic Compass, 11in. Brass Case, bevel glass, plain dial, unsealed, new, 9d. War Office Prismatic, 25/-. Traveller's pocket, 15/-. SHORT WAVE 2-pin short wave coils 3, 4, 5 and 6 turns, 1/- Steatite lead in with brass stem, 8d. 3in. stand-off insul., 6d. CABLE AND WIRE. Lead covered single, 3/029, 7/- 50 yds.; 7/029 ditto, 12/- per 50 yds. L.C. Twin, 1/064, 12/- per 50 yd. coil; L.C. Twin, 1/044, 16/- per 50 yd. coil. Plain V.I.R. Lighting, 1/044, 4/3 per 100 yds. Heavy Mains Flex, 4/- per doz. yds. post 4d. Twin Lighting Flex, 2/- per doz. yds. post 4d. AIR COMPRESSORS for Paint Spraying, Set Cleaning, Inflation, etc., Foot Operated, 37/6. Electric No. 1 size, 25/15/-.

MORSE KEYS
MORSE & SIGNAL KEYS, 2/-, 2/6, 3/8 and 25/-. BUZZERS, 1/-, 2/6 and 5/-. SOUNDERS, 5/-, 7/6 and 10/-. Morse Practice Sets complete, 4/9. WIRE WOUND POWER RESISTANCES. 5 watt 8,000 ohms, 10 m.a., 10d. 5 watt Potential Dividers, tapped 50,000 ohms, 1/8 in gong, 2/-. Wall Bell Pushes, Pendant Pushes, 6d. Mains Transformers, 3/8. 1 mfd. Condensers, 4d. H.T. TRANSFORMERS. 200-240 v. to 10,000 v. 25 m.a., 34/-; 5,000 volts 20 m.a., 19/6; 2,500 v. 15 m.a., 17/6. Large Coronation Neon Signs, 4ft. 2in. x 4ft. 11in. x 6in., on glass panel, ready for use, £7. METERS.—DIX-ONEMETER. 50-range microamps, amps., milli-volts and volts, ohms and megs., all in one. Precision moving coil Meter with multipliers. Accurate and marvellously cheap; 55/-. Multipliers extra. Worth £10. The "Dix-Mipanta" is an A.C. D.C. mains-volt-pocket, bakelite Voltmeter. List £2. Trade 19/6. Micro-Ammeter 2 1/2in. panel 0-50 m/m, 40/-. 1,000 switchboard, Service and panel Meters in stock, lowest prices. Meters, all ranges, 50 microamps, 40/-, Weston Table Meters, 15/6. Charging Volt Testers, 2/6. 0-20 volts, 5/-, 0-50 volts, 5/-. 0-100 volts, 5/-, 0-200 volts, 6/-. All A.C. or D.C. Repairs to all types. 1,000 other bargains in New Sale List "N" post free.

ELECTRADIX RADIOS,
218, Upper Thames Street, London, E.C.4. Phone: Central 4611.

RADIO BARGAINS

AMAZING prices. I lead, others follow. All-wave A.C./D.C. Table models, £6/15/0; Halcyon A.C.7, £7/7/0; Halcyon, A.C./D.C., Listed 14 gns., £7/7/0; Austin twin Rola speakers, Listed 15 gns., £7/7/0; A.C./D.C. Compacts, 65/-. Other Mains receivers, £5. Stamp for list. Speakers, Components, English, American Valve replacements. Full stock the amazing All-wave Ferguson models. Trade supplied. State requirements.—Littler, The Midland Dealer, 2, Barras Lane, Coventry.

LETTERS FROM READERS

The Editor does not necessarily agree with opinions expressed by his correspondents.



All letters must be accompanied by the name and address of the sender (not necessarily for publication).

S.W. Listeners' Review

SIR,—In reply to J. W. Ismay's letter regarding the "Short-wave Listeners Review," I don't know whether his glasses were fogged or what, but if he will use a little intelligence and re-examine the "Review" and read it properly, he will find it definitely does not rely on the QSL card for its existence. Suppress the QSL card and I doubt if it would account for one page of the "Review."

As regards transmitters wasting their time and money replying to reports, that cuts both ways. Why should S.W.L.'s waste time and International Reply Coupons if their reports go unanswered? Mr. Ismay says there are thousands of fictitious and exaggerated reports circulated throughout the world. Perhaps he will kindly explain how he knows that. If I were to report G6JI QSA5, R8; QSB to R5, G6JI does not know whether my report is exaggerated; there is only one person who knows, and that's the S.W.L. who sends the report.

I greatly admire Mr. Everard in publishing a blacklist; a "Ham" who receives a report with International Reply Coupon regardless of whether it's of value or not and hasn't the courtesy to reply, deserves blacklisting.

Mr. Ismay says the S.W.L.'s killed the "Goose that laid the golden eggs." No such thing. The "Goose" is very much "alive" to-day, so much so that I have dozens of QSL cards at my QRA, from various parts of the world and several from across the Channel, who ask me to send further reports whenever I hear them.

So S.W.L.'s, by all means send useful reports. Out of some 60,000 amateur transmitters there are thousands who will appreciate your reports. The "Hams" with the same opinion as Mr. Ismay are in the minority.—JOHN A. EDWARDS (Sale).

S.W. Reception in N. Scotland

SIR,—Some months ago I wrote you describing short-wave reception conditions in the north of Scotland. As I have not seen any further reports in your paper, I am sending you my latest report on present conditions.

The 13 m. waveband is poor and W8XX is very difficult to receive. On the 16 m. band things are much better. W3XAL provides a strong signal. GSG is fairly well received but usually fades rather rapidly. Stations on the above bands can only be received in daylight up till about 4 p.m., after which they fade out. On the 19 m. band DJB, FYA, and GSF are all R9. W2XAD also provides a very strong signal, and gives 3-4 hours entertainment each afternoon. W8XX also is very reliable on this band which only gives reception up till about 4 p.m.

The 20 m. amateur band is very reliable, and signals can be heard here at almost any time. Americans come over very well indeed during daylight, and also during the evening. Switzerland, Holland, Portugal and Italy all come in well on this band.

On 25 m. conditions are at their best,

and many stations may be relied upon to give continuous entertainment. This band is at its best about 6-7 p.m.

On the 30 m. band conditions are excellent, signals from Portugal, Germany, Italy, Moscow, U.S.A., and Denmark being received at good loud-speaker strength after 6 p.m.

On the 40 m. amateur band multitudes of stations may be heard. I find Sunday mornings are the best. On Sunday afternoon it becomes a hopeless jumble, and the QRM is unbearable. British amateurs are replaced in the evenings by French amateurs putting out very badly distorted speech and music. The 49 m. band can best be described as a "mess"! The stations just pile in on top of each other, and the band seems to have spread far beyond its limits.

Very few amateurs are heard on the 160 m. band. In fact, I consider it good going if I log more than half a dozen of them after several hours of searching!

My set is home-constructed and consists of an untuned S.G. stage followed by the ordinary detector and 2 L.F. I have a jack for cutting out one of the L.F. stages so that I can feed the signals into a 12-watt power amplifier which employs 2 PX25.s in the output and drives two loud-speakers. I find this a good method of checking up quality of stations.

My aerial is about 30ft. long, running east and west. I hope this report will be of some interest to other readers.—A. H. MILLER (Strathpeffer, Ross-shire).

Back Number Wanted

ONE or two readers are anxious to obtain a copy of *Amateur Wireless* dated June 9th, 1934. If any readers who have this copy to spare will send them on to this office they will be forwarded to the readers requiring them.

Reception of W2XEM

SIR,—I have just received a letter from Newark's "Department of Public Safety," confirming reception of their police transmitter W2XEM on 30.1 mc/s. Details of their transmitter are as follows: 500 watts with Class "B" amplification. Frequency is crystal controlled to within 25 cycles, and is obtained by doubling the third harmonic of the crystal stages. Transmitter is housed within Newark's tallest building and is on the thirty-fourth floor. The antenna consists of a half-wave vertical "chaffie impedance" on top of the hollow steel flag mast 100ft. long on top of building. The antenna is energised by a concentric feed some 200ft. long. Starting at the transmitter, this feed goes through a concrete floor, up a hollow tile wall, through flag mast and connects to antenna. This places antenna 650ft. above the street level. The transmitter is powered by an A.C. voltage network—three-phase, 208 volts—supplied by local light and power company. Alarms are dispatched from a central room at Police H.Q., about half a mile from transmitter. Receivers are Western Electric superhets powered by dynamotors.

Their station is being consistently heard throughout South-west U.S.A., but to date

mine is but the seventh report from the British Isles.

Further reports will be appreciated.—
JOHN C. BARRON (Aberdeen).

This QSL Business!

SIR,—If I had not sent out reports to amateurs in various countries and continents since my return from service overseas, I feel I should have missed a very great deal. It sometimes happens that a far distant amateur gets an unexpected report, indeed, the first he has ever had from that country, and he is pleased—especially when he finds the other fellow knows his language, or, again, when it is extra good DX. Sometimes it has indicated to the sender far away that a relative in Europe, say, could do the same as the one who sent that QSL, and, to say the least of it, he is both grateful and pleased. My radio friends in many cases I know by photo, by voice, and by letter, and both sides experience evident pleasure in that way of contact and exchange of views. The real amateur co-operates with many friends, and, as far as I am concerned, it is not always DX—or cards—that are the consideration, but to offer information where it is wanted, because there are still many, many things about the propagation of short waves that nobody yet knows.

All my reports go direct by post—if reports are not accurate they are not worth the stamp nor the paper—and some of the replies to my QSL's come by air. I am a practised linguist of time before the war, and, therefore, am keen on all that leads to understanding other people. In amateur radio our friends' friends are our friends, and vice versa. I do not keep a Black List but. . . —DELEGATE FOR RUEDA ASSOCIATION OF BUENOS AIRES (Southampton).

CUT THIS OUT EACH WEEK.

Do you know

- THAT the down-lead attached to a doublet aerial should not be less than half a wavelength long.
- THAT dead-spots in the tuning of a short-wave receiver may often be found to be due to an unsuitable H.F. choke.
- THAT an extension speaker may be connected direct to the two anodes of a push-pull output stage, without the inclusion of fixed condensers.
- THAT the crystal used in a transmitter should not be handled, as grease will affect its properties.
- THAT when cleaning a crystal of the above type, or a crystal used in a crystal receiver, petrol is not suitable.
- THAT an insulated top-cap connector should be fitted to the high-voltage rectifiers such as are employed for television apparatus.

The Editor will be pleased to consider articles of a practical nature suitable for publication in PRACTICAL AND AMATEUR WIRELESS. Such articles should be written on one side of the paper only, and should contain the name and address of the sender. Whilst the Editor does not hold himself responsible for manuscripts, every effort will be made to return them if a stamped and addressed envelope is enclosed. All correspondence intended for the Editor should be addressed: The Editor, PRACTICAL AND AMATEUR WIRELESS, George Newnes, Ltd., Tower House, Southampton Street, Strand, W.C.2.

Owing to the rapid progress in the design of wireless apparatus and to our efforts to keep our readers in touch with the latest developments, we give no warranty that apparatus described in our columns is not the subject of letters patent.

FREE ADVICE BUREAU COUPON

This coupon is available until February 6th, 1937, and must be attached to all letters containing queries.
PRACTICAL AND AMATEUR WIRELESS,
30/1/37.

CLIX

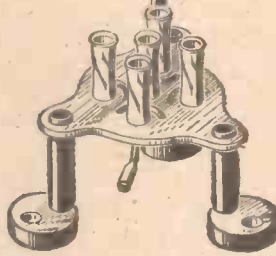

CLIX VALVEHOLDERS

Two 4-pin ... 1/9 each
One 5-pin ... 2/- each
(With Terminals)

As specified for the "Telecent."

Yours faithfully
LECTRO LINX LIMITED

79^A ROCHESTER ROW. LONDON S.W.1

LOUD SPEAKER CONTROL PANEL

"A useful device and a valuable safeguard."

Vide: "Practical and Amateur Wireless," Sept. 12th, 1936.

"A useful device for fitting to the "TELECENT" so that an external loudspeaker or headphones may be used in conjunction with the internal one, or without it, or the internal speaker used alone."

Vide: "The Wireless World," Nov. 27th, 1936.

Specified for the "TELECENT"



1/-
Complete as illustrated.

Fault Tracing with precision

Don't let faults stump you. Every cause of trouble is accurately revealed by the AvoMinor. Thirteen Meters in One. Provides unique testing facilities. Milliamp ranges sufficient for testing all valves and apparatus. Six voltage ranges for all radio voltage tests. Ohms ranges adequate for all resistance tests. In case, with leads, testing prods, crocodile clips, and Instruction Booklet.

13 Meters in One

- Current
- 0-6 m/amps.
- 0-30 "
- 0-120 "
- Voltage
- 0-6 volts
- 0-12 volts
- 0-120 volts
- 0-240 volts
- 0-300 volts
- 0-600 volts
- Resistance
- 0-10,000 ohms
- 0-60,000 ohms
- 0-1,200,000 "
- 0-3 megohms

Price **45/-**



BRITISH MADE

Deferred Terms if desired

The D.C. **AVOMINOR**
REGD. TRADE MARK

Write for descriptive pamphlet and details of Easy Terms.

THE AUTOMATIC COIL WINDER & ELECTRICAL EQUIPMENT CO., LTD.
Winder House, Douglas St., London, S.W.1
Vic. 3404/7

You've paid your Licence
You've got your set
AND IF you've used
FLUXITE—
You won't need a "VET."



See that **FLUXITE** is always by you—in the house—garage—workshop—wherever speedy soldering is needed. Used for 30 years in government works and by leading engineers and manufacturers. Of Ironmongers—in tins, 4d., 8d., 1/4 and 2/8. Ask to see the **FLUXITE SMALL-SPACE SOLDERING SET**—compact but substantial—complete with full instructions, 7/6. Write for Free Book on the art of "soft" soldering and ask for Leaflet on **CASE-HARDENING STEEL and TEMPERING TOOLS** with **FLUXITE**.

TO CYCLISTS! Your wheels will NOT keep round and true, unless the spokes are tied with the fine wire at the crossings AND SOLDERED. This makes a much stronger wheel. It's simple—with **FLUXITE**—but IMPORTANT.

THE FLUXITE GUN

is always ready to put Fluxite on the soldering job instantly. A little pressure places the right quantity on the right spot and one charging lasts for ages. Price 1/6.



ALL MECHANICS WILL HAVE

FLUXITE

IT SIMPLIFIES ALL SOLDERING

FLUXITE LTD. (Dept. W.P.) DRAGON WORKS,
BERMONDSEY STREET, S.E.1.

Practical and Amateur Wireless BLUEPRINT SERVICE

PRACTICAL WIRELESS.

CRYSTAL SETS.

Blueprint, 6d.	Date of Issue.	No. of Blueprint
1937 Crystal Receiver	9.1.37	PW71
STRAIGHT SETS. Battery Operated.		
One-valve: Blueprint, 1s.		
All-wave Unipen (Pentode)		PW31A
Two-valve: Blueprint, 1s.		
Four-range Super Mag Two (D, Pen)	11.8.34	PW36B
Three-valve: Blueprints, 1s. each.		
Selectone Battery Three (D, 2 LF (Trans))		PW10
Sixty Shilling Three (D, 2LF (RC & Trans))		PW34A
Leader Three (SG, D, Pow)		PW35
Summit Three (HF Pen, D, Pen)	8.8.34	PW37
All Pentode Three (HF Pen, D (Pen), Pen)	22.9.34	PW39
Hall-Mark Three (SG, D, Pow)		PW41
Hall-Mark Cadet (D, LF, Pen, (RC))	16.3.35	PW48
F. J. Camm's Silver Souvenir (HF Pen, D (Pen), Pen) (All-Wave Three)	13.4.35	PW49
Genet Midget (D, 2 LF (Trans))	June '35	PM2
Cameo Midget Three (D, 2 LF (Trans))	8.6.35	PW51
1936 Sonotone Three-Four (HF Pen, HF Pen, Westector, Pen)	17.8.35	PW53
Battery All-Wave Three (D, 2 LF (RC))		PW55
The Monitor (HF Pen, D, Pen)		PW61
The Tutor Three (HF Pen, D, Pen)	21.3.36	PW62
The Centaur Three (SG, D, P)		PW64
The Gladiator All-Wave Three (HF Pen, D, Pen)	29.8.36	PW66
F. J. Camm's Record All-Wave Three (HF Pen, D, Pen)	31.10.36	PW69
The "Colt" All-Wave Three (D, 2 LF (RC & Trans))	5.12.36	PW72
Four-valve: Blueprints, 1s. each.		
Fury Four (2 SG, D, Pen)		PW11
Beta Universal Four (SG, D, LF, Cl. B)		PW17
Nucleon Class B Four (SG, D (SG) LF, Cl. B)	6.1.34	PW34B
Fury Four Super (SG, SG, D, Pen) Battery Hall-Mark 4 (HF, Pen, D, Push-Pull)		PW40
F. J. Camm's "Limit" All-Wave Four (HF Pen, D, LF, P)	26.9.36	PW67
Mains Operated.		
Two-valve: Blueprints, 1s. each.		
A.C. Twin (D (Pen), Pen)		PW18
A.C.-D.C. Two (SG, Pow)	7.10.33	PW31
Selectone A.C. Radiogram Two (D, Pow)		PW19
Three-valve: Blueprints, 1s. each.		
Double-Diode-Triode Three (HF Pen, DDT, Pen)	10.6.33	PW23
D.C. Ace (SG, D, Pen)		PW25
A.C. Three (SG, D, Pen)		PW29
A.C. Leader (HF Pen, D, Pow)	7.4.34	PW35C
D.C. Premier (HF Pen, D, Pen)	31.3.34	PW35B
Ubique (HF Pen, D (Pen), Pen)	28.7.34	PW36A
Armada Mains Three (HF Pen, D, Pen)	18.8.34	PW38
F. J. Camm's A.C. All-Wave Silver Souvenir Three (HF Pen, D, Pen)	11.5.35	PW50
"All-Wave" A.C. Three (D, 2 LF (R.C.))	17.8.35	PW54
A.C. 1936 Sonotone (HF Pen, HF Pen, Westector, Pen)		PW56
Four-valve: Blueprints, 1s. each.		
A.C. Fury Four (SG, SG, D, Pen)		PW20
A.C. Fury Four Super (SG, SG, D, Pen)		PW34D
A.C. Hall-Mark (HF Pen, D, Push-Pull)		PW45
Universal Hall-Mark (HF, Pen, D, Push-Pull)	9.2.35	PW47
SUPERHETS.		
Battery Sets: Blueprints, 1s. each.		
£5 Superhet (Three-Valve)		PW10
F. J. Camm's 2-valve Superhet (Two-Valve)	13.7.35	PW52
F. J. Camm's £4 Superhet		PW58
Mains Sets: Blueprints, 1s. each.		
A.C. £5 Superhet (Three-Valve)		PW43
D.C. £5 Superhet (Three-Valve)	1.12.34	PW42
Universal £5 Superhet (Three-Valve)		PW44
F. J. Camm's A.C. £4 Superhet 4		PW59
F. J. Camm's Universal £4 Superhet 4		PW60
SHORT-WAVE SETS.		
Two-valve: Blueprint, 1s.		
Midget Short-Wave Two (D, Pen)	15.0.34	PW38A
Three-valve: Blueprints, 1s. each.		
Experimenter's Short-Wave Three (SG, D, Pow)		PW30A
The Prefect 3 (D, 2 LF (RC and Trans))		PW63
The Bandsread S.W. Three (HF Pen, D (Pen), Pen)	29.8.36	PW69

PORTABLES.

Three-valve: Blueprint, 1s.		
F. J. Camm's ELF Three-valve Portable (HF Pen, D, Pen)	16.5.36	PW65
Four-valve: Blueprint, 1s.		
Featherweight Portable Four (SG, D, LF, Cl. B)		PW12
MISCELLANEOUS.		
S.W. Converter-Adapter (1 valve)		PW48A
AMATEUR WIRELESS AND WIRELESS MAGAZINE CRYSTAL SETS.		
Blueprints, 6d. each.		
Four-station Crystal Set	12.12.36	AW427
1934 Crystal Set		AW444
150-mile Crystal Set		AW450
STRAIGHT SETS. Battery Operated.		
One-valve: Blueprints, 1s. each.		
B.B.C. Special One-valver		AW387
Twenty-station Loudspeaker One-valver (Class B)		AW449
Two-valve: Blueprints, 1s. each.		
Melody Ranger Two (D, Trans)		AW388
Full-volume Two (SG det. Pen)		AW392
B.B.C. National Two with Lucerne Coil (D, Trans)		AW377A
Big-power Melody Two with Lucerne Coil (SG, Trans)		AW338A
Lucerne Minor (D, Pen)		AW426
A Modern Two-valver	July '36	WM409
Three-valve: Blueprints, 1s. each.		
Class B Three (D, Trans, Class B)		AW386
New Britain's Favourite Three (D, Trans, Class B)	15.7.33	AW394
Home-built Coil Three (SG, D, Trans)		AW404
Fan and Family Three (D, Trans, Class B)	25.11.33	AW410
£5 5s. S.G.3 (SG, D, Trans)	2.12.33	AW412
1934 Ether Searcher: Baseboard Model (SG, D, Pen)		AW417
1934 Ether Searcher: Chassis Model (SG, D, Pen)		AW419
Lucerne Ranger (SG, D, Trans)		AW422
Cosser Melody Maker with Lucerne Coils		AW423
Mullard Master Three with Lucerne Coils		AW424
£5 5s. Three: De Luxe Version (SG, D, Trans)	19.5.34	AW435
Lucerne Straight Three (D, RC, Trans)		AW437
All-Britain Three (HF Pen, D, Pen) "Wireless League" Three (HF Pen, D, Pen)		AW448
Transportable Three (SG, D, Pen)	3.11.34	AW451
£6 6s. Radiogram (D, RC, Trans)		WM271
Simple-tune Three (SG, D, Pen)	June '33	WM318
Economy-Pentode Three (SG, D, Pen)	Oct. '33	WM327
"W.M." 1934 Standard Three (SG, D, Pen)		WM337
£3 3s. Three (SG, D, Trans)	Mar. '34	WM351
Iron-core Band-pass Three (SG, D, QP 21)	June '34	WM354
1935 £6 6s. Battery Three (SG, D, Pen)		WM362
PTP Three (Pen, D, Pen)	June '35	WM371
Certainty Three (SG, D, Pen)	Sept. '35	WM389
Minutube Three (SG, D, Trans)	Oct. '35	WM393
All-wave Winning Three (SG, D, Pen)	Dec. '35	WM396
Four-valve: Blueprints, 1s. 6d. each.		
65s. Four (SG, D, RC, Trans)		AW370
"A.W." Ideal Four (2 SG, D, Pen)	16.9.33	AW402
2 H.F. Four (2 SG, D, Pen)		AW421
Crusaders' A.V.C. 4 (2 HF, D, QP 21)	18.8.34	AW445
(Pentode and Class B Outputs for above: Blueprints, 6d. each)	25.8.34	AW445A
Self-contained Four (SG, D, LF, Class B)	Aug. '33	WM331
Lucerne Straight Four (SG, D, LF, Trans)		WM350
£5 5s. Battery Four (HF, D, 2 LF)	Feb. '35	WM381
The H.K. four (HF Pen, HF Pen, D, Pen)	Mar. '35	WM384
The Auto Straight Four (HF Pen, HF Pen, DDT, Pen)	April '36	WM404
Five-valve: Blueprints, 1s. 6d. each.		
Super-quality Five (2 HF, D, RC, Trans)	May '33	WM329
Class B Quadradyne (2 SG, D, LF, Class B)	Dec. '33	WM344
Mains Operated.		
Two-valve: Blueprints, 1s. each.		
Consoelectric Two (D, Pen) A.C.		AW403
Economy A.C. Two (D, Trans) A.C.		WM286
Unicorn A.C./D.C. Two (D, Pen)	Sept. '35	WM394
Three-valve: Blueprints, 1s. each.		
Home-Lover's New All-electric Three (SG, D, Trans) A.C.		AW383

These blueprints are drawn full size. Copies of appropriate issues containing descriptions of these sets can in some cases be supplied at the following prices, which are additional to the cost of the blueprint. A dash before the Blueprint Number indicates that the issue is out of print.

Issues of Practical Wireless	4d. Post paid
" Amateur Wireless	4d. "
" Practical Mechanics	7d. "
" Wireless Magazine	1/3. "

The Index letters which precede the Blueprint Number indicate the periodical in which the description appears; thus, PW refers to PRACTICAL WIRELESS, AW to Amateur Wireless, PM to Practical Mechanics, WM to Wireless Magazine. Send (preferably) a postal order to cover the cost of the blueprint and the issue (stamps over 6d. unacceptable), to PRACTICAL AND AMATEUR WIRELESS Blueprint Dept., Geo. Newnes, Ltd., Tower House, Southampton Street, Strand, W.C.2.

Three-Valve: Blueprints, 1s. each (contd.)		
S.G. Three (SG, D, Pen) A.C.		AW390
A.C. Triodyne (SG, D, Pen) A.C.	19.8.33	AW399
A.C. Pentaquester (HF Pen, D, Pen) A.C.	23.6.34	AW439
Mantovani A.C. Three (HF, Pen, D, Pen) A.C.		WM374
£15 15s. 1936 A.C. Radiogram (HF, D, Pen)	Jan. '36	WM401
Four-valve: Blueprints, 1s. 6d. each.		
All Metal Four (2 SG, D, Pen)	July '33	WM326
Harris Jubilee Radiogram (HF Pen, D, LF, P)	May '35	WM386
SUPERHETS.		
Battery Sets: Blueprints, 1s. 6d. each.		
Modern Super Senior		WM375
Varsity Four	Oct. '35	WM395
The Request All-Waver	June '36	WM407
1935 Super Five Battery (Superhet)		WM370
Mains Sets: Blueprints, 1s. 6d. each.		
1934 A.C. Century Super A.C.		AW425
Heptode Super Three A.C.	May '34	WM359
"W.M." Radiogram Super A.C.		WM366
1935 A.C. Stenode	Apr. '34	WM385
PORTABLES.		
Four-valve: Blueprints, 1s. 6d. each.		
Midget Class B Portable (SG, D, LF, Class B)	20.5.33	AW389
Holiday Portable (SG, D, LF, Class B)	1.7.33	AW393
Family Portable (HF, D, RC, Trans)	22.9.34	AW447
TWO H.F. Portable (2 SG, D, QP21)	June '34	WM363
Tyers Portable (SG, D, 2 Trans)		WM367
Five-valve: Blueprint, 1s. 6d.		
New Class-B Five (2 SG, D, LF, Class B)	Nov. '33	WM340
SHORT-WAVE SETS.—Battery Operated.		
One-valve: Blueprints, 1s. each.		
S.W. One-valve converter (Price 6d.)		AW329
S.W. One-valve for America	23.1.37	AW420
Rome Short-Waver		AW452
Two-valve: Blueprints, 1s. each.		
Ultra-short Battery Two (SG det., Pen)	Feb. '36	WM402
Home-made Coil Two (D, Pen)		AW440
Three-valve: Blueprints, 1s. each.		
World-ranger Short-wave 3 (D, RC, Trans)		AW355
Experimenter's 5-metre Set (D, Trans, Super-regen)	30.6.34	AW438
Experimenter's Short-wave (SG, D, Pen)	Jan. 19, '35	AW463
The Carrier Short-waver (SG, D, P)	July '35	WM390
Four-valve: Blueprints, 1s. 6d. each.		
A. W. Short-wave World-Beater (HF, Pen, D, RC, Trans)		AW436
Empire Short-waver (SG, D, RC, Trans)		WM313
Standard Four-valve Short-waver (SG, D, LF, P)	Mar. '35	WM383
Superhet: Blueprint, 1s. 6d.		
Simplified Short-wave Super	Nov. '35	WM397
Mains Operated.		
Two-valve: Blueprints, 1s. each.		
Two-valve Mains short-waver (D, Pen) A.C.		AW453
"W.M." Band-spread Short-waver (D, Pen) A.C./D.C.		WM368
"W.M." Long-wave Converter		WM390
Three-valve: Blueprint, 1s.		
Emigrator (SG, D, Pen) A.C.		WM352
Four-valve: Blueprint, 1s. 6d.		
Standard Four-valve A.C. Short-waver (SG, D, RC, Trans)	Aug. '35	WM391
MISCELLANEOUS.		
Enthusiast's Power Amplifier (1/6)	June '35	WM387
Listener's 5-watt A.C. Amplifier (1/6)	Sept. '35	WM392
Radio Unit (2v.) for WM392 (1/-)	Nov. '35	WM393
Harris Electrogram (battery amplifier) (1/-)	Dec. '35	WM399
De-Luxe Concert A.C. Electrogram	Mar. '36	WM403
New Style Short-waver Adapter (1/-)	June '35	WM388
Trickle Charger (6d.)	Jan. 5, '35	AW462
Short-wave Adapter (1/-)	Dec. 1, '34	AW456
Superhet Converter (1/-)	Dec. 1, '35	AW457
B.L.D.L.C. Short-wave Converter (1/-)	May '36	WM405
Wilson Tone Master (1/-)	June '36	WM406
The W.M. A.C. Short-wave Converter (1/-)	July '36	WM408



QUERIES and ENQUIRIES

Accumulator Charging

"I have two 60-volt blocks of high-tension accumulators and want to charge them at a quarter of an amp. each block. My mains supply is 100 volts D.C. What wattage of lamp is required to charge the above accumulators? I am asking this for the purpose of clearing up an argument, as I have already told a fellow a 50-watt lamp is required, but am told I'm nowhere near the right wattage. Perhaps, if you would state in your Queries column the correct wattage, it would help to clear up a little misunderstanding."—W. M. (Kirkconnel).

AS the blocks are to be connected in parallel the total current may be double, and thus .5 amps. may be passed. Wattage is the product of volts and amps., and, therefore, 100 multiplied by .5 will give you 50 watts, which, as you state, is the correct value. To lower the charging rate to, say, quarter of an amp. you would need 100 multiplied by .25 or 25 watts.

Receiving Television

"Is it possible to obtain successfully the television transmissions, on ultra-short-waves, with the 'Home-made Televisor' described in 'Fifty-Tested Wireless Circuits,' using a good 2 or 3 valve set, or is the definition too high."—B. N. (W.14).

AS the television receiver in question utilises a scanning disc with 30 holes it could not be used alone for the reception of the present high-definition signals. Theoretically, the scanning disc of this type is useless for high-definition systems, but there may be some method in which multipliers, consisting of one or more scanning discs fitted with slots arranged in a definite manner, or of mirrors, may be used to obtain a 240 line picture. The illumination would be decreased, of course, and some method of improving brilliancy would have to be adopted. If you desire to experiment in this connection, it would be preferable to use a mirror-drum or mirror-screw, as these enable a much brighter light source to be adopted. So far as we are aware, there is no satisfactory manner of carrying out the reception of the present vision signals on any apparatus other than the cathode-ray tube receiver.

Converting a Short-waver

"I have a commercial 5-valve superhet short-wave battery-operated set, and having recently received a gift of a short-wave set, built to a circuit published by you last August, I find that this is better than the one referred to previously. I have accordingly

decided to convert this to an ordinary receiver. Would you please advise me how to do this? I presume that I shall have to get another coil system. What type do you recommend? I just want it to cover from 200 to 2,000 metres. I should like to congratulate you on the neat little 1937 Crystal Set and the Automatic Two-valver."—D. N. B. H. (Brechin).

IT is contrary to our policy to give instructions for modifying commercial receivers. You would probably find it easier to dispose of the receiver as it stands, and with the proceeds obtain the parts to make a modern broadcast set from our pages. To

RULES

We wish to draw the reader's attention to the fact that the Queries Service is intended only for the solution of problems or difficulties arising from the construction of receivers described in our pages, from articles appearing in our pages, or on general wireless matters. We regret that we cannot, for obvious reasons—

- (1) Supply circuit diagrams of complete multi-valve receivers.
- (2) Suggest alterations or modifications of receivers described in our contemporaries.
- (3) Suggest alterations or modifications to commercial receivers.
- (4) Answer queries over the telephone.
- (5) Grant interviews to querists.

Please note also, that queries must be limited to two per reader, and all sketches and drawings which are sent to us should bear the name and address of the sender.

Requests for Blueprints must not be enclosed with queries as they are dealt with by a different department.

If a postal reply is desired, a stamped addressed envelope must be enclosed. Send your queries to the Editor, PRACTICAL AND AMATEUR WIRELESS, George Newnes, Ltd., Tower House, Southampton Street, Strand, London, W.C.2.

The Coupon must be enclosed with every query.

convert the receiver in question you would have to obtain new coils, new I.F. transformers, and a new tuning condenser assembly, and in addition to the expense, you would probably find it very difficult to accommodate these parts on the chassis and to modify the wiring to produce a stable receiver.

Automatic Bias

"I have a six-valve superhet. battery set with output stage Class B. I run this from the D.C. mains with an eliminator. I find this fairly satisfactory only it uses one 16½-volt G.B. battery in less than a month, regulating it so that I get the required voltage. The set has only one G.B.—connection which should be 3½ volts. The output valve is P.M.2B. Would it be possible to use automatic G.B., and how can I fit it? I know it is something like G.B. over current in amps., but I am not sure how to find the milliamps of the valve or valves."—B. A. (Brighton).

AS the output valve is designed to operate with no applied bias, the G.B. tapping is obviously designed to feed

the Driver valve. It is very unusual for the grid battery to run out in such a very short time, and we suspect that there is some leakage. Connect a milliammeter in series with the G.B. tapping, and by this means see if there is any current flowing, both when the set is switched on and off. This will show whether there is a short-circuit, perhaps caused by negative lead coming into contact with the chassis, or a short-circuit between the transformer secondary and the chassis. It is possible to fit automatic bias and for this purpose the G.B. terminal on the L.F. transformer should be connected to earth through two resistors in series, the first having a value of about .25 or .5 megohms; and the second (the one joined to earth) a value of about 500 ohms. To the junction of these two resistors the H.T. negative battery lead should be joined, and a large capacity condenser (1 or 2 mfd.) should then be connected from earth to the G.B. terminal on the L.F. transformer.

The 1937 Crystal Set

"Could you give me the address of the makers of the crystal detector and condenser used in the 1937 crystal set, and the price? Your articles on short-wave sets, etc., are very helpful and have enabled me to get a great deal of enjoyment out of my set that I would not otherwise have had."—W. G. F. (Glasgow, S.3).

THE crystal detector is sold at 2s. 6d. by the Jewel Pen Company of 21, Great Sutton Street, E.C.1, and the condenser is a Formo Product, obtainable from Formo Products, Ltd., Masons Hall, Bromley, Kent, price 6s. 6d., complete with the dial specified. These parts may, of course, be obtained together with the necessary panel, wire and other parts direct from Messrs. Peto-Scott. The complete kit costs 22s. It is proposed to add to the receiver month by month, by easy stages.

An All-wave Aerial

"I wish to make an all-wave aerial. Have you published any details for winding the transformers for this, and could you let me have details of same?"—P. J. W. (Roath, Cardiff).

YOU are apparently confusing the all-wave aerial with the all-wave anti-interference aerial. In an all-wave aerial system it is only necessary to arrange that a short length is employed for short-wave reception and the complete aerial for ordinary wavelengths, or to design the aerial of such a size that it gives good results on all waves. A standard aerial of about 25 feet will answer the second case, or you can arrange to cut out the horizontal portion and use the lead-in only for short waves. For an anti-interference aerial system, impedance-matching transformers are connected at each end of the transmission line to overcome the losses which may be encountered in such a line, and we gave details for constructing these in our issue dated March 10th, 1934.

The coupon on page 609 must be attached to every query.

TO MAKE YOUR SET REALLY SELECTIVE

FIX PIX IN YOUR AERIAL

A PIX can be fitted to any set—battery or mains. Just disconnect your aerial from the set and join it to one end of the PIX—connect the other end to the Aerial terminal. By opening the PIX you can cut out interfering stations and get the one you want.

RECEPTION CLEAR & FREE FROM INTERFERENCE



Miscellaneous Advertisements

Advertisements are accepted for these columns at the rate of 3d. per word. Words in black face and/or capitals are charged double this rate (minimum charge 3/- per paragraph). Display lines are charged at 6/- per line. All advertisements must be prepaid. All communications should be addressed to the Advertisement Manager, "Practical and Amateur Wireless," Tower House, Southampton Street, Strand, London, W.C.2.

RECEIVERS, COMPONENTS AND ACCESSORIES

Surplus, Clearance or Secondhand, etc.

RADIOMART

SHORT-WAVE SPECIALISTS

Announce 1937

SHORT-WAVE MANUAL

Packed with short-wave information and circuits of mains and battery receivers, including straight, superhet and 5-metre transmitters, modulators, etc. Information on transmitting licences, aerials, Class B amplifications, neutralization, superhet alignment, etc. The most comprehensive manual published, written by practical engineers, price 6d., post free 7d., including catalogue.

1937 Catalogue only (3 times enlarged) price 1½d. post free.

TELSEN screened dual range coils, switched, 2/11 each Pair 5/3. Milliammeters, 25 ma. upwards, 5/9. Super, 6/9.

AMERICAN mains transformers 230v. fully shrouded, 350/350, 6.3v., 5v., 6/11. Majestic 250/250, 2.5v., 5v., 4/11.

HEAVERY DUTY mains transformer worth 35/-, 350/350, 150 ma.; 4v. 2.5ACT, 4v. 6ACT, 12/6. 465 KC/S., IF transformers, 2/11. Telsen Ace, 1/11. RG4, Radiogram, 2/9. 2mf. 300v., 9d.

UTILITY straight line wavelength dials, 3/11. Telsen H.F. chokes, 1/11.

UTILITY 2-gang unknob and dial, 3/11; 1,500-volt tubular condensers, all sizes, 6d.

LECTROLYTICS 500-volt 8 mf., 1/6; 4 mf., 1/6; 4x4, 1/11; 8x8, 3/6; 25 mf. 25v., 1/-, etc.

SMOOTHING chokes, 20 hy. 120 ma., 3/11; 100 ma., 2/11; 40 ma., 1/11.

PUSHBACK wire, 6 yds., 6d.; heavy 9d.; 2 gross solder tags, 6d.; resin-cored solder, 9ft., 6d.

CENTRALAB pots, all sizes, 1/6; switched, 2/-; tubular glass fuses, 2d.

JENSON P.M. speakers, 12/6. Varley Iron core coils, 2/6; matched pair, 4/6.

SPECIAL OFFER Class B valve, driver transformer and valveholder, new, 10/5.

TRADERS' monster bargain parcels, value £4/10/-, for 10/-; also 5/- parcels.

FAMOUS Continental A.C. valves, 4/6; American Duotron, etc., all types, 3/6; battery from 2/3.

UTILITY 8/6, microdisc dials, 3/11; Radiophone, 0.00016 short-wave condensers, 3/6; series gap, twin, 3/9.

CERAMIC all brass microvariables, 15 mmfd., 1/4; 40 mmfd., 1/7; 100 mmfd., 1/10; short-wave H.F.C., 6d.

CLEARANCE catalogue 1½d. Goods over 5/- post free. All enquirers must send stamp. Branches: 19, John Bright St., 44, Dale End. Mail Orders, 44, Holloway Head, Birmingham. Telephone, MID 3254.

MISCELLANEOUS

WANTED.—ambitious young men to prepare for well paid posts in TELEVISION, the great career of the future. Apply for free booklet from BRITISH INSTITUTE OF ENGINEERING TECHNOLOGY, 18P, Shakespeare House, 17-19, Stratford Place, London, W.1.

DETECTION. New theory, system, circuits, book, post free 1s. 1d.—D'Arcy Ford, Gandy Street, Exeter.

NEW RECEIVERS, COMPONENTS, AND ACCESSORIES

YOU WANT SOMETHING COMPLETELY DIFFERENT. If you have a nicely furnished home and the stereotyped models you see on every street corner do not appeal to you, you will delight in our superb range of exclusive quality models. We have Radiograms with and without Auto Record Changers, A.C. and A.C./D.C., which are a complete breakaway from the usual types in the local shops. If you prefer good furniture to boxes, if you want outstanding short-wave performance, and above all if you appreciate true quality of reproduction when you hear it, we have what you are looking for. Come and see. Come and listen. You will be agreeably surprised, not only to find that such splendid models exist, but that they can be sold at such very reasonable prices.—WIRELESS SUPPLIES UNLIMITED, 278-280-282, High Street, Stratford, E.15. Maryland 3191.

PREMIER SUPPLY STORES

Offer the following Set Manufacturers' Brand New Surplus Goods at a Fraction of the Original Cost; all goods guaranteed perfect; carr. paid over 5/-; under 5/- postage 6d. extra. Orders under 5/- cannot be sent C.O.D.

ALL POST ORDERS TO JUBILEE WORKS, 167, LOWER CLAPTON RD., LONDON, E.5
CALLERS, AS USUAL, TO 20-22 HIGH ST., CLAPHAM, S.W.4 (Macaulay, 2381). Phone: Amherst 4723
And 165 & 165a, FLEET ST., E.C.4 (Next door to Anderton's Hotel). Central 2833.

MAINS VALVES, famous Europa 4 v. A.C. types, 4/8 each. H.L., L., S.G., Var.-Mu-S.G., H.F.-Pens., Var.-Mu.-H.F.-Pens. 1, 3 and 4-watt A.C. directly-heated output Pentodes. Full-wave rectifiers, 250 v. 60 m.a. A.C./D.C. types. 20-volt, .18 amp. S.G., Var.-Mu.-S.G., H., H.L., Power.

Following Types all 5/6 each. Full-wave rectifiers, 250 v. 120 m.a. and 500 v. 120 m.a. 2½ watt indirectly-heated Pentodes, Frequency Changers, Octodes and Heptodes.

BATTERY VALVES, 2 volts H.F., L.F., 2/3. Power, Super-Power, 2/9. S.G., Var.-Mu-S.G., 4- or 6-pin Pentodes, H.F. Pens., V.-Mu.-H.F. Pens., 5/-, Class B, 3/8.

AMERICAN VALVES, Genuine American HYTRON and TRIAD first-grade Valves. 3 months' guarantee. All types in stock, 5/6 each. 210 and 250, 3/8 each. New Metal-Glass Valves, all types, 5/6 each. Genuine American DUOTRON Valves, all types, 3/8 each. Valve holders for all above types, 6d. each. Metal bases, 9d. each.

SHORT-WAVE COILS, 4- and 6-pin types, 13-26, 22-47, 41-94, 78-170 metres, 1/9 each, with circuit. Special set of 3 4-pin S.W. Coils, 14-150 metres, 4/- set, with circuit. Premier 3-band S.W. Coil, 11-25, 15-43, 35-85 metres. Simplified S.W. receiver construction, suitable any type circuit, 2/6. **COIL FORMERS**, in finest plastic material, 1½in. low-loss ribbed, 4- or 6-pin, 1/- each.

SUPER CERAMIC CONDENSERS, S.L.F. .00016, .0001, 2/9 each; double-spaced, .00005, .000025, .000015, 3/- each. All brass with integral slow motion, .00015 tuning, 3/9; .00015 reaction, 2/9. British Radiophone 2-gang .00016, 5/6.

H.F. CHOKES, S.W. 10-200 metres, 9d.; S.W. screened, 1/6; standard screened 180-2000 metres, 1/6. Telsen 200-2,000 Binocular H.F. Chokes, 1/6.

NEW 1937 SHORT-WAVE KIT for 1 valve Receiver or Adaptor, 13-80 metres, 12/6. **VALVE GIVEN FREE!** **DE LUXE MODEL, 17/6. SUPERHET CONVERTER KIT, 13/6. S.W. SUPERHET CONVERTER** for A.C. Mains Receivers, 20/-. A.C. Valve given FREE!

2-VALVE S.W. KIT 19/6. VALVES GIVEN FREE! **3-VALVE S.W. KIT 8/6. Del and Pen., 42/-. VALVES GIVEN FREE!**

BAND-PASS TUNING PACK comprising set of Telsen 3-gang iron-cored coils with switching mounted on steel chassis with 3-gang condenser, illuminated disc-drive and 4 valve holders 25/- the lot. All Mains or Battery circuit. FREE!

SPECIAL OFFER, LISSEN 2-GANG ALL-WAVE COILS, 12-2,000 metres, with switching and circuit diagram, 6/11 set.

3-VALVE BAND-PASS KIT, 200-2,000 metres. Complete kit of parts, including chassis, all components, valves, M.O. speaker and wiring diagram. Battery Model 50/-. A.C. Mains Model, 70/-.

Wire-end type **MAINS TRANSFORMERS** with screened Primaries, tapped 200-250 v. All Filaments O.T. Guaranteed One Year. H.T. 8 and 9 or H.T. 10 with 4 v. 4 a. C.T. and 4 v. 1 a. C.T. 8/6, 250-250 v. or 300-300 v. 60 m.a. 4 v. 1 a., 4 v. 2 a. and 4 v. 4 a., all C.T., 9/6. 350-350 v. 120 m.a. 4 v. 1 a., 4 v. 2 a., and 4 v. 4 a., all C.T. Any of these transformers with engraved panels and N.P. terminals, 1/6 extra.

500-500 v. 150 m.a., 4 v. 2-3 a., 4 v. 2-3 a., 4 v. 2-3 a., 4 v. 3-4 a., all C.T., 17/8. Super Model, 19/8.

Auto transformers, step up or down. 60 watts, 7/6; 100 watts, 10/-.

SPECIAL OFFER PLESSEY mfg. type transformer, 350-350 v. 120 m.a., 4 v. 2 a., 4 v. 3-5 a., 3/8. U.S.A. mains transformer 300-300 v. 90 m.a. 5 v. 2 a. and 6.3 v. 1-3 a., 6/11.

HAVE YOU HAD OUR GIANT ILLUSTRATED CATALOGUE AND VALVE LIST? IF NOT, SEND 4d. IN STAMPS FOR THIS AMAZING LIST OF BARGAINS!

SMOOTHING CHOKES, 25 m.a., 2/9. 40 m.a., 4/-; 60 m.a., 5/6; 150 m.a., 10/6. 2,500 ohms, 60 m.a. Speaker Replacement Chokes, 5/6.

MILLIAMMETERS, moving-iron, flush 2½in., all ranges from 0-10 m.a., 5/9. Visual tuning, 0 or 12 m.a., 5/9. Moving-coil meters, 2½in. 0-1 m.a., 18/6; 3½in. 0-1 m.a., 22/6. Multipliers, 1/- each.

AMPMETERS, all ranges, from 0-1 amp., 5/9. **TELSEN A.C./D.C. MULTIMETERS**, 3 and 30 m.a., 8, 15 and 240 v., 8/6.

TRANSFORMERS, latest type Telsen R.G.4 (list 12/6), 2/9. Lissen Hypernik Q.P.P. (list 12/6), 3/6. **ORMOND Midget Parafed transformer**, manufacturer's type, 2- OUTPUT TRANSFORMERS, Power or Pentode, 2/8; Multi-Ratio, 4/8; Push-Pull Input Transformers by prominent manufacturer, 4/8 each.

ELIMINATOR KITS, for A.C. mains, 120 v. 20 m.a., or 150 v. 25 m.a., 15/-, tapped S.G., det. and output. Complete Kit with long-life valve rectifier (replacement cost only 2/-).

PREMIER L.T. CHARGER KITS for A.C. mains, including Westinghouse Rectifiers and Tapped Mains Transformers. 8 volt at 1 amp., 14/8; 8 volts 1 a., 17/8; 15 volts 1 a., 19/-; 8 volts 2 a., 25/6.

TELSEN iron-cored screened coils, W.349, 4/- each. Electric **SOLDERING IRONS**, 200-250 v., A.C./D.C., 2/3

PREMIER H.T. KITS, all with Westinghouse rectifiers; tapped transformers and adequate smoothing. All Kits absolutely complete. 120 v. 20 m.a., 20/-; with 4 a. L.T. Charger, 28/-; 150 v. 30 m.a., 25/-; with 4 a. L.T. Charger, 31/6; 250 v. 60 m.a., with 4 v. 3 a. C.T., 30/-.

MAGNAVOX Mains energised M.C. SPEAKERS, 154, 7½in. cone, 2,500 ohms 4 watts, 12/6; "112" 9½in. cone, 2,500 ohms 17/6; "152" "Magna" 9½in. cone, 2,500 ohms, 6 watts, 37/6. Magnavox P.M.s.—"254" 7½in. cone, 16/6; "262" 9½in. cone, 22/6. Reliable P.M.s 10/6. **ROLA** latest type P.M.s 18/6.

GOODMANS' 6in. mains energised, 1,000 ohms field, 10/8 each. **JENSON P.M.s**, 10/8.

Potentiometers by well-known makers. All values up to 1 meg., 2/-; with switch, 2/6.

COSMOCORD PICK-UPS with arm and vol. control, 10/8 each. **PICK-UP HEADS** only, 4/6 each.

TUBULAR CONDENSERS, non-inductive, all values up to 5 mfd., 6d. each.

Wire-end **RESISTORS**, any value, 1 watt, 6d.; 4 watts, 1/-; 8 watts, 1/6; 15 watts, 2/-; 25 watts, 2/6 each.

Reliable **MORSE KEYS** with Morse Code engraved on bakelite base, 2/- each.

Bakelite case **BUZZERS**, 1/6, Walnut Case "Loudtone," 2/6 each.

Super Quality lightweight **HEADPHONES**, 3/9 pair.

HIGH-GRADE I.F. TRANSFORMERS, 465 kc. Ceramic trimmers, 5/6.

1936 TELSEN Iron-cored 3-Gang Band-Pass Coils with integral switching, 200-2,000 metres, 12/6 set, with instruction Booklet.

ELECTROLYTICS, U.S.A. 4, 8 or 16 mfd. 500 v. peak, 1/9 each. Dubilier, 4 or 8 mfd. 500 v. 3/-; 50 mfd. 50 v. 1/6; 10 mfd. 50 v. 6d.; 25 mfd. 25 v. 1/-; T.C.C. 4 or 8 mfd. 650 v. 4/-; 15 mfd. 50 or 100 v. 1/-; 60 mfd. 12 v. 1/-; Paper Condensers. V.E. 250 v. working 4 mfd., 2/-; 2 mf., 1/8. 1 mf., 6d.; 350 v. working 4 mfd. 2/6; 2 mf., 1/8. Dubilier 500 v. working 4 mf., 4/-; 800 v. 4 mfd., 6/-.

RECEIVERS, COMPONENTS AND ACCESSORIES

3/- EACH—American valves all popular types. 90-day guarantee. Full range in stock. National Union, Hytron, Triad, Metal, Glass and M.G. Send for lists.

3/- EACH—Mullard, Cosor, Mazda, Marconi, Osram valves for D.C. receivers; all perfect. 90-day guarantee. State type: Send cash or C.O.D. **RADIOGRAPHIC, LTD.**, 66, Osborne Street, Glasgow, G.1.

SITUATIONS VACANT

YOU CAN USE YOUR SPARE TIME to Start a Mail Order Business that quickly brings you a full-time income. Follow the lead of others who are averaging £12 per week net profits. Get away from a drudgery routine job—join the big-money class. No previous experience necessary. Few pounds capital only needed. No samples or outfits to buy; no rent, rates or canvassing. New method makes success certain. Write to-day for **FREE BOOKLET** to Business Service Institute (Dept. 84D), 6, Carmelite Street, London, E.C.4.

LOUDSPEAKER REPAIRS

REPAIRS to Moving Coil Speakers, Cones and Coils fitted or rewound. Fields altered. Prices Quoted including Eliminators. Loudspeakers Re-paired, 4/-; L.F. and Speech Transformers, 4/- post free. Trade invited. Guaranteed. Satisfaction. Prompt Service. Estimates Free. L.S. Repair Service, 5; Balham Grove, London, S.W.12. Batterssea 1321.

VALVES

NOTHING better available. **SIX MONTHS' GUARANTEE**, complete range of **BATTERY, A.C. MAINS, RECTIFIERS** always in stock. 2½in. Det., H.F., L.F., 2/3. **POWER 2/9, SCREEN GRID, PENTODE, H.F. PENTODE 5/-**. American types, fully guaranteed, 5/6 each, Nos. 18, 24A, 35, 42, 43, 45, 47, 56, 57, 68, 75, 77, 78, 80, 2A5, 2A6, 2A7, 6A7, 2B7, 6B7, 6C6, 6D6, 25Z5, 25Y5. Write for other prices to Dulci Electrical Co., Ltd., Devonshire Works, Duke's Avenue, Chiswick, W.4.

RECEIVERS, COMPONENTS AND ACCESSORIES

Surplus, Clearance or Secondhand, etc.

SOUTHERN RADIO'S WIRELESS BARGAINS. All Goods Guaranteed and sent Post Paid.

RECEIVERS. BELMONT.—6-Valve Superhet. Receivers complete in handsome cabinet with moving coil speaker and six valves. A.C./D.C. mains, 100/250 volts. Ready for use on any mains, £4.

VIDOR.—3-Valve Battery Sets. Model C.N. 212. Complete in attractive Walnut Cabinet with three Mullard Valves, Moving Coil Speaker, Batteries and Accumulator. Now in sealed cartons, £3/17/6 (List 6½ gns.).

LUCILLE.—5-Valve American Midget Sets. Complete with 5 Valves, Moving Coil Speaker. Ready for use on any mains 100/250 volts A.C./D.C. Long and Medium Waves, £3/15/0. New, in sealed cartons.

RECORD CHANGERS.—GARRARD Model R.C.4, plays automatically and changes eight 10in. or 12in. records of any kind. New, in sealed cartons, £6.

GRAMOPHONE MOTORS.—COLLARO ELECTRIC Radiogram Units. For A.C. or D.C. mains 100/250 volts. Fully Auto Stop, complete with Pick-ups. Can be used on any mains. Brand new in sealed cartons, 57/6 each. COLLARO ELECTRIC Radiogram Units, complete with Pick-up and fully Auto Stop, for A.C. mains only, 37/6 each. COLLARO Single Spring Gramophone Motors with 10in. turntables, complete with all accessories, 11/- Double Spring Motors with 12in. turntable, 15/- COLLARO BATTERY RADIOGRAM UNITS, comprising Double Spring Motor and Pick-up mounted on plate, with all accessories, 35/- each. ALL COLLARO MOTORS ARE BRAND NEW IN SEALED CARTONS.

SPEAKERS.—CELESTION Soundex, permanent magnet, 10/-. TELSEN permanent magnet with 10-Ratio Transformers to suit any Receiver, 12/6. Telsen Loudspeaker Units, 2/6. ALL BRAND NEW AND BOXED.

COILS.—TELSEN Iron Core. W349 (Midget size), 4/- Type W478 (Twin), 9/- pair. Type W477 (Triple), 15/- per set. Type W476 (triple Superhet, Selector and Oscillator), 16/- per set. All ganged coils complete on base with switch. TELSEN I.F. TRANSFORMER COILS, 110 k/c., 5/-. TELSEN DUAL RANGE COILS with aerial series condenser incorporated type, W76, 4/-. Telsen Aerial condensers with shorting switch, 2/-. ALL TELSEN COMPONENTS brand new in sealed cartons.

CAR RADIO AERIALS.—Ekco copper mesh aerials can be used on roof or floor of car. 30in. x 20in., 4/-; 36in. x 20in., 5/-.

AMERICAN VALVES. A FULL RANGE OF VALVES FOR ALL AMERICAN RECEIVERS, 6/- each.

MISCELLANEOUS BARGAINS. ALL BRAND NEW IN ORIGINAL SEALED CARTONS: TELSEN A.C./D.C. Multimeters test anything radio or electrical, 8s. 6d. Telsen 2-Range Voltmeters, 3/- 3-Range meters, including milliamperes, 4/-. ACE (P.O.), Microphones, with transformer ready for use with any receiver, 4/6; 36 Assorted Tru-ohm Resistances, 1 watt, colour coded and marked, 36 on card, 6/- per card. BELL TRANSFORMERS, 200/250 volts input, 3, 5 and 8 volts output, 3/6. MORSE SIGNAL UNITS incorporating buzzer, tapper and flash with international code, complete with batteries and bulb, 3/9 each. Varley Square Peak Coils, BP5, 2/-. MARCONI V24 and Q Type valves (useful for short wave experiments), 1/6; Glass insulators, 4d.; Light-weight headphones, double-pole, 4,000 ohms each ear-piece, 3/- pair. A.C. Trickle Chargers, for 2, 4 and 6 volts, 17/6.

CAR and RADIO BATTERY CHARGERS incorporating WESTINGHOUSE METAL RECTIFIER. This Charger will enable you to keep your CAR BATTERIES FULLY CHARGED, for use on 2, 6 and 12 volts, 45/- each.

REGENTONE ELIMINATORS, A.C. 200/250 volts, Type W5a, with trickle charger, 37/6.

SOUTHERN RADIO.—Branches at 271-275, High Road, Willesden Green, N.W.10; 46, Lisle Street, London, W.C.2. All mail orders to 323, Euston Road, London, N.W.1.

SOUTHERN RADIO, 323, Euston Road, London, N.W.1 (near Warren St. Tube). Phone: Euston 3775.

RADIO CLEARANCE

63, HIGH HOLBORN, W.C.1

TEL.: HOLBORN 4631

Special Clearance Sale now taking place at our London Premises; the following bargains are offered to enable our Mail Order customers to participate in this eagerly awaited annual event.

£6 19s. 6d. 8-Valve A.C. Mains Superhet, by well-known manufacturer, fitted Visual Tuning, Volume Control, Tone Control, etc., handsome bird's-eye maple cabinet, size 16ins. wide, 12ins. deep, 23ins. high; Valves as follows: AC/VP1, FC4, AC/VP1, AC/VP1, AC/HLDD, V914, AC 2 Pen. 1W3, pre H.F. Stage, 2 I.F. Stages, full A.V.C., a super bargain.

£4 15s. LISSEN 4-VALVE UNIVERSAL AC/DC RECEIVER, fitted in handsome dark finish walnut cabinet of upright design, clock face tuning, volume control, reaction control, etc., a really fine receiver. Exclusive British Rights Held by us for AMERICAN CONSTRUCTRAD KITS. During the sale these kits are offered as follows:

21/- 1-Valve Battery Kit, complete with valve.
25/- 2-Valve Battery Kit, complete with valves.
29/6 1-Valve AC/DC Kit, complete with valve.
32/6 2-Valve AC/DC Kit, complete with valves.
These are Complete Sets not Converters, covering a Waveband of 15 to 600 metres by means of 5 interchangeable plug-in coils.

£6 7s. 6d. 8-VALVE A.C. SUPERHET CHASSIS, complete with valves, details as above.

4/11 ROLA 9in. ENERGISED TYPE MOVING COIL SPEAKERS, 600 Ohms field, less transformer.

4/11 Rola 10,000 Ohm 7½in. Cone, complete with transformer, pentode type.

8/- per pair. LISSEN ALL-WAVE COILS, complete with circuit, switching, etc., in matched pairs.

4/6 DITTO SINGLE COILS.

1/3 LISSEN 126 I.F. TRANSFORMERS, fully screened.

1/3 G.E.C. 110 I.F. Transformers, Midget type, complete with trimmers.

1/- WEARITE 1-meg. Volume Controls, with switch.

2/3 CENTRALAB VOLUME CONTROLS, with switch, 5,000, 10,000, 25,000, 50,000.

SPECIAL SPECIAL SPECIAL

5/9 JENSEN 7½in., 2,500 FIELD PENTODE TYPE MOVING COIL SPEAKERS. Few Only.

2/3 Handsome STRAIGHT LINE, SLOW MOTION DIAL, complete with esutchetoon.

THE FOLLOWING CONDENSERS, BY WELL-KNOWN MANUFACTURER.

3/- 8 plus 8 plus 4 Electrolytics, wire end type, metal cases.

2/- 14 plus 8 Electrolytics, wire end type, metal cases.

3/- 8 plus 8 Electrolytics, wire end type, cardboard cases.

2/11 8 Mfd., 550 surge, 500 volt working, metal can, 1-hole fixing.

2/6 8 Mfd. 500 surge, 450 volt working, metal can, 1-hole fixing.

6d. TUBULAR CONDENSERS, paper type, all sizes up to 0.1.

1/6 50 Mfd., 50 volt working condensers, well-known manufacture.

1/3 50 Mfd., 25 volt working condensers, well-known manufacture.

1/- 25 Mfd., 50 volt working condensers, well-known manufacture.

1/- 50 Mfd., 12 volt working condensers, well-known manufacture.

2/6 UTILITY 3-GANG CONDENSER, Superhet type, two .0005 Sections, one 110 K/C Section, fully screened with top trimmers.

1/9 AMERICAN VALVES, special clearance, 3 types only. 12Z3, 6B7, 6A7.

*AMERICAN VALVES FIRST CLASS BRAND, TRIAD. 4/6 following types: 34, 38, 47, 42, 43, 49, 6B7, 56, 58, 55, 6A7, 80, 75, 48, 41, 5Z3, 2A3, 12Z3, 45, 6CC, 6D6, 6F7, 30, 59.

* All these valves carry a 90-day guarantee, and free replacement provided that the filament or heater is intact and the glass not broken when returned to us.

1/9 LISSEN CLASS B. DRIVER TRANSFORMERS, ratio 1-1, brand new and boxed.

1/- LISSEN INTERVALLE CHOKES, brand new and boxed.

BRYCE MAINS TRANSFORMERS AND CHOKES, standard for the season, British and Guaranteed.

8/6 250-0-250, 80 m.a. 2-0-2 volts, 2.5 amp., 2-0-2 volts, 4 amp.

10/6 350-0-350, 120 m.a. 2-0-2 volts, 2.5 amp., 2-0-2 volts, 4 amp.

11/6 350-0-350, 150 m.a. 2-0-2 volts, 2.5 amp., 2-0-2 volts, 4 amp. 2-0-2 volts, 2 amp.

16/6 500-0-500, 150 m.a. 2-0-2 volts, 2.5, 2-0-2 volts 6 amp., 2-0-2 volts 2 amp., 2-0-2 volts 2 amp.

8/6 H.T.8 TRANSFORMER, 250 volts 60 m.a. 2-0-2 volts 4 amp.

16/6 Ditto with H.T.8 Metal Rectifier. ALL TRANSFORMERS ARE FULLY SHROUDED. BRYCE MAINS CHOKES. 3/6 40 m.a. 30 Hys., 500 Ohms. 5/- 60 m.a. 40 Hys., 500 Ohms. 9/9 150 m.a. 40 Hys., 100 Ohms. 5/3 60 m.a. 80 Hys., 2,500 Ohms for Speaker replacement, etc. Enquiries 14d. stamp if reply expected. Hours of business, 9 a.m. to 7 p.m. Saturdays, 9 a.m. to 1 p.m. All orders value 5/- or over post free; orders under 5/- must be accompanied by a reasonable amount for postage. C.O.D. Orders under 5/- cannot be accepted. Radio Clearance, 63, High Holborn, W.C.1. Holborn 4631.

RECEIVERS, COMPONENTS AND ACCESSORIES

BANKRUPT BARGAINS. List free. All new goods. Battery all-wave 3v. sets with valves and M.C. speakers in handsome walnut cabinets, 79/6. Haleyon A.C.7 14 gn. superhets, 27. Ormond 3v. A.C./D.C., M.C. speakers, 59/6. All-wave 5v. superhets, £6/17/6. Mains superhets, 5v., £6/17/6. Ormond 5v. superhets, A.C., £6. Amplion P.M. 8in. speakers, 12/6. Rola, 18/6. Telsen, 12/6. Celestion, 10/- American valves from 3/-. I.A.C. mains valves from 3/6. D.C. eliminators, 8/-. Morse keys, with battery lamp buzzer, 4/6. Ferguson, Pilot and Truphonic sets, trade supplied. Large stock. Let me quote first.—Butlin, 6, Stanford Avenue, Brighton. Preston 4030.

ALL goods previously advertised are standard lines, still available. Post card for list free.

VAUXHALL UTILITIES, 163a, Strand, W.C.2. Over Denny's the Booksellers, Temple Bar 9338.

CONVERSION UNITS for operating D.C. Receivers from A.C. Mains, improved type, 120 watts output, at £2/10/0. Send for our comprehensive list of speakers, resistances and other components.

WARD, 46, Farringdon Street, London, E.C.4. Telephone: Holborn 9703.

SINCLAIR SPEAKERS Have Quantity New Speakers, P.M. and energised, 8 and 10 inch, also P.A. 10 watt; to clear from 8/6 each; all guaranteed.—Alma Grove, Copenhagen St., London, N.1. Ter. 4355.

SHORT WAVES

ALL-WAVE RADIO FOR 9/6; send for illustrated catalogue of RIDCO short-wave units, from 9/6 complete.—Radio Industries, Birch Street, Hanley, Staffs.

SHORT WAVE on a crystal set. Full building instruction and crystal 1/2 post paid.—Radiomail, Tanworth-in-Arden, Warwickshire.

NEW RECEIVERS, COMPONENTS AND ACCESSORIES

OURS is now the only store in London handling a complete and comprehensive range of high grade Components and Accessories as distinct from clearance and surplus stuff. Everything from the smallest plug to the complete Auto Changer Unit; finest makes, really keen prices, and efficient personal service unobtainable from chain stores, clearance houses, department stores or by mail. Come and see.—WIRELESS SUPPLIES UNLIMITED, 278-280-282, High Street, Stratford, E.15. Maryland 3191.

RADIO BARGAINS

ALCO ELIMINATORS AND CHARGERS. Chargers from 7/6. Eliminators 18/-. Standard outputs. Year guarantee. Full details free.—P. and D. Radio, 1, Gooding Road, N.7.

W.B. STENTORIAN SPEAKERS



The Finest Permanent Magnet Loudspeakers on the market, supplied on lowest terms.— 37S: Cash or C.O.D. 42/-. or 2/6 down and 11 monthly payments of 4/-.

GARRARD TYPE "B" RADIOGRAM UNIT (consisting of Garrard Electric Motor and Garrard High-grade Pick-up). Cash or C.O.D. 23/2/6; or 6/6 with order and 10 monthly payments of 6/3.

PROMPT DELIVERY. Anything and everything Radio supplied on lowest terms.

THE LONDON RADIO SUPPLY CO., LTD., 11, Oat Lane, Noble Street, London, E.C.2.

Varley **NICORE COIL UNITS**

Four NEW CIRCUITS. We have recently published four new circuits which are giving excellent results with our new ganged units. No. 1 (BP 111) Mains Superhet for 110 k/c No. 2 (BP 112) Battery Superhet for 465 k.c. No. 3 (BP 113) Three-valve mains receiver with band-pass tuners. No. 4 (BP 114) S.C. Battery Three with Pentode. Blueprints now ready, 6d. each (BP 114 is 3d) Post Free

OLIVER PELL CONTROL, LTD., BLOOMFIELD ROAD, WOOLWICH, S.E.18 **WOOLWICH 2345**

NEWNES' HOME MECHANIC

WILL SAVE HUNDREDS OF POUNDS

A Practical Work for the Practical Man



NEWNES' HOME MECHANIC is produced for the man who wants to do things for himself and to do them correctly. It gives just those practical tips which are known to the professional craftsman and which make all the difference between merely doing a thing and doing it well.

It enables the handyman or woman to beautify or renovate any part of the house, to repair fittings, and to make hundreds of useful articles.

Particular attention has been devoted to the subject of wood-working tools and methods, and an interesting series of articles, each illustrated by action photographs, is included.

Valuable Contents Include:—

The House.—Deals with Wet and Dry Rot, Fencing Repairs, Concrete, Distemp- pering, Painting (inside and out), Repairing and Laying Floors, Papering Walls, Pointing, Glazing, Defective Plaster, Sash Cords, Electric Burglar - alarms, Locks, Smoky Chimneys, Heating and Lighting, Electricity in the Home, Cisterns, Pipes, Water Supply, etc.

Home Hobbies.—Main- tenance of Gramophones, Wireless, Pianos, Pianolas, Motors, Cycles, Metalwork, Photography, Rugmaking, Soldering, Boot and Shoe Repairs, Pressing and Clean- ing Suits, Sewing-machine Repairs, Picture-framing, Dyeing, Bookbinding, Gar- den Tools and Mower Repair, Stencilling, Beadwork, Leatherwork, etc.

How To Make: Shelves, Folding Chest, Steps, Sheds, Lawn, Garden Seat, Concrete Path, Pergola, Dog's Kennel, Tent, Tree Seat, Rockery, Tables, Clothes Airer, Kitchen Cabinet, Plate Rack, Egg Stand, Ironing Board, Ice Box, Tea Wagon, Lady's Work Table, Table Lamp, Bookshelf, Panelling, Modern Furniture, Window Seat, Pel- mets, Barometer, Miniature Grandfather Clock, Baby's High Chair, Boot Rack, Child's Desk, Play Pen, Many Toys, etc.

BIG RECIPE AND METALWORK SECTIONS. HOW-TO-REPAIR-FURNITURE SECTION HOME LEGAL AIDS.

WONDERFUL SERIES OF CHARTS!

Each chart explains how to make some useful piece of furniture, or valuable appliance for the home. Amongst the charts are: GATE LEG TABLE, COMBINED BATHROOM STOOL AND LINEN LOCKER, SMALL REVOLVING BOOKSTAND, ELECTRIC CLOCK, SIDEBOARD, MODEL ELECTRIC LOCOMOTIVE, etc.

Complete in 4 Handsome Volumes

20 Specialist Contributors

POST THIS COUPON TO-DAY FOR PARTICULARS

To THE HOME LIBRARY BOOK CO., Tower House, Southampton Street, Strand, London, W.C.2.

Please send me, FREE of all cost and without obligation, the folder describing Newnes' HOME MECHANIC and particulars of the scheme whereby I shall be able to have the immediate use of the four volumes at an outlay of a few shillings per month.

Name

Address

(Prac.W. 30137)

If you do not wish to cut your copy, send a postcard mentioning "Practical Wireless" to the address above.