

INSIDE! AN EFFICIENT H.F. UNIT

Practical and Amateur Wireless

3^D
EVERY
WEDNESDAY

Edited by F. J. CAMM

A GEORGE
NEWNES
Publication

Vol. 7, No. 178.
February 1st, 1936.

AND PRACTICAL TELEVISION

Next Week!

**FREE
BLUEPRINT
of
F. J. CAMM'S
MONITOR
THREE
for
BEGINNERS**



Mr. Camm's Choice

1936 STENTORIAN

WHITELEY ELECTRICAL RADIO CO., LTD., MANSFIELD, NOTTS.



ADVT.

The New **COSSOR**

SEVEN STAGE BATTERY **SUPERHET** MODEL 376B



ANTI-FADING

**PENTAGRID
FREQUENCY CHANGER**

CLASS 'B' OUTPUT

**MOVING-COIL
LOUD SPEAKER**

SPECIFICATION INCLUDES

Seven Stages, Anti-fading circuit, with Pentagrid Frequency Changer, Variable-mu H.F. Pen. I.F. Amplifier, Double Diode Det., High Slope Power Driver and Class "B" output. Single Knob tuning, sloping detachable Scale. Four-way combined On/Off, Wavechange and pick-up Switch. Volume Control, 8" Moving Coil Speaker. Cabinet with accommodation for suitable Accumulator and Battery.

PRICE £9.19.0

(exclusive of Batteries)

H.P. Terms: 17/- deposit and 12 monthly payments of 17/-, or, 40/- deposit and 12 monthly payments of 15/-.

Prices do not apply in I.F.S.

THIS Superhet sets an entirely new and higher standard in Battery Superhet performance. It incorporates many refinements usually found only in mains models, and consists of a 7 Stage Superhet circuit of a special Anti-fading type. A Pentagrid Frequency Changer, a Variable-Mu H.F. Pentode I.F. Amplifier, a Double Diode second detector, and High Slope Power Driver, together with a fine Moving Coil speaker matched to Class "B" output, combine to give the complete answer to your most critical demands. But go to your usual wireless shop and hear it for yourself.

COUPON

To A. C. COSSOR LTD., Melody Dept.,
Highbury Grove, London. N.5.

Please send me free of charge, literature giving full particulars of the new Cossor 7 Stage Battery Superhet Receiver Model 376B

Name.....

Address.....

THIS COUPON BRINGS FULL DETAILS

L.177.

PRAC. 1/2/36

A SIMPLE & EFFICIENT H.F. UNIT SEE PAGE 630

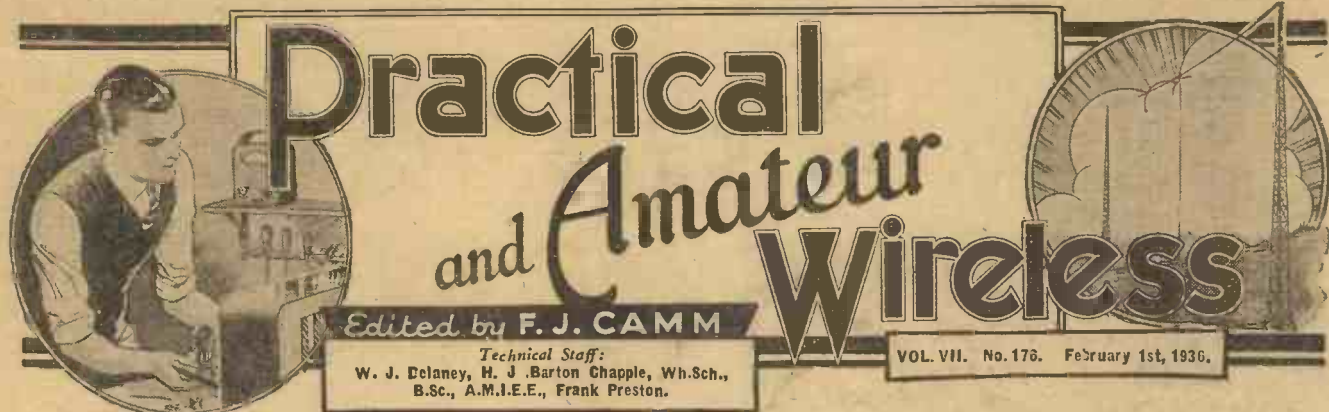

ROUND *the* WORLD of WIRELESS

Mr. F. J. CAMM'S MONITOR THREE!

NEXT week's Special Enlarged Issue will be devoted to the interests of the beginner and will deal especially with the requirements of the newcomer to radio.

A Blueprint will be presented free and will deal with the construction of Mr. F. J. Camm's Monitor Three, a simple and cheap three-valver specially designed for beginners, and which may be modified in accordance with articles to be given subsequently, until it is converted into an Efficient Five-Valve Superhet. No components need be scrapped and the additions will cost only a trifling sum.

In addition to articles on One-valve and Crystal Receivers, there will be a complete and up-to-date Chart of Modern Wireless Circuit Symbols and various Facts and Formulae. Future issues will also devote a considerable amount of space to the newcomer, and articles will be given in simple language so as to bring the beginner right into line with the experimenter who has been following broadcasting since its inception.

These new features will be additional to those which we provide, week by week, for the more experienced experimenter.

All the usual features, such as the Short-wave Section, Wrinkles, etc., will also be included and the constructor will find the simple Short-wave Three receiver an admirable set for commencing experiments on the short waves, whilst the advanced experimenter will also find

this a valuable receiver for the purpose.

New Saarbruecken Station

THE reception of broadcasts from Radio Nice Juan-les-Pins (France) has been wiped out in the British Isles through the advent of the new 17-kilowatt Saarbruecken (Germany) station using the same channel, namely, 240.2 metres (1,249 kc/s). The German transmitter is on the air daily from G.M.T. 10.55 until roughly G.M.T. 22.30. In addition to its own programmes it relays also broadcasts from Deutschlandsender and other German stations. The call is: *Hier Reichssender Saarbruecken.*

Alternative Broadcasts for Prague

PRAGUE (II), which so far has been using the old 5-kilowatt Stranice station for the purpose of a second programme to listeners in the capital, is to be given a 100-kilowatt transmitter, in order that these entertainments may be

ALSO NEXT WEEK!

FREE BLUEPRINT OF Mr. F. J. CAMM'S "MONITOR" THREE AND CONSTRUCTIONAL DETAILS OF THE "PREFECT" S.-W. THREE

A Highly Efficient Short-wave Receiver for the Beginner.

Full Constructional Details will be given in Next Week's Greatly Enlarged Number.

heard beyond the frontiers. The wavelength is 249.2 metres (1,204 kc/s).

France's New Provincial Station

IT is expected that the new 90-kilowatt transmitter which the French State has erected at Realtor, near Marseilles, will be on the air regularly by now. It will take over the channel used by the existing station, namely, 400.5 metres (749 kc/s), a wavelength shared with Pori, a small Finnish transmitter.

Listen to Marseilles

ALTHOUGH it was expected to bring the Marseille-Realtor high-power broadcasting station into operation by the end of 1935, the station is still carrying out its initial tests. They may be heard nightly on 400.5 metres (740 kc/s) between G.M.T. 23.00 and 01.00 at the end of the day's programme.

Both Early and Late

BRUSSELS has extended its broadcasts and is now on the air on Sundays from G.M.T. 06.30 until midnight; on weekdays the stations work from G.M.T. 06.30-09.00, and from midday to midnight on one or other of the two wavelengths.

Alterations to Spanish Stations

ALTHOUGH no new transmitters have been built, certain changes have been recently made in the power of the Spanish stations. EAJ7, Madrid, on 274 metres, now broadcasts on 10 kilowatts; Seville EAJ5 (410.4 m.), on 5.5 kilowatts; Barcelona, EAJ1 (377.4 m.), on 7.5 kilowatts; San Sebastian, EAJ8 (238.5 m.), on the other hand, has been brought down to 1 kilowatt.

Is Breslau First on the Air Daily?

GERMAN stations for some months have been vieing with each other in establishing early broadcasts. Breslau at present tops the list with a popular concert at G.M.T. 04.00 daily, and a weather forecast thirty minutes later.

New Musical Signal

BERLIN, with the advent of the new year, has improved its interval signal to make it of greater use to instrumentalists. The letter B in morse (-...) is broadcast on a tone giving the normal A; then follows a stroke on a gong, one octave lower.

The Berlin 1936 Radio Exhibition

IN view of the fact that the Olympic games are expected to attract large numbers of foreign visitors to Berlin, the 1936 Radio Show will be held between August 28th and September 6th.

Daily Television Transmissions

FROM January 15th the Berlin Witzleben television transmitter resumed its daily broadcasts (except Wednesdays and Saturdays) between G.M.T. 11.30-12.30, 16.00-19.00, and from 21.00-23.00. Vision is on 6,772 metres, and sound on 7,053 metres.

ROUND the WORLD of WIRELESS (Contd.)

Variety from Morecambe

EXCERPTS from the variety bill will be broadcast from the Winter Gardens, Morecambe, on February 5th, but no details are yet available.

Air Force Band

THE Band of H.M. Royal Air Force College at Cranwell, Lincolnshire, broadcasts for the first time from the Leeds studios on February 6th. This famous military band is well known to Midland listeners, who have often heard it broadcast in the days when Lincolnshire was part of the Midland Region.

"After Sunset"

"AFTER SUNSET" is the title of a programme to be broadcast from the Western Regional on February 3rd, in which relays will be taken from contrasting evening entertainments in the West Country. Listeners will first hear a sing-song from the Blackborough House Home for Wayfarers, then the dog watch from a ship in Bristol Harbour, and, lastly, cabaret from the Pump Boom, Bath.

Musical Mélange

MARTYN WEBSTER will present, on January 29th, another musical mélange on the lines of "Love is in the Air Again." It is entitled "What's in a Name?", and a bachelor's reverie, in which he recalls names of places and girls, will provide the cues for vocal and instrumental numbers. There are four soloists—Raymond Newell, Webster Booth, Mavis Bennett-Levin, and Jack Wilson, the pianist. Reginald Burston will conduct the B.B.C. Midland Orchestra and Revue Chorus.

The House Next Door

FOR the second of his talks in this series, to be given on February 5th, Moore Raymond has chosen a shilling-a-night lodging house in Birmingham, with an imaginary address, 79, Shard Lane. He will give a realistic picture of the occupants. Mr. Raymond, who came to this country from Australia, was a London journalist and radio critic, and is now working in the Midlands as a free-lance. He wrote the radio burlesque "The Marmalade Mystery."

Sunday Afternoon Concerts

A LIGHT programme by Jan Berenska and his Orchestra will be relayed from the Pump Room, Leamington Spa, on February 2nd. The vocalist is Arthur Wilkes, a native of Birmingham now resident in Manchester. He was tenor lay clerk at the Birmingham Cathedral before leaving to take up an appointment in Manchester Cathedral.

A studio recital follows; it is devoted to

INTERESTING and TOPICAL PARAGRAPHS

the songs of Wilfrid Sanderson, and is given by Mark Mellers, the Nottingham baritone.

SKATING CHAMPIONS LISTEN IN



Albert Enders and Sadie Cambridge, World's Professional Pair Skating Champions, who come from Australia, keep a Pye receiver in their dressing-room.

Concert from Gloucester

IN this concert, which is to be relayed from the Guildhall at Gloucester, Cyril Jackson will conduct the Gloucester Madrigal Singers, which he founded, in nine part-songs, and Eda Kersey and Herbert Sumsion will play the Bach Sonata in A for Violin and Pianoforte. The Singers, who have broadcast several times, were formed in 1929 and specialise in Tudor music. Dr. Leo Williams, himself an enthusiastic madrigalist, gave them his warm support, and they have given a number of "period" concerts. Mr. Sumsion is Organist and Master of the Choristers at Gloucester Cathedral. This broadcast will be given in the Midland Regional programme on January 30th.

"1066 and All That"

THE second act of "1066 and All That," presented by the Birmingham Repertory Theatre Company, will be relayed from the Midland Regional on February 5th. It opened at that theatre in Christmas week. Reginald Arkell based the play on the well-known book and also wrote

the lyrics. The music is by Alfred Reynolds. There have been previous Midland broadcasts of Act 2 and of the whole play. In this performance James Hayter takes the part of "The Common Man," formerly taken by Hugh E. Wright, and Charles Victor is the compère. The scenes include Henry VIII (Stephen Murray) playing musical chairs with his wives; Guy Fawkes (Hilary Wontner) being tried for failing to blow up the Houses of Parliament; and Charles II and Nell Gwynn (played by Donald Eccles and Curigwen Lewis respectively). The producer is Herbert M. Prentice.

"Rhythms Round the World"

THIS is the title of a programme which will be given by the B.B.C. Welsh Orchestra, conducted by Reginald Redman, on February 5th. This is another programme in the series in which we travel round the world giving representative rhythms from various countries. Starting from our own country with the March "Knightsbridge," which has become the signature tune of "In Town Tonight," we journey through most of the European countries and reach the Far East by way of Russia. Usually the B.B.C. have brought listeners back home by way of Hawaii and America, but this time, owing to the programme being shorter than usual, we shall finish up in Japan with the Dance of the Wolves from Gustav Holst's Japanese Suite. The tunes in this suite are authentic and were supplied to the composer by the Japanese dancer Michio Ito for whom the suite was written.

SOLVE THIS!

PROBLEM No. 176.

Hayes built the £4 Superhet 4 recently described in PRACTICAL AND AMATEUR WIRELESS, but was surprised to find that London National tuned in at good volume at 261 metres—its normal wavelength—and also at approximately 450 metres. Further tests showed that other stations transmitting on wavelengths between 200 and approximately 300 metres tuned in at their correct wavelength setting, and also at points between 400 and 550 metres. He tested the coils but found that these were in order. What was the trouble? Three books will be awarded for the first three correct solutions opened. Address your envelope to the Editor, PRACTICAL AND AMATEUR WIRELESS, Geo. Newnes, Ltd., 8-11, Southampton Street, Strand, London, W.C.2. Envelopes must be marked Problem No. 176 in the bottom left-hand corner, and must be posted to reach this office not later than the first post Monday, February 3rd, 1936.

Solution to No. 175.

Carlton was using an external wave-change switch, one of its terminals being connected to the junction of the medium and long-wave grid windings in the usual manner, and the other terminal to earth. When switched to medium waves the grid of the H.F. valve was joined to earth through the medium-wave winding and switch and, therefore, no bias could be applied to the valve. A condenser of, approximately, .1 mfd. should be connected between the wave-change lead of the coil and the switch terminal or the switch should be joined across the ends of the long-wave winding.

The following three readers, successfully solved Problem No. 174, and books are accordingly being forwarded to them:

J. Tollerton, 22, Oole Rd., Cleethorpes, Lincs.; R. Ellis, 2, Wrentham Estate, Old Tiverton Rd., Exeter, Devon; J. W. Bearon, 38, Maxwell St., Crewe.

A VISUAL TUNING DEVICE

A Description of the "Tuneon" Indicator, and How It Can be Wired Into a Receiver



AN interesting device which has been on the market for some considerable time and shows signs of increasing in popularity is the "Tuneon" Indicator, which is, as its name implies, a neon-filled tube for tuning purposes. Before describing how the Tuneon Indicator can be wired into a receiver, it may be interesting to ascertain why such a device is needed.

It is well known to radio amateurs that the older type of non-selective receiver normally tuned to a signal has a very wide spread, or skirt, on either side of the carrier frequency, due to the damping of the tuned circuits. The effect of this "side-band spread" is to give a tuning characteristic of the shape shown in Fig. 1. With such a tuned circuit it will be seen that a signal may be considerably off tune and yet the voltage across the coil may not vary very greatly for a wide band of audio frequencies. Thus it is immaterial, from the point of view of quality of reproduction, whether the dial is dead in tune on the station or not, and an error on either side of the correct tuning point will not give a very great difference in audible response of the different audio frequencies.

Such a receiver, in a locality where the signal strength from a local station is sufficiently strong to allow such a reduced sensitivity as would wipe out reception on any other station, would be quite adequate for quality reception without any critical tuning. Under modern conditions, however, this state of affairs very seldom is possible. The modern receiver, in order to pick up a number of stations free from interference from each other, is usually made with selective tuned circuits, and the addition of automatic volume control, designed with the object of enabling reception of all these stations at approximately equal strength, considerably complicates the matter of tuning. It is the introduction of automatic volume control which really necessitates some form of visual tuning device.

The Function of A.V.C.

Automatic volume control is simply a means of suppressing the sensitivity of the receiver to a given pre-determined level so that any signal which would normally be applied to the detector above this level must be diminished in strength by the required amount. The sensitivity of an

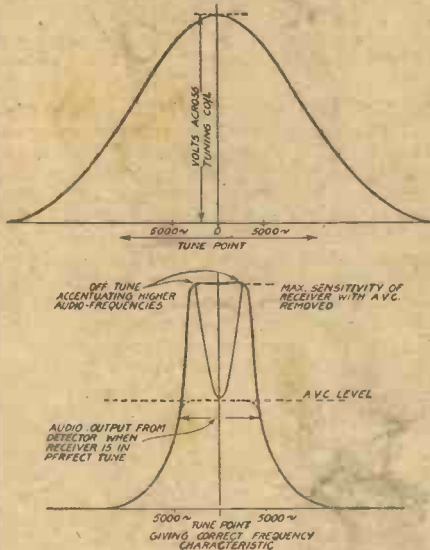

Figs. 1 and 2.—Showing the difference in response of a single circuit tuner and a selective type of tuner, showing the necessity of providing a visual indicator.

effective automatic volume control (A.V.C.) receiver must necessarily therefore be high, or only the strongest stations will be received at all.

The A.V.C. is effected by the carrier wave of the received signal, and if this exceeds a certain voltage the result is to damp down, so to speak, the H.F. amplifying valves when the set is tuned exactly to the carrier frequency. At this point the audible frequency response, which determines the quality of reproduction, is a function of the design of tuned circuits (neglecting distortion in the L.F. amplifier), and the shape of the tuning resonance curve is shown above in Figs. 1 and 2.

Now supposing the set is slightly off tune; the effect of this is to reduce the control action on the higher frequencies in the side band, and the whole shape of the frequency response curve is changed, resulting in over-emphasis of the high frequencies and a distorted output in which the signal becomes exceedingly shrill and unpleasant to listen to. The better the A.V.C., the worse this effect, and it is not always easy to judge by ear or by the tuning dial when such a receiver is dead on tune. Here is where

the visual tuning device comes in, and hence the reason for the introduction of the Tuneon Indicator

How the Tuneon Indicator Operates

The Tuneon Indicator, supplied by the General Electric Company, Ltd., consists of a neon-filled tube containing three electrodes, two short and one much longer. The long electrode is the cathode, and the two short electrodes may be described as anodes. In operation, a luminous glow creeps up the tube round the long cathode as the signal approaches its correct tuning point, reaching a maximum when the set is dead on tune. One short electrode anode is used to employ an increasing voltage, depending upon the signal, and the other short electrode (tickler anode) is used to facilitate starting up of the glow.

It is not a difficult matter to apply the Tuneon Indicator to a receiver, where it is normally inserted in what is virtually a potentiometer circuit in conjunction with one of the controlled variable-mu valves. A typical circuit is shown in Fig. 3. In this circuit it will be seen that a falling anode current in the controlled valve introduces a rising voltage across the Tuneon, and when the anode current of the controlled valve rises to the order of 1.5 milliamp. the glow completely covers the long electrode. The Tuneon should, therefore, be used in a valve anode circuit where there is at least 1.5 milliamp. change in the valve anode current between the strongest station with full A.V.C. volts and the weakest station before A.V.C. has commenced. The length of glow obtained on the strongest station can be controlled by a resistance R1 in series with the anode, which should be made either in the form of a tapped resistance or a semi-variable pre-set type, the maximum value depending upon the maximum H.T. voltage obtainable. This resistance R1 accommodates the normal variations between tubes and valves, but once adjusted for a given set of valves and Tuneon Indicator, no further adjustments are required until the valves or tube are replaced. The resistance should never be reduced below a value sufficient to give a full length glow on the strongest station required. If excessive brightness of glow is allowed under this condition then the life of the Tuneon may be appreciably shortened.

A further resistance R2 should be inserted in circuit if, as will usually be the case, the range of current variation obtained

(Continued overleaf)

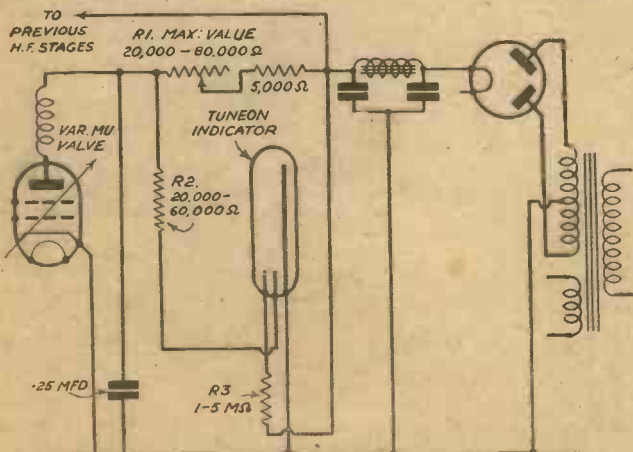

Fig. 3.—A typical circuit for the Neon Indicator.

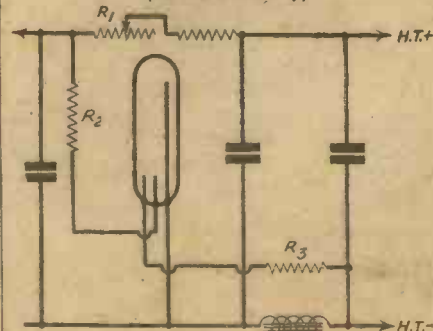

Fig. 4.—An alternative method of arranging the circuit.

(Continued from previous page)

from the valve is greater than that required by the Tuneon. This resistance may be a fixed one. The third resistance shown, R3, is inserted in series with the third, or tickler electrode, and the positive H.T. line. The value of this resistance determines the amount of initial glow before a signal is indicated.

As would normally be anticipated with a gas discharge device depending for its action on the ionisation of an inert gas, there is to be expected a material variation between tube and tube, and the striking voltage may vary over a considerable range. This, however, may largely be

taken up by the intelligent use of the variable resistance R1.

Advantages

Some of the advantages of the Tuneon Indicator over other forms of visual tuning device are that it does not occasion a complete shut-down of the receiver should a failure occur in the neon tube or its associated circuit. When a meter device is employed this is necessarily placed in series with the anode circuit of one or other of the valves, and should an open circuit occur in the meter this would result in a breakdown of reception unless shunted by a resistance in some way. With the neon

tube the only part of the associated circuit in series with the valve is a resistance which could be so made that the danger of its breakdown is negligible. Also the movement of a column of light, such as in the Tuneon Indicator, is attractive, and even though other devices to simplify tuning were included in the receiver design, there is no doubt that the appearance of a receiver fitted with the Tuneon is improved by the moving column of light which it gives.

For convenience in fitting, the Tuneon Indicator is usually supplied with a very small four-pin base for which sockets are readily obtainable on the market.

A Compact Twin-gang Condenser Assembly

THE great advantage of the twin-gang condenser about to be described is its compactness. It has one-hole fixing, and thus can be removed from the set in a few seconds, without the necessity of unscrewing brackets, etc., from the base-board. The completed component can be clearly seen in the photograph, and the various constructional details are shown in the drawing.

The chief components required (probably already to hand) are as follows. First, a slow motion disc-drive, of the pattern shown in the photograph. Second, two solid dielectric condensers of equal capacity, either .0003 or .0005 as desired. These should preferably be of the type having a nut on the end of the spindle for the fixture of the pig-tail. Some fairly stout sheet brass or aluminium will also be required to make a supporting bracket, some thinner gauge copper or aluminium for the screen, and four set screws with nuts. From the thicker gauge sheet, cut out the strip to the shape and size given in the sketch, but leaving the marking and drilling of the bushing hole A until after bending the strip into bracket form. This hole A should then be drilled to coincide with that in the main disc-drive bracket. As different condenser spindles vary in length, it may be found necessary to deviate from some of the dimensions given, and it will be best to check up the distances required for the condensers it is proposed to use.

Assembling the Parts

One of the condensers should then be taken, and an additional nut screwed on to the spindle end, just sufficient to form a

flat face, and solder should then be run in to fix to the spindle. Fit this condenser to the disc-drive, making sure that any terminal screw which is connected to the fixed vanes clears the bracket, otherwise the condenser will be shorted and results will be nil. One or two washers placed over the condenser bush will give the necessary spacing should this trouble occur. The terminal screws referred to are marked B in the side view. With the second condenser fitted to the constructed bracket (again taking care as to clearance of terminal screws) loosely fasten to the main disc drive bracket by two set screws, as shown. The elongated holes allow the spindle of the rear condenser to be pushed up against the soldered nut of the front one, when the two should then be sweated together, both sets of moving vanes being first turned full in. The set screws can then be tightened up.

It now only remains to construct the screen from the thinner sheet of aluminium or copper and fit it between the two

condensers by means of the remaining set screws, and the component is completed. Two trimmer condensers will, of course, be necessary to match up the circuit, and these might be old neutrodyne condensers fixed at convenient positions on the baseboard, but as close as possible to their respective condenser.

The twin-gang condenser described was made up by the writer for use in a portable, where very little space was available, and gave a very good performance. A certain amount of loss occurs, of course, due to the solid dielectric condensers, and it cannot be expected to give results equal to commercial midget twin-gang condensers, which are air spaced, and which have been advertised in these pages from time to time.

NEXT WEEK!
FREE FULL-SIZE BLUEPRINT
 OF
F. J. GAMM'S MONITOR THREE!
 Specially Designed for Beginners



The complete twin-gang assembly.

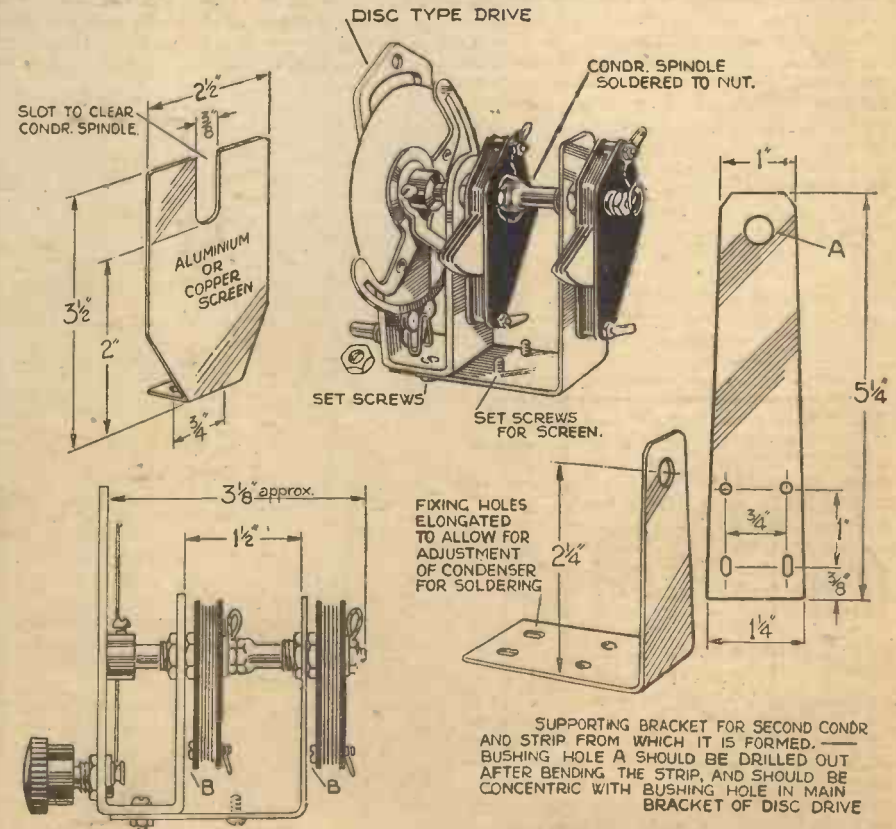

Full constructional details for making a twin-gang condenser.



FOR THE EXPERIMENTER

SERVICING SETS FOR PROFIT

In this Sixth Article of the Series, Constructional Details of a Simple Valve-voltmeter for the Serviceman are Given

AS was outlined in the previous article of this series, I propose to deal this week with the construction of a voltmeter which will enable the serviceman or amateur to measure either A.C. voltages irrespective of their frequency, or D.C. voltages, without appreciably loading the circuit to which it is connected. In fact, the current taken to operate the meter is so small as to be negligible under ordinary circumstances, and this is best illustrated by stating that the meter connected across a gramophone pick-up, for instance, will indicate the voltage developed at the pick-up terminals, and, if a constant frequency record is played, the characteristic curve of the pick-up may be plotted.

I have no doubt that many of my readers regard the valve-voltmeter as a highly complicated piece of apparatus, so difficult to calibrate and operate that it would be quite out of the question to construct one, far less use it. I will therefore endeavour to touch lightly on the theory governing the operation of the type of valve-voltmeter which is to be constructed, in order that this impression may be dispelled and a very useful instrument added to the equipment of every keen reader.

Most readers will be aware of the fact that the grid of a valve used as an anode-bend detector is biased negatively until no current flows in its anode circuit. Now, if a voltage be applied to the grid circuit in opposition to the grid-bias voltage, i.e., positive to grid and negative to filament circuit, a certain percentage of the negative bias will be cancelled out and current will commence to flow in the anode circuit. The magnitude of this current will be governed by the reversed voltage applied, and if we connect an appropriate D.C. milliamp. range of our universal meter in the anode circuit of the valve we shall be able to measure this voltage by calibrating the milliammeter in terms of the applied voltage.

Alternating Voltage

When an alternating voltage is applied to the grid of an anode bend detector valve the negative half-cycles are suppressed because the valve is so heavily biased that no further change in anode current can take place with an increase of negative volts, but the positive half-cycles reduce the negative bias in precisely the same way as a steady positive direct voltage, and the anode current of the valve will rise in sympathy.

It will thus be seen that it is quite easy to connect up a suitable valve in such a way that the application of positive voltages to its grid will produce visible indications of current through a meter connected in its anode circuit. When a given alternating voltage is applied to the grid, exactly identical indications will be obtained on the anode milliammeter, no matter whether the frequency of the applied voltage is 50 cycles from the mains or an extremely high frequency generated by a wireless transmitter. Of course, there are limitations to the frequency accuracy of a valve-voltmeter, but as the limitations are set by the grid-filament capacity of the valve used, the shortness of the wiring to it, and similar factors, an ordinary receiving valve will operate quite satisfactorily in this respect over a range of frequencies from 50 to 1,500,000 cycles per second, a range more than sufficient to meet the needs of the majority of my readers.

The valve chosen for this valve-voltmeter is the Marconi or Osram P2, because with an anode voltage of 50 volts and 9 volts on the grid the characteristics will allow us to measure 5 volts D.C. or A.C. without

running into positive grid current. It may seem unnecessary to provide a "grid-bias" of 9 volts in order to measure a change of only 5 volts, but my readers will remember that a R.M.S. voltage of 5 volts A.C. has peaks which are 1.404 times the magnitude of the R.M.S. volts which we are to measure, and the voltage will actually rise to 7 volts peak. Therefore, by allowing a grid base of 9 volts we effectively prevent the flow of grid current within the range of our instrument.

If we wished to measure, say, 50 volts directly, we should require a valve which needed at least 70 volts grid bias to stop anode current flowing and a correspondingly higher anode voltage. This would obviously be impracticable with any battery-driven valve, and so we must incorporate some form of potential divider to multiply the initial voltage range of our instrument. Reference to Fig. 1 will show that the voltage we wish to measure is applied across a 1-megohm potentiometer, the slider of which is connected to the grid of the valve. It will be seen that if the slider is turned to the end of the potentiometer which is connected to input terminal G, the whole of the external voltage applied is received by the grid of the P2 valve and therefore our calibration will be direct, but if we set the slider half-way down the resistance element only half the applied voltage will be received by the grid of the valve and our calibration will be doubled. This is extremely convenient and it has been found possible to extend the range of the instrument to read 50 volts quite easily by this means.

(Continued overleaf)

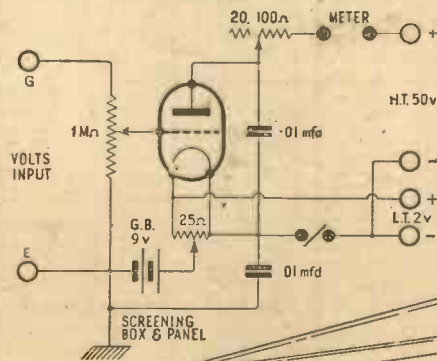
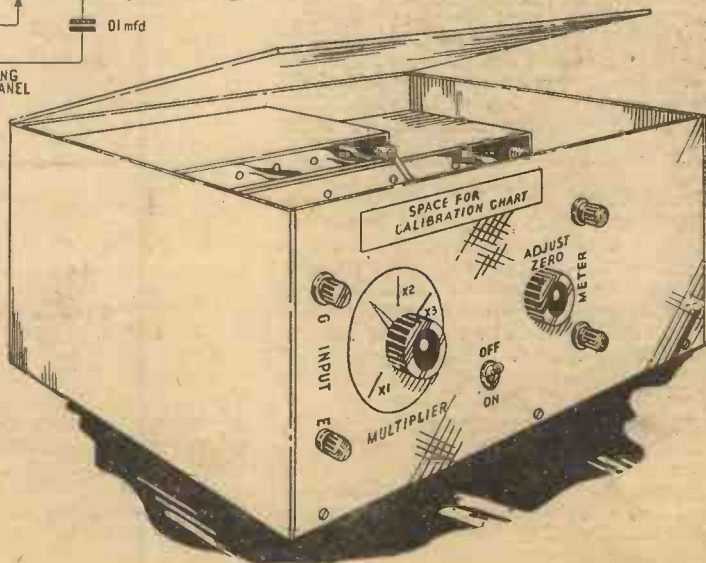

Fig. 1 (above) — The theoretical circuit of the valve-voltmeter described in this article, and Fig. 2 (right) the completed instrument in its screened box showing the space left for the calibration chart.



FOR THE EXPERIMENTER

(Continued from previous page)

Setting the Zero

The next point of interest in the circuit is the method adopted for setting the "zero" of the valve-voltmeter. It will be appreciated that as we increase the grid bias on our P2 valve its anode current will fall, and as it will be very difficult to read on the milliammeter in its anode circuit the exact point when the current falls to zero, it will be more convenient to select an arbitrary point on the scale, say, the first small division, or .01 milliamp. and set the meter to read this value before we commence to take readings. For this purpose we must use a grid-bias battery and select a negative tapping which will reduce the anode current to approximately the value we require, and then make our final adjustment by rotating the 25-ohm

with the milliammeter to 50 volts positive H.T. This resistance provides a means of limiting the current taken by the valve when grid bias is removed or neutralised by an applied voltage. If we look at the characteristic curves of a P2 valve we shall find that with no volts on the grid and 50 volts positive on the anode the anode current will rise to approximately 12 m/A. This would obviously be greater than we could read on the 0-1 m/A. scale of our universal meter and, furthermore, would be a fairly heavy load on the small capacity H.T. battery we intend to use. If, however, we include a resistance in the anode circuit of the valve we can cut down the anode current which will flow for low values of grid bias without affecting the grid circuit or the maximum range of our meter in any way. Also, by making this resistance variable we have an easy method of arrang-

Constructional Details

The foregoing would appear to explain all the major technical details of the meter, and we can proceed with the constructional details.

The whole apparatus is mounted on a metal panel and wooden baseboard, which should be inserted, as shown in Fig. 2, into a metal screening box in order that the readings obtained on the meter are unaffected by stray H.F. fields. The size of the screening-box is governed by the size of the H.T. battery and unspillable accumulator which the constructor wishes to incorporate, and hard and fast dimensions are, therefore, not given. At this juncture it may as well be mentioned that the valve-voltmeter will work quite satisfactorily without the complete screening box provided that extremely high accuracy is not required, but in all cases the metal panel should be retained. This introduces slight complications because three of the terminals to be mounted on this panel are not at earth potential and it will, therefore, be necessary to insulate their stems by suitable insulating bushes. Also the 1-megohm and 25-ohm

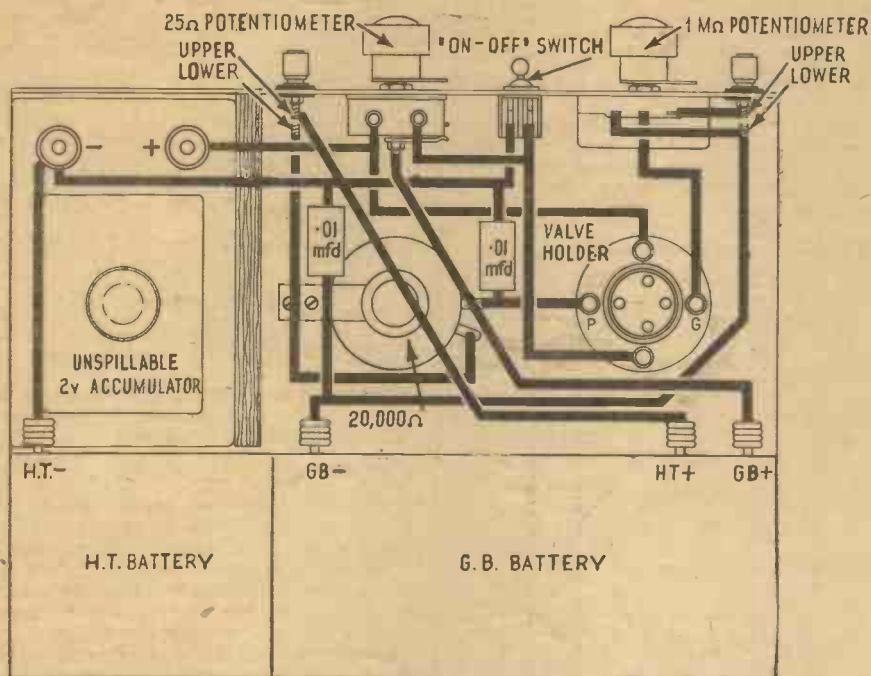

Fig. 3.—The full wiring plan for the valve-voltmeter.

potentiometer across the filament circuit of the valve, which gives us a final control over a range of 1 volt positive to 1 volt negative. Fortunately a P2 valve with 50 volts on its anode and 9 volts negative on its grid is almost biased to "cut-off" and the filament potential divider will be found to give ample adjustment.

Coming next to the anode circuit of the valve we see that a variable resistance of 20,000 ohms is connected in series

with that our milliammeter shall read exactly 1 milliamp. when the maximum voltage we wish to measure is applied to the grid circuit of the P.2. As will be seen from Fig. 3, the 20,000-ohm resistance is mounted on a bracket on the baseboard, as it is unnecessary to adjust this continually and, provided it is set at the commencement of calibration or measurement, all further adjustment is carried out by the external controls.

LIST OF PARTS REQUIRED FOR VALVE-VOLTMETER.

- 1 Screening Box (see text).
 - 1 Panel (metal) and baseboard to fit above.
 - 1 60-volt H.T. Battery.
 - 1 9-volt G.B. Battery.
 - 1 2-volt unspillable Accumulator.
 - 1 1 megohm Potentiometer (ungraded and with insulated spindle).
 - 1 20,000 ohm Wire-wound Variable Resistance (with insulated spindle).
 - 1 Mounting Bracket for above.
 - 1 25-ohm Filament Rheostat.
 - 1 4-pin baseboard-mounting Valve-holder.
 - 2 0.01 mfd. Fixed Condensers.
 - 1 "On-off" Switch.
 - 4 Terminals (three with insulating bushes for metal panel).
- Connecting Wire, Screws, etc.

potentiometers should be of the type whose spindles are not connected to the rotating contact. Suitable components are made by Reliance and other manufacturers. Alternatively, the spindles could also be insulated by suitable bushes, but this system is not quite so satisfactory, as the screening is impaired by bringing "live" spindles through the panel.

The remainder of the constructional work and wiring is straightforward, and if the explanatory drawings are followed carefully, no difficulty should be experienced in constructing the valve-voltmeter.

All that now remains is to calibrate the 1-megohm potentiometer and to set and calibrate the meter, and this procedure, together with some of the uses of the meter, will be dealt with in the next article of this series.

Radio Grass Widows

IN the city of San Francisco, it is reported that a number of women, whose husbands devote the bulk of their leisure time to amateur experimental transmission or listening on short waves, propose to establish an exclusive club in which they can find counter attractions.

Installation of Radio Linz

THE 17-kilowatt station at Rosenhugel, which previous to the opening of the new high-power transmitter broadcast the Vienna programmes, has now been dismantled and transferred to Linz. It has been entirely brought up to date, and will take over its service on 231.8 metres

HERE and THERE

(1,294 kc/s), a wavelength common to other Austrian relays.

The Czechs Plan Something Big!

THE Czech Government has earmarked the sum of twenty-seven million kronen for the improvement of the broadcasting system. A new 60-100 kilowatt transmitter is to be installed at Prague as a second station; the Prague II (Strasnice) 5-kilowatt plant to be maintained as a stand-by in case of emergency. A similar

transmitter is to be erected near Uzhorod, and a new 100-kilowatt station built north of Neutra, to extend the area now covered by Bratislava. Finally, Brno is to be given a 40-kilowatt transmitter. Possibly, also smaller relays may be installed at Carlsbad and Budweis.

Farthest North

MOSCOW reports good reception of broadcasts from a 1-kilowatt station which has been erected on the Taimir Peninsula, on a site near Cape Chelyuskin, possibly the most Northern station in Siberia, and is destined to provide news bulletins and entertainments to the scattered population in the Arctic Circle.

A PAGE OF PRACTICAL HINTS

SUBMIT YOUR IDEA

READERS WRINKLES

THE HALF-GUINEA PAGE

Preventing Meter Leads Breaking

HERE is a dodge for preventing the wire in meter leads breaking off where they join the test points. Obtain an old lamp socket and remove the springs from the

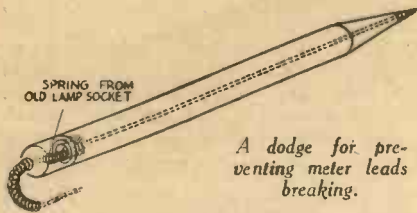

A dodge for preventing meter leads breaking.

two plungers. Pull these out a little and slip one over each lead. Push one into the end of each test prod and twist the spring slightly so that it grips. The springs prevent the leads from bending too sharply, and I find they now last for months.—W. TAYLOR (Derry).

A Fuse Hint

TO test the anode current taken by a valve under working conditions in a set the milliammeter should be inserted in the plate circuit of the valve on the H.T. side of any transformers, resistances, etc., connected to it. This often means breaking, in turn, the leads from H.T. positive to each valve—a lengthy and exasperating process.

The following idea has been incorporated with great success in a number of sets, and

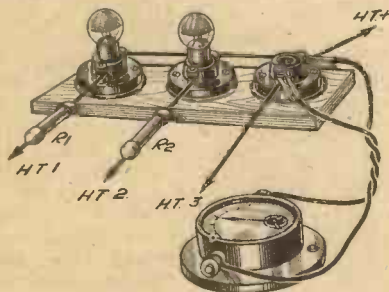

A useful fuse-board arrangement.

serves several useful purposes. On a strip of plywood mount as many fuse-holders, of the flashlight bulb type, as there are valves in the set, and mount this so that it is accessible when the set is working.

All the terminals on one side are connected together and to H.T.+ The terminals on the other side are wired up to each valve and form convenient anchorages for wire-ended decoupling resistances. A length of twin flex is connected to the milliammeter and crocodile clips soldered to the other ends. To obtain the anode current reading of any valve it is then only necessary to take out the fuse, connect the appropriate clips (coloured red and black) to the two terminals of the holder, and switch on the set.

THAT DODGE OF YOURS!

Every Reader of "PRACTICAL AND AMATEUR WIRELESS" must have originated some little dodge which would interest other readers. Why not pass it on to us? We pay £1-10-0 for the best wrinkle submitted, and for every other item published on this page we will pay half-a-guinea. Turn that idea of yours to account by sending it in to us addressed to the Editor, "PRACTICAL AND AMATEUR WIRELESS," George Newnes, Ltd., 8-11, Southampton Street, Strand, W.C.2. Put your name and address on every item. Please note that every notion sent in must be original. Mark envelopes "Radio Wrinkles." Do NOT enclose Queries with your Wrinkle.

In addition, if a fault develops anywhere, and the set will not work, all the valves and current-carrying components can be quickly tested by this means—often a most valuable asset.—A. B. C. (Liverpool).

An Easily-made Microphone

A CARBON-BUTTON type microphone can be very easily and cheaply made, using paper for the diaphragm. All that is required is a block of wood 2½ in. by 2½ in. by 1½ in., a piece of good hand-made drawing

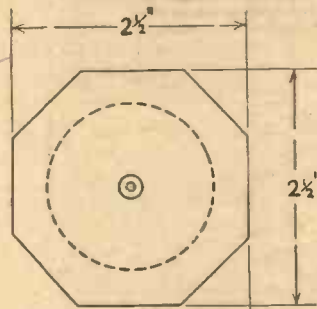

Marking out the wood block for a simple microphone.

paper such as "Whatmans," the microphone button, and its mounting. The block of wood is cut to the conventional octagonal shape, and a hole 1½ in. diameter drilled through it, as shown in the sketch. To make the diaphragm cut a piece of the paper about 4 in. by 4 in. and "damp-stretch" it over one end of the block. This is done by thoroughly soaking the paper in water and pulling until it has been stretched in every direction as much as it will go. While it is still damp fix it round the edges of the block with thin glue, and allow it to dry under pressure for about twelve hours.

When dry, it will be found that the paper is tightly stretched over the hole in the block. Trim off the surplus paper round the edges and carefully make a small hole in the centre of the diaphragm. By means of hard cardboard or leather washers attach the button, which must also be

firmly mounted at the back. Cover up the back of the microphone with wood or cardboard, and bring out the two wires from the button to terminals or sockets. The microphone can then be mounted on one of the many stands which have been described in this paper, and connected to the set in the usual way.

This microphone has been found to give as good quality, and to be slightly more sensitive than a metal diaphragm micro-

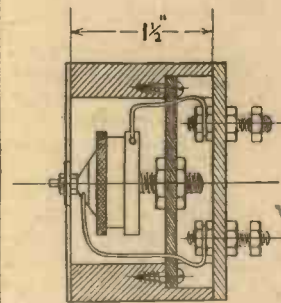

A section of an easily-made microphone.

phone with the same button, while it is much simpler and cheaper to make.—WILLIAM MUIRHEAD (Falkirk).

A Multi-contact Rotary Switch

THE accompanying sketch shows a multi-contact rotary switch I have devised from some spare toggle switches, an old potentiometer casing, a bush and spindle from an old reaction condenser, and a circular piece of brass. The sketch shows the constructional details clearly.

As there are a number of different types of toggle switches, and single and double pole on-off types, a multi switch of this kind could be made up to suit a dozen different requirements that are always cropping up in wireless construction.—JOSEPH SUTCLIFFE (Salford).

NEXT WEEK! Full-size Blueprint of Mr. F. J. Camm's Monitor Three! Specially Designed for Beginners.

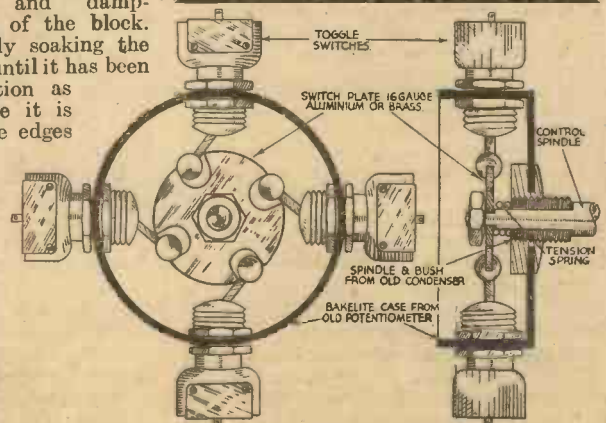

Two views of a multi-contact switch.

Resistance, Inductance and Capacity

Do You Know What these Much-used Terms Mean and their Significance in the Design and Construction of Wireless Sets? This Article Tells You in Simple Language. By FRANK PRESTON

THE terms forming the title of this article are used so frequently in all wireless work that the constructor is apt to take them too much for granted without understanding their meaning and importance. When you talk of ohms, megohms, microfarads, micro-microfarads, henries, millihenries, and microhenries, do you know exactly what is meant, and do you know the importance of keeping resistance, inductance, and capacity in their right places? If you do, the following will probably not prove very helpful to you; if you do not, it should give you a clearer insight into wireless-set construction.

Resistance, Current, and Voltage

Let us consider resistance first, because this is perhaps most easily understood. By resistance we mean the opposition which any wire or material offers to the passage of an electric current through it. Thus, each material—more especially each

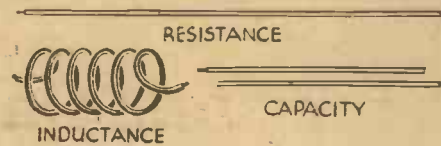

Fig. 1.—A straight length of wire has resistance only; when it is coiled it has inductance (and resistance), and when it is cut in two and the two halves placed close together there is capacity between them.

metal—has a particular *specific resistance*, by which is meant its resistance relative to a standard. Thus, the specific resistance of aluminium is 2.83; brass, 7.0; copper, 1.7; platinum, 10; zinc, 5.8, and so on. The actual resistance of a piece of metal, however, depends not only upon the specific resistance, but upon the cross section and length. It is obvious that a thin wire must offer a higher resistance than a thick one of the same material, because its conducting path is narrower.

It may not at once be apparent, but it is a fact that resistance, current, and voltage in a circuit are all allied, one being dependent upon the other two. This fact is governed by the well-known formula known as Ohm's Law, due to the discoverer. The formula reads $I = \frac{E}{R}$, where I is the current flowing,

E is the voltage or electro-motive force causing the current to flow, and R is the resistance in circuit. The mathematical aspect of this formula need not be considered here because it will be amply covered in another article entitled "Simple Wireless Arithmetic," in a later issue.

Changing Resistance into Inductance and Capacity

Now we may turn our attention away from resistance for a moment, and consider the other two terms to which reference has previously been made—inductance and capacity. These are most easily understood by considering a length of wire and making reference to Fig. 1. When the wire is in a straight length it has resistance only

(actually there is a negligible proportion of inductance), but if the wire is made into a coil or helix it has both resistance and capacity, whereas if it is cut in two and the two lengths placed parallel to each other and a small distance apart, capacity exists between them. This is probably the simplest method of noticing the relationship between the three expressions.

Units of Measurement

Before going farther it might be desirable to consider the units used in the measurement and definition of the properties which are being described. Resistance, as we have seen, and as most readers know, is measured in ohms, but it is often more convenient to speak in terms of millions of ohms, since it would be rather unwieldy to write, say, 5,000,000 ohms. Thus, the term megohm is used, and 1 megohm is equivalent to 1,000,000 ohms.

The unit of capacity is the farad, but this is far too high for most wireless purposes, so we work in millionths of farads, or microfarads. Even a microfarad is too large a unit for many purposes, and this is therefore split up again into millionths, which are known as micro-microfarads. Thus, 25 micro-microfarads is the same as .000025 microfarad or .00000000025 farad.

A similar splitting-up has to be carried out in the unit of inductance—the henry.

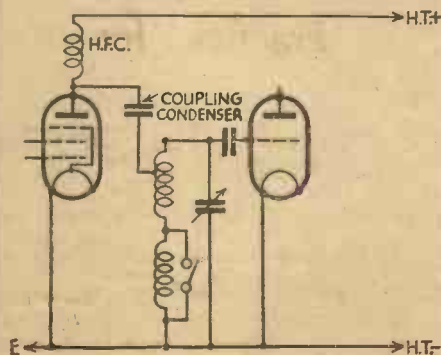

Fig. 2.—A condenser used for coupling two valves, as indicated in this circuit, acts as a complete insulator to the D.C. supply from the high-tension battery, but offers a low resistance to H.F. currents.

Here we have millionths of henries, or microhenries, and, though not very often used, thousandths of henries or millihenries. Summing up the above we see that micro-micro means one billionth, micro means one millionth, milli means one thousandth, and meg. or mega means one million.

The Importance of Inductance

Inductance is often wrongly understood, but an idea of the meaning of the term can best be grasped by considering it as being the resistance to alternating or high-frequency current. No matter how a length of wire is coiled its resistance to D.C., which is governed by Ohm's Law, does not change, but its resistance (impedance or reactance) is a more correct term) to alternating currents alters vastly. For example, the

length of wire used for the average high frequency choke has a resistance to direct current of about 300 ohms, whilst its inductance may be approximately 250,000 microhenries. This means that its impedance to low-frequency currents having a frequency of 1,000 cycles per second (equivalent to the highest note of the human voice) is 1,500 ohms, whilst the impedance to currents of 1,000,000 cycles per second (the frequency equivalent to a wavelength of 300 metres) is 1,500,000 ohms. These figures are not necessarily perfectly accurate, but are sufficiently so for our present purpose.

Function of L.F. Chokes

A similar position exists with regard to low-frequency chokes, for a choke rated at, say, 20 henries would have an approximate D.C. resistance of 250 ohms. But the impedance of the choke to an A.C. current at 50 cycles would be about 6,000 ohms, or 12,000 ohms if the frequency were doubled. These examples show one important use of inductance: an inductance coil or choke can be designed to provide an easy path for direct current whilst offering a considerable resistance to alternating currents, or, by using a smaller inductance value, to offer a comparatively low impedance to low-frequency alternating currents and a high impedance to high-frequency currents. It will have been gathered from the foregoing that the impedance of a choke increases with inductance and frequency, and *vice versa*; it is important to remember this simple fact.

The Effect of Capacity

So far we have said very little about capacity, but this generally indicates the property of a condenser for storing electricity, just as the capacity of a water tank indicates the amount of water that the tank will hold. Thus, a 1-mfd. condenser will hold twice as much as a .5-mfd. condenser, and so on. This particular property of capacity is used to only a small extent in wireless practice, however,

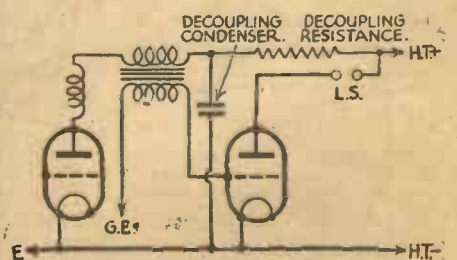
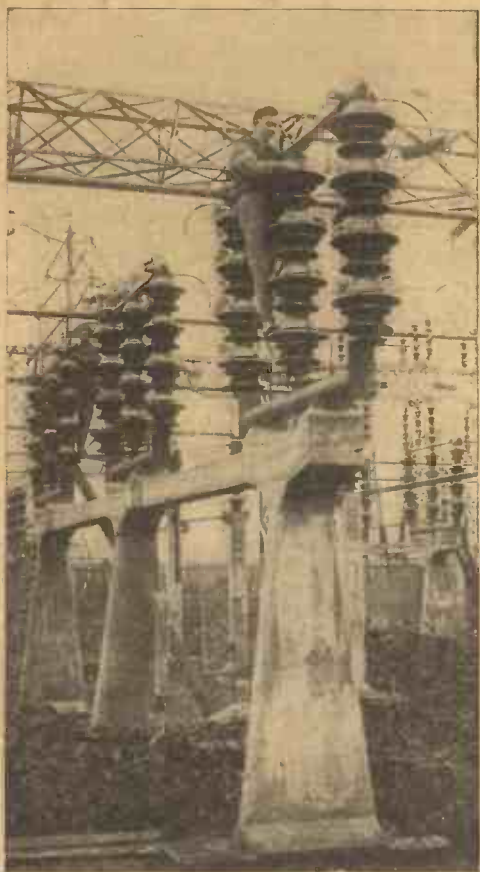

Fig. 3.—A decoupling condenser provides a perfect barrier to direct current, but has a comparatively low resistance to low-frequency currents.

and the main point to consider is that a condenser offers infinite resistance to direct current (it can be considered as an almost perfect insulator, in fact), but it does not prevent the passage of alternating or high-frequency current. This can readily be

(Continued on page 633)

● THE MOST SUCCESSFUL ELECTRICAL WORK OF THE YEAR



*Sent to your Home
FREE on approval for 7 days*

If YOU Work in
Any Branch of the
Electrical Industry
YOU NEED THIS NEW BOOK

The FIRST and ONLY one of its kind

The Electrical Encyclopedia

A Handbook of Modern Electrical
Practice for the Working Electrician

4 Volumes ... 1,480 Pages

**Over 2,300 Photographs,
Drawings, Diagrams, etc.**

**A Few of the
2,000 Articles**

- Broadcasting: Complete Process in Outline
- Bus-Bars in Power Work
- Cables for All Purposes
- Cinema Plant: Modern Design and Organisation
- Circuits: The Main Varieties Expanded
- Clocks, Electric: A Modern Development
- Confectionery Works, Electricity in
- Daylight Lamp
- Distribution of Electricity: Modern Methods
- Earths and Earthing System
- Electricity: Its Nature and Action
- Electrolysis: Its Industrial Applications
- Faults and Fault Location
- Heaters and Heating
- Mathematics for Electrical Engineers
- Mercury Arc Rectifiers
- Neon Tube and Neon Lighting
- Power Factor and its Correction
- Quantum Theory of Energy
- Radio-Gramophone Electrical Equipment
- Resistance in D.C. Circuits
- Stage Lighting
- Television: The Principles
- Traction, Electric: Principles and Equipment
- Trolley-Bus, The
- Ultra-Violet Light Apparatus
- Vacuum Cleaners

SEND NO MONEY NOW
YOURS
for
2'6
DOWN
if kept after examination

Just sign and post the form at right and on acceptance we will send you these four volumes, carriage paid, to examine for one week free. You may either return them to us, carriage forward, within 8 days, to end the matter, or you may keep them on the very easy terms outlined. 

General Editor: S. G. Blaxland Stubbs

Associate Editors: Arthur Arnold, A.M.I.E.E., A.M.I.Mech.E., Editor of "The Power Engineer."
R. A. Baynton, B.Sc. (Eng.) A.C.G.I. Philip Kemp, M.Sc. (Tech.), M.I.E.E.E., Mem. A.I.E.E., Head of the Polytechnic School of Engineering. S. O. Pearson, B.Sc., A.M.I.E.E. S. Austen Stigant, M.I.E.E., F.Am.I.E.E. G. W. Stubbings, B.Sc. (Lond.), F. Inst.P., A.M.I.E.E.

THIS comprehensive work contains sound, up-to-date, authoritative information written by experts in every branch of the profession, and covers thousands of problems and questions of everyday work. The rapid development of electrical technology means an enormous increase of opportunities for the electrical engineer who keeps abreast of advancing knowledge. YOU can seize these new opportunities NOW by the aid of "The Electrical Encyclopedia." Whatever your particular subject or job you will find that this work will add to your efficiency, aid your advance in your profession and secure certain SUCCESS.

SPECIAL "PRACTICAL WIRELESS" FREE EXAMINATION FORM
To the WAVERLEY BOOK CO., LIMITED,
96 and 97, Farringdon Street, LONDON, E.C.4.

Please send me, carriage paid, for seven days FREE Examination, "The ELECTRICAL ENCYCLOPEDIA," complete in four volumes. It is understood that I may return the work on the eighth day after I receive it and that there the matter ends. If I keep the books I will send you on the eighth day a First Payment of 2s. 6d., and, beginning thirty days after, thirteen further monthly payments of 2s. each and a final one of 6s., thus completing the purchase price. (Price for Cash on the eighth day, 70s.).

Name

Address

Occupation State if householder.....

Parent's Signature required under 21..... Date

Pr.W.5 PLEASE FILL IN ALL PARTICULARS ASKED.

Running Costs

A Simple Explanation of the methods of determining the Amount of Power, and Hence the Cost of Running Various types of Receiver. The Question of Ensuring Economy is Also Considered



Two Drydex H.T. batteries. (Above) a triple capacity battery, and (right) a standard 120 volts battery.

WHEN the purchase of a new car is contemplated the question of upkeep and running expenses is one of the first to be considered, since the answer to this generally enables one to decide whether or not one can afford the car. In radio, unfortunately, the corresponding question is rarely given the attention it deserves; probably the reason is that the cost is so much less, and that the difference in running expense between various receivers is also less. But if the matter is considered on a basis of percentage difference between, say, a three-valve receiver with S.G. and pentode stages and a five-valve superhet with frequency-changer and push-pull output the result might be surprising to many.

A Two-valve Battery Set

Suppose we examine a few figures in order to obtain more definite results. In the first place we might take as an example a two-valve battery receiver with detector and pentode valves intended for loud-speaker operations. In order to ensure a reasonable output from this, 120 volts H.T. will be essential, and the total current consumption—assuming the use of a high-efficiency pentode giving an output of about 500 milliwatts—will be about 7 m/A for the pentode and 1 m/A for the detector, or 8 m/A altogether. A set of this kind could be operated from a battery of the lower-capacity type having a rated discharge of 6.8 m/A costing about 7s. 6d., and about 300 hours' service would be obtained. On the other hand, use could be made of a super-capacity battery rated at about 12 m/A discharge and costing approximately 10s. 6d. When using the larger battery costing only about 40 per cent. more, however, the hours of useful service would be just about doubled; the saving in expense when using the larger battery is evident.

Economy of Super-capacity Batteries

If the receiver were a three-valver with an average current consumption of, say, 12 m.A. the economy effected by using the larger battery would be still more pronounced, since the life of a normal-capacity battery would be relatively short. For example, the cheaper battery would have a useful life of only about 120 hours, whilst the other could be expected to last for at least 320 hours. In other words, the running costs, so far as H.T. is concerned, are only very slightly higher for a set taking 12 m/A and operated from a super-capacity battery than for the smaller set when used with a battery of normal or standard capacity.

receiver is normally used 25 hours per week, and when using a battery at its average rated output, a useful life of about twelve weeks can be expected. This means that a two-valve set of the type first referred to would cost 2s. 6d. per month for H.T. current when operated from a normal-capacity battery, or about 1s. 9d. when a super-capacity battery were used.

The larger receiver would cost approximately 5s. per month when using a normal-capacity battery, or less than 3s. 6d. per month with the super-capacity battery. In estimating the cost of battery current for other types of receiver a fairly close approximation can be obtained by assuming that a life of at least 300 hours should be obtained when the battery is operated at its average rated output, whilst 600 hours is a safe estimate when it is operated at about "two-thirds load." The saving is still greater when using a battery of larger relative capacity, because the length of service is not proportional to the capacity of the battery, but almost to the square of the capacity. This means that a battery of, say, 5,000 milliampere-hours' capacity would last very nearly four times as long as one of 2,500 milliampere hours on the same load. It might be mentioned, incidentally, that milliampere-hour ratings

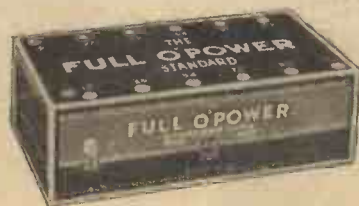

A Siemens Standard 108 volts battery.

are of little value in computing the probable life of the battery, since so much depends upon the regularity of use, maximum current at any time, and several other factors, and the above figures are used merely to illustrate the point in question.

Special Cases

A receiver with a class B or Q.P.P. output stage is extremely economical of current in proportion to the output which it gives, but can be expensive to run if the battery is not correctly chosen. It is frequently thought because the average H.T. consumption is only about 10 milliamps., that a battery intended to supply this output is perfectly satisfactory. This is far from correct, because the maximum current consumption may be as high as 30 milliamps, although such a current is drawn only for a very few seconds per hour. In order to cope with these "peaks" the

battery employed should have a rated output of at least 16 m/A if economy is to be considered. With a battery of such a rating a useful life of 4 to 6 months is to be expected, and thus, taking the price of a 120-volt, 20 m/A battery as 15s., the cost per month will average 3s. 6d., which is little more than the cost of current for a normal three-valve receiver with pentode output when used with a 12 m/A battery.

Accumulators

One of these forms of supply becomes a practical essential if a continuous current in excess of about 20 milliamps. is required, especially where economy must be considered. The eliminator will be considered later after dealing with mains-operated receivers, so we are left to consider the advantages of accumulators. The normal type of lead-plate accumulator is best known and is ideal when there are good facilities for charging, but it is rather a nuisance if the accumulator has to be carried for some distance to the charging station. The price varies according to capacity rating, but an average figure is 6s. per 10-volt section. Having a capacity of about 5,000 milliampere-hours, such accumulators will give a discharge of 20 milliamps. for about 250 hours. Thus the battery will give about three months' service per charge, the latter costing about 2s. per 60 volts. When a discharge rate up to, say, 40 milliamps. is required it is best to use accumulators having a capacity of 10,000 milliampere-hours and costing about 12s. per 10 volts. Such batteries will run for at least six months at 20 milliamps., or for between two and three months at double the output, and cost a little more for charging.

(To be continued)



The Siemens Super Radio 50 volts H.T. battery.

On Your Wavelength

Cats and Mice

TIME has come, the walrus said, to talk of many things, and one of the things of which I wish to speak this week is cats, if you will allow me to be ungrammatical. I read the other day that cats and mice have actually got in the news. One wandered into the apparatus at Radio-Normandie the other day and the short circuit which resulted caused a small fire. It is not known what happened to the cat, but I will refrain from making the obvious joke about its whiskers; and a mouse ate the insulation off the mains transformer of a set owned by a reader. When he switched on, I am informed that the mouse had about 350 volts to help its digestion. I hope this item of news will not inspire the many budding inventors who frequently write to me to design special mouse-traps of which the home radio forms the integral part.

"Wanted—a Volume Control"

A. J. C., of Sutton, writes: "In reply to your article in PRACTICAL AND AMATEUR WIRELESS of January 4th, Vol. 7, No. 172, you write 'Wanted—A Volume Control.'"

"Well, I wish to state that I have had



More about cats—one caused a small fire at Radio-Normandie the other day.

a volume control in use from November, 1931.

The potentiometer called for, and still in use to-day, is made by Claude Lyons, Ltd., 76, Oldhall Street, Liverpool, or 40, Buckingham Gate, London, and is sold in many resistances from 100 ohms to 50,000 ohms. One in use is 4,000 ohms, type M4, for two variable-mu valves.

"I have nothing but praise for this potentiometer, as I had several potentiometers, which were not all they should have been.

"This potentiometer has been in constant use since November, 1931, and has done all and above what a good potentiometer should do. They are not dear, about 5s. 6d. each. C. Lyons also stock the 'Hum-Dinger,' which is another fine article.

"The usual 'I have no connection with C. Lyons, Ltd.,' etc.

"Trusting you will try one of these potentiometers yourself, and find what a good job they are."

Floods—A Compensation

A CHEERFUL correspondent who refuses to have his high spirits submerged even by floods tells me that he has been living in his bedroom for some time as the

By Jhermion

water has entered the ground floor of his demesne and the furniture is afloat. He managed to retrieve the wireless set and rigged it up in the bedroom aforesaid. He noticed a marked improvement in reception which he puts down to the improved earth provided by the water. At last, he says, he is sure that he has got a good earth.

The Luxembourg Effect

CAN'T anything be done about the "Luxembourg effect"? I heard a man say the other day: "What's the good of buying a good or expensive set if every station is to be ruined by a background of advertising announcements? This is an exaggeration, but trade is bound to be affected by people buying cheaper "local" receivers unless the trade make some appearance of "doing something about it" and not just saying "For technical reasons it can't be helped."

Debates

THE B.B.C. announce that there are to be fewer debates. I am glad to hear it. A recent debate completely ruined an evening for me. I had asked a friend round for a quiet evening and switched on the wireless. We had not listened to much of the debate before it became obvious that on that subject we could not agree. We parted at the end of the evening mortal enemies. Unfortunately, he is one of those people who becomes abusive in the heat of argument.

Tuning Dials

IT is many moons since I stated that the tuning dial should be dispensed with. Since that day the manufacturers seem to have gone even more whole-heartedly into the question of devising intricate and elaborate tuning devices, and I must say that I am intrigued by some of the schemes which have been produced. However, I still maintain that the tuning scale is not an ideal device for the location of stations. But, unfortunately, many listeners still seem to want a wireless receiver to do things outside its capabilities. They want this station and that station at all times of the day or night, without first considering whether or not the receiver is suitable for the reception of that station. Consequently, there is much searching and manipulation of the controls in an endeavour to make a very weak signal audible, and it seems that if the tuning dial is crammed full of the names of stations it gives the user an added sense of superiority. My ideal receiver only gets two stations, and there is no tuning dial. A simple switch has two positions marked National and Regional, and I hear nothing but these. But the quality is astounding to those who are used to the more usual type of reception, and there is no reaction or other artifice for bringing up the strength of more or less inaudible stations. Two flatly-tuned H.F. stages feed

a diode which feeds a super-power output stage with 500 volts H.T., delivering at maximum over 6 watts. A volume control is fitted, and normally the output is adjusted to about 2 watts level. After using this no member of my household would be bothered with a tuning dial and various tuning adjusters, and I am sure that the production of a commercial receiver with a neat row of buttons, limited to no more than half a dozen, would have an appeal to those who are interested in good quality signals. What about it, manufacturers?

Portable Troubles

IT is a long time since I saw a portable which had broken down due to accumulator fumes. This was a very common complaint in the early days of broadcasting, but seems to have died out quite considerably of recent years. The fumes from the accumulator play upon the finer wires in the receiver (such as the frame aerial), and corrosion sets in with eventual breakage. This trouble generally makes itself evident by crackling noises which increase steadily in intensity. If you have a portable in which the accumulator is of the "free acid" type, and this is enclosed in amongst the wiring or near the frame aerial, you should take steps to avoid the trouble. A very simple and efficient dodge is to fit a short length of rubber tubing to the vent cap of the accumulator and lead this out through a hole in the side of the case. Alternatively, the adjacent parts may be painted with anti-sulphuric paint, or a thin sheet of glass may be supported above the accumulator to prevent the fumes from coming into contact with the wires. The first arrangement is the most efficient.

Incompetent Radio Dealers

I HAVE written on this subject before, but I am constantly being reminded of the lack of elementary radio knowledge and equipment by so-called service engineers, dealers, and their assistants. It seems that a large number of these people have not the slightest idea how to check a tuning coil or a transformer, and about all

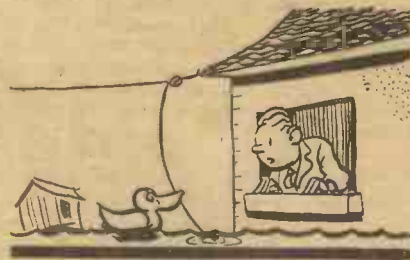

At last he has a good earth.

they seem capable of doing is applying a voltmeter to the terminals of the high- and low-tension batteries. Even then they are frequently very uncertain as to the exact meaning of the readings which they obtain, and either forget all about the variation in voltage which occurs when the battery is "loaded," or otherwise use a low-resistance meter which is itself an appreciable

(Continued overleaf)

(Continued from previous page)

"load." There is no excuse whatever for any professional wireless engineer to tolerate cheap and inefficient meters to-day, for perfectly reliable ones can be bought at reasonable prices, and they are made by nearly every instrument maker. I strongly recommend every person engaged in the service business to obtain—if he already does not possess one—a reliable multi-purpose test meter which is suitable for measuring both A.C. and D.C. After that, I recommend him to learn how to use it correctly, and to study the makers' literature. When he has mastered that side of the business, he might invest in a good resistance and capacity bridge and a local oscillator; these must be used still more skilfully, but practice makes perfect!

All About Fog

IN this interesting feature programme (Regional, February 3rd) an endeavour will be made to portray some of the many activities of the public services in their efforts to reduce to a minimum the inconvenience which fog causes to the public.



Can't anything be done about the Luxembourg effect?

On land, sea, and air, life is held up, but great efforts are made to overcome the dangers and delays which we all know only too well.

In the air the difficulties can be partly overcome by means of wireless telegraphy, and on the sea, ships can find their positions by means of echo sounding apparatus and by means of wireless telegraphy, as in the case of aeroplanes; but the danger to large and well-equipped vessels as well as to the smaller fishing vessels remains considerable. On land, the railway and underground companies, as well as the omnibus and tram companies, are hard at work to keep their services running; and indirectly, fog affects the Post Office, the electric light and power supplies, as well as numerous varieties of business firms.

All these difficulties and the steps taken to counteract them will be illustrated and explained in this programme, listeners to which will realise that, although in times of fog they may feel themselves abandoned to the whim of nature, there are in actual fact large and efficient organisations doing everything in their power to enable them to continue life with as little interruption and inconvenience as possible. The programme has been devised and will be produced by Robin Whitworth.

Conquest of the Air

WHO owns the air? Does the future of aviation depend on subsidy? Can air-raid precautions ever be effective? These are a few of the many questions which the layman asks himself about aviation, and a series of talks, beginning on February 11th, in the National programme, has been arranged in which these questions will be discussed by leading authorities. To introduce this series a feature programme has been arranged, which will show how from an isolated pioneer's experiment with man-



Notes from the Test Bench

H.F. Transformers

IF good selectivity is to be obtained with only two tuned stages, it is advisable to employ H.F. transformer coupling between the aerial and the first valve, and also between the first valve and the detector. This type of coupler is generally less efficient than the tuned grid type, however, unless the coils are very well designed. In the cheaper type of H.F. transformer it is often found that the efficiency is very low, and therefore readers are advised to use well-tryed components of well-known make. It would seem that the most difficult point in the construction of H.F. transformers is the size and disposition of the primary winding, and in several cheap samples which we have tested it has been found that efficiency is low on one or other of the wavebands. Coils that have proved satisfactory on the medium waveband have been inefficient on the long waveband, and vice versa. This is almost invariably due to the use of a common primary winding for both wavebands. To obtain best results it is desirable to have separate primary windings for the two bands, with a switch to short-circuit the long-wave section at the same time as the long-wave section of the grid winding. This procedure complicates the switching, of course, but will, in most cases, prove worth while.

£4 Superhet Addition

A FEW readers have written to ask us whether they can substitute a Class B output stage in the £4 Superhet in place of the pentode stage. This substitution is not recommended as the sensitivity would be greatly lowered thereby; the amplification obtained from a Class stage is much lower than that obtainable from a good pentode stage. If a Class B valve is to be used in the output stage, it should be preceded by a triode driver. The existing pentode could be used as a driver valve if desired, but it would be necessary to connect its priming grid (centre pin) to approximately 60 volts and reduce its bias voltage to 6 or 7½ volts. Used in this manner in conjunction with a correctly-matched driver transformer and Class B valve good results should be obtained. This modification would reduce the total H.T. current consumption, but would increase the L.T. consumption.

Class B Consumption

WHEN using Class B valves a reliable dry or wet H.T. battery should be used, as the small type of dry battery has too low a current output to satisfactorily feed this type of valve; this precaution also applies in cases where a power pentode or super-power valve is employed. Another point worth noting in connection with Class B and Q.P.P. valves is their L.T. consumption, which, in some cases, is .4 amp. If used in a four-valve set the total L.T. consumption can therefore be of the order of .8 amp. and the small mass-plate accumulator becomes unsuitable. For sets of this type it is advisable to use a large multiple-plate accumulator.

lifting kites, the science of aviation has reached the complexity and importance of to-day. The history of aviation is a peculiarly interesting and exciting one. The programme will describe in turn the reckless and immensely valuable experiments of the early pioneers, the amazingly rapid development during the war, and the almost equally rapid organisation and expansion which has continued from the end of the war to the present day. Finally, mention will be made of some of the problems, still to be overcome, which have arisen from man's conquest of the air.

Films and Television

IN these columns recently we drew attention to the concern shown by the Cinematograph Exhibitors' Association towards the televising of films. It is now learned that a new standard contract between the film renters and exhibitors is under consideration, and this contains a clause to the effect that there is to be a ban on the televising of films until the expiry of three months after exhibition in British cinemas. This veto, which by all accounts



A radio debate spoiled my evening.

seems certain of adoption, will produce an awkward situation for the B.B.C. in the provision of suitable programme material. It is hoped, however, that a suitable arrangement will be effected, and in the meantime further effort is being made to effect improvements in direct pick-up scanners, so that all forms of studio subjects can be televised without the necessity of employing subject matter from films.

The Television Cable

THE installation of the new co-axial cable between London and Birmingham is now well in hand, and if anticipated hopes are realized this will be capable of handling signals with a frequency extending up to one million. Apart from multiple telephonic communications on the one line, and its use for television programme distribution, the idea is already being mooted abroad that it could be employed as a visiotelephony link between the two cities. Then not only will subscribers from special booths be able to converse with one another, but they will have the added advantage of being able to see one another's features in the form of television pictures. For certain business matters and on domestic anniversaries this will be of great value, and if properly exploited should prove quite remunerative to the Post Office.

**FREE BLUEPRINT
OF THE
MONITOR THREE
NEXT WEEK!**

Specially Designed for Beginners.

Substitutes and Replacements

There are Many Ways in which Expense may be Saved, and a Receiver Probably Improved, by Using Alternative Parts when a Breakdown Occurs or when Opportunity Arises. Some Interesting Schemes are here Discussed

By W. J. DELANEY

MANY listeners are under the impression that when a component or valve breaks down or develops a fault, a similar item must be obtained as a replacement. In general, this statement is perfectly true, but with a little careful thought it is often possible to utilise another component or valve with a view to subsequent changes in some other part of the circuit, so that the general scheme may be improved or modified in order to take advantage of some new idea. A similar state of affairs exists when an opportunity is presented for the acquisition of some component which at the moment may not be of any use in the receiver, and it may be used as a substitute with a view to some future scheme.

It is, of course, unwise to make such substitutions and exchanges when the theoretical knowledge which you possess is insufficient to enable a full understanding of such change to be obtained, but the following notes will give some idea of the possibilities of the scheme.

Breakdowns

Let us deal first with breakdowns which might occur and prevent a receiver from working. In general, the only components which are likely to suddenly break down and prevent reception are those across which a difference in potential exists, or, in other words, those which are carrying a current. In the average receiver these will consist of the coils, chokes, and transformers. A breakdown of a component in an anode circuit will prevent signals,

and in this position we find chokes and transformers—components which are generally found to fail when an excess current is passed. Under normal conditions, therefore, a breakdown will indicate that an excessive current has been passed, and before carrying out any replacement an examination should be made to ascertain the cause of the breakdown.

When this has been located and the

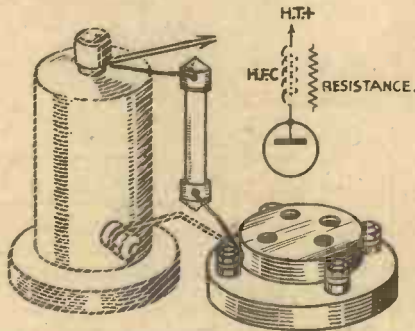

Fig. 1.—An H.F. choke may be replaced by a resistance in most circuits without marring the performance.

fault remedied, a new component will be indicated, and it may so happen that a similar item is not readily obtainable. In the case of an H.F. choke a resistance may be included in many cases with very little loss of efficiency, and the only general trouble will be found in a reduced voltage

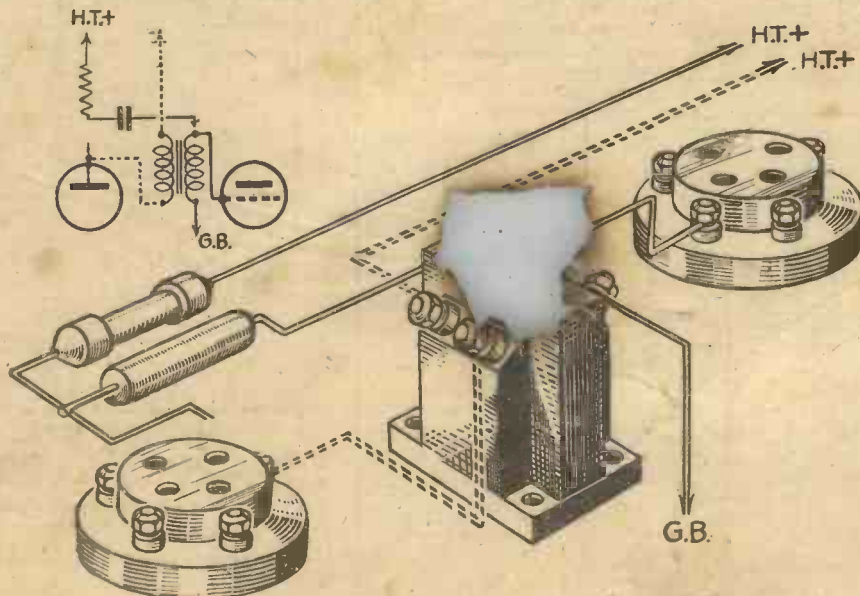

Fig. 2.—An L.F. transformer primary may break down. It may be replaced by a resistance and condenser as shown here.

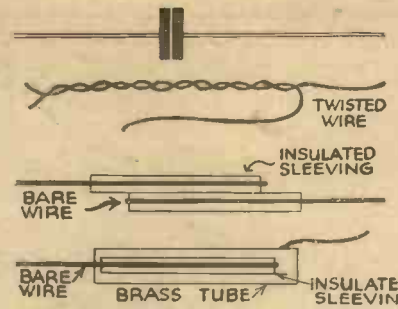

Fig. 3.—As a substitute for a broken condenser, one of the schemes shown above may be employed.

on the valve. In many cases this may be remedied in a very few moments by connecting the H.T. lead from that valve to a higher tapping on the H.T. battery, or connecting it to the maximum H.T. positive lead. For normal reaction circuits the value of the substitute resistance will not be found critical, and for many types of H.F. coupling also the resistance will be found to function as well as the choke, except, perhaps, on the lower wavelength ranges.

Transformers and Resistances

In the case of a transformer breakdown it may be safely taken for granted that only the primary will be found faulty, as there is no current of any magnitude flowing through the secondary. Temporarily, the secondary could be used in the anode circuit, but such a course is not recommended in view of the fact that it is not designed for the passage of a steady D.C. Therefore, in order to enable reception to be carried out, a resistance may be placed in the anode lead, with a coupling condenser between the anode and the grid of the following valve, the secondary remaining in its original position, but now serving as a grid leak in the form of a choke. It may even be found that results are improved by this scheme. If desired, subsequent modification would consist only of a resistance in place of the transformer secondary, thus substituting R.C. coupling for transformer coupling.

Where a resistance has failed, it may generally be found that only another resistance may be used in its place, although in the case of a decoupling resistance it may be taken for granted that an H.F. choke will answer the same purpose, but will permit the application of a higher voltage to the valve. This point should therefore be borne in mind when making this substitution.

Condensers and Valves

A condenser of one value may generally be replaced by a component of another value for temporary listening purposes, although if the condenser forms part of the main tuning circuits it is possible for ganged tuning schemes to be put out of alignment. A temporary expedient in such a case may be to alter the necessary trimmers for the time being, or until a correct value of component may be obtained. If the faulty condenser is of a low value, a temporary condenser may be readily constructed by twisting together a length of wire, the capacity varying according to the thickness of the wire, the insulation thickness, and the length of the wire. Two alternative schemes are also shown in Fig. 3. It may even be found that by adopting one of these schemes in place of a condenser already in use a much more critical value is found, with consequent improved performance.

(Continued on page 632)

A SIMPLE

Constructional Details are Here Given of a Simple

set as the aerial coil *By L. Or...*
in the unit, and use the aerial coil as the tuned grid coil and provide another coil for the aerial circuit of the unit. For after all, the output of the unit is identical to the signals received in the aerial, only more powerful; therefore, there seems no reason why the output should not be taken to the aerial terminal of the receiver.

The Circuit

On referring to Fig. 6, which shows the actual circuit of the H.F. unit, you will note that it is the same as Fig. 3, with the exception that no tuned-grid coupling coil is provided, as the aerial coil in the receiver will now serve its purpose.

The second item, handling a powerful signal, is taken care of by using a Mazda variable mu H.F. pentode, which can cope with a very large input without the fear



Fig. 1.—A rear view of the completed H.F. unit.

If you are the possessor of a good two- or three-valve "straight" receiver, this H.F. unit will no doubt appeal to you, as its purpose is to overcome many of the snags which are now present with a large majority of the simple sets. By straight sets I mean those of the detector and L.F. variety.

While most of the owners of such sets seem very happy and content with the results they obtain, they have to admit that they could do with a little extra pulling power—just to bring one or two foreigners up to scratch—while the selectivity, of course, is not all that it could be. But the old set is too good to scrap or else it is a question of time and trouble to build a new one. It is for these listeners that this simple H.F. unit has been designed. By its use not only will the range and selectivity of your receiver be improved, but there will be less fiddling about with the reaction control and pushing the set to its utmost, with the attendant loss of quality.

General Considerations

In designing the unit, the first thing that had to be considered was ease of attachment to any existing receiver. Secondly, it had to be capable of handling a powerful signal without distortion, for those living near a transmitter, and thirdly, it had to give a reasonable degree of amplification without being sufficiently sensitive to set up background noises and instability under various conditions.

The first requirement is dealt with in the following manner. Fig. 3 shows the circuit of an H.F. stage in which a very popular form of coupling is used, namely, "tuned grid," and you will also notice that two coils are used, one for the aerial circuit, and one for the coupling.

Such an arrangement is quite usual in receivers employing one or more stages of H.F. amplification but in this instance we already have an aerial coil in the receiver.

As the unit has to be simple, we can dispense with the present aerial coil in the receiver.

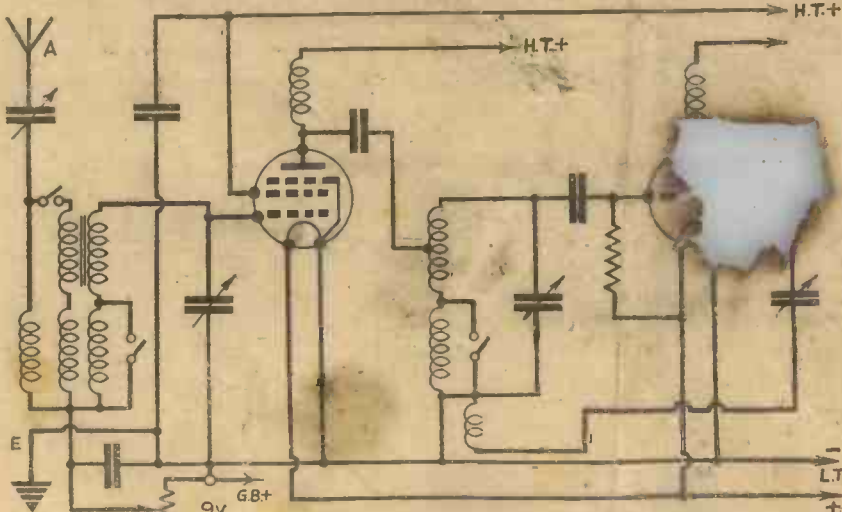

Fig. 3.—An H.F. stage employing tuned-grid coupling.

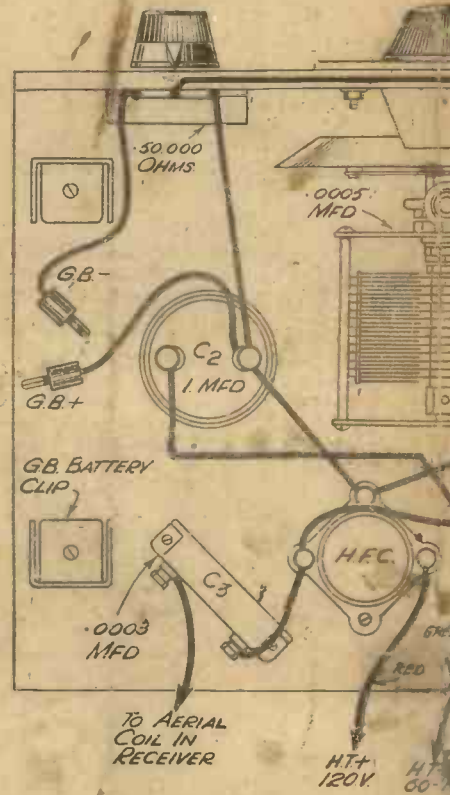

Fig. 4.—The wiring diagram for

LIST OF COMPONENTS

- One type P.I.C. Tuning Coil (Wearite).
- One .0005 mfd., type No. 4, Tuning Condenser (Polar).
- One S.M. Dial (panel mounting type) (Polar).
- One .0005 mfd. Fixed Condenser (Graham Farish).
- Two 1 mfd. type 9200 Fixed Condensers (Dubilier).
- One pre-set Condenser, .0003 mfd. (Ward and Goldstone).
- One Terminal Mount (Belling Lee).
- Two Terminals (type R—A. E.) (Belling Lee).
- Two G.B. Battery Clips (No. 1) (Bulgin).

E H.F. UNIT

Simple Unit for Adding an H.F. Stage to a Straight Three-valve

Diamond Sparks of distortion, while the variable mu characteristics allow a very satisfactory form of volume control to be obtained, together with other advantages.

The third requirement, sufficient amplification without background noise, is settled by using only one stage of amplification. Bearing in mind the fact that only signals reaching the aerial with a certain strength are really worth amplifying, it will be found that the single valve will give very satisfactory results.

From Fig. 6 will be seen that the aerial circuit employs one of the latest Wearite P.I.C. coils, which is of the iron-cored type, and is designed to eliminate "break-through" effects, a valuable asset for those operating near a transmitter.

Bias is provided by means of the 9-volt G.B. battery, the voltage being controlled

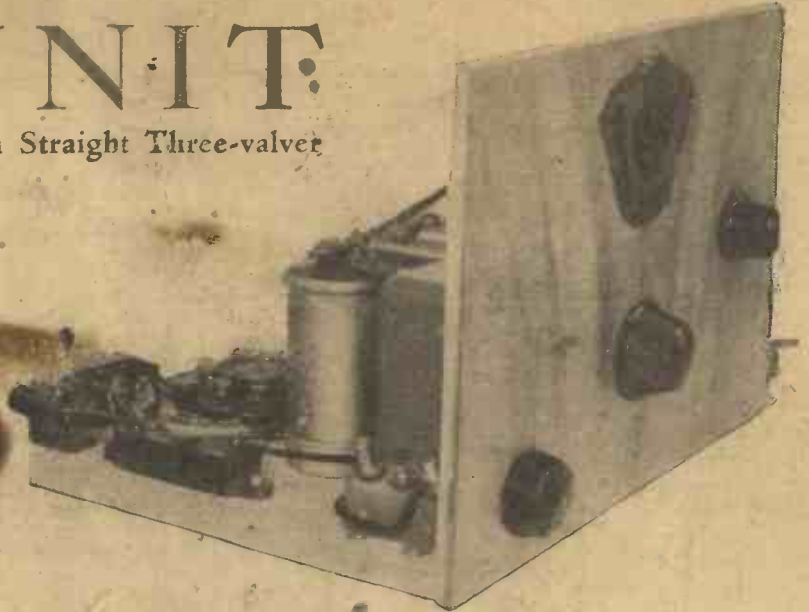

Fig. 2.—A three-quarter front view of the unit showing the panel arrangement.

by the 50,000-ohm Erie potentiometer which allows a very smooth adjustment to be obtained. As usual, in a circuit of this type, the coils are not connected direct to earth, but are anchored to one side of the 1 mfd. fixed condenser.

In the anode circuit of the V.P.215 is inserted a reliable H.F. choke. As it is necessary that this component must be efficient, a choke of well-known make such as the Wearite H.F.P. should be used.

The output from the valve is fed to the receiver through the small fixed condenser C.3, which acts as the coupling condenser, and prevents the passage of any direct current from the H.T. on the anode. So much for the actual circuit. Now let us see how the unit is connected to a receiver.

Practically every receiver has the common negative connected to the earth circuit, that is, the L.T. and H.T. negatives are joined to the earth terminal. This arrangement is desirable as it simplifies coupling between the unit and the receiver.

Four leads are provided. Black, red, green and blue. First of all, remove the earth wire from the receiver and connect it to the E terminal on the unit, and then do likewise with the aerial lead. Now connect the black wire to the earth terminal on the receiver, the blue to the positive L.T. terminal on the accumulator, the red one to the 120-volt tapping in the H.F. supply, and the green to a 60- or 70-volts tapping. The vacant terminal on C.3 must now be connected to the aerial terminal on the receiver or, better still, the associated terminal on the set's aerial coil, in case

(Continued overleaf.)

Connecting the Unit

There is only one point to watch.

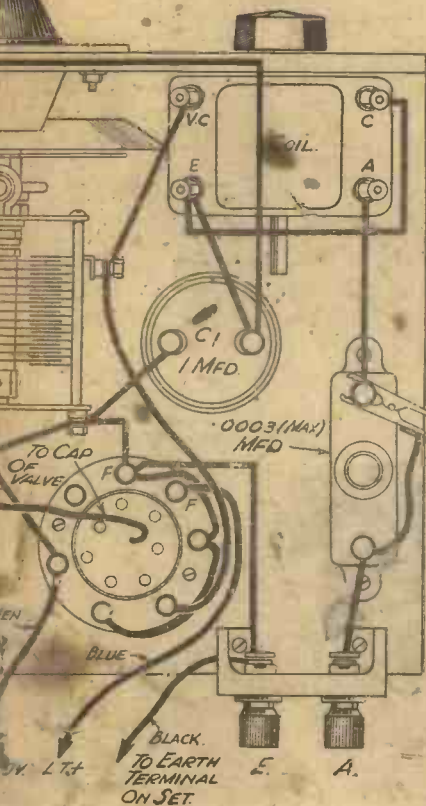

this interesting and efficient unit.

LISTS FOR H.F. UNIT

- One 50,000-ohm Potentiometer Volume Control (Erie).
- One Screened H.F. Choke (type HFP) (Wearite).
- One baseboard, type 7-pin Valveholder (W.B.).
- One wooden baseboard, 10in. by 7in.
- One wooden panel (10in. by 7in.).
- One Crocodile Clip (Bulgin).
- Flex, Wire, Screws, etc.
- One Var.-Mu. H.F. Pentode, type VP. 215 (Mazda).

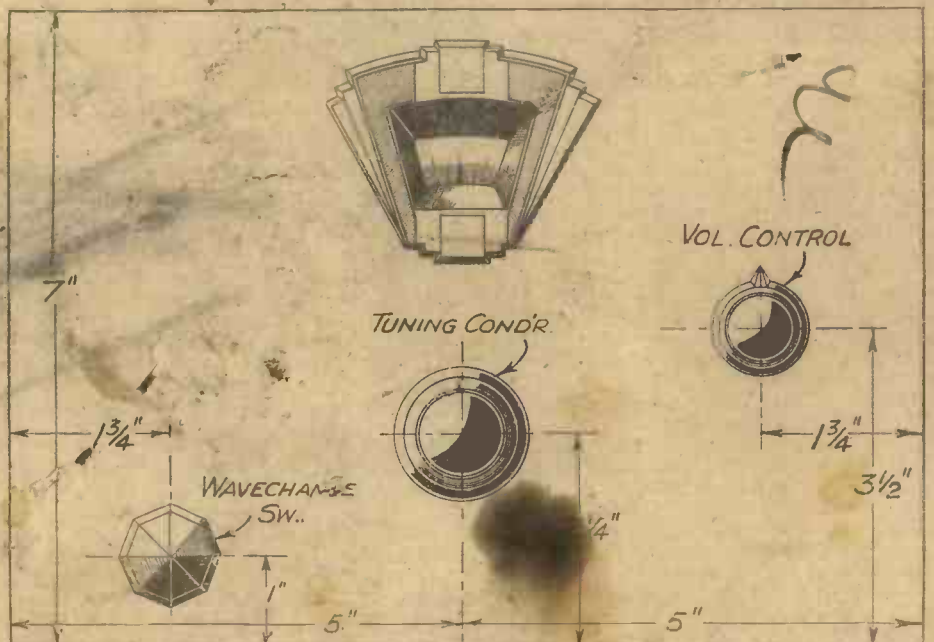

Fig. 5.—Use this diagram for marking out the panel

A SIMPLE H.F. UNIT

(Continued from previous page)

condensers are inserted between the coil and the aerial terminal. The unit is now ready for use, so, with the bias control set somewhere near its maximum, commence to tune in by adjusting the tuning condensers on both the unit and the receiver. The reaction control will be used in the normal manner, but you will not need to use it as much as before.

It will be noticed that no switch has been provided as the L.T. should be controlled

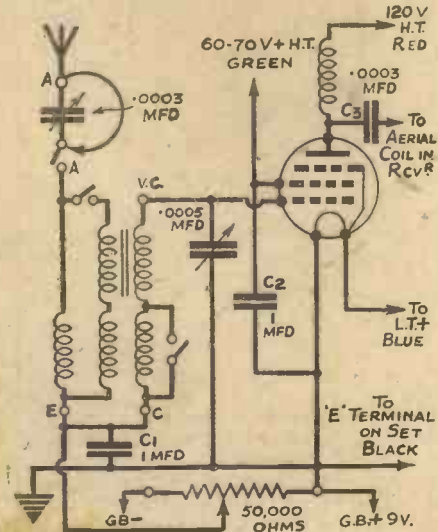

Fig. 6.—The theoretical circuit diagram of the H.F. unit.

by the switch on the receiver. However, if you have a spare switch handy, it can be fitted between the negative filament terminal on the valve-holder and the earth terminal. Another point is, it is advisable to pull out the positive plug in the G.B. battery when the unit is not in use. The lead and clip on the aerial series condenser is provided to allow the condenser to be shorted out when the long waves are being received, as it is not likely to be required for that wave-band.

SUBSTITUTES AND REPLACEMENTS

(Continued from page 629)

In the case of valves there is not the same latitude, although it is possible to make preparations for circuit modification at a future date. For instance, take the case of a straight three receiver of the detector and two L.F. arrangement in which a valve breaks down. In obtaining a new valve one of the S.G. type could be obtained and used in the present detector stage. If the L.F. valve was the faulty valve, a change round should be made to enable the S.G. valve to be used in the detector valve-holder. The necessary extra items could then be obtained at odd times and the circuit eventually converted to an S.G. detector-power arrangement with increased range and volume.

Old-type coils will certainly be replaced by modern components, and no attempt should be made to obtain out-of-date coils because they were originally used. The majority of manufacturers to-day supply a diagram with the coil showing the connections and wiring details, and it is not a difficult matter to incorporate this in an existing circuit. The improvement will be well worth the expenditure involved, and it may even be said that such a course should be adopted with all receivers in which the coil is two years old or more.

TELEVISION NOTES

The Physical Society Exhibition

THIS year's Physical Society Exhibition was fully up to past standards, but general regret was expressed by the committee's ruling that no television exhibits would be allowed. In other years demonstrations of this science have been featured by various firms and the only approach towards a practical exhibit of this nature was a working model of a cathode-ray tube. A line scan was shown without any form of picture modulation. With the tube run bright it was possible to notice a trace of flicker at scanning speeds of 25 per second, but it is conceded that when modulation is applied the degree of apparent flicker reduces very considerably. This is somewhat similar to the mains hum present in a radio set. When not tuned to a station the hum is heard distinctly, but when the broadcast is heard the hum disappears completely or is noticed only as a faint background.

be encouraged during the early days of the service.

Revival of Television Inventions

ALTHOUGH the official figures for patent applications during 1935 have not yet been revealed, it is estimated that over 36,000 were made. This is up to normal average, although about a thousand less than 1934. A leading patent agent reports that there has been a marked revival of activity in television inventions, particularly on the receiver side, with a view to securing bright, flickerless pictures free from interference.

In Sequel

The British film industry, or at least certain sections of it, still seem to be antagonistic towards any idea that the B.B.C. should use up-to-date films for television. Surely this situation has arisen as a result of a misunderstanding on the



Here is the largest cathode-ray tube made in England, with Dr. J. B. Kramer, of the G.E.C., who have just produced it, indicating the frosted end upon which a 12in. x 9in. picture of any colour is viewed. No other apparatus save amplifier comprises the picture receiver, while at the studio a special camera—which develops the artist's photograph immediately it has secured it, projects it to the transmitter, and then re-sensitises its endless film.

Being Up-to-Date

ALTHOUGH not in a position to make any tests in order to ascertain local conditions for ultra-short-wave high-definition television reception, it has been announced that a block of flats in London offers as an extra inducement to would-be purchasers the advantage of "wind for television reception." This seems a trifle too previous although the idea is one which should commend itself to builders once the B.B.C. service is in full swing. Synonymous with this comes the information that television sets are shortly to be installed in a number of hotels and railway stations in the eastern part of the United States of America. The manufacturers of the sets are said to be responsible for the scheme, and no doubt they feel that it will enable travellers to become acclimatised to the service offered, while the time factor is not a pressing one. It is equivalent to the free televiewing rooms proposed for this country, and should

part of the exhibitors and film companies. It was never intended that long feature films should be included in any high-definition television programme in the present state of the art's development. This would only give an unnecessary eye strain unless the film was produced specially for television. The intention of the B.B.C. was to televise trailers or excerpts from films and these shorts would be an excellent free advertisement for the film proper, just the same as single play acts or a vaudeville turn broadcast on the normal sound wavelengths. No doubt the film trade will appreciate this point ere long, but, in any case, the B.B.C. can secure a very large number of interest films which have been made as "shorts" by the Post Office Film Unit. Added to this there are the films which have been made by various Empire governments and commercial interests, and are ideally suited to the requirements of present-day television pictures.

THE SET FOR MODERN CONDITIONS

A WESTINGHOUSE DESIGN FOR AMATEUR CONSTRUCTORS

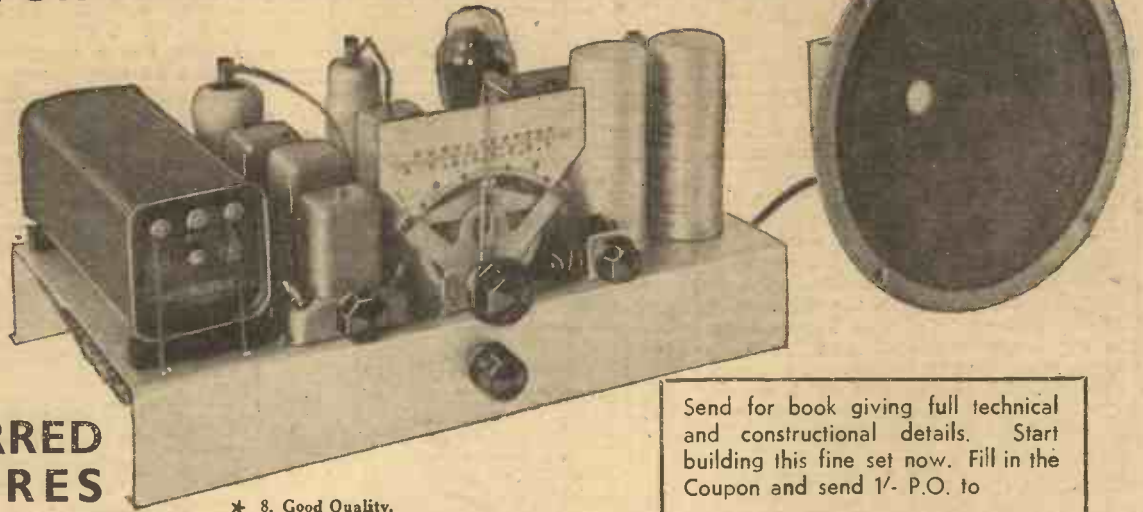

14 STARRED FEATURES

- * 1. Designed by Westinghouse Engineers.
- * 2. 3-valve "reflex" superhet giving 5-valve performance.
- * 3. Universal operation on A.C. or D.C. Mains.
- * 4. WESTECTOR 2nd detector.
- * 5. WESTINGHOUSE Metal Rectifier for H.T. Supply.
- * 6. Automatic Volume Control.
- * 7. High Selectivity.
- * 8. Good Quality.
- * 9. 3-watts output.
- * 10. Very low "hum" level.
- * 11. Reception of at least eight stations during daylight.
- * 12. Reception of most Continental stations during darkness.
- * 13. All components specially chosen for reliability and efficiency.
- * 14. Just as safe as an A.C. Receiver. Chassis at earth potential.

Send for book giving full technical and constructional details. Start building this fine set now. Fill in the Coupon and send 1/- P.O. to

Westinghouse Brake & Signal Co., Ltd.,
82, York Road, King's Cross, London, N.1.

Name.....

Address.....

Pract. W. 1/2/36.

Switch off! . . . If sopranos bore you, why listen? Here is a story of a girl who was absolutely base. You are bound to be interested.

DAUGHTER OF SATAN

THE WORST BOOK OF THE YEAR

This is a novel of a girl who listened in to Life without paying her licence. She wanted everything for nothing, and she nearly got it! Bad CONNECTIONS however brought her to EARTH, and she was eventually ensnared in the COILS of sin. You will be enthralled . . . and you will laugh!

From Your Library
For Goodness Sake
Read it!

NEWNES

Price and Preference

For many of us, price marks a boundary; but no limit need be set to the enjoyment from one's pipe. Price and preference can be reconciled. Hosts of smokers who first considered cost, now "fill up" with "Airman" for choice.



MIXTURE
FLAKE
NAVY CUT

10d
PER OZ

NAVY CUT
DE-LUXE!!

PLAYER'S AIRMAN
TOBACCOS

PA 44J



FROM STUDIO TO LISTENER.—2.

The Principles of Transmission and Details of a Simple Transmitting Circuit are Given in This Article. By IDRIS EVANS.

IN the first article of this series the various stages through which the sound, or its electrical equivalent, passes before reaching the listener were discussed in brief, and a description of the first component in the series—the microphone—was given. The carbon microphone was dealt with, as this is the type most commonly used by home-constructors. It is pointed out, however, that the B.B.C. favours the moving-coil microphone, but readers need not trouble about the principle of operation of this type at the moment; a brief description of this will be given when discussing moving-coil speakers in a later article.

The Carrier Wave

As previously mentioned, the low or audible-frequency vibrations produced in the microphone are carried from the transmitter to the receiver by means of the carrier wave—a high-speed electrical vibration. At this juncture most students are naturally apt to ask why the

that this ripple is only slightly less at the far end than at the end which is jerked. If the rope is moved slowly, however, the ripple will not be produced, and the rope movement at the end remote from the hand will be negligible.

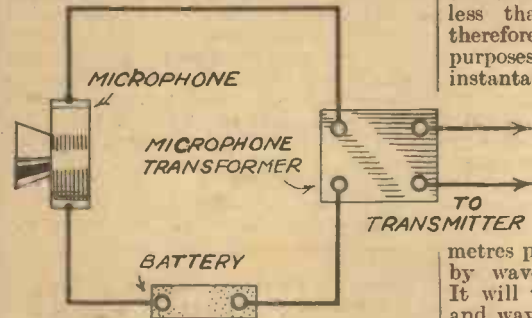

Fig. 1.—Showing the output circuit of the microphone.

In the same way, if the electrical vibration in the transmitting aerial is rapid, the ripples formed in the surrounding air (or ether) will travel a long distance without becoming reduced in strength, whereas with a slow vibration (low frequency) the ripple is negligible and can only be detected at a short distance from its source. The ripples produced by the high-frequency electrical vibrations are known as electro-magnetic waves, and the distance between the crests of these waves is known as wavelength—a term commonly known to all listeners.

Velocity

The distance travelled by the ripple or wave in one second is equal to 300,000,000 metres per second; this is known as the velocity of the wave, and is equivalent to the velocity of light. As the circumference of the earth is much less than 300,000,000 metres it will therefore be clear that for all practical purposes transmission and reception are instantaneous.

As each electrical vibration or oscillation produces one ripple or wave, the frequency of the oscillation multiplied by the length of the wave will be equal to the velocity, and as the velocity is 300,000,000 metres per second, frequency multiplied by wavelength is equal to 300,000,000. It will therefore be seen that frequency and wavelength (as marked on the tuning scale of the receiver) are interdependent—e.g., 300 metres is equivalent to a frequency of 1,000,000 cycles per second, or 1,000 kilocycles—kilocycles are commonly referred to as kc/s. The wavelengths normally used for broadcasting lie between approximately 200 and 2,000 metres, but much lower wavelengths are now being used for special long-distance broadcasts and experimental work; these are known as the short and ultra-short wave-bands. High wavelengths between 2,000 and 30,000 metres are also utilised, mostly for long-distance telegraphic communication.

Producing Oscillations

There are several methods of producing high-frequency vibrations for transmission work, but the valve oscillator is the one most commonly used nowadays; the spark, arc, and alternator methods are gradually falling into disuse and will not, therefore, be discussed in this short series.

(Continued on page 637)

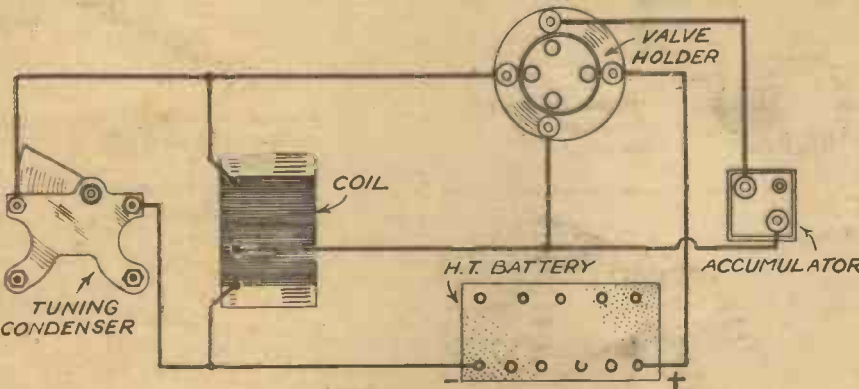

Fig. 2.—A simple oscillator circuit.

low-frequency vibrations in the microphone circuit cannot be amplified and fed direct to the aerial and transmitted through space. Low-frequency electrical vibrations can, of course, be passed along a wire as is exemplified in the land line telephone system, but unfortunately transmission through space cannot be effected so easily; the following simple mechanical analogy will help the reader to understand why the high-frequency carrier is necessary.

Mechanical Analogy

If a long length of rope is tied to a post and its free end is held in the hand and is given a sudden jerk, the section of the rope near the hand will follow the movement of the latter, but towards the end of the rope the movement will occur a short time after the movement of the hand. The resultant effect will be the production of a ripple along the whole length of the rope, and it will be noted

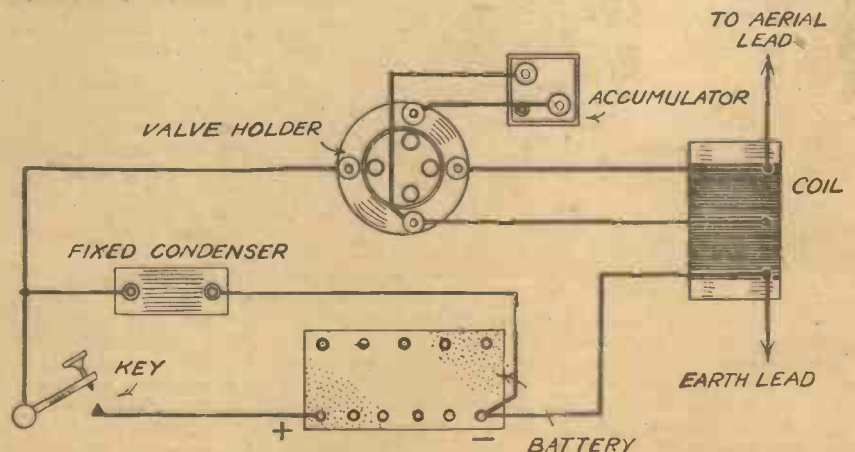
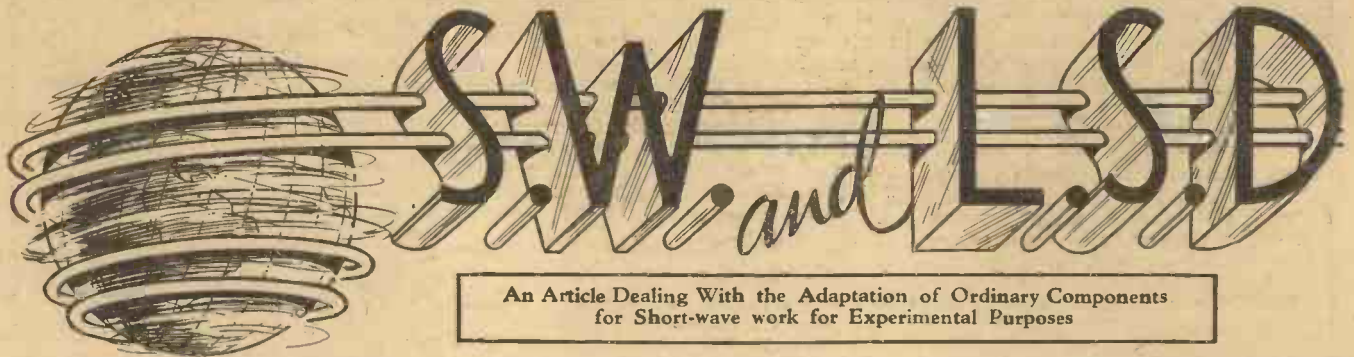

Fig. 3.—Showing the simplest type of transmitter.



An Article Dealing With the Adaptation of Ordinary Components for Short-wave work for Experimental Purposes

In spite of the fact that the number of components in a short-wave set is usually small when compared with those in a normal broadcast receiver, the fact remains that a percentage of these components is special to this wave-band, and the beginner finds it necessary to pay out hard cash when building his first short-wave receiver.

It is the purpose of this article to suggest ways and means of adapting normal receiver components so that, in the early stages, they can be substituted for the theoretically correct parts pending the gradual purchase of the orthodox components.

The tuning condenser is of paramount importance, and if this is to be an adapted component a small well-made condenser should be chosen. A small tuning condenser is preferable, first because of the smaller "mass" of metal, and also because of its greater solidity and consequent lesser tendency to variation due to vibration.

An air-spaced reaction condenser, possibly fitted with a pigtail, should prove suitable in this position, and a similar component, dismantled and rebuilt with double spacing forms an ideal band-spread component. These points are illustrated in Figure 5.

Chokes and Valve-holders

Short-wave chokes are perhaps the most elementary parts as far as construction is concerned, the major parts consisting of wire and a former. The latter may be paxolin, ebonite, or bakelite, the former two being the easiest to procure. About an

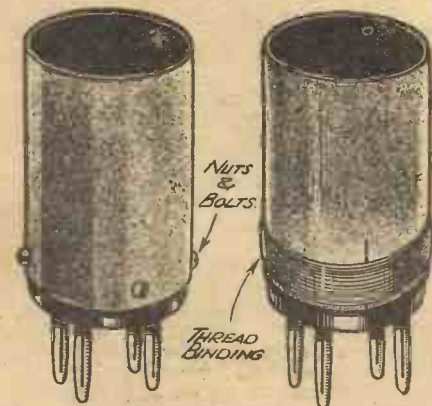

Fig. 1.—Easily made but efficient coil formers may be made from paxolin tube and ordinary valve bases.

inch in diameter is suitable, a length of two inches of this being necessary. The winding may be continuous or section wound, enamelled or silk-covered wire of about 34 s.w.g. being both convenient and suitable. As a rough guide a choke consisting of 125 turns of 34 s.w.g. enamelled or silk-covered wire (1 1/2 in. winding length) on an inch diameter former has an inductance of 200 microhenries.

Valve-holders can be a source of trouble, but here again if well-made components are used, or adapted, trouble from faulty contacts should be non-existent. Figure 4 shows a W.B. horizontal type valve-holder in which the top has been sawn off (after removal of the sockets) thus making a low-loss component. The normal "vertical" type may be treated in the same manner, and they are suitable either for coils or valves. Small pillars of ebonite will in some cases assist in shortening the wiring and thus increase efficiency.

Coil Construction

As to the coils, ribbed formers may be bought (threaded) for 2s. 3d., or paxolin

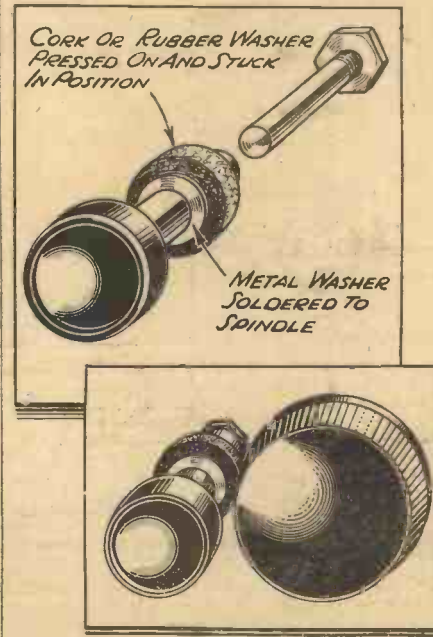

Fig. 2.—Friction drives for condensers and similar panel controls.

tubes may be used. The latter can be mounted on old valve bases (Fig. 1), provided that the inside diameter is approximately correct, nuts and bolts or stout thread binding being used for fixing purposes. Enamelled wire of 20 s.w.g. is suitable for the spaced grid winding, and the reaction may be a bunched winding of thin, insulated wire.

Possibly the constructor possesses one of the old type slow-motion dials illustrated in Figure 3. Their only disadvantage is their appearance, and as this is relatively unimportant, the smooth movement, absence of backlash, and high reduction ratio make them ideal for tuning or band-spreading. If insulated extension spindles are used in conjunction with this type of dial, tuning becomes a comparatively simple operation, conspicuous by its lack of hand capacity, even with minimum shielding, and even

ultra-modern tuning devices have few advantages to offer over a system of this kind.

Previous articles in this paper have dealt with slow-motion dials, and possibly one or more of the suggestions might be of use if no spare dial is at hand.



Fig. 3.—A removable slow-motion drive and some examples of extension spindles.

Control Knobs and Switches

At least two manufacturers list 2in. diameter knobs, and these are an extremely useful size. They afford much better grip than the smaller variety, and in effect they are similar to a very low ratio, slow-motion dial. Figure 2 illustrates a removable knob, which will convert a 2in. dial to a 4-1 reduction control, the small knob is pressed in slightly, when in use, thus keeping the 3/4 in. diameter rubber or cork disc in contact with the sloping side of the 2in. knob.

Chassis Construction

Opinions differ as to the amount of screening necessary, but whatever is required may be made at home from aluminium sheet. If a chassis is to be constructed, 1/16in. material is the thinnest that should be used, but for normal screening 1/32in. material will prove to be adequate, and it can be easily shaped.

For the really non-mechanical men metallised paper should prove a boon. This may be glued on a wooden chassis or to cardboard when intended for screens, and providing it does not have to carry any current it should prove to be quite capable of separating the stray capacities.

With reasonably accurate construction flexible couplings for spindles may seem superfluous, but if the constructor feels that they are advisable it is possible to purchase them for as low as 6d. each.

The suggestion for a home-made coupling

(Continued overleaf)

(Continued from previous page)

is to use a piece of stout rubber tubing about an inch long, the ends being clamped or bound if there is any tendency to slip.

Small Metal Parts

Some constructors may not be aware of the fact that small metal parts may be purchased. Amongst the comprehensive list available is sheet tin plate, insulating and bushing washers, plain and locking washers, shaft couplings, threaded rod, soldering tags, and brown bakelite sheet. These items are necessary at certain times,

speaker is a personal one, but apart from the question of convenience the former appears to score on many points. It is obviously easier to read a weak signal on 'phones than on a loud-speaker; one can listen-in independent of any (normal) outside noise, and less power is needed to produce equivalent volume. In conjunction with the latter a comparatively small H.T.

Fig. 4.—(right) Converting a well-known type of valve-holder for short-wave work.

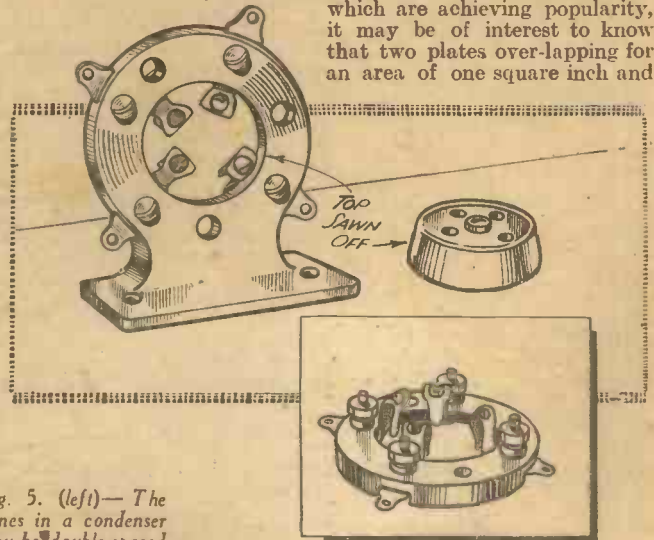
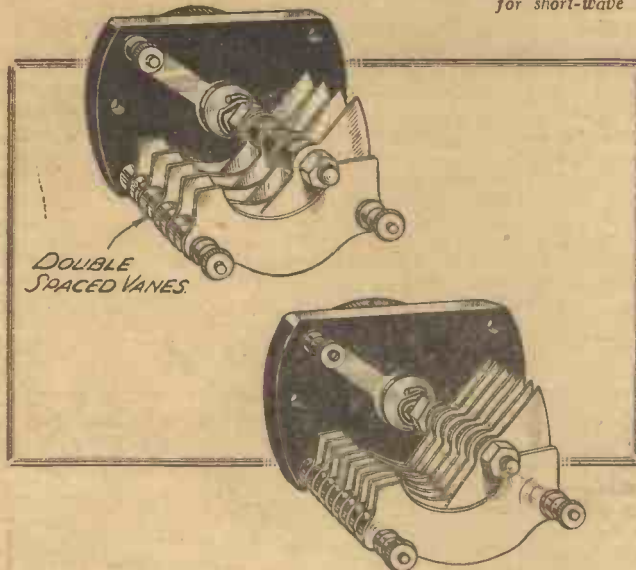

Fig. 5. (left) The vanes in a condenser may be double spaced to reduce the capacity and make the condenser suitable for short-wave work.

they are almost sure to be weak after several years storage. It is possible to get these re-magnetised and generally overhauled, and a few firms do this for a reasonable figure, and any 'phones entrusted to their care should prove to be eminently suitable for short-wave work.

Fixed condensers hardly seem worth the trouble of making, but if the constructor decides to build one of the air-spaced type which are achieving popularity, it may be of interest to know that two plates over-lapping for an area of one square inch and

spaced 1/50in. (half millimetre) apart, have a capacity of approximately 25 micro-microfarads (.000025 mfd.).

In conclusion it should be pointed out that these adaptations (apart from the tuning dial suggestion), are intended only as temporary measures. They may prove quite serviceable and efficient, but in the majority of cases it will probably be found that the substitution of properly designed and manufactured components (as funds permit) will improve reception to a considerable degree.

especially from the point of view of economy. Incidentally, it is often worth while dismantling obsolete parts for the sake of the terminals and other metal parts so obtained.

The question of 'phones versus loud-

voltage is sufficient, and the lower current ensures longer life for the battery.

It is, of course, essential that the 'phones be sensitive. Possibly some of the 'phones used in "crystal" days are available, but

International Conference

SO many mushroom stations, in particular in South America, have made their appearance during the past twelve months that in many instances the more serious ones are in danger of being crowded out and some drastic steps are to be taken to protect their interests.

An International Conference, to which representatives of all broadcasting associations will be invited to attend, is to take place in February at Paris. There, amongst other radio matters, experts will be asked to devise a plan for the allotment of channels to short-wave transmitters, in a way similar to that introduced at Lucerne for the stations working on the medium- and long-wave channels.

If the different nations interested in the matter can agree as to the allocation of the wavelengths and secure the authority of their respective governments, it would be possible to evolve a plan which would give a better all-round allotment than at present exists.

The number of official short-wave stations is growing daily, and, in consequence, it is essential that some steps should be taken to secure, so far as possible, clear channels, not only for the old stagers, but also for the newcomers. In the meantime, one country at least, Bolivia, has taken measures to check an outcrop of mushroom transmitters which was threatening to get out of hand. No transmitting licences are granted to

Leaves from a Short-wave Log

any stations, barring experimental amateurs working in a restricted band, unless the power of the transmission exceeds 500 watts; failing this, it must remove to an ordinary broadcast channel.

CT1AA, Lisbon, which was working for many months on 31.25 metres, appears to have lowered its wavelength to secure a better position. It is to be found now on 31.09 metres (9,650 kc/s), just under the Rome (12R03) station, which is next on the dial. CT1AA, easily identified by the familiar cuckoo call, maintains a regular tri-weekly schedule of transmissions, namely, Tuesdays, Thursdays, and Saturdays, between G.M.T. 21.00-24.00. Do not be misled by the call *Radio Colonial*, which you might mistake for that of the Paris short-waver; it is always followed by either the call letters CT1AA (*say-tay-ooonah-ah*) or the word *Lisboa*.

There are but few regular broadcasts in the Portuguese language on the air, the only two others being PRA8, Pernambuco, and PRF5, Rio de Janeiro, of which details were published in PRACTICAL AND AMATEUR WIRELESS (January 18th).

New Spanish Station

Last week I picked up test transmissions by a new station on, roughly, 45.32 metres, which would appear to be situated near Madrid. So far, I have not secured full particulars, but the call included the name of Philips-Iberica. Has any other listener logged this transmission?

The signals were very strong, and announcements were made in several languages; unfortunately, I came in at the end of the test and missed some which may have given details such as wavelength, power, and locality.

Cali and Bogota

A new South American station has made its appearance on the ether; it is HJ5ABG, Cali, which is reported to be a 500-watter. You should find it on favourable nights, in the amateur waveband, on 41.946 metres (7,150 kc/s). It was recently heard in London.

Occasionally, reports are received of broadcasts picked up in the British Isles of HJN, Bogota (Colombia), which styles itself the *Radioemisora Nacional*, on 49.42 metres (6,070 kc/s). It works daily from G.M.T. 23.00-02.30. If veris are desired, reports should be addressed to Señor Luis Ramirez Arana, Jefe del Servicio de Inalambricos, Ministerio de Correos y Telegrafos, Bogota, Colombia. The dial reading is a fraction above Vienna (OER2).

LEAVES FROM A SHORT-WAVE LOG

Halifax (Nova Scotia)

DURING the week under review, CJHX (formerly VE9HX), Halifax (Nova Scotia), was captured at excellent strength on 49.1 metres (6,110 kc/s), the channel used by Daventry G.S.L. The programme was one from the Canadian Radio Commission, and was simultaneously broadcast by Bowmanville (CRCX), on 49.26 metres (6,090 kc/s), part of it having been relayed from the N.B.C. Network. On most nights it was possible to tune in one or other of these Canadian short-wave transmitters.

Musical Interval Signals

In view of the fact that short-wave stations, similarly to those on the broadcast band, are adopting some kind of musical interval signal to identify themselves to their listeners, I have been compiling an index which has already proved itself of considerable assistance on many occasions. It is a simple matter to take a small ring loose-leaf file, obtainable at most cheap stores, and in it enter under different headings the name, wavelength, and frequency of stations using certain signals. As an instance, I have such headings as: bird calls (such as VK2ME, CT1AA, and so on), bugle calls, carillons (chimes), metronomes, closing signals (given in full), gongs, bells (divided into number of notes and combinations of notes, etc.). It happens frequently that the call of the station is not received, but that an interval signal is picked up. Incidentally, as the same file serves for medium- and long-wave transmitters, its helpfulness is increased. A few minutes only are needed to trace the interval signal, and if by chance more than one station uses it, the wavelength or frequency indicated will always permit identification.

With the number of stations increasing, as it does, every month, one cannot equip oneself with too many aids to assist in tracing the source of a broadcast, and this, frequently, is far from easy on the higher frequencies.

BEGINNER'S SUPPLEMENT.

(Continued from page 634.)

Most listeners will be accustomed to the effect produced in the receiver when the reaction condenser is rotated too far—a rushing noise is set up, and a whistle is heard when tuned to a station. When this happens the valve to which the reaction condenser is connected is said to be in a state of oscillation. The valve has, in fact, become a miniature transmitter, and if it is connected to the aerial circuit, radiation will occur and interference will be caused to neighbouring receivers; this interference takes the form of a whistle. Fig. 2 shows the simplest form of oscillating circuit—this is known as the Hartley circuit.

Before transmission of intelligible sounds can be effected it is necessary to control the duration of the high-frequency waves. In the telegraph transmitter this is done by means of a key; the diagram of the simplest form of transmitter is shown in Fig. 3. By depressing and releasing the key at regular intervals the oscillations are set in motion and stopped in unison with the key motion. In a telephone transmitter the microphone takes the place of the key, and the low-frequency vibrations from the former are superimposed on the high-frequency oscillations.

DIFFICULTIES EXPERIENCED WITH THE £4 SUPERHET

WE have received hundreds of satisfactory reports concerning the £4 Superhet, and it would therefore seem that the majority of constructors have not experienced any difficulty in the construction and operation of this set. A few snags have been met with by some readers, however, especially in connection with the I.F. transformers. The positions of the leads in the later models are not the same as those of the ones used in our laboratory receiver, and several constructors have written to ask us whether they should ignore the position of the leads and wire in accordance with the markings on the bottom baseplate, or vice-versa. The baseplate markings should be adhered to in all cases, and it is advisable to ascertain that there is continuity between P and HT leads, and between G and GB leads before screwing these components down. Another precaution is necessary: an insulated screwdriver should be used for trimming purposes, or a small insulated bush should be dropped into the trimming holes before inserting a metal screwdriver.

Trimming

Trimming is proving a troublesome procedure to some readers, but this should not present any difficulties even if an oscillator is not available. C2 trimmer should be set at approximately 1/3 of a turn from the full-in (clockwise rotation) position, and the I.F. trimmers should be rotated in an anti-clockwise direction until at least half-way out. A station should then be tuned in at approximately 250 metres and C2 adjusted slightly until the correct wavelength reading is obtained on the dial. The tuning control should then be rotated to approximately 500 metres and another station tuned in. If it is found that stations tune high at this setting, it will indicate that the I.F. transformer trimmers require to be rotated in an anti-clockwise direction. A setting of C2 and the I.F. trimmers should be found at which all stations on the medium wave-band tune at the correct wavelength setting on the specified Polar tuning drive. In some cases it is found that the capacity of the long-wave padding condenser is insufficient, and therefore it is suggested that the connection of a .0001 mfd. or a .0002 mfd. fixed condenser across the existing .0004 mfd. be tried.

L.T. Leads

Some readers have queried the filament wiring. Twisted wires are shown in the wiring diagram, and the querists have traced these and state that they are not correctly wired. It is not intended that the constructor should trace every twist of the flex between the valve-holder pins. Each set of filament pins is marked + and — respectively, and constructors should wire these pins accordingly—positive (+) to positive, and negative (—) to negative of each valve in turn.

Constructors should also definitely ascertain that the tuning condenser is of the 465 kc/s Superhet type; C2 section should have much smaller moving vanes than C1.

It is therefore advisable to remove the screening can of this component and carefully examine the vanes before commencing the wiring. If the condenser has already been mounted the can may easily be lifted if the four fixing screws (two each side) are removed.

THOUSANDS BUILT!
Peto-Scott 1936
UP-TO-DATE SENSITIVE S.G.3. KIT

THE latest Peto-Scott Kit Set triumph! This wonderful receiver is the last word in sensitivity and selectivity, in high fidelity reproduction under modern broadcasting conditions, as the thousands who have built it will testify. Build it and see for yourself!



- 2 gang Air Dielectric Tuning Condenser
- Automatic Grid Bias
- Full Vision Slow Motion Tuning
- Detector, S.G., Pentode Valves
- Modern Air-spaced Coils

COMES TO YOU FOR

2/6
DOWN

KIT "A" CASH or C.O.D. 35/-
Carriage Paid
Or 2/6 down and 9 monthly payments of 4/-

Comprises all parts, including ready-drilled chassis and panel, less Valves, Speaker and Cabinet.

KIT "B" As Kit "A" but with set of 3 valves less speaker and cabinet. Cash or C.O.D. Carr. Paid. £2/19/9, 5/- Down and 11 monthly payments of 5/6.	KIT "CT" As "A" but including valves and Peto-Scott Walnut Table Cabinet, less speaker. Cash or C.O.D. Carr. Paid, £3/14/9, 12 monthly payments of 6/9.	KIT "CC" As "A" but including valves and Peto-Scott Walnut Console Cabinet, less speaker. Cash or C.O.D. Carr. Paid, £3/19/9, or 12 monthly payments of 7/3.
---	--	---

POST THIS COUPON NOW FOR FREE BLUEPRINT!

PETO-SCOTT CO., LTD., 77, Pr.W12, City Road, London, E.C.1. Tel.: Clerkenwell 946/7.

Please send me full details and FREE BLUEPRINT of the Peto-Scott 1936 Up-to-Date Sensitive S.G.3.

NAME..... Pr.W12. Est.: 1919
ADDRESS.....

IT PAYS TO BUY THE BEST



WIDE VISION PRECISION DIAL.

Built particularly for Short Wave tuning purposes where accuracy and smoothness of movement are essential. Free from backlash with 22:1 slow-motion ratio.
No. 973. Price 10/6d.



SHORT WAVE H.F. CHOKE.

Eddystone patent design with no metal or shorted wire loop at ends to cause losses. Greatest efficiency, small size and light weight for mounting in wiring.
No. 1010. 5-180 metres. Price 2/-.

STRATTON & CO. LTD.
Bromsgrove Street, BIRMINGHAM.
London Service Depot: Webb's Radio Stores, 14, Soho Street, Oxford Street, W.1.

EDDYSTONE
SHORT WAVE COMPONENTS

THE PYE MATCHED DIPOLE AERIAL

An Interesting Aerial Kit Designed Especially for Use with All-wave Receivers

It is often found that the commercial type of receiver which has been designed for "all-wave" use will function much more satisfactorily on the short wavelengths when a special type of aerial is employed. It is difficult for the average listener to arrange to erect two aerials, and thus it is generally found that the standard type of broadcast aerial is fitted and the results on the short waves naturally fall off and the maximum performance is not obtained from the receiver.

A Novel Idea

To meet this case Messrs. Pye have developed an interesting kit which is primarily designed for use with their "Empire" receivers, and which permits of the advantages of both types of aerial to be obtained. As may be seen from the illustration below, the kit comprises a length of twisted lead (of the unscreened type) and a special impedance-matching

a good opportunity of being received as against stations in the direction of India, etc. Listeners abroad who wish to receive the Empire transmissions should arrange for maximum reception from the British Isles and so on. At the receiver a small unit is fitted to the cabinet side, and the two plugs at the end of the twisted lead are inserted into sockets on top of the transformer. The two leads from the bottom of the transformer are inserted in the aerial and earth terminals of the receiver, and the normal earth lead is inserted into the socket on the dipole earth plug.

Using Both Schemes

A switch is mounted on the base of the transformer and two positions are marked Dipole and T Aerial, and when this switch is adjusted the aerial is automatically converted from one type of aerial to the other, without the necessity of modifying any connections.



This is the complete Pye Aerial Kit referred to in this article.

transformer for attachment to the receiver. The makers instructions regarding this aerial may briefly be summarised as follows: The aerial should be erected as high as possible and clear of houses, trees, etc. It is looped at the centre and joined by means of an insulator and all supporting leads must consist of rope. On no account should wire be used. The two ends of the special lead are attached to the centre point of the split aerial, or, in other words, the twin lead passes from the receiver and rises to a certain level, when the two ends are separated and pass outwards on a level in opposite directions.

Directional Effects

An aerial of this type is, of course, strictly directional, the pick-up being greatest in directions at right angles to the horizontal portion. When erecting this type of aerial, therefore, it is necessary first to ascertain the direction of the most important short-wave station which it is desired to hear, so that this directional effect may be used to good purpose. Where no definite station is required, it may prove worth while to arrange the aerial so that America, for instance, will be given

When a weak station is received it is worth while trying both positions of the switch, but generally on and around 25 metres it will be found that best reception will be obtained when the dipole arrangement is in use. At 50 metres and above maximum results will be obtained with the T aerial arrangement, that is, with the two ends joined together. In the case of the latter arrangement experiments may be tried in tuning it by connecting a very low minimum capacity condenser in series with the lead to the receiver. On rotating this condenser a point should be found at which appreciable increase of strength is obtained on a weak station. If, however, no such increase is observed, then a small coil (50 to 70 turns of 34 s.w.g. s.c.c. wire close wound on a lin. former) may be inserted also in series and the experiment repeated.

The price of the complete equipment is 25/-, and it may be obtained from all accredited Pye agents or direct from the makers.

RESISTANCE, INDUCTANCE AND CAPACITY

(Continued from page 624)

appreciated by considering for a moment the fixed condenser, generally having a capacity of .0002 mfd., which is connected between the anode of an H.F. valve and the tuned-grid coil of the detector, as shown in Fig. 2. The condenser has to prevent the passage of current from H.T. + to earth and H.T.—, but it has to provide an easy path for the signal currents. And the impedance of a .0002-mfd. condenser to a current having a frequency of 1,000,000 cycles per second, or 1,000 kc/s, is only 800 ohms, which is negligible in a circuit of this nature.

The Bypass Condenser

The same idea holds good when considering a bypass condenser used in an anode-decoupling circuit, as shown in Fig. 3. The purpose of this condenser is to provide an easy path to earth for low-frequency currents, but at the same time it must, of course, act as a complete barrier to the high-tension current, for otherwise the H.T. supply would be short-circuited. A capacity of 2mfd. is commonly used, and the resistance of such a condenser to a frequency of 1,000 cycles is only about 80 ohms. If the capacity were halved the impedance would be doubled, and also if the frequency were only 500 cycles the impedance would be doubled; alternatively, the impedance would be half the value mentioned if the frequency were doubled. It can be seen from this that the effect of a condenser is the opposite of that of a choke or inductance.

Combined Inductance and Capacity

Although capacity, inductance, and resistance have been considered as existing alone, it is usual to find that components have two or all three of these properties. This may lead to difficulties, and that is why we have so-called non-inductive condensers, non-inductive resistances, and low-capacity chokes. If a condenser used in a high-frequency circuit had an appreciable inductance it would offer a much higher impedance than it should and its useful effect might be nil. In the same manner, if a grid-bias resistance in a mains receiver were inductive it would offer too great an impedance to high-frequency or alternating currents passing through it, with a result that instability or other form of trouble would arise.

Choke Effect Nullified

Then again, if the capacity between the turns of a choke were other than extremely small the effect of the choke might easily be nullified, because the capacity would allow an easy passage to the alternating currents which it is the purpose of the choke to check.

There is only one part of the circuit where inductance and capacity must be used together, this being in the tuning portion. Here, a variable condenser is connected in parallel with the inductance, or tuning coil, so that the impedance of the circuit can be varied. Actually, the object is not simply to vary the impedance of the circuit, but to keep this at a maximum for any particular wavelength or frequency. This subject is too lengthy to be dealt with adequately in this article, so we must leave it after stating merely the elementary facts.

**FREE BLUEPRINT OF F. J. CAMM'S
MONITOR THREE IN NEXT WEEK'S ISSUE!**

IMPRESSIONS ON THE WAX

By T. ONEARM

Sandler's Serenades

SANDLER'S name is associated with numerous serenades, and for his latest he has recorded the serenade from "Hassan." That he regards this as a classic may be gauged from the fact that he has coupled it with Tchaikowsky's "None But the Weary Heart," and it is a safe assertion that both will find as ready a welcome as his lighter pieces. The number of the record is *Columbia DB1616*.

Robert McEachern, of "Flotsam and Jetsam" fame, sings in his deep bass voice "Old Stay at Home" and "Speed" on his latest record, *Columbia DB1618*.

A Novelty

A NOVELTY in Columbia's January list is a record entitled simply "Bugles." It is an authentic rendering by the 2nd Battalion of the King's Light Infantry of Bugle Calls and Fanfares, introducing "Light Cavalry," "Marching thro' Georgia," and other tunes popular with regimental bands, and winding up with the Shropshires' own march. Army men, and the thousands who annually visit the various tattoos, where bugles and fanfares are always a strong feature, will be interested in this record, *Columbia FB1247*.

Humour

FOLLOWING up the success of their previous issue, with its list of leading comedians, Columbia again present more famous names that create laughs in their popular 1s. 6d. series. Clapham and Dwyer do their "Day's Broadcasting" skit on *Columbia FB1242*, Flanagan and Allen their "New M.P." on *Columbia FB1241*, Haver and Lee raise the wind with their "Smash and Grab Raid" on *Columbia FB1243*, while Norman Long's "Anything Can Happen Nowadays" and "Wot For," on *Columbia FB1245*, are cockney cameos in his funniest vein.

"Theatre Memories"

THE Yacht Club Boys, appearing in the current musical film "Thanks a Million," sing four snappy songs on *Columbia FB1237-8*, whilst "Theatre Memories" on *Columbia FB1239-40*, recall Harry Welchman in his best-known songs from "Rose Marie," "Desert Song," "New Moon," etc.

Songs of the Backwoods

ESTABLISHED by their broadcasts and gramophone records, the Rocky Mountaineers have been nicknamed "The B.B.C. Hill Billies." Their songs are those of the backwoods and the singers themselves are authentic Canadians. Their latest recordings are "Little Red Caboose Behind the Train," coupled with "Red River Valley" (a famous landmark in North America) and "In 1992" (an amusing peep into the future) on *Columbia FB1249*.

Betty Balfour was one of Britain's first big stars in pictures, and she is introduced on *Columbia FB1225* this month singing "One Way Street" and "Londonola," both numbers coming from her recent film "Squibs." Stanley Holloway is also in the film, and does his famous "Beef-eater" number from his record *Columbia DX603*.

REPLIES IN BRIEF

The following replies to queries are given abbreviated form either because of non-compliance with our rules, or because the point raised is not of general interest.

H. C. (Southall). We regret that there is no blueprint for this particular receiver, and the issue in which it was described is now out of print.

W. A. C. (King's Cross). Blueprints cost 1s. each, but there are many types of three-valve set. If you could give further details we may be able to suggest a suitable receiver, or you may be able to select one from the list of blueprints included in each issue.

A. K. (Hawick). If sufficient interest is shown in the speaker in question we may publish further details.

A. H. M. (Acton). The valve is no longer on the market. The filament was rated at 1.5 volts and the H.T. at about 80 volts.

S. M. (Blendon). The circuit intricacies using the separate valves you mention would render the circuit less inefficient and more difficult to put into good working condition than when using the combination valves. We do not agree with your suggestion, and many readers who previously thought as you do have been converted upon trying one of the receivers in question.

H. T. P. (Woolston). You cannot put a voltage-dropping resistance in the A.C. supply leads. The only alternative is to use another mains transformer built to deliver 210 volts from the 240-volt supply and rated to give the correct current for the mains unit. Is there no tapping point on the mains primary winding?

J. W. A. (Newton Mearns). We would consider that your speaker is defective. The output valve delivers an output of 1 watt, which should be ample. The speaker must, of course, be matched to the valve, and the required load is 7,500 ohms.

E. W. T. (Leytonstone). As we pointed out on page 545 the tapping point on the primary is terminal No. 3. We reiterate our previous remarks, and cannot enter further into this discussion. If you wish for confirmation we suggest you communicate with the makers of the coils.

H. J. C. (Edinburgh 12). We regret that we cannot suggest what is wrong, but it is obvious that there is some mistake in your wiring or a faulty component. You should certainly hear a click when making the H.T. circuit, and the speaker which we specified was mentioned as it gives suitable results in this particular receiver. It is true you could use any speaker, but best results will be obtained with the specified parts and speaker.

D. W. (Rhondda). We regret that we cannot give you the coil-winding details. We hope to publish an article on the subject in the near future.

EASY PAYMENTS

"THERE'S NO PLACE LIKE HOLMES."

SPEAKERS	Deposit	Monthly Payments
W.B. DUPLEX	84/-	4/8 11 of 7/8
W.B. SENIOR	42/-	4/7 9 of 4/7
W.B. JUNIOR	32/6	4/5 7 of 4/5
BLUE SPOT	19/6	2/8 7 of 2/8
ROLA F. 720	35/-	3/10 9 of 3/10

Any make of speaker supplied.

KIT SETS	of merit and fins value.
LISSEN Skyscraper 3, with valves ..	60/- 5/6 11 of 5/6
GRAHAM FARISH STENTORIAN A. ..	94/8 3/10 9 of 3/10
GRAHAM FARISH Sensity Super ..	50/- 4/7 11 of 4/7
B.T.S. OCEANIC 3	65/- 5/- 11 of 3/-
B.T.S. S.W. ADAPTOR	52/6 4/10 11 of 4/10

ACCESSORIES	of merit and fins value.
3 VALVES S.G.D.P.	25/- 3/6 7 of 3/6
ATLAS ELIMINATOR T. 10/50 ..	69/6 6/- 11 of 6/4
AVONINOR METER	40/- 5/6 7 of 5/6
B.T.E. LATEST PICK-UP	40/- 4/5 9 of 4/5

PARTS FOR ANY SET. ANY MAKE OF SPEAKER.

New goods obtained for every order.
Send us a list of parts or valves you require or any speaker or set you may select and we will forward you a definite quotation. Ten years' advertiser in the Wireless Press. Thousands of satisfied customers.

H. W. HOLMES:

NEW ADDRESS: 333, EUSTON ROAD, LONDON, N.W.1.
Phone: Museum 1414.

THE FAMOUS H.J.B. VOICE



MICROPHONE

Never in the history of Radio has such value been offered to the Public.

H. J. BENNETT

10/6 Post Free.
Trade Enquiries Invited.
287, PENTONVILLE ROAD, KING'S X.
Phone: Terminus 4876.

Let Us Send You This 40-Page Booklet - Free



It gives full information regarding various I.C.S. Courses of Instruction in Radio work.

The Radio industry is progressing with amazing rapidity. Only by knowing thoroughly the basic principles can pace be kept with it. I.C.S. Instruction includes American broadcasting as well as British wireless practice. It is a modern education, covering every department of the industry.

OUR COURSES

Included in the I.C.S. range are Courses dealing with the Installing of radio sets and, in particular, with their Servicing, which to-day intimately concerns every wireless dealer and his employees. The Equipment Course gives sound instruction in radio principles and practice.

There is also a Course for the Wireless Salesman. This, in addition to inculcating the art of salesmanship, provides that knowledge which enables the salesman to hold his own with the most technical of his customers.

Then there are the Preparatory Courses for the City and Guilds and I.W.T. Exams.

We will be pleased to send you details and free advice on any or all of these subjects. Just fill in, and post the coupon, or write in any other way.

International Correspondence Schools, Ltd.,
Dept. 94, International Buildings,
Kingsway, London, W.C.2.

Without cost, or obligation, please send me your "Radio" booklet of information about the Courses I have marked X

- COMPLETE RADIO
- RADIO SERVICING
- RADIO EQUIPMENT
- RADIO SERVICING AND SALESMANSHIP
- WIRELESS ENGINEERING
- EXAMINATION (state which)

Name

Address

LETTERS FROM READERS

The Editor does not necessarily agree with opinions expressed by his correspondents.

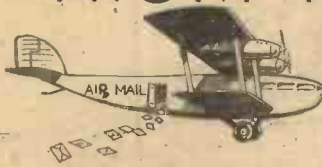

All letters must be accompanied by the name and address of the sender (not necessarily for publication.)

Midget Coils

SIR,—I noticed that you published my letter concerning my "Midget" coil in the issue for January 4th, and I now give a few details of its construction.

The coil former is a piece of thin cardboard tube, 3/4 in. diameter and 1/2 in. long, and is wound with 50 turns, tapped at the 25th turn, which is at E. The wire used was taken from an old transformer, and is very fine and shellacked. The turns are "pile" wound and are only about 1/4 in. in width

and I have always found coils having a narrow width of windings give much superior results to any other. The coils are fixed in the cabinet and secured to the sockets, as illustrated.

Fig. 2 shows the theoretical circuit diagram of the set I am using at present. I can tune in 40 to 50 stations any evening on this set, every one at full strength and stations such as the Regionals, Athlone, Luxembourg, etc., in broad daylight. For this set I use an A.C. eliminator, 150 volts, 35 milliamps, which I made myself. The tone is well balanced and the quality is excellent, the volume being equal to the average mains set. Sometimes I put another super-power valve in parallel with the present one and the volume then is large enough to fill a cinema and the quality is fine.

The coils are shown connected to their sockets, the flex leads completing the circuits with plugs.

The intermediate coil enables me to tune in

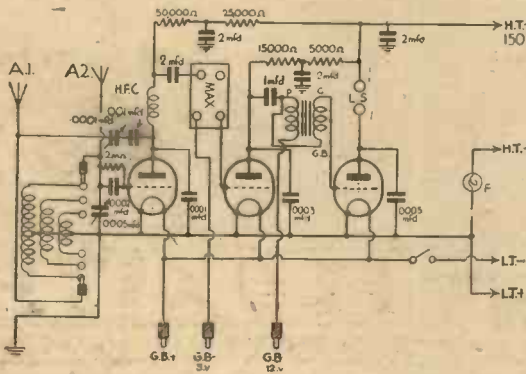
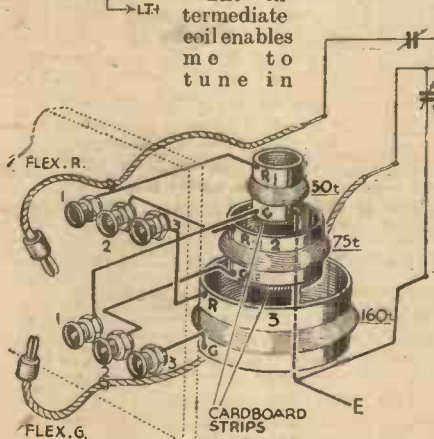

Fig. 2 (above).—Circuit diagram of Mr. Tucker's three-valve receiver. Valves—P.M.20X, P.M.1L.F., P.M.202S.P. Transformers—(1) Max, (2) Ferranti A.F.8; Resistances—Graham Farish. Condensers—Graham Farish and T.C.C. Coils—Own make. Speaker—W.B. Stentorian.

Fig. 1 (right).—Diagram showing coils and detector stage.



when finished. This coil of 50 turns, when used with a .0005 tuning condenser in an old-fashioned det. and 2 L.F. set using condenser controlled reaction, with a meg. grid leak and .0002 grid condenser in parallel, will tune in nearly every station from 200 to 400 metres, all at loud-speaker strength. This coil is No. 1 in the accompanying sketch (Fig. 1).

The No. 2 coil is composed of 75 turns of the same wire but wound on a 1 1/4 in. tube, and tapped at the 25th turn, which is earth, the start of the 25 turns goes to reaction, the end of 75 turns going to the grid.

No. 3 is the long-wave coil, and is wound on a 2 in. tube. It has 60 turns for reaction and 100 turns for the grid. After the turns are wound on, the ends are cleaned and soldered to a short piece of 24 D.C.C. wire.

The three coils are then mounted on top of one another with an intervening cardboard strip, the three earths are coupled together and soldered to the main earth. There is no break-through with this method of mounting.

Six sockets are now fixed at the side of the cabinet, and two plugs with two pieces of flex complete the connections, as shown, and tuning is simplicity itself.

Some years ago, it was pointed out in an article that the efficiency of a coil varies in proportion to the width of its winding,

the North Reg., Athlone, etc., at full strength. There may be some features in this design of interest, such as L.T.+ going to earth, coils, grid leak, A.I., etc. They all have their respective merits and join together in making an excellent set.—Wm. TUCKER (Swansea).

Back Number of "A.W." Wanted

SIR,—I shall be very glad if you can put me in touch with any reader who has a spare copy of *Amateur Wireless*, No. 648.—H. BAKER, 30, Harrow Road, Barking, E.

Component Prices

SIR,—As a regular reader and a proud possessor of one of your receivers, may I make a suggestion? Accompanying all your excellent receivers is a column headed "List of Parts." This column, I think, plays a great part to the constructor, and I suggest that it would be a good plan if the prices, or approximate prices, were inserted after each item. This, I think, would save constructors from searching for prices, and perhaps purchasing cheap or inferior parts, and damaging the quality of reproduction.—JOHN W. LEECH (Llandudno).

(What do other readers think?—ED.)

Activity on the 160-metre Band

SIR,—It will be interesting to all short-wave amateurs to know that the 160-metre amateur band is again very active.

From station G2JG I had the great pleasure to contact and pass on the greetings for the new year to a good number of amateur stations, the last being G6SR from Scotland, this was at about 4 a.m. Although a radio dealer, like many other short-wave amateurs I find time after the long hours of the day in the shop to give to my hobby, short-wave radio. It really is a break from the BCL class and stimulates a new interest, one I shall be very reluctant to give up. One can pick up almost at will any of the ordinary broadcast stations, but what a thrill to pick up an American amateur and to learn he is only working on low power. The W stations are luckier than most of the Englishmen because they seem to be able to get high-power tickets much easier than us, but still we claim the biggest honours here, as we get out on very low power, and get just as much of a thrill as the Yanks do.—W. T. COOPER, (2AYB), Walthamstow.

RADIO CLUBS AND SOCIETIES

Club Reports should not exceed 200 words in length and should be received First Post each Monday morning for publication in the following week's issue

NEWPORT AND DISTRICT S.W. RADIO CLUB

A SHORT-WAVE radio club, known as the Newport and District Short-wave Society, has been formed in Newport, Monmouthshire.

The society will welcome heartily any PRACTICAL AND AMATEUR WIRELESS readers who are short-wave enthusiasts and membership is open to all those readers who live in Monmouthshire or near thereto. There is no subscription.

Monthly meetings are to be held at the Queens Hotel, Newport, whereat there will be discussions and lectures on points of interest to all members.

I shall be glad to hear from those interested in these arrangements and invite them to write to me at the undermentioned address.—R. V. ALBRIGHT (G2JL), Hon. Sec., 2, Palmyra Place, Newport, Mon.

SPHERE S.W. CLUB.

OWING to its increasing membership the above club is having to look for bigger quarters. The club now possesses a receiving licence, thus enabling experiments to be carried out with different types of circuits and aerials. For those interested in Morse an instruction class is being inaugurated. A hearty welcome is offered to any new member. The membership fee: 5s. per year, which may be paid quarterly.—Hon. Sec.: G. Walker, 33, Napier Road, Thornbury, Bradford, Yorks.

SHORT-WAVE RADIO AND TELEVISION SOCIETY (THORNTON HEATH)

A MEETING of this society was held at St. Paul's Hall, Norfolk Road, on Tuesday the 14th ult. under the chairmanship of Mr. R. E. G. Copp.

The subject of the evening was a talk and demonstration by Mr. O. L. Crossley, M.P.S., on 5-metre receivers. Mr. Crossley said that the idea that 5-metre waves were quasi-optical had had to be revised in view of the long distances over which these waves had been received and the theory now receiving attention is that there is another ionised layer above the Heaviside and Appleton layers. Apart from long-distance communication in the U.S.A., G5CV has radiated a signal from the top of Mount Snowdon which was picked up over 200 miles away and G6SI in Birmingham was received over 100 miles away. In both these cases the optical distance was very considerably shorter than the distance received.

Mr. Crossley then gave the diagram of his receiver and also demonstrated its capabilities. The meeting closed with a vote of thanks to Mr. Crossley.

The Hon. Secretary is Mr. Jas. T. Webber, 268, Brigstock Road, Thornton Heath.

The Editor will be pleased to consider articles of a practical nature suitable for publication in PRACTICAL AND AMATEUR WIRELESS. Such articles should be written on one side of the paper only, and should contain the name and address of the sender. Whilst the Editor does not hold himself responsible for manuscripts, every effort will be made to return them if a stamped and addressed envelope is enclosed. All correspondence intended for the Editor should be addressed: The Editor, PRACTICAL AND AMATEUR WIRELESS, Geo. Neaves, Ltd., 8-11, Southampton Street, Strand, W.C.2.

Owing to the rapid progress in the design of wireless apparatus and to our efforts to keep our readers in touch with the latest developments, we give no warranty that apparatus described in our columns is not the subject of letters patent.

Facts and Figures

COMPONENTS TESTED IN OUR NEW LABORATORY

H.M.V. All-Wave Receiver

"HIS MASTER'S VOICE" announce the release of their first all-wave receiver, which is a six-valve (including rectifier) A.C. mains-operated instrument. It is capable of receiving programmes broadcasting on the short-wave range between 16.7 metres and 141 metres without any gaps, in addition to stations on the medium and long wavebands.

Priced at 17½ guineas the instrument has an undistorted output of three watts, and incorporates many useful features to ensure easy location of short-wave stations. These include an aeroplane type tuning dial, four separate tuning scales (each being calibrated in wavelengths), the medium and long wavebands also bearing the station names. In addition, another scale calibrated in degrees is situated in the centre of the main scales. A fine tuning knob moves a pointer against this latter scale, thus enabling it to act as a vernier adjustment and providing duplex tuning controls.

Other important features of this instrument include separate tone controls for bass and treble, and a waveband indicator which shows visually which waveband is in use.

Westinghouse A.C.-D.C. Three-Valve Superhet

AN interesting constructional booklet has now been released by the makers of the Westinghouse Metal Rectifier, giving full details of an interesting universal mains type superhet. The booklet costs 1s., and is complete with a full-size wiring and panel-drilling diagram. The circuit employed in this receiver is of the triode-pentode, variable- μ , Westector, and L.F. pentode type, with the mains section completed by means of an H.T.10 rectifier but, of course, without a mains transformer. The main novelty lies in the fact that the second valve (the variable- μ pentode) functions both as the intermediate-frequency amplifier and as a low-frequency amplifier, the rectified signals from the Westector being fed back to this particular stage. The coupling is entirely resistance-capacity and thus losses are reduced and the Westector and the valve are enabled to operate at maxi-

mum efficiency. Refinements in the circuit consist of A.V.C., volume control on the output stage, and a wavelength calibrated dial. The receiver is strictly of the "one-knob" type, the only controls on the panel consisting of tuning, wavechange, volume control, and on-off switch. The approximate cost of all the components, including valves and loud-speaker, is £14 10s. The booklet may be obtained on application to the Westinghouse Brake Company, at 82, York Road, King's Cross, London, N.1.

Telsen Test Meters

THE value of a test meter is now apparent to every listener, and although it was at one time only the experimenter who could afford a good meter, it is now possible for every listener, no matter how modest his means, to obtain an instrument of the utmost value in the correct and most economical operation of a radio receiver. The two meters shown at the foot of this page are taken from the Telsen range of components, and that on the left is the multimeter designed for use on A.C. or D.C., and giving readings from 0 to 8 and from 0 to 16 volts for L.T. circuits, up to 240 volts for H.T. circuits, and current readings up to 300 m/A. There are, of course, numerous applications for an instrument of this nature, such as continuity tests, valves, and circuit tests, and to facilitate the various connections which may have to be made the instrument is supplied with twin flexible leads fitted with pin connections to which spade ends (supplied with the instrument) may be readily attached. The case is finished in walnut shade bakelite and the price is 12s. 6d. (ref. No. W.520). The remaining instrument is a three-range meter, giving direct readings from 0 to 9 volts, from 0 to 180 volts, and from 0 to 30 m/A. It is thus suitable for use in the measurement of H.T., L.T., and G.B. batteries, and for the reading of certain circuit currents. The resistance is not sufficiently high to enable it to be used for the measurement of eliminator outputs nor detector voltages under working conditions, but it will be found an extremely useful meter for all normal requirements for the battery user. The price is 6s. 6d.



Two of the Telsen Meters mentioned in the above report. That on the left is of the A.C.-D.C. type, whilst on the right is an efficient 3-range meter obtainable for 6s. 6d.

"I'm better connected than most,"
Said Miss Rody O. Sett.
"I can boast
A Pure FLUXITE strain
Which indicates brain.
I now have a very high post."

See that FLUXITE is always by you—in the house—garage—workshop—wherever speedy soldering is needed. Used for 30 years in government works and by leading engineers and manufacturers. Of Ironmongers—in tins, 4d., 8d., 1/4 and 2/8.

Ask to see the FLUXITE SMALL-SPACE SOLDERING SET—compact but substantial—complete with full instructions, 7/6.

Write for Free Book on the art of "soft" soldering and ask for Leaflet on CASE-HARDENING STEEL and TEMPERING TOOLS with FLUXITE.

TO CYCLISTS! Your wheels will NOT keep round and true unless the spokes are tied with fine wire at the crossings AND SOLDERED. This makes a much stronger wheel. It's simple—with FLUXITE—but IMPORTANT.

THE FLUXITE GUN

is always ready to put Fluxite on the soldering job instantly. A little pressure places the right quantity on the right spot and one charging lasts for ages.
Price 1/6.



ALL MECHANICS WILL HAVE

FLUXITE

IT SIMPLIFIES ALL SOLDERING

FLUXITE LTD. (Dept. W.P.) DRAGON WORKS, BERMONDSEY STREET, S.E.1.

EASY TERMS

We specialise in the supply of all good quality Radio sets, components, and accessories. Send list of requirements and keen quotation will be sent promptly.

W.B. STENTORIAN 36S

Cash Price £22 0 or 2/6 with order and 11 monthly payments of 4/-

CASH & C.O.D. ORDERS DESPATCHED BY RETURN POST. PRICE LIST FREE.

Estd: 1925 THE NATIONAL 1977

LONDON RADIO SUPPLY COMPANY

11, OAT LANE, NOBLE STREET, LONDON, E.C.2

Piano Tone!

RADIO GRAM CABINETS

as supplied to B.B.C.

65/- POLISHED 35/- CABINET FOR No Middle Profits.

Famous maker offers finest Radio Furniture. As supplied to B.B.C., a quality and value impossible to better. Beautifully hand-polished! GUARANTEED Piano-Tone acoustically.

DIRECT—on FREE TRIAL (or 10/- monthly) LIST FREE! From makers

PICKETT'S

Piano Tone

Cabinet (P.R.) Works, Albion Road, Bexleyheath, near London.

Practical and Amateur Wireless BLUEPRINT SERVICE

PRACTICAL WIRELESS. STRAIGHT SETS. Battery Operated

One-Valve : Blueprints, 1s. each. *Date of Issue.* *No. of Blueprint.*

All-Wave Unipen (pentode)	14.10.33	PW31A
Two-valve : Blueprints, 1s. each.		
Four-range Super Mag. Two (D, Pen)	11.8.34	PW36D
Three-valve : Blueprints, 1s. each.		
Selectone Battery Three (D, 2 LF (trans.))	—	PW10
Alpha Q.P.P. Three (D.Q.P.P.)	25.8.33	PW14
Ferrocatt Q.P.P. Hi-Mag Three (SG, D, Q.P.P.)	25.3.33	PW15
Sixty-Shilling Three (D, 2 LF (R.C. & trans.))	2.12.33	PW34A
Leader Three (SG, D, Pow.)	—	PW35
Summit Three (HF Pen, D, Pen)	18.8.34	PW37
All-Pentode Three (H.F. Pen, D (pen), Pen)	22.0.34	PW39
Hall-Mark Three (SG, D, Pow.)	—	PW41
Hall-Mark Cadet (D, LF, Pen (R.C.))	23.3.35	PW48
F. J. Camm's Silver Souvenir (HF Pen, D (pen), Pen) (All-wave Three)	13.4.35	PW49
Geut Midget (D, 2 LF (trans.))	June '35	PM1
Cameo Midget Three (D, 2 LF (trans.))	8.6.35	PW51
1936 Sonotone Three-Four (HF Pen, HF Pen, Westector Pen)	17.8.35	PW53
Battery All-wave Three (D, 2 LF (R.C.))	31.8.35	PW55
Four-valve : Blueprints, 1s. each.		
Fury Four (2 SG, D, Pen)	—	PW11
Beta Universal Four (SG, D, LF Cl. B)	15.4.33	PW17
Nucleon Class B Four (SG, D (SG), LF, Cl. B)	6.1.34	PW34B
Fury Four Super (SG, SG, D, Pen)	—	PW34C
Battery Hall-Mark 4 (HF Pen, D, Push-Pull)	2.2.35	PW46
F. J. Camm's Superformer (SG, SG, D, Pen)	12.10.35	PW57

Mains Operated

Two-valve : Blueprints, 1s. each.		
A.C. Twin (D (pen), Pen)	22.4.33	PW18
A.C.-D.C. Two (SG, Power)	7.10.33	PW31
Selection A.C. Radiogram Two (D, Pow.)	20.4.33	PW10
Three-valve : Blueprints, 1s. each.		
Double-Diode-Triode Three (HF Pen, D.D.T., Pen)	10.6.33	PW23
D.C. Ace (SG, D, Pen)	15.7.33	PW25
A.C. Three (SG, D, Pen)	16.9.33	PW29
A.C. Leader (HF Pen, D, Power)	7.4.34	PW35C
D.C. Premier (HF Pen, D, Pen)	31.3.34	PW35B
Urbica (HF Pen, D (Pen), Pen.)	28.7.34	PW36A
Armada Mains Three (HF Pen, D, Pen)	18.8.34	PW38
F. J. Camm's A.C. All-Wave Silver Souvenir Three (HF, Pen, D, Pen)	11.5.35	PW50
"Allwave" A.C. Three (D, 2LF (R.C.))	17.8.35	PW54
A.C. 1936 Sonotone (HF Pen, HF Pen, Westector, Pen)	31.8.35	PW56
Four-valve : Blueprints, 1s. each.		
A.C. Fury Four (SG, SG, D, Pen)	25.2.33	PW20
A.C. Fury Four Super (SG, SG, D, Pen)	—	PW34D
A.C. Hall-Mark (HF Pen, D, Push-Pull)	—	PW45
Universal Hall-Mark (HF Pen, D, Push-Pull)	9.2.35	PW47

SUPERHETS.

Battery Sets : Blueprints, 1s. each.		
£5 Superhet (Three valve)	—	PW40
F. J. Camm's 2-valve superhet (two valve)	13.7.35	PW52
F. J. Camm's £4 Superhet 4	10.11.35	PW58
Mains Sets : Blueprints, 1s. each.		
A.C. £5 Superhet (three valve)	—	PW43
D.C. £5 Superhet (three valve)	1.12.34	PW42
Universal £5 Superhet (three valve)	15.12.34	PW44
F. J. Camm's A.C. £4 Superhet 4	7.12.35	PW50
F. J. Camm's Universal £4 Superhet 4	11.1.36	PW60

SHORT-WAVE SETS.

Two-valve : Blueprints, 1s. each.		
Midget Short-wave Two (D, Pen)	15.9.34	PW38A
Three-valve : Blueprints, 1s. each.		
Experimenter's Short-wave Three (SG, D, Power)	23.9.33	PW30A
Three-valve : Blueprints, 1s. each.		
Atom Lightweight Portable (SG, D, Pen)	2.6.34	PW36
Four-valve : Blueprints, 1s. each.		
Featherweight-Portable Four (SG, D, LF, Cl. B)	6.5.33	PW12

PORTABLES.

Four-valve : Blueprints, 1s. each.		
Standard Four-valve Short-waver	Mar. '35	WM383

MISCELLANEOUS. S.W. Converter-Adapter (valve) 23.2.35 W48A

AMATEUR WIRELESS AND WIRELESS MAGAZINE. CRYSTAL SETS.

Blueprints, 6d. each.		
Four-station Crystal Set	—	AW427
1934 Crystal Set	—	AW444
150-mile Crystal Set	—	AW450

STRAIGHT SETS. Battery Operated.

One-valve : Blueprints, 1s. each.		
B.B.C. Special One-valver	—	AW387
Twenty-station Loud-speaker One-valver (Class B)	—	AW440
Two-valve : Blueprints, 1s. each.		
Melody Ranger Two (D, Trans)	—	AW388
Full-volume Two (SG, Det, Pen)	—	AW392
Iron-core Two (D, Trans)	—	AW395
Iron-core Two (D, Q.P.P.)	12.8.33	AW396
B.B.C. National Two with Lucerne Coil (D, Trans)	—	AW377A
Big-power Melody Two with Lucerne Coil (SG, Trans)	—	AW388A
Lucerne Minor (D, Pen)	—	AW426

Three-valve : Blueprints, 1s. each.

P.T.P. Three (Pentode-Triode-Pentode)	June '35	WM389
Class-B Three (D, Trans, Class B)	22.4.33	AW386
New Britain's Favourite Three (D, Trans, Class B)	15.7.33	AW394
Home-Built Coil Three (SG, D, Trans)	14.10.33	AW404
Fan and Family Three (D, Trans, Class B)	25.11.33	AW410
£5 5s. S.G.3 (SG, D, Trans)	2.12.33	AW412
1934 Ether Searcher : Baseboard Model (SG, D, Pen)	20.1.34	AW417
1934 Ether Searcher : Chassis Model (SG, D, Pen)	—	AW419
Lucerne Ranger (SG, D, Trans)	—	AW422
Coscor Melody Maker with Lucerne Coils	—	AW423
P.W.H. Mascot with Lucerne Coils (D, RC, Trans)	—	AW337A
Mullard Master Three with Lucerne Coils	—	AW424
£5 5s. Three : De Luxe Version (SG, D, Trans)	19.5.34	AW435
Lucerne Straight Three (D, RC, Trans)	—	AW437
All Britain Three (HF Pen, D, Pen)	—	AW448
"Wireless League" Three (HF Pen, D, Pen)	3.1.34	AW451
Transportable Three (SG, D, Pen)	—	WM271
£6 6s. Radiogram (D, RC, Trans)	Apr. '33	WM318
Simple Tune Three (SG, D, Pen.)	June, '33	WM327
C.B. Three (D, LF, Class B)	—	WM333
Economy-pentode Three (SG, D, Pen)	Oct. '33	WM337
"W.M." 1934 Standard Three (SG, D, Pen)	—	WM351
£3 3s. Three (SG, D, Trans)	Mar. '34	WM354
Iron-core Band-pass Three (SG, D, QP21)	June '34	WM362
1935 £6 6s. Battery Three (SG, D, Pen)	—	WM371
Graduating to a Low-frequency Stage (D, 2LF)	—	WM378

Four-valve : Blueprints, 1s. 6d. each.

65/- Four (SG, D, RC, Trans)	—	AW370
"A.W." Ideal four (2SG, D, Pen)	16.9.33	AW402
2 H.F. Four (2SG, D, Pen)	—	AW421
Crusaders' A.V.C. 4 (2HF, D, QP21)	18.8.34	AW445
(Pentode and Class-B Outputs for above : blueprints 6d. each)	25.8.34	AW445A
Quadradyne (2SG, D, Pen)	—	WM273
Calibrator (SG, D, RC, Trans)	—	WM300
Table Quad (SG, D, RC, Trans)	—	WM303
Calibrator de Luxe (SG, D, RC, Trans)	—	WM316
Self-contained Four (SG, D, LF, Class-B)	Aug. '33	WM331
Lucerne Straight Four (SG, D, LF, Trans)	—	WM350
£5 5s. Battery Four (HF, D, 2LF)	Feb. '35	WM381
The H.K. Four	Mar. '35	WM384

Five-valve : Blueprints, 1s. 6d. each.

Super-quality Five (2HF, D, RC, Trans)	May '33	WM320
New Class-B Five (2SG, D, LF, Class B)	Nov. '33	WM340
Class-B Quadradyne (2SG, D, LF, Class B)	Dec. '33	WM344
1935 Super Five (Battery Superhet)	—	WM379

These blueprints are full size. Copies of appropriate issues containing descriptions of these sets can in most cases be obtained as follows:—"Practical Wireless" at 4d., "Amateur Wireless" at 4d., "Practical Mechanics" at 7jd., and "Wireless Magazine" at 1/3, post paid. Index letters "P.W." refer to "Practical Wireless" sets, "P.M." to "Practical Mechanics" sets, "A.W." refer to "Amateur Wireless" sets, and "W.M." to "Wireless Magazine" sets. Send (preferably), a postal order (stamps over sixpence unacceptable) to "Practical and Amateur Wireless" Blueprint Dept., Geo. Newnes, Ltd., 8-11, Southampton Street, Strand, W.C.2.

Mains Operated.

Two-valve : Blueprints, 1s. each.		
Two-valve Mains Short-waver (D, Pen) A.C.	—	AW453
"W.M." Band-spread Short-waver (D, Pen) A.C./D.C.	Aug. '34	WM368
"W.M." Longwave-Converter	—	WM380
Three-valve : Blueprints, 1s. each.		
Emigrator (SG, D, Pen), A.C.	—	WM352
Four-valve : Blueprints, 1s. 6d. each.		
Gold Coaster (SG, D, RC, Trans) A.C.	—	WM292
Trickle Charger	Jan. 5, '35	AW462

MISCELLANEOUS.

Enthusiasts Power Amplifier (1/6)	June '35	WM387
Newstyle Short-wave Adaptor (1/-)	June '35	WM388

Mains Operated.

Two-valve : Blueprints, 1s. each.		
Consoelectric Two (D, Pen) A.C.	23.9.33	AW403
Economy A.C. Two (D, Trans) A.C.	—	WM286
Three-valve : Blueprints, 1s. each.		
Home-lover's New All-electric Three (SG, D, Trans) A.C.	—	AW383
S.G. Three (SG, D, Pen) A.C.	3.6.33	AW390
A.C. Triodyne (SG, D, Pen) A.C.	19.8.33	AW399
A.C. Pentaquester (HF, Pen, D, Pen) A.C.	23.6.34	AW439
D.C. Calibrator (SG, D, Push-pull Pen) D.C.	July '33	WM323
Simplicity A.C. Radiogram (SG, D, Pen) A.C.	Oct. '33	WM333
Six-guinea A.C./D.C. Three (HF, Pen, D, Trans) A.C./D.C.	—	WM364
Mantovani A.C. Three (H.F, Pen, D, Pen) A.C.	Nov. '34	WM374
Four-valve : Blueprints, 1s. 6d. each.		
A.C./D.C. Straight A.V.C.4 (2 HF, D, Pen) A.C./D.C.	8.0.34	AW446
A.C. Quadradyne (2 SG, D, Trans) A.C.	—	WM370
All Metal Four (2 SG, D, Pen)	July '33	WM329
"W.M." A.C./D.C. Super Four	Feb. '35	WM382
Harris Jubilee Radiogram	May '35	WM386

SUPERHETS.

Battery Sets. Blueprints, 1s. 6d. each.		
"W.M." Stenode	—	WM373
Modern Super Senior	—	WM375
Mains Sets : Blueprints, 1s. 6d. each.		
1934 A.C. Century Super, A.C.	10.3.34	AW425
Seventy-seven Super A.C.	—	WM305
"W.M." D.C. Super, D.C.	May '33	WM321
Merrymaker Super, A.C.	Dec. '33	WM345
Heptode Super Three, A.C.	May '34	WM359
"W.M." Radiogram Super A.C.	—	WM366
"W.M." Stenode, A.C.	Sep. '34	WM370
1935 A.C. Stenode	Apr. '35	WM385

PORTABLES.

Four-valve : Blueprints, 1s. 6d. each.		
Midget Class-B Portable (SG, D, LF, Class B)	20.5.33	AW389
Holiday Portable (SG, D, LF, Class B)	1.7.33	AW393
Family Portable (HF, D, RC, Trans)	22.9.34	AW447
Town and Country Four (SG, D, RC, Trans)	—	WM282
Two H.F. Portable (2 SG, D, QP21)	June '34	WM363
Tyers Portable (SG, D, 2 Trans)	Aug. '34	WM367

SHORT-WAVERS—Battery Operated.

One-valve : Blueprints, 1s. each.		
S.W. One-valve converter (price 6d.)	—	AW329
S.W. One-valve for America	—	AW429
Roma Short-waver	—	AW452
Two-valve : Blueprints, 1s. each.		
Home-made Coil Two (D, Pen)	14.7.34	AW440
Three-valve : Blueprints, 1s. each.		
World-range Short-wave 3 (D, RC, Trans)	—	AW355
Experimenter's 5-metre Set (D, RC, Super-regen)	30.6.34	AW438
Experimenter's Short-waver	Jan. 19, '35	AW403
Short-wave Adapter	Dec. 1, '34	AW456
Superhet, Converter	Dec. 1, '34	AW457
The Carrier Short-waver	July '35	WM390

Four-valve : Blueprints, 1s. 6d. each.

A.W. Short-wave World Beater (HF Pen, D, RC, Trans)	2.6.34	AW436
Empire Short-waver (SG, D, RC, Trans)	—	WM313
Standard Four-valve Short-waver	Mar. '35	WM383

If a postal reply is desired, a stamped addressed envelope must be enclosed. Every query and drawing which is sent must bear the name and address of the sender. Send your queries to the Editor, PRACTICAL AND AMATEUR WIRELESS, Geo. Newnes, Ltd., 8-11, Southampton Street, Strand, London, W.C.2.

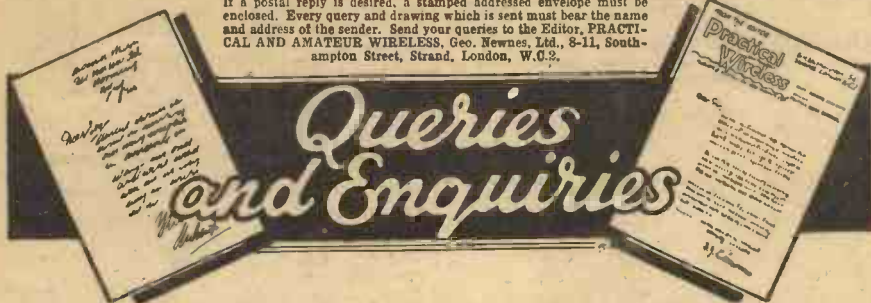

Queries and Enquiries

SPECIAL NOTE

We wish to draw the reader's attention to the fact that the Queries Service is intended only for the solution of problems or difficulties arising from the construction of receivers described in our pages, from articles appearing in our pages, or on general wireless matters. We regret that we cannot, for obvious reasons—

- (1) Supply circuit diagrams of complete multi-valve receivers.
- (2) Suggest alterations or modifications of receivers described in our contemporaries.
- (3) Suggest alterations or modifications to commercial receivers.
- (4) Answer queries over the telephone.
- (5) Grant interviews to querists.

Please note also that queries must be limited to two per reader, and all sketches and drawings which are sent to us should bear the name and address of the sender.

Adding an H.F. Stage

"I have a two-valve A.C. receiver (det. and pen.), but find that the selectivity and range is not adequate for my present needs. I think the best improvement would be to add an H.F. stage, preferably var. mu, and should be glad if you could recommend a blueprint or issue in which the construction of such a unit was given. Any other details would be appreciated."—B. T. R. (Penge).

ALTHOUGH the addition of an H.F. stage is not normally a difficult matter, as yours is an A.C. receiver, there are one or two difficulties. Firstly, it is to be taken for granted that the mains section has been designed to deliver the output voltage and current required by the present two valves. An extra valve would impose a further load on the mains section, which, if unaltered, would probably result in reduced supplies to the remaining two valves with consequent loss of power. Secondly, there may be no provision for an additional heater winding on the transformer and a further load may result in a drop in voltage. These facts depend, of course, upon the regulation properties of the mains transformer and the general circuit arrangements. It will thus probably be found desirable to build the H.F. unit complete with its own mains section, but we have not previously described a unit of this type.

A Portable and Reaction

"I have built the Goodwill Portable, and whilst this proves admirable in most respects there is one point upon which I should like advice. On medium waves volume and quality are all that can be desired, but on the long waves the reaction control does not function satisfactorily. I have increased the H.T. on the detector valve, changed the valve, but cannot get the same reaction

control as is obtained on the medium waves. What can you suggest?"—J. E. T. (West-cliff-on-Sea).

IF the frame aerial is examined it will be found that there are three separate windings. One is the medium-wave grid winding, one the long-wave loading coil, and one the reaction winding. This is arranged in between the two grid windings, and thus produces coupling between both coils. When trouble such as you have experienced is found the usual cure is to move the reaction winding bodily towards the long-wave section, and this may generally be accomplished without difficulty. The spacing may be found critical, but there should be a position where a given number of turns will provide smooth reaction control on both bands. In the event of reducing the reaction effect on the medium waves, a further turn or two should be wound on the reaction winding.

Dipole Aerial

"Would I gain anything by making my aerial into a centre-tapped or dipole arrangement for use with my Silver Souvenir receiver? I find results very good taken as a whole, but the lower short-wave ranges do not come up to the remaining wavebands and I feel that this is due to the aerial. I should be glad if you could suggest some device to avoid using two different aerials for this receiver."—G. B. (Watford).

IF you wish to avoid aerial changing (which is undoubtedly the most efficient way of overcoming your difficulty) you could compromise by adopting a dipole aerial. The article on page 638 may prove of assistance to you.

A Conclusive Test

"My three-valve receiver recently gave very much reduced signal strength, and I searched everywhere for the trouble. After failing to trace it I switched on again and noticed a still further falling off and eventually signals ceased altogether. I only own a cheap dual-reading meter, but when I joined this in each anode circuit I found there was only a kick on the needle in the first L.F. stage and no direct reading. Does this indicate that the transformer primary has gone? If so, why does the needle kick when I connect it in circuit?"—F. L. (Aberdeen).

THE needle kick is no doubt due to a condenser charging effect, but if there is no steady current reading with varying H.T. and G.B. voltages the indication is definitely that the primary or other anode component has broken down. If

you are using a parallel-fed transformer device, or if there is a decoupling condenser in the anode circuit, it would be possible to obtain a kick on some types of meter when the circuit was switched on, but without a wiring diagram we cannot state whether or not this is definitely the case. It may be possible that the transformer primary is broken in such a manner that a small discharge takes place when the H.T. circuit is made, and this discharge caused a breakdown of the insulation causing the broken ends of the wire to open and thus break the circuit. A new transformer is indicated.

Interference Elimination

"I am running a three-phase rotary converter in the house, and I find bad interference on the domestic broadcast receiver. I often want the converter on while the family are listening in, but have so far failed to find any device to use with the set to stop the trouble. What is the best way of doing this at the lowest expense and without interfering with the internal arrangements of the receiver?"—H. B. I. (Brighton)

A NETWORK of condensers of suitable rating should be fitted to the converter, and you will no doubt find it essential to employ no less than six of these condensers arranged in "bridge" formation. Capacities and actual connections will depend upon the particular piece of apparatus and it will, in view of the lack of particulars which you supply, be preferable to write to one of the firms who specialise in interference-reducing apparatus for details of a suitable unit.

Screened Transformer Primary

"I have a rather old mains transformer, and in view of the hum difficulties which I am experiencing I have come to the conclusion that the transformer primary is responsible. I think it would solve the difficulty if this were screened. Is it practicable to carry out such screening on the transformer without dismantling, and if so, what is the best way?"—B. H. F. (Newport).

IT will depend upon the method of winding whether or not you can carry out your idea. If the windings are overwound one upon the other you will undoubtedly find the primary is on the inside immediately next to the core, and under such conditions it would not be practicable to carry out the screening. If, on the other hand, the windings are carried on separate bobbins, arranged vertically on the core, each separate winding being placed side by side, then it is possible to screen the primary in either of the following ways. A thin piece of copper foil may be cut to slide between the former carrying the primary and the remaining formers, but the foil must not be complete—that is to say, a small slot should be left to permit the coils to couple inductively. An alternative scheme is to remove all of the bobbins and to replace them with the L.T. windings interposed between the primary and the H.T. secondary winding.

The coupon on page 644 must be attached to every query.

THE ONE AERIAL FOR THE MODERN SET

PIX INVISIBLE AERIAL

PIX LONDON S.E.1

Highly efficient, self adhesive aluminium strip—gives wonderful pick-up clear of interference—fixed in a jiffy without tools—just press it and it sticks.

2/-

Double Length 3/6

Miscellaneous Advertisements

Advertisements are accepted for these columns at the rate of 3d. per word. Words in black face and/or capitals are charged double this rate (minimum charge 3/- per paragraph). Display lines are charged at 6/- per line. All advertisements must be prepaid. All communications should be addressed to the Advertisement Manager, "Practical and Amateur Wireless," 8, Southampton Street, Strand, London.

RECEIVERS, COMPONENTS AND ACCESSORIES

Surplus, Clearance or Secondhand, etc.

PREMIER SUPPLY STORES

PREMIER SUPPLY STORES

PREMIER SUPPLY STORES

ALL previous bargains advertised are still available. Send 3d. for large illustrated catalogue including Bargain Supplement.

WATCH for next week's special announcement.

PREMIER SUPPLY STORES

20-22, High St., Clapham, S.W.4 (Phone: Macaulay 2381), and 105, Fleet St., E.C.4 (next door to Anderson's Hotel). Phone: Central 2833.

WESTERN ELECTRIC MIKES, 1/9 each. List price, 21/-. Transformer to match, 1/3 each. 4 mfd. B.I.C. Electrolytic condensers, 450 volts working, 1/8 each, and 500 clearance lines. Catalogues 3d. each.—J. Bearfield, 105, Upper Street, London, N.1.

HIGHEST possible allowance made on your old set or components in part exchange for any new set or Peto-Scott kit.—R. Wigfield, Furlong Road, Goldthorpe, Yorks.

VAUXHALL.—T.C.C. 4 and 8 mfd. Electrolytic condensers, 550, 3/-; 500 v., 2/6.

VAUXHALL.—T.C.C. condensers, tubular, non-inductive, 0.1, 6d.; 50 mfd., 50v. working, 1/6; 50 mfd., 15v., 1/3; 0.05, 6d.; 0.002, 0.0002, 0.001, 0.0001, 4d. each.

VAUXHALL.—T.C.C. mica 0.002, 2,000 volt test, 10d.; 0.0001, 6d.; 0.001, 0.01, 1/-; 1 mfd. Mansbridge, 1/3.

VAUXHALL.—Resistances by well-known manufacturers, 1-watt type, 6d. each; all values.

VAUXHALL.—Colvern G.1, G.2, G.3, or G.1, G.2 and G.8 superhet. type, 30/-; Colpaks, £2/4.

VAUXHALL.—Volume controls, Erie, Colvern, Centralab, 2/-; with switch, 3/-; all values, from 3,000 to 2 meg., Benjamin, class "B" transformers, 1-1½ to 1, 6/6.

VAUXHALL.—Polar station named scales, for horizontal dials, latest settings; 1/9 each.

VAUXHALL.—Polar Midget 3-gang condensers, straight or superhet, 8/9; Polar full vision, horizontal or Arcuate dial and drives, 4/6.

VAUXHALL.—Centre tapped iron cored L.F. transformers, bases, terminals, 110 k/c; 6/6 guaranteed.

VAUXHALL.—Set manufacturers' surplus, skeleton type Westinghouse rectifiers, H.T.3, 9/6; H.T.9, H.T.10, 10/-; complete with fixing brackets; Westectors, W.4, W.X.0, 5/9.

VAUXHALL.—Guaranteed for twelve months; mains energised, 2,500 or 0,500 field coil, 10in. cone, 17/6; 7in. cone, 12/6.

VAUXHALL.—Permanent magnets, universal, suitable for Class "B" power or pentode, 7in. cone, 16/6; 10in. cone, 22/-.

VAUXHALL.—The above complete with hum-bucking coils; state power or pentode transformer; immediate delivery.

VAUXHALL.—B.T.H. Minor, 16/6; Senior needle, armature, 20/-; Radiophone, 14/6; others from 10/-.

VAUXHALL.—B.T.H. Trussed gramophone motor 30/-; Universal D.C./A.C., 47/6; sealed cartons.

VAUXHALL.—Collaro 32 model, 32/6; Universal model, 47/6; complete unit, A.C. 200-250v., first quality pick-ups and volume control, 48/-.

VAUXHALL.—T.C.C., 200 mfd., 10-volt, 2/6. Continental valve holders for Universal valves, with terminals, 9d.

VAUXHALL.—Clix valve holders, terminals, 7-phen, 9d., 5-pin, 7d., W.B. 5-pin 4½d.; baseboard mounting, 6d.; post paid 2/6 or over, or c.o.d.

VAUXHALL.—Hivac Valves, all types Mains and Battery in stock for immediate delivery.

VAUXHALL UTILITIES, 163a, Strand, W.C.2, over Denny's, the Booksellers, Temple Bar 9338. Send postcard for lists free.

NEW RECEIVERS, COMPONENTS, AND ACCESSORIES

30/- SHORT-WAVE CONVERTER/ADAPTORS. Guaranteed. Metal Cabinet. 13/52 metres. Use with your present set. Descriptive leaflet free. BENNETT TELEVISION CO., REDHILL.

MORE G. W. BARGAINS

SPECIAL PURCHASES

Special offer, 134 only **ORMOND CLASS B3** Battery Receivers, housed in magnificent grained walnut cabinet; fitted with two matched P.M. speakers and covering wave range of 200/550 metres and 1,000/2,000 metres; has alternative aerial tappings, plugs for gramophone pick-up, provision for extension speaker; fitted with Mullard valves, C.A.V. battery and Exide accumulator. Cabinet size 23½ins. wide x 11ins. wide x 9½ins. Brand new and fully guaranteed in sealed cartons. List price £7/10/-; our Price £4/5/-, carriage paid.

50 only **Ormond A.C./D.C. Mains Receivers** complete with 3 Mullard Valves and Barretter, Moving Coil Speaker, Wave range 200-550 and 1,000-2,000 metres. Provision for Extension Loud-speaker and Gramophone Pick-up. Brand new and fully guaranteed, in sealed cartons, listed £7/10/-, our price £4/10/-, carriage paid.

Cash with order or deposit and balance C.O.D. Money refunded if not satisfactory within 7 days.

G. W. RADIO, 7, Chapel Street, Lamb's Conduit Street, London, W.C.1.

Phone: Holborn 4434.

ENGINEERS!

ARE YOU EARNING LESS THAN £10 PER WEEK?

If so, you cannot afford to carry on without reading our 268-page Handbook. The book explains clearly and definitely many ways of carving out a successful career. Among other things it explains the Services of our unique Appointments Department, outlines Home-study Courses in all branches of Civil, Mechanical, Electrical, Motor, Aero, Wireless, "Talkie," Engineering, Building, Govt. Employment, etc., and gives details of B.Sc., A.M.I.C.E., A.M.I.E.E., A.M.I.Mech.E., A.M.I.A.E., A.M.I.W.T., A.M.I.R.E., G.P.O., MATRIC, and all Exams. We Guarantee—"NO PASS NO FEE." Whether you be an old hand or a budding apprentice, get this book to-day—FREE and POST FREE. BRITISH INSTITUTE OF ENGINEERING TECHNOLOGY.



409, Shakespeare House, 17/19, Stratford Place, London, W.1.

NEW RECEIVERS, COMPONENTS AND ACCESSORIES

SHORT WAVE SETS.—Canadian 5 valve short-wave superhets with medium-wave band. Ultra selective and powerful. Complete with 6in. moving coil speaker in handsome cabinet. A.C. mains, £12. Free delivered in U.K.—Dickson Radio Inc., 216, Earl's Court Rd., London, S.W.5. Fla. 1800.

CLARION VALVES.—All brand new; battery types 2-volt, H.2, HL.2, L.P.2, 1/9; super power P.2, 2/6; screens and L.F. pentodes, 3/9; A.C. mains, 4-volt, 1-amp., general purpose, 3/3; power, 4/-; screens and L.F. pentodes, 4/6; full-wave rectifiers, 3/6; postage paid, cash with order, or C.O.D. over 10/-—Clarion Valves, Dept. 2, 885, Tyburn Road, Erdington, Birmingham.

MISCELLANEOUS

REPAIRS to Moving Coil Speakers, Cones and Coils fitted or rewound. Fields altered. Prices Quoted including Eliminators. Loud-speakers Repaired, 4/-. L.F. and Speech Transformers, 4/- Post Free. Trade invited. Guaranteed Satisfaction. Prompt Service, Estimates Free. L.S. Repair Service, 5, Balham Grove, London, S.W.12. Battersea 1321.

L. ORMOND SPARKS, Late Technical Staff Amateur Wireless and Wireless Magazine, is still THE CONSTRUCTOR'S CONSULTANT. Technical Queries 1/- each. Blueprint alterations, Theoretical Diagrams and Plan Drawings quoted by return. Stamped envelope requested with all letters. 9, Phoebe Road, Brockley, S.E.4. Phone, Lee Green 1271.

FREE ADVICE BUREAU COUPON

This coupon is available until February 8, 1936, and must be attached to all letters containing queries. PRACTICAL AND AMATEUR WIRELESS, 1/2/36.

RADIO CLEARANCE

63, HIGH HOLBORN, W.C.1.

TEL: HOLBORN 4631

Owing to increase of business we have found it necessary to remove to larger and more spacious premises at Number 63, High Holborn. All orders in future should be sent to this Address. All orders to the value of 10/- or over, carriage paid in United Kingdom. Orders under 10/- must be accompanied by a reasonable amount of postage.

"SPECIAL" "SPECIAL"
70/- LISSEN 4-VALVE A.C. SET complete in Cabinet with Valves and P.M. Moving Coil Speaker, Aerial tested. Few only.

60/- LISSEN 4-VALVE D.C. SET complete in Cabinet with Valves and Moving Coil Speaker, Aerial tested. Few only.

105/- 4-VALVE A.C. SET. 200 to 250 volts. By well-known proprietary manufacturer. Mullard Valves, Moving Coil Speaker, Band Pass tuned, in handsome Walnut Cabinet. Brand new, boxed. H.P. terms can be arranged on application.

75/- 4-VALVE A.C. MAINS CHASSIS. 200 to 250 volts. By well-known proprietary manufacturer. Mullard Valves, Moving Coil Speaker, Band Pass tuned. Brand new.

55/- LISSEN 4-VALVE A.C. CHASSIS. 200 to 250 volts, complete with Valves, aerial tested. Few only.

47/6 LISSEN 4-VALVE D.C. MAINS CHASSIS. Complete with Valves, aerial tested. Few only.

70/- LISSEN 100 STATIONS SET. Complete in Cabinet with Valves and P.M. Moving Coil Speaker, aerial tested. Few only.

32/6 LISSEN SKYSCRAPER 3-VALVE BATTERY CHASSIS. Aerial tested, with Valves.

21/- LISSEN SKYSCRAPER PATTERN CHASSIS. Aerial tested, less Valves.

2/6 LISSEN 2-VOLT BATTERY VALVES. L2 Metallised. Brand new, boxed.

3/6 LISSEN 2-VOLT CLASS B VALVES. Type BB220 A. Brand new, boxed.

8/11 LISSEN RECTIFYING UNITS. Complete with Valves, input 100 to 250 volts, Output 250 volts, 60 M/A. Brand new, in sealed cartons.

5/- UTILITY 3-GANG MIDGET CONDENSERS. Straight or Superhet with 110 k/c section, fully screened.

2/11 BRITISH RADIOPHONE 3-GANG SUPER-HET CONDENSERS. With 110 k/c Oscillator section, unscreened. Wonderful bargain.

2/6 8 MFD and 4 MFD DRY ELECTROLYTIC CONDENSERS. By well-known manufacturer. 450 volt working, 500 volt peak, brand new.

3/- LISSEN HANDSOME WALNUT TABLE CABINET. With provision for Speaker, cut out front for Lissen Band Pass 3 Kits. Few only left. Wonderful bargain.

17/6 HANDSOME WALNUT FLOOR MODEL CONSOLE CABINET. An unrepeatable bargain.

1/11 LISSEN CENTRE TAP OUTPUT CHOKES. Brand new, boxed. List price, 7/6.

1/6 LISSEN INTERVAL SMOOTHING CHOKES. Brand new, boxed. List price, 7/6.

9d. LISSEN HF By-pass UNIT. List 5/6. Brand new, boxed.

1/11 LISSEN 3-GANG SUPERHET COILS. Mounted on base, complete with Switch, unscreened, brand new.

6d. DRILLED METAL CHASSIS. 3-Valve type.

6d. 1 WATT RESISTANCES. All sizes, by well-known manufacturer.

6d. TUBULAR CONDENSERS. All sizes up to .1. By well-known manufacturer.

1/- 1 MFD CONDENSER. 500 volt working.

1/- 4 MFD POST OFFICE TYPE MANSBRIDGE. 250 volt working.

2/6 4 MFD PAPER CONDENSERS. 750 volt test.

HIVAC VALVES. Complete range in stock. Send for lists.

RADIO CLEARANCE

63, HIGH HOLBORN, W.C.1.

TEL: HOLBORN 4631.

NEW RECEIVERS, COMPONENTS, AND ACCESSORIES

DANKRUPT Bargains. List free. All brand new goods. Latest type Amphon 5v. A.C. superhets, £7/10/0. Ever Ready A.C. superhet model 6002, 7 gns. Burgoyne Fury 4v., £5. I will allow £5 for your old set against a Mullard MU35 at 12 gns., or £3/10/0 against a new Mullard MB3A battery set at 8 gns. Three only KB model 383 left at 10 gns. Burgoyne A.C./D.C. radiogram, 1936 15 gn. model, 10 gns. Electric soldering irons, 1/4. Electric irons, 3/9. Cycle dynamo sets, 9/6. Large stock valves of all kinds, speakers, eliminators, and components. You will not buy cheaper. Following goods secondhand in good order. Telsen 6v. A.C. superhet, as new, £4/15/0. Clarkes Atlas S.G., 3v. A.C. set with M.C., 45/0. Both complete and ready to use. Carriage extra.—Butlin, 6, Stanford Avenue, Brighton, Sussex. Preston 4030.

BIRMINGHAM RADIOMART

W. NIGHTINGALE (G5NI)

ANNOUNCES

quality goods at lowest prices consistent with a square deal.

- RADIOMART.**—Bargain parcel value 30/-, containing binocular H.F.C. 4 750v. test condensers, 6 resistances, 4 valveholders, .0003, .0005 variable, electrolytic condenser, etc., 5/-. Traders' parcel, £4/10/0 value, 10/-.
- RADIOMART.**—Telsen 7/6. Ace transformers made for leading Company, boxed, 1/11.
- RADIOMART.**—Ball-bearing air-spaced condensers; World's finest manufacturers 4-gang, 3-gang superhet, 1/11.
- RADIOMART.**—Non-inductive condensers by leading makers, T.C.C., Dubiller, etc., 0.5, 0.25, 0.1, 0.02, 0.005, 3d.
- RADIOMART.**—Astounding offer electrolytic condensers, world-famous maker, 4+3 mfd. (separate) 500v. working, 1/6.
- RADIOMART.**—Genuine 15/6 Frost potentiometers, wire-wound, tapered, 10,000 ganged to 50,000 ohms, 1/6.
- RADIOMART.**—Lissen 2-gang coils, 12-2,000 metres, switched and screened, nothing else required to convert SG3 to all-wave, 12/6.
- RADIOMART.**—Lissen 3-gang bandpass superhet coils, 4/6; 3-gang bandpass Tuned grid, 6/11. All with circuits.
- RADIOMART.**—Ampron, 3/6; screened H.F. choke, 1/11; Iron-cored binocular, screened, 2/3. Climax binocular, 1/3. Telsen, 1/11.
- RADIOMART.**—Utility 2-gang .0005 Uniknob with large disc drive, 3/11. Ditto, single, with disc, 2/3.
- RADIOMART.**—Lissen 30hy., 40 ma., chokes, 2/-; 20 hy., 100 ma., 2/11. Lissen eliminator chokes, 1/3.
- RADIOMART.**—Igranic tapered potentiometers 1-meg., 1-meg. with 3-point switch, 2/-. Centralab, 1-meg., 1/6.
- RADIOMART.**—2 gross roundhead woodscrews, assorted, 9d. Solder tags, 6d.; resincore solder, 9ft., 6d.
- RADIOMART.**—Pushback connecting wire, ready tinned and sleeved, 6yds., 6d. Heavy, for heaters, 9d.
- RADIOMART.**—Screened iron-cored selective dual-range coils, with reaction; circuit diagrams, 2/11.
- RADIOMART.**—Non-inductive tubulars, 1,500 v., 0.01, 0.02, 0.04, 0.05, 0.1, 6d.; 0.2, 0.25, 8d.; 0.5, 9d.
- RADIOMART.**—Lissen 6-way battery leads, with plugs, 6d. Belling-Lee safety mains plug and socket, 6d.
- RADIOMART.**—Insulated terminals, Belling-Lee, black, Telsen, red, black, 1d. Telsen 0.0003 presets, 9d.
- RADIOMART.**—Transformers B.T.H. speaker; suit all moving coils, 2/11. Manufacturers push-pull, 1/11.
- RADIOMART.**—Fuses, Telsen 1-amp., 1-amp., 3-amp., 2d. Telsen, 100 ma., 2d.
- RADIOMART.**—Telsen latest differentials, .0003, 1/3; .00015, 1/-.
- RADIOMART.**—Special. Four assorted Telsen grid-leaks, 5d.; twelve various wire-ended resistances, 2/6.
- RADIOMART.**—Milliammeters; flush 2 1/2 in., 5/9; 2 1/2 in., 6/9. All ranges above 25 ma.
- RADIOMART.**—T.C.C. bias electrolytics, 50 mfd., 50 v., 1/9; 25 mfd., 25 v., 1/3; 15 mfd., 100 v., 1/-; 6 mfd., 50 v., 6d.
- RADIOMART.**—Caution: Beware of coilforms, etc., moulded in cheap bakelite. Our coils and formers are guaranteed efficient.
- RADIOMART.**—4-pin interchangeable short-wave coils; set 3. Cover 15-100 metres, latest ribbed former, 7/6.
- RADIOMART.**—1 1/2 in. ribbed short-wave coil forms; valveholder type, 10loss, 4-pin, 1/6. 6-pin, 1/9. Threaded for winding, 2d. extra.
- RADIOMART.**—Utility 9/6 microdisc dials, fitted famous micro high reduction, only perfect short-wave dial, 3/11.
- RADIOMART.**—Short-wave H.F. chokes, 9d. *Wireless World* states: "Very efficient—100 to below 10 metres."
- RADIOMART.**—Utility microvariables 15, 40 mfd., 1/-; 405 kc/s litz wound I.F.'s, 5/6.
- RADIOMART.**—Radiophone super ceramic insulated short-wave condensers, .00016, 3/6; series gap, 3/9.
- RADIOMART.**—Continental A.C. valves, 4/6, VMPT, HPT, VMSG, ACSG, ACH, ACHL, PT4. Most American types, A.C. Pen., 5/6.
- RADIOMART.**—2 v. types, H.F. detector, L.F., 2/3; LP2, P2, 2/9; Supower, 3/3; VMPT, HPT, 5/6; Class B, 4/6; S.G., VMSG, 5/-.

RADIOMART

Orders over 6/- post free. Enquirers must enclose stamp. Catalogues; general catalogue gives hundreds of bargains; short-wave illustrated catalogue also gives diagram of efficient transmitter and receiver; each 1/4d. Pair 3d., post free.

THE SQUARE DEALERS

19, John Bright St., 22, Summer Row; mail-orders: 44, Holloway Head, Birmingham. Telephone: Midland 3254

ELECTRADIX

HOME RECORDING is interesting on your gramophone. Cost in low. New acoustic sets, complete outfits in carton de luxe, 21/-. No. 2 Mivoice, 12/6. Junior, 7/6. Electric recording Turntables, 25/-. Recorders, type K, 7/6. CM Trackers, screw traverse, 7/6. Spiral Drive, F type, 4/6. Cutter needles, Diamond Jewel, 7/6.



Raycraft outfit, with relay and amplifier, 45/-. Photo-Cells, for sound on Film, Television and Ray Work, B.T.F., 15/-; R.C.A., 25/-; G.E.C., 25/- to 33/6s. Beck Angle Prism, mounted in carrier, 5/6. Micro-meter adjusters for lens, 1/-.

1,000 DYNAMOS OF ALL SIZES IN STOCK.

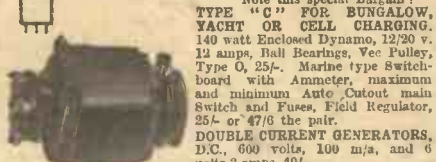

ROTARY CONVERTERS. For A.C. sets on D.C. mains. 90 watts output with filter. All in silence cabinet. E. D. Co., as new, 27. Full guarantee.

CIRCUIT BREAKERS replace fuses now. Magnet Trip Overload Switches, A.C. or D.C. mains, 1 to 4 amps, 7/6; 6 amps, 10/-; 10 amps, 12/-; 15 amps, 14/-; 20 amps, 16/-. Trips may be remote controlled.

SPEAKER BARGAIN. Special Bargain line for 5/-. Just the extra speaker you want for tone balance or to another room. New Siemens Table Magnet Cone in sealed carton, 5/- only.

FREQUENCY TEST RECORD. New Multirange Model, 9 bands, 25 to 8,000 cycles for checking your responses, 2/3.

MICROPHONES for all purposes. Usually sold at 3/6. Our price has always been 1/-. We have supplied thousands.

A NEW PRACTICAL HOME MICROPHONE for broadcasting at home. It is a general-purpose, robust mike, with solid bakelite body, back terminals, front metal grille. No. 11. New design, finely finished, 5/6. No. 11A. Special in solid brass body, unequalled at the price on speech and music, 7/6.

FLOOR STANDS. 26in., 12/6; 37in., 15/-; 48in., 18/6.

PEDESTAL TABLE No. 12 is 13in. high, 18/6.

"N" W. No. 11 TABLE MIKE. This is a splendid microphone for speech and music. The bakelite case, containing a 2in. mike and transformer, is on a bronze pedestal, detachable for sling. Switch and plug fitted. Unrivalled for quality and price, 15/-.
Send for February Bargain List "N."

ELECTRADIX RADIOS
218, UPPER THAMES STREET, E.C.4
Telephone: Central 4611.

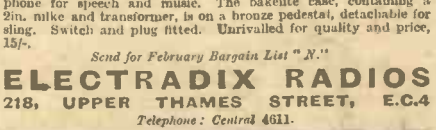

100 VALVES
THE VALVE WITH THE SIX MONTHS GUARANTEE!
STONEHAM ROAD, LONDON, E.S. Phone: Clissold 6007

100 VALVES

THE VALVE WITH THE SIX MONTHS GUARANTEE!

STONEHAM ROAD, LONDON, E.S. Phone: Clissold 6007

RECEIVERS, COMPONENTS AND ACCESSORIES

Surplus, Clearance or Secondhand, etc.

- T**HE following unused set manufacturers' Surplus; all goods guaranteed perfect; immediate delivery.
- M**AGNAVOX speakers complete with hum-bucking coil, output transformers, etc. DC152 (9in. cone), 22/6. DC154 (7in. cone), 16/-. All with 2,500 or 6,500 ohms fields.
- W**ESTINGHOUSE rectifiers, HT8, 9/6. HT9, 10/-. HT10, LT5, LT4, 10/9. Regentone transformers for HT8 or HT9, with 4v. 4 amp. LT winding, 7/-. Eliminators, first-class make. Outputs 150v. 25 ma. SG and Detector. AC type with Westinghouse rectifier, 25/-. AC type with 5 amp trickle-charger, 30/-. DC type, 12/6.
- D**UBILIER or TCC dry electrolytic condensers 8 mfd. or 4 mfd., 500v. working, 50 mfd., 50v., 200 mfd., 10v., 3/3. 50 mfd., 15v., and 15 mfd., 100v., 2/3. 50 mfd., 12v., 2/-. TCC type "M" condensers, any value up to .001 mfd., 6d. Erie resistances, 1 watt type, 7d., 2 watt, 1/2, 3 watt, 1/9. Send for comprehensive list.
- C**ONVERSION Units for converting D.C. Receivers to A.C. Mains operation up to 80 watts, £2 each.
- W**ARD, 46, Farringdon Street, London, E.C.4. Telephone: Holborn 9703.

MISCELLANEOUS

- R**ESISTANCES.—1 dozen good sizes, 1-watt metallised, 1/6. 1,000v. 2 mfd. Helsby, 3 for 1/10. Bakelite-cased, 4 mfd., 1/1; 1 mfd., 7/4d.—Fleming, 115, Ridley Road, E.8.
- 10/- WONDERFUL VALUE.** Parcel of components. All new. Useful stock for service.
- S**PECIAL LINE. Limited quantity. Radiophone 3-gang, 0.005 condensers, 8/-. Double reading voltmeters, 7,500 ohms, 1/4.—Herberts, 1, Essex Road, Leytonstone, E.11.

RECEIVERS, COMPONENTS AND ACCESSORIES

Surplus, Clearance or Secondhand, etc.

- S**OUTHERN RADIO'S WIRELESS BARGAINS, ALL GOODS GUARANTEED NEW AND SENT POST PAID.
- S**PEAKERS.—Blue Spot 1935 Series, with Universal Transformers to match any circuit, 99 P.M., 24/6; 45 P.M., 20/-; 32 P.M. in exquisite cabinet, 42/6 (List, 87/6); Celestion Soundex Permanent Magnet, 11/-; Telsen Permanent Magnet Speakers, 10/-; Telsen Units, 2/9.
- L**ISSEN KITS, ALL NEW IN SEALED CARTONS AND COMPLETE. With Specified Valves. Lissen Skyscraper 3-Valve Battery Kits, 42/- each (List, 77/6). Lissen BAND PASS 3-Valve Battery Kits, 62/6 (List, 99/6). Lissen ALL-WAVE 4-Valve Battery Kits, 65/- (List, 152/12/6).
- D**ENMARK SHORT-WAVE ADAPTOR KIT. Complete with all accessories for adapting set for 14-150 Metres, 20/-. Superhet Short-wave Converter Kit, 20/-.

MULLARD M.B.3. THREE-VALVE BATTERY SETS. Complete with 3 Mullard Pentode Valves, Permanent Magnet Speaker, Batteries and Accumulator. Contained in handsome walnut cabinet, £57/6 (List, 8 guineas). In original sealed cartons.

C.E.C. A.C./D.C. 3-VALVE RECEIVERS. Ring C Valves. Universal Mains and Voltage. Complete in exquisite Cabinet, ready to plug-in, £4 (List 87/15). Not a midget.

HOUSE TELEPHONES. A SPECIAL BARGAIN. Complete on stand, with or without Automatic Dials. Cost £4 each to manufacture, 10/- each.

ELIMINATORS.—Regentone 1935 Series. A.C. Mains, 200/250 volts, Type W5a, complete with trickle charger, 39/6; W1a (less trickle charger)—carries 30 milliamps, 33/-. W1c (less trickle charger), 30/-. Telsen Latest Model A.C. Eliminators with trickle charger for 10, 20 or 30 milliamps, 45/- (List 44/15/-).

CONDENSERS.—Lotus 0.0005. Fully screened, with trimmers, escutcheons, dials and knob. 3-gang, 11/-; 2-gang, 7/3. DYBLOCK SINGLE, 0.0005, complete with all accessories, 4/-. TELSEN SINGLE VARIABLE CONDENSERS, 0.0005, 2/3; Plesky 4-gang Superhet fully screened with trimmers, 7/3. Igranic, 1 mfd., 1/3, 2 mfd., 1/9.

COILS.—Igranic Superhet Coil set of four (1 Osc., 2 I.F. with Pigtail, 1 I.F. plain), 9/- per set (List, 50/-). Varlet Square Peak Coils, B.F.5, complete, 2/3. Telsen Iron-core Coils, W349 midget size, 4/6 each.

THE following Telsen Components in original sealed cartons at sacrifice prices:—**A**CE I.F. TRANSFORMERS.—5/1, 2/9; Binocular H.F. Chokes, 2/-; Standard Screened H.F. Chokes, 2/-; ACE MICROPHONES (P.O.) with Transformers, 5/- each. This Microphone can be used with any radio set and is a very efficient article.

"TRU-OHM" RESISTANCES, 1 watt wire ends, 1/1 colour coded and marked, 36 on card, assorted capacities, 7/6 per card.

AMERICAN VALVES.—A full range of valves for all American sets at 7/- per valve.

SOUTHERN RADIO BARGAIN PARCELS.—We are offering the following parcels of mixed components at a fraction of their value. The items comprise up-to-date Radio parts, new and perfect, which are too varied to be advertised individually.—**5/- PARCEL.**—Contains modern components valued at 20/-, including Resistances, Condensers, Coils, Wire, etc. Circuits of modern Receivers included with each parcel.

20/- PARCEL.—This is known as the "small trader's" parcel, and contains a wonderful selection of components valued at 85/-. We have supplied this parcel to hundreds of Traders for re-sale at a profit.

SOUTHERN RADIO, 323, EUSTON ROAD, LONDON, N.W.1 (near Warren Street Tube). Phone: Museum 6324.

SOUTHERN RADIO Branches at 271-275, High Road, Willesden Green, N.W.10; 46, Lisle Street, W.C.2. All Mail Orders to 323, Euston Road, London, N.W.1.

NEW RECEIVERS, COMPONENTS, AND ACCESSORIES

ALL-WAVE A.C. Five, £9/9/0. Novo Radio, St. John Street, Newcastle-on-Tyne 1.

HULBERT for Quality Surplus Speakers.

HULBERT. All speakers previously advertised still available. All are brand new and made by one of the best-known British makers of high-grade moving-coil speakers. Prices from 10/6. All Music lovers interested in realistic reproduction should write for list of amazing bargains. Repeat orders are coming in daily.

HULBERT, 6, Conduit Street, W.1.

VALVES by well-known manufacturer. Complete range of Battery, A.C. Mains, Rectifiers. Brand new stock with six months' guarantee, 2 volt: Detector 2/3, Power 2/9, Screen Grid, Pentode, H.F. Pentode 5/-. Write for other prices to: Dulci Electrical Co. Ltd., 7, Lizard Street, London. F.C.1.

Taking a Seaplane for a Ride!

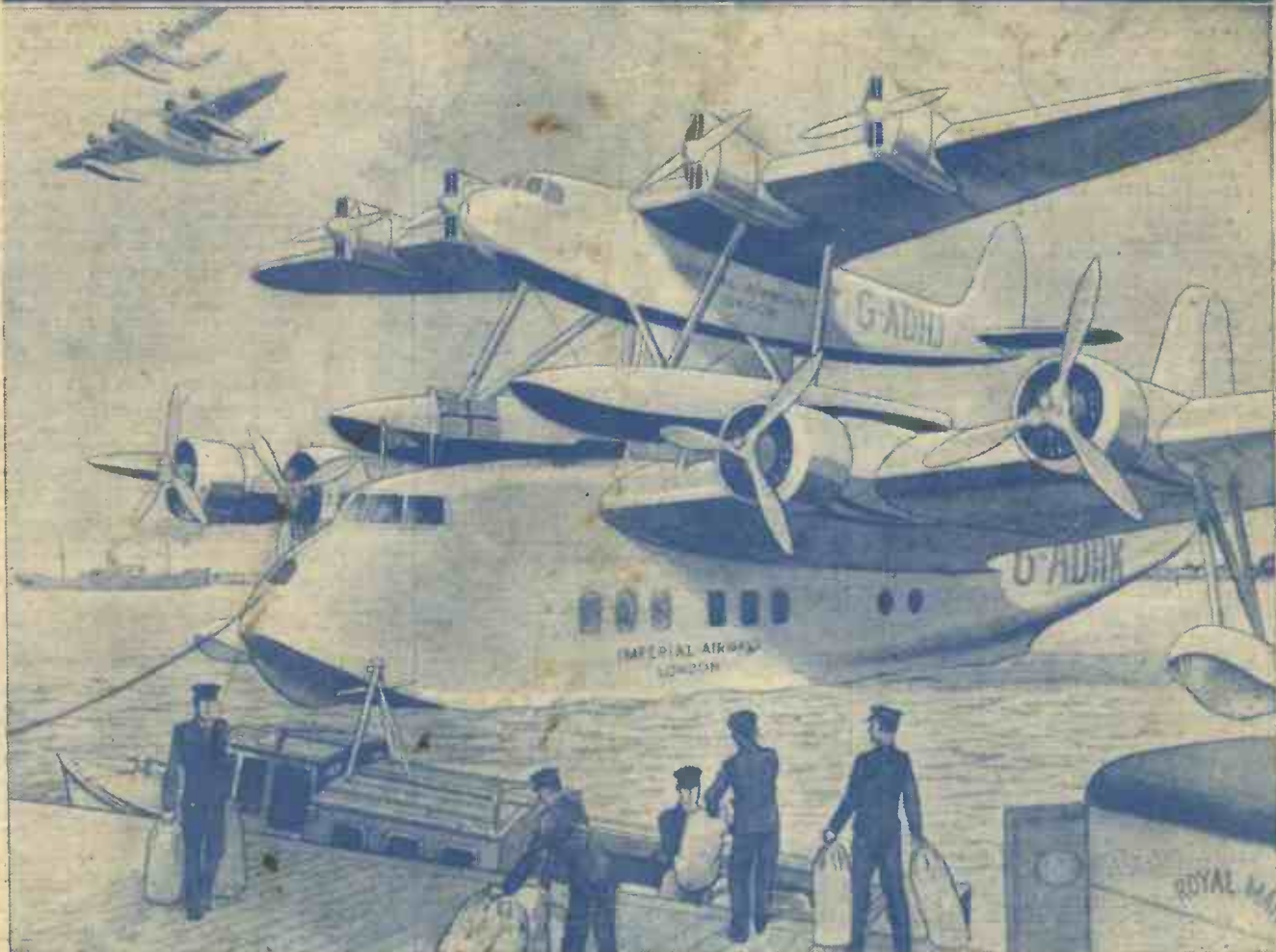

IMPERIAL AIRWAYS have recently designed a composite aircraft for crossing the Atlantic, which is a combination of two machines—a large aircraft ascending with a smaller machine mounted upon the upper surface of its wings, the latter being launched in mid-air for ocean flight. This most interesting development is an attempt to solve the problem besetting all long-distance aircraft carrying a full load. The story of this British endeavour will be found in the February PRACTICAL MECHANICS, the famous magazine dealing with the latest marvels of science and invention.

Other special features in the February PRACTICAL MECHANICS include—

Steam Turbines, Scale Model Supermarine S.6.B., Petrol-driven Model Biplane, Finding Longitude at Sea, British Architectural Freaks, Hints about Hobbies, Working Model Steam Engines, Synchronised Photo-flash Bulbs, Ice-Flying's Gravest Risk, Sun Motors, Model Railways, An Efficient 3-valve Battery Receiver.

PRACTICAL MECHANICS

FEB.
NUMBER
OUT JAN. 31 **6^d**

George Newnes, Ltd.

Published every Wednesday by GEORGE NEWNES, LIMITED, 8-11, Southampton Street, Strand, London, W.C.2. and Printed in Great Britain by THE NEWNES & PEARSON PRINTING CO., LTD., Exmoor Street, London, W.10. Sole Agents for Australia and New Zealand: GORDON & GOTCH, LTD. South Africa: CENTRAL NEWS AGENCY, LTD. *Practical and Amateur Wireless* can be sent to any part of the World, post free, for 17s. 8d. per annum; six months, 8s. 10d. Registered at the General Post Office as a newspaper and for the Canadian Magazine Post.

FREE INSIDE! BLUEPRINT OF F. J. CAMM'S 45/- MONITOR THREE

Practical and Amateur Wireless

3^D
EVERY
WEDNESDAY

Edited by F.J. CAMM

A GEORGE
NEWNES
Publication

Vol. 7. No. 177.
February 8th, 1936.

AND PRACTICAL TELEVISION

2 Sets for Beginners!

1 F.J. CAMM'S
MONITOR 3

and

2 The
PREFECT
SHORT WAVE 3



Full Constructional Details

EVERYMAN'S WIRELESS BOOK

With
200
Illustrations

By F. J. CAMM (Editor, "Practical and Amateur Wireless," etc.)
A Radio Consultant for the Listener, Expert and Amateur Constructor, explaining the Operation, Upkeep and Overhaul of all Types of Wireless Receivers, with Special Chapters on the Principles of Radio Telephony, Installation, and Systematic Fault-finding.
From all Booksellers.

Only
3/6
net

GEORGE NEWNES, LIMITED, 8-11, SOUTHAMPTON STREET, STRAND, LONDON, W.C.2.

The

COSSOR

BATTERY VARIABLE-MU H.F. PENTODE 210 V.P.T.

THE high mutual conductance and the unique construction of this Cossor Battery Pentode permit of very high stable amplification. A worthy type from a most comprehensive range, the 210 V.P.T.—in common with all Cossor Valves—owes its popularity to its strict conformity to published characteristics—assured by rigorous adherence to laboratory principles during every stage of manufacture, and the use of the famous Cossor Mica Bridge.

Filament Volts	-	-	-	2
Filament Current (amps.)	-	-	-	.4
Mut. Conductance	-	1.1m.a./v.		
Max. Anode Volts	-	-	150	
Max. Aux. Grid Volts	-	-	80	

PRICE **13/6**



KINGS OF THE AIR

CONSISTENT • EFFICIENT • DEPENDABLE

British Made by A. C. Cossor Ltd., Highbury Grove, London, N.5.



SPECIAL BEGINNER'S NUMBER



Edited by F. J. CAMM

Technical Staff:

W. J. Delaney, H. J. Barton Chapple, Wh.Sch.,
B.Sc., A.M.I.E.E., Frank Preston.

VOL. VII. No. 177. February 8th, 1936.

ROUND *the* WORLD of WIRELESS

The "Monitor" and the "Prefect" THIS issue is specially prepared for the beginner, and the two receivers—Mr. F. J. Camm's Monitor Three and his Prefect Short-wave Three—represent the quintessence of simplicity. They are backed by his personal guarantee of free advice, and free service, if the receiver fails to function. As Mr. Camm says in his article on another page, the Monitor forms the spear-point of a series of articles which will enable the reader to learn as he builds, and thus put him on the right road to an absorbing hobby and a lucrative career. Later articles will show how the Monitor may be adapted and added to. They will also show how an extra H.F. stage may be added, how it may be converted into a superhet, how to add visual tuning and automatic volume control, and so on. Each article will be complete in itself, but the series has been carefully and progressively planned so that the beginner, whilst adding to the receiver, also implements his knowledge.

If you have a friend who would be interested in radio you will, of course, tell him about this new series without any prompting from us.

Austria's New Relay

THE small 2-kilowatt transmitter at Dornbirn, which has been working on 231.8 metres (1,294 kc/s), is to see its power increased to 6 kilowatts. The wavelength is shared with Klagenfurt and Linz.

France's High-power Stations

ACCORDING to an official statement published by the Ministry of Posts and Telegraphs, the regional transmitters of a power from 60 to 120 kilowatts already in operation are those of Strasbourg, Lille, Lyons, Marseilles, Nice-Corsica and Paris P.T.T. The high-power station at Toulouse Muret will be brought into action at Easter.

An Early News Bulletin

LISTENERS who understand French or German may now hear the Radio-Luxembourg daily news bulletin timed to be broadcast at G.M.T. 07.00.

Egypt Increases the Broadcast Network

IT is reported from Paris that a broadcasting station is to be built at Assiout, and that a small transmitter, working on

222.5 metres (1,348 kc/s), is to be installed in the neighbourhood of Cairo to provide an alternative programme. Similar plant will also be erected at Alexandria.

Palace for Transmitter and Studio

THE Bangkok broadcasting station, working on 250 metres (1,200 kc/s), operated by the Siamese Government, is housed in the Palace of Phya Thai, on the

ACHIEVEMENT!

It is now patent to everyone that the "Practical and Amateur Wireless" policy of designing its editorial contents absolutely for the home-constructor (expert or amateur) has placed this journal in a position of unassailable pre-eminence.

ORIGINALITY!

It is merely a statement of fact that our new policy and our new outlook has been responsible for a great revival in Wireless Construction during the past 3 years. We can justly claim to have entirely altered the course of home construction and to have brought it to its present high standard. The Wireless Constructor's Encyclopædia; our Data sheets; our Handy Gauge; our Spanners; our Tool Kit; our Encyclopædia of Practical Mechanics; our Transfer print System; our Guarantee; our Solus Specification, the metallised chassis system—are but a few of the milestones which have marked our previous issues and which have been eagerly read by the hundreds of thousands of home-constructors who constitute our regular readers. It is a source of extreme gratification to us to observe that so many of our ideas have been and are being generally adopted.

CONFIDENCE!

Every reader places extreme confidence in our circuits (carefully produced in our well-equipped laboratories) because they are backed by a free advice guarantee to function according to our claims. Readers may now build a receiver with that same confidence as when purchasing a ready-made receiver.

SERVICE!

We make no charge for answering readers' queries. Every reader of this paper may freely avail himself of this unique service in the knowledge that accurate advice will be speedily, helpfully, and cheerfully forthcoming.

"PRACTICAL AND AMATEUR WIRELESS"
LEADS AND SHOWS THE WAY!

outskirts of the capital. Transmissions are given in the Siamese and English languages daily between noon and 15.30 G.M.T., and on Saturday afternoons between G.M.T. 14.00-15.00. Occasionally relays of programmes are made from Manila, Hong Kong, and Batavia (N.E.I.).

Alterations in Wavelengths

SOME changes have recently been made in the channels used by European transmitters. Archangel (U.S.S.R.) has adopted the wavelength of 857.1 metres (350 kc/s), as against 512 metres (586 kc/s); the Finmark (Norway) station works on 857 metres (345 kc/s), instead of 859.6 metres (349 kc/s), and Radio-Midi, at Beziers, on 209.9 metres (1,429 kc/s), a reduction of 9 metres.

Late French Cabaret Broadcasts

EVERY alternate Saturday Poste de l'Île de France, Paris, on 222.6 metres (1,348 kc/s), relays a special performance from the popular Sheherazade in the French capital.

High-power Station at Buenos Aires

LR1, Radio El Mundo, on 280.4 metres (1,070 kc/s), which so far has been working on 50 kilowatts, is to see its power increased within the next three months by fifty per cent. The station is on the air nightly until G.M.T. 04.00, and is frequently heard in the British Isles.

Record Broadcast from the "Queen Mary"

WHEN Great Britain's crack liner carries out her first trip to New York on May 27th next, listeners may expect to hear a daily broadcast, as she crosses the Atlantic. Some twenty odd microphone points are to be installed to permit relays from various parts of the vessel, and one feature will be a forty-five minute conducted tour, with a running commentary by Mr. John Snagge. The B.B.C. is sending for this purpose a number of its officials who will be in charge of the broadcasts. It is possible that we may also pick up relays from the liner through Continental and U.S.A. stations, as authority has also been granted to several countries to place their own commentators on board.

Call It A Day

THE activities of some U.S.A. stations is such that they remain on the air throughout the twenty-four hours of the day and night. There are at least twelve transmitters which never close down; of these stations the most likely to be picked up in Great Britain are WNEW, Newark (New Jersey), 239.9 metres (1,250 kc/s); 1 kilowatt; and WHN, New York, 296.9 metres (1,010 kc/s) 1 kilowatt.

ROUND the WORLD of WIRELESS (Contd.)

B.B.C. Dance Orchestra

IN connection with the forthcoming fourth anniversary of the B.B.C. Dance Orchestra, the B.B.C. announces important changes in the constitution of this orchestra and the programmes performed by it. In order that, from Monday, March 16th, Henry Hall may be able to develop in all his broadcasts a new type of entertainment programme, in which, of course, dance music will play the leading part, the

H.M. THE KING AT THE MICROPHONE



His Majesty King Edward VIII, when Prince of Wales, broadcasting an appeal for funds in connection with the Jubilee Trust.

orchestra is to be enlarged to twenty-one players, and will be reinforced regularly by a special group of singers, and from time to time by the services of celebrity artists.

Sir Hamilton Harty

THE B.B.C. announces that, owing to pressure of work, Sir Hamilton Harty is obliged to postpone the series of talks which he was to have given in March, under the title of "The Reflections of a Musician." The series of Keyboard Talks will now be continued until Easter. Mr. Harold Samuel is giving the first six in this series.

Some Temperature!

ON the occasion of the first French television transmission at Paris recently, the heat generated by the electric lights was such that within a very short time the violins and other wooden instruments were quite out of tune. Musicians consider that unless some cooling system can be installed, it will be impossible to use certain instruments in television studios.

Russia's Big Plan

THE Soviet Authorities, anxious to extend their broadcast network, are considering the replacement of twenty existing stations by transmitters of from 100-150 kilowatts. Of these it is planned to install fifteen in European Russia and five in Asia.

INTERESTING and TOPICAL PARAGRAPHS

Programme Correspondence

CORRESPONDENCE about programme matters forms one of the main links between the B.B.C. and the listening public, and is always given careful attention. Any suspicion that may exist among

listeners that letters are thrown unread into wastepaper baskets can be at once dispelled. On the contrary, all comment is of interest, and above all the B.B.C. is anxious to have the views of people who listen regularly and carefully. Constructive criticism which takes into account the great variety of tastes to be considered is particularly welcome.

Recorded Programmes

THE use of specially recorded material in programmes continues to increase. The original recording equipment used by the B.B.C. has been supplemented by the addition of machinery specially designed to enable events or speeches, which cannot be broadcast at the time they occur, or which warrant reproduction at a better listening hour, to be cut, edited, and reproduced as a summarised impression of the whole. This method of presentation is being employed in an increasing degree, especially as a means of illustrating news bulletins.

The work has been further facilitated by the addition of a mobile recording unit, which has made it possible for such events as the return of H.R.H. the Duke of Gloucester from the Antipodes, and the election of the Lord Mayor at the Guildhall to be reproduced in summarised form in the evening programmes on the day of their occurrence.

"Christopher Columbus" Broadcast

THE B.B.C. announces that, owing to the impossibility of securing adequate rehearsals, due to the pressure of work on the Chorus entailed by the general alteration of programmes, the special concert performance of "Christopher Columbus," by Darius Milhaud, announced for February 5th at Queen's Hall, will not take place. It is hoped that it will be possible to perform this important new work during the 1936-1937 season.

Italy Cuts Down Programmes

WITH a view to an economy in electrical current, all broadcasting stations in Italy have curtailed their daily transmissions, and on most evenings it will be found that the studios sign off shortly after G.M.T. 22.00. As a rule the main evening programme is advanced one hour, and concerts, operatic performances, and so on, are timed to begin at G.M.T. 19.30. Much of the time is devoted to the broadcast of news bulletins.

The Two U.S.A. Networks

AT the end of 1935, the National Broadcasting Company possessed eighty-nine transmitters in seventy different cities, the network being connected by some twenty thousand miles of telephone cable. The aggregate power of the stations was 1,723.9 kilowatts. The Columbia Broadcasting System consists of ninety-eight transmitters installed in ninety-six cities or towns.

The Voice of South Africa

THE most powerful station of the South African system is ZTJ, Johannesburg (15 kW), on 465.1 metres (645 kc/s). Every weekday it is on the air with two sessions, namely, G.M.T. 09.00-10.00, and from 14.00-21.00; on Sundays, in addition to the morning broadcast, the station transmits from 12.15-15.15, and from 17.30-20.00. The short-wave relay works on 49.2 metres (6,097 kc/s).

SOLVE THIS!

PROBLEM No. 177.

Walters thought he would try home-broadcasting, using his receiver and a cheap microphone he had procured. He was told by his dealer to connect the microphone to the pick-up terminals of the set, but when this was done he was surprised to find that L.F. instability was experienced. The receiver worked satisfactorily in conjunction with a pick-up. Why did the microphone produce instability? Three books will be awarded for the first three correct solutions opened. Address your envelope to the Editor, PRACTICAL AND AMATEUR WIRELESS, Geo. Newnes, Ltd., 8-11, Southampton Street, Strand, London, W.C.2. Envelopes must be marked Problem No. 177 in the bottom left-hand corner, and must be posted to reach this office not later than the first post Monday, February 10th, 1936.

Solution to Problem No. 176.

Hayes had used a straight two-gang condenser instead of the specified 465 K.c. superhet type. The moving vanes of the oscillator section of the superhet type are smaller than those of the straight .0005 mfd. section.

The following three readers successfully solved Problem No. 175 and books are accordingly being forwarded to them:

J. Platts, 56, Cowlishaw Rd., Hunters Bar, Sheffield 11; J. D. Stuart Martin, 14, Wolverhampton Road, Stafford; W. A. Roberts, 1, Belston Road, Childwall, Liverpool 16.

The Prefect 3

An Ideal Three-valve Receiver Designed for Use on the Short-wave Band. It is Simple to Build, Simple to Operate, and may be Relied Upon to Provide Splendid Results under all Normal Conditions

By F. J. CAMM

AS has been mentioned elsewhere, this number is devoted to the interests of the beginner or newcomer to radio receiver construction. It has been fully appreciated that there are many who have in the past been listeners only, but who now wish to learn something more of the intricacies of receiver construction and who wish to find out just "how it works." The "Monitor" receiver described on other pages is intended for the listener who only wishes to obtain reception on the ordinary broadcasting bands, but, as no doubt many readers are aware, there is a vastly more interesting field to be explored on other wavelengths. The ordinary broadcasts take place from 200 metres upwards, but it is possible to employ wavelengths which extend down to centimetres, although, of course, such minute wavelengths are only employed in the research laboratories.

From 10 metres up to, say, 100 metres there may be heard the tongues of every nation, broadcasting not only programmes of a musical nature, but also radiating special talks for colonial inhabitants, experimenters carrying out interesting tests and trials, and on certain wavebands there may be heard the thrills of the police radio cars in the United States of America. There is no knowing just what may be heard at

BUILD THIS SIMPLE RECEIVER AND MAKE ACQUAINTANCE WITH THE MARVELS OF THE SHORT WAVES

any time of the day or night, and the listener with a short-wave receiver which is sufficiently powerful is in the same position as the man with an immense bran-tub—he can delve into it at odd moments, and the prize which he will acquire may be insignificant or may reach an enormous value.

Tuning Possibilities

Unfortunately, the average listener has become so used to experiments carried out on unsuitable apparatus that he has found that short-wave tuning is difficult, and the word has been passed along that short-wave work is not worth while. Why is it that bad news always travels so widely, whilst good news never gets passed along? However, when a correctly-designed short-wave receiver is employed it will be found that it is no more difficult to tune than a standard broadcast receiver, and there are one or two artifices which may be employed in the design of such a set which will make it even easier to operate. There are, however, certain vagaries in the short-wave sphere which render it necessary to use a short-wave set with discretion. For instance, the sun and darkness can affect the short-wave signal, whereas a standard signal on

a wavelength of 500 metres or so is not so affected. Thus, certain wavelengths will be found to be "dead" during the hours of daylight, whilst during the hours of darkness it will be found that these wavelengths travel over immense distances in spite of the small power used, and signals which could formerly be heard in the daylight will no longer be received. By designing the short-wave receiver with an adjustable tuning circuit, however, it is possible to obtain a number of separate tuning elements which will permit of the receiver being used

DON'T BE OUT-OF-DATE— BUILD THIS SHORT-WAVE SET WITHOUT DELAY!

under all conditions, and thus there is a much wider field obtainable.

The Circuit of the "Prefect."

Let us now see how these points have been covered in the design of the "Prefect" receiver. Dealing firstly with the tuning arrangements, it is admitted that a very small movement of a normal tuning condenser is required in order accurately to locate a station, although the reason for this will not be gone into here. But practically every listener is familiar with a vernier

adjustment, and it is possible to employ a scheme which amounts almost to a micro-meter adjustment of the tuning circuits of a short-wave receiver, and yet does not entail any difficult operations in finding the stations. If you glance at the illustrations of the "Prefect" receiver you will see that the panel carries three separate variable condensers. One of these is employed in the normal manner for reaction purposes, but the remaining two are joined together in parallel. That is to say, the larger condenser has its two terminals joined to two terminals on a very small condenser mounted near to it. The size or capacity of this smaller condenser has been so chosen that it covers only an extremely small range, very little more, in fact, than is obtained when the main tuning condenser is turned through one small degree. Thus, the main condenser may be turned through this small distance, and the smaller condenser then turned through a complete revolution; this spreads out the stations which are covered by the larger condenser. From this spreading-out action, the combination of the two tuning condensers is known as a "band-spread tuner," and it brings to the short-wave receiver all the advantages of normal tuning. To make everything quite simple for the operator the main tuning condenser in the "Prefect" is fitted with a

THE FIRST COMPLETE VOLUME TELEVISION & SHORT-WAVE HANDBOOK 2nd EDITION
3/6, or 3/10 by post from George Neumes, Ltd., 8/11, Southampton Street, Strand, W.C.2.



Fig. 1.—The complete receiver. In this illustration the Microfuse is not shown, but it was subsequently fitted at the rear edge, so that in the event of renewal it is easily accessible.

slow-motion knob, and it is thus possible to explore every part of the tuning scale in the most accurate manner and it is almost impossible to miss a station which is within range of the receiver.

A Well-tried Arrangement

The actual valve combination in the "Perfect" follows the well-tried detector and two L.F. arrangement, and it has been found that this is productive of really excellent results under all normal conditions. The coil which is used is of the six-pin type and a special holder is employed so that any other six-pin coil may be inserted. The listener may acquire a complete set of these coils to cover all his requirements. Coupling between the first and second valve is by means of what is known as resistance-capacity-coupling, and this ensures good quality, whilst an L.F. transformer of sound design is employed between the second and third valves. Thus a really good signal may be expected

EASY TO BUILD AND EASY TO USE

at the loud-speaker, free from any circuit distortion and of sufficient power to provide good entertainment value. A five-way battery cable is employed and a separate H.T. voltage is provided so that the most suitable operating conditions of the detector stage may be located.

It will be noticed by experienced amateurs that no aerial condenser has been fitted, and the reason for this is that the receiver has been designed for the beginner to short-wave reception. My advice under such conditions is that a special short-wave aerial be fitted, and experiments carried out with a view to finding the most suitable type of aerial for all average conditions. Where it is desired to employ this receiver in conjunction with a standard broadcast aerial of large dimensions, it will be necessary to fit a condenser between the aerial lead and the aerial terminal, in order to obtain smooth reaction and to provide good signal strength. An air-spaced condenser should be used for this purpose, and it should be mounted on a bracket fitted inside the rear of the cabinet. The control knob may then be adjusted as required for various wavelengths to provide the required degree of aerial damping.

Constructional Work

The actual construction of this receiver is extremely simple, and it may be under-

taken by the youngest member of the family. The chassis is of metallised plywood and may be obtained from Messrs. Peto-Scott. It measures only 10in. long by 6½in. wide, and is provided with two runners at the sides measuring 2½in. in height. To complete the chassis a further strip of the same wood is placed across the rear, upon which the terminals are mounted. At the front no wooden strip is employed, but the

apart. The centre of the coil-holder hole is 3¼in. from the rear edge and 2in. from the side of the chassis. When these holes have been drilled a ¼in. drill should be used to drill the six holes in the upper surface of the chassis, and the same size drill should be used to drill the rear strip for the terminals. Finally, a ¼in. hole should be drilled in the centre of the rear strip through which to pass the battery cable.

THEORETICAL CIRCUIT

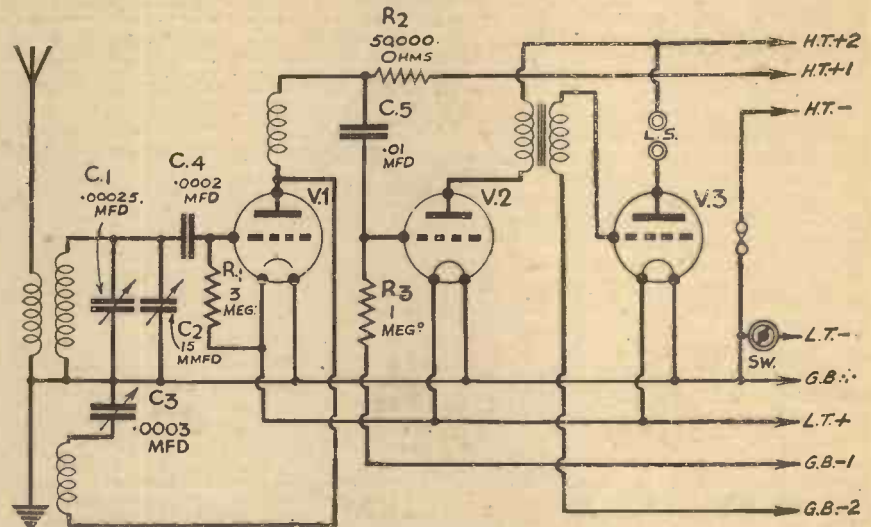

Fig. 2.—All the essential features may be seen in this illustration.

reaction condenser which is mounted in this position is fitted to a special metal component mounting bracket.

Having obtained the chassis, the constructional work may be commenced, and the first task is to drill four large holes upon which to mount the valve-holders and

SUITABLE FOR ALL WAVE-BANDS

the coil holder. For the latter a hole 1¼in. in diameter is required, and for the valve-holders the hole must be 1in. in diameter. The positions of these holes may be ascertained from the wiring diagram which is printed on page 650. The centre holes for the valve-holders may be positioned as follows: V3 is 1¼in. from the edge of the chassis and 2in. from the rear edge. The remaining two holders are exactly 2in.

Mounting the Components

Before placing the component mounting brackets in position, the coil holder should be attached on the *under side* of the chassis, taking care that the sockets are centrally disposed in the hole. Next, the three valveholders should be screwed in position, again making quite certain that the sockets clear all the edges of the chassis to avoid difficulties at a later stage. Now lay the chassis upside down on the table or workbench, and screw the Niclet transformer in its approximate position. There is no need to measure the exact position of this, and it may be placed anywhere near the position indicated in the wiring diagram. Next obtain two ¼in. countersunk No. 4 screws (or similar dimensions) and screw these into the under surface of the chassis. It should be noted particularly that the wooden chassis which are employed in our receivers are only metallised on the upper surface, and if you endeavour to employ a metal chassis or make up one, there is every possibility of doing damage, due to short-circuits and interconnections which are not intended. The two wood screws just mentioned, for instance, are only anchor points and thus if the under surface is metallised, these screws become joined together. The same

SHORT-WAVE TUNING AS SIMPLE AS A CRYSTAL SET

thing will apply if the screws are long enough to project to the metallised surface on the other side of the chassis, and thus they should not be any longer than ¼in. One of these screws is attached close to the valveholder for valve No. V2, whilst the other is placed close to the L.F. transformer fixing screw. Three similar screws are now attached to the upper side of the chassis, one next to the Microfuse holder,

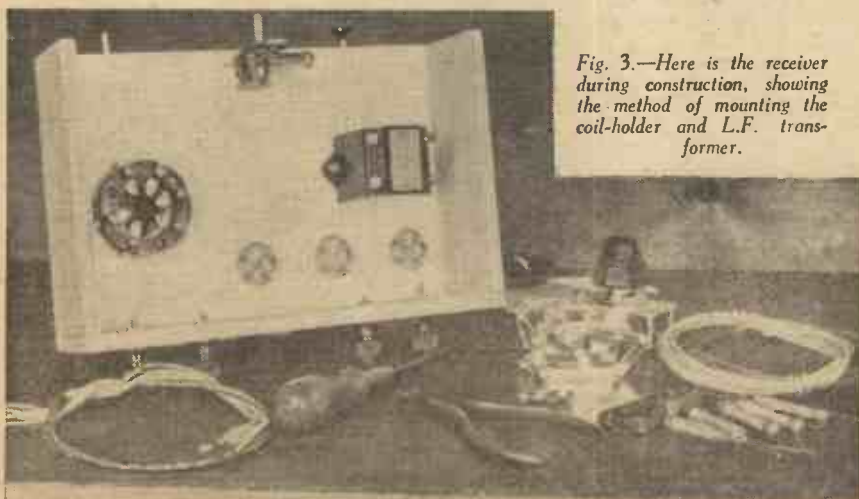

Fig. 3.—Here is the receiver during construction, showing the method of mounting the coil-holder and L.F. transformer.

one next to the bracket which supports the on/off switch, and one in approximately the centre of the upper surface. These screws are marked M.B. on the wiring diagram and simply indicate that wires attached to them are in contact with the metal surface.

Next screw the bracket to the centre of the front edge of the chassis on the underside and mount the Dilecon reaction condenser on this bracket, locking it in position when the spindle is in from the lower edge, as indicated on the front of panel layout, below. Screw the Belling-Lee type R terminals in position, as indicated by the letters A, E, LS+ and LS-, and then com-

spread condenser, and attach the holder for the Microfuse. The variable condenser is attached to the J.B. slow-motion dial, and in the ordinary way this should be held in position on the front of the cabinet. If, however, it is desired to make this a fixture to the chassis, a strip of wood must be cut and recessed to hold down the slow-motion dial. This may be cut from any old piece of wood so long as it effectively holds the dial in position. Now mount switch and band-spread condenser and complete the wiring, soldering the leads to the screw heads marked M.B. if possible. If, however, you cannot solder, or feel that

the bias battery, G.B.—1 into the 4.5-volt socket, and G.B.—2 into the 7.5-volt socket. Pull out the on/off switch and the receiver will be ready for station location.

The following Short-wave information will no doubt prove of use to constructors of this receiver.

On the 10-metre Band

For those who are interested in 10-metre DX, let it be known that there exists a 1935-1936 Andes-Amazon expedition which, provided with radio equipment, will keep in touch with Ecuador, as and when possible. A Long Island (New York) amateur, holder of call sign W2DPQ, is operator, and that messages will be transmitted at frequent intervals at HC1FG, Rio Bamba, Ecuador. This station, operating on 45.31 metres (6,620 kc/s) will re-broadcast them with a power of 2 kilowatts. El Prado has been installed for some time and transmits a regular programme every Friday between G.M.T. 02.30-04.40. It possesses a woman announcer giving out call alternately in Spanish and English.

MAKE CERTAIN YOU OBTAIN ONLY THE SPECIFIED PARTS AND SO AVOID DISAPPOINTMENT

Although the regular Moscow short-wave broadcasts are sent out on 50 metres, RW59, on 24.99 metres (12,005 kc/s), has not been closed down. It is still used occasionally for broadcasts to the U.S.A., and recently was heard handling a special transmission simultaneously broadcast for the same purpose by RKI, Moscow, on 19.88 metres (15,090 kc/s). There is also an alternative channel on 19.95 metres (15,000 kc/s). As a rule, these two frequencies are used for morning transmissions.

That Moscow proposes to develop these "all-world" broadcasts is strengthened by the rumour that a 120-kilowatt station is under consideration.

Another item of news which reaches me is that Japan proposes to install a 50-kilowatt station at, or near, Tokyo, for transmission of radio programmes to Europe.

Another high-power short-waver which we may expect to hear this year is the 35-kilowatt transmitter which the Czechs have under construction at Podebrady, near Prague; so far, any programmes destined to listeners on the other side of the Atlantic Ocean have had to be sent through foreign channels.

Paris Colonial Transmitters

Although they are less heard than their British and German confrères, the Paris Colonial transmitters FYA are on the air for a large number of hours daily. So far the power has been limited to 10

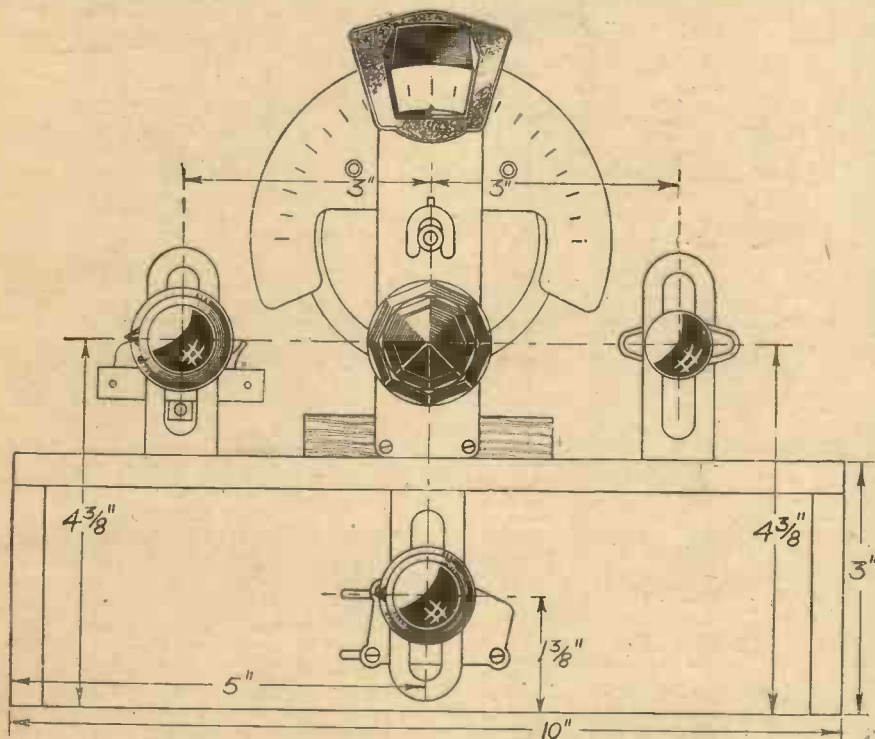

Fig. 4.—These dimensions will enable you to drill the cabinet front or the panel. The maker's template should be employed when marking out the hole for the escutcheon.

mence the wiring on the underside. It will be noted that at the moment there are no brackets or large components on the upper surface of the chassis, and this method of construction enables the chassis to be laid conveniently on the table or work-bench, and greatly facilitates the wiring operations. Carry out as much wiring as is possible without passing wires through the various holes, and when this part of the work has been completed, attach the battery cords to the various points and turn the chassis over.

An Alternative Scheme

Now screw the two component brackets into position for the switch and band-

your soldering is not effective, you can twist a loop of the wire below the head of the screw before it is driven right home, but do not tighten it so much that the wire breaks through the metal surface and thus interrupts the electrical circuit.

Testing Out

Plug in the coil which is specified for this receiver, and which covers a wave-band from 24 to 52 metres, plug in the three valves as follows: D210 in V1, L210 in V2, and P215 in V3, and connect the H.T. battery plugs into the H.T. battery with H.T.2 in the 120-volt socket, and H.T.1 in the 60-volt socket. G.B.+ is now inserted into the positive socket of

LIST OF COMPONENTS FOR THE "PREFECT" BAND-SPREAD S.W. THREE

One 6-pin S.W. Coil, type S.P.C. (B.T.S.).
One .00025 popular log tuning condenser, type 1040 (J.B.).
One dual-ratio S.M. drive, type 2092 (J.B.).
One 15 mfd. band-spread condenser, type 2140 (J.B.).
One .0003 mfd. Dilecon reaction condenser (J.B.).
One Niclet L.F. transformer (ratio 1:5), type D.P.22 (Varley).
Three 4-pin valve-holders, type U.H./4 (B.T.S.).
One 6-pin S.W. coil base, type S.P.B. (B.T.S.).
Two fixed condensers (.0002 mfd. and .01 mfd.), type 300 (T.C.C.).

Three 1-watt resistances (50,000 ohms, 1 megohm and 3 megohms) (Dubilier).
One S.W. choke, type H.F.3 (Wearite).
One 60 mA. Microfuse and holder (Microfuse).
Four type R terminals (Aerial, Earth and L.S.+ and L.S.—) (Belling Lee).
One 5-way battery cord (30in.) (Belling Lee).
Three "Bow-spring" wander plugs (G.B.+ , G.B.—1 and G.B.—2) (Belling Lee).
One pair G.B. battery clips, type No. 5 (Bulgin).
One Junior on/off switch, type S.38 (Bulgin).
Three component-mounting brackets (Peto-Scott)

One Metaplex chassis (10in. x 6½in. with 2½in. runners (Peto-Scott)).
Three valves (D210, L210, and P215) Hivac.

ACCESSORIES

One 120-volt H.T. battery.
One 9-volt G.B. battery.
One 2-volt L.T. accumulator.
One W.B. Stentorian 36/J loud-speaker and pair of headphones.
One cabinet.

kilowatts and in consequence it is more difficult to pick them up than their powerful neighbours. From G.M.T. 09.00-10.00 on 25.23 metres (11,880 kc/s), France broadcasts to New Caledonia; on the same channel from 16.15-20.00 to Madagascar, the Reunion Islands, and from 20.00-23.00 to the French Soudan, Senegal, Ivory Coast, Dahomey, and French Equatorial Africa. On 19.68 metres (15,243 kc/s) special broadcasts are made from G.M.T. 11.55-16.00 for French residents in Indo China, and on 25.6 metres (11,720 kc/s) from G.M.T. 23.15-06.00 the transmissions are destined to Central and South America. News bulletins are given out at fixed periods in English, French, Arabic, Italian, Spanish, Portuguese, and German. In the course of a few weeks we may expect to log a more powerful transmission on a higher portion of the band, as the 100-kilowatt station is nearing completion and will be testing shortly on 48.82 metres (6,145 kc/s).

Cuban Stations

Of the Cuban stations at present CO9GC, Santiago, on 48.78 metres (6,150 kc/s) is the one which is the easiest to log. It is run by any important concern and gives out in its call that it is the Santiago Experimental Short-wave Station. Interval signal: bugle call. Both Spanish and English languages used. There are many Santiagos in the world, but this one is in Cuba.

Above 50 metres, signals have been coming in freely and at good volume; it is a portion of the band often neglected, but which so frequently reveals surprises.

IDEAL FOR THE BEGINNER AND A USEFUL SHORT-WAVE SET FOR THE "OLD HAND"

HJ4ABE, Medellin, Colombia, a 1 kilowatt on 50.59 metres (5,930 kc/s), just above Moscow, is on the ether nightly, and on some nights when favourable conditions obtain might be mistaken for one of the more powerful Yanks. HRN, Tegucigalpa, Honduras, on 51.06 metres (5,875 kc/s), *La Voz de Honduras*, was another entry in the log.

Particulars culled from an announcement included the information that the transmissions were made from G.M.T. 22.00-03.00 daily, and that an English hour, for U.S.A. listeners, was given regularly on Mondays at G.M.T. 02.00. In true N.B.C. fashion, we were told that: *Your announcer is Paul Jones*. HRN is sandwiched between YV8RB, Barquisimeto, 51.02 metres (5,880 kc/s), and YV5RMO, Maracaibo, 51.28 metres (5,850 kc/s), both installed in Venezuela.

In the same band a search should be made for a new station which has just been opened in Guatemala City, namely, TGS on 52.26 metres (5,740 kc/s). The details given are that it uses a metronome as an interval signal. This may at first sight appear to be scanty data for identification, but, on the other hand, most of the South Americans use bells, gongs, or other musical gadgets, and the tick-tock on that part of the band at least should be quickly recognised.

Full details for using this receiver will be given in next week's issue, together with some details of the best types of aerial and the most suitable listening times for various wavelengths.

WIRING DIAGRAM OF THE "PREFECT" BAND-SPREAD S.-W. THREE

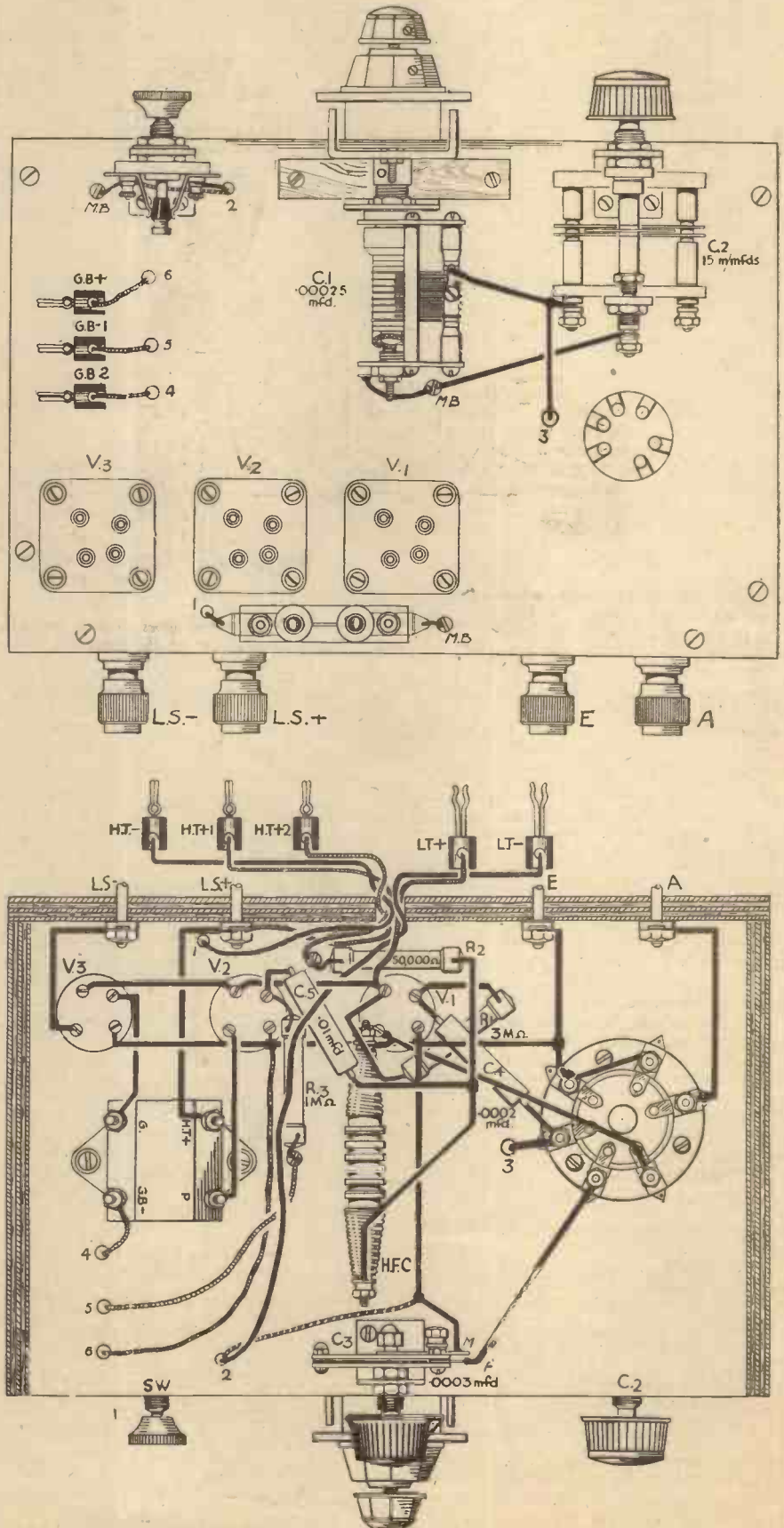

Fig. 5.—This diagram shows all the wiring details, and is slightly under half size.

A Simple D.C. Trickle Charger.

This Article Deals with the and Inexpensive Unit.

Construction of an Easily-made By L. ORMOND SPARKS

A TRICKLE charger for use on D.C. mains is a very simple piece of apparatus, and, unlike the type required for A.C. supplies, does not involve the use of a mains transformer and rectifier. The average D.C. or *direct current* supply is, in itself, a satisfactory source of energy for recharging accumulators, providing some suitable means of regulating the flow of current are employed.

Before considering the construction of the charger about to be described, it is

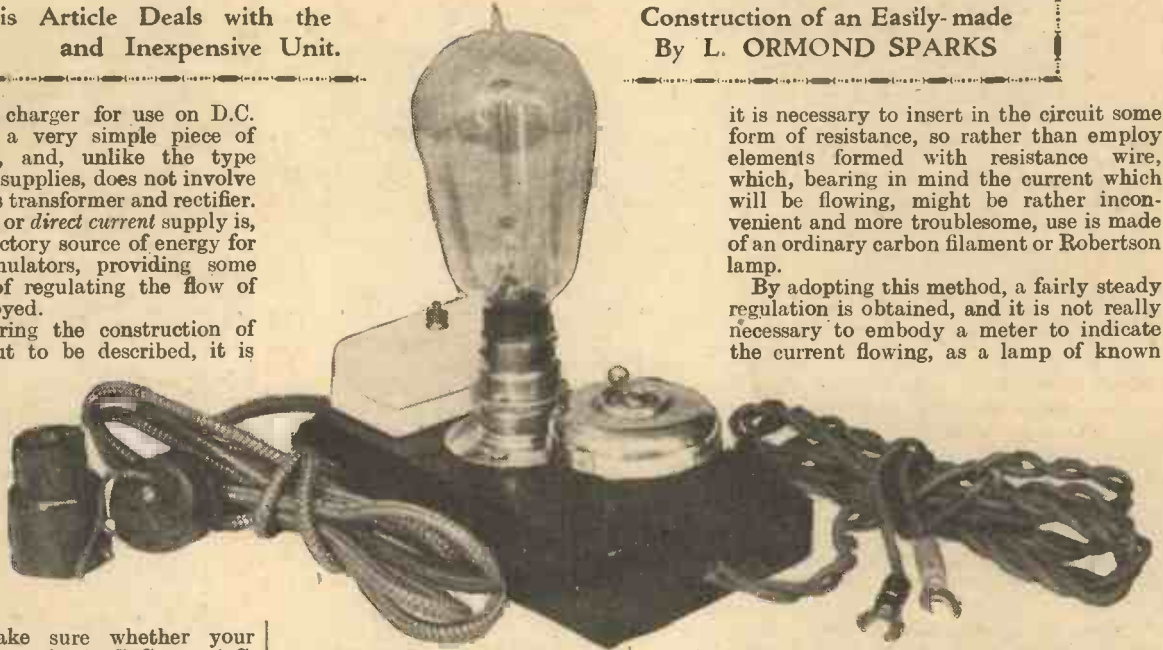

Fig. 1.—This illustration gives a good idea of the compact arrangement of the completed D.C. trickle charger

necessary to make sure whether your house electrical supply is D.C. or A.C. If it is the latter, then this unit will not be of the slightest use to you, as it is designed solely for use on D.C. supplies. Should you not be too sure, then it would be advisable to inquire at the local supply company's office or examine the supply meter, on which you should find the necessary details.

The advantages of a D.C. trickle charger are many. In the first place, it is very inexpensive to make; it can be so arranged that the charging can be carried out without any extra cost for current; any size cell can be charged at a high or low current rating, without harm to the apparatus or complicated alterations and, lastly, it can quite easily be adapted to pass the required output for H.T. accumulators.

Simple Construction

A glance at Figs. 1, 2 and 3 will show that the unit is both compact and simple, and that all it consists of is a lamp in series with one side of the mains, a lamp-holder, a fuse-holder, an on-off switch, four yards of good twin flex, a two-pin plug or an adaptor, and two spade terminals. All the required parts need not cost more than five or six shillings. If one desires to be economical, the lamp, which I will refer to later, can be connected, by means of a length of flex and an adaptor, to the unit and so placed in the room that it is used for illumination purposes, thus allowing either the light or the charging to be obtained for the cost of the other. A trickle charger is really intended to maintain the L.T. cell or cells in a fully-charged condition, and it is usual to adjust the charging rate and period, so that the same number of ampere-hours (one ampere flowing for one hour) are put into the accumulator, if such an expression can be used, as those taken out by the filaments of the valves during the hours the receiver is in use. For example: If the total current required by all the valves is, say, 4 amperes, and the receiver is used for, say, four hours a day, then the discharge is

equivalent to .4 x 4 ampere-hours or 1.6 amp.-hours.

Current Regulation

To obtain the desired current regulation,

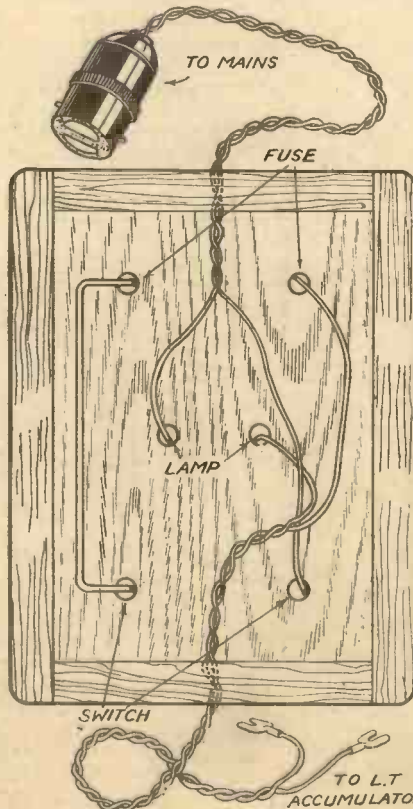

Fig. 2.—Underside of baseboard of the D.C. trickle charger, showing the wiring connections.

it is necessary to insert in the circuit some form of resistance, so rather than employ elements formed with resistance wire, which, bearing in mind the current which will be flowing, might be rather inconvenient and more troublesome, use is made of an ordinary carbon filament or Robertson lamp.

By adopting this method, a fairly steady regulation is obtained, and it is not really necessary to embody a meter to indicate the current flowing, as a lamp of known

wattage will only pass a certain current; therefore, it is quite an easy matter to select a lamp capable of passing the current required for the output. While a carbon filament lamp, owing to its characteristics, is the most satisfactory, any type of lamp can be used, provided that its operating voltage is the same as that of the mains supply concerned.

All lamps have a certain wattage rating but, as some makes of carbon filament lamps are rated by their candle power, the table below, which shows the current passed by lamps of various wattage and candle power, will be found handy for reference.

Carbon Filament. 200/260 volt.	Wattage.	Current Amps.
8 Candle Power	36	.18 to .15
16 " "	66	.33 to .27
32 " "	136	.68 to .50
Other Lamps		
Voltage according to supply :		
40 at 200 Volts		.2
60 " "		.3
75 " "		.35
100 " "		.5

For other voltages, it is quite an easy matter to calculate the current for a given wattage by using the formula: Watts=

$$\text{Current} \times \text{Voltage, or, turning it about,}$$

$$\text{Current} = \frac{\text{Watt}}{\text{Voltage.}}$$

Charging Rate

While it is not necessary to determine the exact number of hours a cell should be on charge, it is advisable to keep an eye on things and not overcharge, particularly if the charging current is high, otherwise the life of the cell will suffer. A low charging rate for a long period is the most satisfactory method. Most makers of accumulators usually state the charging rate for their products, but a safe way is to not exceed one tenth of the actual capacity of the cell. If the capacity is 20 ampere-hours, then the charging rate should not exceed 2 amperes, and that should only be

(Continued on page 674)

Advantages of Home Construction

The Constructor Scores Over the User of a Ready-made Receiver, not only Financially, but Due to the Fact that his Set can be kept Up to Date with the Minimum of Trouble. By "THERMION"

MANY regular readers of PRACTICAL AND AMATEUR WIRELESS are keen constructors and would no more think of using a ready-made receiver than they would of giving up wireless as a hobby. They appreciate the many advantages of the home-constructed receiver, and have found these out in the course of their long experience. But, as this issue is a special one for beginners, and will be read by thousands of new readers and prospective wireless enthusiasts, it will be useful to them to be acquainted with some of the points which have been proved during many years of wireless experimenting and construction.

Initial Cost

A number of years ago a home-constructed receiver was obviously a good deal cheaper than one which could be bought ready made, but this advantage is less evident to-day, although it still applies just as forcibly. Nevertheless, if one looks at the catalogues of receiver manufacturers, one finds that three-valve battery sets can be obtained for, say, £7, complete with valves, batteries and speaker, whilst an average price for a four-valve receiver is about £10. It is a fact that, when the prices of home-constructed receivers described in this journal are determined, they are often not very much lower than those mentioned; there is generally a saving of one or two pounds, but this does not look very impressive.

We must look a little further to see just how much is saved by home construction. In the first place, the accessories used for the home-made set are generally of rather better quality, and in the second, the running costs are generally lower. Additionally, however, the latest types of constructor receiver are more advanced in the way of circuit design than are the current models of commercial receivers—which were probably designed at least a year ago. This is not a reflection on the manufacturers, for it is inevitable that they

should make their plans, and ensure ample stocks, well in advance of the time that the receivers will be on sale to the public.

A Typical Example

As an example, reference might be made to the extremely popular "£4 Superhet" which, complete in every detail, costs rather less than £10. The price is comparable with that of the average four-valve commercial receiver, but the set is at least equal in quality and performance to most ready-made five- or six-valve superhets costing at least twelve guineas! As has been pointed out in these pages before, the number of valves is not necessarily any criterion of performance, and a well-designed four-valver is often far superior to a receiver with six valves used in a different circuit.

Fully Guaranteed

The arguments put forward above are generally applicable to every type of home-constructed receiver described in this journal, and you need only examine the specifications of different types of receiver to see how really true these arguments are.

There is another very important point which concerns receivers built according to designs published in PRACTICAL AND AMATEUR WIRELESS, which is that they are guaranteed for an indefinite period, and if a set built exactly according to the published details fails to give the results claimed it is serviced free of charge. Compare this with the 90-day (maximum) guarantee given with the best commercial receivers!—comment would be superfluous.

Keeping Abreast of Developments

When the constructor builds a receiver he uses components which are easily interchangeable, and they can be used time after time in many receivers without the slightest

difficulty. They are provided with terminals and generally some "universal" form of mounting so that they can be attached to a metal chassis, a wooden chassis or a baseboard. But it is nearly always a practical impossibility to dismantle a commercial receiver and to use the parts in another set; they are often held in place by rivets, and their

The Centaur Three, a simple and efficient receiver in which baseboard mounting of components is used.



The Hall Mark Cadet, a low-priced receiver designed for quality reproduction.

characteristics are such that the components are suitable only for one particular circuit.

This means that when a commercial receiver becomes out of date it must be scrapped and a new one bought. As new models are introduced each year, this means that—in order to have a modern set at all times—a new receiver must be bought each year. It is true that the old one can be "traded in" in part exchange, but this involves a very heavy loss, for a year-old instrument originally bought for say, 12 guineas, would not be worth more than about £4 in the second-hand market.

Contrast this state of affairs with that applying to the home constructor; as soon as his set becomes obsolete, or immediately a new form of circuit or new device becomes available, he can dismantle the existing set and use a large percentage of the components in a new one. The result is that the change costs him from a few shillings to a couple of pounds, according to the exact nature of the new set.

In setting forth a few of the advantages of home construction no mention has been made of the inestimable amount of enjoyment and interest which is to be gained from making one's own receiver, although this is a point of considerable importance, especially to the man with mechanical inclinations. To such a person the enjoyment to be gained by carrying out the constructional work is far greater than any which could be obtained from merely listening to broadcasts.

Correcting Faults

Yet another item on which the constructor scores is when the receiver develops some slight fault. This may be due to nothing more serious than a loose connection, a strained switch contact or a component which has become damaged in use, but the owner of a commercial set can do little to rectify it. The constructor, on the other hand, having made the set, knows just where every component is, so that he is in a position easily to find what is wrong and to put it right. Manufacturers of commercial receivers invariably employ a trained staff of service engineers, but time is lost in awaiting the arrival of an engineer after writing to the Service Department, in addition to which it is the general practice to make a charge for the services of an engineer when he is called to the house. The alternative, if the set is in its guarantee period, is to return, or have it returned to the makers—probably just because a valve has "gone," or because a connecting wire has come adrift.

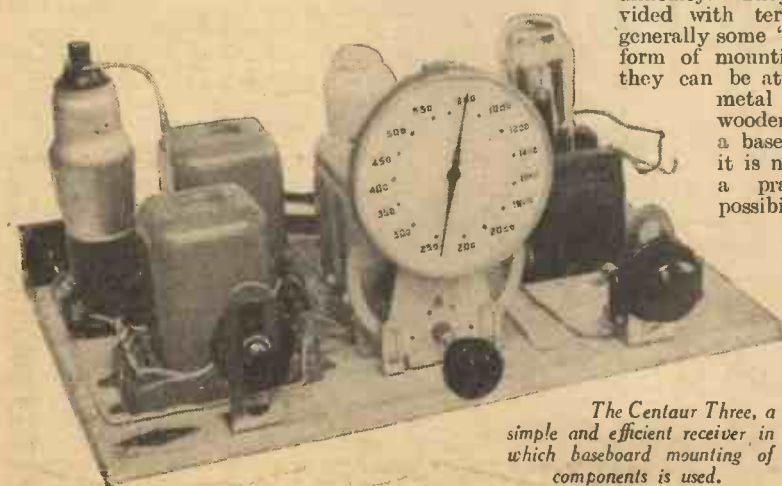

**A GOOD FOUNDATION
FOR BUILDING ANY
BATTERY SET**

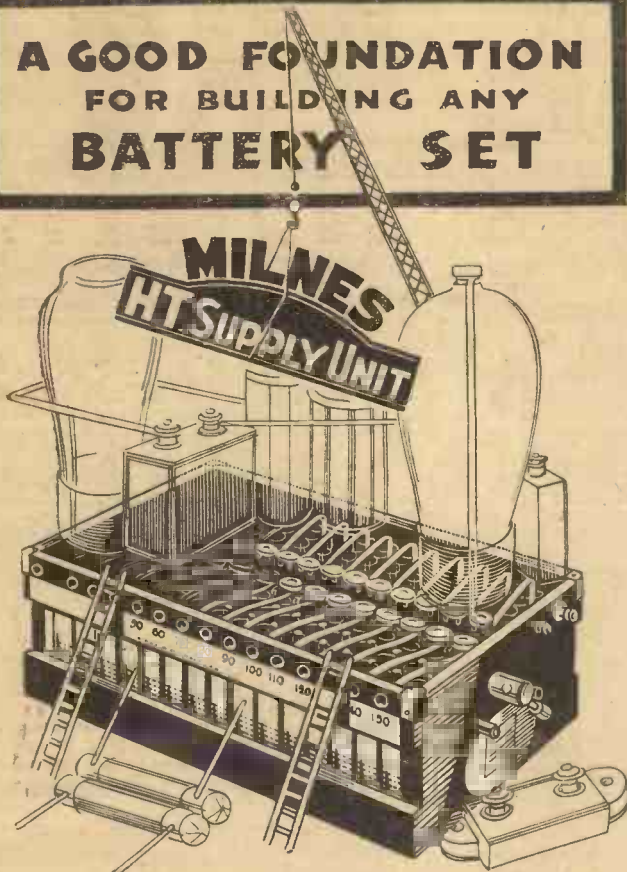

**SPECIFIED for "PRACTICAL WIRELESS"
BATTERY RECEIVER IN THIS ISSUE!!**

If you are building or operating a battery set you can get satisfactory results only if the H.T. supply is adequate. H.T. current is the life-blood of the set.

A Milnes H.T. Supply Unit will keep that life-giving current circulating strongly and vigorously. No off-colour days, no gradual languishing into feebleness. A Milnes Unit will keep your battery set perpetually young because it is the only H.T. battery in the world which starts each day's and every day's listening at full voltage.

The Milnes Unit never has a chance to run down because by means of a simple, reliable and ingenious series-parallel switch, it recharges automatically from the L.T. whenever the set is not in use.

A Milnes Unit is not only the most efficient—it is also the most economical form of H.T. supply. Sole running costs—for H.T. and L.T.—are the charging of one L.T. cell per week—a few pence at most.

Use a Milnes Unit and end H.T. troubles and expense.

**POST THE COUPON TO-DAY FOR
FREE DESCRIPTIVE BOOK.**

MILNES RADIO CO., LTD., CHURCH ST.,
BINGLEY, YORKS.

Please send me your Free Book about the Milnes Unit.
No obligation.

NAME

STREET

TOWN

COUNTY P.3.

PLEASE WRITE IN BLOCK LETTERS.
Stick coupon to envelope flap to avoid loss.

*I.F.S. Enquiries
only to Kelly &
Shiel, Ltd., 46,
Fleet St., Dublin.
All other enquiries
to Milnes Radio
Co., Ltd., Church
St., Bingley, Yks.*

*Precision-built Components
that 'MAKE' a short wave set!*

For the best possible performance from your short-wave set incorporate these Formo short-wave components! Exhaustive tests for efficiency and reliability preceded their manufacture and thousands of delighted short-wave constructors enthusiastically endorse their outstanding quality!

**SHORT-WAVE VARIABLE
CONDENSER**

Has die-cast rotor and stator vanes on a spindle insulated with ceramic material. The bank of vanes is mounted on a ceramic base, resulting in extremely low minimum capacity. Maximum capacity **3/6**.
0.0016 mfd.

Snail dual ratio drive and escutcheon suitable for the above. **6/6**
Complete

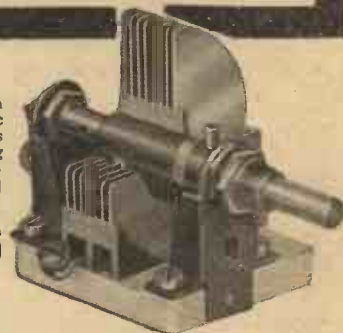

FORMO SHORT-WAVE COILS

Are wound on formers of Frequentite ceramic material. Undoubtedly the most efficient short-wave coils available. Designed to plug into the Formo single or 2-way coil stands. Type B 12/25 metres. Type C 21/50 metres. Type D 38/102 metres. Each **3/6**

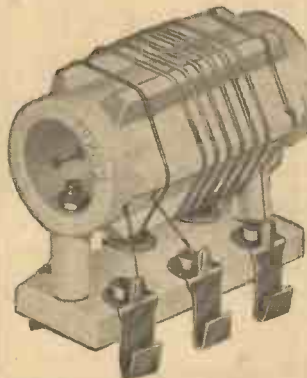

**FORMO SINGLE SHORT-
WAVE COIL STAND**

Designed to accommodate any one of the single Formo plug-in short-wave coils as illustrated. Extremely low-loss construction, Frequentite ceramic insulation being used throughout. **1/-**
Price



**TWO-WAY SHORT-WAVE
COIL STAND**

Accommodates two Formo short wave coils and so avoids constant coil changing. Frequentite ceramic insulation used throughout. Either of the two coils can be switched in or out at will by means of the switch incorporated. **2/6**
Price

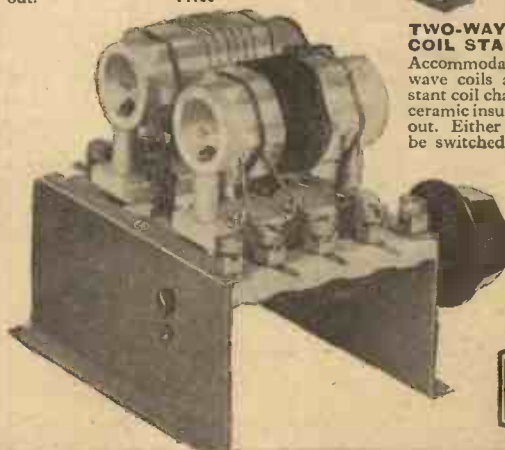

Auxiliary Switch (for filament and 'phones - to speaker), extra **2/-**



POST THIS COUPON NOW!

Messrs. Formo Products, Ltd.,
Masons Hill, Bromley, Kent.

Dear Sirs,
I enclose 1d. for Beautifully Illustrated Short-Wave Circuits and Wiring Diagrams.

Name

Address

‘No Battery can equal this for Value!’



RED TRIANGLE 120 volts **7'6**

Drydex BATTERIES FOR WIRELESS

Other Drydex Batteries :

Drydex 'Super-Life' - 120 volts - 10/6

Drydex 'Textet' - 120 volts - 6/-



For wireless LT get the EXIDE 'INDICATOR' BATTERY. It tells you in time the time to recharge.

● From Exide Service Stations and all reputable dealers. Exide Service Stations give service on every make of battery. EXIDE BATTERIES, Exide Works, Clifton Junction, near Manchester.

POLAR CONDENSERS SPECIFIED FOR F. J. CAMM'S MONITOR THREE



POLAR "COMPAX" CONDENSERS

Solid dielectric condenser for tuning or reaction. Bonded rotor vanes.

ONE .0005 REQUIRED
PRICE 2/6

Also made in .0003, .00015, .0001, and .00005. Price 2/6 each.

POLAR DIFFERENTIAL CONDENSERS



A solid dielectric condenser of great utility and moderate price. Constructed with insulated spindle.

ONE .00015 REQUIRED

Also made in .0003 and .0001. Price 3/-

PRICE 3/-

Send for fully illustrated Polar catalogue of Polar and N.S.F. Components.

WINGROVE & ROGERS, LTD.,
188/189, STRAND, LONDON, W.C.2.
'Phone : Temple Bar 2244.
Works : Old Swan, Liverpool.

Simple Crystal Receivers

MANY listeners rely upon a crystal receiver when the accumulator is being charged, and in certain parts of the country the ordinary valve receiver is not popular owing to the difficulty of obtaining facilities for battery charging. Many schoolboys find that the crystal receiver may be included as part of the school kit for use in the dormitory during the evenings, and for use under similar conditions many listeners adopt the crystal set in order to avoid annoying others with a programme which is only of appeal to them at the moment. With the modern high-power broadcasts it is really surprising what results can be obtained

Although Despised by Many Listeners To-day, the Crystal Receiver is Extremely Valuable as a Stand-by and for Use Under Certain Conditions. Constructional Details of Some Simple but Efficient Receivers are Given in this Article

By W. J. DELANEY

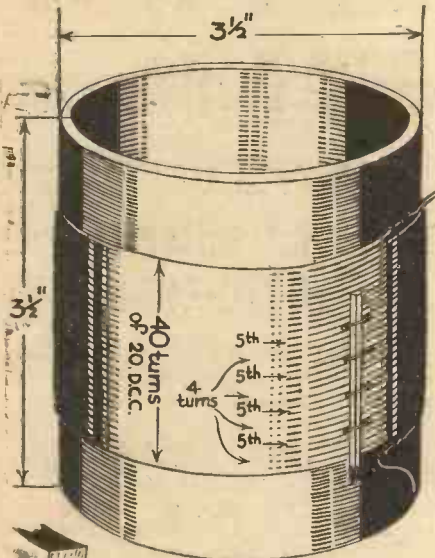

Fig. 1.—How to wind a simple coil for use in a crystal receiver, and, inset, how the ends of the wire are anchored.

with the crystal receiver if it is correctly designed, and in view of the small power which is available it is essential to reduce losses to a minimum.

The design and construction of a crystal receiver should, of course, be taken as the first step in wireless theory and practice, and there is nothing better for the newcomer to radio than to build such a receiver and graduate through the various stages introduced by the one-valver, the two-valver, and so on, in order to make full acquaintance with the various principles involved.

The Tuning Coil

The tuning coil is naturally of simple design, although it is necessary to arrange for selectivity as well as for sensitivity. The absence of reaction windings and other complications reduces the design to simple details, and efficiency may be still further increased if the long-wave winding is also omitted. In most parts of the country to-day there is a local National and Regional, and thus, with the choice of these two programmes available, there is no need for long-wave reception. The long-wave National radiates practically the same programme as the short-wave National, and the Regional provides the alternative pro-

gramme. In view of the usual short range of reception, it is not worth while fitting a long-wave coil in the hope of hearing long-wave distant stations, and if the selectivity is ample there are a number of medium-wave foreigners which may be heard under favourable circumstances.

The simplest coil will consist of a solenoid or a single layer coil wound on a large diameter former. A coil which may be guaranteed to give good all-round results will be made up as shown in Fig. 1. This consists of a 3 1/2 in. length of 3 1/2 in. diameter paxolin or ebonite tube, and on this is wound 40 turns of No. 20 gauge double-cotton-covered wire, or D.C.C. wire as it is

IF YOU ARE A BEGINNER BUILD ONE OF THESE CRYSTAL RECEIVERS AND BECOME ACQUAINTED WITH WIRELESS RECEIVER PRINCIPLES.

called for short. The ends of the wire are anchored as shown in the small inset drawing, and to give the coil universal application tapping points are made as shown in Fig. 2. A strip of thin cardboard or a matchstick is placed over the wire when the fourth turn has been placed in position, and the fifth turn is wound over the matchstick. A further four turns are wound, the match-

stick is slid along the wire and the tenth turn is wound over the match. This process is continued until the twentieth turn is reached, after which the remaining twenty turns are wound without moving the matchstick. After the end of the wire is anchored the cotton on the wire over the matchstick

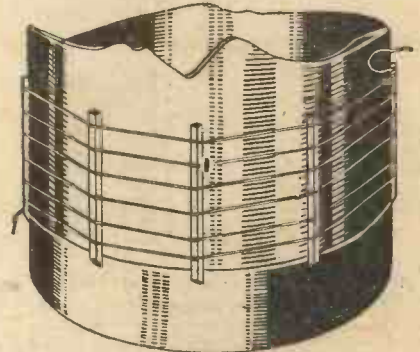

Fig. 4.—A more efficient type of coil having a separate aerial winding.

is scraped away and the bare wire is used for tapping on the aerial. A crocodile clip is attached to the aerial terminal and used to make the connection, whilst the crystal and headphones are wired, as shown in Fig. 3. The headphones should have a resistance of 2,000 or 4,000 ohms, and it pays to get the best you can afford.

Alternative Coils

Where the cost is deemed worth while the coil may be improved by winding a separate coil for the aerial circuit, and the efficiency will depend upon the method of winding this coil. The coupling between it and the remaining or tuned coil should be only inductive, but it is almost impossible to obtain such a coupling in practice. The most suitable method of arranging that the

(Continued on next page)

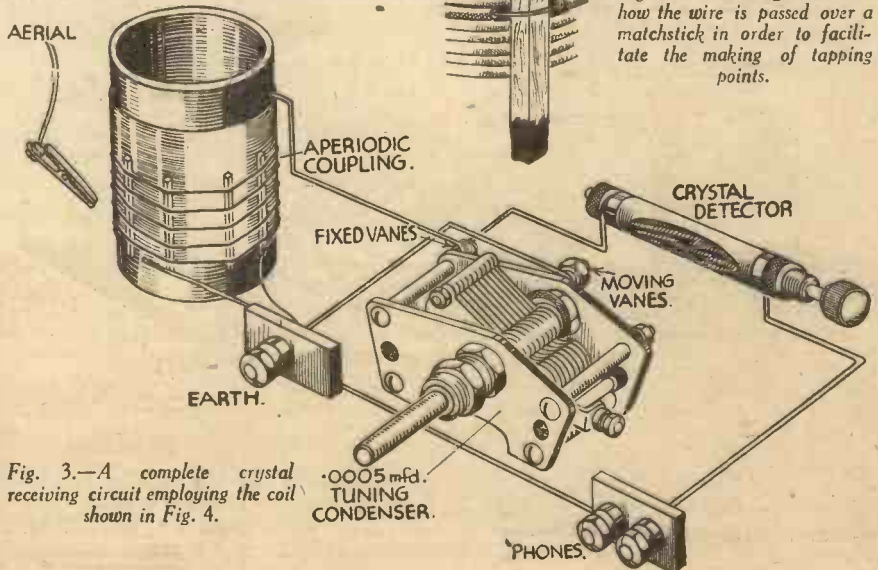

Fig. 3.—A complete crystal receiving circuit employing the coil shown in Fig. 4.

Fig. 2.—This diagram shows how the wire is passed over a matchstick in order to facilitate the making of tapping points.

(Continued from previous page)

capacity coupling is removed is to use a very thin wire for the primary and to arrange this a short distance from the secondary or tuned winding, and also to endeavour to make the thin wire come opposite the spaces between the turns of the thick wire. The diagram Fig. 4 shows the arrangement, and the matchsticks should each be nicked slightly with a pen-knife in order to make the thin wire lay in the correct position. Alternatively, the thin wire may be wound on the thick wire so that the wire falls in the spaces between the thick wire, as shown in Fig. 5.

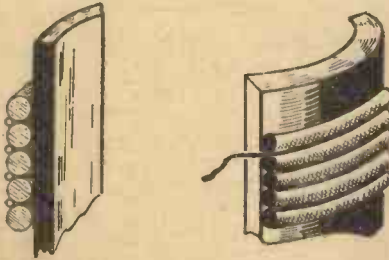

Fig. 5.—An alternative method of including an aerial winding on a simple coil.

The Crystal

The sensitivity of the entire receiver will depend upon the detector, and there are many different forms from which to select one. For actual signal strength one of the proprietary brands which were at one time so popular (and which are prepared from natural galena) will prove best, but the difficulty with these is the location of a sensitive spot. When the contact point (or cat's-whisker) is placed on the crystal signals may or may not be obtained, and in practice it is found that the point has to be moved about in different directions and different pressures employed in order to get the best results. Much valuable time may be wasted in this manner and an important item may be missed. Therefore, a permanent type of detector should be employed and undoubtedly the old carborundum crystal will be found hard to beat. This is preferably employed with a small potential applied to it through a battery and potentiometer, and the complete circuit is shown in Fig. 7. To save the expense of buying a proper centre-tapped potentiometer the following wrinkle may be adopted. Obtain an H.B. pencil of standard size and carefully split it along its entire length without, however, breaking the lead. Wrap round each end and in the

centre a few turns of bare copper wire, and take these to terminals mounted on a small piece of wood. A loop of the wire may be passed through the wood in these three positions in order to hold the pencil firmly on the wood. Next, from a piece of brass, cut a thin strip of sufficient length to enable it to be mounted by a screw at one end of the wooden baseboard and to move to the wrapped ends of the pencil, rubbing across the bared lead (Fig. 6). A flash-lamp battery may then be joined to the terminals, as shown, and the movement of the brass arm will enable any desired potential from negative to positive to be applied to the crystal and a suitable position easily found. The contact with the crystal will be found easy to obtain if a standard three-hole razor blade is screwed to the wooden base-

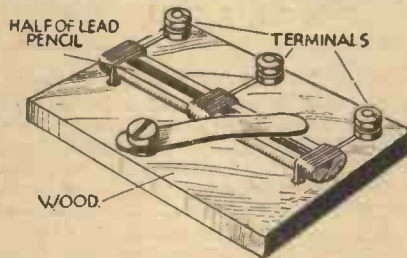

Fig. 6.—How to make up a simple potentiometer from a pencil.

board. The screw may be tightened until the blade makes a sufficiently firm contact with the crystal.

**BUILD A CRYSTAL SET—
IT FORMS A USEFUL
TEACHER AS WELL AS A
STAND-BY RECEIVER !**

How To Use The Receivers

The idea underlying the tapping points on the coils described is to enable the most suitable degree of selectivity to be obtained, and it is only necessary to connect the aerial clip to one of the tapping points and then to turn the tuning condenser until a signal is heard. Then, if there is any interference from another station, the clip should be placed on one of the tapping points nearer to the earth end of the coil. When the clip is placed higher up the coil greater volume will be obtained, but the selectivity will not be so high.

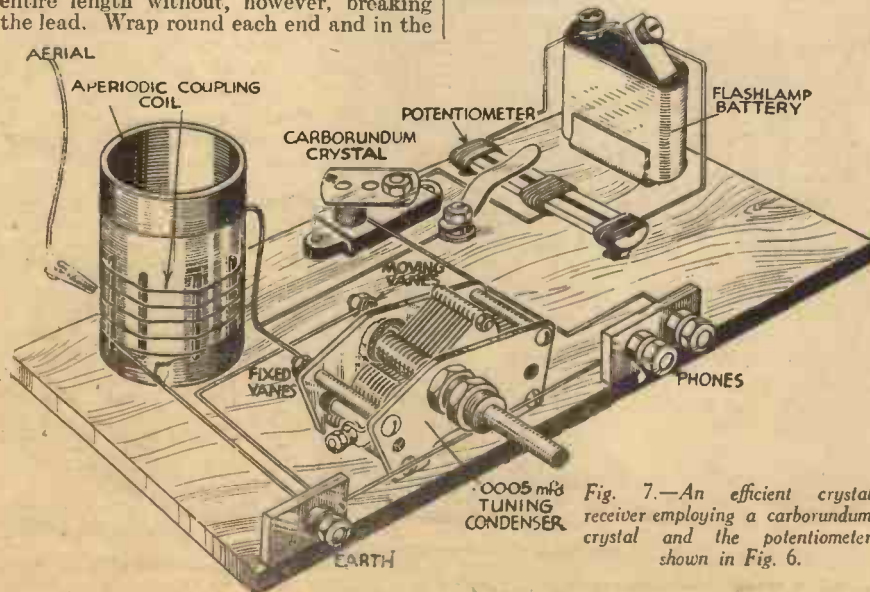

Fig. 7.—An efficient crystal receiver employing a carborundum crystal and the potentiometer shown in Fig. 6.

**LOOKING BACK WITH
THE SCRAPBOOKS**

FOUR months' work on one programme of an hour's duration sounds pretty heavy going for the B.B.C., but such ambitious relays as Leslie Baily's Scrapbooks, which need absolute and complete accuracy, demand collection of quite three times as much material as is ever used.

Patient reference to books in the British Museum, the careful combing of newspaper cuttings, old gramophone records to be traced, the seemingly well-nigh impossible search for characters from years gone by, and the recording of such events as cannot be given direct from the studio, are a few of the things to be done.

Small Beginnings

Like so many ideas which catch on like wildfire, the Scrapbooks came from small beginnings. One day Leslie Baily happened to stroll along Oxford Street and, having an hour or two to spare, visited the film "King of Jazz." In this event were shown coming out of the leaves of an enormous book as they turned over. Mr. Baily sat up and took notice. Several miscellany programmes had already been produced by the B.B.C., and he now suggested that the same scheme might well be adopted with a wider appeal, and the items linked up by the idea of each coming from the page of a book.

He set to work and assembled material, odd information, scenes of unusual type and records, and the whole was soon welded into the first experimental Scrapbook programme and relayed from North Regional in 1932. It was well received and three more of a similar character followed.

Mr. Baily, however, was not entirely satisfied. He felt that there should be a central theme to pull the whole thing together. At the same time he had been busy with another programme: "As It Might Have Been," a reconstruction of events of thirty years previous. Now it occurred to him to amalgamate the two. A general scheme for the Scrapbooks would be provided, and the public's love of looking back catered for.

Hotfoot he rushed off to see the Variety Director, who, delighted with the suggestion, promised to give it a trial—cautiously adding, "merely as an experiment."

Charles Brewer, recently transferred to London, had been connected with Mr. Baily when he produced for him in Birmingham, and so they formed a new partnership.

Finding the Characters

For the first programme the year 1910 was selected and for the next four months work went forward. Ideas were exchanged, material sorted, and then Mr. Baily wrote the script, while Charles Brewer completely undertook the production side. When the items had been more-or-less mapped out the problem was to find people to take part and then the fun began.

Film stars and actresses were the biggest stumbling block, for if they were still working they coyly explained that it would be bad policy to give away their ages by admitting that they had been the vogue at least twenty years before. If retired they were often difficult to find. Ida Crisp was an actress of the period and after much delay she was finally located in a hotel at Nottingham. Luckily she was enthusiastic at the thought of a return to public life.

A PAGE OF PRACTICAL HINTS

SUBMIT YOUR IDEA

READERS WRINKLES

THE HALF-GUINEA PAGE

A Novel Lock-switch

THIS simple switch is made with four strips of springy brass, and the lock is of the type which works both ways.

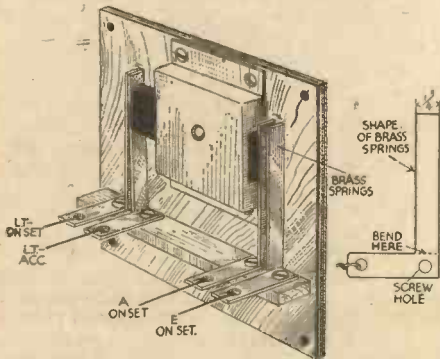

An automatic lock-switch for a radio cabinet.

When the key is placed in the lock and is turned to the left, the set is switched off, and the aerial and earth are connected together. When the key is turned to the right it switches the L.T. on and the aerial and earth are disconnected. This is a very handy arrangement where there are children who tamper with your receiver.—A. J. MARTIN (Balham).

A Vibrationless Speaker Mounting

THE accompanying sketch shows a vibrationless speaker mounting, which will cure many cases of boom and micro-phonous howl. The sketch is self-explanatory, the strips of insulating material being either

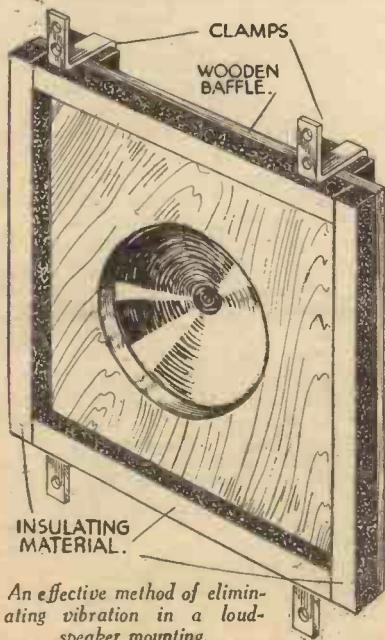

An effective method of eliminating vibration in a loud-speaker mounting.

sponge rubber or thick felt. The fixing clamps are also fitted on blocks of insulation material.—G. MACKIE (Aberdeen).

THAT DODGE OF YOURS!

Every Reader of "PRACTICAL AND AMATEUR WIRELESS" must have originated some little dodge which would interest other readers. Why not pass it on to us? We pay £1-10-0 for the best wrinkle submitted, and for every other item published on this page we will pay half-a-guinea. Turn that idea of yours to account by sending it in to us addressed to the Editor, "PRACTICAL AND AMATEUR WIRELESS," George Newnes, Ltd., 8-11, Southampton Street, Strand, W.C.2. Put your name and address on every item. Please note that every notion sent in must be original. Mark envelopes "Radio Wrinkles." Do NOT enclose Queries with your Wrinkle.

Simple Switch Construction

SMALL switches, made as shown in the sketch, are extremely cheap, consisting of a small piece of scrap tinfole, two nuts and bolts, and a few brass paper fasteners. The ends of the fasteners are bent over in opposite directions after pushing through the ebonite, or other material.

The switch arm consists of three small strips of tinfole fastened together at one end by a 6BA bolt, which passes through all three strips which are cut successively

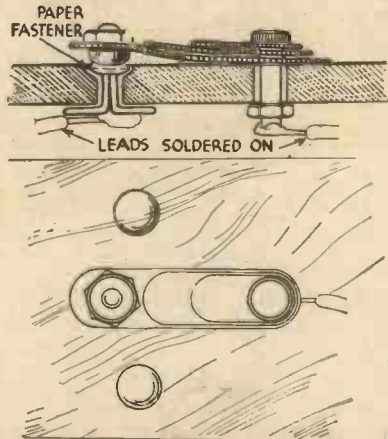

An easily-made stud switch.

short, as shown. The bolt serves as a pivot, being passed through a hole in the switch-board and secured by a nut. If desired, washers may be used between the strips to act as spacers, but these are not essential. The free end of the longest strip has a small brass cheese-headed bolt passed through it and is fixed with a nut. The head of the bolt should be rounded with a file. The strips for switch arm need not be more than 1 in. long, and the whole is extremely compact.—M. D. ARMITAGE (Goole).

Pilot Lamp for a Pick-up

MY radio set stands in a rather dark corner, and finding some difficulty in setting the pick-up in the first groove of the record, I fixed a small fuse-holder and bulb at the edge of the turntable which was switched on and off by the brake lever, the bulb being connected to one of the valves. The accompanying sketch shows the arrangement quite clearly.—W. J. BROOKER (Abinger Common).

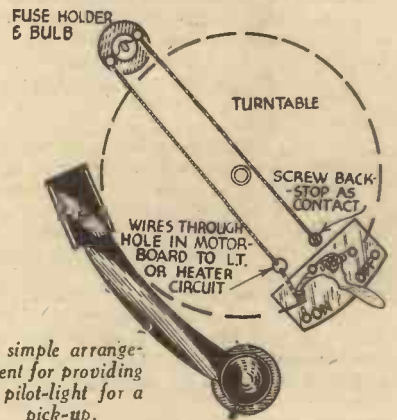

A simple arrangement for providing a pilot-light for a pick-up.

An Induction Coil from a Transformer

AN old or burnt-out transformer may easily be converted into a small induction coil, which works very efficiently, owing to the closed magnetic circuit employed. It should be of the type in which the primary and secondary windings are side by side. The primary winding is replaced by as much No. 22 or 24 S.W.G. enamelled wire as possible. Owing to the closed magnetic circuit, there are no "free" poles produced to operate a circuit breaker. It will be found, however, that there is a sufficiently strong field in the position indicated on the diagram. The armature can be taken from an old electric bell, and this will fit underneath the coil, as indicated.—R. H. BARKER (Hull).

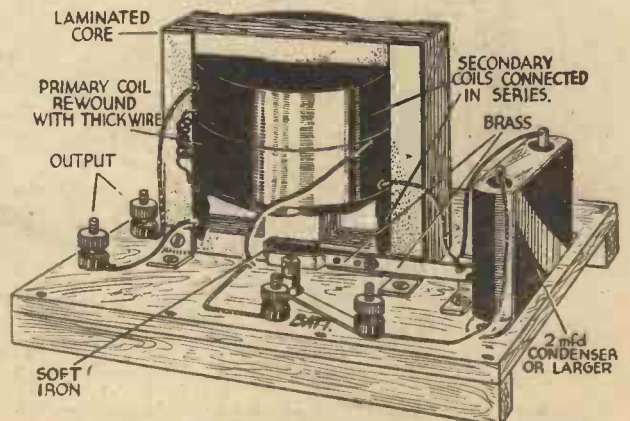

A method of making an induction coil from an old transformer.

Running Costs

Concluded from Last Week, This Article Deals With Special H.T. Units, the Low-tension Supply and Mains- and Eliminator-Operated Receivers



One of the many Heayberd eliminators. Many types are available, and inexpensive trickle chargers are available from the same makers.

In addition to dry batteries, there are three other standard methods of obtaining high-tension current: from H.T. accumulators of the lead type, from special accumulators which can be charged from an L.T. accumulator, and from an eliminator fed from the mains supply.

A Special H.T. Unit

The second type of accumulator mentioned, and of which the foremost example is the Milnes H.T. unit, is obtainable in two amp.-hour ratings, and is provided with a self-contained switch by means of which the separate sections can be wired in parallel for purposes of charging. This can then be carried out by means of an ordinary 6-volt accumulator. The latter must, of course, be charged, but it is much easier to carry than a complete H.T. assembly and costs very little. The recommended method is to keep the six-volt accumulator attached to the unit and to switch over to the "charge" position when the set is out of use. This is equivalent to trickle charging an L.T. accumulator and ensures that the battery is always up to its work. The H.T. unit is virtually everlasting, and is therefore both convenient and economical in the long run. The six-volt accumulator may also be used to feed the valve filaments (by tapping off different two-volt sections) and should be charged once a month, as usual.

If a 2-volt accumulator is already available it is necessary only to obtain two similar cells which can be wired in series with it. Alternatively, Milnes Radio can supply a complete 6-volt battery

(tapped every 2 volts) which is ideal for the purpose.

The Low-tension Supply

Turning now to the cost of low-tension current, it will be seen that this, also, is largely dependent upon the ampere-hour capacity of the L.T. battery, since the majority of charging stations now have a fixed rate for all two-volt accumulators, this ranging from 4d. to 8d. A three-valve set taking .5 amp. (.2 amp. for the

ampere-hour ratings; one of these is for slow discharge and the other for discharge at the so-called 100-hour rate. In most cases it is the latter which must be taken into account, since the slow-discharge capacity applies only when the current taken is less than, say, .2 amp. In using this type of accumulator it is a good plan to choose a battery which will give just about 100 hours' service at the current consumption of the set. This means that the battery will last for about one month on each



One of the popular, economical, and almost everlasting Milnes H.T. units. These can be obtained in various types and can be charged from a 6-volt accumulator, the charging being carried out when the set is not being used.

S.G. and pentode valves, and .1 amp. for the detector) can be operated for 100 hours, or four weeks at the average hours per week taken above, from an accumulator with a capacity of 50 ampere-hours, or for half this length of time from an accumulator rated at 25 ampere-hours. There is an important point to be considered in this respect, however, when using the type of accumulator which is now so popular and which is known as the "mass-plate" type, because this has two

charge, and it tends to ensure that it will be charged once a month. It is always wise to have the accumulator charged at such intervals so as to keep it in its best condition, and to ensure the longest possible life—which should be several years.

Charging Costs

In the case of a receiver which takes more than .5 amp. it is better to buy an accumulator of the normal-plate type and of such a capacity that it will give about four-weeks' service per charge. Thus, if the receiver has four valves arranged as



The Atlas Model T10/30 battery eliminator which operates from 200-250-volt A.C. mains of 40-120 cycles.



An excellent trickle charger for keeping the L.T. battery in good condition. Operating from any A.C. supply between 200 and 250 volts, it gives an output of 1/2 amp. at 2, 4 or 6 volts. This Ferranti Unit costs £2 15s. 0d.

two H.F. valves taking .15 amp. each, a detector taking .1 amp. and a class B valve taking .4 amp., an 80-ampere-hour accumulator will be most suitable and economical, since it will last for 100 hours. The cost of a good accumulator of this capacity is about £1, whilst the price of one of half the capacity is about 11s. 6d. If we take the life of the battery as four years the larger one costs 5s. per year and the smaller one about 3s. per year. But the cost of charging the first will be 6s. a year (taking the average cost per charge as 6d.) and of the second 12s. From this it is evident that the larger accumulator is more than justified, and the difference in price is thus wiped out in less than two years.

Mains-receiver Running Costs

In dealing with a mains set the running costs are entirely different and invariably much less. For example, a three-valve mains receiver with an undistorted output of 3 watts need not take more than 60 m/A of H.T. at 250 volts, whilst the L.T. consumption amounts to 4 amps. at 4 volts (1 amp. each for the heaters of the receiving and rectifying valves). To determine the consumption in standard units it is necessary to consider the power required in terms of watts, one watt being equal to 1 volt at 1 amp., and the number of watts being found by multiplying the voltage by the current in amps. Thus, the H.T. wattage of the set taken as an example is 250 times 60/1,000, or 15 watts, and the L.T. consumption is 4 times 4, or 16 watts. This means that the total consumption is 31 watts, which is the power taken from the rectifier. But as the efficiency of a transformer and rectifier combined is not generally greater than about 80 per cent., the calculated wattage must be increased by $\frac{1}{4}$, so that it becomes nearly 40 watts.

Now one unit of power is 1,000 watts per hour, and therefore it will be consumed by this set in 25 hours. The cost of electric power varies in different localities from $\frac{1}{2}$ d. to 9d. per unit, but if we take the high average of 6d. per unit we see that the



An Ekco power unit. There are models from £1 12s. 6d. upwards, and in almost every type for A.C. or D.C.

total cost of running the receiver works out at only 6d. a week.

A High-grade Radiogram

At the other end of the scale we might consider an A.C. radiogram with automatic record changer and an output of 5 watts or so. There would probably be five valves plus rectifier, and the receiving valves would take, say, 120 m/A at 500 volts in H.T.

**MAKE A START ON
THE SHORT WAVES.
BUILD THE
"PREFECT"**

The L.T. consumption would be 4 volts 1 amp. for the first four valves, 4 volts 2 amps. for the output valve, and 4 volts 2.5 amps. for the rectifier. If the average consumption of the record changer is taken at 50 watts, the total consumption is 50 watts, plus 34 watts L.T., plus 500 times 120/1,000, or 60 watts for H.T., we get a grand total of 144 watts, to which

must be added 36 watts for "loss" in the transformer, thus bringing the figure to 180 watts. Again with power at 6d. per unit, the complete instrument could be used for nearly six hours for 6d., so that the cost per week would be under 2s. 6d. Even this figure is based on the assumption that the gramophone portion is constantly in use, whereas in practice it would probably be used for a comparatively short time, and the estimated cost of running could be reduced to, at most, 1s. 6d. a week.

D.C. and Universal Receivers

The consumption of a D.C. or universal receiver is rather more difficult to compute than that of an A.C. set, since voltage-dropping and regulating devices are incorporated which themselves "consume" a certain amount of power. The simplest method of determining the number of watts they take is to insert an ammeter or watt-meter in series with one of the mains leads. If the current is known, the wattage can be found by multiplying this by the mains voltage. For example, if the current passed is .2 amp. and the mains voltage is 220, the wattage is .2 multiplied by 220, or 44 watts.

It is interesting to record, in passing, that Bulgin have recently introduced a very convenient device for recording the consumption of any type of mains receiver, A.C. or D.C. This consists of a watt-meter fitted with a 5-amp. plug and a corresponding socket. The meter is inserted into the mains-supply point and the plug from the set is inserted into the socket on it. When the set is switched on the meter gives a direct reading in watts.

Eliminators

Reference has previously been made to the use of battery eliminators, so we may now consider the question of running costs when using one of these. Actually, the method of calculation is exactly the same as that applied in the case of an A.C. receiver; the H.T. current is multiplied by the voltage output of the rectifier, allowance being made for the loss in the mains transformer (in an A.C. instrument), or by the mains voltage in the case of D.C.

A Useful Combination Tool

THE following is a brief description of a handy combination tool which I have just made. The tool can be used as a marking-gauge with either a steel point or pencil, and it will also mark out circles, on baffle boards, or paper for cones or coil speakers.

A wire reel or bobbin is sawn half through lengthwise, the central hole being cut out square to take a length of hard stripwood $\frac{1}{2}$ in. square. The square hole must be accurately cut so that the sliding bobbin is just gripped when the two halves are nearly closed together. An adjustable earth clip—the kind used for fixing round water pipes—or a hosepipe clip is fitted round the reel, as shown. If it is not wide enough to fit nicely against the flanges it can be secured with a short nail on each side; otherwise the clip will slip about when setting the slider. Alternatively, a nail can be pressed into a hole bored through one side of the reel.

Near one end of the slider a hole is made to take a nail for marking wood or ebonite, though a steel point will be required for satisfactory use on steel, or for fine work. About $\frac{1}{2}$ in. farther from the end, another hole is made for a pencil, the two holes

being connected by a saw-cut. A $\frac{1}{2}$ in. screw is fitted between the holes, at the side, and the nut can be sunk into the wood to prevent its turning with the screw. A small piece of brass, or a washer, can be soldered into the slot in the screw head so that it can be tightened without a screwdriver. The slider can be marked off in fractions of an inch and millimetres, and the other end drilled to take the scriber. A small cork closes the opening.

Another nail or steel point is fitted into the underside of the reel for use when marking circles, and its distance from the edge can be allowed for when used with the scale.

If a fairly large slider is made, say of $\frac{1}{2}$ in. square wood, a safety razor blade may be fixed to the end with small brads and washers when it is desired to cut out paper cones. The sketch shows the completed tool.—J. EVANS.

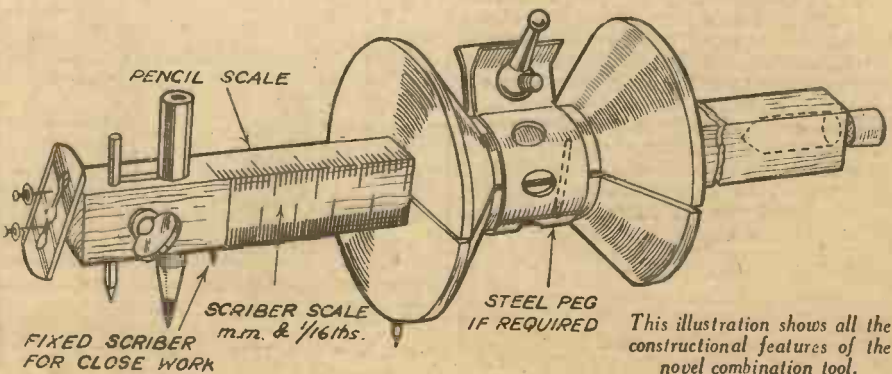

This illustration shows all the constructional features of the novel combination tool.

READING A CIRCUIT DIAGRAM

IT is surprising how many constructors there are, even among those who have built two or three receivers, who are still unable to follow intelligently a theoretical circuit diagram. Apparently the main reason for this is that these people look at a rather complicated circuit, see a mass of lines and symbols, and immediately consider the whole matter hopeless. But if they were first of all to examine carefully, step by step, a simpler type of circuit, and to study the chief features in turn, they would very soon find that the matter was not really complicated or involved.

Advantages of a Theoretical Circuit

There are doubtless a few readers who feel that it would be a waste of time to

Any Constructor Can Easily Follow a "Theo" after a Little Practice if he First Understands the Fundamentals, which are Here Described By FRANK PRESTON

There are many methods of learning, but I think that the simplest is to start by examining the circuit for a single-valve receiver, such as that represented by Fig. 1, where different kinds of line are used for different connections. You will see, for example, that the filament circuit

circuit is built up from what we might call sub-circuits, which is an important fact to be noted.

The Filament Circuit

Let us look at the filament circuit first, for this is the simplest, carrying only direct current (D.C.). There is simply one wire from the L.T.+ terminal to one filament terminal of the valveholder, another to the earth terminal, and a third to the second filament terminal from L.T.—, this one passing through the on-off switch; the latter, of course, simply serves to break the circuit and prevent the flow of current when the set is out of use. Now we can examine the grid circuit (broken lines), and we see that it really extends from the grid terminal of the valve, through the grid condenser, to the grid coil, and back again to the filament circuit and earth. It will also be noted that there is a certain over-

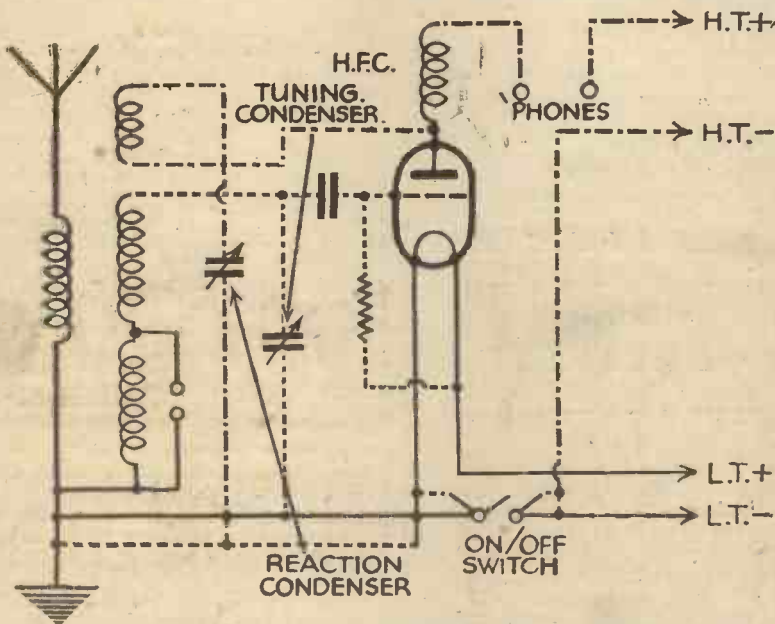

Fig. 1.—The circuit of a single valve set, in which the principal sub-circuits are indicated by different kinds of line.

bother about learning to read a circuit diagram, because the majority of the circuits described in this journal are illustrated by pictorial circuits and wiring plans. On the other hand, however, many readers constantly write to say that the pictorial diagrams are useless for them because so much time is wasted in tracing through them to find the most important features.

The fact is that a theoretical circuit shows at a glance every detail of the receiver or component referred to, and enables anyone who understands this form of representation to grasp the arrangement in a few seconds. Besides, a pictorial diagram tells the user nothing whatever about the type of coils or transformers used, since terminal connections only are given and the windings might be arranged in one of dozens of ways. The same idea applies even to valveholders, for even if the connections to them are clearly shown it is not possible to tell what kind of valve is intended to fit the holder, especially since most types are now available with seven-pin bases.

Sub-division Simplifies

But sufficient has been said concerning the utility and value of "theo's," as they are popularly called, and it is time that we proceeded to learn more about them.

is represented by full lines, while broken lines are used for the grid-circuit connections, and dot-dash lines for the anode circuit. This form of representation makes it easier to understand that the complete

AN ARTICLE SPECIALLY WRITTEN FOR BEGINNERS
See also Page 671

lapping of the grid and filament circuits, and this fact is brought out by showing two connections from the bottom of the grid coil and earth, to the filament. In the particular circuit shown, there is another grid-filament circuit of lesser importance, this comprising the grid-leak, which is joined between the grid and the positive filament lead.

In the particular circuit under consideration, there is really a fourth circuit—the aerial-to-earth circuit—which merely embraces a winding of the coil, this being connected between the aerial and earth terminals. Very often this circuit is combined with the grid circuit by joining the aerial to a tapping on the grid coil, or even by connecting it through a pre-set condenser to the upper end of the grid coil.

From Anode to Filament

The anode circuit (shown by dot-dash) (Continued on page 662)

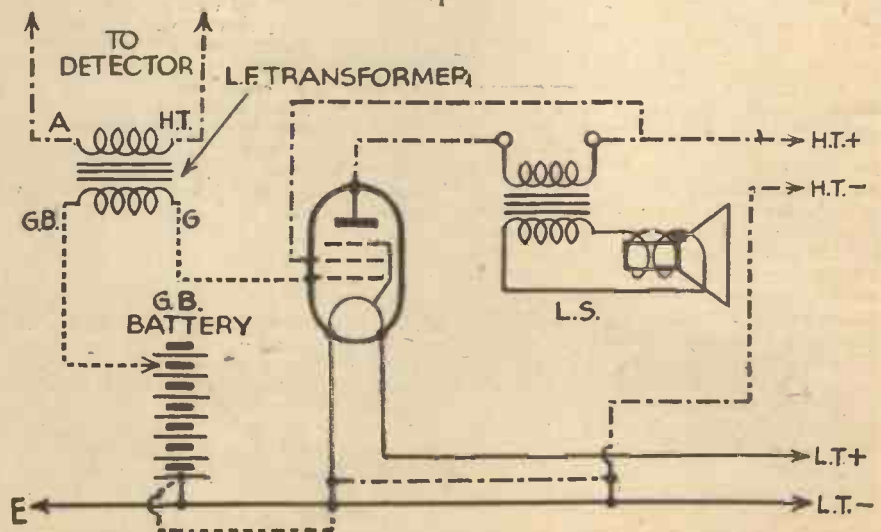

Fig. 2.—This is the theoretical circuit for a simple Z.F. amplifier, and sub-circuits are indicated in the same manner as in Fig. 1.

A NEW ALL-WAVE RECEIVER

Interesting Details of a Newly-released H.M.V. Mains Receiver

THE design of receivers for operation on the short-wave bands as well as on the broadcast bands is now becoming more efficient, and there are now a number of such receivers on the market. The utility of such receivers now needs no emphasis, and the inclusion of the short waves provides a much wider field of entertainment, as well as providing much interesting experiment with regard to the design of the aerial and earth system. The new H.M.V. receiver, as may be seen from the illustration below, bears very little difference in appearance from a normal broadcast receiver, and no additional tuning complications have been incorporated for the short-wave bands. The tuning dial is the most novel external part of the receiver, and this is calibrated for five separate wavebands. Two pointers travel over this dial, and the longer of these is coloured black and indicates the actual

The Circuit

The circuit is of very interesting design and incorporates a number of interesting features. The aerial is fed into a tuning unit consisting of four individually screened circuits, each having its own trimming condenser. One of these tuned circuits from each tuning unit is selected by the wave-band switch and connected across the main tuning condenser. This system of individual tuned circuits is adopted throughout the H.F. circuits of the receiver, the circuits not in use being suitably switched or shorted to prevent the dead spots experienced with some short-wave receivers.

The grid of the first H.F. valve is connected to the first tuning unit and thence transformer coupled to the mixer valve. The resultant intermediate frequency of 460 kc/s is fed through the primary of the first I.F. transformer.

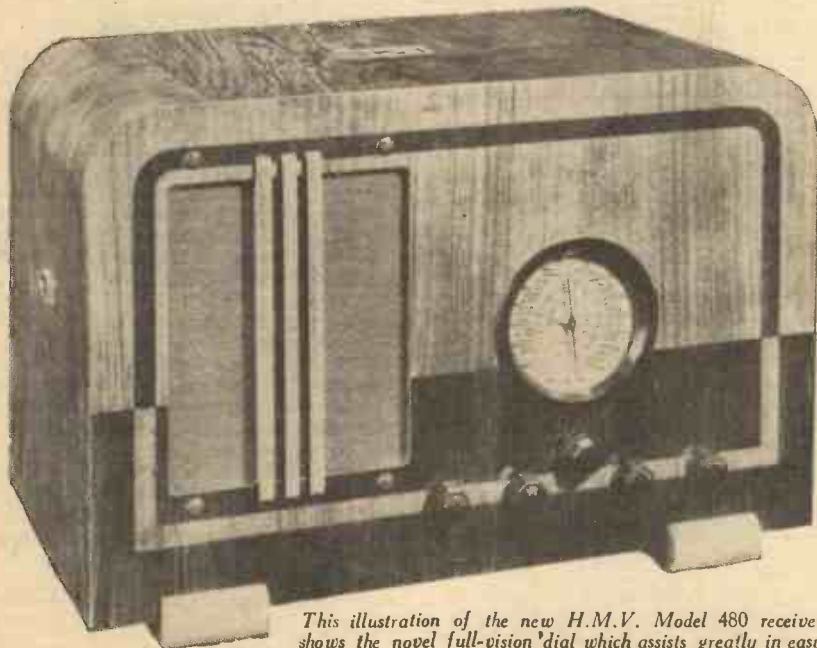

This illustration of the new H.M.V. Model 480 receiver shows the novel full-vision dial which assists greatly in easy logging on the short as well as the broadcast wavelengths.

wavelength to which the receiver is tuned, whilst the second hand (which is coloured red) travels over an inner scale which is marked in degrees, and this is used in conjunction with a small knob which is concentric with the main tuning control in order to provide a vernier setting.

The Controls

The remainder of the controls on the panel consist of a waveband selector, a volume control, and tone controls—of which there are two. One of these provides for the attenuation of the higher frequencies, whilst the other controls the bass or lower frequencies, and thus it is possible to adjust the reproduction in order to remove interference from atmospheric as well as to obtain a musical balance to suit the individual or the particular surroundings. The range of control is adequate for all normal purposes, and the reproduction may be balanced over very wide limits. The mains on/off switch is mounted on the left-hand side of the cabinet in an inconspicuous manner and permits the remaining controls to be grouped in the most convenient manner.

The secondary of the transformer is connected to the combined I.F. amplifier and A.V.C. driver valve, which further amplifies the signal and passes it through the second I.F. transformer to a double-diode-triode valve, which rectifies the I.F. signal, amplifies the rectified L.F., and provides A.V.C. voltage. The L.F. portion of the double-diode-triode is coupled to the pentode output valve by the resistance capacity method.

The bass tone control consists of a variation in coupling capacity between the last two valves.

The treble tone control comprises a series of condensers connected across the output transformer.

The total consumption of the receiver is approximately 90 watts, and the maximum undistorted output is 3 watts. The speaker is, of course, of the energised moving-coil type, and sockets are provided at the rear for the connection of additional loudspeakers. Provision is made for the use of a gramophone pick-up, and the wavelengths covered on the four wavebands are 16.7 to 50, 46 to 141, 185 to 560 and 750 to 2,250 metres. The price is 17½ guineas.

IT PAYS TO BUY THE BEST

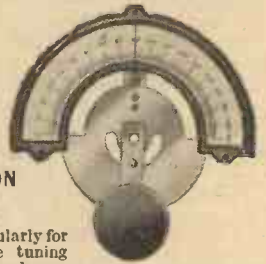

WIDE VISION PRECISION DIAL.

Built particularly for Short Wave tuning purposes where accuracy and smoothness of movement are essential. Free from backlash with 22:1 slow-motion ratio.

No. 973. Price 10/6d.



SHORT WAVE H.F. CHOKE.

Eddystone patent design with no metal or shorted wire loop at ends to cause losses. Greatest efficiency, small size and light weight for mounting in wiring.

No. 1010. 5-180 metres. Price 2/-.

STRATTON & CO., LTD.
Bromsgrove Street, BIRMINGHAM.
London Service Depot: Webb's Radio Stores, 14, Soho Street, Oxford Street, W.1.

EDDYSTONE

SHORT WAVE COMPONENTS

Practical and Amateur Wireless KITS

ALL OR ANY OF THE COMPONENTS SUPPLIED EXACT TO SPECIFICATION.

MONITOR 3

COMPLETE KIT (less valves, speaker and batteries) £2.2.6
Valves 32/6 extra. Batteries 20/6 extra.

1	B.T.S. Monitor Coil	5	0
1	POLAR 0.0005 mF. Compax Condenser	2	6
1	J.B. Airplane Drive	5	9
1	POLAR 0.00015 mF. Differential Condenser	3	0
4	T.M.C. Fixed Condensers	3	9
2	DUBILIER Fixed Resistances	2	0
1	BULGIN HF9 H.F. Choke	3	6
1	BULGIN "Senator" L.F. Transformer	6	0
2	BULGIN Switches, S22, S36	2	9
	BULLING-LEE, Sockets, Plugs, Spades	2	11
3	CLIX Valve Holders	1	3
	PETO-SCOTT Metallised Chassis and 4 Brackets	4	1

PREFECT S.W.3

COMPLETE KIT (less valves, speaker and batteries) £2.13.0
Valves, 12/3 extra. Batteries, 20/6 extra.

1	B.T.S. SFC Coil with SFB Coil Base	6	3
1	J.B. Type 1040 0.00025 mF. Tuning Condenser	5	0
1	J.B. Type 2092 Dual Ratio S.M. Drive	6	6
1	J.B. Type 2140 15 mF. Bandspread Condenser	3	9
1	J.B. 0.0005 mF. "Dilecon" Reaction Condenser	2	6
1	VARLEY DP22 "Nictet" L.F. Transformer	7	6
3	B.T.S. UH/4 4-pin Valve Holders	3	0
2	T.C.C. Type 306 Fixed Condensers	2	6
2	DUBILIER 1 Watt Fixed Resistances	3	0
1	WEARITE Type HF3 S.W. Choke	3	6
1	MICROFUSE 60 mA. Fuse and Fuse Holder	1	0
	BELLING-LEE Terminals, Plugs, Battery Cord	3	4d
2	BULGIN No. 5 Battery Clips	0	4
1	BULGIN S35 Junior On/Off Switch	0	10d
	PETO-SCOTT Metallised Chassis with 3 Brackets	4	0

SIMPLE H.F. UNIT

COMPLETE KIT £1:17:10 Valve 13/6 extra.

Lightweight Headphones (Foreign), 6/9 per pair

SCIENTIFIC SUPPLY STORES

(WIRELESS) LTD., 126, Newington Causeway, LONDON, S.E.1. Phone: HOP 1800.

READING A CIRCUIT DIAGRAM

(Continued from page 660)

lines) is an important one, and extends from the anode or plate of the valve, through the H.F. choke, 'phones and high-tension battery, back to the filament. The high-tension negative lead is generally joined directly to the low-tension negative terminal, but in Fig. 1 two lines are indicated to show the duplication of the circuit at this point. It may not be quite clear to some readers why the anode circuit should be shown as extending to the filament, but it should be understood that the current from the high-tension battery flows from the filament of the valve to the anode, through the choke and 'phones, and back to the positive terminal of the H.T. battery.

There is another branch of the anode circuit which extends from the anode to the reaction winding on the coil, through this and the variable reaction condenser to the filament and earth. This may be considered as a separate circuit in one respect, because it carries high-frequency currents only, whereas the other circuit carries (theoretically) no H.F., but only low- or audio-frequency current and the direct current from the filament to the anode.

A Switching Point.

Nearly all of the sub-circuits described could be further subdivided if desired, but this is not generally necessary, and if we considered this aspect now it might possibly lead to a certain amount of confusion. There is, however, one point which should be explained, for it is one which is often misunderstood; the point is that the breaking of the filament circuit by the switch also effectively breaks the H.T. circuit. This is because the filament cannot "emit" H.T. current if it is not heated. Thus, when the filament is switched off the high-tension supply is also switched off; this is true in the simple circuit we have considered, but it does not apply in certain other instances, one of which will be dealt with later.

The L.F. Circuit

Let us now look at the circuit of a simple type of transformer-coupled low-frequency amplifier in which a pentode valve is used. This is shown in Fig. 2, where different

types of line are used to correspond with those shown in Fig. 1. The primary winding of the low-frequency transformer replaces the 'phones and is connected to the two terminals shown in the anode circuit of Fig. 1; the terminal marked A is joined to the anode (through the H.F. choke, as a matter of fact), and that marked H.T. is joined to the positive terminal of the H.T. battery, through a fixed resistance, which is used for decoupling. The transformer terminal marked G is connected to the grid of the pentode, as might be expected, and that marked G.B. is connected to a tapping on the grid-bias battery. The anode of the valve is connected, through the primary

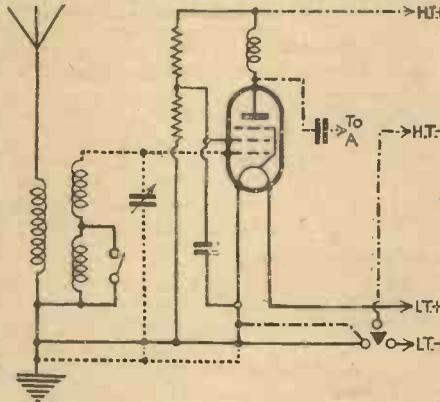

Fig. 3.—The theoretical circuit of a typical H.F. amplifying stage.

windings of the loud-speaker transformer, to H.T.+, and the auxiliary grid—which is situated between the main or control grid and the screening grid—is also joined to H.T.+. The screening grid is generally connected to the filament inside the valve, although in some valves an external connection must be made.

It will be appreciated that only one set of batteries is used, and that the same L.T. terminals feed both valves, the H.T. battery supplying them both in like manner.

H.F. Amplification

The circuit of a high-frequency amplifying valve is similar in principle to the two other circuits with which we have dealt,

and a typical arrangement is shown in Fig. 3, where the same three kinds of line are used. This circuit comprises an aerial-earth circuit, a grid circuit consisting of a coil and a condenser, a filament circuit, an anode circuit, a filament circuit, and the screening-grid circuit, the latter being shown in thin lines.

When the H.F. stage is fitted in front of the detector stage, shown in Fig. 1, the aerial and earth leads are transferred to the H.F. amplifier, and the lead from the anode circuit of the H.F. pentode marked "to A" replaces the aerial lead to the detector-valve tuning coil. It is the screening-grid circuit which must receive most attention, because this is different from the arrangements previously mentioned. As will be seen, the H.T. supply for the screening grid is obtained from the junction of two fixed resistances which form a potentiometer, and the appropriate voltage is obtained by proper choice of the two resistance "arms." But as these two resistances in series are constantly in parallel with the H.T. leads a means must be provided of preventing the leakage of current through them when the set is switched off; unlike the valve, the resistances pass current whether the valve filament is heated or not.

A Three-point On-off Switch

The method of preventing this waste of current is to use a three-point on-off switch, as shown in Fig. 3, of which one terminal is joined to H.T.—, another to L.T.—, and the third to the earth line—which is joined to the valve filaments. This switch actually breaks both H.T. and L.T. circuits, so that the fixed potentiometer is isolated when the set is switched off. Although the switch is shown in circuit with the H.F. valve only, it would, in practice, replace that shown in Fig. 1 when the set combined all three of the stages to which reference has been made.

It has not, of course, been possible to refer to every kind of circuit in use, but it will be appreciated that every circuit, however complex, is based on various combinations of those discussed. Consequently, once the general principles outlined have been grasped there should be no difficulty in gaining sufficient proficiency to follow any arrangement.

BROADCASTS TO SCHOOLS

ACCORDING to a recent B.B.C. announcement, some three hundred and eighty-one thousand pamphlets have been issued in connection with the 1936 Spring Term Broadcasts to Schools. Designed to aid the listening pupil in his following of the respective broadcast courses, the pamphlets with their notes, abundant photographs, and other illustrations are in themselves a lesson and an entertainment. While the pamphlets have always been attractively produced, the present issue shows an even greater wealth of detail and care in preparation than hitherto.

Regional Geography

The Regional Geography pamphlet, covering ten broadcasts on China and Japan, affords a particularly good example of a first-class aid to listening, since it contains not only climatic, population, agricultural, and relief maps of the districts, but also a series of photographs of the people, customs, cities, and landscapes dealt

with by the broadcasters. The geography lessons of the listening children are thus



Jack Edge, the comedian, seems to recognise the voice of a fellow artist as he listens to his new Pye Portable.

vitalised by these real impressions of the countries about which they are learning.

All the three History pamphlets are illustrated by photographs and reproductions of old prints and engravings, while in the Tracing History Backwards pamphlet the old is contrasted with the new to considerable effect. Miss Rhoda Power, who writes a foreword to the British History pamphlet, defines the proper working of school broadcasting probably as well as it has ever been defined when she says: "My part at the microphone is to try to make the history in these lessons come to life. Your part at the loud-speaker is not only to listen, but to try to see with your ears as clearly, as you see with your eyes when you go to the pictures."

German and French Lessons

Both the Junior German and Junior French pamphlets have their texts interspersed with photographs, poems, songs, and humorous pictures, the whole being designed to make these lessons as entertaining to young listeners as they are instructive. Songs and poems are also included in the German section of the Broadcasts for Secondary Schools pamphlet.

On Your Wavelength

Make and Break!

ISN'T it funny how the wireless has made some tunes and yet killed others? I have lost all interest in Rachmaninov's Prelude and Liszt's Hungarian Rhapsody. I heard a record of the Rhapsody made, if I remember rightly, by some Italian vocalists whom I do not know. They recorded a vocal arrangement and I am still wondering whether it was meant to be fun or not. If it was meant to be funny, it was very funny, but if it was meant to be serious, it was extremely funny.

What's the Difference?

HONESTLY I cannot tell the difference between some of the skilled kerbstone violinists and the £1,000-per-concert super-highbrow violinist who, for hours and hours, plays tuneless sounds which are merely examples of instrumental and digital acrobatics. It is all a matter of luck, I suppose. To them that hath, more shall



I can see no difference between the street musician and the super highbrow.

be given unto them. Personally I believe in the music and not in the individual. Anyone can croon; thousands of people can play the violin really well.

Drop in Licences

AS we approach the 8,000,000 total licence figures the rate of increase is naturally showing a tendency to slow up. The Post Office has just issued the figures for December and these show a greater decrease, if you will permit the paradox, than was expected. During December 894,856 licences expired and 940,964 new licences were issued. Thus, the increase for the month is only 46,108 as compared with 119,565 in December, 1934, and 101,722 in December, 1933.

The approximate totals of current licences in force on December 31st last were:

	Paid Licences	Free for the Blind
England and Wales	6,685,000	38,450
Scotland	610,000	4,700
Northern Ireland	77,000	650
	7,372,000	43,800

The increase in licences during the whole of 1935 amounted to 635,600; for 1934 the increase was 805,950, and for 1933 it was 729,973.

Television Viewing Rooms

AT a recent B.B.C. Press Conference Sir Noel Ashbridge and Mr. Gerald Cock outlined the present state of progress

By Jhermion

in the projected television service. He explained that work is being pushed forward at the Alexandra Palace, but the site is not yet ready for the installation of the transmitting equipment by E.M.I. and Baird. It is hopefully anticipated that sufficient progress will have been made to enable the first tests to be carried out in March. Tests and experiments will occupy at least two months, and Sir Noel said that, barring snags, there may be a regular television service starting in June. It is proposed to have three one-hour transmission periods each day, namely, 3 to 4 p.m., 6.15 p.m., to 7.15 p.m., and 9.30 p.m. to 10.30 p.m. Film and direct television will be employed, but it is not intended at the moment to transmit long films, although it is possible that excerpts may be made from current film releases. It is proposed to give the public an opportunity of seeing for themselves what television will be like, and for this purpose viewing-rooms will be established in various parts of London; one will probably be in the West End, and others may be located in some of the Big Stores and the News Theatres. The service range of the Alexandra Palace transmitters will be approximately twenty-five miles radius, and no steps will be taken to establish other stations for at least a year.

"The Abyssinians have the war well in hand"

THIS remark was heard a short time ago by a short-wave listener to Addis Ababa. The American announcer was making tests, and concluded with a message to his wife to say that he would shortly be returning to New York as "The Abyssinians had the war well in hand."

Mr. J. C. Hodson, of Ever Ready Radio, Ltd., manufacturers of the all-wave set used on this occasion, said that it was quite possible to get programmes from distant stations such as Addis Ababa as clearly and loudly as British transmissions.

Added Realism

THE B.B.C. apparently spends a great deal of time, thought, and hard cash in the improvement of the transmissions, and anyone who has visited the studios recently will have noticed the new microphones which are now in more or less general use. But how many experimenters or designers are engaged in a quest at the same time to keep pace with the improvement in the transmissions? New tuning systems and new arrangements of old circuits does not justify the word "development," and I have only met one amateur who spends practically every spare moment in trying out some new type of coupling. Is there any better arrangement than push-pull—either of the ordinary transformer-coupled type or of the paraphase or inverted-phase type? I do not think there is a single commercial receiver on the market

in which any coupling is employed for which greater claims are made than for the above schemes. Yet surely we have not reached finality in this direction. Not many moons ago I heard that the B.B.C. employed only resistance-capacity couplings in the low-frequency monitoring circuits, and yet on a recent visit I found push-pull was being employed, and transformer coupling was in use. Does this represent a development or a retrograde step? I cannot imagine the latter, yet we are told that the iron losses are terrible in an ordinary transformer. What about battery coupling, which at one time was stated to have great promise? The circuit developed by Major Prince, and generally referred to as the trigger circuit, was also acclaimed and was found to be capable of great things at the time. Yet these couplings have died. I would suggest that all amateurs who also have an interest in quality reproduction spend some time in reading through the various patent specifications at the Patent Office, or otherwise familiarise themselves with various couplings, and carry out experiments with a view to improving the L.F. circuits. There is obviously room for improvement, and who knows what might be discovered by an at present unknown experimenter?

A Knowing Parrot

I LEARN from a daily paper that a parrot at Kingston-on-Thames insists that the wireless should be switched on for the children's hour, and when he hears "Hello! children," replies, "Hello, dear," but talks and chamber music make him shout, "Don't like it, shut up." This must indeed be a knowing parrot, and I should very

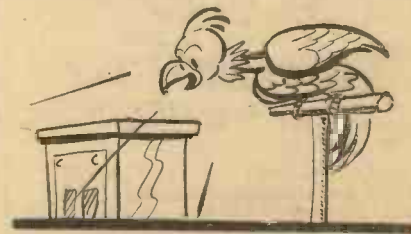

How do your pets like the wireless?

much like to meet it. After all, a journalist is in large part a parrot, and must repeat in many cases what he is taught. As one parrot to another we might have a friendly conversation. Perhaps he would be good enough to read my notes and give me his comments. How do your pets like the wireless?

Music from Bits of Glass and Metal

FROM molten glass and little bits of metal comes music to thrill a million homes! How often when you sit listening to the pure notes issuing from the speaker of your radio set do you think of the "wonder" already so commonplace in our twentieth century existence? How often do you think of those marvels of ingenuity, those little pieces of glass and metal which

have made it possible for stars to shine nightly in your drawing-room? This fact was brought home to me last week when I visited the five huge factories of A. C. Cossor, Limited, at Highbury. In an afternoon tour of these vast rooms I was practically struck dumb with the wonderful intricacies of the machinery with which Cossor valves are made; of the amazingly slick movements of the workers, performing miracles of dexterity every minute of the day.

Some of the girls are able, with a deft twist of the finger, to fix an infinitesimal spring through a hole as big as a pin and under a "filament" wire as thick as a human hair. Dozens of other microscopic operations are necessary before the valve is ready to conjure music from the air—dozens of little pieces have to be placed the right number of "thousandths of an inch" apart before the valve can pass all the stringent tests to which it is subjected. The most amazing thing about these girls of the nimble finger is that each of the fiddly little adjustments must be made *with gloves on*, for it is fatal to a valve if the tiniest particle of grease or moisture is left inside. I always thought that radio was a man's game, but half an hour in Cossor's valve works convinced me that it is definitely the other way about.

One of the machines fascinated me very much for the thing was almost human. It had hands, mechanical hands which lifted bits of glass about as naturally as I could. For some obscure reason the robot machine is called the "footmaker," and it is used for manufacturing the glass foot on which all the valve parts ("electrodes," murmurs the expert) are mounted. There are many other interesting machines, one of which, the "escalator," subjects the finished valve to characteristic stabilisation. This mammoth machine is called an escalator because it is rather similar in principle to a moving stairway, only instead of carrying passengers, it has countless valves plugged into each step. Another thing that impressed me was the hydrogen oven. This is a long cylinder with a furnace inside through which all the metal valve parts are passed. They emerge purified from the other end, and are once more whisked off for assembly.

Loud Buzzing Noise in House

THE following appeared in the *Carpenter and Builder*: "LOUD BUZZING NOISE IN HOUSE.—I am troubled in my

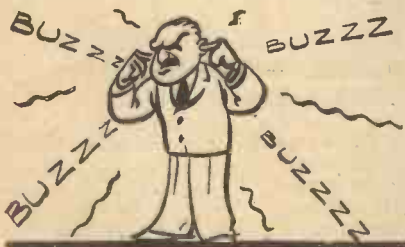

He has a buzzing all over the house caused by the reaction battery next door!

house by a strong buzzing noise which is continuous all day and night. At times it is so strong that it prevents me using my battery wireless set and it affects our nerves badly. It is not confined to any one place, and I believe the source of trouble is from a reaction battery in the house next door. I have no electricity in my house. Can anyone suggest the best method to counteract this nuisance?"—From *Carpenter and Builder*, January 17th, 1936.
Well!



Notes from the Test Bench

Using Eliminators

A READER wrote to us the other day complaining that he was not getting sufficient volume from his three-valve receiver, which, he mentioned, was being supplied with H.T. from a 15-m/A eliminator. The valves used were of the indirectly-heated type, the last one being a power type of well-known make. Naturally, we informed the reader that his eliminator was unsuitable for supplying his mains valves, as the normal current consumption of the output valve alone was nearly twice the rated output of his eliminator; the unit he was using was designed for supplying battery-type valves of the low-consumption type. Very few battery eliminators are suitable for supplying mains valves, and they are likely to become damaged if used for this purpose. If a mains power or pentode-output valve is employed the mains unit should have an output of 40 to 60 m/A.

Mains Units

ON the other hand, mains units designed for supplying mains valves should not be used in conjunction with battery-type valves, otherwise the latter are liable to become damaged owing to the application of excessive voltage to their anodes. The majority of mains units, or power packs as they are sometimes called, designed for supplying mains valves have an output of approximately 200 volts at 60 m/A. The H.T. consumption of the average battery receiver is less than 30 m/A., and the required anode voltage less than 150 volts. If only 30 m/A. are taken from the unit the output voltage is liable to rise to 250 volts, and, therefore, valve damage is almost certain to occur.

Trickle Charging

IF an A.C. mains supply is available in the home the accumulator can be charged very cheaply. All that is necessary is a rectifier and a suitable transformer; the L.T. type of metal rectifier is very suitable for this purpose. When the supply is D.C., however, charging an accumulator is an expensive procedure, as some form of resistor has to be used to drop the voltage to the required value. In the A.C. charger the transformer drops the voltage and very little loss is experienced.

If it can be arranged to do the necessary charging during the evening when the lights are on, however, one of the lamps normally used for lighting purposes can also be used as the resistor in the charger. The positive main lead should be joined to one of the lamp sockets, the other lamp socket to the positive terminal of the accumulator, and the negative terminal of the accumulator to the negative mains lead. The lamp can then be mounted where required and the leads made sufficiently long to reach the accumulator. A 100-watt, 200-volt lamp connected in this manner to 200 volt mains will provide a charging current of approximately .5 amp.

Mechanical Radio

I KNOW an experimenter who has a son I at present in the early school age. He gave him one of the well-known mechanical constructional toys for a Christmas present, and although only one month has passed, I found on calling round the other day that the major portion of this toy has now been included in the radio outfit. The result was not only interesting but very amusing, and the following will give you an idea of the set as it appeared to me. I was shown into the drawing-room as usual, and nothing appeared to differ from my previous visit. Radio is my friend's one pleasure in life, and, after the usual family greetings, I said casually, "How's the radio?" At this my friend turned to the receiver, and instead of operating the usual tumbler switch at the side of the cabinet in the usual manner, I was surprised to see him take out a key from his pocket. I naturally immediately thought that he had been forced to lock the set against the interference of his son, but was surprised the next minute to see him turn to a small cupboard in the opposite corner of the room. He stopped and did something with the key, and I heard a faint whirring start in the cupboard. He then turned to me and, with a smile, said, "What station would you like to hear?" Thinking there was some joke on, I replied airily, "Stuttgart," and he simply pointed to the set, and I was surprised to see the dial light suddenly burst into light, and a medley of quiet sounds came from the speaker. These gradually steadied down, and then music burst forth. I waited, with some impatience and, when the music ceased, was surprised to hear the well-known voice of the announcer at Stuttgart. Yet my friend had not touched the set. He then said, "What now?" and in an endeavour to trace the stunt, said "Poste Parisien," and apparently without doing anything the set automatically tuned itself to this station, very little noise being heard as the set passed through the tuning range. At first I was astounded, but when I was shown "the works," I must admit that his son will one day slang his father for stealing all his toys. In the cabinet was a most amazing collection of wheels, motors, and pulleys, all connected in a novel manner to drive a motor in the radio cabinet. The tuning condenser was simply being driven from a distance, and an automatic

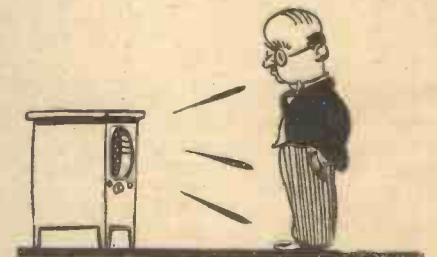

Liszt's Hungarian Rhapsody leaves me cold now that I have heard it so often.

quenching device was thrown across the speaker when the condenser started to move. He had a number of studs connected to an arrangement which acted in the manner of a time-switch, and this turned off the motor at the end of a pre-determined period, and he had arranged for the reception of nearly a dozen stations in this manner. But what a waste of energy! Still, I suppose this is an outlet for the mechanical bent which lies dormant in most of us.

F. J. Camm's **Monitor** **3**

SPECIALLY DESIGNED FOR BEGINNERS
By F. J. CAMM

EASY TO BUILD — — — — — —AND GUARANTEED!

A REMARKABLE RECEIVER FOR 45'.

I AM addressing this article particularly to the beginner, and in that class I must necessarily include those many thousands of new readers who make their acquaintance with PRACTICAL AND AMATEUR WIRELESS for the first time with this issue. It is customary for editors to issue from time to time carefully prepared special issues of their papers to appeal to particular interests, and in this issue I have included special features of interest to those who are taking up radio for the first time. If you are a regular reader of this paper I have no need to implore you to tell your friends about it, nor do I need to offer you a packet of toffee or some other trifle in order to secure your interest. The tendrils which hold my readers are, I am gratified to know, not of the effeminate kind which need to be revived by palliatives, artifices, and tautological rhetoric. As a regular reader you will know of the services which this journal has faithfully rendered to home constructors and to home construction. The "Wireless Constructor's Encyclopædia," the "Television and Short-wave Handbook" (the first authoritative book on television—written in popular language), our Free Gift Steel Spanners, our Pocket Tool Kits, our Home Constructors' Steel Drill Gauge and Wire Stripper, our Free Gift Data Sheets, "Everyman's Wireless Book," "The Encyclopædia of Popular Mechanics"—these are but a few of the high-class productions issued in free gift form to our readers. I cannot immodestly claim that a new interest was brought to home construction when this journal was issued, but I am naturally flattered to observe the general adoption

of many of the schemes sponsored by this journal. These schemes were introduced to make available to the reader in easily consultable form all of the available knowledge required by him for an intelligent understanding of this absorbing hobby.

LEARN AS YOU BUILD!

A Sound Combination of Cheapness, Simplicity, and Reliability

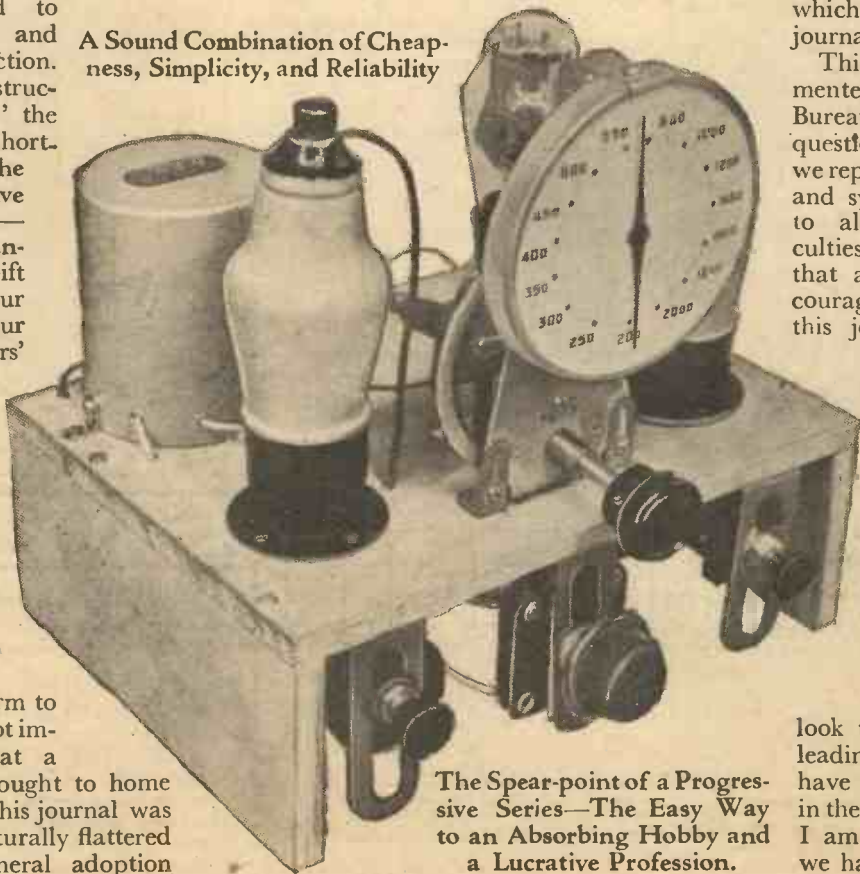

The Spear-point of a Progressive Series—The Easy Way to an Absorbing Hobby and a Lucrative Profession.

As a new reader it is important that you should know that this journal stands behind every receiver built from designs published in its pages, with the only proviso that the parts specified be used. This is the first journal to issue a guarantee of this sort. If a receiver made from one of our designs fails to work, we are delighted to adjust and test it for you. This is a service of which many beginners have availed themselves, and the inevitable result has been that our receivers have attained unassailable renown and reputation. Readers have not failed to tell their friends about our free service, and this has formed one of the finest national advertising media which it is possible for any journal to possess.

This Free Service is augmented by our Free Advice Bureau. We answer your questions free of charge, and we reply promptly and fully, and sympathetically attend to all our readers' difficulties. I have always felt that a reader who is encouraged by an article in this journal to build one of our receivers should obtain the service which he gets from the manufacturer of a commercial receiver. In taking this personal interest in every receiver built from our designs, and by instituting our unrivalled free technical advice bureau, home constructors throughout the world now

look to this journal as the leading authority, and we have obtained our reward in the leading position which I am encouraged to think we have attained by merit.

A FINE RECEIVER BY OUR LEADING

THE

Prior to the publication of this journal nearly all receivers were of the baseboard type, and it was this journal which sponsored the metallised chassis which is now almost universally adopted. In fact, I think I can lay claim to having introduced it many years before this journal commenced publication. Metal chassis are not popular with amateurs because of the difficulty they sometimes experience in cutting large holes in them. The metallised wooden chassis, however, is equal in every way to the metal chassis, and that system has been selected for my Monitor.

Every year many thousands of new recruits join the ranks of home constructors. They endeavour to gain their fundamentals in radio technique by building a simple receiver before graduating to more complicated designs. The technical press has in a large measure neglected this large influx, and except for a few designs tucked away without splash or glamour, the beginner has had to grope his way. Left neglected and to his own devices the beginner falteringly attains success with his first receiver after many expensive mistakes, and in some cases forsakes the hobby as being beyond his pocket and his ken.

I have received many thousands of letters during the past three years pointing out that the technical press ignored this large increment of beginners, and the urge is now upon me to encourage, expand, and develop the constructor market by turning my attention to them. My urge takes the practical form of the Monitor Three, of which a full-size blueprint is given in this issue. This blueprint is but the spear-point, for it will form the basis of a weekly series of articles, each of which will show how the veriest beginner may adapt, implement, and modify the Monitor Three so that he may add automatic volume control, visual tuning, an extra H.F. stage, Class B output, and so on. Thus will the beginner learn as he builds. The weekly articles will tell him how to convert the

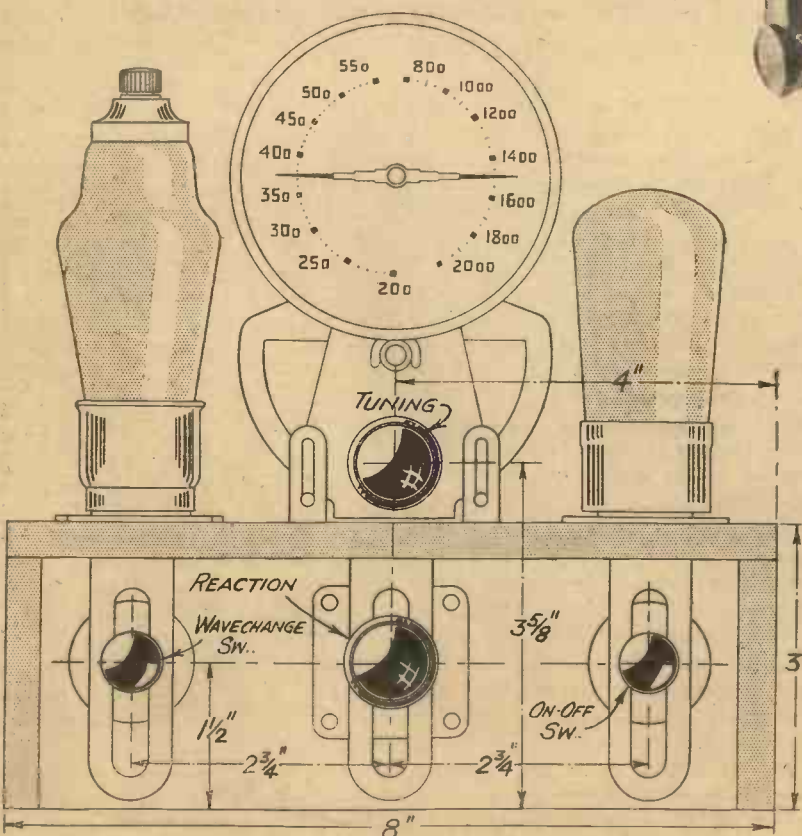
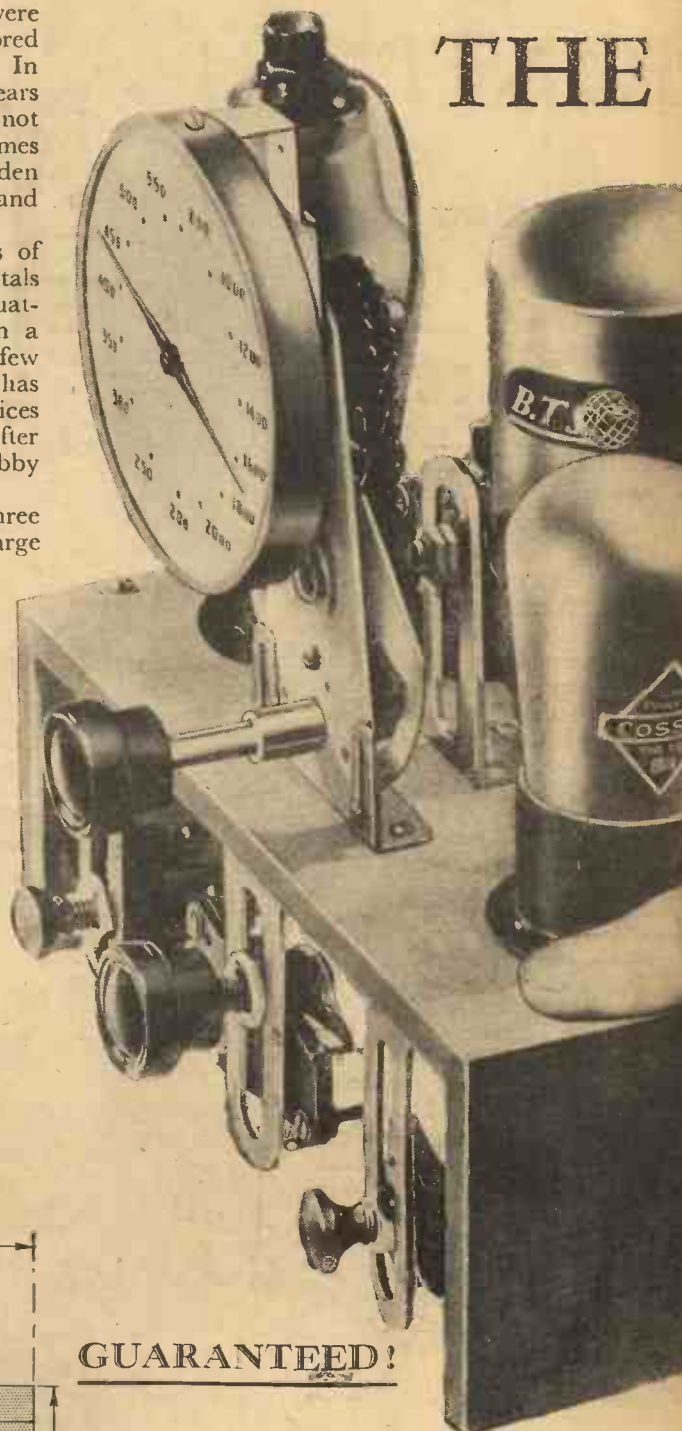

Front elevation and cabinet-mounting dimensions.

GUARANTEED!

LIST OF CO

- One coil (B.T.S.)
- One .0005-mfd. Compax condenser (Polar).
- One airplane drive (J.B.).
- One .00015-mfd. differential reaction condenser (Polar).
- Four fixed condensers: .5 mfd., .1 mfd., .002 mfd., .0003 mfd. (T.M.C.).
- Two fixed resistances: 40,000 ohms, 1 megohm (Dubilier).
- One H.F. choke, type HF9 (Bulgin).
- One Senator L.F. transformer (Bulgin).
- One three-point switch, S36 (Bulgin).
- One two-point switch, S22 (Bulgin).
- Three socket strips: A/E, L/S, P/U (Belling-Lee).

NG DESIGNER! MONITOR!



HIGH-EFFICIENCY COIL PENTODE OUTPUT VALVE DETECTOR VALVE

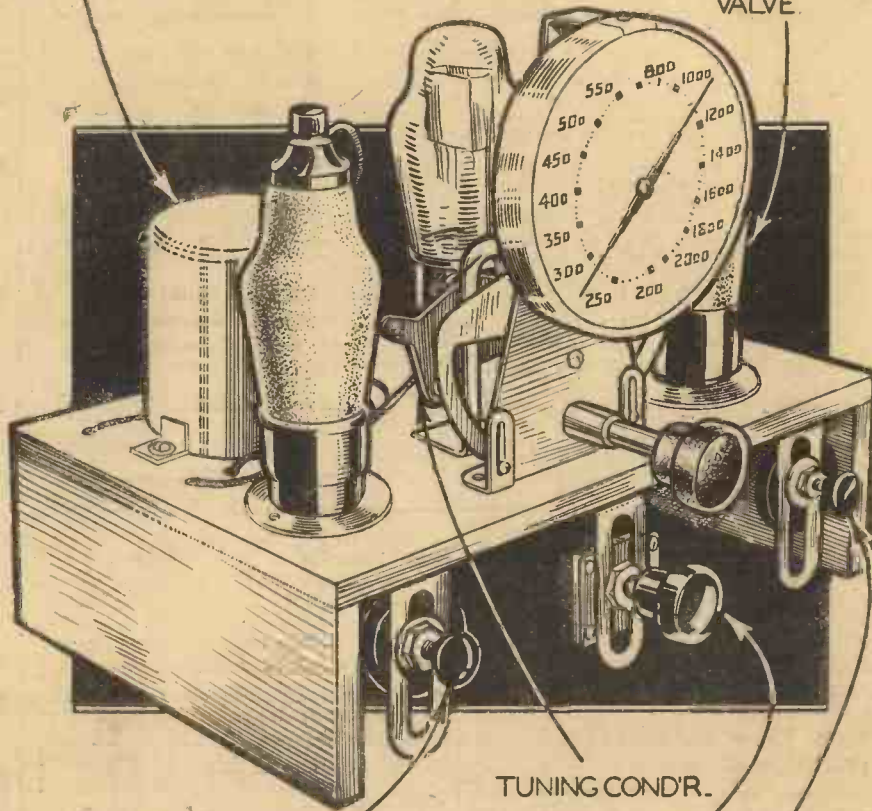

WAVECHANGE SWITCH DIFF. REACT. COND'R. ON-OFF SW.

The Veriest Beginner Can Make The Monitor

Monitor Three into a superhet, or into a radiogram, and they are particularly designed in carefully planned progressive stages.

The serial interest of which the Monitor Three is the precursor will, I am positive, be the best means of gaining a sound and exhaustive knowledge of radio and of starting the beginner on an absorbing hobby or a lucrative career. This new series will augment, not replace, the existing policy which has been found so successful. I would ask all readers, and particularly beginners, to co-operate with me in this scheme, and I welcome their suggestions in order that it may be brought to successful fruition.

The Monitor is an ideal receiver for beginners, for it is inconceivable that the veriest novice will make a mistake with it. There are no tricky adjustments, no expensive components, and it can be made in an evening. Most important of all, it costs only 45s. to build. In spite of its simplicity, however, it is just possible that a faulty component may get into stock, and I realise that [a beginner in such circumstances may blame either himself or the design. I ask you, therefore, to let me come to the rescue. If, after carrying out the instructions given in this issue, the receiver fails to work, to let me test and adjust the receiver for you. This service to beginners I shall gladly undertake, and free of charge. If there is any other way in which my practical assistance may be rendered, let me know. My offer expresses my confidence in the design, and my desire to encourage rather than to disappoint. Let me help you if you strike the slightest difficulty.

Another important point about the Monitor is that it is cheap to run. Also it is small in size and easily handled. It may be made with the simplest of tools and the fewest possible wires are used to connect the various components.

(Continued overleaf)

COMPONENTS

- Three valve-holders : two 4-pin, one 5-pin (Clix).
- Four component brackets (Peto-Scott).
- Six plugs : H.T.—, H.T.1, H.T.2, G.B.—, G.B.—1, G.B.—2 (Belling-Lee).
- Two spades : L.T.—, L.T.+ (Belling-Lee).
- One metallised chassis, 8in. by 6in. by 2½in. (Peto-Scott).
- Three valves : 210VPT, 210Det., 220HPT (Cossor).
- 120-volt H.T. battery (Drydex).
- 9-volt G.B. battery (Drydex).
- 2-volt accumulator (Exide).
- Speaker, Stentorian, Model 36/S (W.B.).

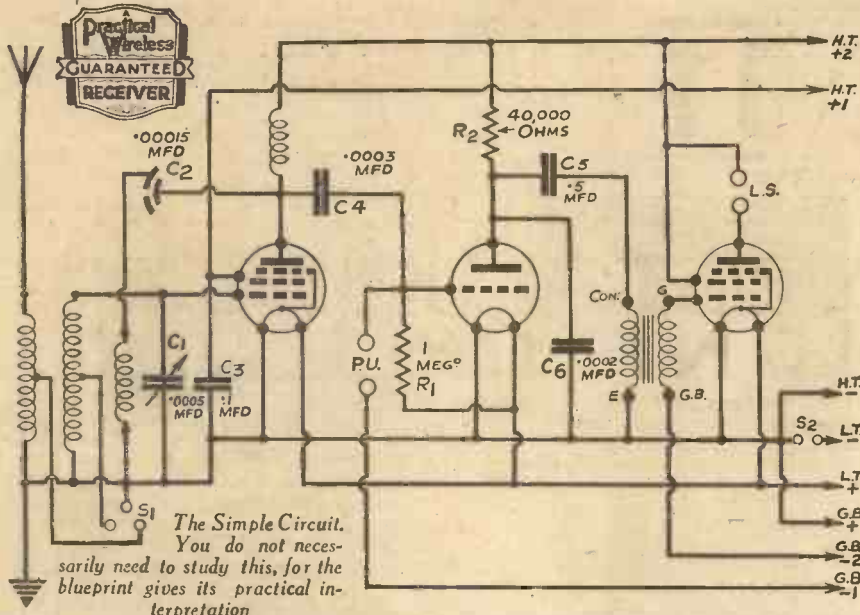

(Continued from previous page)

The majority of three-valve receivers cannot easily be improved or converted into four- or five-valvers, but the Monitor Three design has been carefully thought out with a view to making it suitable in its existing form as a reliable little three-valver for the beginner and also as the nucleus for an ambitious five-valver.

The Circuit Arrangement

Readers who are acquainted with theoretical diagrams will note that the circuit arrangement consists of a tuned aerial stage using an H.F. pentode valve, choke-resistance coupled to a triode detector, this in turn being parallel-fed transformer coupled to a pentode output valve. This arrangement is not as selective as the two tuned circuit type, of course, but selectivity is adequate for most requirements, and an additional tuned circuit can be added at a later date if found desirable. The straight detector, two L.F. circuit arrangement could have been used, of course, but this does not lend itself as well as the chosen arrangement to later modifications and additions, and the quality of reproduction obtainable from a straight three is inferior to that obtainable from the Monitor. This is due to the fact that in most straight three receivers having a detector as first valve the latter is not fully loaded by the aerial; in the Monitor the aerial feeds into an H.F. stage which amplifies the input before the detector is reached. The amplification obtained from the untuned stage is not quite equal to that obtainable from a fully-tuned stage, of course, but a very useful degree of amplification is, nevertheless, obtained. Another cause of bad quality in the detector two L.F. type of battery set is the overloading of the first L.F. valve; this valve is not used in the Monitor and, therefore, a common source of distortion is removed.

Current Economy

A study of the characteristics of the valves used will indicate that their H.T. current consumption is very low, and, therefore, the receiver can satisfactorily be supplied from the small type of dry H.T. battery. If the instructions given at the end of this article are carefully followed the total consumption will only be approximately 6 m.A. This is, of course, well within the limits of the low-capacity dry battery, but if an eliminator or a large-capacity

battery is available, there is no reason why these should not be used. The 10 to 12 m.A. 120-volt type of eliminator should prove quite satisfactory. The L.T. consumption is also reasonably low—.4 amp. to be exact—and therefore a low capacity

THE MONITOR CARRIES ITS DESIGNER'S GUARANTEE!

accumulator may be used for supplying the filament current. If the set is used for two to three hours a day, a 20 A.H. accumulator should last about ten days.

Constructional Work

As the small number of components used are easily accessible no difficulty should be

experienced with the constructional work and wiring. The first job should be the mounting of the valve-holders and socket strips. A 1/16 in. drill is suitable for the valve-holder holes, and a 1/8 in. drill may be used for the socket strip holes, although the actual size of the latter is not critical. After the valve-holders have been screwed down, the sub-baseboard components should be mounted and the wiring of these completed as far as possible. When fixing the sub-baseboard component brackets care should be taken to use short screws so that there is no possibility of their piercing the metallised surface—in the case of the reaction condenser bracket connection between the bracket and the metallised surface of the baseboard could cause serious damage. After the underneath components have been carefully fixed and the various connecting wires joined up, the tuning coil and tuning condenser can be mounted. In the case if these two components it is essential that their mounting brackets be in good contact with the metallised surface of the chassis, as several of the internal wires of the coil are joined to the screening can, and the moving vanes of the tuning condenser are joined to the coil and earth terminal via the mounting bracket and the chassis metallised covering. The wiring of these last two components can now be completed, and the airplane drive locked to the spindle of the tuning condenser.

Battery Leads

After the wiring has been carefully checked and found to be in order, the battery, aerial-earth, and loud-speaker leads may be connected to their respective sockets and terminals and the receiver is ready for switching on. If a milliammeter is available it is suggested that this be connected between the H.T.—lead and the H.T.—socket of the battery so that the current consumption may be checked. As mentioned before, a reading of 6 to 7 milliamps. should be registered if everything is in order. The G.B.—1, G.B.—2, and G.B.—3 plugs should be inserted in the +1 1/2, and 4 1/2 sockets of the G.B. battery respectively, the H.T.—, H.T.—1, and H.T.—2

(Continued on page 670)

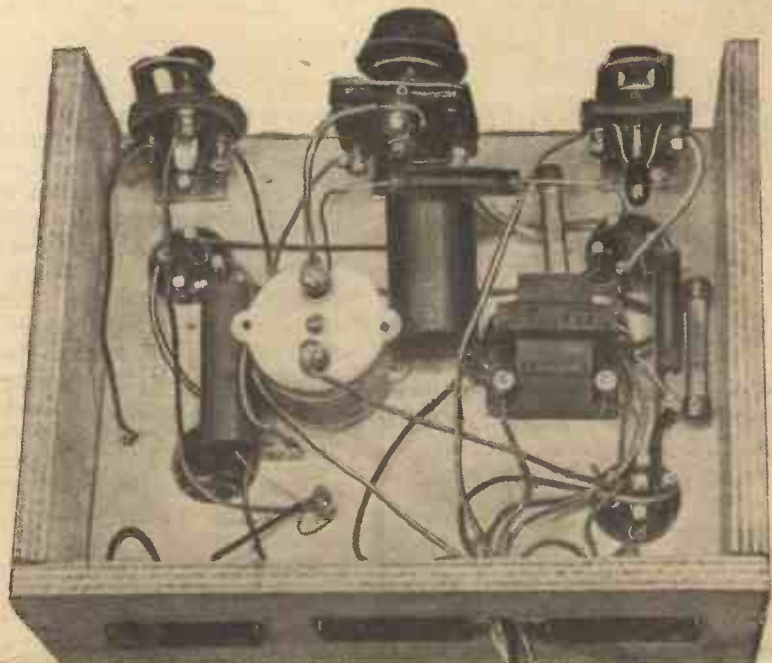

Under-chassis view of the Monitor.

PETO-SCOTT PILOT AUTHOR KITS EXACT TO SPECIFICATION

Peto-Scott 1936 UP-TO-DATE SENSITIVE S.G.3 KIT SEND for FREE BLUEPRINT

The latest Peto-Scott Kit Set triumph! The last word in Sensitivity, selectivity, and high fidelity reproduction under modern broadcasting conditions.

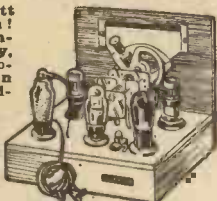

- 2 gang Air Dielectric Condenser
- Automatic Grid Bias
- Full Vision Slow Motion Tuning
- Detector, S.G., Pentode Valves
- Modern Air-spaced Coils

KIT "A" comprising all parts, including ready drilled chassis and panel, less Valves, Speaker, Cabinet. Cash or C.O.D. Carriage Paid, 35/ or 2/6 down and 9 monthly payments of 4/.

KIT "B" with valves. Cash or C.O.D. Carr. Paid, £2/19/9, or 5/- deposit and 11 monthly payments of 5/.

2/6 DOWN

Peto-Scott 1936 UNIVERSAL SHORT-WAVE ADAPTOR - CONVERTER KIT SEND FOR FULL DETAILS and FREE BLUEPRINT

Covers 13-80 METRES. Converts your existing battery or A.C. Receiver for operation on short waves, with no alterations, bringing you America direct, programmes from all over the world. Two hours to build... a life-time of world-wide radio entertainment!

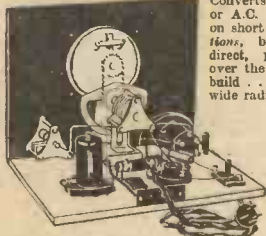

2/6 DOWN

KIT "A" CASH OR C.O.D. £1:19:6 Carriage Paid. Or 2/6 down and 10 monthly payments of 4/3. All parts for building, including Full-size Blueprint and assembly instructions, less Cabinet.

SPEAKER BARGAIN

Manufacturers stock of BRAND NEW Permanent Magnet Moving-Coil Speakers at less than cost. 6-in. Cone. Large magnet and complete with input transformer suitable for Power, Super-Power or Pentode. Cash or C.O.D. Carriage Paid 10/6

B.T.S. BANDSPREAD OCEANIC SHORT-WAVE 3 DELIVERY FROM STOCK

The latest B.T.S. Short Wave Kit for the beginner. Simple to build, simple to operate. Incorporates efficient Band Spreading system, enabling you to tune-in long-distance Short Wave stations nearly as easily as London. Every kit supplied complete with Blueprint and copy of "The Short Wave Constructor."

- Triode detector, amplifier and output valves.
 - B.T.S. Triple range coil.
 - Range 12-80 metres.
 - No coil changing.
 - Ready Drilled Aluminium Chassis and Panel.
- KIT "A" CASH OR C.O.D. £2:15:0** Carriage Paid. Or 5/- down and 12 monthly payments of 5/-. Send for Full Details and Free Blueprint.

STENTORIAN SENIOR

Model 368 P.M. Speaker. Suitable for any output and incorporating improved Microtone device. Cash or C.O.D. Carriage Paid, £2/2/0, or yours for 2/6 down, balance in 11 monthly payments of 4/-. W.B. Stentorian Junior Model 363. Cash or C.O.D. Carr. Paid, £1/12/6, or 2/6 down and 11 monthly payments of 3/-. **2/6 DOWN**



Any Other Speaker on Easy Terms. Send for Lists.

IMPORTANT PILOT AUTHOR KITS are only obtainable direct from Peto-Scott. We can supply any Kit featured in this journal during the past three years. Miscellaneous Components, Parts, Kits, Finished Receivers or Accessories for Cash or C.O.D. or H.P. on our own system of Easy Payments. Send us a list of your wants. We will quote you by return. C.O.D. orders value over 10/- sent carriage and post charges paid (GREAT BRITAIN ONLY). Hire purchase terms are NOT available to Irish and Overseas Customers.

IMMEDIATE DELIVERY-CASH-C.O.D. or H.P. MONITOR 3 KIT "A" 45/-

These are the Parts Used by Mr. F. J. GAMM and Contained in PILOT AUTHOR KIT "A" Any item supplied separately. Orders over 10/- sent C.O.D.—carriage and post free.

	£	s.	d.
1 Peto-Scott Drilled Metaplex chassis, 8" x 6" x 2 1/2"	2	9	
1 B.T.S. Monitor coil	5	0	
1 Polar Compax condenser	2	6	
1 J.B. Airplane drive	5	9	
1 Polar diff. reaction condenser	3	0	
4 T.M.C. tubular condensers	4	3	
2 Dubilier 1-watt fixed resistances	2	0	
1 Bulgin H.F. choke, type H.F.9	3	6	
1 Bulgin L.F. transformer	6	0	
1 Bulgin 3-point switch	1	6	
1 Bulgin 2-point switch	1	3	
2 Belling Lee spades	2	3	
3 Clix valveholders	2	1	
4 Peto-Scott Component brackets	1	4	
6 Belling Lee Bowspring plugs	4		
2 Belling Lee spades	4		
Connecting wire, screws, flex	1	6	

KIT "A" CASH OR C.O.D. Carriage Paid £2 5 0

VALVES - Set of 3 Cosor Valves as specified. Cash or C.O.D. Carriage Paid £1/2/6, or 5/9 down and 5 monthly payments of 5/9.

ANY ITEM SUPPLIED SEPARATELY—ORDERS OVER 10/- SENT C.O.D. CARRIAGE AND POST CHARGES PAID

PREFECT SHORT-3 KIT "A" £2:15:0

These are the Parts Used by Mr. F. J. GAMM and Contained in PILOT AUTHOR KIT "A" Any item supplied separately. Orders over 10/- sent C.O.D.—carriage and post free.

	£	s.	d.
1 PETO-SCOTT Drilled Metaplex chassis, 10" x 8 1/2" with 2 1/2" runners	3	0	
1 B.T.S. 6-pin short-wave coil	4	6	
1 J.B. Popular log condenser	5	0	
1 J.B. Dual radio drive	6	0	
1 J.B. Bandsread condenser	3	9	
1 J.B. Dilexon reaction condenser	2	6	
1 VARLEY Niclet L.F. transformer	7	6	
3 B.T.S. 4-pin valveholders	3	0	
1 B.T.S. 6-pin Short-wave coil base	2	0	
3 DUBILIER 1-watt resistances	3	0	
1 WEARITE Short-wave H.F. choke	3	6	
1 MICROFUSE 60 m.a. fuse and holder	1	0	
4 BELLING LEE type "B" terminals	1	0	
1 BULGIN on-off switch	2	0	
3 BELLING LEE Bowspring wander plugs	4		
1 BULGIN on-off switch	10		
3 PETO SCOTT Component mounting brackets	1	0	
2 T.C.C. Fixed condensers, type 300	2	0	
2 BULGIN G.B. battery clips, No. 5	4		
Connecting wire, screws, flex	2	3	

KIT "A" CASH OR C.O.D. Carriage Paid .. £2 15 0

VALVES - Set of 3 Hivac Valves as specified, Cash or C.O.D., 12/3. Postage 6d. extra.

Ericsson's HEADPHONES

The most famous headphones on the market. Receivers and headbands are of aluminium. Extremely light and comfortable in use. Wound to 4,000 ohms resistances. Per Pair Carriage Paid **12/6**

NEW Cosmocord PICK-UP

MODEL 278. Entirely new product designed to give high fidelity reproduction with large distortionless output. Incorporates special method of frictionless armature suspension. Supplied complete with volume control, screened leads and combined pick-up arm rest and needle cups. **CASH OR C.O.D. £1:7:6** CARRIAGE PAID. Or 5/- deposit and balance in 5 monthly payments of 5/-.

Author's Kit of First Specified parts, including Ready Drilled Metaplex Chassis, less Valves, Cabinet and Speaker.

7/6 DOWN

Balance in 6 monthly payments of 7/-.

KIT "B" As for Kit "A," but including set of 3 specified valves, less Speaker and Cabinet. Cash or C.O.D. Carriage Paid £3/17/6. Or 10/- deposit and 10 monthly payments of 7/6.

C.O.D. PARCEL

Comprising ● B.T.S. Monitor Coil. ● Polar Compax Condenser. ● J.B. Airplane drive. ● Peto-Scott Ready Drilled Metaplex Chassis, 4 Component Brackets, and all necessary connecting wire, wood screws and flex. Cash or C.O.D. Carriage Paid, 18/6. **CASH OR C.O.D. 18/6 CARRIAGE PAID.**

ANY ITEM SUPPLIED SEPARATELY—ORDERS OVER 10/- SENT C.O.D. CARRIAGE AND POST CHARGES PAID

CASH OR C.O.D. CARR. PD.

Author's Kit of First Specified parts, including Ready-drilled Metaplex Chassis, less Valves, Cabinet, Speaker and Headphones.

7/6 DOWN

Balance in 7 monthly payments of 7/9.

KIT "B" As for Kit "A," but including set of 3 specified valves, less Speaker, Headphones and Cabinet. Cash or C.O.D. Carriage Paid, £3/7/6, or 10/- deposit and 7 monthly payments of 9/3.

KIT "C" As for Kit "A," but including valves and Peto-Scott Walnut finished Cabinet, less speaker and headphones. Cash or C.O.D. Carriage Paid, £4/6/6, or 12/6 deposit and 7 monthly payments of 12/-.

C.O.D. PARCEL

Comprising ● B.T.S. 6-pin Short-Wave Coil and Base ● J.B. 15 mmf. Bandsread condenser ● 3 B.T.S. Short-Wave valveholders. ● Wearite Short-Wave H.F. Choke. ● Peto-Scott Ready-drilled Metaplex Chassis. ● 3 component brackets, and all necessary connecting wire, wood screws and flex. Cash or C.O.D. Carriage Paid, 22/6. **CASH OR C.O.D. 22/6 CARRIAGE PAID**

POST THIS COUPON NOW

PETO-SCOTT CO., LTD., 77 Pr. W. 13, City Road, London, E.C.1
Tel.: Clerkenwell 9406/7.

Please send me CASH/C.O.D./H.P.

NAME

ADDRESS

Pr. W. 13

Please also send me FREE BLUEPRINT of

Buy by Post-its Quicker-CASH-C.O.D.-EASIWAY

THE MONITOR IS A MASTER RECEIVER!

(Continued from page 668)

plugs in the —, 36-, and 120-volt sockets of the H.T. battery, and the L.T.— and L.T.+ spades should be joined to the — and + terminals of the L.T. accumulator.

It should be noted that on the blueprint a fixed condenser having a capacity of .0002 mfd. is shown, but in the list of components a condenser of .002 mfd. is specified. The latter value is correct and the blueprint should be modified by striking through one of the noughts. It may be mentioned that this is not a draughtsman's error, but is a change in design which was effected after the preparation of the blueprint, and after the receiver had been given a special test with a number of alternative valves. In the case of some makes of valve it was found that the .0002 mfd. condenser was suitable, but in certain cases instability was experienced on the long-wave band. Subsequently it was found that the larger value gave complete stability with practically all valves which were tried, and thus it was thought desirable to specify this capacity instead of the original smaller value.

Aerial Damping

To reduce aerial damping it may be found desirable to include a fixed condenser of .0001 mfd. or a pre-set with a maximum capacity of .0003 mfd. in the aerial lead. This is especially the case when a long aerial is used, and the aerial lead should simply be attached to one terminal on this condenser and the other terminal joined to the aerial terminal on the Monitor.

Many constructors will no doubt find that the reaction in this receiver does not function in the usual way, and it is naturally not so good as when a special reaction winding is coupled to the detector

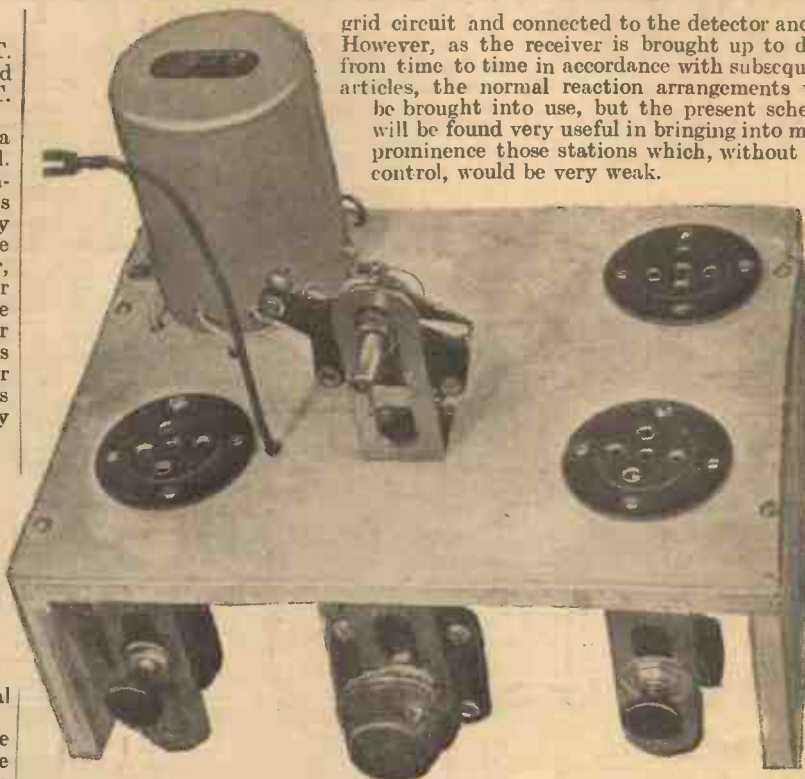

In this illustration the condenser drive has been removed to show how the condenser is mounted.

grid circuit and connected to the detector anode. However, as the receiver is brought up to date from time to time in accordance with subsequent articles, the normal reaction arrangements will be brought into use, but the present scheme will be found very useful in bringing into more prominence those stations which, without the control, would be very weak.

WE have already mentioned in these pages certain of the Graham Farish products, and recently referred to the range of valves which may now be obtained from this firm. One point of interest in connection with the short-wave valves which we did not mention was the fact that the connection to the cap on this valve is not the anode connection as is usually the case, but is joined to the control grid. In a short-wave receiver it is essential to reduce all sources of loss to a minimum, and as the signals arrive at the grid it is obviously necessary to make quite

INTERESTING GRAHAM FARISH VALVES AND COMPONENTS

certain that they pass through the valve and so receive the necessary rectification and amplification. Any leakage path from the grid to earth will result in not only a weakening of the signal, but if the leak is sufficiently large in complete absence of

weak signals. In the ordinary type of valve the grid connection is placed on the valve base, and many experimenters are familiar with the device adopted to avoid loss by sawing across the valve base and the valve-holder so as to form an air barrier between the valve legs. Realising this source of loss, Messrs. Graham Farish have taken the grid connection to the top of the valve, and thus the leading-out wire is removed from proximity to the other electrode wires, and the connection from grid to tuning circuit may be considerably reduced in length and losses avoided by placing the valve in a horizontal position, and otherwise designing the circuit to take full advantage of this novel method of construction.

Other Interesting Items

Amongst the remaining interesting components in the Graham Farish and Formo ranges may be mentioned the Sensity coils and the special tuning devices. Some of these may be seen in the group of components which is reproduced herewith, and it will be seen that the coils are available in various types from a single element to a ganged unit complete with filament and radiogram switch. These coils are of extremely small dimensions and cost 5s. each. They may also be obtained complete with a chassis base in which is incorporated a wave-change switch, and the price in this case is 6s. 6d. An additional 2s. is charged for a filament and radiogram combined switch.

The short-wave coils seen in the centre of the group are wound on a ceramic former, and again the coils may be obtained as a single unit, or as a complete ganged unit complete with wave-change and filament, and phones-to-speaker switch. These coils are 3s. 6d. each, whilst the small stand upon which to mount the coils costs 1s. For a two-way coil stand the price is 2s. 6d.

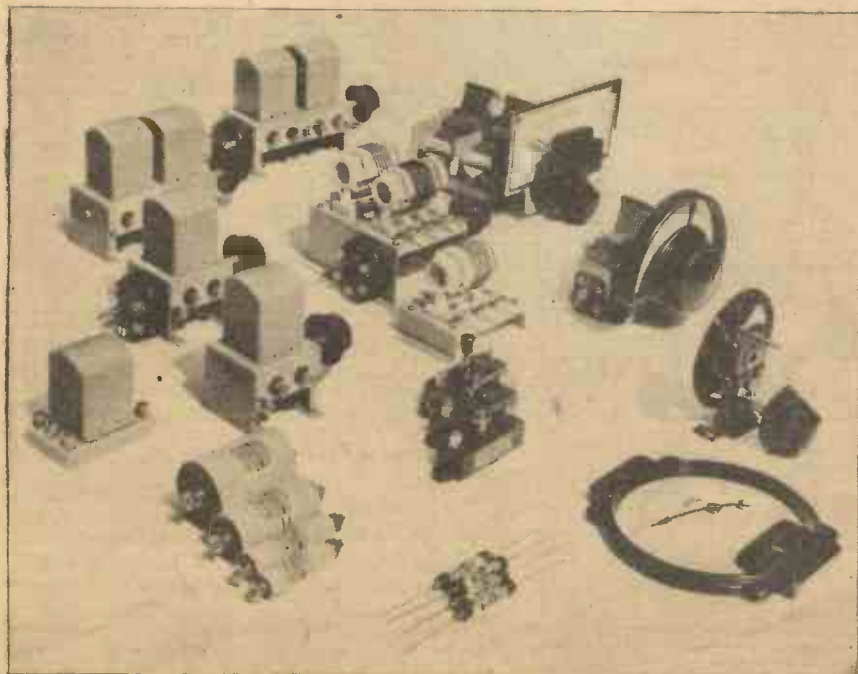

Wireless Shorthand

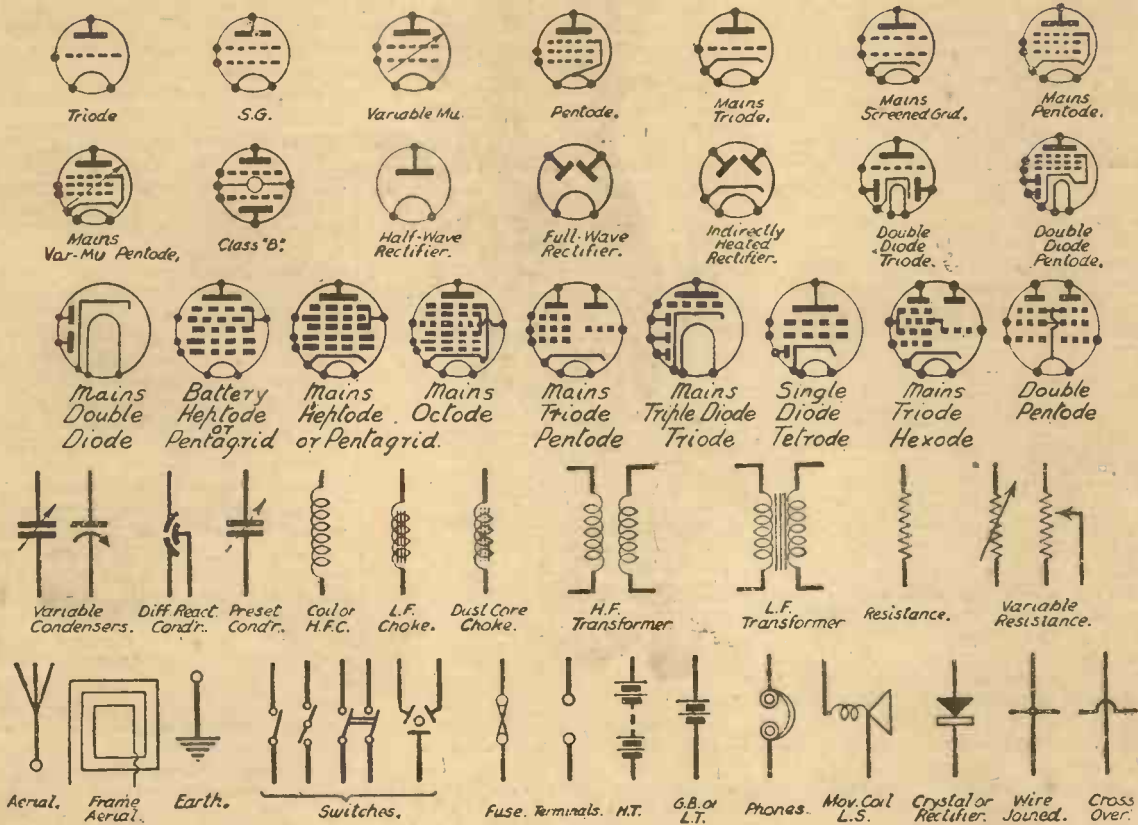

The Above Chart shows the Various Symbols which are Used in Drawing a Wireless Circuit.
Read the Article on Page 660

ABBREVIATIONS

- | | | |
|--|--|--|
| <p>A—Anode, or plate.
A.C.—Alternating current.
A or Ad—Aerial.
A.F.—Audio frequency.
A.G.C.—Automatic gain control.
A.T.C.—Aerial tuning condenser.
A.T.I.—Aerial tuning inductance.
A.V.C.—Automatic volume control.
B.A.—British Association.
B.O.T. unit—Board of Trade unit.
C.C.C.—Closed circuit (or secondary) condenser (or S.T.C.).
C.C.I.—Closed circuit (or secondary) inductance (or S.T.I.).
cm.—Centimetre.
C.P.—Candle power.
C.W.—Continuous waves.
D.C.—Direct current.
D.C.C.—Double cotton covered.
db—decibel.
D.E.—Dull emitter.
D.P.—Difference of potential.
D.P.D.T.—Double pole, double throw.</p> | <p>D.P.S.T.—Double pole, single throw.
D.S.C.—Double silk covered.
D.X.—Long distance.
E.—Earth.
E.M.F.—Electro-motive force.
F.—Filament.
G.—Grid.
G.B.—Grid bias, or grid battery.
G.C.—Grid condenser.
G.L.—Grid leak.
H.F.—High frequency (same as radio frequency).
H.P.—Horse power.
H.R.—High resistance.
H.T.—High tension.
I.C.—Intermittent current.
I.C.W.—Interrupted continuous waves.
I.F.—Intermediate frequency.
I.P.—In primary (of transformer); start of primary.
I.S.—In secondary (of transformer); start of secondary.
kw.—Kilowatt.
L.F.—Low frequency (same as audio frequency).
L.R.—Low resistance.
L.S.—Loud-speaker.</p> | <p>L.T.—Low tension.
mfd.—Microfarad.
mhy.—Microhenry.
mm.—Millimetre.
O.P.—Out primary (of transformer); end of primary.
O.S.—Out secondary (of transformer); end of secondary.
P.—Plate, or anode.
P.D.—Potential difference (same as D.P.).
Pot.—Potentiometer.
P.V.—Power valve.
Q.A.V.C.—Quiet automatic volume control.
Q.P.—P.—Quiescent push-pull.
R.F.—Radio frequency (same as high frequency).
R.M.S.—Root-mean-square value.
S.C.C.—Single cotton covered.
S.I.C.—Specific inductive capacity.
S.P.—Series parallel.
S.P.D.T.—Single pole, double throw.
S.P.S.T.—Single pole, single throw.
S.S.C.—Single silk covered.
S.W.G.—Standard wire gauge.
T.T.—Tonic train.</p> |
|--|--|--|

SYMBOLS

<p>QUANTITIES</p> <p>Amplification factor Capacity Current Conductance Dielectric constant Efficiency Energy E.M.F. (voltage) Frequency Impedance Magnetic flux Magnetic flux density</p>	<p>μ C I G ε η W E f Z S</p>	<p>Magnetic field Power Period time Phase angle Quantity Resistance Resistivity (specific resistance) Reactance Self-inductance</p>	<p>H P T Φ Q R P X L</p>	<p>Coulomb Farad Henry Ohm Volt Watt Watt hour</p>	<p>C F H O V W Wh</p>
		UNITS		PREFIXES	
		<p>Ampere Ampere hour</p>	<p>A Ah</p>	<p>Mega Micro Milli Kilo</p>	<p>M μ m K</p>



FROM STUDIO TO LISTENER—3.

The Various Methods of Modulation are Discussed this Week.
By IDRIS EVANS

IN the simple transmitting circuit described last week a key was used to interrupt the high-frequency waves. The interruption of the continuity of the waves results in a similar interruption of the current in the receiving aerial, and if

mission. A device is used at the transmitting end for interrupting the continuous high-speed oscillations at regular intervals, independent of the transmitting key. By breaking the transmitting circuit 800 to 1,000 times per second; the

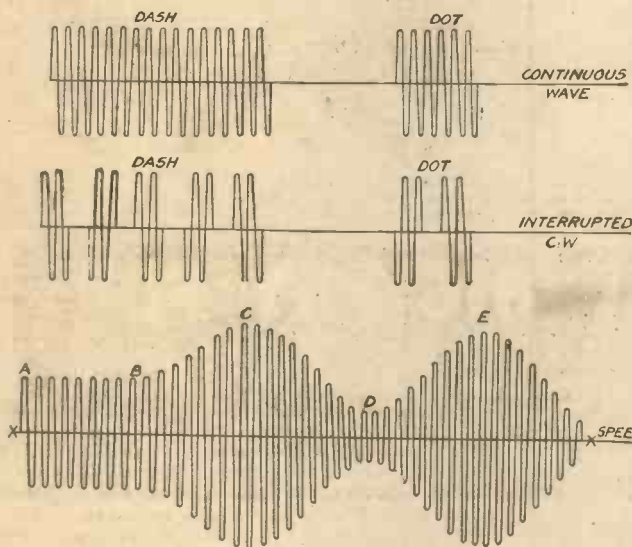

Fig. 1.—(left) Showing methods of modulation using for the purpose of explanation the dots and dashes of the Morse Code and speech variations.

Fig. 2.—(below) Direct modulation with microphone fed into the grid circuit.

speaker or 'phone at the receiving end will vibrate at this audible frequency and a musical note will be heard as long as the transmitting key is kept depressed. This method of transmission is very commonly used for ship-to-ship and ship-to-shore transmission, and has superseded the older spark method.

Telephony

The process of transmitting code in the form of dots and dashes representing letters of the alphabet is known as telegraphy, as distinct from telephony—the process of transmitting speech and music. For telephony transmission a microphone must be substituted for the morse key. The audible frequency vibrations from the microphone (corresponding with the original sound waves produced by the artist's voice) are then superimposed on the high-speed continuous waves, as shown in Fig. 1. What actually happens is that the low-frequency vibrations passing through the microphone circuit add and subtract themselves to the continuous high-frequency vibrations, thereby producing a variation of the amplitude or height of the radiated wave, height variation occurring in accordance with the original sound-wave variations.

Referring to Fig. 1, AB represents a period when no sounds are picked up by the microphone. When a sound is received the electrical equivalent of this (produced by the microphone) changes the height of the high-frequency carrier wave as depicted by XC, and as the sound decreases the carrier current decreases to the minimum value XD. An imaginary line joining maximum and minimum points BCDE represents the sound picked up by the microphone.

Direct Modulation

The simplest method of superimposing the speech electrical vibration on the high-frequency carrier is to connect the microphone directly in the transmitting

a predetermined code is used at the transmitting end (e.g., morse), this can be decoded by the listener at the receiving end. Neither the human ear nor the loud-speaker cone can vibrate at the high speed of these waves, however, and therefore they cannot be heard unless special measures are taken at the receiving end.

In a straight receiver reception of these continuous waves can be effected by advancing the setting of the reaction condenser until the detector valve is oscillating; this process is generally referred to by listeners as "obtaining reaction." Beyond this oscillation for reaction point speech and music is not intelligible, but high-pitched morse signals will be heard, especially on the short-wave bands. It is worth noting at this stage that the majority of superhet receivers are unsuitable for the reception of continuous-wave signals as a reaction condenser is not incorporated, and, therefore, when buying a receiver for reception of morse care should be taken to choose one having an effective reaction control.

Interrupted C.W.

Readers who have listened on the short-wave bands will have noticed that some morse stations can be heard without having the receiver in a state of oscillation, i.e., before the reaction plop occurs. These stations usually have a musical note, and use what is called the interrupted continuous-wave method of trans-

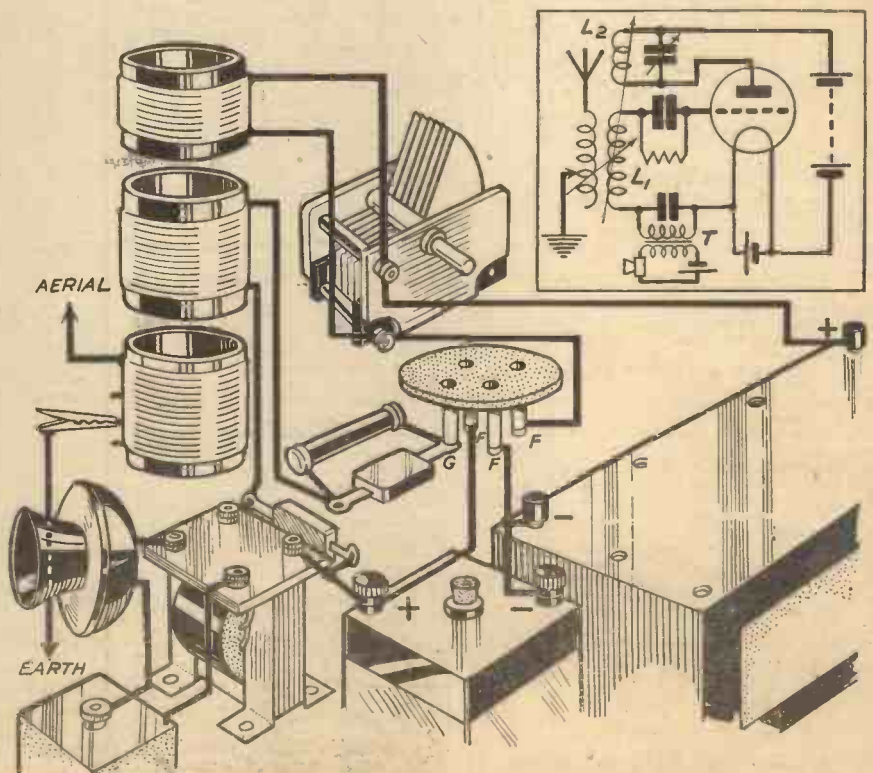

aerial circuit, as shown in Fig. 3, but this method can only be adopted for very low powers. Fig. 2 shows the method of connection commonly adopted in small transmitters.

L1 is placed sufficiently near L2 to enable the valve to oscillate; it will be noted that the circuit is similar to that of a one-valve reacting detector receiver. The speech currents are fed into the oscillating circuit via the microphone transformer T—this is a somewhat similar type of component to the L.F. transformer, commonly known to listeners, except that the primary to secondary turns ratio is slightly different.

Indirect Modulation

The direct methods of modulation described above are unsuitable for high-power transmitters, and in the latter indirect modulation should be employed. With this method the microphone is fed into an amplifier which increases the strength of the speech vibrations before passing them on to another valve which, in turn, controls the output of the oscillator valve. This controlling valve is generally referred to as the modulator, and its method of operation will be described in the next article of the series.

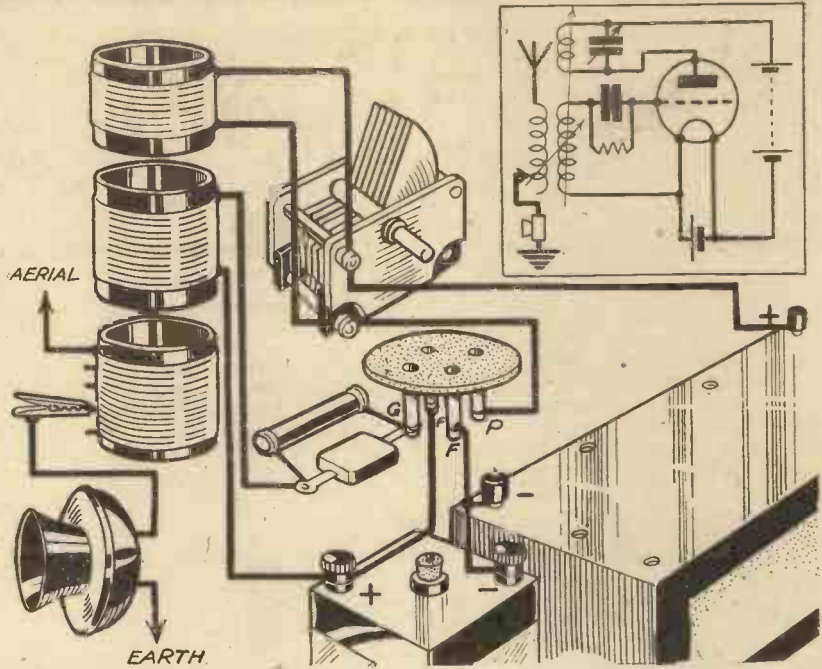

Fig. 3—Direct modulation with microphone connected in aerial circuit.

BOOKS RECEIVED

"THE LIFE OF KING GEORGE V"

IN the annals of the British Throne no sovereign has been held in greater affection than the late King. The love and esteem he commanded during his life will remain in the hearts of his people long after his death, and a memento of his glorious reign will be treasured in every home.

To-day a most beautiful memorial book, "The Life of King George V," is published for our readers. It tells the story of his unstinted devotion to his subjects; of a reign that saw the world transformed. Written in moving language, you will read of his boyhood; his youth as a sailor; the early death of the Duke of Clarence that made him heir-apparent; his marriage to his cousin, then Princess May; and his accession to the throne.

Superbly illustrated on every page, the story unfolds through the years that brought Women's Suffrage, the World War, the Conquest of the Air, Talking Films and Radio, Speed, the Jubilee, and the King's last illness.

"The Life of King George V" also includes most impressive photographs taken specially for this work at the funeral procession in London and Windsor.

You can obtain this magnificent all-photogravure record for only sixpence, at your newsagent's and book-stall. It is a complete pictorial panorama of a great and glorious reign.

TALKS FOR DISCUSSION GROUPS

THE B.B.C. has just issued the "Talks for Discussion Groups" pamphlet, which is the latest one in the series published each term in connection with the talks arranged on three evenings a week, from 7.30 to 8 p.m., for the purpose of group discussion. The series to be broadcast between now and Easter are: on Mondays, "Galsworthy's Plays"; on Tuesdays, a series entitled "If Plato lived again"; and on Thursdays, "The Public Social Services."

The talks on Galsworthy's plays will be given by Mr. Eric Gillett, who will discuss the plays not only from the dramatic point of view, but also for their psychological significance.

The speaker for the talks on Plato will be Mr. R. H. S. Crossman, who is engaged in teaching Philosophy in Oxford. In his study of Plato he has been impressed with the similarity between the world in which Plato lived and the world to-day. Mr. Crossman will talk about modern Authoritarian States, the struggle of democracy for survival, the relationship of propaganda and education, the significance of the Christian tradition in modern civilisation, and so on.

A special pamphlet has been prepared containing essays by Professor Sir Alfred Zimmern and Mr. R. H. S. Crossman, and other material which will help listeners to understand better the background of these talks. It is obtainable at any B.B.C. office, price three-pence, by post, fourpence.

LATHE-WORK FOR AMATEURS

by F. J. CAMM

1/- or 1/2 by post from

Geo. Newnes, Ltd., 8-11, Southampton Street, Strand, W.C.2.

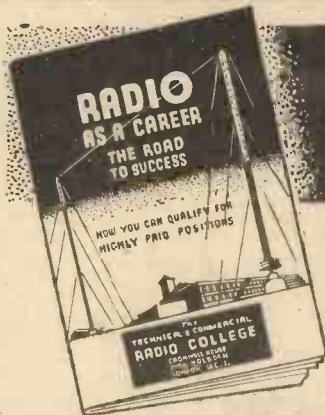

BIG PAY FOR TRAINED MEN

Over seven million homes now have radio sets. More and still more trained men are needed to make and maintain this huge number of radio installations. Many specialised and highly-paid positions are open to the men with a thorough knowledge of modern radio.

Are you content to remain an onlooker whilst others seize the highly-paid jobs? Are you wasting precious hours when you should be preparing for well-paid employment and an assured future?

We can train you for a successful radio career and introduce you to employers or teach you how to earn money in your spare time. We have helped others; we can help you. Many of our students are now in well-paid regular employment, whilst others are earning good money in their spare time, solely as a result of our training.

Our Home Study Courses are praised and recommended by leading Radio Manufacturers and the Technical Press. We specialise in radio and all our Courses are conducted by Radio Experts with practical knowledge of the qualifications that lead to success, employment and a good income.

Why jog along in the same old rut? Why fear the consequences of losing your job? Why waste your valuable spare time?

FREE Take the first step to success by sending at once for your free copy of "Radio as a Career," which tells how you can earn more money by becoming a qualified radio expert.

POST COUPON BELOW

To: T. & C. RADIO COLLEGE, Cromwell House, High Holborn, London, W.C.1.

Please send me free copy of your book describing your training and telling me how I can make more money.

Name

Address

P.R. 34. Post in unsealed envelope—jd. stamp

Sales and Service Manager in six months... thanks to our training.

Student "A. E. A." writes: "I owe so much to you that I write to tell you I now hold a position as Sales and Service Manager. The comprehensive knowledge imparted to me by your splendid system and untiring personal attention have adequately prepared me for the very stiff task ahead."

Other students write as follows:—

"He engaged me at a big increase in salary. I couldn't have got this situation without your help."—A. G. (Finchley.)

"The position was only obtained because I mentioned your Course."—J. O. M. (Beds.)

"I have obtained fresh employment at a much higher salary, through giving particulars of your Course which I am taking."—F. J. G. (Surrey.)

"I am indebted to you for this situation, as without the Technical Course I should not have lasted five minutes in Service Work."—W. S. C. (Milford Haven.)

"I have much pleasure in announcing an increase in salary and promotion."—J. A. (Ilford.)

"Since enrolling with you I have taken over practically all the battery set work for a local dealer."—J. T. (Dundee.)

"I am now working at — and am pleased to say that I could not have obtained the job without the Course."—J. M. (London.)

Technical & Commercial RADIO COLLEGE
 CROMWELL HOUSE
 HIGH HOLBORN LONDON W.C.1
 Telephone Chancery 7054 & 7055

As they say at Clapham Junction:

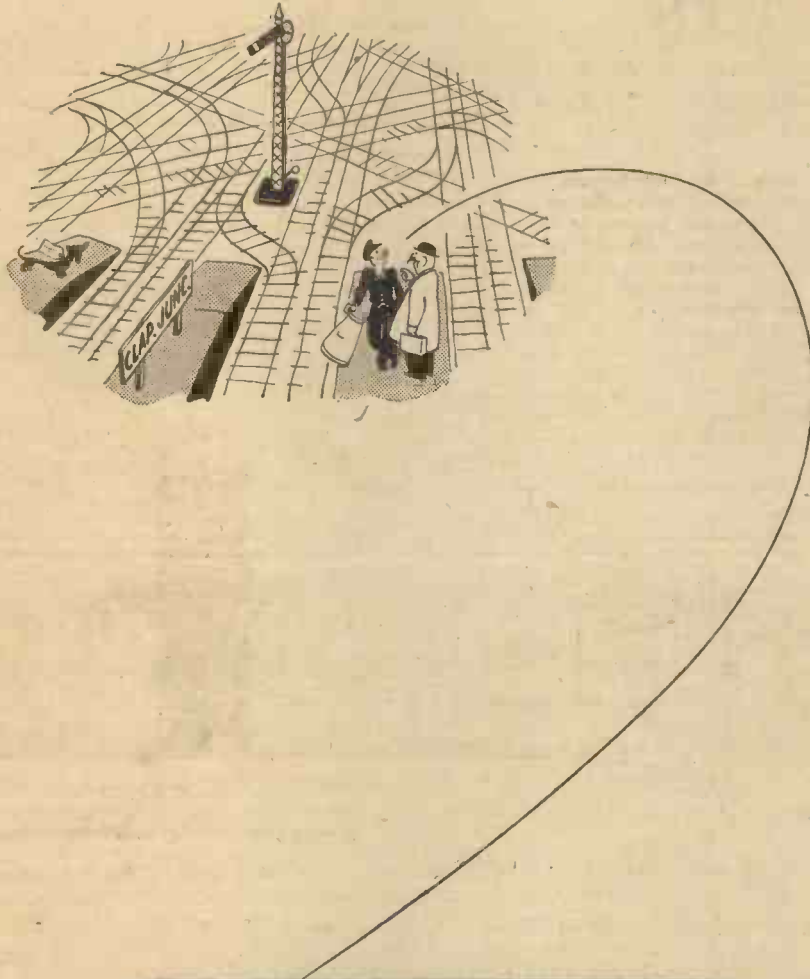

'BETTER BUY CAPSTAN.
they're blended better
- they're Wills's.

CAPSTAN CIGARETTES
 PLAIN OR CORK TIPPED

10 for 6d.
 20 for 11½d.

C.C.4908

A SIMPLE D.C. TRICKLE CHARGER
 (Continued from page 651)

applied for ten hours. Another point, which is sometimes overlooked by those carrying out accumulator charging at home, is the fact that the liquid or electrolyte in the cell gradually becomes less, until its level is below that of the top of the plates. Such a state is harmful to the cell, and the level should be raised to about a quarter of an inch above the plates by the addition of *distilled water*. On no account should acid be added.

Simple Construction

As regards the construction of the trickle charger, there is very little to be said. A standard 6½in. x 3½in. switch block is used for the base, six holes being drilled to allow the necessary connections to be made to the components, and two, one through each end, for the mains and the accumulator leads.

The fuse-holder, lamp-holder, and switch are screwed to the face of the block, in the desired positions, and connected in the manner indicated by the wiring diagram, Fig. 1. Before the red and black spade terminals can be fixed to the free ends of

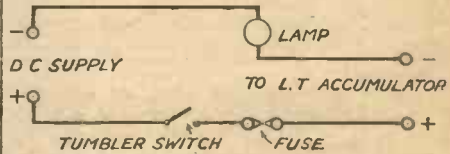

Fig. 3.—Theoretical circuit diagram of the D.C. trickle charger.

the accumulator leads, it is *absolutely essential* to determine which is the negative and which is the positive. There are several ways of doing this, and one of the following methods can be used, provided a little care is taken. Insert the mains plug, and, after making sure that the accumulator leads are not touching, switch on. The leads can now be placed on a moistened piece of "pole" indicating paper, keeping the ends of the leads about two inches apart. The negative wire will cause the paper to turn red. Another method is to apply the leads to the clean surface of a cut potato, when the negative wire will produce violent frothing, and the positive will cause the surface of the potato to turn green. If these methods cannot be applied, then the leads can be inserted in a vessel, *not metal*, filled with water, taking care to keep the ends apart as in the previous tests. The negative will produce a steady stream of bubbles.

When the polarity has been determined, the red and black spade terminals should be fitted to their respective wires, and the mains plug or adaptor marked in a permanent manner to make sure that it will always be inserted in the same way in the holder. If these precautions are not taken, serious harm can be caused to the accumulator if the polarity of the leads is reversed.

For charging H.T. accumulators, it is necessary to reduce the current output without lowering the voltage below a certain figure. The same method of using a lamp can be employed, but instead of using a 200-volt lamp on a 200-volt supply, one of half the voltage should be used, namely 100 volt. See that the accumulator terminals and the spade connectors are kept clean and bright. Always switch off before handling output leads. Always remember that you are dealing with the mains voltage. Make sure that the vent plug in the accumulator is clear, to allow easy escape of gases.

Super One-valve Receivers

Some Interesting Details of Old and New Receivers in Which a Very High Standard of Performance is Obtained from a Single Valve

IN the early days of broadcasting, when valves and other components were very expensive items, it became the practice of amateur experimenters to devise circuits and arrangements by which the performance of the usual single valve receiver could be improved. Only the very rich could afford two valves and the associated parts, and yet at that time one valve arranged in the orthodox manner gave a very good performance, as the high degree of selectivity which is now demanded was not required. There were only a few stations, and the range of frequencies which were broadcast covered such a small band (comparatively) that high fidelity was not needed and thus it was possible to utilise schemes which to-day could not be tolerated.

A single valve set must, of necessity, employ rectification, and although a crystal detector may be incorporated for this purpose, the loss of reaction makes such a combination rather inefficient. Fig. 1 shows a standard one-valve circuit, and this is no different from the earliest circuit except in so far as may concern the reaction arrangements and the characteristics of the old components. It would appear that

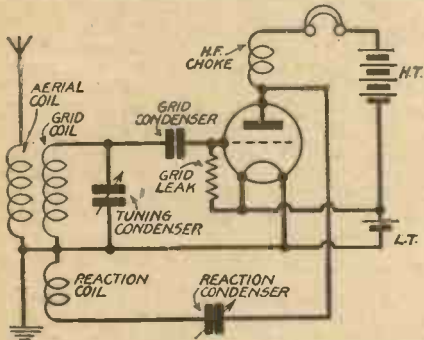

Fig. 1.—The circuit of a standard one-valve receiver.

such a scheme could not be elaborated upon, and the only improvement which was found possible in such a straightforward circuit was the application of excessive reaction. Actually, of course, the term reaction was not applied, but the action was known as 'regeneration,' and by applying this in a certain manner the circuit known as the Armstrong Super-regenerative circuit was brought into use and the modification may be seen in Fig. 2. Here two special coils are included in the earth side of the circuit, but many experimenters have found it difficult to obtain stable working conditions with this except for short-wave work and the arrangement is not very popular for broadcast reception.

Reflex Circuits

It was found in the early days that an ordinary type of valve could handle two separate types of current, and no doubt every listener to-day knows that the currents which are received by the aerial

are known as high-frequency (or H.F.) currents, whilst after the detector stage the currents are known as low-frequency (or L.F.) currents. The differences between these two currents are so marked that the two may pass along a circuit without mixing, and this led to the development of what was known as a reflex circuit in which one valve did the work of two. To keep down the cost a crystal detector was employed in the early reflex circuit for detection and the valve acted as an H.F. and an L.F. amplifier. Fig. 3 shows the

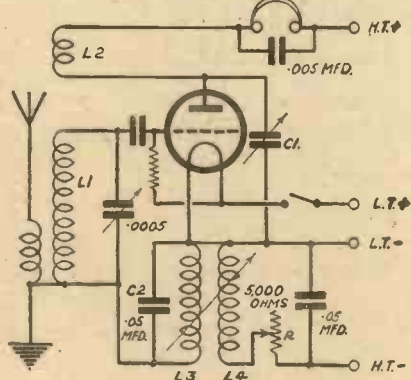

Fig. 2.—A super-regenerative one-valve receiver, with constructional details of the quenching coils L3 and L4.

main circuit details of such an arrangement, and it will be seen that the signals are fed into the valve in the usual way, but they pass out at the anode into the crystal detector circuit and from there are fed through a transformer in the usual manner, but the secondary of the transformer is included in the valve grid circuit, so that the L.F. currents are then taken back

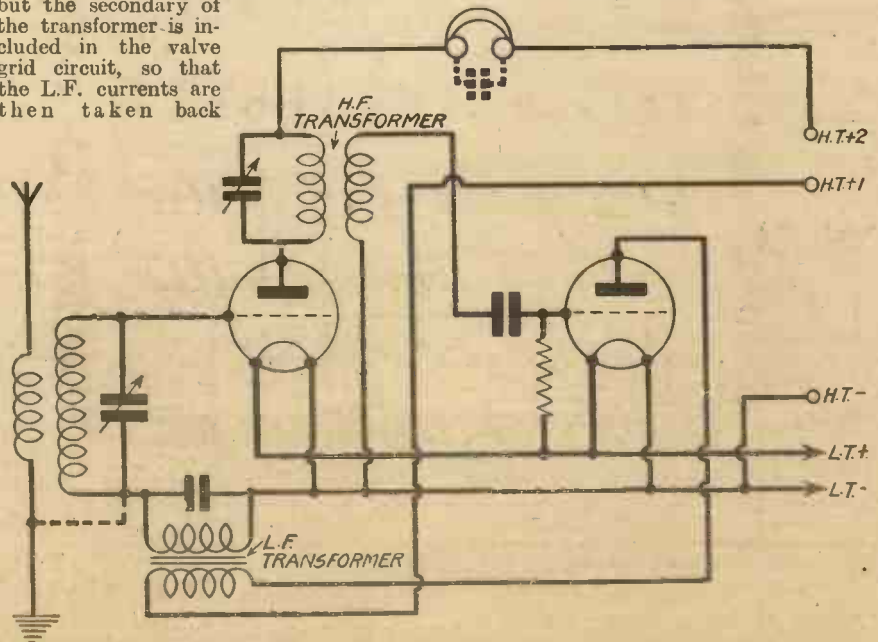

Fig. 4.—A development of Fig. 3, in which a valve takes the place of the crystal detector.

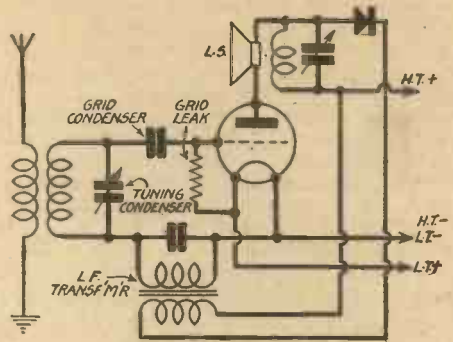
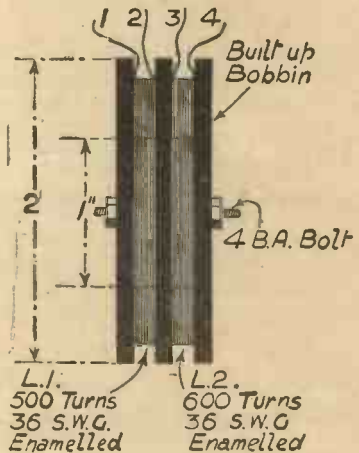

Fig. 3.—This circuit depicts a one-valve and crystal reflex arrangement giving greatly improved results.

through the valve. From the anode they now pass to the headphones or loud-speaker, and thus with one valve and a crystal we have obtained a circuit which is virtually a "three valve" arrangement, namely H.F., detector, and L.F.



Combined Valves

Such an arrangement will still be found very useful to-day, although quality is not up to the standard of a modern straight receiver, and the loss of reaction may be (Continued overleaf)

(Continued from previous page)

found vital. An improvement is obtained if the crystal is replaced by a valve, when the circuit of Fig. 4 is adopted, but here the H.F. stage will probably be found unstable with the majority of modern valves, and in view of the low cost of such valves there is very little saving in expense with this circuit. In the old days, of course, when the valve cost over £1 this was an important matter.

The production of modern valves of the

built up with this valve as the main factor. The circuit is shown in Fig. 5, together with a pictorial diagram of the arrangement, but it should be pointed out that the lay-out may follow any desired scheme and the circuit is thus ideal for the beginner who wants something better than an ordinary one-valve set. A receiver of this type may be relied upon to provide loud-speaker reception of a number of stations, although selectivity will not rise to very high limits unless a good modern iron-core tuning coil

is employed, and then it may be found desirable in the vicinity of a high-power broadcasting station to use a band-pass tuner or a wave-trap with the resultant loss of signal strength. The degree of loss will, of course, depend upon the actual circuit which is employed.

One-valve Superheterodyne

There is no counterpart of this particular receiver for the mains user, but in this respect the listener with mains supply facilities may build a much more ambitious receiver in which, although only one valve is used, the set employs a full superheterodyne circuit, and a circuit which has been developed by R. D. Washburne in the U.S.A. is shown in Fig. 7. It will be seen that the valve is of the type known as a "triode-pentode" and this has been produced especially for the superhet type of receiver. In the circuit in question the arrangement which is followed is perfectly standard and the pentode section acts as first detector, and then, by utilising a coupling coil in the cathode circuit, a local oscillation is fed into the pentode section, and the usual special shaped ganged condenser is employed for tuning both this and the aerial coil. The intermediate frequency which is produced by this means is then fed to an ordinary I.F. transformer, the secondary of which is joined to the triode section of the dual-purpose valve, and from the anode of this part of the valve the signal is conveyed to headphones or loud speaker. The important additional superhet features which are incorporated in this particular

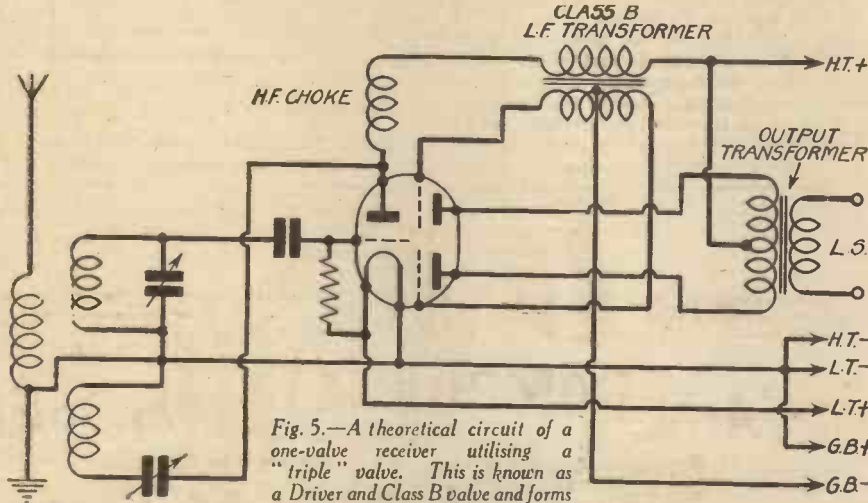

Fig. 5.—A theoretical circuit of a one-valve receiver utilising a "triple" valve. This is known as a Driver and Class B valve and forms a very novel and efficient circuit.

multi-electrode type has, however, brought us once more into the field of "super" receivers, not as expense savers, but purely as experimental apparatus of real scientific interest in, which standard principles may

**BUILD THE MONITOR
SIMPLE THREE-
VALVER—(See page 665)**

be adopted without "stunts" and without loss of efficiency.

There is at present on the market a battery valve in which the elements are divided to form the essentials of two separate valves, namely a driver and a class B amplifier. Normally this is intended for use after a detector stage, but a really remarkable little one-valver may be

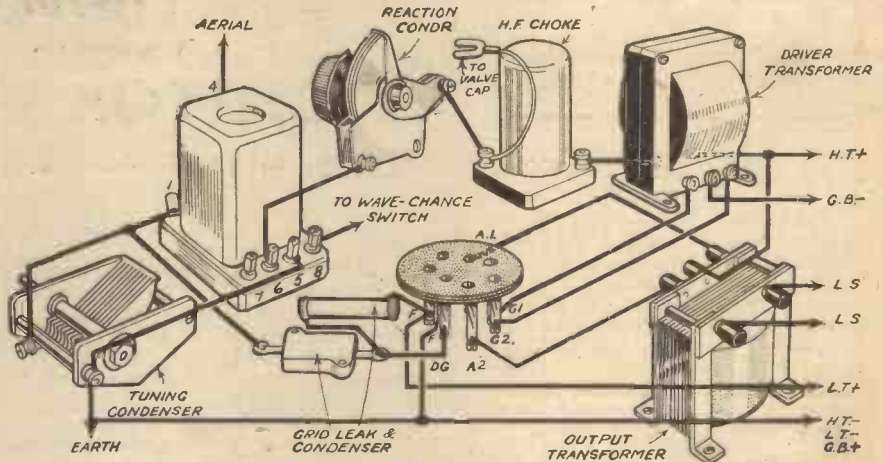

Fig. 6.—The pictorial representation of the arrangement shown in Fig. 5.

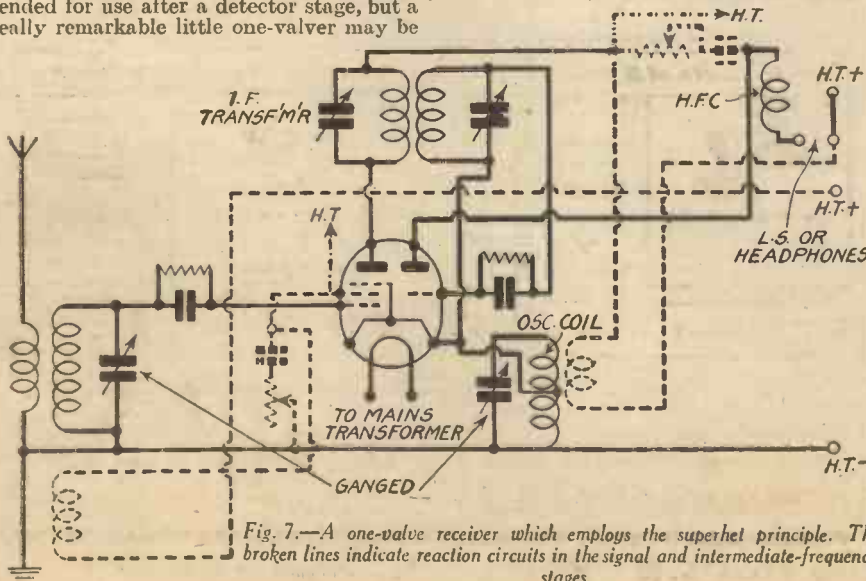

Fig. 7.—A one-valve receiver which employs the superhet principle. The broken lines indicate reaction circuits in the signal and intermediate-frequency stages.

circuit are the reaction arrangements on the aerial circuit and on the I.F. transformer circuit and these are claimed to provide greatly increased signal strength. There are, unfortunately, no suitable coils at present on the market, although the circuit may be built up from perfectly standard components by ignoring the reaction components which are indicated by broken lines. In this case the H.T. is applied direct to the suppressor grid of the pentode section and to the primary of the I.F. transformer as indicated by the chain lines in the diagram. The layout of such a circuit is not critical and no doubt the circuit will prove of interest to beginner and "old-hand" alike.

THE WIRELESS CONSTRUCTOR'S ENCYCLOPEDIA
By F. J. CAMM
(Editor of "Practical and Amateur Wireless")
4th Edition 5/-net.
Wireless Construction, Terms and Definitions explained and illustrated in concise, clear language.
From all Booksellers, or by post 5/6 from George Newnes, Ltd., 8-11, Southampton Street, Strand, London, W.C.2.

TELEVISION NOTES

A French Inventor

ASSOCIATED with the development of the new French television service is the inventor Barthelemy, whose system is the one at present being sponsored by the Government. Although it is claimed that the results obtained from the studios in the Rue de Grenelle are very satisfactory, the inventor is taking steps to carry out improvements.

Barthelemy is of the opinion, however, that the received images are the best in the world so far, a statement which it is hoped will soon be challenged by this country. Because of his rheumatism the inventor is compelled to go about on crutches, but this in no way affects his enthusiasm for the work he is now undertaking.

C.R. Tube Requirements

IN investigating the problems of television many readers are anxious to know, in brief, what are the requirements of a good cathode-ray tube suitable for reproducing television pictures on the fluorescent screen. This is difficult to summarise in a few words, but, first of all, it is necessary to ensure the formation of a good beam of electrons directed from the incandescent cathode as a result of the relatively high voltage applied to the orificed

WATCH OUR PAGES
FOR NEWS OF THE
LATEST TELEVISION
DEVELOPMENTS.

anode. This beam must be capable of being focused on to the screen into a circular spot of very small diameter, so that when formed finally it is no larger than the size necessary just to accommodate the number of scanning lines required in the depth of scan available. The deflecting of this beam in two directions at right angles without any trace of distortion must next be watched in order to ensure that the picture formed on the screen is perfectly rectangular and even; that is, the low-frequency and high-frequency scanning strokes must be truly linear in action. Next comes the modulation of the intensity of the beam of electrons so that the resulting intensity of the spot as seen by the observer looking in, can be made to vary from black to white through all the half tone values in accordance with the incoming signal voltage impressed on the control electrode. Another important point concerns the choice of a fluorescent material of suitable colour which is pleasing to the eye, and has just sufficient lag to overcome any effects of flicker arising from the picture repetitive rate. Apart from these important details it is necessary to pay attention to such practical points as tube construction with as large a screen as possible consistent with low cost of production, mechanical strength, long working life, and complete freedom from mechanical or electrical failure. Although at first sight it may seem impossible to achieve all these points, it is known that intensive development work has been made in this connection by some firms, and it is confidently anticipated that when placed on the market these new type cathode-ray tubes will be of a very high standard and give little trouble to the user.

A Special Lamp

QUITE apart from the lamps required in the studio when working with direct pick-up scanners, attention has to be paid to the source of light necessary for use in conjunction with film projectors when these machines are adapted to work in conjunction with mechanical or electronic scanners to produce high-definition television signals. Particular interest is, therefore, attached to an advance made by Philips in connection with what is termed an ultra high-pressure mercury vapour lamp. With this device it is possible to produce an illumination rivalling that of a powerful arc lamp, yet the source of "glow" is only a tiny quartz tube. The

lamp calls for a very high working voltage, while with ordinary cameras or projector shutters it must be fed with alternating current which is synchronised both for phase and periodicity with the shutters. This is because of the low thermal inertia, but as far as film projectors for television are concerned the shutter mechanism is removed, although the intermediate film camera still retains this device when taking film scenes.

Mayfair Parties

PLANS are already well ahead for the first Mayfair television party. This is to be staged in the home of Lady Seldon, wife of the chairman of the original television committee. The cabinet accommodating the receiving and reproducing equipment, together with the screen, are to be let into the drawing-room wall so as to harmonise with the decorative scheme. This is probably the forerunner of other parties.

B.T.S.

AGAIN COMPONENTS CHOSEN

Produced by specialists and preferred by experts, therefore Mr. F. J. Camm has once again

EXCLUSIVELY SPECIFIED

B.T.S. Components for the most vital portions of the

MONITOR 3

B.T.S. MONITOR COIL

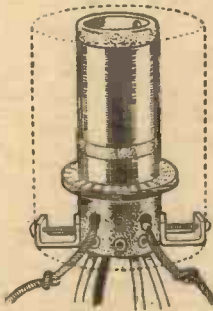

Dotted portion shows metal screening can.

Mr. F. J. Camm relied on B.T.S. to make a good job of the most vital component in his new set—the specially designed coil. Constructed of high quality materials and wound carefully to specification — it ensures success of your Monitor 3. Supplied with coloured leads for easy connecting. **5/- EACH**

PREFECT S.W.3

B.T.S. 6-PIN Short Wave COIL

Wound with hard drawn copper wire, accurately spaced to give correct distributed self-capacity. Type **4/6** SFC, 22-47 metres. **EACH**



B.T.S. 6-PIN Short Wave COIL BASE

For use with B.T.S. 6-pin Coils. Sockets mounted on special low-loss insulators. Type **SPB**. **2/- EACH**



B.T.S. 4-pin VALVEHOLDERS

Special low-loss insulating material. Silver-plated sockets of special design ensuring firm grip. Type **UH4**. **1/- EACH**



Send for Lists of B.T.S. Components & Short Wave Adaptor/Converters

B.T.S. Ultra Short Wave TUNING CONDENSER
67 mfd. Type **UVG/67**
7/6. Condenser bracket Type **UB 1/- extra.**

B.T.S. TRIMMING CONDENSER, any capacity up to 40 mfd. Type **UTC**. **2/9**

B.T.S. VOLUME CONTROL
Carbon track 25,000—500,000 ohms, 3/6. Wire-wound 1,000—30,000 ohms. **3/9 and 4/3**

B.T.S. Ultra Short Wave H.F. CHOKE Type **UHF**
No. 1. 10-100 metres **1/6**
No. 2. 3-20 metres **1/-**

B.T.S. Short Wave AERIAL KIT

A specially designed half-wave doublet aerial essential to perfect S.W. reception. Supplied complete with coupling unit and instructions. **Current Feed or Voltage Feed Types. 2/-**

Obtainable from ALL GOOD DEALERS. In cases of difficulty send direct, with name and address of nearest dealer.

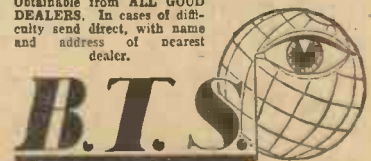

BRITISH TELEVISION SUPPLIES LTD., Faraday Ho., 8-10 Charing Cross Rd., London, W.C.2.
Telephone: Temple Bar 0134.

Let Us Send You This 40-Page Booklet — Free



It gives full information regarding various I.C.S. Courses of Instruction in Radio work.

The Radio industry is progressing with amazing rapidity. Only by knowing thoroughly the basic principles can pace be kept with it. I.C.S. Instruction includes American broadcasting as well as British wireless practice. It is a modern education, covering every department of the industry.

OUR COURSES

Included in the I.C.S. range are Courses dealing with the Installing of radio sets and, in particular, with their Servicing, which to-day intimately concerns every wireless dealer and his employees. The Equipment Course gives sound instruction in radio principles and practice.

There is also a Course for the Wireless Salesman. This, in addition to inculcating the art of salesmanship, provides that knowledge which enables the salesman to hold his own with the most technical of his customers.

Then there are the Preparatory Courses for the City and Guilds and I.W.T. Exams.

We will be pleased to send you details and free advice on any or all of these subjects. Just fill in, and post the coupon, or write in any other way.

International Correspondence Schools, Ltd.,
Dept. 94, International Buildings,
Kingsway, London, W.C.2.

Without cost, or obligation, please send me your "Radio" booklet of information about the Courses I have marked X

- COMPLETE RADIO
- RADIO SERVICING
- RADIO EQUIPMENT
- RADIO SERVICING AND SALESMANSHIP
- WIRELESS ENGINEERING
- EXAMINATION (state which)

Name.....Age.....

Address.....

LETTERS FROM READERS

The Editor does not necessarily agree with opinions expressed by his correspondents.



All letters must be accompanied by the name and address of the sender (not necessarily for publication).

Blueprint Wanted

SIR,—Is it possible that one of your readers might have an unwanted blueprint of the "Super Century 60" of the year 1932? If so, I shall be very glad if he would communicate with me at the address given below.—L. A. BENSON, Hotel Lamont, Wilmington Square, Eastbourne.

The A.C. Penta-Questa

SIR,—A few months ago I wrote to you about the A.C. Penta-Questa, and as I have been so delighted with the set I feel duly bound to tell you about it. In fact, I think the set would suit 90 per cent. of your readers who want to build an A.C. set. It is very selective on both bands, but what I am so pleased about is the fine quality and volume. The only alterations I have made are an A.C.V.P.1 for the A.C.T.P. I find the variable-mu H.T. Pen. a great help in not overloading, and I have a Ferranti A.F.5 transformer. The reaction is the smoothest I have ever managed to get in any set. I experienced some bad hum, but by turning the mains transformer on its side I have completely cured it.

In all modern mains sets I notice that 50-mfd. condensers are used to decouple the cathode bias, but I find that if I use more than 2 mfd. I get distortion and booming, so I am keeping to 2 mfd.

The coils I am using are Telsen Twin-Matched Iron-Cored W.478, which are much better than the coils specified. Superhets may have their uses, but I cannot endure their absence of top notes and their accentuation of the bass. Some of my friends have very expensive models, and they are all alike in that they give one a headache, and speech is most unreal.—GEO. W. JOHNS (Holloway).

[All Superhets are not the same. Have you heard the reproduction of the £4 Superhet or the £5 Superhet designed in the P. & A. W. laboratories?—Ed.]

A 10-metre Log from Blackpool

SIR,—In view of the present interest shown in 10-metre reception, I enclose herewith two logs, hoping they will be of interest to other readers. December 22nd

(14.30 to 16.00), W3ENX, W8CRA, W3AIR, W2TP, W3BPH, W2AIW, W8IIL, W8AGU, W2AOG, W3PC, W2HFS, W8MWL, W9BQM, W2DTB, W2FWK, G2NH, W9NY, WIBUX.

December 29th (14.30 to 16.30), W8AN, W2CDL, W8CXC, W3AIR, W1AF, W3SI, W3ENX, W2HFS, W2BCR, W2DC, W1CBZ, W2DYK, W4MR, W1CTV, W9NFM, W9ABE, W1AEF, W2BEF, W9BPU, W8IXM.

I use an outdoor aerial 50ft. long, and my set is an o-v-l.—H. STANBOROUGH (Blackpool).

Short-wave Listeners Please Note

SIR,—The reception of unconventional and experimental transmissions from the amateur stations is undoubtedly, to the beginner, extremely interesting, but in common with other enthusiasts in this district I am amazed at the contents of the majority of logs which you have recently

published. One may tune in these local G stations and the more powerful American amateurs with monotonous regularity, and I fail to see how such reports can possibly be of any interest to the majority of your readers. Let us have readers' logs by all means, but please confine them to real DX. Looking through some of these logs I am really surprised that our attention has not been drawn to the possibility of receiving the Empire Stations or Zeesen!

Regarding overcrowding on the amateur bands, surely this is half the fun. I once heard an American Q.R.P. amateur remark when discussing Q.R.M. on his frequency, "I don't mind, old man; if there was no Q.R.M. there would be no amateurs transmitting." It is a pity such a spirit is not universal. From a listening point of view, I consider the present conditions are ideal, it is an accomplishment to log a DX station through heavy Q.R.M.

In any case, there can be no restriction of amateur transmissions unless your readers imagine the bands being allotted to a select few with 9 kilocycle separation.—R. F. HEWSON (Abingdon-on-Thames).

An Amplifier for the Deaf!

SIR,—In a recent number of PRACTICAL AND AMATEUR WIRELESS, you were kind enough to remember that usually forgotten section of the community—deaf people. I am sure that the efforts of your staff and self must have enabled many of them to emerge from their depressing world of terrible silence to the enjoyment of social intercourse. Only those who are or have been deaf can form any idea what this means, and the thanks of all who saw the article were most certainly rendered to you even if not in actual words. Since you have shown your sympathy in such a practical way I am wondering if you can be persuaded to extend that sympathy just a little farther? My suggestion is that you publish in PRACTICAL AND AMATEUR WIRELESS a suitable circuit comprising, say, a two-valve amplifier, with microphone and head-phones, capable of being used at a family gathering round the table, or at a small meeting, in order to ensure that the deaf ones shall enjoy the pleasure of taking part in the general conversation. Many of us who are able to hear speech and music only by the aid of wireless are possessed of components which would help in producing the amplifier, and we wish to escape being tied to the broadcast receiver. What we would like is something which we could take with us when visiting friends or on similar missions. In these days of widespread electric-grid systems, I think that a circuit devised for mains operation would be preferred. It certainly would in my case, as I have a H.T.8, Westinghouse metal rectifier, a Heayberd mains transformer with filament heating winding —4 + 4— and many condensers suitable for mains operation.—"SOCIAL EXILE" (Sedlescombe, Sussex).

[We do not think a mains amplifier is desirable as the reproducer is to be in contact with the head of the user, in view of the possibility of accidents. However, we will bear your request in mind and probably produce a "deaf" aid in the future.—Ed.]

Jamming on the 40-metre Band

SIR,—I have followed with some interest the correspondence about jamming on the 40-metre amateur band, and I should like to endorse the views of A. E. Millinchip (Hartlebury). Some amateur transmitters, who are members of the R.S.G.B., seem to consider membership of that admirable organisation the "cure-all" for any "grouch" whatever on amateur matters; but if the R.S.G.B. is all that these over-enthusiastic members seem to consider, why is it so helpless in this matter? If the R.S.G.B. is as influential as it is said to be, why cannot it do something to obtain for amateurs a bigger place in the 40-metre band, or in some other way take steps to alleviate the horrible QRM on this band?

Some of your correspondents seem to think the whole business is a local one that can be adjusted by mutual courtesy on the part of other local "hams," but this is definitely not the case. For example, I listened on the band in question on a Sunday recently from 15.45 G.M.T. to 16.30 G.M.T., and during that time I heard numerous G stations, some of which could just be identified, others almost obliterated by QRM. That the QRM was not local is proved by the fact that nearly all the G's I logged were heard to complain about it (as far apart as Kendal and Henley-on-Thames, to mention two).

Now, gentlemen of the R.S.G.B., let us have some constructive suggestions.—**F. W. T. ATKIN** (Sheffield).

Swansea Readers Please Note

SIR,—I have been a keen short-wave enthusiast for the past twelve months, and would be glad to get in touch with any other Swansea reader who would like to co-operate with me on short-wave work. Many thanks for PRACTICAL AND AMATEUR WIRELESS, which has been a splendid help.—**R. F. ARMSTRONG**, "Blaigowrie," Caswell Road, Bishopston, Swansea.

(Continued overleaf)

CUT THIS OUT EACH WEEK.

Do you know

- THAT when two L.F. stages are employed in a receiver it is preferable to vary the type of L.F. coupling in order to avoid distortion.
- THAT where two L.F. transformers are employed it is preferable to employ two different makes unless it can be ensured that the components are free from objectionable resonances.
- THAT when screening leads in an unstable receiver, the grid leads should not be screened unless absolutely essential in view of the risk of loss of signal strength.
- THAT a smooth form of reaction control may be fitted to many receivers by including a variable resistance across the reaction winding, and fitting a fixed reaction condenser on the baseboard.
- THAT there are many other similar reaction controls available which are smooth and noiseless.
- THAT ordinary wire netting (provided that the joints are soldered) forms an effective H.F. screen and will prove invaluable for screening a room in which delicate H.F. measurements have to be carried out.

The Editor will be pleased to consider articles of a practical nature suitable for publication in PRACTICAL AND AMATEUR WIRELESS. Such articles should be written on one side of the paper only, and should contain the name and address of the sender. Whilst the Editor does not hold himself responsible for manuscripts, every effort will be made to return them if a stamped and addressed envelope is enclosed. All correspondence intended for the Editor should be addressed: The Editor, PRACTICAL AND AMATEUR WIRELESS, Geo. Neumes, Ltd., 8-11, Southampton Street, Strand, W.C.2.

Owing to the rapid progress in the design of wireless apparatus and to our efforts to keep our readers in touch with the latest developments, we give no warranty that apparatus described in our columns is not the subject of letters patent.

AGAIN EXCLUSIVELY SPECIFIED BY MR. CAMM



Read this message from Mr. F. J. Camm, Editor of "Practical Wireless" :—

"You have surpassed yourselves with this new 'Stentorian' speaker. I thought you had reached the apogee when you introduced the 'Microlode' last year; but to this present speaker, which I have submitted to test, I unhesitatingly accord full marks for a rich and entrancing quality in tone, and for an even greater sensitivity for a given input than was obtainable even from your past high standard of speaker."

"I feel that your Engineers must always be at work striving after the apparently unattainable and attaining it. Good sales to you!"

F. J. Camm

If you are a regular reader of "Practical Wireless" you will have noticed that for every important receiver described since August last Mr. Camm has specified the use of a 1936 Stentorian. He has many makes and types from which to choose. Have you realised how significant is this consistent selection of this one instrument?

If you would understand the reason, ask your dealer to demonstrate a 1936 Stentorian. When you hear the extra volume, cleaner reproduction, and brilliant realism this supremely modern speaker brings, you will know that Mr. Camm's preference is based on incontrovertible fact.



To any receiver, new or old, this unique loud-speaker brings a truly amazing improvement in performance. Never before have such sensitivity, marvellous "transient" response, and wide frequency range been available at "commercial" prices. Ask your dealer to demonstrate today, and hear for yourself!

PRICES :—

1936 STENTORIAN.		Chassis Models.	
Cabinet Models.		Senior	42/-
36S	63/-	Junior	32/6
36J	49/6	Baby	23/6
36B	29/6	Midget	17/6
		Duplex	84/-
		EM/W	70/-

1936 STENTORIAN

PERMANENT MAGNET MOVING-COIL SPEAKERS.

WHITELEY ELECTRICAL RADIO CO., LTD. (Technical Dept.), MANSFIELD, NOTTS.

Designers Choose Clix

Because:—

All Clix components, in addition to giving Perfect Contact, are easy to wire: for instance, the centre socket of the 5-pin and two sockets of the 7-pin valveholders are made longer than the others: this reduces the possibility of short-circuits and adds to the ease of wiring. The Clix range of Baseboard and Chassis Mounting Valveholders includes the types illustrated. Types V.5, and V.7, were designed to comply with the essentials in short and ultra-short-wave work. The whole of the technical Press recommend them.

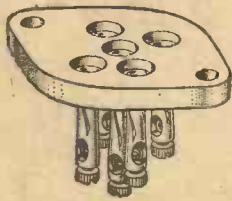

(V. 5.)

MR. F. J. CAMM CHOOSES, USES AND RECOMMENDS CLIX

Specified for the
"MONITOR 3"

Clix Standard Type (V.1.)
4-pin 8d. 5-pin 9d.

Recommended for the
"PREFECT S.W. THREE"

Clix Short-wave Type (V.5.)
with low-loss, ceramic base
4-pin 7d. 5-pin 8d.

Clix Baseboard Type (V.7.)
4-pin 1/6. 5-pin 1/7

"The Wireless World" said:—
"Tested in a short-wave set this new valveholder was found to be very satisfactory. . . . It was fitted, also, in an ultra-short-wave set, and again the performance was exemplary."

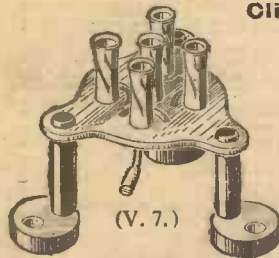

(V. 7.)

FOLDER "N" FREE ON REQUEST

LECTRO LINX LIMITED,
79a, ROCHESTER ROW, LONDON, S.W.1



(V. 1.)

ON OCTOBER 12th, 1935

every reader of this journal was presented with a Short-Wave Handbook, and in it was described a "Short-wave Converter/Adaptor"—An "Ultra Short-wave Converter" and a "Short-Wave Three Valver." For all this apparatus Hivac Valves received "Solus" Specification.

In this issue you have further proof of the high efficiency of Hivac Valves for Short-Wave work—because MR. F. J. CAMM again Specifies Hivac; this time for his

"PREFECT S.W. THREE"

These are the Valves you need:
D.210 3/9d. L.210 3/9d. P.215 4/9d.
A Complete Set of Valves for only 12/3.

For those who decide to build the "Monitor Three" we recommend with every confidence the following types.

V.P.215 10/6d. D.210 3/9d. Y.220 10/6d.
A Complete Set of Valves for only 24/9d.
Fit Hivac—Maintain Efficiency and Save 25% on Valve costs.

Hivac Valve Guide "N" Free on Request.



BRITISH MADE



High Vacuum Valve Co., Ltd., 113-117, Farringdon Road, London, E.C.1.

LETTERS FROM READERS

(Continued from previous page)

Club Membership Sought

SIR,—As a reader of your journal, I should be glad to know whether there is a short-wave radio club or society in Brighton.—N. FREEDMAN, 8, Western Road, Brighton.

[Perhaps readers would like to get into touch with Mr. Freedman.—ED.]

A Suggested Rearrangement of Wavelengths

SIR,—The poor spacing of radio stations on the long-wave band has frequently been commented upon in PRACTICAL AND AMATEUR WIRELESS. It will be observed that only three stations have a complete long-wave channel to themselves. Few stations can be tuned in free of interference or powerful whistles at present, but within a year or so, if the present plan is followed, the interference will be greatly increased. Lahti will increase its power to 220 kW, Reykjavik to 100 kW (heterodyning Droitwich), Warsaw to 200 kW, Oslo (perhaps) to 150 kW, Paris to 150 kW, and Berlin to 150 kW. Also room must be found for the 150 kW plant being constructed at Madrid. I have evolved a wavelength plan which I believe will work if put into practice, and which I believe would be readily acceptable to all powers concerned, except possibly Russia. Even the latter country would be benefited in that Moscow I would be free under this plan from the bad jamming which it endures at present from Paris, and would also save the station from inaudibility, due to heterodyning when the 220 kW Lahti station starts transmitting.

Station.	Power in kW in 1 1/2 yrs. time.	Frequency in kc/s.
Brasov (Romania) ..	150	151
Kaunas (Lithuania) ..	7	155
{ Kootwijk (Holland) ..	100	160
{ Novosibirsk (Russia) ..	100	160
Lahti ..	220	169
Moscow I ..	500	179
Radio Paris ..	150	188
Berlin ..	150	197
{ Reykjavik (Iceland) ..	100 (?)	206
{ Madrid (Spain) ..	150	206
{ Droitwich ..	150	215
{ Minsk (Russia) ..	35	215
Motala ..	150	224
Warsaw ..	200	234
{ Kalundborg ..	60	244
{ Kharkov ..	20	244
Leningrad ..	100	253
{ Luxembourg ..	150	262
{ Tiflis ..	35	262
{ Oslo ..	150 (?)	271
{ Tashkent ..	25	271
Moscow II ..	100	280

There seems to be far fewer disadvantages to this plan than to the present one, remembering the future power increases and the necessity for finding a channel for Madrid. A separation of 9 kc/s has been adhered to in all cases, except that of Kaunas, and a 10 kc/s separation has been allowed between Moscow and Lahti, and on either side of Warsaw. Possibly it would be better to synchronise Reykjavik with Leningrad rather than with Madrid, but the Russian wavelengths suffer most under the plan as it is.

I should like to have other readers' criticisms of this wavelength plan. It seems to me to be the fairest compromise possible at present, but, of course, I am unaware of difficulties of administration, etc., which might prevent its adoption.—D. BOXALL (Erith).

RADIO CLUBS AND SOCIETIES

Club Reports should not exceed 200 words in length and should be received First Post each Monday morning for publication in the following week's issue.

THE CARDIFF AND DISTRICT SHORT-WAVE CLUB
A VERY successful meeting of the above Society was held at the Barry's Hotel, St. Mary St., Cardiff, on Thursday, January 23rd, at which the attendance, including several well-known amateur transmitters, was forty. It was decided at this meeting that the name should be changed from "The Cardiff Amateur Transmitters Society" to that given above. The question of future procedure was discussed, it being decided to start morse practice at the next meeting, February 6th, when the instructor will be Mr. W. Sutton. All readers of PRACTICAL AND AMATEUR WIRELESS, especially those interested in short-wave work, are cordially invited to attend this meeting which will be held at the Barry's Hotel, St. Mary Street, Cardiff. The Hon. Sec., Mr. H. H. Phillips, 132, Clare Road, Cardiff, will be pleased to give any further information to anyone interested.

NORTH MANCHESTER RADIO SOCIETY (NORTHERN HEADQUARTERS. BRITISH LONG-DISTANCE LISTENERS CLUB)
THE North Manchester Radio Society, the largest Society of its kind in Manchester, caters for all radio enthusiasts, from the beginner to keen "DX" and short-wave enthusiasts. Meetings are held every Friday commencing at 8 p.m., at which lectures and demonstrations are given of the latest receivers, components, etc., by representatives of the various manufacturers. On meeting nights the room is open for the use of members from 7 p.m., and for those interested morse instruction is given from 7.30 to 8 p.m. Besides the usual routine of meetings, visits are made to places of interest from time to time. There is also an interesting social side, which includes dances, whist drives, suppers, etc. The first dance of the Society is being held at the "Ritz," Manchester, on February 19th, tickets 1s. 6d. each. All interested in radio are welcome at the Society's meetings, which are held at the British Legion, Elms Street, Bury New Road, Whitefield, Near Manchester. Further particulars can be obtained from the Secretary, Mr. R. Lawton, 10, Dalton Avenue, Thatch Leach Lane, Whitefield, Near Manchester.

SHORT-WAVE RADIO AND TELEVISION SOCIETY (THORNTON HEATH)
THE weekly meeting of this Society was held at Pauls Hall, Norfolk Road, on Tuesday, January 21st. The programme for the evening consisting of a talk by Mr. B. R. Arnold on 5-metre receivers. He began by describing his own 5-metre receiver, comprising a detector which was of the self-quenching type. The detector circuit was the conventional Split-Coupled. This was followed by one stage of low-frequency amplification—transformer coupled. Mr. Arnold had experimented with several types of aerials and had found that a simple directive aerial produced a pronounced gain in signal strength on reception. Particulars of future programmes, etc., can be obtained from the Hon. Secretary, Mr. J. T. Webber 308, Brigstock Road, Thornton Heath, Surrey.

PETERBOROUGH SHORT-WAVE SOCIETY
AT a meeting of the above Society, held at the Museum, Peterborough, on Wednesday, January 15th, particulars were given of the Boyce Reception Cup contest. The President, Mr. L. Neaverson (G5NX), presided and urged the members to support the contest which lasts from January 18th until February 18th. Competitors must produce confirmations of what they consider their best twelve reception reports for the period of the contest, and they must be submitted to the competition secretary (Mr. C. Boyce, 39, Craig St., Peterborough), by April 18th. The winner will hold the cup for three months and he will also receive a certificate, as will the runner-up. The President, and the donor (Mr. C. Boyce) will act as judges, and members holding transmitting licences (radiating aerials) are not eligible to compete. A junk sale was held, half of the proceeds going to the Society. There was also a morse class. Hon. Secretary, Mr. H. E. Daft, 31, Eastfield Road, Peterborough.

INTERNATIONAL SHORT-WAVE CLUB (MANCHESTER CHAPTER)
MEETINGS of the above club are held every Tuesday, except the last in the month, at The British Legion Club, Long Street, Middleton, Lancs., at 8.0 p.m. PRACTICAL AND AMATEUR WIRELESS readers will be given a welcome, and will find something of interest at every meeting. Recently a member brought along a 5-metre receiver, and members had an opportunity of listening on that band. A transmitting member had his transmitter working, and the reception was obtained. Members are now constructing receivers for use at the club, and some interesting discussions take place on the type of circuit, etc. Morse instruction is given at 7.30 p.m. by a group of efficient operators. Future attractions include, on February 18th, a demonstration of a whole range of Zenith receivers, at prices from 19 to 100 guineas. Further details can be obtained by writing to the Secretary, H. Wild, 1, Elm Street, Middleton, Lancs., enclosing a 1d. stamp for reply.

RADIO BULGIN PRODUCTS

SAFETY IN THE HOME



YOU won't have any electrical accidents if all your apparatus is safely fused, so that fire cannot break out. It's false economy to have a few pence and run risks. "FUSE-PLUGS" fit to any apparatus.

LIST N° P.27
 Mahogany bakelite FUSE-PLUG with internal double-pole fuses. Fits all two-pin 5.A. type sockets.

2-COMPLET WITH FUSES

Skeletonised EFFICIENCY

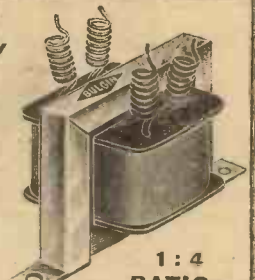

Efficiency comes from the works, not from beautiful cases, and finish. Because the insides of our components are what count, and because we are never ashamed of them, we sell skeletonised components for all the world to see. This skeleton equivalent of L.F.12 (below) costs 2/- less. But you lose nothing, except the case.

1:4 RATIO

List No. L.F.33 4/- EACH

Specified

PUSH-PULL SWITCHES



Incorporated and specified in every leading circuit since 1924. and giving satisfaction in hundreds of thousands of sets, this switch embodies twelve years of experience and constant improvement, and is the finest of its type. Nickel-silver contacts.

List No. S.22 1/3 EACH

FOR THE "MONITOR 3" AND THE "PREFECT" SHORT WAVE 3

Remarkable value for money, this Switch was used by the designers because they wanted efficiency, compactness, and reliability. They know that they could rely on Bulgin, and that thousands of constructors building the "PREFECT" SHORT WAVE 3 could do likewise.

Small, but certain in action, it can be fitted to any panel.

List No. S.38 10d. EACH

SCREENED H.F. CHOKES



This popular model is a Standard to the industry. It is fully screened, and has an inductance of 250,000 μH., and a self-capacity of only 2.5 μμF. Aluminium-finished iron case, and locked terminals. Resistance, 400Ω.

List No. H.F.9 3/6 EACH

NICKEL ALLOY TRANSFORMERS



Because the "MONITOR 3" is a quality receiver, the designers used this Bulgin L.F. Transformer. It gives straight-line amplification from below 50 to over 8,000 cycles, and has a turns ratio of 1:4. Although small, it leads, and sets a standard that is unapproached.

List No. L.F.12 6- EACH

The KEY to Better Reception..



You lock your doors, your car, your wine-cupboard, of your valuables. Lock up your radio, and avoid unauthorised use and tampering. Never again need the accumulator be mysteriously discharged "on its own."

For mains or batteries, 3 amp. 250 v. max., complete with key. **CANNOT** be operated without the key.

List No. S.124 3/- each

FOR AERIAL ARRESTERS



YOU CAN RELY ON BULGIN immunity from damage depends on your precautions. Many valuable sets have been ruined by atmospheric electric discharges, but had proper arresters been fitted, no harm would have resulted.

YOU CAN RELY ON BULGIN

List No. L.1, Aerial Arrester with protected internal disc. Price and low-loss insulator. COMPLETE 2/-

List No. L.2, Aerial Arrester with gap, and replaceable internal fuse for set lead-in. Low loss Price under all conditions. 3/6 COMPLETE

Just WIRE— and SKILL



Tuning coils look so simple. Remove the can, and there is—just wire, and SKILL. Our knowledge (which you can't see) has made these better than the rest. By buying a make which you can trust you will get that difference. The verdict of thousands is: BULGIN FOR COILS. We make coils to cover from 5 metres to 2,000 metres. Bulgin Dual-Wave Coils, 200-550 and 1,000-2,000 metres. They are chassis or board fixing. They are of every type for every set and every use. Efficiency from the highest order. 4/6 to 8/6

BULGIN RADIO COMPONENTS

To Messrs. A. F. Bulgin & Co., Ltd., Abbey Road, Barking, Essex.

Please send me your complete Catalogue No. 155 "N", for which I enclose 5d. stamps.

NAME

ADDRESS

(Please use Block Letters.)

SEND THIS COUPON NOW!

Advert. of A. F. BULGIN & CO., LTD., BARKING, ESSEX. RIPPleway 3474 (3 lines) Showrooms: 64, HOLBORN VIADUCT, E.C.1. CENTRAL 2751. BULGIN PUBLICITY

Facts and Figures

COMPONENTS TESTED IN OUR NEW LABORATORY

Drydex Battery Changes

THE Drydex "Textet" carton has been redesigned to bring it into line with the carton used for the standard "Red Triangle" range of batteries, and all "Textet" batteries are now being sent out in the new carton.

Another change recently adopted in order further to popularise the use of Drydex special sizes is the fitting of a special label which indicates the receivers for which the particular battery is suitable—e.g. Type H.1100 bears a label signifying that the battery is suitable for Murphy: B.24 and B.25.

Dubilier Oil-immersed Condensers

FOR television purposes and also for use in connection with certain types of high-voltage receivers and amplifiers, some special oil-immersed condensers have been produced by Messrs. Dubilier. Amongst these is a 10 mfd. 750-volt D.C. working model, priced at 17s. The general appearance and make-up of this condenser will follow the lines of the range of 951 condensers already on the market.



Some of the Dubilier Type 950 and 951 condensers.

Bennett Microphone

A NEW low-priced microphone has been produced by H. J. Bennett, of 287, Pentonville Road, King's Cross, which is suitable for use with practically any type of broadcast receiver or amplifier. The unit is of the carbon type, provided with an additional diaphragm of special construction, and this has an over-all diameter of 2½ in. A rectangular metal box is used to house the microphone, and a central opening measuring 2½ in. by 1½ in. is cut at the front and protected with a piece of metal gauze. A metal ring 6 in. in diameter supports the microphone through three springs, and the assembly is mounted on a vertical support which is fitted to a metal and wood base, inside which a special matching transformer is mounted. The secondary and primary windings are brought out to separate terminals so that the instrument may be biased and connected to any type of receiver with a minimum of

trouble. The base of the microphone is covered with felt to prevent damage to any polished surface upon which it may be placed. Used correctly, this type of microphone is capable of exceedingly good results for either speech, instrumental, or orchestral music, and the price is only 10s. 6d.

New Ferranti Brochure

WE recently mentioned that a new range of all-wave sets had been produced by Messrs. Ferranti, and we have now received a copy of the new brochure, R108, which gives particulars of the complete range. The list gives fairly complete information regarding the various models, together with a most interesting analysis of the advantages of all-wave reception and the vital reasons why all-wave radio is so worth while in these days. A smaller booklet is also available, showing all the models in colour, and it may be obtained upon application to the Radio Works, Moston, Manchester. For the benefit of new readers we may mention that these receivers range in price from 9½ guineas to 17 guineas, and are designed for use on all wavebands from 19 to 51 metres, as well as the normal broadcast wavebands of 200 to 550 and 900 to 2,000 metres.

McCarthy Radio Ltd.

AN interesting range of all-wave receivers is now obtainable from McCarthy Radio Ltd., and these are obtainable in chassis form so that they may be included in any desired cabinet to harmonise with an individual furnishing scheme. The chassis are of metal construction, and amongst the types obtainable may be mentioned an eight-valve superhet, with push-pull output stage, at £11, and a four-valve battery band-pass superhet at £4 5s. The chassis are complete with circuit diagrams and instruction sheets and valves. A copy of the leaflet describing these chassis may be obtained on application to McCarthy Radio Ltd., at 44a, Westbourne Grove, London, W.2.

Philco All-wave All-mains Six

PHILCO announce a full range of their new Empire Six All-wave A.C./D.C. Mains Models 290. The Baby Grand model (recently introduced at 17 guineas) is now supplemented by a Concert Grand and two radiogram types.

The Concert Grand at 21 guineas is extremely good value. It has the Philco patent-inclined sounding board and an 11 in. speaker in a beautifully-shaped walnut cabinet. The handsome radiograms are built with twin speakers and are noteworthy for their high standard of reception and reproduction. The one model has an automatic record changer and is listed at 44 guineas. The other model (without record changer) is 38 guineas.

Mervyn Short-wave Converter-adaptor

MERVYN SOUND AND VISION CO., LTD., announce that a new short-wave converter-adaptor will shortly be placed on the market at 42s. without valve. Further details will be given in due course.

New Polar Compax Condenser

MESSRS. WINGROVE AND ROGERS announce that in future a special Compax condenser will be obtainable with a maximum capacity of .00095. The condenser has been designed primarily for use in certain types of rejector circuit, but there are, no doubt, many opportunities for using a variable of this particular rating. The price is 3s.

Gramplan P.A. Components

A NEW range of public address components is announced by Gramplan Reproducers, Ltd. These include a mains-energised speaker rated at 9-12 watts, and selling at £6 15s. Amongst other models is a special extension speaker in leatherette case costing 3 guineas. Included in the complete amplifying equipment is a universal mains amplifier complete with microphone and speaker listed at 20 guineas. There are also complete outfits fitted with A.C. or clockwork-driven turntables. The address of Gramplan Reproducers is Kew Gardens, Surrey.

Telsen Coils

IN addition to the well-known dual-range (unscreened) types of coil obtainable from the Telsen Company, there are some interesting screened coils of the air-core and the powder-iron core type. A pair of the latter are shown in the illustration below and these may be obtained in various combinations. For a simple H.F. detector circuit, a pair of these coils may be used for tuning the S.G. or aerial circuit and the detector-grid circuit, in which case a reaction winding is included in the latter. For use in a simpler type of circuit, two of the coils may be used for band-pass tuning, the reaction again being applied to the second coil. For the construction of a very simple superhet the pair of coils may be obtained for use as an aerial circuit tuner and an oscillator, in which case the latter coil is not provided with an iron core. The coils may also be obtained in sets of three covering combinations of the above arrangements. An I.F. transformer is also obtainable designed in a similar manner and is intended for use with the superheterodyne combination. The novelty in these coils lies in the square screening can and the high base-plate which houses a most efficient switching system. The operating rod is provided with a substantial "position lock" and a circular indicating plate showing clearly at a glance just what range is in use. A pair of coils, as illustrated, costs 12s., whilst a set of three costs 18s., for use either in a band-pass detector or a superhet combination.

An Ideal Book for the Beginner! Everyman's Wireless Book

By F. J. CAMM

3/6 or 3/10 by post from Geo. Newnes, Ltd.,
8-11, Southampton Street, Strand, W.C.2.



Telsen matched iron-core coils, type W478.

REACH OUT FOR WORLD RADIO

YOU CAN greatly increase the entertainment value of your present set—in fact, you can enjoy all the advantages of an expensive all-wave set by just attaching this guaranteed De-Luxe "Micro" model.

UNIT SHORT-WAVE CONVERTER

to your A.C. or Battery set, without alteration. Wavelength range, 12 to 70 metres. Full vision scale, 100 to 1 tuning. Aerial coupler for adjusting aerial to set. Change-over switch allows instant change from short-waves to normal broadcast. Simple connecting and operating instructions with each unit. No need to disconnect leads after once fitted.



Price complete with coils 50s. From all dealers or direct.

Free: Leaflet "N" of 50/- cash or C.O.D. this and other models.

UNIT RADIO 'Phone: CLE 5340.
347, City Road, London, E.C.1.

F. J. CAMM'S PREFECT S.W. 3

The designer's Specifications:

BELLING-LEE

For a good job well done

F. J. CAMM'S MONITOR THREE

"R" Type Terminals:

Aerial, Earth and L.S.+ and L.S.—
Four at 3d. each .. 1.-

Battery Cord:
One 5-way 30-in. .. 2.-

"Bow-Spring" Wander Plugs:

G.B.+; G.B.—1;
G.B.—2 4½
Three at 1½d. each .. 3/4½

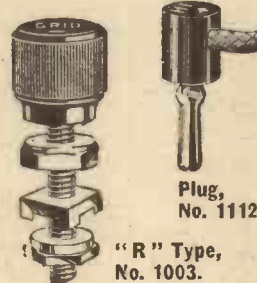

"Bow-Spring" Wander Plugs:

H.T.—; H.T.+1;
H.T.+2; G.B.+;
G.B.—1; G.B.—2
Six at 1½d. 9

Socket Strips:
A/E; L/S; P/U.
Three at 9d. 2 3

Spade Terminals:
L.T.+; L.T.— .. 1.-
Two at 6d. 4/-

Battery Cord

SEND THIS COUPON

MICROFU GOLD FILM FUSES



20 Stock Ratings
Type F.2, Suitable for Battery sets. 150 m/A blows at 300 m/A. Resistance 7½ ohms. Voltage 260 Volts D.C.
Type F.2, suitable for Mains sets. 500m/A blows at 1 amp. Resistance 1½ ohms 260 Volts D.C. Now available 2 m/A, 4/-, 1 m/A, 4/6.
FUSES 6d. HOLDERS 6d.

Specified for the "PREFECT S.W. THREE"

You need one Type F2, 60m/A Fuse and Holder.
MICROFUSES Ltd., 4, Charterhouse Bldgs., Goswell Rd., London, E.C.1. 'Phone: OLE 4049.



Spade Terminal, No. 1246.

Socket Strip, No. 1047.



BELLING & LEE LTD

CAMBRIDGE AERIAL ROAD, ENFIELD, MIDDLESEX

Please send, free, your complete Catalogue, "Radio Connections."

Name

Address

Pr.W. 8.2.36

CHOSEN!

FOR THE PREFECT S.W. THREE

This set as well as being exceedingly simple to build is outstanding in performance. The J.B. components chosen are as follows:

Popular Log (.00025)...	5/-
Two Ratio Slow Motion Dial	6/6
Bandspread Condenser (15 mmf.)	3/9
"Dilecon" Condenser (.0003)	2/6

FOR THE MONITOR THREE

Also described in this issue, is chosen the famous J.B. Airplane dial. Price, 5/9

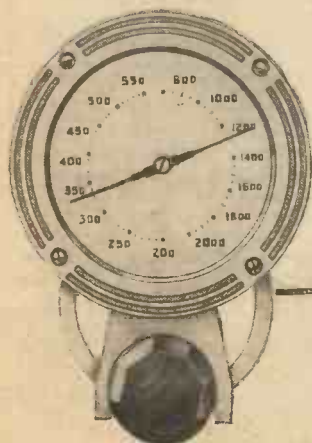

Practical and Amateur Wireless BLUEPRINT SERVICE

PRACTICAL WIRELESS.		
STRAIGHT SETS. Battery Operated		
One-valve : Blueprints, 1s. each.	Date of Issue.	No. of Blueprint.
All-Wave Unipen (pentode)	14.10.33	PW31A
Two-valve : Blueprints, 1s. each.		
Four-range Super Mag. Two (D, Pen)	11.8.34	PW36D
Three-valve : Blueprints, 1s. each.		
Selectone Battery Three (D, 2 LF (Trans.))		PW10
Alpha Q.P.P. Three (D, Q.P.P.)	25.3.33	PW14
Ferrocart Q.P.P. Hi-Mag Three (SG, D, Q.P.P.)	25.3.33	PW15
Sixty-Shilling Three (D, 2 LF (R.C. & trans.))	2.12.33	PW34A
Leader Three (SG, D, Pow.)	3.3.34	PW35
Summit Three (HF Pen, D, Pen)	18.8.34	PW37
All-Pentode Three (H.F. Pen, D (pen), Pen)	22.0.34	PW39
Hall-Mark Three (SG, D, Pow.)		PW41
Hall-Mark Cadet (D, LF, Pen (R.C.))	23.3.35	PW48
F. J. Camm's Silver Souvenir (HF Pen, D (pen), Pen.) (All-wave Three)	13.4.35	PW49
Genet Midget (D, 2 LF (trans))	June '35	PM1
Cameo Midget Three (D, 2 LF (trans))	8.0.35	PW51
1936 Sonotone Three-Four (HF Pen, HF Pen, Westector Pen)	17.8.35	PW53
Battery All-wave Three (D, 2 LF (R.C.))	31.8.35	PW55
Four-valve : Blueprints, 1s. each.		
Fury Four (2 SG, D, Pen)		PW11
Beta Universal Four (SG, D, LF, Cl. B)	15.4.33	PW17
Nucleon Class B Four (SG, D (SG), LF, Cl. B)	6.1.34	PW34B
Fury Four Super (SG, SG, D, Pen)		PW34C
Battery Hall-Mark 4 (HF Pen, D, Push Pull)	2.2.35	PW40
F. J. Camm's Superformer (SG, SG, D, Pen)	12.10.35	PW57
Mains Operated		
Two-valve : Blueprints, 1s. each.		
A.C. Twin (D (pen), Pen)	22.4.33	PW18
A.C.-D.C. Two (SG, Power)	7.10.33	PW31
Selection A.C. Radiogram Two (D, Pow.)	29.4.33	PW19
Three-valve : Blueprints, 1s. each.		
Double-Diode-Triode Three (HF Pen, D.D.T., Pen)	10.6.33	PW23
D.C. Ace (SG, D, Pen)	15.7.33	PW25
A.C. Three (SG, D, Pen)	16.9.33	PW20
A.C. Leader (HF Pen, D, Power)	7.4.34	PW35C
D.C. Premier (HF Pen, D, Pen)	31.3.34	PW35B
Ubique (HF Pen, D (Pen), Pen)	28.7.34	PW36A
Armada Mains Three (HF Pen, D, Pen)	18.8.34	PW38
F. J. Camm's A.C. All-Wave Silver Souvenir Three (HF Pen, D, Pen)	11.5.35	PW50
"Allwave" A.C. Three (D, 2LF (R.C.))	17.8.35	PW54
A.C. 1936 Sonotone (HF Pen, HF Pen, Westector, Pen)	31.8.35	PW56
F. J. Camm's Monitor Three	8.2.36	PW61
Four-valve : Blueprints, 1s. each.		
A.C. Fury Four (SG, SG, D, Pen)	25.2.33	PW20
A.C. Fury Four Super (SG, SG, D, Pen)	10.2.34	PW34D
A.C. Hall-Mark (HF Pen, D, Push-Pull)		PW45
Universal Hall-Mark (HF Pen, D, Push-Pull)	9.2.35	PW47

SUPERHETS.		
Battery Sets : Blueprints, 1s. each.		
£5 Superhet (three valve)		PW40
F. J. Camm's 2-valve superhet (two valve)	13.7.35	PW52
F. J. Camm's £4 Superhet 4	16.11.35	PW58
Mains Sets : Blueprints, 1s. each.		
A.C. £5 Superhet (three valve)		PW43
D.C. £5 Superhet (three valve)	1.12.34	PW42
Universal £5 Superhet (three valve)	15.12.34	PW44
F. J. Camm's A.C. £4 Superhet 4	7.12.35	PW59
F. J. Camm's Universal £4 Superhet 4	11.1.30	PW60
SHORT-WAVE SETS.		
Two-valve : Blueprints, 1s. each.		
Midget Short-wave Two (D, Pen)	15.9.34	W38A
Three-valve : Blueprints, 1s. each.		
Experimenter's Short-wave Three (SG, D, Power)	23.9.33	PW30A
PORTABLES.		
Three-valve : Blueprints, 1s. each.		
Atom Lightweight Portable (SG, D, Pen)	2.6.34	PW36
Four-valve : Blueprints, 1s. each.		
Featherweight Portable Four (SG, D, LF, Cl. B)	0.5.33	PW12
MISCELLANEOUS.		
S.W. Converter-Adapter (valve)	23.2.35	W48A1P
AMATEUR WIRELESS AND WIRELESS MAGAZINE.		
CRYSTAL SETS.		
Blueprints 6d. each.		
Four-station Crystal Set		AW427
1934 Crystal Set	4.8.34	AW444
150-mile Crystal Set		AW450
STRAIGHT SETS. Battery Operated		
One-valve : Blueprints, 1s. each.		
B.E.C. Special One-valver		AW387
Twenty-station Loud-speaker One-valver (Class B)		AW440
Two-valve : Blueprints, 1s. each.		
Melody Ranger Two (D, Trans)		AW388
Full-volume Two (SG, Det, Pen)	17.6.33	AW392
Iron core Two (D, Trans)		AW395
Iron-core Two (D, Q.P.P.)	12.8.33	AW396
B.B.C. National Two with Lucerne Coil (D, Trans)		AW377A
Big-power Melody Two with Lucerne Coil (SG, Trans)		AW338A
Lucerne Minor (D, Pen)		AW426
Three-valve : Blueprints, 1s. each.		
P.T.P. Three (Pentode-Triode-Pentode)	June '35	WM389
Class-B Three (D, Trans, Class B)	22.4.33	AW386
New Britain's Favourite Three (D, Trans, Class B)	15.7.33	AW394
Home-Built Coil Three (SG, D, Trans)	14.10.33	AW404
Fan and Family Three (D, Trans, Class B)	25.11.33	AW410
£5 5s. S.G.3 (SG, D, Trans)	2.12.33	AW412
1934 Ether Searcher : Baseboard Model (SG, D, Pen)	20.1.34	AW417
1934 Ether Searcher : Chassis Model (SG, D, Pen)	3.2.34	AW419
Lucerne Ranger (SG, D, Trans)		AW422
Coscor Melody Maker with Lucerne Coils		AW423

These blueprints are full size. Copies of appropriate issues containing descriptions of these sets can in most cases be obtained as follows:—
 "Practical Wireless" at 4d., "Amateur Wireless" at 4d., "Practical Mechanics" at 7d., and "Wireless Magazine" at 1/3, post paid. Index letters "P.W." refer to "Practical Wireless" sets; "P.M." to "Practical Mechanics" sets; "A.W." refer to "Amateur Wireless" sets, and "W.M." to "Wireless Magazine" sets. Send (preferably), a postal order (stamps over sixpence unacceptable) to "Practical and Amateur Wireless" Blueprint Dept., Geo. Newnes, Ltd., 8-11, Southampton Street, Strand, W.C.2.

P.W.H. Mascot with Lucerne Coils (D, RC, Trans)	17.8.34	AW337A
Mullard Master Three with Lucerne Coils		AW424
£5 5s. Three : De Luxe Version (SG, D, Trans)	19.5.34	AW435
Lucerne Straight Three (D, RC, Trans)		AW437
All Britain Three (HF Pen, D, Pen) "Wireless League" Three (HF Pen, D, Pen)	3.1.34	AW448
Transportable Three (SG, D, Pen)		AW451
£6 6s. Radiogram (D, RC, Trans)	Apr. '33	WM318
Simple tune Three (SG, D, Pen)	June, '33	WM327
C.B. Three (D, LF, Class B)		WM333
Economy-pentode Three (SG, D, Pen)	Oct. '33	WM337
"W.M." 1934 Standard Three (SG, D, Pen)		WM351
£3 3s. Three (SG, D, Trans)	Mar. '34	WM354
Iron-core Band-pass Three (SG, D, QP21)	June, '34	WM362
1935 £6 6s. Battery Three (SG, D, Pen)	Oct. '34	WM371
Graduating to a Low-frequency Stage (D, 2LF)	Jan. '35	WM378
Four-valve : Blueprints, 1s. 6d. each.		
65/- Four (SG, D, RC, Trans)		AW370
"A.W." Ideal Four (2SG, D, Pen)	16.9.33	AW402
2 H.F. Four (D, Pen)		AW421
Crusaders' A.V.C. 4 (2HF, D, QP21)	18.8.34	AW445
(Pentode and Class-B Outputs for above : blueprints 6d. each)	25.8.34	AW445A
Quadradyne (2SG, D, Pen)		WM273
Calibrator (SG, D, RC, Trans)	Oct. '32	WM300
Table Quad (SG, D, RC, Trans)		WM303
Calibrator de Luxe (SG, D, RC, Trans)	Apr. '33	WM310
Self-contained Four (SG, D, LF, Class-B)	Aug. '33	WM331
Lucerne Straight Four (SG, D, LF, Trans)		WM350
£5 5s. Battery Four (HF, D, 2LF)	Feb. '35	WM381
The H.K. Four	Mar. '35	WM384
Five-valve : Blueprints, 1s. 6d. each.		
Super-quality Five (2HF, D, RC, Trans)	May '33	WM320
New Class-B Five (2SG, D, LF, Class B)	Nov. '33	WM340
Class-B Quadradyne (2SG, D, LF, Class B)	Dec. '33	WM344
1935 Super Five (Battery Superhet)	Jan. '35	WM379
Mains Operated.		
Two-valve : Blueprints, 1s. each.		
Two-valve Mains Short-wave (D, Pen) A.C.	10.11.34	AW453
"W.M." Band-spread Short-waver (D, Pen) A.C./D.C.	Aug. '34	WM368
"W.M." Long-wave Converter	Jan. '35	WM380
Three-valve : Blueprints, 1s. each.		
Emigrator (SG, D, Pen), A.C.		WM352
Four-valve : Blueprints, 1s. 6d. each.		
Gold Coaster (SG, D, RC, Trans)		WM202
A.C.	Aug. '32	WM202
Trickle Charger	Jan. 5, '35	AW46

3 6 2

IT IS WITH REGRET THAT WE HAVE TO ANNOUNCE that owing to the unprecedented demand for some of our newer types there is liable to be delay in the execution of orders during the next few weeks. This applies particularly to the Universal Range and to Public Address Output Valves.

THE 362 RADIO VALVE CO., Ltd.,
 Stoneham Works, Stoneham Road,
 Northwold Road, Upper Clapton, LONDON, E.5.

Phone: CLISSOLD 6607.

The Story of a Gracious King

"THE LIFE OF KING GEORGE V"

Commemorating a Great and Glorious Reign

Profusely illustrated in On Sale
 Gravure including Historic 6d. at all Newsagents and
 Funeral Photographs Bookstalls

Published by George Newnes, Ltd., 8-11, Southampton Street, Strand, W.C.2.



QUERIES and ENQUIRIES

nections to the secondary terminals of the L.F. transformer.

Split Connections

"I find great difficulty in getting reception of my two-valve set free from scratches. The set is old, but I keep it well dusted and must admit that it has given great satisfaction for the past four years. I am still using the same components, including valves, but there is a peculiar scratchy background the whole time, and I find this sometimes increases when anyone walks near the set. Are the valves worn out and could they cause the trouble?"—**F. T. (Wiggenhall).**

As the receiver is old it is possible that coils and valves are fitted with split pins for connecting purposes. With time, the springiness has gone out of these and they are making poor contact. The pins should

The Frequency Changer

"I have built a superhet from home-made coils and following, as near as I could, the arrangement used in your £4 model. I have found that I cannot get any results at all, and I have sent the valves to the makers for test and they have reported that they are in order. Can you suggest any possibility for the failure of the receiver to work? I appreciate that you have very little to go on as the receiver is home-made, but anything you have found to cause trouble in this type of receiver may be of assistance to me in tracing my difficulties."—**H. U. (Maidenhead).**

WE note that the valves have been checked and that the circuit is wired correctly. The failure to get any results may be due to inaccurate trimming adjustments or failure of the frequency-changing stage to work. We presume that you have carefully trimmed all the necessary circuits and are certain that the trouble is not due to the fact that all the tuned circuits are adjusted to different positions, and, therefore, we suggest that you check the connections and voltages applied to the frequency-changer. It is essential that the oscillator section shall oscillate, but if it oscillates too fiercely it will prevent reception, as also will be the case if it fails to oscillate. Perhaps this information will enable you to trace the trouble.

Pick-up Leads

"I have been trying to get my radiogram working, but cannot make certain regarding the pick-up connections and most suitable arrangement for this component. I have tried short and long leads, and there appears to be no difference in results, but there is a faint background whistle all the time. I do not get this on radio reception, and the quality on gramophone is not as good as radio. Can you suggest anything?"—**B. E. E. (Bristol).**

THE fact that you mention a faint whistle leads us to suppose that you have not broken the grid circuit when connecting the pick-up, although you give no details at all concerning the circuit arrangements of the complete apparatus. You are probably including the pick-up in the grid circuit in addition to the normal tuning coil, and thus are getting a certain amount of H.F. interaction due to coupling between the present H.F. circuit and tuning coils and the long pick-up leads. The grid circuit should be broken and a change-over switch fitted so that the tuned circuits are cut out whilst the pick-up is in use. It may be found worth while also to reverse the con-

REPLIES IN BRIEF

The following replies to queries are given in abbreviated form either because of non-compliance with our rules, or because the point raised is not of general interest.

M. B. (Southampton). The noise may be due to a faulty valve or component. Have the valves tested, and test each stage of the receiver in order to locate the faulty part.

W. K. (Woolwich). It would appear that the wiring is incorrect, or the component is faulty. It should not modify the tuning as you suggest. In view of the remaining faults we think the oscillator section is faulty, either through defective coils or wrong voltage (probably due to a faulty component).

J. R. (West Stanley). We regret that we have no details of a circuit to suit the parts mentioned by you.

A. J. D. (Hereford). We are sorry we have no details of a set using the coils in question.

J. E. P. (Towyn). In view of your test it would appear that it is the detector valve which is at fault. We advise you to have this tested.

H. G. (Marton). We regret that we have no details of the coils in question. The makers should be able to supply you with this information.

A. M. (Edinburgh). The arrangement is quite in order and is, in fact, the recognised method of making extension-listening points with a push-pull stage.

F. W. N. (Crayford). Write direct to the R.S.G.B., at 53, Victoria Street, London, S.W.1.

C. W. (Salford 6). Write direct to the English Agent, B. J. Forbat, 28, Southampton Street, Strand, London, W.C.2.

R. H. (Erith). You could not add to the set at present. An H.F. stage would not improve matters, and we would suggest that you obtain the necessary parts to convert it into a superhet.

J. S. C. (Leicester). The effect was due to "earth induction," and the conversation was heard through the earth of your receiver. It may be remedied by using an alternative earth connection, or probably by fitting a counterpoise earth. You may find that the telephone earth is close to your own earth connection, and in that case you should remove yours to a more distant point.

H. J. G. (Starbeck). We advise you to communicate with the makers of your receiver as you may be damaging the valves or other components due to the removed lead.

D. R. (Woodford Green). An article on the subject has been given in our issue (see page 247, May 11th, 1935). Addresses may be obtained from the Radio Amateurs' Call Book, obtainable from F. L. Postlethwaite, 41, Kinafons Road, Goodmayes, Essex.

S. M. (Edgehill). The arrangement in question should function quite satisfactorily, but you must beware of H.T. on the grid of the L.F. valve. A 1 to 1 transformer would probably be found desirable for coupling purposes.

J. M. (Lisboa). Cannot understand your letter. The £4 superhet is, of course, complete. It is not intended as an all-wave receiver.

G. S. (Beaumaris). Sorry, but we have no book such as you require. Your suggestions will, however, be carefully borne in mind. Many thanks for your appreciation.

N. D. (Neath). Regret we cannot furnish details of a transmitter. An article on the transmitting licence will shortly be published.

M. B. (Anstey). Aluminium could certainly be employed, but you must bear in mind that the underside of our type of chassis is insulated and, therefore, you must be careful when mounting components in this position.

D. McC. (St. Johnston, Londonderry). A relay must be employed as the signal strength is insufficient. It may also be necessary to fit a rectifier between the output circuit and the recorder.

F. G. A. (Tottenham). A suitable add-on H.F. unit was described in last week's issue. We regret that we cannot give constructional details for an H.F. transformer.

H. E. H. (Andover). We cannot give you the advice in view of the lack of details concerning the coils. Certain types of coil are already provided with a winding which may be used for a link winding, and we therefore suggest that you communicate with the makers for further details.

G. F. S. (Portuguese East Africa). We regret that we cannot recommend any individual commercial receiver and we have no details of conditions in your part of the world. We have not described a suitable all-wave superhet which you could construct yourself, and we suggest you write to various English manufacturers for details of their products which are designed for use in the colonies.

(Continued at foot of preceding column.)

RULES

We wish to draw the reader's attention to the fact that the Queries Service is intended only for the solution of problems or difficulties arising from the construction of receivers described in our pages, from articles appearing in our pages, or on general wireless matters. We regret that we cannot, for obvious reasons—

- (1) Supply circuit diagrams of complete receivers.
- (2) Suggest alterations or modifications to receivers described in our contemporaries.
- (3) Suggest alterations or modifications to commercial receivers.
- (4) Answer queries over the telephone.
- (5) Grant interviews to querists.

Please note also, that queries must be limited to two per reader, and all sketches and drawings which are sent to us should bear the name and address of the sender.

If a postal reply is desired, a stamped addressed envelope must be enclosed. Send your queries to the Editor, PRACTICAL AND AMATEUR WIRELESS, Geo. Newnes, Ltd., 8-11, Southampton Street, Strand, London, W.O.2.

be opened out slightly with a penknife or similar implement, and they should also be cleaned at the same time with a fine piece of emery cloth. It would also be as well at the same time to make quite certain that all terminal connections are tight and that no soldered connections have become loose. It would, no doubt, be worth while to obtain modern valves and perhaps also to modernise the circuit.

(Continued from Column 3.)

H. L. G. (Edinburgh). We regret that we cannot offer any solution without further details. There is obviously some faulty component or valve, and we should be pleased to help you if you could give any more complete data.

J. B. (Sale). The .25 megohm resistance in the aerial circuit is the "stopper" resistance referred to in the article in question.

A. H. P. (Small Heath). We do not know of any bulb of the type you mention, but a 15-watt lamp is obtainable from almost any electrical store, and may be used for the purpose. The fuse wire need only be included in one lead, although you will probably find it preferable to use a twin fuse connector with a 1 amp. fuse in each lead.

SPECIFIED for F. J. CAMM'S MONITOR THREE

PIX INVISIBLE AERIAL

PIX, LONDON, S.E.1.

The one aerial for the modern set
Self-adhesive aluminium strip
Gives wonderful pick-up
Just press it and it sticks

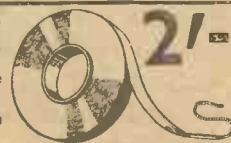

Double Length 3/6

THE PREMIER SUPPLY STORES

Have pleasure in announcing an enormous extension of premises. We have acquired a magnificent Factory and Warehouse, with a floor space of 20,000 ft., making our total floor space over an acre in extent. This has become necessary owing to the enormous growth of our business, far in excess of the generous arrangements we have already made. We trust that the increased range of goods and speedier service will be to your satisfaction. The Management takes this opportunity of thanking the many thousands of Patrons for their valued support in past years.

All goods guaranteed perfect. Manufacturers' Surplus. Carriage paid over 5/-; under 5/- postage 6d. extra. I.F.S. and Abroad, carriage extra. Orders under 5/- cannot be sent C.O.D. Send 3d. for the most Comprehensive Illustrated Value and Component Catalogue in the Trade, and save pounds.

VARIABLE CONDENSERS

Utility 0.0005 2-gang bakelite dielectric, semi-shielded condenser, Slow Motion and Uniknob Trimmer, 3/11. Utility 0.0005 3-gang fully screened with Trimmers and Illuminated Disc Drive, 7/6. American 0.0005 3-gang with Trimmers, 3/-. Polar Star (manufacturer's type), 3-gang, 0.0005, fully screened with Trimmers, 5/6. Polar 0.0005 with slow motion, 3/11. Lissen 2-gang 0.0005 with Front Trimmer and Disc Drive, 5/11. Bakelite Reaction and Tuning Condensers, 0.0001, 0.00015, 0.0002, 0.0003, 0.0005, 0.00075. 9d. each. Preset Condensers, any value, 6d. each.

LOUDSPEAKERS

PERMANENT MAGNET. Moving Coil Speakers all fitted with output transformers. Magnavox 254, 7" diameter, 16/6. Magnavox 252, 9" diameter, 22/6. Blue Spot 29 PM, 8" diameter, 15/-; without transformer, 12/6. Energised Moving Coil Speakers, all fitted with output transformers (unsuitable for battery sets). Kolster Brandes, 7" diameter, 1,500, 2,000 or 2,500 ohm fields, 7/9. Whiteley Boneham, 8" diameter, 2,500 ohm field, 9/11. Magnavox DC 154, 7" diameter, 2,500 ohm field, 4 wats, 12/6. Magnavox DC 152 Magna, 9" diameter, 2,500 or 5,000 ohm fields, 6 wats, 37/6. B.T.H., 8" diameter, 1,500 or 7,500 ohm fields, 8/6. AC Energised Units for any of the above Speakers, 10/-. B.T.H. matched pairs, 1,500 and 7,500 ohms (1,500 ohm Speaker as choke, 7,500 ohm in parallel with H.T. supply), 15/6 pair. AC Energising Kit, 12/6 extra. Magnavox 6v. Field Model, 6 wats, 12/6. Large type Ormond Cone Units, 3/6.

FIXED CONDENSERS

Electrolytics.	Paper Types.
T.C.C.:	Dubilier:
8mf. 650v. (surge) 4/-	4mf. 500v. working 4/-
4mf. 650v. (surge) 4/-	4mf. 800v. working 6/-
15mf. 500v. 1/-	2mf. 750v. working 3/-
15mf. 100v. 1/-	4mf. 1000v. working 10/6
50mf. 12v. 1/-	4mf. 2000v. working 13/-
Dubilier:	Western Electric:
4mf. 500v. 3/-	4mf. 250v. working 2/-
8mf. 500v. 3/-	2mf. 250v. working 1/6
8-4 mf. 500v. 4/-	1mf. 250v. working 6d.
50mf. 50v. 1/9	4mf. 350v. 2/6
12mf. 20v. 6d.	2mf. 500v. working 1/6
25mf. 25v. 1/-	

CONDENSER BLOCKS

U.S.A.:	All 250 volts working
4, 8, or 12mf. 530v. peak	Dubilier: 2+2+2mf. 2/-
100mf. 12v. 1/3	2+2 1+1+1mf. 2/6
8+4mf. 500v. peak 2/3	H.M.V.: 4+1+1+1+5+5+5mf. 1/6
4+4mf. 500v. peak 1/6	Lissen: 4+4+1+1mf. 3/-
8+8mf. 500v. peak 2/6	
12+8mf. 500v. peak 2/6	
12+4mf. 500v. peak 2/6	

DIALS

Clarion Moving Light Slow Motion Dial, with 2" knob. Ideal for Short Waves, 2/-. Simpicon Full Vision Slow Motion Dial, 2/-. Utility Disc Drive, complete with 2" knob. Ideal for Short Waves, 2/-.

MICROPHONES

3 Guinea model with stand and transformer, single button type, 19/6. Western Electric type on base, with transformer, 4/6. Home Broadcaster Microphone, low priced two-button type with transformer, 7/6. Carbon Microphone with transformer, in handsome Bakelite case, 10/6.

H.F. AND L.F. CHOKES

Premier Screened H.F. Choke, 100-2000 metres, 1/6 each. Premier Screened H.F. Choke, for Short Waves, 10-200 metres, 1/6 each. Premier Short Wave H.F. Choke, 10-200 metres, 9d. Premier Mains H.F. Choke, carry 1 amp., 1/6.

PREMIER SMOOTHING CHOKES.

25 M.A., 20 henrys	2/9	250 M.A., 15 henrys	20/-
40 M.A., 30 henrys	4/-	60 M.A., 80 henrys	5/6
60 M.A., 40 henrys	5/6	2,500 ohm for Speaker Replacement	5/6
150 M.A., 40 henrys	10/-		

20-22, HIGH STREET, CLAPHAM, LONDON, S.W.4. (Hours 9 a.m.—8 p.m. Weds. 1 p.m.)
165 & 165A, FLEET ST., E.C.4. (Hours 9.30 a.m.—7 p.m. Sats. 1.30 p.m.) CENTRAL 2833. (Next door to Anderton's Hotel)
ALL POST ORDERS TO HIGH STREET, CLAPHAM.

SHORT WAVE COMPONENTS

Enormous Selection of the Finest Quality

Premier Short Wave Tuning condensers (S.L.F.), complete Ceramic Insulation. Silver Sprayed Brass Vanes. Noiseless Pigtail, 0.00016, 0.0001, 2/9 each. Double-spaced, 0.00005, 0.000015, 0.000025, 3/- each. Premier all-brass Short Wave condensers, 0.00015 with integral slow motion, 3/9. British Radiophones, all brass, 2-gang short-wave condensers, 0.00015, each section, 5/6 each. Ormond, 0.00025, O.K. for Short Waves, marvellous value, 1/6 each. With slow motion, 2/- each. Ormond, 0.00025, slow motion condensers, all brass, super value, 2/6. Ormond, 0.00025 with special Logging Dial, ideal for band setting, 2/- each. Short Wave Reaction Condensers, all brass, integral Slow Motion, 0.00015, 2/9 each. Polymet Midget: Mica Condensers, with wire ends, 0.00002, 0.00003, 0.00004, 0.00005, 6d. each. Premier Super Short Wave Coils, with circuit, 4- and 6-pin type, 13-170 metres. Set at 4, either type, 7/-; Premier Low Loss, 4- and 6-pin ribbed formers, 1 1/2" diameter, finest quality, 1/- each. Please note that only the very highest grade Plastic material is used in the manufacture of Premier Short Wave Coils and Formers. Premier Short Wave Valve Holders, Steatite Insulation 4-, 5- and 7-pin, chassis type, 6d. each. Baseboard, 8d. each. Reliable Morse Keys with Code engraved on Bakelite base, 2/-. Reliable Short Wave Coils, 4-pin type, 14-150 metres with circuit, 4/- set of 3.

WORLD-FAMOUS CONTINENTAL VALVES

Mains Types. ACHL. ACL. Screen Grid. Variable Mu. 1, 3 and 4 watt directly heated Output Pentodes. H.F. Pentodes. Variable Mu. H.F. Pentodes. Double Diode Triodes. Diode Tetrodes. 250 volts 60 m.a. Full-wave Rectifiers. All 4/6 each. 20 volt 18 amp. AC/DC types. Screen Grid. Variable Mu. H. HL. Power. Pentodes. All 4/6 each. 350 volt 120 m.a. Full Wave Rectifiers. 500 volt 120 m.a. Full Wave Rectifiers. 2 1/2 watt indirectly heated Pentodes. 2 watt indirectly heated Power 2 1/2 watt directly heated Power. All 5/6 each. 2 volt Battery types. H.F. L.F., 2/3. Power. Low Consumption Power. Super Power, 2/9. Screen Grid. Variable Mu. 4- or 5-pin Pentodes. Variable Mu., H.F. Pentodes. H.F. Pentodes, Class B Valves. All 5/- each. American Types: 250, 210, 245, 47, 46, 24, 35, 37, 51, 55, 57, 58, 80, 6A7, 2A7, 2A5, 27, 77, 78, 281. All 4/6 each.

All the following super quality American types, Hytron Brand, 6/6 each: 1A6, 1C6, 2A5, 2A6, 2A7, 2B7, 6A4, 6A7, 6B7, 6C6, 6F7, 12A5, 19, 24A, 26, 27, 30, 31, 32, 33, 34, 35/51, 36, 37, 38, 39/44, 41, 42, 43, 45, 46, 47, 49, 6D6, 53, 55, 56, 57, 58, 59, 75, 76, 77, 78, 79, 85, 89, 6A6, 83, 523, 2525, 1223, IV. All output valves can be supplied in matched pairs at no extra charge. 100,000 Valves in Stock.

WIRE-WOUND RESISTANCES

4 wats, any value up to 50,000 ohms, 1/- each. 8 wats up to 100,000 ohms, 1/6 each. 15 wats up to 50,000 ohms, 2/- each. 25 wats up to 50,000 ohms, 2/6 each. 15- and 25-watt Resistors can be supplied semi-variable at 6d. extra, 1,000 ohms, 150 m.a. semi-variable Resistance, 2/-, 1,000 ohm, 250 m.a. Resistance tapped for any number of 0.18 amp. valves, 3/6. 800 ohm 350 m.a. tapped resistance, 2/-.

TRANSFORMERS

Premier Mains Transformers have tapped Primaries, and C.T., L.T.'s Engraved Terminal Panels, with N.P. Terminals. All windings paper interleaved. Combined H.T.8 and H.T.9. 4v. 1-2a. and 4v. 3-4a., 10/-. Westinghouse Rectifier, 8/6 extra. H.T.10 with 4v. 1-2a. and 4v. 3-4a., 10/-. Westinghouse Rectifier, 9/6 extra. 250+250v. 60 m.a. with 4v. 1-2a., 4v. 2-3a., 4v. 3-4a., 10/-. 300+300v. 60 m.a. with 4v. 1-2a., 4v. 2-3a., 4v. 3-4a., 10/-. 350+350v. 150 m.a. with 4v. 1-2a., 4v. 2-3a., 4v. 3-4a., 12/6. Auto Transformers, tapped, 100v., 110v., 200v., 220v., 240v. Step up or down, 100 wats, 10/-; 50 wats, 7/-; Manufacturer's type Transformers, 350+350v. 120 m.a. with 4v. 1-2a., 4v. 2-3a., 4v. 3-4a., 10/6. 500+500v. 150 m.a. with 4v. 2-3a., 4v. 2-3a., 4v. 2-3a., 4v. 3-4a., 19/6. 500+500v. 200 m.a. with 4v. 2-3a., 4v. 2-3a., 4v. 3-5a. and 5v. 3a. for American Rectifier, 25/-; Valve Rectifier, 6/6 extra. 1,000+1,000v. 250 m.a. with 4v. 3a., 4v. 3a., 39/6, or with 2 G.U.'s, 59/6.

TRANSFORMERS—Continued

Premier Eliminator Kits, all incorporating Westinghouse Rectifiers, high quality Mains Transformers and Chokes. Generous Smoothing and Decoupling Condensers and Resistances. 120 volts 20 m.a., 20/-; with Trickle Charger, 28/-; 150 volts 30 m.a. with 4v. 3-4a. C.T.L.T., 25/-; with Trickle Charger, 32/6. 250 volts 60 m.a. with 4v. 3-5a. C.T.L.T., 30/-; 300 volts 60 m.a. with 4v. 3-5a. C.T.L.T., 37/6. 200 volts 100 m.a. with 4v. 3-5a. C.T.L.T., 42/6. Premier L.T. Charger Kits all incorporate Westinghouse Rectifiers. 14/6 2 volts at 1/2 amp. 11/- 2 to 6 volts at 1/2 amp. 17/6 30 volts at 1/2 amp. 37/6 2 to 6 volts at 2 amp. 27/6 50 volts at 1 amp. 50/- The following lines 6d. each or 5/- per dozen:—4-, 5- or 7-pin Baseboard or 4-, 5-, or 7-pin Chassis Mounting Valve Holders, American Valve Holders, 1 watt resistances, wire end every value; tubular wire end Condensers, 1,500 volt, every value up to 0.5, 3 amp.; 2- or 3-point Switches; Gylodon Double Trimmers; 6 yds. Systoflex; 1, 1.5, 2 or 2.5 mm. 1 yd. 7-way Cable; 9ft. zinc core Solder; 6 yds. push-back Connecting Wire; 2in. Knobs. Any type and quantity of Instrument Wire can be supplied from stock.

AMPLIFIERS

PREMIER Super Public Address Amplifier, incorporating the new 6B5 Valve (see "Wireless World," July 15), 10-watt model, all AC, enormous gain, phase inversion, £7 7s. with valves; 20-watt model, £10 10s. Suitable Speakers in stock. Premier Soldering Irons, 200-250 volts; consumes 0.2 amps, 2/6. High-grade Push-Pull Input Transformers, 4/6 each. High-grade Intervalve Transformers, 3/6 each. "Voltra" Intervalve Transformers, 1/9 each. Ferranti A.F.3 Transformers, 8/11. Moving Coil Multi-Ratio Output Transformers, 2/6 each. 1-1 or 2-1 Output Transformers, 2/6 each. Microphone Transformers, 50-1 and 100-1, 2/6 each. Telsen 1.75-1 Radiogrand Transformers, 2/9. Telsen "Class B" Driver Transformers, 2/9. Cossor "Class B" Driver and Output Transformers, 2/6 either type. "Standard Telephone" "Class B" Driver Transformer, 1/6.

POTENTIOMETERS

By best manufacturers. 200, 350, 500, 1,000, 2,500, 5,000, 8,000, 10,000, 15,000, 25,000, 50,000, 100,000, 250,000, 500,000, 1 meg. 2/- each. 5,000, 10,000, 15,000, 100,000, 500,000, 1 meg. with switch, 2/- each. Dual Potentiometers: 10,000 and 50,000; 5,000 and 50,000; 5,000 and 100,000; 10,000 and 100,000; with switch, 1/6 each.

METERS

British-made Moving Iron Meters. Flush mounting, 2 1/2" diameter. 0-10, 0-20, 0-30, 0-50, 0-100, 0-150, 0-250, 0-500-milliamperes; 0-1, 0-3, 0-5 amperes. All read AC and DC, 5/9 each. Moving Coil Milliammeters, B.E.S.A., first grade. 0-1 M.A., 2 1/2" diameter, 18/6. 0-1 M.A., 3 1/2" diameter, 22/6. All Meters flush mounting bakelite cases.

COILS

Lissen 3-gang Band Pass Screened Coils, complete with switching and blueprint, 6/11. Lissen All-wave 2-gang Screened Coils for Screened Grid Tuned H.F. stage; and Detector, 12 to 2,000 metres. Complete circuit diagram supplied, 12/6. Selective Iron Cored Coils circuit, 2/11 each. Varley Band Pass Aerial Coils, B.P.5, 2/9. Varley Band Pass Transformer, B.P.8, 2/6. Special Offer. Set of three Lissen Band Pass Screened Coils with Switching, Utility 3-gang Condenser and Illuminated Disc Drive, 4-volts Chassis and Valve holders and blueprint, 14/6 the lot.

GRAMOPHONE MOTORS

B.T.H. Truesped Induction type, A.C. only; 100-250 volts, 30/-. D.C. ditto, 42/6. Collaro Gramophone Unit, consisting of A.C. Motor, 100-250 volts, high quality Pick-up and volume control, 45/-. Collaro Motor only, 30/-. Collaro Universal Gramophone Motor, 100-250 volts, A.C.-D.C., with high quality Pick-up and volume control, 67/6. Collaro Universal Motor only, 49/6. Edison Bell Double Spring Motors, including Turntable and all fittings, 15/-.

PICK-UPS

Cosmocord Pick-ups, with arm and volume control, wonderful value, 10/6 each. Cosmocord Pick-up only, fits any gramophone tone arm, 4/6.

Miscellaneous Advertisements

Advertisements are accepted for these columns at the rate of 3d. per word. Words in black face and/or capitals are charged double this rate (minimum charge 3/- per paragraph). Display lines are charged at 6/- per line. All advertisements must be prepaid. All communications should be addressed to the Advertisement Manager, "Practical and Amateur Wireless," 8, Southampton Street, Strand, London.

RECEIVERS, COMPONENTS AND ACCESSORIES
Surplus, Clearance or Secondhand, etc.

SOUTHERN RADIO'S WIRELESS BARGAINS. ALL GOODS GUARANTEED NEW AND SENT POST PAID.

SPEAKERS.—Blue Spot 1935 Series, with Universal Transformers to match any circuit, 90 P.M., 24/6; Celestion Soundex Permanent Magnet, 11/-; Telsen Permanent Magnet Speakers, 16/-; Telsen Units, 2/9. **ISSN KITS, ALL NEW IN SEALED CARTONS AND COMPLETE.** With Specified Valves. Lissen Skyscraper 3-Valve Battery Kits, 42/- each (List, 77/6). Lissen BAND PASS 3-Valve Battery Kits, 62/6 (List, 99/6).

DEEMARK SHORT-WAVE ADAPTOR KIT. Complete with all accessories for adapting set for 14-150 Metres, 20/-. Superhet Short-wave Converter Kit, 20/-.

MULLARD M.B.3. THREE-VALVE BATTERY SETS. Complete with 3 Mullard Pentode Valves, Permanent Magnet Speaker, Batteries and Accumulator. Contained in handsome walnut cabinet, 25/7/6 (List, 3 guineas). In original sealed cartons.

E.C. A.C./D.C. 3-VALVE RECEIVERS. Ring Valves. Universal Mains and Voltage. Complete in exquisite Cabinet, ready to plug-in, 23/19/6 (List 27/15). Not a midget.

HOUSE TELEPHONES. A SPECIAL BARGAIN, BRAND NEW ONE-HAND TELEPHONES. Complete on stand, with or without Automatic Dials. Cost 24 each to manufacture, 10/- each.

ELIMINATORS.—Regentone 1935 Series. A.C. Mains, 200/250 volts, Type W5a, complete with trickle charger, 39/6; W1a (less trickle charger—carries 30 milliamperes), 33/-. W1c (less trickle charger), 30/-. Telsen Latest Model A.C. Eliminators with trickle charger for 10, 20 or 30 milliamperes, 45/- (List 24/15/-).

CONDENSERS.—Lotus 0.0005. Fully screened, with trimmers, escutcheons, dials and knob. 3-gang, 11/-; 2-gang, 7/3. **DYBLOCK SINGLE, 0.0005,** complete with all accessories, 4/-. **TELSEN SINGLE VARIABLE CONDENSERS, 0.0005, 2/3;** Plessey 4-gang Superhet fully screened with trimmers, 7/3. Igranite 1 mfd., 1/3, 2 mfd., 1/9.

COILS.—Igranite Superhet Coil, set of four (1 Osc., 2 I.F. with Pigtails, 1 I.F. plain), 9/- per set (List, 50/-). Varley Square Peak Coils, B.P.5, complete, 2/3. Telsen Iron-core Coils, W349 midget size, 4/6 each.

The following Telsen Components in original sealed cartons at sacrifice prices:—

CELF TRANSFORMERS.—5/1, 2/9; Binocular H.F. Chokes, 2/-; Standard Screened H.F. Chokes, 2/-; ACE MICROPHONES (P.O.) with Transformers, 5/- each. This Microphone can be used with any radio set and is a very efficient article.

"TRU-OHM" RESISTANCES, 1 watt wire ends, colour coded and marked, 36 on card, assorted capacities, 7/6 per card.

AMERICAN VALVES.—A full range of valves for all American sets at 7/- per valve.

SOUTHERN RADIO BARGAIN PARCELS.—We are offering the following parcels of mixed components at a fraction of their value. The items comprise up-to-date Radio parts, new and perfect, which are too varied to be advertised individually.

5/- PARCEL.—Contains modern components valued at 20/-, including Resistances, Condensers, Coils, Wire, etc. Circuits of modern Receivers included with each parcel.

20/- PARCEL.—This is known as the "small traders" parcel, and contains a wonderful selection of components valued at 85/-. We have supplied this parcel to hundreds of Traders for re-sale at a profit.

SOUTHERN RADIO, 323, EUSTON ROAD, LONDON, N.W.1 (near Warren Street Tube). Phone: Museum 6324.

SOUTHERN RADIO Branches at 271-275, High Street, Willesden Green, N.W.10; 46, Lisle Street, W.C.2. All Mail Orders to 323, Euston Road, London, N.W.1.

All goods advertised in last week's issue still available.
WARD, 46, Farringdon Street, London, E.C.4. Telephone: Holborn 9703.

WANTED, good modern radio sets, parts, etc. spot cash paid; exchanges; bring or send.—University Radio Ltd., 142, Drummond Street, Euston, London, N.W.1.

WESTERN ELECTRIC MIKES, 1/9 each. List price, 21/-. Transformer to match, 1/3 each. 4 mfd. B.I.C. Electrolytic condensers, 450 volts working, 1/8 each, and 500 clearance lines. Catalogues 3d. each.—J. Bearfield, 105, Upper Street, London, N.1.

RYALL'S RADIO
280, High Holborn,
LONDON, W.C.1

Tel.: Hol. 3529

Now London's lowest prices and best value, we guarantee to pack safely to stand post, note postage extra, enquiries stamp.

Knock-out Prices.—B.T.H. Energised Speakers, with Pentode Transformers, 2,500 ohm field, fitted hump-bucking coil; 7/6 each.
Valve Holders, good quality, chassis type. 5-pin, 3d.; 7-pin, 4d.; and 5-pin baseboard with terminals, 4d.
Telsen Chokes, 15H 10 ma., 3/-; 20H 15 ma., output choke, 2/-; 40H 4 ma., 1/-.
Hellesens 8 mfd. dry Electrolytic, 350 v.w., 450 v. peak, 1/6 each. TCC type 802 wet 8 mfd., 2/-; B.I.C. 8 x 4 mfd. 275 v.w. can be reversed without damage, 1/9 each.
TCC Mica Tag Condensers, at 2d. each, .0005, .001, TCC non-inductive tubular condensers, .01, .02, .04, .05 and 1 at 6d. each. TCC 2 mfd. and 200 v.w. electrolytic, 9d. TCC tubular, 25, 9d., 5, 9d.

Ryall's Resistors, wire ends, suitable for any position where a 1-watt resistance is specified. In sizes: 100, 150, 250, 300, 400, 450, 500, 1,000, 2,000, 5,000, 10,000, 15,000, 20,000, 25,000, 30,000, 40,000, 50,000, 75,000, 100,000, 150,000, 25,000, 1/2 meg., 1 meg., 2 meg. values in ohms, 4d. each.

Volume Controls, Centralab type, 250,000 less switch, 1/-; TCC bias type, Electrolytic, 15 mfd. 100 v., 9d. each. 6 mfd. 50 v., 3d. 25 mfd. 25 v., 9d. 50 mfd. 50 v., 1/3.
Telsen Class B Output Transformers, 35-1, etc., 2/6 each, unused.

Cosser L.F. Transformers, shrouded, with terminals, listed 10/6, ratio 3-1, 3/6 each, nickel core; one of the best.

Special offer of Heayherd Moving Coil Meters, unused, in ranges 0-15 m.a., 0-25 m.a., 0-30 m.a., 0-50 m.a. panel mounting flush, bronze or nickel, and baseboard mounting with slide terminals, 10/-.

Collaro AC Induction Gramophone Motors, unused, with auto stop, Model 32, 30/-; Model 34, 25/-; or complete with pick-up and volume control, 40/-.

Smoothing Chokes, Stalloy type, 40H 60 m.a. resistance, 500 ohms, 3/3. Nickel core chokes, 50 H 50 m.a. resistance, 400 ohms, 2/3.

British-made soldering Irons, guaranteed, complete, with flex and adaptor, 200/250v. AC or DC, 3/- each. Many New Lines, stock of wholesaler, retired from business. Telsen .0004 mica condensers, 2d. Telsen standard screened HF chokes, 1/4. Telsen twin all-wave screened HF chokes, 1/2. Telsen HF chokes, small type, 150,000 microhenrys, 9d.

Telsen Preset Condensers, .0001 and .001, 9d. each. Telsen .0001, .00015 reaction condensers, all 6d. each. Telsen differential reaction condensers, all 6d. each. Telsen power pentode chokes, 3/-.

Dubilier .1 Condensers in tin cases, 500 v. AC working, 9d. each. Ferranti mica condensers with terminals, .00025 and .0001, 9d. each.

Preh 30 ohms Resistance on porcelain panel type, make excellent humbiders, 6d. each; also striptype for baseboard mounting, 6 ohms, 6d. each. Regenstat 10 watt (100 v. 100 m.a.), variable resistances suitable any eliminator, etc., 1/6 each; listed 7/6. Preh 10 watt variable resistances, 1/6 each. Detex HF Chokes, 4d., 6/- doz.

Bulgin Grid Bias Clips, No. 2, 2d. each, or 1/6 dozen. Standard grid leak clips, 1d. each, 9d. dozen. Red and black flex, 15 yds., 1/-, or 72 yds. 3/6. Formo plugs, suit average jack, 6d. each.

Varley Class B Output Chokes, 5/6. RI class B drivers, double ratio, DY37, 7/6; DY39, 1-1, 4/6. Multitone class B drivers, 1-1, 3/-. Multitone Puchokes, 3/-.

RI Difeed transformers, 3/6. Wearite senior class B drivers, universal ratios, 6/6; junior type, 4/-.

Metal Chassis, extra strong, 12 x 6 1/2 x 3 1/2, 3d., postage 7d. Westectors for AVC voltage doubling, 3/6. HTS, 7/9.

Wamel binocular DX2 HF chokes, 1/6. Polar 4-gang straight type midget, screened, etc., 12/3; 2-gang midget, 5/9.

Special offer of 1 watt Colour Coded Resistances with wire ends, made by one of the best-known manufacturers, price 2d. each in sizes only 2,500, 7,500, 9,000, 10,000, 30,000, 40,000, 50,000, 150,000, 300,000, 1/2 meg.

High Voltage Condensers by well-known manufacturer, 4 mfd. 750 v. working, 6/-; 2 mfd. 650 v. working, 2/-; 1 mfd. 500 v. raw D.C. working, 1/- each or 8/- doz. Mahogany Panels, 10 x 10 or 9 x 9, 1/- each or 8/- dozen. Loud speaker silks, 6d. each or 4/6 dozen.

Telsen .0004 Fixed Mica Condensers, 2d. each or 1/6 dozen packet. Telsen Pentode tone correctors, 1/-.

Good Class 7-pin Baseboard Valve Holders, WB Type, 6d. each or 3/6 dozen. Systofex 1 1/2 mm., 1/- dozen or 7d. for 6. Red topped fuse bulbs for 2 v. valves, 2d. each or 1/- dozen. 5-pin Baseboard Valve Holders, 3/6 dozen or 2/9 1/2 gross lots. Ryall's Resistors, 2/6 per dozen one size or 7/6 per 1/2 gross assorted. Telsen 4-point P.P. Switches, 6d. or 4/6 dozen.

RYALL'S RADIO
280, High Holborn,
LONDON, W.C.1

BIRMINGHAM RADIOMART
SHORT-WAVE SPECIALISTS

Proprietor, G5NI. Manager, G2AK. Staffed by experienced transmitting amateurs. Obviously we can serve you better.

SPECIAL offer, British Radiophone 8-valve colonial all-wave chassis, B.V.A. valves, A.V.C., Shadow-graph tuning, 6in. airplane dial, Magnavox Magna 12in. Speaker, fitted for Gramophone and transposed Aerial. Six only, £9 17s. 6d.

CAUTION: Beware of coilforms, etc., moulded in cheap bakelite. Our coils and formers are guaranteed efficient.

4-PIN interchangeable short-wave coils; set 3. Cover 15-100 metres, latest ribbed former, 7/9.

11IN. ribbed short-wave coil forms; valveholder 12 type, 10less, 4-pin, 1/8. 6-pin, 1/9. Threaded for winding, 2d. extra.

UTILITY 8/6 microdisc dials, fitted famous micro high reduction, only perfect short-wave dial, 3/11.

SHORT-WAVE H.F. chokes, 9d. Wireless World states: "Very efficient—100 to below 10 metres."

UTILITY microvariables 15, 40 mmfd., 1/-; 465 kc/s litz wound I.F.'s, 5/6.

RADIOPHONE super ceramic insulated short-wave condensers, .00016, 3/6; series cap, 3/9.

CONTINENTAL A.C. valves, 4/6. VMPT, HPT, VM5G, AMSG, ACH, ACHL, PT4. Most American types, A.C. Pen., 5/6.

2V. types, H.F. detector, L.F., 2/3; LP2, P2, 2/9; 2V. Supower, 3/3; VMPT, HPT, 5/6; Class B, 4/6; S.G., VM5G, 5/-.

BARGAIN parcel value 30/-, containing binocular HFC, 4 750v. test condensers, 6 resistances, 4 valveholders, .0003, .0005 variable, electrolytic condenser, etc., 5/-. Traders' parcel, £4/10/0 value, 10/-.

TELSEN 7/6, Ace transformers made for leading Company, boxed, 1/11.

BALL-BEARING air-spaced condensers; World's finest manufacturers 4-gang, 3-gang superhet, 1/11.

NON-INDUCTIVE condensers by leading makers, T.C.C., Dubilier, etc., 0.5, 0.25, 0.1, 0.02, 0.005, 3d.

ASTOUNDING offer electrolytic condensers, world-famous maker, 4+4 mfd. (separate) 500v., working, 1/6.

GENUINE 15/6 Frost potentiometers, wire-wound, tapered, 10,000 ganged to 50,000 ohms, 1/6.

ISSEN 2-gang coils, 12-2,000 metres, switched L and screened, nothing else required to convert SG3 to all-wave, 12/6.

ISSEN 3-gang bandpass superhet coils, 4/6; 3-gang bandpass Tuned grid, 6/11. All with circuits.

AMPLION, 3/6; screened H.F. choke, 1/11; Iron-cored binocular, screened, 2/3. Climax binocular, 1/3. Telsen, 1/11.

UTILITY 2-gang .0005 Uniknob with large disc drive, 3/11. Ditto, single, with disc., 2/3.

ISSEN 30hy., 40 ma., chokes, 2/-; 20 hy., 100 ma., 2/11. Lissen eliminator chokes, 1/3.

IGRANIC tapered potentiometers 1/2-meg., 1-meg. with 3-point switch, 2/-. Centralab 1/2-meg., 1/6.

2 GROSS roundhead woodscrews, assorted, 9d. Solder tags, 6d.; resincore solder, 9ft., 6d.

PUSHBACK connecting wire, ready tinned and sleeved, 6yds., 6d. Heavy, for heaters, 9d.

SCREENED iron-cored selective dual-range coils, with reaction; circuit diagrams, 2/11.

NON-INDUCTIVE tubulars, 1,500 v., 0.01, 0.02, 0.04, 0.05, 0.1, 6d.; 0.2, 0.25, 8d.; 0.5, 9d.

ISSEN 6-way battery leads, with plugs, 6d. Belling-Lee safety mains plug and socket, 6d.

INSULATED terminals, Belling-Lee, black, Telsen, red, black, 1d. Telsen 0.0003 presets, 9d.

TRANSFORMERS B.T.H. speaker: suit all moving coils, 2/11. Manufacturers push-pull, 1/11.

FUSES, Telsen 1/2-amp., 1-amp., 3-amp., 2d. Telsen, 100 ma., 2d.

TELSEN latest differentials, .0003, 1/3; .00015, 1/-. Radiogrand transformers, 2/9.

SPECIAL. Four assorted Telsen grid-leads, 5d.; twelve various wire-ended resistances, 2/6.

MILLIAMMETERS; flush 2 1/2in., 5/9; 2 1/4in., 6/9. All ranges above 25 m.a., visual tuning, 6/9.

T.C.C., etc., bias electrolytics, 50 mfd., 50 v., 1/9; 25 mfd., 25 v., 1/3; 15 mfd., 100 v., 1/-; 6 mfd., 50 v., 6d.

RADIOMART

Orders over 6/- post free. Enquirers must enclose stamp.

Catalogues; general catalogue gives hundreds of bargains; short-wave illustrated catalogue also gives diagram of efficient transmitter and receiver; each 14d. Pair 3d., post free.

THE SQUARE DEALERS

19, John Bright St., 22, Summer Row; mail-orders: 44, Holloway Head, Birmingham. Telephone: Midland 9254

RADIO CLEARANCE

63, HIGH HOLBORN, W.C.1.

TEL: HOLBORN 4631

Owing to increase of business we have found it necessary to remove to larger and more spacious premises at Number 63, High Holborn. All orders in future should be sent to this Address. All orders to the value of 10/- or over, carriage paid in United Kingdom. Orders under 10/- must be accompanied by a reasonable amount of postage.

"SPECIAL" "SPECIAL"
70/- LISSEN 4-VALVE A.C. SET complete in Cabinet with Valves and P.M. Moving Coil Speaker, Aerial tested. Few only.

60/- LISSEN 4-VALVE D.G. SET complete in Cabinet with Valves and Moving Coil Speaker, Aerial tested. Few only.

105/- 4-VALVE A.C. SET. 200 to 250 volts. By well-known proprietary manufacturer. Mullard Valves, Moving Coil Speaker, Band Pass tuned, in handsome Walnut Cabinet. Brand new, boxed. H.P. terms can be arranged on application.

75/- 4-VALVE A.C. MAINS CHASSIS. 200 to 250 volts. By well-known proprietary manufacturer. Mullard Valves, Moving Coil Speaker, Band Pass tuned. Brand new.

55/- LISSEN 4-VALVE A.C. CHASSIS. 200 to 250 volts, complete with Valves, aerial tested. Few only.

47/6 LISSEN 4-VALVE D.G. MAINS CHASSIS. Complete with Valves, aerial tested. Few only.

70/- LISSEN 100 STATIONS SET. Complete in Cabinet with Valves and P.M. Moving Coil Speaker, aerial tested. Few only.

32/6 LISSEN SKYSCRAPER 3-VALVE BATTERY CHASSIS. Aerial tested, with Valves.

21/- LISSEN SKYSCRAPER PATTERN CHASSIS. Aerial tested, less Valves.

2/6 LISSEN 2-VOLT BATTERY VALVES. L2 Metallised. Brand new, boxed.

3/6 LISSEN 2-VOLT CLASS B VALVES. Type BB220 A. Brand new, boxed.

8/11 LISSEN RECTIFYING UNITS. Complete with Valves, input 100 to 250 volts, Output 250 volts, 60 M/A. Brand new, in sealed cartons.

5/- UTILITY 3-GANG MIDGET CONDENSERS. Straight or Superhet with 110 k/c section, fully screened.

2/11 BRITISH RADIOPHONE 3-GANG SUPERHET CONDENSERS. With 110 k/c Oscillator section, unscreened. Wonderful bargain.

2/6 8 MFD and 4 MFD DRY-ELECTROLYTIC CONDENSERS. By well-known manufacturer. 450 volt working, 500 volt peak, brand new.

3/- LISSEN HANDSOME WALNUT TABLE CABINET. With provision for Speaker, cut out front for Lissen Band Pass 3 Kits. Few only left. Wonderful bargain.

17/6 HANDSOME WALNUT FLOOR MODEL COMPLETE CABINET. An unrepentable bargain.

1/11 LISSEN CENTRE TAP OUTPUT CHOKES. Brand new, boxed. List price, 7/6.

1/6 LISSEN INTERVAL VALVE SMOOTHING CHOKES. Brand new, boxed. List price, 7/6.

9d. LISSEN HF BY-PASS UNIT. List 5/6. Brand new, boxed.

1/11 LISSEN 3-GANG SUPERHET COILS. Mounted on base, complete with Switch, unscreened, brand new.

6d. DRILLED METAL CHASSIS. 3-Valve type.

6d. 1 WATT RESISTANCES. All sizes, by well-known manufacturer.

6d. TUBULAR CONDENSERS. All sizes up to 1. By well-known manufacturer.

1/- 1 MFD CONDENSER. 500 volt working.

1/- 4 MFD POST OFFICE TYPE MANSBRIDGE. 250 volt working.

2/6 4 MFD PAPER CONDENSERS. 750 volt test.

HIVAC VALVED. Complete range in stock. Send for lists.

3/- LISSEN SPEAKER CABINET, with baffle board, brand new, boxed.

2/11 2-GANG CONDENSERS, unscreened.

3/11 LISSEN 3-GANG S/H CONDENSER, 120 k/c section, with dial.

8/11 BRYCE MAINS TRANSFORMERS. 250.0.250 80 m.a., 202 volts 2.5 amp., 202 volts 4 amp.

9/6 350.0.350 volts 120 m.a., 202 volts 2.5 amp., 202 volts 4 amp.

11/6 350.0.350 150 m.a., 202 volts 2.5 amp., 202 volts 4 amp., 202 volts 2 amp.

17/6 500.0.500 volts 150 m.a., 202 volts 2.5 amp., 202 volts 6 amp., 202 volts 2 amp., 202 volts 2 amp.

8/11 H.T.8 Transformer, 250 volts 60 m.a., 202 volts 4 amp.

17/6 Ditto, with H.T.8 Metal Rectifier.

All the above transformers are first class manufacture, brand new, fully shrouded.

RADIO CLEARANCE

63, HIGH HOLBORN, W.C.1.

TEL: HOLBORN 4631

EASY TERMS

We specialise in the supply of all good quality Radio sets, components, and accessories. Send list of requirements and keen quotation will be sent promptly.

CASH & C.O.D. ORDERS DESPATCHED BY RETURN POST. PRICE LIST FREE.

Estd. 1925 THE NATIONAL 1977

LONDON RADIO SUPPLY COMPANY

11 OAT LANE NOBLE STREET LONDON, E.C.2

ENGINEERS! ARE YOU EARNING LESS THAN £10 PER WEEK?

If so, you cannot afford to carry on without reading our 268-page Handbook. The book explains clearly and definitely many ways of carving out a successful career. Among other things it explains the Services of our unique Appointments Department, outlines Home-study Courses in all branches of Civil, Mechanical, Electrical, Motor, Aero, Wireless, "Talkie," Engineering, Building, Govt. Employment, etc., and gives details of B.Sc., A.M.I.E.E., A.M.I.E.E., A.M.I.Mech.E., A.M.I.A.E., A.M.I.W.T., A.M.I.R.E., G.P.O., MATRIC, and all Exams. We Guarantee—"NO PASS—NO FEE." Whether you be an old hand or a budding apprentice, get this book to-day—FREE and POST FREE. BRITISH INSTITUTE OF ENGINEERING TECHNOLOGY.

409, Shakespeare House, 17/19, Stratford Place, London, W.1

G.W.R.'s LATEST ORMOND RECEIVERS

AT NEARLY HALF-PRICE

We have purchased the entire stock of the well-known ORMOND CLASS B RECEIVERS.

This low consumption set is housed in magnificent grained WALNUT CABINET. Fitted with TWO matched MOVING-COIL Speakers, and covers wave range of 200/550 and 1,000/2,000 metres. Provision is made for PICK-UP and EXTENSION SPEAKER, complete with MULLARD VALVES, C.A.V. Battery and EXIDE Accumulator. Size of cabinet, 24ins. long x 11ins. x 10ins. Brand New and Fully Guaranteed in Maker's Own Cartons.

SPECIAL 14 DAYS' OFFER

£3/19/6 (List £7/10/-)

50 only Ormond A.C./D.C. Mains Receivers complete with 3 Mullard Valves and Barretter, Moving-Coil Speaker, Wave range 200/550 and 1,000/2,000 metres. Provision for Extension Loudspeaker and Gramophone Pick-up. Brand new and fully guaranteed, in sealed cartons, listed £7/10/-, our price £4/10/-, carriage paid.

Cash with order or deposit and balance C.O.D. Money refunded if not satisfactory within 7 days.

G. W. RADIO,

7, Chapel Street, Lamb's Conduit Street, London, W.C.1.

Phone: Holborn 4434.

PATENTS AND TRADEMARKS.

KINGS PATENT AGENCY LTD. (Director: B. T. King, C.L.M.E., Regd. Patent Agent G.B., U.S.A. and Canada). Advice, Handbook and Consultations free. 50 years' refs.—146a, Queen Victoria Street, E.C.4. Phone: City 6161.

RECEIVERS, COMPONENTS AND ACCESSORIES

Surplus, Clearance or Secondhand, etc.

V AUXHALL.—T.C.C. 4 and 8 mfd. Electrolytic condensers, 550 3/-; 500 v, 2/6.

V AUXHALL.—T.C.C. condensers, tubular, non-inductive, 0.1, 6d.; 50 mfd., 50v. working, 1/6; 50 mfd., 15v., 1/3; 0.05, 6d.; 0.002, 0.0002, 0.001, 0.0001, 4d. each.

V AUXHALL.—T.C.C. mica 0.002, 2,000 volt test. 10d.; 0.0001, 6d.; 0.001, 0.01, 1/-; 1 mfd. Mansbridge, 1/3.

V AUXHALL.—Resistances by well-known manufacturers, 1-watt type, 6d. each; all values.

V AUXHALL.—Colvren G.1, G.2, G.3, or G.1, G.2 and G.8 superhet. type, 30/-; Colpaks, £2/4.

V AUXHALL.—Volume controls, Eric, Colvren, Centralab, 2/-; with switch, 3/-; all values, from 3,000 to 2 meg., Benjamin, class "B" transformers, 1-1 1/2 to 1, 6/6.

V AUXHALL.—Polar station named scales, for horizontal dials, latest settings; 1/9 each.

V AUXHALL.—Polar Midget 3-gang condensers, straight or superhet, 8/9; Polar full vision, horizontal or Arcuate dial and drives, 4/6.

V AUXHALL.—Centre tapped iron cored L.F. transformers, bases, terminals, 110 k/c; 6/6 guaranteed.

V AUXHALL.—Set manufacturers' surplus, skeleton type Westinghouse rectifiers, H.T.8, 9/6; H.T.9, H.T.10, 10/-; complete with fixing brackets; Westectors, W.4, W.X.6, 5/9.

V AUXHALL.—Guaranteed for twelve months: mains energised, 2,500 or 6,500 field coil, 10in. cone, 17/6; 7in. cone, 12/6.

V AUXHALL.—Permanent magnets, universal, suitable for Class "B" power or pentode, 7in. cone, 16/6; 10in. cone, 22/-.

V AUXHALL.—The above complete with hum-bucking coils; static power or pentode transformer; immediate delivery.

V AUXHALL.—B.T.H. Minor, 16/6; Senior needle armature, 29/-; Radiophone, 14/6; others from 10/-.

V AUXHALL.—B.T.H. Trusped gramophone motor 30/-; Universal D.C./A.C., 47/6; sealed cartons.

V AUXHALL.—Collaro 32 model, 32/6; Universal model, 47/6; complete unit, A.C. 200-250v., first quality pick-ups and volume control, 48/-.

V AUXHALL.—T.C.C., 200 mfd., 10-volt, 2/6. Continental valve holders for Universal valves, with terminals, 9d.

V AUXHALL.—Clix valve holders, terminals, 7-pin, 9d., 5-pin, 7d., W.B. 5-pin 4 1/2d.; baseboard mounting, 6d.; post paid 2/6 or over, or c.o.d.

V AUXHALL.—Hivac Valves, all types Mains and Battery in stock for immediate delivery.

V AUXHALL UTILITIES, 163a, Strand, W.C.2, over Denny's, the Booksellers, Temple Bar 9333. Send postcard for lists free.

HEADPHONES.—Brown, G.E.C., B.T.H., Sterling, Nesper, Siemens, Ericsson, etc., 2,000 ohms 2/6; 4,000 ohms, 5/-. Postage 6d. Guaranteed.—Kodesh, 56, Barnsbury Street, London, N.1.

NEW RECEIVERS, COMPONENTS AND ACCESSORIES

BANKRUPT Bargains. List free. All goods new.

B Amplion A.C. 12 gm. superhets, £7/10. Radiogram listed 21 gns., £14/10. Burgoyne Radiogram, A.C./D.C., listed 15 gns. 1936, 10 gns. Fury 4 v. A.C./D.C., £5. Table radiogram, A.C., listed 11 gns., for £7/10. Large stock valves all types. Electric irons, 3/9. 2, 3- and 4-gang condensers, 2/9. J.B. aeroplane S.W. dials, 4/9. Transformers, Telsen, 2/9. Dual coils, 1/4. Resistances, 1 watt, 6d. Telsen I.C. coils, 4/-. Celestion M.C. speakers, Sonndex, 10/6; larger type, 16/6; Amplion, 15/-, 17/6, and 22/6. Amplion pick-ups, complete, 14/6. Large stock components. Write for quotations.—Butlin, 6, Stanford Avenue, Brighton. Preston 4030.

RECTIFYING VALVES.—2,000 v. Half Wave 5 m.a., 10/6. Full Wave 500 v., 120 m.a., 5/-. 350 v., 120 m.a., 4/6. 250 v., 60 m.a., 2/6, post free. All fully guaranteed.—Pix, 118, Southwark Street, S.E.1.

ALL-WAVE A.C. Five, £9/9/0. Novo Radio, St. John Street, Newcastle-on-Tyne 1.

HULBERT for Quality Surplus Speakers.

HULBERT. All speakers previously advertised still available. All are brand new and made by one of the best-known British makers of high-grade moving-coil speakers. Prices from 10/6. All Music lovers interested in realistic reproduction should write for list of amazing bargains. Repeat orders are coming in daily.

HULBERT, 6, Conduit Street, W.1.

VALVES by well-known manufacturer. Complete range of Battery, A.C. Mains, Rectifiers. Brand new stock with six months' guarantee. 2 volt: Detector 2/3, Power 2/9, Screen Grid, Pentode, H.F. Pentode 5/-. Write for other prices to: Dulci Electrical Co. Ltd., 7, Lizard Street, London, E.C.1.

30/- SHORT-WAVE CONVERTER/ADAPTOR. Guaranteed. Metal Cabinet, 13 1/2 metres. Use with your present set. Descriptive leaflet free. BENNETT TELEVISION CO., REDHILL.

MERVYN

1936 SHORT-WAVE CONVERTER-ADAPTER

Add popular short-wave reception to your present set—and tour the World. *America. Italy. Australia, etc., on your own speaker.*

SPECIFICATION.

100-1 dual ratio slow-motion tuning, 13-52 metres, switching wave-change. Brass tuning condensers. Slow reaction control. Complete in metal case.

PRICE 42/-

For A.C. Mains or Battery (without valve).
Send for free descriptive leaflet.

MERVYN SOUND & VISION CO., LTD.
4, Holborn Place, London, W.C.1.

Engineers' Guide

containing the widest choice of engineering courses in the world

Outlines The T.I.G.B.'s up-to-date home-study Courses in Wireless, Electrical and Mechanical Engineering, etc. Shows how to become A.M.I.E.E., A.M.I.W.T., A.R.A., etc., and how to qualify for a well-paid post. Training until Successful Guaranteed.
WRITE NOW for Free Guide.
THE TECHNOLOGICAL INSTITUTE OF GREAT BRITAIN,
42, Temple Bar House, London, E.C.4. (Founded 1917. 19,000 Successes.)



To Success

THE FAMOUS H.J.B. VOICE

MICROPHONE

Never in the history of Radio has such value been offered to the Public.

Incorporating Heayberd Transformer. Voice and Song clearly reproduced from any receiver.

10/6 Post Free. Trade Enquiries Invited.

187, PENTONVILLE ROAD, KING'S X.

Phone: Terminus 4976.

MOD. 276 **PRICE 27/6**
PATENT PENDING



THE NEW COSMOCORD PICK-UP

FRICITIONLESS ARMATURE SUSPENSION
PLEASE WRITE FOR EASY TERMS
COSMOCORD, LTD.—HEYFIELD—MIDDSX.

Add 50-WEEKLY to your earnings

Charge accumulators in your spare time

Complete Charger, incorporating Westinghouse Metal Rectifiers. Will charge 84 accumulators weekly.
Trade Price £4.4.0

Send for full particulars.

M.P.R. ELECTRICAL CO., ROMFORD, ESSEX.

NEW RECEIVERS, COMPONENTS, AND ACCESSORIES

CLARION VALVES.—All brand new; battery types 2-volt, H.2, H.L.2, L.P.2, 1/0; super power P.2, 2/6; screens and L.F. pentodes, 3/9; A.C. mains, 4-volt, 1-amp., general purpose, 3/3; power, 4/-; screens and L.F. pentodes, 4/6; full-wave rectifiers, 3/8; postage paid, cash with order, or C.O.D. over 10/-.—Clarion Valves, Dept. 2, 885, Tyburn Road, Erdington, Birmingham.

ALCO ELIMINATORS AND CHARGERS. 4 H.T. taps, 120/150 v., 20/30 m.a., 18/-. With charger, 25/-. Charger alone, 7/6, 1/2 amp., 11/- Westinghouse rectifiers. Years guarantee. Complete. Details free.—P. & D. Radio, 1, Gooding Road, N.7.

UNIVERSAL RADIO BARGAINS.—Celestion Soundex Moving Coils, 9/11. Cosmocord Pick-Ups, with Arm and Volume Control, 9/11. Telsen Eliminators, with Trickle, 30/-. Electric Soldering Irons, 2/6. Stal Class B Transformers, 2/3. Mullard M.B.3 Battery Receivers, complete, 5 Gns. All-Wave Battery Sets, 6 Gns. Mains, ditto, 8 Gns. K.B. Universal Mains Superhet Consoles (List 19 Gns.), £10/5/0. Above are all brand new and in original cartons. Thousands of other bargains. Stamp for list.—"UNIVERSAL," 94, Grove Vale, East Dulwich, S.E.22.

MISCELLANEOUS

REPAIRS to Moving Coil Speakers, Cones and Coils fitted or rewound. Fields altered. Prices Quoted including Eliminators. Loud-speakers Repaired, 4/-. L.F. and Speech Transformers, 4/- Post Free. Trade invited. Guaranteed Satisfaction. Prompt Service, Estimates Free. L.S. Repair Service, 5, Balham Grove, London, S.W.12. Battersea 1321.

MOVIES At Home. How to make your own Cinema Projector. Particulars free.—Movie-scope, 2, Pear Tree Green, Dodinghurst, Essex.

REPAIRS.—Moving Coil Speakers. Complete Rewinding Service for Transformers, etc. Receivers Repaired. Trade Discount.—Weedon's Radio Repair Service, 202, Romford Road, London, E.7. Maryland 1782.

HOME CONSTRUCTORS of Coils, Chokes and Transformers should send for Catalogue.—Lumen Electric Co., Litherland, Liverpool, 21.

CAMM'S PREFECT S.W.3. Complete Specified Kit, 40/-. **MONITOR THREE,** 35/-. complete. Cash. C.O.D. Easyway. Bargain List Free.—Melforad, Queen's Place, Hove. (Trade supplied).

BIG INTRODUCTORY OFFER.

Suitable valves for each kit by well-known manufacturers included at the kit price to all purchasers of one of our new low-priced home construction kits.
"AIR CUB" short-wave, 13-55 metres, bandspread, dual-band switching, 12s. 6d. All-wave, 13-2,000 metres, 18s. 6d.
"LITTLE SCOUT" short-wave bandspread III, dual-band 15-55 metres, 22s. 6d. All-wave 13-2,000 metres, 30/-. Continental III, 180-2,000-metres, 15s. 6d.
"AIR CUB" dual-band 15-55 metres, s.-w. adaptors, band-spread, 10s. 6d. Superhet s.-w. converter, ditto, 18s. 6d.
"SCOUT" two-note constructor's valve buzzer L.F. oscillator kit, for Morse practice, 12s. 6d. Morse keys (adjustable), 3s.

EXCEPTIONAL COMPONENT VALUES.

Speaker units, 2s. 11d. L.F. transformers, 1s. 11d. Utility 2-gang .0005, with illuminating drive, 3s. 6d. H.M.V. 4 x .0005, 2s. 11d. Lissen 3 x .0005, 3s. 9d. Ormond, combined reaction and tuning control, illuminated S.M. drive, .0005 + .0003 mfd. condensers included, 2s. 3d. Microphone Bargains, Western Electric (list 21s.), 1s. 9d. 100/1 transformers, 1s. 3d. The two complete in attractive stand, 4s. 3d. Utility .0003-5, tuning and reaction condensers, 8d. Short-Wave Bargains, 4-pin plug in coils, aerial, and reaction, 13-26 metres, 22-47, 41-94, 2s.; 70-170, 150-325, 250-500, 2s. 6d.; 400-800, 1,100-2,000, 3s. 6-pin (with grid windings), 6d. extra. S.M. tuning condensers, .00015, .00016, .00025 mfd. each, 2s. 11d.; with steatite end plates, 4s. 6d.; direct drive, 3s. 6d. .00015 reaction, 8d. (1 watt resistors, all sizes, 3d.). Enclose also 3d. stamps for complete lists. Will save you pounds. Terms, Cash or C.O.D. Post: components over 10s., post free. All Kits 1s. Anglo-American Radio Distributing Corporation (Dept. 7), 1, Lower James St., Piccadilly Circus, London, W.1. (Gerrard 3040).

FREE ADVICE BUREAU COUPON

This coupon is available until February 15, 1936, and must be attached to all letters containing queries.
PRACTICAL AND AMATEUR WIRELESS,
8/2/36.

MICROPHONES

For Home Broadcasting, etc., etc.

TABLE HOME BROADCASTING MIKE, No. "N.W." 11, containing transformer, switch and plugs; is a marvellous production at a low price. Bakelite square body on bronze base. Worth 2 guineas. Only 15/-. Lesdix No. 10B Pedestal, 10in. high, 12/6; Lesdix Superior, No. 12BB, Ring, 12in. Pedestal, 15/6. Low prices, all purposes. We are makers and carry the biggest and most varied stock in England.



ERISSON PEDESTAL TRANSMITTERS, 12in. high, with mouthpiece, as illustrated. Standard model, 4/6. Post 9d. **AMPLIFIERS.** We can supply from stock 3, 6 or 10 watt Mains or Battery amplifiers in portable or chassis form at lowest prices. Special Election Public Address or Dance Band Portable with Mike and speaker, £12. **PORTABLE P.A. OUTFITS.** Professional model for any mains, D.C. or A.C. New in cabinet with valves, mike, speaker and cables. Ready for use on speech or dance band, 6 watts, £12. Portable Gramo. type, ditto, with turntable, pick-up and mike, £15. Large Set for 16 watts output, with 4 speakers, £25.

PUBLIC ADDRESS SPEAKERS, with Tone Correct Horn and Slings. New Perm. Mag. M.C. 15 watts without distortion, 24in. Flare, 40in. long, £8/8/0.

COIL TURN COUNTERS, for checking the number of turns up to 9,999 on dial. Solid, 1/3 each.

HOME RECORDING on your Gramo. can be done by anyone with a gramophone. Complete sets, with accessories, in carton. De Luxe, 21/-; No. 2 Mivoice, 12/6; Junior, 7/6. For Electric Recording: Electric Motor Turntable, 25/-. Tracker Recording Carriers: No. 2 C.M. Screw-thread Traverse, 7/6; Type F. Central Spiral Drive, 4/6. Recording Pick-ups: Type K, 12/6; Jewel Sutter Needles, mounted diamond, 7/6. **METERS.** All ranges and sizes in stock.

THE DIX-MINUTA. This is a wonderfully versatile pocket moving-iron multi-range meter for service on A.C. jobs. No projecting terminals. THREE ranges of volts: 0-7.5, 0-150, 0-300. Used for MILLIAMPS reads 0-121 m.a. and 0-75 m.a. In black bakelite case. Measures only 2 1/2in. by 2 1/2in.

ROTARY CONVERTERS by E. D. Co. New A.C. for D.C. 90 watts, £7. £16 D.C. to D.C. 12-v. to 500-v., 200 m.a., 75/-; ditto to 350 m.a., in cabinet, 95/-.

EXTRA SPEAKERS for 5/. These new 2,000 ohm Table Model Siemens are going quickly, so hurry up. Tones your boomer. Just the Speaker for an extension. New, only 5/-.

PARCELS of experimental odd Coils, Magnets, Wire Chokes, Condensers, Switches, Terminals, etc., post free, 10 lb. 5/-; 5 lb. 5/-.

CHARGERS, SWITCHES AND RHO-STATS. A range of almost all sizes and capacities. New. We shall be glad of specified inquiries for any type of switchgear.

February Bargain List "N" now ready.

ELECTRADIX RADIOS,

218, Upper Thames Street, E.C.4.
Central 4611.

RECEIVERS, COMPONENTS AND ACCESSORIES

Surplus, Clearance or Secondhand, etc.

HIGHEST possible allowance made on your old set or components in part exchange for any new set or Peto-Scott kit. Bargains.—Peto-Scott "Superformer" kit, £27/0, "Fury 4," £22/10/6. Lists free. R. Wigfield, Furlong Road, Goldthorpe, Yorks.

ADVERTISEMENT INDEX

Advertisement	Page
Belling & Lee, Ltd.	683
Bennett, H. J.	Inside Back Cover
British Institute of Engineering Technology	688
British Television Supplies, Ltd.	677
Bulgin, A. F., & Co.	681
Cosmocord, Ltd.	Inside Back Cover
Cossor, A. C., Ltd.	Inside Front Cover
Electradix Radios	Inside Back Cover
Fermo Products	653
Exide Batteries	654
G.W. Radio	688
General Electric Co., Ltd.	Back Cover
High Vacuum Valve Co., Ltd.	680
International Correspondence Schools, Ltd.	678
Jackson Bros., Ltd.	683
Kings Patent Agency, Ltd.	688
Lectro Linx, Ltd.	680
London Radio Supply Co.	688
M.P.R. Electrical Co.	Inside Back Cover
Mervyn Sound & Vision Co., Ltd.	Inside Back Cover
Microfuse, Ltd.	683
Milnes Radio Co., Ltd.	653
Peto-Scott Co., Ltd.	669
Pix	685
Premier Supply Stores	686
Ryall's Radio	687
Scientific Supply Stores	661
Stratton & Co., Ltd.	661
362 Radio Valve Co., Ltd.	684
Technical & Commercial Radio College	673
Technological Institute of Gt. Britain	Inside Back Cover
Unit Radio	683
Whiteley Electrical Radio Co., Ltd.	679
Wills, W. D. & H. O.	674
Wingrove & Rogers, Ltd.	654

OF TECHNICAL IMPORTANCE

FOR EFFICIENT SHORT WAVE FREQUENCY CONVERSION

Osram Valves

MADE IN
ENGLAND

Sold by All Radio Dealers

TRIODE HEXODES

TYPE

X41

TYPE

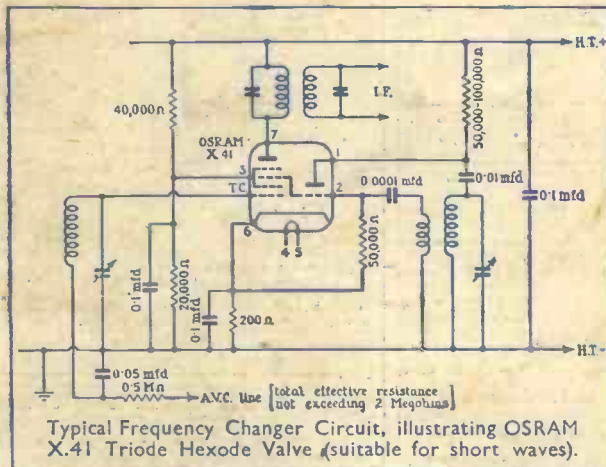
X31

The Triode Hexode is a frequency changer for superheterodyne receivers, designed to overcome various causes of trouble inherent in other forms of combined Detector-oscillator, particularly on reception of short wavelength signals.

It is made in two forms :

OSRAM X41 for A.C. Mains Sets.

OSRAM X31 for DC-AC Receivers and Car Radio.

The Triode Hexode offers the following advantages :

1. Almost complete absence of inter-action between Triode (oscillator) and Hexode (mixer) sections.
2. High conversion gain due to high Impedance. This also means less damping on the tuned circuit.
3. High mutual conductance in Oscillator section. This assists in simplifying coil design and by reduction of coupling required reduces "squegging" and uneven oscillation.

CHARACTERISTICS	TYPE X41	TYPE X31
Heater Volts...	4.0	13.0
Heater Current ...	1.2	0.3 amp.
Anode Volts ...	250 max.	...
Screen Volts ...	80 max.	...
Oscillator Anode Volts ...	150 max.	...
Oscillator Grid Peak Volts ...	12	...
Conversion Conductance ...	550	...
Conversion Impedance ...	1.25 megohm	...
Osc. Grid-Control Grid Capacity	0.26 mmfd.	...
Control Grid-Anode Capacity	0.046 mmfd.	...

Price each: 20/-

WRITE FOR NEW OSRAM VALVE GUIDE

OSRAM VALVES—DESIGNED TO ASSIST THE DESIGNER

Advt. of The General Electric Co., Ltd., Magnet House, Kingsway, London, W.C.2.

MONITOR AND PREFECT—LEADING SETS OF THE SEASON

Practical and Amateur Wireless



Edited by F.J. CAMM

a GEORGE
NEWNES
Publication

Vol. 7. No. 178.
February 15th, 1936.

AND PRACTICAL TELEVISION

More about

THE **MONITOR** *and* THE **PREFECT**

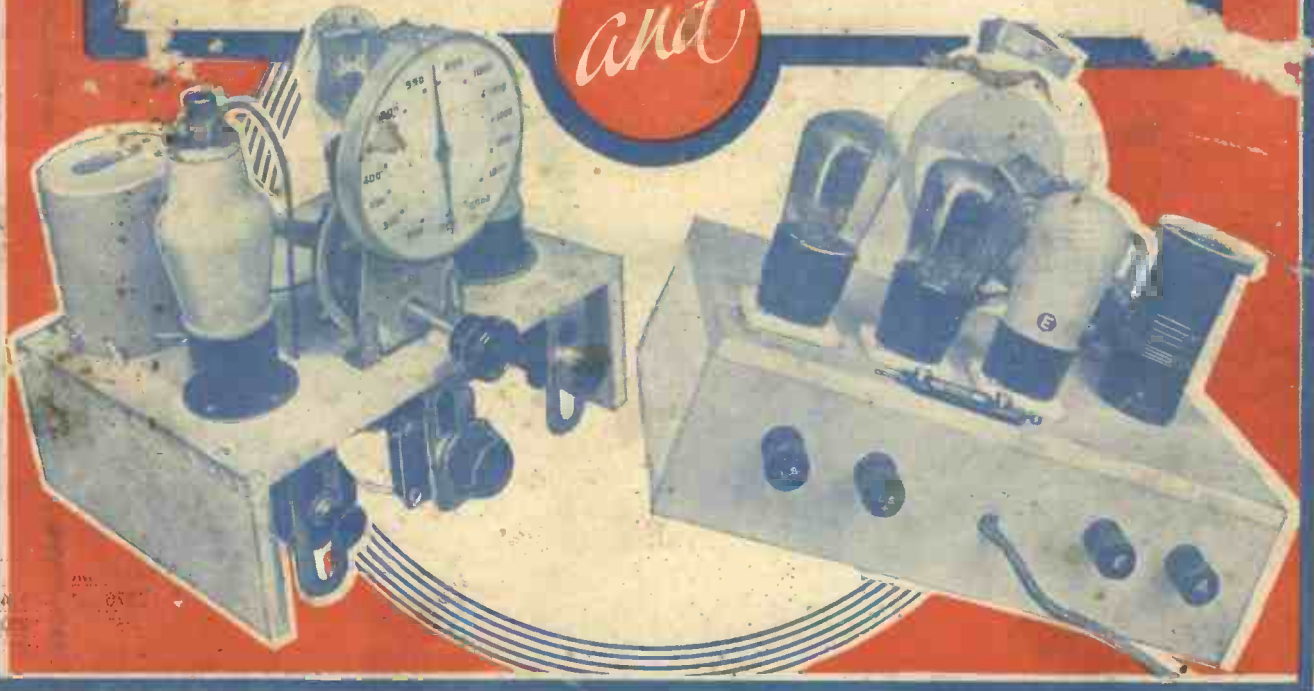

Mr. Camm's Choice

1936 STENTORIAN

WHITELEY ELECTRICAL RADIO CO., LTD., MANSFIELD, NOTTS



The

COSSOR

BATTERY VARIABLE-MU H.F. PENTODE 210 V.P.T.

THE high mutual conductance and the unique construction of this Cossor Battery Pentode permit of very high stable amplification. A worthy type from a most comprehensive range, the 210 V.P.T.—in common with all Cossor Valves—owes its popularity to its strict conformity to published characteristics—assured by rigorous adherence to laboratory principles during every stage of manufacture, and the use of the famous Cossor Mica Bridge.

Filament Volts	-	-	-	2
Filament Current (amps.)	-	-	-	.1
Mut. Conductance	-	-	-	1.1m.a./v.
Max. Anode Volts	-	-	-	150
Max. Aux. Grid Volts	-	-	-	80

PRICE **13/6**



KINGS OF THE AIR

CONSISTENT • EFFICIENT • DEPENDABLE

British Made by A. C. Cossor Ltd., Highbury Grove, London, N.5.



THE LEADING WIRELESS WEEKLY



Practical and Amateur Wireless

Edited by F. J. CAMM

Technical Staff:
W. J. Delaney, H. J. Barton Chapple, Wh.Sch.,
B.Sc., A.M.I.E.E., Frank Preston.

VOL. VII. No. 178, February 15th, 1936.

ROUND *the* WORLD of WIRELESS

The Best German Dance Band

IN order to ascertain the popularity of the numerous dance bands of which the performances are broadcast by the Deutschlandsender, the authorities organised a plebiscite amongst home and foreign listeners. As a result the Barnabas von Geczy Orchestra, so often heard in the dance hour, topped the list.

Listen to Lahti

IT is reported that the inauguration of the Finnish 220-kilowatt transmitter was officially carried out on January 25th; the station, which relays the Helsinki programmes, works on 1,807 metres (166 kc/s).

Proposed Move of P.T.T. Grenoble

IN view of its proximity to the city, broadcasts from the 15-kilowatt Grenoble transmitter are not covering the required area. It is therefore proposed to transfer the station to a more suitable site and to increase its power to 50 kilowatts. The channel used is 514.6 metres (583 kc/s).

Station in a Bomb-proof Shelter

THE Posen transmitter is installed in an underground cellar, which formed part of a theatre built during the period of the Great War. So far relays have been taken from Warsaw by cable; it is now planned as a stand-by in case of emergency, to use as air link on the long channel.

Alterations in Wavelengths

AS it has been found necessary to avoid interference caused by the new German 17-kilowatt Saarbruecken transmitter, Radio Côte d'Azur (Juan-les-Pins) has reduced its wavelength from 240.2 metres (1,249 kc/s) to 235.1 metres (1,276 kc/s), and now occupies a channel used by both Stavanger and Christiansand (Norway). Another change to note is that of Poste de l'Île de France, Paris, now working on 219.6 metres (1,366 kc/s), as against its previous wavelength of 222.6 metres (1,348 kc/s).

Somewhat Misleading!

DURING the past few days the '60-kilowatt P.T.T. station at Nice-le Brague, has been giving out the call: *Ici Nice-Côte d'Azur, Station d'Etat*, which would lead listeners to believe that they are receiving

the privately-owned Nice-Cannes-Juan-les-Pins broadcasts. It should be remembered that the former is on 253.2 metres (1,183 kc/s), and the latter on 235.1 metres (1,276 kc/s).

Charity Broadcasts

CERTAIN German studios have introduced a new feature in their programmes; it consists of request items chosen by listeners. The only condition enforced is that anybody wishing the transmission of a selected number should make a donation to the Nazi Winter Welfare

Manchukuo, Norway, Poland, Sweden, Switzerland, and the United States. In addition, through the Daventry Empire service, the ceremony was heard by listeners in all the British Dominions and Colonies overseas.

Long, Medium, and Short Waves

ALTHOUGH attempts have been made at various times to introduce a standard classification, it is generally accepted that long waves are those from 1,000 metres upwards, medium from as low as 50 to 600 metres, short from 50 to 10 metres, and ultra shorts below. In actual broadcasting the waves are comprised between roughly 200 and 600 metres, with a band borrowed from other services, namely, 600 to 1,000 metres.

Radio-minded Nations

UNTIL recently Denmark easily held its position in the list of countries possessing the greatest number of listeners per thousand head of population. The figure of 157.8 per 1,000 is now being seriously contested by Great Britain with 157.4, and it is expected that within the next few months the British Isles will secure the envied record.

Musical Broadcasts from U.S.S.R.

ALTHOUGH the Moscow transmitters are usually associated with talks, it should be borne in mind that transmissions of orchestral and vocal concerts, relays of operatic performances, and other outside broadcasts, are regularly carried out daily from G.M.T. 15.30 by the high-power station working on 1,744 metres. No foreign talks are broadcast before G.M.T. 21.05, after the chiming of the Kremlin bells.

February and March Anniversaries

BOTH months in the past have recorded interesting events. Alessandro Volta was born on February 19th, 1745, and died on March 5th, 1827. The former month in 1857 also saw the birth of the famous German inventor, Professor H. Hertz, and that of Sir William Preece in 1834, another celebrated pioneer. George Simon Ohm, a famous contributor to electric science, was born on March 6th, 1787, and on March 27th, 1899, the English Channel was first spanned by radio.

ON OTHER PAGES

	Page
Making Simple Components ..	691
The A B C of the Superhet ..	693
Readers' Wrinkles ..	695
The All-Important Aerial ..	696
Further Notes on the 24 Superhet ..	698
Thermion's Notes ..	699
The Monitor Three ..	702
The Prefect Three ..	704
The Graham-Farish Discovery : S.W.3 ..	706
Beginners' Supplement ..	708
Short-Wave Section ..	709
Club Notes ..	712
Readers' Letters ..	714
Facts and Figures ..	716
Queries and Enquiries ..	717

Fund. As Berlin, in the course of a few days, was favoured with 1,200 requests and monetary gifts, to satisfy subscribers it is initiating a special series of concerts.

A Record of Records

ALTHOUGH on several occasions broadcasts from Europe have been relayed to many parts of the world, there appears little doubt that the description of the late King George's funeral was heard by more foreign countries than any other transmission hitherto made. Running commentaries were carried out by English, German, French, Flemish, Dutch, Italian, and Japanese observers, and were re-broadcast by stations in Algeria, Argentine Republic, Austria, Belgium, Czecho-Slovakia, Denmark, Egypt, France, Germany, Holland, Hungary, Italy, Japan,

ROUND the WORLD of WIRELESS (Contd.)

Organ Recital

TWO organ broadcasts come from Bristol in the near future, one from the Regent Theatre, by Colin Howson, on February 20th, and the other from the Colston Hall, Bristol, by Arthur J. Baker, on February 21st.

Programme Reaction

FREQUENTLY, considerable interest is expressed in the reaction to B.B.C. programmes. It may interest listeners to know that the radio programme for 1935 which headed the fan-mail at Broadcasting House was Charles Brewer's Christmas Party. This evoked more than 600 letters of appreciation. The year 1936 appears to have started well, for an unheralded and unadvertised programme, conceived and carried out by Stanford Robinson and the Theatre Orchestra, received 400 letters. It was a straightforward musical programme called "Victorian Melodies." This reaction is all the more surprising, for whereas the Christmas Party had a multitudinous appeal, "Victorian Melodies" had a single theme and yet called forth an immediate and large response from listeners.

Pounds of Valves

A CONSIGNMENT of wireless valves, weighing 1,374lb., was recently sent by air from Holland to Australia. The transport charges were £1,000.

Carl Rosa at Wolverhampton

THE Royal Carl Rosa Opera Company had its last Midland broadcast at Nottingham. Its next visit is to the Grand Theatre, Wolverhampton, from which it will be heard in Act 2 of Gounod's "Faust." Keith Douglas is the conductor, and the three chief parts are Parry Jones as Faust, Kingsley Lark as Mephistopheles, and Helen Ogilvie as Marguerite. This broadcast will be given in the Midland Regional programme on February 22nd.

Concert of Contemporary Music

A DISTINGUISHED foreign composer whose work will be broadcast this month is Signor G. Francesco Malipiero, the well-known Italian composer. Two short music dramas of his will be performed at the Contemporary Music Concert on February 21st in the B.B.C. Concert Hall. One is entitled "Philomela and the Infatuated Lover"—a fantastic story from the German of R. St. Hoffmann; the other is "Le Baruffe Chiozzotte"—a modern setting of the Goldoni comedy which provided the libretto for the opera by Sinigaglia.

INTERESTING and TOPICAL PARAGRAPHS

Famous Orchestras

THE fifteenth recital in the series of gramophone records from famous orchestras will be given on February 16th

THE NEW H.M.V. RECEIVER



With the aid of their new "His Master's Voice" All-wave Receiver, these four listeners find that they can receive many interesting Short-wave programmes from all parts of the globe, in addition to an abundance of medium- and long-wave broadcasts.

from the Western Regional, and in this series, which covers music from all over the world, we have now reached Hungary. Most of the items will be by the Budapest Philharmonic Orchestra.

Variety from Birkenhead

AN excerpt from the variety bill (details of which are not yet available) will be relayed from the Argyll Theatre, Birkenhead, on February 19th.

Music-hall

JOHN SHARMAN produces a further music-hall programme on February 15th. These music-hall radio productions are popular with listeners to the Saturday night programmes and have been restored to their fortnightly basis. The producer has secured the now popular mouth-organ band led by Borrah Minnevitich, who so amused audiences at the Piccadilly Theatre during the season of music-hall at that venue. In support is the popular comedian, Will Fyffe, and Bertha Willmott, the radio comedienne, who started her career with Philip Ridgeway in the Ridgeway Parade. Further artists will be announced later.

Oxford Repertory Company

THIS company, of which Stanford Holme has been in charge at the Oxford Playhouse for nearly six years, first broadcast last summer in Neville Coghill's short play, "The Tudor Touch." They will visit the Midland studios for the first time

on February 16th, when they will give Lord Dunsany's "Three Moods of Fame." This play was specially written for broadcasting and had a London production by Lance Sieveking. The Birmingham producer is Owen Reed. Thea Holme will take the part of Fame, which comes too late for one poet, is never seen at all by another (although a poem of his written on a £5 note sells for 150 guineas after his death),

and to a third arrives with all the embarrassment of modern publicity in full blast. David Tree, who plays the poet in the second episode, is a son of Viola Tree and grandson of Sir Herbert Beerbohm Tree. Caroline Bayly, who is also in the cast, was trained at the Old Vic.

Follies from Halifax

LISTENERS who have enjoyed the summer-time broadcasts by the Arcadian Follies from Blackpool may have wondered what this popular concert party does with itself in the winter time. In fact, it goes on tour, but the Northern microphone will track them down at the Palace Theatre, Halifax, on February 20th, from which the Follies are to broadcast in the evening.

SOLVE THIS!

PROBLEM No. 178.

Jones built a three-valve receiver, but when the valves were switched on he was annoyed to find that the programmes were drowned by a piercing whistle. This whistle disappeared when the grid of the output valve was touched, however. What was the trouble, and what remedy should be applied? Three books will be awarded for the first three correct solutions opened. Address your envelope to the Editor, PRACTICAL AND AMATEUR WIRELESS, Geo. Newnes, Ltd., 8-11, Southampton Street, Strand, London, W.C.2. Envelopes must be marked Problem No. 178 in the bottom left-hand corner, and must be posted to reach this office not later than the first post Monday, February 17th, 1936.

Solution to Problem No. 177.

Walters had omitted to screen the microphone from the speaker. Unless a screen is used, or the microphone and speaker are kept a good distance apart, the speech or music emanating from the speaker will be picked up by the microphone and instability will occur.

The following three readers successfully solved Problem No. 176 and books are accordingly being forwarded to them:

J. W. Weston, 17, Magdalen Avenue, Wells Road, Bath; N. Wilkinson, Holly Well Cottage, Faddley, Nantwich, Cheshire; J. H. Frederick, 37, Hartington Street, Chatham, Kent.

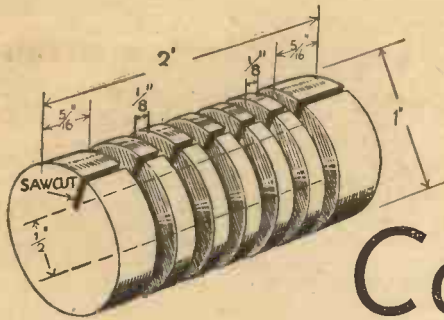

Fig. 1.—H.F. chokes can be wound on an ebonite former made as shown, or one built up from shellacked cardboard discs.

COMPONENTS for home construction are now so cheap and reliable that little or nothing is to be gained financially by making them. Nevertheless, there is considerable interest in real home construction—that is, not only assembling the parts, but also making them—and much to be learned by making at least a few of the simpler parts. The function of the components can always be followed more fully if their form of construction is clearly understood, and this is one excellent reason why all readers are advised to make one or two components for experimental use.

Of the simple components which can be made without the need for special apparatus or instruments, mention might be made of tuning coils (old favourites with most readers of this journal), high-frequency chokes, fixed resistances and fixed condensers. The essential details required for the construction of these items will be given, it being assumed that readers have at least a slight knowledge of practical work.

Coil Data

Many designs for particular types of tuning coil have been given in the past, so in this case it is proposed to detail the most important points and to give a small table so that coils can be made for any ordinary

COIL WINDING TABLE

Mean Diam. of Former (in.)	M.W. 32 S.W.G. Enam.	Reaction 36 S.W.G. Enam.	L.W. 36 S.W.G. Enam.
1	90	100	300
1 1/4	75	90	220
1 1/2	68	80	200
2	56	75	165
2 1/2	50	70	150

purpose, using materials which are on hand, or which can easily be obtained. A coil intended to cover the two wavebands of 200 to 600 metres, and 900 to 2,000 metres (approximately) requires to have an inductance of 2,200 microhenries altogether, and the medium-wave winding should have an inductance of 167 microhenries. These actual figures may be ignored for the moment, because the constructor could not possibly make coils exactly to the specification without the use of comparatively-expensive testing and measuring apparatus. For this reason, it is never wise to attempt to use home-made coils in conjunction with a gang condenser; in nearly every case accurate trimming would be impossible.

The most convenient winding arrangement for simple types of coil is one of those indicated in Fig. 4. In one case use is made of cardboard impregnated with shellac or a paxolin former, fitted with spacing washers of the same material; in the other case a ribbed ebonite former is employed, the long-wave and reaction windings being accommodated in notches filed in the ribs. The most important points to bear in mind

Making Simple Components

The Principal Details of Construction are Given for Coils, Chokes, Condensers and Resistances
By FRANK PRESTON

are that the medium-wave winding consists of side-by-side turns near one end of the former, the reaction and long-wave windings are pile wound in sections, and that the reaction winding is placed between the other two, but rather nearer to the long-wave than the medium-wave section. The dimensions given are applicable to coils wound on formers of any diameter from about 1 in. to 2 in. but for larger diameters it is better slightly to increase the distances between the windings.

Important Points

The table reproduced on this page shows the appropriate number of turns for long-wave, medium-wave and reaction windings for formers of a few different sizes, on the assumption that 32-gauge enamelled wire is used for the medium-wave section, and 36-gauge enamelled wire for the reaction and long-wave sections. It should be observed that the mean diameter of the

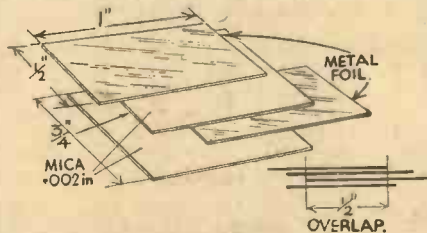

Fig. 3.—These illustrations show the chief constructional details for fixed condensers.

long-wave and reaction windings differs according to the type of former used, even though both formers have the same overall

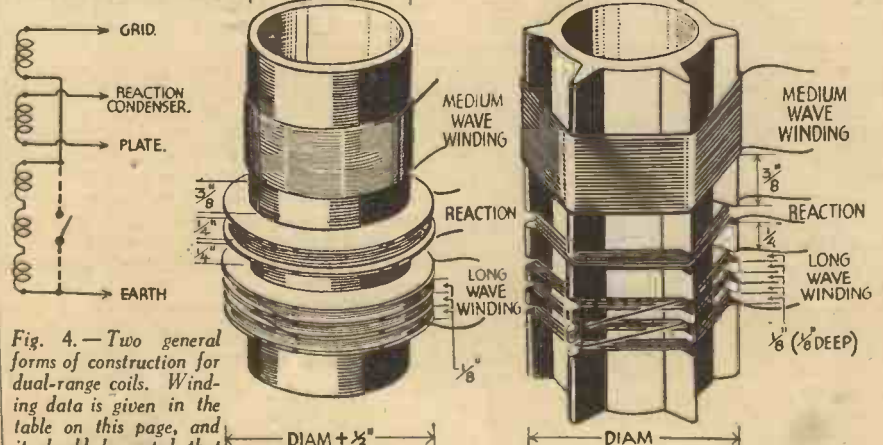

Fig. 4.—Two general forms of construction for dual-range coils. Winding data is given in the table on this page, and it should be noted that all turns must be wound in the same direction.

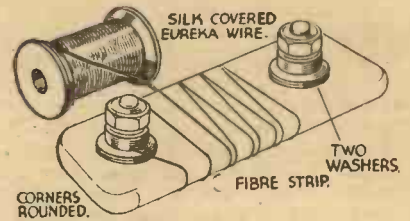

Fig. 2.—Showing a simple method of making fixed resistances. Note that the wire is wound backward and forward on the fibre strip. See the table for resistance-wire data.

diameter. This is because 1/4 in.-deep slots are made in the ribbed former, thus reducing the average diameter of the winding by 1/4 in. When the paxolin former is used, however, the average diameter is increased by about 1/4 in. This point should be borne in mind, and slight allowances made when using the table.

In the majority of instances it will be required to have tapings on either one or both of the windings, but this does not affect the numbers of turns indicated, and tapings can be made as required for the circuit in which the coil will be used.

Two Types of H.F. Choke

High-frequency chokes can be made quite easily in various ways, one of which is suggested in Fig. 1. There is a grooved ebonite rod, 1 in. in overall diameter and having slots 1/4 in. deep. A saw cut is made lengthwise down the former, and this provides a simple means of passing the wire from one slot to the next. A good detector-circuit, or reaction choke can be made by winding a total of 1,200 turns on the former, these being roughly divided between the six slots. The wire should be 36-gauge enamelled, and the ends should be soldered to lengths of thin rubber-covered flex, which can be used for making connection with terminals or with other components. If the choke is intended to be used in the anode circuit of an S.G.-type valve the number of turns should be increased to about 2,000, although following the same general form of construction.

Screening

The ebonite former shown could not normally be made without having recourse to a small lathe, and for this reason it might be beyond many readers. It could, however, be built up from discs of ebonite, or even from discs of cardboard which have been well impregnated with shellac. The discs may be held together by passing a length of 4 B.A. screwed brass rod down the centre, and clamping them tightly

(Continued on next page)

MAKING SIMPLE COMPONENTS

(Continued from previous page)

with nuts or terminal heads. Should it be desired to screen the choke, this can be done by using an aluminium canister not less than 1½ in. in diameter and 2½ in. long; there are certain shaving-soap tubes which are suitable. The former should be attached to the centre of the lid by means of a 4 B.A. screw tapped into the ebonite, or by means of the central screwed rod, after which it is necessary only to fit the lid in place to have a well-screened component. The connections can be made by means of lengths of flex passing through holes in the lid, or the complete screened choke can be attached to an ebonite base plate.

Special Bias Resistances

Fixed resistances can be bought so cheaply that it is rarely worth while to make them, but there are instances when a non-standard value is required—particularly in the case of a bias resistance for a power or super-power valve. The construction is then fully justified, and can be carried out as shown in Fig. 2, where it will be seen that a length of resistance wire is wound on a strip of fibre fitted with two terminals, under the heads of each of which are two washers. The method is to determine the gauge and length of wire required from the accompanying table, and then carefully to scrape away the insulation for a distance of about ½ in. at one end of the wire and to clamp this between the two washers on one of the terminals. The wire should then be wound on to the fibre strip, spacing the turns fairly well; after winding to one end continue winding towards the other end, going backward and forward until all the wire has been used. After this, the end should be bared and clamped

under the washers on the second terminal. It should be added that the object in winding backward and forward is to make the component almost completely non-inductive.

Maximum Current

It is not recommended that resistances of more than 2,000 ohms should be home made, because the construction becomes tedious, due to the comparatively great length of wire required. Additionally, it is not wise to attempt the use of wire of smaller gauge than 38, because it is then so thin that it cannot be handled very easily. A point which should be stressed is that the wire should not be stretched when winding, for this would alter the resistance per yard, and might have a pronounced effect when, say, five yards of wire were used. It should also be mentioned that, in using the table, it is a good plan to use wire which is rated to carry rather more than the maximum current which will be passed through the resistance; by this means the component is prevented from becoming more than slightly warm. As a matter of fact the maximum current ratings given are for a normal temperature rise of 100 degrees Centigrade, which is not excessive if the resistance is not placed too close to fixed condensers or other parts with wax filling.

Making Fixed Condensers

Fixed condensers in capacities up to .002 mfd. or so can be made quite easily by interleaving sheets of copper or tinfoil with sheets of mica .002 in. thick, this being a standard thickness for mica. Using plates and micas of the dimensions shown in Fig. 3, a capacity of approximately .00015 mfd., .0005 mfd., .001 mfd. and .002 mfd. can be obtained by using two, four, seven or fourteen pieces respectively

of foil. As the capacity is proportional to the area of overlap of the plates and also to the number of plates used (actually, to the number of facing surfaces of plates), *pro rata* capacities can be obtained by varying one or other of these factors in proportion.

The simplest method of construction is to cut the mica and foil to size with sharp scissors, being careful that the mica is not split or damaged in the process, and then lightly to coat one piece of foil with very thin shellac varnish. Next, this foil should be laid in position on a mica, and a second mica placed over it and pressed firmly down so as to avoid air bubbles between the foil and the mica. The complete condenser can then be built up by following this procedure; care must be taken, however, that varnish is applied only to the surfaces which overlap, for if it were applied all over the foil there would be bad contact between the various end tabs. After all the strips have been assembled the condenser should be placed under a weighted board and allowed to remain until the varnish has thoroughly set. It can then be mounted on a strip of ebonite by passing terminals through the foil end tabs and covering them with a strip of copper or brass before the terminal nuts are tightened down. Alternatively, if copper foil is used, the tabs can be soldered together round their edges, and flexible leads attached.

EUREKA RESISTANCE WIRE TABLE

Gauge	Ohms per yd.	Current Carrying Capacity m/A.
32	7.35	470
34	10.128	370
36	14.84	280
38	23.8	190

ARE COMMERCIAL SETS HOTTED UP TOO MUCH?

High Efficiency is One Thing and Consistent Performance Over a Long Period of Service is Another. It is in the Latter Respect that, according to Our Contributor, the Home Constructor Often Scores Over the Purchaser of a Factory-built Set

EVERYONE who has been intimately connected with radio receivers, both of the home-built and factory-made types, since the very beginnings of broadcasting, is ready to admit, and even to wonder at, the very high standard of efficiency which has been attained by the commercially-built article. This high standard, which shows itself in range, selectivity, and output, almost amazing in their degree, is often put forward as an argument to belittle the value of home construction as applied to radio receivers.

While not for one moment admitting that anything which can be produced in a modern mass-assembly factory cannot be reproduced, and even excelled, by the knowledgeable amateur who possesses in addition good craftsmanship and a reasonable outfit of tools and instruments, it is probably true that a large proportion of home constructors, by reason of lack of experience and limited equipment, must inevitably content themselves with a somewhat lower standard of *initial* efficiency than that observed in many commercial receivers.

Please note the stress placed upon the word "initial" in the last paragraph. Signs are not wanting that, at any rate so

far as some set manufacturers are concerned, the high efficiency achieved by the sets on the test bench, and experienced by the ultimate purchaser when the instrument is first installed in his home, is due to a careful "hotting up" of each receiver during the final stages of manufacture and adjustment, and there is no assurance that this high efficiency is likely to be maintained over a lengthy period of service.

Individual Testing of Components

That each individual component should be separately tested and, if need be, especially designed for the receiver of which it is to form a part, is good and perfectly legitimate practice; and that each completed set should be lined up and adjusted to maximum efficiency before dispatch is also reasonable. But it appears to be the practice of many set manufacturers to adjust their sets with the particular valves which will be sold with them, and, in cases where two valves of the same type are employed in one receiver, to mark each of these two valves with the number of the valve-holder in which it is to be placed. Thus, in a set employing a vari-mu H.F. pentode as

radio-frequency amplifier and another as intermediate-frequency amplifier, or in a set having two identical intermediate-frequency valves, one will be marked No. 1 and the other No. 2.

A set adjusted to maximum efficiency with these valves in their correct positions may give sensitivity, selectivity, and overall performance of a very high order. But what will happen in a few months' time, or in a year's time, when it is found necessary to replace the original valves? Will new valves taken at random from the stock of the local radio shop give the same performance as the selected valves with which the set was originally adjusted? It seems hardly likely that they will.

Now consider the position of the amateur constructor. Whether he produces a set of his own design, or whether he follows one of the designs published in PRACTICAL AND AMATEUR WIRELESS, he will be dealing with major components, and also valves and other renewable units obtained from stock in the ordinary way. It is well known that what are called "manufacturing tolerances," that is to say, the limits of accuracy either in dimensions or characteristics which products must not exceed if they are to pass the standard factory inspection, are, in some cases, fairly wide. But experience has shown that in no case will a reputable manufacturer allow tolerances so wide that reasonable efficiency is imperilled. Moreover, the law of averages will usually see to it that errors on the low side in certain components are more or less balanced out by errors on the high side in others, with the result that the home constructor can rely upon a pretty high

(Continued on page 707)

The ABC of the Superhet

The Principle of the Superheterodyne Circuit has Been Explained in These Pages More Than Once, but for the Express Benefit of New Readers it is Described Here in a New Form

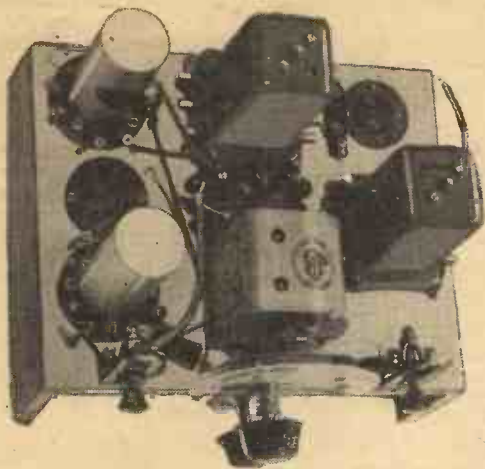

A view of Mr. F. J. Camm's two-valve superhet, showing the simple layout of components.

THE title of this article seems to be singularly appropriate because there are three distinct parts of the superhet, which might well be referred to as A, B, and C. These are: the frequency-changer, which includes the first detector; the intermediate-frequency amplifier; and the second detector. Generally, of course, there is a low-frequency amplifier after the second detector, but this does not affect the superhet principle, because it is just the same as that used in any other type of receiver.

Changing the Frequency

The whole idea of the superhet is that the frequency of the signals received is changed before being amplified and detected. Thus, no matter whether the frequency (generally referred to as wavelength) of the transmission it is desired to receive is 1,500 kilocycles (200 metres), 500 kilocycles (600 metres) or 150 kilocycles (2,000 metres) it is changed to a standard frequency, which may be 110, 150 or 465 kilocycles. The last-mentioned frequency is now most generally used because it has been proved to be most suitable.

First the signal is received as a fluctuating high-frequency current, and then it is mixed with another high-frequency current of different frequency so that the result is another entirely different frequency, known as the intermediate frequency. After the frequency has been changed, the signal is of similar form to that originally striking the aerial, and amplification can be carried out just as it is in a "straight" receiver.

Simple Analogies

It is the changing of the frequency which generally puzzles the beginner, but there is a very simple analogy which explains the matter rather well. When travelling in a car or 'bus one hears the regular "burr" of the engine and exhaust, but when another vehicle is being passed the sound seems to undergo a change, with a result that a kind of "bub-bub-bub" noise is heard. This is not the sound that the other vehicle is making, but a "mixture" of the sounds made by the two vehicles, and may be referred to as a "beat" note, for obvious reasons. A similar effect is often noticed when listening to an organ; when a low-pitched chord is being played it is often possible to hear a periodic "thumping" noise, which is quite apart from the sound of the individual notes forming the chord. This, again, is a beat note.

It is not now difficult to imagine two

frequencies which are higher than any which are audible combining to form a beat note of different frequency from either of the originals. An example of this is to be found in a receiver which is made to oscillate, for when the receiver is tuned very near to the wavelength or frequency of a transmission, a whistle is heard; that whistle is a beat note. It can also be noticed that the pitch of the whistle rises as the set is tuned away from the transmission, while it vanishes as the accurate tuning position is reached.

Two Valves in One

A very similar process takes place in the frequency-changer of a superhet, which generally consists of a pentagrid or similar type of valve. This valve is really two valves in one, and the first portion acts as a kind of detector operating at the frequency of the received signals, while the other is an oscillator which generates oscillations of a different frequency. When these two frequencies are combined inside the valve, or in the external circuits of the valve, a beat note is produced. By altering the frequency to which the oscillator is tuned the beat note can be made to have any desired frequency.

In the case of a modern superhet using an intermediate-frequency amplifier working at 465 kilocycles, the oscillator is tuned to a frequency of 465 kilocycles higher than that of the first detector, with a result that the beat note is of this frequency. The chief difficulty in this respect is of that

tuning the first detector and oscillator together so that the frequency difference between them always remains constant. To permit of this the tuning coil used in the oscillator circuit is made with a smaller inductance than that in the input circuit, and that section of the gang condenser which operates in conjunction with the oscillator coil has specially-shaped vanes. In addition, it is sometimes necessary to use additional series and parallel fixed or pre-set condensers to ensure that the frequency difference holds good regardless of the wavelength or frequency of the station it is desired to receive.

The I.F. Amplifier

The output from the frequency-changer is at the beat or intermediate frequency and must be passed to a high-frequency-amplifying valve, which is known as the I.F. valve. The coupling is by means of so-called intermediate-frequency transformers, which are no more than pairs of coils coupled together and tuned to, say, 465 kilocycles. Each of these coils is provided with a pre-set variable condenser by means of which the coils can be adjusted to tune to the exact frequency required while the set is in operation. In many cases provision is also made for moving the two transformer coils towards, or away from, each other and by this means the selectivity of the circuits can be varied. Another method sometimes used is to allow for the iron-dust core which passes through the coils to be moved, and this produces a similar effect.

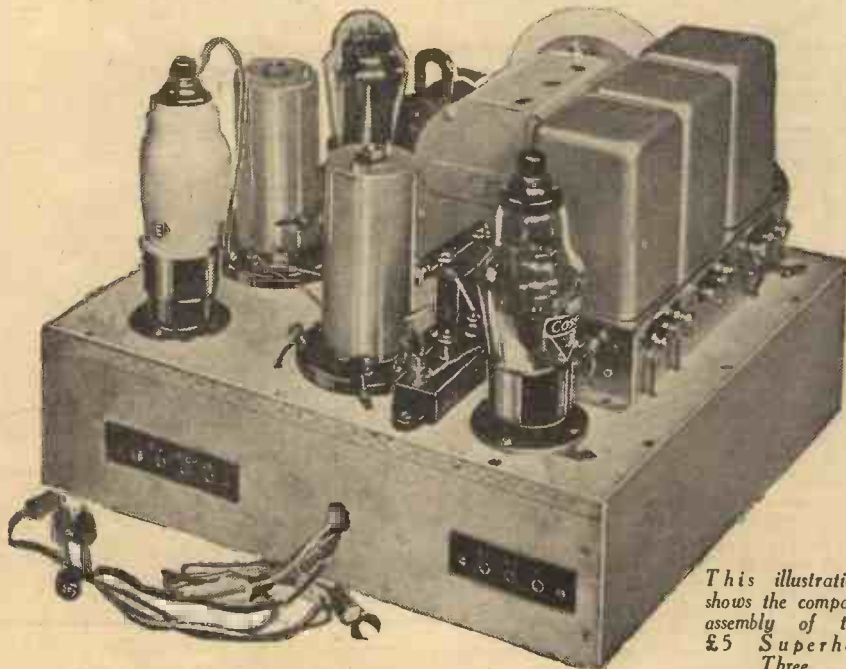

This illustration shows the compact assembly of the £5 Superhet Three.

A PAGE OF PRACTICAL HINTS

SUBMIT YOUR IDEA

READERS WRINKLES

THE HALF-GUINEA PAGE

Converting a Switch

A SIMPLE method of converting a plain on-off switch to single pole change-over is shown in the accompanying sketch. One blade is removed, the terminal top replaced and the blade secured with an additional nut. This blade should be spaced sufficiently to allow of the moving part breaking contact with one blade before

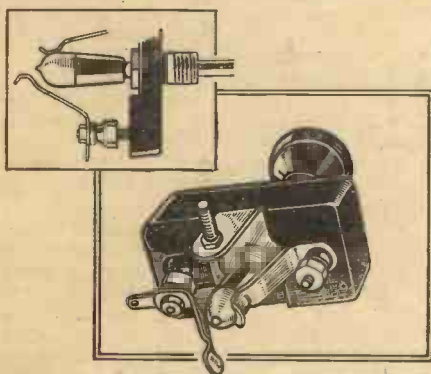

Converting an "on-off" switch.

touching the other. The centre contact is taken via the fixing bush or a length of flex soldered to the metal end-piece.—E. PARKER (London, S.E.).

A Rectifier from a Pick-up

A HEAVY output can be taken from this cheap mechanical rectifier. An old 10,000-ohm pick-up, mains transformer, and a neon lamp are the principal requirements. The movement of the armature is slackened to give ample play, and the pick-up is then fixed to a piece of ebonite, as in the sketch below, and an input of about 30 volts is taken from the transformer primary windings to it.

About 4ins. of 18 S.W.G. copper wire is inserted in the needle hole, the exact length to give resonance or maximum deflection having to be determined experimentally. A 0.5mfd. condenser is fixed in series to

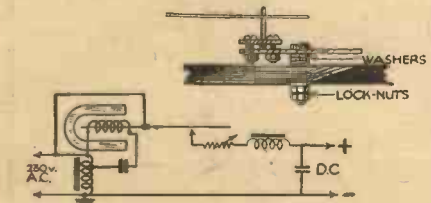
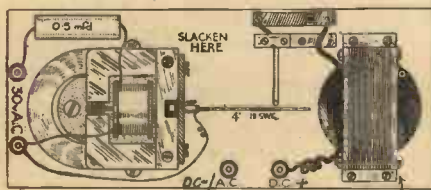

Details of a mechanical rectifier made from a pick-up.

THAT DODGE OF YOURS!

Every Reader of "PRACTICAL AND AMATEUR WIRELESS" must have originated some little dodge which would interest other readers. Why not pass it on to us? We pay £1-10-0 for the best wrinkle submitted, and for every other item published on this page we will pay half-a-guinea. Turn that idea of yours to account by sending it in to us addressed to the Editor, "PRACTICAL AND AMATEUR WIRELESS," George Newnes, Ltd., 8-11, Southampton Street, Strand, W.C.2. Put your name and address on every item. Please note that every notion sent in must be original. Mark envelopes "Radio Wrinkles." Do NOT enclose Queries with your Wrinkle.

correct the phase of vibration which is found by observing it in the light of the neon lamp. The correct value is when a distinct gap is seen in the vibrating wire. The A.C. input is connected by a flexible wire to the needle holder, while D.C. is taken from the spring contact at the end of the vibrator. This consists of 1 1/2 in. of 28 S.W.G. wire, fixed on an adjustable clamp. When a choke is used in the output, sparking can be eliminated by adjusting the contact pressure.—J. M. SCOTT (Aberdeen).

Aerial and Earth Contact Plates

THERMION'S note recently on "Tangled Wires" prompts me to forward the following "Wrinkle," which has removed my last pair of loose wires, gives entire satisfaction, and at the same time allows

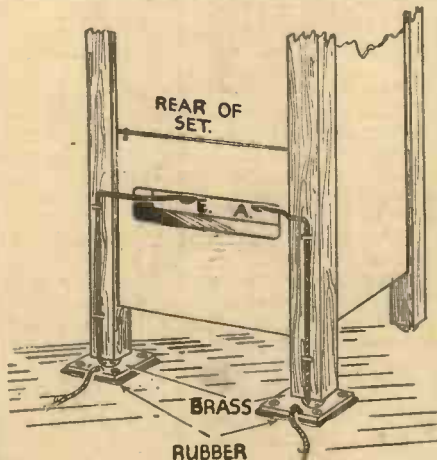

A novel arrangement of aerial and earth contact plates for a radio cabinet.

madam with the dust pan to pull the set forward without fear of doing any damage. Wires from the A and E terminals on the set are taken along the bottom rail, pass through two small screw eyes, and then down the back of the two legs, and are soldered to

LATHE WORK FOR AMATEURS

By F. J. CAMM.
1/- or 1/2 by post from
GEORGE NEWNES, LTD., 8/11, Southampton St., Strand, W.C.2.

the gliding castors at the bottom. The actual aerial and earth leads are soldered to two small brass plates, about 1 1/2 in. square, which are loosely screwed to the floor with a layer or two of rubber (old cycle tube) underneath. The reason for not screwing the plates down tightly is to allow the rubber to act as springs, and therefore make better contact. Any unevenness of the floor can be made good by slipping extra pieces of rubber under the lowest corner.—ALEX. J. MASSON (Aberdeen).

Condenser Calibration

THIS instrument is for finding the capacity of a fixed or variable condenser when the markings have become defaced, or when a home-made condenser is to be brought to a definite capacity. The coils A.B. are wound in opposite directions, to produce opposite polarity in iron poles,

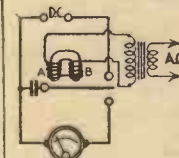
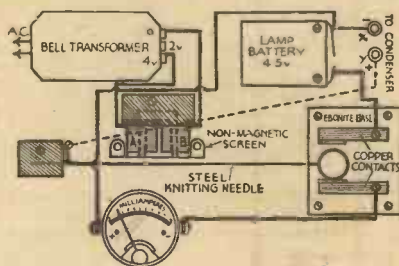

The wiring and theoretical diagrams of a useful unit for ascertaining the capacities of condensers.

and should, if possible, be taken from an old bell. They are fastened eccentrically to the shallow chassis and must be clamped down very tightly. The steel needle has a loop of thick copper wire (18 s.w.g.), at one end and contact is also made at the other end. It is then firmly clamped between two pieces of hard wood which are secured to the chassis like the coil unit A.B. The L-shaped copper contacts are fastened to a piece of ebonite or similar low-loss material to prevent leakage. The screen in front of the magnet is to prevent the needle sticking.

To use the instrument a condenser of known capacity is placed across the terminals X and Y. (Be careful to preserve polarity when testing electrolytics.) Having taken the reading on the meter, the condenser of unknown capacity is substituted for the first, and the capacity of the first being known, the capacity of the second is worked out by direct comparison of the readings. For example, if a condenser of 2mfd. capacity gives a reading of 9 m.A., and the other a reading of 4.5 m.A., the capacity of it is obviously 1mfd. For more accurate results in minute capacities a galvanometer could be used, and the higher the frequency of the A.C. current, the more accurate the result will be.—A. M. WILDING (Wallasey).

The All-important Aerial

IN the early days of broadcasting the amateur spent considerable time and money in putting up the best possible aerial, and it would appear from an examination of the majority of back gardens in these days that it is now regarded as the minor part of the wireless receiving equipment. There is, however, a very important point connected with the aerial, and one which is often lost sight of. Those listeners who work in offices or factories where they have opportunities of discussing the reception of various stations from time to time may

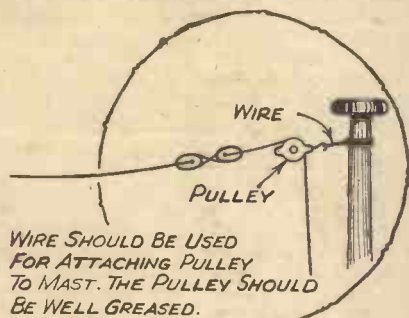

Fig. 1.—A simple but important part of the aerial system.

have noticed that where two listeners are resident in the same locality and have similar receivers it often occurs that one listener will hear a certain station clearly at regular times, whereas the other listener cannot hear the station at all, or at best can only obtain weak reception from this particular station. This appears to the listener to be unaccountable, as the receivers may be absolutely identical and the listeners may even live in the same street. How, then, can this difficulty be explained? An examination of the aerials would probably reveal the fact that one was erected in one direction, whilst the other was suspended in such a manner that it formed a right angle with the first aerial. The explanation lies in the fact that a single wire suspended in the air will possess definite directional properties, and these may be employed to increase the efficiency of a receiver or to make up for some defect in certain directions.

Aerial Insulation

Dealing with the question of the aerial from the very beginning, it is—or should be—well known that the aerial is the most vital link between the transmitter and receiver, and the question of insulation must be considered before anything else. The usual chain of insulators which at one time was considered essential now seems to be omitted, and in many cases it is found that the aerial wire is attached direct to the supporting rope or wire. This is bound to lead to loss of signal strength, which, although perhaps not noticeable on the local station, is certainly of very great importance when considering distant station reception. Therefore, if you have not yet erected the aerial, or have put up a more or less temporary affair, obtain a dozen china insulators and attach these together to form a string of at least six for each end of the aerial. The egg type is the simplest and strongest, although if you are considering short-wave reception one of the special glass or similar insulators may be used in place of the egg type. Attach

Some of the Points of Interest in Connection with the Receiving Aerial which are Often Overlooked, and Hints on obtaining Improved Performance

By W. J. DELANEY

the insulators as shown in Fig. 2 and use good hemp rope, or, alternatively, galvanised wire such as is sold for clothes lines. Rope is, however, preferable, and the type sold for clothes lines may be relied upon to stand up to a certain amount of atmospheric corrosion, etc.

Aerial Direction

Now before erecting a pole in the garden, consider the direction of various stations which it is desired to hear. A map will be of assistance in this connection, and it must be remembered that the signals which strike the aerial at right-angles will be the weakest, whilst those which are in the direction of the free end of the aerial will be strongest. If this point is first considered you may find that it is not possible

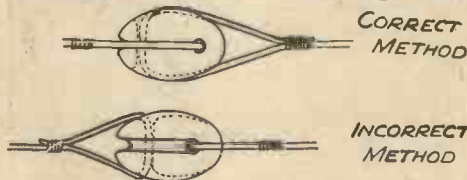

ATTACHING INSULATORS

Fig. 2.—This illustration shows how the standard egg insulators should be attached.

to put up a supporting mast which will provide the desired effect, and thus the alternative will be to erect a non-directional (or vertical) aerial, or improve the efficiency of the high-frequency stages in the receiver. Having decided upon this point, the mast may be erected, and here it pays to spend a little money upon a good scaffold pole, and not to make do with lengths of two-by-two or similar timber tied together with string so that they will fall at the slightest gale and probably result in the loss of any important transmission at a critical moment. Creosote the lower end of the pole, and for added protection adopt the dodge of

wrapping a length of tin or similar material round the pole so that half of the metal is in the ground and half out of the ground. Alternatively, the pole may be set into concrete, which is poured into a large-diameter pipe whilst the pole is supported in the centre of this. It will be found that rot generally takes place at the ground level, and this dodge prevents an early breakage due to damp.

Aerial Height

The height of the aerial must be chosen with as much care as its insulation and direction, and it will invariably be found that best results are obtained when the end remote from the receiver is higher than the receiver end. Again, remember that height must be considered not above the actual ground level, but above the various earthed bodies in the proximity of the aerial. Thus, although a 30ft. pole may be placed at the foot of a 50ft. garden, if an outhouse or other building runs half the length of the garden and is 20ft. high (with the aerial passing over this) the effective height of the aerial is only 10ft.

If telephone wires, high-voltage distribution wires, or other electrical apparatus is in the proximity of the aerial the wire must be arranged as nearly as possible at right angles to avoid interference, and one of the screened cables will probably be found essential to reduce the interference.

Where the wire approaches the house a long supporting rope should be employed so that the aerial may be led down to the receiver without coming closer to the walls, gutters, etc., than about 18in. to 2ft. To maintain the wire steady and prevent fading caused by the wire approaching the

(Continued on page 707)

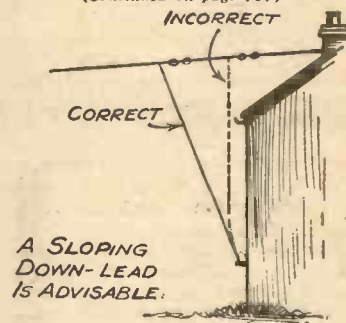

Fig. 3.—Do not run the lead-in wire parallel to the house.

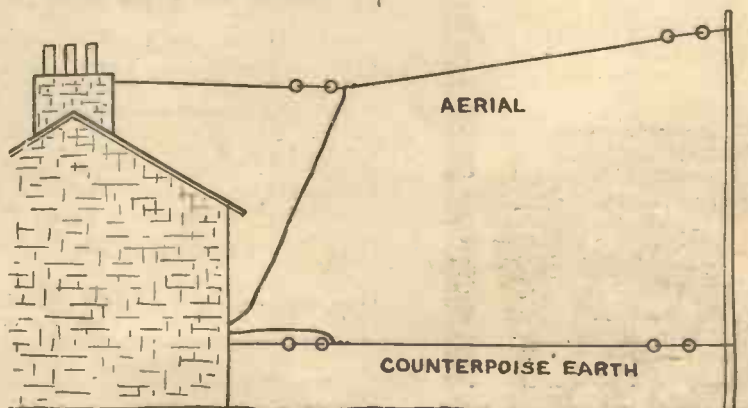
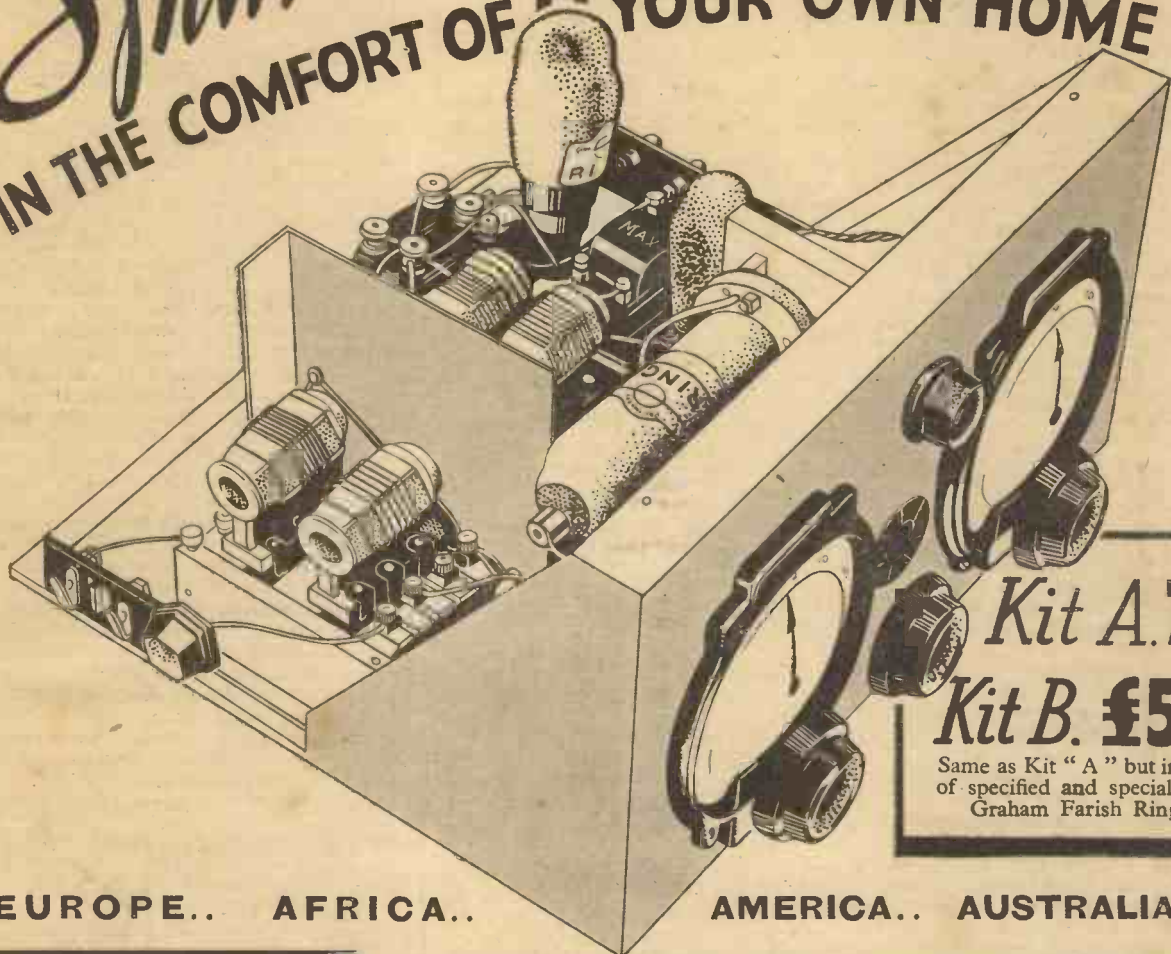

Fig. 4.—A good aerial arrangement, utilising a counterpoise instead of an earth connection.

Span the five continents IN THE COMFORT OF YOUR OWN HOME!



Kit A. 72'6
Kit B. £5.0.0
 Same as Kit "A" but including set of specified and specially matched Graham Farish Ring Valves.

EUROPE.. AFRICA.. AMERICA.. AUSTRALIA.. ASIA

You 'short-wave' fans!

Ever read "Radio Contact"? It's one of the brightest, most informative journals ever published dealing with modern radio! Contents of No. 3 include full technical description of the "Discovery" Short Wave S.G. Three, together with articles and general topics on radio. "Radio Contact" costs only 4d. Read it once and you'll read it REGULARLY! If any difficulty in obtaining, send coupon below enclosing 5½d.—to cover cost and postage.



To the pleasure of constructing and the joy of anticipation is added the final MARVEL of SUPERLATIVE PERFORMANCE! Distance means nothing to the wonderful "Discovery" Short Wave S.G. THREE! Programmes from New Zealand, Moscow, Honolulu, America and other distant stations "come through" with truly astonishing clarity and vividness. That, in a word, is the PROMISE of the "Discovery" Short Wave S.G. Three; and that is the PERFORMANCE you can confidently expect! The "Discovery" Short Wave Three will give you a new outlook—a new angle—on the affairs of this amazing world. Build it—and open the door to a new thrill which must be experienced to be believed.

POST THIS COUPON TO-DAY!

Messrs. Graham Farish, Ltd., Dept. D.1, Bromley, Kent.

- A. Please send me a copy of "Contact" No. 3, for which I enclose 5½d. in stamps.
- B. Please send me details of your Hire Purchase Arrangements for the "Discovery" Short Wave S.G. Three.
- C. Please send me details of your "Quest" Short Wave Two.
Cross out items not required.

NAME

ADDRESS

FURTHER NOTES on the £4 SUPERHET 4

Some Important Details concerning the Correct Adjustment of the Receiver, Especially in Relation to the Frequency-changing Stage, are here given

THE large number of £4 superhets which have now been made up, and an analysis of the various queries which have been received, has enabled us to localise the difficulties which are met with in the building and operation of a superheterodyne receiver of this nature. Apart from minor difficulties connected with the use of defective components, it would appear that the major portion of the troubles met with are due to the fact that the frequency-changing stage does not function in the correct manner, in spite of the use of the specified components and the specified method of connection. The general cause of this trouble may be traced to the fact that the wrong voltage is applied to the oscillator section owing to the use of a defective H.T. battery, or when the receiver is employed with a battery eliminator which is unsuitable for this particular receiver.

milliammeter to plus 80/100 volts H.T. An extra by-pass condenser, having a capacity of 0.1 mfd. or larger should be connected between 3 on the B.P.87 and earth. Note the reading on the milliammeter, which should be between 1 and 2 milliamps, then touch terminal 5 or connect it to earth. If the oscillator portion is functioning satisfactorily the meter reading will increase, but if the oscillator part is not oscillating the meter reading will not change. If no oscillation is occurring, increase the oscillator anode voltage until it does, but if it will not oscillate with 100 volts, some other cause must be sought, such as poor insulation in the oscillator grid circuit, or too low a resistance for the oscillator grid leak.

The test for oscillation should be repeated at various points on the tuning scale to make sure that oscillation occurs over the whole range.

those from the oscillator in the superhet. Once a whistle has been detected, tune both sets a few degrees higher or lower, keeping the whistle audible, and in this way test over the whole tuning range of the superhet to see that the oscillator functions. If no whistle can be detected, and one is certain that the straight set is oscillating, it is a fairly certain indication that the oscillator in the superhet is faulty in some way. All the Duo-Nicore oscillator coils are tested before despatch, and unless a complete break has occurred in the winding, it is unlikely that the coils are faulty. It should be pointed out that the high resistance of the reaction winding (terminals 1 and 3 on the BP.87), approximately 100 ohms, is due to this winding being wound with Eureka resistance wire, to avoid spurious oscillation, and does not indicate a faulty coil.

Ganging Hints

If the oscillator is found to be satisfactory, incorrect ganging may be the cause of poor results. The I.F. transformers must be tuned to 465 kc/s, but due to the necessarily wide range of variation possible on the trimmers, it is possible, unless the trimming is carried out carefully, to tune the I.F. circuits to some other frequency.

It is best to line up the I.F. amplifier by means of a test oscillator and output meter if these can be borrowed or hired, but if these are not available the I.F. frequency can be ascertained by noting the station upon which second channel whistles are heard, the aerial coupling being altered to give a strong second channel. (When the receiver is correctly ganged the second channel interference is negligible.)

The aerial should be connected to terminal 5 on the BP.80 coil through a .0001 mfd. pre-set condenser. Set the wave-change switch to long waves. If the receiving location is near the London stations, London National (1,149 kc/s) will cause a loud whistle on Motala (216 kc/s) the frequency difference being 933 kc/s, which is about exactly double the desired intermediate frequency of 465 kc/s. Listeners near North National and West National can use the same method of determining the intermediate frequency.

If the whistle does not come on or near Motala, the I.F. trimmers and oscillator parallel long-wave padder should be varied until the whistle is obtained within a few degrees of this point.

The trimming operation should be carried out carefully. If results are poor, or nothing can be heard at all, do not make hasty indiscriminate adjustments to the trimmers, for the likelihood is that this will result in the trimming adjustments being thrown so far out that it will be necessary to return the components to have their trimmers re-adjusted. Most I.F. transformer makers, for example, test these components in a receiver with stray capacities similar to those in the average receiver, so that large alterations to the trimmers should not be necessary.

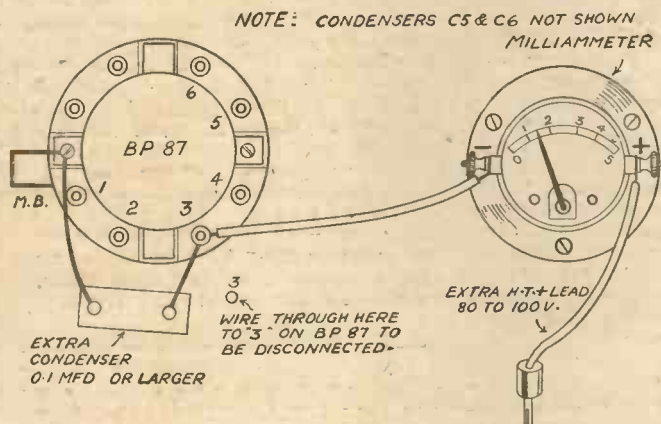

This illustration shows the modifications necessary to include the milliammeter in the oscillator stage as described in this article.

Testing for Oscillation

To test whether the oscillator portion of the heptode is oscillating, connect a milliammeter in the oscillator anode lead. As, however, the H.T. plus 1 lead supplies the screen-grid of the I.F. valve and the second detector anode, as well as the oscillator anode of the pentagrid, it is preferable to fit an additional H.T. plus lead for the oscillator anode to make this test.

The method of doing this is shown in the above illustration. The lead through hole 3 to terminal 3 on the B.P.87 is removed, and 3 on the B.P.87 connected to the negative terminal on the milliammeter, and the positive terminal of the

An Alternative Method

If a milliammeter is not available another receiver (a straight circuit, not a superhet) can be used to detect whether the oscillator is functioning. A temporary one-valve set made from odd parts will do quite well, provided that it can be made to oscillate and cover the desired tuning range. This test is made as follows:—

The straight circuit receiver is made to oscillate, and then the tuning control of the superhet is varied until a whistle is heard in the loud-speaker or phones attached to the straight set. This whistle is due to the beat note between the oscillations produced by the oscillating straight set and

The Growth of Wireless

THE spread of radio throughout the world is such that to-day, according to official figures published at Berne, there are now 35,700 transmitters in operation. Of these roughly 7,700 broadcast entertainments.

At the Top of the Band

BROADCASTS from the 16-kilowatt station at Wilno (Poland) on 559.7 metres (535 kc/s), are shortly likely to suffer interference, inasmuch as the new 20-kilowatt Bolzano (Italy) transmitter is

HERE and THERE

expected to take the air towards the middle of March. Two powerful stations can hardly share the same channel without causing trouble.

Electricity in the Home

FROM recent figures published it would appear that of 11,336,376 homes in Great Britain, 6,073,708 possess an electrical supply, representing 53.6 per cent. of the

total, and in effect the lowest in Europe. Switzerland is specially favoured, inasmuch as only one per cent. of her dwellings do not possess electric light, hence the rarity of crystal sets in that country.

B.B.C. Midland Orchestra

THERE are two evening concerts by the B.B.C. Midland Orchestra during the week. Reginald Burston conducts on February 17th, when the light music is chosen from the works of Midland composers. On February 19th, when Leslie Heward conducts, the programme includes Grieg's Lyric Suite.

On Your Wavelength

Effect of Radio on Health

ACCORDING to a daily paper, a well-known radiologist indicated at a demonstration that people who said that broadcasting bored them to death might be nearer to the truth than they supposed. He said that there must be a certain amount of effect (whatever that may mean) from ordinary wireless transmissions both on animals and human beings. He said that a friend of his whose aerial once fell down found field mice lying beside it, and it was his opinion that wireless rays had affected those mice. Most of my neighbours seem to have receivers capable of putting out about $1\frac{1}{2}$ kilowatts distorted output.

Have Two Speakers in One Room

IF you are getting a bit tired of the tone of your set, try the experiment of having two loud-speakers in the room. Only recently I have listened to the broadcasts from two loud-speakers—one



Have two loud-speakers in the room.

low in tone and the other high. This was obtained with the aid of condensers and a transformer. It gets away from the directional effect and sounds much more realistic—perhaps because it overcomes the bad acoustics of the normal sitting-room.

Rude Letters to the Editor

I WENT in to see the Editor the other day, but he did not seem his usual cheery self. His blood pressure seemed to be rising rapidly and just as I was slinking out of the office before I caught a packet he handed me a letter with a peremptory "Read this!" It was a letter from a reader who had failed to make one of his receivers work. Mr. Camm, as I think generously, had asked the reader to send the receiver in. I say generously, because if I had received this particular letter I should have felt like punching the reader's head. After I had perused the aforesaid scurrilous document, he led me gently by the arm into the laboratory and asked me to endeavour to tune in a station on the aforesaid receiver. Although it was connected up and switched on, the set was dead silent. Removing the cover of the variable condenser, Mr. Camm exhibited the reason therefor. The drive was not locked! This reader had been struggling for months with this receiver and Mr. Camm later invited the reader to attend a demonstration. The reader arrived still in a truculent frame of mind. Mr. Camm had left the receiver with the dial still loose, and demonstrated that when locked the receiver worked satisfactorily. Of course apologies were made and accepted. Another reader built his

By Jhermion

£4 Superhet, and after a dealer had juggled about with the thing for three days sent it in to Mr. Camm, talking a lot of rot about second harmonics and displayed that, like many radio dealers, he knew something less than nothing about the subject. The whole trouble with this particular receiver was that instead of using a two-gang superhet condenser a straight two-gang condenser had been used. Mr. Camm thereupon got into touch with the dealer, asking that he might have the reader's name and address, since, knowing the wiles of radio dealers, it occurred to him that this dealer had damned the designer and the set rather than give away to our reader the fact that he was incompetent. When the reader visited the Editor it was explained to him how important it was to deal with wireless retailers who knew something about it. There are still, fortunately, many dealers who have graduated from the early days of construction and who do not make such stupid and elementary mistakes. This particular dealer was anxious to unload some old-type variable condensers which, not having an oscillator section, were quite unsuitable for a superhet. The guarantee behind all PRACTICAL AND AMATEUR WIRELESS receivers is your safeguard if you use the specified parts. If you allow yourself to be misled by an incompetent dealer there is nothing more to be said.

Another Source of Interference

I SEE that a new use for wireless is being tried in France. At the moment it is in the experimental stage only, but if it develops, I wonder what effect it will have on increasing interference, which is already bad enough. Experimental cars are equipped with combined transmitter-receivers—of low power, I suppose and hope—and the transmitter is connected to the normal horn button. Thus, instead of giving a blast on the horn to advise the driver of the car in front that you wish to overtake, you simply press the button and so transmit a wireless carrier wave, which is heard by the other driver through the medium of a small loud-speaker or pair of 'phones. Presumably a special wavelength is being used for the "wireless hooter," but nevertheless I should imagine that interference will still present a difficult problem. Not only will drivers hear "hoots" which are not given, but users of receivers connected to aerials near to the roadside will have their programmes punctuated with pips and squeaks.

The scheme is interesting technically, but it appears to me that it will be an expensive matter to fit a car with a "transceiver" and the necessary appurtenances. Besides, what is to happen in the case of cars already fitted with car-radio equipment? Interference must then be of paramount importance. I believe that it is suggested that this method of giving

"audible warning of approach" may become compulsory eventually. Much as I appreciate reasonable silence, I sincerely hope that legislation of this nature will not spread to old England.

Meddling with Music

IT is really surprising how it is possible to meddle with music, if I might use the term. In a modern receiver, if it is designed to take full advantage of the present system of transmission, a cut-off must be provided to avoid side-band splash and heterodyne whistles caused by stations overlapping. The result of this is to impair the musical reproduction due to loss of high notes, but in many commercial receivers arrangements are made to put back these high notes by means of resonant circuits on the L.F. side, and it seems to be a mystery to many how you can put back something which has been taken away in this manner. What actually happens, of course, is that after rectification the various musical harmonics are over-emphasised by the tone control arrangements, and these impart a brilliance to the reproduction, although, of course, the top notes which have been lost cannot be regained. Certain American receivers seem to be nothing else but a network of such cut-offs and resonant circuits, and it is really surprising what a fine balance of reproduction seems to be obtained. Naturally, however, for real quality nothing must be lost from the original transmission, and thus the full waveform must be retained.

Wireless Telephones?

LOTS of listeners are greedy. They want their receivers to pick up all the Regional programmes equally well when the Regional scheme is intended more or less for local service. Some years ago there was a

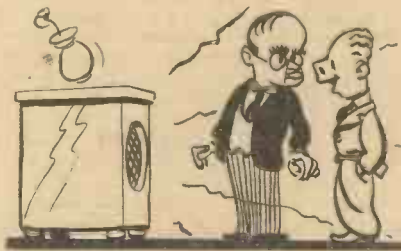

I know some people whom radio seems to have sent mad.

device called, I believe, the Electrophone which enabled telephone subscribers for a small annual sum to be able to listen-in to various theatre programmes. There are those who believe that the listener to-day is allowed far too much licence and that his efforts to receive all of the British and Continental programmes should be curtailed, and that the average listener has no right to go abroad for his entertainment. They envisage a time when the home radio installation will consist of a piece of apparatus like the automatic telephone, a

(Continued overleaf)

(Continued from previous page)

limited number of stations being available by turning a selector dial. Personally, I hope not. Radio is one of the few things which is not unnecessarily restricted. Let us have a little freedom left in this country. If you agree with me, signify your approval in the usual manner. If you disagree with me I know my readers well enough to feel certain that they will express their disapproval also in the usual manner.

Radio Plays

G. H. (Beckenham) writes: "I was pleased to note that you are keen on radio plays. You can be assured that your taste is not depraved, and obviously you have a quality set. I consider plays the best form of entertainment and most plays broadcast are first class; my only complaint being that one hour is too short.

I think you would be right in saying that the majority of the receivers of those friends of yours who dislike plays are inferior in speech. They probably like music because most music covers a multitude of errors in reproduction to the untrained ear. I also think, with certain exceptions, that the majority of the mass-produced sets of to-day are also inferior in speech reproduction.

On my own set, built for quality, every voice is perfectly distinguishable and a perfect delight to listen to. It is usually an eye (or ear?) opener to people who hear it.

So I say more plays and still more plays and longer ones and, if necessary, scrap Henry Hall and his atrocities and spend the money on plays!"

"Since it was a Crystal Set"

I WENT into a friend's elaborate wireless den. It was a wonderful place with a 10-watt "rack" amplifier for recording, short-wave set, and quality local receiver. He amused me by saying that he "had had the set since it was a crystal set." Which

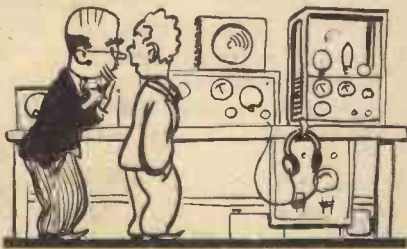

"I had it when it was a crystal set."

is perfectly true, because he started with a small crystal set, and with the aid of PRACTICAL AND AMATEUR WIRELESS, has added bits here and there until he has this wonderful station. That shows just one of the advantages of building your own set.

A Big Task

THE structural alterations to that section of the Alexandra Palace which is to be the B.B.C.'s television headquarters is proceeding apace, but it is proving a somewhat more difficult task than was anticipated originally. The Palace itself was opened in 1875 with the object of being a North London rival to the Crystal Palace, at Sydenham. During building operations problems arose in consequence of the slipping sub-soil and gravel of Muswell Hill and a similar situation has been faced by the B.B.C. architects. Undoubtedly, the most important engineering task is in connection with the erection of the ultra-short-wave aerial mast over one of the towers, as this is to be 300ft. high. Both the



Speaker Hum

A trouble often experienced with energised speakers is hum. If hum occurs after the grid circuit of the output valve has been short-circuited it can generally be traced to the speaker. High-priced instruments are fitted with hum-bucking coils, but these are seldom found on the cheaper type of speaker. It is not a difficult matter to add a hum-bucking coil, however; it should consist of the same number of turns as the speech coil, and should be wound around the field winding in series with the speech coil, with the turns wound in opposite direction to those of the latter. If an L.F. choke and a 4 mfd. condenser of suitable rating is available, the hum can be eliminated without adding a hum-bucking coil, by smoothing the energising current before it reaches the speaker field winding. This is done by connecting the choke between the field winding lead and the rectifier output lead, and then connecting the condenser between the junction of the choke and field winding and H.T.—This method applies in cases where the speaker field is being used as a smoothing choke.

L.F. Transformers

THE selectivity of a superhet is mainly governed by the number of intermediate frequency stages used and the degree of coupling between the primary and secondary windings of the transformers. During the past twelve months variable selectivity transformers have come into prominence. In this type of transformer one of the windings is movable so that the distance between the two windings may be varied to suit individual requirements. When the coupling is decreased beyond a certain point, however, the quality of reproduction invariably suffers, and therefore it is advisable to use fairly tight coupling if good quality is desired. Readers who possess receivers having fixed I.F. transformers can easily improve the degree of selectivity at the expense of sensitivity and quality by pushing the two windings farther apart, care being taken not to break the internal connecting wires when this is being done. Selectivity can also be greatly improved by adding an extra intermediate frequency stage, or even by adding an extra I.F. transformer only.

Quality Reproduction

IF realistic reproduction is desired, however, it is advisable to dispense with the intermediate frequency stage. This can be done by means of a change-over switch, wired in such a manner that the I.F. valve can be brought into use when distant station reception is desired. If this arrangement is used in a battery set, economy of L.T. may be effected by arranging a switch contact to break the filament circuit of the I.F. valve when the change-over is being made. This additional switch is not recommended in mains operated sets, however, as a rise in the heater voltage would occur if the heater circuit of the unwanted valve were broken, and therefore the remaining valves would be over-run.

foundations and lower part of the brickwork have had to be strengthened to bear the weight of the aerial array. This last-named is understood to be a number of dipoles arranged to give equal signal radiation in every direction over the radius encompassed by the service.

High Quality

THE columns of this paper have from time to time stressed the fact that on the ultra-short waves it is possible to secure very high quality sound owing to the absence of a narrow side band limitation. The point was confirmed a few days ago by Sir Noel Ashbridge in connection with the sound accompaniment of the high-definition television transmissions. Incidentally, it was also revealed that a new system of modulation is to be employed so that quite an interesting situation will arise when listeners tune in to these transmissions, and compare them with the quality now obtained on the medium and long waves.

Torment of Jazz

A NEW block of flats has as an added attraction wireless installed—no independent receivers are allowed. There is only one programme and no alternative, the idea being that if the man next door is listening to the same programme as you are, there is no interference or, at least, not

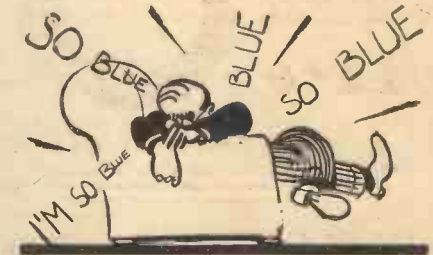

The torment of being forced to listen to jazz.

so much as if he were listening to a different programme. The walls must be pretty thin, and suppose you didn't want to listen and switched off the set, you would be forced to continue listening, as every other set in the block would be audible. I can imagine no worse fate than being forced to listen to jazz when you wanted a quiet snooze in your favourite arm-chair.

London Fifty Years Ago

THE B.B.C. will produce in the National programme on February 20th an interesting broadcast dealing with London life fifty years ago. So much is written of progress and happier times that Mr. Moray McLaren of the B.B.C. Talks Department conceived the idea of approaching Londoners in all walks of life who remember the "good old days" more than fifty years ago. The programme is very definitely biased in favour of the "good old days." There will be no attempt to introduce well-known people; rather, it is the idea to seize on anyone representative of a certain type which definitely preferred the London of fifty years ago. No names will appear in the programme, and there will be no announcements. Preceding each champion of Victorian London there will be music suited to the type of speaker.

A small piece of the curtain may be raised by revealing that a grand specimen of the late Victorian cab-driver has been discovered driving a taxi. One of his remarks will be that he much preferred the smell of the horses to the poisonous petrol fumes of the present day.

Selected and Specified for the
"PREFECT SHORT WAVE 3"

Ericsson

SUPER SENSITIVE TELEPHONES

No wonder the designer of the "Prefect Short Wave 3" features Ericsson Telephones as indispensable.

They are simply perfect for the 100 per cent. functioning of this fine set.

Wonderfully sensitive, comfortable in wear, and very pure in tone, they have come to be regarded as standard for the keen short-wave enthusiast's equipment. Hook them up to your "Prefect Short Wave 3."



Three resistances —one price 120, 2,000 and 4,000 ohms.

12'6

At all good radio dealers. If you have any difficulty in procuring, write direct to:—

ERICSSON TELEPHONES, LTD.

67-73, Kingsway, London, W.C.2, Eng. Telephones: 3271/13 Holborn.

Building with the BEST to get the BEST results



A four-million-pound plant to convert coal into oil! . . . that is the great undertaking that is changing Bilton, a north-country village, into a thriving industrial centre. No room for make-shift measures here. Results depend on having the best — the best of brains, the best of workmanship and the best of materials. There is a moral here for set constructors. Building with the best must bring you the best results. So make T.M.C.-HYDRA Condensers the foundations of your new set. Their extra reliability, accuracy and uniformity are indispensable.

THE FOUNDATIONS OF A GOOD SET ARE—

T.M.C. HYDRA CONDENSERS
MADE IN ENGLAND



Write for Catalogue

T.M.C.-HARWELL (SALES) LTD
Britannia House, 233 Shaftesbury Ave., London, W.C.2
(A few doors from New Oxford Street)
Telephone: Temple Bar 0055 (3 lines)

Made by TELEPHONE MANUFACTURING Co.Ltd.

by
F. J. CAMM

EVERYMAN'S WIRELESS BOOK

A Radio Consultant for the Listener, Expert and Amateur Constructor explaining the Operation, Upkeep and Overhaul of all Types of Wireless Receivers, with Special Chapters on the Principles of Radio Telephony, Installation, and Systematic Fault-finding.

With 200 Illustrations and Diagrams.

Only 3/6 net

From All Booksellers.

NEWNES

F. J. Camm's Monitor 3

MORE ABOUT THIS SPECIAL RECEIVER

EASY TO BUILD—

By F. J. CAMM

—AND GUARANTEED!

THIS week I give a Point-to-Point Wiring Diagram of the Monitor Three, a full-size Blueprint for which was given last week. I give this Point-to-Point Diagram so that the beginner can adopt some orderly sequence in the construction. This is far preferable to starting anywhere in the set.

The Monitor will, when connected up to its batteries, burst into song if I may use the phrase. If it does not, may I remind you of my promise of last week to test and adjust it for you. There is just one point which I should like to make clear about this. I have unfortunately found that dishonest wireless dealers are sending their customers' receivers in to me for free service, but are passing along a charge to the reader. I wish to advise the reader to deal with me direct, and I hope that such dealers will take this straight tip that I must refuse to service receivers received from them. My guarantee applies only to readers, and I have my own methods of ascertaining whether the application for my service is *bona fide*, even though an innocuous looking letter arrives on ordinary notepaper!

One or two readers have raised the point as to whether the Monitor will work on an indoor aerial. Most of these letters come from beginners, and the Monitor is their first receiver. They tell me that another set is already installed in their homes, and that they wish to operate the Monitor from their bedroom or their den. Naturally their parents object to the erection of a second aerial, and for some unearthly reason object to two sets being operated from one aerial. Fortunately there are excellent tape aerials, such as Pix, on the market on which the Monitor will give excellent results. I have personally tried the Monitor on a Pix aerial, both on the ground floor and on the first floor, and find that it yields uniformly excellent results. I can thoroughly recommend it. Many other readers desire to know whether they can use a Milnes H.T. unit. Here again the reply is in the

affirmative. I can only speak in terms of praise of this excellent source of H.T. supply. You will find it most economical in use and silent.

My post indicates that many hundreds of readers have already decided to build the Monitor. School teachers have decided to let their pupils build it during Handcraft classes, and many parents have decided to make their mechanically-minded children a present of a kit of parts. Next week I shall show how the design may be carried a

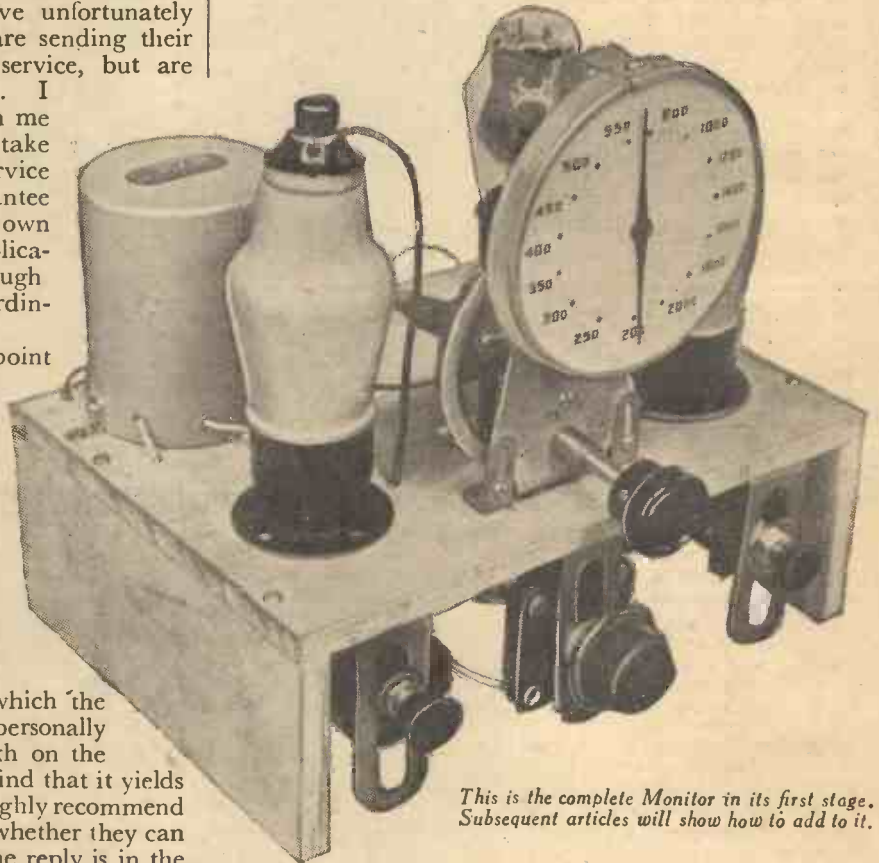

This is the complete Monitor in its first stage. Subsequent articles will show how to add to it.

LIST OF COMPONENTS

One coil (B.T.S.).
 One .0005-mfd. Compax condenser (Polar).
 One airplane drive (J.B.).
 One .00015 mfd. differential reaction condenser (Polar).
 Four fixed condensers : .5 mfd., .1 mfd., .002 mfd., .0003 mfd. (T.M.C.).
 Two fixed resistances : 40,000 ohms, 1 megohm (Dubilier).
 One H.F. choke, type HF9 (Bulgin).
 One Senator L.F. transformer (Bulgin).
 One three-point switch, S36 (Bulgin).
 One two-point switch, S22 (Bulgin).
 Three socket strips : A/E, L/S, P/U (Belling-Lee).

Three valve-holders : two 4-pin, one 5-pin (Glix).
 Four component brackets (Peto-Scott).
 Six plugs : H.T.—, H.T.1, H.T.2, G.B.+, G.B.—1, G.B.—2 (Belling-Lee).
 Two spades : L.T.—, L.T.+ (Belling-Lee).
 One metallised chassis, 8in. by 6in. by 2½in. (Peto-Scott).
 Three valves : 210VPT, 210Det., 220HPT (Cossor).
 120-volt H.T. battery.
 9-volt G.B. battery.
 2-volt accumulator (Exide).
 One "Pix" Indoor Aerial.
 Speaker, Stentorian, Model 36/S (W.B.).

step farther, and I shall include a Service Data Sheet showing how the beginner may measure up the various voltages, resistances, and currents, and thus to check over the circuit to ensure that it operates as I intend that it shall be operated.

Economy

The reaction control is the most important part of a receiver of this nature, and thus it is essential that it shall operate in a smooth and easy manner. By far the greatest factor in the operation of this control is the value of the high tension which is applied to the screen of the S.G. valve, or, in other words, the voltage at H.T.+1. I suggest that you insert this plug into the socket on the battery marked 36 volts, for a start, and should you find that with the characteristics of your particular valve the control is not ideal, move the plug above and below this point in order to select the most suitable voltage. Remem-

ber, however, that by using a lower voltage the total current consumption will be decreased and an economy may thus be effected. But as with all simple receivers the earth connection is of very great importance, and therefore some tests should be made in order to find the most suitable arrangement in each individual listener's case.

POINT-TO-POINT WIRING DIAGRAM OF F. J. CAMM'S MONITOR

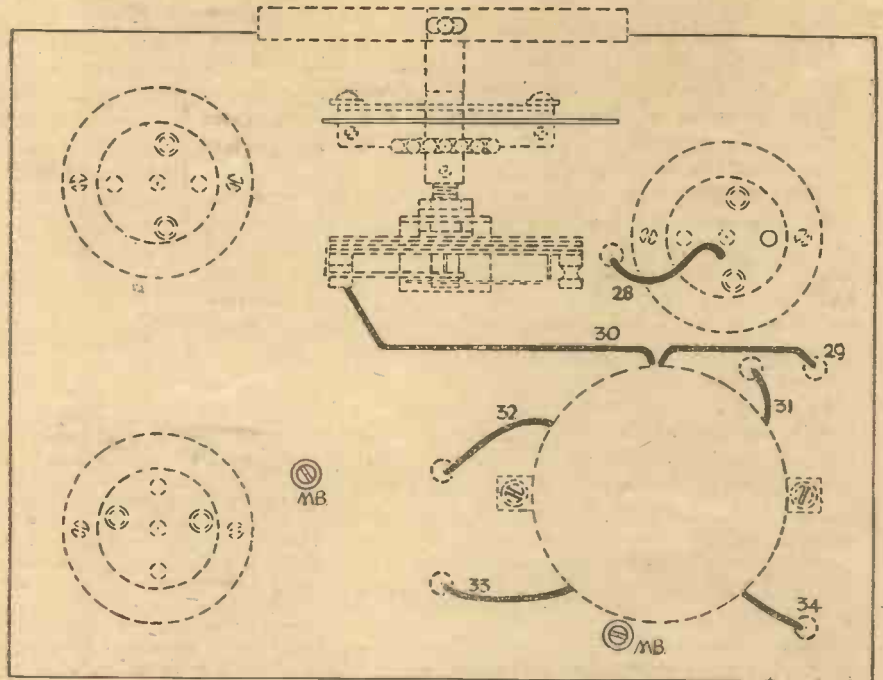

- No. 1.—Filament+ of V1 to filament+ of V2.
- No. 2.—Filament+ of V2 to filament+ of V3.
- No. 3.—Filament- of V1 to filament- of V3.
- No. 4.—Filament- of V2 to filament- of V3.
- No. 5.—H.F. choke to C4.
- No. 6.—H.F. choke to moving vanes of reaction condenser.
- No. 7.—C4 to grid leak R1.
- No. 8.—Grid leak to filament+ of V2.
- No. 9.—Grid leak to grid of V2.
- No. 10.—Grid of V2 to P.U. socket.
- No. 11.—Plate of V2 to C6.
- No. 12.—Plate of V2 to R2.
- No. 13.—Plate of V2 to C5.
- No. 14.—C5 to Con. of L.F. transformer.
- No. 15.—C6 to E of L.F. transformer.
- No. 16.—E of L.F. transformer to M.B. bolt.
- No. 17.—G of L.F. transformer to grid of V3.
- No. 18.—R2 to centre socket of V3.
- No. 19.—Centre socket of V3 to L.S. socket.
- No. 20.—Plate socket of V3 to L.S. socket.
- No. 21.—L.S. socket to H.F. choke.
- No. 22.—M.B. bolt to filament- of V3.
- No. 23.—Filament- of V1 to wave-change switch.
- No. 24.—Screening grid socket of V1 to C3.
- No. 25.—C3 to E socket.
- No. 26.—E socket to M.B. bolt.
- No. 27.—Filament- of V2 to on-off switch.
- No. 28.—H.F. choke to cap of V1.
- No. 29.—Grid of V1 to white lead of coil.
- No. 30.—Fixed vanes of tuning condenser to white lead of coil.
- No. 31.—Yellow lead of coil to wave-change switch.
- No. 32.—Brown lead of coil to fixed vanes of reaction condenser.
- No. 33.—Blue lead of coil to wave-change switch.
- No. 34.—Black lead of coil to A socket.
- No. 35.—H.T.2 lead to L.S. socket.
- No. 36.—G.B.—1 lead to P.U. socket.
- No. 37.—L.T.— lead to on-off switch.
- No. 38.—L.T.+ lead to filament+ of V3.
- No. 39.—H.T.— lead to E of L.F. transformer.
- No. 40.—G.B.—2 lead to G.B. of L.F. transformer.
- No. 41.—H.T.1 lead to screening grid of V1.
- No. 42.—G.B.+ lead to M.B. bolt.

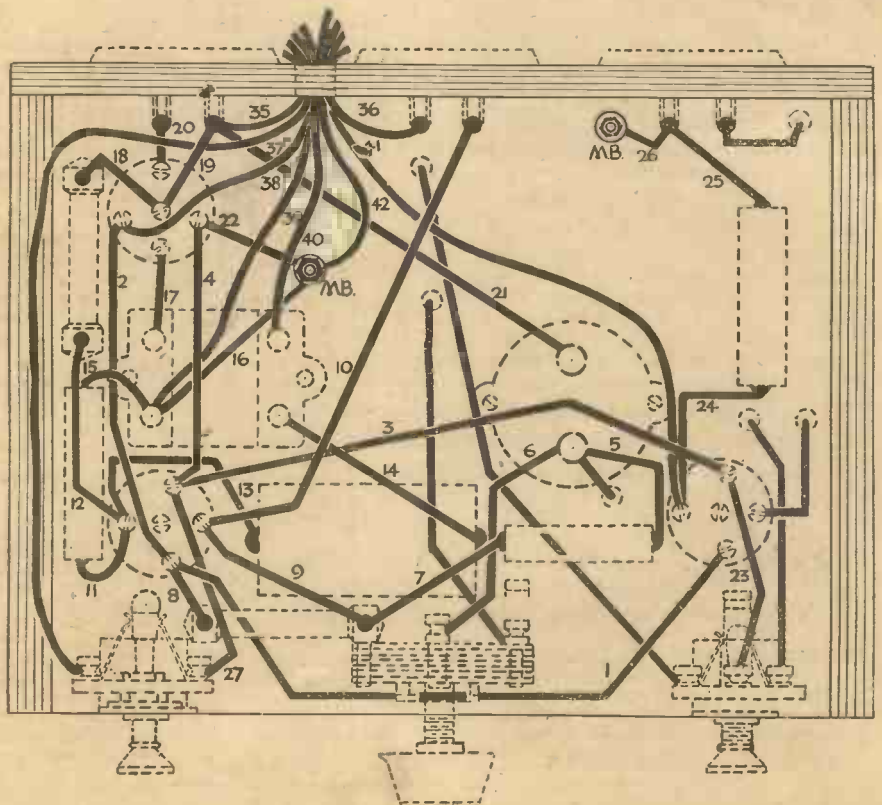

A Blueprint of this Receiver was Given Free with Last Week's Issue.

OPERATING NOTES

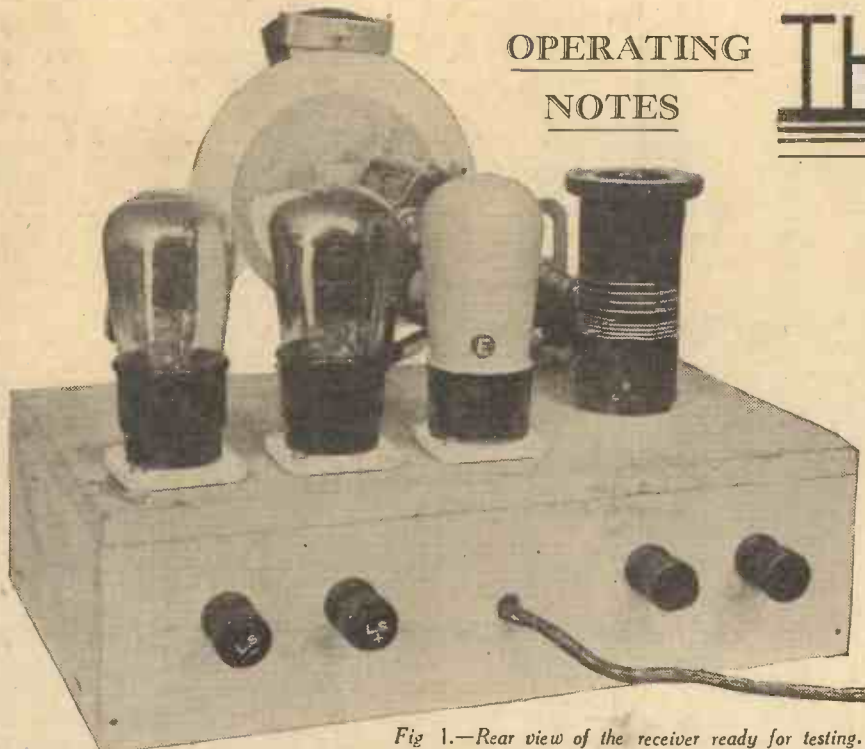

Fig. 1.—Rear view of the receiver ready for testing.

AN aerial must be joined to the aerial terminal, and it is here that probably the greatest difficulty will be encountered. If this is your first receiver, and there is no aerial erected at your house, you must erect a wire to serve the purpose, whilst if you already have an aerial which is used for normal broadcast reception, you will find that for certain wavelengths this will probably be quite suitable. In general it may be taken that the aerial should not be unduly large, and if the standard horizontal wire arrangement is employed, a total length of 30ft. will be sufficient.

The most efficient arrangement, however, will consist of a vertical wire (preferably 18 or 20 gauge copper) held about 18in. from the walls of the house. It is possible to obtain special supports to facilitate the erection of this type of aerial, and one of the principal features of this vertical arrangement is that it is non-directional. With the horizontal wire it will be found that signals from one direction may be heard at greater strength than those from another direction, and this is due to the fact that the electrical impulses travelling through the atmosphere are more easily picked up when they strike the length of the wire at a certain angle, depending on the arrangement of the wire. Consequently, by erecting the aerial in a vertical position, signals from all directions are more or less equally received, and many

of the difficulties of station location are eliminated. The earth, too, must be efficient, and a good buried plate should be employed. Having connected the aerial and earth leads, a pair of headphones or a loudspeaker should be joined to the L.S. terminals, and if this is your first attempt at short-wave reception you will no doubt find it preferable to use the headphones for a start in order to hear very weak signals and thus obtain some idea of the sharpness of tuning which is to be expected on a short-wave set.

Tuning-in the Signals

Before commencing to locate signals it is necessary to remember that on certain of the short wavebands the effects of light and darkness play a great part in the distance over which a signal will travel, and thus the listening times must be chosen according to the stations which it is desired to hear. The coil which is specified in the list of components covers the waveband from 24 to 52 metres, and this is of the greatest use during the hours of darkness when the majority of listeners are able to devote their leisure hours to listening. Signals on this band may be obtained right up to the dawn, and the number of stations which may be heard will prove greater than on the normal broadcast band. In most parts of England it will be found possible to tune

The Prefect

Testing the Receiver and Some In- to be Heard

in one of the Empire transmissions from Dayentry, as well as one of the Zeesen radiations. These two stations transmit special programmes to the Colonies and utilise a number of different wavelengths at different hours according to the particular colony for which the transmission is intended. The English transmissions are generally referred to as "No. 3 transmission" or "No. 1 transmission," etc., and careful note should be made of the call

THEORETICAL

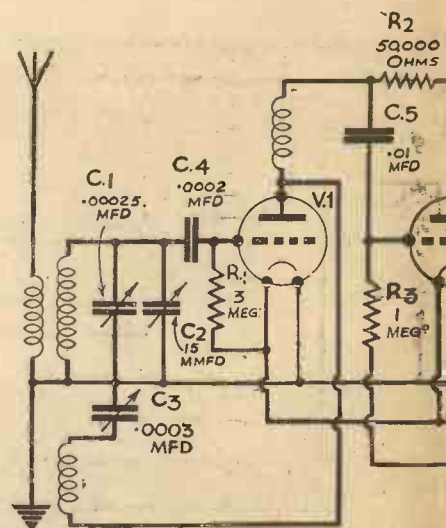

Fig. 2.—The simple arrangement

letters, which are clearly announced as "G.S.F.—F for fading," or "G.S.G.—G for greeting," and so on. Similarly the Zeesen transmissions use the call letters DJ, followed by a further letter according to the particular wavelength. Thus you will find DJB, DJQ, DJN, and so on. Some of the more regularly-received trans-

LIST OF COMPONENTS FOR THE "PREFECT" BAND-SPREAD S.W. THREE

One 6-pin S.W. coil, type S.P.C. (B.T.S.).
One .00025 popular log tuning condenser, type 1040 (J.B.).
One dual-ratio S.M. drive, type 2092 (J.B.).
One 15 mmfd. band-spread condenser, type 2140 (J.B.).
One .0003 mfd. Dilecon reaction condenser (J.B.).
One Niclet L.F. transformer (ratio 1 : 5), type D.P.22 (Varley).
Three 4-pin valve-holders, type U.H./4 (B.T.S.).
One 6-pin S.W. coil base, type S.P.B. (B.T.S.).
Two fixed condensers (.0002 mfd. and .01 mfd.), type 300 (T.C.C.).

Three 1-watt resistances (50,000 ohms, 1 megohm and 3 megohms) (Dubilier).
One S.W. choke, type H.F.3 (Wearite).
One 60 m/A Microfuse and holder (Microfuse).
Four type R terminals (Aerial, Earth and L.S.+ and L.S.—) (Belling Lee).
One 5-way battery cord (30in.) (Belling Lee).
Three "Bow-spring" wander plugs (G.B.+ , G.B.—1 and G.B.—2) (Belling Lee).
One pair G.B. battery clips, type No. 5 (Bulgin).
One Junior on/off switch, type S.38 (Bulgin).
Three component-mounting brackets (Peto-Scott).

One Metaplex chassis (10in. x 6½in.) with 2½in. runners (Peto-Scott).
Three valves (D210, L210, and P215) Hivac.

ACCESSORIES

One 120-volt H.T. battery.
One 9-volt G.B. battery.
One 2-volt L.T. accumulator.
One W.B. Stentorian 36/1 loud-speaker and pair of headphones.
One cabinet.

Practical 3

Interesting Details of Stations Likely on this Set

missions are given in the table included in this article, and once these have been received, a note should be made of the actual setting of the main tuning condenser and the band-spread dial in order that they may be located in future, and a calibration chart may be drawn up.

To commence with the tuning-in operation, therefore, choose a time about 10 o'clock at night, with the specified coil, and when the set has been switched on, turn the

Wiring Circuit

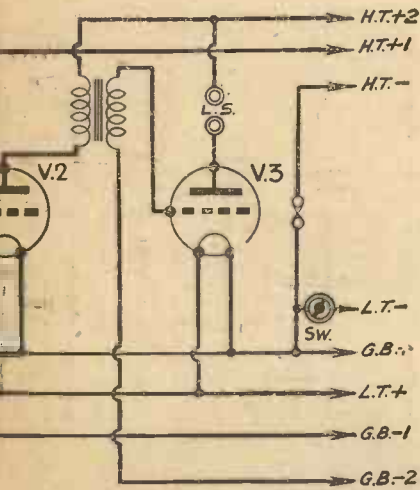

which is employed in the Prefect 3.

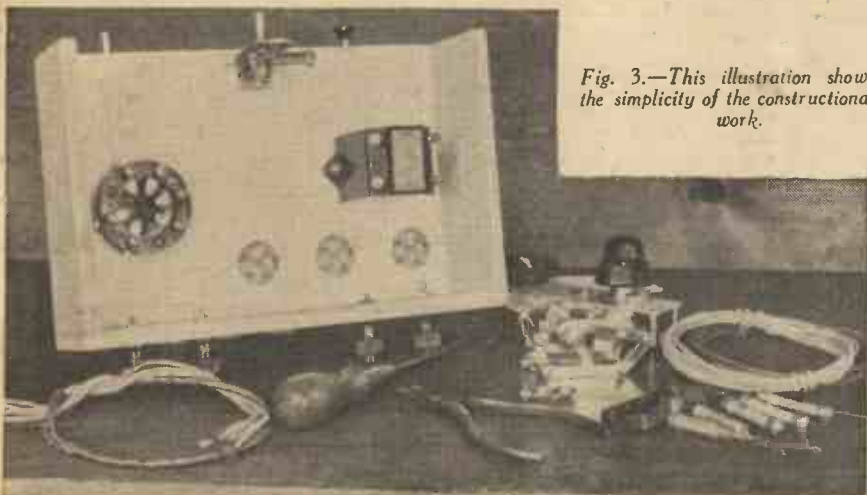

Fig. 3.—This illustration shows the simplicity of the constructional work.

central control knob so that the number 10 on the dial is in the centre of the escutcheon window, and then hold the lower control knob (reaction) with the right hand, and the left-hand control (the band-spread condenser) with the left hand. Carefully turn the right-hand knob until the set goes into oscillation, as will be shown by a sudden "plop" in the speaker, and then turn it back slowly until the "plop" occurs again, but this time much fainter. The receiver is then in its most sensitive

condition, and the left-hand control should be turned slowly from minimum to maximum, or, in other words, from the position where the single vane is "all out," until it is entirely enmeshed between the two fixed vanes. There is no stop in either position, and therefore the control knob should be marked in some way so that it may be identified. One of the special Eddystone small dials (type 1027), costing 1s. 3d., will no doubt be found by many listeners to be a valuable addition to this particular condenser, although the ordinary type of knob will answer quite satisfactorily if an indicating mark is made on it. This may be done by the constructor by simply drilling a one-sixteenth hole near the edge of the knob and filling this with Chinese white, and scribing a short line on the panel or cabinet front and filling this similarly.

Critical Settings

As the band-spread condenser is turned it will be found that stations will be tuned in and out almost as broadly as with a standard broadcast condenser, although in many cases, even in spite of the smallness of this condenser, the stations will be heard only over an extremely small distance of the dial. When the condenser has been moved throughout its entire capacity, the main tuning control should be turned over a degree or so, and the band-spread condenser again turned through its capacity. In this way the entire range of the main condenser is split up into a number of separate sections, and this greatly simplifies the tuning operation. The whole time the reaction condenser must be kept just short of the oscillation point, and it will be found that when advanced too far a whistle will be heard instead of any speech or music,

and the reaction condenser must then be slackened off until speech is resolved. For the reception of continuous wave morse signals, of course, the reaction must be set so that the signal is heterodyned, and the note of transmission may then be adjusted to provide the clearest readable signal.

Experiment with the earth connection—and remember that in some cases it may be found that better results are obtained on some wavelengths without an earth—although in general this will indicate that the earth is inefficient, or that undue capacity is existing between the aerial lead and some earthed body.

Important Short-wave Transmissions

The following short-wave transmissions should be received on most evenings under

IMPORTANT STATIONS WHICH MAY BE HEARD ON THE 24-50 METRE WAVEBAND

WAVE-LENGTH (metres)	STATION	CALL SIGN
24.83	Lisbon (Portugal)	CTICT
25.0	Moscow (U.S.S.R.). (Relays No. 2 Station)	RW59
25.23	Paris, Radio - Coloniale (France)	FYA
25.27	Pittsburg (U.S.A.). (Relays KDKA)	W8XK
25.29	Empire Broadcasting	GSE
25.42	Rome (Italy)	2RO
25.45	Boston, Mass. (U.S.A.)	W1XAL
25.49	Zeesen (Germany)	DJD
25.53	Empire Broadcasting	GSD
25.57	Eindhoven (Holland)	PHI
25.6	Paris, Radio - Coloniale (France), (Colonial Station E-W)	FYA
30.43	Madrid (Spain)	EAQ
31.13	Rome (Italy)	2RO
31.28	Sydney (Australia)	VK2ME
31.28	Philadelphia, Pa. (U.S.A.). (Relays WCAU)	W3XAU
31.36	Bombay (India)	VUB
31.38	Zeesen (Germany)	DJA
31.45	Zeesen (Germany)	DJN
31.48	Schenectady, N.Y. (U.S.A.) (Relays WGY)	W2XAF
31.54	Melbourne (Australia)	VK3ME
31.55	Empire Broadcasting	GSB
31.58	Rio de Janeiro (Brazil)	PRF5
32.88	Budapest (Hungary)	HAT4
38.48	Radio Nations, Frangins (Switzerland)	HBP
48.86	Pittsburg, Pa. (U.S.A.)	W8XK
49.1	Empire Broadcasting	GSL
49.18	Chicago, Ill. (U.S.A.)	W9XF
49.2	Johannesburg (S. Africa)	ZTJ
49.3	Rome (Italy)	2RO
49.42	Vienna Experimental	OER2
49.5	Philadelphia, Pa. (U.S.A.) (Relays WCAU)	W3XAU
49.59	Empire Broadcasting	GSA
49.83	Zeesen (Germany)	DJC
50.0	Moscow (U.S.S.R.). (Relays No. 1 Station)	RW59

normal conditions on the Prefect, and will serve as indicating settings for the various wavelengths and thus enable other stations to be located according to their actual wavelength. The times of transmission vary in each case.

THE WIRELESS CONSTRUCTORS' ENCYCLOPAEDIA

By F. J. CAMM (Editor of "Practical and Amateur Wireless") 4th Edition 5/- net.
Wireless Construction, Terms, and Definitions explained and illustrated in concise, clear language.
From all Booksellers, or by post 5/6 from George Newnes, Ltd., 8-11, Southampton Street, Strand, London, W.C.2.

The GRAHAM FARISH DISCOVERY 3

Full Details and Test Report of the New Short-wave Receiver Designed in the Graham Farish Laboratories

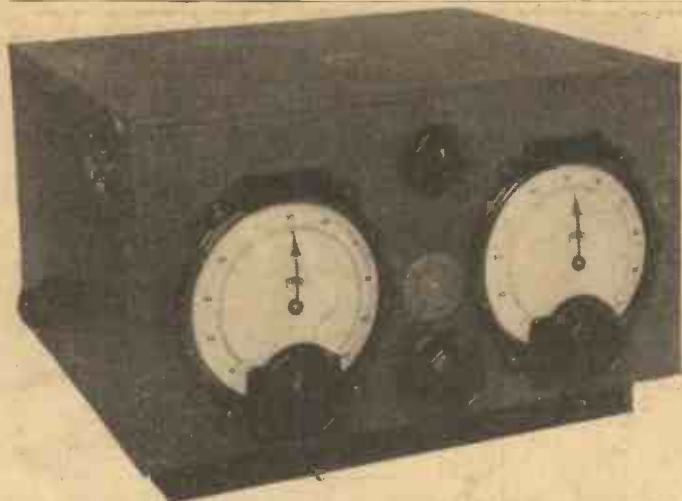

This illustration shows the attractive cabinet which is supplied for the Discovery Three.

IT is a very interesting hobby to study the various types of short-wave receiver which are produced by the amateur as well as by the various commercial houses which supply both complete receivers and component parts. Some of the interesting schemes which are introduced for the elimination of the losses which are so serious on short waves range from the cutting away of insulating material with drills and saws in order to increase the leakage path, to the adoption of specially-compounded material designed to have a very high insulation factor. In addition to the difficulties involved in the elimination of losses in the components and circuit design, however, there still remains the valves which have to be employed, and with many at present on the market little can be done in the way of improvement here. Thus, many steps taken by an amateur may even be rendered null and void when the necessary valve is plugged into its holder.

The "Ring" Valve

In the Graham Farish "Discovery" we find that in addition to the adoption of all the more usual expedients, such as the elimination of poor dielectric material and the inclusion of the special low-loss insulation for coil formers, etc., the makers have introduced also a special valve manufactured by themselves especially for the specific purpose of avoiding losses in the standard type of a short-wave receiver.

Thus, we find that the circuit employed in this new receiver consists of what is generally referred to as an "S.G. Three," that is, a screen grid H.F. stage, followed by a detector and L.F. stage. This circuit is built up on a baseboard with a vertical screen to separate the H.F. and detector stages, and the valve employed in the H.F. stage is placed in such a position that the grid is in one section and the anode is in the other, together with the tuning condenser and coils for each section occupying their respective places. This particular method of construction is only rendered possible by the fact that the valve is made upon unorthodox lines, and instead of the anode being taken to the terminal on top of the valve, the grid is joined to this terminal, whilst the anode is joined to the usual anode pin on the four-pin base. The latter is manufactured from special insulating material known as Frequentite, and this is the material which is also employed for the coils, coil bases, and the valve-holder for the H.F. valve.

The Tuning Circuits

The tuning circuits are of the H.F. transformer type, whilst septate formers

enable wave-changing to be carried out. The tuning condensers have been designed especially for use on the short waves and a die-cast assembly with the special insulating material for a supporting plate renders losses practically negligible in these circuits.

Coupling between the detector and output valve is by means of one of the Graham-Farish "Max" transformer, and a special output circuit is employed to enable headphones to be employed. To improve reproduction, and to eliminate certain faults generally experienced when headphones are worn with a receiver of this type, a special by-pass is included in the output anode circuit.

A complete kit for this receiver may be obtained from the makers for 72s. 6d., and with valves the cost is £5.

Test Report

A complete kit was tested under the normal test conditions and the receiver

gave a very good account of itself. The H.F. stage was certainly found to pull its weight, and it enabled smooth reaction to be obtained throughout the entire scale due to the removal of aerial damping which so often causes trouble when a detector stage is coupled direct to the aerial. Throughout the tests the reaction was found perfectly controllable and acted exactly as in a normal broadcast receiver.

The actual aerial which is used played only a small part in the results obtained, but it was certainly found that it had less effect than is usual with a short-wave receiver. A vertical arrangement did, however, prove of most use, principally on account of its non-directional effects and because it could be well supported clear of the wall and thus reduce the aerial-earth capacity. On the 21 to 50-metre band results were most profuse, and in addition to many broadcast programmes, commercial and amateur transmissions were picked up. On the shorter waves from 12 to 25 metres it was possible to hear the Pittsburg transmission almost whenever it was required and the only difficulty—if such it can be called—is to remember when these transmissions may be heard. In this connection it must be remembered that during certain hours it is almost-impossible to hear certain transmissions due to the effects of the sun, and thus listening times must be carefully chosen according to the wavelength which is required.

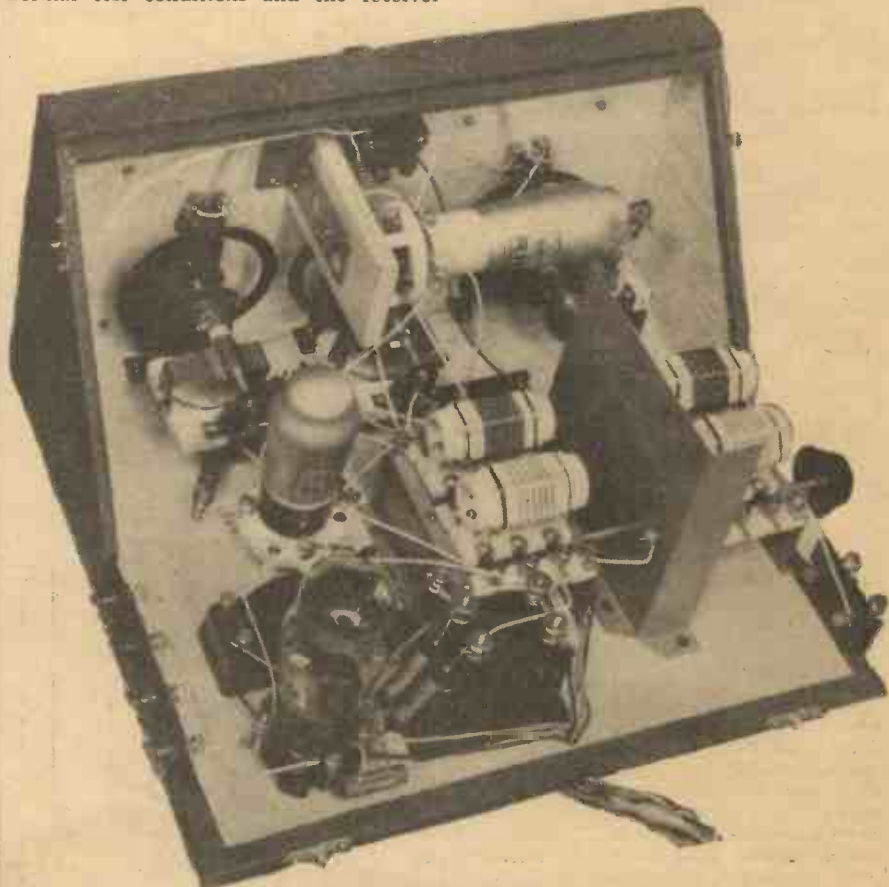

The neat arrangement of the parts, and the simple wiring of the receiver are shown here.

ARE COMMERCIAL SETS HOTTED UP TOO MUCH?

(Continued from page 692)

standard of overall efficiency in the set he builds. That efficiency will not materially alter if and when, for any reason, he finds it necessary to make replacements.

"Practical and Amateur Wireless" Sets

It is, of course, on this basis that the PRACTICAL AND AMATEUR WIRELESS sets are designed and published, and that the above arguments are substantiated is proved by the fact that performance guarantees can be given for these designs.

The implication of this state of affairs would seem to be that the home-built set, constructed of standard parts obtained from stock, and adjusted to the best of the builder's ability, should be an efficient and reliable apparatus which, moreover, will give consistent performance throughout its life even though all renewable parts are replaced as and when necessary from the ordinary retailer's stock. On the other hand, there is always a possibility that the commercial set, although giving perhaps a more spectacular performance when new, will begin to fall off in efficiency after a few months because it has been "tuned up," so to speak, to the last hair's breadth, and that, at any rate when new valves are fitted, the overall efficiency is not likely to exceed greatly, if at all, that of the more conservatively-rated home-built counterpart.

THE ALL-IMPORTANT AERIAL

(Continued from page 696)

walls, a stand-off insulator should be employed.

To carry the wire into the house a special insulated tube should be employed, and under all these conditions the aerial may be relied upon to give perfect reception.

Precautions

It must be remembered, however, that a 50ft. aerial suspended 30ft. above the ground and used with, say, a five- or six-valve set

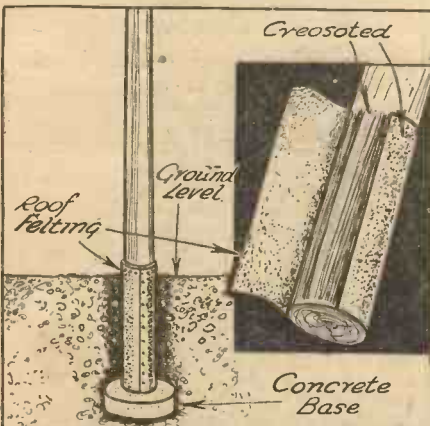

Fig. 5.—One method of preventing mast breakage due to damp.

two or three miles from a main B.B.C. station will cause great difficulty in regard to the elimination of such a station. Thus, it is necessary to bear in mind the receiver with which the aerial is going to be employed, and it may be found in such cases that a vertical wire, held away from the walls, and fitted at the upper end with a capacity pick-up (such as one of the commercial devices now readily obtainable) will prove better than the usual or orthodox aerial on account of the fact that it is non-directional.

PETO-SCOTT **EVERYTHING RADIO—CASH C.O.D. or EASY TERMS**

IMMEDIATE DELIVERY

Of all makes of Speakers, Eliminators, Kits, Pick-Ups, Testing Meters, Receivers, for CASH, C.O.D., or H.P. PILOT AUTHOR KITS are only obtainable direct from Peto-Scott. We can supply any Kit featured in this Journal during the past 3 years.

13 to 52 METRES on your PRESENT SET for 37'6

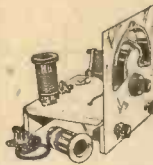

THIS AMAZING SHORT WAVE ADAPTOR will make your set an all-wave set, bringing you programmes from every corner of the world. Wonderfully efficient and inexpensive. Here is the latest up-to-the-minute design of the foremost short-wave experts. Simply plugs into almost any A.C. or battery receiver there's nothing more to do! Incorporates 100 : 1 ratio aerial tuning and slow-motion reaction. Ready assembled on aluminum chassis (as illustrated) and 2 coils, covering 13-26 and 24-52 metres. Cash or C.O.D. Carriage Paid. **37/6** Or 5/- down and 7 monthly payments of 5/-. Extra coils 46-96 and 90-190 metres 4/6 each.

5/- DOWN

Peto-Scott 5-VALVE BATTERY SHORT-WAVE SUPERHET KIT

12 to 80 METRES

SEND FOR FREE BLUEPRINT and FULL DETAILS



VITAL FEATURES

- NO COIL CHANGING
- TRIPLE WAVELENGTH COILS
- PENTODE OUTPUT
- SPECIAL NOISE-FREE OSCILLATOR MIXING CIRCUIT
- STAMPED METAL CHASSIS
- 5 B.V.A. VALVES
- WITH SIMPLE-TO-BUILD "INSTRUCTIONS"

KIT "A" £4:10:0

Cash or C.O.D. Carr. Pd. Or 7/6 deposit and 11 monthly payments of 8/3. All parts for building, less valves and cabinet. KIT "B." As for Kit "A." but with valves, less cabinet. Cash or C.O.D. Carriage Paid, 27/1/6, or 12 monthly payments of 13/-. KIT "C." As for Kit "A." but including set of 3 specified valves, less Speaker, Head-phones and Cabinet. Cash or C.O.D. Carriage Paid, 23/7/6, or 10/- deposit and 7 monthly payments of 9/3.

B.T.S. SHORT WAVE COMPONENTS



SHORT-WAVE COILS
4-pin, No. 1, 13-26, No. 2, 21-52 metres, 4/- ea. No. 3, 46-96, No. 4, 90-190 metres, 4/6 ea. 6-pin, Type SPA, 13-26, 31/C, 24-52 metres, 4/6 ea. 8/PD, 46-96 metres, 5/- ea.



INTERMEDIATE FREQUENCY UNIT
For high definition television reception (sound) on superhet receivers. Type U1F/12. 9/6 ea.



TRIMMING CONDENSER
Rigidly constructed ensuring complete absence of crackle. Type UTC. 2/9 ea.



OSCILLATOR COIL and HOLDER.
Mounted on low-loss former. Metal parts silver plated. Complete with base. Type VO 4/3 ea.

● Send 3d. in stamps for the new B.T.S. Magazine, "The Short Wave Constructor," containing diagrams and instructions for 3 new S.W. circuits, and complete lists of B.T.S. Short and Ultra-Short Wave Components. Component orders over 30/- available on Easy Terms.

W. B. STENTORIAN SENIOR

Model 368 P.M. Speaker. Suitable for any output and incorporating improved Microdole device. Cash or C.O.D. Carriage Paid, 22/2/0, or 2/6 down, balance in 11 monthly payments of 4/-. W.B. Stentorian Junior Model 363, Cash or C.O.D. Carr. Paid, 11/12/6, or 2/6 down and 11 monthly payments of 3/-. Any Other Speaker on Easy Terms. Send for Lists.

2/6 DOWN



B.T.H. PIEZOELECTRIC POWER PICK-UP. Cash or C.O.D. Carriage Paid, 22/2/0. Balance in 11 monthly payments of 4/-. **2/6 only**

PILOT AUTHOR KITS

Any item supplied separately. Orders over 10/- sent C.O.D.—carriage and post free.

MONITOR 3 KIT "A" CASH or C.O.D. £2:5:0

Author's Kit of First Specified parts, including Ready Drilled Metaplex Chassis, less Valves, Cabinet and Speaker.

7/6 DOWN

Balance in 6 monthly payments of 7/-.

KIT "B" As for Kit "A," but including set of 3 specified valves, less Speaker and Cabinet. Cash or C.O.D. Carriage Paid 23/12/6. Or 10/- deposit and 10 monthly payments of 7/6.

Set of 3 Cossor Valves, as specified	12 6
J.B. Airplane Drive	5 9
1 Ready Drilled Metaplex Chassis	2 9
B.T.S. Monitor Coil as specified	5 0

C.O.D. PARCEL

Comprising ● B.T.S. Monitor Coil. ● Polar Compax Condenser. ● J.B. Airplane drive. ● Peto-Scott Ready Drilled Metaplex Chassis, 4 Component Brackets, all necessary connecting wire, wood, screws and flex. **18/6 CASH OR C.O.D. CARRIAGE PAID.**

PREFECT SHORT-WAVE 3 KIT "A" CASH or C.O.D. £2:15:0

Author's Kit of First Specified parts, including Ready-drilled Metaplex Chassis, less Valves, Cabinet, Speaker, and Head-phones.

7/6 DOWN

Balance in 7 monthly payments of 7/9.

"KIT B" As for Kit "A," but including set of 3 specified valves, less Speaker, Head-phones and Cabinet. Cash or C.O.D. Carriage Paid, 23/7/6, or 10/- deposit and 7 monthly payments of 9/3. **"KIT C"** As for Kit "A," but including valves and Peto-Scott Walnut finished Cabinet, less speaker and head-phones. Cash or C.O.D. Carriage Paid, 24/0/9, or 12/6 deposit and 7 monthly payments of 12/-.

Set of 3 Hivac Valves, as specified	12 3
1 B.T.S. 6-pin Short-Wave Coil and base	6 6
1 J.B. Dual Ratio Drive	6 6
1 J.B. 15 mmfd. Bandspread Condenser	3 9
1 Ready Drilled Metaplex Chassis	3 0
3 B.T.S. Short-wave Valveholders	3 0

C.O.D. PARCEL

Comprising ● B.T.S. 6-pin Short-Wave Coil and Base. ● J.B. 15 mmfd. Bandspread condenser ● 3 B.T.S. Short-Wave valveholders. ● Wearite Short-Wave H.F. Choke. ● Peto-Scott Ready-drilled Metaplex Chassis. ● 3 component brackets and all necessary connecting wire, wood screws and flex. **22/6 CASH OR C.O.D. CARRIAGE PAID.**

£4 SUPERHET 4 BATTERY VERSION

KIT "A" CASH OR C.O.D. £4/4/0
Author's Kit of first specified parts, including ready-drilled Metaplex Chassis, less valves, cabinet and speaker. **7/6 SEND**

Balance in 11 monthly payments of 7/9. ONLY 1 set of 4 first specified valves, 22/11/0 or 0 monthly payments of 9/3.

POST THIS COUPON NOW

PETO-SCOTT CO. LTD., 77 Pr.W. 14, City Road, London, E.C.1. Tel.: Clerkenwell 9406/7.

Please send me CASH/C.O.D./H.P. _____

NAME _____

ADDRESS _____

Pr.W.14

I am interested in _____
Please send me Full Particulars without obligation.



FROM STUDIO TO LISTENER—4.

Further Methods of Modulation, and Brief Details Concerning the Radiation of Electro-magnetic Waves are Given in This Article of the Series.

By IDRIS EVANS

THE simple method of connecting the microphone direct in the aerial circuit, or in the grid circuit of the oscillator valve, as explained last week, can only satisfactorily be used in very low-powered transmitters. When high power has to be employed, what is known as indirect modulation must be used.

Choke Control

The most commonly used method is that which is dependent on choke control. The circuit of a simple choke-controlled transmitter is shown in Figs. 1 and 2. In

type would get over-heated. By using a low-powered oscillator to feed large amplifying valves in this manner no difficulty is experienced in modulating the high-frequency oscillations with speech or music for telephony transmissions, or in stopping them for transmission of telegraphy.

We have now briefly covered the various stages between the microphone and the transmitting aerial—microphone to low-frequency amplifier in the studio, by land-line to the modulator, oscillator and amplifier at the transmitting station—but before we commence studying the

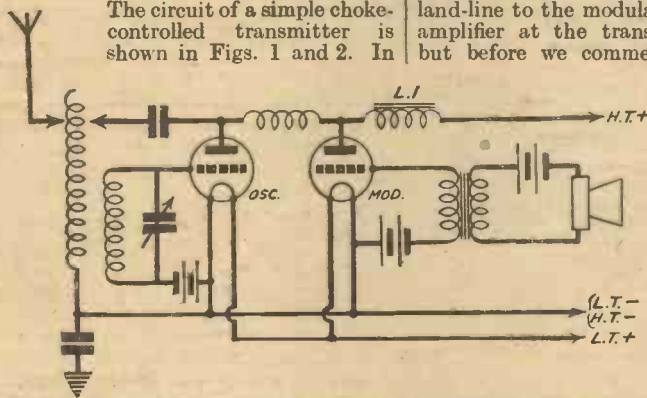

Fig. 1.—Theoretical diagram of the transmitter shown in Fig. 2.

this type of transmitter the low-frequency vibrations from the microphone are applied via the microphone transformer to the grid of what is termed a modulator valve, this valve being coupled to the oscillator. Wireless experts are not all agreed concerning the exact action of this form of control, but at this point the beginner need not worry himself unduly concerning the technicalities involved. The following simple explanation is probably the most easily understood. A study of the diagrams will indicate that the anode current of both valves passes through the low-frequency choke L.I. The speech vibrations cause a variation of the grid potential of the valve to which the microphone is connected (the modulator), and thus the anode current of this valve will vary accordingly. The resultant varying voltage is also applied to the anode of the oscillator valve, however, and therefore the high-speed oscillations produced by this valve will be varied in amplitude by the low-speed speech variations, and modulation will be effected, as explained last week.

Master Oscillator

In very high-power transmitters the method of connecting the oscillator valve to the aerial circuit is unsatisfactory. The output from the oscillator must be amplified by large valves having a very high voltage on their anodes, and in cases where exceptionally high power is necessary these output valves have to be of the water-cooled type as the air-cooled

stages of the receiver a brief description of what happens between the transmitting and receiving aerials will be given.

Radiation

In one of the earlier articles of this series it was explained that the high-speed oscillations passed to the transmitting aerial produce ripples in the surrounding air. These ripples, or electro-magnetic waves, as they are termed, radiate outwards in all directions and hit the receiving aerials within range. All

the waves from transmitters within range of the receiver hit the receiving aerial, of course, but unless the latter is tuned to the same wavelength as that of the transmitted waves (e.g. by means of the receiver tuning condenser) the current induced in the receiving aerial will be very low. From this it will be seen that the efficiency of the tuner in the receiver is of great importance if only one station is to be heard at a time. The various methods adopted to ensure efficient tuning, with consequent effective separation of the stations, will be discussed next week.

Fading

There are many things that affect the radiation of electro-magnetic waves, chief amongst these being the fact that the earth has a curved surface. As electro-magnetic waves are propagated in a straight line it would seem that transmission over long distances would be impossible as the earth is by no means a perfect conductor. In the early days of wireless, transmission of signals across the Atlantic was considered to be a fantastic dream until reception in Canada of signals sent out from England was actually accomplished. Long-distance transmission is possible owing to the existence of a layer of gas, known as the Heaviside Layer, above the surface of the earth. When the transmitted waves hit this layer they are reflected back to earth and this process of radiation and reflection continues until all the energy of the wave is expended.

In the daytime the sun has a marked effect on the gas layer and reflection is consequently poor. After sunset reflection improves and the range of the transmitter is therefore increased. During the continued process of reflection over long distances at night time the wave becomes distorted, however, causing what is commonly known as fading. Up to the present it has not been found possible to eliminate this fading, although special precautions can be taken in the receiver to counteract its effect to a certain extent.

Ideal for the Beginner

F. J. CAMM'S EVERYMAN'S WIRELESS BOOK

2nd Edition.

283 Pages and over 200 Illustrations. Now 3/6, or 3/10 by post, from George Newnes, Ltd., 8-11, Southampton Street, Strand, W.C.2.

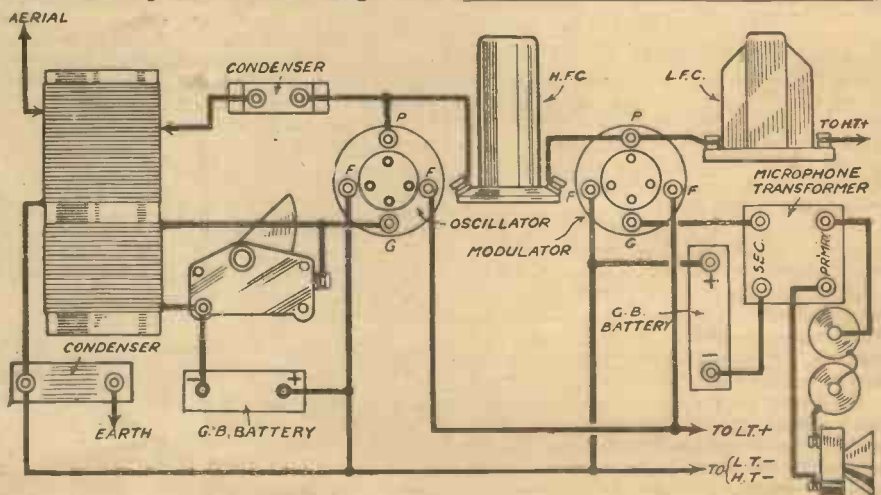
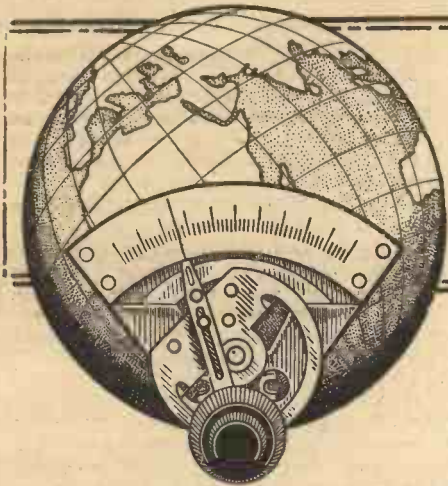

Fig. 2.—A simple choke-controlled transmitter.



SHORT WAVE SECTION

CHASSIS DESIGN

An Article Dealing Chiefly with Inter-stage Screening in Short-wave Receivers.
By A. W. MANN

MANY experimenters fail to realise the scope that the application of screening, and a general break-away from standard amateur practice, offers to those who care to tackle the subject.

In the following notes are a few ideas relative to chassis design, which may be modified to suit individual requirements. Dimensions are not given, because these

noticed that twin screens are shown with an air space between the H.F. and detector screens. This may appear to be unnecessary, but nevertheless is a feature of sound design. A single screen, whilst apparently sufficient, suffers the disadvantage that it acts as a coupler between the two stages, instead of a screen. As one stage consists of a regenerative detector, the fundamentals of the idea will be obvious. As shown, screens are bolted at one end to the panel, whilst the far ends are open.

Separate Screening Boxes

In Fig. 2 another arrangement in which

other components in relation to each other should, however, be exercised, and when screening—i.e. shields, coil cans, etc., are used, the associated tuning coils should be as far as possible from the screening, and at least at a distance equal to the diameter of the coil.

Screened leads which inter-connect stages other than those at earth potential are most desirable in the interests of stability and efficiency, especially when one or more H.F. stages are used.

If it is desired to incorporate individually-screened coils, or tuners, use an experimental former, and by cut-and-try methods determine the exact number of turns, spacing of turns, and spacing between windings, in order to cover the desired wavebands and to obtain smooth reaction and general stability.

The Advantages of Screening

To obtain the full benefits of screening, coils and screens should be chosen and coil winding undertaken with the idea of the whole forming a complete unit, and extra turns will be necessary in order to overcome range reduction due to screening. It is important also to use comparatively large diameter screens, allowing at least 3/4 in. clearance between coil and wall of screening can.

A number of dual-wave and all-wave tuner units, covering the S.W. and B.W. bands, are now available and worthy of consideration by those who wish to build short-wave and all-wave receivers with a minimum of trouble and expense. In some instances the coil units are screened. When using these types, make quite certain that perfect contact exists between chassis and screening base, also between screening can and screening base. Test for continuity, also touch screening can; if this is alive with H.F., see that it is earthed straight away. Another point, see that all cans

(Continued overleaf)

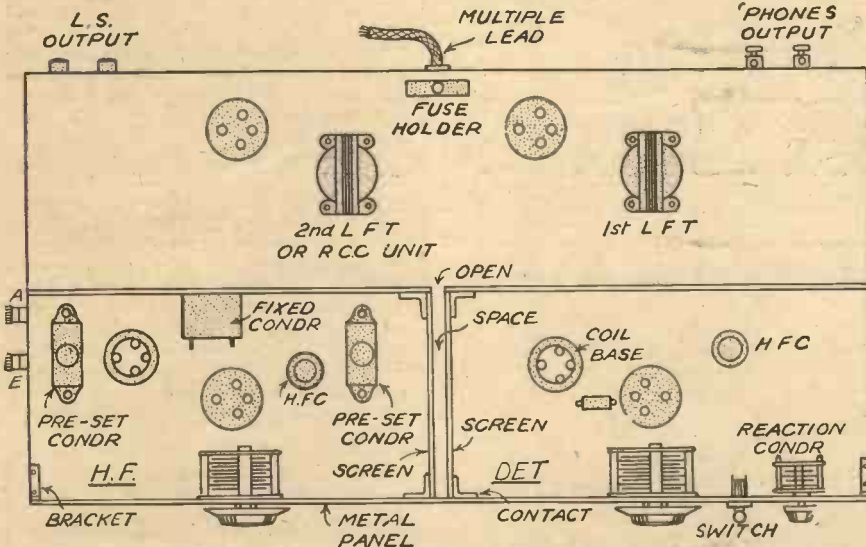

Fig. 1.—The lay-out of a four-valve short-wave receiver, showing the inter-stage screening.

will be governed in individual instances by the size and shape of the components it is desired to use.

A Four-valver

Fig. 1 shows the plan view of a four-valve TRF receiver chassis, complete with inter-stage screening, using a sheet aluminium or plywood chassis lined on the face side in the latter instance with copper foil. The screens, however, should be cut from 20-gauge aluminium sheet.

Before purchasing materials for construction, lay out the various components on a sheet of drawing-paper pinned to a drawing-board. Having decided on the exact layout, mark round each component; also mark screen positions on the plan. If possible, arrange matters so that standard size panels may be used.

Fit panel brackets in every instance and thus ensure freedom from intermittent contact noises, crackles, etc., and test for continuity between earth, screens, chassis, and between chassis bolts, chassis, and earth respectively.

Referring again to Fig. 1, it will be

the H.F. and detector stages are contained in separate screening boxes is shown.

Plug-in coils and dual-range tuners of small dimensions are now standardised and in common use, and thus screening problems are greatly simplified, due to the fact that interaction caused by widely-spreading magnetic fields are minimised, owing to the field spread of modern coils being very restricted.

Care in the placing and arranging of coils and

Fig. 2.—Another suggested lay-out for a four-valve short-wave receiver in which separate screening boxes are used for the H.F. and detector stages.

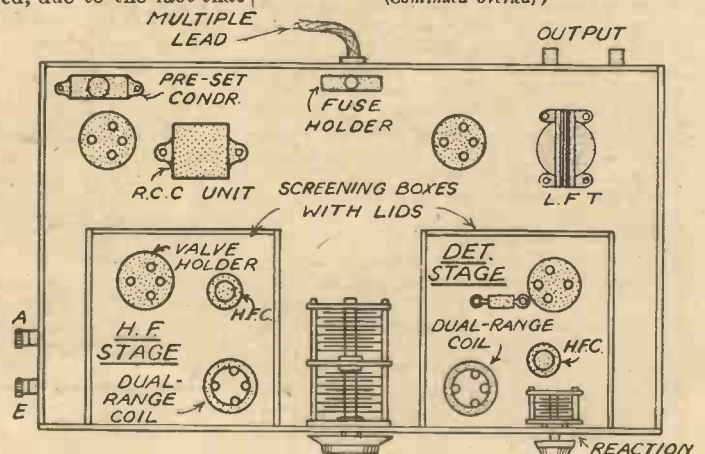

(Continued from previous page)

are vertically mounted; otherwise tracking and calibration will be drastically upset.

Whilst on this subject, just a few pointers relative to grid condensers. Do not mount them directly on the chassis, but at least one inch from it, to avoid undesirable capacity effects, and insulate baseboard valve-holders from the chassis, if used.

DX Work

For serious DX work and amateur communication purposes, a carefully-designed and efficiently-screened TRF receiver is worth while, unless one desires crystal super-selectivity. Pre-detector volume control, band-spread tuning, and a realisation that the aerial and system of coupling it does matter are a sound foundation on which to base design when funds are limited. When hyper-selectivity is required, the superhet is, of course, the thing.

It is generally accepted that any old aerial will meet short-wave requirements, and whilst it is true that a rough and ready arrangement will pick up short-wave signals, it is equally true that a well-designed aerial, which is, after all, a comparatively cheap affair to erect, will do the job much better.

Getting back to short-wave sets, it is noticeable that results in terms of station logs, which always make interesting reading, are obtained in most instances by users of simple apparatus, which do not incorporate H.F. amplification, or at most one stage of tuned or untuned S.G. H.F.

Baseboard Assembly

Simple circuits are still popular, and their popularity is in some measure due to the use of chassis construction. The writer is aware that a number of experimenters still favour baseboard constructional methods, but the fact remains, however, that baseboard construction is a retrograde method when taking into account the screening benefits of a metal or metallised chassis, and the resultant shortening of wiring made possible.

That baseboard assembly allows component and wiring modifications to be carried out with a minimum of trouble is admitted, but usually the experimenter is not pushed for time. Grid condensers and leaks may be mounted above the chassis, and if R.C.C. coupling is used, a suitable holder can be made which will enable quick changing to be carried out by simply uplifting the chassis. By fitting the correct values of resistances and condensers according to preceding valve used at the start, such changes will be unnecessary, unless valve tests are under way.

Chassis Pointers

Users of straight receivers are advised to adopt the practice of totally screening the set in a metal cabinet, making quite sure that the latter is effectively earthed. Direct signal pick-up on coils and set wiring will thus be considerably reduced, and the general efficiency improved. These remarks also apply to H.F. receivers, but whilst

inter-stage screening of H.F. and detector stage is desirable, there is no point in screening between L.F. stages.

When considering screening, remember that energy loss, or damping, is a most important consideration, therefore low resistance material must be used in order to reduce such losses; and whilst aluminium and copper are effective for high-frequency screening, they are ineffective for low-frequency screening, sheet iron being most suitable.

One other point worth remembering is that shielding correctly applied will result in negligible electrostatic losses compared with magnetic field losses. Screening, therefore, is, if correctly applied, undoubtedly a great advantage.

Chassis construction is not difficult, but when integral screens, screening boxes, etc., are to be incorporated, drawings should be made beforehand, and adhered to in order to avoid waste and expense.

Every component, screen, etc., should be firmly bolted to the chassis, and continuity tests run. Build experimental sets with the same care and attention to detail devoted to permanent jobs.

To those who care to study screening and its applications, various ideas will suggest themselves. Experimenting with a view to improving the apparatus when measured in terms of results, efficiency, and practical experience will prove to be well worth while.

A Mixed Log

DURING the past two or three weeks conditions were so variable that on some nights there was no difficulty in logging stations in Central and South America; on others even the nearest Continental short waves showed signs of flutter, and reception of some of the most powerful was poor. Taking all in all it was a mixed log, and possibly on account of the unexpected catches it proved an interesting period.

The number of transmitters operating in the New World is such that one may always expect to catch the strains of a rumba or tango after midnight, but it is a curious fact that although when weather conditions are favourable for DX work, and broadcasts from a comparatively great distance provide good signals, whereas there may be several operating in the same band, in neighbouring districts, it is seldom that many from one locality are heard.

One of the first to be bagged on a recent night was T12PG, San José, where a woman announcer was calling Radio Costa Rica; the wavelength was 46.8 metres (6,410 kc/s), and the time G.M.T. 02.00. For an hour an English broadcast was given. The advertised times are G.M.T. 23.00-04.30 on Wednesdays and Saturdays. Somewhat below, a newcomer appeared, namely, HI4V or HI4D, Santo Domingo (Dominican Republic) on 46.51 metres (6,450 kc/s), a station which styles itself *La Voz de la Marina*. It was logged at G.M.T. 22.30. As the signals faded out it was impossible to ascertain how long the broadcast lasted. I am told that, as a rule, the studio closes down with the *Stein Song*.

YV12RM, Maracay, Venezuela, on 47.62 metres (6,300 kc/s), although not recently established, does not appear to have been reported in the British Isles. Its call: *Emisora Vienticuatro de Julio*, either refers

Leaves from a Short-wave Log

to the address of the station or to the commemoration of one of the periodical revolutions in which South America so frequently indulges. The reading is just above HIZ, Santo Domingo (47.48 metres, 6,315 kc/s), previously heard this winter.

Russian Transmissions

No doubt when you have searched for stations you will have found, possibly to your surprise, a number of Russian commercial telephony transmitters. In particular, around 20-25 metres during the past few months they have been particularly active. RKL, Moscow (25 kW.), on 19.94 metres (15,040 kc/s), is heard daily working with RIM, Tachkent (20 kW.), 19.67 metres (15,252 kc/s). RIR, Tiflis (15 kW.), on 29.76 metres (10,080 kc/s) may be heard in communication with Moscow and Tachkent between G.M.T. 12.00-16.00 every day. RIO, Bakou (15 kW.), 29.5 metres (10,170 kc/s), will be picked up in the early morning, namely, between G.M.T. 04.00-08.00, a time when most U.S.S.R. medium-wave broadcasting stations are on the air with their news bulletins. Finally, RKR, Novosibirsk (15 kW.), on 23.33 metres (12,860 kc/s), works at midday, and RTZ, Irkutsk (20 kW.), on 20.28 metres (14,790 kc/s), starts calling Moscow at G.M.T. 14.30. By the way, RW59, Moscow, on 50 metres, is now on the air every night from G.M.T. 19.00-23.00 with its international programme.

Cuban Stations

Of the distant broadcasts recently received, the Cuban stations have been found well to the fore. Although there

now exist quite a number who, forsaking the true status of amateur, put out a regular programme, the better heard are the following:—

CO9GC, Santiago, calling itself the Santiago Experimental Short-wave Station, on 48.78 metres (6,050 kc/s), and which works from G.M.T.

22.00-04.00, using a bugle as an interval signal. COCD, Havana, a 250-watt on 48.94 metres (6,130 kc/s), which relays the medium-wave CMCD of the same city, has a woman announcer and is usually a strong signal between G.M.T. 01.00-02.30; on Sundays the station only works from G.M.T. 17.00-21.00 at present. Announcements are made in Spanish, English, and occasionally in French.

Somewhat lower in the scale, COCH, Havana, on 31.8 metres (9,430 kc/s), namely, just below PLV, Bandoeng, has also been logged this winter. Its call is *Estacion COCH, de Onda Corta*, and the times are roughly the same as for the other stations. Chimes were heard between items, and also a clock striking the hours.

Finally, CO9JQ, Camaguey, on 36.59 metres (8,200 kc/s), is a newcomer, whose choice of channel is erratic, as it has also been reported on 34.62 metres (8,665 kc/s). It transmits daily between G.M.T. 01.00-02.00, and closes down with a gramophone record of a melody announced as "Over the Waves."

Empire Transmitters

You may have noticed how carefully the B.B.C. announcers give out the call signs of the Daventry Empire transmitters. In order that there should be no confusion, a word is given to indicate the last letter. It may be of interest to listeners to make a note of them. They are: GSA (A for aerial); GSB (broadcasting); GSC (corporation); GSD (Daventry); GSE (Empire); GSF (fortune); GSG (greeting); GSH (home); GSI (Island); GSJ (justice); GSK (king); GSL (liberty).

RANDOM JOTTINGS

New Radio Station for Guiding Aircraft

ACCORDING to a recent report, Southampton is to have a direction-finding wireless station, and it is understood that the Air Ministry have decided to begin work shortly. The new station, which will be situated at Eastleigh, will enable flyers, who at the moment have to rely upon the bearings given by the Portsmouth station, the Southern area control, to keep in direct touch with Southampton.

Apart from the area control station, Southampton will be one of the first municipal airports in the country to have a transmitting and receiving station of its own. The new development will be a great boon to the four air lines operating from the airport, which was opened only three years ago. It will make safe landing possible in almost any weather.



A girl worker, in the Ferranti Radio works at Moston, winding an audio transformer on a specially designed compressed-air turbine-driven machine.

Wireless for the Blind

A GENEROUS sporting offer has been received by the British "Wireless for the Blind" Fund, which was inaugurated by the present King six years ago. On Christmas Day Lord Sankey broadcast an appeal for the Fund, asking the public to contribute £12,000 for the installation of wireless in the homes of the blind throughout the country. About £6,000—half the amount required—was actually received.

With a view to making good the deficit, the maker of the offer agrees to add a fifty per cent. bonus to every further donation received till the total sum reaches the required £12,000. Thus, so far as the Fund is concerned, every shilling now subscribed will automatically become eightpence, and every pound will become thirty shillings.

The person who has made this generous offer, which should eventually total £2,000, wishes to remain anonymous.

ONLY EXPERIENCE CAN BRING DEPENDABILITY OF PRODUCT

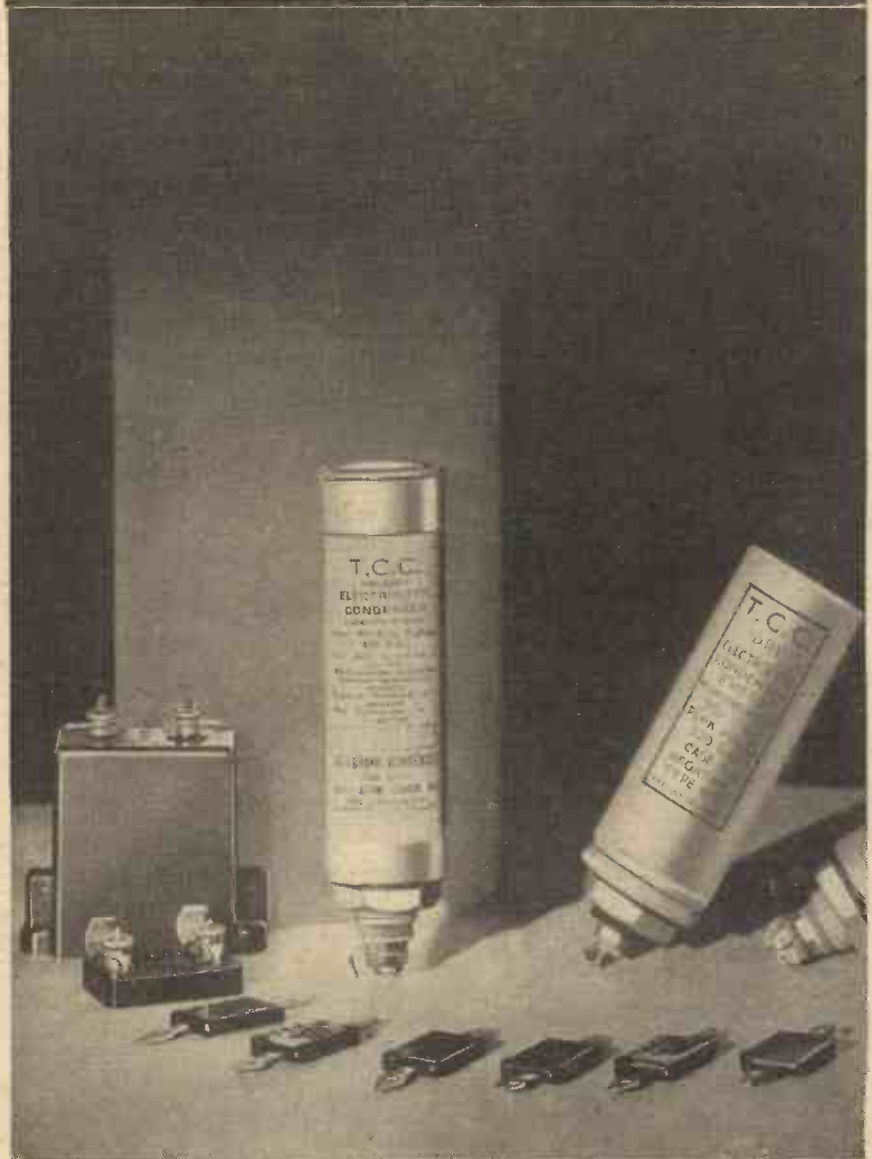

T.C.C. HAVE MADE
CONDENSERS—AND
CONDENSERS ONLY
FOR 28 YEARS

T.C.C.
ALL-BRITISH
CONDENSERS

THE TELEGRAPH CONDENSER COMPANY LIMITED.

WALES FARM ROAD · N · ACTON · LONDON · W · 3

B.T.S.

TESTED COMPONENTS

Produced by specialists and preferred by experts, therefore Mr. F. J. Camm has once again

EXCLUSIVELY SPECIFIED

B.T.S. Components for the

MONITOR 3

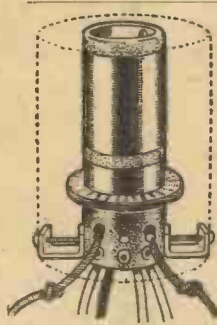

B.T.S. MONITOR COIL
 Mr. F. J. Camm relied on B.T.S. to make a good job of the most vital component in his new set—the specially designed coil. Constructed of high quality materials and wound carefully to specification—it ensures success of your Monitor 3. Supplied with coloured leads for easy connecting. **5/- EACH**
 Dotted portion shows metal screening can.

PREFECT S.W.3

6-PIN COIL
 Wound with hard drawn copper wire, spaced for correct distributed self-capacity. Type S.P.C. 22-47 metres. **4/6 Each**

COIL BASE
 For B.T.S. 6-pin Coil. Low-loss insulators. Type S.P.B. 2/- each

4-pin Short Wave V-HOLDERS
 Low-loss insulating material. Type UH 1/- each

Send for lists of B.T.S. Short Wave Components.

Obtainable from ALL GOOD DEALERS. In cases of difficulty send direct, with name and address of nearest dealer.

BRITISHTELEVISION SUPPLIES LTD.
 Faraday Ho., 8-10, Charing Cross Rd., London, W.C.2
 Phone: Ten. Bar 0134-5. Grams: Television, Leaque, London.

EASY TERMS

We specialise in the supply of all good quality Radio sets, components, and accessories. Send list of requirements and keen quotation will be sent promptly.
 Cash and O.O.D. Orders Despatched by Return of Post.

W.B. STENTORIAN SPEAKERS

36.S
 Cash Price £2 2/0. or 2/6 with order and 11 monthly payments of 4/-

36.J
 Cash Price £1 2/6. or 2/6 with order and 11 monthly payments of 3/-

Payment Number Monthly Cash with order and Instal- Price Order Months ment.
 B.T.H. Piezo Electric 42/- 2/6 11 4/-
 Marconiphone 25 .. 32/6 2/6 11 3/-
 All makes of pick-ups supplied. Illustrated price lists available. ALL CARRIAGE PAID

Estd. 1925 THE LONDON RADIO SUPPLY COMPANY
 11, OAT LANE, NOBLE STREET, LONDON, E.C.2

LONDON RADIO SUPPLY COMPANY

11, OAT LANE, NOBLE STREET, LONDON, E.C.2

36 VALVES

THE VALVE WITH THE SIX MONTHS GUARANTEE!

STONEHAM ROAD, LONDON, E.5. Phone: Clissold 6807

RADIO CLUBS AND SOCIETIES

Club Reports should not exceed 200 words in length and should be received First Post each Monday morning for publication in the following week's issue.

SLADE RADIO SOCIETY
 ON Thursday, January 16th, Mr. H. C. Taylor, of the Joseph Lucas Limited Research Laboratories, gave an illustrated lecture upon automobile equipment. This included a demonstration of various headlamps and the special flat top beam fog lamp. He brought with him many examples of dynamos, starters, automatic starting and voltage control components which had sections cut out in order that the interior might be seen. He also demonstrated the new wind tone matched horns.—Hon. Secretary, Chas. Game, 40, West Drive, Heathfield Park, Handsworth, Birmingham, 20.

BRITISH SHORT-WAVE LEAGUE
 THE formation of an organisation, to be known as the above, is being considered by several enthusiastic short-wave listeners, with the object of providing a means whereby the listener may learn of his fellow members' DX activities and share his tuning tips through the medium of the League's monthly booklet. The latter, under the title "British SWL Review," will contain news on BC and commercial 'phone stations operating below 100 metres, amateur activities by a prolific DXer, long lists of station QIAs, identification notes, photo, SWL card and correspondence exchange bureau, and other matter likely to prove of interest to the listener. This booklet is already being produced, and it will constitute the official organ of the proposed League. Anyone interested is invited to address comments or suggestions to the British Short-Wave League, Ridgewell, Essex.

PLYMOUTH RADIO AND TELEVISION SOCIETY
 THE first meeting of the Plymouth Radio and Television Society took place on January 23rd, and the second meeting on Tuesday, February 4th, at Plymouth Chambers, at which several prospective members were present.—J. H. Light (Hon. Sec.), 4, Peverell Terrace, Peverell, Plymouth.

BIDEFORD AND DISTRICT S.W. SOCIETY
 THOSE interested in short-wave radio in N. Devon are invited in get in touch with Mr. E. K. Jensen, secretary of the Bideford and District Short-wave Society, 5, Fuzrebeam Terrace, East-the-Waters, Bideford. Meetings are held fortnightly on Mondays at the Red House Café, The Quay, Bideford, and the society has two transmitting members in its Chairman, G6FO, and 2ADJ.

PROPOSED SOCIETY FOR WEST WIRRAL
 AN amateur Transmitting and Short-Wave Club is to be formed in the district of Hoylake, West Kirby, Grange, and Heswall. Anyone interested is invited to write to the Hon. Secretary, stating their particular interests in radio. All members of the

Radio Society of Great Britain are automatically admitted, whilst certain qualifications are required of other applicants.
 Hon. Secretary, B. O'Brien, "Coldy," Irby Road, Heswall, Cheshire.

WEST LONDON RADIO SOCIETY
 SIXTY-ONE persons were present at the inaugural meeting of the West London Radio Society, which was held at Ealing Town Hall, on Wednesday, January 15th. The proceedings were opened with a demonstration of a modern all-wave superhet, kindly loaned by Messrs. Lissen, Ltd. This was followed by the election of the President, Mr. Douglas Walters, G5CV, and other officers. A novel feature was then introduced when the newly-elected President returned to his residence at Chiswick, and gave his Presidential Address over "the air." His transmission was received at excellent strength, and provided a very appropriate conclusion to the evening's activities.
 Those interested are asked to communicate with the Hon. Sec., Mr. H. A. Williamson, 22, Camborne Avenue, West Ealing, W.13, from whom full particulars of the society's activities may be obtained.

SHORT-WAVE CLUB FOR WORSLEY!
 IT is proposed to form a short-wave club in the Worsley district of Manchester, and interested readers in the vicinity are asked to write for particulars to Mr. R. Sears, 9, Douglas Road, Worsley, Manchester.

AMATEUR TRANSMITTING IN SHEFFIELD
 MEETINGS are now being held in Sheffield by local members of the Radio Society of Great Britain. Morse practice is being arranged, and it is hoped to extend this service on the amateur wavebands. Anyone interested is asked to communicate with Mr. A. Pemberton (G2JY), 57, Tillotson Road, Sheffield, 8.

EXETER AND DISTRICT WIRELESS SOCIETY
 PARTICULARS of the spring programme of this Society are given below.

- February 17th. *Some Mysteries of Wireless.* By Mr. H. A. Bartlett, G5QA. (1) As a professional operator. (2) As an amateur transmitter.
 - February 24th. *A Surprise Item.* By Mr. K. C. Harvey.
 - March 2nd. *A GREAT ATTRACTION.* 5-Metre Work with Demonstration. By Mr. W. B. Sydenham, B.Sc., G5SY. (The D.B. for District No. 6).
 - March 9th. Open.
 - March 16th. *Ultra-short Waves and Measurements.* By Mr. R. C. Lawes, M.I.W.T., G5ZV.
 - March 23rd. *A.C. Mains.* By Mr. L. Cornish, of Exeter City Electricity Department.
 - March 30th. *A Demonstration of the Latest Sets.* By Mr. F. J. Thorn.
 - April 6th. *The Theory and Practice of Loud-Speaker Design.* By Mr. D. R. Barber, B.Sc. A. Inst. E.
- Members are requested to attend all lectures if possible. All meetings are held at the Y.M.C.A., High Street, Exeter, at 8 p.m. on Mondays. Annual Subscription, 5s. Entrance Fee, 1s. 6d. Lower rates for juniors under seventeen years of age. W. J. Ching, Hon. Sec., 9, Sivel Place, Heavitree, Exeter.

OUR FREE CATALOGUE SERVICE

HEAYBERD BATTERY CHARGERS
 THE operation of charging car or wireless accumulators is greatly simplified by installing a Heayberd Battery Charger, and a folder giving particulars of these units has just been issued by F. C. Heayberd and Co., 10, Finsbury Street, London, E.C.2. The Heayberd Charger Models A.O.3 and A.O.5 have been specially designed to meet the requirements of all motorists, and those desiring to charge their own wireless batteries. Home charging with efficient apparatus ensures that the accumulator receives proper care and attention, and is always fully charged when required. All Heayberd Chargers are fitted with metal rectifiers and, if preferred, constructors can build their own battery charger from a special kit of parts, particulars and prices of which are given in the folder.

To save readers trouble, we undertake to send on catalogues of any of our advertisers. Merely state on a postcard, the names of the firms from whom you require catalogues, and address it to "Catalogue," PRACTICAL AND AMATEUR WIRELESS, Geo. Newnes, Ltd., 8-11, Southampton St., Strand, London, W.C.2. Where advertisers make a charge, or require postage, this should be enclosed with applications for catalogues. No other correspondence whatsoever should be enclosed.

Coils, and Test Apparatus. The new "Unigen" dual-range coil is designed for universal use in sets, and is an extremely compact and efficient unit. The new iron-cored coils, type I.C., are the firm's latest development. In high efficiency coils, the use of the iron dust cores allowing a considerable reduction in size. The screening cans are only 1 1/4 in. square, and the complete range meets the requirements of all sets, whether "straight" or superhet. New volume controls include a range of wire-wound potentiometers, and a carbon-type control having a carbon element of new design. This control is obtainable with or without mains switch. Amongst the new short-wave components are low-loss coils, H.F. chokes, and coil formers. Various testing units and meters are also included in the catalogue, which is priced at 3d.

1936 STENTORIAN SPEAKERS
 IF you examine one of the latest Stentorian speakers you will observe several important improvements, which result in the remarkable performance given by this instrument. For instance, the larger "Mansfield" magnet increases sensitivity, and a larger and improved "Microlode" device extends the frequency range. The extreme accuracy with which the "Whiteley" speech coil and former are positioned in the gap is largely responsible for the noticeable clearness of reproduction. Interested readers should write for a copy of a descriptive folder which has just been issued by the Whiteley Electrical Radio Co., Ltd., Radio Works, Mansfield, Notts.

PHILCO'S SHORT-WAVE BOOKLET
 ON account of its popularity and the heavy demand that still continues, this booklet, "Glorious Adventure at Home," has now been fully revised and extended to twenty-four pages. The second edition is available to the public either direct from Philco, or through Philco dealers at 2d. a copy.
 Publication coincides with the announcement by Philco of a universal Empire Six and an Empire Five, which complete a range of Philco all-wave receivers and radiograms extending in price from 15 to 100 guineas. It describes in detail the new world of entertainment available to short-wave listeners, tells the romantic history of short-wave development, explains in simple language the technicalities and terms connected with transmission and reception, and includes a very useful world-map of broadcast and experimental short-wave stations, together with an up-to-date list showing their frequencies and wavelengths. Other features include advice on aerial construction, a time conversion log, an alphabetical list of long and medium-wave stations, and interesting radio illustrations from distant lands.

WEARITE COMPONENTS
 IN the new season's catalogue recently issued by Wright and Weaire, Ltd., 740, High Road, Tottenham, N.17, all of this firm's most popular lines are given, and also several new components such as "Wearite" Iron Cored Coils, Unigen Coils, Potentiometers with and without mains switch, Short-wave

TELEVISION NOTES

Two Distinct Forms

ALTHOUGH it is agreed on all sides that television will be applied in many industrial directions as soon as further improvements are effected, there are two distinct forms which will make their bow to the public this year. First of all there is the service to the home, which intensive research within the last two years has now made possible. Apart from the natural development of old methods of scanning, the perfection of the electron scanner in its two well-known forms, for scanning outdoor and indoor scenes, the improvements in large cathode-ray tubes capable of reproducing pictures on their fluorescent screens of a size and brightness sufficient to give sustained entertainment value, together with the practical application of a new technique in ultra-short waves as a transmitting medium, are amongst the items which have contributed to this stage of advance.

Distinct from the home, however, will be the initiation of big-screen television in the cinema. The fundamental problems of this form of entertainment have been solved, but the particular method which will be used generally has yet to be settled. One idea is to use back projection from a modulated light source and a scanner with reflecting surfaces. Another favours the method of intermediate film projection whereby the signals are recorded on standard 35-millimetre film and after rapid photographic processing are passed through a standard film projector on to the screen in the normal manner. Thirdly is the projection type cathode-ray tube, which theoretically is the simplest method, but which is not in such an advanced stage of development as the two other schemes.

In confirmation of this cinema aspect comes the official report that yet another cinema in London, the News Cinema now in process of construction in Leicester Square, is to include television as part of its public programme. It is to open in April, and two screens are being provided, one for ordinary film projection and the other for television. At first it is anticipated that the television screen will be used for transmitting film sequences, and later it is hoped to project direct news.

Another Zworykin Invention

VLADIMIR ZWORYKIN is not content to rest on his achievements in the television world with his Iconoscope and new electron multiplier, for, according to information from America, both he and a Dr. Morton, of R.C.A., have developed and demonstrated what they term a "third eye." This is an electron tube having a fluorescent screen as an artificial retina. This surface is sensitive to both the infra-red and ultra-violet ends of the spectrum. Whereas the normal human eye is said to cover a range of 6,500 to 3,500 Angstrom units, the artificial eye extends from 13,000 to 1,800 units. As it is claimed that the device can be used both as a telescope and a microscope in its ultimate finished form, it will prove a great aid in medicine, biology, astronomy, aviation, naval and military operations. Those micro-organisms which can only be seen in a microscope with very intense light, or with the aid of special stains which quite frequently kill them, can now be illuminated by infra-red rays which reveal tissue and cell-structure details not seen readily by visible light.

CAPSTAN CIGARETTES
PLAIN OR CORK TIPPED

10 for 6d.
20 for 11½d.

'BETTER BUY CAPSTAN.
they're blended better
- they're Wills's



- as the daughter said to her father

Let Us Send You This 40-Page Booklet — Free



It gives full information regarding various I.C.S. Courses of Instruction in Radio work.

The Radio industry is progressing with amazing rapidity. Only by knowing thoroughly the basic principles can pace be kept with it. I.C.S. Instruction includes American broadcasting as well as British wireless practice. It is a modern education, covering every department of the industry.

OUR COURSES

Included in the I.C.S. range are Courses dealing with the Installing of radio sets and, in particular, with their Servicing, which to-day intimately concerns every wireless dealer and his employees. The Equipment Course gives sound instruction in radio principles and practice.

There is also a Course for the Wireless Salesman. This, in addition to inculcating the art of salesmanship, provides that knowledge which enables the salesman to hold his own with the most technical of his customers.

Then there are the Preparatory Courses for the City and Guilds and I.W.T. Exams.

We will be pleased to send you details and free advice on any or all of these subjects. Just fill in, and post the coupon, or write in any other way.

International Correspondence Schools, Ltd., Dept. 94, International Buildings, Kingsway, London, W.C.2.

Without cost, or obligation, please send me your "Radio" booklet of information about the Courses I have marked X

- COMPLETE RADIO
- RADIO SERVICING
- RADIO EQUIPMENT
- RADIO SERVICING AND SALESMANSHIP
- WIRELESS ENGINEERING
- EXAMINATION (state which)

Name.....Age.....

Address.....

LETTERS FROM READERS

The Editor does not necessarily agree with opinions expressed by his correspondents.



All letters must be accompanied by the name and address of the sender (not necessarily for publication).

Reception of W8XX

SIR,—With reference to "Leaves from a S.W. Log." It is of interest to know that W8XX is operating on 13.92 metres. Personally, both my son and I received this station last week and that averaging from R2-R8 on peaks. In fact he has been quite as good as, and at times better than, the 19-metre band station when this has been working. All reception was on an M.C. loud-speaker.

It may interest other readers to know that Bandoeng, on 29 metres, is a worth-while station on Sundays, between 1 and 3 p.m.; it was coming in at R9 up to close down. The receiver used is modified in the H.F. stage to take an Eddystone H.F. 6-pin transformer and pentode output in the final stage.—W. D. A. KING (Sheffield).

Back Numbers Wanted!

SIR,—I am in need of a back number of PRACTICAL WIRELESS, dated January 21st, 1933, which contains details of tantalum strip charging. Perhaps one of your readers could supply me and I should be very grateful.—W. HINKS (183, Stringle Lane, Willenhall, Staffs).

"Practical and Amateur Wireless," dated January 26th, 1935

A NUMBER of readers are in need of a copy of the above issue of PRACTICAL AND AMATEUR WIRELESS. Will any reader who has a spare copy please forward it to this office?

"For the Experimenter": A Correction

SIR,—With reference to my series of articles entitled "For the Experimenter—Servicing Sets for Profit," I would like to point out a draughtsman's unfortunate error which has occurred in Fig. 3 of Part 1. Readers will notice that the 10 milliamp. shunt must be omitted when calibrating the meter for voltages. This 10 mA shunt should only be paralleled across the meter when calibration is in

Charging from D.C. Mains

SIR,—In your issue of 28/12/35 I noticed an inquiry for charging from D.C. mains. Your reply to A. L. E. P. (E.12) is to the point, but maybe your querist would care to have fuller details. Accordingly I enclose a sketch of an arrangement which I have found very effective during the last eight months. I have never been (up to the time of writing) without

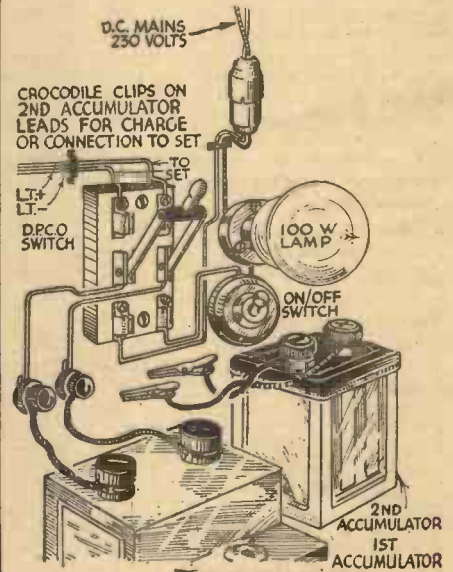

An effective method of charging from D.C. mains.

L.T., and this method has many advantages. The sketch is self explanatory. It is important to find the correct polarity of the mains leads before connecting up, and this can be ascertained by dipping the mains leads into a glass of salt water, the one giving most bubbles off being the negative. Keep the leads well apart, and always plug them in correctly. For twelve-hours' charge you receive twelve hours L.T. for three valves at 4 amp.—H. F. CALDWELL (West Hartlepool).

"Amateur Wireless," No. 560

SIR, I shall be greatly obliged if one of your readers could supply me with a copy of AMATEUR WIRELESS for March 4th, 1933 (No. 560).—ED. McNAIR (8, Granton Street, Glasgow, C.5).

An Appreciation from South Africa

SIR,—As a reader of your excellent journal for the last two years, I think it is about time I wrote and told you what a godsend PRACTICAL AND AMATEUR WIRELESS is to us out here. The dealers here do not seem to be of much assistance, so we have to rely on your journal for all our knowledge.

Like so many other Colonial readers, I would like to see a really efficient S.W. set built especially for Colonial use. I should suggest a four-valve with an untuned H.F., pentode or S.G. stage, S.G. detector, L.F. and pentode output. Both mains and battery set designs would be necessary as many districts are without a mains supply. I

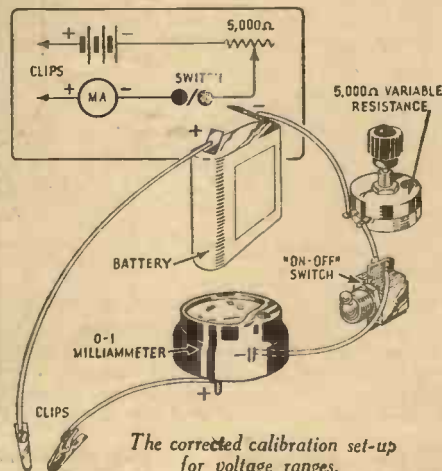

The corrected calibration set-up for voltage ranges.

progress for the 100 mA range, as explained in the text. Regretting any inconvenience this may have caused readers.—"TEST ENGINEER."

notice several South African readers have suggested six and seven-valve circuits, but I am sure that for the average person the initial cost of the components and the high maintenance charges would make such a set prohibitive.

I wish PRACTICAL AND AMATEUR WIRELESS all the success it deserves in 1936.—W. M. BLACKETT (Capetown, S. Africa).

Our S.W. One-Valver: A Good Log

SIR.—After having tried two and three-valve short-wavers I decided to build the one-valver described in your issue for September 14th, 1935, and I am very pleased with the results. The following log may interest other readers:—

Commercial: 2RO, DJA, DJB, DJC, DJN, RW59, GSL, GSB, W2XAF, OER2.

Amateurs: G2HT, G2, G2SM, G5CJ, G6WR, G2NJ, G6TR, G2HG, G6A8, G6IA, G6FH, GSGC, G6ZQ, G5TP, G5WK, G5KJ, G2XC, G2NF, G6P7, G2XC, G6TB, G6LX, G2UZ, G6GO, G2MF, G5OI, EIHG, G2OC, G6WU, G2IL, G2CT, WIKJ, W3WJ, G2ZT, G6A5, G2TA, G6PL, G5TT, G5XG, G2AX, G5YY, EI7G.

I also received a few more unidentified commercial transmissions.—M. POLIMENI (New Malden).

Radio Philips—Ibérica S.A.E.

SIR.—The writer of "Leaves from a Short-wave Log" inquires re a new Spanish station. The details of this station are as follow:—

Radio Philips—Ibérica S.A.E., Paseo de las Delicias 71, Madrid. Man announcer. Languages: Spanish, Dutch, German, French, and English. Announced wavelength 44 to 45 metres. Reports requested. I might add that they verify promptly by card.—E. A. A. HARDWICK (Misterton, Somerset).

Charging Accumulators

SIR.—Referring to Mr. Bolton's letter under the above heading in your issue of January 25th, may I, in deference to your

less technically-minded readers, offer a mild word of criticism.

To my mind, your correspondent's lengthy discrimination between simultaneously grasping the live circuit ends after disconnecting the accumulator, and accidentally touching one main of a "leaky" system, has confused the issue. Where does Mr. Bolton find support for his contention that the latter is the real danger?

In the first case, if we assess the resistance of the human body at a figure between 2,000 and 3,000 ohms (fair average limits) and place it in series with a lamp of 625 ohms resistance on a 250-volt supply, a simple calculation shows that anything from 180 to 200 odd volts may be dropped across the body. Surely not a mild shock for some unsuspecting mortal!

Secondly, leakage on any electrical system is a measure of the insulation resistance of that system to earth. Assuming this value

for any one main to be as low as 625 ohms (a very low figure from an engineer's point of view), then a person, solidly earthed, touching the other main receives a shock comparable to the previous case.

I think, therefore, it ought to be realised that placing one's hands across a break in an otherwise closed circuit may involve anything but a "mild" shock if the remaining resistance in circuit is sufficiently low; while contact with any one main depends for its results on two things, viz., the insulation resistance of the other main to earth, and the type of contact the body makes with "ground."

A person standing on a dry wooden floor is perfectly safe in touching one main of any lighting system. But a person grasping the open ends of an otherwise closed circuit has no guarantee of immunity even though he be suspended in mid-air!—JAMES J. BEVERIDGE (Glasgow).

AGAIN EXCLUSIVELY SPECIFIED by Mr. Camm



If you are a regular reader of "Practical Wireless" you will have noticed that for every important receiver described since August last Mr. Camm has specified the use of a 1936 Stentorian. He has many makes and types from which to choose. Have you realised how significant is this consistent selection of this one instrument?

If you would understand the reason, ask your dealer to demonstrate a 1936 Stentorian. When you hear the extra volume, cleaner reproduction, and brilliant realism this supremely modern speaker brings, you will know that Mr. Camm's preference is based on incontrovertible fact.



Read this message from the designer of the "Monitor Three" and the "Prefect S.W. Three."

"Every constructor owes your engineers a debt of gratitude for your 1936 'Stentorian.' Once again they have beaten their best—excellent precision workmanship, even wider frequency response, higher degree of magnetic flux, entrancing tone at which the most critical could not cavil—and, above all, outstanding sensitivity."

"Can there be a better speaker?"

J. Camm

To any receiver, new or old, this unique loud-speaker brings a truly amazing improvement in performance. Never before have such sensitivity, marvellous "transient" response, and wide frequency range been available at "commercial" prices. Ask your dealer to demonstrate to-day, and hear for yourself!

1936 STENTORIAN

Cabinet Models.	
36A	63/-
36J	49/6
36B	29/6
Chassis Models.	
Senior	42/-
Junior	32/6
Baby	23/6
Midjet	17/6
Duplex	84/-
SM/W	70/-



1936 STENTORIAN

PERMANENT MAGNET MOVING-COIL SPEAKERS.

WHITELEY ELECTRICAL RADIO CO., LTD. (Technical Dept.), MANSFIELD, NOTTS.

CUT THIS OUT EACH WEEK.

Do you know

—THAT when using headphones with a short-wave receiver, much of the difficulty of hand-capacity effects may be removed by incorporating an H.F. choke in each 'phone lead.

—THAT it is sometimes found that erratic tuning effects may be traced to the use of a defective earth connection arising through water and gas pipes.

—THAT in the above event it will prove of advantage to use a buried separate earth, even if the lead is long.

—THAT it is possible to employ two metal rectifiers for the separate functions of rectification and A.V.C.

—THAT where heater supplies are important the above arrangement will enable subsequent L.F. amplification to be more usefully employed.

—THAT precautions must be taken regarding the H.F. currents after a metal rectifier, and effective H.F. filtering is generally essential.

—THAT long leads to the pick-up switch may generally be rendered free from trouble if an H.F. choke and by-pass condenser are connected near the actual valve-holder.

The Editor will be pleased to consider articles of a practical nature suitable for publication in PRACTICAL AND AMATEUR WIRELESS. Such articles should be written on one side of the paper only, and should contain the name and address of the sender. Whilst the Editor does not hold himself responsible for manuscripts, every effort will be made to return them if a stamped and addressed envelope is enclosed. All correspondence intended for the Editor should be addressed: The Editor, PRACTICAL AND AMATEUR WIRELESS, Geo. Nevnes, Ltd., 8-11, Southampton Street, Strand, W.C.2.

Owing to the rapid progress in the design of wireless apparatus and to our efforts to keep our readers in touch with the latest developments, we give no warranty that apparatus described in our columns is not the subject of letters patent.

Facts and Figures

COMPONENTS TESTED IN OUR NEW LABORATORY

Three New Marconiphone Releases

THE Marconiphone Company announce the release of three new receivers as follows:

Model 238, a four-valve receiver of the "straight" type, having the standard and well-tried S.G., detector, and pentode circuit, with a valve rectifier for the mains supply. This receiver gives an output of 3 watts undistorted and cost 8 guineas.

The second is Model 237, which is exactly similar so far as the circuit arrangement is concerned, but it is housed in a different cabinet, finished in midnight blue leatherette with a mother-of-pearl tuning scale in a chromium escutcheon. The controls are of chromium, and triangular bevels at the bottom of the front edges also carry simple chromium decorations. The price is also 8 guineas.

Model 245A is a radio-gramophone, in which the chassis is similar to the above models, with the addition of the gramophone section. The cabinet is of figured walnut, and the price is 16 guineas.

Battery "Packs"—A New Idea

TO meet any difficulties that might be experienced by the trade in supplying the correct batteries for those wireless receivers which are now being sent out by many manufacturers without batteries, the Exide Company has introduced the "Exide and Drydex Pack," which consists of a set of Exide and Drydex batteries suitable for a particular receiver, the "pack" being clearly labelled with the name of the receiver or receivers for which the contents are suitable, and bearing a clear indication of the inclusive list price.

Four types of "pack" have now been issued, the details being:

Full Description of Set and Model.	Exide. L.T.	Price s. d.	Drydex H.T.	Price s. d.	Drydex G.B.	Combined List.	
						Price s. d.	Price s. d.
A. Ekco B.86	PLF5	13 0	H. 1114	14 3	*	—	27 3
B. Philco 255	CZ3	11 0	H. 1104	14 6	*	—	25 6
C. Cossor 436B	DMG	11 0	H. 1070	15 6	H. 1001	10d.	27 4
D. Aerodyne Snipe Ultra Battery "77" Cossor 300	DFG	8 6	H. 1006	7 6	H. 1001	10d.	16 10

*Indicates Grid Bias incorporated in H.T.

W. Andrew Bryce & Co.—Change of Address

THE entire northern works of the above company, formerly situated at Bury, Lancs., together with the London office, have now been moved to larger premises at North Road, Burnt Oak, Edgware, Middlesex, where special departments have been planned for dealing independently with coil winding, mains transformers, and chokes and condensers. All communications should, therefore, be sent to the Edgware address in the future.

"Radio Amateur Call Book"

THE Winter 1935 edition of the above magazine is now obtainable from F. L. Postlethwaite, of 41, Kinfauns Road,

Goodmayes, Ilford, price 6s. post free. This book, as many readers are aware, contains full details of the various amateur transmitters in all parts of the world, giving, where the information is available, the full postal address of each one. In addition, it contains much useful information regarding call signs, the letters used for each country for identification purposes, etc. The "Q" code, Who's Who on the Short Waves, High-frequency Press and Weather Reports, and other interesting information is included in the book, which consists of 320 pages, and should be in the possession of every DX enthusiast.

B.T.S. "Adaband"

WE are asked by Messrs. British Television Supplies to point out that the price given by them in a recent advertisement of the battery-operated "Adaband" Unit was incorrectly given as 4 guineas. This should have been 5 guineas.

A.C. Units for D.C. Sets

THE change-over in certain localities from D.C. supplies to A.C. mains leads many listeners to difficulties regarding the supply of the D.C. receiver which they will already possess. In certain districts, of course, the local authorities make arrangements to supply such apparatus as is required to enable the receiver to function, but in cases an allowance only is made and the user must provide the necessary equipment. There are also cases where a listener may acquire D.C. apparatus for use at a very low figure, and the only difficulty is to be found in the operation of this from an A.C. supply. Special A.C. units are now obtainable from Messrs. Holiday &

Hemmerdinger, of Holmer Works, Dolefield, Bridge Street, Manchester, which have been supplied to several districts where the change-over has been carried out. The necessary unit is obtainable for any specified load, and utilises valve rectification, with an efficient smoothing circuit consisting of a large choke and a by-pass capacity totalling 16 mfd. The entire unit is enclosed in a mesh cage and fitted with input and output leads.

As an indication of the types and prices we may mention the smaller units up to

100 m/A loading costing £2 17s. 6d., and the large unit, rated at 450 m/A, costing £7. Between these ranges are many available types, and quotations may be obtained for larger models.

New Bulgin Mains Connectors

TWO new mains connectors have recently been produced by Messrs. Bulgin, and these, unlike the earlier models, are provided with three pins in order to come into line with the more recent methods of house wiring. Under the new schemes, of course, the third connection is for earth purposes, and one of the I.E.E. regulations lays down that all metal casing of electrical apparatus must be joined to a separate cable, which must be earthed. The new Bulgin plug, shown on the left in the illustration below, has these three pins arranged in such a manner that they may only be connected in the correct manner (one pin being of larger diameter, and the plug being provided with an ebonite rib which passes along a slot in the socket), and this may be employed in the above manner. The socket may be attached to any suitable mains equipment, such as a radio receiver or a radiogram, and the plug may be fitted with a three-wire cable joined to the mains socket of the house supply.

The other component in the illustration is a two-pole connector, with the pin portion fitted with a metal bracket so that it may be attached to the chassis of a radio receiver, and the plug portion is identical in other respects to that of the previously-mentioned connector, except that only two sockets are employed.

An important feature of these two plugs is that the plug portion is provided with an enlarged end, which will permit of the plug being inserted into a hole in a cabinet or metal box, and will necessitate the removal of the mains supply (by withdrawing the plug) before access may be gained to the interior, and thus will comply with a further regulation of the I.E.E. now in force, or about to be introduced.

The first type of plug costs 2s. 3d., whilst the second is 2s.

A New Industry

NOW that cathode-ray tubes of quite large sizes—a 15in. diameter bulb is necessary for a picture approximately 12ins. wide by 9ins. deep—are being used for television, a new industry has arisen in connection with the making of the glass bulbs. These are long and narrow at one end to accommodate the electrode system and then open out in conical fashion to an almost flat-faced but circularly-bounded front screen. These tubes can be "blown" in one piece, and it is interesting to note that the manufacture is still undertaken by skilled craftsmen using their unaided lungs for the blowing operation. It is stated that good samples cannot be secured by mechanical methods or automatic air blast.



The two new Bulgin mains connectors which are reviewed on this page.



QUERIES and ENQUIRIES

Class B Amplification

"I attach a circuit of my receiver which does not give loud enough signals. What is the most suitable way of increasing the volume? I thought of adding class B or Q.P.P., but am not certain regarding the best way of adding this. Perhaps you could give me your valued advice."—F. E. (Birmingham).

As your circuit already employs three L.F. stages, it would not be advisable to add a class B stage to this, and if you intend to adopt such an output stage it would be preferable to remove the present output stage, and to make the penultimate stage the Class B driver. However, we do not think this would give any appreciable increase in volume, as in view of your situation it would appear that you will only experience lack of volume on distant stations and not on the local. Therefore, it is clear that you need an improvement in the H.F. stages in order that distant signals may fully load the present output stage.

Anode-circuit Switching

"I wish to modify my commercial receiver so as to reduce the volume on the local stations. There is no volume control on the set and I do not wish to interfere with the wiring to such an extent that I can fit a control, but I thought that I could switch out the first L.F. stage as shown in my sketch herewith. Is there any objection to this arrangement, or can you suggest a more satisfactory method of carrying out the desired reduction in strength?"—H. V. (Barnet).

THE arrangement which you show consists simply of a transfer of the anode connection of the first L.F. valve to the second L.F. valve, and whilst this would certainly effect the desired reduction in strength, there is a serious drawback to the arrangement. Unless the receiver is first switched off, the operation of your suggested switch will result in the breaking of the anode circuit whilst current is flowing, and in view of the fact that there is an L.F. transformer in this circuit it will be possible to damage the output valve, due to the surge which will probably be produced by the sudden breaking of the anode circuit. It is bad practice to break an anode lead without first switching off, and we do not therefore favour your idea. The simplest way of carrying out the volume control is to fit a differential reaction condenser on a bracket at the rear or on the side of the cabinet and to connect one set of fixed plates to the aerial terminal and the other set of fixed plates to the earth terminal.

The aerial should then be removed from the present aerial terminal and joined to the moving plates of the differential condenser, when the operation of the control knob on this component will permit of perfectly smooth control from the maximum to minimum volume. The capacity of the condenser should be .0003 mfd.

H.F. Leakage

"I have built a receiver on the lines of the Superformer, but with several alterations to make it suit my own requirements. I find that there is a very high-pitched whistle when the receiver is tuned to long waves, although on medium waves the results are not too bad. The whistle seems to start at about 900 metres and gets more intensive as I turn to the top of the long-wave scale. Can you suggest anything which may be causing this and a cure for it?"—F. H. (Cardiff).

RULES

We wish to draw the reader's attention to the fact that the Queries Service is intended only for the solution of problems or difficulties arising from the construction of receivers described in our pages, from articles appearing in our pages, or on general wireless matters. We regret that we cannot, for obvious reasons—

- (1) Supply circuit diagrams of complete receivers.
- (2) Suggest alterations or modifications to receivers described in our contemporaries.
- (3) Suggest alterations or modifications to commercial receivers.
- (4) Answer queries over the telephone.
- (5) Grant interviews to querists.

Please note also, that queries must be limited to two per reader, and all sketches and drawings which are sent to us should bear the name and address of the sender.

If a postal reply is desired, a stamped addressed envelope must be enclosed. Send your queries to the Editor, PRACTICAL AND AMATEUR WIRELESS, Geo. Newnes, Ltd., 8-11, Southampton Street, Strand, London, W.C.2.

WITHOUT a circuit diagram it is not possible to ascertain whether there is any mistake in the circuit arrangement, but it would appear that the trouble is due to leakage of the H.F. currents into the L.F. circuits. The particular values of components which you are using may be the cause of the instability only setting in at certain frequencies. Have you an anode by-pass condenser from the anode of the detector valve to earth? The value of this may prove critical in your particular circuit and you should experiment with various values. It may be found that a value as high as .002 mfd. is required, although high note loss will then be experienced.

The coupon on cover iii must be attached to every query

REPLIES IN BRIEF

The following replies to queries are given in abbreviated form either because of non-compliance with our rules, or because the point raised is not of general interest.

E. T. C. (Watford). You cannot carry out the scheme outlined by you in view of the fact that the H.T. positive lead would be joined to the grid of the L.F. valve. A 1 to 1 L.F. transformer could be used as a coupling component to overcome this difficulty.

L. B. (Bardon Mill). The coil in question would tune approximately from 20 to 40 metres.

L. S. (Leicester). The A.C. unit could be employed with your meter, or you could use an old triode valve as an ordinary half-wave rectifier for the purpose of making A.C. measurements.

F. J. G. (Catterick Camp). It would appear that your headphones are wrongly connected. Perhaps they were modified for some purpose previously, where a lower D.C. resistance was required. The two headphones should be in series, and as the markings may not be correct the individual components should be tested by passing the usual current through them and testing the strength of the magnet. The connections should be made so as to increase the magnetism.

L. A. F. (No Address). The converter could certainly be adapted for use with A.C. supplies by arranging for the necessary heater and H.T. connections.

E. C. (Garstang). There are many different schemes for the purpose mentioned by you, but a circuit diagram would be necessary before we could suggest the most suitable arrangement in your particular case.

H. S. W. (Thornton Heath) and R. C. (Belfast). You have probably omitted the usual tone control across the L.S. terminals, and thus are not actually receiving a deficiency of bass but an over-accentuation of the higher notes. Connect a .01 mfd. condenser and a 10,000 ohms resistance in series across the speaker and this will probably remedy your trouble. For details of the licence, inquire at your local Post Office.

L. G. C. (Norwich). Your eliminator may be unsuitable, and we suggest before carrying out any further tests that you try the receiver with a dry battery. It is possible that some modification may be required to the H.T. supply leads in order to prevent instability, which may be causing your troubles.

F. H. (Barking). Your aerial may be unsuitable. Try removing it entirely, and if, then, the set will oscillate you will know that the present arrangement is unsuitable, either on account of undue length or excessive capacity to earth.

A. M. (Harlesden). It would appear that the by-pass condenser on the receiver side of the choke is defective and is shorting the H.T. supply to earth. Remove this condenser and see if it remedies matters. If so, a new condenser is indicated.

A. E. G. (Northfield). We regret that we cannot give you any information on the circuit, and suggest you communicate direct with the manufacturers.

W. B. (Leeds). The connections are correct but it will probably be necessary either to break the grid connection entirely, so that the radio portion of the receiver is removed when gramophone reproduction is required, or to fit an H.F. choke and by-pass condenser in the leads to the pick-up. A single-pole change-over switch is the most suitable modification, and will cut out the radio side entirely.

J. K. (Liverpool). It would appear that the firm in question are no longer in business.

F. C. S. M. (Edgbaston). The majority of valve rectifiers are designed to give their rated output when loaded with a 4 mfd. fixed condenser, and the use of a larger one may result in damage to the valve. On the receiver side of the smoothing choke any capacity may be used, and the most popular arrangement is to employ an 8 mfd. electrolytic.

C. W. (Salford). We have no details of the component and suggest you communicate direct with the makers concerning the unusual use to which you wish to put it.

E. S. (Dagenham). We have no details of the particular American receiver, and cannot therefore suggest the most suitable modification. If the English representatives cannot help you, we regret that we are not in a position to do so.

A. H. K. (Lancaster). We are sorry that we cannot help you without further details. From your brief remarks it would appear that the rectifier has become damaged.

F. T. (Bristol). It is not possible to give you full transformer winding details from the information supplied. We refer you to back issues, in which the subject of transformer design has been dealt with.

H. B. (Shepherds Bush). The insulated wire would be preferable, and if the sheet of zinc is sufficiently large it will definitely be an improvement. A better scheme would be to use a large mat of copper gauze.

THERE IS NO MYSTERY ABOUT THE PIX

It is a variable condenser specially designed to enable anyone to balance the capacity of the aerial circuit, and so obtain optimum selectivity on any set. Over a movement of 2ins. the range is from .000004 to .000167 mf. (Faraday House Test Report), giving easy adjustment for hair-line tuning.

BRITISH PIX CO., LTD., 118, Southwark Street, S.E.1.

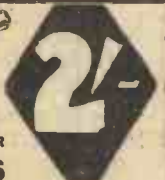

ELECTRADIX



ROTARY CONVERTERS. For A.C. set on D.C. mains, 90 watts output with filter. All in silence cabinet. E. D. Co., as new, 90 watts, £7. Full guarantee.

DYNAMOS, CHARGING OR LIGHTING. 240 watt Enclosed Dynamo, 12/20 v. 12 amps. Ball Bearings, Yee Pulley, Type C. SWITCHBOARD (Marine type) with Ammeter, maximum and minimum Auto Cut-out main-switch and fuses, Field Regulator, etc., 50/-.

DOUBLE CURRENT GENERATORS, D.C., 600 volts 100 m.a., and 6 volts 3 amps, 40/-.

CHARGERS, H.T. and L.T., off A.C. Metal cased, Transf. and Rectifier, 2, 4 and 6 volts, 500 m.a., 60, 90 and 120 volts 100 m.a., complete, 37/6. Larger, 6 volts 2 amps. All in steel case, 57/6.

X-RAY VACUUM DISCHARGE TUBES, only 10/- each. Brand New Government Hospital Surplus. 7" dia. bulb. Big solid Tungsten electrodes. Emission Guaranteed. Cost £3. Sale 10/-.

LIGHT AND RAY CELLS. Selenium Raycraft, 21/-; Kingston, 15/-; Raycraft outfit with relay and amplifier, 45/-; Photo-Cells, for sound on Film, Television and Ray Work, B.T.P., 15/-; R.C.A., 25/-; G.E.C., 25/- to £3 10s. Beck Angle Prisms, mounted in carrier, 5/6. Micrometer adjusters for lens, 1/6. Eyepieces with prism and lenses for photo-cell inspection, 12/6. Service Set Headlamps with Battery Holder, 7/6.

HOME RECORDING APPARATUS. Our machine-made accuracy-cut Trackers are the cheapest on the market. Centre-drive worm. Type F, 4/6. Leadcrew traverse Spindle, Type G.M., 7/6, or fitted Outer Pick-up, 21/-. Sapphire Needles, 3/6. Diamond, 7/6. Blank Discs, 4/- doz.

RECORDING.—Complete Acoustic Sets de Luxe, 21/-; No. 2, 12/6; Junior type, 7/6 each, complete in carton.

THE SUPERSIDER makes H.T. from your L.T. 2-volt battery; rectified and smoothed. Three tapings. Lasts indefinitely. A boon! List £3 15s. New, guaranteed, 37/6.

KEYS.—Morse and Signal, from 4/6. Sounder Buzzers, 5/-. Headphones, 2/6 pair. Bells, best British desk, 2/-. Mains Transformers, 3/6. 1 in. Condensers, 4/-; Telescopes, naval, 25/- and 17/6. Mains Motors, 15/-; 250-watt Dynamos, 25/-.

PARCELS of experimental odd coils, magnets, wire, chokes, condensers, switches, terminals, etc., post free, 10 lbs. 7/-; 7 lbs. 5/-, 1,000 other Bargains in New Sale List "N".

ELECTRADIX RADIOS

218, UPPER THAMES STREET, E.C.4
Telephone: Central 4611.

BARGAINS!

1936 S.G.3 CHASSIS AT LESS THAN COST PRICE

LIST PRICE, OUR BARGAIN PRICE £4.4.0

WE have purchased and offer you at less than cost price the whole of a leading manufacturer's supplies of 1936 S.G.3 Chassis. Each brand new and tested on British and Foreign Broadcasts before dispatch. Circuit comprises: Screened-Grid H.F. Detector and Pentode Output Valves. Screened wave-wound coils. 2-Gang Air Dielectric Condenser. Metal Chassis. Only 9 m.a. H.T. consumption. Illuminated and wavelength Calibrated Dial. Wave range 200-2,000 metres. High quality components.

37/6

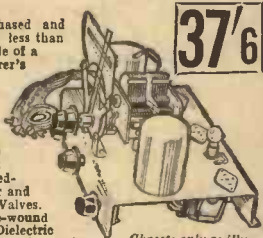

Chassis only as illustrated, less valves.

With black escutcheon and control knobs, less Valves, Batteries and Cabinet. Cash or C.O.D. Carriage Paid 37/6 or fitted in table model cabinet with S.G., Det., and Pentode Output Valves, less Speaker and Batteries, £3/17/6, or 7/- down and 11 monthly payments of 7/3.

PAVILION STR. 3 RECEIVER

Complete in Table Console Cabinet with Det., L.F. and Power Valves, Speaker and Batteries. READY TO PLAY. Cash or C.O.D. Carriage Paid £2 2 0, or 5/- deposit and 8 monthly payments of 5/3.

W.B. SPEAKERS

W.B. 1935 Senior, 25/-; W.B. 1935 Standard, in cabinet, 30/-; W.B. P.M.4, Q.P.P., 25/-; R. & A. Victor, 30/-; R. & A. Multimu, 20/-; R. & A. Alpha, 30/-; Magnavox Energised 2,500-5,000, 7,000-7,500 ohms, 27/6. Manufacturers P.M. 10/6.

WEARITE 2-gang Coil Unit

W.L.Q., W.L.T., with switch and complete with circuit diagram, brand new in manufacturer's carton, 7/6. Guaranteed by the Makers.

NEW TIMES SALES CO. 56 (Pr. W. 3) Ludgate Hill, London, E.C.4
Est. 1924

Practical and Amateur Wireless BLUEPRINT SERVICE

PRACTICAL WIRELESS. STRAIGHT SETS. Battery Operated
One-valve: Blueprints, 1s. each.

	Date of Issue.	No. of Blueprint.
All-Wave Unipen (pentode) ..	14.10.33	PW31A
Two-valve: Blueprints, 1s. each.		
Four-range Super Mag. Two (D, Pen) ..	11.8.34	PW30D
Three-valve: Blueprints, 1s. each.		
Selectone Battery Three (D, 2 LF (trans.)) ..	—	PW10
Alpha Q.P.P. Three (D, Q.P.P.) ..	25.3.33	PW14
Ferrocort Q.P.P. Hi-Mag Three (SG, D, Q.P.P.) ..	25.3.33	PW15
Sixty-Shilling Three (D, 2 LF (R.C. & trans.)) ..	2.12.33	PW34A
Leader Three (SG, D, Pow.) ..	3.3.34	PW35
Summit Three (HF Pen, D, Pen) ..	18.8.34	PW37
All-Pentode Three (H.F. Pen, D (pen), Pen) ..	22.9.34	PW30
Hall-Mark Three (SG, D, Pow.) ..	—	PW41
Hall-Mark Cadet (D, LF, Pen (R.O.)) ..	23.3.35	PW48
F. J. Camm's Silver Souvenir (HF Pen, D (pen), Pen.) (All-wave Three) ..	13.4.35	PW49
Genet Midget (D, 2 LF (trans.)) ..	June '35	PM1
Cameo Midget Three (D, 2 LF (trans.)) ..	8.6.35	PW51
1936 Sonotone Three-Four (HF Pen, HF Pen, Westcort, Pen) ..	17.8.35	PW53
Battery All-wave Three (D, 2 LF (R.C.)) ..	31.8.35	PW55
Four-valve: Blueprints, 1s. each.		
Fury Four (2 SG, D, Pen) ..	—	PW11
Beta Universal Four (SG, D, LF, Cl. B) ..	15.4.33	PW17
Nucleon Class B Four (SG, D (SG), LF, Cl. B) ..	0.1.34	PW34B
Fury Four Super (SG, SG, D, Pen) ..	—	PW34C
Battery Hall-Mark 4 (HF Pen, D, Push Pull) ..	2.2.35	PW40
F. J. Camm's Superformer (SG, SG, D, Pen) ..	12.10.35	PW57

Mains Operated

Two-valve: Blueprints, 1s. each.		
A.C. Twin (D (pen), Pen) ..	22.4.33	PW18
A.C.-D.C. Two (SG, Power) ..	7.10.33	PW31
Selection A.C. Radiogram Two (D, Pow.) ..	29.4.33	PW19
Three-valve: Blueprints, 1s. each.		
Double-Diode-Triode Three (HF Pen, D.D.T., Pen) ..	10.6.33	PW23
D.C. Ace (SG, D, Pen) ..	15.7.33	PW25
A.C. Three (SG, D, Pen) ..	16.9.33	PW29
A.C. Leader (HF Pen, D, Power) ..	7.4.34	PW350
D.C. Premier (HF Pen, D, Pen) ..	31.3.34	PW35B
Ubique (HF Pen, D (Pen), Pen) ..	23.7.34	PW36A
Armada Mains Three (HF Pen, D, Pen) ..	18.8.34	PW38
F. J. Camm's A.C. All-Wave Silver Souvenir Three (HF Pen, D, Pen) ..	11.5.35	PW50
"All-wave" A.C. Three (D, 2LF (R.C.)) ..	17.8.35	PW54
A.C. 1936 Sonotone (HF Pen, HF Pen, Westcort, Pen) ..	31.8.35	PW56
F. J. Camm's Monitor Three ..	8.2.30	PW61
Four-valve: Blueprints, 1s. each.		
A.C. Fury Four (SG, SG, D, Pen) ..	25.2.33	PW20
A.C. Fury Four Super (SG, SG, D, Pen) ..	10.2.34	PW34D
A.C. Hall-Mark (HF Pen, D, Push-Pull) ..	—	PW45
Universal Hall-Mark (HF Pen, D, Push-Pull) ..	9.2.35	PW47

SUPERHETS.

Battery Sets: Blueprints, 1s. each.		
£5 Superhet (three valve) ..	—	PW40
F. J. Camm's 2-valve superhet (two valve) ..	13.7.35	PW52
F. J. Camm's £4 Superhet 4 ..	16.11.35	PW53
Mains Sets: Blueprints, 1s. each.		
A.C. £5 Superhet (three valve) ..	—	PW43
D.C. £5 Superhet (three valve) ..	1.12.34	PW42
Universal £5 Superhet (three valve) ..	15.12.34	PW44
F. J. Camm's A.C. £4 Superhet 4 ..	7.12.35	PW59
F. J. Camm's Universal £4 Superhet 4 ..	11.1.36	PW60

SHORT-WAVE SETS.

Two-valve: Blueprints, 1s. each.		
Midget Short-wave Two (D, Pen) ..	15.9.34	W38A
Three-valve: Blueprints, 1s. each.		
Experimenter's Short-wave Three (SG, D, Power) ..	23.9.33	PW30A

PORTABLES.

Three-valve: Blueprints, 1s. each.		
Atom Lightweight Portable (SG, D, Pen) ..	2.6.34	PW36
Four-valve: Blueprints, 1s. each.		
Featherweight Portable Four (SG, D, LF, Cl. B) ..	6.5.33	PW12

These blueprints are full size. Copies of appropriate issues containing descriptions of these sets can in most cases be obtained as follows:—"Practical Wireless" at 4d., "Amateur Wireless" at 4d., "Practical Mechanics" at 7d., and "Wireless Magazine" at 1/3, post paid. Index letters "P.W." refer to "Practical Wireless" sets, "P.M." to "Practical Mechanics" sets, "A.W." refer to "Amateur Wireless" sets, and "W.M." to "Wireless Magazine" sets. Send (preferably), a postal order (stamps over sixpence unacceptable) to "Practical and Amateur Wireless" Blueprint Dept., Geo. Newnes, Ltd., 8-11, Southampton Street, Strand, W.C.2.

MISCELLANEOUS.
S.W. Converter-Adapter (1 valve) 23.2.35 PW49A

AMATEUR WIRELESS AND WIRELESS MAGAZINE. CRYSTAL SETS.

Blueprints 6d. each.		
Four-station Crystal Set ..	—	AW427
1934 Crystal Set ..	4.8.34	AW444
150-mile Crystal Set ..	—	AW450

STRAIGHT SETS. Battery Operated

One-valve: Blueprints, 1s. each.		
B.B.C. Special One-valver ..	—	AW387
Twenty-station Loud-speaker One-valver (Class B) ..	—	AW440

Two-valve: Blueprints, 1s. each.

Melody Ranger Two (D, Trans) ..	—	AW388
Full-volume Two (SG, Det, Pen) ..	17.6.33	AW392
Iron core Two (D, Trans) ..	—	AW395
Iron-core Two (D, Q.P.P.) ..	12.8.33	AW396
B.B.C. National Two with Lucerne Coil (D, Trans) ..	—	AW377A
Big-power Melody Two with Lucerne Coil (SG, Trans) ..	—	AW338A
Lucerne Minor (D, Pen) ..	—	AW426

Three-valve: Blueprints, 1s. each.

P.T.P. Three (Pentode-Triode-Pentode) ..	June '35	WM380
Class-B Three (D, Trans, Class B) ..	22.4.33	AW336
New Britain's Favourite Three (D, Trans, Class B) ..	16.7.33	AW394
Home-Built Coil Three (SG, D, Trans) ..	14.10.33	AW404
Fan and Family Three (D, Trans, Class B) ..	25.11.33	AW410
£5 5s. S.G.3 (SG, D, Trans) ..	2.12.33	AW412
1934 Ether Searcher: Baseboard Model (SG, D, Pen) ..	20.1.34	AW417
1934 Ether Searcher: Chassis Model (SG, D, Pen) ..	3.2.34	AW419
Lucerne Ranger (SG, D, Trans) ..	—	AW422
Cosor Melody Maker with Lucerne Coils ..	—	AW423
P.W.H. Mascot with Lucerne Coils (D, RC, Trans) ..	17.3.34	AW337A
Mullard Master Three with Lucerne Coils ..	—	AW424
£5 5s. Three: De Luxe Version (SG, D, Trans) ..	19.5.34	AW435
Lucerne Straight Three (D, RC, Trans) ..	—	AW437
All Britain Three (HF Pen, D, Pen) "Wireless League" Three (HF Pen, D, Pen) ..	—	AW448
Transportable Three (SG, D, Pen) ..	3.1.34	AW451
£6 6s. Radiogram (D, RC, Trans) ..	Apr. '33	WM318
Simple tano Three (SG, D, Pen) ..	June, '33	WM327
C.B. Three (D, LF, Class B) ..	—	WM333
Economy-pentode Three (SG, D, Pen) ..	—	WM337
"W.M." 1934 Standard Throo (SG, D, Pen) ..	Oct. '33	WM351
£3 3s. Three (SG, D, Trans) ..	Mar. '34	WM354
Iron-core Band-pass Three (SG, D, QP21) ..	June, '34	WM362
1935 £6 6s. Battery Three (SG, D, Pen) ..	Oct. '34	WM371
Graduating to a Low-frequency Stage (D, 2LF) ..	Jan. '35	WM378

Four-valve: Blueprints, 1s. 6d. each.

65/- Four (SG, D, RC, Trans) ..	—	AW370
"A.W." Ideal four (2SG, D, Pen) ..	16.9.33	AW402
2 H.F. Four (2SG, D, Pen) ..	—	AW421
Crusaders' A.V.C. 4 (2HF, D, QP21) ..	18.8.34	AW445
(Pentode and Class-B Outputs for above: blueprints 6d. each) ..	25.8.34	AW445A
Quadradyne (2SG, D, Pen) ..	—	WM273
Callibrator (SG, D, RC, Trans) ..	Oct. '32	WM300
Table Quad (SG, D, RC, Trans) ..	—	WM303
Callibrator de Luxe (SG, D, RC, Trans) ..	Apr. '33	WM316
Self-contained Four (SG, D, LF, Class-B) ..	Aug. '33	WM331
Lucerne Straight Four (SG, D, LF, Trans) ..	—	WM350
£5 5s. Battery Four (HF, D, 2LF) ..	Feb. '35	WM381
The H.K. Four ..	Mar. '35	WM384

Miscellaneous Advertisements

Advertisements are accepted for these columns at the rate of 3d. per word. Words in black face and/or capitals are charged double this rate (minimum charge 3/- per paragraph). Display lines are charged at 6/- per line. All advertisements must be prepaid. All communications should be addressed to the Advertisement Manager, "Practical and Amateur Wireless," 8, Southampton Street, Strand, London.

RECEIVERS, COMPONENTS AND ACCESSORIES
Surplus, Clearance or Secondhand, etc.

PREMIER SUPPLY STORES
PREMIER SUPPLY STORES
PREMIER SUPPLY STORES

ALL previous bargains advertised are still available. Send 3d. for large illustrated catalogue including Bargain Supplement.

WATCH for next week's special announcement.
PREMIER SUPPLY STORES
20-22, High St., Clapham, S.W.4 (Phone: Macaulay 2381), and 165, Fleet St., E.C.4 (next door to Anderton's Hotel). Phone: Central 2833.

VAUXHALL.—T.C.C. 4 and 8 mfd. Electrolytic condensers, 550, 3/-; 500 v., 2/6.
VAUXHALL.—T.C.C. condensers, tubular, non-inductive, 0.1, 6d.; 50 mfd., 50v. working, 1/6; 50 mfd., 15v., 1/3; 0.05, 6d.; 0.002, 0.0002, 0.001, 0.0001, 4d. each.

VAUXHALL.—T.C.C. mica 0.002, 2,000 volt test, 10d.; 0.001, 6d.; 0.001, 0.01, 1/-; 1 mfd. Mansbridge, 1/3.

VAUXHALL.—Resistances by well-known manufacturers, 1-watt type, 6d. each; all values.

VAUXHALL.—Colvern G.1, G.2, G.3, or G.1, G.2 and G.8. superhet. type, 30/-; Colpaks, £2/4/-.

VAUXHALL.—Volume controls, Eric, Colvern, Centralab, 2/-; with switch, 3/-; all values, from 3,000 to 2 meg., Benjamin, class "B" transformers, 1-13 to 1, 6/6.

VAUXHALL.—Polar station named scales, for horizontal dials, latest settings: 1/9 each.

VAUXHALL.—Polar Midget 3-gang condensers, straight or superhet, 8/9; Polar full vision, horizontal or Arcuate dial and drives, 4/6.

VAUXHALL.—Centre tapped iron cored L.F. transformers, bases, terminals, 110 k/c; 6/6 guaranteed.

VAUXHALL.—Set manufacturers' surplus, skeleton type Westinghouse rectifiers, H.T.8, 9/6; H.T.9, H.T.10, 10/-; complete with fixing brackets; Westectors, W.4, W.X.6, 5/9.

VAUXHALL.—Guaranteed for twelve months: mains energised, 2,500 or 6,500 field coil, 10in. cone, 17/6; 7in. cone, 12/6.

VAUXHALL.—Permanent magnets, universal, suitable for Class "B" power or pentode, 7in. cone, 16/6; 10in. cone, 22/-.

VAUXHALL.—The above complete with hum-bucking coils; state power or pentode transformer; immediate delivery.

VAUXHALL.—B.T.H. Minor, 16/6; Senior needle armature, 20/-; Radiophone, 14/6; others from 10/-.

VAUXHALL.—B.T.H. Trusped gramophone motor 30/-; Universal D.C./A.C., 47/6; sealed cartons.

VAUXHALL.—Collaro 32 model, 32/6; Universal model, 47/6; complete unit, A.C. 200-250v., first quality pick-ups and volume control, 48/-.

VAUXHALL.—T.C.C., 200 mfd, 10-volt, 2/6. Continental valve holders for Universal valves, with terminals, 9d.

VAUXHALL.—Clix valve holders, terminals, 7-pin, 9d., 5-pin, 7d., W.B. 5-pin, 4d.; baseboard mounting, 6d.; post paid 2/6 or over, or c.o.d.

VAUXHALL.—Hivac Valves, all types Mains and Battery in stock for immediate delivery.

VAUXHALL UTILITIES, 163a, Strand, W.C.2, over Denny's, the Booksellers, Temple Bar 9338. Send postcard for lists free.

WANTED, good modern radio sets, parts, etc. spot cash paid; exchanges; bring or send.—University Radio Ltd., 142, Drummond Street, Euston, London, N.W.1.

HIGHEST possible allowance made on your old set or components in part exchange for any new set or Peto-Scott kit. Bargains.—Peto-Scott "Superformer" kit, £2/7/6, "Fury 4," £2/12/6. Lists free. R. Wigfield, Furlong Road, Goldthorpe, Yorks.

BANKRUPT Bargains. List free. All goods new. Highest allowances in part exchange against Mullard Mu 35 and MB3A sets. Get my offer. Amp-hion 5v AC latest 12gn. superhets £7/10/0. Burgoyne Fury 4v AC/DC, £5; Radiogram, 15gn., AC/DC, 10gns. Table radiogram, AC, £7/10/0. Large stock valves. All types AC, universal, American, etc. Very low prices. Electric irons, 3/9. Soldering irons, 1/4. Dual coils, 1/4. MC speakers from 10/6. Get my price for anything radio. Butlin, 6 Stanford Avenue, Brighton. Preston 4030.

N.T.S. BARGAINS in LUCKY DIP PARCELS

Each of these "LUCKY DIP" parcels contains a variety of useful BRITISH components, each of which is either brand new or shop soiled only. We guarantee that every component is a genuine constructor's component and must not be confused with the multitude of manufacturers' surplus or rejects which are at present on the market. Each parcel contains components to a list value of at least four times the price we ask.

ORDER NOW—LIMITED STOCKS

- No. 1** This parcel contains a .0005 air-spaced variable condenser, an L.F. transformer, a binocular choke, 2 resistances, 6 terminals, 1 fixed condenser, 3 valveholders, and 6 blueprints. Total List Value 20/-.
- No. 2** This parcel contains a screened coil, an L.F. transformer, a 3 mfd. condenser, a reaction condenser, a fixed condenser, a fixed resistance, 6 terminals, and 6 blueprints. Total List Value—30/-.
- No. 3** This parcel comprises a 2 gang screened coil unit with switch, an air spaced variable condenser, a vernier dial, an L.F. transformer, a 2 mfd. condenser, a mansbridge type 25 mfd. condenser, a grid leak, a fixed condenser, 2 component mounting brackets, a reaction condenser, an electrolytic condenser, and 6 blueprints. Total List Value—42/6.
- No. 4** This parcel comprises a 3 gang screened coil unit with switch, a slow motion illuminated drive, 2 .0005 air spaced tuning condensers, 1 volume control, 1 4 mfd. mansbridge condenser, 1 L.F. transformer, 1 differential reaction condenser, 1 H.F. choke, 12 terminals, 3 fixed condensers, 3 fixed resistances, 2 component mounting brackets and 6 blueprints. Total List Value—85/-.

FREE with each PARCEL

- Each of the above parcels contains a FREE GIFT of 6 Blueprints giving all the information necessary for building—
- 1. 3-Valve S.G. set.
 - 2. 3-Valve straight 3.
 - 3. Class B. 4-Valve set.
 - 4. Short-wave Adaptor.
 - 5. AC/DC Short-wave Superhet
 - 6. 4-Valve Battery Short-wave Set.

Each of these circuits has been carefully designed, and we have built and tested them to ensure that they are both 100% efficient and easy to assemble and build.

NEW TIMES SALES Co.
56, LUDGATE HILL, LONDON, E.C.4
EST. 1924.

THE FAMOUS H.J.B. VOICE

MICROPHONE



Never in the history of Radio has such value been offered to the Public.

Incorporating Heayberd Transformer. Voice and Song clearly reproduced from any receiver.

H. J. BENNETT
10/6 Post Free.
Trade Enquiries Invited.
287, PENTONVILLE ROAD, KING'S X.
Phone: Terminus 4876.

FOYLES
Booksellers to the World
New and secondhand books on every subject.
Catalogues free on mentioning interests.
119-125 CHARING CROSS ROAD, LONDON, W.C.2
Telephone: Gerrard 5660 (12 lines)

MISCELLANEOUS

CAMM'S PERFECT 8.W.3, Complete Specified Kit, 40/-. MONITOR THREE, 35/-, complete. Cash. C.O.D. Eastway. Bargain List Free.—Melfo-Rad, Queen's Place, Hove. (Trade supplied).

RADIO CLEARANCE
63, HIGH HOLBORN, W.C.1.
TEL: HOLBORN 4631

Owing to increase of business we have found it necessary to remove to larger and more spacious premises at Number 63, High Holborn. All orders in future should be sent to this Address. All orders to the value of 10/- or over, carriage paid in United Kingdom. Orders under 10/- must be accompanied by a reasonable amount of postage.

- "SPECIAL" "SPECIAL"**
 - 70/-** LISSEN 4-VALVE A.C. SET complete in Cabinet with Valves and P.M. Moving Coil Speaker, aerial tested. Few only.
 - 60/-** LISSEN 4-VALVE D.C. SET complete in Cabinet with Valves and Moving Coil Speaker, aerial tested. Few only.
 - 105/-** 4-VALVE A.C. SET. 200 to 250 volts. By well-known proprietary manufacturer. Mullard Valves, Moving Coil Speaker, Band Pass tuned, in handsome Walnut Cabinet. Brand new, boxed. H.P. terms can be arranged on application.
 - 75/-** 4-VALVE A.C. MAINS CHASSIS. 200 to 250 volts. By well-known proprietary manufacturer. Mullard Valves, Band Pass tuned. Brand new.
 - 55/-** LISSEN 4-VALVE A.C. CHASSIS. 200 to 250 volts, complete with Valves, aerial tested. Few only.
 - 47/6** LISSEN 4-VALVE D.C. MAINS CHASSIS. Complete with Valves, aerial tested. Few only.
 - 70/-** LISSEN 100 STATIONS SET. Complete in Cabinet with Valves and P.M. Moving Coil Speaker, aerial tested. Few only.
 - 32/6** LISSEN SKYSCRAPER 3-VALVE BATTERY CHASSIS. Aerial tested, with Valves.
 - 21/-** LISSEN SKYSCRAPER PATTERN CHASSIS. Aerial tested, less Valves.
 - 2/6** LISSEN 2-VOLT BATTERY VALVES. L2 Metallised. Brand new, boxed.
 - 3/6** LISSEN 2-VOLT CLASS B VALVES. Type BB220 A. Brand new, boxed.
 - 8/11** LISSEN RECTIFYING UNITS. Complete with Valves, input 100 to 250 volts. Output 250 volts, 60 M/A. Brand new, in sealed cartons.
 - 5/-** UTILITY 3-GANG MIDGET CONDENSERS. Straight or Superhet with 110 k/c section, fully screened.
 - 2/11** BRITISH RADIOPHONE 3-GANG SUPERHET CONDENSERS. With 110 k/c Oscillator section, unscreened. Wonderful bargain.
 - 2/6** 8 MFD and 4 MFD DRY ELECTROLYTIC CONDENSERS. By well-known manufacturer. 450 volt working, 500 volt peak, brand new.
 - 3/-** LISSEN HANDSOME WALNUT TABLE CABINET. With provision for Speaker, cut out front for Lissen Band Pass 3 Kits. Few only left. Wonderful bargain.
 - 17/6** HANDSOME WALNUT FLOOR MODEL CONSOLE CABINET. An unrepeatable bargain.
 - 1/11** LISSEN CENTRE TAP OUTPUT CHOKES. Brand new, boxed. List price, 7/6.
 - 1/6** LISSEN INTERVALVE SMOOTHING CHOKES. Brand new, boxed. List price, 7/6.
 - 9d.** LISSEN HF By-Pass UNIT. List 5/6. Brand new, boxed.
 - 1/11** LISSEN 3-GANG SUPERHET COILS. Mounted on bass, complete with Switch, unscreened, brand new.
 - 6d.** DRILLED METAL CHASSIS. 3-Valve type.
 - 6d.** 1 WATT RESISTANCES. All sizes, by well-known manufacturer.
 - 6d.** TUBULAR CONDENSERS. All sizes up to .1. By well-known manufacturer.
 - 1/-** 1 MFD CONDENSER. 500 volt working.
 - 1/-** 4 MFD POST OFFICE TYPE MANSBRIDGE, 250 volt working.
 - 2/6** 4 MFD PAPER CONDENSERS. 750 volt test.
 - 6d.** HIVAC VALVES. Complete range in stock. Send for lists.
 - 3/-** LISSEN SPEAKER CABINET, with baffle board, brand new, boxed.
 - 2/11** 2-GANG CONDENSERS, unscreened.
 - 3/11** LISSEN 3-GANG S/H CONDENSER, 126 k/c section, with dial.
 - BRUCE MAINS TRANSFORMERS.**
 - 8/11** 250.0.250 30 m.a. 202 volts 2.5 amp., 202 volts 4 amp.
 - 9/6** 350.0.350 volts 12Q m.a. 202 volts 2.5 amp., 202 volts 4 amp.
 - 11/6** 350.0.350 150 m.a., 202 volts 2.5 amp., 202 volts 4 amp., 202 volts 2 amp.
 - 17/6** 500.0.500 volts 150 m.a., 202 volts 2.5 amp., 202 volts 6 amp., 202 volts 2 amp., 202 volts 2 amp.
 - 8/11** H.T.8. Transformer, 250 volts 60 m.a., 202 volts 4 amp.
 - 17/6** Ditto, with H.T.8 Metal Rectifier.
- All the above transformers are first class manufacture, brand new, fully shrouded.

RADIO CLEARANCE
63, HIGH HOLBORN, W.C.1.
TEL: HOLBORN 4631

BIRMINGHAM RADIOMART SHORT-WAVE SPECIALISTS

Proprietor, G5NI. Manager, G2AK. Staffed by experienced transmitting amateurs. Obviously we can serve you better.

SPECIAL offer, British Radiophone 8-valve colonial all-wave chassis, B.V.A. valves, A.V.C., Shadow-graph tuning, 6in. airplane dial, Magnavox Magna 12in. Speaker, fitted for Gramophone and transposed Aerial. Six only, £9 17s. 6d.

CAUTION: Beware of coilforms, etc., moulded in cheap bakelite. Our coils and formers are guaranteed efficient.

4-PIN interchangeable short-wave coils; set 3. Cover 15-100 metres, latest ribbed former, 7/9.

1 IN. ribbed short-wave coil forms; valveholder type, loloss, 4-pin, 1/6, 6-pin, 1/9. Threaded for winding, 2d. extra.

UTILITY 8/6 microdisc dials, fitted famous micro high reduction, only perfect short-wave dial, 3/11.

SHORT-WAVE H.F. chokes, 6d. *Wireless World* states: "Very efficient—100 to below 10 metres."

UTILITY microvariables 15, 40 mfd., 1/-; 405 kc/s litz wound I.F.'s, 5/6.

RADIOPHONE super ceramic insulated short-wave condensers, .00016, 3/6; series cap, 3/9.

CONTINENTAL A.C. valves, 4/8, VMPT, HPT, VMSG, ACH, ACHL, PT4. Most American types, A.C. Pen., 5/6.

2V. types, H.F. detector, L.F., 2/3; LP2, P2, 2/9; 2 Supper, 3/3; VMPT, HPT, 5/6; Class B, 4/6; S.G., VMSG, 5/-.

BARGAIN parcel value 30/-, containing binocular HFC, 4 750v. test condensers, 6 resistances, 4 valveholders, .0003, .0005 variable, electrolytic condenser, etc., 5/-. Traders' parcel, £4/10/0 value, 10/-.

TELSEN 7/6, Ace transformers made for leading Company, boxed, 1/11.

BALL-BEARING air-spaced condensers; World's finest manufacturers 4-gang, 3-gang superhet, 1/11.

NON-INDUCTIVE condensers by leading makers, T.C.C., Dubilier, etc., 0.5, 0.25, 0.1, 0.02, 0.005, 3d.

ASTOUNDING offer electrolytic condensers, world-famous maker, 4+4 mfd. (separate) 500v., working, 1/6.

GENUINE 15/6 Frost potentiometers, wire-wound, tapered, 10,000 ganged to 50,000 ohms, 1/6.

LISSEN 2-gang coils, 12-2,000 metres, switched and screened, nothing else required to convert 8G3 to all-wave, 12/6.

LISSEN 3-gang bandpass superhet coils, 4/6; 3-gang bandpass Tuned grid, 6/11. All with circuits.

AMPLION, 3/6; screened H.F. choke, 1/11; Iron-cored binocular, screened, 2/3. Climax binocular, 1/3. Telsen, 1/11.

UTILITY 2-gang .0005 Uniknob with large disc drive, 3/11. Ditto, single, with disc, 2/3.

LISSEN 30hy., 40 ma., chokes, 2/-; 20 hy., 100 ma., 2/11. Lissen eliminator chokes, 1/3.

IGRANIC tapered potentiometers 1/2-meg., 1-meg. with 3-point switch, 2/-. Centralab, 1/2-meg., 1/6.

GROSS roundhead woodcrews, assorted, 9d. Solder tags, 6d.; resincore solder, 9ft., 6d.

PUSHBACK connecting wire, ready tinned and sleeved, 8yds., 6d. Heavy, for heaters, 9d.

SCREENED iron-cored selective dual-range coils, with reaction; circuit diagrams, 2/11.

NON-INDUCTIVE tubulars, 1,500 v., 0.01, 0.02, 0.04, 0.05, 0.1, 6d.; 0.2, 0.25, 8d.; 0.5, 9d.

LISSEN 6-way battery leads, with plugs, 6d. Belling-Lee safety mains plug and socket, 6d.

INSULATED terminals, Belling-Lee, black, Telsen, red, black, 1d. Telsen 0.0003 presets, 9d.

TRANSFORMERS B.T.H. speaker; suit all moving coils, 2/11. Manufacturers push-pull, 1/11.

FUSES, Telsen 1/2-amp., 1-amp., 3-amp., 2d. Telsen, 100 ma., 2d.

TELSEN latest differentials, .0003, 1/3; .00015, 1/4. Radiogram transformers, 2/9.

SPECIAL. Four assorted Telsen grid-leaks, 5d.; twelve various wire-ended resistances, 2/6.

MILLIAMMETERS; flush 2 1/2 in., 5/9; 2 1/2 in., 6/9. All ranges above 25 m.a., visual tuning, 6/9.

T.C.C., etc., bias electrolytics, 50 mfd., 50 v., 1/9; 25 mfd., 25 v., 1/3; 15 mfd., 100 v., 1/-; 6 mfd., 60 v., 6d.

RADIOMART

Orders over 6/- post free. Enquirers must enclose stamp.

Catalogues; general catalogue gives hundreds of bargains; short-wave illustrated catalogue also gives diagram of efficient transmitter and receiver each 1 1/2d. Pair 3d., post free.

THE SQUARE DEALERS

19, John Bright St., 22, Summer Row; mail-orders: 44, Holloway Head, Birmingham, Telephone: Midland 3254

G.W.R.'s LATEST BARGAINS

ORMOND RECEIVERS

AT NEARLY HALF-PRICE

ORMOND CLASS B RECEIVERS

This low consumption set is housed in magnificent grained WALNUT CABINET. Fitted with TWO matched MOVING-COIL Speakers, and covers wave range of 200/550 and 1,000/2,000 metres. Provision is made for PICK-UP and EXTENSION SPEAKER, complete with MULLARD VALVES, C.A.V. Battery and EXIDE Accumulator. Size of cabinet, 24ins. long x 11ins. x 10ins. Brand New and Fully Guaranteed in Maker's Own Cartons.

SPECIAL 14 DAYS' OFFER

£3/19/6 (List £7/10/-)

59 only Ormond A.C./D.C. Mains Receivers complete with 3 Mullard Valves and Barretter, Moving-Coil Speaker, Wave range 200/550 and 1,000/2,000 metres. Provision for Extension Loudspeaker and Gramophone Pick-up. Brand new and fully guaranteed, in sealed cartons, listed £7/10/-, our price £4/10/-, carriage paid. Cash with order or deposit and balance C.O.D. Money refunded if not satisfactory within 7 days.

G. W. RADIO,

7, Chapel Street, Lamb's Conduit Street, London, W.C.1.

Phone: Holborn 4434.

EASY PAYMENTS

"THERE'S NO PLACE LIKE HOLMES."

SPEAKERS	Deposit.	Monthly Payments
W.B. DUPELX	84/-	7/8
W.B. SENIOR	42/-	4/7
W.B. JUNIOR	32/8	4/5
BLUE SPOT	19/8	2/8
ROLA F. 720	35/-	3/10

Any make of speaker supplied.

KIT SETS	Deposit.	Monthly Payments
LISSEN Skyscraper 3, with valves ..	60/-	5/6
GRAHAM FARISH STENTORIAN A. 34/8	34/8	3/10
GRAHAM FARISH Sensitivity Snapper ..	50/-	4/7
B.T.S. OCEANIC 3	55/-	5/-
B.T.S. S.W. ADAPTOR	62/8	4/10

ACCESSORIES	of merit and fine value.
3 VALVES S.G.D.P.	25/- 3/8
ATLAS ELIMINATOR T. 10/30	69/8 6/-
AVOMINOR METER	40/- 5/8
B.T.H. LATEST PICK-UP	40/- 4/5

PARTS FOR ANY SET. ANY MAKE OF SPEAKER.

New goods obtained for every order. Send us a list of parts or valves you require or any speaker or set you may select and we will forward you a definite quotation. Ten years' advertiser in the Wireless Press. Thousands of satisfied customers.

H. W. HOLMES:

NEW ADDRESS: 333, EUSTON ROAD, LONDON, N.W.1. Phone: Museum 1414.

"ENGINEERING OPPORTUNITIES" FREE!



This unique Hand-book shows the easy way to secure a M.I.C.E., A.M.I.Mech.E., A.M.I.E.E., A.M.I.A.E., A.M.I.W.T., A.M.I.R.E., and similar qualifications.

WE GUARANTEE—NO PASS—NO FEE.

Details are given of over 150 Diploma Courses in all branches of Civil, Mech., Elec. Motor, Aero., Radio and Television Engineering, Building, Government Employment, etc.

Write for this enlightening Hand-book to-day FREE and post free.

British Institute of Engineering Technology, 409, Shakespeare House, 17, 18, 19, Stratford Place, W.1.

RECEIVERS, COMPONENTS AND ACCESSORIES

Surplus, Clearance or Secondhand, etc.

SOUTHERN RADIO'S WIRELESS BARGAINS, ALL GOODS GUARANTEED NEW AND SENT POST PAID.

SPEAKERS.—Celestion Soundex Permanent Magnet, 11/-; Telsen Permanent Magnet Speakers, 16/- Telsen Units, 2/9.

LISSEN KITS, ALL NEW IN SEALED CARTONS AND COMPLETE. With Specified Valves. Lissen Skyscraper 3-Valve Battery Kits, 42/- each (List, 77/6). Lissen BAND PASS 3-Valve Battery Kits, 62/6 (List, 99/8).

DEEMARK SHORT-WAVE ADAPTOR KIT. Complete with all accessories for adapting set for 14-150 Metres, 20/- Superhet Short-wave Converter Kit, 20/-.

MULLARD M.B.3. THREE-VALVE BATTERY SETS. Complete with 3 Mullard Pentode Valves, Permanent Magnet Speaker, Batteries and Accumulator. Contained in handsome walnut cabinet, £5/7/6 (List, 8 guineas). In original sealed cartons.

G.E.C. A.C./D.C. 3-VALVE RECEIVERS. Ring Valves. Universal Mains and Voltage. Complete in exquisite Cabinet, ready to plug-in, £3/19/6 (List £7/15). Not a midget.

HOUSE TELEPHONES. A SPECIAL BARGAIN. BRAND NEW ONE-HAND TELEPHONES. Complete on stand, with or without Automatic Dials. Cost £4 each to manufacture, 10/- each.

ELIMINATORS.—Regentone 1935 Series. A.C. Mains, 200/250 volts, Type W5a, complete with trickle charger, 30/6; W1a (less trickle charger)—carries 30 milliamps, 33/- W1c (less trickle charger), 30/- Telsen Latest Model A.C. Eliminators with trickle charger for 10, 20 or 30 milliamps, 45/- (List £4/15/-).

CONDENSERS.—Lotus 0.0005. Fully screened, with trimmers, escutcheons, dials and knob. 3-gang, 11/-, 2-gang, 7/3. DYBLOCK SINGLE, 0.0005, complete with all accessories, 4/- TELSEN SINGLE VARIABLE CONDENSERS, 0.0005, 2/3.

COILS.—Igranic Superhet Coil, set of four (1 Osc., 2 I.F. with Pigtales, 1 I.F. plain), 9/- per set (List, 50/-). Varley Square Peak Coils, B.P.5, complete, 2/3. Telsen Iron-core Coils, W349 midget size, 4/6 each.

The following Telsen Components in original sealed cartons at sacrifice prices:—

ACE L.F. TRANSFORMERS.—5/1, 2/9; Binocular H.F. Chokes, 2/-; Standard Screened H.F. Chokes, 2/-; ACE MICROPHONES (P.O.) with Transformers, 5/- each. This Microphone can be used with any radio set and is a very efficient article.

TRU-OHM RESISTANCES, 1 watt wire ends, colour coded and marked, 36 on card, assorted capacities, 7/6 per card.

AMERICAN VALVES.—A full range of valves for all American sets at 7/- per valve.

SOUTHERN RADIO BARGAIN PARCELS.—We are offering the following parcels of mixed components at a fraction of their value. The items comprise up-to-date Radio parts, new and perfect, which are too varied to be advertised individually. —

5/- PARCEL.—Contains modern components valued at £20/-, including Resistances, Condensers, Coils, Wire, etc. Circuits of modern Receivers included with each parcel.

SOUTHERN RADIO, 323, EUSTON ROAD, S LONDON, N.W.1 (near Warren Street Tube). Phone: Museum 6324.

SOUTHERN RADIO Branches at 271-275, High Road, Willesden Green, N.W.10; 46, Lisle Street, W.C.2. All Mail Orders to 323, Euston Road, London, N.W.1.

The following unused set manufacturers' Surplus; all goods guaranteed perfect; immediate delivery. **MAGNAVOX** speakers complete with hum-bucking coil, output transformers, etc. DC152 (9in. cone), 22/6. DC154 (7in. cone), 16/- All with 2,500 or 6,500 ohms fields.

WESTINGHOUSE rectifiers, HT8, 9/6. HT9, 10/-. HT10, LT5, LT4, 10/9. Regentone transformers for HT8 or HT9, with 4v. 4 amp. LT winding, 7/- Eliminators, first-class make. Outputs 150v. 25 ma., SG and Detector. AC type with Westinghouse rectifier, 25/- AC type with 5 amp trickle-charger, 30/- DC type, 12/6.

DUBILIER or TCC dry electrolytic condensers 8 mfd. or 4 mfd., 500v. working, 50 mfd., 50v., 200 mfd., 10v., 3/3. 50 mfd., 15v., and 15 mfd., 100v., 2/3. 50 mfd., 12v., 2/- TCC type "M" condensers, any value up to .001 mfd., 6d. Erie resistances, 1 watt type, 7d., 2 watt, 1/2, 3 watt, 1/9. Send for comprehensive list.

CONVERSION Units for converting D.C. Receivers to A.C. Mains operation up to 80 watts, £2 each. **ARD, 46, Farringdon Street, London, E.C.4.** Telephone: Holborn 9703.

NEW RECEIVERS, COMPONENTS, AND ACCESSORIES

ALL-WAVE A.C. Fife, £9/9/0. Novo Radio St. John Street, Newcastle-on-Tyne 1.

HULBERT for Quality Surplus Speakers. All Music Lovers should write for List of amazing bargains. Prices from 8/6 brand new. Made by best known British maker.—Hubert, 6, Conduit Street, W.1.

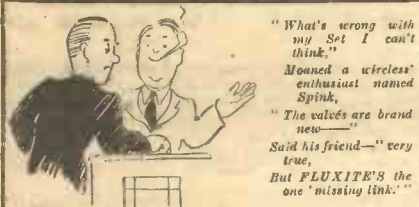

"What's wrong with my Set I can't think,"
Moaned a wireless enthusiast named Spink,
"The valves are brand new—"
Said his friend—"very true,
But FLUXITE'S the one 'missing link.'"

See that FLUXITE is always by you—in the house—garage—workshop—wherever speedy soldering is needed. Used for 30 years in government works and by leading engineers and manufacturers. Of Ironmongers—in tins, 4d., 8d., 1/4 and 2/8.

Ask to see the FLUXITE SMALL-SPACE SOLDERING SET—compact but substantial—complete with full instructions, 7/6.

Write for Free Book on the art of "soft" soldering and ask for Leaflet on CASE-HARDENING STEEL and TEMPERING TOOLS with FLUXITE.

TO CYCLISTS! Your wheels will NOT keep round and true unless the spokes are tied with fine wire at the crossings AND SOLDERED. This makes a much stronger wheel. It's simple—with FLUXITE—but IMPORTANT.

THE FLUXITE GUN

is always ready to put Fluxite on the soldering job instantly. A little pressure places the right quantity on the right spot and one charging lasts for ages. Price 1/6.



ALL MECHANICS WILL HAVE

FLUXITE

IT SIMPLIFIES ALL SOLDERING

FLUXITE LTD. (Dept. W.P.) DRAGON WORKS, BERMONDSEY STREET, S.E.1.

Piano Tone

RADIO GRAM CABINETS

As supplied to B.B.C.

65/- POLISHED 35/- CABINET FOR No Middle Posts

Famous maker offers finest Radio Furniture. As supplied to B.B.C., a quality and value impossible to better. Beautifully hand-polished! GUARANTEED Piano-tone acoustically.

DIRECT—on FREE TRIAL (or 10/- monthly) LIFT FREE From makers

PICKETT'S

Piano Tone

Cabinet (P.R.) Works, Albion Road, Bexleyheath, near London.

GEARYS' LEAD AGAIN

The new five-valve universal "LOTUS COMPACT," giving medium and long waves, illuminated aeroplane dial calibrated in metres, energised moving-coil speaker, 3 pentodes, British type Triotron valves, no flexible resistance, operates on full voltage, giving increased efficiency, consumption only 50 watts. Gives truly wonderful results from British and many foreign stations. Size 10 x 8½ x 7 in., suitable for A.C. or D.C. mains, any £3/17/6 CARR. PAID

Cash with order or C.O.D.

J. J. GEARY & SONS, 196, Canterbury Road, W. Croydon.

MISCELLANEOUS

REPAIRS.—Moving Coil Speakers. Complete Rewinding Service for Transformers, etc. Receivers Repaired. Trade Discount.—Weedon's Radio Repair Service, 202, Romford Road, London, E.7. Maryland 1782.

RECEIVERS, COMPONENTS AND ACCESSORIES

Surplus, Clearance or Secondhand, etc.

MILD MAY RADIO Offers The Following Brand New Bargains. All in sealed boxes.
 14/- REGENTONE DC mains units, Type D.C.1. Listed @ 39/6.
 15/- RADIOPHONE Pickups, complete with built-in volume controls, list price 30/-.
 37/6 BKCO Latest type AC mains units with trickle charger for 2, 4, or 6 volt accumulators.
 4/6 TELSEN Screened Iron Core Coils. Type W.349. 15/-, Telsen Triple Matched coils, iron core, type W.349.
 2/6 TELSEN Class "B" Driver transformers. 2/6, Telsen Class "B" Output transformers.
 2/3 TELSEN Screened All Wave HF chokes. 1/9, Telsen Standard Screen HF chokes. 2/-, Telsen Short Wave HF chokes screened. 1/6, Telsen Standard HF chokes.
 4d. each. Telsen Tubular. Tag and Fixed Mica Condensers. Spaghetti and 1 Watt resistors. 7-pin, also 4-pin holders, Grid leaks. All sizes and values.
 MILD MAY RADIO EXCHANGE, 6 & 8 Pentonville Road, London, N.1.

SHORT WAVE on a crystal set. Full building instructions and crystal 1/2 post paid.—Radionial, Tanworth-in-Arden, Warwickshire.

NEW RECEIVERS, COMPONENTS, AND ACCESSORIES

CLARION VALVES.—All brand new; battery types P.2 2/6; H.2, HL.2, L.P.2, 1/9; super power P.2 2/6; screens and L.F. pentodes, 3/9; A.C. mains, 4-volt, 1 amp, general purpose, 3/3; power, 4/-; screens and L.F. pentodes, 4/6; full-wave rectifiers, 3/6; postage paid, cash with order, or C.O.D. over 10/-.—Clarion Valves, Dept. 2, 885, Tyburn Road, Erdington, Birmingham.

UNIVERSAL RADIO BARGAINS.—Celestion Soundex Moving Coils, 9/11. Cosmocord Pick-Ups, with Arm and Volume Control, 9/11. Telsen Eliminators, with Trickle, 30/-. Electric Soldering Irons, 2/6. Stal Class B Transformers, 2/3. Mullard M.B.3 Battery Receivers, complete, 5 Gns. All-Wave Battery Sets, 6 Gns. Mains, ditto, 8 Gns. K.B. Universal Mains Superhet Consoles (List 19 Gns.), £10/5/0. Above are all brand new and in original cartons. Thousands of other bargains. Stamp for list.—"UNIVERSAL," 94, Grove Vale, East Dulwich, S.E.22.

MISCELLANEOUS

REPAIRS to Moving Coil Speakers, Cones and Coils fitted or rewound. Fields altered. Prices Quoted including Eliminators. Loud-speakers Required, 4/-. L.F. and Speech Transformers, 4/- Post Free. Trade invited. Guaranteed. Satisfaction. Prompt Service, Estimates Free. I.S. Repair Service, 5, Balham Grove, London, S.W.12. Battersea 1321.

BIG INTRODUCTORY OFFER.

Suitable valves for each kit by well-known manufacturers included at the kit price to all purchasers of one of our new low-priced home construction kits.

"AIR CUB" short-wave, 15-55 metres, band-spread, dual-band switching, 12s. 6d. All-wave, 13-2,000 metres. 18s. 6d.

"LITTLE SCOUT" short-wave band-spread III, dual-band 15-55 metres, 22s. 6d. All-wave 13-2,000 metres, 30/-. Continental III, 180-2,000 metres, 15s. 6d.

"AIR CUB" dual-band 15-55 metres, s.-w. adaptors, band-spread, 10s. 6d. Superhet s.-w. converter, ditto, 18s. 6d.

"SCOUT" two-note constructor's valve buzzer L.F. oscillator kit, for Morse practice, 12s. 6d. Morse keys (adjustable), 3s.

Enclose also 3d. stamps to-day for complete lists. Hundreds of component bargains covering every need. Will save you pounds.

MONITOR 3 KITS 27/6

PREFECT BAND-SPREAD S.W. III KITS, 30s. Really good kits, including grey cellulosed pressed steel chassis, ready drilled exact to specification. Includes specified B.T.S. coils, Polar drives, etc. Terms: Cash or C.O.D. Post: Kits, 1s. Components over 10s. post free. Anglo-American Radio Distributing Corporation (Dept. 8), 1 Lower James St., Piccadilly Circus, London, W.1. (Gerrard 3040).

FREE ADVICE BUREAU COUPON

This coupon is available until February 22, 1936, and must be attached to all letters containing queries.
 PRACTICAL AND AMATEUR WIRELESS, 15/2/36.

The Specified Valveholders

For The "MONITOR 3"

Clix Standard Type (V.1.)
 4-pin - 8d.
 5-pin - 9d.



Specified Because:—

All Clix components, in addition to giving Perfect Contact, are easy to wire; for instance, in Clix Chassis Mounting Valveholders the centre socket of the 5-pin and two sockets of the 7-pin type are made longer than the others; this reduces the possibility of short-circuits and adds to the ease of wiring.

Mr. F. J. Camm is a firm believer in the efficiency of all Clix types of Valveholders, he consistently specifies

CLIX

Latest List "N" free

LECTRO LINX LIMITED, 79a, Rochester Row, London, S.W.1

IT PAYS TO BUY THE BEST

ULTRA S.W. COILS

The coils are wound with 14g. copper wire, heavily silver-plated. The mean diameter is 2". A Frequentite base is used for mounting purposes.

- No. 1020. 3-turns, 1/6.
- 4-turns, 1/6.
- 5-turns, 1/7.
- 6-turns, 1/8.
- 8-turns, 1/10.

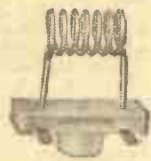

ULTRA SHORT-WAVE H.F. CHOKES

These chokes are single layer space wound on DL-9 formers, and have an exceedingly low self-capacity.

- No. 1011. D.C. Resistance 1.3 ohms. Price 1/3.
- No. 1021. D.C. Resistance 1.4 ohms. Price 1/3.

EDDYSTONE MICRODENSER

No. 900. For Ultra Short Waves from 5-10 metres, DL-9 insulation. Low-series resistance at high frequencies. Noiseless operation.

- 15 m.mfd., 3/9.
- 40 m.mfd., 4/3.
- 100 m.mfd., 5/-.

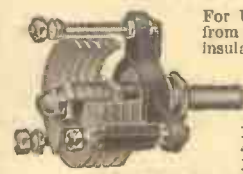

STRATTON & CO., LTD., Bromsgrove St., BIRMINGHAM
 London Service Depot: Webb's Radio Stores, 14, Soho Street, Oxford Street, W.1.

EDDYSTONE

SHORT WAVE COMPONENTS

Full of Beautiful Photographs

HIS MAJESTY
KING EDWARD VIII

6^D

THE life of King Edward as Prince of Wales is a record of worthy achievement, of work well done and an intense eagerness to serve his people. At home and abroad, in the humble cottage, in trade and industry, his sincerity has gained for him that same love and devotion that was bestowed by all upon the late King.

"HIS MAJESTY KING EDWARD VIII" is a book which tells the story of his life from his birth at White Lodge in Richmond Park, on June 23rd, 1894. It tells of schooldays, of the robust atmosphere of Dartmouth, of his life at Oxford University as an ordinary undergraduate, of his work during the war, of his visits to every part of the Empire and South America, and of his splendid social service.

Profusely illustrated in photogravure, it is a book that you must have in your home. Make sure of it to-day—hours of most interesting reading and many beautiful photographs.

Published every Wednesday by GEORGE NEWNES, LIMITED, 8-11, Southampton Street, Strand, London, W.C.2, and Printed in Great Britain by THE NEWNES & PEARSON PRINTING Co., LTD., Exmoor Street, London, W.10. Sole Agent for Australia and New Zealand: GORDON & GOTCH, LTD. South Africa: CENTRAL NEWS AGENCY, LTD. *Practical and Amateur Wireless* can be sent to any part of the World, post free, for 17s. 6d. per annum; six months, 8s. 10d. Registered at the General Post Office as a newspaper and for the Canadian Magazine Post.

6^D

ON SALE
FRIDAY,
FEB. 14

Published by
George Newnes, Ltd.,
London, W.C.2.

Of all Newsagents
and Bookstalls.

THE MONITOR—THE 2ND STAGE!

Practical and Amateur Wireless

3^D
EVERY
WEDNESDAY

Edited by F.J. CAMM

a GEORGE
NEWNES
Publication

Vol. 7, No. 179.
February 22nd, 1936.

AND PRACTICAL TELEVISION



THE HOME MECHANIC ENCYCLOPAEDIA

By F. J. CAMM (Editor of "Practical Mechanics" etc.)

With
627

Illustrations

An up-to-date and comprehensive guide to the Mechanical, Scientific and Technical Interests of the day—with expert articles on Aircraft, Television, Models, Astronomy, Electricity, Photography, Chemistry, Woodwork, Motor Cars, Wireless, Home Cinema, etc., etc. From all booksellers or 4/- post free from—

GEORGE NEWNES, LIMITED, 8-11, SOUTHAMPTON STREET, STRAND, LONDON, W.C.2.

Only
3/6
net

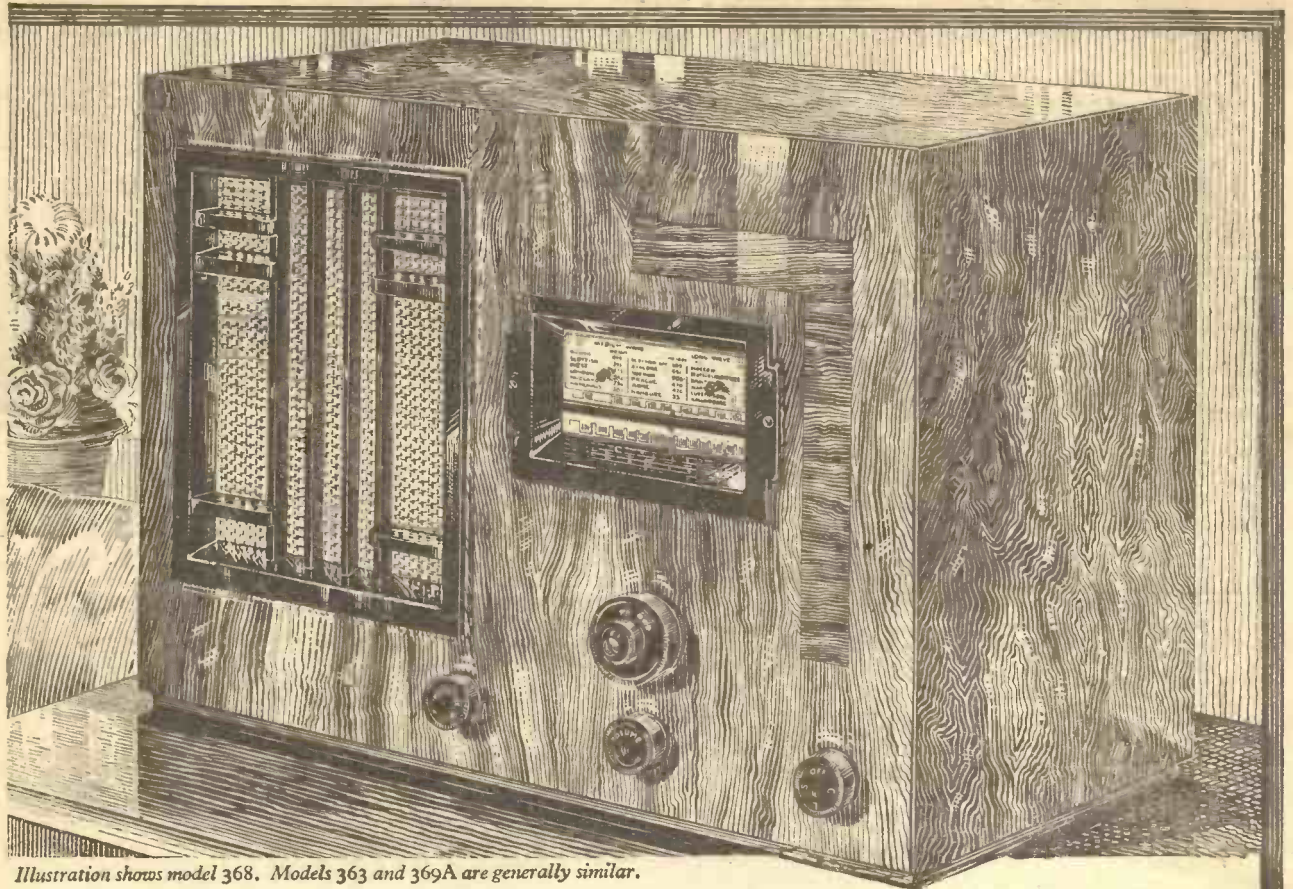

Illustration shows model 368. Models 363 and 369A are generally similar.

COSSOR RADIO

THIS Cossor Receiver is available in three splendid Models. All incorporate the latest "Super-Ferrodyne" developments. Their selectivity is exceptionally good. Due to the Cossor H.F. Pentodes in H.F. stage and Detector stages, a high degree of distortionless amplification is assured. All models are fitted with full-sized

Moving Coil Loud Speakers carefully matched to give a quality of reproduction which is really magnificent—rich, clear and true-to-life. Other Cossor Receivers are illustrated and described in our catalogue—send coupon to-day.

To A. C. COSSOR LTD., Melody Dept., Highbury Grove, London, N.5.
Please send me, free of charge, a copy of your latest catalogue in full colour giving details of Cossor Receivers and Radiograms.

Name

Address

B.29 PRAC. 22/2/36

Three Splendid Models

Battery Model 363

With Variable-mu H.F. Pentode, H.F. Pentode Detector, Economy Pentode Output. Super-selective iron-cored coils. Provision for Pick-up and Extension Speaker. 8" Moving Coil Speaker. Price **£6.15s.**
(without batteries)

H.P. Terms: 13/- deposit and 11 monthly payments of 13/-.

A.C. Model 368

With Variable-mu H.F. Pentode, H.F. Pentode Detector, Triode Power output. Heavy duty Rectifier. Super-selective iron-cored coils. 8" energised Moving Coil Speaker. Provision for pick-up and extension speaker. For A. C. Mains 200/250 volts adjustable 40/100 cycles. Price - **£8.8s.**

H.P. Terms: 14/6 deposit and 12 monthly payments of 14/6.

D.C./A.C. Model 369A

Universal type. Variable-mu H.F. Pentode, H.F. Pentode Detector, Super-power output, indirectly heated Rectifier. Super-selective iron-cored coils. 8" energised Moving Coil Speaker. For D.C. 200/250 volts (adjustable) and A.C. 200/250 volts (adjustable) 50-100 cycles. Price - **£8.8s.**

H.P. Terms: 14/6 deposit and 12 monthly payments of 14/6.

Prices do not apply in I.F.S.

F. J. CAMM'S MONITOR—TOP OF ITS CLASS!



Practical and Amateur Wireless

Edited by F. J. CAMM

Technical Staff:
W. J. Delaney, H. J. Barton Chapple, Wh.Sch.,
B.Sc., A.M.I.E.E., Frank Preston.

VOL. VII. No. 179, February 22nd, 1936.

ROUND *the* WORLD of WIRELESS

Radio for the London Fire Brigade
EXPERIMENTS are being carried out in radio transmission from cars equipped with apparatus to permit communication with headquarters when the brigades are dealing with fires. This would supplement the telephone system now existing between H.Q. and the various stations.

Improved Reception of U.S.A. Broadcasts

THE recently resumed series of B.B.C. broadcasts featuring *Five Hours Back* from the U.S.A. have demonstrated the progress made in the reception of transatlantic transmissions during the past few months. At the B.B.C. Tatsfield station three separate receivers coupled to three different aerials are used to pick up the broadcast, and by this means much fading has been eliminated.

Round-the-World Radio

PREPARATIONS are being completed by the B.B.C. for a special celebration of Empire Day in May. Not only shall we be taken round the Empire, but may be given as an "extra" a relay of a broadcast from the new Radio Jerusalem station.

Proposed Move of Radio-Paris

WITH the inclusion in the French State Network of the new P.T.T. high-power Paris station, the Authorities are seriously thinking of transferring the transmitter of Radio-Paris to a site in central France and thus provide a long-wave relay for the whole country.

Radio Television and Publicity Programmes

IN view of the cost of the new television service in France, a suggestion has been made to the Ministry of Posts and Telegraphs to defray a portion of the expenses by organising sponsored televised programmes, at least during the months in which experimental tests are to be made. Offers from publicity firms have already been made, by which the Government can be guaranteed a fixed monthly revenue of half a million francs!

Interesting Statistics

ACCORDING to figures published in the United States of America, it is computed that at present there are

56,221,784 radio receiving sets in the world. Of these North America alone owns 25,632,881, with Europe a close second possessing 22,897,981. Asia is represented by 2,553,396, of which Japan's share is 2,190,040. South America, notwithstanding its great number of stations, can only show 1,088,374, and Africa is last on the list with 209,201.

Proposed Television Transmissions in Sweden

FOLLOWING the example of Germany, England, and France, Sweden is shortly to have its first television service.

ON OTHER PAGES

	Page
A Useful Valve-Voltmeter ..	723
Simple Wireless Arithmetic ..	725
For The Experimenter ..	727
Practical Television ..	730
On Your Wavelength ..	731
The Monitor—Second Stage ..	735
Modern Coil Connections ..	737
Beginners Supplement ..	738
Short-Wave Section ..	741
Readers' Letters ..	744
Impressions on the Wax ..	745
Club Notes ..	747
Queries and Enquiries ..	749

The *Svenska Radioaktiebolaget* has erected two transmitters at Stockholm and will shortly carry out tests.

The Salzburg Music Festival

THIS annual festival will take place in the period July 25th-August 31st, and as in previous years the most important concerts and operatic performances will be broadcast through most European and American transmitters. Four of the leading conductors have already been engaged for the Festival; they are Toscanini, Weingartner, Bruno Walter and Monteux.

Another Station for Paris

RADIO MIDI (Beziers), is to close down shortly and the plant transferred to the French capital. It has been acquired

by a Paris daily, *Paris Soir*, which is the third newspaper to own a private broadcasting station. The Radio Midi transmitter will be re-erected at Rueil-Malmaison. Whether it will be allowed to work on its wavelength of 209.9 metres (1,429 kc/s) is a moot point, as the channel is very close to that used by the Eiffel Tower, considering the respective sites of the stations. The power employed is 300 watts.

Radio Telegrams to Yachts

ON 163.3 metres, the channel used by coast stations for calling ships, the G.P.O. transmits telegrams in telephony at specified times, for the benefit of yacht owners whilst cruising. The service is carried out by all post office coast stations with the exception of those at Rugby and Portishead.

Nearly 7½ Million British Listeners

WITH a total population in Great Britain and Northern Ireland of roughly forty-six million inhabitants, the British Isles can boast of nearly 7½ million licensed listeners. Taking an average of four persons to each receiver, we can assume that thirty million people hear the B.B.C. programmes daily.

At the Bottom of the Band

FREQUENTLY below the Bournemouth and Plymouth channel (203.5 metres), broadcasts may be occasionally picked out of the welter of small Belgian and Spanish stations working on wavelengths between 201 and 203 metres. Of these the Belgian are the most frequently heard, and from their calls may be identified as Radio Wallonic (Binche) on 201.8 metres, Châtelaineau-Charleroi, Radio Anvers (Antwerp) on 201.1 metres, which have different time schedules.

Viennese Nights

WITH the New Year, the Austrian stations have extended their daily transmission until midnight, and offer, from roughly G.M.T. 22.25, dance music relayed from the most popular hotels, restaurants, and palais de danse in the capital. In addition, on certain nights a visit is made to some of the resorts of the Prater, the "Earl's Court" of Vienna.

ROUND the WORLD of WIRELESS (Contd.)

Festival Choral Society's Concert

THE Birmingham Festival Choral Society is one of the oldest musical societies in Birmingham, having been founded ninety-one years ago, and it has nearly 200 active members. For its annual concert this year, to be broadcast on February 20th from the Midland Regional,

INTERESTING and TOPICAL PARAGRAPHS

give a programme in the evening of February 27th. This combination has had contracts for resident seasons at Cheltenham and Malvern. It was begun by

THE NEW COSSOR ALL-MAINS SET.



Eddie Hapgood, the well-known back of the Arsenal football team, and International captain, tunes in on his new Cossor receiver. This is an all-mains model (367) and is priced at 9½ guineas.

the City of Birmingham Orchestra has been engaged, and the work to be given is Dvorak's cantata "The Spectre's Bride." Harold Gray is the conductor. The soloists are May Blyth (soprano), Parry Jones (tenor), and Watcyn Watcyns (bass)

"Blackbirds" in Carlisle

THOSE two popular coloured comedians, Battie and Porter, who scored such a hit in "Blackbirds," head the variety bill at Her Majesty's Theatre, Carlisle, on February 26, when an excerpt from the show will be broadcast to Northern listeners.

"I Remember"

IN the series of personal recollections from Wales and the South West, the fifth talk will be given by E. J. Plaisted in the Western Regional programme on February 22nd. Mr. Plaisted has fought two Parliamentary Elections: the Isle of Thanet in 1929, and Salisbury in the General Election last November. He worked in the coal-mines for twenty-five years and has been unemployed for five years. Mr. Plaisted possesses a voice with unusual vibrations, and it was always a source of amusement to his parents in his childhood when the sound of his voice caused objects to vibrate in sympathy. In his own words: "When I came near the bath in my home my voice invariably made the bath give forth a terrific rumble."

Dance Music

BILLY GAMMON and his Star Players, a recent addition to broadcasting dance bands in the Midland region, will

Billy Gammon and Ken Lancey. Three of the members—Ken Lancey, Al Brown and Jim Donnelly—also form a vocal trio.

Debate on Land Settlement

THE question whether land settlement offers an effective alternative to mass unemployment has been brought into prominence by the talks given by S. L. Bensusan after a rural survey of the Midland counties. Under the chairmanship of Lord Phillimore, this question is to be discussed at the microphone in the Midland regional programme on February 21st. Mr. Bensusan leads off for the affirmative, and is seconded by Robert Aldington, J.P., who farms in the Vale of Evesham, and has contested the Evesham Division in the Labour interest. For the negative, the first speaker is a well-known authority on agricultural economics, C. S. Orwin, Director of the Research Institute of Oxford University, author of a number of books, and a former President of the Agricultural Section of the British Association. His second, F. S. Milligan, comes from the North. He has had experience of urban unemployment at a social service centre on Merseyside.

Rugby Town Band

THIS popular band, which was founded sixty years ago, will give a programme of marches and overtures; William Compton will conduct. One of the oldest Midland broadcasters, Charles Dean, of Birmingham, is to sing a group of baritone solos. Just before the band concert, which will be given

on February 28th, one of the popular original entertainments by Ronald Gourley, who is a Warwickshire man, will be broadcast.

Cinema Organ Recital

THIS relay of a cinema organ, which is to be broadcast on February 24th, is a new feature in Midland programmes. The Forum Theatre, Coventry, was opened about sixteen months ago, and Lew Harris, then at the Commodore, Southsea, was appointed organist. Mr. Harris, who is to give this recital, studied under Reginald Foort at Bournemouth. In childhood he was keenly interested in music, but on leaving school he qualified as a marine engineer and draughtsman, and it was not until he was twenty-two that he became a professional musician as pianist-leader of the resident dance orchestra at the Empress Rooms, Portsmouth. In the days of the British Broadcasting Company, he broadcast two pianoforte recitals from the Bournemouth station.

Music-hall Memories

MIRIAM FERRIS, the popular music-hall artist who has been well known in radio for many years, will, on February 22nd, produce the second of her amusing programmes called "Music-hall Memories." The idea of these programmes is based on Miriam's unique connection with Savoy Hill and early radio. They entail considerable research work. This versatile artist first has to find out what Savoy Hill music-hall stars will be available on a certain date and then to discover what material they used in those far-off days. After arranging her programme—with frequent disappointments owing to cancellations—she, eventually, writes up her commère material and presents it to the Variety Director at St. George's Hall. As a rule the whole programme is perfectly balanced and a gem of production, for Miriam Ferris knows her music-hall from "gods" to stage door. She will have the assistance of Alma Vane, now so well known for her "All Girls Together" parties, Tommy Handley, Jean Allistone, Foster Richardson, John Rorke, and Florence Oldham.

SOLVE THIS!

PROBLEM No. 179.

Jackson built a 465 kc/s superhet, but was disappointed to find that the selectivity was not as good as he had expected. What steps should he take to improve the selectivity? Three books will be awarded for the first three correct solutions opened. Address your letters to the Editor, PRACTICAL AND AMATEUR WIRELESS, Geo. Newnes, Ltd., 8-11, Southampton Street, Strand, London, W.C.2. Envelopes must be marked Problem No. 179 in the bottom left-hand corner, and must be posted to reach this office not later than the first post Monday, February 24th, 1936.

Solution to Problem No. 178.

The whistle which troubled Jones was due to the fact that the internal wiring of the L.F. transformer was reversed. Reversal of the external leads to the G. and G.B. terminals of this component should provide a remedy.

The following three readers successfully solved Problem No. 177, and books are accordingly being forwarded to them: William Eastham, 172, Wellington Rd., Eccles, Manchester; G. Wooldridge, The Limes, South Rd., Stourbridge. Wores; J. A. Milton, 45, Tyzack Rd., Sheffield-8.

An Efficient Valve - Voltmeter

An Easy-to-build Portable Type of Meter which has Many Useful Applications to the Keen Experimenter

Fig. 1.—The complete instrument being placed in the neat carrying case.

MANY constructors purchase a simple type of voltmeter in order to make various test readings of batteries under working conditions and also in order to ascertain whether or not the valves in a receiver are receiving the correct working potentials. But a voltmeter, or a measurer of voltages, can be made to perform a very much greater service than this, provided that it is designed in a certain manner. In a cheap meter, the visible indication of the voltage applied across the ends is carried out by the movement of a piece of iron suspended in a magnetic field, and, owing to the fact that the resistance of a meter of this type is very low, a high current is passed and thus in many circuits and tests a false reading is obtained.

A better class of instrument employs a moving coil connected to the pointer, and this particular type of instrument is wound to a very high resistance and thus operates with a very small current. Consequently, it has a much greater field of utility and can be used under more general conditions. There are, however, certain conditions under which even an instrument of this

values. Any change in any one of these voltages will result in a change in the current flowing in the anode circuit, and it is found that by maintaining the filament and anode voltages constant and changing the applied grid voltage, it is possible, by a simple law, to ascertain the degree of change in such voltage simply by the change in the anode current.

The usual difficulty with such an instrument is to maintain a constant setting of the anode current with a deteriorating H.T. or L.T. supply, and this is one of the defects which has been overcome in the instrument now being described. This has been developed in the Graham Farish Laboratories and, in view of the novelty of the complete arrangement, we thought that

nature is of little use, and then it is essential to call to aid the valve voltmeter, in which the measurement of voltage is carried out by applying it to the grid circuit of a valve and measuring the change in anode current.

readers would be interested in the design, and accordingly we have made arrangements to publish the full wiring diagram and constructional details.

A Portable Instrument

From the photographic illustrations it will be seen that a neat carrying case is provided, and this may be obtained, with the necessary internal supporting structure, direct from Messrs. Graham Farish. The valve which is employed is of the screen-grid type, and it has been found that this

(Continued overleaf)

How it Operates

For the benefit of those to whom this type of instrument is not familiar, it may be briefly stated that a valve gives a certain emission of current when the filament, grid, and anode voltages are adjusted to definite

10,000 OHMS POT METER AND 3 POINT SWITCH

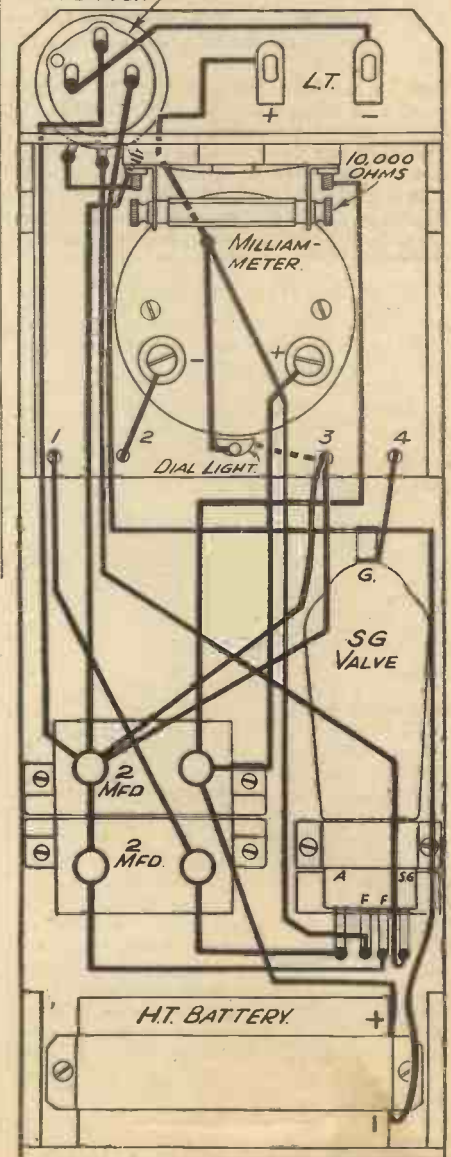

Fig. 3.—Wiring diagram showing all the connections.

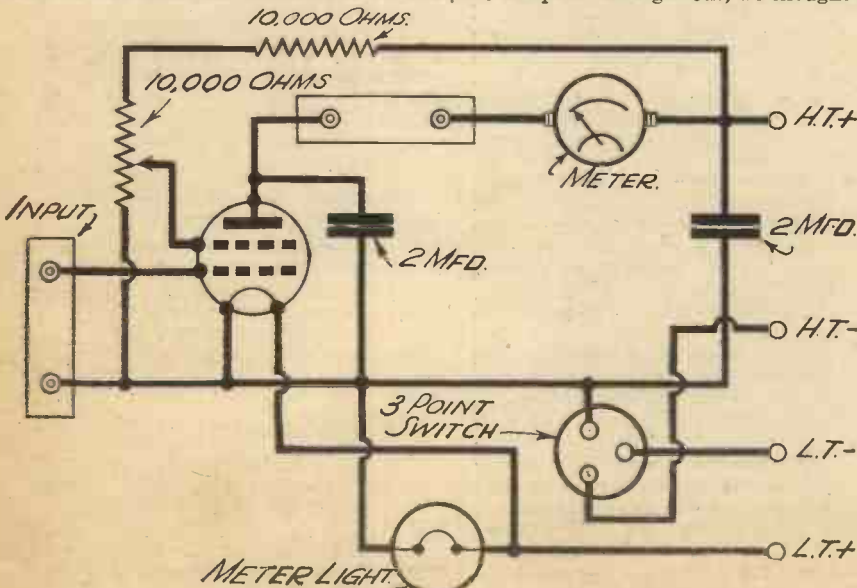

Fig. 2.—Theoretical circuit of the valve voltmeter.



Fig. 4.—This sketch shows the front of the instrument and the connections to the input and loading terminals.

may be employed with a varying screen voltage to compensate for the falling H.T. supply, as well as to set the meter to zero for use when taking measurements. No valve-holder is specified for this valve, and it is simply held on the bottom of the cabinet by means of a strip of brass or other metal bent across the ceramic base of the valve and screwed direct to the wooden cabinet base. The leads from the valve are soldered direct to the valve legs and the terminal cap, and to simplify construction these connections should be made before the valve is placed in position.

The small L.T. battery is held in position on the upper shelf, whilst the H.T. battery must be retained by means of a clip con-

structed from a strip of brass or aluminium. This may be made up to any individual idea, provided that it holds the battery firmly in place, and, as this will not need renewing very often, there is no necessity to introduce any form of quick release.

The Dial Light

In order to facilitate easy reading, the original model is provided with a small bulb enclosed in a metal screen arranged at such an angle that the light is thrown on to the face of the meter. This light is operated from the L.T. battery and, in view of the very small capacity of this battery, it is essential that the additional load imposed by the lamp shall be extremely low. A special bulb must, therefore, be employed, and on no

account should a pocket lamp bulb be used for the purpose.

Using the Voltmeter

The meter may be employed for measuring the output voltages of amplifying stages, pick-up characteristics, valve characteristics, and numerous other purposes where it is essential that the additional load of the measuring instrument must be extremely small. The source to be measured is joined to the two clips, and the reading obtained on the meter is used as the basis for computing the voltage applied across the clips. In the instrument as described the maximum reading is 2 volts, and it is, therefore, necessary to ascertain roughly the magnitude of the applied voltage in order that suitable adjustments may be made to accommodate any voltage which is in excess of that shown by the meter. For this purpose, the anode circuit is broken and two terminals are provided on the front of the instrument. Normally, for the low ranges these terminals will be kept bridged by means of a piece of wire, and in the original model this is mounted on a small strip of paxolin provided with two lugs, so that it may easily be slipped into the terminals and held in position. Resistances may be similarly mounted for inclusion in this part of the circuit in order to modify the range, and a number may be made up on small strips and kept handy, with a suitable indication on the paxolin strip to indicate the difference in the meter reading. A calibration chart would be very useful with this instrument in order to avoid working out each range, and these may be included in the form of a small booklet kept with the instrument.

LIST OF PARTS FOR USEFUL VALVE-VOLTMETER

- One "Laurence" cabinet (Graham Farish).
- One SWG2 short-wave valve (Graham Farish).
- One 10,000-ohm combined potentiometer and 3-point switch (Dubilier).
- One milliammeter type M.C.1 (Bulgin).
- One terminal mount "Pop" with two terminals (Graham Farish).
- One Formo clip mount (Formo).
- Two 2-mfd. fixed condensers (Graham Farish).
- One 10,000-ohm Ohmite resistance and holder (Graham Farish).
- One low-consumption dial light (Graham Farish).
- One 2-volt dry cell, type Gel-Cel PRP3 (Exide).
- One H.T. battery, Type X.325 (Exide).
- Wire, strip, brass, screws, etc.

To Track That Fault—to learn how a wireless receiver works, obtain

EVERYMAN'S WIRELESS BOOK

by F. J. Camm, 5/-, or 5/6 by post from George Newnes, Ltd., 8-11, Southampton Street, Strand, London, W.C.2.

"Tale Twisting"

WEST COUNTRY folk who had such extraordinary experiences to tell listeners in the programme called "Tale Twisting" on January 29th last will come again to the microphone on February 26th, to tell of the adventures they have had in the interval. Honest John Plym is flying back from the Pacific so as to be in time to spin his latest yarn, and perhaps the item of greatest West Country interest will be the story of King Arthur and what he did with the Round Table. "Tale Twisting" will be repeated on February 27th in the Regional programme.

Theatre Variety

A RELAY of a variety bill on February 26th from Aston Hippodrome will be preceded by reminiscences of the history of this theatre, which has been a home of variety since 1908. The Aston Hippodrome is under the same ownership as the Coventry Hippodrome, and Charles Shadwell, who conducts the orchestra at the latter theatre for broadcasting, is also in charge of the music at the Aston theatre. The resident conductor is Ernest Moss. The theatre has recently been renovated so as to provide up-to-date amenities but without sacrificing the intimate atmosphere of the old music-hall. In the variety bill to be broadcast, Henschel Henlere is the chief turn.

PROGRAMME NOTES

"The Dreaming Man"

THIS is the title of a play, by Leonard Crabtree, which will be broadcast from the Regional on March 5th, and from the National on March 6th. The spirit of the play is very similar to the now famous radio comedy "Matinée." In this case, a rather Wellsian character, the same type of man as the hero of "The Purple Pileus," rather disgruntled with his life both domestically and otherwise, experiences in an intermittent dream one summer afternoon a more complete wish fulfilment of worldly success than most of us are able to conjure up in similar dreams. The audience goes with him in the impossible and entertaining situations which his dreaming mind conjures up, as he leaps to wealth and power without having to undergo any of the intermediate processes which are unavoidable in the world of real fact. The producer, Lance Sieveking, is going to treat the play in somewhat the same manner as he treated his radio version of "Emil and the Detectives," where the nightmare in the train attracted so much attention among listeners. The fact that the hero is dreaming will be conveyed in a most convincing manner.

"Nets in the Sea"

THE second talk in the series called "Nets in the Sea," under the general editorship of Lieutenant W. B. Luard, will be given on February 28th in the Western Regional programme. This series of talks deals with West Country fishing. In Cornwall there are about two thousand men employed in various forms of fishing, of which the pilchard drift fisheries, the herring fishery, long-lining, and shell fishing (crab, lobster, and crayfish) are undoubtedly among the best known.

Police Musicians

THIRTY-FOUR Yorkshire police constables, constituting the Military Band of the City of Sheffield Police, will broadcast from the Leeds studios on February 25th. The band was originally formed as a brass band; it passed out of existence during the War, and in 1926 was reorganised as a military combination. In 1933 Major F. S. James, the Chief Constable, secured the appointment of E. W. Hesse, of the Seaforth Highlanders, as bandmaster. Since then the band has progressed and now ranks as one of the country's leading military bands. Sir Henry Coward, Sheffield's "Grand Old Man" of music, has always taken a keen interest in the band, and has on several occasions acted as its "guest" conductor.

Simple Wireless Arithmetic

It is Not Necessary to be a Mathematician to Make the Few Simple Calculations Entailed by Wireless Constructional Work, and This Article Deals With the Most Important of the Calculations Involved. By FRANK PRESTON

THERE are many constructors who do not enjoy their hobby to the full because they will not take the small amount of trouble necessary to enable them to make the few simple calculations required to determine, say, the correct value for a decoupling or bias resistance, the wavelength range which can be covered when using a certain coil and variable condenser, or the sizes of resistances required to form a fixed potentiometer. It is often thought that the arithmetic involved is of a difficult nature, or that the equations are for mathematicians only, whereas the calculations are often a good deal simpler than those required to draw up a cricket analysis or in working out the sums that are regularly done at school by boys of twelve; the only real difference is that a little knowledge of wireless practice is required in addition to that of arithmetic.

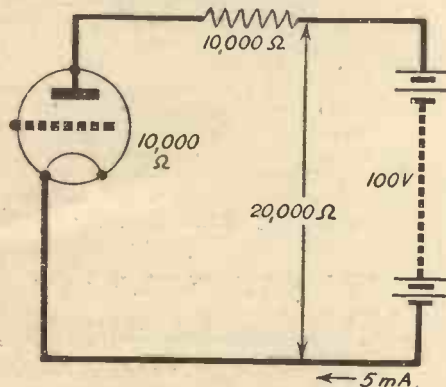

Fig. 1.—A simple circuit which shows the relationship between current, voltage and resistance.

Ohm's Law

Of all the calculations that must be made time after time that in connection with resistance values is the commonest, as well as being the easiest. All calculations involving resistance, current and voltage, are based on Ohm's Law, which states that the current flowing in a circuit is always equal to the voltage causing the flow divided by the resistance which tends to oppose it. Thus, if a voltage of 100 were applied to the simple circuit shown in Fig. 1, the current passing through it would be 100 divided by 20,000, which is 1/200 of an amp. It is generally more convenient to work in terms of milliamps, which are one-thousandths of an amp., so that the figure becomes 5 m.A. The simple circuit shown is typical of all valve anode circuits, and the fixed resistance might be a coupling resistance or it might represent the resistance of a transformer or other component.

The formula for Ohm's Law which we have just used is written, in mathematical terms, thus: $I = \frac{E}{R}$, where I is the current

in amps., E is the voltage, and R is the resistance in ohms. This simple and useful formula can be re-written in at least two other ways in order to make it more convenient when the voltage or resistance is required, the other two factors being

known. For example, we could write: $R = \frac{E}{I}$, or $E = I \times R$.

Bias Resistance Value

Let us see how it works out when we want to find the value of the bias resistance shown in Fig. 2. In this case it is known that the current passed by the resistance (the anode current of the valve) is 10 m.A., and that the required voltage drop across the resistance—the bias voltage—is 20. The required resistance is obviously found by dividing 20 by 10 and multiplying by 1,000 (to change the milliamps into amps.), and the answer is 2,000 ohms.

A SPECIAL ARTICLE FOR THE BEGINNER. FACTS AND FIGURES SIMPLIFIED.

Now suppose that in the circuit shown in Fig. 1, we know that 5 milliamps is required to flow through the valve and that the resistance of the valve is, say, 5,000 ohms, while the anode resistance has a value of 10,000 ohms; we want to know the voltage necessary to ensure the correct current. All that we need to do is to multiply the current in amps. by the resistance in ohms, and we get $5/1,000 \times 15,000$, which is 75 volts.

Once we have seen these applications of Ohm's Law it is not difficult to apply it to all resistance, voltage and current calculations, when two of the values are known and the third is required.

Resistance-Wattage Rating

There is another application of Ohm's Law which must be used when it is required to find the correct wattage rating for a resistance. Power, in watts, is actually the product of the voltage and the current, in amps., but we often know the current passing and the resistance value of, say, a coupling resistance, without knowing the

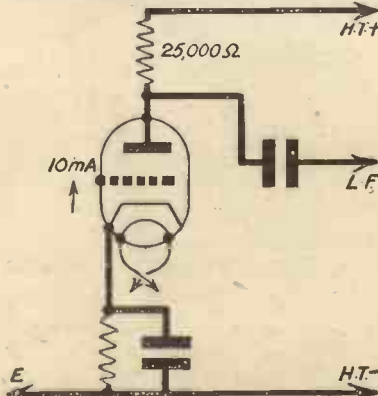

Fig. 3.—In order to determine the wattage rating of an anode resistance, it is necessary to know its resistance rating, and the current passing through it.

exact voltage dropped across the resistance. But it is not difficult to see from the above equations that wattage can be determined from the formula: $W = I^2 R$. In words, this formula reads: the wattage is equal to the current in amps. multiplied by itself and by the resistance in ohms. Thus, in Fig. 3 we have a resistance value of 25,000 ohms and a current of 10 m.A.,

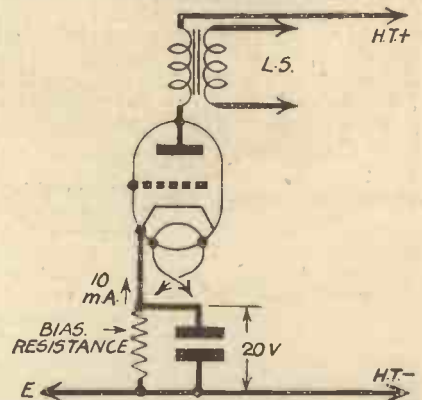

Fig. 2.—The method of determining the correct value of a bias resistance can be understood by reference to this circuit.

or 1/100 amp. We see, therefore, that the power in watts which is dissipated (or

lost) is $1/100 \times 1/100 \times 25,000$, or $\frac{25,000}{10,000}$

which is obviously 2.5 watts. Having made this calculation we know that the resistance used in this circuit must be rated at not less than 2.5 watts, and we should generally use a 3-watt component to provide a sufficient factor of safety; a resistance of lower wattage rating would be liable to burn out in use, due to the resistance being overloaded.

It might not be clear to some readers how the expression $I^2 R$ was found from the original Ohm's Law equations to be the same as ER —voltage multiplied by resistance—or, in other words, how I^2 was found to be the same as the voltage drop. But we

(Continued overleaf)

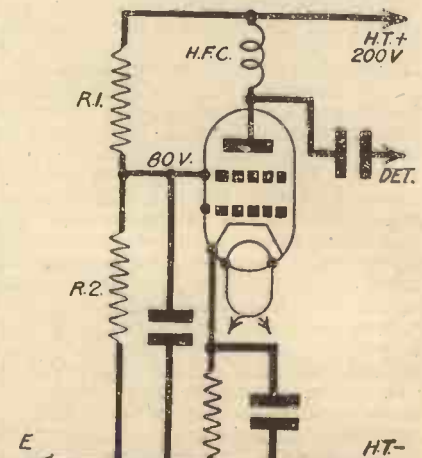

Fig. 4.—Several interesting points arise when calculating the values of resistances required for a fixed screening-grid potentiometer.

SIMPLE WIRELESS ARITHMETIC

(Continued from previous page)

saw that the voltage drop (E) is equal to I multiplied by R, and if also we multiply this by I we get the expression I²R.

Finding the Wavelength Range

Now let us turn to another simple piece of arithmetic which is not difficult to follow. Suppose it is required to find the highest wavelength that can be reached when a coil of 2,200 microhenries (a typical long-wave coil) is used in parallel with a .0005-mfd. tuning condenser. The wavelength is found by using the equation: wavelength = $1,884\sqrt{L \times C}$ where L is the inductance of the coil in microhenries, and C is the capacity of the condenser in microfarads, the wavelength being in metres. We have first of all to multiply together the inductance and capacity, and then to find the square root of the result, and finally to multiply this by 1,884. Taking the first step we get $2,200 \times .0005$, or

$$\frac{2,200 \times 5}{10,000}$$

which works out to 22/20; when this is multiplied by 1,884 we get as the result 2,082.4, this being the wavelength in metres.

If the required wavelength and coil inductance were known, the correct capacity could be found by reversing the calculation, and in the same manner the correct inductance could be determined from a knowledge of the wavelength and capacity. These calculations are slightly more involved, however, and since it is rarely necessary to use them, we will not consider them further.

Screening-grid Potentiometers

In the opening paragraph mention was made of finding the values of resistance required in forming a fixed potentiometer,

and this is a problem which often crops up in connection with an S.G. valve of which the screening grid is supplied from a potentiometer as shown in Fig. 4. If the screening grid did not pass any current, the two resistances would have values proportional to the maximum supply voltage and the voltage required. In other words, if the H.T. supply delivered a voltage of 200 and 80 volts was required for the screening grid, the upper resistance, marked R.1, could have a value of 60,000 ohms and the lower one, marked R.2, a value of 40,000 ohms. Alternatively, values of 30,000 and 20,000 ohms could be used. It will be seen from this that the first step is to decide upon the approximate total resistance; with a mains set a maximum value of 50,000 ohms is generally suitable, and with a battery set, 100,000 ohms can be used successfully.

In the above assumption of no current we simply made the lower resistance of such a value that its proportion to the total was the same as the proportion between the required voltage and the total H.T. voltage—2 to 5, but let us see what would happen if the screening grid passed 1 m/A. The voltage drop occasioned by the upper resistance would be 1/1,000 multiplied by, say, 30,000, or 30, and thus, the voltage actually applied to the screening grid would be 80 less 30, or only 50 volts. Consequently, either the resistance marked R.1 must be reduced in value, or that marked R.2 must be increased. This apparent peculiarity is due to the fact that the cathode screening-grid circuit is in parallel with the lower resistance, thus reducing its effective value. It is possible to evolve an equation from which the exact values of resistance could be determined, but it is generally better for the non-mathematical constructor to use trial-and-error calculations, and working on the lines indicated above, until suitable values are found.

Series and Parallel Resistances

In dealing with resistance calculations above we did not consider the effect of connecting resistances in series and in parallel. If resistances are placed in series the effective value is, as might be supposed, equal to the sum of the resistances. Thus, if resistances of 500, 1,000, and 20,000 ohms were joined in series, the total value would be 21,500 ohms. When they are joined in parallel the result is entirely different, and the effective resistance of the combination is, mathematically speaking, equal to the reciprocal of the sum of the reciprocals. This expression is simplified if written:

$$\text{Total R} = \frac{1}{1/R_1 + 1/R_2 + 1/R_3}$$

etc. This means that if the three resistances mentioned above were connected in parallel the effective value could be found by adding together: 1/500, 1/1,000, and 1/20,000, which equals 61/20,000, and reversing this to 20,000/61, which gives the result as approximately 330 ohms. It will be noticed that this is less than the value of the smallest resistance.

Condensers in Series and Parallel

When two or more condensers are used together the effective capacity is found by reversing the methods described in respect of resistances. Thus, when condensers are joined in parallel, the total capacity is equal to the sum of the capacities of the individual components. When condensers are in series the resulting capacity is equal to the reciprocal of the sum of the reciprocals. If, for example, a .0005-mfd. condenser is connected in series with one of .0003-mfd., the resultant

$$\text{capacity is } \frac{1}{1/0005 + 1/0003}$$

which is $\frac{1/8}{.0015}$ or $\frac{.0015}{8}$ which is .0002-mfd. approximately.

Popular Radio Turns

EDGAR WALLACE'S "On the Spot," "Mrs. Buggins Sees Stars," and the "Air-do-Wells" were the three most popular radio turns of the week ending December 14th according to the results of the second of the competitions organised by the Radio Co-operative Advertising Committee.

A play has again come out on top; in the first competition Clemence Dane's "A Bill of Divorcement" received by far the most votes. Radio comedians, who in the first week were accused of being dull and out of date, have made a triumphant come-back. More than 25 per cent. of the entrants favoured Variety performances, and specially commended the comedians.

Old-fashioned dance music was preferred to jazz; Geraldo's orchestra in "Dancing Through" and Hamer's in "Old Time Dance Tunes" had three times as many votes as Ambrose, Henry Hall, and Jack Payne. This apathy for modern dance music may be due to the fact that the best time for broadcasters was clearly established as between 8 p.m. and 9 p.m., when all the five most popular turns were on the air. Light classical music was much appreciated, particularly that in "The Table under the Tree."

Lord Snowden's account of Keir Hardie was the most popular talk. Otherwise there was little enthusiasm for talks or the news, though a number of women chose the announcement of the safety of the three girl hikers as the happiest turn. Several listeners regarded broadcast services as the most important item of the week.

HERE and THERE

B.B.C. Symphony Orchestra to Visit Leicester

THE B.B.C. Symphony Orchestra, under the direction of Adrian Boult, will appear twice in the provinces in the spring before starting on its Continental tour to Paris, Zurich, Vienna, and Budapest.



Here is Stanelli, of Horn-chestra fame, listening to his Cossor radiogram.

Its first visit will be to Leicester on March 11th, when Dr. Boult will conduct an attractive programme. Opening with Weber's Overture to "Euryanthe," a piece of romantic music that time has not robbed of its freshness and appeal, the orchestra will then play Beethoven's Sixth Symphony (the "Pastoral"), which will be the main item in the programme. In the second part, modern music will be represented by four numbers from Gustav Holst's "The Planets," and Ravel's "Pavane" and "Bolero," all of which works will afford the full B.B.C. Symphony Orchestra every opportunity to exhibit its fine qualities. The four Planets chosen are Mars, Mercury, Saturn, and Jupiter, representing the contrasting moods of ferocity, sprightliness, serenity, and joviality.

Mid-land music-lovers will welcome especially this opportunity of admiring once again the B.B.C. Symphony Orchestra's rendering of "Bolero," which is being played on this occasion in response to a general demand. This brilliant orchestral "tour de force" brings a well-chosen programme to a fitting close.



FOR THE EXPERIMENTER

SERVICING SETS FOR PROFIT

7—A Method of Calibration, and Some of the Uses of the Valve-Voltmeter Described Last Week are Dealt With in this Seventh Article of the Series

THE previous article in this series dealt with the theoretical considerations and constructional work necessary in the manufacture of a simple type of valve-voltmeter, and it is now proposed to show the method by which this instrument may be calibrated, and a scale produced to enable voltages of any frequency to be read on the 0-1 milliammeter incorporated in the multi-range meter.

It will be observed that we have provided a space on the front panel of the instrument or a calibration scale to be gummed on,

voltage, as their voltage will remain reasonably constant with a current drain of 24 milliamperes, over the short period which we shall use to make measurements. The accumulator or dry cells, and the 250-ohm potentiometer, should be connected up as shown in Fig. 3, but the actual connection to one terminal of the voltage supply should only be made when calibration is in progress in order to limit the current drain imposed and maintain the voltage as stable as possible.

Connections and Adjustments

Now connect the H.T., L.T., and G.B. batteries to the valve-voltmeter, making sure that the switch is "off" before doing so, and connect the milliamp. terminals of the universal meter to the "meter"

terminals of the valve-voltmeter. The positive terminal of the universal meter should be connected to the "meter" terminal of the valve-voltmeter which is connected internally to the H.T. positive plug, and the switch should be set at 1 m.A. The multiplier potentiometer is then rotated in a fully anti-clockwise direction, i.e., to ratio 1, and the 20,000-ohm variable anode resistance mounted on the base-board set until the whole of the resistance element is in circuit. Now switch on the valve-voltmeter, and it will be noticed that the pointer of the universal meter gives a little "kick" and then returns to a very low reading on the

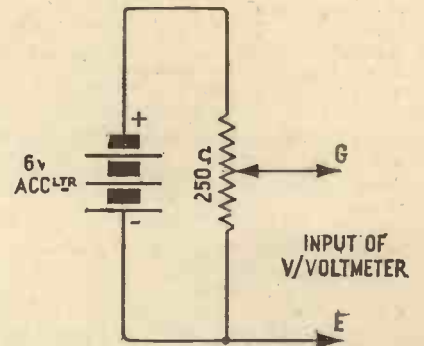

Fig. 3.—Theoretical circuit of the calibration apparatus.

scale. It might be thought that the 25-ohm zero-adjusting potentiometer on the front panel should now be set so that zero was actually indicated on the milliammeter, but this is not the case, owing to difficulty in ascertaining the exact setting at which the milliammeter reads zero. A much more satisfactory method, and the one adopted in this case, is to adjust the 25-ohm potentiometer until the pointer of the milliammeter reads .02 milliamp., or, in the case of the Ferranti instrument used by the writer, to the first small division on the scale. This point will now become the zero point for the voltage scale of the valve-voltmeter, and the meter should always be checked before making measurements to ensure that, under the foregoing conditions, a true zero is indicated.

The valve-voltmeter should now be switched off, the multi-range meter disconnected, and its 10-volt D.C. range

(Continued overleaf)

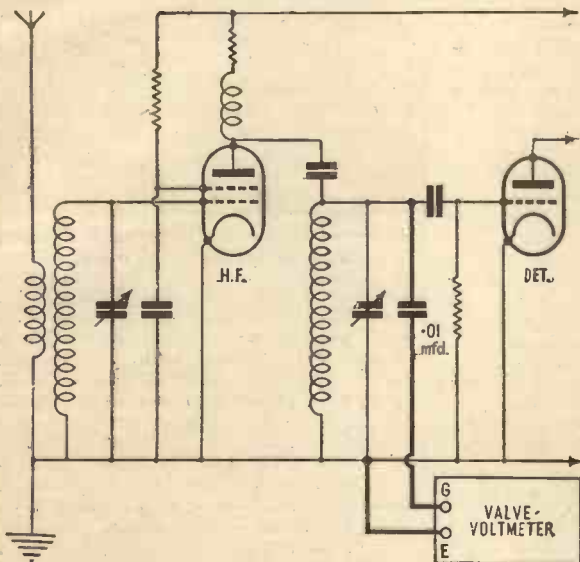

Fig. 1.—Method of measuring the voltage developed across a tuned circuit.

and also, that a circular white paper scale is to be gummed to the panel under the knob of the 1-megohm multiplier potentiometer. Alternatively, if the surface of the panel is matt-finished aluminium, it is quite possible to omit these paper scales and draw the calibration points on the metal itself in Indian ink, afterwards covering the markings with a coat of colourless cellulose lacquer.

Before we commence calibration it will be necessary to procure a 6-volt accumulator, and a 250-ohm variable potentiometer. If it is inconvenient to get a 6-volt accumulator, four large-capacity dry cells may be used to supply the calibration

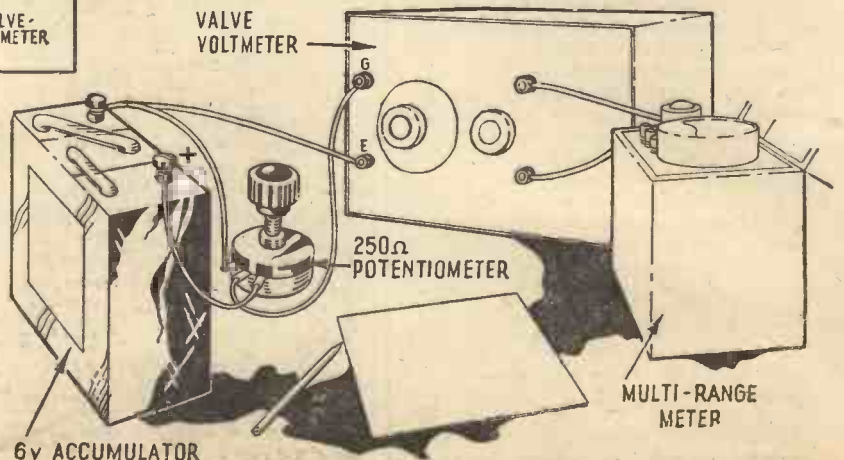

Fig. 2.—Adjusting the zero reading.

FOR THE EXPERIMENTER

(Continued from previous page)

connected across the leads from our calibrating voltage supply marked G and E, and the 250-ohm potentiometer varied until exactly 5 volts (or half-scale deflection) is registered. Then re-connect the universal meter to the "meter" terminals of the valve-voltmeter and the calibration leads G and E to their appropriate input terminals as shown in Fig. 2. Switch on the valve-voltmeter, and it will be found that the pointer of the universal meter will now give a reading somewhat higher than the zero reading which we previously selected. By rotating the 20,000-ohm resistance on the baseboard until the universal meter reads exactly 1 milliamp., the scale will be set to read 5 volts between .02 milliamps. and 1 milliamp. It may be advisable now to disconnect the calibration voltage by removing one of the leads from the accumulator, or dry batteries, and to note that the pointer of the milliammeter falls immediately to our previously selected zero position. If it does not do so, a slight readjustment of the zero-adjusting potentiometer will be necessary. The internal 20,000-ohm resistance will not need re-setting unless the characteristics of the

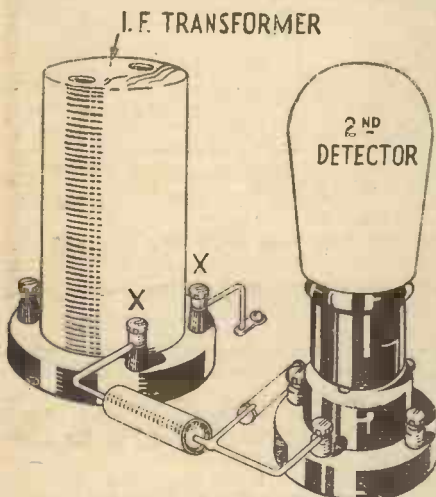

Fig. 4.—The meter is connected to the points XX, across the secondary of the I.F. transformer nearest the second detector.

P2 valve change considerably, and with the limited periods of use which we are likely to give the instrument, the life of the valve should be almost indefinite. It has also been found that the replacement of the valve has very little effect on the calibration of the instrument, provided the instrument is reset for zero and maximum readings whenever it is necessary to make this replacement.

Checking the Deflections

All that remains now is to make a note of the deflections given by the milliammeter for various voltages between 0 and 5 volts applied to the input terminals, and to obtain these readings the required voltage is selected by adjustment of the 250-ohm potentiometer with the 10-volt range of the universal meter connected across leads G and E and then noting the deflection given by the milliammeter when this voltage is applied to the valve-voltmeter. Some readers may care to plot a graph of these readings, and so be able to measure intermediate values directly, but I have found that the valve-voltmeter calibration is nearly linear, and a chart prepared in the same way as the capacity chart described and illustrated in Part 4 of this series is quite suitable.

Having prepared the graph or chart it only remains to calibrate the multiplier potentiometer. This is quite a simple matter, and should present no difficulty. First apply 5 volts to the input terminals of the valve-voltmeter so that a full-scale deflection is given by the milliammeter, then rotate the multiplier knob in a clockwise direction until the milliammeter indicates 2.5 volts in accordance with our calibration chart. Mark the position of the multiplier pointer and call it X2, then if the pointer is left in this position all the readings obtained on the valve-voltmeter will be multiplied by two, and we have extended our range to 10 volts maximum. Again rotate the multiplier knob until 0.83 volts is indicated and mark this point X6. This extends the

FOR THE NEW READER.

Previous articles in this series have dealt with a D.C. Multi-Range Meter; Adapting it for reading A.C. Voltages; and the Construction of a Simple Valve-voltmeter.

range to 30 volts maximum, and all readings obtained with the multiplier knob in this position must be multiplied by six. Finally, carefully rotate the multiplier until 0.5 volts are indicated, and mark this point X10. We shall now have extended the scale to 50 volts maximum, and all readings must be multiplied by ten.

Using the Valve-voltmeter

The calibration is now complete, and we can start to make use of the valve-voltmeter. It will not be out of place here to describe a few of the more obvious of its uses, although later articles in this series will describe it in use in conjunction with other apparatus. It will find its major application in the measurement of voltages in circuits where the current flowing is too small to actuate any other type of voltmeter; for instance, it will measure the voltage developed by a steady signal across the load resistance of a diode detector—a very useful guide to A.V.C. efficiency. Also it will measure accurately the voltage developed by a signal of any frequency

across the secondary circuit of an output transformer.

To measure the radio-frequency voltages across tuned circuits it will be necessary to prevent the H.T. voltages from reaching the grid of the P2 valve, and mica condensers of .01 mfd. capacity should always be connected in series with the input terminals before making measurements in any circuit where D.C. currents are also flowing. When measuring A.C. voltages existing across, say, the anode resistance of an L.F. amplifier, the capacity of the condensers should be increased to as large a value as possible, though care should be taken to see that the insulation of the condensers chosen is high. Fig. 1 will show the connections to the valve-voltmeter when measuring the H.F. voltage developed across a tuned circuit, in this case the tuned-grid coil of an H.F. amplifier, and it will be noticed that the "G" terminal is connected to the high potential end of circuit and the "E" terminal to earth. This procedure should always be followed wherever possible because it is advisable to keep the metal case of the valve-voltmeter at earth potential to eliminate stray pick-up effects. The valve-voltmeter connected as shown in Fig. 1

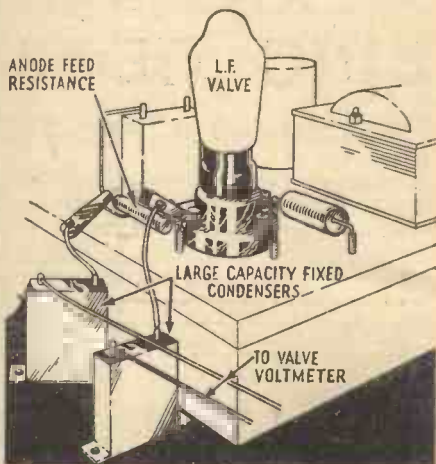

Fig. 5.—Measuring the A.C. volts developed across an anode feed resistance.

will actually measure the H.F. voltage presented to the grid of the detector valve if the set is tuned to a powerful local station, and by experimenting with the voltages applied to the H.F. valve and, incidentally, by making any modifications to the aerial coupling coils, etc., it is possible to see the result of such experiments as a gain or loss in voltage. The I.F. and frequency-changer circuit of a superheterodyne could also be experimented with using the meter connected across the secondary of the I.F. transformer nearest to the second detector (Fig. 4), and, if the magnification is not too great, it is possible to measure the amplification of a valve, and its coupling components, by first adjusting the voltage across its grid circuit by an H.F. volume control to 0.5 volts, then transferring the valve-voltmeter to the coil in the anode circuit of the same valve and again measuring the voltage. If the reading given is, say, 45 volts, then the stage gain is $\frac{45}{.5}$ or 90.

Many other uses will no doubt be apparent to the experimenter, but a fuller description of the uses of the instrument will be given when we have constructed an L.F. and H.F. oscillator to provide the energy required to make our measurements. The L.F. oscillator will be the subject of the next article.

MARVELS
of
MODERN
SCIENCE

By F. J. Camm

All about television, helicopters, streamlining, harnessing the invisible ray, etc., etc., with the latest pictures of all the newest and most thrilling inventions.

From all Booksellers

Only 3'6 net

GEORGE NEWNES, LIMITED

362

Would members of the public taking advantage of our FREE TECHNICAL ADVICE SERVICE please bear in mind that we are able to make a much more accurate diagnosis of their troubles if a circuit diagram, no matter how rough, is sent with the enquiry.

THE 362 RADIO VALVE CO. LTD.
STONEHAM WORKS, E.5.

Clissold 6607.

The Story of a Gracious King

"THE LIFE OF KING GEORGE V"

Commemorating a Great and Glorious Reign

Profusely illustrated in
Gravure including Historic
Funeral Photographs

6^D.

On Sale
at all Newsagents and
Bookstalls

Published by George Newnes, Ltd., 8-11, Southampton Street, Strand, W.C.2.

USE

Westinghouse

METAL RECTIFIERS

AND "INSURE" YOUR POWER SUPPLY

No fragile filaments to burn or wear out. Nothing to break. No replacements. Constant output. You can rely on Westinghouse Metal Rectifiers:

"The All Metal Way, 1936" contains full details of, and circuits for use with, these reliable rectifiers. A 3d. stamp to Dept. P.R.A. will bring you a copy.

Westinghouse Brake & Signal Co., Ltd.,
82, York Road, King's Cross, London, N.1.



TWO COMPLETE WORKS on Practical Electrical Engineering!

Here are two practical works for everyone engaged or interested in the electrical industry. Each is entirely comprehensive, written by experts famous in their respective spheres, and fully illustrated by drawings, photographs, tables and diagrams—post coupon now for free descriptive leaflets.

THE ELECTRICAL EDUCATOR

Edited by Sir Ambrose Fleming, M.A., D.Sc., F.R.S. Complete in 3 handsomely bound volumes containing over 1,000 text illustrations and over 100 plates and folded insets. Contributions by eminent authorities are included, amongst whom may be mentioned Sir W. Bragg, Sir R. Hadfield, and R. Faraday Proctor. The work deals completely with the application of electricity to all fields of industry and special sections deal with the problems of wireless engineers. As textbook or reference work it is absolutely indispensable.

ELECTRICAL WIRING & CONTRACTING

Edited by H. Marryat, M.I.E.E., M.I.Mech.E. The theory and practice of electrical wiring and contracting is here completely treated in 7 convenient pocket-sized volumes. Experts in every branch place their specialized knowledge at your disposal, the resulting work being not only practical but eminently authoritative. This is recognized as the standard work for this field—one which offers complete instruction in the simplest and clearest manner imaginable.

THE NEW ERA PUBLISHING CO., LTD.
12-14, NEWTON ST., HOLBORN, LONDON, W.C.2

Post the Coupon TO-DAY—

To: THE NEW ERA PUBLISHING Co., Ltd.,
12-14, Newton Street,
Holborn, London, W.C.2

Please send me by return, free and post paid, your descriptive leaflets on

THE ELECTRICAL EDUCATOR,
and
ELECTRICAL WIRING AND CONTRACTING

Whilst this request is free of all obligation, please send me at the same time full particulars of how I may secure these works on out-of-income terms.

Strike out the book not required.

Name

Address

Practical Television

THE TWO TELEVISION STANDARDS—I By "CRITIC"

THE publication of the Television Committee's report dealing with the chosen site for the first high-definition television station in London, namely, the Alexandra Palace, together with the information that the two companies who are to supply the transmitting equipment (that is, Baird Television, Ltd., and Marconi-E.M.I. Television, Ltd.) are to work on quite different standards, has provoked considerable discussion. This has centred very primarily round the whole question of these two different standards.

ment value of television, it is a common practice (although in my opinion a wrong comparison) to compare the results with modern talking films. In any cinema the detail which is observed on the screen depends very primarily upon the picture illumination provided by the arc lamp and optical system, the photographic grain of the film itself and, lastly, upon the mechanical precision with which the recording and reproducing processes work. The Society of Motion Picture Engineers published in March, 1934, the standard of

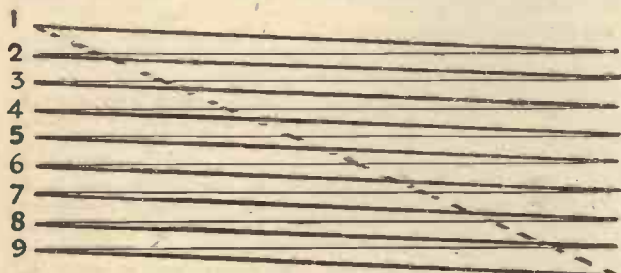

Fig. 1.—A nine line scan greatly exaggerated, showing how an orthodox sequential scan is built up.

Two Scanning Schemes

In the case of the former the system adopted is a picture definition of 240 lines scanned in sequence at 25 picture traversals per second and 25 complete frames per second. With the latter, however, it is proposed to use as a standard 405-line definition, 25 pictures per second interlaced to give 50 frames per second each of 202½ lines. It is further stated that the Committee have satisfied themselves that television sets can be constructed capable of receiving both sets of transmissions (they will be radiated alternately) without unduly complicated or expensive adjustment. The tenders submitted by the companies have been accepted, and each firm has furnished the technical information regarding the characteristics of the television signals radiated, so as to facilitate the design of receiving equipment capable of picking up these signals.

At first sight these rather bald facts appear quite satisfactory, but actually they have been instrumental in promoting many discussions, primarily in connection with the reason for "interlacing" and how such scanning operates, and also whether the higher line standard is a reasonable proposition at the moment.

The object of the scanning process is to dissect the scene or object to be televised into a series of lines sufficiently great in number that quite small detail will be recognisable in the received picture, assuming perfection in the scanners, amplifiers, radio transmitter, radio receivers, and final picture reproducers. Any form of amplitude or phase distortion in a single link of this chain of events will naturally mar the picture, but this is a factor which lends itself to remedy, once the technique which is involved is mastered.

Cinema Comparison

In assessing the pictorial or entertain

performance laid down by the Projection Practice Committee in the following terms: "If the projector is in first-class condition and the intermittent movement and picture gate are properly adjusted, the picture jump should not exceed one-third of one per cent. of the picture height."

This standard can be interpreted literally in one or two ways. First of all, if the pro-

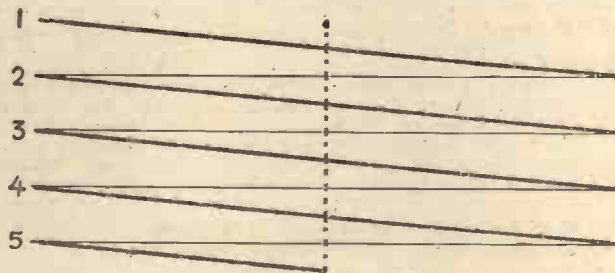

Fig. 2.—Showing how the first section of an interlaced scan is built up in a similar manner to the orthodox, or sequential, system.

jector is in first-class condition, then working to the standard limits, an otherwise perfect picture is blurred to the extent of one-third of one per cent. or, in other words, any object which is so small that it occupies only one three hundredth of the total picture height is blurred into non-recognition. This precision is really an extremely good one, for taking, say, a screen 15ft. high the non-recognisable

average of these two extremes and a grey colour will be seen. When this condition occurs, it can be said that the extreme frequency limit has been reached. Taking as an example, therefore, a picture repetition frequency of 25 per second, picture ratio of four horizontal to three vertical and 240-line horizontal dissection, the limiting frequency becomes $240 \times (240 \times \frac{1}{3}) \times 25$ which equals 1,920,000 or 1.92 megacycles.

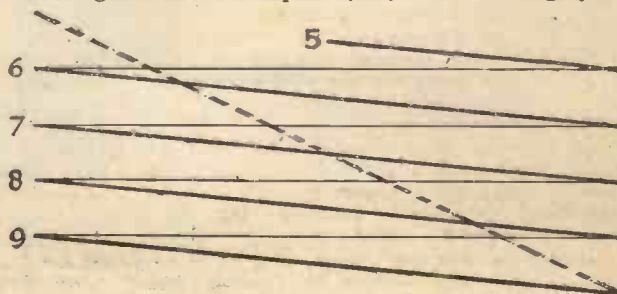

Fig. 3.—The second or intermediate section of an interlaced scan, where, on the completion of the final line trace, both time bases trip together.

object only represents three-fifths of an inch. Furthermore, when seated in a cinema the audience is occupied in discerning (and no doubt enjoying) the central figure or figures, together with the action portrayed and the story being unfolded, and has little thought for such minute details as have been quoted.

Conversion to Television

The human element must, and will, play an important part in assessing the value of a television picture in terms of line definition, so if we convert the cinema standard to one of television, the limit is a loss of detail identity to the extent of one-third of one per cent., that is a single scanning line in a complete picture of 300-line definition (this being the reciprocal of one-third of one per cent.). When the Television Committee produced its report, their recommended minimum standard was given as 240 lines, which is only 20 per cent. below the cinema limit just explained.

Communication Channel

Quite apart from this, however, there is the all-important point of whether the wavelength which is to be used for the radiation of the television signals, that is 6.6 metres, is capable of accommodating a line definition standard which is in excess of 240 lines. While it is impossible to arrive at a hard and fast form of calculation to obtain the frequency spread involved in a complete television signal, it is a simple matter to see how the limiting factors impose conditions which must not be exceeded if satisfactory results are to accrue.

Considering for a moment a picture built up of alternate pure white and black strips, the scanning spot or exploring aperture will just fail to reproduce the effect or become blind in the television sense when the spot size is equal to the width of two strips (one black and one white). The actual response will be the

On Your Wavelength

A Danger Signal

I SEE that music from one of the popular French stations is being heard by the signalmen in boxes on the Great Western Railway between Paddington and High Wycombe—and this in spite of the fact that there are no receivers in the signal boxes. The trouble is said by experts to be due to leakage from rediffusion wires attached to telephone poles near Wembley. It seems rather hard on the railway officials that even when at work they are unable to escape from the "plugging" of somebody's soap or some other item which is being mentioned in the English programmes from this particular station. Imagine the plight of a signalman, anxiously awaiting an "all clear" signal, but who receives instead an injunction from the announcer to take Green Pills, or who is confronted by the "strains" of a crooner. It must be enough to make him set all the signals at danger or to send the Cheltenham Flyer to Margate!

Assistance from a Club

AT a certain church in the Midlands the acoustics were so bad that it was found that only the front few pews were within range of the pulpit, and the padre, being one of the modern go-ahead ministers, decided that a good public-address equipment would prove extremely valuable. He also conceived the idea of fitting a standard receiver in the vestry so that on occasions when there was no service in the church he could pick up relayed services and similar items and broadcast them in the church. To obtain the money to purchase the necessary apparatus he hit on the original idea (?) of holding a bazaar.

The mothers met, and over the parochial cup of tea they decided that it would be an "ungodly act to place such a modern invention in the precincts of the church" and refused to help with the bazaar. Luckily there was a broad-minded reader of PRACTICAL AND AMATEUR WIRELESS in the



A crooner in the signal box.

district and he came to the aid of the padre by collecting discarded apparatus from the local club members, and a really excellent piece of apparatus is now installed.

"Calling All Cars"

I WAS trying out a new short-waver the other night and whilst on the lower ranges I picked up a transmission from Police Headquarters in an American city, giving directions to a patrol car regarding a certain suspicious car in a shopping centre. It was most thrilling, but I failed

By Jhermion

to hear the scream of the siren or the magic words of the movies "Calling all cars."

Quoth a Reader

MY remarks sometimes seem to upset some people, although others must take my writings to bed with them. Here is a short and to-the-point epistle from Mr. A. Jones, of Leicester: "I read your remarks about not being able to tell the difference between a highbrow violinist and a street musician, and I think you have a very poor taste for music. You owe a sincere apology to the street musician, P.S.—But I agree with you about crooners." But what about this from Mr. G. Gay, of Hereford. He says: "I was pained to read your remarks on violinists in the current issue (*sorry to have caused you any pain*), but I know you are—from your remarks—extremely unmusical and thus unfortunate. (*Am I unmusical?*) I have studied the violin and have played first violin in the best amateur orchestras in London and Leeds, and also in dance combinations, and I can assure you that the difference between street musicians and a £1,000 concert violinist is very real. Do you know that it takes ten years or more of hard work—eight hours a day—to play the simplest of things really well? (*Yes, I do, and so do many poor folk who live in flats. There should be a law against it!*) Street violinists would not be on the street if they were any good (*I seem to have heard of such misfortune*). I have heard all the leading violinists and many street musicians, but my only reactions to the latter are ones which make me think of rat poison. Well, this is only a small part of what I feel when I hear and read remarks such as yours, and I think you ought to give us news of the B.B.C., etc.—talk of something you understand." The italics are mine! And that's that.

The Foundations of Music

THE other day a radio critic tabulated the "for and against" letters which he has received. I was not surprised to see that there was an unanimous vote against crooners and the Foundations of Music (why do the B.B.C. continue to lay these very heavy foundations? They must be the most unpopular feature of all the broadcast programmes. Although I did see a letter in a book the other day praising them—from Sacheverell Sitwell); but I was surprised to see a heavy vote *against* Henry Hall, mentioning particularly the Glee Club with its "churchy atmosphere."

Those Junk Parts

MEMBERS of the Technical Staff are constantly telling me of those readers who write to ask for a wiring plan suitable for using a number of components which they bought cheaply at a junk shop. Sometimes the letters are accompanied by rather crude sketches of the coils and

similar components, but otherwise there is nothing to guide those geni who work it is to design some of those excellent receivers that are products of the PRACTICAL AND AMATEUR WIRELESS laboratories. They have therefore asked me to refer to this matter in these notes, in the hope that they may reach the eyes of a large number of "junk-shop" merchants. The fact of the matter is that second-hand and discarded components are rarely of any real practical value to anyone except those who are capable of designing a complete set; to the inexperienced constructor they are often worse than useless, since they may result in damaged valves and other good components due to incorrect use.

I should, of course, point out that the Free Advice Service offered so willingly by this journal does not apply to the provision of complete wiring diagrams or designs for receivers. Such a service could not operate satisfactorily, because designs must be thoroughly tested before they are offered to the public, and it is obvious that the hard-working Technical Staff could not possibly make up, test, modify, and re-design those hundreds of sets a day for which readers ask! It might be asked why the policy of this journal is to refrain from giving wiring plans for untried receivers. The reason is that every PRACTICAL AND AMATEUR WIRELESS receiver is covered by a very valuable guarantee, and the Editor has rightly considered it most undesirable to pass on to any reader details of an instrument which has not been fully tested and which cannot be guaranteed to function in a perfectly satisfactory manner, without the need for further experiment by the constructor. Therefore, dear readers, do not be annoyed if, in reply to your query, you receive a letter politely informing you that the Technical Staff cannot undertake to supply wiring diagrams and lists of components for a seven-valve all-wave superhet, to be built from parts taken from an old set, or a three-valve mains receiver



A gift from the local radio fans.

with A.V.C. constructed from a collection of components bought for five shillings in Farringdon Market.

Believe me, it does pay—and pay well—to buy new and guaranteed components in the first place, if only because these can be used over and over again with full assurance that they will not let you down.

My Quality Set

A NUMBER of readers have written for details of my quality receiver which I mentioned in these notes recently.

(Continued overleaf)

(Continued from previous page)

I regret that I cannot supply a diagram of this set, but in brief the arrangement is as follows: The H.F. stages are not controlled by any A.V.C. system, although I am using variable-mu valves. There are certain features to be obtained in this type of valve which render it suitable when biased to a certain point, and I have them so adjusted. The tuned circuits employ converted commercial coils in which the self-contained wave-change switches are employed for the purpose of bringing into circuit pre-set condensers which are adjusted for the two local stations. This scheme has already been mentioned in these pages and forms a very useful domestic control which avoids all complications regarding the wavelengths of stations, etc. The detector is a double-diode valve with diodes strapped together, and the output is a push-pull stage employing



Hearing American broadcasts.

resistance-capacity coupling. A home-made mains section is employed, the mains transformer being wound especially for this set and delivers 500 volts. The panel controls are only two in number, namely, the station selector switch (which has three positions, on or off, National and Regional) and a volume control. A coloured light indicator is used to show the listener to which station the set is tuned—a device copied from the Science Museum receiver.

Sequential Smoothing

SEEKERS after "perfection" might be interested in a scheme which I tried out in a set I recently built for experiment, and which seems to be an absolute certainty with regard to the elimination of hum—that bugbear of the majority of mains receivers. I was trying to locate the various sources of hum in mains sets and had come down to some really peculiar points. The final arrangement which I incorporated was so good that it enabled me to dispense with the usual 50 mfd. smoothing condenser in the bias circuit of a DO.24 valve and to use a 1 mfd. in its place without the faintest sound from the speaker (other than the signals, of course). The set was provided with a weak H.F. amplifier so that only the locals could be heard, and when tuned to a point midway between the National and Regional it was definitely impossible to hear even the faintest hum when the head was placed right up against the loud-speaker. This was an energised model provided with hum-bucking coil, and the scheme which was adopted was to use smoothing circuits in series, and which I think could very well be termed "sequential smoothing." The output valve required 400 volts H.T., and to obtain this from the 450 volts output from the eliminator, I used a standard high-inductance smoothing choke. From this point the output valve was fed, and the H.T. lead to the remaining valves was passed through the field of the speaker. From this point the first L.F. valve was fed, and the H.T. for the earlier valves was again passed



S.W. Superhets

THE straight type of short-wave receiver, with or without an H.F. stage, seems to be the most widely used by listeners. There are many superhets available, but these have not yet attained the popularity they enjoy in the medium-long-wave class. This may be mainly due to the question of price, as the simple straight set is cheaper than the superhet type. It is probable, however, that the main advantage of the straight set is its ability to pick up continuous wave morse signals. The majority of superhet short-wave sets cannot do this, their reception being limited to telephony, interrupted continuous wave morse, and spark morse. For this reason home constructors experimenting with short-wave superhets for the first time are inclined to think that the straight receiver is much more sensitive.

There is no doubt, however, that the superhet is the ideal type of receiver for short-wave listening, provided that it has been carefully designed and is being correctly operated. It is a very easy matter to provide reaction in the intermediate-frequency stage in order to enable the listener to receive continuous wave morse when desired; the simplest method is probably the connection of a short length of insulated flex to the cap terminal of the I.F. valve. The free end of this should then be allowed to rest on or near the G. and G.B. terminals of the preceding intermediate-frequency transformer. By this means a feed-back takes place from the anode to the grid circuit of the I.F. valve and oscillation occurs which can be controlled by the I.F. valve bias volume control.

Baseboard Screens

WHEN a metallised chassis has been in use for a lengthy period, or has been handled so often that the surface has become dirty, bad contact between the various earth return points sometimes occurs. When this trouble is suspected the metallised surface screws should be joined together by means of ordinary connecting wire. This is particularly advisable if the metallising is used for conducting direct current. The same warning applies to thin foil covered chassis; the metallising or foil provides an effective H.F. screen, but cannot be relied upon to provide a perfect path for direct current after prolonged use. If the above-mentioned precaution is taken, however, the wooden chassis of the foil-covered or metallised type is much more suitable for the home-constructor than the all-metal type commonly used in commercial sets.

Class B and Q.P.P.

IF a high tension eliminator is used for supplying a Class B or Q.P.P. receiver it should be of the type that gives a constant output voltage regardless of the current consumption of the set. Some of the modern eliminators have a sufficiently good regulation to give the necessary steady voltage, but in many cases the addition of a stabiliser is necessary.

through a standard smoothing choke. Each of these smoothing circuits was completed by the usual 8 mfd. electrolytic, and it seemed that the additional expense of the chokes was fully justified. Perhaps other experimenters would like to carry out some trials on these lines.

Running Costs

WHEN an A.C. eliminator is provided with a trickle charger the consumption of L.T. must be added to that of H.T. For example, suppose that the receiver has four valves taking .5 amp. L.T. and is used for 25 hours a week. The weekly watt-hour consumption will be 12.5, and this is therefore the amount of power drawn from the charger by the accumulator; approximately the same amount of power must be taken from the charger, and thus, allowing for the loss in the rectifier and mains transformer, the power taken from the mains will be about 16 watt-hours. In any case, however, the cost of A.C. current when using an eliminator is almost negligible, and can be measured in pence per month. When only H.T. is taken from the eliminator the cost may well amount to a matter of pence only in the course of a whole year.

Radio and Architecture

THAT radio is making its presence felt in the realm of architecture was brought to the fore a week or so ago when a committee of the Royal Institute of Architects presented a report dealing with wireless reception in flats. It stated that all the technical difficulties have been solved, and showed how by treating a block of flats as a whole instead of in sections, good radio could be obtained by every tenant. A common aerial with shielded feeder lines, and suitable matching transformers screened from any likely source of electrical interference, is the best way of tackling the problem. The remarkable part of the whole report, however, lies in the suggestion that in all new flats provision should be made for special circuits which would enable television reception to be undertaken. The suggestion is an admirable one, and will no doubt bear fruit in the near future.



The Foundations of Music are getting deeper.

A Bad Slip

ALL readers of this journal are no doubt familiar with the light sensitive properties of selenium, for in the early days of television it was applied at the transmitting end in order to achieve crude results. Its sluggish action eventually caused it to be discarded for this work, but where the time factor is not of such importance selenium is still employed. In this connection a Sunday newspaper recently made a bad slip in describing an instrument which enables the blind to read ordinary printed type by converting each letter of the alphabet into distinct sounds. It was stated that a ray of light working on the "solignum" principle, passes under the lines of type.

A PAGE OF PRACTICAL HINTS

SUBMIT YOUR IDEA

READERS WRINKLES

THE HALF-GUINEA PAGE

A Multi-valve Test-adaptor

HERE is a very simple and inexpensive adaptor, which will enable tests to be carried out with any standard 4- or 5-pin base valve whilst under working conditions.

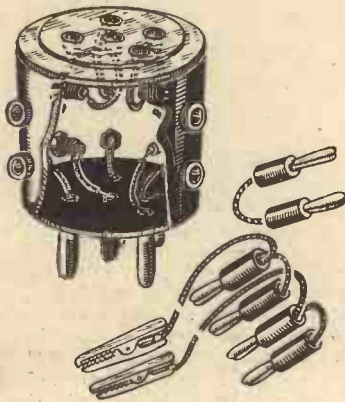

A simple multi-valve test-adaptor.

It is made from a base of a 5-pin valve and a 5-socket valve holder, and a few sockets and "banana" plugs.

Carefully make two holes one above the other (and a little to the side of the "legs") to each leg, and two extra ones for the centre pin in the valve base, each hole being large enough to take a "socket." Insert the sockets, and join each lower socket to their respective pins with short pieces of wire. Next take a valve-holder and join the rest of the sockets to the corresponding sockets in the holder. It is best to use insulated wire so that when the valve-holder is placed in position no short circuiting will take place. The holder can be held in position with a little pitch from an old H.T. battery. Take a banana plug for each socket, pair them up, and join together with 2in. or so of flex. Two extra connections can be made with double banana plugs at the ends, with longer leads and either spade or crocodile ends for connecting to the appropriate meter. The two plugs are required to couple sockets when reading voltages. With this device, both voltage and consumption can be tested in anode, grid, cathode, and heaters of any valve whilst working by putting the meter leads in the correct sockets, after withdrawing coupling leads. A similar unit can be made to test 7-pin base valves.—V. R. SALES (Gt. Yarmouth).

Automatic Switch for a Pick-up

MOST pick-ups have a rest, and through this rest a small hole must be drilled. An ebonite rod is placed in this hole so that it projects from the top about 1/4in. The other end rests on the middle spring of a triple contacting piece, which is built up with three thin brass strips and a piece of 1/2in. ebonite as shown in the sketch. These three strips are screwed or riveted

THAT DODGE OF YOURS!

Every Reader of "PRACTICAL AND AMATEUR WIRELESS" must have originated some little dodge which would interest other readers. Why not pass it on to us? We pay £1-10-0 for the best wrinkle submitted, and for every other item published on this page we will pay half-a-guinea. Turn that idea of yours to account by sending it in to us addressed to the Editor, "PRACTICAL AND AMATEUR WIRELESS," George Newnes, Ltd., 8-11, Southampton Street, Strand, W.C.2. Put your name and address on every item. Please note that every notion sent in must be original. Mark envelopes "Radio Wrinkles." Do NOT enclose Queries with your Wrinkle.

to the pieces of ebonite, and it will be seen that one of the three contacting pieces is shorter than the other two. At the ends of the strips are soldered pieces of silver wire to obtain a better contact. The whole is then screwed to the bottom of the gramophone board so that the ebonite rod just rests lightly on the middle contacting piece. The shorter contacting piece is bent downwards so that it engages with the

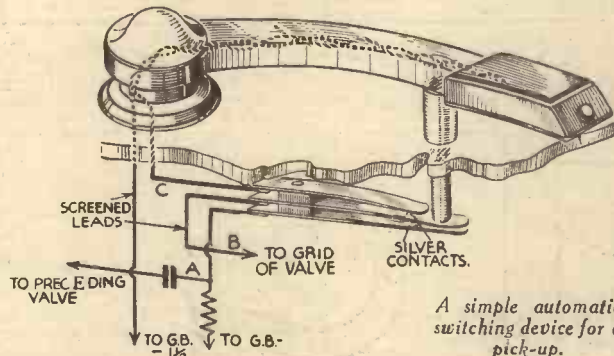

middle piece when the pick-up is off its rest. When the pick-up is replaced on the rest the middle contacting piece disengages with the top contacts, and engages with the bottom one.

The middle contact is wired (as short as possible to prevent picking up any hum) to the grid of an L.F. valve. The top short contact is wired to one of the pick-up leads, the bottom contact being connected to the broken end of the grid circuit. The other pick-up wire is joined permanently to the 1 1/2 volts G.B. tapping or (in a mains set) through an appropriate resistance to earth. When the pick-up is lifted off its rest and placed on a record, the contacts are set for the L.F. amplifier, and when the pick-up is replaced on the rest, the contacts are set for radio control.—L. E. LESSEL (Putney).

A Reisz-type Carbon Microphone

THE simple microphone shown in the accompanying sketches is of the transverse current type and, besides being inexpensive, is far superior as regards frequency response and sensitivity to the carbon-button type. The sketches should make the construction clear. The part C is cut from 1/4in. deal and the terminals fixed in it. Part B is the same size as C, but a cavity is cut in it 2ins. by 1 1/2ins. to a depth of 1/4in. at each end, but curving upwards to a depth of 1/4in. at the centre. The carbons, which may be obtained from an old torch battery, are wedged in at each end. The granules may be obtained from Electradix Ltd.

A plywood cover (A) holds the diaphragm into place. This diaphragm is of fine linen and should be stretched as much as possible over the cavity before glueing into place; this is to raise its natural vibration frequency as high as possible. After the cavity is filled almost to the top with carbon granules a thin layer of cotton wool is placed over the carbon rods and the granules in direct contact with them, before the diaphragm is fixed, so as to prevent vibration at this point. The completed microphone may be enamelled white and suspended in the usual way. It should be fed to the amplifier through a step-up transformer, an ordinary intervalve transformer being quite suitable for the purpose.—DOUGLAS

PAYNTER (East Ham).

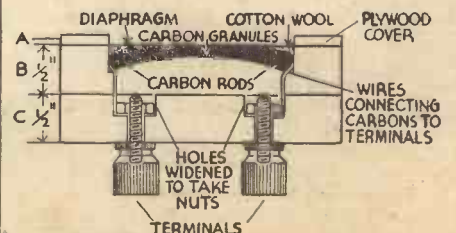
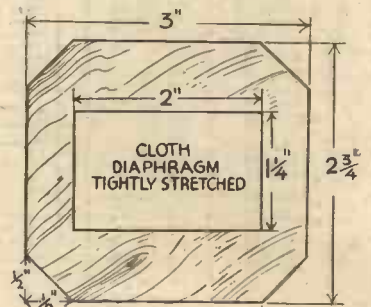

An easily-made carbon microphone.

THE WIRELESS CONSTRUCTOR'S ENCYCLOPEDIA
 By F. J. CAMM 4th Edition 5/- net.
 (Editor of "Practical and Amateur Wireless")
 Wireless Construction. Terms and Definitions explained and illustrated in concise, clear language.
 From all Booksellers, or by post 5/6 from George Newnes, Ltd., 8-11, Southampton Street, Strand, London, W.C.2.

Practical and Amateur Wireless

SERVICE DATA SHEET No. 18

FOR THE

MONITOR THREE

FULL-SIZE BLUEPRINTS OF ALL "PRACTICAL AND AMATEUR WIRELESS" RECEIVERS ARE AVAILABLE. SEE PAGE 748.

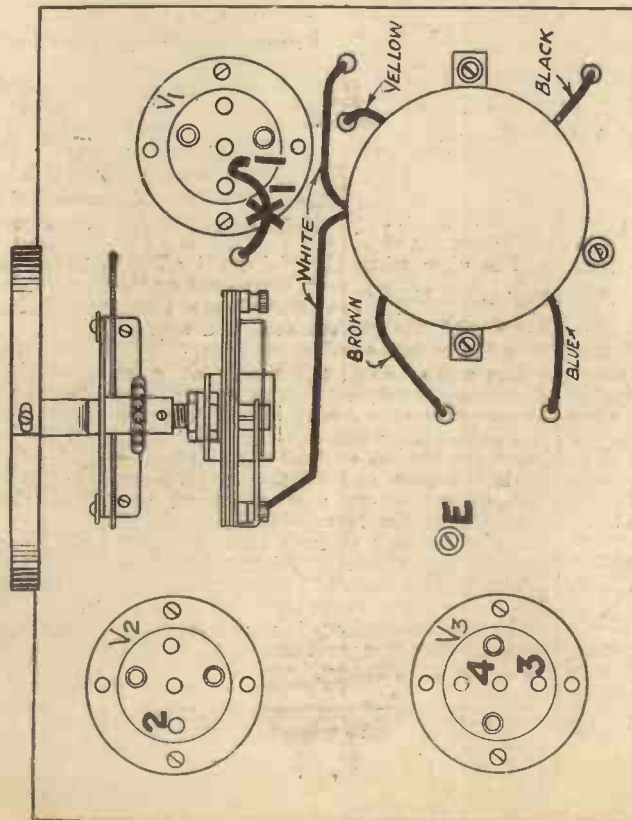

Top of Chassis View

Approximate Voltage Readings

- Voltmeter—to E
- + to 1=120 volts.
- + to 2=60 volts.
- + to 3=115 volts.
- + to 4=120 volts.

Approximate Current Readings

- Milliammeter connected at $\times 1=1\frac{1}{2}$ m.A.
- " " $\times 2=1\frac{1}{2}$ m.A.
- " " $\times 3=7$ m.A.

Approximate Resistance Readings

- Coil
- Ohmmeter connected across white leads and screening can =17 ohms.

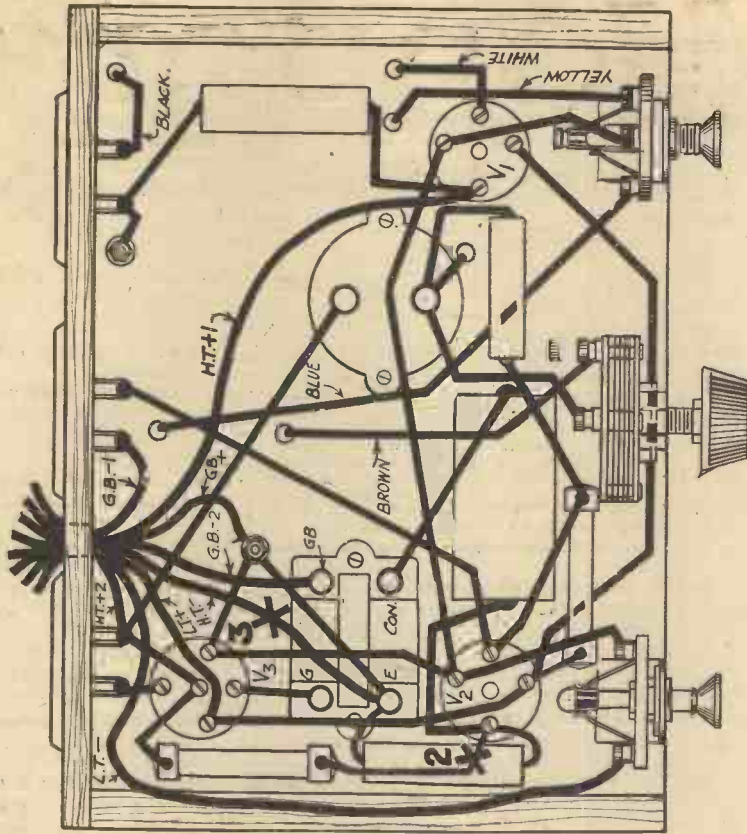

Underside of Chassis

- Ohmmeter connected across white leads and yellow lead =3 ohms.
- Ohmmeter connected across black lead and screening can =16 ohms.
- Ohmmeter connected across black lead and blue lead = $\frac{1}{2}$ ohm.
- Ohmmeter connected across brown lead and screening can = $1\frac{1}{2}$ ohms.

- L.F. Transformer
- Ohmmeter connected across G and GB=2,250 ohms.
- " " " " " "
- " " " " " "
- " " " " " "
- Ohmmeter connected across Con. and E=750 ohms.

F. J. Camm's Monitor 3

THE SECOND STAGE

By F. J. CAMM

EASY TO BUILD— —AND GUARANTEED!

This week we describe how to Modify the Novel Monitor Receiver in order to Proceed a Stage Farther in the Development of this Interesting Educational System of Construction, and Notes are given concerning the Future Developments

THOSE readers who have built the Monitor will undoubtedly have found that they now possess a really efficient little three-valve receiver which, under average conditions, will give all that is desired in the way of broadcast reception. Obviously, in such a simple form it cannot be expected to provide station separation of the order of 9 kc/s, nor can it be expected to deliver sufficient volume to fill a small hall. For general use, in the average home, however, it will in its present condition fulfil the rôle of the domestic receiver. The idea underlying the design of this receiver, as was pointed out in our issue dated February 8th last, was to take a small more-or-less standard arrangement, which would be capable of development by easy stages, until a really powerful modern superhet would be obtained, and the various stages would provide really sound ideas concerning the function of the circuit and components. Thus, we may at this point consider the next step in the conversion of the Monitor, and as may be seen from the illustrations accompanying this article, there are still only three valves in use, but the design of the tuning circuits and the general arrangement of the chassis has now been improved, and a higher standard of performance will be obtained.

The Circuit

The fundamental circuit is still unaltered, and the combination of screen-grid, detector, and pentode stages remains. It will be seen, however, that the grid circuit of the detector stage is now provided with a complete tuning circuit consisting of a coil and condenser, and this addition will provide greater selectivity. The incorporation of any tuned circuit in a receiver may be likened to the use of a graduated sieve, and it permits only a certain band of frequencies to pass—the narrowness of the band being dependent upon the design of the coil and the arrangement of the remainder of the circuit.

In addition to this increased selectivity, however, there will be a slight increase in volume in view of the fact that the coil which is employed is wound in the form of a high-frequency transformer, and the secondary winding (which is joined in the grid circuit of the detector valve) is larger than the primary winding (which is included in the anode circuit of the H.F. valve), and thus there will be a step up in the voltage which is transferred from primary to secondary. It will thus be seen that the modifications now introduced will result in the acquisition of a more powerful receiver without any increase in running costs, and to enable full advantage to be taken of the improvements in tuning a control has also been included, so that the benefits of volume control may be obtained and the local station thus kept within the limits set by the output valve to avoid distortion due to overloading.

The New Components

Before purchasing the extra components which are

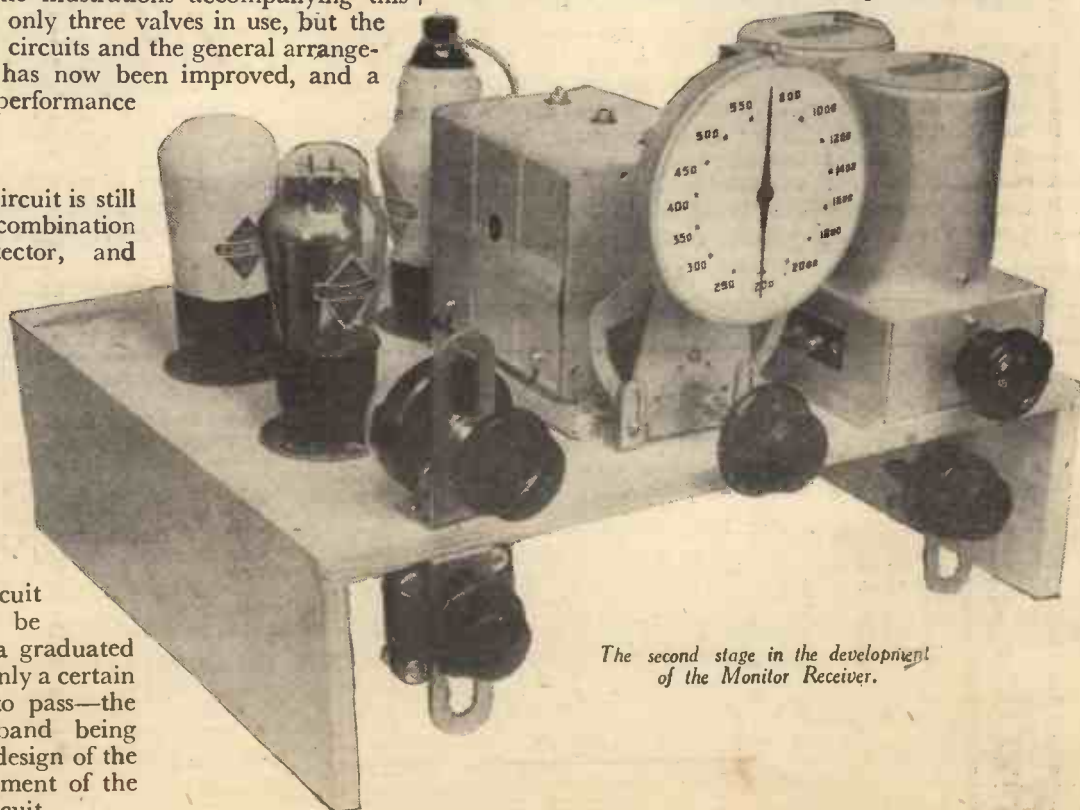

The second stage in the development of the Monitor Receiver.

required for the modifications it is necessary first to consider to what stage you ultimately wish to take the receiver. In its final stage it will incorporate the superhet principle, but it is, as has been pointed out in the introductory articles, possible to leave the receiver at any stage and it will be complete in that form. The modifications which are introduced this week will demand that a new chassis is obtained, in addition to an extra coil and a further tuning condenser. The coil should be ordered complete with a special chassis which is designed to accommodate three of these coils. There will thus still be room for a further coil at a later date, and this may take the form of a similar coil or a special oscillator circuit coil. If you do not intend to carry the design any farther after this week you will need only a two-gang condenser, but if you desire to proceed farther, you should obtain a three-gang model to avoid the scrapping of any part at some future date. The present single condenser which is in use should be placed on one side for the time being, but it will, together with the two-point on-off switch, which is also dispensed with for the time being, be required later on.

In making your choice of circuit you will be guided in your selection of the correct type of three-gang condenser. If you wish to proceed to the superhet receiver, you should obtain a three-gang superhet condenser having a specially-shaped oscillator tracking section, designed for use on an intermediate frequency of 465 kc/s, and this section should be at the rear of the condenser—that is, farthest from the operating spindle. If, however, you do not wish to make a superhet but would desire to incorporate a band-pass tuning circuit, the three-gang condenser must be of the "straight" type. As mentioned previously, however, if you are content to retain the receiver in the form described this week, only a two-gang model will be needed. A volume control must also be obtained, and this will be mounted on a bracket in place of one of the switches now used, and the three-point switch is now employed for switching on and off the battery circuits in order to break the G.B. circuit and avoid waste through the volume control potentiometer.

Constructional Work

The modifications now incorporated will necessitate

the use of a new chassis and this will have to be drilled in accordance with the Wiring Diagram which will be given next week.

In spite of the increase in selectivity which has now been obtained, it must not be assumed that finality has been reached. In very congested areas it may be found that a number of distant stations are lost on wavelengths close to the local high-powered stations, but this difficulty will be overcome quite definitely in the final stages

THEORETICAL CIRCUIT OF THE MONITOR—2nd STAGE

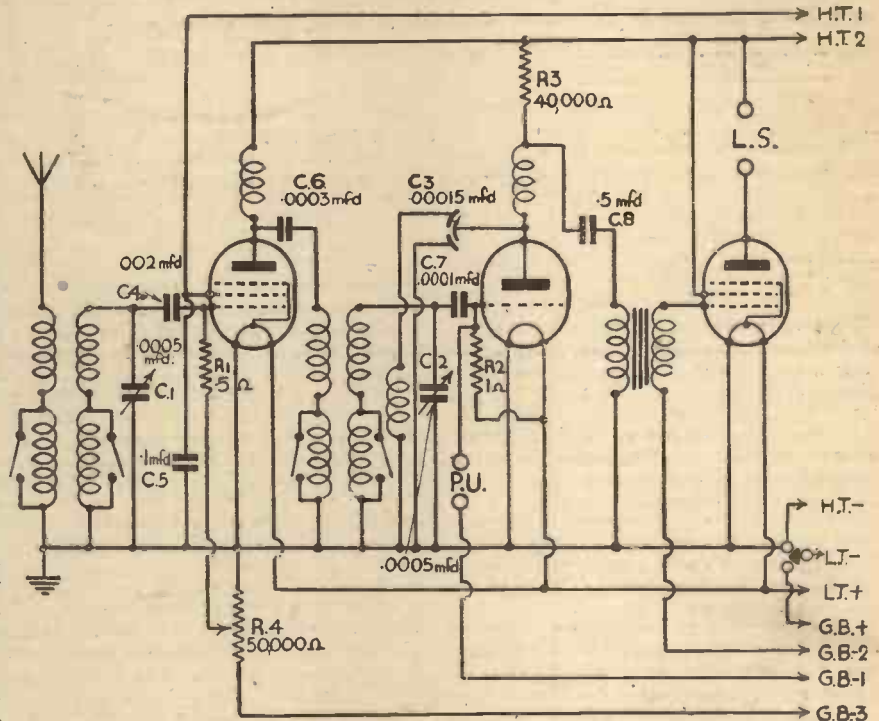

of the receiver. For instance, in the next stage to which the receiver is to be taken a further tuned circuit will be added to introduce band-pass tuning, and, as most amateurs are now aware, this will provide adequate selectivity for practically every case, although it does not surpass that obtained in the superhet arrangement.

No Further Chassis

It may also be mentioned at this point that no further modification to the chassis will be required, as all future circuit alterations may be carried out with the receiver in its present arrangement. The final arrangement of the controls will form a symmetrical layout, using the brackets already employed.

LIST OF COMPONENTS

One coil (B.T.S.).
 One .0005-mfd. Compax condenser (Polar).
 One airplane drive (J.B.).
 One .00015 mfd. differential reaction condenser (Polar).
 Four fixed condensers : .5 mfd., .1 mfd., .002 mfd., .0003 mfd. (T.M.C.).
 Two fixed resistances : 40,000 ohms, 1 megohm (Dubilier).
 One H.F. choke, type HF9 (Bulgin).
 One Senator L.F. transformer (Bulgin).
 One three-point switch, S36 (Bulgin).
 One two-point switch, S22 (Bulgin).
 Three socket strips : A/E, L/S, P/U (Belling-Lee).

Three valve-holders : two 4-pin, one 5-pin (Clix).
 Four component brackets (Peto-Scott).
 Six plugs : H.T.—, H.T.1, H.T.2, G.B.—, G.B.—2 (Belling-Lee).
 Two spades : L.T.—, L.T.— (Belling-Lee).
 One metallised chassis, 8in. by 6in. by 2½in. (Peto-Scott).
 Three valves : 210VPT, 210Det., 220HPT (Cossor).
 120-volt H.T. battery.
 9-volt G.B. battery.
 2-volt accumulator (Exide).
 One "Pix" Indoor Aerial.
 Speaker, Stentorian, model 36'S (W.B.).

ADDITIONAL COMPONENTS REQUIRED FOR THE MONITOR 3—2nd STAGE

One Monitor coil, with special 3-coil chassis (B.T.S.).
 One two-gang .0005 mfd. condenser (Polar), or
 One three-gang .0005 mfd. condenser (Polar), or
 One three-gang superhet 465 kc/s condenser (Polar). (See Text.)
 One .0001 mfd. fixed condenser (T.M.C.).

One .5 megohm 1 watt resistance (Dubilier).
 One H.F. choke, type H.F.9 (Bulgin).
 One 50,000 ohm volume control (Polar).
 One metallised chassis, 12in. by 10in. with 3in. runners (Peto-Scott).

Modern Coil Connections-4

An Article dealing with Short-wave Units, Permeability Tuners, and General Mechanical Constructions such as Coil Mountings, Incorporated Switchgear, and Screening Cans. By G. V. COLLE

OWING to the fact that most tuning coils for home construction purposes are fitted with terminals, which in turn must be screened, the screening cans have to be removable, in order to allow the terminals to be accessible. A present tendency is to dispense with terminals, and to provide bottom soldering lugs such as on 'set-makers' coils.

Stripped Units

Where the home constructor can make neat soldered joints these stripped units offer definite advantages, in that they are less costly, are slightly more compact (the diameter of the screening can may be reduced without a noticeable loss of efficiency), and possess lower dielectric and capacity losses due to the smaller amount of insulating material and metal used in their construction.

A number of firms supplying stripped types of coils arrange them, where required, on switch chassis, thus obviating one source of difficulty to constructors possessing only limited kits of tools. It will be perceived that the alternative use of a separate switch allows more ambitious constructors to arrange the control knobs in a symmetrical manner, assuming such is not otherwise possible.

Switch mechanism, which forms an integral part of a coil kit, is often sandwiched between the coils and the receiver chassis. In the event of a high resistance contact developing due to oxidation or dirt at the contact points it is obvious the complete coil assembly must be removed, a somewhat laborious proceeding. Easy inspection and accessibility of vulnerable radio components is an essential in the interests of service work on a modern commercial receiver, and hence constructors are enjoined, where possible, to follow a similar method of assembly, even if this necessitates a larger degree of initial labour in fitting a separate switch.

These remarks apply, of course, particularly to the stripped tuning units, because the majority of coil assemblies for constructors still embrace their own switch mechanisms, and cannot be obtained in the form indicated. There are already indications that component manufacturers are to list an increasing number of stripped-type coils without switches which will be equally suitable for home construction, and small set-makers' purposes (the mass production companies usually make their own coils).

Screening Cans

Metal screening cans average about three dozen in sizes and in gauge from about 18 to 24 s.w.g. The most popular fixing method is to attach two eye-screws by rivets to opposite sides of the can, and pass the screwed portions through corresponding holes in the metal chassis, the latter acting as the base of the can and

thereby completely enclosing the coil unit. The coil itself is attached to the chassis by a single screw engaging with a screwed flat brass strip which rests in two slots made near the bottom of the coil former.

Another scheme whereby both can and coil are mounted simultaneously is to provide a cupped metal base and indent a round recess in it, as well as one in the top of the can, so that the projecting metal fits into the inside spaces at the ends of the coil former. With this latter method the can and base are permanently locked together to prevent the coil becoming loose. The coil ends are joined to tags projecting through holes in the cupped base or flex leads are fixed prior to "canning."

Switch Construction

Reverting to the question of switching, there seems a definite trend towards the use of the flat disc type, a number of makes of which have recently appeared in the radio market. The contacts are attached to each disc in circular formation, and edgewise to each other, resulting in a compact and low capacity construction. Numbers of these switch units are controlled by a single knob, each switch being mounted immediately facing (and usually below) the coil it is intended to wave-change. Apart from the low capacity construction, it is obvious that, by isolating each group of contacts, stray H.F. couplings can be reduced to a minimum, particularly as simple vertical screens can be introduced between successive switch units to render the effect absolute.

Commercial set-makers naturally employ a multitude of different switch constructions for use in H.F. circuits, but it seems that

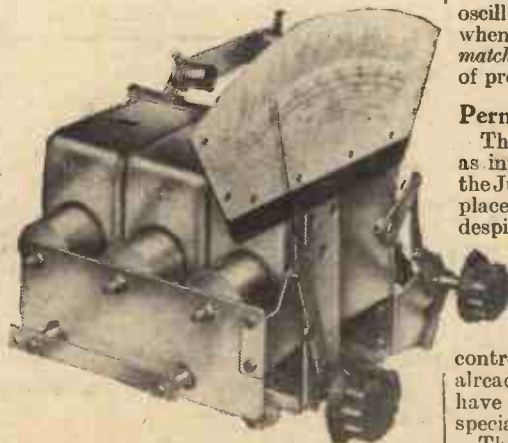

In this tuner the variable condenser has been eliminated and tuning is carried out by the variation in inductance caused by the iron core. This is the Varley permeability tuner.

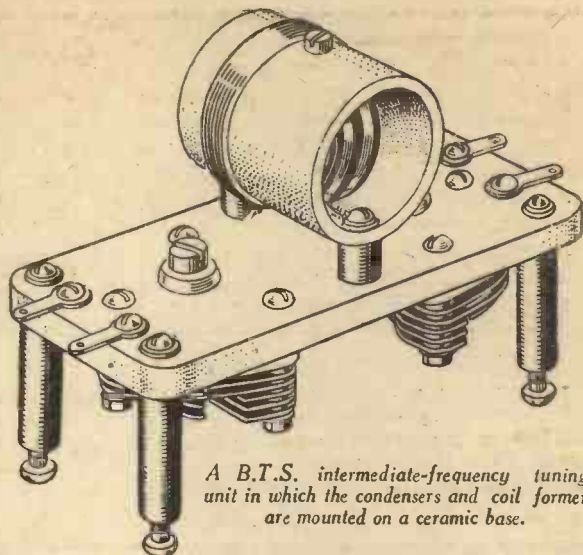

A B.T.S. intermediate-frequency tuning unit in which the condensers and coil former are mounted on a ceramic base.

with the introduction of all-wave sets the switch specifications will become more stringent, and eventually lead to the adoption of a type substantially as described.

Short-wave Coils

Short-wave coils must be mounted as close as possible to their respective switches in order to avoid undesirable capacity effects, and thereby restricted wave-range coverage. Also, owing to the high radio frequencies covered, the H.F. coil fields spread to a far greater extent than on broadcast frequencies. Close screening by the aid of round or square metal cans cannot therefore be tolerated.

The difficulty is overcome by employing very small short-wave coils and metal screening compartments rather than individual canisters. Ceramic coil formers such as "Frequentite" are extensively used, but ribbed ebonite and moulded low-loss material are equally in evidence.

Most of the all-wave sets introduced at the last Radiolympia were arranged to include only one signal circuit, and an oscillator section for short-wave operation. Owing to the latter circuit "taking charge" of tuning, the aerial section being comparatively flat, close matching of the two coils in their respective spheres was not essential.

In the more ambitious 1936 receivers, attempts will be made to eliminate the "image" response of each station at the alternative dial position by providing two or more signal coil circuits in addition to the oscillator. Hence the time is not far distant when short-wave coils will be made in matched sets, representing a new standard of precision in receiver mass production.

Permeability Tuning

The new system of permeability tuning, as introduced to readers of this journal in the June 24th, 1933, issue, has not yet found a place for itself in commercial receiver design, despite the lapse of two and a half years.

Among the various patents granted on permeability tuners those of Polydoroff, Varley, and S. G. Brown are outstanding by reason of commercialisation. Those firms controlling the patents in question have already evolved practical tuners, which have in turn been incorporated in a few specialised published receiver designs.

The present high cost of permeability tuning units has somewhat restricted their popularity, apart from the question of rendering gang condensers redundant. It

(Continued on page 739)



FROM STUDIO TO LISTENER—5

The High-frequency Amplifier of the Receiver is Briefly Described this Week

By IDRIS EVANS

LAST week it was explained that the ripples produced by the transmitter strike the receiving aerial, and if this is tuned to the same wavelength as the transmitter a current will flow in the aerial circuit of the receiver. Unless the transmitter is very near to the receiver, however, these currents are very weak, and therefore in most cases it is found necessary to amplify them before passing them on to the detector, or, to be more correct, the de-modulator. There are many receivers in use which do not have a high-frequency amplifier, the aerial being connected to the detector stage. This form of connection is only recommended when the receiver is in close proximity to the transmitter, however, as apart from the fact that many of the distant stations are missed, the quality of reproduction suffers unless a reasonably strong signal is applied to the detector; this is especially true of the modern type of diode detector.

Selectivity

The term selectivity is well known to most readers as that applied to the ability of a receiver to separate stations. Generally speaking, the selectivity of a receiver can be improved by adding a tuned H.F. amplifying stage; that is, by making the signal picked up by the aerial pass through more than one tuned circuit before feeding it to the detector. It will therefore be realised that the use of a high-frequency stage serves the double purpose of amplifying the weak aerial currents and providing an improved degree of selectivity.

The H.F. Stage

The H.F. amplifying stage consists of a variable tuning condenser connected across a fixed tuning coil joined to an amplifying valve, this in turn being coupled through another tuned condenser and coil combination to the detector valve. The effective size (capacity) of the condenser is varied by rotating the tuning control, and an easy method of tuning the receiver to the same wavelength as the desired incoming signal is thereby provided. It is pointed out at this juncture, however, that tuning can also be effected by varying the effective size of the coil (inductance), keeping the size of the condenser fixed. This was actually done in the earlier type of receiver and is done at present in what are known as "permeability tuners."

Aerial Coupling

There are two main methods of coupling the aerial-earth system to the first tuned circuit of the H.F. amplifying valve; these are shown in Figs. 1 and 2. Fig. 1 indicates the tap method, in which the aerial lead is directly connected to one

of the turns of the coil forming the first tuned circuit. This method is very satisfactory provided that the aerial

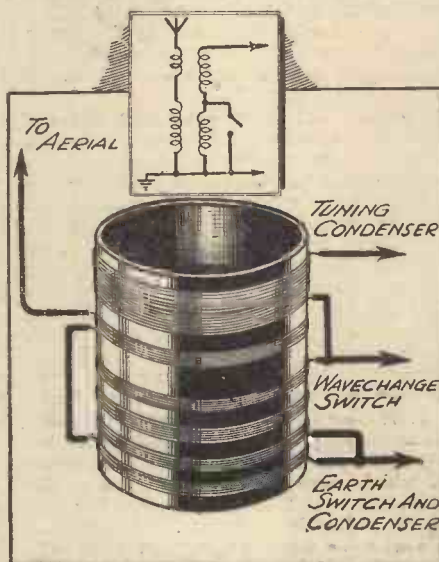

Fig. 1.—Showing aerial transformer coupling.

lead is tapped to a suitable point on the coil. In the older type of coil it was customary to provide one tap near the lower end of the medium-wave winding; this gave satisfactory results on the medium-wave band, but provided very broad tuning on long waves. If the tap method of connection is adopted, a change-over switch should be fitted as shown, so that the best tapping point on both long- and medium-wave windings is utilised.

Fig. 1 indicates the transformer method of coupling. In this case the aerial lead is not directly connected to the first tuned coil, transference being obtained by passing the aerial current through an untuned winding placed near the tuned winding. With this method of connection great care must be taken to provide the correct degree of coupling between the two windings, this being done by placing them

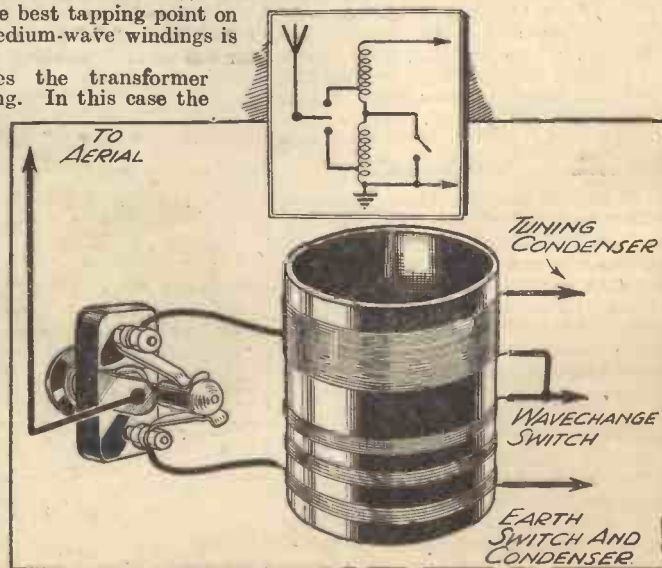

Fig. 2.—Tap method of aerial coupling.

using the correct number of turns in the primary untuned winding. It is advisable to short circuit a section of this winding by means of a switch if best results are to be obtained.

Band-pass Coupling

In some receivers it will be noticed that the first valve is preceded by two tuned circuits—that is, two tuning condensers working in conjunction with two coils. The extra tuned circuit is employed to improve selectivity, for as previously mentioned selectivity is governed to a great extent by the number of tuned circuits used. These two circuits are coupled together by means of a small coupling coil or a small condenser, and the combination is known as a band-pass coupler. The term band-pass is applied to this form of coupler because a definite band of frequencies can be passed, the width of the band (or in other words the spread of the received signal) being governed by the size of the coupling element (coil or condenser) between the two tuned circuits constituting the complete coupler.

H.F. Valves

Until about eight years ago the ordinary triode type of valve was used as an H.F. amplifier, and unless great precautions were taken in the design of the complete stage, instability was experienced and the actual amplification obtained was very low. In many of the old types of receiver employing this type of H.F. valve, the only advantage obtained from the use of an H.F. stage was that of improved selectivity.

The advent of the screen-grid valve considerably improved matters, as with this type of valve a high degree of amplification can be obtained before instability occurs. The modern H.F. pentode is a further improvement on the screen-grid type of H.F. amplifier, and by using the former in conjunction with suitable components a remarkable degree of high-frequency amplification is obtainable. To obtain the full benefit of this type of amplifying valve, however, it is necessary to screen the components, especially the coils preceding the valve from those following it; inadequate screening results in instability.

MODERN COIL CONNECTIONS

(Continued from page 737)

is a matter of considerable interest to set constructors to learn the reasons for the evolution of this class of tuner. The mere fact that tuning by means of moving iron cores in and out of H.F. coils is a logical step from fixed iron-cored coils is no justification for incentive in itself for scrapping existing apparatus.

Advantages Offered

Permeability tuning must, therefore, offer advantages which normal tuning schemes do not possess. A dual-range coil of fixed inductance values, when tuned by a standard variable condenser, usually exhibits a variable response over each waveband. On the medium waveband, for instance, the sensitivity or amplification is highest at the bottom end of the range, decreasing as the wavelength is increased. With regard to selectivity, this takes the *opposite* course, being low at the low-dial settings and increasing with wavelength.

An examination of the dynamic resistance curve of a typical tuning coil shows that this falls with increasing wavelength. On the other hand, the H.F. equivalent series resistance, which represents selectivity, decreases with increase of wavelength. When it is considered an *increase* in dynamic resistance represents higher amplification and a *decrease* in H.F. resistance higher selectivity, it will be seen the two factors are diametrically opposed.

The provision of a *constant* L/R ratio represents the ideal condition of operation, as its attainment would lead to sensibly constant sensitivity and selectivity. Theoretically, by dispensing with the normal tuning condensers and linking up the movement of the tuning dial with that of the movable cores, the desired effect is achieved. Variation in wavelength is accomplished by gradual change of coil inductance, the iron cores merely increasing or decreasing the lines of force in the H.F. field surrounding the coils. Constancy of H.F. resistance and hence selectivity may be judged in the following manner. From the minimum wavelength, with the cores removed, to the point of maximum wavelength, with the cores fully inserted, the inductance increases in value from 3.5 to five times. Commencing at the lowest tuning point, each coil without its core will possess a certain H.F. resistance, depending on its physical construction and losses due to surrounding materials.

When the cores are moved say, halfway, in, the coils will increase in inductance, which in itself is sufficient to increase their H.F. resistance. At the same time the increase in wavelength tends to counteract these H.F. losses for the reasons previously given, the net result being a fairly constant H.F. resistance value throughout the tuning range.

Amplification Factor

With regard to the dynamic impedance or amplification factor, this is maintained at a constant level by the action of the coil in increasing its inductance and the corresponding lower losses of the powder-iron core with decrease of frequency (that is, increase in wavelength).

To be strictly accurate, a theoretically perfect permeability-tuned coil assumes that circuit and associated valve losses will be constant at all receiving frequencies. The fact remains, however, that some of these losses vary with frequency, particularly when stray capacitive couplings produce slight regenerative effects between H.F. stages. Furthermore, there are certain technical grounds for stating that permeability tuning does not lend itself to band-pass couplings.

PETO-SCOTT EVERYTHING RADIO - CASH C.O.D. or EASY TERMS

IMMEDIATE DELIVERY Of all makes of Speakers, Eliminators, Kits, Pick-Ups, Testing Meters, Receivers, for CASH, C.O.D., or H.P.: **PILOT AUTHOR KITS** are only obtainable direct from Peto-Scott. We can supply any Kit featured in this Journal during the past 3 years.

B.T.S. INTERNATIONAL SHORT WAVE 2 KIT

WITH ASSEMBLY INSTRUCTIONS & FULL SIZE BLUEPRINT

A different 2-valve short-wave—the number of stations obtainable on this remarkable set will amaze you!

KIT "A" £2:12:6

Cash or C.O.D. Carriage Paid, Or 5/- down and 11 monthly payments of 5/-.

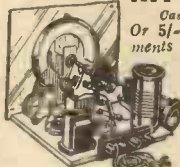

Contains every part for building, including 2 coils, 15-52 metres, wiring, assembling and operating instructions and full size blueprint, less valves. Set of 2 H.V.A.C. valves, 9/3 extra.

This remarkable two-valver has a range never before accredited to this number of valves, and will bring you programmes from all over the world.

Send coupon below with 3d. in stamps for the B.T.S. "SHORT-WAVE CONSTRUCTOR" Magazine, which fully describes the above and TWO other amazing short-wavers.

LISSEN BAND SPREAD S.W.3

FREE BLUEPRINT WITH EVERY KIT A new easy-to-build Band Spread tuning S.W. Receiver. Range 13 to 55 metres. Complete Kit of components, including ready-drilled chassis and condenser plate, 3 valves and full instructions. Cash or C.O.D. Carriage Paid, £3/9/6. Balance in 11 monthly payments of 6/6.

B.T.S. 1936 SHORT WAVE ADAPTOR



RECEIVE AMERICA DIRECT The famous B.T.S. SHORT WAVE ADAPTOR on EASY TERMS. Simply plugs into your present battery or A.C. Mains set. The only adaptor at this price incorporating 100-1 ratio aerial tuning and slow-motion reaction: for use either as Plug-in or Superhet Short Wave Adaptor. Walnut finished Cabinet illustrated.

With 2 plug-in coils, 13-26 and 24-52 metres. Extra coils, 46-96 and 90-190 metres. 4/6 each. **READY ASSEMBLED 52/6** and 11 monthly payments of 5/-.

NEW Cosmocord PICK-UP



MODEL 276. Entirely new, and designed to give high fidelity reproduction with large distortionless output. Incorporates special method of frictionless armature suspension. Attractive Mottled bakelite finish. Complete with volume control, screened leads and combined pick-up arm rest and needle caps. **£1:7:6** CASH OR C.O.D. CARRIAGE PAID, 5/- deposit and balance in 5 monthly payments of 5/-.

GARRARD A.C.6 Induction ELECTRIC MOTOR. Complete with 12in. turntable, Unit Plate and fully automatic Switch. For A.C. mains only. Cash or C.O.D. **2/6** Carriage Paid, £2/2/6.

Balance in 11 monthly payments of 4/-.

GARRARD No. 30 Double Spring MOTOR. Complete with 12in. Plush-covered Turntable, Brake, Speed Indicator, Patent Winding Crank. Will play 2 sides of a 12in. record at one wind. Cash or C.O.D. Carriage Paid, £1/8/0. Balance in 10 monthly payments of 2/6.

1936 Peto-Scott ELIMINATORS 1936



MODEL A.C.12 (Illustrated). A.C. 200/250 volts, 50/100 cycles. 120 volts at 13 m.a. 4 tappings. Cash or C.O.D. Carr. Paid, 30/-, or 2/6 down and 10 monthly payments of 3/-. MODEL A.C.25. 3 H.T. tappings 25 m.a. at 150-v. A.C. 200/250-v. 50/100 cycles. Westinghouse rectifier. Cash or C.O.D. FROM Carriage Paid, £2/9/6, or 5/- down and 10 monthly payments of 5/-.

MODEL M.A. 10/50. With 1-amp. Trickle Charger for 2-v. Accumulator. For A.C. 200/250-v. 50/100 cycles. Westinghouse rectifier. 4 tappings. Output 30 m.a. at 150-v. Cash or C.O.D. Carriage Paid, £2/19/6, or 5/- down and 11 monthly payments of 5/6. MODEL D.C.25. 3 H.T. tappings. Output 25 m.a. at 150-v. For D.C. mains. Cash or C.O.D. Carriage Paid, £1/7/6, or 2/6 down and 11 monthly payments of 2/6.

PILOT AUTHOR KITS MONITOR 3

KIT "A" CASH or C.O.D. £2:5:0

Author's Kit of First Specified parts, YOURS FOR including Ready Drilled Metaplex Chassis, less Valves, Cabinet and Speaker. **7/6**

Balance in 6 monthly payments of 7/-.

- **ADDITIONAL COMPONENTS** as specified in this issue:
- 1 Peto-Scott Ready-Drilled Metaplex Chassis 10" x 10" x 3" s. 6. 3 9
 - 1 Polar Midget 2-gang Condenser (Straight Type) 11 0
 - OR 1 Polar Midget 3-gang Condenser (Straight or Superhet Type) 16 6
 - 1 B.T.S. Monitor 3 Anode Coil as specified 5 0
 - 1 B.T.S. Switch Chassis, type M, as specified 6 6
 - 1 T.M.C. .0001 mfd. Tubular Condenser 6 6
 - 1 Dubilier .5 meg. Resistance 1 0
 - 1 Bulgin H.F.9 Choke 2 6
 - 1 Polar 50,000 ohms Potentiometer 4 0

C.O.D. PARCEL

Comprising • B.T.S. Monitor 3A Coll. • Polar COMPAX CONDENSER. • J.B. Airplane drive. • Peto-Scott Ready Drilled Metaplex Chassis, 4 Component Brackets, all necessary connecting wire, wood screws and flex. **18/6 CASH OR C.O.D. PAID.**

PREFECT SHORT WAVE 3

KIT "A" CASH or C.O.D. £2:15:0

Author's Kit of First Specified parts, YOURS FOR including Ready-drilled Metaplex Chassis, less Valves, Cabinet, Speaker and Headphones. **7/6**

Balance in 7 monthly payments of 7/9.

C.O.D. PARCEL

Comprising • B.T.S. 6-pin Short-Wave Coil and Base. • J.B. 15 muf. Bandsread condenser. • 3 B.T.S. Short-Wave Valveholders. • Wearite Short-Wave H.F. Choke. • Peto-Scott Ready-drilled Metaplex Chassis. • 3 component brackets, and all necessary connecting wire, wood screws and flex. **22/6 CASH OR C.O.D. PAID.**

£4 SUPERHET 4

BATTERY VERSION

KIT "A" CASH OR C.O.D. £4/4/0

Author's Kit of first specified components only. Or 7/6 down and 11 monthly payments of 7/9.

A.C. MAINS VERSION

KIT "A" CASH OR C.O.D. £10/2/6

Author's Kit of first specified parts. Or 17/6 down and 11 monthly payments of 18/6.

Peto-Scott 1936 UP-TO-DATE SENSITIVE S.G. 3 KIT.

- 2-gang Air Dielectric Tuning Condenser.
 - Automatic Grid Blas.
 - Full Vision Slow-motion Tuning.
 - Detector, S.G., Pentode Valves.
- Modern Air-spaced Coils. **KIT "A" 35/-** Cash or C.O.D. Carr. Paid, or 2/6 down and 9 monthly payments of 4/-.



POST THIS COUPON NOW

PETO-SCOTT CO., LTD., 77 FR.W. 15, City Road, London, E.C.1 Tel.: Clerkenwell 9400/7.

Please send me CASH/C.O.D./H.P. _____

NAME _____

ADDRESS _____

I am also interested in _____ Pr. W. 13

Please send me full details without obligation.



SIGNS of the TIMES

The Budget has restored
POLICE OPPORTUNITIES.

The Air Force is to be increased.
AVIATION MUST DEVELOP.

Pay Cuts have been restored.

CIVIL SERVICE

Suitable to both sexes. Ages 15½ to 21.

G.P.O. ENG. DEPT.

CUSTOMS AND EXCISE, INSPECTOR OF TAXES, Etc.
NO EXPERIENCE REQUIRED. OPEN EXAMS.

MATRICULATION

There are many ways of commencing a career, but Matriculation is the jumping off board for all the best ones.

We prepare candidates for all

INSTITUTE EXAMS.

Technical, Accountancy, Secretarial, Insurance, etc.

ENGINEERS AND DRAUGHTSMEN

All Branches—Employers are advertising for them.

TELEPHONY, RADIO and MOTOR ENGINEERING are expanding rapidly. There are lots of vacancies. Our postal courses will make you eligible. Advice on all careers free.

Also ask for our New Book (Free of charge)

THE HUMAN MACHINE

Secrets of Success

YOU CAN HAVE A COLLEGE TRAINING IN ALMOST ANY CAREER FOR A FEW SHILLINGS MONTHLY

Accountancy Exams.	Matriculation
Advertising and Sales Management	Metalurgy
A.M.I. Fire E. Exam.	Mining, all subjects
Applied Mechanics	Mining, Electrical Engineering
Army Certificates	Motor Engineering
Auctioneers and Estate Agents	Motor Trade Municipal & County Engineers
Aviation Engineering	Naval Architecture
Banking	Pattern Making
Boilers	Police, Special Course
Book-keeping, Accountancy and Modern Business Methods	Preceptors, College of Pumps and Pumping Machinery
B.Sc. (Eng.)	Radio Service Engineering
B.Sc. (Estate Management)	Radio Communication
Building, Architecture and Clerk of Works	Road Making and Maintenance
Cambridge Senior-School Certificate	Salesmanship
Civil Engineering	Sanitation
Civil Service	Secretarial Exams.
All Commercial Subjects	Ship-building
Commercial Art	Shorthand (Pitman's)
Concrete and Structural Engineering	Structural Engineering
Draughtsmanship, all branches	Surveying
Engineering, all branches	Teachers of Handicrafts
Subjects and examinations	Telephony and Telegraphy
General Education	Transport Inst. Exams.
G.P.O. Eng. Dept.	Weights & Measures Inspector
Heating & Ventilating	Welding
Industrial Chemistry	Wireless Telegraphy and Telephony
Insurance	Works Managers
Mathematics	

If you do not see your own requirements above, write to us on any subject.



Dept. 104, THE BENNETT COLLEGE, SHEFFIELD.

The New Twin-Speaker McMichael Radiogram

McMICHAEL RADIO, LTD., have recently released their new radiogram (Model 365), which is designed to provide critical listeners with an instrument of unquestioned quality and reliability, with every worth-while refinement of 1936 technique.

Externally, the design of the new model follows the style initiated in the firm's highly popular 15-guinea twin-speaker superhet (Model 135). The inlaid walnut cabinet is bow-fronted in shape, supported on gracefully curved legs and although of very generous dimensions, has none of the excessive solidity frequently encountered. Thus, whilst not ultra-modern, it is thoroughly in harmony with the surroundings of the home in which it will be placed. Particular care has been taken over the construction and detail finish of the cabinet, and it is interesting to note that its genuine piano-finish is obtained by an entirely new process combining the virtues of both cellulose and french polish, on which an ordinary wax-polish can be used by the housewife; this process, used by piano manufacturers, is here employed for the first time in this country for a radio cabinet.

The Circuit

The circuit is a five-valve eight-stage band-pass A.C. superhet fitted with full A.V.C., and the constant-gain coupling system giving uniform performance over both wave-bands. Multiple valves are employed in conjunction with seven tuned circuits, and an elaborate mains-static filter which gives exceptionally quiet operation, while over 4 watts undistorted output is supplied to the extra large twin-stereophonic speakers. The successful McMichael Giant Dial is, of course, a prominent feature, this time ten inches in diameter, is fitted with colour-changing illumination for the two wavebands, the motor turntable on the opposite side of the cabinet being recessed in harmony with the dial. The high quality turntable and pick-up are provided with a separate system of overhead floodlighting—a most useful innovation—while the volume control, operating on both radio and gramophone, is tone-compensated to a new degree of efficiency.

Model 365 possesses exceptional tone, high range and selectivity, extreme simplicity of operation, and a new low-level of background noise, while its cabinet work is above reproach.

Specification

Circuit.—Five-valve (including rectifier) eight-stage superselective band-pass A.C. superhet employing seven tuned circuits, full A.V.C., mains static suppression and multiple valves. The valve sequence comprises a triode-pentode frequency-changer, an H.F. pentode for I.F. amplification, followed by a distortionless double-diode

triode for A.V.C. second detection, and first stage of L.F. amplification; the output is a high-power pentode, while the last valve is a heavy duty H.T. rectifier.

Constant-gain Couplings.—The band-pass input circuits are specially arranged to provide substantially level gain from top to bottom of the scale, and operate in conjunction with an efficient image-suppression device.

Controls.—Four only—tuning, wave-change-gram., volume and tone—neatly disposed over the tuning dial. The tuning dial is 10in. in diameter, with two concentric scales, calibrated in both station names and wavelengths; the medium-wave scale alone is 22in. in circumference, and all names are three times larger than usual; red and green illumination for the different wavebands simplifies tuning still



This illustration of the new McMichael twin-speaker radiogram shows the fine lines of the cabinet work, and the giant dial.

further, and greatly improves appearance.

Twin stereophonic moving-coil speakers.—Reproduction from the two carefully balanced energised speakers—an extra large unit for middle and low frequencies, and a second unit for treble—is remarkably fine and very uniformly distributed.

Undistorted output.—Over 4 watts, much above average and enough for a small hall; this is a great aid in the rendering of heavy passages and gramophone records.

Volume Control.—Very efficiently tone-compensated to preserve a constant musical balance at all volumes; the tone control is of the wide-range type with even gradation.

Gramophone Equipment.—High-quality pick-up and electric motor.

Price.—28 guineas.



SHORT WAVE SECTION

THE S.-W. OUTPUT CIRCUIT

In Some Respects the Output Arrangements of the Short-wave Receiver Differ from Normal Broadcast Apparatus, and Some Interesting Points are Here Discussed. By W. J. DELANEY

MANY listeners have probably found, when using a short-wave receiver for the first time, that much difficulty is occasioned by what are loosely termed "hand capacity" effects, but which should more correctly be described as "body capacity" effects. Owing to the very high frequencies which are dealt with in a short-wave receiver it is usually found that the H.F. currents are not stopped or blocked so easily as they are in a broadcast receiver, and it is to this that the troubles may be traced. For the benefit of new readers or those to whom the above statement may be rather obscure it may be stated quite briefly that the frequency of the normal broadcasting stations ranges downward from about 1,500 kilocycles, whilst the short waves will vary in frequency from 6,000 kilocycles upwards (50 metres and below), and thus there is a much greater risk of leakage as distinct from actual stoppage.

We will assume, for the purpose of this article, that the short-waver consists of a straight receiver, as the superhet type of apparatus requires different treatment, due to the change in frequency $L.T.$ which takes place. The

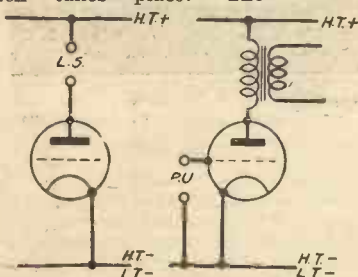

Fig. 2.—The output circuit of an S.W. set and the input circuit of an L.F. amplifier.

receiver may or may not employ an H.F. stage, but it may be ignored for the purposes of this article, as the H.F. currents must be passed along to the detector stage in order to provide an audio signal for subsequent amplification, and it is usual to provide adequate insulation on this side of the circuit to ensure that the maximum transfer of these currents takes place without loss.

The Detector Anode

Thus, we arrive at the point where a large H.F. supply is fed to the grid of the detector stage, and we must assume that the tuning circuit is so arranged that there is no loss and complete rectification takes place. At the anode circuit there will thus be present a rectified signal oscillation,

in which will be found a fairly large percentage of H.F., and in the interests of good theory this must be stopped at this point, or, if you prefer it, diverted direct to earth. What happens if this is not done? Firstly, the presence of H.F.

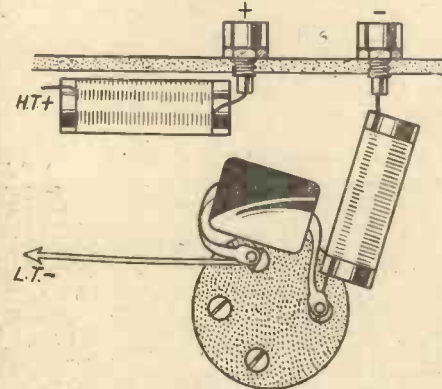

Fig. 1.—An output scheme which will be found very valuable for headphone work.

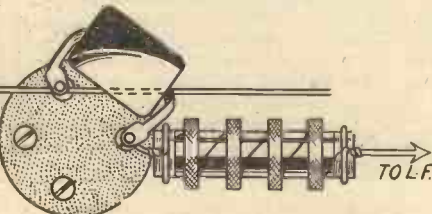

Fig. 5.—The correct method of wiring the detector anode circuit to ensure correct H.F. by-passing.

currents in the L.F. circuits will lead to all sorts of instability and distortion, although the latter is generally unimportant in a normal short-wave receiver, it will, however, become of greater importance when television transmissions are considered. Jumping from the detector stage to the output stage, let us assume that the H.F. currents have leaked right through the set and are to be found at the output valve anode circuit. What difference will this make to the operation of the receiver? Any experimenter who

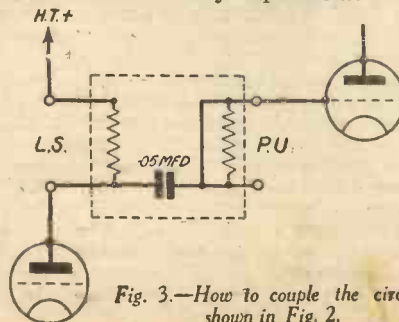

Fig. 3.—How to couple the circuits shown in Fig. 2.

has used a pair of headphones with a short-wave set may have noticed that sometimes when wearing the 'phones it is impossible to hear stations which are heard on the speaker when this is in circuit, or, alternatively, that it is absolutely impossible to obtain any signals whilst the headphones are being worn. In most cases this will be due to the H.F. currents at this point, and it will be found that there is a form of feed-back from the output to the detector stage, due to the capacity effects of the body to earth, and very little transfer of signal takes place through the L.F. circuit,

H.F. Filters

As an experiment the listener can incorporate high degrees of insulation to the detector stage (using old glass dishes, etc., to avoid capacity losses to earth) and then connect a coil in series with the 'phones and couple this to the detector tuned circuit. It will, in almost every case, be found possible to obtain strong oscillation by this method, providing proof of the presence of the H.F. currents. Accurate tuning with headphones under such conditions is impossible. Assuming the use of a good short-wave choke in the anode circuit of the detector stage, a by-pass condenser to earth should be adequate to stop the passage of these currents, but where maximum results are required the following precautions will be found desirable.

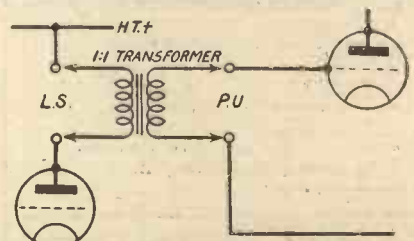

Fig. 4.—An alternative method of coupling the circuits shown in Fig. 2.

able and may be arranged on a very inexpensive basis. Firstly, in the detector anode circuit, the usual H.F. choke should be sectional wound on the highest insulation material which can be found, and should be joined direct to the anode terminal (Fig. 5). If you cannot afford to buy one of the modern H.F. chokes wound on a ceramic base, wind your own on a glass tube, using a dab of Chatterton's Compound to retain the ends, and splitting the winding up into a number of small sections. The choke should be as compact as it is possible to make it without introducing too large a self-capacity. This is where the commercial component will score, on account of the fact that a special wave-wound arrange-

(Continued on page 743)

Let Us Send You
This 40-Page
Booklet — Free



It gives full information regarding various I.C.S. Courses of Instruction in Radio work.

The Radio industry is progressing with amazing rapidity. Only by knowing thoroughly the basic principles can pace be kept with it. I.C.S. Instruction includes American broadcasting as well as British wireless practice. It is a modern education, covering every department of the industry.

OUR COURSES

Included in the I.C.S. range are Courses dealing with the Installing of radio sets and, in particular, with their Servicing, which to-day intimately concerns every wireless dealer and his employees. The Equipment Course gives sound instruction in radio principles and practice.

There is also a Course for the Wireless Salesman. This, in addition to inculcating the art of salesmanship, provides that knowledge which enables the salesman to hold his own with the most technical of his customers.

Then there are the Preparatory Courses for the City and Guilds and I.W.T. Exams.

We will be pleased to send you details and free advice on any or all of these subjects. Just fill in, and post the coupon, or write in any other way.

International Correspondence Schools, Ltd.,
Dept. 94, International Buildings,
Kingsway, London, W.C.2.

Without cost, or obligation, please send me your "Radio" booklet of information about the Courses I have marked X

- COMPLETE RADIO
- RADIO SERVICING
- RADIO EQUIPMENT
- RADIO SERVICING AND SALESMANSHIP
- WIRELESS ENGINEERING
- EXAMINATION (state which)

Name

Address

B.T.S. Ultra- and Short-wave Components

Some Details of a Most Interesting Range of Components Designed to Fill a Specific Need of the Short-wave Listener

In our various articles on short-wave reception we have dealt with the subject of losses which are often incurred owing to the use of apparatus which is not designed for the purpose. The distinction between the design of apparatus used on the short- and ultra-short wavelengths is almost as great as the differences between standard broadcast apparatus and normal short-wave components, and in the illustration below may be seen some of the specially-designed ultra-short-wave items selected from the B.T.S. range. As may be seen in this illustration, no ebonite or other rubber-base material is employed for insulation purposes, and to make perfectly certain of the highest efficiency from the point of view of insulation a new ceramic material is employed and this is known in these components as "Megacite." This has a high-power factor and extremely low losses and may be used right down to 2 or 3 metres without any difficulty in many parts of the circuit.

which the primary winding is wound. This, also, is provided with an adjustable control on the top so that the degree of coupling between primary and secondary may be adjusted to provide the necessary bandwidth determined by the apparatus in which the unit is employed. Thus, for sound reception it may be loosened to prevent interference between adjacent signals, whilst for vision reception it may be set to provide a wide response curve and so avoid side-band losses. The design of the coils is such that a band-width of 2.5 megacycles (2,500 kilocycles) may be obtained. The price of this particular component is 9s. 6d.

Condenser Adjustments

The variable condenser seen in the background is also fitted with silver-plated vanes and the Megacite end-plates, but the most interesting feature in this component is the large adjustable metal bush which is fitted to the centre spindle, and which may

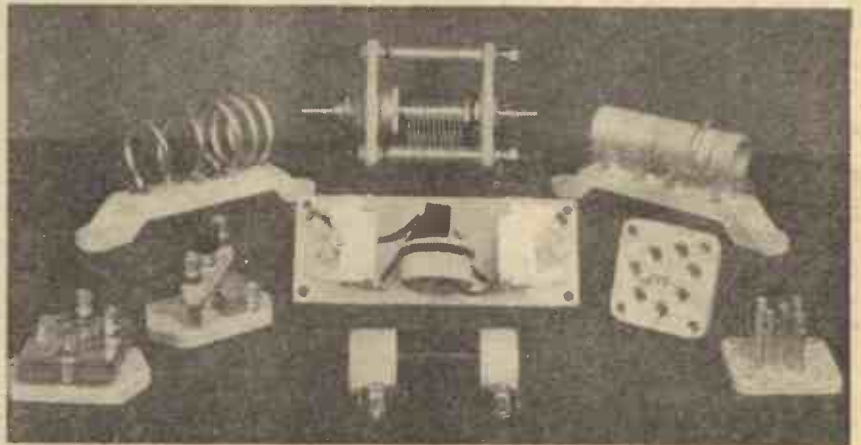

An interesting group of short-wave components in which every precaution has been taken to avoid losses. These B.T.S. components are characterised by silver-plated metal parts and ceramic material for insulation purposes.

H.F. Resistance

In addition to this use of Megacite, the makers of these components have also carefully studied the question of high-frequency resistance in those components where H.F. currents may be found, and as a result we find that all metallic surfaces of this nature are silver-plated, and this extends not only to inductances and other coil windings, but also to the plates of the small condensers, the valve sockets and terminals. It may thus be taken for granted that all of this apparatus will be found highly satisfactory in the construction of short- and ultra-short-wave receivers or transmitters.

Amongst the items shown in the illustration may be seen a special I.F. unit and this is to be seen in the centre of the group. A piece of the Megacite material carries two special low-loss air-dielectric trimming condensers which are provided with slotted heads on the upper surface of the Megacite, and adjustment may be made by means of a screwdriver-shaped piece of wood. The secondary winding of the I.F. transformer is carried on a tubular former of Megacite, and inside this is a smaller former upon

be seen close to the left-hand plate in the illustration. This adjusts the tension on the spindle and thus makes it a simple matter to provide just that degree of friction which will enable the condenser to be operated through any type of drive but will still permit of perfect contact being made, and complete elimination of noises whilst the rotor is moving. The extended spindle will enable any number of these condensers to be ganged together, and there will be no likelihood of the weight of the moving vanes causing the setting to vary, due to vibration. The price of this condenser is 7s. 6d.

Other Items

Amongst the remaining items are the tuning coil and oscillator coil, a trimming condenser and padding condenser, an H.F. choke and two valve-holders. The trimming and padding condensers will be found extremely useful for other purposes, although they are intended primarily for use in a superhet circuit. These two condensers may be obtained with practically any capacity, the trimming condenser up to 40 mfd. and the padding condenser up to .0002 mfd.

SHORT-WAVE SECTION

(Continued from page 741)

ment may be incorporated. The by-pass^s condenser should also be joined to the anode terminal, and the other side of this condenser should be joined to cathode or to the negative filament leg of the valve-holder.

As a further part of the filter, a second condenser should be joined from the other side of the choke direct to the nearest earthed point in the receiver, and both of these by-pass condensers should be of the mica-dielectric type, as it has been found on experiment that a number of peculiar tuning effects have been traced to the tubular type of condenser.

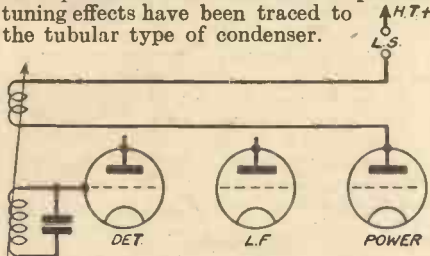

Fig. 6.—A simple method of testing the efficiency of the H.F. arrangements.

Isolating the 'Phones

Theoretically, no H.F. currents should now be experienced in the L.F. circuits, but as a further precaution it is worth while to provide a good choke on each side of the 'phone or loud-speaker terminals, again arranging for good components, and this time taking into account the anode current which may be passing. As the valve will be of the power type there will be probably a fairly heavy current flowing, and thus the component does not come within the same category as the detector choke. To construct your own is not so difficult here, and 100 turns of 24 D.C.C. on a lin. ebonite, paxolin, or glass former will be found quite suitable. The first choke should again be joined direct to the anode terminal on the valve-holder, whilst the second choke should be joined direct to the positive loud-speaker or 'phone terminal (Fig. 1). A fixed condenser should be joined between anode and earth, and again mica should be employed for the dielectric, whilst the capacity may be found to be critical, and thus some experiment should be carried out with a view to finding the most suitable value for the valves and circuit in use.

Using Two Sets

Some readers have built a simple short-wave set and wish to increase the strength of signals by adding the L.F. stages of another broadcast receiver. They have asked whether it is possible to use the pick-up terminals on the standard set for the purpose. In Fig. 2 the output circuit of the average short-wave set is shown by the side of the pick-up circuit generally employed, from which it will be seen that if the L.S. and pick-up terminals are directly connected, the H.T. will be applied to the grid of the L.F. valve, or, if the terminals are reversed, the H.T. supply will be short-circuited. The two pieces of apparatus may, however, be coupled in a very simple manner either by an L.F. transformer or by a resistance-capacity coupling unit as shown in Figs. 3 and 4. The transformer should be of low ratio to avoid overloading the first valve in the amplifying chain, whilst if an R.C. unit is made up the resistance in the anode circuit will have to be of low value to avoid a serious reduction in the H.T. applied to the valve.

C.C.495B

As they say in Auchtermuchty:

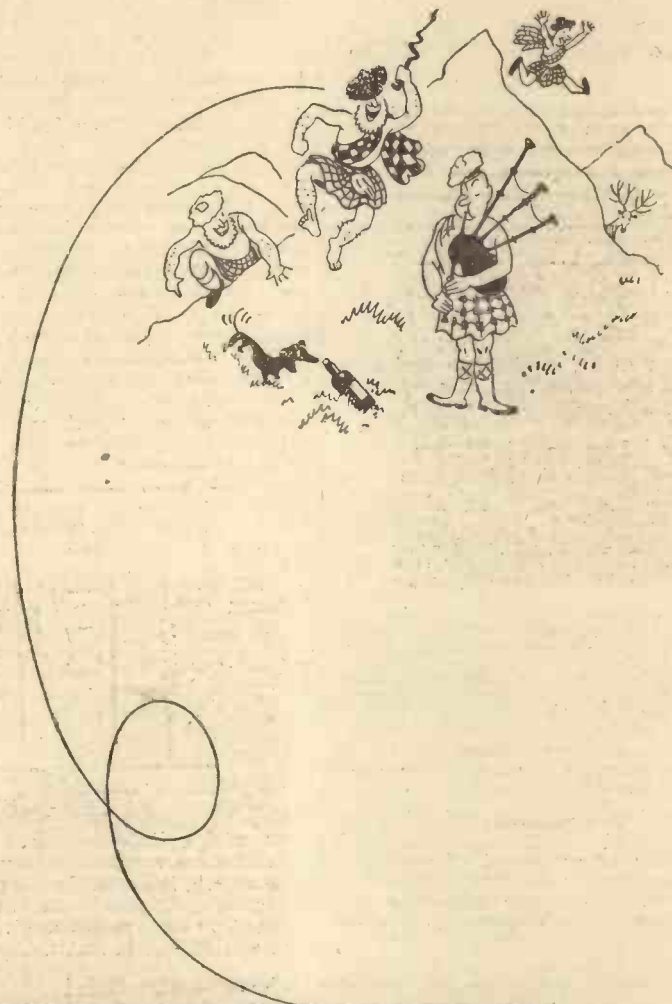

'BETTER BUY CAPSTAN.

they're blended better

- they're Wills's



**CAPSTAN CIGARETTES
PLAIN OR CORK TIPPED**

**10 for 6d.
20 for 11½d.**

LETTERS FROM READERS

The Editor does not necessarily agree with opinions expressed by his correspondents.



All letters must be accompanied by the name and address of the sender (not necessarily for publication).

Our Simple Short-waver

SIR,—I recently constructed the simple short-wave receiver, particulars of which were published in the issue of September 14th, 1935, and below is a short log of some of the stations I have received:—

W8XK, W2XE, 2RO, WIAXL, EAQ, CTIAA, HBL, VK2ME, W2AXF, PRF5, LKJI.

To this circuit I have added another valve, and it is now possible to obtain quite a strong signal. Instead of the fixed condenser in series with the tuning condenser, I use a pre-set condenser.—D. LEVEY (Leek, Staffs).

A Good Log on 40 Metres

SIR,—Having noticed from time to time various reports in your paper with regard to Amateur "S.W." Transmission, etc., I thought the following might be of interest. The receiver in use is a simple 2-valve (o-v-1) with very short aerial and earth.

Heard on 40 metres on January 4th to 6th were the following: W3QE, W2ISZ, W8OZU, W1QG, W1RY, W1IE, W1HO, W2HTO, W8NPR, W1JNL, W3DAJ, W8FSM, W3EOG, W5CGQ, W9DMF, W2CP, W3AUF, W2BVS, W3CDG, W1DEK, W3EPR, W8AUP, W8FIP, W1EO, W8LED, W1BBS, W8OQF, W3BUY, W2IOP, W2NTR, W2ABX, W1FH, W3DFX, W1HYV, W9TBW, W3CGG.

It should be mentioned, of course, that the above were "all C.W." I have also noticed recently in your columns requests from readers for articles dealing with amateur transmission.

I beg to agree on this matter. Simple and easily understood articles on this phase of radio would, I am sure, be very welcome to a considerable number of your readers.

Thanking you for a very fine weekly, of which I have been a regular reader since 1924.—S. GEOFFREY WOOD (Rotherham).

Club Membership Wanted

SIR,—I have tried for some time to find a wireless club in this vicinity, but without success. If there is such a club in this district I shall be glad if the secretary will get in touch with me at the address given below.—J. R. WATSON (158, Runley Road, Luton, Beds.).

Jamming on the 40-metre Band

SIR,—Re the letter from A. E. Millinchip (Hartlebury) on the subject of "40-metre Jamming," may I respectfully suggest that if the above-mentioned gentleman considers 40 metres too crowded, why not do the most obvious thing—use the 160-, 80-, 20-, 10-, or 5-metre bands. Why use 40 metres?

In all sincerity I think it is quite possible to carry out a 100 per cent. QSO on 40 metres if good operating is employed. If one takes a percentage of stations working on the 40-metre band on Sunday mornings, I am convinced that the 10-watt amateurs will be found to be about 70-80 per cent. of the total. I am sure there are comparatively few QRO telephony transmitters

who use the 40-metre band for work on Sunday mornings.

In conclusion, may I add that patience is a virtue, and good operating an absolute necessity. To grouse is the most obvious way out; why not try to do something?—H. J. CHATER, G2LU (Coventry).

An Unusual Circuit

SIR,—Your readers may be interested to know of the unusual circuit I use. The set is a HF.D.LF. mains receiver, which I use for local station quality recep-

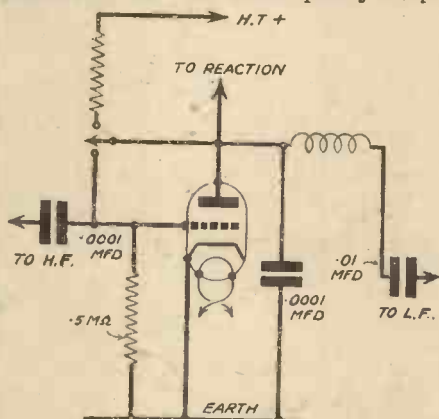

A circuit for a combined diode and power-grid detector.

tion with a diode detector. When foreign stations are required, however, a turn of the switch, indicated in the accompanying diagram, changes over to power-grid detection with reaction, giving increased sensitivity.—J. L. SHAW.

The 40-metre Band

SIR,—It would seem that your correspondent "A. E." has been misinformed in regard to several matters affecting the amateur transmitter and the facilities which he may enjoy. In the first place, I must point out that there are six bands from which he may choose and not the 40-metre band, as he appears to think. Some of these offer ample accommodation but are comparatively neglected. Secondly, whilst it is generally admitted that most transmitters are members of R.S.G.B., which is the only organisation which looks after their interests, nevertheless there is no sort of compulsion whereby non-members are penalised. "A. E." stands exactly the same chance of obtaining his transmitting licence, whether he is a member of R.S.G.B. or not.

While not wishing to take up your space unnecessarily, I do, however, think that one or two observations on the state of affairs on 40 metres might not be out of place from an old timer.

The reasons for the congestion can be roughly summarised as under:—

1. Stations using unnecessarily high power to effect local contacts which would be much more reliable on one of the other bands. The 100-watt phone station on a Sunday morning working over twenty miles is a pest.

2. The reluctance to use the portion of the band between 7,200 and 7,288 kc/s

owing to its not being in harmonic relationship with the 14 mc. (20-metre) band. A crystal between these limits will, therefore, not "double" into the other band.

3. The general disinclination to work during the week and boldly tackle the problem of interference to broadcast listeners when this occurs.

4. The over-modulated, unstabilised, and bad quality "telephony" emanating from many foreign stations, particularly in France.

5. Many of the transmissions now taking place on open aerials are unnecessary, and could be quite as easily and efficiently conducted with an artificial aerial.

6. The general lack of interest in the 160-metre and 10-metre bands, plus the tendency of certain stations to use their apparatus for conducting a species of family party on the air, instead of getting down to the serious experimental work for which their licences were granted.

I agree there is something wrong, but like poverty, war, disease, and the hundred-and-one other problems of life, the remedy is in the hands of the victims, waiting to be applied.—ARTHUR O. MILNE, G2MI (Maidstone).

(This correspondence is now closed.—ED.)

A S.W. Log from Chingford

SIR,—Having regularly read with great interest the logs of other readers, I have never yet seen one from this district, so I append a short log of stations I have recently received, on 40 metres and upwards, W3AL, W8XK, W3XL, W2XE, W9XF, WEN, VE9BJ, YVQ, YV6RV, HJ4ABE, HJ3ABI, HJ1ABB, HCRL, RW72, EA8AB. The amateurs are too numerous to mention, and on Sunday mornings on 40 metres it is simply the survival of the fittest. My receiver is a simple 3-valver, using 6-pin home-made coils, and all components came out of the junk box. I should like to see a bigger short-wave section in your excellent paper.—F. ANDREWS (Chingford).

CUT THIS OUT EACH WEEK.

Do you know

—THAT when a tone filter is included in a circuit to compensate for very selective tuners, a switch should be included to eliminate the device for gramophone record reproduction.

—THAT where bare copper wires are employed for short-wave tuners on the ultra-short wavelengths, cleanliness must be observed to avoid H.F. losses.

—THAT for the above reason certain commercial coils are now wound with silver-plated wire to avoid corrosion.

—THAT where a spark-gap is provided on the aerial lead, some form of protection from moisture should be fitted.

—THAT if the above precaution is not taken noises and loss of signal strength may be obtained due to leakage across the gap.

—THAT where incurable H.F. instability is experienced the H.F. valve may be suspected of oscillation.

—THAT to test for the above fault a milliammeter should be included in the anode circuit and the grid terminal earthed. The meter reading will be increased when this is done if the valve is oscillating.

The Editor will be pleased to consider articles of a practical nature suitable for publication in PRACTICAL AND AMATEUR WIRELESS. Such articles should be written on one side of the paper only, and should contain the name and address of the sender. Whilst the Editor does not hold himself responsible for manuscripts, every effort will be made to return them if a stamped and addressed envelope is enclosed. All correspondence intended for the Editor should be addressed: The Editor, PRACTICAL AND AMATEUR WIRELESS, Geo. Nevens, Ltd., 8-11, Southampton Street, Strand, W.C.2.

Owing to the rapid progress in the design of wireless apparatus and to our efforts to keep our readers in touch with the latest developments, we give no warranty that apparatus described in our columns is not the subject of letters patent.



IMPRESSIONS ON THE WAX

By
T. O'nearn

H.M.V. Records

THE series of short plays presented in triple bill form and grouped under the title of "To-night at 8.30" is having extraordinary success at the Phoenix Theatre, London. Gertrude Lawrence and Noel Coward have recorded scenes from three of the plays, "Shadow Play," "Red Peppers" and "Family Album" on H.M.V. C2815-7. They were specially rewritten by the author for gramophone recording. "Red Peppers" is, perhaps, the best of three unusual records.

From the Films

A NEWCOMER to the film world is Lily Pons, the operatic soprano, and she has recorded two of the songs from her new film, "I Dream Too Much," on H.M.V. DA1456.

Frances Day's record of "Me and My Dog," from her film "Public Nuisance No. 1" on H.M.V. BD323, is sung in her own inimitable style, and mention must also be made of Robert Ashley, the young baritone, who is yet another B.B.C. discovery. His numbers, "Thanks a Million" and "Moon for Sale," on H.M.V. BD315 are from the film, "Thanks a Million."

King George's Last Message to His People

IN the past, the real personalities of our Sovereign Ruler have been known to few. With this generation it is different. King George will always be with us. His simplicity and kindliness, his devotion to duty and his steadfast faith in his people are there for all to hear in a record of his last Christmas Day Message. The number of the record is H.M.V. RCS2811 and the profits made by "His Master's Voice" from its sale are being given to charities nominated by the late King.

"Dance of the Hours"

A RECORDING that should make its appeal is the "Dance of the Hours" from Ponchielli's "La Gioconda." This is one of the best-known pieces of operatic ballet music and is played by the Boston Orchestra (composed of selected players from the Boston Symphony Orchestra) on H.M.V. C2812.

Gigli the famous tenor has recorded "Plaisir d'amour," coupled with the mournful "Elegie" by Massenet, on H.M.V. DB2530, and Miliza Korjus, the "Swedish Nightingale," sings two Italian songs, "Funiculi, Funicula" and "La Danza" by Rossini on H.M.V. C2813.

Dancing Time

JACK HYLTON'S ORCHESTRA is well to the fore with "She shall have Music" and "Do the Runaround" on H.M.V. BD5017, also "My First Thrill" and "May all Your Troubles be Little Ones" on H.M.V. BD5018, all of which are from their new film "She shall have Music."

Noel Coward's latest tunes "You were there" and "Family Album" waltz from his new show "Tonight at 8.30" are played

by the Phoenix Theatre Orchestra on H.M.V. BD5019. The first of these has a vocal refrain sung by Sam Browne.

Decca

HANDEL'S "Samson Overture" appears in this month's list played by the Queen's Hall Orchestra, conducted by Sir Henry J. Wood, on Decca K812. I think you will like this.

A record which has no scholarly pretension is Mozart's "Serenata Notturmo" on Decca K810-11. It is extremely well played by the Boyd Neel String Orchestra.



How are your ears?

Believe it or not, there are in use this minute literally hundreds of old moving-iron horn type speakers. Their owners like the "purity of tone" (lack of bass). The absurdly narrow frequency range, appalling resonances, and violent "colouration" are not consciously noticed; and until those listeners hear a good modern speaker for a few minutes they will never realise the true reason for their lack of interest in the broadcast programmes.

This is an extreme instance of the common phenomenon known as "aural tolerance." You are not proof against it. Nobody is. You may even now be satisfied with radio reproduction far inferior to that which your set could give with a W.B. 1936 Stentorian, simply because your ear has become accustomed to the present imperfections.

Make this test. Ask yourself "Am I delighted with my set's reproduction?" "Do I get vivid life-like entertainment from my radio, as distinct from merely treating it as a pleasant 'background accompaniment' to other activities?"

If you cannot honestly answer "yes," go straight to your radio dealer and ask to hear a W.B. 1936 Stentorian loudspeaker. Afterwards, in the intervals between listening to the vivid presentation of broadcast items which it brings you, you can reflect on "aural tolerance"—and the pleasure of which it has cheated you for so long.

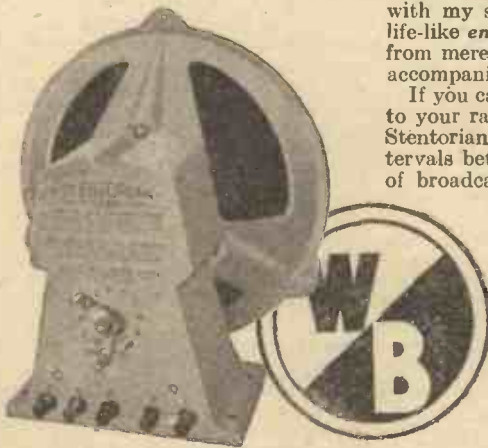

1936 STENTORIAN CHASSIS MODELS.

Senior	42/-
Junior	32/6
Baby	23/6
Midget	17/6
Stentorian Duplex	84/-
Type EM/W	70/-

CABINET MODELS.

36S (Senior)	63/-
36J (Junior)	49/6
36B (Baby)	29/6

1936 STENTORIAN

WHITELEY ELECTRICAL RADIO CO., LTD. (Technical Dept.), MANSFIELD, NOTTS. Sole Agents in I.F.S., Kelly & Shiel, Ltd., 47, Fleet Street, Dublin.

Facts and Figures

COMPONENTS TESTED IN OUR NEW LABORATORY

Bulgin Community Aerial Coupler

IN the past the experimenter has found it often necessary to arrange for separate aeriels in order that the standard family receiver could be used in one room whilst he experimented in another with a different receiver. It is difficult to arrange for separate aeriels to prevent interaction, and also to avoid making the house look like a small transmitting station, and thus the new aerial coupler introduced by Messrs. Bulgin will be found especially welcome in such instances. In many modern

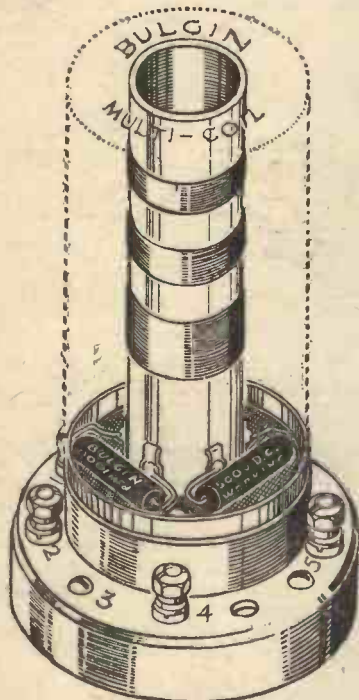

A diagrammatic view of the new Bulgin multi-set aerial coupler.

homes it is now the custom to provide a separate receiver in the kitchen, with a larger receiver in the drawing-room, for instance, and perhaps an experimental or short-wave receiver in another room, and this new coupler will enable all these sets to be operated from one aerial without interference. As may be seen from the illustration, the device consists of an ebonite base and screening can, inside which is an inductive unit with separate capacitors. Separate tapping points are provided and five terminals are fitted. A shielded lead-in is taken from the aerial to terminal No. 1, and from the remaining terminals screened leads are taken to the aerial terminals on the additional receivers, with an earth lead to the fourth terminal to complete the circuit. If the receivers are placed near each other and the length of the additional aerial lead is less than twelve feet, the screening may not be found necessary. The coupler is effective over a waveband from 20 to 2,000 metres, and the price is 5s. Screened cable for use with the coupler may be obtained for 6d. per coil, or 2s. 3d. for fifteen feet.

Cosmocord Pick-up

THE recently-introduced 5s. pick-up which was reviewed in our issue dated December 28th last, has been tested with a number of amplifiers and records and found to give every satisfaction. The arm clamp which is provided enables it to be mounted on practically every type of standard acoustic gramophone arm, and no difficulties will be experienced from rattle or looseness at this point. The length of lead provided may be twisted round the arm or passed through a hole in the motor board for connection to the amplifier or receiver, and it was not found necessary in the majority of cases to screen this lead. With one or two receivers, however, it was found desirable to pass the lead through a length of metal braiding and to tie this to the carrier arm, afterwards earthing the metal parts. With the majority of simple broadcast receivers this will not be necessary unless the lead from the pick-up to the receiver is of undue length. The weight of the pick-up is not sufficient to cause any undue wear and it was found, in fact, that it was lighter than certain acoustic instruments. The actual weight is slightly over 4 ozs., but this may, of course, be reduced, if desired, by fitting a counterweight on the rear of the carrier arm. The response curve is, to all intents and purposes, straight when used with a good amplifier, and it is not essential to fit any form of tone compensator. The slight rise in the characteristic at the lower end of the scale compensates for the reduced recording strength of the lower frequencies, and thus produces a well-balanced bass response, whilst a drop which is not sharply accentuated at the upper end of the scale helps to reduce to some extent the surface noise or needle scratch. The volume produced by this neat little component is sufficient to enable it to be satisfactorily employed with a two-valve battery amplifier.

Two New Mullard Valves

THE introduction of two new valves by the Mullard Wireless Service Co., Ltd., is a further contribution to the development of battery-operated receivers. The P.M.22D, listed at 13s. 6d., is a high-sensitivity output pentode, and has been designed to take the fullest consumption of anode current (the rated figure is less than half that of Class "B" or Q.P.P. valves).

The operating data, etc., is given below:—

Operating Data	
Filament voltage	2.0 volts
Filament current	0.3 amp.
Max. anode voltage	150 volts
Max. aux. grid voltage	150 volts

Base Connections

Standard B.V.A. 5-pin base.

The second valve which will be released with the P.M.22A is a battery double-

diode which will be known as the 2.D.2. The price of this new valve is 5s. 6d.

The most interesting feature of the 2.D.2 is its indirectly-heated cathode which permits the application of delayed automatic volume control, a refinement unobtainable with the directly-heated type of battery valve in which diodes are embodied.

It was designed essentially for quality receivers and will be largely employed in

those sets using the P.M.22D into which it can be directly fed without an intermediate stage.

Like the output pentode, the 2.D.2 is exceptionally economical, its filament consumption being no more than 0.09 amp. The valve is fitted with the standard B.V.A. 5-pin base.

Both the P.M.22D and the 2.D.2 will be generally released in a few weeks.

Ediswan Power Valve

A NEW power output valve has just been released by the Ediswan Company, and is shown on the left. It is known as the E.S.100 and, as may be seen, is

A new power output valve produced by the Ediswan Company.

of the high-voltage type designed for use in public address amplifiers or in high-quality home receivers in which the advantage of a very large output is to be taken into account when receiving high quality signals at moderate volume. The question of handling peak voltages has, of course, often been mentioned in these pages, and many listeners prefer to employ a very large power stage, although it is only operated at low volume. In this way one may rely all the time upon obtaining the utmost perfection in response, irrespective of the character of the received signal. The special 4-pin base is fitted, and it is recommended that the valve be employed in a

(Continued on opposite page)



This illustration shows the neat appearance of the new Avo oscillator.

FACTS AND FIGURES

(Continued from opposite page)

vertical position, although if certain precautions are taken it may be used when mounted horizontally. The valve becomes very hot whilst working, and thus ample ventilation is required. The main characteristics are as follows:—

Filament volts	6
Filament current	3 amps
Maximum anode voltage	1,000 volts
Impedance	1,750 ohms
Amplification factor	5½
Maximum dissipation	100 watts
Optimum load, approx.	7,000 ohms
A.C. power output, approx.	30 watts

List Price, £10 10s.

RADIO CLUBS AND SOCIETIES

Club Reports should not exceed 200 words in length and should be received First Post each Monday morning for publication in the following week's issue.

THE RADIO, PHYSICAL AND TELEVISION SOCIETY

MEMBERS of this society from all parts of London had the pleasure of hearing a lecture entitled "Advances in Receiver Technique," given by Messrs. L. A. Moxon, B.Sc., A.C.G.I., and J. E. Marshall, M.E.N.G., at a meeting held on Friday, January 24th. Mr. Marshall, in introducing the lecturer, indicated some of the problems encountered by the designers of modern receivers, and Mr. Moxon outlined the ways in which these problems are being tackled. He dealt lucidly with the superhet circuit and its pitfalls. "The chief fault of this circuit," he said, "is image interference, which takes the form of whistles. The remedy," he explained, "is pre-detector selectivity." The advent of ganged condensers enabled many tuned circuits to be used together, and the screen-grid valve solved other problems.

A.V.C. was dealt with fully and lucidly, while problems, such as noise suppression, valve noises, and interference, were explained. Full particulars of the society may be obtained from the Hon. Sec., M. E. Arnold, 12, Nassau Road, Barnes, S.W.13.

THE SURREY RADIO CONTACT CLUB

THE Surrey Radio Contact Club, which was formed last autumn, has met with a ready response from enthusiastic amateurs.

Formed as it was with the definite object of bringing together those transmitters and listeners who so frequently spoke and listened to each other "on the air" but rarely met in person, it was thought that it would attract but few members. However, its policy of having no "figureheads," having a committee composed of three active transmitters and two "A.A." men, and of providing a programme keeping the members in touch with the latest technical advances seems to be popular with a large number of amateurs.

Recent lecturers have been Mr. H. L. O'Heffernan, G5BY, a well-known transmitter, and also a member of the club, who gave a talk on "Five-Metre Transmitters and Receivers." On December 10th Mr. P. G. A. H. Voigt, well-known P.A. and microphone

Characteristic curves and full operating details can be obtained from the Radio Division, The Edison Swan Electric Co., Ltd., 155, Charing Cross Road, London, W.C.2.

Avo Oscillator

THE illustration on page 746 shows the oscillator which has been produced by the Automatic Coil Winder Company, and which was reviewed in our issue dated January 25th last. This particular instrument is now being tested in our laboratories and is being found very satisfactory in every way. It is very neat and compact, the actual dimensions being only 6in. by 4in. by 3in. The price is £5 10s. complete with shielded lead, valve, and self-contained H.T. and L.T. batteries.

technician, visited the club, and at the last meeting on January 14th, so that the members should have the latest information possible. Mr. Edwards, of the 302 Valve Co., lectured on the new R.F. pentode recently introduced by his company.

Apart from these regular meetings, visits have been made to the Physical Society's Exhibition on January 8th, and to the Ongar Radio Station on January 12th, and arrangements are being made for visits to the Western Electric Co.'s theatre and to the Dollis Hill Research Station of the G.P.O. A suitable location for a club transmitter is being sought, and if possible a club entry will take part in the A.R.R.L. D.N. Test next March.

Visitors to the club are cordially welcomed, and should communicate with the Secretary, Mr. E. C. Taylor, of No. 35, Grant Road, Addiscombe.

A CLUB FOR WYTHALL!

IT is proposed to start a Radio Society in the Hollywood and Wythall District, nr. Birmingham, and interested readers in this district are invited to write to I. Qulton (2AGV), "Jesmond-Dene," Shawhurst Lane, Hollywood, Nr. Birmingham.

THE CROYDON RADIO SOCIETY.

MEMBERS had been waiting for just such an opportunity as happened at a recent meeting in St. Peter's Hall, South Croydon. It was a Question night, and it was soon apparent that many teasing topics had been saved for the occasion. For instance, Mr. J. T. Haynes, a new member, discussed two aerials which did not "play the game." In other words, they disobeyed all the rules. The first one began all wrong by fixing itself to a water pipe at the top of the house; then it travelled downstairs to the set in the dining-room. Earthing of the receiver was effected normally to a water pipe in the cellar, so that aerial and earth were attached to the same system. Mr. Haynes insisted that the aerial must be earthed as described to get the best results. The second aerial also contravened the tradition of the old school. Its lead-in shocked members by trailing along a wall and ending at its pole with no insulator. Even so it gave better results than another aerial on the same pole properly insulated. Mr. Chubb then described his circuit, and how it was affected by substituting a wire-wound resistance for a choke. Mr. P. G. A. H. Voigt's loud-speaker demonstration, postponed from January 21st, took place on Tuesday, February 18th, and many PRACTICAL AND AMATEUR WIRELESS readers were able to attend the meeting—Hon. Pub. Sec., E. L. Cumbers, Maycourt, Campden Road, S. Croydon.

ELECTRADIX

Your voice amplified from your radio set to loudspeaker.



5/- **BUTTON MICRO-PHONES** for all purposes. Usually sold at 3/6. Our price has always been 1/-. We have supplied thousands.

15/-
N.W. No. 11 **TABLE MIKE.** This is a splendid Microphone for speech and music. The bakelite case, containing a 2in. mike and transformer, is on a bronze pedestal, detachable for sling. Switch and plug fitted. Unrivalled for quality and price, 15/-. Other types: Lesdix No. 10B Pedestal, 10in. high, 12/6; Lesdix Superior No. 12B Ring, 14in. Pedestal, 18/6; Hand Mikes in 2in. case, No. 11 at 5/6; Superior type No. 11A, 7/6; Elsel public address and hand Mike (Reisz principle), 55/-. Ask for Illustrated Mike List of 25 models. Our famous PARTS for making your own mike: Carbon Granules in glass capsule: Grade 1. 8d.; No. 2. 1/-; No. 3. fine, 1/6; No. 4. extra fine, 2/-; Black Blocks, 4d.; Diaphragm, 6d.; Button in 1½in. hard wood case with 2in. mica diaph. 2/6; Ditto, mounted on pedestal, 3/6.



N.W. No. 11.

AMPLIFIERS. We can supply from stock 3, 6, or 10 watt mains or Battery Amplifiers in portable or chassis form at lowest prices. Special A.C. or D.C. Public Address or Dance Band Portable with mike and speaker.

HOME RECORDING IS THE LATEST HOBBY. Home recording on your Gramo, can be done by anyone with a gramophone. Complete sets, with accessories, in carton. De Luxe, 21/-; No. 2 Mivole, 12/6; Junior, 7/6. For Electric Recording: Electric Motor Turntables, 25/-; Tracker Recorder Carriers: No. 2 C.M. Screw-thread Traverser, 7/6; Type F. Central Spiral Drive, 4/6. Recording Pick-ups: Type K, 12/6; Jewel Cutter, mounted diamond, 7/6. **DYNAMOS. CHARGING OR LIGHTING.** 240 watt Enclosed Dynamo, 12/20v, 12 amps., Ball Bearings, Vee Pulley, Type C.

SWITCHBOARD (Marine type), with Ammeter, maximum and minimum Auto. Cut-out main Switch and Fuses, Field Regulator, etc., 50/-.

DOUBLE CURRENT GENERATORS, D.C., 600 volts, 100 m.a., and 6 volts 3 amps., 40/-.

CRYSTAL SETS are still popular for perfect, quiet, personal reception. All-Wave Permanent Detector Set, 5/6.

HEADPHONES for short-wave work, 2,000 or 4,000 ohms, 4/6.

Send for New Illus. Bargain List "N" Free.

ELECTRADIX RADIOS.

218, UPPER THAMES ST. LONDON, E.C.4.

Phone: Central 4611.

EASY TERMS

Everything Radio supplied on the lowest terms. Send list of requirements for quotation by return. Prompt delivery.

Cash and C.O.D. Orders Despatched by Return of Post.

W.B. STENTORIAN 36.S

Cash Price £22/2/0, or 2/6 with order and 11 monthly payments of 4/-

36.J

Cash Price £12/2/6, or 2/6 with order and 11 monthly payments of 3/-.

ROLA L.S. Units supplied on similar terms.

VALVES (every type supplied)

S.G., Det. and Power, any make. Cash price £1.5.0, or 5/- with order and 5 monthly payments of 4.6. ALL CARRIAGE PAID

Est'd. 1925 **THE NATIONAL** 1977

LONDON RADIO SUPPLY COMPANY

11, OAT LANE-NOBLE STREET-LONDON, E.C.2

BRITISH SHORT WAVE LEAGUE

A British organisation catering exclusively for the Short Wave listener through the medium of its own publication, the

"BRITISH SWL REVIEW"

a booklet full of interesting data for the DXer, up-to-date news on Broadcasting, Amateur and commercial stations, long list of station addresses, signals and slogans, new QSLs, how to collect them, Postal identification Service, SWL photo and correspondence exchange Bureau, etc., etc.

BUY YOUR COPY NOW and JOIN the B.S.W.L. Price 6D. or 6d. by Post from the publishers—

BRITISH SHORT WAVE LEAGUE - - Ridgwell, Essex.

PATENTS AND TRADEMARKS.

KINGS PATENT AGENCY, LTD. (Director: B. T. King, O.I.M.E., Regd. Patent Agent G.D., U.S.A. and Canada). Advice, Handbook and Consultations free. 50 years' exp. - - 146a, Queen Victoria Street, E.C.4. Phone: City 6161.

OUR FREE CATALOGUE SERVICE

COSSOR RADIO

VERY attractive booklet has just been issued by A. C. Cossor, Ltd., which gives full details of their very comprehensive range of wireless receivers. There is a set for every purpose and every pocket. For example, there are the super-ferrodyn models for battery or mains operation; battery and A.C. mains superhets; and a fine range of radiograms. The receivers range in price from £5 15s. to £14 14s., and the radiograms from £16 16s. to 55 guineas. There are sixteen pages of information, together with full colour illustrations, printed on art paper, and a complete specification of each model is given. A postcard addressed to A. C. Cossor, Ltd., Publicity Dept., B29, Highbury Grove, London, N.5, will bring you a copy of this booklet, post free.

To save readers trouble, we undertake to send on catalogues of any of our advertisers. Merely state, on a postcard, the names of the firms from whom you require catalogues, and address it to "Catalogue," PRACTICAL AND AMATEUR WIRELESS, Geo. Newman, Ltd., 8-11, Southampton St., Strand, London, W.C.2. Where advertisers make a charge, or require postage, this should be enclosed with applications for catalogues. No other correspondence whatsoever should be enclosed.

push-pull arrangements, and so on. The receiver catalogue is fully illustrated and describes all the present types of receivers, which range from a £7 12s. 6d. battery receiver to a fifty-two-guinea nine-valve automatic radio-

gram. The list also includes details of cabinet loud-speakers and the new Marconiphone gramophone pick-up. The lists may be obtained free from Radio House, Tottenham Court Road, London, W.1., or direct from this office.

FULL O' POWER BATTERIES

FULL particulars of the complete range of these batteries suitable for battery set users are given in a compact little booklet (No. 667), issued by Siemens Electric Lamps and Supplies, Ltd., 38 and 39, Upper Thames Street, London, E.C.4. In the single capacity type there are two series, the "Cadet," which is suitable for modest sets requiring from 6 to 7 milliamps. of H.T. current, and the "Standard," designed for the more ambitious receiver taking up to 10 milliamps. Where space and weight are of little importance, there is the power and triple capacity series, which is recommended for a discharge rate of 10 to 20 milliamps. There is also the super radio battery intended for use where a discharge rate of from 15 to 30 milliamps is required.

MARCONI VALVES AND RECEIVERS

THE Marconiphone Company have recently issued two new catalogues, one dealing entirely with the large range of valves bearing the Marconi trade mark, and the other describing the various types of Marconiphone receivers. The valve catalogue gives, in addition to a complete guide to each valve, with all characteristics tabulated, a comparative table of Marconi equivalents and various technical details, such as valve-holder connections, various A.V.C. circuits

Practical and Amateur Wireless BLUEPRINT SERVICE

PRACTICAL WIRELESS.
STRAIGHT SETS. Battery Operated
One-Valve : Blueprints, 1s. each.

	Date of Issue.	No. of Blueprint.
All-Wave Unipen (pentode) ..	14.10.33	PW31A
Two-valve : Blueprints, 1s. each.		
Four-range Super Mag. Two (D, Pen) ..	11.8.34	PW36D
Three-valve : Blueprints, 1s. each.		
Selectone Battery Three (D, 2 LF (trans)) ..	—	PW10
Alpha Q.P.P. Three (D,Q.P.P.) ..	25.3.33	PW14
Ferrocart Q.P.P. Hi-Mag Three (SG, D, Q.P.P.) ..	25.3.33	PW15
Sixty-Shilling Three (D, 2 LF (R.C. & trans)) ..	2.12.33	PW34A
Leader Three (SG, D, Pow.) ..	—	PW35
Summit Three (HF Pen, D, Pen) ..	18.8.34	PW37
All-Pentode Three (HF Pen, D (pen), Pen) ..	22.0.34	PW39
Hall-Mark Three (SG, D, Pow.) ..	—	PW41
Hall-Mark Cadet (D, LF, Pen (R.C.)) ..	23.3.35	PW48
F. J. Camm's Silver Souvenir (HF Pen, D (pen), Pen) (All-wave Three) ..	13.4.35	PW40
Genet Midget (D, 2 LF (trans)) ..	June '35	PM1
Cameo Midget Three (D, 2 LF (trans)) ..	8.6.35	PW51
1936 Sonotone Three-Four (HF Pen, HF Pen, Westector, Pen) ..	17.8.35	PW53
Battery All-wave Three (D, 2 LF (R.C.)) ..	31.8.35	PW55
The Monitor ..	8.2.36	PW61
Four-valve : Blueprints, 1s. each.		
Fury Four (2 SG, D, Pen) ..	—	PW11
Beta Universal Four (SG, D, LF, Cl. B) ..	15.4.33	PW17
Nucleon Class B Four (SG, D (SG), LF, Cl. B) ..	0.1.34	PW34B
Fury Four Super (SG, SG, D, Pen) ..	—	PW34C
Battery Hall-Mark 4 (HF Pen, D, Push Pull) ..	2.2.35	PW46
F. J. Camm's Superformer (SG, SG, D, Pen) ..	12.10.35	PW57
Mains Operated		
Two-valve : Blueprints, 1s. each.		
A.C. Twin (D (pen), Pen) ..	22.4.33	PW18
A.C.-D.C. Two (SG, Power) ..	7.10.33	PW31
Selection A.C. Radiogram Two (D, Pow.) ..	29.4.33	PW19
Three-valve : Blueprints, 1s. each.		
Double-Diode-Triode Three (HF Pen, D,D.T., Pen) ..	10.6.33	PW23
D.C. Ace (SG, D, Pen) ..	15.7.33	PW25
A.C. Three (SG, D, Pen) ..	16.9.33	PW29
A.C. Leader (HF Pen, D, Power) ..	7.4.34	PW35C
D.C. Promler (HF Pen, D, Pen) ..	31.3.34	PW35B
Ubique (HF Pen, D (Pen), Pen) ..	28.7.34	PW36A
Armada Mains Three (HF Pen, D, Pen) ..	18.8.34	PW38
F. J. Camm's A.C. All-Wave Silver Souvenir Three (HF Pen, D, Pen) ..	11.5.35	PW50
"All-wave" A.C. Three (D, 2LF (R.C.)) ..	17.8.35	PW64
A.C. 1936 Sonotone (HF Pen, HF Pen, Westector, Pen) ..	31.8.35	PW56
Four-valve : Blueprints, 1s. each.		
A.C. Fury Four (SG, SG, D, Pen) ..	25.2.33	PW20
A.C. Fury Four Super (SG, SG, D, Pen) ..	—	PW34D
A.C. Hall-Mark (HF Pen, D, Push-Pull) ..	—	PW45
Universal Hall-Mark (HF Pen, D, Push-Pull) ..	9.2.35	PW47
SUPERHETS.		
Battery Sets : Blueprints, 1s. each.		
£5 Superhet (Three valve) ..	—	PW40
F. J. Camm's 2-valve superhet (two valve) ..	13.7.35	PW52
F. J. Camm's £4 Superhet 4 ..	16.11.35	PW58
Mains Sets : Blueprints, 1s. each.		
A.C. £5 Superhet (three valve) ..	—	PW43
D.C. £5 Superhet (three valve) ..	1.12.34	PW42
Universal £5 Superhet (three valve) ..	15.12.34	PW44
F. J. Camm's A.C. £4 Superhet 4 ..	7.12.35	PW59
F. J. Camm's Universal £4 Superhet 4 ..	11.1.36	PW60
SHORT-WAVE SETS.		
Two-valve : Blueprints, 1s. each.		
Midget Short-wave Two (D, Pen) ..	15.9.34	PW38A
Three-valve : Blueprints, 1s. each.		
Experimenter's Short-wave Three (SG, D, Power) ..	23.9.33	PW30A
PORTABLES.		
Three-valve : Blueprints, 1s. each.		
Atom Lightweight Portable (SG, D, Pen) ..	2.0.34	PW30
Four-valve : Blueprints, 1s. each.		
Featherweight Portable Four (SG, D, LF, Cl. B) ..	6.5.33	PW12

MISCELLANEOUS.
S.W. Converter-Adapter (1 valve) 23.2.35 PW48A
AMATEUR WIRELESS AND WIRELESS MAGAZINE CRYSTAL SETS.

Blueprints, 6d. each.		
Four-station Crystal Set ..	—	AW427
1934 Crystal Set ..	—	AW444
150-mile Crystal Set ..	—	AW450

STRAIGHT SETS. Battery Operated.

One-valve : Blueprints, 1s. each.		
B.B.C. Special One-valver ..	—	AW387
Twenty-station Loud-speaker One-valver (Class B) ..	—	AW449
Two-valve : Blueprints, 1s. each.		
Melody Ranger Two (D, Trans) ..	—	AW388
Full-volume Two (SG, Det, Pen) ..	—	AW392
Iron-core Two (D, Trans) ..	—	AW395
Iron-core Two (D, Q.P.P.) ..	12.8.33	AW396
B.B.C. National Two with Lucerne Coil (D, Trans) ..	—	AW377A
Big-power Melody Two with Lucerne Coil (SG, Trans) ..	—	AW388A
Lucerne Minor (D, Pen) ..	—	AW426

Three-valve : Blueprints, 1s. each.

P.T.P. Three (Pentode-Triode-Pentode) ..	June '35	WM389
Class-B Three (D, Trans, Class B) ..	22.4.33	AW386
New Britain's Favourite Three (D, Trans, Class B) ..	15.7.33	AW394
Home-Built Coil Three (SG, D, Trans) ..	14.10.33	AW404
Fan and Family Three (D, Trans, Class B) ..	25.11.33	AW410
£5 5s. S.G.3 (SG, D, Trans) ..	2.12.33	AW412
1934 Ether Searcher : Baseboard Model (SG, D, Pen) ..	20.1.34	AW417
1934 Ether Searcher : Chassis Model (SG, D, Pen) ..	—	AW419
Lucerne Ranger (SG, D, Trans) ..	—	AW422
Cosor Melody Maker with Lucerne Coils ..	—	AW423
P.W.H. Mascot with Lucerne Coils (D, RC, Trans) ..	—	AW377A
Mullard Master Three with Lucerne Coils ..	—	AW424
£5 5s. Three : De Luxe Version (SG, D, Trans) ..	19.5.34	AW435
Lucerne Straight Three (D, RC, Trans) ..	—	AW437
All Britain Three (HF Pen, D, Pen) "Wireless League" Three (HF Pen, D, Pen) ..	3.1.34	AW451
Transportable Three (SG, D, Pen) £6 6s. Radiogram (D, RC, Trans) ..	Apr. '33	WM271
Simple tune Three (SG, D, Pen) ..	June, '33	WM327
C.B. Three (D, LF, Class B) ..	—	WM333
Economy-pentode Three (SG, D, Pen) ..	Oct. '33	WM337
"W.M." 1934 Standard Three (SG, D, Pen) ..	—	WM351
£3 3s. Three (SG, D, Trans) ..	Mar. '34	WM354
Iron-core Band-pass Three (SG, D, QP21) ..	June '34	WM362
1935 £6 6s. Battery Three (SG, D, Pen) ..	—	WM371
Graduating to a Low-frequency Stage (D, 2LF) ..	—	WM378
Four-valve : Blueprints, 1s. 6d. each.		
65/- Four (SG, D, RC, Trans) ..	—	AW370
"A.W." Ideal four (2SG, D, Pen) ..	16.9.33	AW402
H.F. Four (2SG, D, Pen) ..	—	AW421
Crusaders' A.V.C. 4 (2HF, D, QP21) ..	18.8.34	AW445
(Pentode and Class-B Outputs for above : blueprints 6d. each) ..	25.8.34	AW445A
Quadradyne (2SG, D, Pen) ..	—	WM273
Callibrator (SG, D, RC, Trans) ..	—	WM300
Table Quad (SG, D, RC, Trans) ..	—	WM303
Callibrator de Luxe (SG, D, RC, Trans) ..	—	WM316
Self-contained Four (SG, D, LF, Class-B) ..	Aug. '33	WM331
Lucerne Straight Four (SG, D, LF, Trans) ..	—	WM350
£5 5s. Battery Four (HF, D, 2LF) ..	Feb. '35	WM381
The H.K. Four ..	Mar. '35	WM384
Five-valve : Blueprints, 1s. 6d. each.		
Super-quality Five (2HF, D, RC, Trans) ..	May '33	WM320
New Class-B Five (2SG, D, LF, Class B) ..	Nov. '33	WM340
Class-B Quadradyne (2SG, D, LF, Class B) ..	Dec. '33	WM344
1935 Super Five (Battery Superhet) ..	—	WM379

These blueprints are full size. Copies of appropriate issues containing descriptions of these sets can in most cases be obtained as follows:— "Practical Wireless" at 4d., "Amateur Wireless" at 4d., "Practical Mechanics" at 7d., and "Wireless Magazine" at 1/3, post paid. Index letters "P.W." refer to "Practical Wireless" sets, "P.M." to "Practical Mechanics" sets, "A.W." refer to "Amateur Wireless" sets, and "W.M." to "Wireless Magazine" sets. Send (preferably) a postal order (stamps over sixpence unacceptable) to "Practical and Amateur Wireless" Blueprint Dept., Geo. Newnes, Ltd., 8-11, Southampton Street, Strand, W.C.2.

Mains Operated.

Two-valve : Blueprints, 1s. each.		
Consolectric Two (D, Pen) A.C. ..	23.9.33	AW403
Economy A.C. Two (D, Trans) A.C. ..	—	WM286
Three-valve : Blueprints, 1s. each.		
Home-lover's New All-electric Three (SG, D, Trans) A.C. ..	—	AW383
S.G. Three (SG, D, Pen) A.C. ..	3.6.33	AW390
A.C. Triodyne (SG, D, Pen) A.C. ..	19.8.33	AW399
A.C. Pentaquester (HF, Pen, D, Pen) A.C. ..	23.6.34	AW439
D.C. Calibrator (SG, D, Push-pull Pen) D.C. ..	July '33	WM323
Simplicity A.C. Radiogram (SG, D, Pen) A.C. ..	Oct. '33	WM333
Six-gulnea A.C./D.C. Three (HF, Pen, D, Trans) A.C./D.C. ..	—	WM364
Mantovani A.C. Three (HF, Pen, D, Pen) A.C. ..	Nov. '34	WM374
Four-valve : Blueprints, 1s. 6d. each.		
A.C./D.C. Straight A.V.C.4 (2 HF, D, Pen) A.C./D.C. ..	8.9.34	AW446
A.C. Quadradyne (2 SG, D, Trans) A.C. ..	—	WM279
All Metal Four (2 SG, D, Pen) "W.M." A.C./D.C. Super Four ..	July '33	WM329
Harris Jubilee Radiogram ..	Feb. '35	WM382
..	May '35	WM386

SUPERHETS.

Battery Sets. Blueprints, 1s. 6d. each.		
"W.M." Stenode ..	—	WM373
Modern Super Senior ..	—	WM375
Mains Sets : Blueprints, 1s. 6d. each.		
1934 A.C. Century Super A.C. ..	10.3.34	AW425
Seventy-seven Super A.C. ..	—	WM305
"W.M." D.C. Super D.C. ..	May '33	WM321
Merrymaker Super A.C. ..	Dec. '33	WM345
Heptode Super Three, A.C. ..	May '34	WM359
"W.M." Radiogram Super A.C. ..	—	WM306
"W.M." Stenode, A.C. ..	Sep. '34	WM370
1935 A.C. Stenode ..	Apr. '35	WM385

PORTABLES.

Four-valve : Blueprints, 1s. 6d. each.		
Midget Class-B Portable (SG, D, LF, Class B) ..	20.5.33	AW380
Holiday Portable (SG, D, LF, Class B) ..	1.7.33	AW393
Family Portable (HF, D, RC, Trans) ..	22.9.34	AW447
Town and Country Four (SG, D, RC, Trans) ..	—	WM282
Two H.F. Portable (2 SG, D, QP21) ..	June '34	WM363
Tyers Portable (SG, D, 2 Trans) ..	Aug. '34	WM367

SHORT-WAVERS—Battery Operated.

One-valve : Blueprints, 1s. each.		
S.W. One-valve converter (price 6d.) ..	—	AW329
S.W. One-valve for America ..	—	AW429
Roma Short-waver ..	—	AW452
Two-valve : Blueprints, 1s. each.		
Home-made Coil Two (D, Pen) ..	14.7.34	AW440
Three-valve : Blueprints, 1s. each.		
World-ranger Short-wave 3 (D, RC, Trans) ..	—	AW355
Experimenter's 5-metre Set (D, Trans, Super-regen) ..	30.6.34	AW438
Experimenter's Short-waver ..	Jan. 19, '35	AW463
Short-wave Adapter ..	Dec. 1, '34	AW456
Superhet, Converter ..	Dec. 1, '34	AW457
The Carrier Short-waver ..	July '35	WM390
Four-valve : Blueprints, 1s. 6d. each.		
A.W. Short-wave World Beater (HF Pen, D, RC, Trans) ..	2.0.34	AW436
Empire Short-waver (SG, D, RC, Trans) ..	—	WM313
Standard Four-valve Short-waver ..	Mar. '35	WM383

Mains Operated.

Two-valve : Blueprints, 1s. each.		
Two-valve Mains Short-waver (D, Pen) A.C. ..	—	AW453
"W.M." Band-spread Short-waver (D, Pen) A.C./D.C. ..	Aug. '34	WM368
"W.M." Long-wave Converter ..	—	WM380
Three-valve : Blueprints, 1s. each.		
Emigrator (SG, D, Pen), A.C. ..	—	WM352
Four-valve : Blueprints, 1s. 6d. each.		
Gold Coaster (SG, D, RC, Trans) A.C. ..	—	WM202

MISCELLANEOUS.

Enthusiasts Power Amplifier (1/6) ..	June '35	WM387
Newstyle Short-wave Adaptor (1/-) ..	June '35	WM388
Trickle Charger ..	Jan. 5, '35	AW462

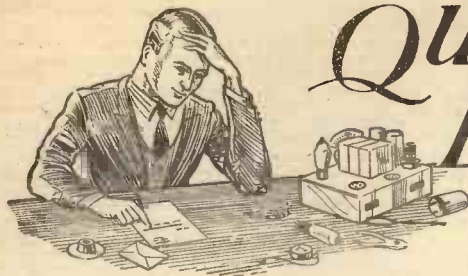

QUERIES and ENQUIRIES

is no better earth in this room, you will probably find that signal strength may be improved at this point by running a separate earth wire into another room, or even back to the receiver.

Valves and Volume

"I have fitted a new valve to my set but am disappointed with the results which I have obtained. The set is a two-valver and has been very good for a long time with a PM2DX and a PM1LF. The latter had gone soft and when I bought a new one I got a PM202, which is supposed to give more than twice the volume. Can you tell me why it doesn't, please?"—B. L. P. (Leicester).

THE new valve will certainly give a greater output than the valve you had at first, but only when it is fully loaded. This is a very important point, and if you examine the characteristics of the two valves you will find that the amplification factor of the new valve is actually less than that of the first valve, but, on the other hand, it will handle a much greater signal. Thus, if you had, say, a four-valve set you would find that in order to prevent overloading the L.F. type of valve you would have to keep the volume turned well down and would only obtain a total output of about 100 milliwatts without distortion. If, however, you kept the same receiver but replaced the L.F. valve by the PM202 you would find that you could then increase the volume and could put much more into the valve without distortion, and so obtain an output of 300 milliwatts. With your present two-valve set, however, you cannot fully load the PM202 and thus cannot take advantage of the valve characteristics. If you want greater volume you should fit an S.G. valve before the present detector in order to obtain the extra load for the output valve. The H.F. unit which was described in last week's issue will prove very suitable for this purpose.

Extension Speaker Problem

"I have fitted an extension speaker circuit to each room in my house and have noticed a rather peculiar point in one room. I have used a single extension wire, with a separate lead in each room from the speaker to earth. In this particular room I find that the removal of the earth lead from the speaker makes no difference whatever, and the signals are just as loud as when it is joined. Can you explain this?"—G. B. (Dover).

THE indication is that the earth connection in this particular room is ineffective and you are probably using a gas pipe or some other pipe which, owing to paint at the joint, is not in good contact with the earth and thus the only earth connection to this speaker is of a capacity type, and so when the lead is removed you do not obtain a drop in signal strength. If there

A Quality Receiver

"Can you recommend from your blueprints a design which will enable me to build a set to give a fair number of stations with quality as the first consideration? I do not want a whole crowd of stations at all times, but simply to hear the B.B.C. stations at really good volume and with the best quality without unnecessary expense. The recently-described Paraphase amplifier and H.F. unit would be too ambitious for me."—B. U. P. (Crewe).

RULES

We wish to draw the reader's attention to the fact that the Queries Service is intended only for the solution of problems or difficulties arising from the construction of receivers described in our pages, from articles appearing in our pages, or on general wireless matters. We regret that we cannot, for obvious reasons—

- (1) Supply circuit diagrams of complete multi-valve receivers.
- (2) Suggest alterations or modifications of receivers described in our contemporaries.
- (3) Suggest alterations or modifications to commercial receivers.
- (4) Answer queries over the telephone.
- (5) Grant interviews to querists.

Please note also, that queries must be limited to two per reader, and all sketches and drawings which are sent to us should bear the name and address of the sender.

If a postal reply is desired, a stamped addressed envelope must be enclosed. Send your queries to the Editor, PRACTICAL AND AMATEUR WIRELESS, Geo. Newnes, Ltd., 8-11, Southampton Street, Strand, London, W.C.2.

IN view of your remarks we think the A.C. or Universal Hall-Mark receiver will prove most suitable. This particular receiver employs a push-pull output stage and may be relied upon to give really good volume and quality.

Unavoidable Hum

"I have built a battery receiver to one of your designs. Every part is as specified and the set is wired exactly in accordance with your blueprint, and the only departure from your specification is in the valves, of which I have used three of my own which are practically identical in characteristics. I have fitted the set in the top part of a radio-gram cabinet and the eliminator is on the lower shelf behind the M.C. speaker. There is a loud hum all the time and I have moved the eliminator away from the speaker without effect. Is it possible to explain the cause of this hum and how to get rid of it?"—V. E. W. (Sudbury).

THE trouble is no doubt due to the eliminator, and this point may be confirmed in the simplest manner by

removing the eliminator and using a dry battery for the H.T. supply. If the noise ceases you will know that the mains unit is causing the trouble and that it is not due to earth induction or some other source. If it persists, try a new earth, and also move the lead-in wire and speaker leads in case they are picking up the hum from mains supply wires inside the walls or beneath the floor. If the hum ceases when the mains unit is removed, you will have to modify the circuit, by fitting more complete decoupling or by earthing the containing case of the eliminator. This should be in an iron box, or the position so modified that the internal transformer and choke do not introduce coupling with any of the inductive components in the receiver.

Coil Details

"Can you explain the meaning of P and + on the coil diagram I am sending, and what is the meaning of the winding marked Aerial or Reaction? Can you give me any other details of the coil?"—W. E. W. (Wolverhampton).

THE winding which is marked Reaction or Aerial is a small winding included on the majority of coils which are designed to have what might be termed universal application. The winding may thus be employed for aerial coupling when the coil is used as an aerial coil, or may be used for reaction purposes when it is desired to couple the aerial direct to the grid winding. This is known as the secondary winding, and the primary winding may be employed in the anode circuit of the H.F. valve when the coil is used as an H.F. transformer. In such a case the points marked P and positive are connected respectively to the anode or plate of the H.F. valve and to H.T. positive.

Remagnetising Headphones

"I have a pair of 4,000-ohm headphones, and should like to know if I can remagnetise them by connecting the leads to a 230-volt D.C. mains supply with a 60-watt bulb in series as a safeguard. Perhaps you could let me know of a better method if you do not approve of this. Also could you kindly give me the name of a firm from which I could obtain stalloy suitable for headphone diaphragms."—W. C. W. (Dudley).

THE method of remagnetising may prove suitable, but care would have to be taken not to burn out the fine wire winding by the current which is passed. Thus, a good meter should also be included in circuit to avoid this difficulty. A better arrangement would be to remove the bobbins carrying the present windings, and to put another winding over the magnet poles which would carry a much higher current. You will probably find that it will be cheaper and more satisfactory to send the headphones to a good repair depot for remagnetising. Stalloy diaphragms may be obtained from advertisers in this journal.

The coupon on cover iii must be attached to every query

SPECIFIED for F. J. CAMM'S MONITOR THREE

PIX INVISIBLE AERIAL

PIX, LONDON, S.E.1.

The one aerial for the modern set
Self-adhesive aluminium strip
Gives wonderful pick-up
Just press it and it sticks

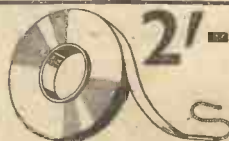

Double Length 3/6

B.T.S.

Acknowledged the Best
SHORT WAVE COMPONENTS
Produced by Specialists—Preferred by Experts

SHORT WAVE COILS
4-PIN. No. 1 13-26, No. 2 SET of 4
24-32 metres, 4/- each. No. 3 **16/-**
46-96, No. 4 90-190 metres, 4/8 each.

6-PIN. Type SPA 13-26, SPC SET of 3
24-52 metres, 4/6 each. SPD **13/6**
46-96 metres, 5/- each.

COIL BASES For B.T.S. Coils. Baseboard or sub-chassis mounting. 4-pin, Type 4CH, 1/8 each. 6-pin, Type 6PB, 2/- each.



ALL WAVE H.F. CHOKE (Screened)
An efficient choke giving maximum choking effect from 10-2000 metres. Comprises a multi layer winding specially arranged on an eight slotted machined low loss former reducing self-capacity to negligible proportions. Enclosed in an effective non-inductive screen—preventing 'field interaction.' Type 112. **4/6 EACH**



AGAIN SPECIFIED for the MONITOR 3
B.T.S. SWITCH CHASSIS. Rigidly constructed of Aluminium. Ready Drilled and complete with terminals and multi-contact switch Type M. **6/6**

MONITOR 3 ANODE OR AERIAL COIL. Supplied with coloured leads for easy connecting. **5/-**

Dotted line shows metal screening can.



Send for lists of B.T.S. Short Wave Components.

Obtainable from ALL GOOD DEALERS. In cases of difficulty send direct, with name and address of nearest dealer.



BRITISH TELEVISION SUPPLIES LTD.
Television and Short Wave Specialists
Faraday Ho., 8-10, Charing Cross Rd., London, W.C.2
Phone: Tom. Bar 0134-5. Grams: Televise, Leasure, London.

IT PAYS TO BUY THE BEST

ULTRA S.W. COILS
The coils are wound with 14g. copper wire, heavily silver-plated. The mean diameter is 3". A Frequentite base is used for mounting purposes.
No. 1020. 3-turns, 1/6.
4-turns, 1/6.
5-turns, 1/7.
6-turns, 1/8.
8-turns, 1/10.



ULTRA SHORT-WAVE H.F. CHOKES
These chokes are single layer space wound on DL-9 formers, and have an exceedingly low self-capacity.
No. 1011. D.C. Resistance 1.3 ohms. Price 1/3.
No. 1021. D.C. Resistance 1.4 ohms. Price 1/3.

EDDYSTONE MICRODENSER No. 900.
For Ultra Short Waves from 5-10 metres, DL-9 insulation. Low series resistance at high frequencies. Noiseless operation.
15 m.mfd., 3/9.
40 m.mfd., 4/3.
100 m.mfd., 5/-.



STRATTON & CO., LTD.,
Bromsgrove St., BIRMINGHAM
London Services Depot: Webb's Radio Stores,
14, Soho Street, Oxford Street, W.1.

EDDYSTONE

SHORT WAVE COMPONENTS

REPLIES IN BRIEF

The following replies to queries are given in abbreviated form either because of non-compliance with our rules, or because the point raised is not of general interest.

A. J. M. (Bainham) It is possible that your receiver has some whistle-preventing device which will prevent satisfactory reception with the converter, and we therefore advise you to communicate with the makers concerning the suitability of the receiver.

W. L. (Henley-on-Thames). You do not give the type number of your new coil. We cannot reprint your diagram, and therefore you should enclose a stamped addressed envelope in order that your diagram may be returned to you suitably modified.

R. R. (Chiswick). Theoretically, the only modification will be to replace the existing valves by D.C. valves, but you will probably find that the circuit will require to be re-designed in view of the higher efficiency of the mains valves and the instability which might result from the present circuit design.

L. H. (Belfast). Your eliminator may be unsuitable for this particular receiver. Communicate with the makers of the set and give details of the eliminator.

W. K. (Glodwick). We do not know of any book, but suggest you follow our Beginner's Supplement and obtain the "Wireless Constructor's Encyclopaedia."

G. S. (Handsworth). We have no receiver employing the parts from the sets you mention. We suggest, however, that you build the £5 Superhet Three or the £4 Superhet Four, disposing of your present sets as they stand and obtaining the necessary new parts for one of the above receivers.

R. M. (Barnsbury). You cannot expect to obtain results until the various circuits are trimmed. You should follow the instructions given in the issue in which the construction was described.

W. W. (Dundee). It would appear that the long-wave padding condenser is not sufficiently large or that the coils are defective in some respect. Try the addition of a fixed condenser in parallel with the padding condenser.

J. S. (Hull). We regret that we do not know of any English agent for the American receiver in question.

T. R. (Paisley). The components you have would be of no use in the £4 Superhet Four, and you should therefore obtain the specified parts.

W. H. B. (Ghelmsford). Unfortunately there is no way of reducing the height of this receiver as every available inch has been cut in the original design. Would not the £4 Superhet be more suitable?

H. F. R. (Belfast). Write to the Marconi Company, at Tottenham Court Road, London, W, for details of the mains power unit. We are not able to advise you concerning this matter.

P. C. (Leicester). We have no modern set using the parts listed by you, but Blueprint H.3 describes a two-valve which utilises the coil you have.

B. W. H. (Sandbach). Your circuit is perfectly in order except that the grid leak of the detector valve should be joined direct from the grid to the L.T. positive terminal and not in parallel with the grid condenser. Your H.T.1 lead may quite possibly be found unnecessary, and it could be joined to H.T.3 without ill-effect.

A. R. C. (Edinburgh). Your receiver was not designed by us, but was described in a contemporary and you should, therefore, communicate direct with the publication concerned.

G. B. (Berkhamsted). We could not give all the characteristics of the valves mentioned by you and suggest that you write to the makers for copies of their valve guides in which such information will be found.

A. E. S. (Ballingarry). The I.F. transformers are of the 465 kc/s type.

R. S. B. (Eggbaston). The Wearite Ulgen coil would be suitable for your use. A short-wave adaptor could certainly be used with this set with every satisfaction.

H. G. S. (Bristol). The resistance in the H.T. negative lead is all that is necessary. You cannot include the resistance in the transformer lead as shown by you as there is no current at that point.

J. I. (Leicester). Your circuit may be wrongly wired, and we suggest you check it with the manufacturers' blueprint.

L. W. M. (Newton Abbot). If the adaptor is satisfactory as a separate unit you could certainly combine the entire apparatus on one baseboard.

R. T. (Bramley). The valve is of Osram or Marconi manufacture and is to be found in the Osram or Marconi valve guide. The type No. is X21.

A. G. W. (Bury). It is definitely not successful to combine the two valve functions as you mention. A separate driver must be employed to obtain the full results of the Class B amplifier. You can employ the parallel-fed or the direct-fed arrangement as you desire.

E. S. (H.M.T. "Lyminge"). The total current is 18 to 20 mA and naturally depends upon the grid-bias applied to the output valve.

R.T.C. (Birmingham). Your trimming adjustments are obviously incorrect, and we advise that you re-adjust as described in our issue last week.

B. M. (Slough). A resistance may be joined across the heater winding, but should not be necessary if the transformer has good regulation. A value of .5 ohms is required, but it would be worth while to plug in the valve and measure the voltage on the valve. It will no doubt be very little higher than 4 volts.

S. S. (Bristol 5). It is not possible to design coils to individual requirements, and many more details would

be required to enable us to comply with your particular request.

T. R. (Denbigh). Your arrangement is perfectly sound, and the only snag is that the current delivered by the transformer winding is only .5 amps. Thus you will probably find that the valve will be underworked. It may thus be advisable to omit the resistances, when the increased current load on the winding will result in a voltage drop and thus the valve will receive more or less its correct values. The winding may heat up, however, and, therefore, measurements should be taken with the valve in circuit.

W. B. (Willesden Green). Our series of articles on Servicing can be recommended. We do not know of any other data on the subject which may be classified as general.

J. A. R. (Nr. Hull). A very selective set is required, preferably a superhet. Alternatively a good wave-trap or Drotwich suppressor may be used. The batteries could be used, but they would last a very short time and would be uneconomical.

M. O. (Berkhamsted). The howl is quite normal and is the result of applying too much reaction. It would appear that you are trying to force the receiver beyond its normal scope, and an H.F. stage is indicated if you wish to obtain greater volume on the distant stations with which reaction is now necessary.

A. H. (Knutsford). A certain amount of heat is unavoidable, and it is only necessary to make certain that the makers' wattage dissipation figure is not being exceeded.

D. J. W. (Hove). We cannot give you any indication of the present-day value, but think that an advertisement in your local paper would enable you easily to sell the receiver in order to construct a more modern set.

A. B. (Wigan). You could certainly adopt a simple H.F. and detector stage, but in order to obtain good quality the H.F. stage should not be omitted. Your band-pass coil unit is quite suitable, although side-band cutting should be avoided if possible. We regret that we cannot understand your last query concerning valves.

L. W. (Harringay). Messrs. Wearite sell a wave-trap suitable for your needs. The price is 7s. 6d., and the coils included are of the iron-core type.

T. H. A. (Leyburn). The wire required is immaterial, but you will no doubt find that 24 or 26 D.C.C. for the grid winding and 30 or 32 for the reaction winding would be suitable.

M. E. R. (Lewes). We are sorry that we cannot recommend a set in which the components could be included. It would be preferable to dispose of the receiver as it stands and to buy new parts with the proceeds and build a modern receiver.

A. A. B. (Barnes). If the pick-up is joined in the detector-grid circuit the volume should be quite satisfactory. We cannot recommend any modification as it is a commercial receiver, and probably the makers may be able to suggest something.

E. J. S. (Wimbledon Chase). We have no details of the circuit and cannot suggest whether an output circuit is provided for. Similarly, we cannot suggest the fault on the gramophone side. Communicate direct with the makers, whose address is Cromwell (Southampton), Ltd., 32-33, Brinton's Terrace, Southampton.

C. H. W. (Handsworth). The design of the amplifier will govern the low-note response. We do not advise tone adjusters for the purpose, but careful arrangement of the L.F. couplings and the correct load for the output valve.

K. M. T. (Sparkhill). Your speaker will probably be quite satisfactory, and without an actual test of yours and the specified component we cannot state definitely which will prove the better.

J. O'H. (Birmingham). The 5-1 transformer may be used in place of the one you have broken.

D. B. G. (Probus). The Q.P.P. stage should be adopted, but a proper Q.P.P. transformer should be obtained.

G. M. (Aberdeen). We suspect a by-pass condenser to be faulty. This, on switching on, acts normally and the maximum H.T. is applied to the valves. When these are fully heated, however, the extra current causes the condenser to break down and this shorts the H.T., resulting in a low H.T. on the valves and reduced volume.

H. L. C. (Corstorphine). The extra lead on the speaker is intended for H.T. when a push-pull stage is employed and, therefore, should be ignored at present. The difference in volume on the stations is due to the fact that the National is of much lower power and the effect is thus quite normal.

S. A. B. (Parson's Green). We have no short-wave set using the valves mentioned by you.

A. C. R. (W.2). The whistle filter could probably be included in some other part of the circuit to avoid the difficulty, but a full circuit diagram would be necessary in order to advise you concerning the most suitable position. The L.F. transformer could be parallel-fed to provide a bass resonance, or you could experiment with old L.F. transformers and condensers to provide a tone compensator for the pick-up alone. Full details cannot be given here.

G. O. (Clongarf). The list of abbreviations, etc., given in a recent issue has probably proved of use to you.

F. E. T. (Reading). We cannot understand the device you mention, and suggest you communicate direct with the makers of the receiver.

H. W. (New Malden). The items advertised are quite reliable, provided they are used in the method intended by the makers.

B. T. (Burnley). You only need replace the valves for the battery supply, but it is possible that the various voltage-dropping resistances in circuit will have to be reduced in size unless you intend to use a 250-volt H.T. supply.

THE PREMIER SUPPLY STORES

THE LARGEST RADIO MAIL ORDER HOUSE IN THE WORLD

All goods guaranteed perfect. Manufacturers' Surplus; Carriage paid over 5/-; under 5/- postage 6d. extra. I.F.S. and Abroad, carriage extra. Orders under 5/- cannot be sent C.O.D. Send 3d. for the most Comprehensive Illustrated Value and Component Catalogue in the Trade, and save pounds.

VARIABLE CONDENSERS

Utility 0.0005 2-gang bakelite dielectric, semi-shielded condenser, Slow Motion and Uniknob Trimmer, 3/11. Utility 0.0005 3-gang fully screened with Trimmers and Illuminated Disc Drive, 7/6. American 0.0005 3-gang with Trimmers, 3/-. Polar Star (manufacturer's type), 2-gang, 0.0005, fully screened with Trimmers, 5/6. Polar 0.0005 with slow motion, 3/11. Lissen 2-gang 0.0005 with Front Trimmer and Disc Drive, 5/11. Bakelite Reaction and Tuning Condensers, 0.0001, 0.00015, 0.0002, 0.0003, 0.0005, 0.00075. 9d. each. Preset Condensers, any value, 6d. each.

LOUDSPEAKERS

PERMANENT MAGNET. Moving Coil Speakers all fitted with output transformers. Magnavox 254, 7" diameter, 16/6. Magnavox 252, 9" diameter, 22/6. Blue Spot 29 PM, 8" diameter, 15/-; without transformer, 12/6. Energised Moving Coil Speakers, all fitted with output transformers (unsuitable for battery sets). Kolster Branded, 7" diameter, 1,500, 2,000 or 2,500 ohm fields, 7/9. Whiteley Boneham, 8" diameter, 2,500 ohm field, 9/11. Magnavox DC 154, 7" diameter, 2,500 ohm field, 4 wats, 12/6. Magnavox 152, 2,500 ohms, 9ins. 17/6. Magnavox DC 152 Magna, 9" diameter, 2,500 or 5,000 ohm fields, 6 wats, 37/6. B.T.H., 8" diameter, 1,500 or 7,500 ohm fields, 8/6. AC Energised Units for any of the above Speakers, 10/-. B.T.H. matched pairs, 1,500 and 7,500 ohms (1,500 ohm Speaker as choke, 7,500 ohm in parallel with H.T. supply), 15/6 pair. AC Energising Kit, 12/6 extra. Magnavox 6v. Field Model, 6 wats, 12/6. Large type Ormond Cone Units, 3/6. Conversion Units for D.C. Sets on A.C. Mains 40 watt 25/-, 80 watt 35/-.

FIXED CONDENSERS

Electrolytics.
T.C.C.:
8mf. 650v. (surge) 4/-
4mf. 650v. (surge) 4/-
15mf. 50v. 1/-
15mf. 100v. 1/-
50mf. 12v. 1/-
Dubilier:
4mf. 500v. 3/-
8mf. 500v. 3/-
8+4 mf. 500v. 4/-
50mf. 50v. 1/9
12mf. 20v. 6d.
25mf. 25v. 1/-

CONDENSER BLOCKS

U.S.A.:
4, 8, or 12mf. 530v. peak each 1/9
100mf. 12v. 1/3
8+4mf. 500v. peak 2/3
4+4mf. 500v. peak 1/6
8+8mf. 500v. peak 2/6
12+8mf. 500v. peak 2/6
12+4mf. 500v. peak 2/6

DIALS

Clarion Moving Light Slow Motion Dial, with 2" knob. Ideal for Short Waves, 2/-. Simplicon Full Vision Slow Motion Dial, 2/-. Utility Disc Drive, complete with 2" knob. Ideal for Short Waves, 2/-.
MICROPHONES
3 Guinea model with stand and transformer, single button type, 19/6. Western Electric type on base, with transformer, 4/6. Home Broadcaster Microphone, low priced two-button type with transformer, 7/6. Carbon Microphone with transformer, in handsome Bakelite case, 10/6.

H.F. AND L.F. CHOKES

Premier Screened H.F. Choke, 100-2000 metres, 1/6 each. Premier Screened H.F. Choke, for Short Waves, 10-200 metres, 1/6 each. Premier Short Wave H.F. Choke, 10-200 metres, 9d. Premier Mains H.F. Choke, carry 1 amp., 1/6.

PREMIER SMOOTHING CHOKES.

25 M.A., 20 henrys 2/9
40 M.A., 30 henrys 4/-
60 M.A., 40 henrys 5/6
150 M.A., 40 henrys 10/-
250 M.A., 15 henrys 20/-
60 M.A., 80 henrys } 5/6
2,500 ohm for Spea-
ker Replacement }

SHORT WAVE COMPONENTS

Enormous Selection of the Finest Quality

Premier Short Wave Tuning condensers (S.L.F.), complete Ceramic Insulation. Silver Sprayed Brass Vanes. Noiseless Pigtail. 0.00016, 0.0001, 2/9 each. Double-spaced, 0.00005, 0.00015, 0.00025, 3/-. Premier all-brass Short Wave condensers, 0.00015 with integral slow motion, 3/9. British Radiophones, all brass, 2-gang short-wave condensers, 0.00015, each section, 5/6 each. Ormond, 0.00025, O.K. for Short Waves, marvellous value, 1/6 each. With slow motion, 2/- each. Ormond, 0.00025, slow motion condensers, all brass, super value, 2/6. Ormond, 0.00025 with special Logging Dial, ideal for band setting, 2/- each. Short Wave Reaction Condensers, all brass, integral Slow Motion, 0.00015, 2/9 each. Polymet Midget: Mica Condensers, with wire ends, 0.00002, 0.00003, 0.00004, 0.00005, 6d. each. Premier Super Short Wave Coils, with circuit, 4- and 6-pin type. 13-170 metres. Set at 4, either type, 7/-. Premier Low Loss, 4- and 6-pin ribbed formers, 14" diameter, finest quality, 1/- each. Please note that only the very highest grade Plastic material is used in the manufacture of Premier Short Wave Coils and Formers. Premier Short Wave Valve Holders, Stacite-Insulation 4-, 5- and 7-pin, chassis type, 6d. each. Baseboard, 8d. each. Reliable Morse Keys with Code engraved on Bakelite base, 2/-. Reliable Short Wave Coils, 4-pin type, 14-150 metres with circuit, 4/- set of 3.

WORLD-FAMOUS CONTINENTAL VALVES

Mains Types.
ACHL. ACL. Screen Grid. Variable Mu. 1, 3 and 4 watt directly heated Output Pentodes. H.F. Pentodes. Variable Mu H.F. Pentodes. Double Diode Triodes. Diode Tetrodes. 250 volts 60 m.a. Full-wave Rectifiers. All 4/6 each. 20 volt 18 amp. AC/DC types. Screen Grid. Variable Mu. H. HL. Power. Pentodes. All 4/6 each. 350 volt 120 m.a. Full Wave Rectifiers. 500 volt 120 m.a. Full Wave Rectifiers. 2 1/2 watt indirectly heated Pentodes. 2 watt indirectly heated Power 2 1/2 watt directly heated Power. All 5/6 each. 2 volt Battery types. H.F. L.F., 2/3. Power. Low Consumption Power. Super Power, 2/9. Screen Grid. Variable Mu. 4- or 5-pin Pentodes. Variable Mu., H.F. Pentodes. H.F. Pentodes, Class B Valves. All 5/- each. American Types: 250, 210, 245, 47, 46, 24, 35, 37, 51, 55, 57, 58, 80, 6A7, 2A7, 2A5, 27, 77, 78, 281. All 4/6 each.

All the following super quality American types, Hytron Brand. 6/6 each: 1A6, 1C6, 2A5, 2A6, 2A7, 2B7, 6A4, 6A7, 6B7, 6C6, 6F7, 12A5, 19, 24A, 26, 27, 30, 31, 32, 33, 34, 35/51, 36, 37, 38, 39/44, 41, 42, 43, 45, 46, 47, 49, 6D6, 53, 55, 56, 57, 58, 59, 75, 76, 77, 78, 79, 85, 89, 6A6, 83, 5Z3, 25Z5, 12Z3, 1V. All output valves can be supplied in matched pairs at no extra charge.

WIRE-WOUND RESISTANCES

4 wats, any value up to 50,000 ohms, 1/- each. 8 wats up to 100,000 ohms, 1/6 each. 15 wats up to 50,000 ohms, 2/- each. 25 wats up to 50,000 ohms, 2/6 each. 15- and 25-watt Resistors can be supplied semi-variable at 6d. extra. 1,000 ohms, 150 m.a. semi-variable Resistance; 2/-, 1,000 ohm, 250 m.a. Resistance tapped for any number of 0.18 amp. valves, 3/6. 800 ohm 350 m.a. tapped resistance, 2/-.

TRANSFORMERS

Premier Mains Transformers have tapped Primaries, and C.T., L.T.'s Engraved Terminal Panels, with N.P. Terminals. All windings paper interleaved. Combined H.T.8 and H.T.9, 4v. 1-2a. and 4v. 3-4a., 10/-. Westinghouse Rectifier, 8/6 extra. H.T.10 with 4v. 1-2a. and 4v. 3-4a., 10/-. Westinghouse Rectifier, 9/6 extra. 250+250v. 60 m.a. with 4v. 1-2a., 4v. 2-3a., 4v. 2-3a., 4v. 3-4a., 10/-. 300+300v. 60 m.a. with 4v. 1-2a., 4v. 2-3a., 4v. 3-4a., 10/-. 350+350v. 150 m.a. with 4v. 1-2a., 4v. 2-3a., 4v. 3-4a., 12/6. Auto Transformers, tapped, 100v., 110v., 200v., 220v., 240v. Step up or down, 100 wats, 10/-; 50 wats, 7/-. Manufacturer's type Transformers, 350+350v. 120 m.a. with 4v. 1-2a., 4v. 2-3a., 4v. 3-4a., 10/6. 500+500v. 150 m.a. with 4v. 2-3a., 4v. 2-3a., 4v. 2-3a., 4v. 3-4a., 19/6. 500+500v. 200 m.a. with 4v. 2-3a., 4v. 2-3a., 4v. 3-5a. and 5v. 3a. for American Rectifier, 25/- Valve Rectifier, 6/6 extra. 1,000+1,000v. 250 m.a. with 4v. 3a., 4v. 3a., 39/6, or with 2 G.U.I.s, 59/6.

TRANSFORMERS—Continued

Premier Eliminator Kits, all incorporating Westinghouse Rectifiers, high quality Mains Transformers and Chokes. Generous Smoothing and Decoupling Condensers and Resistances. 120 volts 20 m.a., 20/-; with Trickle Charger, 28/-, 150 volts 30 m.a. with 4v. 3-4a. C.T.L.T., 25/-; with Trickle Charger, 31/6. 250 volts 60 m.a. with 4v. 3-5a. C.T.L.T., 30/-, 150v. 50 m.a. 4v. 3-4a. 27/6, with Trickle Charger, 35/-, 300 volts 60 m.a. with 4v. 3-5a. C.T.L.T., 37/6. 200 volts 100 m.a. with 4v. 3-5a. C.T.L.T., 42/6. Premier L.T. Charger Kits all incorporate Westinghouse Rectifiers.
2 to 6 volts at 1 amp. 14/6 2 volts at 1/2 amp. 11/-
2 to 6 " at 1 " 17/6 30 " at 1 " 37/6
2 to 6 " at 2 " 27/6 50 " at 1 " 50/-
The following lines 6d. each or 5/- per dozen:—4-, 5- or 7-pin Baseboard or 4-, 5-, or 7-pin Chassis Mounting Valve Holders, American Valve Holders, 1 watt resistances, wire end every value; tubular wire end Condensers, 1,500 volt, every value up to 0.5, 3 amp.; 2- or 3-point Switches; Cydon Double Trimmers; 6 yds. Systoflex; 1, 1.5, 2 or 2.5 mm. 1 yd. 7-way Cable; 9ft. resin cored Solder; 6 yds. push-back Connecting Wire; 2in. Knobs, 4in. Dials. Any type and quantity of Instrument Wire can be supplied from stock.

AMPLIFIERS

PREMIER Super Public Address Amplifier, incorporating the new 6B5 Valve (see "Wireless World," July 15), 10-watt model, all AC, enormous gain, phase inversion, £7 7s. with valves; 20-watt model, £10 10s. Suitable Speakers in stock. Premier Soldering Irons, 200-250 volts; consumes 0.2 amps, 2/6. High-grade Push-Pull Input Transformers, 4/6 each. High-grade Intervalve Transformers, 3/6 1 each. Voltra Intervalve Transformers, 1/9 each. Ferranti A.F.3 Transformers, 8/11. Moving Coil Multi Ratio Output Transformers, 2/6 each. 1-1 or 2-1 Output Transformers, 2/6 each. Microphone Transformers, 50-1 and 100-1, 2/6 each. Telsen 1.75-1 Radiogrand Transformers, 2/9. Telsen "Class B" Driver Transformers, 2/9. Cossor "Class B" Driver and Output Transformers, 2/6 either type. "Standard" Telephones "Class B" Driver Transformer, 1/6.

POTENTIOMETERS

By best manufacturers, any size available from 500 ohm to 1 meg, with or without switch 2/-. Dual Potentiometers: 10,000 and 50,000; 5,000 and 50,000; 5,000 and 100,000; 10,000 and 100,000; with switch, 1/6 each.

METERS

British-made Moving Iron Meters. Flush mounting, 2 1/2" diameter. 0-10, 0-20, 0-30, 0-50, 0-100, 0-150, 0-250, 0-500 milliamperes; 0-1, 0-3, 0-5 amperes. All read AC and DC, 5/9 each. Moving Coil Milliammeters, B.E.S.A., first grade. 0-1 M.A., 2 1/2" diameter, 18/6. 0-1 M.A., 3 1/2" diameter, 22/6. All Meters flush mounting bakelite cases.

COILS

Lissen 3-gang Band Pass Screened Coils, complete with switching and blueprint, 6/11. Lissen All-wave 2-gang Screened Coils for Screened Grid Tuned H.F. stage; and Detector, 12 to 2,000 metres. Complete circuit diagram supplied, 12/6. Selective Iron Cored Coils circuit 2/11 each. Varley Band Pass Aerial Coils, B.P.7, 2/9. Varley Band Pass Transformer, B.P.8, 2/6. Special Offer. Set of three Lissen Band Pass Screened Coils with Switching, Utility 3-gang Condenser and Illuminated Disc Drive, 4-valve Chassis and Valve holders and blueprint, 14/6 the lot.

GRAMPHONE MOTORS

B.T.H. Truespeed Induction type, A.C. only; 100-250 volts, 30/-. D.C. ditto, 42/6. Collaro Gramophone Unit, consisting of A.C. Motor, 100-250 volts, high quality Pick-up and volume control, 45/-. Collaro Motor only, 30/-. Collaro Universal Gramophone Motor, 100-250 volts, A.C.-D.C., with high quality Pick-up and volume control, 67/6. Collaro Universal Motor only, 49/6. Edison Bell Double Spring Motors, including Turntable and all fittings, 15/-.

PICK-UPS

Cosmocord Pick-ups, with arm and volume control, wonderful value, 10/6 each. Cosmocord Pick-up only, fits any gramophone tone arm, 4/6.

20-22, HIGH STREET, CLAPHAM, LONDON, S.W.4. (Hours 9 a.m.—8 p.m.) MACAULAY 2381/2.
165 & 165A, FLEET ST., E.C.4. (Hours 9.30 a.m.—7 p.m.) Weds. 1 p.m. CENTRAL 2833. (Next door to Anderton's Hotel)
Sats. 1.30 p.m.
ALL POST ORDERS TO HIGH STREET, CLAPHAM.

Miscellaneous Advertisements

Advertisements are accepted for these columns at the rate of 3d. per word. Words in black face and/or capitals are charged double this rate (minimum charge 3/- per paragraph). Display lines are charged at 6/- per line. All advertisements must be prepaid. All communications should be addressed to the Advertisement Manager, "Practical and Amateur Wireless," 8, Southampton Street, Strand, London.

RECEIVERS, COMPONENTS AND ACCESSORIES

Surplus, Clearance or Secondhand, etc.

- V **AUXHALL**.—T.C.C. 4 and 8 mfd. Electrolytic condensers, 550, 3/-; 500 v., 2/6.
- V **AUXHALL**.—T.C.C. condenser, tubular, non-inductive, 0.1, 6d.; 50 mfd., 50v. working, 1/6; 50 mfd., 15v., 1/3; 0.05, 6d.; 0.002, 0.0002, 0.001, 0.0001, 4d. each.
- V **AUXHALL**.—T.C.C. mica 0.002, 2,000 volt test, 10d.; 0.0001, 6d.; 0.001, 0.01, 1/-; 1 mfd. Mansbridge, 1/3.
- V **AUXHALL**.—Resistances by well-known manufacturers, 1-watt type, 6d. each; all values.
- V **AUXHALL**.—Colvern G.1, G.2, G.3, or G.1, G.2 and G.8. superhet. type, 30/-; Colpaks, £24/4-.
- V **AUXHALL**.—Volume controls, Erie, Colvern, Centralab, 2/-; with switch, 3/-; all values, from 3,000 to 2 meg., Benjamin, class "B" transformers, 1-1 1/2 to 1, 6/6.
- V **AUXHALL**.—Polar station named scales, for horizontal dials, latest settings: 1/3 each.
- V **AUXHALL**.—Polar Midget 3-gang condensers, straight or superhet, 8/6; Polar full vision, horizontal or Arcuate dial and drives, 4/6.
- V **AUXHALL**.—Centre tapped iron cored L.F. transformers, bases, terminals, 110 k/c; 6/6 guaranteed.
- V **AUXHALL**.—Set manufacturers' surplus, skeleton type Westinghouse rectifiers, H.T.8, 9/6; H.T.9, H.T.10, 10/-; complete with fixing brackets; Westcofers, W.4, W.X.9, 5/9.
- V **AUXHALL**.—Guaranteed for twelve months: mains energised, 2,500 or 5,500 field coil, 10ln. cone, 17/6; 7ln. cone, 12/6.
- V **AUXHALL**.—Permanent magnets, universal, suitable for Class "B" power or pentode, 7ln. cone, 16/6; 10ln. cone, 22/-.
- V **AUXHALL**.—The above complete with hum-bucking coils; state power or pentode transformer; immediate delivery.
- V **AUXHALL**.—B.T.H. Minor, 16/6; Senior needle armature, 29/-; Radiophone, 14/6; others from 10/-.
- V **AUXHALL**.—B.T.H. Truspeed gramophone motor 30/-; Universal D.C./A.C., 47/6; sealed cartons.
- V **AUXHALL**.—Collaro 32 model, 32/6; Universal model, 47/6; complete unit, A.C. 200-250v., first quality pick-ups and volume control, 48/-.
- V **AUXHALL**.—T.C.C., 200 mfd. 10-volt, 2/6. Continental valve holders for Universal valves, with terminals, 9d.
- V **AUXHALL**.—Clix valve holders, terminals, 7-pin, 9d., 5-pin, 7d., W.B. 5-pin, 4 1/2d.; baseboard mounting, 6d.; post paid 2/6 or over, or c.o.d.
- V **AUXHALL**.—Hivac Valves, all types Mains and Battery in stock for immediate delivery.
- V **AUXHALL UTILITIES**, 163a, Strand, W.C.2, over Denny's, the Booksellers, Temple Bar 9338. Send postcard for lists free.

ORMOND RECEIVERS as advertised in last week's issue still available.
W. Radio, 7, Chapel St., Lamb's Conduit St., London, W.C.1.

BANKRUPT BARGAINS.—List free. All new goods. Kolster Brandes model 383, 1936. 19 gn. 7v. superhets A.C./D.C., 10 gns. Cossor S.G. 3v. D.C. console sets, £47/6. Burgoyne Fury, 4v. A.C./D.C. sets, £417/6. Amplion 5v. A.C. superhets, latest, 12 gn. models, £710/0. Very high part exchange offers on Mullard MU35 6v. A.C./D.C. superhets and M13A battery sets. Get my quote. Large stock of replacement valves and components. Quotations per return.—Butlin, 6, Stamford Avenue, Brighton, Preston 4030.

NEW RECEIVERS, COMPONENTS, AND ACCESSORIES

ALL-WAVE A.C. Five, £9/9/0. Novo Radio, St. John Street, Newcastle-on-Tyne 1.

HULBERT for Quality Surplus Speakers. All Music Lovers should write for List of amazing bargains. Prices from 8/6 brand new. Made by best known British maker.—Hulbert, 6, Conduit Street, W.1.

BARGAIN PARCELS.

ONLY QUARTER OF LIST PRICE. NEW TIMES SALES CO. offer the following parcels of useful British components at an extremely low price. Each part is entirely brand new or shop soiled only. We guarantee that every component is a genuine constructor's component and must not be confused with the multitude of manufacturers' surplus or rejects which are at present on the market. Each parcel contains components to a list value of at least four times the price we ask.

5/- PARCEL (post 6d./extra). Contains an air-spaced variable condenser, an L.F. transformer, a binocular choke, 2 resistances, 6 terminals, 1 fixed condenser, 3 valveholders, and 6 blueprints. Total List Value 20/-.

7/6 PARCEL (post 6d. extra). Contains a screened coil, an L.F. transformer, a Mansbridge type condenser, a reaction condenser, a fixed condenser, a fixed resistance, 6 terminals, and 6 blueprints. Total List Value 20/-.

10/6 PARCEL (post 9d. extra). Contains a 2-gang screened coil unit with switch, an air-spaced variable condenser, a vernier dial, an L.F. transformer, a 2 mfd. condenser, a Mansbridge type .25 mfd. condenser, a grid leak, a fixed condenser, a reaction condenser, an electrolytic condenser, and 6 blueprints. Total List Value 42/6.

20/- PARCEL (post 9d. extra). Contains a 3-gang screened coil unit with switch, a slow motion illuminated drive, 2,000 air spaced tuning condensers, 1 volume control, 1 4 mfd. Mansbridge condenser, 1 L.F. transformer, 1 differential reaction condenser, 1 H.F. choke, 12 terminals, 3 fixed condensers, 3 fixed resistances, 2 component mounting brackets and 6 blueprints. Total List Value 35/-.

FREE WITH EACH PARCEL. Each of the above parcels contains a FREE GIFT of 6 Blueprints giving all the information necessary for building—3-Valve S.G. set. 3-Valve straight 3. Class B. 4-Valve set. Short-wave Adaptor. A.C./D.C. Short-Wave Superhet Converter. 4-Valve Battery Short-wave set. Each of these circuits has been carefully designed, and we have built and tested them to ensure that they are both 100 per cent. efficient and easy to assemble and build. VALVES: Reliable British battery type valves at half price. Parcels of 3 Det., L.F., and Power. List price 13/- Our Bargain Price 7/6. S.G., Det. and Power (19/9d.), Our Bargain Price 9/6. S.G., Det. and Pentode (24/9d.), Our Bargain Price 12/6.

NEW TIMES SALES Co.

56, Pr. W.9, LUDGATE HILL, London, E.C.4 EST. 1924.

RECEIVERS, COMPONENTS AND ACCESSORIES

Surplus, Clearance or Secondhand, etc.

SHORT WAVE on a crystal set. Full building instructions and crystal 1/2 post paid.—Radiomail, Tanworth-in-Arden, Warwickshire.

ALL goods advertised in last week's issue still available.

WARD, 46, Farringdon Street, London, E.C.4. Telephone: Holborn 9703.

MISCELLANEOUS

SUITABLE valves for each kit by well-known manufacturers included at the kit price to initial purchasers of one of our new low-priced home construction kits.

"**AIR CUB**," short-wave, 10-55 metres, band-spread, 12/6. All-wave, 10-2,000 metres, 18/6. "Little Scout," short-wave bandspread III, 15-55 metres, 22/6. "Straight" Super III, 180-2,000 metres, 15/6. Short-wave adaptors, 10/6. Every kit complete with metal chassis and sundries. EVERY KIT WITH VALVES, a real double bargain; order early and secure. Cash or C.O.D. post 1/- Enclose also 3d. stamps for complete component lists.

ANGLO AMERICAN RADIO DISTRIBUTING CORPORATION (Dept. 9), 1, Lower James Street, Piccadilly Circus, London, W.1.

ENGINEERS

HERE'S YOUR OPPORTUNITY AND OUR GUARANTEE!

We are prepared to coach you for recognized Examinations such as A.M.I. Mech.E., A.M.I.E.E., A.M.I.R.E., A.M.I.W.T., A.M.I.A.E., G.P.O., etc. under our definite Guarantee of "NO PASS—NO FEE." This is your opportunity to get out of the "hammer and file brigade" and to commence earning real money. Full particulars will be found in the 1936 edition of "ENGINEERING OPPORTUNITIES." This book gives details of all Engineering Examinations and outlines Home-Study Courses in all branches of Civil, Mech., Elec., Motor, Aero, and Radio Engineering, Television, Building, etc. Send for your copy of the book to-day—FREE.

BRITISH INSTITUTE OF ENGINEERING TECHNOLOGY 409, SHAKESPEARE HOUSE, 17/19, STRATFORD PLACE, OXFORD ST., LONDON, W.1.

RADIO CLEARANCE

63, HIGH HOLBORN, W.C.1. TEL: HOLBORN 4631

Owing to increase of business we have found it necessary to remove to larger and more spacious premises at Number 63, High Holborn. All orders in future should be sent to this Address. All orders to the value of 10/- or over, carriage paid in United Kingdom. Orders under 10/- must be accompanied by a reasonable amount of postage.

"SPECIAL" "SPECIAL"

70/- LISSEN 4-VALVE A.C. SET complete in Cabinet with Valves and P.M. Moving Coil Speaker, aerial tested. Few only.

60/- LISSEN 4-VALVE D.C. SET complete in Cabinet with Valves and Moving Coil Speaker, aerial tested. Few only.

105/- 4-VALVE A.C. SET. 200 to 250 volts. By well-known proprietary manufacturer. Mullard Valves, Moving Coil Speaker, Band Pass tuned, in handsome Walnut Cabinet. Brand new, boxed. H.P. terms can be arranged on application.

75/- 4-VALVE A.C. MAINS CHASSIS. 200 to 250 volts. By well-known proprietary manufacturer. Mullard Valves, Band Pass tuned. Brand new.

55/- LISSEN 4-VALVE A.C. CHASSIS. 200 to 250 volts, complete with Valves, aerial tested. Few only.

47/6 LISSEN 4-VALVE D.C. MAINS CHASSIS. Complete with Valves, aerial tested. Few only.

70/- LISSEN 100 STATIONS SET. Complete in Cabinet with Valves and P.M. Moving Coil Speaker, aerial tested. Few only.

32/6 LISSEN SKYSCRAPER 3-VALVE BATTERY CHASSIS. Aerial tested, with Valves.

21/- LISSEN SKYSCRAPER PATTERN CHASSIS. Aerial tested, less Valves.

2/6 LISSEN 2-VOLT BATTERY VALVES. L2 Metalised. Brand new, boxed.

3/6 LISSEN 2-VOLT CLASS B VALVES. Type BB220 A. Brand new, boxed.

8/11 LISSEN RECTIFYING UNITS. Complete with Valves, input 100 to 250 volts, Output 250 volts, 60 M/A. Brand new, in sealed cartons.

5/- UTILITY 3-GANG MIDGET CONDENSERS. Straight or Superhet with 110 k/c section, fully screened.

2/11 BRITISH RADIOPHONE 3-GANG SUPERHET CONDENSERS. With 110 k/c Oscillator section, unscreened. Wonderful bargain.

2/6 8 MFD AND 4 MFD DRY ELECTROLYTIC CONDENSERS. By well-known manufacturer. 450 volt working. 500 volt peak, brand new.

3/- LISSEN HANDSOME WALNUT TABLE CABINET. With provision for Speaker, cut out front for Lissen Band Pass 3 Kits. Few only left. Wonderful bargain.

17/6 HANDSOME WALNUT FLOOR MODEL CONSOLE CABINET. An unrepeatable bargain.

1/11 LISSEN CENTRE TAP OUTPUT CHOKES. Brand new, boxed. List price, 7/6.

1/6 LISSEN INTERVALLE SMOOTHING CHOKES. Brand new, boxed. List price, 7/6.

9d. LISSEN Hf By-Pas UNIT. List 5/6. Brand new, boxed.

1/11 LISSEN 3-GANG SUPERHET COILS. Mounted on bass, complete with Switch, unscreened, brand new.

6d. DRILLED METAL CHASSIS. 3-Valve type.

6d. 1 WATT RESISTANCES. All sizes, by well-known manufacturer.

6d. TUBULAR CONDENSERS. All sizes up to 1. By well-known manufacturer.

1/- 1 MFD CONDENSER. 500 volt working.

1/- 4 MFD POST OFFICE TYPE MANSBRIDGE. 250 volt working.

2/6 4 MFD PAPER CONDENSERS. 75 volt test.

HIVAC VALVES Complete range in stock. Send for lists.

3/- LISSEN SPEAKER CABINET, with baffl. board, brand new, boxed.

2/11 2-GANG CONDENSERS, unscreened.

3/11 LISSEN 3-GANG S/H CONDENSER, 126 k/c section, with dial.

8/11 BRYCE MAINS TRANSFORMERS. 250.0.250 80 m.a. 202 volts 2.5 amp., 202 volts 4 amp.

9/6 350.0.350 150 m.a., 202 volts 2.5 amp., 202 volts 4 amp.

11/6 500.0.500 150 m.a., 202 volts 2.5 amp., 202 volts 4 amp.

17/6 500.0.500 150 m.a., 202 volts 2.5 amp., 202 volts 6 amp., 202 volts 2 amp., 202 volts 2 amp.

8/11 H.T.8. Transformer, 250 volts 60 m.a., 202 volts 4 amp.

17/6 Ditto, with H.T.8 Metal Rectifier.

All the above transformers are first class manufacture, brand new, fully shrouded.

RADIO CLEARANCE

63, HIGH HOLBORN, W.C.1. TEL: HOLBORN 4631.

BIRMINGHAM RADIOMART SHORT-WAVE SPECIALISTS

Proprietor, G5NI. Manager, G2AK. Staffed by experienced transmitting amateurs. Obviously we can serve you better.

SPECIAL offer, British Radiophone 8-valve colonial all-wave chassis, B.V.A. valves, A.V.C. Shadow-graph tuning, 6In. airplane dial, Magnavox Magna 12in. Speaker, fitted for Gramophone and transposed Aerial. Six only, £9 17s. 6d.

CAUTION: Beware of coilforms, etc., moulded in cheap bakelite. Our coils and formers are guaranteed efficient.

4-PIN interchangeable short-wave coils; set 3. Cover 15-100 metres, latest ribbed former, 7/9.

1 1/2 IN. ribbed short-wave coil forms; valveholder 1 1/2 type, loloss, 4-pin, 1/6, 6-pin, 1/9. Threaded for winding, 2d. extra.

UTILITY 8/6 microdisc dials, fitted famous micro high reduction, only perfect short-wave dial, 3/11.

SHORT-WAVE H.F. chokes, 9d. *Wireless World* states: "Very efficient—100 to below 10 metres."

UTILITY microvariables, 15, 40 mmfd., 1/-; 465 ke/s litz wound I.F.'s, 5/6.

RADIOPHONE super ceramic insulated short-wave condensers, .00016, 3/6; series cap, 3/9.

CONTINENTAL A.C. valves, 4/6. VMPT, HPT, VMSG, ACSG, ACH, ACHL, PT4. Most American types, A.C. Pen., 5/6.

2V. types, H.F. detector, L.F., 2/3; LP2, P2, 2/9; Snuper, 3/3; VMPT, HPT, 5/6; Class B, 4/6; 8.G., VMSG; 5/-.

BARGAIN parcel value 30/-, containing binocular HFC, 4 750v. test condensers, 6 resistances, 4 valveholders, .0003, .0005 variable electrolytic condenser, etc., 5/-.

TELESEN 7/6, Ace transformers made for leading Company, boxed, 1/11.

BALL-BEARING air-spaced condensers; World's finest manufacturers 4-gang, 3-gang superhet, 1/11.

NON-INDUCTIVE condensers by leading makers T.C.C., Dubilier, etc., 0.5, 0.25, 0.1, 0.02, 0.005, 3d.

ASTOUNDING offer electrolytic condensers, world-famous maker, 4+4 mfd. (separate) 500v., working, 1/6.

GENUINE 15/6 Frost potentiometers, wire-wound, tapered, 10,000 ganged to 50,000 ohms, 1/6.

LISSEN 2-gang coils, 12-2,000 metres, switched and screened, nothing else required to convert 8G3 to all-wave, 12/6.

LISSEN 3-gang bandpass superhet coils, 4/6; 3-gang bandpass Tuned grid, 6/11. All with circuits.

AMPLION, 3/6; screened H.F. choke, 1/11; Iron-cored binocular, screened, 2/3. Climax binocular, 1/3. Telsen, 1/11.

UTILITY 2-gang .0005 Uniknob with large disc drive, 3/11. Ditto, single, with disc, 2/3.

ISSSEN 30hy., 40 ma., chokes, 2/-; 20 hy., 100 ma., 2/11. Lissen eliminator chokes, 1/3.

IGRANIC tapered potentiometers 1/4-meg., 1-meg. with 3-point switch, 2/-.

GROSS roundhead woodscrews, assorted, 9d. Solder tags, 6d.; resin-core solder, 9ft., 6d.

PUSHBACK connecting wire, ready tinned and sleeved, 6yds., 6d. Heavy, for heaters, 9d.

SCREENED iron-cored selective dual-range coils, with reaction; circuit diagrams, 2/11.

NON-INDUCTIVE tubulars, 1,500 v., 0.01, 0.02, 0.04, 0.05, 0.1, 6d.; 0.2, 0.25, 8d.; 0.5, 9d.

LISSEN 6-way battery leads, with plugs, 6d. Belling-Lee safety mains plug and socket, 6d.

INSULATED terminals, Belling-Lee, black, Telsen, red, black, 1d. Telsen 0.0003 presets, 9d.

TRANSFORMERS B.T.H. speaker; suit all moving coils, 2/11. Manufacturers push-pull, 1/11.

FUSES, Telsen 1-amp., 1-amp., 3-amp., 2d. Telsen, 100 ma., 2d.

TELESEN latest differentials, .0003, 1/3; .00015, 1/-.

SPECIAL Four assorted Telsen grid-leaks, 5d.; twelve various wire-ended resistances, 2/6.

MILLIAMMETERS: flush 2 1/2 in., 5/9; 2 1/4 in., 6/9. All ranges above 25 ma., visual tuning, 6/9.

T.C.C., etc., bias electrolytics, 50 mfd., 50 v., 1/9; 25 mfd., 25 v., 1/3; 15 mfd., 100 v., 1/-; 6 mfd., 50 v., 6d.

RADIOMART

Orders over 6/- post free. Enquirers must enclose stamp.

Catalogues; general catalogue gives hundreds of bargains; short-wave illustrated catalogue also gives diagram of efficient transmitter and receiver; each 12d. Pair 3d., post free.

THE SQUARE DEALERS

19, John Bright St., 22, Summer Row; mail-orders: 44, Holloway Head, Birmingham. Telephone: Midland 3254

RECEIVERS, COMPONENTS AND ACCESSORIES

Surplus, Clearance or Secondhand, etc.

SOUTHERN RADIO'S WIRELESS BARGAINS, ALL GOODS GUARANTEED NEW AND SENT POST PAID.

SPEAKERS—Celestion Soundex Permanent Magnet, 11/-; Telsen Permanent Magnet Speakers, 16/-, Telsen Units, 2/9.

LISSEN KITS, ALL NEW IN SEALED CARTONS AND COMPLETE. With Specified Valves. Lissen Skyscraper 3-Valve Battery Kits, 42/- each (List, 77/6).

DEEMARK SHORT-WAVE ADAPTOR KIT. Complete with all accessories for adapting set for 14-150 Metres, 20/-.

MULLARD M.B.3. THREE-VALVE BATTERY SETS. Complete with 3 Mullard Pentode Valves, Permanent Magnet Speaker, Batteries and Accumulator. Contained in handsome walnut cabinet, £57/6 (List, 8 guineas). In original sealed cartons.

G.E.C. A.C./D.C. 3-VALVE RECEIVERS. Ring Valves, Universal Mains and Voltage. Complete in exquisite Cabinet, ready to plug-in, £319/6 (List £7/15). Not a midget.

HOUSE TELEPHONES. A SPECIAL BARGAIN. BRAND NEW ONE-HAND TELEPHONES. Complete on stand, with or without Automatic Dials. Cost £4 each to manufacture, 10/- each.

ELIMINATORS—Regentone 1935 Series. A.C. Mains, 200/250 volts, Type W5a, complete with trickle charger, 39/6; W1a (less trickle charger—carries 30 milliamperes), 33/-.

W.C. Latest Model A.C. Eliminators with trickle charger for 10, 20 or 30 milliamperes, 45/- (List £4/15/-).

CONDENSERS—Lotus 0.0005. Fully screened, with trimmers, escutcheons, dials and knob, 3-gang, 11/-; 2-gang, 7/3.

DYBLOCK SINGLE, 0.0005, complete with all accessories, 4/-.

TELESEN SINGLE VARIABLE CONDENSERS, 0.0005, 2/3.

COILS—Igranice Superhet Coil, set of four (1 Osc., 2 I.F. with Pigtails, 1 I.F. plain), 9/- per set (List, 50/-).

Varley Square Peak Coils, B.P.5, complete, 2/3. Telsen Iron-core Coils, W349 midget size, 4/8 each.

The following Telsen Components in original sealed cartons at sacrifice prices:—

ACE L.F. TRANSFORMERS.—5/1, 2/9; Binocular H.F. Chokes, 2/-; Standard Screened H.F. Chokes, 2/-; ACE MICROPHONES (P.O.) with Transformers, 5/- each.

This Microphone can be used with any radio set and is a very efficient article.

"TRUE-OHM" RESISTANCES. 1 watt wire ends, colour coded and marked, 36 on card, assorted capacities, 7/6 per card.

AMERICAN VALVES.—A full range of valves for all American sets at 7/- per valve.

SOUTHERN RADIO BARGAIN PARCELS.—We are offering the following parcels of mixed components at a fraction of their value.

5/- PARCEL—Contains modern components (Resistances, Condensers, Coils, Wire, etc.)

Circuits of modern Receivers included with each parcel.

SOUTHERN RADIO, 323, EUSTON ROAD, LONDON, N.W.1 (near Warren Street Tube). Phone: Museum 6324.

SOUTHERN RADIO Branches at 271-275, High Road, Willesden Green, N.W.10; 46, Lisle Street, W.C.2. All Mail Orders to 323, Euston Road, London, N.W.1.

WANTED, good modern radio sets, parts, etc., spot cash paid; exchanges; bring or send.—University Radio Ltd., 142, Drummond Street, Euston, London, N.W.1.

HIGHEST possible allowance made on your old set or components in part exchange for any new set or Peto-Scott kit. Lists free. R. Wigfield, Furlong Road, Goldthorpe, Yorks.

HEADPHONES, Brown, B.T.H., Sterling, Nesper, Brunet, Siemens, Erissong, G.E.C. 2000 ohms, 2/6. 4000 ohms, 5/-. Postage 6d. Guaranteed. Kolesh, 56, Barnsbury St., London, N.1.

HOME CONSTRUCTORS of Coils, Chokes and Transformers should send for lists.—Lumen Electric Co., Litherland, Liverpool 21.

NEW RECEIVERS, COMPONENTS AND ACCESSORIES

ALCO ELIMINATORS AND CHARGERS. 4 H.T. taps, 120/150 v., 20/30 m.a., 18/-.

With charger, 25/-. Charger alone, 7/6, 1/2 amp., 11/-.

Westinghouse rectifiers. Years guarantee. Complete. Details free.—P. & D. Radio, 1, Gooding Road, N.7.

CLARION VALVES.—All brand new; battery types 2-volt, H.2 H.L.2, L.P.2, 1/9; super power, P.2, 2/6; screens and L.F. pentodes, 3/9; A.C. mains, 4-volt, 1-amp., general purpose, 3/3; power, 4/-; screens and L.F. pentodes, 4/6; full-wave rectifiers, 3/9; postpaid, cash with order, or C.O.D. over 10/-.—Clarion Valves, Dept. 2, 885, Tyburn Road, Erdington, Birmingham.

MISCELLANEOUS

REPAIRS to Moving Coil Speakers, Cones and Coils fitted or rewound. Fields altered. Prices Quoted including Eliminators. Loud-speakers Repaired, 4/-.

L.F. and Speech Transformers, 4/- Post Free. Trade invited. Guaranteed. Satisfaction. Prompt Service, Estimates Free. L.S. Repair Service, 5, Balham Grove, London, S.W.12. Battersea 1321.

CAMM'S PERFECT S.W.3, Complete Specified Kit, 40/-. MONITOR THREE, 35/-, complete, Cash. C.O.D.—Easieyway. Bargain List Free.—Melfo-Rad, Queen's Place, Hove. (Trade supplied.)

REPAIRS—Moving Coil Speakers. Complete Re-winding Service for Transformers, etc. Receivers Repaired. Trade Discount.—Weedon's Radio Repair Service, 262, Romford Road, London, E.7. Maryland 1782.

VALVES by well-known manufacturer. Complete range of Battery, A.C. Mains, Rectifiers. Brand new stock with six months' guarantee. 2 volt: Detector 2/3, Power 2/9, Screen Grid, Pentode, H.F. Pentode 5/-.

Write for other prices to: Dulci Electrical Co., Ltd., 7, Lizard Street, London, E.C.1.

FIFTY TESTED WIRELESS CIRCUITS, by F. J. Camm, 2s. 6d.—This handbook contains every modern circuit, complete with instructions for assembling, component values, and notes on operation.

Obtainable at all Booksellers and Newsagents.—George Newnes, Ltd., 8-11, Southampton Street, Strand, London, W.C.2.

MORE THRILLING THAN FICTION.—Newnes' Wide World Library contains the finest true-life travel and adventure books, great literature and exhilarating reading. Each 2s. 6d. net from all Booksellers.

George Newnes, Ltd., 8-11, Southampton Street, Strand, London, W.C.2.

PERPLEXITIES AND TANTALISERS.—"The Strand Problems Book" is the finest collection of puzzles of all kinds ever assembled, mathematical, geographical, literary—acrostics and codes, by W. T. Williams (Tantalus) and G. H. Savage. Only 2s. 6d. net from all Booksellers.

George Newnes, Ltd., 8-11, Southampton Street, Strand, London, W.C.2.

EVERYMAN'S WIRELESS BOOK, by F. J. Camm. 3s. 6d. net. An invaluable book of reference explaining the operation, upkeep and overhaul of all types of wireless receiver. 200 illustrations. From all Booksellers and Newsagents.

George Newnes, Ltd., 8-11, Southampton Street, Strand, London, W.C.2.

TELEVISION—Newnes Television and Short-wave Handbook by F. J. Camm, deals authoritatively with Scanning Systems (Drums, Mirror Screws, Discs, etc.), Neon Lamps, The Cathode-Ray Oscillograph, How to Build Short-wave and Ultra-short-wave Receivers. Fully illustrated. 3s. 6d. net. From your bookseller.—George Newnes, Ltd., 8-11, Southampton Street, Strand, London, W.C.2.

THE PRACTICAL MOTORIST'S ENCYCLOPEDIA, by F. J. Camm. 3s. 6d. net. A lucid exposition of the principles, upkeep and repair of every part of the car. 442 illustrations. From booksellers everywhere.—George Newnes, Ltd., 8-11, Southampton Street, Strand, London, W.C.2.

FREE ADVICE BUREAU

COUPON

This coupon is available until February 29, 1936, and must be attached to all letters containing queries.

PRACTICAL AND AMATEUR WIRELESS, 22/2/36.

ADVERTISEMENT INDEX

	Page
Bennett College, Ltd.	740
British Institute of Engineering Technology	752
British Shortwave League	747
British Television Supplies, Ltd.	750
Cosson, A. C., Ltd.	Inside Front Cover
Electradix Radios	747
International Correspondence Schools	742
King's Patent Agency, Ltd.	747
London Radio Supply Co.	747
New Era Publishing Co., Ltd.	729
New Times Sales Co.	752
Peto-Scott Co., Ltd.	739
Pix	749
Premier Supply Stores	751
Stratton & Co., Ltd.	750
362 Radio Valve Co., Ltd.	729
Westinghouse Brake & Signal Co., Ltd.	729
Whiteley Electrical Radio Co., Ltd.	745
Wills, W. D. & H. O.	743

Free

Beautiful
Coloured
Art Plate



THE VICKERS "WELLESLEY" MONOPLANE.

Special Contents of the MARCH Issue:
WINGS OVER HAWAII. An Inter-Island Service.
COLONEL "BILLY" BISHOP, V.C. His Career.
SABOTAGE IN THE BLUE?

Recent Air Mysteries in U.S.A.
MY MOST THRILLING FLIGHT. By Captain Doyle.
BOMB-PROOF CITIES OF THE FUTURE.
Best Topical and Historical Air Pictures.

In The March POPULAR FLYING

The National Aviation Magazine

Now on Sale at all Newsagents
and Bookstalls.

6^d
MONTHLY

C. Arthur Pearson, Ltd.

Published every Wednesday by GEORGE NEWNES, LIMITED, 8-11, Southampton Street, Strand, London, W.C.2, and Printed in Great Britain by THE NEWNES & PEARSON PRINTING CO., LTD., Exmoor Street, London, W.10. Sole Agents for Australia and New Zealand: GORDON & GOTCH, LTD. South Africa: CENTRAL NEWS AGENCY, LTD. *Practical and Amateur Wireless* can be sent to any part of the World, post free, for 17s. 6d. per annum; six months, 8s. 10d. Registered at the General Post Office as a newspaper and for the Canadian Magazine Post.

Amazing Bargain Offer!

Book of 96 LATEST ROAD MAPS and 64 PAGES OF GAZETTEER

Fits The
Coat
Pocket



Exclusively produced
by John Bartholomew
& Son, Ltd., the
famous Map-makers.

HERE is a wonderful opportunity for every Motorist, Motor-cyclist and Cyclist to possess the very latest Complete Section Maps of the British Isles at Bargain Price. All roads classified by the Ministry of Transport, the side roads, short cuts, new arterial roads and bypasses are clearly shown, together with railways, level crossings, stations, churches, inns, contours, historical features, etc.

In addition you are given 64 pages of Gazetteer.
The book fits the coat pocket.

Be sure to take advantage of this magnificent
ALMOST-A-GIFT OFFER. Full particulars in

PRACTICAL MOTORIST

3^d

On Sale Feb. 21st at all Newsagents and Bookstalls

George Newnes, Ltd.

DEVELOPING THE MONITOR— SEE PAGE 766

Practical and Amateur Wireless

3^D
EVERY
WEDNESDAY

Edited by F.J. CAMM

A GEORGE
NEWNES
Publication

Vol. 7, No. 180,
February 29th, 1936.

AND PRACTICAL TELEVISION

Making L.F. AMPLIFIERS



Three
Designs
Inside!

Mr. Camm's Choice

1936 STENTORIAN



WHITELEY ELECTRICAL RADIO CO., LTD., MANSFIELD NOTTS

Adv.

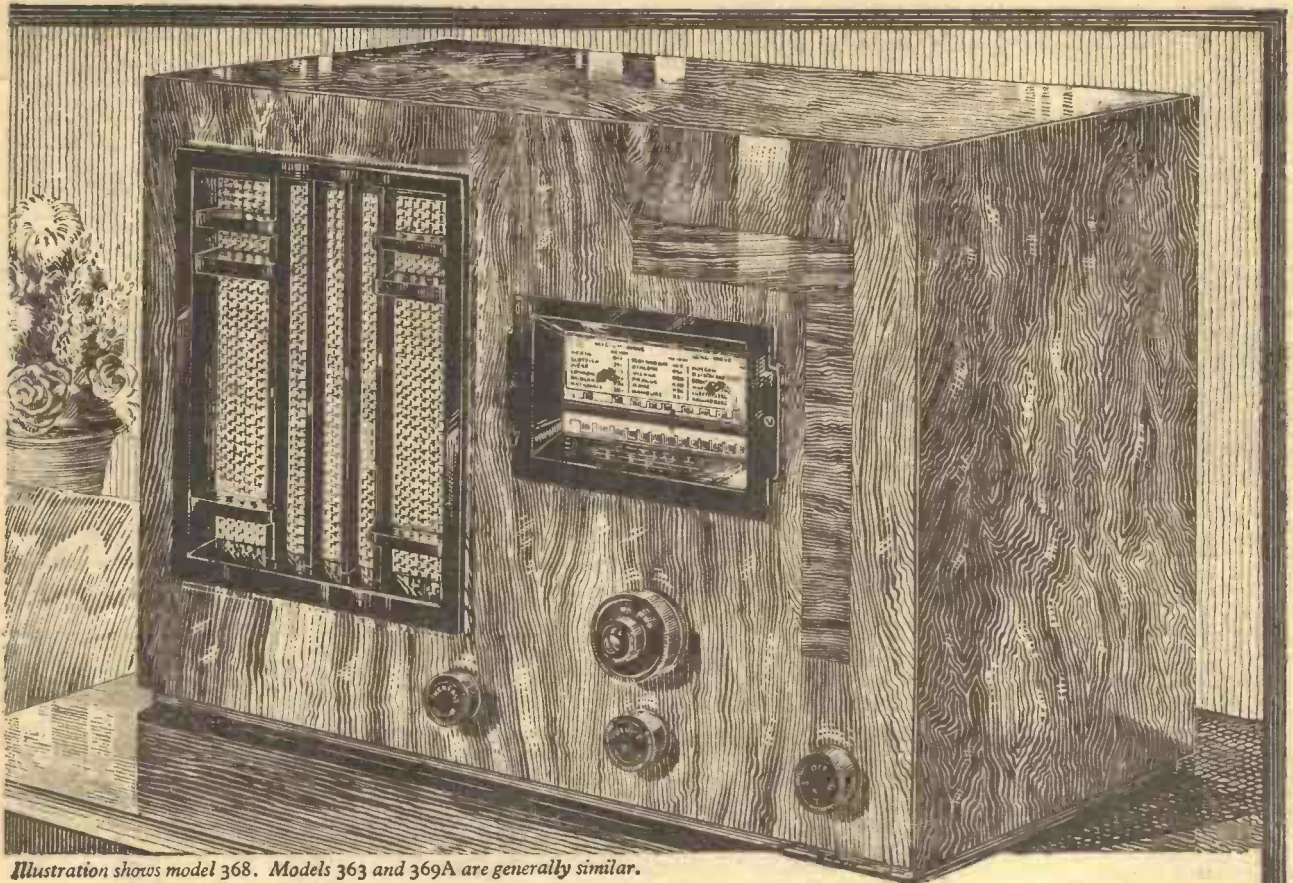

Illustration shows model 368. Models 363 and 369A are generally similar.

COSSOR RADIO

THIS Cossor Receiver is available in three splendid Models. All incorporate the latest "Super-Ferrodyne" developments. Their selectivity is exceptionally good. Due to the Cossor H.F. Pentodes in H.F. stage and Detector stages, a high degree of distortionless amplification is assured. All models are fitted with full-sized

Moving Coil Loud Speakers carefully matched to give a quality of reproduction which is really magnificent—rich, clear and true-to-life. Other Cossor Receivers are illustrated and described in our catalogue—send coupon to-day.

To A. C. COSSOR LTD., Melody Dept., Highbury Grove, London, N.5.
Please send me, free of charge, a copy of your latest catalogue in full colour giving details of Cossor Receivers and Radiograms.

Name.....

Address.....

B.29 PRAC. 29/2/36.

Three Splendid Models

Battery Model 363

With Variable-mu H.F. Pentode, H.F. Pentode Detector, Economy Pentode Output. Super-selective iron-cored coils. Provision for Pick-up and Extension Speaker. 8" Moving Coil Speaker. Price **£6.15s.** (without batteries)

H.P. Terms: 13/- deposit and 11 monthly payments of 13/-.

A.C. Model 368

With Variable-mu H.F. Pentode, H.F. Pentode Detector, Triode Power output. Heavy duty Rectifier. Super-selective iron-cored coils. 8" energised Moving Coil Speaker. Provision for pick-up and extension speaker. For A. C. Mains 200/250 volts adjustable 40/100 cycles. Price **£8.8s.**

H.P. Terms: 14/6 deposit and 12 monthly payments of 14/6.



D.C./A.C. Model 369A

Universal type. Variable-mu H.F. Pentode, H.F. Pentode Detector, Super-power output, indirectly heated Rectifier. Super-selective iron-cored coils. 8" energised Moving Coil Speaker. For D.C. 200/250 volts (adjustable) and A.C. 200/250 volts (adjustable) 50-100 cycles. Price **£8.8s.**

H.P. Terms: 14/6 deposit and 12 monthly payments of 14/6.

Prices do not apply in I.F.S.

THE LEADING WIRELESS WEEKLY!

Practical and Amateur Wireless

Edited by F. J. CAMM

Technical Staff:
W. J. Delaney, H. J. Barton Chapple, Wm. Sch.,
B.Sc., A.M.I.E.E., Frank Preston.

VOL. VII. No. 180, February 29th, 1936.

ROUND *the* WORLD of WIRELESS

Netherlands East Indies

BATAVIA and other Java concerts may be heard in Europe through the short-wave Bandoeng transmitters. In view of the network established by the N.I.R.O.M. over twenty thousand listeners in the Netherlands East Indies are given a broadcast service. Most of the musical transmissions consist of Javanese, Chinese, and Arabic melodies.

Turkey Up to Date

THE programmes of the Istanbul and Angora broadcasting stations are daily assuming a more Western character. The latest feature is a dance hour with tangos and foxtrots, and the transmission of adaptations of German, English, and French musical comedies.

Tri-lingual Announcers Wanted

FOR the numerous studios in its network, Italy is searching for announcers who can speak, in addition to their native language, English, French, and German. In these circumstances they may be of the male sex!

Tastes Differ

IN contradiction to Germany, Polish listeners are appealing to the studios to give them more frequent relays of dance music from restaurants in which the bands play up-to-date melodies. Arrangements are being made to broadcast the cabaret turns given at the principal Warsaw night clubs.

Broadcast Music and Anaesthetics

A FAMOUS Swiss surgeon, Dr. Rusca, contends that from experience derived from 2,400 operations, he has found that patients, whilst being put under the influence of an anaesthetic, reap considerable benefit by listening to suitable music broadcasts. The wearing of headphones, wherever possible, distracts their attention from the operating table and the attendant surgeons and nurses.

Polish "Ham" Saves Shipwrecked Crew

AN experimental amateur in Myslowitz (Poland) recently picked up an SOS call from the Soviet steamer *Lozinski*, which had been wrecked on a reef near the island of Sakhalin. The radio operator had sent out calls for several days but had

received no reply. Passing the information over to the post office authorities, the amateur secured help from the Soviet Authorities with the result that the crew and passengers were rescued within a few hours.

More Work for the Postman

SO far the French broadcast licence-holder has been asked to pay his tax monthly. Owing to the forgetfulness of listeners in this respect the Authorities

GET "THE CYCLIST" TO-DAY

If you are a cyclist you are sure to be interested in the great new Weekly, "THE CYCLIST," just out, price 2d., and published every Wednesday.

Edited by cyclists for cyclists, it is the complete journal for all wheelers, whether you are a club member or a casual rider. It will keep you fully informed on everything that is new in cycling. Its experts will examine, test, and describe new machines, fitments, and inventions. It will contain up-to-the-minute sports features, authoritative club reports, and practical articles well illustrated with diagrams and photographs.

Buy a copy to-day from your news-agent, and read of the WONDERFUL CELEBRATION OFFER to readers. You are presented with a 200-page volume — "NEWNES' "EVERY CYCLIST'S HANDBOOK" at a Special Privilege Price. It contains everything that a cyclist could possibly wish to know — a practical book packed from cover to cover with hundreds of illustrations. It is cloth bound and will last indefinitely.

Additionally, Every Reader is Insured against Accidents!

have decided to adopt the German method, namely, collection of the moneys by the postman on his rounds.

Second High-power Station for Sweden

AN order has been given to the Telefunken works for the erection, near Malmo, of a 100-kilowatt transmitter, of the same model as at present operating at Berlin, Hamburg, Breslan, Langenberg, and Muehlacker. The station is not only destined to give a good service to South

Sweden, but also to provide entertainment for listeners in other parts of Europe.

Putting a Bulge in Bulgaria

WORK on the 100-kilowatt station has already been started on a site at Vakarel, some twenty-five miles from Sofia. It is also planned to install two relays, of which one will be built at Stara-Zagora, and the other at Varna or Bourgas, on the Black Sea coast.

Competition in Barcelona

ALTHOUGH, as a rule, the EAJI Union Radio station is mentioned, Barcelona possesses a 3-kilowatt transmitter working on 293.5 metres, and operated by the Catalan Radio Association. Its power is shortly to be increased by fifty per cent. The call sign is EAJ15.

Holland Will Also Televis

THE Philips experimental television transmitter at Eindhoven (Holland) which, for some time, has been testing on 7 metres, has been brought up to date, and is now carrying out further experiments on 350 lines high-definition.

Proposed Police Transmitter

AT a recent meeting of the Chief Constables of Sussex, a scheme was put forward to install a central station for the use of the entire county, which would maintain communication with all stations and wireless equipped cars. Although no site has yet been selected, it is expected that it would be erected in the immediate neighbourhood of Brighton.

Radio for Mount Everest Expedition

LT. W. R. SMIJTH-WINDHAM, of the Royal Corp of Signals, the wireless officer of the Expedition, will establish stations at various camps in order that intercommunication may be made possible. Weather reports, news bulletins, and instructions will be broadcast daily from the main base headquarters, some 18,000 feet above sea level.

New Interval Signals

HAMBURG, for the opening of its broadcasts, has now adopted a fan of trumpets, giving the reveille of the German Navy. Bremen, for its own transmissions, may be identified by a few bars of an old Frisian folk song.

ROUND the WORLD of WIRELESS (Contd.)

B.B.C. Symphony Concerts

THE Leningrad conductor, Nikolai Malko, will conduct Symphony No. 3 by Dmitri Shostakovich at the B.B.C. Symphony Concert on March 18th. This Symphony is known as "May Day," while No. 2 was "October." Shostakovich is thirty, lives in Leningrad, and is perhaps the best-known of the younger Russian composers. His music may be taken to be an expression of political faith; he has been called the "composer-laureate" of the Soviet State. He believes that "there can be no music without ideology," and is fond of quoting Lenin, who said that "music is a means of unifying broad masses of people."

Bransby Williams

BRANSBY WILLIAMS will again be heard by his many followers on February 27th in the Regional programme, when he will broadcast a selection from favourites with both his music-hall audiences and radio listeners, such as "Devil May Care," "Is Pipe," "The Caretaker" and other well-known sketches.

Brass Band Festival

IN accordance with usual practice Midland is relaying the concert by massed bands which closes the Leicester Brass Band Festival at the De Montfort Hall. This year the entries number about eighty; the festival is one of the best known in the country. All the proceeds go to Leicester Royal Infirmary, for which over £1,400 has been raised. It is hoped that this year's festival will realise £200. C. A. Anderson is the conductor of the concert to be relayed. This broadcast will be given in the Midland Regional programme on March 7th.

Variety from Doncaster

AN excerpt from the variety bill will be broadcast from the Grand Theatre, Doncaster, on March 4th. The bill includes John Baracchi and his Cuban Rhythm Band, Peel and Curtis (patter act), Walter Amner (comedian), and Leslie Childs (impressionist and mimic).

Blues Singer for B.B.C. Dance Orchestra

IF Henry Hall's prognostication is correct—and he is generally credited with sound judgment of the public taste—a new "star" will shortly illumine the world of dance music. She is Vivienne Brooks, contralto, still in her 'teens, blues singer, and a proficient pianist. But it is on account of her vocal ability that Henry Hall has given her a place in the enlarged B.B.C. Dance Orchestra as from March 16th next, and listeners are to have a foretaste of her talent on February 29th, when she takes part in Henry Hall's Hour.

A Circus Story

SOMETHING of the romance associated with the circus will be brought to the microphone in the Northern Ireland programme on March 3rd in a new kind of variety programme under the title "As a Matter of Fact." This is a circus story by Jack Loudan, and it will be presented partly in the form of a story told by the narrator, partly in dialogue, and partly by the introduction of real circus items introduced at various points in the narration. The production is by Wilkinson and

INTERESTING and TOPICAL PARAGRAPHS

the programme will be repeated on the Regional wavelength on March 5th.

Berlioz Concert

A SPECIAL Berlioz concert will be given on March 4th (National) at the Queen's Hall, when Sir Hamilton Harty

of a "baritone" voice, will grace the cast, and listeners will be pleased to welcome back Marjery Wyn, who has been wearing the principal boy's costume with great efficiency and beauty in Edinburgh. The remainder of the cast will be as before, including Hindle Edgar, Brian Lawrence, Claude Gardner, and Ronald Hill. This broadcast is interesting as it uses many scripts and numbers submitted by-listeners themselves.

PHILCO CAR RADIO IN A WELL-KNOWN FILM



An interesting shot from the United Artists film, "The Ghost Goes West," featuring Robert Donat with Jean Parker at the wheel of an Alvis Sports car, which is equipped with a dual-wave Philco car radio.

will conduct "La Grande Messe des Morts" and the "Symphonie Funèbre." Berlioz is still one of the most discussed composers. His ideas about music were grandiose and dramatic; he was a master of orchestral effects (his "Treatise" is one of the most famous books on the subject) and he was very fond of bizarre and unusual combinations of instruments. He dreamed of a vast orchestra with thirty pianos, hundreds of violins, and every possible kind of percussion instrument. In the "Grande Messe" he wrote important parts for an unusual number of kettle-drums. The "Messe" is rarely heard in this country, so that the news that it is to be broadcast will be welcomed by admirers of Berlioz, who was one of the most original and remarkable romantic figures of the nineteenth century.

Air-do-Wells

THE "Air-do-Wells," the popular radio concert party, give more performances on February 28th and 29th. Effie Atherton, the bright star of this party, will still be in Chicago, but her place is to be taken by the brilliant north-country comedienne, Marion Dawson, known to music-halls in the north for her "dame" performances. Marjorie Stedford, the clever Australian singer possessed

SOLVE THIS!

PROBLEM No. 180.

Tomkins decided to construct a simple three-valve receiver for the reception of the two local medium-wave stations and Droitwich. He had been told that reaction has a tendency to spoil quality so he decided to omit the reaction condenser. When the set was switched on, however, he was disappointed to find that quality, especially on the long-wave band, was worse than he had normally obtained from his old three-valve set. Why was this? Three books will be awarded for the first three correct solutions opened. Address your letters to the Editor, PRACTICAL AND AMATEUR WIRELESS, Geo. Nevnes, Ltd., 8-11, Southampton St., Strand, London, W.C.2. Envelopes must be marked Problem No. 180 in the bottom left-hand corner, and must be posted to reach this office not later than the first post Monday, March 2nd, 1936.

Solution to Problem No. 179.

The selectivity of anaperhet can be improved by loosening the coupling between the primary and secondary windings of the intermediate frequency transformers. This can be done by pushing the two windings farther apart.

The following three readers successfully solved Problem No. 178, and books are accordingly being forwarded to them: H. Trafford, 44, Chesson Rd., West Kensington, W.14; Bertram Southall, 28, Great Bridge Street, West Bromwich; C. Mellanby, Bungalow, Penpenmaeu, Pwllheli, N. Wales.

Making L.F. Amplifiers—1

WE are constantly receiving inquiries from readers who require constructional details of a low-frequency amplifier which can be used to operate a loud-speaker from a gramophone pick-up, or which is suitable for use in conjunction with a simple microphone. Complete details of simpler types of amplifier have not been published hitherto, and it will therefore be useful to a large number of readers to have full particulars of two or three suitable units. This article will be confined entirely to amplifiers a

Constructional Details of a Few Easily-made Amplifiers which can be Used with a Receiver, Pick-up, or Microphone. By FRANK PRESTON

It should be noticed that only one terminal is fitted to one of the terminal mounts, this being for an earth connection. When the amplifier is required to operate directly from

stage, or which gives an output which is insufficient for the satisfactory operation of a loud-speaker. On the other hand, if the output from the receiver is fairly good, the 220 P.T. valve should be used, because this gives less amplification, but is able to handle a larger input. It should be made quite clear, however, that the amplifier is not suitable for use after a set with a pentode output valve, or which already provides good speaker-strength reception. It could be used in the latter case only by replacing the pentode by a super-power valve such as the Cossor 230 X.P.

G.B. Voltage

The correct grid-bias voltage should, of course, be chosen according to the valve employed, and is -4.5 volts for the H.P.T., -7.5 volts for the P.T., or -15 volts for the X.P., assuming in every case the use of 120 volts high tension. The latter can be supplied by an H.T. battery, but an eliminator or super-capacity battery is very desirable when using the super-power valve.

Power Supply

In order to use the amplifier with a receiver, the two terminals marked Input should be connected in place of the 'phones or speaker, connecting the terminal marked A in Fig. 1 to that terminal which is joined to the anode of the last valve in the set. If a pick-up or microphone is to be used this component should be joined to the terminals marked P.U., when the other two terminals previously mentioned should be left disconnected. The terminal marked E should, for preference, be connected to an earth lead in every case when using a pick-up or microphone. The method of connecting the flexible leads is obvious, since they are attached to the battery terminals indicated.

When the amplifier is to be used with a receiver it will be desired to employ the

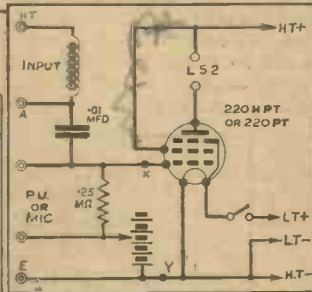
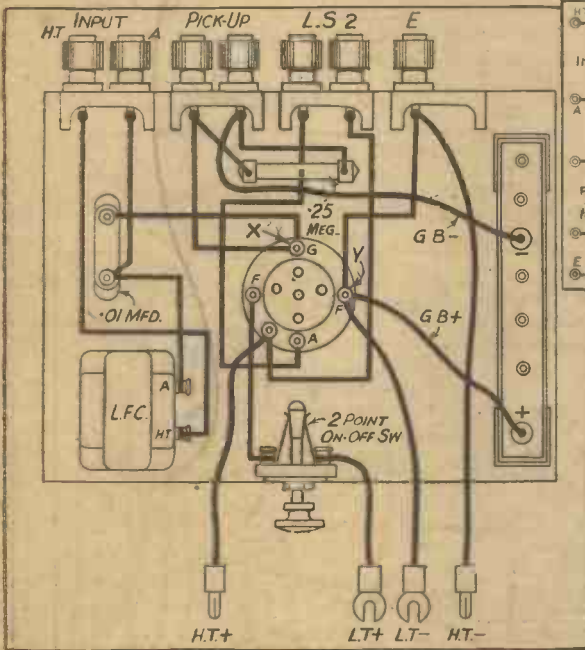

Fig. 1.—The simplest type of battery amplifier without volume control. Tone control can be obtained by connecting a .0003-mfd. pre-set condenser to the points marked x and y.

a pick-up or from a microphone—provided with its own input transformer and battery, of course—a 220 H.P.T. valve is to be preferred, because this has a high amplification factor and will permit of fairly good loud-speaker results. The same valve is also suitable when the unit is to be used after a receiver which is not fitted with an L.F.

simple nature, because more advanced designs have been described very fully in the past.

An Ultra-simple Arrangement

The simplest type of amplifier for what might be called "universal" use is that shown in Fig. 1. This is battery operated, employs a pentode valve, and can be fed equally well from a small battery receiver, pick-up, or microphone unit without alteration. It will be seen that there are very few components required, and that they are mounted on a small wooden baseboard. The parts used are: one baseboard measuring 6in. by 8in.; one W.B. 5-pin baseboard-mounting valve-holder; four Belling-Lee twin terminal mounts; seven terminals, two marked Input, two marked P.U., two marked L.S. and one marked Earth; one T.C.C. .01-mfd. fixed condenser (type 40), one .25-megohm Dubilier 1-watt grid leak; one Varley D.P.24 low-frequency choke; one pair Bulgin G.B. battery clips; one Bulgin push-pull on-off switch, one Peto-Scott component bracket, one Cossor pentode valve. 220 H.P.T., or 220 P.T. (see later note); flex and wander plugs.

Connections

The positions of the few components can clearly be seen in Fig. 1, and no difficulty should be experienced in mounting them and wiring up according to the illustration.

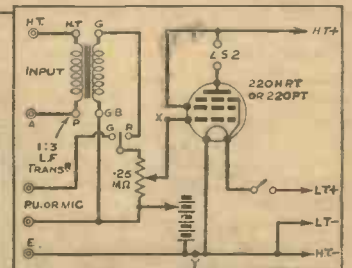
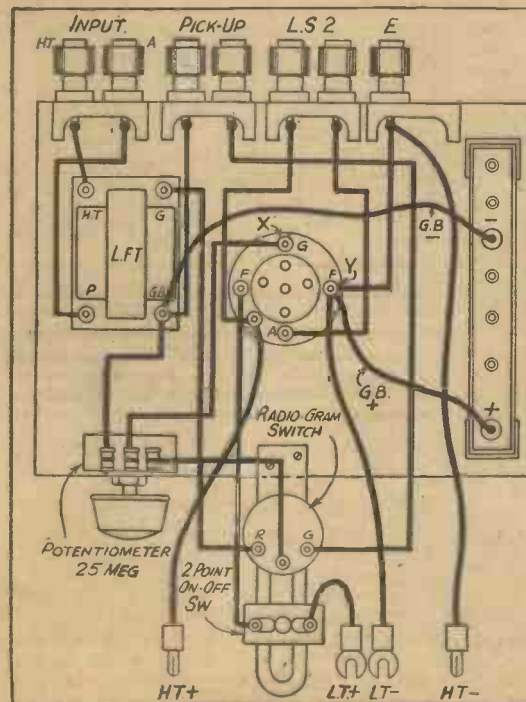

Fig. 2.—A simple pentode amplifier with radiogram switch and volume control. Tone control can be effected, if desired, by connecting a .0003 mfd. pre-set condenser between the points marked x and y.

same H.T. and L.T. supplies for both, and this can be done simply by connecting the flexible leads to the same batteries; in this case, however, the earth terminal should be left free, because an earth-return will be obtained automatically through the batteries.

(Continued overleaf)

(Continued from previous page)

Including a Volume Control

A rather more advanced type of amplifier of very similar type is shown in Fig. 2, but here the L.F. choke is replaced by a 1:3 or 1:5 low-frequency transformer, such as the Ferranti type A.F.3, which actually has a ratio of 1:3.5. Additionally, the grid leak and condenser are replaced by a Polar-N.S.F. .25-megohm potentiometer, which is mounted on a second component bracket. There is also a radiogram change-over switch—the Bulgín rotary snap switch is suitable—and this is mounted on the same bracket as the on-off switch.

This amplifier is particularly suitable for use after a short-wave receiver or other set not fitted with a power or pentode output valve, and when the maximum degree of amplification is required. The method of connecting the unit is as described for the previous arrangement, although it will often be found that greater amplification on pick-up and microphone can be obtained by connecting the appropriate component to the terminals marked Input, leaving the actual pick-up terminals disconnected. By doing this the step-up ratio of the transformer is utilised, so that greater volume is obtained. This idea is especially useful when the pick-up or microphone employed is not of a very sensitive pattern.

When using a pentode valve in either of the circuits described, it might be found that reproduction is somewhat high pitched. The tone can be "mellowed," and a fair degree of tone control obtained by connecting a .0003-mfd. pre-set condenser between the points marked X and Y. The tone may then be lowered by increasing the capacity of this condenser.

Increased Amplification

Neither of the amplifiers described above will give a very high degree of amplification combined with good quality, and if the amplifier is being built particularly for use with a gramophone pick-up or microphone, it will be better to use two valves in the arrangement shown in Fig. 3. This is a combination of the circuits of Fig. 1 and 2, with the addition of a second valve. The input circuit consists of an L.F. choke and .01-mfd. fixed condenser, and these feed into a Cossor 210 L.F. valve, which is, in turn, coupled to the output valve—Cossor 220 P.—through the Ferranti transformer, or a similar component of another make, used in the second circuit. Again the components are mounted on a flat wooden baseboard, but this time it measures approximately 10in. by 6in. The correct G.B. voltages for the two valves, for 120 volts high tension, are —3 volts for G.B.—1 and —6 volts for G.B.—2.

It should be noted in mounting the components that the transformer and choke are placed fairly well apart, and that they are mounted with their cores at right-angles in order to prevent the possibility of low-

frequency instability. The on-off switch is mounted on one component bracket, and the volume control is mounted on a second bracket of the same type.

Points to Watch

It is rare that any difficulty is experienced in building and operating amplifiers of the simple types dealt with, but there are a few points which should be borne in mind if good quality is to be obtained, and if low-frequency oscillation is to be entirely avoided. The main point is that a good high-tension battery must be employed, and it is equally important that the accumulator should be well able to supply the current required. The latter point scarcely arises if the amplifier is being operated alone, but if used in conjunction with a receiver, it should receive its full measure of attention. The reason is that if the accumulator used with the set were chosen so that its capacity was just sufficient for the original set, it would be unable to supply the additional current needed without a voltage drop and, possibly, without damaging the battery.

Should there be any doubt on this score it is well worth while to obtain a separate accumulator especially for the additional valves.

Another important point is that the pick-up or microphone leads should be properly screened, especially if they are more than a few feet in length, the screen being earth-connected. It is also important, in the case of a microphone, that this should be as far away from the loud-speaker as possible, or that it should be screened from it by means of a sheet of card or other non-resonant material. The reason for this is that if sound from the speaker should strike the diaphragm of the microphone a very unpleasant "ringing" or "booming" sound would be created, and there would be distortion.

No mention has been made of the loud-speaker to be used, but it is naturally important that this should be of suitable type. It is best to use one with a tapped transformer, so that it can be used equally well whether it is in the anode circuit of a pentode or triode valve.

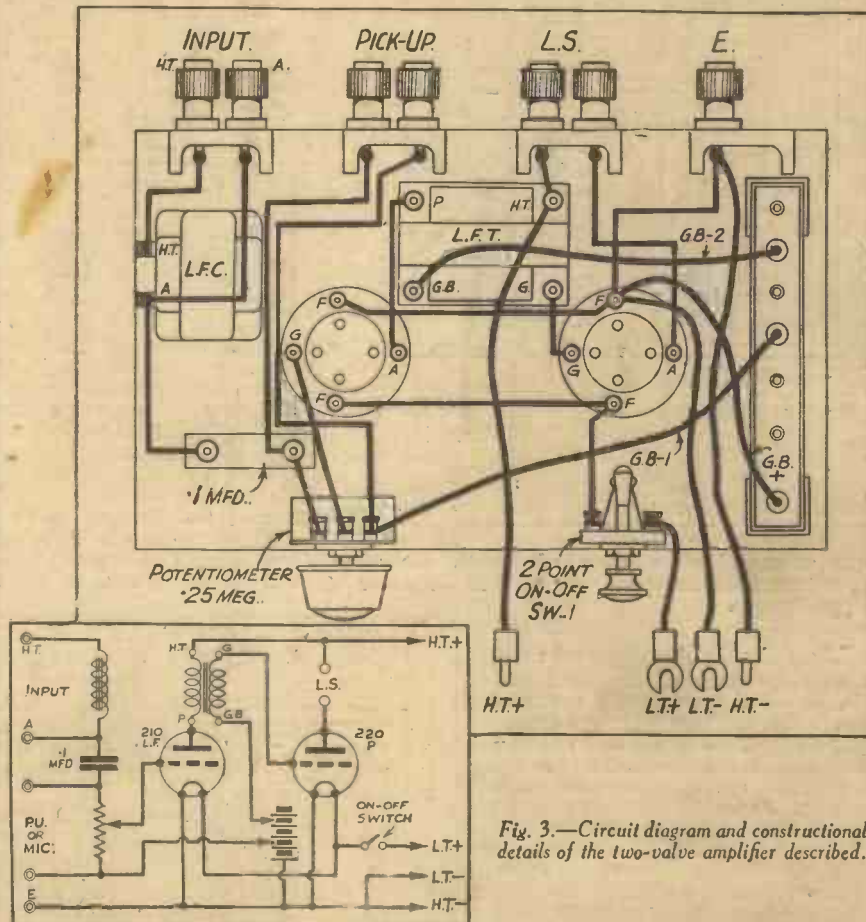

Fig. 3.—Circuit diagram and constructional details of the two-valve amplifier described.

"Measureless to Man"

"MEASURELESS TO MAN" is the title of a programme which will be given from Gough's Caves, Cheddar, on March 2nd. Excavations show that the caves have been occupied by man from the Paleolithic Age. In a fissure leading to the underground river a skeleton known as "The Cheddar Man," more than 10,000 years old, was discovered. "The Cheddar Man" must have found the temperature in his home always to his liking, for in winter the caves are warm and in the summer cool, the temperature varying about one degree. In the broadcast we shall hear of the history and recent

PROGRAMME NOTES

explorations and the Cheddar Carols will be sung.

A Swansea Night

SWANSEA is represented in the St. David's Week programmes by a "Swansea Night" on February 27th. This will consist of a series of Outside Broadcasts culminating in a choral and orchestral concert relayed from the Brangwyn Hall. The programme will begin with an introductory talk by the Mayor of

Swansea from the Brangwyn Hall, after which listeners will be switched over to the Gorse Mission Hall, Cwmbwrla, to hear the Swansea Police Band. This will be followed by a Welsh programme from Landore given by the Swansea and District Royal Male Choir; followed by the Pentrepoth School Choir, from the Gorse Mission Hall; and finally, to complete the circle, listeners will hear the second part of "Elijah" sung by the Swansea Orpheus Choral Society, with Isobel Baillie (soprano), Margaret Tann Williams (contralto), Henry Wendon (tenor), and William Parsons (bass-baritone), relayed from the Brangwyn Hall.

Modernising the Speaker Opening

In this Article the Author Explains an Effective Method of Excluding Dust from the Speaker Fret, and for Improving the Appearance of a Radio Cabinet

IN the design of speaker frets, as incorporated in the cabinet work of modern wireless receivers, the tendency has been, almost without exception, to discard anything that could be described as ornate. While it may be argued that an open fret, backed with fabric or gauze, forms an inexpensive method of covering the loud-speaker opening it must also be remembered that it forms in many cases the means of ingress of fully 50 per cent. of the dust which accumulates in the interior of the set. While this objection is perhaps not serious, as witness the number of sets that are so fitted, it was chiefly for this reason that the writer endeavoured to find a method whereby the speaker opening could be closed when the set was not working. This, of course, as a problem presents no difficulties, as a door or pair of doors would serve the purpose, but such fittings do not lend themselves to modern treatment in this particular instance, and further their opening would entail the operation of what in effect would be another control. The arrangement illustrated serves the purpose without the objections mentioned. While it is recognised that one or other of the particular methods of operation mentioned may be unsuitable in some cases, various suggestions are made upon which modifications may be based.

Briefly, the idea is as follows. In the first place, the speaker opening in the cabinet needs to be either square or rectangular in shape, and this opening is fitted with hinged shutters, or flaps, which are linked together in such a manner that they open and close in unison. The operation of the shutters is controlled by a rod which is actuated by a lever, and one end of this lever rides on a cam operated by the "on-off" switch spindle, being so arranged that the shutters are made to open when the switch is set to the "on" position. An idea of the finished appearance of a set so treated may be gathered by referring to Fig. 1, which shows the metal shutters in the closed position.

It is not necessary to make the shutters of metal as they will be equally satisfactory if made in wood, although, of course, certain metal fittings will also be required.

Alterations to Convert an Existing Set

Where a new set is being built it is easy to bear in mind the special requirements entailed by fitting the shutters, but where it is intended to convert an existing set, certain modifications will be necessary. These include the cutting away of the existing fret, and reshaping the opening on square lines. Where the present shape makes such an alteration necessary, the job should be neatly carried out in such a manner that the sides of the opening are square with each other. It may also be that the baffle board will require setting back from the inside front face of the cabinet so as to provide working clearance for the shutter operating rod. This can be done by

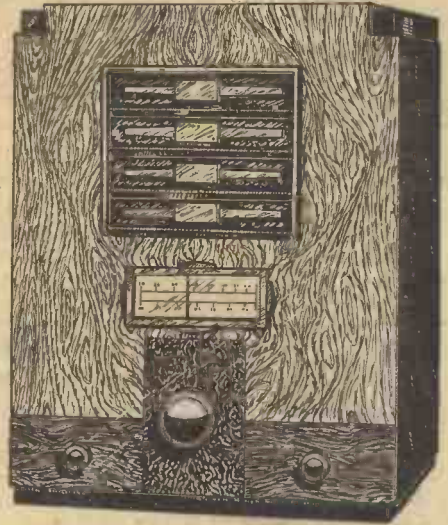

Fig. 1.—Front view of a cabinet fitted with a shuttered speaker opening.

and if it is decided to make them of metal the finishing treatment will have a bearing on the material used. Aluminium lends itself to easy working, and can be polished, but in this condition it will not match any plated metal work. Where a plated finish is desired brass should be used. A completed shutter is shown in Fig. 2, and it will be noticed that the centre is embossed with a simple design. This will provide a little relief and also act as a stiffener. While at first sight this may appear a difficult job, in reality it is not so, providing that a wooden former is made, as shown in section in Fig. 3. One piece of plywood of a suitable thickness is cut out to the shape of the design, and extends to the top edge of the rebate on which the cork strip is cemented. The piece that is cut out of the centre of the plywood is reduced by an equal amount all round to provide clearance for the metal. These pieces of plywood are securely pinned in correct register on to the faces of two pieces of smooth stout board, and a narrow strip is similarly fixed along the front edge of the board holding the smaller piece of plywood.

In effect this arrangement makes a forming die, and it should be pointed out that clearances between the edges of the plywood on the scale shown should be maintained in order to avoid excessive drawing of the metal. The completed board should, when finished, be equal in width to that of the shutter, while in length, they should be slightly less than the opening in the cabinet, minus two thicknesses of metal. As the ends and sides of the wood will be made to serve a definite purpose care must be taken to finish them square and parallel. Do not select metal that is of too heavy a gauge. No. 22 S.W.G. is suitable if brass is used, although the gauge may be increased slightly for aluminium. Both should be of a soft quality or be rendered soft by annealing before working up.

Cut the metal about half an inch wider than the finished shutter to allow plenty for the reduction which will occur after forming, and also to allow for turning up the ends. After the metal is cut, lay it one piece at a time between the halves of the wooden die and squeeze the whole evenly together in a vice. A woodworker's vice will probably be best for the purpose, but a uniform distribution of pressure will be obtained from a small engineer's pattern vice if the boards of the die are backed up with thicker pieces of wood. After having

(Continued overleaf)

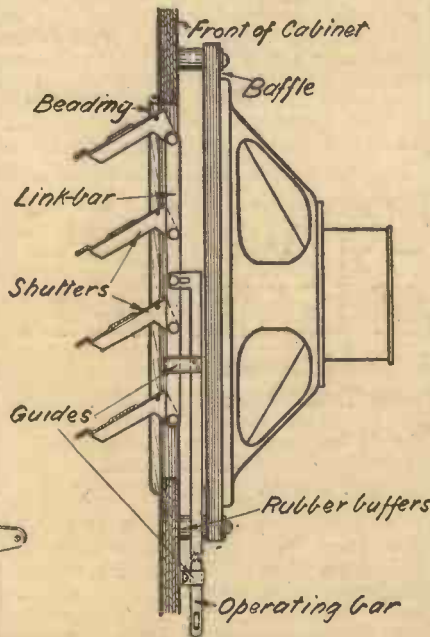

Fig. 5.—Section through a speaker opening showing the operating mechanism for the shutters.

mounting the board on rubber pads, or by framing the edge of it to give the desired clearance. The remaining point is that the switch spindle may require extending to afford the means of mounting the operating cam on it.

Making the Parts

The first question to consider is the shutters,

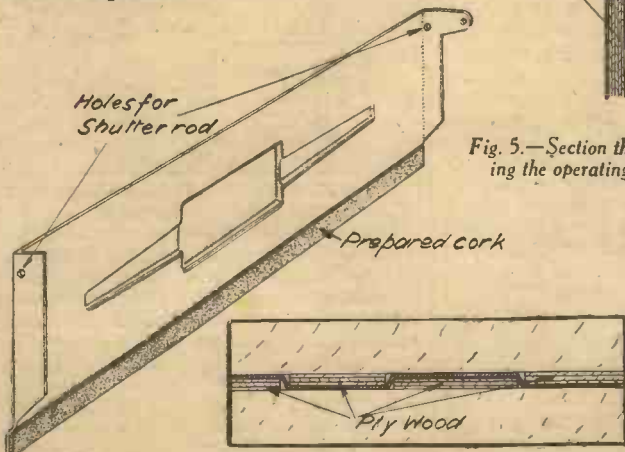

Fig. 2 (left).—A completed shutter. Fig. 3 (right).—Section of a wooden former for shaping the embossed shutters.

(Continued from previous page)

formed the metal, finish up the sides flush with the edges of the die and notch away the corners adjacent to the rebate so that the ends may be bent down, and afterwards finished as shown. Keep the lugs to which the link bar is attached as short as possible.

Attaching the Shutters

Mark out the holes for the hinge-rod so that they are accurately in line in relationship to the top, and uniform on

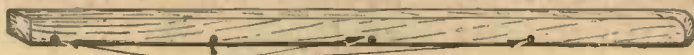

Holes for Rods drilled near edge.

Fig. 4.—A side strip of the speaker opening.

all shutters. Drill them so that the rod will lay close to the inside of the bend, and position the holes in the lugs so that they are identical. Hardwood strips mitred at the corners with which to frame the top and sides of the speaker opening can next be prepared, a side strip being shown in Fig. 4. These strips are attached to the cabinet with screws inserted from the inside. After having fixed them temporarily, mark the side strips off for the hinge pins, and remove and drill holes half way through of a suitable diameter. These pins consist of pieces of 3/32in. or 1/16in. diameter brass rod extending right across the opening, and into the holes on either side. In arranging the position of the shutters the lower or corked edge of the top one should overlap the top edge of the one immediately below.

The link bar is made from stiff brass strip about 1/4in. wide and 1/16in. or 3/32ins. thick. Pitch the holes to match up with those in the lugs when the shutters are in the closed position. Rivets passing through each lug are burred over, but not too tightly to cause binding, when the bar is in position. Make the operating bar of similar material; the slotted end at

right angles to the bar may consist of a separate piece riveted on. The length of this slot is such that the pin in the link bar on which it operates can travel backwards as the shutters close without fouling the end. A guide fitted to the operating bar embraces the link bar to prevent any tendency of the pin to bind in the slot. The bottom of this guide, which is U-shaped, butts against the link bar when the shutters are in the open position, as in Fig. 5. At the lower end the link bar is guided in a

narrow U-shaped saddle screwed to the cabinet. The length of the operating bar will depend upon the position of the switch. One point not made clear in the illustration is that the bar is maintained in an upward direction by means of a light tension spring.

Operating Mechanism

This means that before the operating lever is attached the shutters will take up a closed position. At this stage the assembly must work freely when the lower end of the operating rod is pulled. As will be seen from a glance at Fig. 6 the operating mechanism is of a simple character. A bossed cam-plate of the shape shown attached to the switch spindle, operates a lever, having a follower end, and of a suitable length to pick up the slot in the lower end of the operating bar, which is pivoted from a bracket attached to the cabinet.

It will be understood that no definite dimensions can be given as the distance from the centre of the switch to the operating rod is the decisive factor, but if the cam is given a rise of a 1/16in. it is not a difficult matter to arrange the fulcrum of the lever

in such a position as to cause the end of the lever engaging with the slot to move the distance required to operate the shutters when the follower end is raised by the cam. When arranged as shown, the operating assembly is with the switch set in the "Off" position. Thus it is apparent that by turning the switch spindle in the direction of the arrow the operating rod will be pulled downward causing the shutters to open. As mentioned earlier some types of rotary switches, or at least those operated by a rotary or semi-rotary motion, may necessitate an extension spindle before the cam can be fixed. It is suggested that the best method of effecting this alteration would be to mount the switch on a bracket farther back on the chassis, and to fit the cam in front

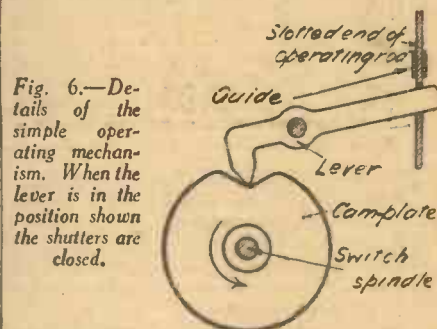

Fig. 6.—Details of the simple operating mechanism. When the lever is in the position shown the shutters are closed.

of it, using a double-bossed cam plate to form the connector between the original spindle and the extension.

Where the shutter parts are made from wood a small brass bracket will form the eye for the rod on one end, and a longer one at the opposite end can be made to serve the same purpose and also form the lug. The bottom of one shutter will be made to clear the top of the next one, and a bead fitted to the lower edge of each can be utilised to form a false rebate.

AN INTRODUCTION TO AMATEUR TRANSMISSION

A Short Article of Special Interest to Prospective Amateur Transmitters

The Artificial Aerial Licence

BEFORE applying for a radiating licence it is usual for the amateur to first apply for an Artificial Aerial Licence. This licence permits experiments with transmitters using a non-radiating aerial.

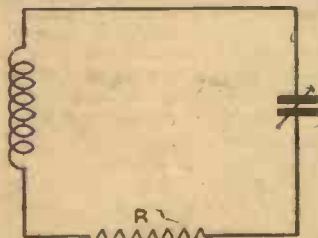

Fig. 1.—A simple artificial aerial.

Considerable insight into transmitter design and operation can be gained, and at the same time the amateur is more likely to be able to get a full licence later on. Serious experimenters will have no difficulty in obtaining the licence if they carefully study the following notes. Applications

should be made to the Engineer-in-Chief, Radio Section, G.P.O., London.

Artificial Aerials

An artificial aerial consists of a closed circuit containing inductance, capacity, and resistance. It is adjusted to impose a load similar to that of an outdoor aerial, at the same time absorbing the high-frequency currents, so that there is no appreciable radiation.

A diagram of a simple artificial aerial is given in Fig. 1. The condenser may be .0005 mfd., the coil five turns, for both 7 megacycle (40 metre) and 14mc. (20 metre) bands, and about twenty turns for the 1.7 mc. (160 metre) band. R is a non-inductive resistance of about 20 ohms. The function of the resistance is to convert the H.F. energy into heat.

The coil is tightly coupled to the anode coil of the transmitter. At this stage signals may be conveniently monitored on the receiver. A bulb or high-frequency ammeter (hot wire, or thermo-coupled types) may be used instead of R to give a visual indication of the H.F. current present.

Valves

It is suggested that in the initial experiments battery valves should be used. The receiver and transmitter may then be isolated, and interaction effects will not occur.

For self-excited transmitters valves of the LP2 or P2 types are suitable. For crystal controlled transmitters, pentodes are more suitable and a Pen. 220A has been used with some success. With 120 volts on the anode a power of 2 watts is obtained which is quite sufficient for these experiments.

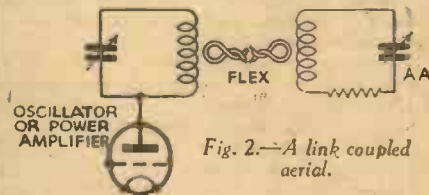

Fig. 2.—A link coupled aerial.

It must be emphasised that an artificial aerial must always be used, and the terms of the licence strictly adhered to.

It may be found convenient sometimes, especially when experimenting with telephony, to have the artificial aerial and monitoring equipment in the next room. This may be done with a link coupled aerial, as shown in Fig. 2.

Coil Connections

A one-turn coil is tightly coupled to the transmitter plate coil, and connected by flex to another single turn coil tightly coupled to the artificial aerial, and provided

(Continued on page 778)



FOR THE EXPERIMENTER

SERVICING SETS FOR PROFIT

8.—The Construction of a "Beat Frequency" Variable L.F. Oscillator for Testing Amplifiers and Loud-speakers

now we wish to alter the pitch of this note and increase its frequency to 2,000 cycles, we must merely re-tune one of our "carrier-waves" so that the difference between the two is 2,000 cycles.

Hartley Oscillators

In the instrument described in this article the two "carrier-waves" are produced by two Hartley oscillators, one with its frequency fixed at approximately 300 kc/s, and the other variable between 300 kc/s and 310 kc/s, thus giving us an audible range of frequencies between 0 and 10,000 cycles which will cover the band of audio-frequencies usually considered adequate for good reproduction.

Reference to the circuit diagram (Fig. 1) will show that the Hartley oscillators are constructed from centre-tapped plug-in coils tuned in one case by fixed condensers of .001 mfd. and .0005 mfd. connected in parallel, and in the other by a pre-set condenser of .002 mfd. maximum capacity

with a variable condenser of .0001 mfd. in parallel. The output from the anodes of the two oscillators is taken via air-spaced trimming condensers of 7m/mfd. maximum capacity to the grid circuit of a detector valve in whose anode circuit the audio-frequency note appears. This audio-frequency component is developed across an L.F. choke and fed through a 2 mfd. by-pass condenser to a 25,000-ohm potentiometer, which acts as a volume control and enables us to adjust the audio-frequency output to the voltage required.

The values of the components have been so selected that the range of 0-10,000 cycles is covered by rotation of the .0001 mfd. variable condenser, and any deviation from the specified coils will result in failure to obtain the full range of the instrument. The coils chosen are Gambrell "Efficiency" Inductances, Range B, and they may be obtained from Messrs. Gambrell Bros. and Co., Ltd., of Merton Road, Southfields, S.W.18, together with suitable base-board mounting holders with an extra fitment to make connection with the centre tap terminal which is on the side of the coil (see Fig. 2). A further reason for the choice of these coils is that their construction renders them reasonably free from inductance variation owing to temperature rise and fall, and this helps to prevent the oscillators from wandering from their pre-selected frequency.

The three "Hivac" L210 valves are also considered to be most satisfactory for the purpose, but good results can be obtained with other medium-impedance triode valves.

(Continued overleaf)

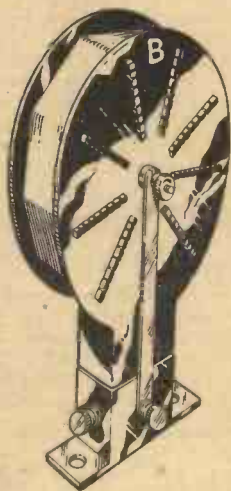

Fig. 2.—The Gambrell type B coil and holder.

In this article particulars are given of an instrument which will fulfil the needs of both the service-man and the amateur when investigating problems connected with L.F. amplifiers; the apparatus is quite simple if the principles governing its working are understood.

All my readers have, no doubt, heard the weird whistles and groans which can be produced by an oscillating detector valve when tuned to a carrier-wave, and will remember that as a carrier-wave is tuned in the pitch of the note varies from a high-pitched squeak to a deep bass note, vanishing at "silent point" and then rises again, finally to vanish as a high-pitched squeak again. This heterodyne note as it is called would, therefore, appear to cover all the audio frequencies, and should be ideal for loud-speaker testing, as we can pick out whatever note we like from the whole musical scale and play it on our loud-speaker for as long as we like while we make adjustments.

However, if all the readers of PRACTICAL AND AMATEUR WIRELESS were to attempt to test their loud-speakers and L.F. amplifiers by heterodyning their local station with an oscillating detector valve the Postmaster-General would soon become annoyed, even had the neighbours not taken the law into their own hands before then.

Using a Fixed "Carrier Wave"

What we must do is to provide our own fixed "carrier-wave" and mix it with a "carrier-wave" whose frequency can be varied to produce the heterodyne note we require in a way which will not interfere with our neighbours. Those readers who have constructed superheterodyne receivers will know that when we mix in the grid circuit of a detector valve the output from two valves oscillating at radio frequencies we produce a third frequency, i.e., the intermediate frequency which is equal to the difference between the two separate frequencies. For instance, a 200 kc/s carrier-wave mixed with a 310 kc/s carrier-wave and then rectified will produce a frequency of 110 kc/s, which is known as the intermediate frequency, or I.F.

Now suppose we make our two "carrier waves" oscillate on frequencies comparatively close together, say, for instance, 300 kc/s and 301 kc/s, we shall produce a frequency of 1 kc/s, or 1,000 cycles which will, after rectification, be audible in a pair of headphones or loud-speaker. Suppose

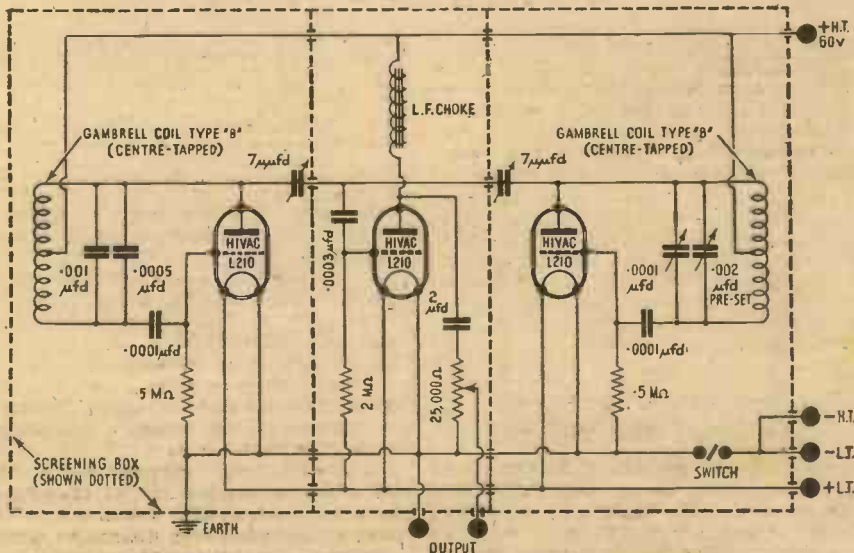

Fig. 1.—Theoretical diagram of the L.F. oscillator.

FOR THE EXPERIMENTER

(Continued from previous page)

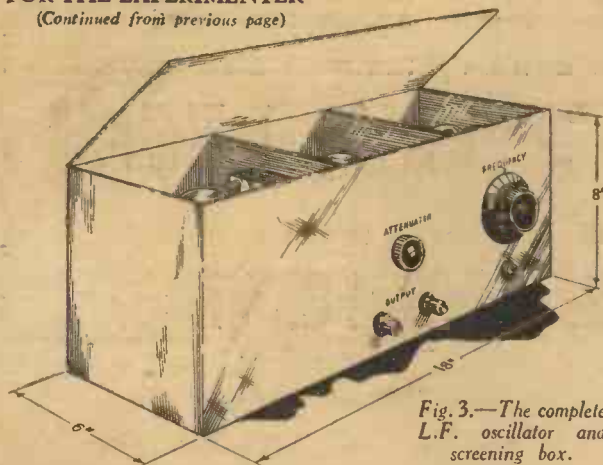

Fig. 3.—The complete L.F. oscillator and screening box.

though the voltage output from the instrument will be affected by the valve chosen as detector.

Screening Box

The three-compartment screening box is not a standard component, and must be made in accordance with the dimensions shown in Fig. 3. The construction of such a box may not be outside the capabilities of some of my readers, but in the event of any difficulty being experienced, many of the advertisers in this journal will, no doubt,

LIST OF PARTS REQUIRED FOR THE L.F. OSCILLATOR.

- Two "Efficiency" inductances, Range B. Messrs. Gambrell Bros. and Co., Ltd.
- One .0001 mfd. variable condenser, with slow-motion drive. The Premier Supply Stores.
- One .002 mfd. (maximum) "Formodensor" pre-set condenser. Graham-Farish, Ltd.
- Two 7 mmfd. air-dielectric pre-set condensers. Bulgin. Type S.W.53.
- One .001 mfd. fixed condenser
- One .0005 mfd. " " " " } T.C.C., Dublin, etc.
- Two .0001 mfd. " " " " }
- One .0003 mfd. " " " " }
- One 2 mfd. " " " " }
- Two .5 megohm fixed resistances } Bulgin Miniature Half-watt Wire-ended.
- One 2 megohm " " " " }
- One 25,000 ohms output control. Bulgin, Type V.C.46.
- One L.F. choke, 40 henries. The Premier Supply Stores.
- One toggle "on-off" switch. Bulgin, Type S.80.T.
- One three-compartment screening box. See text.
- Three 4-pin baseboard mounting valve-holders. Bulgin, Type V.H.19.
- Wire, baseboards, systoflex, etc.
- Three "Hivac" valves, Type L210. The High Vacuum Valve Co., Ltd.

be pleased to quote for the construction of a suitable container, or alternatively, I shall be pleased to supply the name of the manufacturer who constructed the original model. The provision of a screening box exactly as shown is an essential in order to prevent interaction between the two radio-frequency oscillators, which would otherwise prevent extremely low frequencies from being produced owing to the tendency for the two oscillators to pull into step when tuned to nearly the same frequency.

There are two other points to be watched when constructing the apparatus,

viz:—the necessity for insulating the components which are brought out through the screening box. Suitable insulating bushes should be procured for the spindles of the .0001 mfd. variable condenser, the output volume control, and the output terminal which is connected to the slider of the volume control. Actually, in the original model, both output terminals have insulating bushes, but this is purely for the sake of uniformity of appearance. It will be seen that none of the aforementioned points are at earth potential and, in the case of the .0001 mfd. variable condenser, failure to insulate the spindle will short-circuit the H.T. battery.

Checking Connections

Reference to the drawings, and particularly to the wiring diagram in Fig. 4, should enable the constructional work to be completed, and then the connections should

be carefully checked over with the aid of the resistance meter previously described, to ensure that everything is in order before connecting the batteries. Emphasis is laid on this point because the oscillator valves are self-biased by their grid leaks, and failure of these valves to commence oscillating when switched on may cause damage to their filaments. It is also worth while to make certain that the insulating bushes previously mentioned are really efficient, and this can be done by placing the filament switch in the "on" position and joining the terminals of the resistance meter firstly between the H.T. positive lead and the screening box, and then between the junction of the 2-mfd. output condenser and the 25,000-ohm volume control and the screening box. In the first instance there should be no deflection at all, and in the second the meter should read 25,000 ohms if the bushes are satisfactory. Before the second test is made the volume control should be rotated to the maximum position, or fully in a clockwise direction.

If everything is found to be in order the valves may be inserted, the batteries connected, and we are ready to commence the setting and calibration of the instrument. This, together with several useful applications of the instrument, will form the subject of the next article in this series.

Ideal for the Beginner
F. J. CAMM'S
EVERYMAN'S WIRELESS BOOK
2nd Edition.
288 Pages and over 200 Illustrations. Now 3/6, or 3/10 by post, from George Newnes, Ltd., 8-11, Southampton Street, Strand, W.C.2.

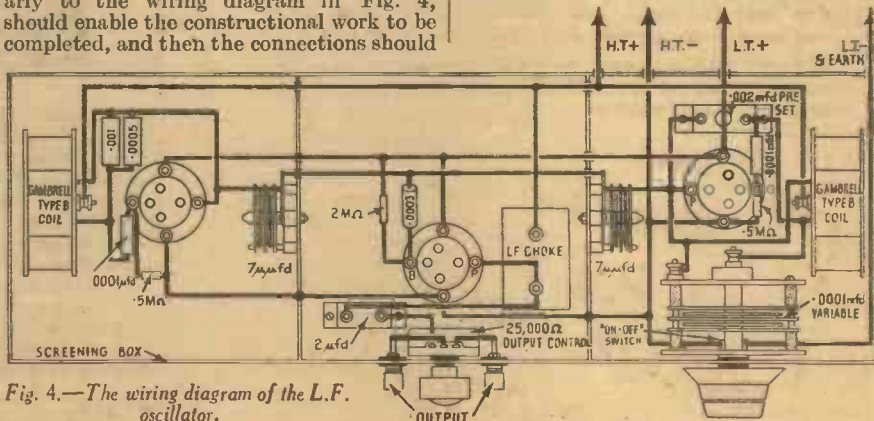

Fig. 4.—The wiring diagram of the L.F. oscillator.

The "Queen Mary" Radio Station

OF all the liners plying between the Old and the New Worlds, the "Queen Mary" will boast of the most complete equipment. In all she will possess eleven aerials, and for her sole use will dispose of thirty-two wavelengths. Of these nine will be used for radiating telephony transmissions. We may look forward to her first trip across the Atlantic in May next, when short-wave listeners in all Continents will no doubt do their best to pick up her signals.

"Music into Play"

SONGS or incidental music appearing in radio plays have been used by Cyril Wood as the basis of a new series of programmes entitled "Music Into Play." On looking through the plays that have been broadcast from the West Region during the last few years Mr. Wood has been astonished to find how much music has been used, and he has conceived the

HERE and THERE

idea of starting a new series of extracts from the plays, consisting not only of the best of the music, but also of the scenes for which the music was written. The series will, therefore, fill a dual purpose.

Light Entertainment

ON February 26th, in the Midland Regional programme, Owen Reed is producing a short sketch entitled "Quits," by Olive M. Popplewell, of Malvern, author of a number of plays, including "The Pacifist," which was recently broadcast. "Quits" is a duologue between a famous middle-aged actress and one of her pupils. The parts are taken by Irene Malin, of Leicester, who has broadcast dramatic recitals, and Helen Hayes, who

spent some years in Egypt and while there broadcast from Cairo. Preceding the sketch there is a light entertainment to which the contributors are Brenda Hart, a Birmingham crooner; Ralph Birch, a Derby pianist; and Heeley and Matthews, a Midland duo who specialise in Old English songs.

£10 Tithe of £100 Prize

A CORNISH woman who recently won a £100 prize in a competition run by the Radio Co-operative Advertising Committee has announced her intention of sending a tenth of the amount as a thank-offering to the British "Wireless for the Blind" Fund.

"Western Cabaret"

"WESTERN CABARET" No. 4 will come from the Walton Park Hotel, Clevedon, on March 7th, when listeners will hear Reginald Williams' Futurist Band.

**GET
IT
TO-DAY!**



THE Cyclist

THE SPLENDID NEW CYCLING WEEKLY **2^d**

THE millions of cyclists on our roads have long awaited a paper such as "THE CYCLIST," just out. A complete journal for all wheelmen—and edited by cyclists for cyclists!

It keeps you fully informed on everything that is new in cycling. Its experts will examine, test and describe new machines, fitments and inventions. It contains up-to-the-minute sports features, authoritative club reports and practical articles generously illustrated with special diagrams and photographs.

It is the cyclist's very own paper—as you will see to your great satisfaction when you get your copy. A wonderful twopennyworth!

**Great
FREE
INSURANCE
£3 A WEEK
DISABLEMENT**

**and £50 FATAL
ACCIDENT BENEFIT**

THE MOST GENEROUS FREE INSURANCE
EVER OFFERED TO CYCLISTS!

**PRESENTED
TO YOU!**

NEWNES' EVERY CYCLIST'S HANDBOOK
At Special Privilege Price

GET "THE CYCLIST" NOW! *Of all Newsagents and Bookstalls 2d.*

George Newnes, Ltd.

POLAR

and

N.S.F.

Specified for
**F. J. CAMM'S
MONITOR**

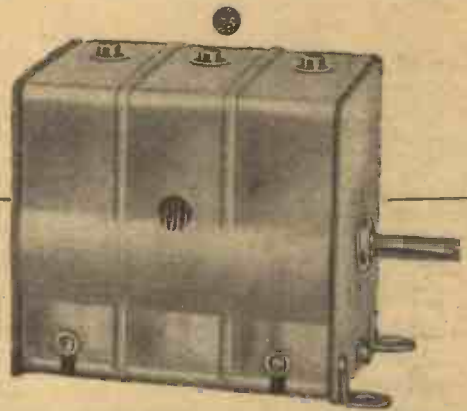

POLAR 'MIDGET' GANG CONDENSERS

Steel frame Ball-bearing shaft. Sections matched within 1/4 per cent. or 1 mmfd., whichever is the greater. Trimmers operated from top.	2 Gang.....	11/-
	3 Gang.....	16/6
	3 Gang Superhet (465 kc.)	16/6
	also made in	
	4 Gang.....	22/-
	4 Gang Superhet.....	22/-

* When ordering your condenser for this circuit 465 kc., I.F. must be mentioned.



POLAR N.S.F. VOLUME CONTROLS

Special carbon element. Silent in operation. Insulated spindle. Types for every circuit.

50,000 ohms (without Switch) - 4/-

The complete range includes—

5,000 and 10,000 ohms for H.F. Circuits.	10,000 ohms. Straight law.	Without Switch	With Switch
50,000, 100,000 ohms, 1/2, 1 and 2 megohms for L.F. Circuits.		4/-	5/-

Send for fully illustrated Polar catalogue of Polar and N.S.F. Components.

WINGROVE & ROGERS, LTD.,
188/189, STRAND, LONDON, W.C.2.
Phone: Temple Bar 2244.
Works: Old Swan, Liverpool.

A Versatile Instrument

ALTHOUGH the famous Ohm's Law has been repeatedly described and is now known by every radio experimenter, and probably nearly every listener, it is not realised by many how the knowledge of this formula will very often save not only a lot of worry and doubt, but even expense. The relationship between volts, resistance, and current enables certain factors to be ascertained with very little difficulty, and we have shown in various articles how the value of a resistance may be ascertained by joining it across a voltage supply and by similar methods have described how to test other small components. There is, however, another very important application of this small formula which will be of great assistance to users of small mains units especially, and also to other readers who are desirous of finding out how certain parts of a receiver are functioning.

The Effect of Load

The majority of mains units are rated to

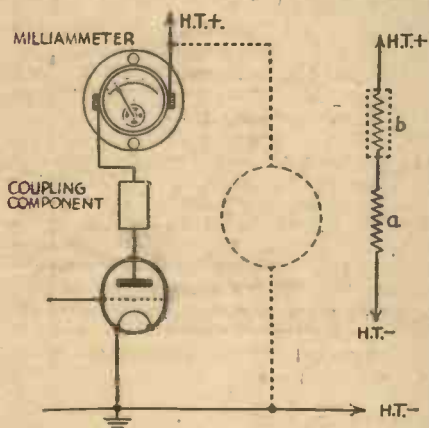

Fig. 1.—A meter connected as shown by the dotted lines would generally give a false reading. The circuit may, however, be considered as shown on the right, and a milliammeter may be used to ascertain the voltage; "a" is the valve resistance.

deliver a certain voltage at a certain current. That is to say, a unit might be stated to deliver 150 volts at 25 milliamps. This particular unit need not, however, be restricted to this current if for any reason a larger drain is required. Owing to the relationship between current and voltage, however, if any larger current drain is imposed the voltage output will be lower than 150 volts. Similarly, if the unit is employed with a small receiver in which the total anode current requirements are only of the order of, say, 10 milliamps., the voltage will be in excess of 150. The actual difference between the voltage at different currents depends upon what is known as the regulation of the unit, and in some modern types of instrument, especially those designed for use with Q.P.P. or Class B valves, this regulation is extremely good and very little difference in voltage exists over very wide limits of current. On cheap and old pattern instruments, however, the difference may be very great. Suppose a listener has such a unit joined to a receiver which is just fully loading the unit and he desires to ascertain whether the voltage applied to his valves is correct. Obviously he would join a voltmeter across the points where the measurement was required.

Although Measuring Instruments are Generally Expensive Items, practically all Testing may be carried out with the aid of a Milliammeter and a knowledge of Ohm's Law as Explained Here
By W. J. DELANEY

From what we have just seen, however, any excess load will vary the voltage, and if a cheap voltmeter having a very low resistance is used for the measurement, a very considerable error will exist in the reading.

The Detector Stage

It is very often desired to measure the voltage applied to the detector valve, and as this is generally only a matter of a few milliamps., the effect of connecting a low resistance across it will be to give a very serious error indeed. How, then, can we find the actual voltage delivered by a small mains unit, or applied to a detector valve, or take similar readings if we cannot afford to purchase a good high-resistance voltmeter? If we obtain a good milliammeter we can, by ascertaining the current which is flowing, obtain a fair idea of the output. A good milliammeter may be obtained much more cheaply than a good voltmeter, and by obtaining a meter having a full scale deflection of, say, 2 milliamps. it will be possible to utilise shunt resistances (as has already been explained in these pages) to obtain higher readings. A meter of this description could, for instance, be joined in the negative H.T. lead, with a suitable shunt to enable it to read somewhere about the total current which is used, when, from the above reasoning, we may obtain a very fair idea of the voltage output. If, for instance, it is found that the total current is only 10 milliamps., and the unit is rated at 150 volts, with 25 milliamps, it would be worth while to add a further resistance across the output terminals of the mains unit in order to bring up the total current drain to 25 milliamps. and thus give you a fair assurance of obtaining the correct 150 volts. Similarly, by including the milliammeter in the anode circuit of the detector valve and noting the current passing, it is possible from a study of the valve-maker's characteristics

to ascertain within close limits the H.T. applied to the valve. In the output stage the combination of grid bias applied and anode current passing, will also enable you to ascertain the voltage. Correct grid bias, with a low anode current, will indicate low H.T. voltage, and vice versa.

Checking Circuits

The same simple instrument may also be employed for the purpose of checking the efficiency of tuning circuits or of adjusting ganged circuits, simply by including it in the anode circuit and adjusting for the maximum deflection. That is to say, if a tuned circuit is being tested against another

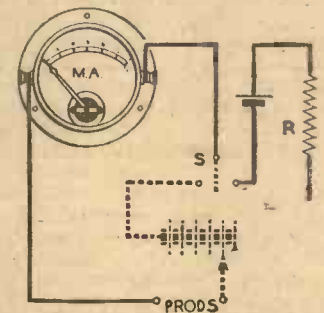

Fig. 3.—This diagram shows how the meter may be used with a high voltage for testing components, etc.

known one, the local station would be tuned in and the total current reading in the anode circuit of the detector valve noted. The new coil would be then included and tuned to the local, and the current reading compared with that obtained with the previous circuit. Similarly, for adjusting ganged circuits, each section could be connected in turn and the appropriate readings noted.

By remembering the relationship between the three different sources previously mentioned, it is also possible to ascertain values which in the ordinary way would perhaps be unreadable. For instance, if the meter be employed with a voltage in series and the circuit under examination be isolated and connected so that the resistance may be ascertained, upon re-connecting the circuit and including the meter in series in order to ascertain the normal current flowing, the voltage applied could easily be worked out.

There are many other uses to which the milliammeter can be put, and it should thus be the first item which the experimenter obtains.

WIRELESS ON MOUNT EVEREST

WE think our readers will be interested to learn that Messrs. Stratton and Co., of Birmingham, have been favoured with an order for the wireless equipment to be used on the forthcoming Mount Everest Expedition led by Mr. Hugh Rutledge. It consists of two short-wave C.W. transmitters with the necessary receiving equipment to maintain contact between the base camp and the outside world. There are also six Eddystone 5-metre transceivers for inter-communication between the advance parties, and it is worth noting that this is the first occasion on which radio is to be used for communication between the various camps.

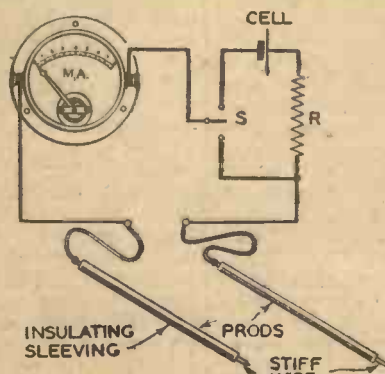

Fig. 2.—How a milliammeter may be used for test purposes over a wide range.

On Your Wavelength

The Radio Ear

FROM that wonderful country whence comes the "tall" story and the rumours of marvellous developments which are going to revolutionise the world's standard of living, I have now received details of a still more ingenious invention—one which I am sure will end for all time more domestic strife, and if, after this invention comes into use the Divorce Courts do not close down—then I'm a Dutchman. Listen to the following description of this epoch-making discovery. Firstly, it is so microscopic that it fits into the human ear! But not only that, it is linked by a "magnetic loop" with the ordinary radio receiver, and the wearer simply walks across to the receiver and switches off the loud-speaker. Thenceforward, the programmes are audible only in the Radio Ear, and thus other members of the domestic circle will not be offended by the quotations of "fat cows" whilst father follows carefully the latest market prices (or, perhaps, the first three home in the Underwood Stakes). However, there may be a strain of truth in the description of the invention, and I can see that it will do much to alleviate the tension which at present exists when an item is broadcast which appeals only to one member of the



There will be no more family squabbles over the radio.

family circle. Personally, I prefer a plug of cotton wool in my ears whilst the majority of my neighbours listen to the programmes.

Quality from Records

APPARENTLY there are still some listeners who really pay great attention to the musical balance and other technical details of the programmes which are received, although from my experience the average listener now switches on the receiver at the first available moment and leaves it blaring away through the remainder of the time that he is at home. However, this listener writes me as follows:—

"Can you tell me why it is that the tone quality of broadcast gramophone records is so much superior to the same items when broadcast direct?"

"I find that no matter whether it is a symphony orchestra, string quartet, piano-forte, organ or soloist, the same thing applies, and whilst there always seems more power from records, my receiver is much less ready to 'blast' when these are being broadcast. For instance, take 'Knightsbridge.' I have heard this played

By Jhermion

by several different bands, but none has succeeded in putting it over with the familiar full clear tone we are used to hearing as a prelude to 'In Town Tonight.'

"Probably you will find fault with my receiver. If you do, I can't blame you, but I have had the same thing on other receivers."

"A friend of mine had a five-pin valve given him and found that it had got one too many pins for him to get it in his set, so he has amputated one and now wants to know why it (the valve) refuses to function. This is not a query—only a short story."

Well, I think I can answer this query, although I may be wrong. At the B.B.C. studios the gramophone pick-ups (or should it be pick-ups?) are connected to special tone-compensating circuits and these restore some of the balance which has to be upset in order to accommodate the recording on the standard record spacing. The percentage modulation thus is not actually so great as is employed when a band is actually playing in the studio, and this accounts for the difference in the balance. Actually, of course, the very lower frequencies are not produced so heavily from the record as from the original band or orchestra. Which reminds me, have you ever succeeded in playing a record through your own pick-up with the same degree of fidelity as that which is obtained by the B.B.C. on their records?

The last paragraph of the above reader's letter certainly shows that there are still some clever people about, and I should not be at all surprised that that is a true episode.

Foreign Languages

THERE was a time when I thought of the wonders which were to be revealed when I possessed a wireless receiver which would span the earth. I thought of the fascination of hearing the various languages of the nations and the interest which might be awakened by the various musical items of the inhabitants of the world. Alas, after using an "all-world receiver" for a few weeks, I realise that there is no place like home. Apart from the fact that the majority of the speech which is heard is unintelligible to me, all the stations, no matter in what country, seem to have to devote nine-tenths of their programme time to the playing of gramophone records, and the choice seems always to rest between cinema organs and jazz bands. From the farthest parts of the globe I hear "Blues I Love to Sing" or "The Music Goes Round and Round" (and incidentally so does my head). Even if I turn to countries nearer home, I am enjoined to avoid night starvation or drink black tea in order to enjoy life. I'm tired of hearing the foreign languages, and it is very soothing to hear our own announcers, with their gentle university

accents reminding me that the "Weather and News follows in one moment."

Crooners ad infinitum

SOME weeks ago I welcomed the news (in our much-maligned daily papers) that crooning was dying. It was too good to be true, however, and the cure would appear to be worse than the curse. In the place of the crooner (who was generally apparently a youth inspired with the spirit of the muse) we are now hearing choirs and glee clubs. Some of the well-trained choirs are all very well (in church) but others are completely untrained and sound absolutely unrehearsed. If this is the progress of civilisation, then I am off to the depths of darkest Africa.

Added Enjoyment

AT a recent big fight a spectator created a mild sensation by listening to the running commentary on a small portable, whilst he watched the performance of the combatants in the ring. At first sight it seems a really excellent idea for anybody who does not know too much about the game to listen to the opinions of an expert sitting at the actual ring-side to add to the enjoyment which is obtained from the actual witnessing of the event. I do not know how powerful the portable was, but I am wondering how he managed to overcome the sound of the blows and the shouting of the crowd—and they are not a particularly quiet crowd at a big fight.

Wireless Experts

I LIKE to hear from other readers regarding their experiences, and from a letter I have received from Mr. Millinchip, of Hartlebury, he has experienced many of the trials which beset the local expert and repairer. This is what he tells me, amongst other things:—

"Looking through your PRACTICAL AND AMATEUR WIRELESS of January 18th, I found 'Curious Receiver Faults,' a very interesting article, and, of course, round here we have to put our own sets right, most of them battery sets, and some people



I'm tired of hearing foreign languages.

are so wooden-headed that they even put the H.T.—in the H.T. +, and then come and ask me what's the matter with their set. Now I know that you know all about wireless and that no doubt you would call me wooden-headed if I asked you what was wrong with some of the sets that we try

(Continued overleaf)

(Continued from previous page)

to put right, and at last put right after a week or so. Curious little faults that would just please you, 'Thermion.' Here's one. A chap here made up a three-valve set; it went well, so he decided to metallise the baseboard to bring it up to date, and to save having all the battery leads outside the cabinet, he joined these terminals on an ebonite block and screwed the block underneath the baseboard. Well, nothing doing, so he brought the set here; we tried, but no sound. We tried for a week; then we took the block off. It went well, put it back, no sound. Had another go at it and found that the two screws holding the block went right through the baseboard and were touching the terminal in the block. Of course, it's little things like these that makes the chap that brought the set say nasty things about you. Another one. This set was tuned by a coil with the reaction coil inside it. This small reaction coil turned round and was joined by two pieces of rubber-covered wire. They took it to a wireless shop because it went off just when the news came on. The wireless shop sent it to me. Well, I had it all to bits. It was no good;



I'm going where I shall be free from crooners.

no sound; no nothing! So I took it back. Coming away from the shop I suddenly thought of the two wires from the reaction. I went back, pulled the two wires, and there the wire had broken inside the rubber covering through twisting the reaction round so much. Two more wires and everything was O.K. Then there's the other chap. You tell him the transformer has gone and put in another to make him believe it, tell him it will cost him 5s. He takes the set away without the new transformer, goes to the wireless shop and asks what's wrong, leaves the set. They fit him up with two or three new valves and a transformer, somewhere round £1 (cheap valves, etc.). But he pays, of course; he doesn't believe you. Oh no! it was the valves that were gone."

Wireless for the Blind

AN unknown benefactor who recently offered to add a 50 per cent. "bonus" to any donation given to the British "Wireless for the Blind" Fund has already been called upon to pay varying amounts totalling £750. The items ranged from three-halfpence in the case of a threepenny gift (in stamps) to £500 on an anonymous £1,000 donation. The offer followed the broadcast appeal made on Christmas Day by Lord Sankey, who asked for £12,000 with which to install wireless in the homes of blind people throughout the country. Up to the end of January, only half this sum had been received at the Fund's headquarters at 226, Great Portland Street, London.

When it seemed that the hopes of some two thousand blind persons anxiously looking forward to having wireless this year would be doomed to disappointment, the committee of the Fund received the present unexpected offer. It is backed by



Notes from the Test Bench

S.G. Detectors

SINCE the advent of the high-frequency pentode this type of valve has become increasingly popular as a detector in simple three-valve receivers, and in this position it provides a higher degree of amplification than the normal type of triode detector. To obtain optimum results from the pentode, however, it is essential to apply the correct voltages to the anode and screen—this type of valve is more critical than the triode in this respect. A mistake commonly made is the application of excessive voltage to the screening grid; a voltage of between 15 and 30 volts is sufficient in most cases.

In battery-operated receivers this voltage can best be obtained by connecting the screening grid by means of a flexible lead to the requisite H.T. battery socket—this is preferable to the use of a series resistance to cut down the voltage to the required value. In a mains receiver this method cannot be adopted, however, and therefore a potentiometer or a fixed series resistance may be used. Another method, which is used in some commercial receivers, is the connection of the detector screening grid to the cathode of the output valve. This cathode is usually about 15 volts positive with respect to the cathode of the detector, and therefore a positive voltage of 15 volts is applied to the detector screening grid.

Oscillator Coils

WE have recently tested many superhet receivers which have failed to function owing to failure of the pentagrid frequency changer to oscillate. In some cases this has been due to a defective valve, but there have also been instances where this lack of oscillation has been due to the reaction winding of the oscillator coil being reversed. This trouble can easily be remedied by reversing the external leads to the reaction winding. A further source of trouble in this connection is the oscillator grid-leak; if this has too low a value the valve will not oscillate. As previously mentioned in these notes the best method to test for oscillation is to connect a milliammeter in the H.T.—lead of the receiver, noting the current consumption before and after the oscillator reaction winding has been short-circuited by means of a piece of wire. If the oscillating circuit is in order an increase in the current reading should be obtained when the wire is connected across the reaction winding.

Adjusting I.F. Frequency

IF an oscillator is available it is a very easy matter correctly to adjust the I.F. transformers of a superhet. The two oscillator leads should be connected to the cap of the pentagrid valve and the earth terminal respectively. After setting the oscillator control to the correct frequency setting, the I.F. transformer trimmers should be adjusted until maximum volume is obtained in the speaker. If the oscillator is of a type that does not tune to a fundamental frequency of 465 kc/s, a second harmonic should be used when testing 465 kc/s receivers, and the oscillator should be set to 232.5 kc/s.

guarantees to cover a 50 per cent. bonus on all further donations till the aggregate reaches £12,000, the amount required for this year's programme. Within a few hours of the publication of the offer, a renewed flow of gifts began to reach the Fund's offices. They soon amounted to £500, on which a "bonus" of £250 was automatically paid. During the past week-end, the receipts were substantially increased by an anonymous donation of £1,000, supplemented by a £500 "bonus."

A Remarkable Record

THIS month the Columbia Company introduce their first record by Egon Petri, the famous pianist, considered by most to be the legitimate successor of the great Busoni, under whose guidance Petri developed his art. A remarkable feature of this record is the new fidelity of tone, due to a successful experiment carried out in their laboratory. It was the placing of a single screen at a particular angle that secured such astonishing results, and the recording took place with the acoustics defined by the new discovery. Petri plays Busoni's arrangement of Bizet's "Carmen" music as a Fantasia. The

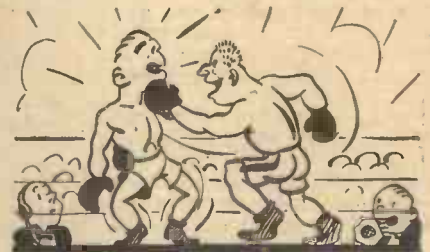

Listening to the Big Fight commentary.

number of this record, which is remarkable in a fullness in bass and clarity in the upper register, is *Columbia LX462*.

Film Stars' Ideal Homes

HOME-LOVERS and film enthusiasts alike will welcome news of a remarkable display now being organised for the *Daily Mail* Ideal Home Exhibition, which opens at Olympia, Kensington, W., on March 24. About 60,000 square feet of space at this ever-popular event will be devoted to a feature entitled "Homes of the Film Stars," in which rooms from the homes of the leading British and American stars of the screen will be reproduced and furnished in full scale and in authentic detail.

Each room will be reproduced and furnished by a leading firm of decorators and furnishers. In many instances the stars are lending their personal belongings, so that the rooms will reflect the intimate atmosphere of their originals. For example Mr. Ronald Colman's library, with its wealth of fine oak panelling, will show how the famous screen actor's taste has remained true to the land of his birth, while Mr. Clark Gable's beautifully proportioned living-room shows the owner's taste for fine antiques and restful decoration in subdued colourings.

From her home in Beverly Hills, California, Miss Constance Bennett has sent details of an upstairs sitting-room which is charmingly original in style. Also, from Miss Grace Moore's villa in the Riviera a bedroom and a dining-room of much interest and charm will be shown. The bedroom, in which the predominating colours are silver, ivory and dull blue, is furnished with eighteenth-century Venetian pieces.

A PAGE OF PRACTICAL HINTS

SUBMIT YOUR IDEA

READERS WRINKLES

THE HALF-GUINEA PAGE

A Simple Microphone

THE construction of this simple microphone is clearly shown in the accompanying sketch. The microphone button was bought for 3d., and the diaphragm

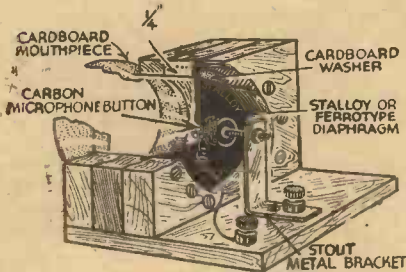

Part sectional view showing the construction of a simple microphone.

used was obtained from an old pair of headphones, but a disc cut from a piece of ferrotype would be suitable. It is drilled in the centre to take the mike button, and is clamped between two pieces of wood, the latter having holes drilled in them with a radius $\frac{1}{16}$ in. less than that of the diaphragm. The third piece of wood, holding the mouthpiece, is screwed to these, and the three are screwed to the baseboard. Eight screws should be used to clamp the diaphragm. One terminal is connected to the front of the button, and the other to the rear part via the bracket.—R. G. VENNING (Porthcawl).

Vernier Adjustment for a Tuning Dial

THE accompanying sketch shows a method of obtaining a vernier adjustment on a short-wave tuning dial. The station may be tuned in, then a slight pres-

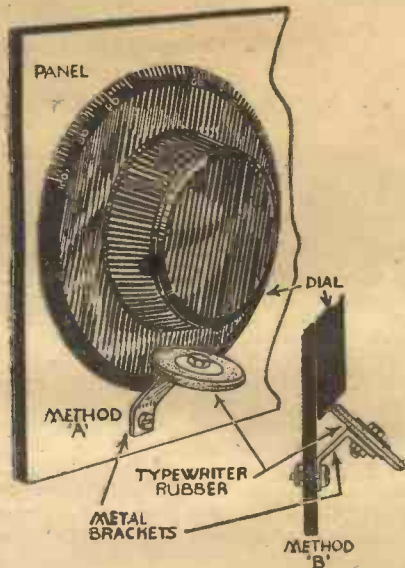

A handy vernier device for a tuning dial.

THAT DODGE OF YOURS!

Every Reader of "PRACTICAL AND AMATEUR WIRELESS" must have originated some little dodge which would interest other readers. Why not pass it on to us? We pay £1-10-0 for the best wrinkle submitted, and for every other item published on this page we will pay half-a-guinea. Turn that idea of yours to account by sending it in to us addressed to the Editor, "PRACTICAL AND AMATEUR WIRELESS," George Newnes, Ltd., 8-11, Southampton Street, Strand, W.C.2. Put your name and address on every item. Please note that every notion sent in must be original. Mark envelopes "Radio Wrinkles." Do NOT enclose Queries with your Wrinkle.

sure on the eraser can be made for fine adjustment. It requires a small piece of strip brass bent in either manner shown, and a typewriter eraser. The eraser is fixed to the bracket and the bracket to the panel by a small nut and bolt. Method "B" can be used with a small dial.—P. BARBAUD (Teddington).

A Coupling Hint

WHEN making couplings and collars it is a good idea to drill the spindle hole a little to one side of true centre (i.e.,

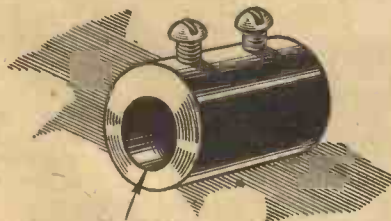

HOLE DRILLED ECCENTRICALLY

A useful coupling hint.

eccentrically). The fixing screw hole is then drilled in the thickest part. This allows for more threads for the clamping screws, a definite advantage over the more usual method, and the slight weakening of the coupling is negligible.—E. PARKER (London, S.E.).

Variable-selectivity I.F. Transformer

THE following is a description of a simple method of adding a variable selectivity device to practically any I.F. coil of similar construction; it may be of interest to add that the I.F. coils so adapted were of the home-made type as described some months ago in PRACTICAL AND AMATEUR WIRELESS.

The first operation is to cut the Paxolin tube holding the coils in two pieces, as shown. The coils themselves are fixed to the tube with thick shellac varnish. The base is drilled and countersunk to hold the two upright lengths of 4BA threaded rod; these two pieces may be approximately $3\frac{1}{2}$ in. long above the base. The lower coil is fixed to the base on its tube as formerly. A piece of $\frac{1}{16}$ in. ebonite is then cut to the shape shown in the lower figure and drilled at either end with 4BA clearance holes, their centres being the same distance apart

as the brass rods; a 4BA clearance hole is also drilled in the centre of the ebonite. A piece of strip brass, $\frac{3}{16}$ in. by $\frac{1}{16}$ in. is then drilled in a similar fashion and a 4BA nut soldered over the centre hole; this strip is then bolted to the ebonite as shown.

A small piece of wood dowelling about $\frac{1}{2}$ in. long is then drilled axially for 4BA clearance and fixed in the end of the second I.F. coil mounting tube; the coil is then fixed to the ebonite block with two long thin brass screws countersunk into the ebonite. A stout piece of brass strip about $\frac{1}{2}$ in. wide is then bolted across the top of the two screwed uprights and has a 4BA clearance hole drilled through its centre. The top coil assembly must, of course, be previously slid over the two guide rods. To vary the distance between the two coils a short piece of 4BA threaded rod is placed through the top brass strip, locknuted on either side, and screwed

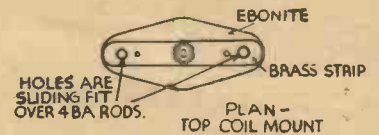
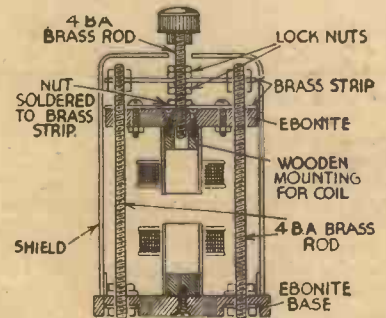

A method of adding a variable-selectivity device to an I.F. transformer.

into the nut on the movable coil mounting.

The coil screen is drilled to give ample clearance for this rod and placed over the coil. An ebonite knob completes the job.

If screwing tackle is available, smoother working might possibly be obtained by using plain brass rods for the uprights, and screwing them at either end. The arrangement previously described, however, works perfectly and may be constructed without any special tools beyond the average wireless constructor's equipment.—J. HADDON (Cricklewood).

THE FIRST COMPLETE VOLUME
TELEVISION & SHORT-WAVE
HANDBOOK 2nd EDITION

3/6, or 3/10 by post from George Newnes, Ltd.,
8/11, Southampton Street, Strand, W.C.2.



Three-quarter rear view of the Monitor—second stage.

F. J. Camm's Monitor

EASY TO BUILD

CONSTRUCTIONAL DETAILS OF THE SECOND STAGE OF THE MONITOR THREE ARE GIVEN THIS WEEK

By F. J. CAMM

PRELIMINARY details of the second stage of the Monitor Three were given last week, and it is probable that many readers have already bought the necessary additional components and commenced the constructional work. The receiver in its original form is an ideal little set for reception of the local stations and a few of the more powerful continentals, but the selectivity cannot be expected to be quite as good as that obtainable from an S.G. three-valver having two or more tuned stages.

Circuit Arrangement

In the second stage of the receiver an additional coil and tuning condenser is

incorporated; this addition improves the selectivity and the sensitivity, and as the L.F. amplifier has been carefully designed the quality of reproduction is also very good. An H.F. transformer has been chosen to couple the H.F. pentode to the detector, as this provides a higher degree of selectivity than the untapped tuned grid coupling commonly used in cheap receivers. A study of the diagram will indicate that the reaction condenser has now been transferred to the anode circuit of the detector valve. In this position a better control is obtained than when the condenser is joined to the cap of the first valve, as in the original version of the set. In order to obtain optimum results from the first valve it was also decided to add a bias voltage volume control. By judicious use of this control in conjunction with the

reaction condenser most of the worthwhile stations may easily be separated. We have found, however, that in some of the very congested areas a two-tuned stage receiver, however good it may be, does not entirely meet local requirements. Readers in these areas need not be deterred from building the set in its present form, however, as the necessary addition—an extra coil—to make it sufficiently selective will only cost a few shillings, and the wiring details for this additional refinement will be given next week.

Coil Chassis

Readers are advised to mount their original Monitor coil on the new chassis before commencing constructional work. The chassis will be received from the suppliers with the new coil wired to the correct switch and terminal strip tags. The original Monitor coil should be mounted over the hole nearest the control knob of the new coil chassis. The leads passing through the holes in the side of the coil

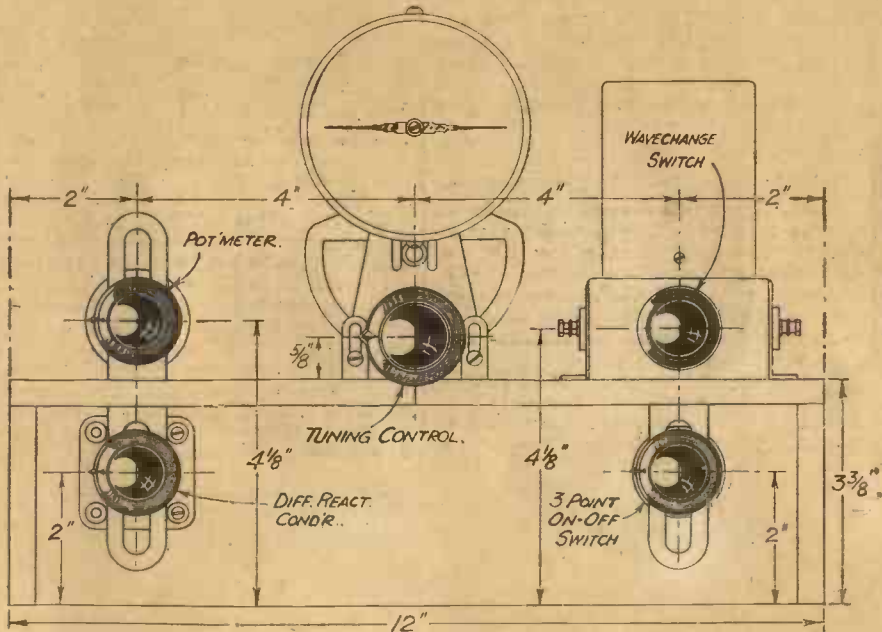

On the left is given the fully-dimensioned layout diagram for the controls, which will be useful in drilling the panel or cabinet front.



This illustration in conjunction with the diagram you in wiring

should be pulled in and passed through the large hole in the coil chassis. The white leads should then be soldered to the internal tag joined to terminal 2, and the

for 3

— GUARANTEED !

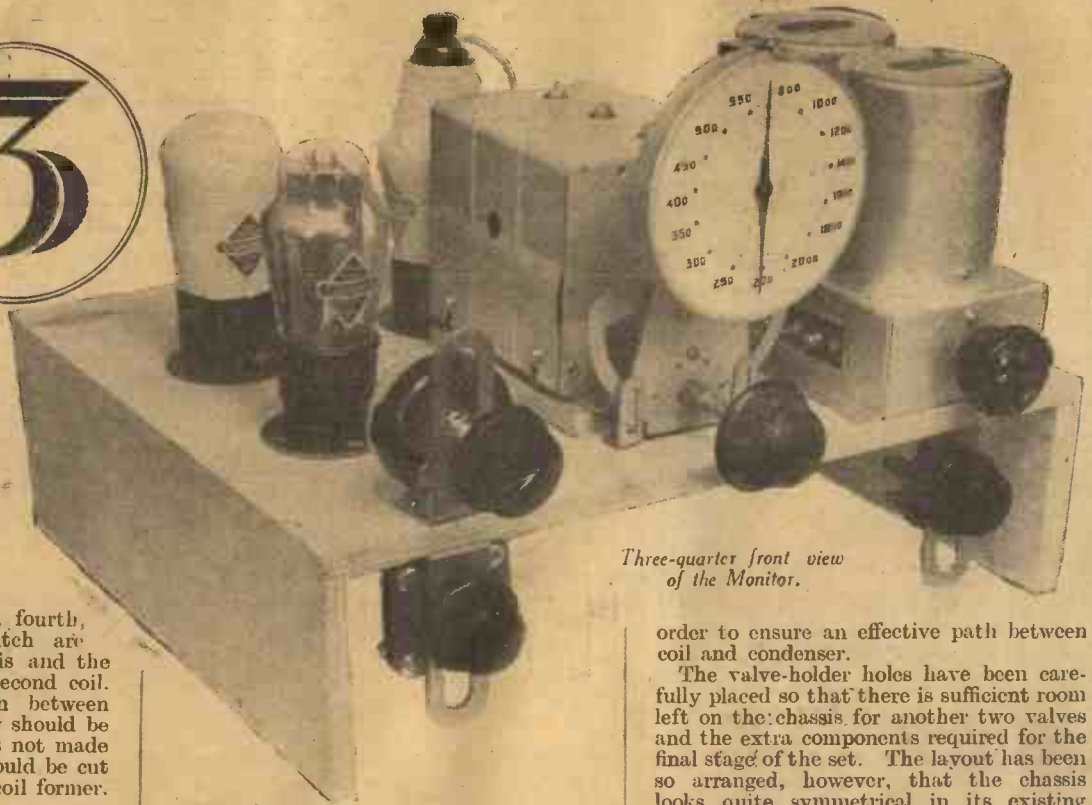

Three-quarter front view of the Monitor.

black lead attached to terminal 1. The blue and yellow leads which were connected to the wave-change switch in the original version of the set should then be soldered to the first two tags (nearest the control knob) of the multiple switch attached to the new coil chassis; it will be noted that the third, fourth, and fifth tags of this switch are connected to the metal chassis and the yellow and blue leads of the second coil. In order to avoid interaction between the leads of the two coils, they should be kept apart. The brown lead is not made use of now, and therefore it should be cut shorter and tucked inside the coil former.

Construction

After the coil has been mounted and the wiring carefully checked, the coil chassis may be mounted on the metaplex chassis, together with the tuning condenser. It is

may be at the correct height for the airplane drive. Normally the chassis of the gang condenser is screwed to the metallised surface of the baseboard and therefore no connection is necessary between the moving vanes of the condenser and the coils as the metallised surface provides the necessary return path. Owing to the addition of the wooden support referred to above it is necessary, in the case of the Monitor, to make a connection between the condenser chassis and the coil chassis in

order to ensure an effective path between coil and condenser.

The valve-holder holes have been carefully placed so that there is sufficient room left on the chassis for another two valves and the extra components required for the final stage of the set. The layout has been so arranged, however, that the chassis looks quite symmetrical in its existing form, as shown in the accompanying illustrations. The additional valves and components will be mounted between the existing detector and H.F. valves and the back of the chassis, and will be so placed that the extra leads required will not be of excessive length. Readers who intend following the various stages to the last one need not, therefore, have any worries concerning the appearance of the final version—this will be very pleasing and symmetrical.

(Continued overleaf)

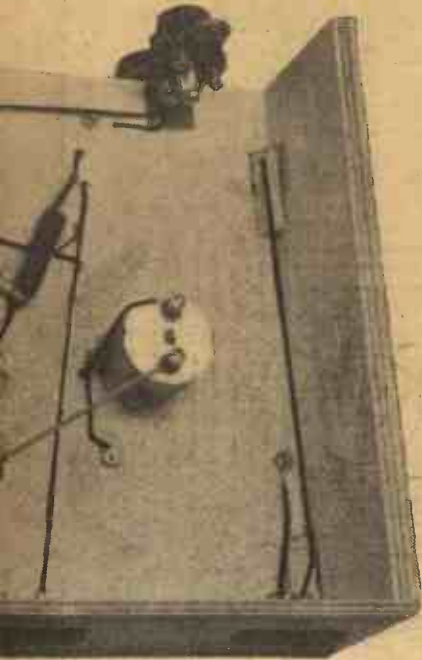

The theoretical circuit is given on the right and all component values have been filled in to assist those who prefer to study the theoretical points incorporated in the receive

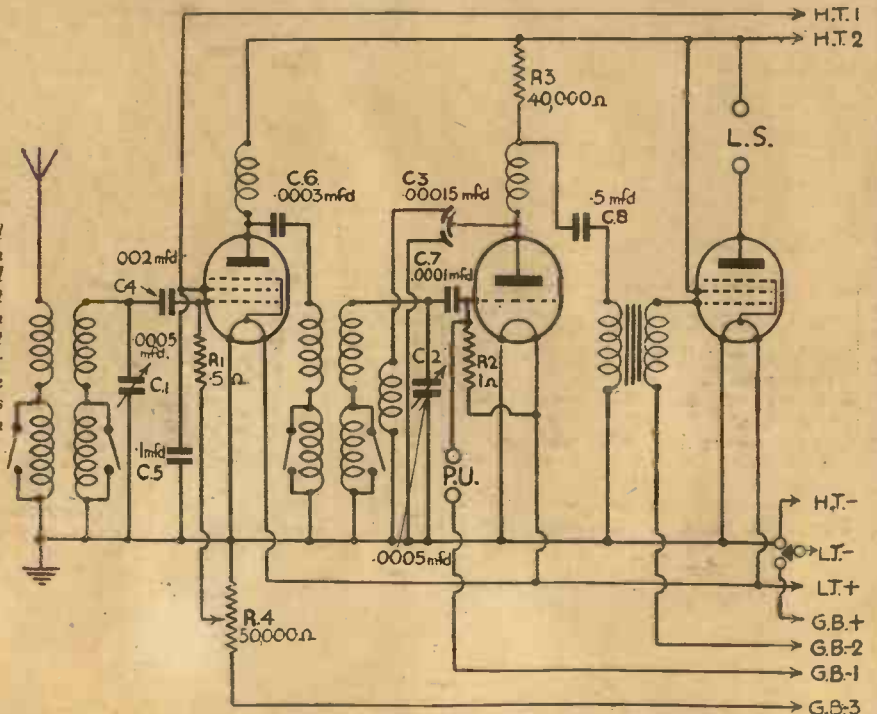

The diagram on the next page will assist in the receiver.

pointed out, however, that a piece of metaplex plywood equivalent in thickness to the baseboard must be placed underneath the gang condenser in order that the latter

(Continued from previous page)

A one-inch drill should be used for the valve-holder holes, and although the size required for the terminal strip holes is not very critical, a 3/16 in. drill will be found quite suitable. As emphasised in most of our previous constructional articles the pins of the valve-holder must be placed centrally in the hole in order to avoid a short-circuit to the metallised surface of the baseboard. After the holders and terminal strips have been mounted, the components on the underside of the chassis may be screwed down and the wiring commenced. As the spindles of the volume control and the reaction condenser are not in contact with any of the terminals it will not be necessary to insulate the mounting brackets of these components from the metallised surface of the baseboard, although as an additional safeguard this may be done.

Wiring

The wiring should not present any difficulties as the components are well spaced and the connecting leads are clearly shown on the wiring diagram.

WIRING DIAGRAM OF THE MONITOR-2nd Stage

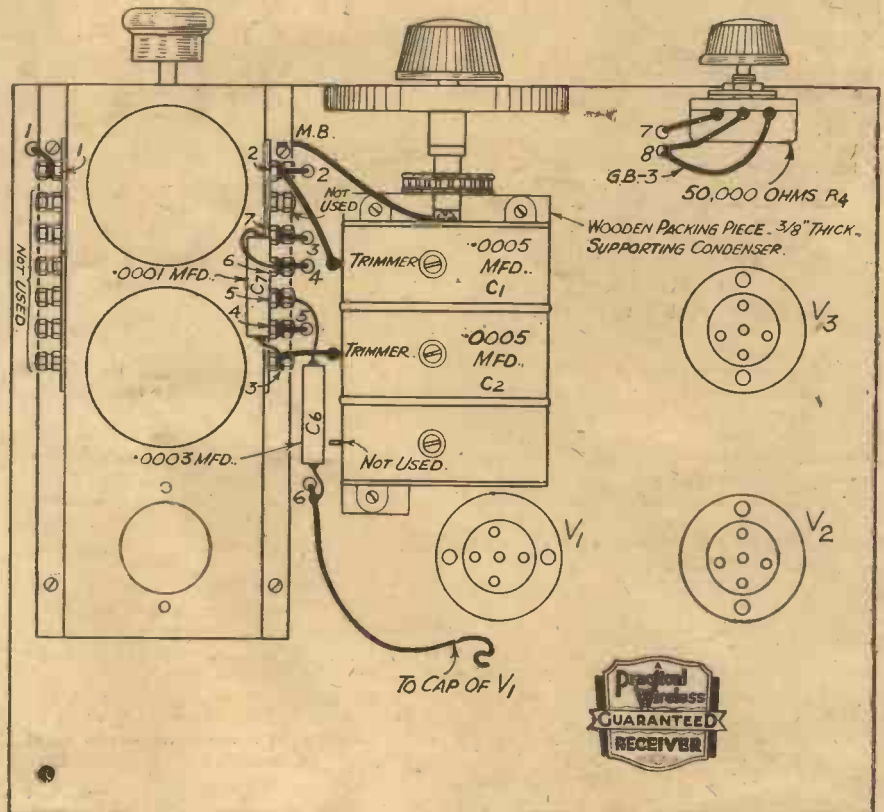

LIST OF COMPONENTS

- One coil (B.T.S.).
- One .0005-mfd. Compax condenser (Polar).
- One airplane drive (J.B.).
- One .00015 mfd. differential reaction condenser (Polar).
- Four fixed condensers: .5 mfd., .1 mfd., .002 mfd., .0003 mfd. (T.M.C.).
- Two fixed resistances: 40,000 ohms, 1 megohm (Dubilier).
- One H.F. choke, type HF9 (Bulgin).
- One Senator L.F. transformer (Bulgin).
- One three-point switch, S36 (Bulgin).
- One two-point switch, S22 (Bulgin).
- Three socket strips: A/E, L/S, P/U (Belling-Lee).
- Three valve-holders: two 4-pin, one 5-pin (Clix).
- Four component brackets (Peto-Scott).
- Six plugs: H.T., H.T.1, H.T.2, C.B.+, G.B.-1, G.B.-2 (Belling-Lee).
- Two spades: L.T.+, L.T.- (Belling-Lee).
- One metallised chassis, 8in. by 6in. by 2 1/2 in. (Peto-Scott).
- Three valves: 210VPT, 210Det., 220HPT (Cossor).
- 120-volt H.T. battery.
- 9-volt G.B. battery.
- 2-volt accumulator (Exide).
- One "Pix" Indoor Aerial.
- Speaker, Stentorian, model 36/S (W.B.).

ADDITIONAL COMPONENTS REQUIRED

- One Monitor coil, with special 3-coil chassis (B.T.S.).
- One two-gang .0005 mfd. condenser (Polar), or
- One three-gang .0005 mfd. condenser (Polar), or
- One three-gang superhet 465 kc/s condenser (Polar). (See Text.)
- One .0001 mfd. fixed condenser (T.M.C.).
- One .5 megohm 1 watt resistance (Dubilier).
- One H.F. choke, type H.F.9 (Bulgin).
- One 50,000 ohm volume control (Polar).
- One metallised chassis, 12in. by 10in. with 3in. runners (Peto-Scott).

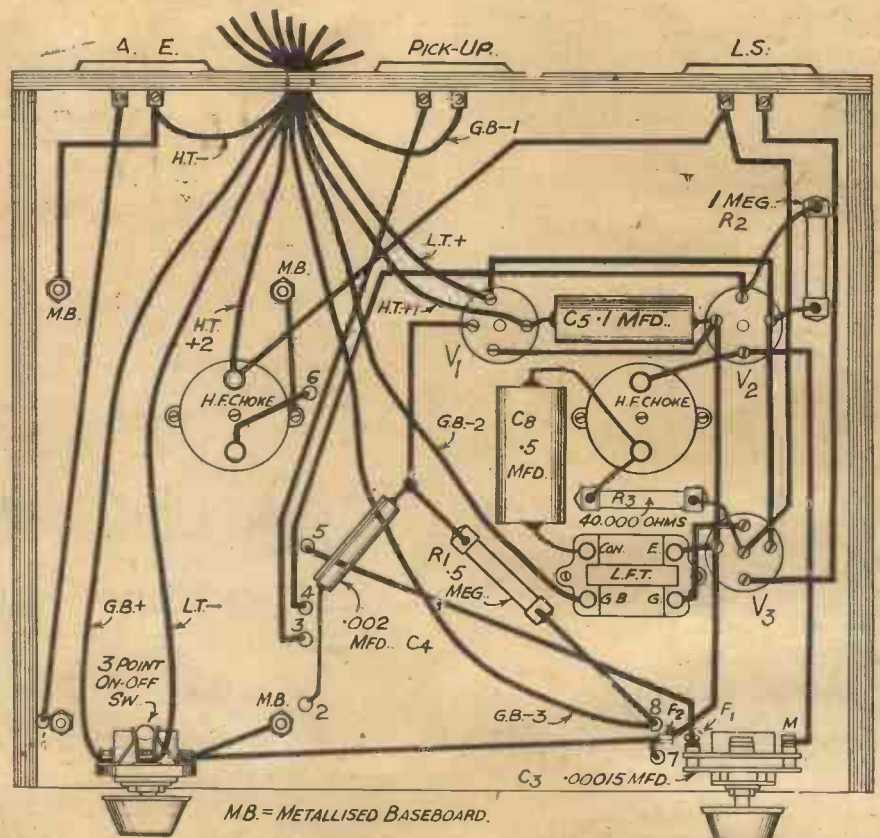

SHORT WAVE SECTION

USING AN S.W. ADAPTER OR CONVERTER WITH A SUPERHET

Details are Given for Replacing the Frequency-changer of the Broadcast Superhet by a Standard Type of S.W. Adapter.



MANY readers write to our Free Advice Bureau to ask how they may use a short-wave converter or adapter in conjunction with a superhet of either home-made or commercial type. In some cases we have to reply that this cannot be done without modifying the existing receiver in some manner, and in other instances it would be impossible to give all

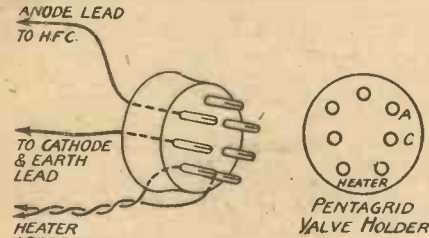

Fig. 2.—The connection required for the 7-pin plug when using a mains-operated adapter.

the necessary information in the form of a letter. It is proposed, therefore, to cover the subject fairly completely here, so that those who contemplate the use of the scheme referred to above will be able to tell exactly what modification will be involved. It must be made quite clear that the diagrams given on this page are intended for use by those who have a fair experience of constructional work, and it should be pointed out that practical wiring diagrams cannot be supplied. At the same time, a good deal of the information will apply to existing adapters, such as have been described in previous issues of this journal, which can be modified very simply and at practically no expense.

Replacing the Detector

The usual type of short-wave adapter comprises a simple leaky-grid detector circuit, and it is designed to replace the detector valve in a "straight" receiver, or the second detector in a superhet. Unfortunately, however, when used with a superhet it means that all those valves which precede the second detector are out of use, the final short-wave arrangement normally having only two valves. In other words, the owner of a powerful superhet of the broadcast type is in precisely the same position—as far as short-wave reception is concerned—as the possessor of the most humble two-valve, det.-L.F. receiver.

For purposes of explanation the circuit of a modern, well-designed adapter is shown in Fig. 1, and it will be seen that this is fitted with a four-pin adapter plug which replaces the detector valve in the normal course of events. By a happy coincidence, however, this adapter can, in

certain circumstances, be used equally effectively as a converter, since all that is necessary is to set the reaction so that the valve will oscillate over the full range of the tuning condenser. When the valve is caused to oscillate in this manner the arrangement automatically becomes that of an autodyne frequency-changer except that there is no inductive load in the anode circuit which can be tuned to a suitable intermediate frequency.

A Better Scheme

But if the adapter can be used merely as a replacement for the frequency changer in the broadcast superhet, the intermediate-frequency amplifier, as well as the second detector and power valve, can be successfully employed. The first I.F. transformer can be used to provide the necessary tuned load, with the result that the short-wave

plug and the anode lead. In order to make the alterations quite clear the three leads concerned are numbered in Fig. 1 so that they correspond in both cases. Since there are only three leads to be taken to the seven-pin valve-holder, it might be considered simpler to use a couple of ordinary wander plugs for the filament leads marked 1, 2 and 3, and this would be quite satisfactory.

General Circuit Data

There is no need to describe the general circuit shown in Fig. 1 in detail because it is given merely as a typical example, but a few notes may be useful. A high-frequency pentode is used in the leaky-grid circuit, and is fed from a standard type of short-wave coil—either single- or multi-range. Reaction is normally controlled by the .0002-mfd. variable condenser, but a fine

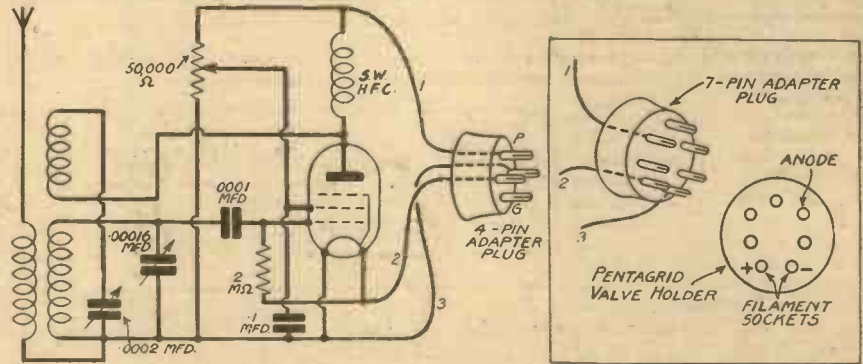

Fig. 1.—A convenient adapter circuit with (inset) a method of using it as replacement for a pentagrid frequency-changer.

superhet has precisely the same number of valves as the broadcast receiver. In order that the adapter can be used as an efficient converter in the manner outlined above it is desirable that the intermediate frequency at which the broadcast set operates should be either 110 or 150 kc/s, since the autodyne arrangement does not function satisfactorily at a high intermediate frequency.

The slight modification required to make the adapter suitable for use with a modern superhet having a battery-operated pentagrid frequency changer, is shown inset in Fig. 1, where it may be seen that a seven-pin adapter plug is used in place of the four-pin plug fitted as standard. The filament leads from the short-wave frequency changer are taken to two of the pins on the plug, whilst the anode or plate lead is connected to the corresponding pin on the plug—No. 7. It is clear that the pentagrid must be removed from the valve-holder, its place being taken by the adapter

control can be obtained by means of the 50,000-ohm potentiometer which feeds the screening grid. A .00016-mfd. condenser is shown for tuning, this being of the standard type, and fitted with a good slow-motion drive. Incidentally, it is worth

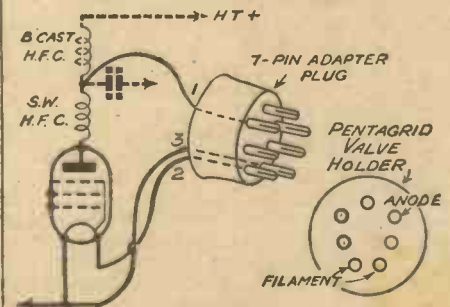

Fig. 3.—This skeleton circuit shows how a converter can be used in the same manner as the adapter shown in Fig. 1.

pointing out that an adapter employing a triode valve could be modified in the manner described and would function quite well.

For Mains Operation

When the broadcast superhet is of the mains-operated type a mains-type adapter could be used in a similar manner to that described for the battery set. The only difference is that four connections must be made to the seven-pin plug; two for the heater leads, one for the anode, and one for the cathode. Should the adapter be provided with a variable- μ volume control it will generally be found better to take the cathode lead directly to the earth line of the set; this will be the earth terminal except in those few cases where a condenser is included in the earth lead, in which case the lead may be joined to the metal or metallised chassis. Where there is a variable- μ volume control in the set which acts upon the frequency changer as well as upon the I.F. amplifier,

this can be used as before, although its effect may not be so pronounced. In using the cathode connection shown in Fig. 2, however, it will probably be found necessary to set the volume control to its "maximum" position.

Modifying a Converter

So far we have considered the modification of an adapter only, but similar conditions obtain when using a converter. The modifications required, however, are of a somewhat different nature, and the method shown in Fig. 3 should be followed. As may be seen, the H.T. lead is not used, and the broadcast-type H.F. choke and coupling condenser are left "in the air"; instead, a lead is taken from the junction of the two chokes to the anode pin of the seven-pin adapter-plug, the two filament leads being attached to the plug as before. The result of this alteration is that the general circuit arrangement becomes identical in principle with that shown in Fig. 1.

Also, the same method can be followed in the case of a mains-operated converter.

The methods described above are the simplest of those possible which are entirely satisfactory, and they have the advantage that the broadcast receiver need not be altered in any way. They also have the advantage that the current consumption of the short-wave arrangement is approximately the same as that obtaining when receiving normal broadcast matter. The latter point is of particular importance in a mains-operated receiver, whether it be A.C., D.C. or universal, because the current-supply components such as mains transformer, ballast resistances, and ballast are accurately designed for one particular voltage and current. There is the additional advantage that the standard on-off switch is operative just the same whether the receiver is used alone or with the converter.

Double Frequency Changing

It is sometimes desired to have a more ambitious short-wave circuit, and there is not very much difficulty in this when the set is battery-operated, but with a mains set it would be necessary to provide a separate power-supply unit for the converter. The circuit of one advanced type of converter is shown in Fig. 4, and this is intended for use in conjunction with the complete superhet. The converter comprises a pentagrid frequency-changer as well as an I.F. amplifier and is intended for connection "before" the broadcast superhet. This means that the complete short-wave receiver has two frequency-changing circuits and two I.F. amplifiers. A point which is often of great importance, however, is that the converter can be used with a superhet working on an intermediate frequency of 465 kc/s. The circuit shown in Fig. 4 is given rather as an experimental arrangement than as one which has been extensively tested.

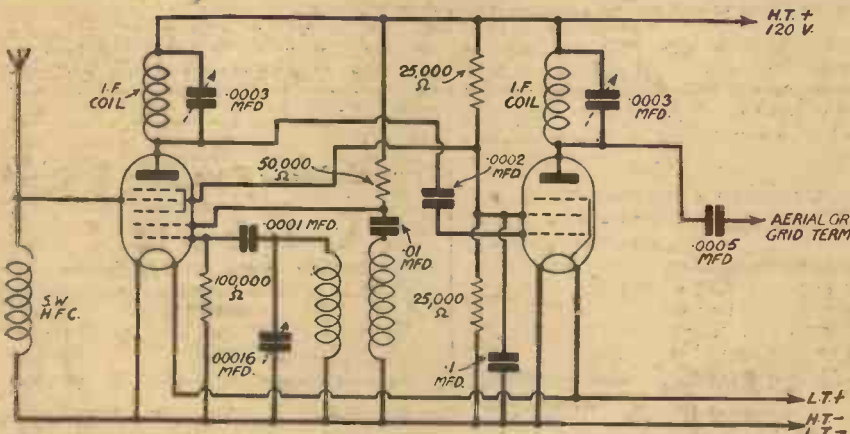

Fig. 4.—An experimental frequency changer and I.F. amplifier to use prior to a battery superhet.

Identification

The question of identification of a transmitter is not always easy; note that I say "transmitter" and not "broadcast," as there is, as you will see, a vast difference. In most instances it is not a difficult matter to trace the origin of a broadcast as, especially in the case of short waves, the call or some other useful indication is frequently given. On the other hand, we may find the transmission on a particular channel which does not coincide with any usually associated with the city or country from which the broadcast emanates. As an example, commercial stations are brought into action for the relay of a special programme destined to a foreign country. But the matter is sometimes further complicated by the fact that a foreign channel may be used for the same purpose. As an illustration, take a Christmas programme originating at Oslo, which the Norwegians had specially prepared for the benefit of their Nationals engaged in the whale-fishing industry in the Antarctic Circle. It was picked up on a frequency which did not tally with any used by the Jeløy short-wave transmitters. In effect, it was passed by cable to PHI, Hilversum, by special arrangement, in view of the power of the plant and the directivity of its aerials. No wonder some difficulty was experienced in identifying the transmitter, although there was never any doubt as to the nationality of the broadcast.

Another troublesome factor which affects possessors of short-wave receivers or converters working on the superhet principle

Leaves from a Short-wave Log

is the presence of the second condenser dial reading, which on many occasions leads one to believe at the outset that the same transmission is being carried out on two different channels and that one is a relay of the other. It is only by making sure of the true channel that an accurate calibration chart can be made. The two settings will differ greatly in the matter of degrees according to the frequency band in which the station operates. On the higher frequencies the readings are close to one another; as you get towards the 40-50-metre band you will find the separation a matter of several degrees.

Canadian Broadcasts

In the 49-metre band three Canadian broadcasts were also picked up at good strength during the month of January. CJHX, Halifax (Nova Scotia), on 49.1 metres (6,110 kc/s), relaying a programme from the Lord Nelson Hotel in that port, and later taking a concert from the C.R.C. station at Montreal; CRCX, Bowmanville (Ontario), on 49.26 metres (6,090 kc/s), which is the main Canadian Radio Commission short-wave transmitter and through which it is possible to hear concerts emanating from Toronto and other Canadian

cities. On weekdays it operates from G.M.T. 22.30-04.30, and on Sundays starts at G.M.T. 16.45, to finish as on other days. CJRO, Winnipeg, on 49.5 metres (6,060 kc/s), although taking the C.R.C. transmissions, would appear to be more of an experimental nature.

The time schedule is daily G.M.T. 23.00-04.00, Saturdays G.M.T. 20.00-05.00, and on Sundays from G.M.T. 21.00-02.30. Generally speaking, for the reception of Canadian broadcasts it is better to try for Halifax, with, as a second string, Bowmanville. The former is, on most favourable nights, an easy capture.

Akaki (Abyssinia)

Much misleading information has been published regarding the stations possessed by the Ethiopian Authorities at Addis Ababa, that it is good to be told that there is, as a matter of fact, only one installation working at Akaki, fifty miles north of the Abyssinian capital. The calls and channels are: ETA, 16.42 metres (18,270 kc/s); ETB, 25.09 metres (11,960 kc/s); ETD, 39.37 metres (7,620 kc/s), and ETG, 51.02 metres (6,880 kc/s). As I have been asked to state to whom reports should be sent, here is the address: Mr. F. Hammar, Ingenieur en Chef, Ministère des Postes, Télégraphes et Téléphones, P.O. 283, Addis Ababa, Ethiopia. It is given in French—the diplomatic language—as I presume that, like me, you do not speak or write Amharic!

Strauss Waltz in Gipsy Style

THE waltzes of Johann Strauss have had many settings, from military bands to mouth-organ. A novelty in this month's Columbia list is Strauss's "Tales from the Vienna Woods," played in gipsy style by Rode and his Tziganes on Columbia FB1265.

Armando di Piramo, the Italian conductor, who recently made a successful recording of "Souvenir d'Ukraine" and "Impression d'Oriente," makes another fine record this month with "Two Guitars" (a Russian gipsy air) and a "Hungarian Caprice," by Ferraris, on Columbia DB1619. He is supported by an orchestra of picked musicians.

Variety

THE popular Columbia 1s. 6d. series of variety stars includes, this month, Fred Astaire singing and step-dancing in his greatest successes from "Gay Divorcee," "Flying Down to Rio" and "Putting on the Ritz"—on three Columbia records—Columbia FB1255-7. The same list is also strong in humour—Clapham and Dwyer do their "Making a Talkie" mess-up on Columbia FB1259, Naughton Wayne, star of "1066 and All That," indulges in his "Nonchalant Non-sense" on Columbia FB1258, while Norman Long is topical in "On the Day that Chelsea went and won the Cup," and "Ten Pahnds Dahn" on Columbia FB1263. Billy Mayerl, Debroy Somers's Band playing "Liebestraum" on Columbia FB1262, an organ medley by Sidney Torch on Columbia FB1261, and saxophone solos from Howard Jacobs, are other artists in this popular series.

The Rocky Mountaineers

WITH some half-dozen or so broadcasts behind them, the Rocky Mountaineers have become one of the best-liked turns on the air. Their records, too, are enjoying a great vogue, the carefree spirit of their radio programmes coming over faithfully on the wax. For their latest they have done "Springtime in the Rockies," "On a Good Old-time Straw Ride," "They out the Old Pine Tree," and "When it's Harvest Time"—all on one record, Columbia FB1268, in the 1s. 6d. series.

Cochran's New Show

IN connection with C. B. Cochran's new show, "Follow the Sun," come records of the show from Columbia, distinguished in one instance by the presence of the composer, Arthur Schwartz, who provides a fine piano medley on Columbia FB1269. Hildegard sings the big hit from the show, "Love is a Dancing Thing" (coupled with "Thanks a Million") on Columbia FB1266.

"Moon For Sale" and "Mine Alone" (from the film "I Live For You") are Les Allen's latest recordings on Columbia FB1278.

Turner Layton's recordings for the month are "On Treasure Island," coupled with "Sailing Home with the Tide," on Columbia FB1275, and "Homestead" and "As Long as our Hearts Are Young" on Columbia FB1267.

Decca

THIS company have this month released what they consider to be the first practical record ever to be made of our National Anthem. It is played by the Boyd Neel String Orchestra,

IMPRESSIONS ON THE WAX

By T. ONEARM

conducted by Boyd Neel. Two renderings appear on each side of the record, one side being a duplicate of the other side.

The first rendering is half of the verse played loud and stately. A blank space follows and then comes the second rendering—the complete verse played in the present-day official tempo, common to all ceremonial occasions—that is, in slow time—beginning quietly and ending loudly. The number of this record is Decca M500 and it is priced at 2s. 6d. You must listen to the Street Singer's version of "On Treasure Island" and "Marilou" recorded on

Decca F5859. Arthur Tracy is at his very best in these two most suitable numbers.

Brunswick

THIS company have produced an interesting novelty in the way

of records, which is called "The Magic Disc." It consists of a running commentary on a race, which can be played on the gramophone. There are six horses, only one of which can win. The result is unknown until the end, when it is announced by the commentator, and there are ten pices for each horse. The price of the record is 2s. 6d.

The Boswell Sisters have made a recording in this month's list of the popular comedy song "The Music Goes Round and Around" coupled with "I'm Gonna Sit Right Down and Write Myself a Letter" on Brunswick 02142.

PETO-SCOTT EVERYTHING RADIO—CASH C.O.D. or EASY TERMS

IMMEDIATE DELIVERY Of all makes of Speakers, Eliminators, Kits, Pick-Ups, Testing Meters, Receivers, for CASH, C.O.D., or M.P. PILOT AUTHOR KITS are only obtainable direct from Peto-Scott. We can supply any Kit featured in this Journal during the past 3 years.

Peto-Scott 1936 UNIVERSAL SHORT-WAVE ADAPTOR CONVERTER KIT. SEND FOR FULL DETAILS and FREE BLUEPRINT. KIT "A" £1:19:6. Cash or C.O.D. Carr. Pd. Or 2/6 down and 10 monthly payments of 4/3. Comprises all parts for building, with full-size blueprint, assembly, and operating instructions, less cabinet. WITH CABINET. Cash or C.O.D. Carriage Paid. £2/10/0, or 12 monthly payments of 4/6. Converts your existing battery or A.C. set for operation on the short waves, with no alterations, bringing you programmes from all over the world. Two hours to build—a lifetime of world-wide entertainment!

PILOT AUTHOR KITS MONITOR 3 ORIGINAL VERSION. KIT "A" CASH or C.O.D. £2:5:0 Carriage Paid. Author's Kit of First Specified parts, YOURS FOR including Ready Drilled Metaplex Chassis, less Valves, Cabinet and Speaker. 7/6. Balance in 6 monthly payments of 7/-. KIT "B" As for Kit "A" but including set of 3 specified valves, less Speaker and Cabinet. Cash or C.O.D. Carriage Paid, £3/7/8, or 10/- down and 10 monthly payments of 7/6.

1936 RADIO ACCESSORIES 1936

- PIFCO ROTAMETER, 9 ranges for 100 tests on mains or battery receivers. Cash or C.O.D. Carriage Paid, £1/9/8. Balance in 10 monthly payments of 3/-. ROTHERMEL PIEZO ELECTRIC PICK-UP, Model 88. Art Steel Bronze Finish. Cash or C.O.D. Carriage Paid, £2/2/0. Balance in 11 monthly payments of 4/-. EKCO K.10.20 ELIMINATOR and TRICKLE CHARGER, A.C. Mains 200-250v., 40-80 cycles. Adjustable output and variable screen grid tappings. 0.3 amp. charger for 2v. accumulators. Cash or C.O.D. Carriage Paid, £2/12/6. Balance in 10 monthly payments of 5/3. REGENTONE ELIMINATOR, V.P.30 for A.C. Mains. 100/250v., three tappings: 10, 20, 30 in.a. With L.T. Charger 2 v., .5 amp. Cash or C.O.D. Carriage Paid, £2/12/6. Balance in 10 monthly payments of 5/3.

2nd VERSION Complete Kit of Components to build the second version of the Monitor 3, including all additional components with 2-gang straight type condenser, less valves. CASH OR C.O.D. CARRIAGE PAID £3:17:6. Or 10/- deposit and 10 monthly payments of 7/6. As above, but with 3-gang straight or superhet type condenser instead of 2-gang. Cash or C.O.D. Carriage Paid, £4/3/-. Or 12/6 deposit and 7 monthly payments of 11/-.

- 1 Peto-Scott Ready-drilled Metaplex Chassis, 12"x10"x3"..... 2 4 0
- 2 B.T.S. Monitor 3 Coils (Anode and Aerial)..... 10 0
- 1 B.T.S. Coil Chassis, complete with terminals and switch 6 6
- Cash or C.O.D. Carriage Paid..... £1:0:0

PREFECT SHORT WAVE 3 KIT "A" CASH or C.O.D. £2:15:0 Carriage Paid. Author's Kit of First Specified parts, YOURS FOR including Ready-drilled Metaplex Chassis, less Valves, Cabinet, Speaker and Headphones. 7/6. Balance in 7 monthly payments of 7/9.

- KIT "B" Cash or C.O.D. £3:7:3 Carriage Paid. Or 10/- down and 7 monthly payments of 9/3
- KIT "C" Cash or C.O.D. £4:6:9 Carriage Paid. Or 12/6 down and 7 monthly payments of 12/-

£4 SUPERHET 4 BATTERY VERSION KIT "A" CASH or C.O.D. £4:4:0 Carriage Paid. Or 7/6 down and 11 monthly payments of 7/9

POST THIS COUPON NOW

PETO-SCOTT CO., LTD., 77, Pr.W. 16, City Road, London, E.C.1. Tel.: Clerkenwell 9406/7. West End Showrooms: 62 (Pr.W.16), High Holborn, London, W.C.1. Please send me CASE/C.O.D./H.P. NAME ADDRESS Pr. W.10 I am interested in Please send me full details without obligation.

W.B. STENTORIAN SENIOR Model 36S. New improved Micro-tone device, giving extended frequency range. Perfectly matches any output. Cash or C.O.D. Carriage Paid, £2/2/0, or 2/6 deposit and 11 monthly payments of 4/-. W.B. Stentorian Junior Model 36J. Cash or C.O.D. Carriage Paid, £1/12/6, or 2/6 down and 11 monthly payments of 3/-. W.B. Stentorian Baby Model 36B. Cash or C.O.D. Carriage Paid, £1/3/6, or 2/6 down and 10 monthly payments of 2/6. ROLA F 620 P.M.T. SPEAKER. Dustproof construction. Suitable for all outputs and fitted with universal transformer. Cash or C.O.D. Carriage Paid, £1/19/6. Balance in 11 monthly payments of 3/-. BLUE SPOT POPULAR P.M. SPEAKER. Universal matching transformer. Cash or C.O.D. Carriage Paid, 19/6. Balance in 8 monthly payments of 2/6.



FROM STUDIO TO LISTENER—6

Describing the Process of De-modulation or Rectification, with Details of Various Types of Rectifier. By IDRIS EVANS

THE high-frequency oscillations picked up by the receiving aerial and amplified by the high-frequency amplifier (as mentioned in last week's article) are too rapid to cause vibration of the receiving telephone or loud-speaker diaphragm. Before the speech or music passed to the microphone in the transmitting studio can be reproduced at the receiving end it is necessary to separate the low-frequency speech currents from the high-frequency carrier wave. The correct term for this process of separation is de-modulation (the opposite to the process of mixing or modulation in the

being similar to that produced in crystal metal combinations. It is not yet clearly understood why the crystal allows current to pass in one direction and not in the other, and as there are so many confusing explanations given, it is not intended to try to explain its action here.

The circuit arrangement of a simple crystal detector receiver is shown in Fig. 1. The high-frequency oscillations are passed from the tuned circuit comprising the tuning condenser and coil to the crystal, which has the effect of

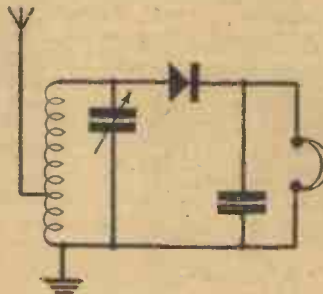
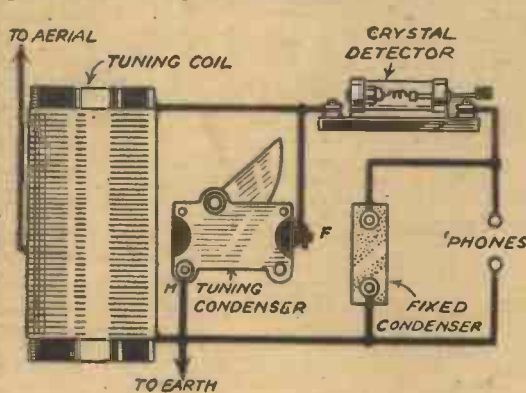

Fig. 1.—Wiring diagram and theoretical circuit for a simple crystal receiver.

transmitter), but it is commonly known as detection or rectification, and the portion of the receiver which fulfils this function is commonly known as the detector stage.

The Crystal Detector

Any conductor which allows current to pass more easily in one direction than in the other will act as a rectifier. Several devices have been tried to produce the required rectifying effect, such as the coherer and magnetic detectors in the early years of wireless, and more recently the crystal and valve rectifiers. The earlier types will not be discussed here, as they are no longer used in practice, but as the crystal detector still enjoys a certain amount of popularity among beginners it will be briefly described.

It is found that certain crystalline substances form a conducting path when in contact with other substances, the resistance of which is different for different directions of current. Some crystals require a metal contact (e.g., carborundum), whereas others work better when in contact with another type of crystal (e.g., bornite and zincite). It is probable that experiments with various crystal-metal combinations produced the most recent addition to the various rectifier types—the Westector. This constitutes a series of metal plates making contact with oxidised plates, the result

cutting the lower half of each oscillation, as shown at B in Fig. 2. Referring again to Fig. 1, it will be noted that a condenser is connected across the telephone. The purpose of this component is to smooth out the very rapid pulses shown at B in Fig. 2, leaving the comparatively slow pulses shown at C. These pulses represent the sound at the transmitting end, and are sufficiently slow to enable the telephone diaphragm to vibrate, thereby reproducing the original sound.

The Valve Detector

Most readers will probably have noticed that the current consumption of the receiver can be reduced by plugging the G.B.—lead of the output valve into a higher socket of the G.B. battery, and a point can be reached at which the anode current taken by the output valve is reduced to zero. This effect is produced because the voltage applied to the grid regulates the anode current passed by the valve, and can be made use of when a valve is to be used as a detector.

Anode Bend Rectification

If a fixed negative voltage is applied to the grid of the detector valve so that the anode current is nearly zero when no signal is being received, the positive half of the high-frequency oscillation passed on from the aerial or the high-

frequency amplifying stage will have the effect of reducing the negative voltage on the grid, and therefore the anode current will rise. When the negative half of the oscillation comes along, however, the grid cannot be made more negative as maximum negative voltage is being applied from the grid bias battery, and therefore the negative half oscillation will have little effect on the anode current. The result of this is the formation of rapid pulsation of plate current, as shown at B in Fig. 2. By connecting a condenser having a capacity of approximately .0003 mfd. between the anode of the valve and the filament circuit, these rapid pulsations can be smoothed, resulting in the low-speed pulsations shown at C. These will operate a telephone diaphragm or may be passed through an amplifying stage to a loud-speaker. The absence of the above-mentioned smoothing condenser results in distortion, and therefore unless a differential condenser is used, the reaction condenser must not be left at minimum setting during reception, unless, of course, a fixed condenser is also connected across anode and filament of the detector valve.

Grid Rectification

The anode-bend method of rectification described above is not very commonly used nowadays owing to its lack of sensitivity to weak signals; what is known as grid rectification is more commonly employed. With this method a fixed condenser is joined between the detector-tuned circuit and the grid, and a high-resistance leak is connected between the grid and filament of the detector. When a positive alternation is passed to the grid from the aerial, negative electrons are attracted to the grid condenser, and this becomes negatively charged. The negative alternation will not attract any electrons, and therefore the negative charge on the grid-condenser will not be affected. Successive oscillations will therefore tend to make the grid more

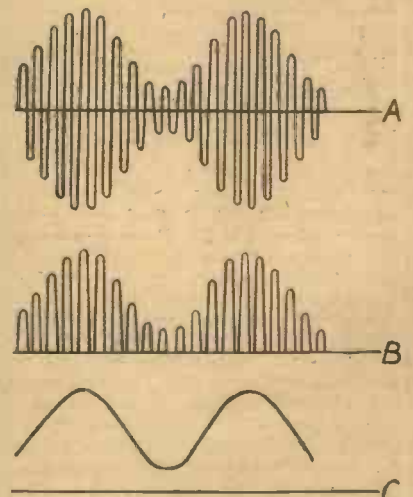

Fig. 2.—Showing the effect produced by the detector.

negative, thus producing a cumulative reduction of anode current. A high resistance is connected between the grid and filament so that the negative charge on the grid can leak away. If this leak has too high a value the negative charge on the grid will become excessive and anode-bend rectification will also occur with resultant distortion.

NEW LAPEL MICROPHONE

ENGINEERS of The Brush Development Company, Cleveland, Ohio, have just introduced a lapel microphone that permits lecturers and after-dinner speakers to move about on the platform—from reading-desk to maps, charts, exhibits, etc., without interfering in any way with the response. This new microphone, known as the BL1, is extremely small—only 1 1/4 in. by 1 1/4 in. in cross section, by 3/4 in. thick. It weighs less than 1 ounce and is provided with an ingenious hooking attachment that enables it to be fastened securely to the clothing. Exceedingly satisfactory reproduction is secured without requiring the speaker to raise his voice above normal conversational levels. Special cushioning of the internal members and the use of a protecting rubber jacket on the case ensures quiet operation. The company reports that there is no interference from breathing noises, cable rattling, the rub of clothing, etc. All the advantages of Brush sound cell operation are secured in the BL1. The instrument is furnished complete with 15 feet of light-weight rubber-covered shielded cable. Additional details can be obtained from The Brush Development Company, Cleveland, Ohio, or from Messrs. R. A. Rothermel, Ltd., Canterbury Road, London, N.W.6.

A NOVEL WAVE-CHANGE SWITCH LIGHT

IN our issue dated January 18th last we published a reader's suggestion for carrying out the operation of wave-changing in conjunction with the change in colour of the dial light and an illustration of the

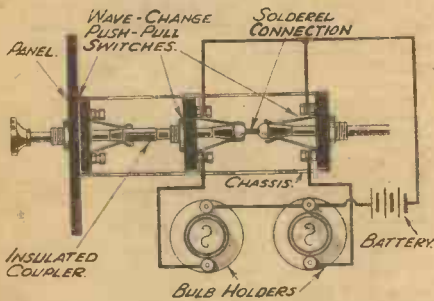

The amended wiring diagram for the wave-change switch light.

reader's switch mechanism was given. Unfortunately, the arrangement which was suggested would not function without slight alteration in the wiring. The amended illustration is given above, from which it will be seen that in order to enable the dial lights also to change over when the coil switching is carried out, the battery supply must be included in the position now indicated. It should be noted that the battery supply should be that which is employed for the valves, and thus the two leads which are shown joined to the battery should actually be taken to the filament terminals on one of the valve-holders. The on/off switch of the receiver will then disconnect the L.T. supply from the dial lights. If a separate battery is employed for these lights, however, an additional on/off switch must be included in the lead to enable the lamps to be switched off when the receiver is not in use.

As they say on the slopes of the Snitzberg:

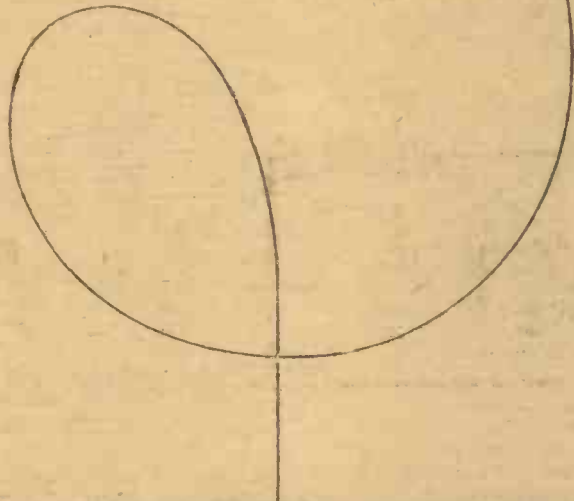

BETTER BUY CAPSTAN.
they're blended better
 - they're Wills's.

CAPSTAN CIGARETTES
 PLAIN OR CORK TIPPED

10 for 6d.
 20 for 11½d

Practical Television

February 29th, 1936, Vol. 2, No. 22.

THE TWO TELEVISION STANDARDS—2

By CRITIC

Modulation Frequency

WHILE there is no definite standard for the percentage of the ultra-short-wave carrier frequency which can be used as the limiting modulation frequency, the present practice is one of 5 per cent. Using the wavelength of 6.6 metres recommended by the Television Advisory Committee, that is a frequency of 45.45 megacycles, 5 per cent. of this is 2.27 megacycles, which accommodates the limiting frequency of the 240-line picture dealt with last week and has a small margin to spare.

On the same calculation 405 lines, 25 pictures per second, with a picture ratio of five horizontal to four vertical (the E.M.I. standard), has a limiting frequency of very nearly 5.1 megacycles, which is right outside the modulation band which can be accommodated on 6.6 metres. The correct wavelength, to give full measure to the benefits conferred by this high line definition, is about 3 metres, this furnishing a spare margin of the order given to the 240-line case. It is therefore reasonable to state that the proposed ultra-short-wave accommodating channel which is to be employed for the initial high-definition tests, while suiting admirably a 240-line picture and giving rein to the full efficiency possible, will not show to full advantage the higher line definition of 405 lines.

Another Important Point

Yet another point arises in connection with limiting factors for the initial high-definition service, being brought about by the fact that the detail along the scanning lines in the direction of scan is limited by the frequency of the amplifiers, particularly those associated with the radio transmitter itself. This is of greater consideration than an appreciation of the improvement in vertical detail brought about by an increase in the number of horizontal scanning lines.

Taking the round figure of 2 megacycles as the frequency channel width, then the number of horizontal elements per line at 25 pictures per second is $\frac{2,000,000}{240 \times 25}$ for a 240-line picture, that is 333 elements. But in a 4 by 3 ratio picture of 240 lines the required elements are $240 \times \frac{4}{3}$, which is 320, therefore the horizontal and vertical detail are almost the same, thus giving a properly balanced television picture. With 405 lines, however, this ratio becomes 0.39, assuming a 5 by 4 picture, and the picture detail balance is in consequence upset very considerably.

Scanning Spot Size

Coming now to the size of the actual spot of fluorescence on the cathode-ray tube screen if overlap is to be avoided between lines, every increase in the number of lines for the picture reproduction means a decrease in spot size. This is not the simple matter it seems if a sharp, truly focused spot is required. With a reasonable-sized picture, say 12ins. by 9ins., the spot size is 0.04ins. and 0.025in. for the two standards which

have been chosen by the Committee. On the other hand, the amateur experimenter will no doubt desire to use smaller cathode-ray tubes on the score of initial costs and possible replacements. Therefore with, say, a picture of 4ins. by 3ins. these two sizes now become 0.013in. and 0.008in.

Complication does not stop here, however, for it is stated that the higher line definition which it is proposed to use will be interlaced scanning, that is 202½ lines at 50 frames per second.

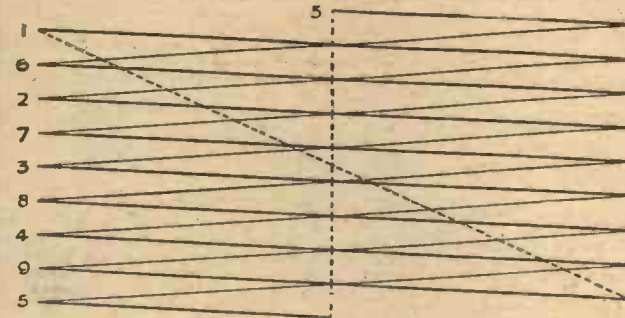

Fig. 4.—The result of combining the arrangements shown in Figs. 2 and 3 (given last week), showing the insertion of one series of lines between the other.

The Orthodox Method

The building up of an orthodox sequential field of scansion lines is now no doubt familiar to readers, but a glance at Fig. 1 which was given in last week's issue will serve to recall what is done. The line 1 is very slightly inclined in the direction of its trace (shown very exaggerated in Fig. 1 for clarity of explanation). A rapid horizontal flyback occurs at the end of the trace when the process is repeated in sequence so that each line is contiguous to its immediate neighbour. At the end of the scan both L.F. and H.F. time bases trigger together and the flyback is made to the point of origin, for the process to repeat itself twenty-five times per second.

Coming now to the other scheme, which results in 202½ lines repeated 50 times per second, it should be mentioned that the term "interlaced" is not the correct one to use. The term "intercalated," however, which was used in one of the original patents describing the idea, leaves no doubt as to the scheme, and for the sake of clarity, therefore, the expression "intercalated" should always be used in preference to "interlaced."

Intercalating

In order to produce an intercalated scan of 405 lines worked 202½ lines 50 frames per second, the L.F. time base pulse generator must work at a frequency which is twice the normal 25 pictures per second standard. The lines of successive scansions are then displaced vertically from each other by one-half the distance between the lines. This will be made clear by a reference to the diagrams. Taking, for the purpose of illustration, a nine-line scan greatly exaggerated, then in Fig. 2 is shown how the first set of lines is built up in a manner similar to the sequential system.

When line 5 is half-way across its total

scanning distance, however, the L.F. time base "trips" and, assuming an instantaneous return, the scanning spot on the screen will move vertically upwards, as shown by the dotted line. The second or intermediate scan is now carried out as in Fig. 3, where, on completion of the final line trace, both time bases trip together and the double sequence of events starts all over again. The combined effect of this intercalated scan really amounts to the insertion of one series of lines between the other as shown in Fig. 4, and owing to the first "trip" taking place after half a scanning line was completed, then theoretically the two sets of lines should just fit one between the other.

An extremely accurate control of the scanning frequencies is necessary, otherwise there is a dithering or shimmering action between the two sets of scansion lines, and this may become a far more distressing effect to watch than any suggestion of a straight flicker. Judged from the point of view of the actual user

of television apparatus, therefore, the decision to work on two standards has not made his task easier, but these points will be capable of investigation when the service starts, and readers can then judge the facts impartially for themselves.

TELEVISION NOTES

Those Olympic Games

IN order to whet the appetites of those who desire to know how television can be applied to the portrayal of sporting events, preparations are now being undertaken by the German Postal Ministry, in conjunction with the organising committee of this year's Olympic Games, so that the most important events can be televised. This will be the first occasion on which such a transmission has been attempted on high-definition standards, although exterior scenes have been shown in a crude form on the thirty-line and multi-zone basis. The standard of definition is to be one of 180 lines, 25 pictures per second, and although no definite decision has yet been arrived at it is hoped to use direct electronic scanners for the purpose. If this does not materialise then the Post Office intermediate film van will come into action.

Programme Distribution

AT a recent company meeting held in Glasgow the chairman stated that the distribution of television programmes by wire was being watched carefully with a view of applying it to relay systems. At the moment this is not feasible owing to the complete mutilation of the signal by the characteristics of the ordinary telephone wire.

RADIO CLUBS AND SOCIETIES

Club Reports should not exceed 200 words in length and should be received First Post each Monday morning for publication in the following week's issue.

THE SHEFFIELD SHORT-WAVE CLUB

THE above club has reopened after the Christmas recess, and five meetings have been held up to the present. On January 22nd Messrs. Stones demonstrated to us the G.E.C. Overseas G Superhet Allwave Set. Many American stations were heard. Morse practice is given each week to those who require it. On February 5th the Secretary demonstrated some interesting apparatus, including an oscillator, and flashing neon capacity and resistance measurer. New members are welcome and are invited to write to Mr. D. H. Tomlin, 32, Moorsyde Avenue, Sheffield, 10, for particulars. The meetings are held every Wednesday at 8 o'clock in the Wharfedale Hotel, West Street, Sheffield.

THE CROYDON RADIO SOCIETY

THAT technical talks are popular was proved by the good attendance at the meeting on Tuesday, February 11th, in St. Peter's Hall, S. Croydon. The occasion was a lecture by Mr. R. Bettridge, of the Marconiophone Co., on "More about Valves." Particularly interesting was his account of why the triode hexode was preferred to the more usual heptode as a frequency changer. For one thing, it avoided "pulling" or interaction between the circuits. The triode hexode had other uses, such as in a modulated oscillator or beat-frequency oscillator.

Low loading was also interesting enough, dealing as it did with the system whereby more power could be obtained from a pair of output valves. For instance, a pair of P.X.25a valves in parallel, normally giving 17 watts, could, by the low-loading method, be persuaded to give 32 watts.

There were plenty of other valves to talk about. Mr. Bettridge preferred the double diode as a detector by itself and not incorporated with a double-diode triode. The double-diode H.F. pentode did quite a lot of work. Its pentode performed H.F. amplification, its diode the detection, and its pentode also functioned for L.F. amplification. In addition to all that, the diode was performing A.V.C.

An ever-popular loud-speaker night takes place on Tuesday, March 3rd, and interested PRACTICAL AND AMATEUR WIRELESS readers are invited to attend and to bring along any loud-speakers for comparison.—Hon. Pub. Sec., E. L. Cumbers, Maycourt, Campden Road, S. Croydon.

BRADFORD SHORT-WAVE CLUB

THE above club, which was formerly the "Sphere Short-wave Club," now holds its meetings at Bradford Moor Council School every Friday evening. The club will be pleased to arrange demonstrations of receivers, and short-wave equipment with any firm who cares to send along the apparatus.

We also welcome new members, and anyone interested. All communications to be addressed to the Secretary, G. Walker, 33, Napier Road, Thornbury, Bradford, Yorks.

SOUTHEND AND DISTRICT RADIO AND SCIENTIFIC SOCIETY

AT a meeting held at the society's headquarters, Cotgrove's Restaurant, 16, High Street, Southend, on January 31st, Mr. W. D. Davies, of Ekco Works, gave an interesting lecture entitled "The Moulding of Synthetic Resins." The lecturer described the chemical constituents of various moulding materials, such as bakelite and beetle, and gave details of the process of manufacture from the preparation of moulding powders to the pressing of the finished articles. He also described the tests carried out on moulded insulating materials. A large number of synthetic resin products were exhibited, ranging in size from caps for tooth-paste tubes to bakelite draining boards and tables. An interesting film illustrating the manufacture of Beetle products was shown by courtesy of the manufacturers concerned.

A series of lectures on Television has been arranged and the Hon. Secretary, Mr. F. S. Adams, of "Chippenham," Eastern Avenue, Southend-on-Sea, will be pleased to hear from prospective members. The society is fully licenced for experimental transmission, and is now affiliated to the Radio Society of Great Britain.

LEICESTER AMATEUR RADIO SOCIETY

ON February 4th this society held a loud-speaker evening, which proved highly popular. Besides entries from a dozen members, we were indebted to the various makers for the opportunity of hearing the Epoch Domino, Ferranti M1 Plus, Magnavox G6, Rola G12, and W.B. Duplex.—Hon. Sec., W. Winder, Luttermouth Road, Leicester.

OUR FREE CATALOGUE SERVICE

CLIX CONNECTORS

NO constructor should be without the latest Clix lists, which describe and illustrate various small items without which no receiver is complete. There are, for instance, in addition to the well-known valve-holders of the chassis-mounting type, such small parts as aerial and earth socket strips; pick-up and loud-speaker socket strips; mains selector plates; plugs and sockets of various types (which, incidentally, may be obtained plain or with various markings engraved thereon). These lists may be obtained on application to Lectrolinx, Ltd., of 79a, Rochester Row, London, S.W.1.

To save readers trouble, we undertake to send on a postcard, the names of the firms from whom you require catalogues, and address it to "Catalogue," PRACTICAL AND AMATEUR WIRELESS, Geo. Newnes, Ltd., 8-11, Southampton St., Strand, London, W.C.2. Where advertisers make a charge, or require postage, this should be enclosed with applications for catalogues. No other correspondence whatsoever should be enclosed.

from 75 to 300,000 ohms. The complete list or separate leaflets of any of these components can be obtained from F. W. Lechner and Co., Ltd., 61, Spencer Street, Clerkenwell, London, E.C.1.

BELLING-LEE RADIO CONNECTIONS

WHEREVER there are wireless sets Belling-Lee connections will be in evidence, due to the dependability of these well-known fittings. A handy booklet of pocket size is available giving full particulars of the complete range of Belling-Lee connections, including plug-top valve connectors, indicating terminals of the non-rotating type, twin-terminals, wander-plugs, battery cords, plugs and sockets, and mains input-connectors. A series of Belling-Lee pick-ups is also included in the list, together with interference suppressors and H.F. mains chokes. The address is Belling-Lee, Ltd., Cambridge Arterial Road, Enfield, Middlesex.

ROLA SPEAKERS

THESE speakers are well known for their remarkable fidelity of reproduction which is the result of several years of research work. Particulars of a complete range of these speakers are given in an attractive folder issued by The British Rola Co. Ltd., Minerva Road, Park Royal, London, N.W.10. Included in the range are various permanent-magnet and field-excited models, ranging in price from 25s. to 35s.; a Class B speaker amplifier unit; universal extension speakers, and the new Rola High Fidelity Speaker, G.12, which is specially designed for greater power-handling capacity, and is intended for use in theatre and public address systems. Several new and important features are embodied in this instrument which is available for either D.C. or A.C. working.

DUBILIER CONDENSERS

THE latest list issued by the Dubilier Condenser Co. gives particulars of various types of condenser ranging from the small "postage stamp" type at 6d. to the large oil-immersed paper-dielectric condensers which cost as much as 30s. In this large range of types may be found aluminums, mica-dielectric condensers, block condensers, and other types which are found necessary in the construction of battery or mains receivers. In addition there are details of the various types of resistances with current ratings; the standard colour code; Spirohm wire-wound resistances; metallised volume controls; car suppressors and anti-interference devices. The list is free from Dubilier Condenser Co., Ltd., Ducon Works, Victoria Road, North Acton, London, W.3.

BROADCASTER TRADE ANNUAL

THE well-known reference work and guide, "The 1936 Broadcaster Radio and Gramophone Trade Annual," has just been published by "The Broadcaster and Wireless Retailer" of 29, Bedford Street, London, W.C.2, at 5s., post free. It is divided into four major parts. The first deals with trade organisation, the second with radio service and all technical matters of concern to the retailer, the third is a commercial and legal guide, and the fourth contains the directories.

The technical section, apart from reference matter, contains what is, in effect, a thirty-page book of servicing. In simple terms, this deals with the subject from the "A B C" stage to a complete systematic test system. For quick reference, general test notes on both components, and subjects such as A.V.C., are given in encyclopaedia form.

Articles in the technical section deal with the Television Report, the Baird and E.M.I.-Marconi television systems, and the British Standards Institution's recommendations for interference suppression. The third section covers in an equally comprehensive way, commercial and legal matters of moment to retailers. New articles deal with service accounts, and the motor van records obligatory under the Traffic Act. Other pages deal with every subject from the Shop Acts to the P.R.S. and Phonographic Performance Licences, and from the "Industry at Law" to the "Pool" and Phillips-Mullard Licences.

KABI COMPONENTS

INCLUDED in the latest list of Kabi components are duplex carbon potentiometers, multi-contact switches, precision wire-wound potentiometers, and various types of Q.M.B. and toggle switches. There is also a useful range of midgeet wire-wound potentiometers, of the 2, 3 or 4 watt types and ranging

B.T.S. ACKNOWLEDGED THE BEST

Produced by Specialists—
Preferred by Experts

AGAIN SPECIFIED for the

MONITOR 3

B.T.S. SWITCH CHASSIS. Rigidly constructed of Aluminium, Ready Drilled and complete with terminals and multi-contact switch Type M. 6/6

MONITOR 3 ANODE OR AERIAL COIL. Supplied with coloured leads for easy connecting. 5/-



Dotted line shows metal screening cm.

ALL-WAVE H.F. CHOKE

(With Ptfd.)

Fully screened to eliminate any external field. Wound on machined ebony bobbin windings in individual slots of eight to ensure low overall self-capacity. G screened piston. Waveband 10-2,000 metres. Natural wavelength 2,600 metres. 3/6



Slow-Motion REACTION CONDENSER

A condenser providing an extremely fine degree of accuracy, the B.T.S. Slow Motion Reaction Condenser has a variable motion of 10 : 1, attaining perfectly smooth action. Constructed from hard brass, with ball-bearing spindle, knob and pointer. Special low-loss material end-plates. Capacity .0002 mfd. Type RC22. 5/6



Obtainable from all Dealers. In cases of difficulty—send direct.

Send 3d. in stamps for "THE SHORT WAVE CONSTRUCTION" the new B.T.S. Magazine containing 3 latest S.W. Circuits.



BRITISH TELEVISION SUPPLIES LTD.
Television and Short Wave Specialists
Faraday Ho., 8-10, Charing Cross Rd., London, W.C.2
Phone: Tem. Bar 0134-5. Grams: Televiz, Leaque, London

ELECTRADIX

1,000 DYNAMOS of all SIZES in STOCK.

Note this special Bargain!

Type "C" for BUNGALOW, YACHT or CELL CHARGING, 140 watt Enclosed Dynamo, 12/20 v. 12 amps. Ball Bearings, Vee Pulley, Type Q, 25/-, Marine type Switch-board with Ammeter, maximum and minimum Auto Cutout main Switch and Fuses, Field Regulator, 25- or 47/6 the pair. DOUBLE CURRENT GENERATORS, D.C., 600 volts, 100 m/a, and 6 volts 3 amps. 40/-.

ROTARY CONVERTERS. For A.C. sets on D.C. mains. 90 watts output with filter. All in silence cabinet. E. D. Co., as new, 57. Full guarantee.

ELECTRIC TOOLS—A.C. induction motor, flex and plug, 1/25 h.p., 2,800 revs., 18/-; 1/10 h.p. ditto with pulley, fan cooled, 1,500 revs., 35/-.

Motor-grinders ditto, double ended, fitted two emery wheels, 21/-.

Light A.C. Drill 4 1/2 lbs. to 1/2-in. hole, 40/-.

All with flex and plug. Electric Water Pumps, A.C. or D.C., 120 galls. per hour to 0 ft., 67/6. Twin Electric Air Compressors, 55 10s.

Feb.-March Bargain List "N" Free.

ELECTRADIX RADIOS,

218, Upper Thames Street, London, E.C.4.
Telephone: CENTral 4611



RADIO GRAM CABINETS

As supplied to B.B.C.

65/- POLISHED 35/- CABINET FOR No Middle Profits.

Famous maker offers finest Radio Furniture. As supplied to B.B.C., a quality and value impossible to better. Beautifully hand-polished! GUARANTEED Piano-tone acoustically.

DIRECT—on FREE TRIAL (or 10/- monthly) LIST FREE! From makers

PICKETT'S

Piano Tone

Cabinet (P.R.) Works, Albion Road, Bechley Heath, near London.



LETTERS FROM READERS

The Editor does not necessarily agree with opinions expressed by his correspondents.



All letters must be accompanied by the name and address of the sender (not necessarily for publication).

Stations VE9HX and SPW

SIR,—It may interest you to know that some of the news in the article "Leaves from a Short-wave Log" published in the issue of January 18th is inaccurate. The writer says that VE9HX has no identification signal, whereas they actually use a four-chime signal every fifteen or thirty minutes, coupled to the call "CHNS Halifax." Furthermore, their QSL card, just received, gives the power as 200 watts, and not 500. The writer also states that SPW now operates regularly, but this is wrong, for this station has ceased broadcasting for the present.

Stations recently heard and confirmed by QSL card include:—YV8RB, YV10RSC, H11J, H1Z, H14D, VE9DN, OAX4D, HC2RL, COCH, JVE, JVH, JVM, CJRX, TGX, HJ4ABC, TIPG, TIRCC, LSX, XECR, the Abyssinian ETB, W4XB, HJ1ABG, HP5B, YVQ, CRCX, PLP, PMN, HJ1ABE, HJ4ABA, HJ3ABH, HJ4ABE, PRA8, COCO, COCD, etc. The receiver used was an 0-v-2.

In conclusion, I would like to add that anyone interested in short-wave reception in my district will be welcomed to my den at any time if they care to call at the address given below.—FRANCIS A. BEANE (Ridgewell, Essex).

Returning Borrowed Issues!

SIR,—In the issue of PRACTICAL AND AMATEUR WIRELESS for February 15th, page 714, I notice an enquiry for back numbers of this journal. I may say I have been a reader since No. 1, and but for one or two copies which I have lent to experimenters which they have failed to return, I have the complete issues numerically filed. I shall be only too pleased to lend any reader a back number, provided they will return unmutated when finished with. I find the issues in question, viz. January 21/33, inquired for by Mr. Hinks, and also the first combined issue, January 26/35, are intact.—A. NICKLEN (Huddersfield).

[Where one reader has been good enough to loan copies of this journal, we think it is too bad that these copies are not returned when finished with. We hope the readers concerned will take note.—ED.]

A Good D.X. Log

SIR,—We, the undersigned, have pleasure in furnishing a report of reception at this station over a period of a half-an-hour between 2.30 a.m. and 3 a.m. recently.

A world tour was planned and signals were received from Australia, N. and S. America, Europe, and Asia. The Australian and South American catches were commercial CW stations—namely, VJP and LST, whereas with the other continents, both phone and CW were logged, also European and American amateurs were heard on the 40 m. band.

The receiver used is a straight three using American valves, and is mains operated.

Complete log of stations received on this tour were as follows: VJP, Australia; LST, South America; WQO, North America; WIV, North America; VEC, Canada; RKB, U.S.S.R.; RAT2, U.S.S.R.; GEK, (?); VAS, Canada; W8XK, North America; W2XAF, North America; DJC, Germany.

All these stations were CW commercial with the exception of the last three, which are broadcast stations. In conclusion, we should like to voice the opinion of many of your readers in this locality, that the Short-Wave Section should be greatly extended.—K. H. COOK and E. J. BUCHAN (Westcliff-on-Sea).

Back Number of "Amateur Wireless" Wanted

SIR,—I shall be very pleased if any reader could supply me with a copy of *Amateur Wireless* dated 10th November, 1934.—J. G. ANDERSON, 1, Longford Road, Southport, Lancs.

Charging Accumulators

SIR,—In reference to Mr. Robert Bolton's remarks in January 25th issue of PRACTICAL AND AMATEUR WIRELESS, I should like to point out that he is mistaken in his belief that a human body across the "mains" (as indicated in his diagram) would cause a dead short-circuit, and give rise to an unknown, presumably large, quantity of current.

Some time ago I performed an experiment to prove that the resistance of my body to an electrical current was very large. For this purpose I used a 100-volt H.T. battery (capable of supplying a steady current of 10 mA!), a 25,000-ohms variable resistance and a milliammeter (0-15 mA), all being connected in series with my hands through a pair of large electrodes. Good contact between my hands and the electrodes was ensured by the use of a strong aqueous solution of sodium chloride (20% NaCl).

It was found that the maximum current obtainable with the H.T. battery at the 100-volt tapping (accuracy of voltmeter = ± 10%; 400 ohms per volt) and with the series resistance reduced to zero was about 5 mA with the electrodes held loosely, and about 9.0 mA when gripped tightly.

This means that the resistance of my body when wet, from hand to hand, is $\frac{100}{.007}$ ohms (taking the mean current as 7 mA's), i.e., 14,300 ohms.

If, therefore, I accidentally "shorted" Mr. Bolton's 250-volt mains, the current through my body would only be $\frac{250}{14,300}$ amp., i.e., 17.5 milliamps.

Your correspondent describes a 4 amp. shock through a lamp as "a mild shock." I agree that the shock is mild, but venture to suggest that such a shock is only a 17.5 milliamps one, even assuming the lamp to be shorted by a conductor of zero resistance. In order to obtain a 0.4 amp. shock, the supply would have to be $250 \times \frac{.4}{.0175}$ volts, i.e., 5,725 volts!—D. N. PARKINSON (Oxford).

Philips Iberica (Madrid)

SIR,—In your "Leaves from a Short-wave Log," recently you asked if readers have heard Philips Iberica testing. I have heard him four times on a wavelength of 44.8 m. I sent reports three times and received verification cards.

I heard another Spanish station testing from 23.00 to 23.45 on 28/1/36 on about 46 m. All announcements were in Spanish and reports were to be sent to Madrid when announcing. Mention was made of Telefonica or Telegraphica, Madrid. I have also been receiving CO9GC regularly at good strength for the last fortnight on 48.7 m.—ABBEY ANDERSON (Selkirk).

On the Short Waves

SIR,—I read with interest the report of a new Spanish short-wave station in a recent issue of PRACTICAL AND AMATEUR WIRELESS.

This station I picked up on Friday, the 10th ult. At 23.15 G.M.T., String Band (Records)—R8. At 23.31 G.M.T., song—"I am in Love." The announcer gave out call sign in Spanish: "Montana, Madrid! Attention! La Banda! Hallo, English listeners; Spanish Short-wave Experimental Station. We are testing our modulation. We kindly ask you for reports."

Whilst on the subject of short waves, quite a number of Venezuelan stations are on the 46-52 metre band every evening, but I notice most of them do not give out their call signs and chimes at the precise times except in the case of YV6RV, 46.01 m.

Last week a very strong signal came in from CO9CG, 48.79 m., and at 22.50-23.00 G.M.T. he gives out short-wave reports from listeners in English. Moscow on 45 metres is also on the air Wednesdays and Saturdays at intervals of every half-minute, before 21.40 G.M.T.

I have also two official verification cards from ETB, Imperial Ethiopian Radio Station Telegraph and Telephone Transmitter, Akaki, 8 kilometres south Addis Ababa, 38-44 E, 08 59 00 N.

Call Sign	Frequency	Wavelength
ETA	18.270	16.42
ETB	11.955	25.09
ETD	7.620	39.37
ETG	5.880	51.02

Antennae power max. 3.5 kW. No directional antennae. Broadcast only on special occasions.—T. W. Moss (Exeter).

CUT THIS OUT EACH WEEK.

Do you know

—THAT the term "push-pull" is applied to any stage in which two valves are fed with the same signal but with a difference of 90 degrees in the phase.

—THAT there are many various schemes for obtaining the above out-of-phase signals, and the centre-tapped transformer is the simplest.

—THAT in certain ganging adjustments it is preferable to arrange for certain of the circuits to have very little effect on the tuning, and thus to facilitate the remaining adjustments.

—THAT care should be exercised when choosing an H.F. choke for coupling purposes, or for use in the anode circuit of an S.G. or pentode valve.

—THAT where it is found necessary to use a wire-wound resistor it may be made non-inductive by dividing the winding into two halves and connecting these so that the winding doubles back upon itself.

The Editor will be pleased to consider articles of a practical nature suitable for publication in PRACTICAL AND AMATEUR WIRELESS. Such articles should be written on one side of the paper only, and should contain the name and address of the sender. Whilst the Editor does not hold himself responsible for manuscripts, every effort will be made to return them if a stamped and addressed envelope is enclosed. All correspondence intended for the Editor should be addressed: The Editor, PRACTICAL AND AMATEUR WIRELESS, Geo. Neunes, Ltd., 8-11, Southampton Street, Strand, W.C.2.

Owing to the rapid progress in the design of wireless apparatus and to our efforts to keep our readers in touch with the latest developments, we give no warranty that apparatus described in our columns is not the subject of letters patent.

Facts and Figures

COMPONENTS TESTED IN OUR NEW LABORATORY

Raymart S.W. Accessories

EVERY experimenter appreciates the value of a short-wave condenser and tuning dial which has been developed solely for short-wave work, and the illustration on this page shows one of these items from the Raymart range. The condenser possesses the advantage that it may be mounted on the baseboard in any desired position, and the tuning dial may then be attached to the panel without the necessity for making up packing pieces or mounting brackets. The base of the condenser is of steatite, offering maximum insulation, and in spite of the large amount of metal

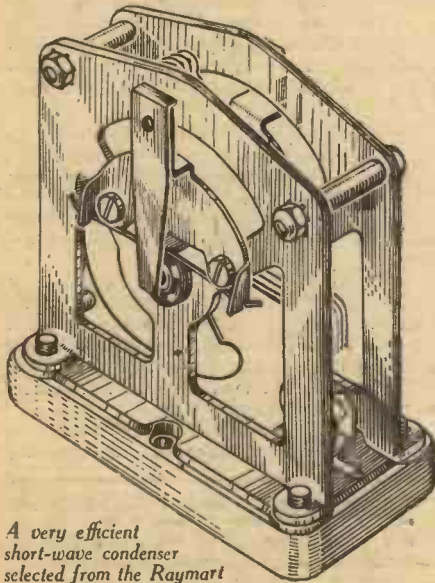

A very efficient short-wave condenser selected from the Raymart range.

in the end plates, these are of such a size and shape that it is not included within the field of the condenser and thus does not lead to loss. A pigtail connection is provided for connection between the rotor spindle and the framework, which should, of course, be employed as the low-potential return connection. All nuts are provided with locking washers to avoid any difficulty due to looseness through vibration, etc., and the stator section is mounted direct on the steatite base, with projecting soldering lugs for connection purposes. The illustration shows the single unit, having a maximum capacity of .00015 mfd., but it is also available in a dual unit

having two matched sections. The insulation is of such a high degree that the condenser may safely be used on circuits at potentials up to 1,000 volts. The single unit costs 4s. 6d. and the double unit 5s.

New Philco All-wave Aerial

THE widespread interest now manifest in all-wave radio reception again emphasises the importance of an efficient aerial, for without this even the most carefully-designed receiver cannot give anything like the performance of which it is capable. Moreover, reception on various wavebands calls for an aerial of variable characteristics.

To ensure maximum performance from their sets and those of other makes, Philco are now producing special British-made all-wave aerial kits. The automatic aerial selector type for Philco all-wave models is 22s. 6d., and that for all other models 27s. 6d., which includes a receiver transformer to compensate for the absence of an automatic aerial selector as fitted to Philco receivers.

The new Philco type is claimed to be the first standard aerial suitable for satisfactory operation on wavebands covering wavelengths between 13 and 3,000 metres. The aerial proper combines (a) a $\frac{1}{2}$ -wave short-wave aerial and (b) inverted "L" long-wave aerial which can be varied in length.

Signals picked up by either aerial section are conveyed to the receiver by means of a low-impedance transposed transmission line, which conveys signals to the receiver with practically no loss, contrary to the usual type of aerial lead-in. In addition, the transmission line, by means of its construction and method of use, eliminates practically all man-made static radiating from rotating equipment such as motor cars, vacuum cleaners, refrigerators, and so on.

The aerial is an improvement even over previous Philco aerials, especially in that an additional resonating circuit has been incorporated with the automatic reactance switching device, so that an actual increase in signal strength is secured over nearly all parts of the long and medium wavebands, which also employ the low-impedance transmission line.

Bulgin Condenser Microphone

THERE are various features to be considered in the design of a microphone, and many experimenters prefer the

condenser type on the grounds of good quality reproduction and freedom from background noises. This type of microphone is, as its name implies, practically a condenser, consisting of two plates separated by an air space. One plate forms one electrode and is generally designed so that it may be stretched, and it is in this that the principal points in design have to be considered. A natural resonance must be either avoided entirely, or at least made so that it is outside the normal frequency range, whilst the prevention of nodes must also be considered. In the Bulgin microphone which is illustrated below, the diaphragm is of a special metal and is firmly clamped round the periphery, with spacing washers arranged on a flange in the metal casing to provide a separation from the fixed electrode of only a few thousandths of an inch. The case is of cast aluminium and is provided with three slots round the edges so that elastic cord or similar material may be passed through for suspension purposes. It is important to bear in mind that, in view of the small capacity effect which is employed, undue lengths of twisted lead must not be employed between the microphone and the amplifier. Accordingly, it is recommended that a special two-stage amplifier be constructed and housed in a small case in which the microphone is mounted, and leads from the amplifier may then be taken to any additional apparatus. The makers of the microphone supply a diagram of a suitable amplifier for this purpose. The microphone has a practically straight-line response from below 50 cycles up to over 6,000 cycles, and no artificial colouration is introduced. Much depends, of course, upon the design of the "head amplifier" or, in other words, the amplifier to which the microphone is directly connected

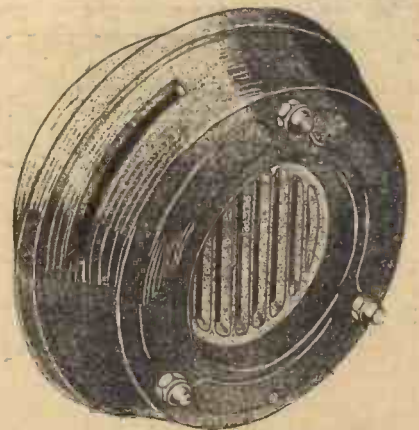

Our artist's impression of the Bulgin condenser microphone, showing the slots for the suspension.

and the maker's instructions should be strictly adhered to with regard to the feed resistance and the general circuit characteristics. The price of the microphone (List No. M1) is 35s.

WHY NOT CHOOSE THE BEST? ★

HYVOLTSTAR ALL WAVE SUPERHET FIVE

Consisting of 8 stages. Covering all Wave Bands from 18-2,000 Metres. HYVOLTSTAR Universal All Waves All Mains A.C./D.C. Models are supreme in every respect, even working efficiently on 100 volt D.C. plants. Quality of tone, beauty of appearance, and the sound construction assure purchasers of a consistently high performance of entertainment. The famous OSTAR-GANZ H.V. Valves fitted. Price of Model illustrated: Chassis 13 Gns. Table Model 17 Gns. Radiogram 23 Gns. Console Radiogram 26 Gns. Console Radiogram with Automatic Record Changer 32 Gns. Send for our New Illustrated CATALOGUE and read the many interesting specifications of all our models. All models obtainable in CHASSIS Form—and can be had ON APPROVAL. Deferred terms or PART EXCHANGE arranged. Write to Dept. "C."

UNIVERSAL HIGH VOLTAGE RADIO, LTD.,

28-29, Southampton Street, Strand, W.C.2. Telephone: TEMple Bar 4985 and 8608.

AN UNSOLICITED TESTIMONIAL

6th December, 1935. Dear Sirs,—I acknowledge safe receipt and good order of my set. It is performing very satisfactorily indeed. May I congratulate you on the accuracy of your advertising, as I decided to obtain this set on your literature alone. I have no regrets. I have been a "listener" since 1928, and have a full appreciation of your set.—R. T. B.

WHY NOT BUILD THE MOST UP-TO-DATE SET?

Universal All Wave KITS for EMPIRE EXCEPTION. Kit Constructors will gain vast knowledge from our FREE Blueprints. 3-Valve All-Wave Receiver Kit, 19-2,000m., £5/0/6. (Valves £2/9/6 extra.) 3 Pentode 4-Valve All Wave Receiver Kit, 20-2,000m., £6/2/0. (Valves £3/7/0 extra.) 6-Valve All Wave Super Kit, 15-2,000m., £9/2/9. (Valves £5/12/3 extra.) Amplifier Kits from ... £3/9/6. S.W. Adaptor Kit ... £2/14/6. Speakers 35/-. Cabinets 2 Gns. Generous Hire Purchase Terms Arranged. LET US MODERNISE YOUR OLD RECEIVER Old Receivers, including Home Made models, converted into up-to-date models for a small cost. Details from Conversion Dept. Results simply amazing. EUGEN J. FORBAT (Dept. "C") 28/29, Southampton St., London, W.C.2. Telephone: TEMple Bar 4985 and 8608.



"What's wrong with my Set I can't think,"
Moaned a wireless-enthusiast named Spink,
"The valves are brand new—"
Said his friend—"very true,
But FLUXITE'S the one 'missing link.'"

See that FLUXITE is always by you—in the house—garage—workshop—wherever speedy soldering is needed. Used for 30 years in government works and by leading engineers and manufacturers. Of Ironmongers—in tins, 4d., 8d., 1/4 and 2/8.

Ask to see the FLUXITE SMALL-SPACE SOLDERING SET—compact but substantial—complete with full instructions, 7/6.

Write for Free Book on the art of "soft" soldering and ask for Leaflet on CASE-HARDENING STEEL and TEMPERING TOOLS with FLUXITE.

TO CYCLISTS! Your wheels will NOT keep round and true unless the spokes are tied with fine wire at the crossings AND SOLDERED. This makes a much stronger wheel. It's simple—with FLUXITE—but IMPORTANT.

THE FLUXITE GUN

is always ready to put Fluxite on the soldering job instantly. A little pressure places the right quantity on the right spot and one charging lasts for ages. Price 1/6.



ALL MECHANICS WILL HAVE

FLUXITE

IT SIMPLIFIES ALL SOLDERING

FLUXITE LTD. (Dept. W.P.) DRAGON WORKS, BERMONDSEY STREET, S.E.1.

IT PAYS TO BUY THE BEST



INTERCHANGEABLE COILS.

New low loss formers of DL-9 high frequency insulation. Rigidly made and each coil matched. First-class results assured. 4-pin coils have two windings. 6-pin three windings. No. 959 6-pin Set of 4 12-170 metres Price 16/- No. 952 4-pin " " " " Price 14/-

Universal Valve-holder



A low loss holder for above or below base-board use. The valve enters the contacts from either side. There is no measurable increase of self capacity to that already in the valve base. DL-9 H.F. dielectric, one piece noiseless contacts. No. 1015 4-pin 1/3d. No. 1016 5-pin 1/5d. No. 1024 7-pin 1/8d.

STRATTON & CO., LTD. Bromsgrove Street, BIRMINGHAM. London Service Depot: Webb's Radio Stores, 14, Soho Street, Oxford Street, W.1.

EDDYSTONE

SHORT WAVE COMPONENTS

REPLIES IN BRIEF

The following replies to queries are given in abbreviated form either because of non-compliance with our rules, or because the point raised is not of general interest.

F. W. F. (Birmingham). A vertical wire with the special arrangement you mention will no doubt prove most suitable in view of the non-directional effects. A good buried earth is advisable, preferably in the form of a mat of copper or zinc gauze. The flux may be taken from a lampholder or a mains-power socket. Any good aerial-earth switch may be employed, preferably of the double-pole change-over type. Plain holes through the window frames are in order, but ebonite tubing should be adopted for the aerial lead, or a commercial lead-in tube obtained.

J. B. Jnr. (Birmingham). A suitable unit may be obtained from the Electrodynamic Construction Co., of 7, Palatine Buildings, Victoria Street, Manchester.

W. H. L. (Penzance). The H.F. unit was probably incorrectly designed or made and should certainly have improved selectivity. The total current shown would be quite correct, as the meter would give the mean reading and not the various intermediate values given by the fluctuating Class B anode current.

T. D. (Swansea). A fuse may be included in the H.T. negative lead, and if you do not wish to interfere with the wiring, a special wander plug, incorporating a fuse, may be obtained from Messrs. Belling and Lee. This should be used in place of the present H.T. negative plug.

F. S. (Plymouth). We cannot supply a diagram of the oscillator, but hope to describe suitable apparatus in a later issue.

A. C. La R. (Amsterdam). The arrangement shown as A in your letter is correct and the reproduction may be affected by the general circuit design. Have you considered the fitting of a tone control?

R. D. G. (Kilburn). You cannot use the eliminator for charging purposes as the output is much too low.

R. J. (Liverpool). It would not be practicable to use the valve in question for a one-valve. There would be no useful way of applying reaction and this would be very important in a one-valve set.

W. B. (Londonderry). It would be quite feasible to use the H.T. unit, and a permanent magnet speaker may be used. Any well-known make will be found suitable.

R. H. (Erith). We have no complete details of the set, but various articles have been given from time to time on the design of this type of receiver.

W. B. (E.C.2). It would appear that you are using your present output valve in the correct manner and your speaker is accurately matched. Thus, the maximum undistorted output is obtained. The comparisons you make are not correct as the push-pull stage, for instance, has a very much lower amplification and would, in addition, require a very much greater input fully to load it. It is also possible that the increased high-note response of the pentode gives an effect of greater power.

P. W. (Dublin). You could not change the two sets, and we can only guarantee the Monitor if you make it with the specified parts. None of the parts of your present set could be used in the Moulton with satisfaction.

J. R. (N.4). The 210 VPT valve is obtainable either with a 4-pin base or a 7-pin base, and for the receiver in question you should obtain the former. If the 7-pin model is obtained it will be necessary to fit a 7-pin valveholder.

P. T. (Manchester). The best plan in your case is to mount small padding condensers across each section, or across the section which fails to hold in matching, and to arrange for these to be operated from the panel. Variables could be used, or ordinary pre-sets with a hole in the panel to enable a screwdriver to be applied to the slotted knobs on these components.

S. T. (Manchester). It would not be wise to carry out the method of modification mentioned by you in view of the fact that the primary winding has to be designed by taking into account the total wattage load of the transformer and thus the voltage outputs would be modified. Resistance loads would be required to bring the new loads up to those for which the transformer was designed. It is not possible to give the length of the wire owing to lack of essential details of the winding.

W. C. (Welling). If the H.T. voltage is too low the application of bias would result in reduced volume. This would also result if the bias you are applying is too great. The possibility of the bias battery being wrongly marked must not be overlooked.

W. T. (Doncaster). You could use the speaker with the set in question, but a triode valve would have to be used in place of the present output pentode in order to feed the Class B stage correctly.

F. W. W. (Stourbridge). Back numbers are obtainable from this office, price 4d.

J. V. C. (Ely). It should only be necessary to connect a 2-mfd. fixed condenser to the anode of the output valve and to join your extension speaker between this condenser and earth. As, however, we have no details of the circuit employed in your set we advise you to communicate with the makers, asking for a circuit diagram, or whether the arrangement mentioned above is applicable to this particular set.

J. B. H. (S.E.2). There are many efficient types of indoor aerial on the market, and we can confidently recommend the Pix tape aerial. This would answer your requirements as it may be stuck on the wall, and will be inconspicuous. No nails or screws need be driven into the walls to hold this in place.

R. C. (Highbury). Do not attempt to make the conversion. You will come up against various snags and the receiver should definitely be entirely re-built using the mains valves in question.

A. R. T. (Balham). The Monitor may certainly be recommended for your friends and it should give the utmost satisfaction. You can modify it from time to time as mentioned in our subsequent articles.

F. G. (Gorleston). Selectivity would be quite adequate in your locality, unless you experience severe interference from ships.

Y. P. (Cardiff). Any local dealer can supply the anti-interference aerial outfit.

AN INTRODUCTION TO AMATEUR TRANSMISSION

(Continued from page 758)

the flex is not longer than about 15ft. almost all the R.F. will be transferred to the aerial without radiation taking place.

The receiver is placed near the aerial, and if signal strength is not sufficient a short aerial may be used on the receiver. Coupling the aerial to the plate coil by means of a condenser is not recommended.

All would-be transmitters are advised to join the Radio Society of Gt. Britain. Members can get free advice from a special section of the society which deals with artificial aeriels, and at the meetings amateurs can meet and discuss difficulties, etc.

Newly-licensed artificial aerial transmitters are allowed to work on 1.7, 7 and 14 mc. (160, 40, 20 metres), and it is worth paying a good deal of attention to the 1.7 mc. band, for while such long distances or DX work cannot be covered as on other bands (when the full licence has been obtained) there is less interference or QRM on this band, and reliable working up to 150 miles is possible with 10 watts input, while the U.S.A. and Canada have been worked on this band.

In the next article of this series the self-excited type of transmitter will be discussed.

EASY TERMS

Everything Radio supplied on the lowest terms. Send list of requirements for quotation by return. Prompt delivery.

Cash and C.O.D. Orders Despatched by Return of Post.

W.B. STENTORIAN 36.S

Cash Price £22/2/0, or 2/6 with order and 11 monthly payments of 4/-

36.J

Cash Price £12/2/6, or 2/6 with order and 11 monthly payments of 3/-

ROLA L.S. Units supplied on similar terms.



VALVES (every type supplied)

S.G., Det. and Power, any make. Cash price £1.5.0, or 5/- with order and 5 monthly payments of 4/6. ALL CARRIAGE PAID

Estd. 1925 THE NATIONAL 1977

LONDON RADIO SUPPLY COMPANY

11, OAT LANE NOBLE STREET LONDON, E.C.2

36J VALVES

THE VALVE WITH THE SIX MONTHS GUARANTEE!

STONEHAM ROAD, LONDON, E.5. Phone: Clisfold 8607.



QUERIES and ENQUIRIES

Short-wave Aerial Circuit

"I cannot trace an H.F. choke in the catalogue for use in the aerial circuit of the short-wave set. Is any special component necessary? Also can I use an untuned S.G. stage in the circuit."—J. L. (Haslemere).

YOU can certainly adopt the arrangement mentioned, but we do not advise any departure from our published specifications. The H.F. choke may be any standard component, and it is not a special item designed for the purpose. In place of the choke a resistance may be employed and is, in fact, adopted by some designers. You should, however, in this particular case adopt the choke specified in our list of parts.

Energising Current

"I am building a mains set as on the circuit which is enclosed with my letter, but am doubtful regarding the speaker field. This has a resistance of 6,500 ohms, but I cannot afford to waste so much voltage across this, as my mains section only delivers an output of 300 volts. Would it not be permissible to connect a special iron-core choke in parallel with the field so that the total voltage drop is reduced without losing the smoothing of the field?"—G. F. (Barnstaple).

THE arrangement referred to, namely, connecting a choke in parallel with a field may often be adopted in the H.T. smoothing circuit, but in the specific case you mention we are afraid that nothing but disappointment would result. Firstly, the high resistance of the field would mean that a similarly high value of choke would have to be paralleled to leave a moderate value for avoiding undue voltage drop. The result of this would be that the current flowing through the field would be rather on the low side, and thus the energising current would fall very much short of that recommended by the makers. The result of this would be that the sensitivity of the speaker would fall off, and thus you would probably find that a small permanent magnet speaker would be more sensitive.

Using an Eliminator

"I note in to-day's issue of 'Practical and Amateur Wireless' that you point out that an eliminator may be unsuitable for the £4 Superhet. I think your readers who contemplate making this receiver would welcome more particulars about this point, especially as this set seems a rather difficult one to tune up correctly."—R. W. J. (Hitchin).

FIRSTLY, we cannot agree that the receiver is difficult to tune up. It is certainly tedious to some, but many constructors will agree that this act of tuning-up is the most interesting part of the actual making up and using of the set. However, that is perhaps a personal preference. With regard to the eliminator problem, you will see that there are two H.T. positive connections to be made to this receiver, and one of these supplies the screening grids of the first two valves.

If the eliminator is fitted with an output marked S.G. or 60-80 volts, it might be found on using this tapping for the H.T.1 supply that instability would be introduced. It is for this reason that we state that an eliminator might prove unsuitable. If it is essential to use an existing mains unit which gives inferior results, the various points which are connected to the H.T.1 tapping should be connected through decoupling resistances to the H.T.2 line, with condensers joined to earth in the usual manner to complete the circuit. In any case where disappointment arises when a mains unit is employed, the receiver should be tested with a dry battery, with

RULES

We wish to draw the reader's attention to the fact that the Queries Service is intended only for the solution of problems or difficulties arising from the construction of receivers described in our pages, from articles appearing in our pages, or on general wireless matters. We regret that we cannot, for obvious reasons—

- (1) Supply circuit diagrams of complete receivers.
- (2) Suggest alterations or modifications to receivers described in our contemporaries.
- (3) Suggest alterations or modifications to commercial receivers.
- (4) Answer queries over the telephone.
- (5) Grant interviews to querists.

Please note also, that queries must be limited to two per reader, and all sketches and drawings which are sent to us should bear the name and address of the sender.

If a postal reply is desired, a stamped addressed envelope must be enclosed. Send your queries to the Editor, PRACTICAL AND AMATEUR WIRELESS, Geo. Newnes, Ltd., 8-11, Southampton Street, Strand, London, W.C.2.

the correct voltages, in order to narrow down the cause of the difficulty, i.e., whether the receiver is at fault, or the mains unit.

Chassis Construction

"I want to replace my present two-valve set with the Monitor 3 and should like to know whether the two valves I have may be employed. They are PM1HL and PM2A. Also, having never used a metal base, would you kindly give elementary instructions how a beginner can avoid serious blunder, such as short circuit, etc.? Must the metal be cut clear away from the screwed parts, and it is not understood why some connecting wires go straight to MB, e.g. No. 26, although it is assumed in this case that there is an external earthing wire, or isn't there?"—A. W. P. (Orpington).

THE characteristics of your valves are not the same as those of the specified components, but they could be employed. We could not guarantee that you would obtain the same performance with this substitution. With regard to the chassis, this is not entirely metal, but consists of a wooden framework which is sprayed with metal under pressure, thus imparting to the entire surface a complete film of metal. This is conductive so far as H.F. currents are concerned, and will also carry a certain amount of ordinary D.C., but it should not be relied upon for this latter purpose. In the case of the mounting brackets it is sometimes necessary to scrape away the

metal surface, but such instructions are always given in our constructional articles; and in the Monitor no such scheme has to be adopted. You can screw down all components with perfect confidence, and the only precaution (as mentioned in the article) is in connection with the mounting of the bracket on the under side of the chassis which accommodates the reaction condenser. The screws used to hold this bracket in position must be short so that they do not penetrate the wood and make contact with the metal surface on top. The points marked M.B. are common earth points, and connection at these points is made by passing a bolt through the chassis or fixing a loop of wire beneath a screw head. An ordinary earth connection is employed and is joined to the earth terminal in the usual manner.

The Duplex Coil

"I am building your short-wave three as described in the 'Television and Short-wave Handbook,' but although I have obtained all of the components easily, I cannot get the Duplex coil and eight-pin holder. Every shop I have been in have told me that they have never heard of it, so I would be much obliged if you would tell me what firm makes them, and the prices."—R. T. (Brockley, S.E.4.)

THE Duplex coil is manufactured by Messrs. J. J. Eastick and Sons, of Eelex House, 118, Bunhill Row, London, E.C.1. The price of the coil is 2s. 6d., and the special eight-pin coil holder costs 1s. 6d.

Fitting a Pick-up

"I have a five-valve portable suitcase type wireless set about three and a half years old. There is no place to fit a pick-up and I would like to know how I can use one."—A. F. (Godalming).

IF you do not wish to open the receiver and connect the appropriate terminal and switch for the pick-up, the simplest solution is to obtain one of the pick-up adapters which is plugged into the valve-holder, and the valve is then inserted into the adapter. Terminals are provided on the adapter for the purpose of connecting the pick-up. Alternatively, if you wish to make a permanent connection, one side of the pick-up should be joined to a grid (depending upon the volume required and the sensitivity of the pick-up) and the other side of the pick-up should be connected to a tapping on the grid-bias battery. The voltage employed will depend upon the valve and the valve-makers' instructions should be followed.

£5 Superhet

F. B. (HARROGATE) and others.—The issue in which a description was given of the modification necessary for coils other than those specified in the receiver is now entirely out of print, and we regret that we are unable to supply any back numbers or additional information regarding this matter. In any case, it is pointed out that the Telsen coils are now obtainable from the new Telsen Company at Fitzgeorge Street, Manchester 9.

FREE ADVICE BUREAU COUPON

This coupon is available until March 7, 1936, and must be attached to all letters containing queries.
PRACTICAL AND AMATEUR WIRELESS,
20/2/36.

Miscellaneous Advertisements

Advertisements are accepted for these columns at the rate of 3d. per word. Words in black face and/or capitals are charged double this rate (minimum charge 3/- per paragraph). Display lines are charged at 6/- per line. All advertisements must be prepaid. All communications should be addressed to the Advertisement Manager, "Practical and Amateur Wireless," 8, Southampton Street, Strand, London.

RECEIVERS, COMPONENTS AND ACCESSORIES

Surplus, Clearance or Secondhand, etc.

PREMIER SUPPLY STORES

PREMIER SUPPLY STORES

PREMIER SUPPLY STORES

ALL previous bargains advertised are still available. Send 3d. for large illustrated catalogue including Bargain Supplement.

WORLD Famous Continental Valves, mains type, 4/6 each H.L., L.; screen grid: variable mu screen grid; 3, 3 and 4 watt A.C. output directly heated pentodes; 250-volt 60 m.a. full wave rectifiers, V.M.H.P., D.D.T., diode tetrodes, A.C., D.C. types, 20 volts, 0.18 amp., filaments; screen grid; variable mu screen grid; H., H.L., power and pentodes. THE Following Types, 5/6 each: 350v. 120 m.a. full wave rectifiers, 500v. 120 m.a. full wave rectifiers, 21 watt indirectly heated pentodes.

2-VOLT H.F., L.F., 2/3; power, low consumption power, super power, 2/0; screen grid, variable mu screened grid, 5- or 4-pin pentodes, V.M.H.P., H.F.P., Class B, 5/-. THE Following American Types, 4/6: 250, 210, 245, 47, 40, 24, 35, 51, 57, 58, 55, 37, 80, 6A7, 2A7, 27, 77, 78, 2A5, 281; all other American types, 6/6 each.

PREMIER Kit of Parts for 1 Valve 14/150 metres receiver or adaptor, complete with coils, chassis, and circuit, 12/0.

SPECIAL Offer. Bargain Parcels. Every parcel is amazing value, being genuinely worth several times its cost; available in 5/-, 10/-, 20/- Parcels.

LISSEN Ganged Bandpass Coils, set of 3 with integral switching, 6/11, or complete with 4v. chassis. Valveholders, 3-Gang Condenser and Drive, 14/6, Circuit supplied.

PREMIER SUPPLY STORES

20-22, High St., Clapham, S.W.4 (Phone: Maccaluy 2381), and 165, Fleet St., E.C.4 (next door to Anderson's Hotel). Phone: Central 2833.

Vauxhall—Polar Midget 3-gang condensers, straight or superhet., 8/9; Polar full vision, horizontal or Arcuate dial and drives, 4/6.

Vauxhall—Polar station named scales for horizontal dials, latest settings; 1/9 each.

Vauxhall—Flat, sheet aluminium, hard rolled, 18 gauge, 12in. x 12in., 2/6; 18 x 18, 5/-. Other sizes pro rata.

Vauxhall—Set manufacturers' surplus, skeleton type Westinghouse rectifiers, H.T.8, 9/6; H.T.9, H.T.10, 10/-; complete with fixing brackets; Westectors, W.4, W.X.6, 5/0.

Vauxhall—Eric Resistances and other well-known makes, 1 watt types, all values, 6d. each.

Vauxhall—T.C.C. electrolytic condensers, 8 mfd. and 4 mfd., 550 volt, 3/-; 500 volt, 2/6; 450 volt, 2/5.

Vauxhall—T.C.C. condensers, tubular, non-inductive, 0.1, 6d.; 50 mfd., 50v. working, 1/6; 50 mfd., 15v., 1/3; 0.05, 6d.; 0.002, 0.0002, 0.001, 0.0001, 4d. each.

Vauxhall—T.C.C. mica 0.002, 2,000 volt test, 10d.; 0.0001, 4d., 0.001, 0.01, 1/-; 1 mfd. Mains-bridge, 1/3.

Vauxhall—Centre-tapped, iron-cored I.F. transformers. Mounted on bases, with terminals, 110 kc/s, 6/6.

Vauxhall—Colvern G.1, G.2, G.3, or G.1, G.2 and G.8 superhet. type, 30/-; Colpaks, £2/4.

Vauxhall—Volume controls, Eric, Colvern, Centralab, 2/-; with switch, 3/-; all values, from 3,000 to 2 meg.; Benjamin, class "B" transformers, 1-1 1/2 to 1. 6/6.

Vauxhall—B.T.H. Minor, 18/6; Senior needle armature, 20/-; Picozo-Electric, 33/9.

Vauxhall—B.T.H. Trusped gramophone motors, 30/-; Universal D.C./A.C., 4/7/6; sealed cartons.

Vauxhall—Collaro 32 model, 32/6; Universal model, 47/6; complete unit, A.C. 200-250v., first quality pick-ups and volume control, 48/-.

Vauxhall—T.C.C., 200 mfd., 10-volt, 3/-; Continental valve holders for Universal valves, with terminals, 9d.

Vauxhall—Clx valve holders, terminals, 7-pin 9d.; 5-pin 7d., W.B. 5-pin 4d.; baseboard mounting, 6d.; post paid 2/6 or over, or c.o.d.

Vauxhall UTILITIES, 163a, Strand, W.C.2 over Denny's the Booksellers, Temple Bar 0338. Send postcard for lists free.

GOLDEN OPPORTUNITY!

HALL MARK 3 KITS

ORIGINALLY £2:5:0 TO CLEAR 27/6

ONLY A FEW LEFT. Send your Order NOW for a Hall Mark 3 Kit, as described in "Practical Wireless" Dec. 8th, 1934. One of the most successful of Mr. F. J. Camm's circuits.

FREE BLUEPRINT WITH KIT EACH KIT

Complete Kit of guaranteed MATCHED and TESTED components, including Peto-Scott ready drilled Metalex chassis, less valves and cabinet. Original price, 45/-, TO CLEAR 27/6 Cash or C.O.D. carriage paid, or 5/- down and 5 monthly payments of 5/-. If required, with set of 3 BRITISH valves, Cash or C.O.D., carriage paid, £2 8s. 3d., or 10 monthly payments of 5/3.

NEW TIMES SALES Co. 58, (Fr.W.10.) Ludgate Hill, London, E.C.4.

EASY PAYMENTS

"THERE'S NO PLACE LIKE HOLMES."

Table with columns: SPEAKERS, Deposits, Monthly Payments. Includes items like W.B. DUPLEX, W.B. SENIOR, W.B. JUNIOR, BLUE SPOT, ROLA F. 720.

Any make of speaker supplied.

Table with columns: KIT SETS, Price, Deposits, Monthly Payments. Includes items like LISSEN Skyscraper 3, GRAHAM FARISH STENTORIAN A, GRAHAM FARISH Sensity Super, B.T.S. OCEANIC 3, B.T.S. S.W. ADAPTOR.

ACCESSORIES

Table with columns: ACCESSORIES, Price, Deposits, Monthly Payments. Includes items like 3 VALVES S.G.D.F., ATLAS ELIMINATOR T. 10/30, AVOIMHO METER, B.T.S. LATEST PICK-UP.

New goods obtained for every order. Send us a list of parts or valves you require or any speaker or set you may select and we will forward you a definite quotation. Ten years advertiser in the Wireless Press. Thousands of satisfied customers.

H. W. HOLMES: 333, EUSTON ROAD, LONDON, N.W.1. Phone: Musetta 1414.

"ENGINEERING OPPORTUNITIES" FREE! This unique Hand-book shows the easy way to secure A.M.I.C.E., A.M.I.Mech.E., A.M.I.E.E., A.M.I.A.E., A.M.I.W.T., A.M.I.R.E., and similar qualifications. WE GUARANTEE—NO PASS—NO FEE. Details are given of over 150 Diploma Courses in all branches of Civil, Mech., Elec., Motor, Aero., Radio and Television Engineering, Building, Government Employment, etc.

RECEIVERS, COMPONENTS AND ACCESSORIES

Surplus, Clearance or Secondhand, etc.

THE following unused set, manufacturers' Surplus; all goods guaranteed perfect; immediate delivery. MAGNAVOX speakers complete with hum-bucking coil, output transformers, etc. DC152 (9in. cone), 22/6. DC154 (7in. cone), 10/-. All with 2,500 or 6,500 ohms fields.

REGENTONE transformers for HT8 or HT9, with 4v. 4 amp. L.T. winding, 7/-. Eliminators, first-class make. Outputs 150v. 25 ma., S.G. and Detector. A.C. type with Westinghouse rectifier, 25/-. A.C. type with 5 amp. trickle charger, 30/-. D.C. type, 12/6.

DUBILIER or TCC dry electrolytic condensers 8 mfd. or 4 mfd., 500v. working, 50 mfd., 50v., 200 mfd., 10v., 3/3. 50 mfd., 15v., and 15 mfd., 100v., 2/3. 50 mfd., 12v., 2/-. TCC type "M" condensers, any value up to .001 mfd., 6d. Eric resistances, 1 watt type, 7d., 2 watt, 1/2, 3 watt, 1/9. Send for comprehensive list.

CONVERSION Units for converting D.C. Receivers to A.C. Mains operation up to 80 watts, £2 each. WARD, 46, Farringdon Street, London, E.C.4. Telephone: Holborn 9703.

BIRMINGHAM RADIOMART SHORT-WAVE SPECIALISTS

Proprietor, G5NI. Manager, G2AK. Staffed by experienced transmitting amateurs. Obviously we can serve you better.

CAUTION: Beware of coilforms, etc., moulded in cheap bakelite. Our coils and formers are guaranteed efficient.

4-PIN interchangeable short-wave coils; set 3. Cover 15-100 metres, latest ribbed former, 7/9. 1-IN. ribbed short-wave coil forms; valveholder 1/2 type, lotces, 4-pin, 1/6. 6-pin, 1/0. Threaded for winding, 2d. extra.

UTILITY 8/6 microdisc dials, fitted famous micro high reduction, only perfect short-wave dial, 3/11.

SHORT-WAVE H.F. chokes, 9d. Wireless World states: "Very efficient—100 to below 10 metres."

UTILITY microvariables, 15, 40 mfd., 1/-; 100 mfd., 1/3; 465 kc/s litz wound L.F.s, 5/6.

RADIOPHONE super ceramic insulated short-wave condensers, .00016, 3/8; series cap, 3/9.

CONTINENTAL A.C. valves, 4/6, VMPT, HPT, VMSG, AMSG, ACH, ACHL, PT4. Most American types, A.C. Pen., 5/6.

2 V. types, H.F. detector, L.F., 2/3; LP2, P2, 2/0; Supower, 3/3; VMPT, HPT, 5/6; Class B, 4/6; S.G., VMSG, 5/-. BARGAIN parcel value 30/-, containing binocular HFC, 4 750v. test condensers, 6 resistances, 4 valveholders, .0003, .0005 variable, electrolytic condenser, etc., 5/-. Traders' parcel, £4/10/0 value, 10/-.

SPECIAL Set Lissen 3-gang superhet coils, two Lissen I.F.s, 3-gang superhet condenser; value 68/- for 10/-.

CABINETS. Climax horizontal set and speaker cabinets, 2/11. Vertical, 3/9. Part postage 6d. extra. Ecco chromium set stands, 12/6.

TELSEN 7/6, Ace transformers made for leading company, boxed, 1/11.

BALL-BEARING air-spaced condensers; World's finest manufacturers 4-gang, 3-gang superhet, 1/11.

NON-INDUCTIVE condensers by leading makers. T.C.C., Dubilier, etc., 0.5, 0.25, 0.1, 0.02, 0.005, 3d.

ASTOUNDING offer electrolytic condensers, 4-4 mfd. (separate) 500v., working, 1/6. 8+8 mfd., 3/6; 8+16 mfd., 3/11.

GENUINE 15/6 Frost potentiometers, wire-wound, tapered, 10,000 ganged to 50,000 ohms, 1/6.

LISSEN 2-gang coils, 12-2,000 metres, switched and screened, nothing else required to convert 8G3 to all-wave, 12/6.

LISSEN 3-gang bandpass superhet coils, 4/6; 3-gang bandpass Tuned grid, 6/11. All with circuits.

AMPLION, 3/6; screened H.F. choke, 1/11; Iron-cored binocular, screened, 2/3. Climax binocular, 1/3. Telsen, 1/11.

UTILITY 2-gang .0005 Unlknob with large disc drive, 3/11. Ditto, single, with disc, 2/3.

LISSEN 30hy., 40 ma., chokes, 2/-; 20 hy., 100 ma., 2/11. Lissen eliminators chokes, 1/3.

GRANIC tapered potentiometers 1/2-meg., 1-meg. with 3-point switch, 2/-. Centralab, 1/6-meg., 2/-. GROSS roundhead woodscrews, assorted, 9d. Solder tags, 6d.; resincore solder, 8/11, 6d.

PUSHBACK connecting wire, ready tinned and sleeved, 6yds., 6d. Heavy, for heaters, 9d.

SCREENED Iron-cored selective dual-range coils, with reaction; circuit diagrams, 2/11.

NON-INDUCTIVE tubulars, 1,500 v., 0.01, 0.02, 0.04, 0.05, 0.1, 6d.; 0.2, 0.25, 8d.; 0.5, 9d.

LISSEN 6-way battery leads, with plugs, 6d. Belling-Lee safety mains plug and socket, 6d.

TRANSFORMERS B.T.H. speaker; suit all moving coils, 2/11. Manufacturers push-pull, 1/11.

TUBES, Telsen 1/2-amp., 1-amp., 3-amp., 2d. Telsen, 100 ma., 2d.

TELSEN latest differentials, .0003, 1/3; .00015, 1/- Radiogram transformers, 2/9.

SPECIAL Four assorted Telsen grid-leaks, 5d.: twelve various wire-ended resistances, 2/6.

MILLIAMMETERS; flush 2 1/2in., 5/9; 2 1/2in., 6/9. All ranges above 25 m.a., visual tuning, 6/9.

T.C.C. etc., bias electrolytics, 50 mfd., 50 v., 1/0; 25 mfd., 25 v., 1/3; 15 mfd., 100 v., 1/-; 6 mfd., 50 v., 6d.

RADIOMART

Orders over 6/- post free. Enquirers must enclose stamp.

Catalogues; general catalogue gives hundreds of bargains; short-wave illustrated catalogue also gives diagram of efficient transmitter and receiver; each 1 1/4d. Pair 3d., post free.

THE SQUARE DEALERS

10, John Bright St., 22, Summer Row; mail-orders: 44, Holloway Head, Birmingham. Telephone: Midland 3254.

MISCELLANEOUS

REPAIRS to Moving Coil Speakers. Cones and Coils fitted or rewound. Fields altered. Prices Quoted including Eliminators. Loud-speakers Repaired, 4/-. L.F. and Speech Transformers, 4/- Post Free. Trade Invited. Guaranteed. Satisfaction. Prompt Service. Estimates Free. L.S. Repair Service, 5, Balham Grove, London, S.W.12. Battersea 1321.

RADIO CLEARANCE

63, HIGH HOLBORN, W.C.1.

TEL.: HOLBORN 4631
Owing to increase of business we have found it necessary to remove to larger and more spacious premises at Number 63, High Holborn. All orders in future should be sent to this Address. All orders to the value of 10/- or over, carriage paid in United Kingdom. Orders under 10/- must be accompanied by a reasonable amount of postage.

"SPECIAL" "SPECIAL"

70/- LISSEN 4-VALVE A.C. SET complete in Cabinet with Valves and P.M. Moving Coil Speaker, aerial tested. Few only.

60/- LISSEN 4-VALVE D.C. SET complete in Cabinet with Valves and Moving Coil Speaker, aerial tested. Few only.

105/- 4-VALVE A.C. SET. 200 to 250 volts. By well-known proprietary manufacturer. Mullard Valves, Moving Coil Speaker, Band Pass tuned, in handsome Walnut Cabinet. Brand new, boxed. H.P. terms can be arranged on application.

79/6 LISSEN BAND PASS 3 BATTERY SETS. Complete in handsome Walnut Cabinets, Iron Cored Coils, Band Pass tuned, P.M. Moving Coil Speaker. Brand new.

59/6 FEW ONLY LISSEN ALL WAVE 4's. Complete in Cabinet with P.M. Moving Coil Speaker. Brand new.

75/- 4-VALVE A.C. MAINS CHASSIS. 200 to 250 volts. By well-known proprietary manufacturer. Mullard Valves, Band Pass tuned. Brand new.

55/- LISSEN 4-VALVE A.C. CHASSIS. 200 to 250 volts, complete with Valves, aerial tested. Few only.

47/6 LISSEN 4-VALVE D.C. MAINS CHASSIS. Complete with Valves, aerial tested. Few only.

70/- LISSEN 100 STATIONS SET. Complete in Cabinet with Valves and P.M. Moving Coil Speaker, aerial tested. Few only.

32/6 LISSEN SKYSCRAPER 3-VALVE BATTERY CHASSIS. Aerial tested, with Valves.

21/- LISSEN SKYSCRAPER PATTERN CHASSIS. Aerial tested, less Valves.

LISSEN 2-VOLT BATTERY VALVES. L2 Metallised. Brand new, boxed.

LISSEN 2-VOLT CLASS B VALVES. Type BB220 A. Brand new, boxed.

LISSEN RECTIFYING UNITS. Complete with Valves, input 100 to 250 volts, Output 250 volts, 60 M/A. Brand new, in sealed cartons.

5/- UTILITY 3-GANG MIDGET CONDENSERS. Straight or Superhet with 110 k/c section, fully screened.

2/11 BRITISH RADIOPHONE 3-GANG SUPERHET CONDENSERS. With 110 k/c Oscillator section, unscreened. Wonderful bargain.

2/6 8 MFD and 4 MFD. DRY ELECTROLYTIC CONDENSERS. By well-known manufacturer. 450 volt working, 500 volt peak, brand new.

3/- LISSEN HANDSOME WALNUT TABLE CABINET. With provision for Speaker, cut out front for Lissen Band Pass 3 Kits. Few only left. Wonderful bargain.

17/6 HANDSOME WALNUT FLOOR MODEL CONSOLE CABINET. An unrepeatable bargain.

1/11 LISSEN CENTRE TAP OUTPUT CHOKES. Brand new, boxed. List price, 7/6.

LISSEN INTERVALVE SMOOTHING CHOKES. Brand new, boxed. List price, 7/6.

LISSEN HF BY-PASS UNIT. List 5/6. Brand new, boxed.

1/11 LISSEN 3-GANG SUPERHET COILS. Mounted on base, complete with Switch, unscreened, brand new.

6d. DRILLED METAL CHASSIS. 3-Valve type.

6d. 1 WATT RESISTANCES. All sizes, by well-known manufacturer.

6d. TUBULAR CONDENSERS. All sizes up to .1. By well-known manufacturer.

1/- 1 MFD CONDENSER. 500 volt working.

1/- 4 MFD POST OFFICE TYPE MANSBRIDGE. 250 volt working.

2/6 4 MFD PAPER CONDENSERS. 750 volt test.

HIVAC VALVES. Complete range in stock. Send for lists.

2/11 2-GANG CONDENSERS, unscreened.

3/11 LISSEN 3-GANG S/H CONDENSER, 126 k/c section, with dial.

8/11 BRYCE MAINS TRANSFORMERS. 250.0.250 80 m.a. 202 volts 2.5 amp., 202 volts 4 amp.

9/6 350.0.350 volts 120 m.a. 202 volts 2.5 amp., 202 volts 4 amp.

11/6 350.0.350 150 m.a., 202 volts 2.5 amp., 202 volts 4 amp., 202 volts 2 amp.

17/6 600.0.500 volts 150 m.a., 202 volts 2.5 amp., 202 volts 6 amp., 202 volts 2 amp., 202 volts 2 amp.

8/11 H.T.S Transformer, 250 volts 60 m.a., 202 volts 4 amp.

17/6 Ditto, with H.T.S Metal Rectifier.

10/6 COMPLETE LISSEN SUPERHET ASSEMBLY. Comprising 3 Gang Superhet Condenser, Oscillator Section, Set of Ganged Superhet

(Continued from the foot of column one)

Coils with Switch and two 126 k/c I.F. Transformers. A wonderful bargain.

2/11 LISSEN INTERMEDIATE FREQUENCY TRANSFORMERS. 126 k/c/s. Brand new, boxed. List price 8/6.

2/11 LISSEN IRON CORED OSCILLATOR COILS. 126 k/c/s. Fully Screened. Brand new, boxed. List price 12/6.

All the above transformers are first class manufacture, brand new, fully shrouded.

RADIO CLEARANCE

63, HIGH HOLBORN, W.C.1.

TEL.: HOLBORN 4631.

RECEIVERS, COMPONENTS AND ACCESSORIES

Surplus, Clearance or Secondhand, etc.

SOUTHERN RADIO'S WIRELESS BARGAINS. ALL GOODS GUARANTEED NEW AND SENT POST PAID.

SPEAKERS.—Celestion Soundex Permanent Magnet, 11/-; Telsen Permanent Magnet Speakers, 16/-; Telsen Units, 2/9.

LISSEN KITS. ALL NEW IN SEALED CARTONS AND COMPLETE. With Specified Valves. Lissen Skyscraper 3-Valve Battery Kits, 42/- each (List, 77/6).

DEEMARK SHORT-WAVE ADAPTOR KIT. Complete with all accessories for adapting set for 14-150 Metres, 20/-. Superhet Short-wave Converter Kit, 20/-.

MULLARD M.B.3. THREE-VALVE BATTERY SETS. Complete with 3 Mullard Pentode Valves, Permanent Magnet Speaker, Batteries and Accumulator. Contained in handsome walnut cabinet, £5/7/6 (List, 8 guineas). In original sealed cartons.

G.E.C. A.C./D.C. 3-VALVE RECEIVERS. Ring Valves. Universal Mains and Voltage. Complete in exquisite Cabinet, ready to plug-in, £3/19/6 (List £7/15). Not a midget.

HOUSE TELEPHONES. A SPECIAL BARGAIN. BRAND NEW ONE-HAND TELEPHONES. Complete on stand, with or without Automatic Dials. Cost £4 each to manufacture, 10/- each.

ELIMINATORS.—Regentone 1935 Series. A.C. Mains, 200/250 volts, Type W6a, complete with trickle charger, 39/8; W1a (less trickle charger—carries 30 milliamps), 33/-; W1c (less trickle charger), 30/-; Telsen Latest Model A.C. Eliminators with trickle charger for 10, 20 or 30 milliamps, 45/- (List £4/15/-).

CONDENSERS.—Lotus 0.0005. Fully screened, with trimmers, escutcheons, dials and knob, 3-gang, 11/-; 2-gang, 7/3. DYBLOCK SINGLE, 0.0005, complete with all accessories, 4/-; TELSEN SINGLE VARIABLE CONDENSERS, 0.0005, 2/3.

COILS.—Igranic Superhet Coil, set of four (1 Osc., 2 I.F. with Ptaiats, 1 I.F. plain), 9/- per set, (List, 50/-). Varley Square Peak Coils, B.P.5, complete, 2/3. Telsen Iron-core Coils, W340 midget size, 4/6 each.

THE following Telsen Components in original sealed cartons at sacrifice prices:—

A.C.E.L.F. TRANSFORMERS.—5/1, 2/9; Binocular H.F. Chokes, 2/-; Standard Screened H.F. Chokes, 2/-; ACE MICROPHONES (P.O.) with Transformers, 5/- each. This Microphone can be used with any radio set and is a very efficient article.

"TRUE-OHM" RESISTANCES, 1 watt wire ends, T colour coded and marked, 30 on card, assorted capacities, 7/6 per card.

AMERICAN VALVES.—A full range of valves for all American sets at 7/- per valve.

SOUTHERN RADIO BARGAIN PARCELS.—We are offering the following parcels of mixed components at a fraction of their value. The items comprise up-to-date Radio parts, new and perfect, which are too varied to be advertised individually:—

5/- PARCEL.—Contains modern components valued at 20/-. Including Resistances, Condensers, Coils, Wire, etc. Circuits of modern Receivers included with each parcel.

SOUTHERN RADIO, 323, EUSTON ROAD, LONDON, N.W.1 (near Warren Street Tube). Phone: Museum 6324.

SOUTHERN RADIO Branches at 271-275, High Road, Willesden Green, N.W.10; 40, Lisle Street, W.C.2. All Mail Orders to 323, Euston Road, London, N.W.1.

WESTERN Electric Microphones, 1/9 each, transformer to match, 1/3 Post free; and 500 clearance lines, catalogues 3d. each.—J. Bearfield, 105, Upper Street, London, N.1.

SHORT WAVE on a crystal set. Full building instructions and crystal 1/2 post paid.—Radiomail, Tanworth-in-Arden, Warwickshire.

HEADPHONES, Brown, B.T.H., Sterling, Nesper, Brunet, Siemens, Ericsson, G.E.C. 2000 ohms, 2/6, 4000 ohms, 5/-. Postage 6d. Guaranteed. Kodesh, 56, Barnsbury St., London, N.1.

ELECTRO DYNAMO "ROTARY CONVERTER for A.C. Set on D.C. Mains, 250 Volts D.C. 230 Volt A.C. in Silent Cabinet as new. Cost £14, accept £6.10.0, or nearest offer.—Meadows, Fallings Park, Wolverhampton.

WANTED, good modern radio sets, parts, etc., spot cash paid; exchanges; bring or send.—University Radio Ltd., 142, Drummond Street, Euston, London, N.W.1.

BANKRUPT BARGAINS.—List free. All new goods only. Get my exchange offer on Mullard MU35 6v. A.C./D.C. superhets and MB3A battery sets. Ormond Class B 3v., 65/-. Alba S.G. 3v. M.C., 77/6. Amplion 5v. A.C. superhets, £7/10/0. Kolster Brandes 19 gn. A.C./D.C. 7v. superhets, 10 gns. Burgoyne Fury 4v. A.C./D.C., £4/17/6. Cosmor D.C. S.G. 3v. console, 85/-. Burgoyne table A.C. radiograms, £7/10/0. Ferguson 6v. A.C./D.C. allwave, £7/10/0. 8v. Push-pull allwave, 11 gns. Truphonic latest 12 gn. allwave superhet, £9/17/6. Everready model 5002 A.C. superhet, £7. Truphonic 5v. Battery superhet 10 gn. models, £7. Second-hand Marconi A.C. 7v. superhet, O.K., £3/17/6. Large stock all kinds of valves, components. I will quote for anything.—Butlin, 6, Stanford Avenue, Brighton.

HIGHEST possible allowance made on your old set or components in part exchange for any new set or Peto-Scott kit. Lists free. B. Wigfield, Furlong Road, Goldthorpe, Yorks.

MISCELLANEOUS

G.P.O. Surplus Condensers. 2 mfd. 500v. wk., 1/9; 4 mfd., ditto, 3/-; 2 mfd. 800v. wk., 2/3; 4 mfd. ditto, 3/9; 2 mfd. 1,000v. wk., 3/3; 4 mfd. ditto, 4/9; postage 4d. or C.O.D.—De-Ware, 364, Fulham Road, S.W.10.

VALVES.—By well-known manufacturer. Complete range of Battery, A.C. Mains, Rectifiers. Brand new stock with six months guarantee. 2 volt: Detector, 2/3, Power 2/9. Screen Grid, Pentode, H.F. Pentode 5/-. Write for other prices to: Dulci Electrical Co. Ltd., 7, Lizard Street, London, E.C.1.

UNIVERSAL Radio Bargains.—Celestion Soundex Moving Coils, 9/11. Cosmocer Pick-ups with Arm and Volume Control, 9/11. Goldring, ditto, 8/11. Ace Mkks, 4/11. Telsen Speaker Units, 1/11. 8 Gn. Battery sets, complete for 5 Gns. 12 Gn. Universal Mains Superhets for 7 Gns. All brand new and in original cartons. Thousands of other bargains. Stamp for lists.—"UNIVERSAL," 94, Grove Vale, East Dulwich, S.E.22.

REPAIRS.—Moving Coil Speakers. Complete Re-winding Service for Transformers, etc. Receivers Repaired. Trade Discount.—Weedon's Radio Repair Service, 262, Romford Road, London, E.7. Maryland 1782.

YOU CAN USE YOUR SPARE TIME to Start a Mail Order Business that quickly brings you a full time income. Follow the lead of others who are averaging £12 per week net profits. Get away from a drudging routine job—Join the big-money class. No previous experience necessary. Few pounds capital only needed. No samples or outfits to buy; no rent, rates or canvassing. New method makes success certain. Write to-day for FREE BOOKLET to Business Service Institute (Dept. 599c), 6, Carmelite Street, London, E.C.4.

SUITABLE valves for each kit by well-known manufacturers included at the kit price to initial purchasers of one of our new low-priced home construction kits.

"AIR CUB," Short-wave, 19-55 metres, bandspread, 12/6. All-wave, 10-2,000 metres, 18/6.

"Little Scout," short-wave bandspread 111, 15-55 metres, 22/6. "Straight" Super III, 180-2,000 metres, 15/6. Short-wave adaptors, 10/6. Every kit complete with metal chassis and sundries. EVERY KIT WITH VALVES, a real double bargain; order early and secure. Cash or C.O.D. post 1/-. Enclose also 3d. stamps for complete component lists.

ANGLO AMERICAN RADIO DISTRIBUTING CORPORATION (Dept. 9), 1, Lower James Street, Piccadilly Circus, London, W.1.

NEW RECEIVERS, COMPONENTS, AND ACCESSORIES

CLARION VALVES.—All brand new; battery types P.2, 2/6; screens and L.F. pentodes, 3/0; A.C. mains, 4-volt, 1-amp., general purpose, 3/3; power, 4/-; screens and L.F. pentodes, 4/6; full-wave rectifiers, 3/6; postage paid, cash with order, or C.O.D. over 10/-.—Clarion Valves, Dept. 2, 885, Tyburn Road, Erdington, Birmingham.

ALL-WAVE A.C. Five, £9/9/0. Novo Radio, St. John Street, Newcastle-on-Tyne 1.

HULBERT for Quality Surplus Speakers. All Music Lovers should write for List of amazing bargains. Prices from 8/6 brand new. Made by best known British maker.—Hulbert, 6, Conduit Street, W.1.

ADVERTISEMENT INDEX

	Page
British Institute of Engineering Technology	780
British Television Supplies, Ltd.	775
Cosmor, A. C., Ltd.	Inside Front Cover
Electradix Radios	775
Eugen Forbat	777
Fluxite, Ltd.	778
General Electric Co., Ltd.	Back Cover
Holmes, H. W.	780
London Radio Supply Co	778
New Times Sales Co	780
Peto Scott Co., Ltd.	771
Picketts	775
Stratton & Co., Ltd.	778
362 Radio Valve Co., Ltd.	778
Wills, W. D. & H. O.	773
Wingrove & Rogers, Ltd.	761

(Continued at the top of column two)

OF TECHNICAL IMPORTANCE

FOR BATTERY SHORT WAVE

FREQUENCY CONVERSION

Osram Valves

MADE IN ENGLAND
Sold by All Radio Dealers

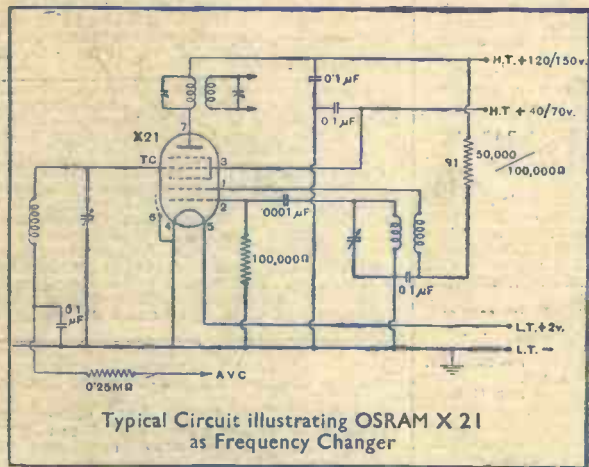

CHARACTERISTICS

- Filament Volts.....2.0 max.
- Filament Current.....0.1 amp.
- Anode Volts 150 max.
- Screen Volts.....40-70
- Oscillator Anode Volts 40-90
- Oscillator Grid Peak Swing 10v A.C.
- Control Grid Voltage 0 to -9
- Conversion Conductance At $E_{g1} = 0$
240 micromhos
- Conversion Impedance.....200,000 ohms.
- Total Cathode Current..... 1.9-7.0 mA max.
dependent on conditions of use.

Price each : 18/6

WRITE FOR OSRAM VALVE GUIDE

HEPTODE TYPE X21

The OSRAM X21 is a variable Mu Heptode designed to give a satisfactory conversion conductance with low H.T. and filament current consumptions.

Due to the small interaction between the oscillator and mixer sections the type is applicable to short wave operation in addition to medium and long Broadcast bands.

With suitable operating voltages and oscillator coil design, the valve will operate as an efficient frequency changer down to 15 metres, or by a slight increase in H.T. current down to 12 metres.

The variable mu characteristics enable the X21 to be connected in a suitable circuit to give Automatic Volume Control if desired.

OSRAM VALVES FOR A BATTERY SUPERHET

- TYPE VS24 Variable Mu Screen Tetrode—H.F. AMPLIFIER.
- „ X21 Variable Mu Heptode—FREQUENCY CHANGER.
- „ VP21 Variable Mu Screen Pentode— I.F. AMPLIFIER
- „ HD22 Double Diode Triode—DETECTOR A.V.C. & L.F.
- „ PT2 Output Pentode — POWER.
- „ QP21 Double Pentode for Q.P.P. circuits — POWER.

OSRAM VALVES—DESIGNED TO ASSIST THE DESIGNER

Advt. of The General Electric Co., Ltd., Magnet House, Kingsway, London, W.C.2.