

Mr. F. J. Camm's Latest Receiver—Important Announcement

Practical Wireless

3^D

Published every Wednesday by

**GEORGE
NEWNES
LTD.**

Vol. 4. — No. 104.
September 15th, 1934.

Registered at the G.P.O. as a Newspaper.

AND AMATEUR TELEVISION
EDITED BY F. J. CAMM.

Building the

MIDGET SHORT WAVE

2

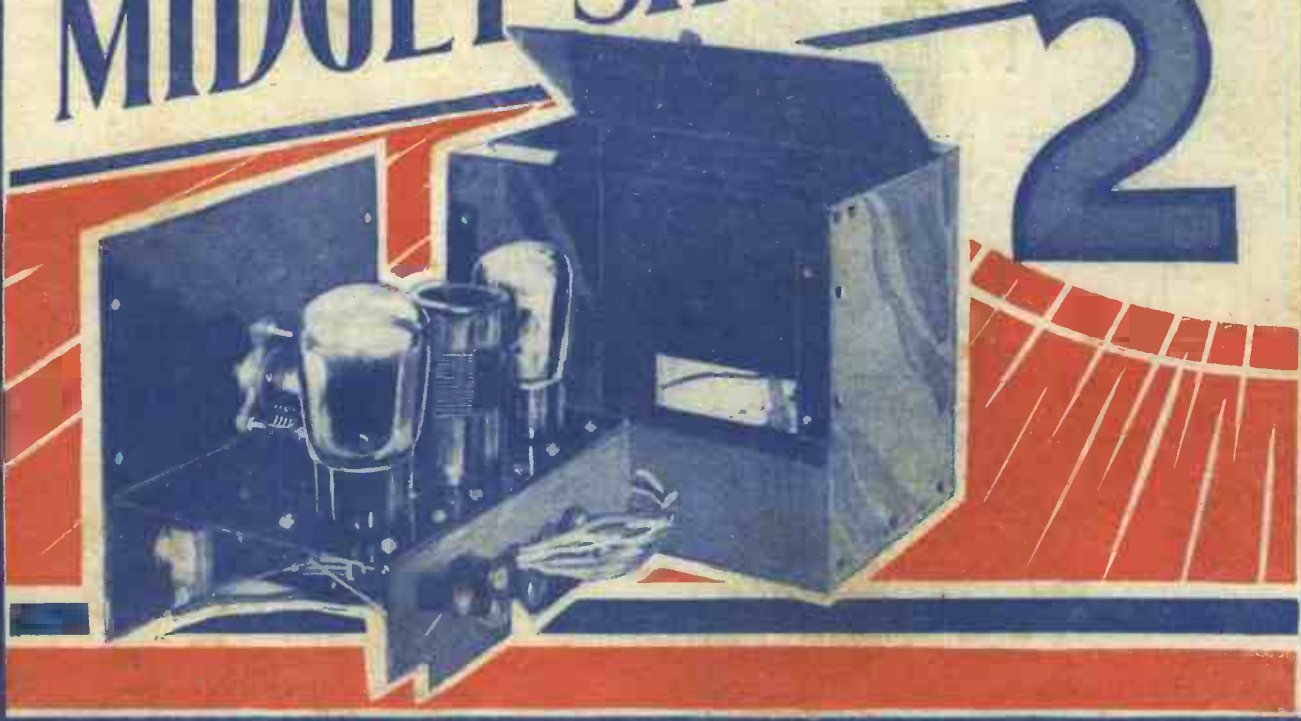

**STENTORIAN
• SPEAKERS •**

PLEASE send all your
HIRE PURCHASE
ORDERS to The PETO-
SCOTT Co. Ltd. 77, City
Road, LONDON, E.C.1.

YOURS FOR
2/6
ALL MODELS



KINGS OF THE AIR

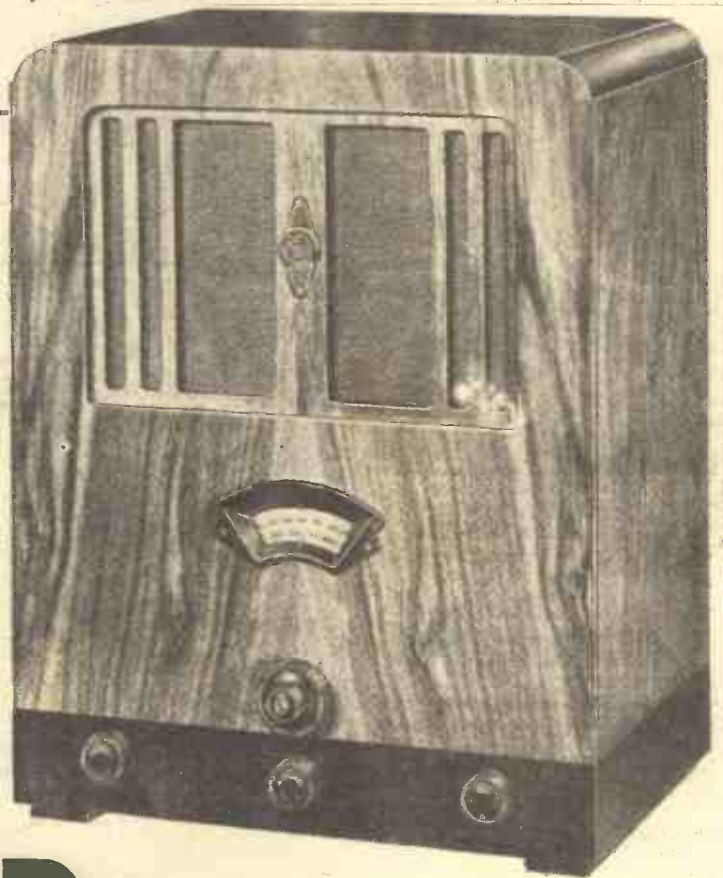

The **NEW** **COSSOR** **MELODY MAKER**

VARIABLE MU S.G.
CIRCUIT

•
SUPER-SELECTIVE
IRON-CORED COILS

•
MOVING-COIL
LOUD SPEAKER

EVERY worth-while radio development is incorporated in the Melody Maker. A modern Variable-Mu S.G. Circuit; new Super-Selective Iron-Cored coils and a Moving-coil Loud Speaker combine to give a performance, in respect of selectivity, range and tonal fidelity, comparable only with Receivers much more costly. And the Melody Maker—with all these advanced features is yours for the bare price of the parts.

**SEND THIS COUPON FOR
CONSTRUCTIONAL CHART**

TWO MAGNIFICENT MODELS

BATTERY MODEL KIT 352

Complete Kit of Parts including 3 valves (Variable-mu S.G.—Triode Detector—Pentode Output). Latest type 8" P.M. Moving Coil Loudspeaker. Super-Selective Iron Cored Coils. Handsome walnut finish cabinet, 18" high, 14" wide, 9½" deep. **£5.19.0**

(exclusive of batteries)

Hire Purchase Terms—14/- deposit and 10 monthly payments of 12/-.

ALL-ELECTRIC MODEL KIT 357

Complete Kit of Parts including 4-valves (Variable-mu S.G.—H.F. Pentode Detector—Mains Power Output, Heavy duty rectifier). Super-selective Iron Cored Coils, Mains energised 8" Moving Coil Loudspeaker. Cabinet similar to Model 352. A.C. Mains 200/250 volts, 40/100 cycles. **£7.19.0**

Hire Purchase Terms—20/- deposit and 10 monthly payments of 16/-.
Prices do not apply in I.F.S.

To A. C. COSSOR LTD., Melody Dept.,
Highbury Grove, London, N.5.

Please send me full-size constructional chart of the new Cossor Melody Maker.

State which model required.....

Name

Address

VOLUME AND QUALITY See page 783

Practical Wireless

EDITOR: F. J. CAMM
 Vol. IV. No. 104. || Sept. 15th, 1934.
 Technical Staff:
 W. J. Delaney.
 H. J. Barton Chapple, Wh.Sch, B.Sc. (Hons.), A.M.I.E.E.
 Frank Preston, F.R.A.

ROUND *the* WORLD of WIRELESS

The Rhythm Symphony Orchestra

MUCH interest was created by the recent broadcast of Harold Ramsay and his Rhythm Symphony Orchestra, and listeners have asked for particulars of the band. The orchestra consists of twenty-one musicians recruited from some of the finest orchestras in the world, including the London Symphony Orchestra and the Grenadier Guards Band. It is normally composed of three violins, cello, double bass, three trumpets, two trombones and a tuba, five saxophones, two pianos, a harp, and two drummers, but this combination gives little indication of the scope of the orchestra because most of the players "double" on several instruments. Listeners will have an opportunity to get better acquainted with the new orchestra, which will be heard in the programme each week this month.

Midland Mischief Makers

THE Midland Mischief Makers, from Wolverhampton, are to revisit the Midland Regional studio on September 19th. Richard Spencer and Garnet Ball, Junior, will devise their programme, which includes numbers for "Joan," the girl "crooner."

Later the same evening (September 19th) Alan Walker and Reginald New will give a pianoforte and organ recital from the Town Hall, Cheltenham, for Midland Regional listeners. The organ there was the gift of Mr. E. J. Burrow, the publisher, its design and construction having been advised on by Sir Herbert Brewer.

The New Bristol Station

THE Lord Mayor of Bristol, Councillor F. C. Luke, J.P., will open the new B.B.C. studios in Bristol on September 18th (London Regional and West Regional programmes). After the opening ceremony a concert will be given by the Bristol Symphony Orchestra, conducted by Hubert Hunt and Reginald Redman, with Eva Turner (soprano) and William Parsons (baritone) as soloists. The singers are both closely associated with the city. Eva Turner spent her childhood in Bristol and William Parsons is a Bristolian. The programme will include two works by Bristol composers, the Lyric Overture,

"From the West Country," by P. Napier Miles, and a Ballad Overture by Frank Merrick. This overture is an entirely new work, and this will be its first performance. The orchestra will also play Vaughan Williams's "Folk Songs from Somerset" and Edward German's "Rhapsody on March Themes." The large orchestral studio designed by John Proctor has been built in what used to be the garden of the B.B.C.'s new premises in Whiteladies Road.

The Youth Hostels

JOHN CADBURY, a member of the National Council of the Youth Hostel Association and Honorary Treasurer of the

NEXT WEEK!

Special Birthday Number containing Full Constructional Details of Mr. F. J. Camm's Splendid New 3-Valve Receiver employing Three Pentode Valves, together with a

FREE 1/- BLUE PRINT

The Issue will also contain Details of a Marvellous Offer of a Free Gift Book which should be in the possession of Every Reader

ORDER YOUR COPY NOW!

Birmingham Regional Group, will, on September 20th, tell Midland Regional listeners of "Youth Hostel Days." He has taken an active part in converting old buildings into youth hostels. Of those which the Birmingham Group control, one has been a mill, another a school, a third a chapel-at-ease, and two are buildings over four hundred years old. Mr. Cadbury's father, Alderman W. A. Cadbury, a former Lord Mayor of Birmingham, opened the latest hostel in the area, at Clent, in Worcestershire, a building specially designed for its purpose.

A New Cinema Organ

A NEW cinema organ, played by a new organist, will be heard by North Regional listeners for the first time on September 18th. The organ is that of the Pyramid Cinema, at Sale, one of the outlying districts of Manchester, the organist, Reginald Liversidge, a Yorkshireman from Huddersfield. A church organist as a child, Liversidge claims, moreover, to have been the youngest man ever to play a cinema organ in the West End of London; he gained this distinction at the age of seventeen and a half, when temporarily employed at the Astoria, Charing Cross Road.

For Scottish Listeners

A PROGRAMME of more than passing interest has been arranged for Scottish Regional listeners on September 18th, under the title of "We've Winter the Night." This takes the form of a typical Meal and Ale celebration, marking the end of the harvest and the forking of the last sheaf on to the rick, and, although this is a custom not now observed in many parts of the country, there will be many listeners to whom this broadcast will bring back memories of this and other similar celebrations which used to be a happy feature of life in the country.

Welsh River Series

THE next number in the Welsh River series will be given for Welsh listeners on September 18th, when the River Rhymney will be celebrated. Among the composers associated with the river are Gwilym Gwent and Tom Price. The artists in the programme will be Megan Foster (soprano), Edgar Phillips, who will give a reading, and the Glan-yr-Afon Glee Party, conducted by T. Emlyn Owen.

Picture People

THE Third Edition of "Picture People" will be broadcast from London Regional on September 20th, when another composite variety programme taken from the sound track of recent film successes and films in the making is to be broadcast. Clayton Hutton is responsible for these feature programmes.

ROUND the WORLD of WIRELESS (Continued)

A West Regional Revival

WEST Regional listeners who remember the dramatic reconstruction of the trial of Samuel Goodere and Matthew Mahony, which was given in the West Regional programmes in May, 1933, will be interested to know that the play based on this famous West Country trial will be revived on September 17th. Although the usual legal procedure will be followed as far as dramatic considerations allow, the reconstruction of this famous trial has been prompted by dramatic rather than legal considerations. All the artists in the cast will be from Bristol, and the play will be produced by Cyril Wood, who has written it for broadcasting.

Another Flitch Trial

BOURNE, Lincolnshire, has arranged a Flitch Trial on the same lines as the famous Dunmow event for September 21st, and this will be relayed by Midland Regional from the local Corn Exchange, with Stainless Stephen as the Judge and Peterborough lawyers as counsel. There will be three pairs of claimants, and the usual jury of spinsters and bachelors. This is the first outside broadcast from Bourne, which is the birthplace of Hereward the Wake, Lord Burghley (the Elizabethan statesman), Sir Everard Digby (of Gunpowder Plot fame), and the late Mr. Charles Frederick Worth, the famous dress designer. The curfew is still rung nightly from Bourne Abbey Church.

A Dr. Johnson Anniversary

THE 225th anniversary of the birth of Dr. Samuel Johnson at Lichfield will be celebrated by a relay in the Midland Regional programme from the house where he was born. It will be the first time this famous literary shrine has been wired for the microphone. A picture of Johnson and Boswell and their times will be followed by a sketch, embodying authentic conversations between them when they visited Lichfield together in 1776 and stayed at the "Three Crowns," next door to the birthplace. The programme will close with a relay of Lord Charnwood's speech proposing "the immortal memory" at the Johnson Society's dinner in Lichfield Guildhall.

Welsh Music

A CONCERT of contemporary Welsh music will be given for West Regional listeners on September 20th, when the artists will be Ivor John (tenor) and the Dorian Trio. This trio has been closely associated with the educational work of Sir Walford Davies for many years and is well known throughout the Principality: recitals have also been given in London and most of the big towns in England and Ireland. During August they were in camp with the Boyd Neel Orchestra in Sussex. Ivor John was tenor soloist of the Morrision Male Voice Party when he was eighteen and was at the time learning engineering. He left engineering, however, to join the Carl Rosa Opera Company.

INTERESTING and TOPICAL PARAGRAPHS

For Anglers

AS a harbour official of a Yorkshire seaside resort, Major V. Seaton Gray recently contributed a talk to the "Holiday Hustle" series; and, returning to the North Regional microphone on September 22nd,

AT THE H.M.V. FACTORIES



The Emir of Gwandu, on his recent tour of England, visited the H.M.V. factories and pressed a record of the King and Queen's voices.

he will tell listeners how he, "A Novice, goes a-tunnying." Although tunny fishing in English waters is a comparatively new sport, it is already exceptionally popular. It is of particular interest in the North Region inasmuch as the two great centres of the sport are Whitby (where the record tunny, 851 lbs., was landed last year) and Scarborough (where a 756 lb. fish was caught only a week or two ago).

Sir Dan Godfrey's Farewell

THE farewell concert to Sir Dan Godfrey to be given by the Bournemouth Municipal Orchestra and the Bournemouth Military Band, conducted by Sir Dan himself, with Ina Souez as the soprano soloist, will be broadcast on the National wavelength on September 30th.

At the conclusion of the concert Sir Hugh Allen, on behalf of British composers, will thank Sir Dan Godfrey, who will reply and introduce his successor, Mr. Richard Austin. This little ceremony will be followed by "For Auld Lang Syne" and "God Save the King." The relay will be from the Pavilion, Bournemouth.

The Darvel Burgh Band

MATTHEW DICKIE (tenor), who takes part in a Scottish Regional programme with the Darvel Burgh Band on September 17th, began his singing career with a juvenile troupe. After the War he took up singing in earnest and went to Milan, where he studied under Maestri Varzo, Cerrado, and Pettinella, and also at the Conservatoire. The Darvel Burgh Band, which is well known as a successful competitor in Scottish band contests, dates back to 1846.

A Midland Band Programme

ON September 17th a Midland Regional studio concert by the Band of the 2nd King's Own Royal Regiment will be conducted by Bandmaster A. T. S. Chandler, with John Lang, of Leicester, who has appeared in many radio plays, giving humorous readings, and Patricia Rossborough rendering syncopated numbers. Miss Rossborough was a "straight" pianist before turning to "jazz." At nine she played Beethoven's Sonata Pathétique from memory. She has toured in South Africa, appeared in two films, and claims to have been the first solo artist to play from Broad-casting House, London.

Some Old Midland Songs

MANY old country songs are associated with the Midlands, and three of the most famous—"The Lincolnshire Poacher," "The Derby Ram," and "The Shropshire Lad," all traditional airs—will be heard in a programme to be given by the Midland Wireless Singers, conducted by Edgar Morgan, on September 16th. The Studio Orchestra, directed by Frank Cantell, will play eight country dances.

For Belfast Listeners

A PROGRAMME with strong local interest will be heard by Belfast listeners on September 15th, when a concert will be given by a selection of first prize-winners from recent festivals in Northern Ireland. Those taking part in the concert have been chosen from prizewinners at Ballymena, Carrickfergus, Coleraine, Dungannon, Larne, Newry, and Portadown.

SOLVE THIS!

PROBLEM No. 104.

Martin constructed a three-valve receiver, and in an endeavour to obtain good quality with a rather cheap transformer, he decided to use the parallel-fed method of connection. He therefore purchased a resistance and a fixed condenser and joined these in circuit in the correct manner. When tested out, however, he found that the receiver gave undue prominence to the bass notes, although he had the speaker tested and found that this had no resonance of this type. What had caused the trouble? Three books will be awarded for the first three correct solutions opened. Address your attempts to The Editor, PRACTICAL WIRELESS, Geo. Newnes, Ltd., 8-11, Southampton Street, Strand, London, W.C.2. Envelopes must be marked Problem No. 104, and must be posted to reach here not later than the first post, Monday, September 17th, 1934.

Solution to Problem No. 103.

When Brown disconnected the resistance he still left the fixed condenser in the cathode lead. Consequently, the cathode was disconnected from the H.T. negative return lead and therefore the H.T. circuit to the output valve was incomplete. He should have short-circuited the condenser or removed it and joined the cathode direct to the H.T. negative line. The following three readers successfully solved Problem No. 102 and books have accordingly been forwarded to them:—Mr. J. D. Morris, 17, Lynton Road, Heaton Moor, Stockport; Mr. A. Blakeley, 14, Dearnley Street, Ravenshorpe, Dewsbury; Mr. A. Simpson, 7, Mafeking Street, Pallion Rd., Sunderland.

VOLUME and QUALITY

The Importance of Tone Correction in Conjunction with Volume Control, and the Relation of Sound Intensity and Frequency Response. By W. J. DELANEY

PROBABLY every listener has noticed that as the volume control on a receiver is operated, the balance of the tone from the loud-speaker also varies in some manner and does not maintain the same quality throughout the complete range of volume control. It will no doubt also have been noticed that when approaching a band in the open air, certain instruments may be heard long before others, and in our own homes it often becomes noticeable that the drums in a dance band may be heard from a neighbour's receiver, although no other instruments or music may appear to accompany them. The question of this balance of tone and volume is a very complex one, and is much too intricate to be gone into here. Suffice it to say that it is due not only to our sense of hearing and the "response curve" of our musical sense, but it is found to be due also to the frequency response of the receiver, the loud-speaker, and the acoustics of the room in which the reproduction takes place. Furthermore, the balance of the musical instruments and their position before the microphone, in conjunction with the characteristics of the microphone and its associated circuits, will also affect the output from our loud-speaker when the volume is varied over the range from silence to maximum.

Tone Control Essential

From the preceding remarks it becomes apparent that in order to maintain a balanced reproduction through the complete movement of the volume control, it is also necessary to vary the frequency response of the receiver, and at first sight it might appear that some difficulty would be experienced in ascertaining the degree of correction which is required. Fortunately, our ear is very accommodating, and certain well-known principles may be incorporated in order to deceive the ear, and thus give

an effect of complete correction where, in fact, such correction is far from complete. If the volume control of your receiver is adjusted whilst you stand well away from the speaker, you will find that in your particular case either the top or the bass, or both are cut, the middle frequencies remaining apparently unaltered, although the reduction in volume is apparent. That is to say, as the degree of volume of the middle frequencies gradually decreases, the bass notes or the top notes fall away much quicker, with the result that before the tune is inaudible certain instruments will appear to have ceased playing. The actual degree of cut-off will vary with different receivers and different speakers, but it will certainly be found that the cut-off is clearly defined at one end of the scale or the other. In an extreme case, of course, both high notes and bass notes will be lost, but this is not usual, and points to rather bad matching between receiver and speaker.

High-note Gain

Dealing first with high-note gain, this may be said to be the most important, as the majority of receivers suffer from a weak high-note response due to the use of reaction, H.F. by-pass condensers, and other losses. Sharply-tuned circuits also present a source of high-note loss, and therefore it is as well, where quality is desired, to replace the higher frequencies by artificial means, irrespective of volume control. This will permit of a more natural reproduction which will probably be maintained throughout the full movement of the volume control, although

further compensation may be added as stated in a later paragraph.

When a condenser is connected across an inductance, a resonant circuit is formed, and it should not be difficult, therefore, to design a circuit, having a resonance in the region of 3,000 cycles or so, to give added amplification to frequencies about this figure, and so produce the desired effect. Such a resonant circuit must be included in the low-frequency side of the receiver, and its effect will be dependent upon the

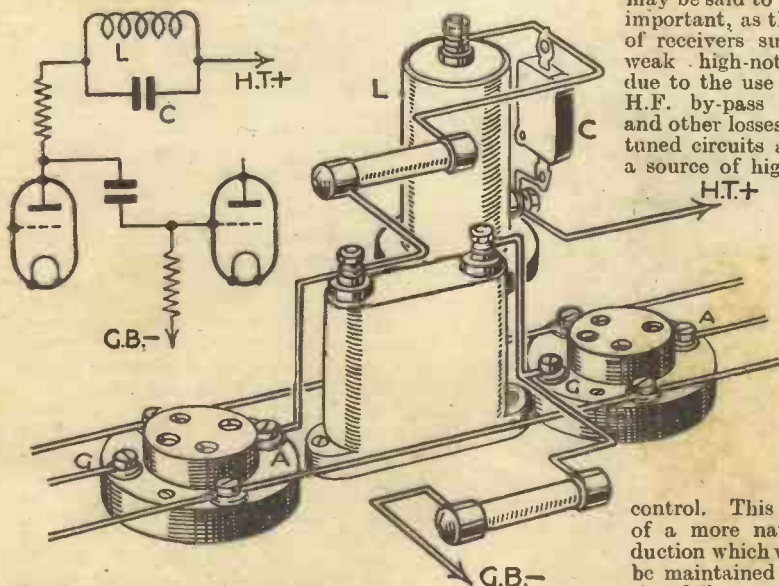

Fig. 2.—A tone compensator fitted to the circuit of Fig. 1.

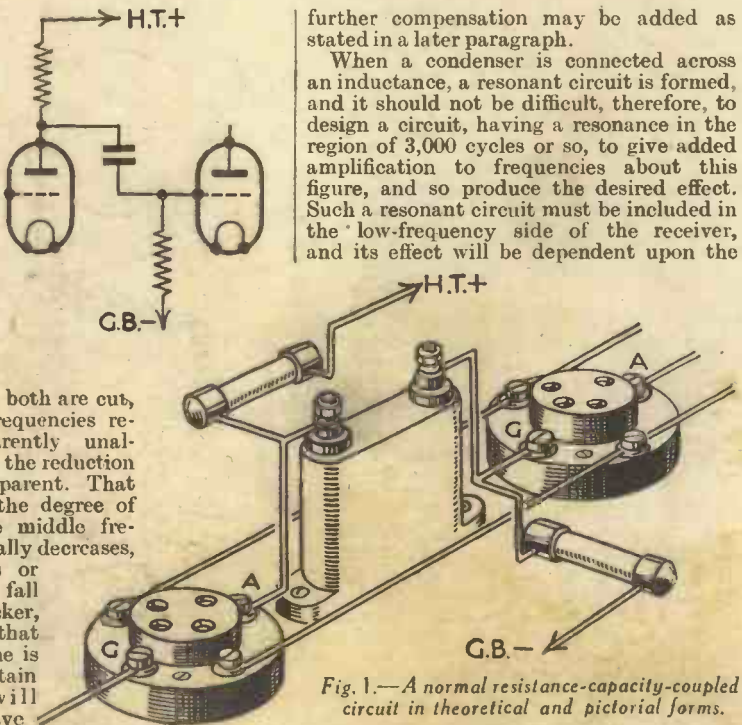

Fig. 1.—A normal resistance-capacity-coupled circuit in theoretical and pictorial forms.

L.F. couplings as well as upon the valve with which it is associated. Where a quality receiver, employing resistance-capacity coupling, is in use, the necessary inductance may be connected in series with the anode resistance, a small parallel condenser completing the tone-control circuit. Fig. 1 illustrates the arrangement, and the choke should have some value between .3 henries and 1 henry. Some experiment may be necessary to find the most suitable value for the particular combination in use.

When transformer-coupling is employed a somewhat different arrangement is called for. The resonant circuit should still be connected in the anode circuit, but the presence of the transformer primary will modify the response, and it becomes necessary to select the value of the resistance with great care. As a guide to the values which might be found desirable L may be selected from the values previously stated, namely .3 to 1 henry; C may be some value between .01 and .0005 mfd., whilst R may be between 500 and 5,000 ohms. As already stated, experiment is essential in order to find the balance required by the particular response of the receiver and associated reproducer. (Fig. 3.)

Combined Control Effects

A more ambitious arrangement is to be found in the fitting of a circuit which varies as the volume control is adjusted, and although it is possible to gang two or more components to produce the desired effect, there is a much simpler solution.

Dealing again with resistance-capacity coupling, the volume control generally takes the form of a variable grid-leak,

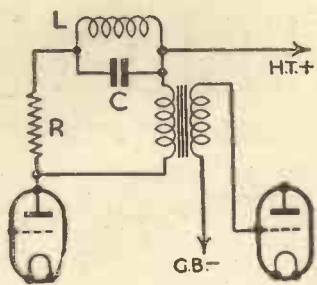

R_1 —500,000 ohm potentiometer.
 R_2 —50,000 ohm resistance in series with potentiometer.
 R_3 —5,000 ohm resistance.
 L —3 henries.
 C_1 —.05 mfd.
 C_2 —.01 mfd.

If a suitable volume-control potentiometer may be obtained, the combination of R_1 and R_2 may be automatically obtained by

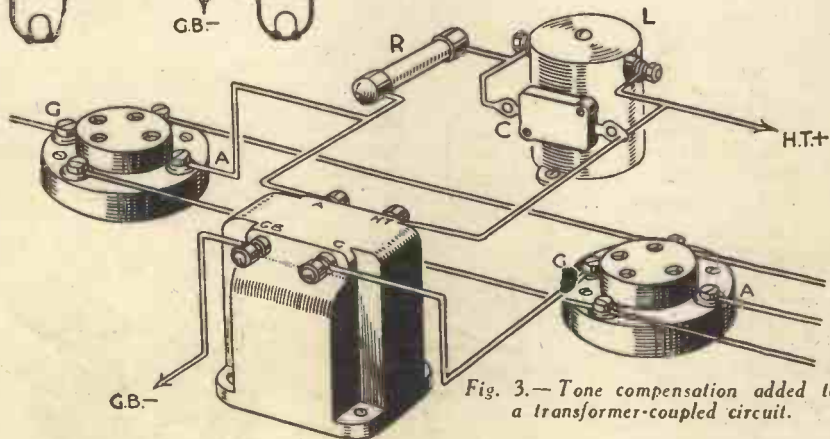

Fig. 3.—Tone compensation added to a transformer-coupled circuit.

(Continued from previous page)

joined in the first L.F. stage. By connecting the resonant circuit already referred to in the grid lead (as shown in Fig. 4), the variation of the tapping point on the grid leak will at the same time modify the total effect of the control and thus, as the volume is reduced, the low notes will this time be strengthened, and therefore the effect is exactly opposite to the previously-described arrangement. Obviously, the two circuits could be combined in one receiver where the results justified such a combination.

In Fig. 5 is seen an arrangement which forms both a high- and a low-note strengthener, and this is a most effective device and is, in fact, incorporated in a well-known commercial receiver. With this arrangement the reduction of signal strength by the volume control R_1 is more rapid on the middle frequencies than on the high and low frequencies and thus preserves an admirable balance. The values chosen for the various parts are as follow:—

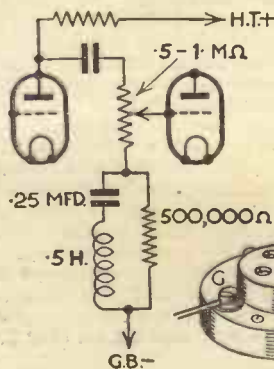
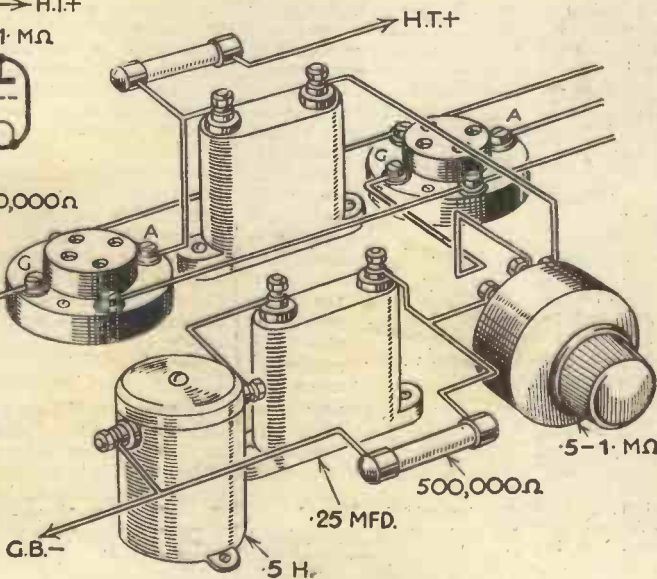

Fig. 4.—A suggested combined volume-tone control for maintaining the strength of the lower frequencies.



making a tapping on the resistance winding. In this case a .5 megohm potentiometer should be obtained and the tapping point should be made at a point about one-sixth to one-tenth of the distance from the minimum volume end.

I have not dealt with circuits designed to modify the loud-speaker response, as these are more intricate and in general will require some modification of the speaker transformer to be made, but the combination of two loud-speakers, one of which is designed especially for high-note response, and which is fed by means of a tuned circuit which passes on to it all frequencies above a certain figure, may be included in the general schemes here outlined.

Filters

It is obvious that when one of the devices which increases the strength of the high notes is fitted to a receiver of the super-heterodyne type, there will be a tendency for an over-accentuation of whistles which might be introduced by the circuit. Similarly where two broadcasting stations are working on a very near-by wavelength there will be possibility of heterodyne whistles or side-band splash being over emphasized. It will obviously, therefore, be unsuitable to fit a high note strengthener where it has already been found that these difficulties exist. It is not a difficult matter to con-

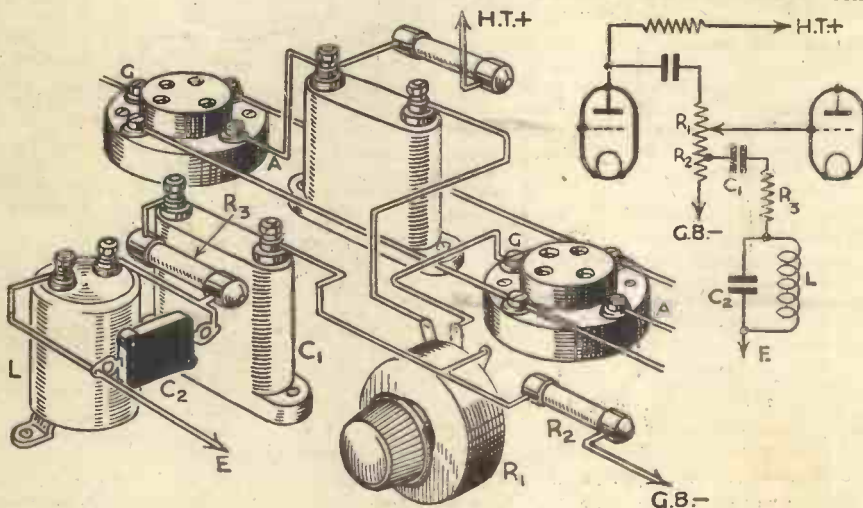

Fig. 5.—A volume control which reduces middle frequencies faster than the high and low frequencies.

struct a circuit which acts in an opposite manner from those given in this article, that is to say, which reduces the strength of certain frequencies or bands of frequencies. By suitable choice of chokes and condensers, a circuit may be constructed to have a definite cut-off at a certain point in order to remedy the above defects, but obviously it will not be possible to obtain high quality reproduction while these filters are in use. Similarly, any resonances which occur in the speaker or cabinet may be modified in the same way, but it should be the aim of the constructor to choose a circuit, speaker, and components which give as near a straight line response as possible, when the addition of the compensating circuits given in the early part of this article will enable a very high standard of reproduction to be obtained under all circumstances from a number of broadcasting stations. The reproduction of gramophone records may require treatment on a different line owing to the restricted frequencies dealt with on the disc.

PIEZO-ELECTRIC LOUD-SPEAKERS

An Explanation of the Function of the Latest Type of Loud-speaker

ABOUT 1890 F. and P. Curie discovered that certain crystals exhibited a remarkable electrical property which they called the *piezo-electric effect* (from the Greek *Piezo*, to press). This property was evinced most strongly by Rochelle salts (sodium potassium tartrate, $\text{NaKC}_4\text{H}_4\text{O}_6 \cdot 4\text{H}_2\text{O}$), but was also found in quartz, cane sugar, tourmaline and zinc silicate.

The Piezo-electric Effect

The Curies found that when a crystal of Rochelle salt was placed between two metallic plates and mechanical pressure was applied—an electrical charge was produced on the plates.

In Fig. 1 a force acting in the direction of the arrows will produce a charge on the plates, and if this force is reversed so that the metal plates (which would be cemented to the crystal) exert a pulling instead of a

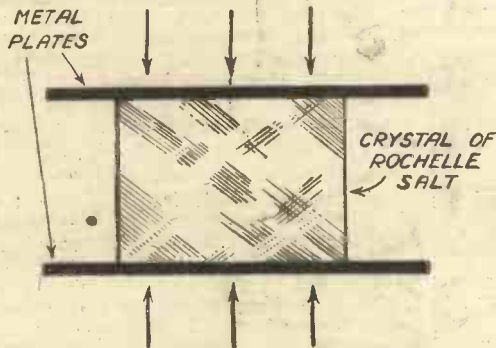

Fig. 1.—Diagram illustrating the piezo-electric effect. If the crystal is pressed between two metal plates an electric charge is produced.

pressing force, then the electrical charge induced will be reversed as well. Thus we have an instance of the conversion of mechanical energy into electrical energy. It is quite reasonable to expect that by reversing the conditions the opposite effect would be produced. This is found to be true.

If a potential difference is established between the plates the crystal will shorten in one direction and lengthen in the other.

It is this property which is made use of in the piezo-electric loud-speaker.

In Fig. 2 examples are shown of natural Rochelle salt and quartz crystals capable of exhibiting these effects. For practical purposes the whole of the crystal is not used, but a slice is cut from the middle as shown. Quartz has an advantage over Rochelle salt in that it is not appreciably affected by atmospheric conditions, and is almost indestructible. It is, therefore, most suitable for such radio uses as crystal resonators and crystal-control transmitters where great constancy is required. For loud-speaker work, however, Rochelle salt is employed owing to its superior response. The difficulty regarding the effects of atmospheric conditions, particularly moisture, is overcome by completely sealing the crystal plates with a coating of waterproof

varnish. Other problems, such as the production of crystals of suitable size and the cutting out and machining of the slabs which are produced from them, have at last been successfully overcome, otherwise the idea of the piezo-electric reproducer is by no means new. Its development was held up, merely due to the practical difficulties encountered in the production of the crystal slab.

Crystal Plates

To illustrate how one of these elements can be used to operate the cone of the speaker refer to Fig. 3. The slab when cut from the crystal in the manner already shown and submitted to a potential difference through two metal electrodes will expand diagonally in one direction and contract in the other. This is indicated by the arrows on the left in Fig. 3. Now, if the corner A of the slab be fixed as depicted in the right-hand sketch and the opposite corner B be connected to the cone of the speaker an electric charge on the foil electrode will cause AB to lengthen or contract according to the polarity of the charge.

Likewise any variation in the magnitude of the charge on the electrodes will cause an instant variation in the degree of distortion of the slab. It is clear, therefore, that if the loud-speaker wires from the receiver are connected to the electrode every variation of the potential of the charge which is produced on the metal foil due to the fluctuations in the speech frequencies will be translated into movements of the crystal and therefore of the cone, thus setting up sound waves in the air.

The degree of movement of the cone when connected to the Rochelle salt element in this way is relatively small, and consequently the volume of sound produced for a given input is poor. In practice, therefore, the element is made up differently from the arrangement shown in Fig. 3. The actual arrangement is rather ingenious.

Instead of one slab, two are used, and these are cemented together with one foil electrode between them and one on the outside of each. (See Fig. 4.) The centre electrode is connected to one input wire and the two outside electrodes are joined together and connected to the other wires. Thus, when the dividing electrode is positive the outside ones are both negative, and *vice versa*, so that the charge applied to the two slabs is opposite. This causes one slab to expand in the direction AB and to contract in the direction CD while the other one does the opposite. The resulting strain causes the whole unit to warp in the manner indicated by the dotted lines and the arrow.

In order to operate the cone of the speaker the three corners ACD

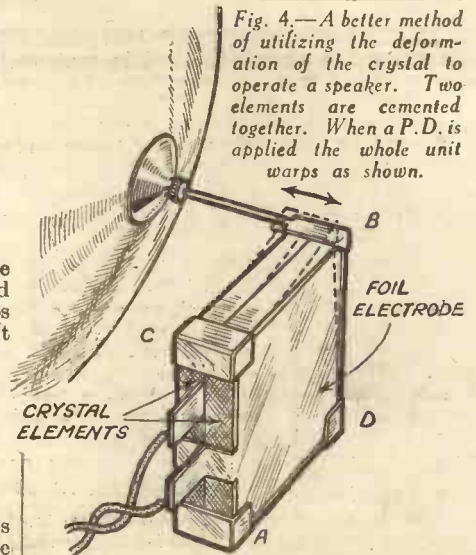

Fig. 4.—A better method of utilizing the deformation of the crystal to operate a speaker. Two elements are cemented together. When a P.D. is applied the whole unit warps as shown.

are fixed while the remaining corner B is free to move. This one is attached to the cone either directly or through the medium of a lever. The lever in this case is similar to the Stylus arm of a gramophone sound box. Its use is, of course, to increase the amplitude of vibration at the apex of the cone. It is arranged as shown in Fig. 4. Here the lever is attached to a multiple element consisting of four crystal plates. The "fixed" corners of the unit, it will be seen, are clamped between rubber blocks. The pressure applied is somewhat critical, and is adjusted to give the best response.

Faithful Reproduction of High Notes

The great advantage of the piezo-electric speaker is its remarkable response to the higher frequencies. For this reason its chief use is as an auxiliary speaker used in conjunction with a large-diaphragm moving-coil speaker.

It is well known that even the best moving-coil speakers have a limited frequency response. For instance, an instrument employing a small diaphragm will usually give good reproduction of the middle and upper notes of the musical scale, but will not give proportionately the same amplitude in the lower register. On the other hand a unit with a large diaphragm will emphasize the low notes, but will give a very attenuated reproduction of the high ones—those corresponding to frequencies of, say, 5,000 to 15,000 cycles. It is here that the piezo-electric unit can be

(Continued overleaf)

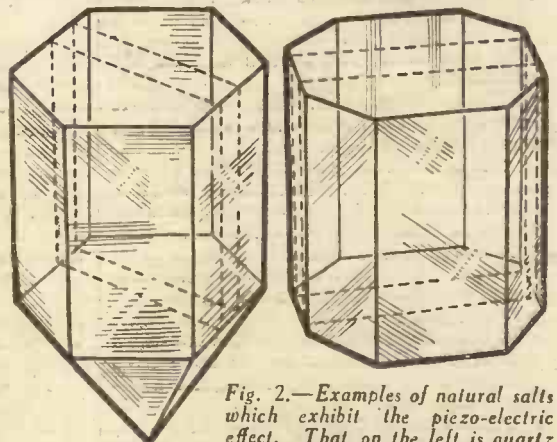

Fig. 2.—Examples of natural salts which exhibit the piezo-electric effect. That on the left is quartz and that on the right Rochelle salt. The dotted lines indicate the part from which the active element is cut.

PIEZO ELECTRIC LOUD-SPEAKERS
(Continued from previous page)

employed to advantage. Used in conjunction with a moving-coil instrument of this latter type, a good response is obtained from the combined units over a wide range of frequencies. In this way far better and more realistic reproduction is obtained than would be possible with

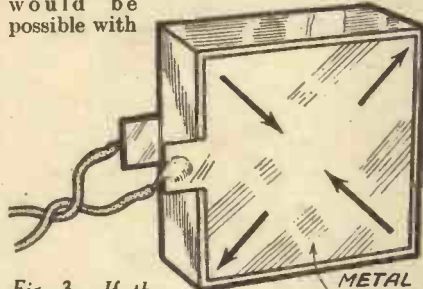
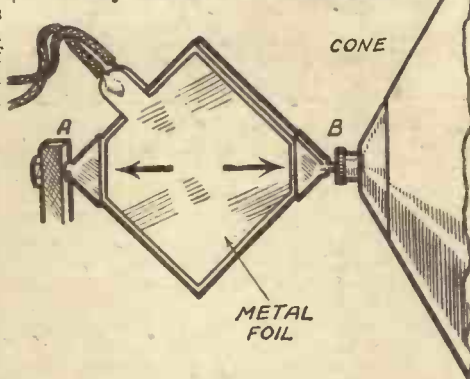

Fig. 3.—If the slab which is cut from the natural crystal be placed between two metal plates at different potential the element will expand and contract, as shown by the arrows. How this property can be utilized to operate the cone of a loud-speaker is shown above.

the moving-coil speaker alone. Although the piezo-electric speaker is eminently suitable as the treble unit



of a matched pair of speakers, it must not be thought that it is entirely unresponsive to the lower frequencies. In fact, the Rothermel Corporation, makers of the well-known Sonochorde speakers, market a large model which employs four piezo-electric units operating a 12in. cone

through the medium of a system of levers. With this model a good response is obtained from something like 8,000 cycles down to 30 cycles.

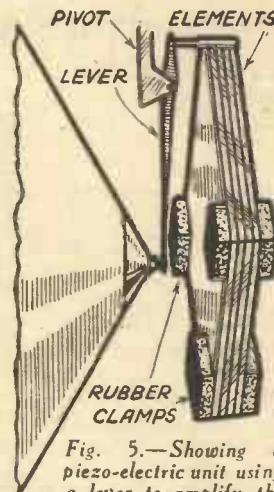

Fig. 5.—Showing a piezo-electric unit using a lever to amplify the movement of the elements.

THIS winder enables one to wind anything ranging from tuning coils to L.F. and mains transformers and chokes. One outstanding feature about this winder is that the wire, whether enamel or d.s.c., is wound side by side perfectly (not pile winding), and so one can paper interleave the windings and thus procure a better job with greater efficiency. The winder operates in both directions, backwards and forwards. It can easily be constructed from the odds and ends which the average amateur has at hand.

A is a 1/4 in. rod held together on each side by a suitable nut.

B and C are two wooden cones cut from a cotton reel and can be moved in or out to suit the size of former employed.

D and E are two thin rods stopping the part F from taking any motion but that of parallel to H.

F is the part which guides the wire and is made from steel or brass having a slight groove at the top to take the wire and also a threaded hole to take the rod G.

G is a rod with a fine thread passing through the part F and has a cotton reel J attached to it at one side.

H is a 1/4 in. rod having attached to it at one end a cotton reel I and a suitable handle N, and at the other two loose pulleys K and L with a nut M acting as clutch between the two pulleys.

I is a cotton reel.

J is a cotton reel.

K is a loose pulley revolving on the spindle H.

L is the same as K. These pulleys are one-third of the size of the reel and can be made from ebonite, etc.

M is a nut which, when screwed against the loose pulley K, will enable F to go in one direction but when screwed against the pulley L, F will go in a reverse direction.

N is a suitable handle.

O and P are two wooden cones cut from a reel and slide along the rod Q.

Q is a 1/4 in. iron rod.

R is a round piece of ebonite one-third size of a reel attached to the spindle Q. S is a cyclometer (very handy for automatic counting).

T is a slanting slot to enable the part Q to be pulled out so as to put on the former for winding.

A UNIVERSAL COIL WINDER

U and V are two springs fitted over the spindle to give the required tension on the wire.

How It Works

It should be noted that the wire is wound from the former held between B and C on to the former held between O and P. When the guider F has travelled across, and therefore one layer has been wound, the screw or clutch M can be screwed against the other pulley so as to lock it and the winding can then be continued in a reverse direction after putting paper on the first layer. This paper could be conveniently of the tissue paper type, but with no creases in it. It should also be noted that one of the belts attached to the pulley K has a twist in it as shown in diagram. This twist is essential for it gives the reverse direction winding.

The belts used could conveniently be of either rubber bands or black tape.

All the details which have been given are those which have been taken from the original model, but it should not be

difficult to adapt any existing ideas and apparatus to this novel winding machine. For instance, in place of the cones B, C, O, and P, a special cylindrical former could be used, somewhat after the fashion of the old gramophone. Where large diameter coils have to be wound, the cones will, of course, have to be constructed on different lines, and some form of adjustable arm could be designed for this purpose.

Wire Tension

The tension which is placed on the wire should be governed principally by the actual constructional work, and if it is all carried out in an efficient manner there should be just sufficient tension to enable each turn to lie snugly against the preceding turn. If desired, a special tensioning device could be constructed and fitted in the space between rod H and Q, and a simple friction arrangement could be used—provided it was not sufficiently tight to remove insulation—either enamel, cotton, or silk. For this reason also, the small slot in the member F might be lined with a piece of felt in order to prevent damage. An improvement on the drives might also be effected by using some of the apparatus from one of the popular

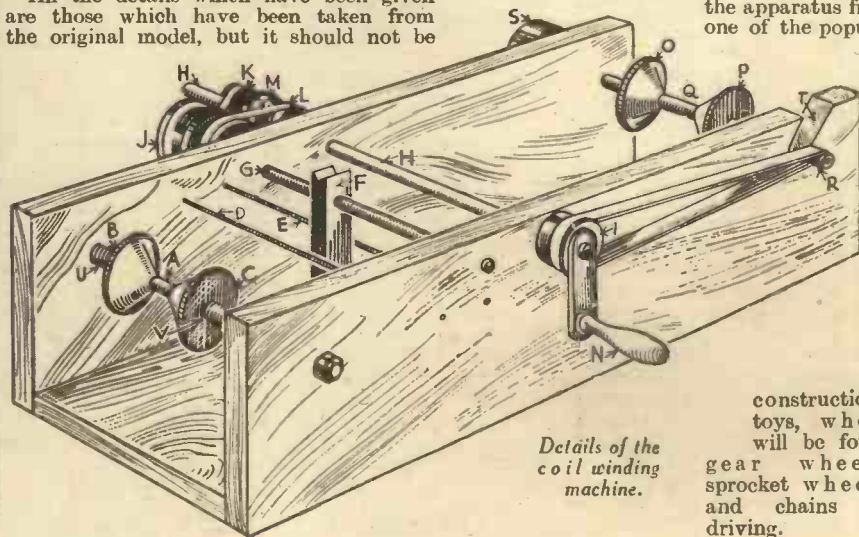

Details of the coil winding machine.

constructional toys, where will be found gear wheels, sprocket wheels, and chains for driving.

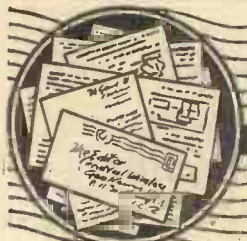

READERS' WRINKLES

THE HALF-GUINEA PAGE

Earthing to a Water Tap

THE following idea may prove of use to other readers for a good earth connection to a water tap. After turning off the water, unscrew the top part of the tap. Now from a piece of thin brass, cut out a washer to fit over the thread of the tap as per sketch. Firmly solder your earth wire to washer by means of the holes drilled in

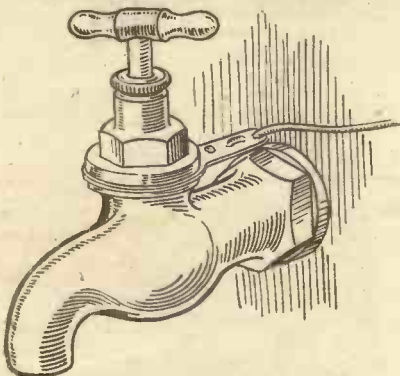

EARTH LEAD THREADED THROUGH HOLES AND SOLDERED.

An ingenious and simple method of earthing to a tap.

the tap and rescrew the tap. This is, I think, much better than a clip.—F. L. BROWN (Birmingham).

A Tone-control Circuit

HERE is a tone-control system which I have found to be rather more satisfactory than the conventional condenser and resistance in series across the output terminals of the receiver.

Incidentally, the introduction of the resistance across the secondary of the transformer seems to considerably flatten out the frequency-response curve of same; in which case an improved performance (except in the case of a really first-class transformer) is inevitable.—H. W. EVANS (London N.7).

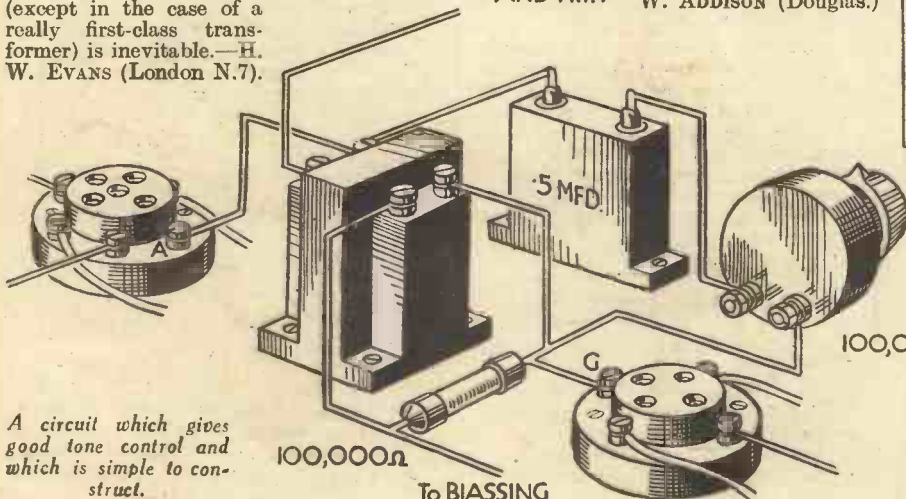

A circuit which gives good tone control and which is simple to construct.

THAT DODGE OF YOURS!

Every Reader of "PRACTICAL WIRELESS" must have originated some little dodge which would interest other readers. Why not pass it on to us? We pay £1-10-0 for the best wrinkle submitted, and for every other item published on this page we will pay half-a-guinea. Turn that idea of yours to account by sending it in to use addressed to the Editor, "PRACTICAL WIRELESS," George Newnes, Ltd., 8-11, Southampton Street, Strand, W.C.2. Put your name and address on every item. Please note that every notion sent in must be original. Mark envelopes "Radio Wrinkles." Do NOT enclose Queries with your Wrinkle.

Increasing Carbon Resistor Values

IT has been found necessary, on numerous occasions, to increase the values of resistances when using them for converting the range of milliammeters, etc., as described in Mr. F. J. Camm's Everyman's "Wireless Book." As these resistances have been of the carbon resistor type, filing away some of the carbon has been found the most effective way of increasing the resistance. For thus, by

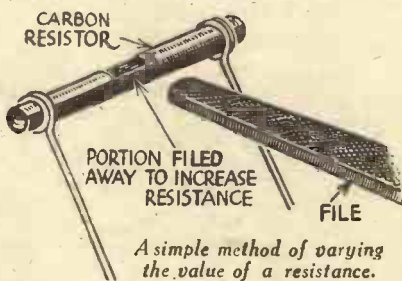

A simple method of varying the value of a resistance.

cutting down the cross section of a carbon resistor the resistance is increased proportionately. The correct value can soon be arrived at by repeated filing and testing of the resistance in series with the meter and a known voltage across the ends. If a little care is taken in filing, very accurate resistances can be thus obtained.—GEORGE C. W. ADDISON (Douglas).

To DECOUPLING AND H.T.+

An H.F. Choke

A NEAT and efficient H.F. choke may be made from an empty cotton reel. Jam the reel by means of paper on a 1/4 in. or 5/16 in. drill and fix in chuck of a brace

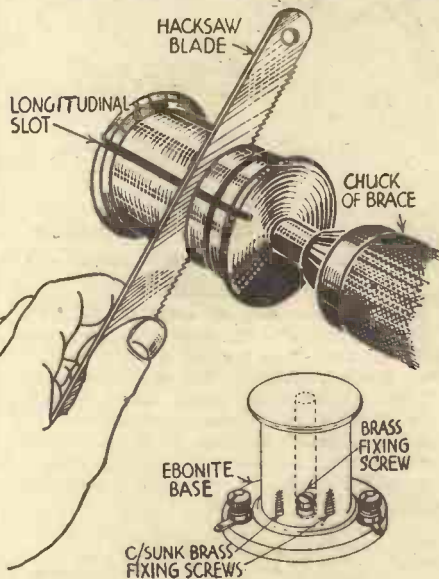

How to construct an efficient H.F. choke.

clamped in the vice. While turning with the right hand hold a small saw blade in the left against the rotating reel. Cut six or seven equidistant slots, about 1/4 in. deep, then with a chisel make one longitudinal slot. Slot by slot wind full of thin insulated wire (I use an old transformer winding), and mount on an ebonite base as shown. A black thread reel, being slightly larger, is the best to use.—C. PAYNE (Goodmayes).

A Neat Tuning Dial

HERE is an easy way to convert a "degree" reading condenser into a more modern and easily readable one. Obtain a piece of plywood or a piece of black-glazed ebonite 3/16 in. thick, not less than 5 in. x 8 in. Cut out the sector (No. 1), as shown in sketch in thick lines, and another disc (No. 2) of the same shape except at the bottom along the dotted line. The reason is obvious, as the pointer has to traverse the whole scale. The pointer is cut from brass or copper to the shape shown (2 1/2 in. is long enough) allowing 3/4 in. x 1/4 in. at the bottom for wrapping round a 3/16 in. rod or nail, so that the pointer may be slipped over the "fast motion" spindle, 1/4 in. diameter. A "fixed" speed condenser may, of course, be converted the same way.

100,000Ω Place a piece of white drawing paper, marking off as shown in sketch, on the panel face, and over it place No. 2 disc, and calibrate the dial. When satisfied, glue a piece of cellophane over No. 2, place No. 1 disc over this, and screw up, after centralizing the whole indicator, dial

(Continued overleaf)

READERS' WRINKLES

(Continued from previous page)

and discs, so that the stations are in their correct positions.

N.B.—The only difference between the two discs is along the inside bottom dotted line.

The grain in plywood should run in the direction of the arrow.—R. M. ROSS (Alness).

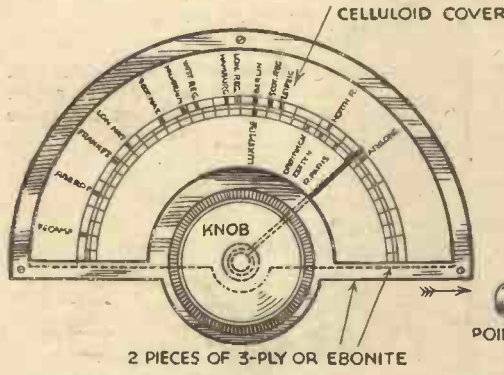

A neat tuning dial improvement.

An Accumulator Indicator

HAVING obtained a glass test tube to just pass through the vent hole in my accumulator, I had a number of small holes made in it, then removed the three coloured balls from small fountain pen filler type hydrometer, inserted these in test tube, then put this in vent hole of accumulator. I can thus tell at a glance the condition of battery.—S. H. WRIGHT (Shadwell, E.).

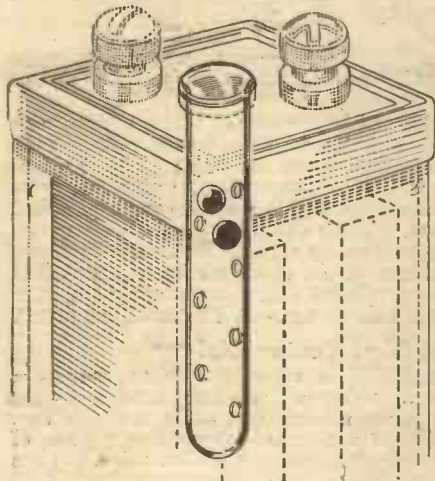

Fitting a condition indicator to an accumulator.

Panel Connectors

A PAIR of snap-fasteners from an old pair of gloves will come in handy for connecting purposes. Into the snap portion solder small sections of 6/32in. bolts, and secure the other part to the panel. For the connectors, wind some wire round the groove in the button, binding the wire as tightly as possible for a good connection. When you want a connection, simply press the button into the snap.

No doubt many other useful adaptations of the snap fasteners will be found by the experimenter, and it is interesting to note that a similar device may also be obtained in a very much larger size, designed primarily for the purpose of attaching carpets or rugs to a polished floor

Improving the Accumulator

THE following idea will keep a constant supply of grease round the accumulator terminals and stop corrosion of acid. Drill the terminal down the centre with a fine drill, and again drill into this one from the side in the thread. You now require a small brass lubricator with screw-down cap to fit in the top of the terminal.—F. C. BEARNE (Grantham).

A Handy Soldering Iron Stand

I HAVE found that my electric soldering iron heats more rapidly in this stand and it is more convenient to use without the troublesome cord.

Two holes are drilled opposite each other in the handle and in a small plug. The leads to the iron are cut, near the handle, and passed through the holes. The old cord-hole in the handle is now plugged forcibly with a wooden dowel. Then the cap of the plug is fastened to this with a wood screw and the heating element leads passed through the holes and connected to the prongs which are then screwed back on the cap. The lead previously cut off is connected to a socket on the bench.

THE materials required are: a lead strip 6in. by 1/2in., a copper plate 6in. by 1in., 1/2lb. lead nitrate, and a jam jar. The copper strips are cut with a 2in. lug connection. There is thus 4in. for immersion in the electrolyte. It is then treated as follows: One side of the plate is burnished with emery cloth and then held in a hot gas or Bunsen flame until the surface of the copper becomes black, due to the formation of cupric oxide. The plate is allowed to cool, and the coating of CuO is dissolved off with cuprous oxide on the plate. The back of the plate is now painted with tar or pitch, and both the lead and copper strips are inserted in the jar through a disc of wood cut to fit the jar tightly. The prepared copper surfaces should be facing the lead strip and be about 1/2in. away from the lead and curved towards it. Terminals are now fitted to the top of each electrode, and electrolyte is next poured into the jar, consisting of loz. of lead nitrate crystals to each gill of water. The whole top of the cell is covered with hot pitch to make the cell airtight and leakproof. The cell is really a photo-voltaic cell, and is polarized, the copper plate being positive and the lead plate

A Photo-electric Cell

negative. With a 60-watt lamp 3ft. from the cell 1 milliamp. current flows, and at 6in. 4 milliamps. flow.

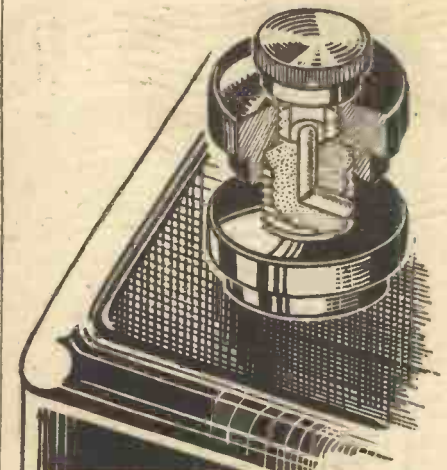

Ensuring a constant supply of grease round the accumulator terminal.

negative. With a 60-watt lamp 3ft. from the cell 1 milliamp. current flows, and at 6in. 4 milliamps. flow.

A Storm-proof Aerial

WHEN an aerial is erected high in an unprotected position it is necessary to take great care to avoid breakage due to strong winds, the weight of snow, etc. Therefore, I have found that by fixing it at one end only, and arranging a counterweight at the other end, the whole erection becomes much safer, and one does not have to be continually fixing the wire. The method which I have adopted is to firmly fasten a simple reel insulator to the lower mast or tree, and pass the end of the aerial wire over this (in the form of a pulley), and attach a fair weight to the end of the wire. The actual weight must be found by experiment, and must be obviously just sufficient to enable the aerial to sway without this movement being too great, and thus give signal variations on weak stations. A spring-loaded insulator could be fitted at the upper end if it was felt desirable, and if the situation was sufficiently open to warrant it.

A Novel Microphone

ANY reader who already possesses a gramophone pick-up can easily convert it, temporarily, into a simple but efficient microphone.

Take an ordinary gramophone sound-box. Insert a long (soft-tone) needle. Then take the pick-up and insert into it the protruding portion of the needle. Screw up tightly, and the microphone is then ready for use. Simply connect the pick-up to the P.U. terminals on the set and speak fairly closely into the gramophone sound-box. The pick-up can easily be dismantled for use in the ordinary way.—W. V. FRANKS (Brighton).

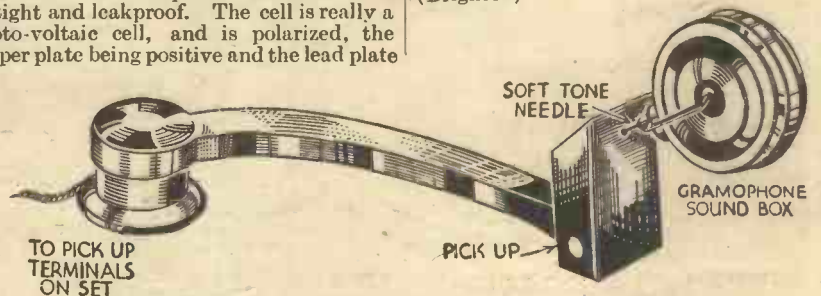

A novel microphone arrangement, utilizing a sound-box and a pick-up.



Your troubles are revealed to *him* in the Crystal...

Whatever lies behind crystal-gazing it is uncanny to think that one person can tell another all about his troubles, with the aid of a crystal globe.

Your *Radio* troubles are revealed to *you* in the Pifco A.C. and D.C. **RADIOMETER**

Magical, too, seems the performance of the Pifco "All-in-One" Radiometer, which makes any radio test quickly—high tension, low tension, A.C. or D.C.

Finely finished in a solidly constructed bakelite case, this new Pifco product, made, adjusted and tested by highly skilled British instrument makers would be cheap at five times its price of... **12/6**

AVOID and REFUSE SUBSTITUTES

Ask your dealer to show you one now or write for fuller details to PIFCO LTD., SHUDEHILL, MANCHESTER and 150, Charing Cross Road, London, W.C.2.

SAFETY FUSE PROTECTS ALL RANGES

PIFCO
'All-in-One' RADIOMETER A.C. AND D.C.
PIFCO ON THE SPOT WILL TRACE YOUR TROUBLES LIKE A SHOT.



Mr. F. J. CAMM

ensures splendid results with his

All-Pentode '3'

using the famous

COLVERN FERROCART COILS

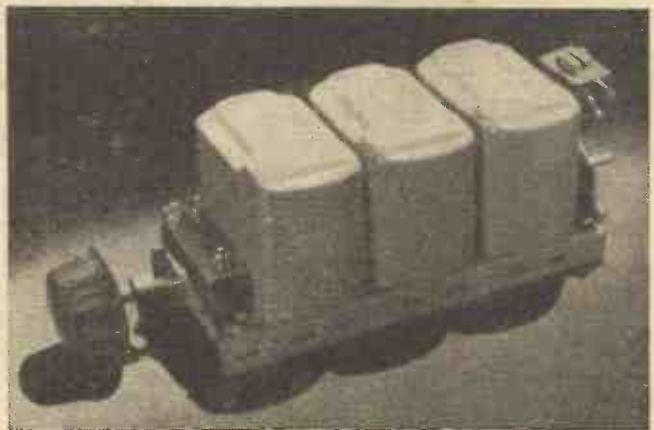

Made under licence from the patents Hans Vogt.

The finest tuning coils of all

The confidence of experts, the enthusiasm of amateur constructors, have combined to make Colvern Coils the most popular tuning units obtainable. Their efficiency and precision are unparalleled. Their simplicity and compactness are readily appreciated by the Constructor, and, incorporating Ferrocarts, the world's finest core, this perfectly matched unit ensures the best results it is possible to obtain. Be sure that you get the same satisfaction from your All-Pentode as did Mr. Camm himself by employing Colvern Ferrocarts Coils. Type G 1, 2 and 3 with 3 point switch 39/-

COLVERN

Send to-day for latest Colvern booklet, No. 13, to Colvern, Ltd., Romford, Essex.

BRITISH MADE

RADIO VALVES

SPECIAL CLEARANCE OF

5,000 British Made Battery Radio Valves. Send P.O. immediately. Any valve replaced free of charge if unsatisfactory.

SCREEN-GRID
DETECTOR
POWER
PENTODE

2/9

EACH

POST FREE

Made by one of Britain's leading Manufacturers.

RADIO & ELECTRICAL WHOLESALE SUPPLY—(Dept G.N.)

6, CONDUIT ST., REGENT ST., LONDON, W.1.

J.B. BABY GANG J.B. ARCUATE DRIVE

SPECIFIED FOR THE P.W.
ALL-PENTODE THREE



3-GANG BABY GANG 15/-

Very compact design made possible by extremely accurate jig assembly. Permanency assured by rigidity of construction and perfect bearings. Complete screening is a notable feature.

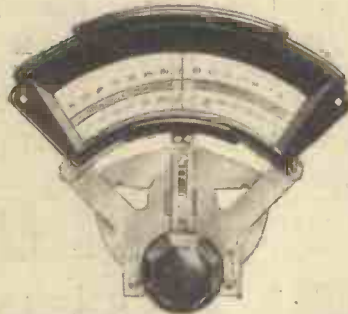

ARCUATE DRIVE - - 5/9 & 6/6

Two colour scale calibrated in Wave Lengths for use with standard inductances. Pilot Lamp Holder arranged to move with hair line indicator with maximum illumination just where required. Plain type (ratio 8-1) Price 5/9 DUAL RATIO MODEL, giving ratios 8-1 and 150-1 for Short Wave work. Supplied with 0-180 degrees. Price 6/6



LARGE BROADSHEET FOR ONLY 4d. POST FREE

We are offering you—for only 3d. (4d. Post Free)—a large broadsheet, "Vivid Radio," containing three full-size blue-prints and full wiring instructions for incorporating a J.B. "Linacore" in your set. Post the coupon to-day, and be sure of getting your broadsheet before they are out of print!

POST THIS COUPON NOW!

To Jackson Brothers (London) Ltd., 72, St. Thomas' Street, London, S.E.1.

Please send me "Vivid Radio." I enclose 4d. in stamps to cover postage, etc.

Name

Address

Pr.W

PRECISION INSTRUMENTS

NEW AND BETTER

- NEW** EP 36 Power Transformer, Semi-shrouded for popular circuits • 22/6
- NEW** EP 37 ditto, for Westinghouse Rectifiers • 25/6
- NEW** EP 38 ditto, for Valve Rectifiers • 50/-
- NEW** DP 45 Improved Power Puncher • 15/6
- NEW** AVC unit BP 28—Improved type • 15/6
- NEW** Three NEW NICORE oscillator coils, BP 45, 46 and 47 • 10/6
- NEW** Wonderful new range of NICORE FLAT-GANG UNITS smaller than before—in any combination • 22/- to 44/-



Varley

Oliver Pell Control Ltd., Bloomfield Road, Woolwich, S.E.18.

Tel. 2345.

UNUSUAL OUTPUT CIRCUITS

An Explanation of the General Principles to be Followed when Designing a "Quality" Receiver, with some Useful Circuit Arrangements, By FRANK PRESTON

UNTIL fairly recently the average listener has been content to accept a standard of reproduction which often fell far short of the original, but there are now definite signs that much better quality is being demanded. This is as it should be, for there is no doubt that well-nigh perfect reproduction is now attainable, provided that the listener is determined to get it, and is prepared to go to a little trouble with that end in view.

One reason why quality of reproduction has to some extent been ignored during the last few years is that listeners have, as a general rule, been too intent upon receiving a multiplicity of foreign stations. And it is almost impossible effectively to combine in a single receiver long range, adequate selectivity for real DX reception, and true reproduction. If the listener will be content to listen to no more than the local stations, however, and to build a high-grade amplifier, excellent reproduction is not too difficult to secure. If long-distance reception is required in addition, it is best to employ a separate receiver for the purpose, providing a change-over switch to transfer the L.F. amplifier from one receiver to the other.

Selectivity and Reproduction

It is by now fairly well known that true reproduction cannot be obtained by using a receiver which is very selective, since the sharply-tuned circuits serve to cut the sidebands of the transmission and so cause the high notes to be seriously attenuated, or reduced in strength. A measure of correction can be secured by using suitable tone-control circuits, but the final result is not generally so good as when the tuning circuits are designed to respond to a bandwidth of 10 to 12 kilocycles.

Since nothing but local stations will be required in the case of the "quality" set it might be considered that no H.F. ampli-

fication will be called for, and that the aerial circuit might be fed straight into the detector. In practice, however, it is nearly always better to employ a single variable-mu H.F. stage, partly to ensure an adequate input to the detector (which should preferably be of the power-grid type), and partly so that there will be no necessity for the use of reaction. Another advantage of the H.F. stage is that a variable-mu valve provides an excellent form of distortionless volume control.

The Tuning Circuits

With regard to the tuning circuits, it is usually found best to employ a single-circuit tuner on the aerial-input side and to use a band-pass circuit, adjusted to give a band width equal to the figure mentioned above, between the H.F. and detector valves. Most ready-made band-pass coils are designed to cover a band width of 9 kilocycles, but it is generally only a matter of reducing the capacity of the coupling condenser to increase the band width; for example, if a 9-kilocycle separation is given by using a .04 mfd. condenser, changing the capacity to .03 mfd. will give just about the desired result.

A suggested circuit for the first two valves of a simple "quality" receiver is given in Fig. 1, from which it can be seen that the general arrangement is quite straightforward. It will be noticed that a high-tension voltage of 300 is indicated, and although this might appear to be rather a high value it is certainly to be recommended in the case of indirectly-heated A.C. valves, although a figure of about 200 would be adequate for battery valves. The high voltage is necessary to compensate for the voltage drop across the anode resistances.

Undistorted Output

The low-frequency side is undoubtedly the most important in the case of any

"quality" receiver, but it would be useless to lavish considerable care on this unless the preceding stages were in order. Until a year or two ago it was the rule to design receivers and amplifiers for home use with maximum outputs of about 1 watt, and it was, in fact, considered that reproduction was uncomfortably loud when greater outputs were provided. This was a fallacy which has since been corrected, with a result that outputs up to 4 watts are by no means uncommon. Moreover, reproduction with such an output is considerably better than

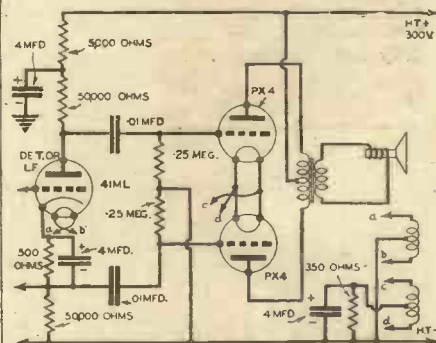

Fig. 2.—This diagram represents a completely resistance-coupled push-pull amplifier.

when the output was less. In other words, the reason for the previous "deafening" effect, when a large output was employed, was not due to the reproduction being too loud, but due to the distortion which was present. It has also been known quite recently that much of the harshness and "drumming" upon the ears was due to what has been described by Mr. Poliakoff, of Multitone Electric, Ltd., as the "masking effect." This can briefly be explained by saying that the middle and lower frequencies came into such great prominence that the higher frequencies were "masked" or hidden. A recent invention of Mr. Poliakoff has overcome this difficulty by the provision of a double-output circuit. One portion of the circuit reproduces the middle and lower frequencies, whilst the other incorporates a special filter and reproduces the high notes only. The system has been developed primarily for use by people who are deaf, but it will probably find a much wider application than this in the realms of "quality" reproduction.

The Best L.F. Circuit

It is perhaps not necessary to adopt this principle in order to secure good reproduction when an output of between 2 and 4 watts is available, but it is desirable that an amplifier operating on the push-pull or similar principle be employed wherever possible. The advantages of normal push-pull amplification have been set forth in these columns on a number of occasions, whilst several push-pull circuits have been described. It is, therefore, unnecessary to deal here with the standard systems in

(Continued overleaf)

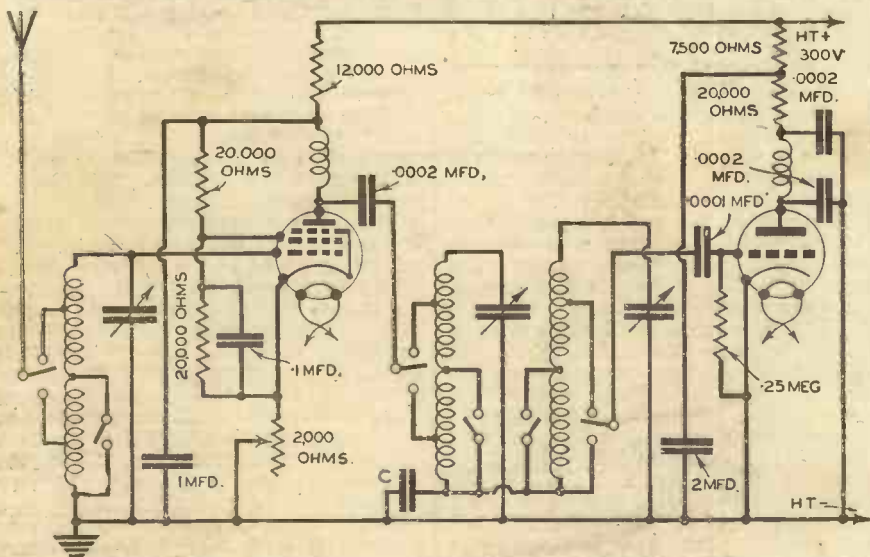

Fig. 1.—The circuit of the first two valves in a "quality" receiver. Important points are referred to in the text.

(Continued from previous page)

which a centre-tapped input transformer is used to feed the push-pull stage, but mention might be made of a modified arrangement in which all the coupling is on the resistance-capacity system. The circuit of such an amplifier is given in Fig. 2, and it will be seen that the L.F. valve has two load resistances, one being in the conventional position between the anode and high-tension positive, and the other between the cathode-circuit bias resistance and high-tension negative; the two push-pull valves are fed (in opposite phase) from the anode and cathode of the L.F. valve respectively.

This circuit is capable of excellent results, the absence of iron-core transformers and chokes ensuring uniformity of response over the full audio scale, besides tending to reduce the cost of the apparatus to a fairly considerable extent. The values of resistances and condensers indicated on the circuit diagram are correct for the particular valves shown, but will have to be varied slightly for other types.

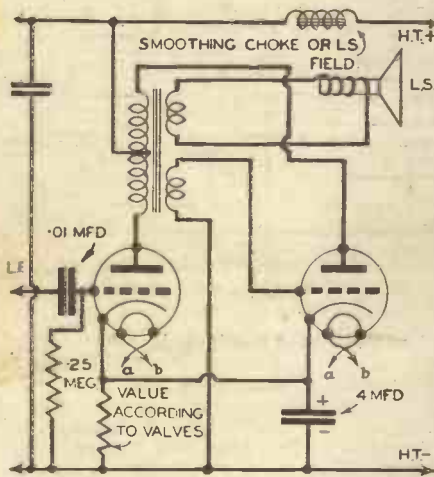

Fig. 3.—The circuit for a standard duo-phase amplifier. A special transformer with two secondaries is employed.

Duo-phase Amplification

A comparatively new development in the way of power L.F. amplification is the duo-phase system, a circuit of which is given in Fig. 3. The circuit is unconventional in that a single transformer with two secondary windings is used both for coupling the two duo-phase valves and for output purposes. Contrary to usual practice, the transformer serves to step-down the signal voltages applied to the grid of the last valve, the step-down ratio being quite high. It is not possible to give complete details of the transformer since it has to be designed particularly to match the valves and speaker employed, but suitable transformers can be obtained from a number of manufacturers by stating the valve combination which is to be used. An undistorted output of about 3 watts can be obtained by employing two valves such as the Cossor type 4IMP, whilst an output up to about 7 watts is possible by using a pair of directly-heated power triodes such as the Mullard type AC 044. In the first case a mains transformer and rectifier giving an output of 350 volts (Class B rectifier) would be needed, and in the second case an output of 500 volts (Class C rectifier) would be called for, assuming in each case the use of a smoothing choke or speaker field having a D.C. resistance of some 1,500 ohms.

Special Advantages

Duo-phase has all the advantages of push-pull, due to the grids of the two valves being fed with signal voltages of opposite phase, plus the rather important advantage that the two grid circuits are not symmetrical, so that parasitic oscillation is practically impossible. That form of trouble is still further obviated due to the fact that the transformer secondary winding in the grid circuit of the last valve has a very low impedance. This same winding eliminates the possibility of mains hum being introduced into the grid circuit due to close proximity of mains equipment.

A Simplified Modification

An interesting modification of the duo-phase arrangement is shown in Fig. 4, and in this case the special duo-phase trans-

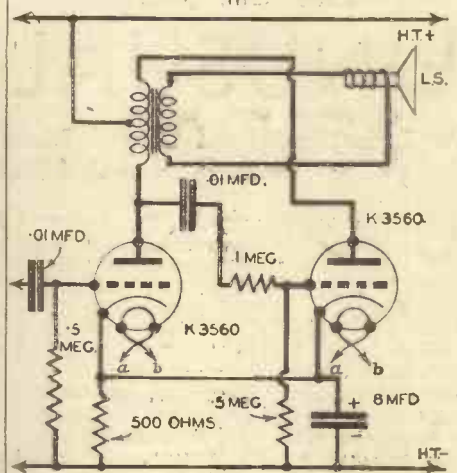

Fig. 4.—A modified duo-phase arrangement; in which a two winding transformer is used for coupling the two valves and feeding the speaker.

former is replaced by a more normal pattern of centre-tapped output transformer. Approximate values of components are indicated, the valves shown being Ostar-Ganz, since the circuit is one which has been successfully employed by the British distributors of these valves, Messrs. The Universal High Voltage Radio. In practice, this modified circuit has proved to be particularly effective, and an output of no less than 7 watts can be obtained when the amplifier is fed from either A.C. or D.C. mains.

It is scarcely necessary to emphasise the fact that no amplifier can give of its best unless it is coupled to an efficient speaker, and in this respect it is worth while to consider one of the pairs of matched units which have recently become so popular; some of these comprise two moving-coil speakers which give maximum response to the high and low frequencies respectively, others combine a small horn speaker (or "tweeter") and a cone speaker, the two being fed from a special filter unit, whilst others combine a piezo-electric crystal unit and a standard M/C movement.

ONE of the most difficult things to trace in an A.C.-operated receiver is the irritating hum which only too often causes poor reproduction. Every care might be taken in building the set, placing the components and wiring in positions where there is the least likelihood of a fault arising, but immediately a test is made this noise creeps in from somewhere, involving hours of careful searching. Some of the points which ought to be given attention in such cases may be any or all of the following.

Unbalance of the filament circuit of a three-electrode valve heated with A.C. The centre tap of the filament winding may not be in the exact centre, or the potentiometer used in place of a centre tap on the winding may not be accurately positioned. The grid return lead may be made to one side of the filament winding.

Improper bias on an amplifying valve sometimes results in hum, especially when the grid becomes positive.

Close proximity of a wire carrying alternating current to a grid lead in an amplifier. The hum is carried over by capacity coupling between the grid and the A.C. wire.

Excessively large capacity in the H.T.

TRACING "HUM"

supply filter next to the rectifier valve. When an electrolytic condenser of large capacity is used in this place the hum is frequently very great. At other points in the filter large capacity is advantageous.

Saturated filter chokes. If the current drawn from the H.T. supply is greater than that for which they have been designed, hum results because the inductance of the chokes is too low. Sometimes chokes are rated so optimistically that even when the current is less than rated value there is considerable hum due to saturation.

In some cases hum results when the plate current for any reason is lower than a certain value depending on the valve.

An open grid circuit on the low potential side often gives rise to hum. The break does not necessarily make the circuit inoperative.

In some instances the hum can be traced to a defective part in the H.T. supply or in the amplifier, such as a punctured condenser, open coil, or burnt-out resistance.

Inadequate filtration in the field current of a moving-coil speaker will often be a source of strong hum when the speaker is exceptionally efficient on the low notes, as most of these speakers are.

Sometimes hum results from the lack of earthing cases and cores of the audio or power transformers.

Oscillation in the amplifier or in the radio portion of a receiver. This may be at any frequency whatever. For example, it may be a very high, parasitic radio-frequency oscillation, or an oscillation in the tuning range of the receiver. Again, it may be an oscillation at audio-frequency due to feed back through the H.T. supply. This oscillation may even be above audibility, or again, below the audible limit. Regeneration is also a possible source of hum since it is the same thing as oscillation. If the regeneration or weak oscillation occurs near the hum frequencies—that is to say, 50 to 100 cycles—the hum is likely to be very severe.

All these points should be watched very carefully if it is desired to find a satisfactory solution from such difficulties as this troublesome fault brings into being.

IMPORTANT ANNOUNCEMENT

MY ALL-PENTODE THREE

Advance Details of the Latest "Practical Wireless" Receiver, Specially Designed to Commemorate our Second Birthday. Free One Shilling Full-size Blue Print to be Given Next Week

ONCE again it is my privilege to place before readers of PRACTICAL WIRELESS de-

By F. J. CAMM

I claim that with the circuit arrangement employed in the All-Pentode Three I have achieved what every

one of my readers has been waiting for, namely, ultra selectivity without loss of signal strength, on a minimum number of valves without introducing the superhet principle.

one of my readers has been waiting for, namely, ultra selectivity without loss of signal strength, on a minimum number of valves without introducing the superhet principle.

This ultra selectivity has been achieved by a careful selection of iron-core coils, which give equal selectivity, moreover, on both wavebands. I must accord a large measure of praise for the results obtained to Messrs. Colvern, Ltd., who allowed me to select a set of standard coils for test.

Owing to the ingenious Colvern Coil assembly the set is delightfully easy to control, for although there is but one knob, this controls wave-changing from the medium to the long bands, and also functions as an on-off and radiogram switch. This knob carries out this function by operating two separate switches in addition to contacts leading off to the coil connections.

We Lead!

After two years' experience with the policy laid down PRACTICAL WIRELESS is in the enviable position of being the leader of its class, respected alike by home constructors the whole world over, and by all manufacturers and designers of repute. Hence, in planning the receiver which was to synchronize with our Birthday Number, I have spared no efforts in producing a design which would in every way be worthy of the high standard set by this journal. Manufacturers tell me that I have the reputation of being a hard task-master and that I am too exacting in my demands! It is true that I insist upon an extremely high order of efficiency before I allow a component to appear in any of my receivers, but I am prepared to justify every component I have ever specified. Justification for my attitude is provided by the cordial relations existing between the editorial staff and our readers, and the fact that many thousands of successful receivers built from PRACTICAL WIRELESS Guaranteed Designs are now in operation all over the world.

Droitwich Anticipated

My latest design is a three-valver employing three pentode valves, and with a lively eye to the opening of the new Droitwich Station I have employed inductively-coupled band-pass tuning which, I think it is generally conceded, is far better than capacitive coupling on the long waves.

one of my readers has been waiting for, namely, ultra selectivity without loss of signal strength, on a minimum number of valves without introducing the superhet principle.

This ultra selectivity has been achieved by a careful selection of iron-core coils, which give equal selectivity, moreover, on both wavebands. I must accord a large measure of praise for the results obtained to Messrs. Colvern, Ltd., who allowed me to select a set of standard coils for test.

Owing to the ingenious Colvern Coil assembly the set is delightfully easy to control, for although there is but one knob, this controls wave-changing from the medium to the long bands, and also functions as an on-off and radiogram switch. This knob carries out this function by operating two separate switches in addition to contacts leading off to the coil connections.

No Stunt Circuit

There is no stunt or untried circuit about the All-Pentode Three. I have not introduced a single redundant component and have made use of one of the most popular circuit arrangements—the H.F. detector and Pentode L.F. circuit. The first valve is a variable-mu, which provides well-nigh perfect volume control by means of a potentiometer. The low-frequency coupling arrangement incorporates a

tapped choke, and several advantages are thus available, not the least of which is that there is no current saturation of the primary. I have also employed what is obviously necessary with a pentode valve, namely, tone correction for the output valve; but this is included in the grid circuit instead of in the anode circuit.

When full details of this receiver appear next week I am certain my readers will agree that I have adopted an unusual layout in an entirely new style of cabinet. In the first place there is no grille as we at present understand it, for I have long been of the opinion that the old-fashioned speaker fret is as obsolete and is as out of touch with modern cabinet design as the fretted front piano. The layout employed provides for the most efficient wiring scheme; all wiring is extremely short and

LIST OF PARTS FOR THE ALL-PENTODE THREE

- One Ferrocrat ganged coil assembly, type G1, 2, 3 (Colvern).
- One 3-gang midget condenser (Jackson Bros.).
- One arcuate drive (Jackson Bros.).
- One .00015 mfd. reaction condenser (Graham Farish).
- One .0001 mfd. fixed condenser, type M (F.C.C.).
- One .0002 mfd. fixed condenser, type M (T.C.C.).
- One .001 mfd. fixed condenser, type M (T.C.C.).
- Two .0003 mfd. fixed condensers, type M (T.C.C.).
- One .1 mfd. fixed condenser, type 65 (T.C.C.).
- One 2 mfd. fixed condenser, type 65 (T.C.C.).
- Two .1 mfd. tubular condensers (T.M.C.).
- One 500 ohm ohmite resistor (Graham Farish).
- One 10,000 ohm ohmite resistor (Graham Farish).
- One 30,000 ohm ohmite resistor (Graham Farish).
- One 80,000 ohm ohmite resistor (Graham Farish).
- One 150,000 ohm ohmite resistor (Graham Farish).
- Two .5 megohm ohmite resistor (Graham Farish).
- One 50,000 ohm volume control (Ferranti).
- One screened binocular choke (Telsen).
- One standard screened choke (Telsen).
- One Max. transformer (Graham Farish).
- Two 4-pin valveholders (Clix).
- One 5-pin valveholder (Clix).
- Two component brackets (2½ in.) (B.R.G.).
- Two socket strips (A, E, and L.S.) (Belling-Lee).
- One G.B. battery clip (Bulgin).
- One 4-way battery cord with wander fuse (Belling-Lee).
- Three "Bouspring" wander plugs, G.B.-1, G.B.-2 (Belling-Lee).
- One Metaplex chassis, 12 in. by 8 in., with 3 in. runners (Peto-Scott).
- One Cossor 210 VPT valve (4-pin).
- One Cossor 210 SPT valve (4-pin).
- One Cossor 220 HPT valve (5-pin).
- One Stentorian standard speaker (PMS2) (W.B.).
- One cabinet (Peto-Scott).
- Wire for connections, screws, flex, etc.
- One 120-volt H.T. battery.
- One 2-volt L.T. accumulator.
- One 9-volt G.B. battery.

direct, and the efficiency is actually demonstrated by the fact that notwithstanding the super-sensitive circuit arrangement employed the receiver is perfectly stable and no screened leads have had to be employed. There is no H.F. or L.F. instability at all, and yet the output is really remarkable.

Station Getting

The station-getting properties of the All-Pentode Three need to be experienced to be believed, and tuning is made additionally easy by means of the new Midget three-ganged condenser employed, which not only adds to the attractive appearance of the receiver, but is operated by a new slow-motion drive in which the lamp travels round with the cursor and thus provides easy and accurate wavelength identification. I am not in the least overstating the case when I say that this is probably my best receiver, and I sincerely recommend it to the constructor public. They may build it in the confidence that they have my advice and assistance at their back, advice and assistance which I cheerfully render to every reader who seeks it.

I shall fully describe the construction of my All-Pentode Three in next week's issue, with every copy of which will be presented a full-size One Shilling Blue Print. Readers will not have to write in for this nor pay any fee whatsoever; a copy will be included in every issue of PRACTICAL WIRELESS dated Sept. 22nd, on sale on Sept. 19th.

Our New Gift Book Offer

Also to commemorate our Birthday, next week's issue will contain full details of our new Gift Book offer, by means of which readers will be able to obtain



The "Practical Wireless" stand at Radiolympia. All home constructors gravitated to this stand during the show.

a copy of my latest work, "Television and Short-Wave Handbook."

I have been encouraged to produce this volume (which is additional to the well-known series of PRACTICAL WIRELESS volumes) owing to the many thousands of letters I have received from readers who have possessed themselves of my earlier works. It is not for me to comment on my own books, but I can modestly claim that this volume will provide a useful auxiliary work to my previous volumes—the "Wireless Constructor's Encyclopædia," "The Encyclopædia of Popular Mechanics," and "Everyman's Wireless Book." The "Television and Short-Wave Handbook" will be available to all regular readers of this paper on terms similar to those applying to our earlier gift books, and it is similar in style, size, and binding. Full details, as I have said before, will appear in next week's issue.

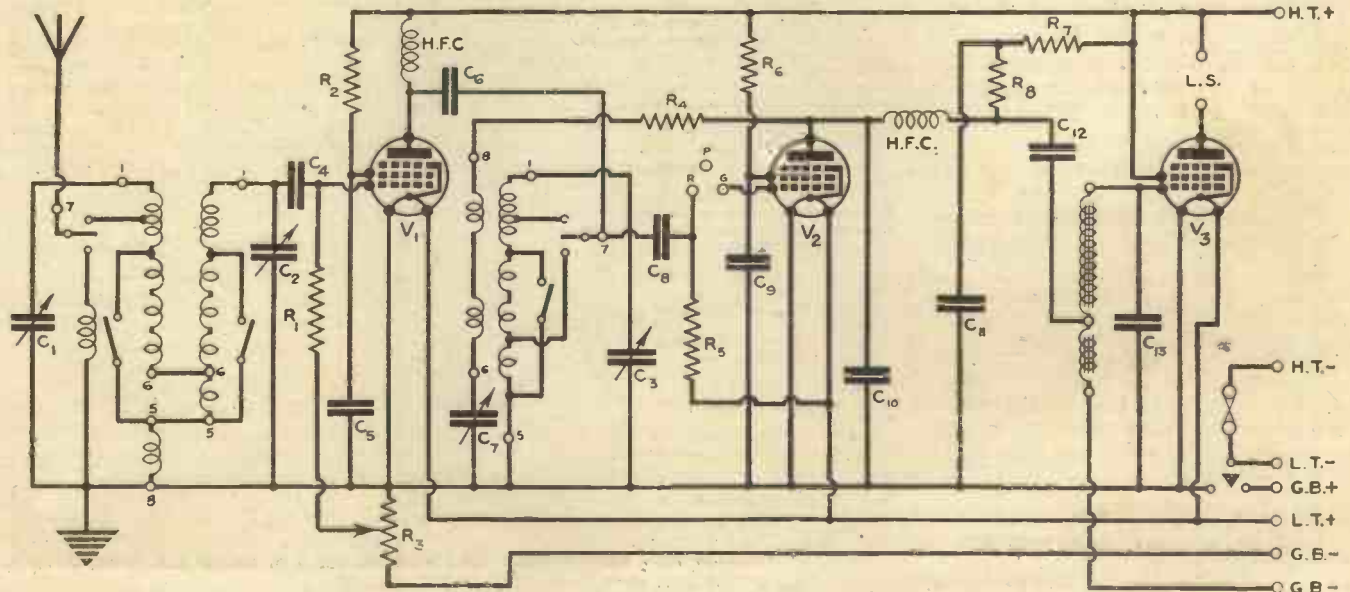

Theoretical circuit of F. J. Camm's All-Pentode Three.

VALVE NOISES

In this Article Various Causes of Microphony are Described

THE valve is undoubtedly the most important component in the wireless receiver, but it is also the one that gives most trouble to the listener. During the past two or three years great improvements have certainly been effected in valve design and construction, but a number of the background noises in the receiver are still due to valve internal defects.

The lay ear cannot, as a rule, differentiate between the various valve noises (commonly termed microphonics), but the experienced wireless engineer can immediately decide in what part of the valve the fault lies, from the type of noise heard in the speaker when the valve is tapped.

Cathode Rattle

The most frequent offender is the cathode, or filament in the case of the directly-heated valve. As is well known, the cathode is held at its top and bottom extremities by thin strips of mica: it is forced into a small hole in the mica, and appears to be tightly fixed. After the valve has been in use for a short period, however, the cathode tends to become loose in the hole, thereby causing cathode rattle. This form of valve trouble has been minimized to a great extent, however, by riveting the cathode to the mica, or by arranging a small spring to hold it against one side of the hole.

In the battery type valve the filament is stretched between two hooks, and as in the case of a violin string, has a natural frequency according to its mass and tension. When the receiver or valve is tapped, the filament vibrates at its natural frequency—generally between 500 and 1,500 cycles. This tendency to vibrate could be obviated by stretching the filament very tightly, of course, but it has been found that this procedure tends to shorten the life of the valve, and therefore the designer has to strike a compromise in this respect.

Should the filament be very slack, and the valve is in a position to catch the direct sound waves from the speaker, sufficient energy may be fed back from the speaker to the valve to form a sound couple. It is,

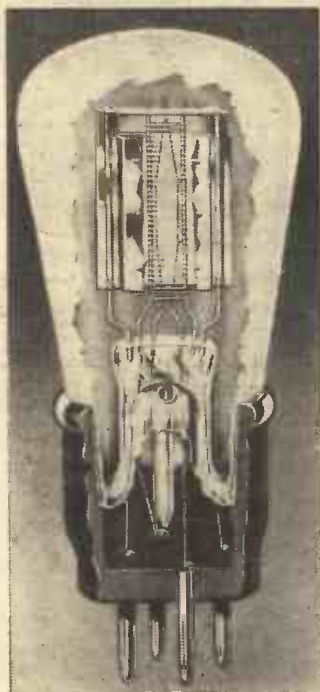

A modern valve, showing the general electrode assembly

therefore, found that when this form of microphonic noise is experienced, placing the speaker in a separate cabinet provides a remedy.

Frame Rattle

A less common valve trouble is frame rattle, caused by badly-welded joints, or loose eyelets. The frame tends to vibrate at a resonant frequency, and whenever this frequency is emitted by the speaker, the valve frame resonates in sympathy with it.

Crackling

Most of the crackles which are heard in the speaker when the valve is tapped are due to a leakage between cathode and anode. This often occurs in pentodes, where the outer screen, at low potential, is very close to the anode, at high potential. Indeed, so short is the mica path from the outer screen to the anode, with the resultant likelihood of a leak across it, that some manufacturers use two micas, one to hold the cathode and grids, and the other to hold the cathode and anode, in order that a comparatively long path may be obtained from cathode to anode.

Distinguishing Noises

All the above-mentioned valve faults cause distinctive noises, which may be easily distinguished. The cathode rattle in the indirectly-heated valve is in the form of a dull rumbling sound, and the filament noise in the directly-heated valve is of a ringing nature having a frequency varying between 500 and 1,500 cycles according to the filament tension. Frame rattle is a tinny, "tizzing" sound, and generally has a frequency of about 1,000 cycles, and cathode to anode leakage results in crackling noises.

The obvious remedy in every case, of course, is to replace the offending valve, but where this is not possible, a temporary improvement may be effected in most cases by using springy (or anti-microphonic) valve-holders, and housing the set and speaker in separate cabinets.

BEING at a loose end during the weekend I paid a visit to one of those Sunday-afternoon discussion classes for men which seem to attract a tremendous number of people. The day in question, I found on arrival, was what they call an open day, and it appeared to me that every man had brought his lady, for there seemed to be as many ladies as gentlemen. A "busman's holiday" never had any particular attraction for me, but on this occasion I thoroughly enjoyed the time spent listening to a debate on the possibilities of radio and its use to the community at large in the future. I had been in the district earlier in the week, and when passing the hall noticed the name of a well-known radio engineer advertised to speak. It wasn't that fact which attracted me, but it appeared to me to be an excellent opportunity of finding out to what extent radio imagination had grown in the minds of the men in the street generally. Believe me, I had a shock, for I came away with the knowledge that these men were far more advanced in their imagination than we dull and dried experts.

Ingenious Applications

I suppose, as a class, experts have to tie themselves down to hard and fast theoretical and technical rules, and their work

POSSIBILITIES OF RADIO

carries them in a kind of rut from which, owing to the direct pressure of their business requirements, there is little or no time to delve into the scientific side of the laboratory. Anyway, I heard sufficient in the two hours spent with these men and their ladies, to know they could provide a budding Verne or Wells with sufficient data for a whole library of new books. The principal speaker of the afternoon had dealt mainly with radio as a means of communication during peace or wartime, and the benefits derived from its use by the community at large, in a very satisfactory manner, but it was left to the men in the body of the hall to introduce the most interesting sidelights.

A Fantastic Idea

One young fellow drifted on into the realms of fantasy by drawing attention to the fact that the main advantage of radio was not altogether the great advantages which it bestowed upon the community, but rather the happiness which it was capable of bringing into human life. He felt convinced that just as radio had up to

the present appealed to the two senses of hearing and seeing, there did not appear to be any reason why we should not anticipate in the future the other senses of smell, touch, and taste should be equally appealed to by the same means. I think he was quite right in dealing with the question of senses in saying that a complete satisfaction of the special senses is essential to the normal and complete happiness of the human mind, and any devised means which would tend to this end easily would increase human happiness accordingly.

Smell by Radio

It was impossible to estimate how much the appeal to the sense of hearing had done for human comfort, or what the appeal to sight by means of television, which was now in the offing, would be able to accomplish. The sense of taste and smell had not yet been gratified by radio, but he saw no reason why in the future some type of radio machine might not be perfected for this purpose. You can quite imagine for yourselves what the mention of a radio appeal to the sense of smell brought forth. The local wit dealt with the introduction to the radio programme by a flooding of the room with the smell of attar of roses, another with the relay of smells and noises from a country farm.

THE MIDGET SH

Full Constructional and Operating Details
for Use on a Waveband

The finished receiver and coils ready for insertion in the cabinet.



It is surprising to find that, comparatively speaking, only a few listeners take advantage of the short-wave wireless transmissions. It is difficult to find the real reason for this, but it may perhaps arise from two causes:

- (1) The wide choice of programmes on the medium and long wavebands.
- (2) The mistaken impression that short-wave work is costly and difficult.

Probably it is the second reason that deters the greatest number from experimenting on the shorter wavelengths, and the Midget S.W. Two is an attempt to prove that the cost involved is very small, while the skill required to operate the set is acquired after a night or two's handling of the controls.

Externally the dimensions of the complete receiver are only 7in. wide, 6in. high, and 5in. deep; while the panel, chassis,

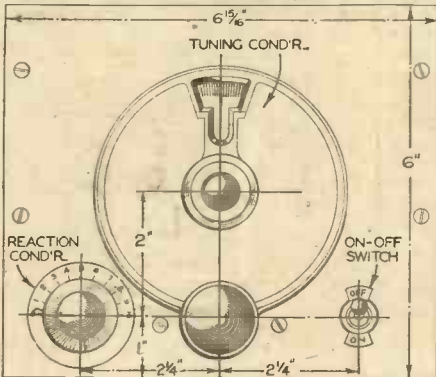

Drilling details for the panel.

and cabinet are made from black sprayed aluminium to give a high-class finish. Neatness and compactness are not its only important features, however, for the performance in long-distance reception of the short-wave stations is outstandingly good.

The Circuit Used

The theoretical diagram shows the circuit which has been employed. Like most short-wave sets, it is quite simple and straightforward, possessing no really novel features. The aerial feed is taken through a .0001 mfd. fixed condenser C_1 to the top of the aerial tuning coil L_1 . This coil, together with the reaction coil L_2 , is wound on a small-diameter ribbed four-pin former. The turns are space-wound with 22-gauge enamelled wire, the ribs being slotted to ensure coil rigidity. The maker's specification for these coils gives their wavelengths when tuned with a .00015 mfd. condenser, but as the C_2 con-

denser specified is only .0001 mfd., the new ranges for the coils are as follows: Type LB (light blue spot identification) 10 to 21 metres; type Y (yellow spot identification) 18 to 37 metres; and type R (red spot identification) 33 to 77 metres. This covers the most important of the short-wave transmissions, and embraces those stations which can be received readily under normal conditions of environment.

The first valve V_1 is a straightforward leaky-grid detector, and the reaction feed from this valve's anode is via coil L_2 and variable condenser C_2 . For good short-wave reception it is absolutely essential to have a really smooth reaction control, and, apart from the necessity of ascertaining the correct detector anode voltage to ensure this, a fine degree of accuracy is required in the reaction control. Erratic or coarse motion must be avoided, and then it is possible to bring in the weak signals which would otherwise not be possible. By having a calibrated scale and a ten-to-one reduction in its drive, the condenser employed in the actual receiver has proved most reliable.

Particular Points

Another factor which has to be watched in the case of

This illustration shows the placement of the chassis. The wire comes through the top of the chassis. This is joined to the...

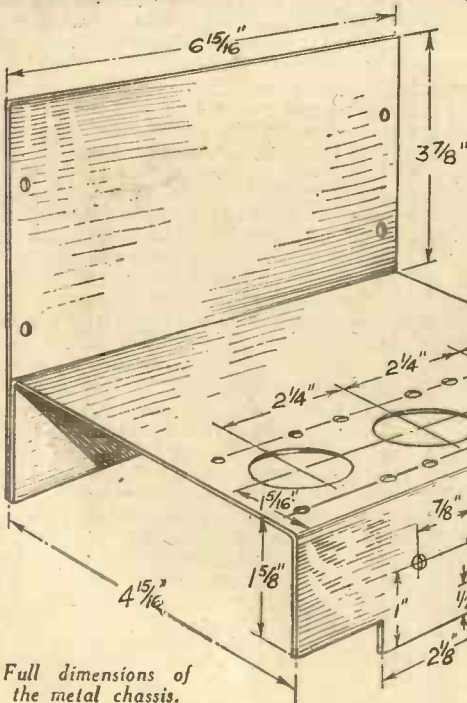

Full dimensions of the metal chassis.

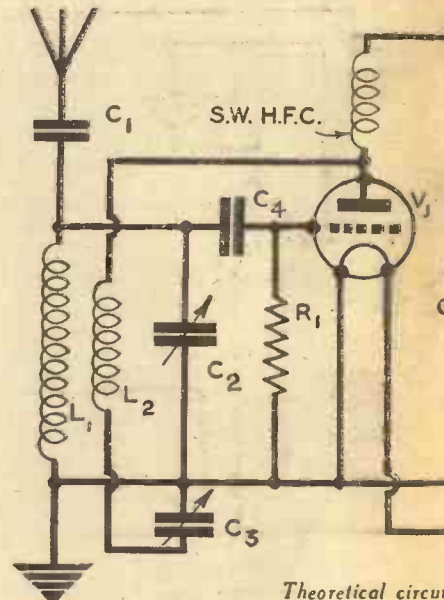

Theoretical circuit.

MIDGET SHORT-WAVE TWO

Plans of a Novel Two-valve Receiver Designed for operation between 10 and 77 metres

A short-wave set is the high-frequency choke. First of all it must be free from any resonance peaks in the wavelength range covered, and the turns so spaced that they have a very low self-capacity. The component chosen embodies these two points, being wound as four small honeycomb coils on a special hollow former. Compactness and a small external field is thus assured, while the wire ends enable it to be mounted directly in the under-chassis wiring.

By employing a compact low-frequency transformer it is possible to accommodate this component below the chassis, while the ratio chosen gives just the right amount of step-up for a circuit of this character. Finally we have the pentode output valve V_2 giving the additional power required when listening to the more distant stations.

The Cabinet

The first work to be undertaken in building this midget set is the making of the panel, chassis, and cabinet, although if preferred the last-named can be left until the set is completed and tested. In any case, the dimensioned drawings on this page give all the information required, 3/32-in. aluminium be-

ing used throughout. If preferred, the chassis, panel, and cabinet can be obtained complete from Messrs. Peto-Scott and Co., Ltd. Drill the chassis to take the valve-holders and terminals, and then fix these items in place. Actually, the panel and chassis are quite separate pieces of metal, but the mounting of the on/off switch, transformer, and reaction condenser (the first and last items with one hole fixing and the remaining item with

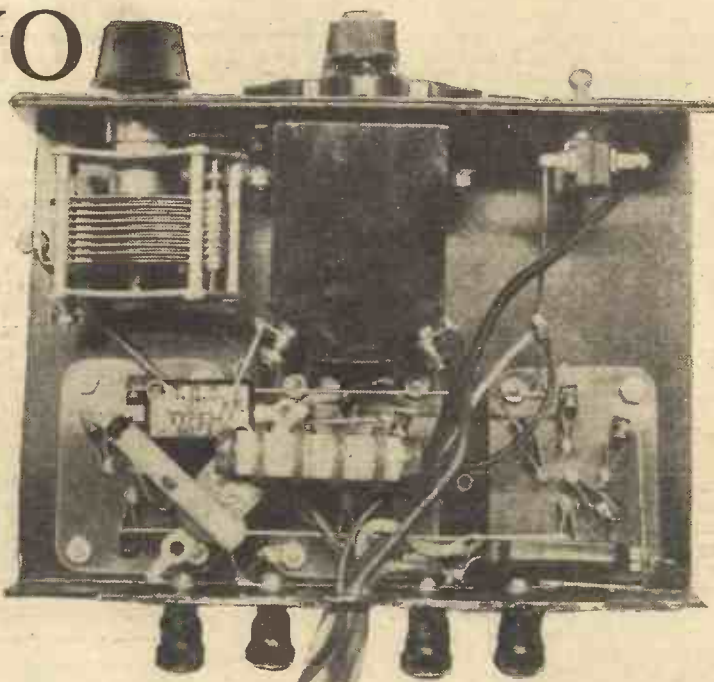

Study this view of the underside of the chassis in conjunction with the wiring diagram on the next page.

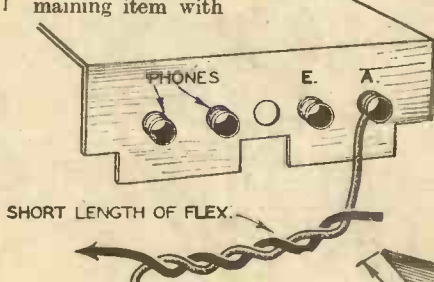

SHORT LENGTH OF FLEX.

Method of using a short length of wire for aerial.

By arranging the components in the positions indicated the length of each wiring run is kept to the barest minimum, so those readers building this set for themselves should follow the layout exactly if good results are desired. The performance of a short-wave set is dependent on layout and careful wiring far more than a broadcast band set, so do not try alternatives on your own account.

As far as the actual wiring is concerned, this is very simple. Bare connecting wire can be

Shows the clean appearance. Note that only one hole is shown from the underside of the variable condenser.

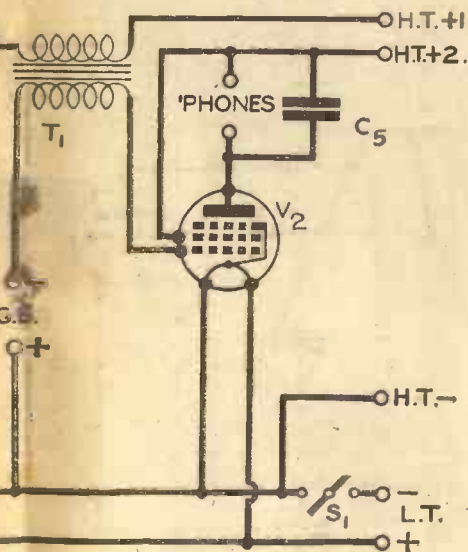

Part of the Midget Short-wave Two.

two countersunk head bolts), grip the panel and chassis edges together very rigidly.

Component positioning is indicated very clearly in the accompanying photographs and wiring diagram overleaf, and these should be studied carefully when adding the remaining items to the set. Note that each terminal, except the one marked "earth," is insulated from the aluminium, but the reaction and tuning condensers make their earth return connection through the aluminium. When making these earth contacts see that the black paint is cleared away carefully, or a defective contact will arise, and this will mar the set's performance.

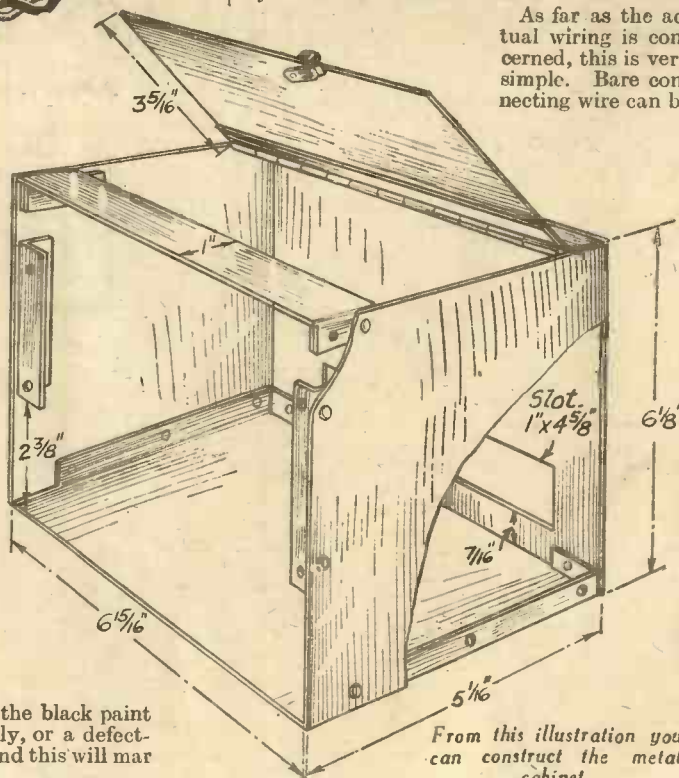

From this illustration you can construct the metal cabinet.



MIDGET SHORT WAYER

NEW SPEAKERS—ELIMINATORS—KITS

PILOT AUTHOR KIT EXACT TO SPECIFICATION

The Pilot Kit SERVICE was founded in 1919.

See the PILOT on the carton. It's a real guarantee.

BARGAIN OFFER

Peto-Scott STRAIGHT BATTERY 3



List Price **£4 19 6**
Bargain Price **£3 7 6**

Cash or C.O.D. Carriage Paid. Wonderful opportunity to secure this amazingly popular battery set at an astounding bargain price. Built on Metalex. Incorporates all the latest battery set improvements. New type non-mercuric detector followed by R.C.C. and final transformer coupled power stage; two-circuit tuner and single dial slow motion illuminated tuning. Complete with B. V. Speaker, British valves, long-life batteries, and modern walnut cabinet illustrated. Ready to Play.

SEND FOR BARGAIN LISTS

- B.T.H. MINOR PICK-UP AND TONE ARM. With volume control. Cash or C.O.D. Carriage Paid, **£1 1/0**.
- Balance in 8 monthly payments of 2/9.
- NEW GARRARD A.C.4 ELECTRIC MOTOR with 12-in. turntable, motor plate and fully automatic stop. Cash or C.O.D. Carriage Paid, **£2 2/6**.
- Balance in 11 monthly payments of 4/-.
- MARCONI K. 19 PICK-UP AND TONE-ARM. Cash or C.O.D. Carriage Paid, **£1 12/6**.
- Balance in 11 monthly payments of 3/-.
- AVOMINER UNIVERSAL A.C.-D.C. Measuring Instrument. Complete in case with leads, clips and testing prods. Cash or C.O.D. Carriage Paid, **£5 0/0**.
- Balance in 11 monthly payments of 9 3.



NEW SPEAKERS

- BLUE SPOT "STAR" MOVING-COIL SPEAKER. Complete with Universal Matching Transformer. Cash or C.O.D. Carriage Paid, **£3 10/0**.
- Balance in 11 monthly payments of 6/6.
- NEW BLUE SPOT 45 P.M. MOVING-COIL SPEAKER, with input transformer. Cash or C.O.D. Carriage Paid, **£2 5/0**.
- Balance in 9 monthly payments of 5/-.
- CELESTION P.P.M. 8 P.M. MOVING-COIL SPEAKER. For Power or Pentode. Also Class "B" and Q.P.P. Models. Cash or C.O.D. Carriage Paid, **£1 15/0**.
- Balance in 9 monthly payments of 4/-.



FOR SPECIAL PETO-SCOTT OFFER SEE OUR ADVERTISEMENT, COVER III

- ROLA FR7-P.M. MOVING-COIL SPEAKER. Universal tapped transformer for Power, Pentode and Class "B." Cash or C.O.D. Carriage Paid, **£2 9/6**.
- Balance in 10 monthly payments of 5/-.
- R & A "Victor" PERMANENT MAGNET MOVING COIL SPEAKER. Complete with Universal Transformer. Cash or C.O.D. Carriage Paid, **£3 13/6**.
- Balance in 11 monthly payments of 7/-.



NEW ELIMINATORS

- ATLAS C.A.12, for A.C. mains, 100/250 v., three tapplings; 60/80, 90/100, 120/150 v., 12 m.a. at 120 v. Cash or C.O.D. Carriage Paid, **£2 12/6**.
- Balance in 10 monthly payments of 5/3.
- BLOCK (Plateless) H.T. ACCUMULATOR. 2-60v. 5,000 m.a. Cash or C.O.D. Carriage Paid, **£3 15/0**.
- Balance in 11 monthly payments of 7/-.

MIDGET SHORT WAYER

KIT "A" Author's Kit of Yours for **5/-** and 11 monthly payments of 5/-
including Peto-Scott Aluminium Chassis and Panel, sprayed black, as specified, less Valves and Cabinet. Cash or C.O.D. Carriage Paid **£2 15/0**.

KIT "B" As for Kit "A" but with set of specified Valves, less Cabinet. Cash or C.O.D. Carriage Paid, **£3 17/0**. Or 12 monthly payments of 7/-.

KIT "C" As for Kit "A" but with set of specified Valves and Peto-Scott Aluminium Cabinet sprayed black, as specified. Cash or C.O.D. Carriage Paid, **£4 18/0**. Or 12 monthly payments of 9/-.



NEW Manufacturers' KITS in Sealed Cartons

- COSSOR 357. 4-valve (including rectifier) A.C. Mains. Complete Kit includes Valves, Cabinet and Mains Energised Moving-Coil Speaker. Cash or C.O.D. Carriage Paid, **£7 19 0**.
- Balance in 12 monthly payments of 13/6.
- LISSEN SKYSCRAPER THREE. Chassis model with (Lissen) S.G. Detector and Pentode Valves. Cash or C.O.D., **£3 17/6**. Carriage Paid.
- Balance in 11 monthly payments of 7/-.
- NEW LISSEN BAND-PASS SKYSCRAPER THREE. Complete Kit comprises all components, including set of Lissen Valves. Cash or C.O.D. Carriage Paid, **£4 18/6**.
- Balance in 11 monthly payments of 9 3.
- LISSEN A.C. SKYSCRAPER. Complete Kit comprises all components, including set of Lissen valves. Cash or C.O.D. Carriage Paid, **£6 10/0**.
- Balance in 11 monthly payments of 12/-.
- TELSEN 323 KIT. Less valves. Cash or C.O.D. Carriage Paid, **29/6**.
- Balance in 5 monthly payments of 5/3.
- GRAHAM FARISH SKY RAIDER 3. Complete Kit for building includes Valves, modern Walnut Cabinet and W.B. Stentorian Baby Speaker. Cash or C.O.D. Carriage Paid, **£7 6/8**.
- Balance in 11 monthly payments of 13/6.
- GRAHAM FARISH MYSTIC G. Kit for building, less valves and Cabinet. Cash or C.O.D. Carriage Paid, **£2 0/0**.
- Balance in 7 monthly payments of 5/8.
- If required complete with Valves, Cabinet and W.B. Stentorian Baby Speaker. Cash or C.O.D. Carriage Paid, **£5 5/6**, or 12 monthly payments of 9/8.
- B.T.S. DISC TELEVISION RECEIVER KIT. Complete kit for building, including B.T.S. Motor and the new TELEVISION Neon Lamp. For A.C. (40-60 cycles) and D.C. Mains. Cash or C.O.D. Carriage Paid, **£4 4/0**.
- Balance in 11 monthly payments of 7/-.
- 6-v. Battery Model. Cash or C.O.D. Carriage Paid, **£3 18/0**, or 15/- Deposit and 11 monthly payments of 6/3.

Peto-Scott SPEAKERS

Type 31 PERMANENT MAGNET MOVING-COIL SPEAKER—Not a Midget—FULL SIZE CONF. Power and Pentode. Complete with input transformer. Send 2/0 with order. Balance in 8 monthly payments of 2/6. Cash or C.O.D. Carriage Paid, **19/6**. Class "B" Model, Cash or C.O.D. Carriage Paid, **£1 2/6**. Or 2/9 down and 9 monthly payments of 2/8

Type 3.3 DE LUKE P.M. 1855 MOVING-COIL SPEAKER. Tapped for Power, Super-Power, Pentode or Class "B." A speaker that is unsurpassed for sensitivity, exquisite tone, reliability and value. With oversize cone and tapped input transformer, CASH OR C.O.D. CARRIAGE PAID. **£1 15/-**. YOURS FOR 2/6. BALANCE IN 9 MONTHLY PAYMENTS OF 4/-.

1935 ADAPTAGRAM

Convert your Present Set to a Magnificent Radiogram



Here is the Ideal Cabinet for converting your present set to a magnificent Radiogram. Hand French Polished by leading experts of London's piano trade. Chromium fret surround. All joints mortised and tenoned. Ready to take your set, speaker, power equipment and your own gram fittings. With ready-fitted motor board. Plain front or vignette to take any panel up to 18 in. by 8 ins. or specially drilled to suit your own dimensioned sketch at slight extra cost.

YOURS FOR **8/3**

MODEL "A" as illustrated, Cash or C.O.D., **63/-**. Carriage and Packing 2/6 extra, England or Wales. Yours for 5/3 and 11 monthly payments of 5/8. Baffle Board 3/6 extra.
WALNUT, OAK or MAHOAGANY to choice. 63/-
MODEL "C" ELECTRIC MOTOR Standard 1935. Adaptagram Cabinet—Collaro or Garrard Induction Electric Motor with Tone Arm, Pick-up and Volume Control—12 in. Turntable—Automatic Stop—Automatic Needle Cup that delivers needles one at a time to your finger tips. A.C. Mains only. Cash or C.O.D. **7 Gns.** Or 12 monthly payments of 12/9. D.C. model prices on application. Loudspeaker Compartment. Baffle-board fitted if required 3/6 extra

Double the Life of your H.T. Battery

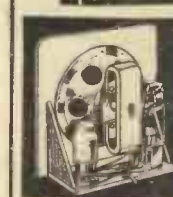

1935 PETO-SCOTT Q.P. SPEAKER-AMPLIFIER KIT

Convert your present battery set to Q.P. Output with this marvelous unit... increase its quality... double the life of your H.T. battery. Comprises B.V.A. Q.P. Valve (22/5), 1935 Peto-Scott Permanent-Magnet Moving-Coil Q.P. Speaker, Special Q.P. Transformer and 7-pin Valve Holder. Peto-Scott Radio and Baseboard Assembly, all Wires and Serewa. With full-size Diagrams and Assembly Instructions.

Cash or C.O.D. **63/-**
Or send only **7/6**.
Balance in 11 monthly payments of 5/6.

IMPORTANT

Miscellaneous Components, Parts, Kits, Finished Receivers or Accessories for Cash or C.O.D. or H.P. on our system of Easy Payments. Send us a list of your wants. We will quote you by return. C.O.D. orders value over 10/- sent carriage and post charges paid (GREAT BRITAIN ONLY). OVERSEAS CUSTOMERS CAN SEND TO US WITH CONFIDENCE. We carry a special export staff and save all delay. We may bill carriage—packed free. Send full value plus sufficient for half carriage. Any surplus refunded immediately. Hire purchase Terms are NOT available to Irish and Overseas customers.

PETO-SCOTT CO., LTD., 77, CITY ROAD, LONDON, E.C.1.
Telephone: Clerkenwell 9406/7. West End Showrooms: 92 High Holborn, London, W.C.1. Telephone: Holborn 3248.
Dear Sirs.—Please send me CASH/C.O.D./H.P.

for which I enclose £
CASH/H.P./DEPOSIT
NAME
ADDRESS
P.R.W. 15/9/34.

Buy by Post—its Quicker—CASH—C.O.D.—EASWAY

*In the days when
this was the
"MIKE"*



WHEN a telephone mouthpiece often did service for a microphone . . . when radio was still almost as "black magic" . . . it was the name of Celestion that meant everything to the man who was buying a Loud-Speaker. To-day the name of Celestion has a greater reputation than ever before. For ten years it has stood for quality in its fullest sense. Throughout that time most of the improvements which have come in the reproduction of sound are the result of the skill of Celestion engineers. Follow the experts' choice—Celestion always.

There is a Celestion Loud-Speaker for every purpose at prices ranging from 17/6 to 18 gu. Write for complete list and technical data to Celestion Ltd., London Road, Kingston-on-Thames. Telephone: Kingston 5659/7/8/9

CELESTION
The Very Soul of Music

**Still to-day—the foremost
name in sound reproduction**

Buckingham

AC
ME4

MAA
**A PENTODE THAT
IS NOT A PENTODE**

The 362 perpendicular anode is employed in the ACME 4. Its effect is to cause the secondary emission to fall back on the anodes instead of upon the fifth electrode as in ordinary pentodes. The result is to suppress the kink in the characteristic; and instead of the usual tail off at anode voltage, a straight characteristic is maintained down to a very low figure. You are thus given a correspondingly greater undisturbed output for the same plate current.

There is a complete range of 362 Valves, battery or mains, all sold at comparative prices. Send for list.

13!

Should not local dealer not stock 362 Valves, 100 P.O. 200 to 300 49 A

**362
VALVES**

362 RADIO VALVE Co. L^{td} STONEHAM RD, LONDON, E.S.

38234/9

CAREW WILSON

This Coupon
together with 3d. in stamps

**The
ALL-METAL WAY
1935**



WESTINGHOUSE
METAL RECTIFIERS
WESTECTORS

STAND
No. 53
Manchester Radio
Exhibition

Please send immediately a copy of the "All-Metal Way 1935" for which I enclose 3d. in stamps

NAME

ADDRESS

PLEASE WRITE IN BLOCK CAPITALS

PRA 15934.

brings to you a copy of "The All-Metal Way 1935," the modern treatise on A.C. Mains operation and the use of Westectors

WESTINGHOUSE

Address your envelope to Dept. PRA 15934.

THE WESTINGHOUSE BRAKE AND SAXBY SIGNAL CO., LTD.,
82 YORK ROAD, KING'S CROSS, LONDON, N.1.



THE BEGINNER'S SUPPLEMENT

LAST week we saw that, all other things being equal, an increase in the number of tuned circuits resulted in an increase in selectivity. The action of a series of tuned circuits is similar to a row of sieves, the top sieve being of coarse mesh and the others of increasing fineness. The top sieve makes a very rough selection of the material being sifted, while each succeeding one narrows down the selection until, with the last one, only the wanted particles are passed. With several tuned circuits in a receiver each one increases the selectivity until the last one passes only a prescribed narrow band of frequencies. Naturally, however, this results in losses being introduced at each stage.

That the increase in selectivity is due entirely to the tuned circuits can be proved by wiring a receiver with several stages of aperiodic, or untuned H.F. amplification (Fig. 1). That is, instead of using a tuning coil and condenser between each H.F. stage the coupling is carried out by means of a resistance or an H.F. choke, as shown in Fig. 1. The amplification is naturally much lower than with tuned stages, but the most noticeable difference is that selectivity is of very low order. In fact, the apparent selectivity, owing to the equal amplification of wanted and unwanted signals, is worse than if no H.F. valves were used at all.

Why We Use H.F. Stages

As previously mentioned, when two tuned circuits are coupled together there is always some loss in signal strength. This depends, of course, on the tightness of the coupling. It may be that only 50 per cent. of the energy is transferred to the second circuit. However, the gain in selectivity is such as to make it worth while. In this respect two coupled circuits differ from a single circuit, for, as we have already seen, none of the devices which are normally used will increase the selectivity of the single circuit without introducing a disproportionate loss in signal strength.

However, although from the point of view of selectivity two tuned circuits are better than one, we cannot go on increasing the number indefinitely without taking into account the loss in sensitivity which each additional circuit entails.

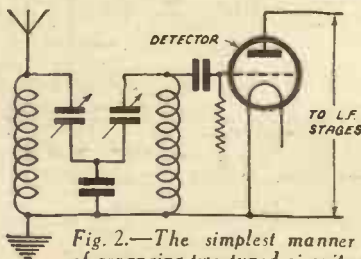

Fig. 2.—The simplest manner of arranging two tuned circuits.

SELECTIVITY

How it is Possible to Separate Stations and Avoid Jamming

This is why the H.F. valve is employed. It makes up for the loss between each successive circuit. Of course, modern valves do more than just make up the loss; they give decided amplification.

In this connection, it may be easier to understand the function of the H.F.

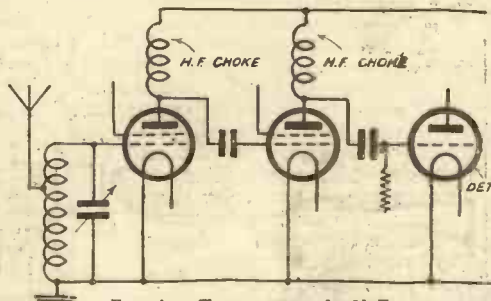

Fig. 1.—Two untuned H.F. stages—a circuit which enables proof to be obtained that selectivity is dependent upon tuned circuits.

stages of a set, if we consider the valves as the means of coupling the tuned circuits rather than the more usual way of looking upon the tuned circuits as the means of coupling the valves.

Alternative Methods

Let us analyze the various methods of coupling several circuits when we have one or more H.F. valves available. Firstly, let us take the case of just two circuits. Here there are two alternatives. The first one, as we have already seen, is to place both circuits before the detector as in Fig. 2. (There are, of course, various methods of coupling these, but there is no need to go into that now.) The second method, which is the more popular, is to employ a screen-grid valve and arrange the second tuned circuit between the S.G. valve and the detector, as in Fig. 3.

Range and Quality

From the point of view of selectivity alone, there is not much to choose between the two methods, but when it comes to the question of range and quality there is some difference. The arrangement of Fig. 3 gives greater range because the signal currents are amplified by the S.G. valve before detection. When dealing with rectification we shall see that the perfect detector has yet to be discovered, and that with the popular leaky-grid arrangement the rectifying effect drops off rapidly below a certain input. This means that very weak signals are to all intents and purposes not rectified at

all. Of course, it's no use adding more L.F. stages to bring them in, because you cannot amplify what is not there! If the detector has not rectified them, then they are lost. This is why the H.F. valve is used. It amplifies the H.F. impulses from weak stations so that they are strong enough to make the detector function. This explains the advantage of the circuit of Fig. 3 over that of Fig. 2.

The advantages of the Fig. 2 circuit are chiefly those of quality and cheapness. If the coupling between the two coils is arranged to give what is known as a band-pass effect, the quality will be good and no tone compensation will be required in the L.F. stages; furthermore, the somewhat expensive screen-grid valve is not required. With the circuit of Fig. 3, on the other hand, band-passing is not possible; therefore, if the circuits are made very selective, some loss of high notes is bound to result.

With three tuned circuits there are again two possible arrangements. The first is to use one H.F. stage with band-pass input and a single intervalve circuit as in Fig. 4, and the other is to use two H.F. stages with a tuned circuit between each. Here again the choice will depend on other considerations than that of selectivity alone, from which point there is not much to choose between them. As the number of tuned circuits is the same, the selectivity will be about equal.

Losses Must Be Avoided

A fact which is not always realized is that to obtain the full selectivity from a number of tuned circuits each must be designed on efficient lines as explained last week. It is not sufficient to have a low-loss aerial coil followed by indifferent intervalve coils, and still less so to have all of them of small inefficient design with the idea that the enormous magnification of modern valves will make up for the losses. Certainly the valves will make up for the loss in sensitivity, but they cannot restore lost sensitivity. Each circuit, if it is to pull its full weight, must, therefore, be designed on low-loss lines. If you need practical proof of this statement, you have only to take the example set by the new iron-core coils. These are essentially low-

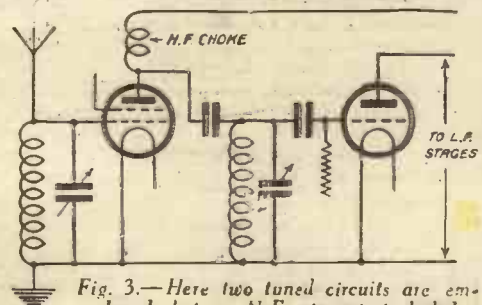

Fig. 3.—Here two tuned circuits are employed, but an H.F. stage is included.

loss coils and give remarkable selectivity. The great feature about them is that they are not only highly efficient, but also extremely compact. On the other hand, the ordinary type of coil is either efficient or compact—but seldom both.

Accurate Tuning is Essential

Another point is that the higher the selectivity, the more accurately must the circuits be tuned. This fact will often

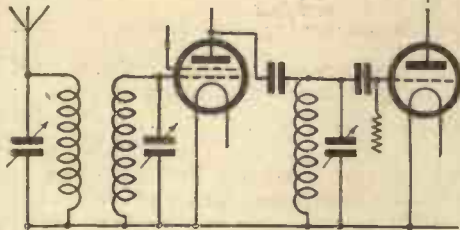

Fig. 4.—Here three tuned circuits are in use, with a single H.F. stage.

explain why a receiver employing two circuits tuned with separate condensers will give better range than one using three circuits tuned with a three-gang condenser. Owing to inaccurate ganging, the second set is not properly tuned and is therefore not giving its best.

It is no use providing selective coils if they cannot be tuned. On the other hand, if the coils are unselective, it does not matter so much about the condensers being dead accurate. Of course, if full advantage is to be taken of really selective coils used with ganged condensers, then both the coils and the condensers must be carefully matched, and all the stray capacities and inductances due to the wiring balanced out. Regarding this last

point, some attempt should be made to obtain some symmetry of lay-out, that is, the connecting wires to each coil should be of the same length and shape as the corresponding wires to the other coils. In this way the added inductances and capacities will be approximately the same for each circuit, and thus ganging will remain more accurate over the whole scale than would be the case if the trimmers were relied upon to make up the differences.

Compactness versus Efficiency

With the increase of tuned circuits there are always two important questions to be considered. One is the means of tuning them and the other is the question of space. With one H.F. stage only (two tuned circuits) it is possible to get a high degree of efficiency by using fairly large coils spaced well away from a single metal dividing screen. This arrangement is very popular, but if still greater selectivity is wanted, then another circuit must be added. To repeat the same arrangement again by using a third similar coil, condenser and screen, would make the whole thing unnecessarily bulky and the three condensers would be exceedingly difficult to tune. The usual thing to do, therefore, is to employ three comparatively inefficient screened coils and a three-gang condenser. The resulting arrangement is even more compact than with the single H.F. stage, but it naturally does not give the same increase in selectivity that three low-loss coils and three separate condensers would. An alternative arrangement is to use a two-gang

condenser and a single condenser instead of the three-gang one as a sort of compromise. Of course, the iron-core coils already mentioned are a distinct step towards a solution. They do provide in a small space coils of an efficiency equal to very large coils of the ordinary type.

The Detector and Selectivity

There is one point in connection with selectivity which must not be overlooked. That is, the damping effect of the detector valve on the circuit immediately preceding it. With leaky-grid detection this is often considerable and results in reduction of selectivity and general alteration of the tuning. It is not so apparent with a single tuned circuit, because there is no other similar circuit with which to compare it, but with two or more the last circuit is found to be flatter in tuning than the others and also to be difficult to gang with them. Anode-bend detection is often suggested as a solution, but there are certain reasons why this is not quite so suitable, and these will be dealt with in a future article when dealing with rectification.

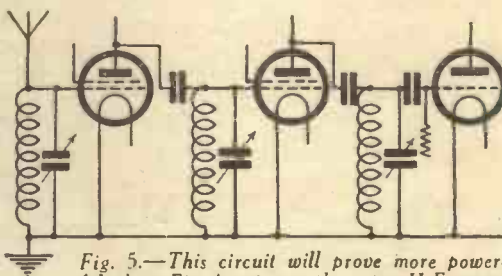

Fig. 5.—This circuit will prove more powerful than Fig. 4 owing to the extra H.F. stage

THE device shown here is quite simple to make and is not costly. To explain its use: suppose the horizontal length of the aerial consists of 75ft. of 7/25 gauge bare copper wire; the aerial could be easily adjusted for selectivity by undoing cord A and B from the cleats, holding one in either hand, and pulling cord B until the brass slider reaches insulator X.

Cord B is then fastened to a cleat; cord A is next tightened and secured also. The horizontal aerial length is now equivalent to about 25ft. of "21/25" gauge aerial wire.

By reversing the proceedings, the horizontal length would be 75ft. of 7/25 wire. The length could be adjusted to any degree between

AN ADJUSTABLE AERIAL.

Two pieces of 1/4 in. sheet brass or copper—about 5ins. by 3in. or 4in., are bent as shown in the sketch. Holes are drilled through which passes a brass bolt. A brass pulley wheel runs on these. Further holes are drilled into which wire connected to insulators is fastened in one case, and through which bolts go into the brass and lead weight in the other. The sketch will make this quite clear.

Two pulley wheels are fitted to the top of one mast with two cleats at the bottom. A cord is taken over pulley wheel A and connected to an insulator on the aerial wire. Another cord

bottom of the brass slider as shown

The free end of the aerial wire is taken through the "slider," then over and under pulley wheel No. 1, then over and under pulley wheel No. 2 on the slider. It is then taken back and a good electrical connection is made (by soldering) to the other bent brass piece. The

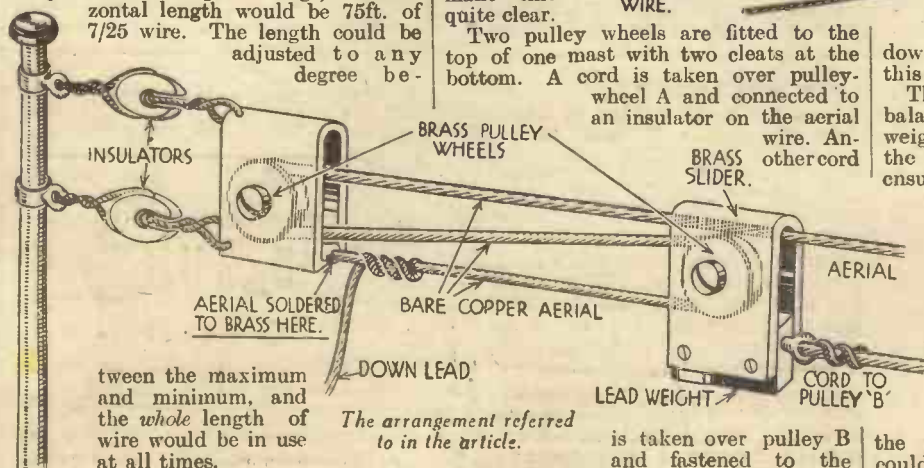

tween the maximum and minimum, and the whole length of wire would be in use at all times.

The arrangement referred to in the article.

is taken over pulley B and fastened to the

down lead is taken from this point.

The lead is fitted to balance the slider; the weight also helps to keep the aerial clean, which ensures that good electrical contact will be made between the aerial and the brass fittings.

The sheet brass is of the shape shown, partly on account of its being a suitable means of keeping the inside brass pulley-wheels sheltered from the weather. The ends could be sealed if desired.

How the ropes are anchored.

ODDS AND ENDS

Keep as Quiet as You Can When Testing

It is a great mistake to do final adjustments at full volume in the owner's house, and that is why it is so very useful to have a pair of headphones with some form of universal transformer, so that these tests can be done quietly without disturbing anybody, the set being only switched on when it is in final going order. From a pure showmanship point of view, this is a much more effective way than howling and whistling half an hour on end in the drawing-room.

Finally, suspect everything, even the owner's common sense.

The New Droitwich Station

Readers will no doubt be interested in the technical details of the new Droitwich transmitting station, which has been carrying out experimental transmissions. The total power in the aerial is 150 kW, which is at least threetimes the power of any existing B.B.C. station. Owing to the difficulty of obtaining good quality on long waves, special precautions have to be taken in the design of the circuits, and this work has been complicated by the fact that the station has been designed as a dual-programme transmitter, as it will, at a later date, radiate the Midland Regional programmes in addition to the National programmes.

Unlike the majority of existing stations, the power house which has been built generates A.C. and not D.C. This, of course, gives much greater scope for all the power circuits owing to the ready manner in which A.C. may be converted into higher and lower voltages. For the purpose of driving the various machines, large tanks are built, each of which has a capacity of 150 tons of fuel oil. This is sufficient to enable the station to radiate two programmes on full power for the normal transmitting periods over a total time of three months.

The power house contains four 750 b.h.p. six-cylinder Diesel generator sets, each coupled to a 470-kW. three-phase alternator, having an output of 415 volts. The normal load when both transmitters are working will be about 1,000 kW.

The new Marconi series modulation system is used in the transmitter and the two units of the transmitter are connected in series, with a total voltage across both stages of approximately 20,000. It is anticipated that the station will give a satisfactory service to nearly the whole of the British Isles. It has been found in most parts of the country that a stronger signal is obtainable than was previously possible from Daventry, and the strength of the programme is generally found sufficient to warrant the abandonment of the National transmitters at Washford Cross, Moorside Edge, and Brookmans Park, but the B.B.C. do not intend to close down these transmitters for some months. Fading is certainly much less noticeable in the majority of districts, but listeners who are at present situated close to the National transmitters mentioned above will no doubt experience a decline in signal strength. Where these listeners are using inefficient sets or aerial systems owing to the local conditions, the remedy is, of course, to improve the equipment and thus take full advantage of the new transmission.



THE PERMANENT MAGNET MOVING COIL SPEAKER THAT CAN BE CORRECTLY MATCHED TO EVERY CLASS OF OUTPUT VALVE.

Ratios are provided for every output valve, with optimum load impedance from 2,000 to 40,000 ohms. The new Sealed Magnetic Gap ensures that quality reproduction is consistently maintained at the pinnacle of perfection!

The **AMPLION** reputation for producing speakers giving life-like reproduction, fine tonal balance, sensitivity and the ability to handle heavy input without the slightest signs of distortion is faithfully upheld in these "**LION**" Speakers.

The matching facilities of "**Lion**" Speakers render them suitable for use with any receiver.

UNIVERSAL TRANSFORMER
1 to 20 AND 2,000 to 40,000 OHMS.

PROVISION FOR VOLUME OR TONE CONTROL AND USE OF ADDITIONAL SPEAKER.



"LION"

47/6 (7" Cone)

"LION SUPER"

(10" Cone) 55/-

Send for Folder "N" on Amplion Speakers, Receivers, Radiograms and Components.

AMPLION (1932) LTD.

82-84, Rosoman Street,
Rosebery Avenue, London, E.C.1

GROSVENOR

DRY BATTERIES AND ACCUMULATORS
"THE BEST IN RADIO"
GROSVENOR ELECTRIC BATTERIES LTD.
2/3, White Street, London, E.C.2.

Build it with your own hands **LISSEN**
"SKYSCRAPER" BAND-PASS 3
WRITE FOR FREE CHART
LISSEN LIMITED, ISLEWORTH, MDDX.



256 PAGES
ENGINEERS!
YOU NEED THIS
EXTRAORDINARY HANDBOOK
Send for your copy to-day - FREE of obligation
BRITISH INSTITUTE OF ENGINEERING TECHNOLOGY,
390, SHAKESPEARE HOUSE, 29/31, OXFORD STREET, W.1.

Do You Know What This Graph Means?

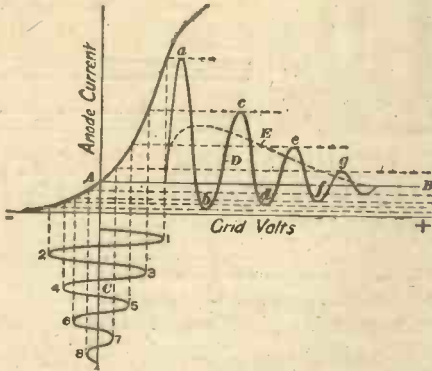

The man who can analyse these curves and understand what they indicate knows his job. But if they do not convey to him perfectly definite information, it would appear that he needs more training than he has had. He is not competent to fill a responsible position in wireless.

Radio has developed so rapidly throughout the last ten years that it has now greatly outgrown the supply of technically qualified men required for the better posts. Moreover, it continues to develop with such speed that only by knowing the basic principles can pace be kept with it.

The I.C.S. Radio Courses cover every phase of radio work. Our instruction includes American broadcasting as well as British wireless practice. It is a modern education, covering every department of the industry.

OUR COURSES

Included in the I.C.S. range are Courses dealing with the installing of radio sets and, in particular, with their Servicing, which to-day intimately concerns every wireless dealer and his employees. The Operating Course is vital to mastery of operating and transmitting.

There is also a Course for the Wireless Salesman. This, in addition to inculcating the art of salesmanship, provides that knowledge which enables the salesman to hold his own with the most technical of his customers.

Then there are Preparatory Courses for the City and Guilds and I.W.T. Exams.

We will be pleased to send you details of any or all of these subjects. Just fill in, and post the coupon, or write in any other way.

International Correspondence Schools, Ltd.
Dept. 94, International Buildings,
Kingsway, London, W.C.2

Without cost, or obligation, please send me full information about the Courses I have marked X.

- COMPLETE RADIO
- RADIO SERVICING
- RADIO EQUIPMENT
- RADIO, SERVICING AND SALESMANSHIP
- WIRELESS ENGINEERING
- WIRELESS OPERATORS
- EXAMINATION (state which)

Name Age

Address



By Jace

Scotland Yard's Autogiro

THE autogiro in which experimental flights over London are being made by Scotland Yard officers in order to determine the possible value of this class of aircraft for traffic control and other purposes, has been fitted with Marconi transmitting and receiving equipment to enable it to maintain two-way communication with the ground.

The wireless apparatus has been specially designed for compactness and light weight. Both the transmitting and receiving panels are fitted beneath the dashboard in the observer's cockpit of the autogiro and the total weight of the equipment, including batteries and all accessories, is 70 lbs.

The transmitter is arranged for 'continuous-wave telegraph working and comprises a master oscillator and magnifier circuit, with a P.625 valve in each stage. The receiver is a straightforward three-valve instrument, with one screen-grid high-frequency valve, type S.410, a detector, type L.410, and one low-frequency valve, type L.410.

High-tension supply for both the transmitter and receiver is taken from a 240-volt dry battery, the power to the anode of the magnifier being 4-5 watts; the battery is tapped at 120 volts for the receiver. A 6-volt accumulator supplies low-tension current to the filaments of the transmitter and receiver valves.

The Marconi Company has previously fitted wireless equipments in the autogiros used by Scotland Yard for traffic control on Derby Day for the past three years, and its efficient operation has contributed materially to the success of this form of traffic control on those occasions, enabling the observers in the air to give immediate information to the police on the ground regarding the state of the roads and any areas where traffic congestion was impending.

Symphony Concert Season

THE London Music Festival, organized by the British Broadcasting Corporation, will consist next year of eight orchestral concerts in the Queen's Hall on May 10th, 17th, 22nd, 27th, June 3rd, 5th, 12th, and 14th (evenings).

For the twelve B.B.C. Symphony Concerts already announced for the coming season the principal conductor will be Adrian Boult. Among the guest conductors engaged are Sir Thomas Beecham, Albert Coates, Felix Weingartner, and Sir Henry Wood.

America's £15-a-minute Baritone

LAWRENCE TIBBETT is one of the best-paid singers in the world. He has recently concluded a contract with a well-known firm of American tyre manufacturers, under which he earns a thousand

dollars for every twenty-minute broadcast, fifteen pounds a minute; and since several of these twenty-minutes are given to advertising and announcing, his pay for actual singing is even higher. Add to that Tibbett's earnings as principal baritone of the Metropolitan Opera House, New York, his fees as one of the most popular concert singers in America, his enormous earnings as a film star, and the huge royalty cheques he receives from the sale of his records—he is one of the best selling gramophone artists in the world—and you know why America's Income Tax collectors

THE WIRELESS POLICE



Marconi transmitting and receiving equipment installed in the observer's cockpit of the Scotland Yard Autogiro. The receiver is immediately below the dashboard, and the transmitter, which is worked by the morse key strapped to the observer's leg, can be seen above his left hand.

look happy when Tibbett's name is mentioned. He has just recorded "Myself when young" and Tchaikovsky's "None but the lonely heart" for "His Master's Voice," and they have chosen it as the record of the month.

(Continued on next page)

THE WIRELESS CONSTRUCTOR'S ENCYCLOPAEDIA

(2nd Edition)

By F. J. CAMM
(Editor of "Practical Wireless")

Obtainable at all Booksellers or by post
5/6 from Geo. Newnes, Ltd., 8-11, Southampton Street, Strand, London, W.C.2.

5/-

(Continued from previous page)

Automatic Programme Selection

With reference to our article on page 753 of last week's issue, it must be understood, of course, that this method of station selection is only applicable to crystal receivers, single valve receivers, or any other type of receiver which has only one tuning circuit. Generally speaking, it is not applicable to receivers employing a H.F. stage, unless such stage is choke (or aperiodically) coupled to the detector stage.

A Valve Receiver

For those readers who wish to make up a valve receiver operating entirely by a push button, we would suggest a Reinartz detector—followed by L.F. stages if necessary—the capacity reaction control being also adjusted by means of the pre-set type of condenser. This will mean, in the case of a two-station set, that four such condensers will be required, one for tuning and one for reaction, on each station. The two sets of condensers will each require a S.P.C.O. switch, but these may be fixed on a small sub-panel behind the main panel, the two knobs being connected together with a length of ebonite strip, and a single control knob then taken from this strip to the front panel. This will enable both the tuning and reaction condensers to be switched with one knob from the front, but it must be remembered that as the H.T. battery deteriorates the reaction condenser usually needs adjusting, so that this arrangement is not really efficient unless a battery eliminator is employed, or you make a point of keeping the H.T. voltage very constant. Fig. 4 given last week illustrated this latter arrangement with the ganged switches.

A Question of Layout

In the receiver illustrated on page 754 of last week's issue perfect control is always possible without raising the lid. This particular receiver will also furnish a number of interesting details for the interested wireless experimenter, amongst which may be mentioned the novel mounting of the loud-speakers. These, it will be seen, are fitted to a sloping baffle, the top of which does not come into contact with the front of the cabinet. This removes all tendency to boom on the bass notes and gives an added brilliancy and crispness to musical items without loss of lower frequencies. The cloth bags surrounding the speakers may also be seen, and these prevent the entry of dust into the magnet gap, and so avoid noises and loss of energy due to restricted movements of the speech coil.

Convenience of Testing

The inter-connecting cables may also be seen, and these enable the two units to be separated for testing purposes. This particular model is therefore an admirable example of careful thought and efficiency in layout, as distinct from circuit design, although, as is to be expected where such thought has been expended on layout considerations, the circuit has been given as much thought and is just as efficient and up-to-date, employing all the latest features, such as A.V.C., etc. The loud-speakers are of the "double-cone" type, giving the effect of four separate speakers, and the design of each cone has been worked out so as to provide a most complete frequency-response curve.

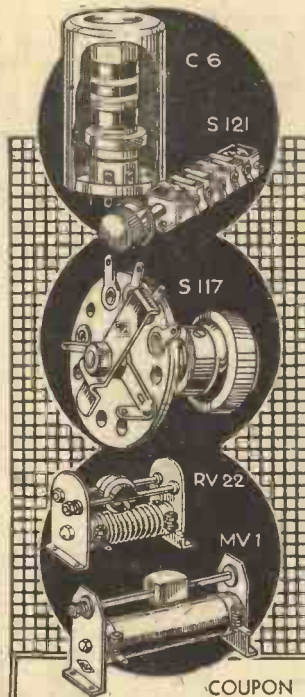

COUPON

Please send me, post free, a copy of the New Bulgin Catalogue No. 154 "N." for which I ENCLOSE THREE PENCE IN STAMPS.

NAME

ADDRESS

BLOCK LETTERS, PLEASE.

BULGIN NEW LINES

SKELETON TUNING COILS

List No. C.6. A screened aerial-coil with balanced reaction, highly efficient. Other types: H.F. trans., tuned-grid, band-pass, oscillator, I.F.

Prices from 4/- each.

Suitable W. Change switch, S.121, 5+5 pt., 4/6 each.

ROTARY STUD-SWITCHES

New and inexpensive types, three-, four- and five-way, one-hole fixing. Perfect contact ensured. For Wave-change, Tone Control, etc. List No. S.117, 3-way, 1/6. List No. S.118, 4-way, 3/9. List No. S.119, 5-way, 2/-.

VARIABLE RESISTANCES

10-WATT TYPES

Useful types for laboratory and all uses. Non-wearing rolling contact. Values from 50Ω to 50,000Ω. Prices from 5/6 each.

60-WATT TYPES

Heavy-duty types for all purposes, for laboratory and general use, charging, etc. Values from 250Ω to 2,000Ω. Price 8/6 each.

A. F. BULGIN & CO. LTD.,
 ABBEY ROAD,
 BARKING,
 ESSEX.



**QUALITY
RADIO
COMPONENTS**

CUT THE CRACKLE OUT OF RADIO

Do your radio programmes suffer from buzzing, clicks and crashes caused by electric signs, etc.?

Write for this book which gives details of the methods evolved by the Post Office and by engineers throughout the world for the suppression of electrical interferences with Broadcast. Results of extensive research work conducted by Belling & Lee Ltd. are also included, together with 37 illustrations.

BELLING-LEE CONDENSER SUPPRESSOR L1118, each 10/6. Approximate dimensions: 3"×3"×1 1/2". Not a "Cure-all" but in about 80 per cent. cases effective.



Get this book from your radio dealer, or post free, 6d., from Belling & Lee Ltd.

BELLING & LEE LTD

CAMBRIDGE ARTERIAL ROAD, ENFIELD, MIDDX

Please forward book "Cut the Crackle out of Radio." Enclosed is remittance value 6d.

Name

Address

PRACTICAL LETTERS FROM READERS

The Editor does not necessarily agree with opinions expressed by his correspondents. All letters must be accompanied by the name and address of the sender (not necessarily for publication).



L.T. TRANSFORMERS FOR WESTINGHOUSE HOUSE RECTIFIERS.

There is a Heayberd Transformer for every purpose.

Here are models for use with Westinghouse Rectifiers in L.T. Battery Chargers—

No.	Westinghouse Rectifier	Charges	Price
W. 36	L.T.2	2, 4, 6v. at 1 amp.	17/6
	L.T.4	2, 4, 6v. at 1 amp.	
W. 37	L.T.5	2, 6, 12v. at lamp.	24/-
W. 38	L.T.6	2, 4, 6v. at 2 amps.	22/6
W. 9	A.4	2, 4, 6, 8v. at 2 amps.	26/-
W. 39	A.6	2, 4, 6v. at 3 amps.	26/-

SEE THE WIDE RANGE OF APPARATUS ON STAND 2—MANCHESTER RADIO EXHIBITION. If you cannot come, cut out this advt. write your name in the margin, and send with 3d. in stamps for NEW RADIO HANDBOOK.

F. G. HEYBERD & CO.,
10, FINSBURY ST.,
LONDON, E.C.2.

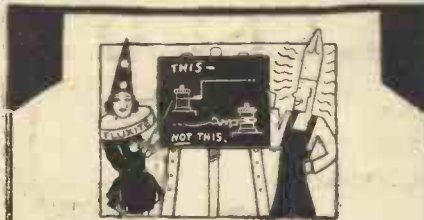

"We're Fluxite and Solder—the reliable pair; Famous for Soldering—known everywhere!" For faulty connections—someone's to blame! When fixing up YOUR Set—let THIS be YOUR aim!

See that Fluxite and solder are always by you—in the house—garage—workshop anywhere where simple, speedy soldering is needed.

ALL MECHANICS WILL HAVE FLUXITE IT SIMPLIFIES ALL SOLDERING

All Ironmongers sell Fluxite in tins: 4d., 8d., 1s. 4d., and 2s. 8d. Ask to see the FLUXITE POCKET SOLDERING SET—complete with full instructions—7s. 6d. Ask also for our leaflet on HARDENING STEEL with Fluxite.

FLUXITE, LTD. (Dept. W.P.),
Dragon Works, Bermondsey Street, S.E.1.

FOR ALL REPAIRS!



Local Experts

SIR,—Your issue of August 25th contains a letter by W. Parsons, which I have found exceptionally interesting. I am greatly indebted to him, as I am sure are also many of your readers, for pointing out that "a shock now and again with 2 or 3 amperes passing is not encouraging." I tremble to think of the awful death I have courted in handling our constant-potential battery charging plant which passes a mere two hundred amperes.

I am in complete agreement with your correspondent when he states that "if a receiver and circuit is understood... reconstructing becomes child's play." Such things as parasitic oscillation and instability, through attempting to use modern high efficiency valves in reconstructed receivers are, of course, mere details—things to be done before one's breakfast. I understand on good authority that modern radio engineers generally complete at least one or two designs each morning before breaking their fast.

It is to be regretted, and once again I am sure your readers are with me in one body, that Mr. Parsons "cannot do better than say that unfortunately design changes so rapidly that people become disappointed after hearing an up-to-date receiver, say, two months after buying what they thought was the best obtainable."

My heart certainly goes out to the six million or so disillusioned listeners which there must be up and down the country. I am glad to say, however, that some of my friends have discovered the complete solution to the problem. They have arranged with their local dealers to have their sets exchanged for the very latest every two months. I pass the tip on for what it is worth.

I also agree with your correspondent "that really good servicemen are few." If he is anxious to become one of them I can strongly recommend "Electricity and Magnetism for Beginners," as being a good starting point. It doesn't contain anything about servicing, but I am sure he will find something of interest about voltage, especially such as is obtained in all-mains sets.—"ANOTHER SERVICEMAN" (Bridge of Allan).

[Correspondents should remember that rudeness is not wit.—ED.]

SIR,—Further to "Observer's" letter re "Local Experts," may I point out that the public, after trying one after another of these self-styled "experts" and local dealers, and finding that one is as bad as another, begin to wonder if anyone is really competent at all. It is, therefore, essential in the public interest that there should be some means of differentiating between the technical dealer and the trader who is just out to sell his wares.

As a service to the many listeners who are members of the Wireless League, this body has instituted a series of examinations and practical tests for wireless retailers. About 400 have, to date, passed these tests,

and the public as well as our members can turn in safety to these retailers for advice and technical help.

The system is to examine the retailer in his own premises. The firm must possess a permanent member of the staff with:—

1. A comprehensive knowledge of the fundamental principles of wireless receivers and
2. Considerable practical experience in the diagnosis and rectification of faults in receivers.
3. Sufficient testing apparatus and meters to put such knowledge and skill into practical use.

In addition the firm or the dealer must be of high integrity; not being merely willing but anxious to give service, not only technically but in other ways. For instance, it is a condition of appointment to our Register of Approved Traders that all accumulators, receivers and apparatus belonging to our members are insured against fire and burglary while on the premises of an approved trader for the purposes of recharging or repair. Further, the dealer is pledged to accept the decision of the Wireless League if a member feels that he is being overcharged or has any other reason for complaint.

Any member can have the name and address of his local dealers—and any listener can have particulars of membership which, incidentally, is only 2s. per annum, and the benefits to be derived therefrom on application to me at 12, Grosvenor Crescent, London, S.W.1.—ALFRED T. FLEMING, M.I.W.T. (General Secretary, The Wireless League).

CUT THIS OUT EACH WEEK

Do you know

- THAT interaction can take place between the anodes of two valves, if these are not of the metallized variety.
- THAT the grid bias applied to two valves in push-pull is the same as applied to one valve singly.
- THAT a swaying aerial may prevent the reception of a short-wave station.
- THAT one of the simplest tests for faults in a defective receiver is to measure the total H.T. consumption.
- THAT copper tube forms a very good medium for the construction of ultra-short wave coils.
- THAT an energized loud-speaker is, generally speaking, more sensitive than the permanent magnet type, owing to the greater field strength.

The Editor will be pleased to consider articles of a practical nature suitable for publication in PRACTICAL WIRELESS. Such articles should be written on one side of the paper only, and should contain the name and address of the sender. Whilst the Editor does not hold himself responsible for manuscripts, every effort will be made to return them if a stamped and addressed envelope is enclosed. All correspondence intended for the Editor should be addressed: The Editor, PRACTICAL WIRELESS, Geo. Neveles, Ltd., 8-11, Southampton Street, Strand, W.C.2.

Owing to the rapid progress in the design of wireless apparatus and to our efforts to keep our readers in touch with the latest developments, we give no warranty that apparatus described in our columns is not the subject of letters patent.

CATALOGUES RECEIVED

To save readers trouble, we undertake to send on catalogues of any of our advertisers. Merely state, on a postcard, the names of the firms from whom you require catalogues, and address it to "Catalogue," PRACTICAL WIRELESS, Geo. Newnes, Ltd., 8-11, Southampton St., Strand, London, W.C.2. Where advertisers make a charge, or require postage, this should be enclosed with applications for catalogues. No other correspondence whatsoever should be enclosed.

EDDYSTONE SHORT-WAVE COMPONENTS

SHORT-WAVE enthusiasts will find much to interest them in the new season's catalogue issued by Messrs. Stratton Co., Ltd., of Eddystone Works, Bromsgrove Street, Birmingham. Here are to be found components designed especially for short-wave work, and these include variable condensers, four-pin interchangeable coils, valve-holders, H.F. chokes, I.F. transformers, reaction condensers, condenser drives, etc. Some novel metal cabinets are also seen in this catalogue, and they enable a most efficient short-wave receiver to be constructed free from all hand-capacity effects. A most interesting array of components are thus gathered together and will prove of interest to the reader.

HEAYBERD MAINS APPARATUS

THE new Heayberd catalogue is known as the "1935 Handbook of Mains Equipment," and in addition to its being a most comprehensive price list of all types of apparatus for mains use, this will be found to be a most useful book for the amateur constructor. Helpful hints are given on the construction and use of mains apparatus, and circuit diagrams are included of a number of different types of mains H.T. supply units, trickie chargers, etc. In addition, it tells you in simple language how to convert a set to mains working, how to run models from the mains, how to modify the voltage output from the mains, and how to charge accumulators. An index enables any particular part of the catalogue instantly to be found. The price of this catalogue is 3d.

MARCONI VALVE LIST

THE new Marconi valve catalogue is printed in a most attractive colour and will be found to be one of the most comprehensive valve lists which is obtainable. In addition to a complete list of all valves which are produced by the Marconi factory, there will be found a complete guide to valve-base connections for all types of valve, as well as a number of interesting circuit diagrams showing the application of certain types, such as the double-diode-triode, heptode, etc. The book also includes a list of all the better-known commercial receivers with a reference to the most suitable Marconi valve for each stage.

ERIE RESISTANCES

THE new Erie technical booklet, in addition to a useful list of all Erie products, also contains some information hitherto excluded from publication. Exhaustive laboratory data, giving such details as humidity factors, noise elimination, temperature co-efficients and other valuable points, is set out on the various pages, as well as some tables enabling various resistance values to be quickly ascertained. The R.M.A. colour code for resistances is also included in this book, which may be obtained by any reader upon receipt of 1½d. in stamps to cover postage. Messrs. Erie's address is: The Radio Resistor Co., Ltd., 1, Golden Square, Piccadilly, W.1.

RADIO CLUBS AND SOCIETIES

Club Reports should not exceed 200 words in length and should be received First Post each Monday morning for publication in the following week's issue.

SLADE RADIO

There was a talk by Mr. G. T. Peck at the meeting held last week. In this he described his direction Finding set, giving full details, and at the conclusion took the set to pieces in order that the members could see the method of construction.

On Sunday the Society held another D.F. test in which members from the Rugby club took part, and this time the transmitter was mobile for the first two hours. The two members who managed to track it down were—

1. Mr. S. J. Phillips (Slade) in at 5.13 p.m.
 2. Mr. H. K. Bourne (Rugby) in at 5.22 p.m.
- The transmitter was Mr. Hornby's (G2TF), and the apparatus, a converted aircraft transmitter, was completely hidden behind the rear seats of a car, the aerial being just under the hood.

There was a debate on "The effect of Droitwich Station on reception in the Birmingham area" at a recent meeting.

This was divided into four parts, 1st, crystal sets, 2nd, valve sets (Det. and L.F.), 3rd, multi-valve sets (straight type), 4th, superhets. From the results of the voting it was decided that it would be a definite advantage for the crystal set users and the service area would be considerably increased.

Hon. Sec., 110, Hillaries Road, Gravelly Hill, Birmingham.

LUCERNE S.G.3

BUILD IT YOURSELF
FREE FULL-SIZE BLUEPRINT
and ASSEMBLY INSTRUCTIONS
with every KIT

Expressly
Designed
for Modern
Broadcast
Conditions



Designed by PETO-SCOTT specialists in KITS of Parts for the Home Constructor since 1919.

EFFICIENCY.—The Peto-Scott Lucerne S.G.3 stands unparalleled among modern Kit sets for selectivity, range, volume and tone under even the most difficult reception conditions.

SIMPLICITY.—The operation of the Lucerne S.G.3 is simplicity itself, the capture and separation of stations a matter of ease to the least radio-minded. Equally simple is the assembly of the Kit, requiring no experience and a few everyday tools.

ECONOMY.—Outstanding value for money and extremely low running costs make the Lucerne S.G.3 a most economical investment for those desiring a home-assembled set with which to enjoy Radio programmes to the full under the existing conditions of the Ether.

BEAUTIFUL CABINETS.—Two beautiful Walnut cabinets (a Console Model as illustrated and a Table Model) are available for the Lucerne S.G.3 at the constructor's choice.



SEND FOR FOLDER L4

KIT "A"
39/6

YOURS FOR
2/6

Comprising complete kit of parts, including ready drilled walnut panel and valves, cabinet and less Speaker. Cash or C.O.D. Carriage Paid 33/6 and 11 monthly payments of 3/6.

KIT "B" As Kit "A" but with set of 3 B.V.A. Valves: S.G. Detector and Super Power, less Cabinet and Speaker. Cash or C.O.D. Carriage Paid £3 9s. 6d. YOURS FOR 5/- and 11 monthly payments of 6/8.

KIT "C" As Kit "A" but with valves and Peto-Scott Walnut Table Cabinet, less Speaker. Cash or C.O.D. Carriage Paid 14 2s. 0d. YOURS FOR 5/- and 11 monthly payments of 8/3.

KIT "CC" As Kit "A" but with valves and Peto-Scott Walnut Console Cabinet as illustrated, less speaker. Cash or C.O.D. Carriage Paid, £4 7s. 0d. YOURS FOR 5/- and 11 monthly payments of 8/3.

If Peto-Scott Permanent Magnet Moving Coil Speaker, Type S.1., required add 19/6 to cash prices or add 1/9 to deposit and each monthly payment.

PETO-SCOTT Co. Ltd.

77, CITY ROAD, LONDON, E.C.1
West End Showrooms— Phone: Clarendon 9466/7
62, High Holborn, London, W.C.1. Phone: Holborn 3243

EST. 1919.

EASY PAYMENTS

"There's no place like HOLMES"

The first firm to supply Wireless parts on easy payments. Ten years' advertiser in Wireless Press. Thousands of satisfied customers.

At the Show: We selected as the finest value Speaker the W.B. Stentorian 42/-, 4/7 deposit. Nine payments of 4/7.

Other selection of fine value:—

	Deposit	Monthly payments
TELSEN Latest 323 Kit	29/6 4/-	7 of 4/1
TELSEN S.G. 3 Kit	39/6 4/4	9 of 4/4
LISSEN Skyscraper 4 Kit	112/6 10/-	11 of 10/3
EXIDE H.T. Accu. 120-v.	60/- 6/-	9 of 6/8
ATLAS Eliminator C.A.25	59/6 5/-	11 of 5/6
AVON MINOR METER	40/- 5/6	7 of 5/6
B.T.H. Pick-up Vol. Con.	21/- 3/10	5 of 3/10

Parts for any Kit Set. Any make of Speaker. New Goods Obtained for Every Order.

Send us a list of the parts you require and the payments that will suit your convenience, and we will send you a definite quotation. Anything Wireless.

H. W. HOLMES, 29, FOLEY ST.,
Great Portland Street, London, W.1.

Phone: Museum 1414.

DOUBLE YOUR VALVE OUTPUT WITHOUT COST

This is now made possible by "TWINIL," a clever Valve-doubling Device which only costs 2/6. Highly praised by Wireless Papers as "something new to try out with very great possibilities." Post free with full instructions to make 2-valve receiver equalling 3-4 valves, 2/6. Details, Stamp Eastern Radio Co., 40c, Waterloo Street, King's Lynn

H.T. THAT LASTS YEARS

"Extremely satisfactory service for 12 months on 6 valves."—R.N.W., Portsmouth. Install a Standard Wet Battery. Cheap annual replacement. Saves Pounds, 120-v. 12,500 m.a. £2, carr. paid. All Standard H.T. Spares.—Write: Wet H.T. Battery Co., 26, Lisie St., London, W.C.2. Any voltage supplied.

TELELUX

FOR
BRIGHTER
PICTURES

Provisional
Patent
No.
15209

6'6"



Invented to
perfect Disc Television

The process of manufacturing TELELUX is one of the latest Television patents, and results in a very highly developed lamp essential to perfect Disc Television reception. Due to the special opaque external coating, "glare" and "bee-hive" flicks are entirely eliminated. Bright, clear and well-defined images result from the concentration of light at the picture aperture by a special light collecting medium, and the special treatment of the aperture itself. Designed for use with 16" and 20" discs, TELELUX lights at 160 volts, and operates with only 18 mμ passing through it.

Obtainable from all dealers
If any difficulty send direct.

B.T.S.

BRITISH TELEVISION SUPPLIES, LTD.
BUSH HOUSE Dept. PRW LONDON, W.C.2

Phone: Temple Bar 0124

SUPPLEMENT TO "PRACTICAL WIRELESS"

AMATEUR TELEVISION

NEON LAMP LIGHT SOURCES

Various Methods of Obtaining Illumination for Television Reception

By H. J. BARTON CHAPPLE, B.Sc., A.M.I.E.E.

THE aim of every television experimenter is to secure a bright image, for in this way it can be enlarged through lenses so as to be visible to a greater number of people when the television transmissions are being watched. Undoubtedly the neon lamp has proved a cheap and faithful servant in this connection, although in the simple beehive or spiral patterned form the resultant luminosity leaves much to be desired.

It is for this reason that many steps have been taken to effect improvements. Taking the "night light" pattern first, there is, of course, the familiar method of coating the outside of the lamp with a silver deposit, or glueing silver paper foil to the glass bulb, leaving a rectangular aperture, which in turn is frosted to obscure the shape of the glowing electrode, whose area is scanned by the tiny apertures in the rotating scanning disc. An improved form of this arrangement is the new Telelux lamp, marketed by B.T.S., Ltd., and shown in Fig. 1. Here the whole of the lamp bulb is provided with an internal reflecting surface so that the quantity of light emitted is the maximum possible.



Fig. 1.—The B.T.S. Telelux lamp. A beehive with many refinements.

Flat Plate Type

With the flat plate type of neon lamp the intrinsic brilliancy is greater, but even so it suffers from the disadvantage common to all disc machines, namely that the revolving scanning member utilizes only a small fraction of the total cathode surface at any one instant. This flat electrode lamp, however, is certainly more efficient. In one form the glow is distributed evenly over the rectangular cathode surface by backing it with thin mica sheet, while polishing the surface also increases luminosity.

In connection with a model developed on the continent it has been claimed that with current densities as low as two milliamperes per square inch the glow surface over the whole of the plate is still unbroken. A reference to Fig. 2 shows the general form of construction of the flat plate type of neon lamp, the negative electrode or cathode being the rectangular metal plate made from nickel, the clips at the four corners holding in place the mica sheet backing located behind the glowing surface. The short horizontal bar below the plate is the anode and under normal operating conditions the working voltage is of the order of 180, while to give a picture of sufficient brilliancy the current flow is 25 milliamperes.

Hot Cathode Types

When it is desired to use a mirror-drum for image integration the flat plate or beehive type neon lamp is quite useless. Recourse must be made here to a form of neon lamp which has the property of concentrating the entire luminosity over an extremely small area. Apart from losses due to reflections the mirror-drum receiver is able to use the entire light given by the point lamp, in distinct contrast to the disc-type machine, which only utilizes a very small area of the total glowing portion at any one moment. A television receiver designed to use these point glow lamps is shown in Fig. 3, the lamp itself being housed in the base of the long focusing tube on the right.

Several point source lamps have been developed in America, but in this country they do not appear to be extremely popular. With one form the cathode is narrow and tubular, this being surrounded by a larger diameter cylinder of metal which acts as the anode. A crater light source is obtained through a special shaped hole at the top of the electrode system. Consistency in operation depends very largely on both the nature of the gas employed in manufacture and also on the degree of internal pressure within the glass walls of the complete lamp.

In some cases use is made of one of the alkali metals in the construction of the cathode. This has the effect of reducing the voltage required for "striking" the source of light, and coupled with this is the property of removing some of the gas impurities.

In yet another case of this type of lamp, which was marketed on the Continent, the anode takes the form of a small chamber. The cathode has a quartz jacket and the light channel is connected up with the first-named chamber. Under working conditions the glow discharge starts with quite low luminosity values, it being claimed that the lamp can be used almost to the point of extinction without any change in brightness. Light concentration on a circular area just over one milliammeter in diameter is possible with these lamps. The working voltage is of the order of 180, but the current variation is stated to be over the wide range of 6 to 150 milliamperes. Good brilliancy and



Fig. 2.—This illustration shows the construction of the flat plate neon.

clarity are claimed for these point light lamps, but of course they still produce the characteristic orange-red image to which exception is so often taken by many television workers.

Neon and Mercury Lamps

Starting with the first colour television experiments, many efforts have been made to produce a lamp containing a mixture of both neon and mercury. One of the latest of these is the new high-intensity gas discharge lamp made by Television Instruments, Ltd. This is of peculiar shape, the glass tube being coiled, while the electrodes are cylindrical in shape. Samples of this new lamp were on



Fig. 3.—Here is a complete receiver, incorporating a crater point lamp in the tube on the right.

show at Olympia, and according to information issued by the makers they give a brilliant and even field of illumination. Owing to their special construction they can be employed in conjunction with a reflector, thus adding to the light available for scanning purposes.

TELEVISION and X-RAYS

THERE does not seem any relation between television and medical X-ray work, but an American has applied the principles of both to assist in diagnosing particular cases. The patient undergoing examination is placed between the X-ray apparatus proper and the fluorescent screen in the usual manner, but the photograph appearing on the screen, instead of being recorded permanently, is scanned by a disc made from lead and having a series of small equiangularly spaced apertures arranged in a spiral. All the light from the photographic image which passes through these holes in turn falls simultaneously upon three separate photo-electric cells.

Associated with these cells are specially designed filters so that No. 1 cell responds to those portions of the picture possessing considerable light, No. 2 cell to the medium light sections, while No. 3 cell is activated only by the dark sections in the picture. After suitable amplification the signal voltage output from the cells is transmitted to one or more receivers where it is made to actuate gaseous discharge lamps of three distinct colours. A second scanning disc geometrically similar, and running in synchronism recreates the image, and the three colour elements are combined.

Facts and Figures

Components Tested in our Laboratory

BY THE PRACTICAL WIRELESS TECHNICAL STAFF

New Lissen Shielded Four-range Coil

THE popular Lissen four-range coil is now obtainable in a completely screened condition and the illustration below will be of interest to short-wave listeners, as it shows very clearly the method adopted in winding this coil to cover both the entire short-wave band as well as the broadcast band. The former is of ribbed ebonite 2in. in diameter, and is slotted to accommodate the various sections of wire.

At the lower end, heavy gauge bare copper wire is employed for the grid circuit windings on short waves whilst thin wires are wound in between to form coupling coils. The upper part of the former contains the medium- and long-wave windings arranged in a more or less normal manner, that is with the medium-wave winding in the form of a solenoid and the long wave in pile-wound sections. The change-over from one band to another is carried out by means of a control spindle



The Lissen four-range coil with screen.

carrying three ebonite cams which operate on four spring fingers arranged in the base of the coil, and as the control knob is rotated, the coils not in use are shorted out and thus erratic reaction effects and other difficulties usually met with in a multi-range coil are avoided. The short-wave band, which is covered, extends from 12 to 84 metres and the broadcast band covers from 200 to 555 metres. The long-wave band extends from 900 to 2,100 metres. The screening can is of very heavy gauge aluminium, and two fixing bolts are provided so that the coil may be firmly mounted to a metal or wooden chassis. It will be seen from the illustration that a large amount of metal has been removed from the side of the can in order to avoid losses due to the proximity of the metal to the wires joined to the terminals. The price of this coil is 17s. 3d. It may be obtained without the screening can for 15s.

Eddystone Cross-feeder Aerial System

THE difficulty of noise-free reception on short waves is rendered very simple by using the new aerial system in which two wires are used for the lead in and these are crossed at intervals throughout their length. For this purpose, small insulating blocks which cost 8d. each are employed, and the aerial wires are linked round the grooved ends of these and crossed over so that although the two wires run apparently parallel throughout their length, they are crossed at regular intervals. This has a very valuable effect on the short waves in reducing various types of interference, and a pamphlet may be obtained from Messrs. Stratton and Co., in which some various types of aerial circuit are shown to utilize this feature. Short-wave enthusiasts should make a point of obtaining details of this scheme.

Erie Potentiometer

ALTHOUGH previously concentrating entirely on fixed resistors, the Radio Resistor Co. have now turned their attention to volume controls and variable resistances and two of these are illustrated below. On the right is seen a plain volume control, and on the left a similar component fitted with a switch mechanism. These components are very compact, measuring only just over 1 1/2 in. in diameter and 1/2 in. in thickness. They are mounted by means of the usual one-hole fixing bush and a standard 1/4 in. spindle is fitted. Connection to the unit is made by means of soldered joints, the lugs for connection forming a very substantial contact with the enclosed element. The control shaft is insulated and thus enables the component to be mounted on a metal panel where desired. The resistance element is manufactured from a hard carbon compound, and the

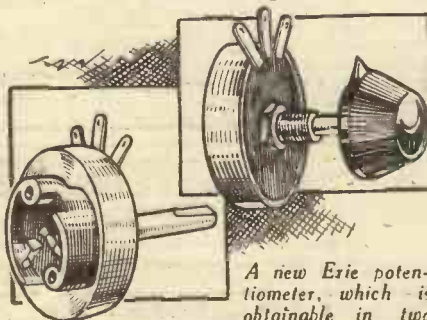

A new Erie potentiometer, which is obtainable in two types, with and without the on-off switch.

contact is a polished disc of nickel alloy which makes contact by means of the so-called floating type. Thus the switch is perfectly noiseless in action. Nickel alloy is employed for all metal parts except the control spindle, which is of nickel-plated steel. Thus difficulties from corrosion are removed and the control should give long, trouble-free service. The switch mechanism is designed to break 125 volts at 2 amps. or 250 volts at 1/2 amp. The price is 3s. 6d. and 5s. 6d., the extra amount being charged for the switch. It can be obtained in the following values: 25,000 ohms, 50,000 ohms, 100,000 ohms, 250,000 ohms, 500,000 ohms, 1 megohm, and 2 megohms.

Clix Aerial-Earth Plug

MANY constructors prefer to use a plug-in method of connecting the aerial and earth instead of the usual terminal connection, and the arrangement certainly has some points to recommend it although, generally speaking, the difficulty which arises is in the accommodation of the thick wire.

The new Clix plug has been designed for this express purpose, and it is designed on similar lines to the normal Clix wander plug, but is of much heavier gauge, although the two prongs are designed to be accommodated in standard Clix sockets. The ebonite top and the ring at the end of the contact are made sufficiently large to accommodate standard aerial and earth leads, and the terminal is finished in black only and is not engraved. The total diameter of wire and insulation which can be accommodated is 3/16 in. The price of this plug is 3d.



A newly designed wander plug. The new Clix aerial-earth plug which accommodates heavy gauge wire.

Telsen Push-Pull Components

SOME new push-pull components have been added to the Telsen range of accessories. These include a push-pull input transformer, having a ratio of 1:4 with a primary inductance of 105 henries. This costs 12s. 6d. An output transformer and an output choke are also obtainable, the former with ratios of 35:1, 50:1 and 61:1. The primary inductance of this component is 16 henries. The output choke provides ratios of 1:1, 1.3:1, 2:1 and 2.6:1, and has an inductance of 18 henries. The price of these two components is also 12s. 6d. A 1:1 output transformer is also obtainable and will be found extremely useful for connecting the loud-speaker or for coupling a neon lamp where voltage drop has to be avoided in the output stage. All these components present a very neat appearance, and are fitted in square section boxes with terminals readily accessible on an ebonite plate at the upper end. The case provides complete magnetic screening and earthing, and therefore enables these components to be mounted close together when circumstances warrant.

PRACTICAL TELEVISION
6d. EVERY MONTH.

REPLIES TO

LET OUR TECHNICAL STAFF SOLVE
YOUR PROBLEMSQUERIES and
ENQUIRIES

by Our Technical Staff

The coupon on Page iii of Cover, must be attached to every query

If a postal reply is desired, a stamped addressed envelope must be enclosed. Every query and drawing which is sent must bear the name and address of the sender. Send your queries to the Editor, PRACTICAL WIRELESS, Geo. Newnes, Ltd., 8-11, Southampton St., Strand, London, W.C.2.

SPECIAL NOTE

We wish to draw the reader's attention to the fact that the Queries Service is intended only for the solution of problems or difficulties arising from the construction of receivers described in our pages, from articles appearing in our pages, or on general wireless matters. We regret that we cannot, for obvious reasons—

- (1) Supply circuit diagrams of complete multi-valve receivers.
- (2) Suggest alterations or modifications of receivers described in our contemporaries.
- (3) Suggest alterations or modifications to commercial receivers.
- (4) Answer queries over the telephone.

Please note also that all sketches and drawings which are sent to us should bear the name and address of the sender.

Band-pass Tuning

"I have read quite a lot about band-pass tuning, and have seen several articles in your paper. Could you tell me whether I could use the arrangement with my existing receiver in which I use two separate tuning condensers and two coils? The present circuit is H.F., detector, and output."—T. R. (Brixton).

You could use the present coils for a band-pass circuit, although for many reasons it will not prove so efficient as a correctly designed band-pass tuner. The two coils should be arranged at right angles, or in some other manner to prevent interaction between them, and the condensers should be joined across each coil. A resistance of some value between 50,000 and 100,000 ohms should then be joined across the high-potential end of the two coils. Commercial coils are generally provided with a small winding on each former and this winding is connected to provide an inductive coupling between the two halves of the band-pass circuit, and this is a more efficient scheme, but cannot easily be made at home.

Portable Without Aerial

"I am keen on building a small set to use as a portable, but I do not want to go to the trouble of winding one of those complicated frame aerials inside the box. Is there any efficient way of arranging a

portable without this aerial? I could use an ordinary aerial attached to the car if this will work satisfactory. I might mention that I am not a wireless fan, and therefore know nothing of the principles of wireless."—G. R. T. (Oxford).

It is certainly not essential to include a frame aerial in the set. In the Atom receiver which we recently described a frame aerial was not included, but in order to provide good signal strength a throw-out aerial arrangement was suggested. This consists simply of a length of flex attached to the normal aerial terminal, and this is rolled and tucked away inside the cabinet. When it is desired to use the set the wire is unrolled and thrown out along the ground, over a bush or tree, or otherwise suspended. You could throw it over your car, or, alternatively, fit a small aerial winding inside the roof if the car body is of the saloon type. A special aerial is obtainable now for attachment to the running board, and this might prove more useful to you.

International Ampere

"I believe you mentioned in your pages some time ago the difference between an amp. and an international ampere. I cannot find the back number and should be glad if you could explain the point, as I have just met the term in a book I am reading. I appreciate that amp. is an abbreviation for ampere, but I find it is used in the book as amp., yet the other term gives the word ampere in full."—E. W. P. (Highgate, N.).

The international ampere is the amount of current which must be passed through a solution of silver nitrate for one thousand seconds in order to liberate one gramme of silver. The standard ampere is measured in the following manner. A small beam scale is mounted with a single turn of wire attached to the beam, and this turn of wire is fixed in the centre of a solenoid. Pans at each end of the scale are provided with weights, and when a current is passed through the solenoid the single turn of wire rotates and thus alters the balance of the scale. The ampere is one tenth of the current which is required to act upon the small coil in order to provide a torque of 4 gramme-centimetres.

Valve or Metal Rectifiers

"I should be glad to know the benefit of the valve rectifier over the metal rectifier. It would appear that the metal rectifier will last indefinitely, whilst the valve will burn out or lose its emission. Is there any other advantage beyond this?"—L. W. Q. (Stroud).

The valve may be broken or fractured due to a knock, whilst the metal rectifier is practically indestructible. The valve is lower in initial cost and will give a greater current output for a given size. The metal rectifier does not generate so much heat as the valve, especially in the larger sizes. The metal rectifier is much larger and therefore takes up much more space in a receiver, and, generally speaking, cannot be obtained in such high ratings as the valve. Actual choice must therefore depend upon the particular circumstances, and it is not really possible to say that one is definitely better than the other.

Changing to A.C.

"I should like you to confirm that the following statement is correct. I have a home-made D.C. mains receiver, in which the two mains leads from the house socket are joined to a smoothing choke and the H.T. negative lead. A smoothing condenser of 4 mfd. is joined across these two points and another condenser is joined across the other side of the choke. I am now moving to a district where the supply is A.C. I understand that I only need a mains transformer and valve to deliver an output equivalent to my former mains voltage. Is this correct?"—N. B. (Kettering).

Your statement is quite correct, and the transformer which you purchase may also be provided with L.T. windings so that you may at some future date change the present valves for those of the indirectly-heated type designed to operate from raw A.C. The choice of the valve, or the smoothing choke resistance, must be made so that the same H.T. voltage is obtainable. This point should not be overlooked. The additional parts may be mounted in a small box and fitted to the present set without any alteration.

THE QUERIES COUPON APPEARS ON PAGE iii OF COVER



THE WORLD'S HANDIEST AERIAL

SELF ADHESIVE
BEST PICK-UP
NEATEST

A revolutionary idea in Aerials. Just unroll the tape and press it up in position around the room or up to the attic—and it sticks. One pull and it's down and leaves no mark. No danger from lightning, reduces static interference and increases selectivity. Ideal for artistic homes. Excellent pick-up for flats. Obtainable everywhere. British Pix Co., Ltd., London, S.E.1.

PIX INVISIBLE AERIAL

2'

DOUBLE LENGTH 3/6

ADVT.

Miscellaneous Advertisements

Advertisements are accepted for these columns at the rate of 3d. per word. Words in black face type and/or capitals are charged double this rate (minimum charge 3/- per paragraph). Display lines are charged at 6/- per line. All advertisements must be prepaid. Radio components advertised at below list price do not carry manufacturers' guarantee. All communications should be addressed to the Advertisement Manager, "Practical Wireless," 8, Southampton Street, Strand, London.

PREMIER SUPPLY STORES

Offer the Following Manufacturers' Surplus New Goods at a Fraction of the Original Cost; all goods guaranteed perfect, carriage paid over 5/-, under 5/- postage 6d. extra, L.F.S. and abroad, carriage extra. Orders under 5/- cannot be sent C.O.D. PLEASE SEND FOR ILLUSTRATED CATALOGUE POST FREE.

STUPENDOUS Purchase of Set Manufacturers' Stock. All electric 3 Valve (S.G. Det. Pen.) Set in Walnut Cabinet with moving-coil speaker 200-250 volt 40-60 cycles. Chassis built. 200-2,000 metres with 4 valves, £4/19/6.

ALL Electric 3-stage Amplifiers, 200-250v., 40-60 cycles, 10 watts, undistorted output, complete with 5 valves, £7/7/-. Suitable speakers, pick-ups and microphones can be supplied.

SPECIAL Offer of P.M. and Energised M.C. Speakers. Purchased from well-known gramophone co. **TYPE 10055F, 9in. diameter, 11,650 ohm field, 20/30 m.a. auditorium type power transformer. Handles 10 watts, 30/-.**

TYPE 10955H, 9in. diameter, 115 ohm field, 350/400 m.a., auditorium type Pentode transformer. Handles 10 watts, 30/-. A.C. Kit, 20/-.

TYPE 4480, 9in. diameter, permanent magnet. Handles 4 watts, 7 ohms speech coil, 13/6. Multi-range transformer, 4/6 extra.

PREMIER SUPPLY STORES announce the Purchase of the Complete Stock of a World Famous Continental Valve Manufacturer; all the following standard mains types, fully guaranteed, 4/6 each, H.L., power, High, Medium, Low magnification, Screen Grid. Directly heated Pentodes, 1 watt, 3 watt and 4 watt A.C. outputs.

THE following Type, 5/6 each; 350 v. and 500 v., 120 milliam full wave rectifiers, 2 1/2 watt indirectly heated pentode.

THE Following American Types at 4/6: 250, 227, 112, 171, 210, 245, 26, 47, 24, 35, 51, 58, 55, 37, 80 and the following types, 6/6 each; 42, 77, 78, 25Z5 36, 38, 33, 39, 44, 53, 6A7, 6B7, 2A5, 2A6, 2A7, 2B7, 5Z3, 6C6, 6A4, 6D6, 6F7.

ELIMINATOR Kits, including transformer, choke, Westinghouse metal rectifier, T.C.C. condensers, resistances and diagram, 120v., 20 m.a., 20/-; trickle charger, 8/- extra; 150v., 30 milliamperes, with 4v., 2-4 amps. C.T., L.T., 25/-; trickle charger, 6/6 extra; 250v., 60 milliamperes with 4v., 3-5 amps. C.T., L.T., 30/-; 300v. 60 m.a. with 4 volts. 3-5 amp., 37/6; 200v. 50 ma. with 4v. 3-5 Amps. L.T. 27/6.

PREMIER chokes, 40 milliamperes, 25 hys., 4/-; 65 milliamperes, 30 hys., 5/6; 150 milliamperes, 30 hys., 10/6; 60 milliamperes, 80 hys., 2,500 ohms, 5/6; 25 milliamperes, 20 hys., 2/6.

ALL Premier Guaranteed Mains Transformers have Engraved Terminal Strips, with terminal connections, input 200-250v., 40-100 cycles, all windings paper interleaved.

PREMIER H.T.7 Transformer, output 135v. 80 m.a. for voltage doubling, 8/6; 4v. 3-4a., C.T. L.T. 2/- extra; with Westinghouse rectifier giving 200v. 30 m.a., 17/6.

PREMIER H.T.8 and 9 Transformers, 250v., 60 m.a. and 300v. 60 m.a. rectified, with 4v. 3-5a. and 4v. 1-2a., C.T. L.T. and screened primary, 10/-; with Westinghouse rectifier, 18/6.

PREMIER H.T. 10 Transformer, 200v. 100 m.a., rectified with 4v. 3-5a., and 4v. 1-2a., C.T. L.T. and screened primary, 10/-; with Westinghouse rectifier, 19/6.

PREMIER Mains Transformer, output 250-0-250v. 60 m.a., 4v. 3-5a., 4v. 2-3a., 4v. 1-2a. (all C.T.) with screened primary, 10/-.

PREMIER Mains Transformers, output 350-0-350v. 90 m.a., 4v. 3-5a., 4v. 2-3a., 4v. 1-2a. (all C.T.) with screened primary, 10/-.

PREMIER Auto Transformers, 100-110/200-250v. or vice versa, 100-watt, 10/-.

WESTERN ELECTRIC Mains Transformers, 300-0-300v. 65 m.a., 4v. 1-2a., 4v. 2-3a., 6/6; 300-0-500v. 150 m.a., 4v. 3-5a., 4v. 2-3a., 4v. 2-3a., 4v. 1a. C.T., 4v. 1a. C.T., 19/6.

SPECIAL Offer of Mains Transformers, manufactured by Phillips, input 100-200v. or 200-250v. output 180-0-180 volts 40 m.a., 4v. 1 amp., 4v. 3 amps., 4/6; 200-0-200v., 4v. 1a., 4v. 3a., 4/6.

PREMIER L.T. Charger Kits, consisting of Premier transformer and Westinghouse rectifier, input 200-250v., A.C., output 5v. 1 amp., 14/6; 8v. 1 amp., 17/6; 6v. 2 amp., 27/6; 30v. 1 amp., 37/6; 2v. 1 amp., 11/-.

B.T.H. Trusped Induction Type (A.C. only) Electric Gramophone Motors, 100-250v.; 30/- complete.

SPECIAL Offer B.T.H. Gramophone Motors, A.C. and D.C., 100/250v., 30/-. Listed £3/3/-.

(Continued at top of column three.)

Easy Terms

Why wait weeks for that new Radio accessory? You'll get it quicker from N.T.S. Any items advertised in this journal on Easy Terms. Strict Privacy Guaranteed. Cash or C.O.D. if preferred. Orders over 10/- Carriage and C.O.D. Charges paid. SEND FOR QUOTATIONS FOR ANYTHING IN RADIO YOU ARE NEEDING.

W.B. STENTORIAN STANDARD

SENT ON 7 DAYS' TRIAL
For Power, Pentode and Class "B"

2/6 DOWN

Send only 2/6 for 7 days' trial. If approved, balance in 11 monthly payments of 3/- Cash or C.O.D. Carriage Paid. £12/6.

W.B. Stentorian Senior Model, Send only 2/6, balance in 11 monthly payments of 4/- Cash or C.O.D. Carriage Paid. £22/0.



ATLAS ELIMINATOR

SEND FOR IT ON 7 DAYS' TRIAL
Model C.A. 12 For A.C. Mains. 100/250-v. 3 tappings; 60/80-v.; 90/100-v.; 120/150-v.; 12 m.a. at 120-v. Send only 5/- for 7 days' trial. If approved, balance in 10 monthly payments of 5/3. Cash or C.O.D. Carriage Paid. £2/12/6.

5/- DOWN

Model C.A. 23. Send only 5/-, balance in 11 monthly payments of 5/6, or cash in 7 days £2/19/6. Carriage paid.



N.T.S. CLASS "B" SPEAKER

SENT ON 7 DAYS' TRIAL
With full-size Cone and tapped Input Transformer. Send only 2/6 for 7 days' trial. If approved, balance in 9 monthly payments of 2/6. Cash or C.O.D. Carriage Paid. £12/9/6.

2/6 DOWN

Power or Pentode Model, same price and terms. When ordering, state which type required. De Luxe Model for power or pentode 35/- (Cash in 7 days) or 2/6 deposit and 9 monthly payments of 4/-.



LISSEN SKYSCRAPER KIT

COMPLETE KIT comprises all components, including set of Lissen Valves. Send only 10/-, balance in 11 monthly payments of 10/3. Cash or C.O.D. Carriage Paid. £5/12/6.

10/- DOWN



BLUE SPOT "STAR" JUNIOR P.M. MOVING-COIL SPEAKER

SENT ON 7 DAYS' TRIAL
With 12-point matching transformer suitable for all outputs. Send only 2/6 for 7 days' trial. If approved, balance in 9 monthly payments of 4/- Cash or C.O.D. Carriage Paid. £1/15/6.

2/6 DOWN



SEND FOR LISTS.

New Times Sales Co.

56, LUDGATE HILL, LONDON, E.C.4.
Dear Sirs:

(a) Please send me.....
(b) I enclose Cash/Deposit.....

NAME.....
ADDRESS.....
Pr. W. 15/9/34

FIRST WITH EASY TERMS IN 1924

(Continued from foot of column one.)

COLLARO Gramo. Unit consisting of A.C. motor, 200-250v. high quality pick-up and volume control, 49/-; without volume control, 46/-.

EDISON Bell Double Spring Gramophone Motors, complete with turn-table and all fittings, a really sound job, 15/-.

SPECIAL Offer of Wire Wound Resistances, 4 watts, any value up to 50,000 ohms, 1/-; 8 watts, any value up to 15,000 ohms, 1/6; 15 watts, any value up to 50,000 ohms, 2/-; 25 watts, any value up to 50,000 ohms, 2/6.

WIRE Wound Potentiometers, 15,000 ohms, 1/6; 50,000 ohms, 2/-; 500,000 ohms, 3/-; 1,000 ohms wire-wound semi-variable resistances, carry 150 m.a., 2/-.

CENTRALAB Potentiometers, 400 ohms 1/-, 50,000, 100,000, 1 meg. any value, 2/-; 200 ohms, wire wound, 1/-.

POLAR Star, manufacturers' model, 3-gang condensers, fully screened, 7/6; with trimmers.

AMERICAN Triple Gang 0.0005 Condensers, with trimmers, 4/11; Utility Bakelite 2-gang 0.0005 screened with unknob trimmer, 3/6; Polar Bakelite condensers, 0.00035, 0.0003, 0.0005, 1/-.

OMOND Condensers, 0.0005 2-gang semi-shielded, 2/6; brass vanes, with trimmers, 3/6. British Radiophone 110 kc/s Intermediate, 3/-.

MAGNAVOX D.C. 152, 2,500 ohms, 17/6; D.C. 154, 2,500 ohms, 12/6; D.C. 152 magna, 2,500 ohms, 37/6, all complete with humbucking coils; please state whether power or Pentode required; A.C. conversion kit for above types, 10/-; Magnavox P.M. 7in. cone, 18/6.

RELIABLE Canned Coils with Circuit, accurately matched, dual range, 3/- per coil; ditto, iron-cored, 3/6.

RELIABLE Intervalve Transformers, 2/-; multi- ratio output transformers, 4/6.

HELLESEN 8 mf. Electrolytic Condensers, 435 volts working, 2/3; Mershon ditto, 1/9.

POLAR 2-gang Unknob Condenser with Trimmers and complete slow-motion Dial, 6/-.

WESTERN ELECTRIC Condensers, 250v. working, 2 mf., 1/-; .25 mf., 6d.

T.C.C. Electrolytic Condensers, 550v. working, 650v. peak, 8 mf., 4/-; 4 mf. or 8 mf. 440v. working, 3/-; 15 mf. 50v. working, 1/-; 25v. working, 25 mf., 1/3; 6 mf. working and 2 mf. 100v. working, 6d.; 8+4 mfd., 450v. working, 4/-; 50 mf., 50 v. working, 2/9.

T.C.C. Condensers, 250 v. working, 1 mf., 1/3; 2 mf., 1/9; 4 mf., 3/-; 4 mf., 450v., working 4/-; 4 mf., 750v., working, 6/-.

H.M.V. Condensers, 400v. working, 4+4+1+1+1+1+1 +0.1+0.1+0.1+0.1, 4/9; 4+2+1+1+1+1+1 +0.5, 3/9.

DUBILIER Condensers, 8 or 4 mfd, dry electro- lytic 450v. working, 3/-.

VARLEY Constant square Peak Coils, band-pass type BP7, brand new in maker's cartons with instructions and diagrams, 2/4.

VARLEY H.F. Intervalve Coils, BPS, band-pass complete with instructions in original cartons, 2/6.

SCREENED H.F. Chokes by One of the Largest Manufacturers in the Country, 1/6.

PREMIER British-made Metals, moving iron flush mounting, accurate, 0-10, 0-15, 0-100, 0-250 m.a., 0-1, 0-5 amps, all at 6/-.

LARGE Selection of Pedestal, table and radio- gram cabinets, by best manufacturers, at a fraction of original cost, for callers.

THE Following Lines 6d. each, or 5/- per dozen.— Chassis valve holders, 5-, 6-, or 7-pin, screened screengrid leads, any value 1-watt wire end resistances, wire end condensers, 0.0001 to 0.1 Bulgain 3-amp. main switches. Cydon capacitors, double trimmers,

PREMIER SUPPLY STORES

20-22, High St., Clapham, S.W.4. Telephone: Macaulay 2188. Nearest Station, Clapham North Underground.

VAUXHALL.—Magnavox permanent magnets, universal, suitable for Class "B" power or pentode, 6in. cone, 15/6; 7in. cone 17/6; 10in. cone, 23/-; mains energised, 2,500 or 6,500. 10in. cone, 23/-; 7in. cone, 15/3; brand new, with humbucking coils; state power or pentode transformer; unused manufacturer's stock; immediate delivery.

VAUXHALL Westinghouse rectifiers, H.T.S., 9/6. H.T.9, 10/-.

WESTECTORS W.4, W.X.6, 5/9.

VAUXHALL Radiophone, Radiopaks, complete with volume control and Lucerne station-named scale and escutcheon, state type, 32/6; intermediate transformers for above, with terminals, 6/-; coils set of 3 on base, with switch and terminal, 16/6; 3-gang condensers, super-het., 14/6; ordinary type, 12/6; disc drives, complete, 4/9.

VAUXHALL UTILITIES, cash with order or C.O.D. Post Paid 2/6 or over. 163a, Strand, W.C.2 (facing Bush House, S.E. Wing). Temple Bar 9338.

REPAIRS—REWINDING—OVERHAULS. Eng-

lish and American receivers, Conversions D.C. to A.C. New Cones and coils fitted to moving-coil speakers. Chokes, L.F. and mains transformers and eliminators. All repairs guaranteed laboratory tested with quick service. Trade discount. Write REPAIR DEPT. A.

WEEDON POWER LINK RADIO CO., 80, Lons- dale Avenue, London, E.6. (Grangewood 1837).

SOUTHERN RADIO'S Bargains.—Set manufacturers' guaranteed surplus.

VARIABLE Condensers.—Lotus 3-gang 0.0005, 12/6; Lotus 2-gang, 0.0005, 8/6; Lotus Dyblock single, 0.0005, 4/6 (list 9/6); all these condensers are complete with dials, escutcheons, knobs, fully screened with trimmers, and boxed; Hydra block condensers, 16 mfd. (2+2+3+2+1+1), 1,000v. D.C., 7/- each; Dubilier 4 mfd. (2+1+1), 1,000v. D.C., 2/9; 4.5 mfd. (2.25+2.25), 1,000v., for mains noise suppression, 3/-; fixed 4 mfd., 2/3; 2 mfd., 1/6; 1 mfd., 1/-; Utility Midget 2-gang variable condensers, 0.0005, with concentric trimmers, 3/6; T.C.C. 0.1+0.1, 1/3 each.

SPEAKERS.—Blue Spot permanent magnet, with universal transformer for power, super power, pentode and Class B; 23/- (list, 39/6).

E.C. Stork Speaker in Cabinet; 19/6 (list, £3/15).

ST.400 Kits, all specified proprietary components; £2/10/6 (list, £4/17/6).

EKCO A.C. Eliminators, each new and boxed, in original sealed cartons: type A.C. 25, 33/6 (list £3/17/6); type K.12, with trickle charger, 37/- (list £3/17/6); Ekco trickle chargers, type T.C.1, for 2-, 4- and 6-volt accumulators, 20/- (list 42/-).

IGRANIC Superhet Coils, set of 4 (1 Osc., 2 I.F., with pig tails, a L.F. plain); 12/6 (list 50/-).

LISSEN Superhet 3 Coils Kit, screened, ganged on base with wave change and filament switches; type L.N.5181, for battery or mains; 12/6 (list 30/-).

VARLEY Constant Square Peak Coils, complete with all accessories, new, boxed, B.P.5, 2/4.

VARLEY H.F. Inter-valve Coils B.P.6; 2/3.

FRAME Aerials.—Lewcos dual wave superhet, 9/- each (list 27/6).

PICK-UPS.—Marconi No. 19 (1934), 22/6 each (list 32/6).

READY Radio Instantan Transformers, for matching any valve to speaker; Junior model, ratios 1: 2, 1: 1, 1 1/2: 1, 2: 1, 3: 1, 7/6 (list 27/6); Senior model, ratios 10: 1, 12 1/2: 1, 14: 1, 16: 1, 20: 1, 25: 1, 12/6 (list 37/6).

RECEIVERS.—3-valve screen-grid Elector Super, complete with valves, Ekide batteries and accumulator, Celestion moving-coil speaker, contained in magnificent walnut cabinet; £3/10 (list £10).

OSRAM Thirty-Three Music Magnet, complete with G.E.C. speaker, 2 Osram screen-grid and Osram power valves in moulded bakelite walnut cabinet; £3/12/6 (list £9/0); in original sealed cases.

BOTOLPH Lightweight Portable Receivers, complete with 5 Mullard valves, Ekide batteries and accumulator, overall size 13in. x 11in. x 8in.; £2/19/6 (list £8/3); a real suitcase portable.

READY Radio Meteor Screen-grid 3-valve Kits, all specified components new, in sealed cartons 25/-, less valves; with 3 Mullard valves, 42/6 (list £57/6).

A Kit, as above, complete with magnificent walnut cabinet and Celestion perm. mag. speaker; less valves, £3/5; with 3 Mullard valves, £4/2/6 (list £8/17/6).

MULLARD Radio for the Million, "Station Master Three" battery kits, complete with cabinet and 3 Mullard valves (screened grid, H.L., power), brand new in original sealed cartons; £2/19/6 complete.

MISCELLANEOUS.—Westinghouse metal rectifiers, M.H.T. 6, 7, 8, 9/3 each; Ferranti chokes, 20 henry 60 m.a., 6/9 each; Lewcos superhet, 8 way bases, complete with valve holders, grid leak, fixed condensers type "48," 2/- each; Lissen base turntables, 1/6 (list 5/-); Lewcos coils, B.P.F./L., 4/-; T.B.F./C., 3/3; O.S.C./126 (Extensor), 3/3; T.O.S./R., 3/3; Morse tapping keys, with buzzer and flashlight signal, complete with battery and bulb, 2/- each.

ALL Goods Guaranteed and Sent Carriage Paid.

BRANCHES at 271-275, High Rd., Willesden Green, N.W.10 and at 46, Lisie St., W.C.2. Please send all post orders to 323, Euston Rd., N.W.1.

SOUTHERN RADIO, 323, Euston Rd., London, N.W.1 (near Warren St. Tube). Phone: Museum 6234.

H.A. Wireless for 1935 receivers, kits, components, eliminators, etc.

20/- approx. will buy you the latest Ekco, Ferranti, Ultra, Philips, Marconi, G.E.C. or any other type receiver.

FULL particulars from H. A. WIRELESS (Shoreditch), Dept. PW, 9 and 13, Hackney Rd., Shoreditch, E.2.

WANTED, good Modern Wireless Parts, Sets, Eliminators, Meters, Valves, Speakers, etc. Spot Cash waiting. Send or bring. We pay more than any other dealer. Open 9-8.—University Radio, 142, Drummond St., Hampstead Rd., N.W.1.

RADIALADDIN (Disposals) Ltd. Exchange your old set for any new model, balance cash or H.P. Write for free quotation to largest radio exchange in U.K. Also clearance sale of reconditioned sets and radiograms at gift prices £1 to £10. Write for list.—46, Brewer Street, Piccadilly Circus, W.1. Gerrard 4055.

ALL goods advertised in last week's issue still available.

WARD, 2nd floor, 45, Farringdon Street, London, E.C.4. Telephone: Holborn 9703.

WONDERFUL BARGAIN

12 ONLY

PETO-SCOTT 1934 ADAPTAGRAMS

List Price 63/-

BRAND NEW.

30/-

IN OAK, WALNUT OR MAHOGANY

Cash or C.O.D. Carriage 2/6 extra

Subject to being unsold on receipt of order.

PETO-SCOTT CO., LTD.,

77, City Rd., London, E.C.1 62, High Holborn, W.C.1

SEND TO FOYLES FOR BOOKS!

New and second-hand books on Wireless and all other subjects. Over two million volumes in stock. Catalogues free on mentioning your interests.

119-125, CHARING CROSS RD., LONDON, W.C.2.

Telephone: Gerrard 5680 (7 lines).

ELECTRADIX RADIOS

Selected Bargains from our new Sale List "N."

ELECTRADIX.—Sin. octagon moulded Bakelite frets improve speaker appearance, black 1/-.

ELECTRADIX.—L.F. chokes, leading maker, 20 H 50 m.a., 4/6; centre tap, 5/-; mains 1 amp. chokes, 8/6.

ELECTRADIX.—Stand-off insulators, 4in. ribbed, 6d.; aerial coil type, 10d.; aerial lead-in, steatite, 8in. at 9d.; 12in. at 1/-; renew your aerial, 7/22 cop. strand, 50ft. 1/3, 100ft. 2/6.

ELECTRADIX.—Fixed condens., Dubil. 1,000v. test .01 mfd., 1/-; Edibell, all from .001 to .0001, 4d. each new; T.C.C. electrolytic, 8 mfd., 3/-; T.C.C. 5 mfd. 500v. test, 3/-; Dubil. pack 1,000v. 6 1/2 mfd. total, 3/-.

ELECTRADIX.—Variable Tuning. Formo Log de Luxe, .0005 mfd., 1/6; Ameco 2-gang .0005 infd. each, 3/6; Pye .00035 with s.m. dial, 2/6.

ELECTRADIX.—Potmeters, 5,000 ohms, 2/6; with switch, 3/6; 10,000 ohms, small, 1/6; 1 meg. Central, 1/6.

ELECTRADIX Coils, all types 2 pen., 1/3; Varley Sq. Peak, 2/6; Formers ribbed and slotted, 4d.

ELECTRADIX Headphones, English, alumin. head bands, 2/9 pair; single receivers, 1/-.

ELECTRADIX G.P.O. Table Pedestal Microphones, 7/6; hand mikes, 5/6.

ELECTRADIX M.C. Speaker Magnets, large 4-claw, powerful, 10/6; kit with magnet, cone, coil and chassis, 14/6.

ELECTRADIX Home Record Cutting Gear, centre drive, 4/6; screw spindle traverse, 7/6.

ELECTRADIX Keys, Morse Coded, 4/6; S. G. Brown transmit key, 8/6; sounders, 5/6; W. D. Bell's, 2/6; Bell wire, 1/- per 100 yds.; insulators, 9d. doz.; Empire cloth, 1/- per 100 sq. in.

ELECTRADIX Chargers, Tungar 6 volts 2 amps., £ 47/6; Philips trickle, 10/-; Westinghouse 24v. 2 amps. meter, s.w. and fuses, 24in. steel case, £6/10.

TUNGAR H.T. and L.T. 6 volts 1 amp. and 120 volts 100 m/a., 37/6; cadmium cell test, 2/6.

ELECTRADIX Dynamos, hand-gear'd alternators, 80v. 20 m/a., 10/-; H.T. and L.T. generators D.C. 600v. 90 m/a., 6 v. 5 amp., 40/-; about 1,200 other machines all sizes, specify wants.

ELECTRADIX Mains Transformers, all 110 to 240v. input, H.M.V. output 350-0-350v. 60 m/a. 4v. la., and 4v. 3a., 10/-; set transformers, output 150v. 30 m/a., 4v. 3 amps., 4/6; special 3 outputs of 8v., 12v. and 20v. 2 amps., 10/- each; Igranic H.T. and G.B. 180v. and 30v., 7/6.

ELECTRADIX Valves for Transmitters, A.T. 40, 4/6; Standard cables, 3/6; Tiny Weco for pocket receivers, 1v. bulb only 3/-; or on 4-pin base, 3/9.

ELECTRADIX Lucas Signal Bulbs, 1/6; Thermo lamp flashers, 2/6; lenses and prisms for television and optics, from 2/6; Veeder coil turn counters, 1/-.

ELECTRADIX Photo Cells Sound Film Bulb, 15/-.

secret ray sets of infra-red cell and amplifier 36/-; electric wax sealers, 110-220v. automatic, 15/-.

ELECTRADIX Meters, largest stock in London, all ranges up to 10,000v. and up to 2,500 amps., 2 1/2in. panel type Bakelite case for radio A.C. or D.C., 6/-; see special lists.

ELECTRADIX Resistances, H.M.V. in glass tube, 10,000, 25,000, 50,000, 100,000, 500,000 ohms, and 1 meg., 1/6 the set of 6.

All above prices do not include C.O.D. or Postage.

ELECTRADIX Parcels of Experimenters' junk, coils, magnets, wire chokes, condensers, switches, terminals, etc., post free, 10lbs. 7/-, 7lbs. 5/-; 1,000 other bargains in New Sale List "N."

ELECTRADIX RADIOS, 218, Upper Thames St., London, E.C.4. Telephone: Central 4611.

MORE AMAZING BARGAINS BY OLYMPIA RADIO LIMITED.

COLUMBIA 2 Valve Battery Receivers, Self-Contained Cabinet, complete with Speaker, and Marconi Valves, but no Batteries. Brand new. List price 4 Guineas. Our price 32/6. Carriage Forward.

EKCO 1934 Model K.25 A.C. Eliminator, 25 m/a output, Variable S.G. Tapping, complete with Trickle Charger, for 2, 4 or 6-volt Accumulator. List price £57/6. Our price 45/-.

CELESTION "Soundex" P.M. Moving Coil Loud-speaker, List price 27/6. Our price 12/9.

CELESTION P.P.M./W. List price 45/-. Our price 17/6.

GRAMPIAN "Nipper" P.M. Loudspeaker. List price 27/6. Our price 17/6.

GRAMPIAN P.M. Dual "Owl" Loudspeaker. Complete with Baffle. List price 55/-.

REVO Horn Loudspeakers. Metal Flare. Original price 65/-.

UNIVERSE Pick-up and Tone-arm, complete with Volume Control. List price 22/6. Our price 12/11.

IGRANIC 2-Gang Condensers, complete with cover. (Plain Boxes.) List price 12/6. Our price 6/9.

IGRANIC 3-Gang Condensers. List price 17/6. Our price 8/11.

WONDER Microphone. List price 12/6. Our price 4/9.

MILLGATE A.C. Trickle Charger. Fitted with Westinghouse Metal Rectifier for 2, 4 or 6-volt. List price 27/6. Our price 17/6.

SONOCHORDE Energised Moving-Coil Speaker. 2,000 D.C. Field. List price 27/6. Our price 12/11.

VARLEY Square Peak Bandpass Coils. List price 15/-.

SOVEREIGN Dual-Range Coils. List price 8/6. Our price 2/9.

RADIOPHONE Pick-up and Arm, complete with Volume Control. List price 30/-.

LOTUS 3-Gang Condenser complete with Disc Drive and Dial. List price 19/6. Our price 14/11.

LOTUS 2 Gang Condenser complete with Disc Drive and Dial. List price 14/-.

We have also a large number of amazing Bargains in BATTERY and A.C. RECEIVERS. Reposition and Decontrolled Models. Lists on application. Also numerous other Bargains in various lines in Components.

TERMS—Cash with Order, or C.O.D. ALL GOODS, Carriage Paid. Everything guaranteed O.K. Money refunded if not satisfactory. Please mention this paper when replying.

OLYMPIA RADIO LIMITED, Mail Order Department, 49a, Shudehill, Manchester. BRANCHES in all Principal Towns.

WOBURN RADIO OFFER FOLLOWING MANUFACTURERS SURPLUS:

UTILITY CONDENSERS, air spaced, 0005 with dial and escutcheon, 3/6. Mershom Electrolytics, 8mfd, 500v., 2/9. Dubilier 2mfd, 1000v. test, 1/3. Wego, 750v. test, 1mfd. 1/-, 2mfd. 1/2, 4mfd. 2/3. Popular iron cored canned coils, 2/6. Eston iron cored coils, 2/6. H.F. Chokes, 10d. Binocular, 1/2. S.W. Chokes, 10d. Tubular Condensers: 0.1, 0.01 and 0.02, 6d. Toggle, 6d. Polymet 0001 tag condensers, 1/3 half doz. Edison 002, 005, 008, 3d. Chassis mounting valve holder 4/5 pin, 1/3 half doz. Igranic tubulars 001, 4d. Class B Drivers and Chokes, 8/6 pair, with B.V.A. Valve and 7 pin holder, 17/-.

Rothermel wire wound resistances with switch, 10,000, 25,000 and 50,000, 3/6. Astra differentials 0002, 1/2. Polar 00035 mica reactions, 1/2. Columbia L.F. Transformers, 3/1 and 5/1, 3/-. Westinghouse Rectifiers. H.T. 5, 6, 4/6. Eston Morse Keys, with code, 3/6. Lissen Output Transformers, 23/1, 3/6. Western Electric microphones, very sensitive, boxed, 2/3. Microphone transformers 85/1, 2/3. Marconi transformers, Push-Pull, 4/-. Microphone transformers (ideal), ratio 100/1, 3/6. Sistofox 7yds., 6d.; screened flex, 3d. v. Ormond twin gang 0005 condenser mica dielectric, with trimmer, and disc drive and escutcheon, 3/9. British Radiophone straight line dials with escutcheon and twin dial lights, 3/9.

RESISTANCES: Bargain parcels of 13 wire wound 1 1/2 watt, resistances accurate 1%, values 100 ohms to 50,000, at 3/9 each, postage 2d.

W.R.C. Eliminators for 150v. 30 m.a. Three positive H.T. Tappings. Guaranteed 12 months. A.C. Model with Trickle Charger (2v. 4v. 6v. 3 amp.), 32/6. A.C. Model, 21/-.

Universal A.C./D.C. Model, 21/-.

D.C. Model, 9/6. (Carriage extra 1/- on each.)

NEW Trade List now ready, enclose heading and stamp.

WOBURN RADIO CO., 9, Sandland Street, Bedford Row, W.C.1. Holborn 7289.

PRACTICAL, private and postal Radio training. All branches. Fees payable, 2/6 weekly. Full particulars without obligation.—R. T. I. G. B., 47, Earl's Court Road, London.

"MELFO-RAD" for all Receivers, Kits, Components, etc.—Lowest prices—Cash, C.O.D. or H.P. Quotations and Lists Free.—Queen's Place, Hove. (Trade Supplied.)

3rd. SEPT. SPECIALS!

AT THE "GOLD-MINE" STORES OF LONDON. LISTED SUPPLEMENTARY TO THE SEPTEMBER RADIO GOLD MINE NOW AVAILABLE. ENCLOSE 3d. STAMPS FOR COPY TO-DAY.

- 27/6 CLASS B A.C. ELIMINATOR KITS, with full assembly instructions.
- 22/6 G.B. III SEALED KITS. An unprecedented bargain.
- 18/6 S.G. III KITS. Complete in sealed cartons. Full diagrams.
- 17/6 A.C. ELIMINATOR KITS, 25 m.a. State mains voltage.
- 14/6 ORMOND PERMANENT MAGNET P.M. SPEAKERS (list 27/6).
- 12/6 SHORT WAVE III VALVE KITS. Will tune in the world.
- 10/6 CLASS B CONVERSION KITS. Complete in sealed carton.
- 10/6 STRAIGHT III KITS. In sealed carton, with full instructions.
- 10/- SAMPLE BARGAIN COMPONENTS PARCEL. Guaranteed value 30/- to 40/-.
- 8/6 SHORT WAVE ADAPTOR KITS, complete to last screw. Full instructions.
- 6/10 BLUE SPOT 66K SPEAKER UNITS. List 15/-.
- 6/6 D.C. ELIMINATOR KITS, with full instructions and sundries. Sealed.
- 6/6 WESTERN ELECTRIC PENDANT MIKES (list 15/6), a real quality microphone.
- 5/11 ORMOND TWIN GANG condensers with S.M. disc drive (list 12/6).
- 5/11 BALDWIN UNITS for horns, public address, etc. (list 21/-).
- 5/- SAMPLE BARGAIN SUNDRIES PARCEL. Guaranteed value, 15/- to 20/-.
- 4/11 A.V.C. UNITS (list 10/-), with full instructions for any battery receiver.
- 4/11 WESTINGHOUSE H.T.5, H.T.6, H.T.7, RECTIFIERS.
- 4/11 H.T.8, H.T.9 MAINS TRANSFORMERS, boxed.
- 3/11 LISSAN OUTPUT TRANSFORMERS, 1: 1, 3: 1, 8: 1, 23: 1 (list 17/6).
- 3/11 WESTINGHOUSE L.T. RECTIFIERS, 1/2 amp., 4 volt. 6 volt.
- 3/3 IGRANICORE IRON-CORE COILS (list 10/6).
- 3/3 FAST AND SLOW-MOTION air-spaced Variable Condensers.
- 2/11 DR. NESPER 4-pole balanced armature units (list 11/6).

SHOP SALES AND DISPATCH DEPTS. now transferred to:—
24, Aldersgate Street, E.C.1.
MAIL ORDERS AND CORRESPONDENCE as before to:—
23, Bartholomew Close, London, E.C.1. | Telephone, all depts.: NATIONAL 7473.

- 2/11 BRITISH RADIOPHONE VOLUME CONTROLS, 10, 20, 50, 100,000 ohms, 1/2, 1 meg. vision straight line, dial and knob.
- 2/11 COLUMBIA L.F. TRANSFORMERS, 3: 1, 5: 1 (list 10/6)
- 2/6 IRON CORED DUAL-RANGE COILS, with diagrams.
- 2/3 VARLEY SQUARE PEAK DUAL-RANGE COILS (list 15/-), boxed with full diagrams. L.F. CHOKES, 20 hen., 30 hen. Worth 5/6.
- 1/11 SCREENED DUAL-RANGE COILS with 6-term. base.
- 1/11 MICROPHONE TRANSFORMERS, 100: 1. Worth treble.
- 1/10 READY RADIO SHORT WAVE COILS. 6 terminal base (list 8/6).
- 1/2 ASTRA DIFFERENTIALS, .0001, .00015, .0003, 20 hen. Chokes (list 8/6), 1/11.
- 1/- POLAR MICA DIELECTRIC Variable Condensers, .0003, .0005.
- 11d. BROWNIE DUAL-RANGE COILS, with reaction. Hetsby 2-mfd. condensers, 11d. S.-WAVE H.F. CHOKES; Med. and long wave, 10d. Glazite 3d. 10ft. roll.
- 7d. MICROPHONE BUTTONS, very sensitive, worth 3/-. V. holders, 4, 5 pin 3d.: 7 pin, 6d.
- 6d. ERIE 1-WATT RESISTANCES. All sizes, 160 ohms to 500,000 ohms, 5/- doz.
- 4d. 1-WATT RESISTANCES, all sizes, 250-100,000 ohms, 1-5 megs., 2 watt. 9d.
- 4d. SPECIAL OFFER, SPAGHETTI RESISTANCES. All sizes, 1,000-70,000 ohms. Or 3/- doz. Each Fixed condensers, .0005, .005, .0001, .0004, .001-006, 1, 2 6d.
- 3d. ONLY, POST FREE. Enclose 3d. stamps to-day for your September number of THE "RADIO GOLD-MINE." By far the most comprehensive lists of up-to-date surplus goods (Kits, Components and Accessories) yet produced, with a general price level lower than ever before. Avoid delay. Send (enclosing 3d. stamps) to-day.

LONDON EAST CENTRAL TRADING COMPANY (Dept. M.125), 23, Bartholomew Close, London, E.C.1. (Telephone: NATIONAL 7473). Immediate delivery. 24 hour service. Cash or C.O.D. Secure your copy of the September Radio Gold-Mine to-day.

THE "GOLD-MINE" STORES
Radio Market of the World.



BRITAIN'S LEADING SPEAKER MANUFACTURERS



BRITAIN'S LEADING RADIO SUPPLIERS

Co-operate in this Amazing **SPEAKER OFFER**



W. B. STENTORIAN BABY (On left) With matching Transformer, suitable Power, Pentode, Class "B" or Q.P.P. Yours for 2/6; balance in 9 monthly payments of 2/6. Cash or C.O.D. Carriage Paid, £12/6.



W.B. STENTORIAN STANDARD (On left) For Power, Pentode and Class "B". Yours for 2/6; balance in 11 monthly payments of 3/- Cash or C.O.D. Carriage Paid, £112/6.

W.B. STENTORIAN SENIOR (Above) For Power, Pentode, and Class "B". Yours for 2/6; balance in 11 monthly payments of 4/- Cash or C.O.D. Carriage Paid, £22/2/0.

EVERYTHING RADIO on equally wonderful easy terms. See our weekly page advertisements in this journal.
PETO-SCOTT Co. Ltd. 77, City Rd., London, E.C.1
EST. 1919

PEARL & PEARL. Bargain List "B" Free. 100, Bishopsgate, London, E.C.2.

- VARLEY Constant Square Peak Band-Pass Coils, type B.P.5. Complete, all accessories and instructions. New, boxed, 2/4. (List, 15/-)
- POLAR 3-gang Star Minor Condenser, full screened, trimmers, new, 7/-. (List, 18/9.)
- ERICSON 3-1 L.F. Transformers, new and guaranteed, 2/3. (List, 17/6.)
- COLLARO Electric Gramo Motor A.C. 100-250v. with pick-up and volume control. Auto Start and Stop. Brand new. List price, £4. Our price, 47/6 carr. paid. Bankrupt set maker's stock.
- VOLUME Controls, 50,000 ohms, New, 1/3.
- CELESTION Energised M.C. Speaker, 2,500ohms. Model D.C. 2054, with universal transformer. List price, £2/5/0. Our price, 12/6.
- PIONEER RADIO CO., LTD., Coptic Street, London, W.C.1. Museum 9607.

ELIMINATORS, 25 m.a., D.C., 10/-, A.C., 21/- Transformers, 3-1, 5-1, 1/0. British-made valves H.F., L.F., and Deet., 1/0. Power 2/-. S.G. 5/-. Carriage Paid Cash with Order.—Radio Electrical Supplies, 237, Camberwell Road, London, S.E.5.

WESTERN ELECTRIC MICROPHONES. Complete with Transformers, 4s. 6d. Radiophone Dials, curved and straight, escutcheons to match, 3s. 6d. 8 mfd. Wet Electrolytics, 2s. 4d.; Columbia Transformers, 3-1, 5-1, 1s. 9d.; Mains Transformers for metal and valve rectifiers; Step up or step down auto-Transformers; special Transformers and Mains Chokes to order. Let us quote you for kits and components. Postage extra.—School Cinema Equipment and Radio Co., 7, Woburn Buildings, London, W.C.1. Phone: Euston 2187.

Practical Motorist
The Weekly for Beginner and Expert.
EVERY WEDNESDAY 3d.

Helpful Books for the Practical Man
The Home Mechanics Series

Price net 1/- each
by post 1/2 each

SIMPLE ELECTRICAL APPARATUS
Interesting and useful apparatus, easily constructed, with which the student is enabled to test for himself the theory and practice of Electricity as laid down in the text-books.

THE HOME WOODWORKER
The various examples of woodwork described in this Handbook have been designed by practical craftsmen. They are modern in style, and their construction is well within the powers of the average home-worker who follows the instructions given.

25 SIMPLE WORKING MODELS
All the models described in this book can be constructed from the simplest materials and with very modest equipment. None requires lathe-work. 147 illustrations.

ACCUMULATORS
An accumulator (whether for Wireless or the Car), if properly used and cared for, is an extremely reliable piece of apparatus. This book shows how to get the best out of it.

There are 10 books in this Series.

Send post card for List

From all Booksellers, Newsagents, etc., or by post ls. 2d. each from the Publishers—

GEO. NEWNES, LTD.,
8-11 Southampton Street, Strand, London, W.C.2

50 Tested Wireless Circuits

Edited by F. J. CAMM

Obtainable at all Booksellers, or by post 2/10 from Geo. Newnes, Ltd., 8-11, Southampton Street, Strand, London, W.C.2. **2/6**

FREE ADVICE BUREAU COUPON

This coupon is available until September 22, 1934, and must be attached to all letters containing queries.
PRACTICAL WIRELESS, 15/9/34.

ADVERTISEMENT INDEX

	Page
Amplion (1932), Ltd.	803
Belling & Lee	805
British Institute of Eng. Technology	803
British Pix Co., Ltd.	810
British Television Supplies	807
Bulgin, A. F., & Co., Ltd.	805
Celestion, Ltd.	800
Colvern, Ltd.	789
Cosser, A. C., Ltd.	Inside Front Cover
Eastern Radio Co.	807
Fluxite, Ltd.	806
Foyles	812
Grosvenor Batteries	803
Hayberd, F. C., & Co.	806
Holmes, H. W.	807
International Correspondence Schools	804
Jackson Bros. (London), Ltd.	790
Lissen, Ltd.	803
New Times Sales	811
Peto-Scott, Ltd. Front Cover Strip, 799, 807, 812, Inside Back Cover	
Pifco, Ltd.	789
Radio Electrical Supply	789
362 Radio Valve Co., Ltd.	800
Varley, Ltd.	790
Westinghouse Brake & Saxby Signal Co., Ltd.	800
Wet H.T. Battery Co.	807

PRACTICAL TELEVISION



Nº 2
ON SALE
FRIDAY

6^d

On sale at all Newsagents and
Bookstalls or post free 7½d.
from George Newnes, Ltd.,
8-11 Southampton Street,
Strand, London, W.C.2.

THE second issue of this new journal which is entirely devoted to the popular aspect of the new hobby—"Television" contains informative articles on Televising Talking Films, Noctovision, Phonovision, the Stixograph, Television side lines, more about Scanning Systems, Methods of Coupling a Visor to an Ordinary Receiver, Constructional Details of a Visor, Telenews of the Month, Televiews, and many other highly interesting articles on the newest of all sciences.

PRACTICAL TELEVISION

Geo. Newnes, Ltd.

C10

Printed in Great Britain by NEWNES & PEARSON PRINTING CO., LTD., Exmoor Street, Ladbroke Grove, W.10, and published by GEORGE NEWNES, LTD., 8-11, Southampton Street, Strand, W.C.2. Sole Agents for Australia and New Zealand: GORDON & GOTCH, LTD. South Africa: CENTRAL NEWS AGENCY, LTD. *Practical Wireless* can be sent to any part of the world, post free, for 17/4 per annum; six months, 8/8. Registered at the General Post Office for Transmission by Canadian Magazine Post.