

FEEDING BATTERY SETS FROM D.C. MAIN.

Practical Wireless

3^d

Published every Wednesday by
GEORGE NEWNES LTD.

Vol. 4. — No. 98.
August 4th, 1934.

Registered at the G.P.O. as a Newspaper.

AND PRACTICAL TELEVISION
EDITED BY F.J.CAMM

Progress in TUNING DIALS

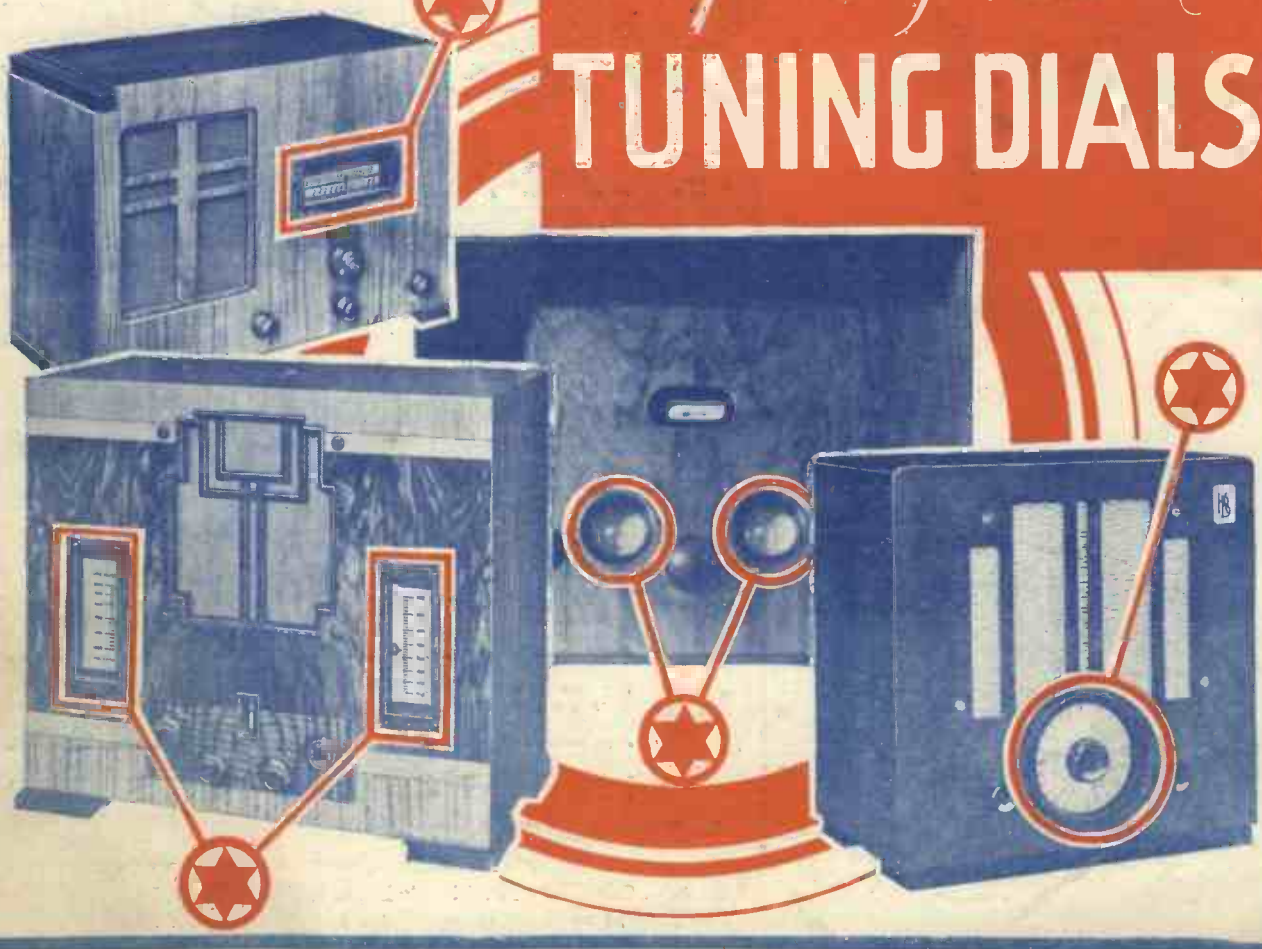

FREE!

1/- SHORT-WAVE BOOK

Simply send 3d. in Stamps.

PETO-SCOTT'S Short-wave Book. 48 pages profusely illustrated. Fascinating and instructive. Constructional articles for building 2-, 3- and 4-valve Short-wave Sets, including the Discoverer S.G.3 and a S.W. Adaptor. With full-size Free Blueprint and Wiring Diagrams. A detailed list of priced parts for every set.

DISCOVERER SHORT-WAVE S.G.3

PETO-SCOTT DISCOVERER (S.W. RECEIVER, as used by the J. H. Martin Arctic Expedition. Combines all the advantages of high efficiency, S.G. amplification, with amazing simplicity of operation. Complete Kit for building, in sealed Carton with all parts, including Valves and Cabinet. Every Kit includes a FREE Full-size Blueprint and FREE copy of PETO-SCOTT SHORT-WAVE BOOK, as described on left. Complete Kit, with valves and cabinet, Cash or C.O.D., Carriage Paid, £7/2/3, or 12 monthly payments of 13/1. Additional Plug-in Coils to tune 40-120 metres, 6/6.
PETO-SCOTT CO, LTD. 77, CITY ROAD, LONDON, E.C.1.

KIT "A"
less valves, cabinet and batteries. Cash or C.O.D., Carr. Pd. **£4 10 0**

Or Yours, for **8/3** and 11 monthly payments of 8/3.



The **NEW** **COSSOR** all-electric **MELODY MAKER**

MODEL 357

Here is the new Cossor All-Electric Melody Maker—a remarkable 1934/5 model which represents the greatest stride forward ever made in Kit design in a single year.

It incorporates every worth-while development—Variable-Mu S.G. Circuit and New Super Selective Low-Loss Coils give a remarkable degree of selectivity. An H.F. Pentode Detector provides extra amplification. Its Moving Coil Speaker gives reproduction of a remarkable high quality. For all-round performance this new Cossor Melody Maker far excels any of its famous predecessors. Send at once for full particulars—use the coupon.

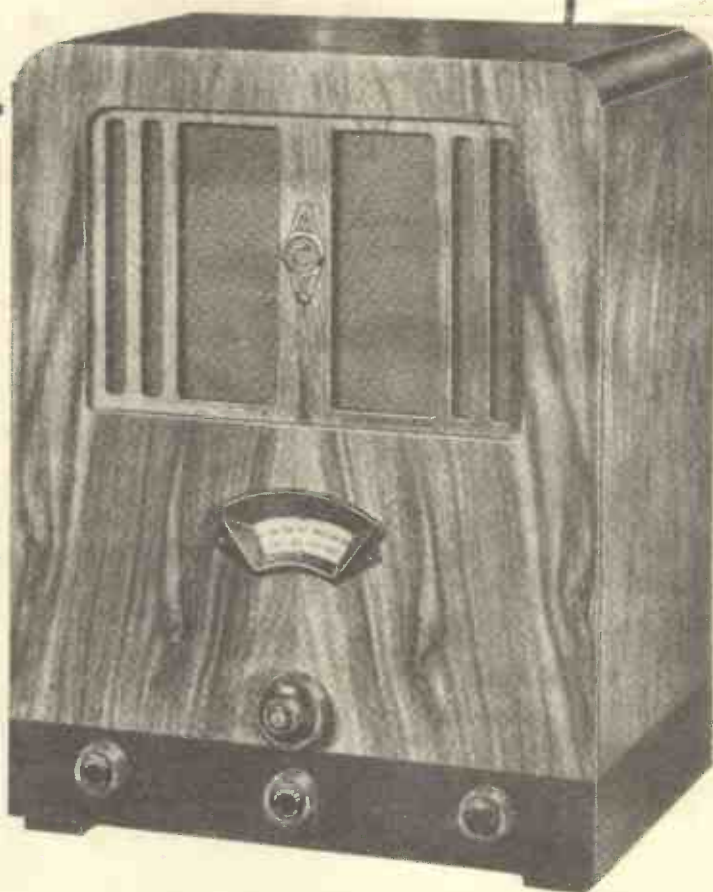

SPECIFICATION

Complete Kit of parts for assembling the Cossor All-Electric Melody Maker 357 as illustrated, including four Cossor Valves, viz.: Variable-Mu Screened Grid, H.F. Screened Pentode Detector, Power Output and Heavy Duty Rectifier. Fully Screened Super-Selective Low-Loss Coils, Combined On/Off Wavelength and Gramophone Switch, Cossor Mains Transformer, pressed all-metal chassis and all the parts necessary for simple home assembly. Handsomely finished cabinet 18" x 14" x 9½". Energised Moving Coil Speaker, terminals for Gramophone Pick-up, Plug and Socket for extension loud speaker. For A.C. Mains only 200/250 (adjustable) 40/100 cycles.

£7.19.0

Hire Purchase Terms: 20/- Deposit and 10 monthly payments of 16/-.

**SEND COUPON FOR
FULL DETAILS**

VARIABLE-MU S.G. CIRCUIT

H.F. PENTODE DETECTOR

MOVING COIL LOUDSPEAKER

To A. C. COSSOR LTD., Melody Dept., Highbury Grove, London, N.5
Please send me free of charge, full details of the new Cossor All-Electric Melody Maker Model 357.

Name

Address

357 FRAC. 4/8/34

MODERN FREQUENCY CHANGERS SEE PAGE 545

EDITOR:
Vol. IV. No. 98. || F. J. CAMM || Aug. 4th, 1934.
Technical Staff:
W. J. Delaney,
H. J. Barton Chapple, Wh.Sch., B.Sc. (Hons.), A.M.I.E.E.,
Frank Preston, F.R.A.

ROUND *the* WORLD of WIRELESS

For Cricket Enthusiasts

IN the evening of August 11 Henry Grierson, of Northampton, who, by the way, was the B.B.C.'s first Rugby commentator, will give his impressions of the first day's play in the Trent Bridge match—Australia v. Notts. He gave an eye-witness account of the Australians' match against Leicestershire early in the season, and his interview of Valentine Jupp at the microphone will also be recalled by listeners who are cricket enthusiasts.

Band Music

BAND programmes including the relay of the Welsh Guards Band, Major Harris conducting, from the Arboretum, Derby, on August 7, and Cresswell Colliery Band (from a Midland Regional studio), David Aspinall conducting, will take place on August 10.

West Regional Items

A RELAY will be taken of the opening ceremony of the Royal National Eisteddfod from Neath on August 6, for West Regional listeners. The Eisteddfod Choir will sing a chorus specially written for the Neath Festival—namely, "Can yr Eisteddfod" ("The Eisteddfod Song"), composed by Mathew Davies, words by Wil Ifan. The speakers taking part include D. M. Evans Bevan, J.P. (Chairman of the Eisteddfod), E. J. Hopes (Mayor of Neath and Vice-Chairman of the Eisteddfod), Philip Thomas, J.P. (Chairman of the Executive Committee), and the Archdruid Gwili. Many members of the Gorsedd will be present.

Singing Competitions

ON August 10th, a relay will be taken from the Pavilion of the concert in which the winners in the soprano, mezzo-soprano, contralto, tenor, baritone and bass solo competitions will sing. Adjudicators will sit in judgment upon their singing at that concert and will award a special medal. The rest of the concert will be devoted to the works of Welsh composers and listeners will hear a number of first performances. The items include solo, chorus and orchestral works and a relay will be taken for

West Regional, National and Empire listeners. A talk from a studio for West Regional listeners will also be given by an Overseas visitor to the Eisteddfod.

Country or Seaside

WEST REGIONAL listeners will have a choice on Bank Holiday of entertainment from the country or from the seaside. "From the Country" presents Ringers' Day at Trowbridge in the company of A. G. Street. Last autumn the bells of the Parish Church of Trowbridge ceased

and one of the few twelve bell-peals in the country cast as one family. The second of the Bank Holiday diversions comes from the seaside when Simrose and Watney, Ltd., present "The Black Notes," relayed from the Cosy Nook Theatre, Newquay.

Ice-cream News

A "HOLIDAY HUSTLE" talk about the ice-cream business will be broadcast to North Regional listeners on August 4 by Mr. J. Laurance Brown, a Sales Manager. The "season" so far as Mr. Brown is concerned, lasts from Easter to September; during that period his organization employs 1,100 cyclists in the Northern area, extending from Sheffield to Newcastle. In the winter many of these have to find other jobs. Curiously Mr. Brown's first job was in a brick-works in Scotland.

"A Bucket of Brass"

THAT "all that glitters is not gold" will be shown when Edwin Lewis's comedy sketch "A Bucket of Brass" is broadcast to the North Region on August 4th. In this, the fourth of the "Conversations in Owdham," listeners will be able to study the reactions of Polly Ann Blenkinsop (played by Mary Eastwood) to a legacy left her by an uncle, and to enjoy the philosophic reflections of Mrs. Bill Brown (played by Lucia Rogers).

From Belfast

THE very appropriate date August 3rd has been chosen for the broadcast of Roger McDougall's play "The Thrush." The play deals with the subject of war and is one that may be truly described as "unusual." Listeners may remember that a revue by this young author entitled "April Foolery" was produced in the Belfast studio some time ago.

Sporting Events

ULSTER abounds in sporting events which provide eye-witnesses with exciting material for their accounts to listeners. Next on the list is the Lisburn and District Grass Track Motor Cycle Championships. This event takes place on the Maze racecourse and an eye-witness account will be given on August 4th.

MAKE A NOTE OF IT!

Olympia Radio Show

Thursday, Aug. 16th to Saturday, Aug. 25th, 11 a.m. to 10 p.m.

Two Special Enlarged Numbers

of

Practical Wireless

The Leading Wireless Weekly

August 18th issue

COMPLETE GUIDE TO THE SHOW

A Forecast of the Exhibits, in At-a-Glance form with a guide to the show Alphabetically arranged

August 25th issue

STAND-TO-STAND SHOW REPORT

A comprehensive report on each exhibit by our Technical Staff.

Order These Issues Now!

ringing; the old bearing had worn and the ringers said they could not ring them any more, so a town's committee was formed and the money was raised not only to have the ten bells recast, but to increase the number of bells from ten to twelve, which gives Trowbridge the honour of having the only twelve-bell peal in the diocese of Sarum

ROUND the WORLD of WIRELESS (Continued)

Broadcast Dramas

RADIO drama for the autumn will include *Old Bannerman*, by Eden Phillpotts; *Nelson*, by Jean Bartlett; and *Ivanoff*, by Tchekov. Charles Dickens's *Oliver Twist* will be given in December, as well as *The Great Adventure*, by Arnold Bennett. *Wuthering Heights*, by Emily Brontë, and that favourite old melodrama, *Maria Marten, or the Murder at the Red Barn*, which drew several generations of playgoers to the Elephant and Castle Theatre during Tod Slaughter's régime, will be heard at an earlier date. Autumn Shakespeare plays are *Measure for Measure*, *Hamlet*, and *Cymbeline*.

"Wild Decembers"

THIS is the title of Clemence Dane's tragically pathetic story about the Brontë family, which is in the Regional programme for August 7th; while National programme listeners are to hear it on August 8th. The play was last broadcast in January this year, when Gordon Gildard was producer; next month, Howard Rose is to act as producer.

Vienna Philharmonic Orchestra

THIS famous orchestra will be conducted by Toscanini when their concert is relayed from the Festspielhaus, Salzburg, to National programme listeners on August 23rd. The concert will consist of Symphony in D major (Mozart), Variations on a Theme of Haydn (Brahms), and Symphony in A, No. 7 (Beethoven). The relay will be carried out in co-operation with the Austrian Broadcasting Company.

Promenade Concerts

ALL forty-nine Promenade Concerts are to be broadcast from Queen's Hall this year, as usual. The first concert takes place on August 11th, and will be heard on the National wavelength. Other "Proms" for National programme listeners during the month are those of August 13th, 15th, 18th, 20th, 22nd, 24th, 28th, and 30th, and they include such eminent soloists as Maggie Teyte, Conchita Supervia, Mary Jarred, Isobel Baillie, Elsie Suddaby, Gladys Cole, Dennis Noble, Solomon, Harold Williams, Keith Falkner, Joseph Farrington, Heddlie Nash, Antonio Brosa, and Sir Walford Davies. Regionals' share of the August series will be on August 14th, 16th, 17th, 21st, 23rd, 25th, 27th, 29th, and 31st, and among the distinguished soloists then to be heard are May Blyth, Katharine Goodson, May Harrison, Beatrice Harrison, Dora Labbette, and Miriam Licette; also Percy Heming, Arthur Cranmer, Roy Henderson, Clifford Curzon, Frank Titterton, Albert Sammons, Percy Manchester, and Howard-Jones.

"Wild Violets"

THE Drury Lane success, *Wild Violets*, is to be broadcast on August 2nd (National) and 3rd (Regional). This musical comedy operetta by Bruno Hardt-Warden, with music by Robert Stolz, has been adapted for broadcasting from the English version of the play by Hassard Short, Desmond Carter, and Reginald Purdell. A notable cast will include Bernard Clifton (Paul Hoffmann), Frank Drew (Otto Bergman), Viola Compton (Madame Hoffman), Jack Clewes (Erik Schmidt), Vivien Lambelet (Lena), Jack Forbes Williams (Carl Hoffman), and

INTERESTING and TOPICAL PARAGRAPHS

Frances Clare (Greta). The Revue Chorus and B.B.C. Theatre Orchestra will be conducted by Charles Prentice.

The Ridgeway Parade

WITH reference to many listeners' inquiries, the B. B. C. announce that Philip Ridgeway is taking "The Ridgeway Parade" on tour for the third year in succession, starting at the end of July. The "Parade" will visit seaside resorts in the south, such as Boscombe, Westcliff, and Margate; then inland towns, working north, and will pay their first visit to Ireland late in the autumn. The earliest date for a return visit to the broadcasting studio will be some time in December.

Variety Shows at Wireless Exhibition

DURING the Wireless Exhibition at Olympia, August 16th to 25th, the B.B.C. is co-operating by putting on for the promoters three variety shows a day,

some of which will be broadcast, starting with the first on August 16th, which will be included in the National programme. The theatre itself will be even larger than that of last year. The B.B.C. will also be doing the amplification for the various stands, as in previous years, as well as the amplification in the auditorium and the theatre. The B.B.C. Dance Orchestra, directed by Henry Hall, will be the main

MUSIC LIGHTENS THE TASK



A cook on a cross-Channel steamer listening to a "His Master's Voice" Superhet A.V.C. Portable Grand whilst preparing the midday meal.

attraction of the shows. Unfortunately a number of regular broadcasting artists, whom listeners might expect to see at Radiolympia, will not be available this year owing to other engagements.

Cabaret Entertainment from Stratford-on-Avon

DURING the evening of August 6th Orlando and his Band will give a cabaret entertainment from the Welcombe Hotel, Stratford-upon-Avon, a stately house on the Welcombe Estate, once the property of the late Sir George Trevelyan. Orlando succeeded Henry Hall in charge of the music at the L.M.S. hotels, after five years at the Embassy Club, London. The band for the cabaret contains no brass; the music will be of the sweet and melodious type, not "hot." Band vocalists include Pat Hyde, Dennis Bland, and The Three Saxes; and at each of the broadcasts—three have been arranged so far—guest artists will provide a surprise item.

Talk for Swimmers

ON August 7th Midland Regional listeners will hear a talk entitled "Mainly for Swimmers," given by Percival H. Hardidge, president of the Midland Swimming Association last year and now Education and Coaching Secretary (Honorary) for that body. He is in his tenth year as president of the Birmingham Association of Swimming Clubs, and is a national water-polo referee. Mr. Hardidge was a boy of nine when he won his first club championship, beating a giant of six foot six in height.

(Continued on page 558)

SOLVE THIS!

PROBLEM No. 98.

Jarrold built a short-wave one-valve set in which normal circuit arrangements were incorporated. The 'phones were connected direct in the anode circuit, and consequently he experienced much difficulty from hand-capacity effects. He reasoned that the H.F. currents were passing through the 'phones and thus into his body, and therefore as his hands approached the tuning controls he fed back these H.F. currents and thus upset the tuning. He decided, therefore, to remove the H.F. currents from the 'phones, and accordingly inserted a fixed condenser (.001 mfd.) in each 'phone lead. When he again tested the receiver he could get no signals at all, and the set only functioned again when the condensers were removed. Why was this? Three books will be awarded for the first three correct solutions opened. Address your envelopes to The Editor, PRACTICAL WIRELESS, Geo. Newnes, Ltd., 8-11, Southampton Street, Strand, London, W.C.2. Mark your envelopes Problem No. 98, and post to reach here not later than the first post August 6th, 1934.

Solution to Problem No. 97.

When Gregory wired his seven-pin valve-holder he mistook the connections which were shown. These gave a view of the base of a valve seen from above, and as he worked below his valve-holder, which was of the chassis type, he reversed all connections.

The following three readers satisfactorily solved Problem No. 96, and books have accordingly been forwarded to them:

W. G. Moffat, 420, Mathieson Street, Glasgow, G.5.
W. Gordon-Harris, Junr., Mar-Ren-Dor, Upper Sea Road, Bexhill.

J. Hall, Station Road, Yate, Nr. Bristol.

PROGRESS IN TUNING DIALS

A Brief Resumé of the Stages Through Which the Development of the Tuning Indicator Has Passed.

DURING the past year great progress has been made in the development of the valve, and also in the design of other components used in the construction of a complete broadcast receiver, but the tuning indicator has not changed to a very great extent. It is obvious that as a receiver is capable of tuning to a number of different stations it is essential that some form of indicator be provided to enable the operator to identify the setting of the tuning control and thus enable him to know to which station he is tuned. It might be stated, therefore, that this part of the operating mechanism is the most vital, and it would appear that more attention should be paid to its design and operation.

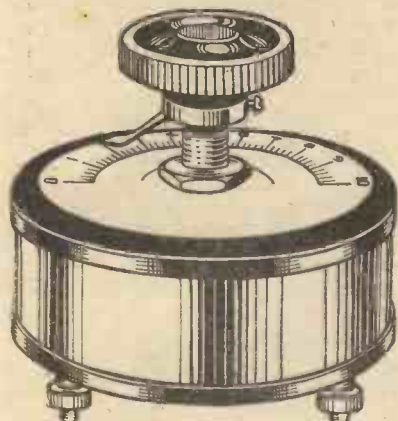

An early condenser fitted with a plain scale and pointer.

The Earliest Indicator

In the very early days of wireless receiver construction a plain operating shaft was fitted to the principal condenser, and to the end of this a small ebonite knob was screwed. Attached at right angles to the shaft was a short arm of metal, flattened at the tip to provide a narrow pointer, and the control panel over which this rotated was engraved with a semi-circular scale. For convenience this scale was generally marked with the degrees of a half circle, namely from 0 to 180.

In view of the very few stations which could be received, this formed quite a suitable identification method, but it is obvious that as the pointer is some distance above the panel an error of quite appreciable dimensions can creep in, due to the fact that the eye may be placed to the right or left of the pointer. This is known as a "parallax" error, and is avoided in testing instruments which use a similar type of pointer by fitting a mirror surface on the actual dial. To obtain an accurate reading the reflection of the pointer and the pointer itself are viewed from such a position that the two overlap. As more stations became operative this defect became noticeable and a new type of indicator became necessary. It took the

form of a disc of ebonite, about three inches in diameter, with a bevelled edge. On this were marked the degree markings, and a line was engraved on the panel to enable the dial to be rotated to a given figure.

The dial could, however, be locked in any position relative to the condenser plates themselves, and thus, should the dial be removed at any time, it became difficult to re-attach it in its original relative position.

Station Calibrations

As time went on it became increasingly evident that a mere set of numbers was not adequate for the listener, and therefore station names became customary. To accommodate even a few names, the curved dial was found cumbersome, and therefore a straight strip of material was used to carry the names, and various ingenious schemes were devised to enable a pointer to move across the straight dial. This type of dial is probably the most popular at the present time, and our cover this week carries two commercial examples of this type of dial. Generally speaking the pointer is not attached to the rotating condenser spindle, but is operated on a separate mechanism, either through cam drives or by means of cords. The H.M.V. instrument, which has a medium wave scale on one side and a long wave scale on the other, employs a length of cord running over pulleys, and has the small

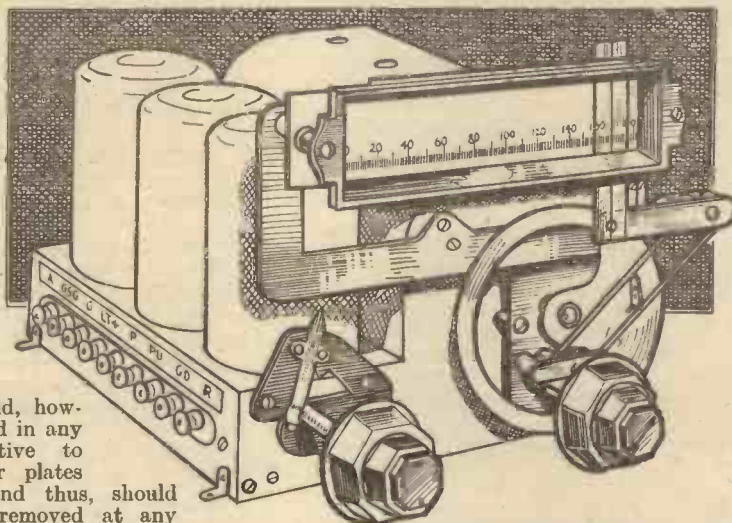

A straight-line scale fitted with an ingenious mechanism controlling the pointer.

travelling pointer clamped to the cord. It is thus a simple matter to re-set the pointer after dismantling, as it only becomes necessary to tune to a station and clamp the pointer to the cord. Both pointers move at the same time, but only one scale is illuminated at a time, the illumination being controlled by the wave-change switch. This avoids another defect of the average tuning scale, namely, the actual range which is being covered. One scheme which has been tried with success is the provision of red and green lights behind the scale and the printing of the station names in those two colours. The wave-change switch operates the lights and so provides a ready indication as to the range, in some cases the light preventing the reading of the names on the opposite range. Whilst this straight-line type of dial is very successful and fairly neat in appearance, it still leaves the receiver with the appearance of some scientific instrument

or laboratory type of apparatus and prevents the complete apparatus from taking its place as an article of furniture in keeping with other domestic furnishings.

Clock-Type Dials

Where the receiver is of the small console type the general appearance of the receiver is not unlike that of a clock, and therefore one or two manufacturers have introduced a tuning dial taking the shape of a

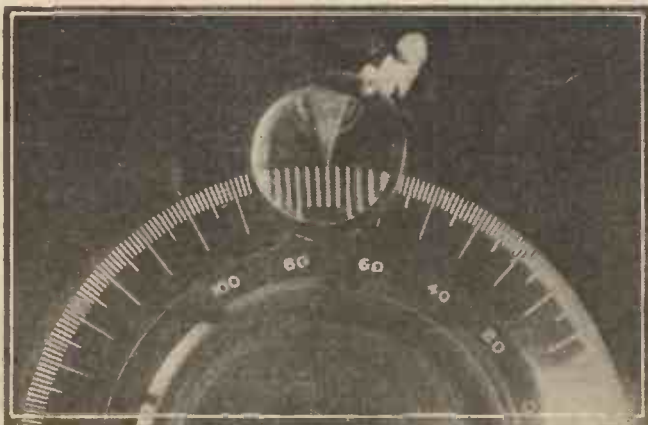

A rotating ebonite dial with fixed pointer and magnifier.

(Continued overleaf)

TUNING DIALS

(Continued from previous page)

clock-face of modern design. The two wave-range scales are marked round the face and two pointers are arranged in the form of clock hands, thus providing a very ready indication which may be said to be ideal from the point of view of the average listener. The whole face is visible, and therefore it is a simple matter to observe quickly in which direction the control has to be moved to select any desired station. This cannot be said of some types of scale which have been designed, and on our cover we also include

one such "obscured" pattern. A small hole is cut in the cabinet front and a powerful magnifying lens is fitted to this. Behind the lens is the rotating scale, engraved with the names of the stations, and this has the merit of removing any possibility of doubt as to which station is being received. The lens magnifies the printing and avoids the necessity of peering close at a scale and also ensures that the condenser setting is exactly correct, as the moving pointer is dispensed with. The only drawback to this device is, as mentioned earlier, that the listener is in some doubt, until thoroughly accustomed to the receiver, as to which way to turn the control to tune to a certain

station. There is still great scope for designers to introduce a dial which will remove the scientific appearance from the receiver and enable it to be built more in keeping with the furnishings and yet avoid the defects above mentioned. Visitors to last year's Radio Exhibition will remember the Marconi exhibit wherein one called out the name of the station it was desired to hear, and the receiver automatically tuned itself to the correct point. This is rather a futuristic hope, but no doubt some equally simple device will be introduced before long to assist in operating the broadcast receiver.

AUTOMATIC TONE CONTROL

An Experimental Circuit Designed to Provide an Automatic Control of the Tone of Reproduction. By "LAMBDA"

WE often become accustomed to the sounds we hear and this is particularly true of radio receivers. The reproduction we obtain from our set is beyond reproach, so we think. In our opinion the performance is excellent, but it is only after comparison with other high-quality receivers that its excellent, quality or defects become really apparent. In many cases we are disappointed with the results of this comparison, and we are naturally anxious to obtain more realistic reproduction.

Many receivers are fitted with a tone-control device which in some cases operates by cutting the higher frequencies. A mellow tone may be obtained by this method, but it certainly does not approach realism in reproduction.

Automatic tone control is being devised to maintain high quality on the local station, only operating on the distant station where it also acts as an interference noise suppressor. So far as the writer is aware, this system has not been employed in receivers manufactured in this country, but it offers possibilities, and constructors may be interested in the circuit described which offers scope for experiment.

Before the introduction of A.V.C. all volume controls were manual, and it was not until the introduction of the variable mu valve that the possibility of a really satisfactory A.V.C. system was considered practicable.

In the earlier types of receivers employing a screen-grid valve, the volume control was usually arranged to precede the first H.F. stage, being employed in either the grid circuit of the valve or in parallel with the first tuned circuit. By these methods the input to the first valve was reduced. Now that the diode is being widely used as a detector valve, the pre-H.F. system of volume control has been superseded.

It is not advisable to reduce the input to the diode below a certain limit, as it would then cease to function as a linear rectifier and distortion would result. Now although a large input is necessary, it may result in overloading the first low-frequency valve, consequently producing distortion. In these circumstances, therefore, the logical position for the manual control is in the grid circuit of the low-frequency valve. With a valve such as the double-diode-triode, the volume control would be in the grid circuit of the valve, which, to all intents and purposes, is the first low-frequency stage.

The Circuit Described

The automatic tone control circuit is the outcome of A.V.C. circuits and depends upon automatic volume control for its operation. The circuit arrangement shown below illustrates a double-diode-triode for A.V.C. and a variable mu valve for automatic tone control. Connected to the negative end of the diode

nected across the output circuit of the diode, and this capacity will increase with a decrease in signal. When a strong signal is received the total capacity is the capacity of the condenser C plus the inter-electrode capacity of the tone control valve. This total capacity is about average for the diode load resistance shunt, so that there is no apparent attenuation of the fre-

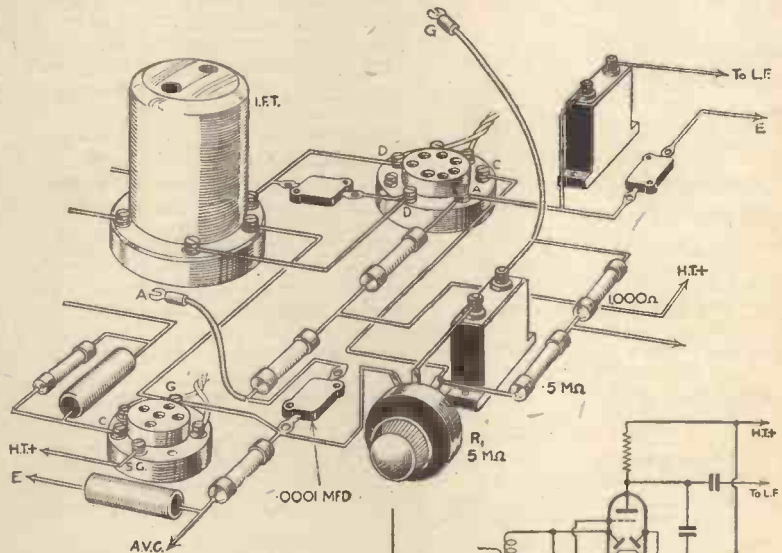

Pictorial and theoretical circuits combining A.V.C. and A.T.C.

load resistance R_1 is the control grid of the variable mu valve, and this resistance also provides the A.V.C. bias. Now between the anode and control grid of the variable mu valve is a small capacity of about 0.0001 mfd.

The functioning of the tone control depends upon the fact that the input of a variable mu valve will vary with its mutual conductance, which is governed by its grid-plate capacity. In the circuit shown this capacity is supplemented by an additional fixed capacity connected in parallel with the valve capacity, i.e., between grid and plate. By this method a relatively large capacity can be obtained, for we know that the resultant capacity of two condensers connected in parallel is equal to the sum of the two individual capacities.

Thus we have a variable capacity con-

frequency band in this part of the circuit. The high frequency, however, may be attenuated in receiving a weak signal. In this case the static value of the capacity will increase very considerably, although quite a moderate value of fixed capacity has been used.

MODERN FREQUENCY CHANGERS

All About the Latest Valves and Circuits for Superhet Receivers.

THE modern superheterodyne receiver resembles very little its earlier prototype of about ten years ago. Although the fundamental principle remains the same, the process of evolution has been so rapid that there is no comparison between a modern superhet and one of the early types; either in quality of reproduction, performance, and last but not by any means least, the initial cost. For some years the superhet appeared to be moribund, but with the introduction of the screen grid valve, it showed signs of recovery. As a matter of fact, the revival was extremely rapid so that at the present

a considerable number of receivers employing a separate oscillator valve, and it is quite possible that for some types of superhet receivers it may still find favour.

Some Examples

Let us examine the circuit in Fig. 1. This shows the first detector and oscillator of the "Premier Super," which was described in PRACTICAL WIRELESS, September 30th, 1933. Here we have a screen grid first detector, and a triode oscillator valve. The locally-generated oscillations are fed into the anode circuit of the first detector. This is a very efficient arrangement, and at

the time that it was designed was probably the best arrangement for a superhet of this type.

With a mains receiver one of the most satisfactory methods of coupling the oscillator to the first detector is by cathode coupling, a separate coupling winding being provided on the oscillator coil.

This system functions quite satisfactorily,

but where economy in valves is desired, the single valve frequency changer has been introduced. There are now single valve frequency changers available which are quite satisfactory, and the latest types are really efficient.

The H.F. Pentode

If the H.F. pentode be substituted for an ordinary screen grid valve in a receiver there should be some improvements in sensitivity. The impedance of the H.F. pentode is much greater than that of the tetrode and consequently, if it is desired

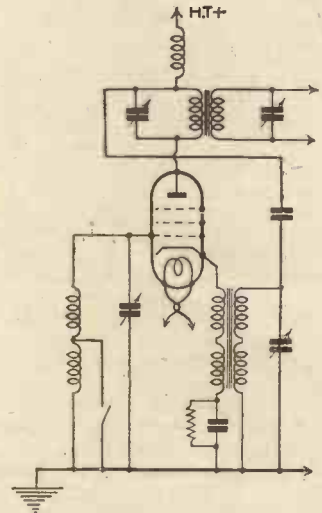

Fig. 2.—The frequency changer circuit of the Luxus A.C. Super.

to increase the sensitivity to any great extent, the dynamic resistance of the tuned circuit must be increased. In other words, the advantage to be obtained from an H.F. pentode can only be realized by employing really efficient tuned circuits. This valve has been employed fairly successfully as a single valve frequency changer particularly in mains receivers; a circuit employing it was the "Luxus A.C. Super," described in PRACTICAL WIRELESS, October 14th, 1933. One of the advantages of employing this valve as a frequency changer was that cathode coupling could be employed.

This allows a simplification of the oscillator coil as the additional coupling winding can be dispensed with, the reaction winding being placed in series with the cathode circuit of the valve. One of the

(Continued overleaf)

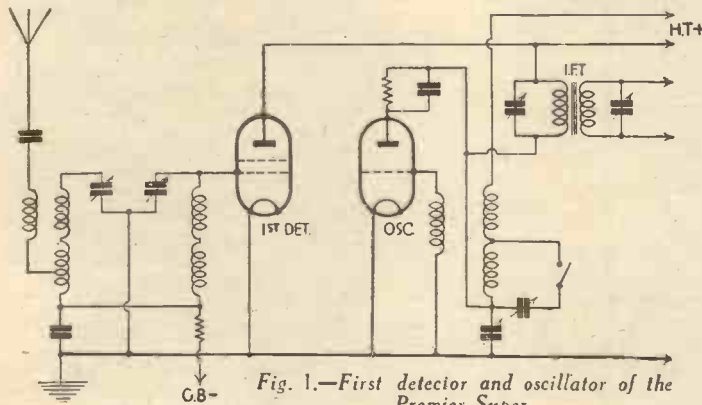

Fig. 1.—First detector and oscillator of the Premier Super.

time it has become one of the most popular types of receiver. It can safely be said that the progress in valve design has been primarily responsible for the remarkable recovery of the superhet. Ganged tuning condensers and matched coils have also played their part in making the superhet a universal set. There has been a gradual diminution in the number of valves employed and it is highly probable that at the forthcoming Radio Exhibition at Olympia three-valve superhets will be in evidence; the four-valve receiver is already quite common.

Multi-electrode Valves

What has made this type of set possible? Valves! Not more, but less! A lesser number, but greater efficiency.

The principle of employing one valve to do two jobs has previously been utilised, with more or less success, in the frequency-changing process of a superhet. Various attempts have been made to combine the function of local oscillator and first detector in one valve. We have had the bi-grid valve, which was fairly satisfactory, but it had a low mutual conductance and consequently its efficiency was not very high.

All the present frequency changing systems might be classified into two headings:—

(1) Those which employ a separate triode oscillator valve and use as an anode bend first detector, either a screen grid or variable mu valve.

(2) Circuits in which we employ some form of single valve frequency changers.

Perhaps in the near future the single valve frequency changer will become universal, but at the present time we have

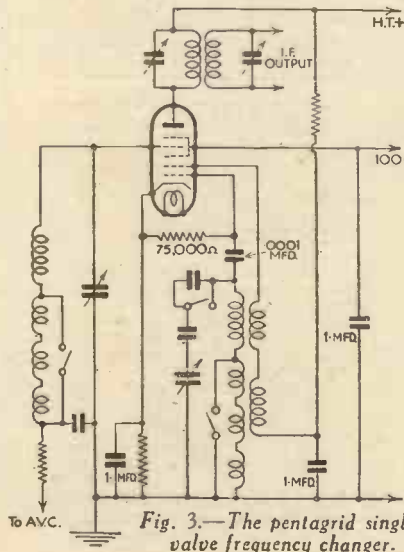

Fig. 3.—The pentagrid single-valve frequency changer.

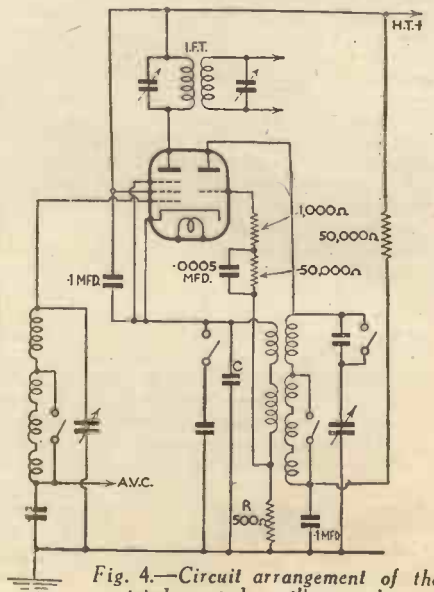

Fig. 4.—Circuit arrangement of the triode pentode oscillator valve.

(Continued from previous page)

advantages of the valve is that larger voltage swings are possible than with the screen grid valve. However, it still suffers from the one disability that all preceding frequency changers have suffered from, and that is it could not be used in A.V.C. circuits, as a satisfactory variation of the grid bias was not possible.

The Pentagrid

Here at last was a valve really designed to do its job. Designed for a specific purpose—as a single valve frequency changer. The theoretical circuit is shown in Fig. 3. Actually it consists of two valves, a tetrode and a triode oscillator contained in one glass envelope. Mixing occurs within the valve. First of all we have the oscillator portion consisting of cathode, grid and the oscillator anode. This portion is screened from the tetrode position by the first screening grid. The cathode is common to both oscillator and first detector, but as a matter of fact, the cathode for the tetrode portion consists of a cloud of electrons which are located between the first screening grid and the detector control grid. Next, we have the tetrode portion consisting of the control grid, second screening grid and the anode; these electrodes constitute an ordinary variable mu screen grid valve.

Apart from the other advantages of this valve, the tetrode portion has variable mu characteristics, consequently automatic volume control is capable of being applied to it.

A unique feature of this valve is that coupling occurs within the valve itself, therefore, the difficulties associated with the

injection of the local oscillations into the first detector when a separate oscillator valve is employed are avoided.

Conversion Conductance

A new technique appears to be developing in connection with single valve frequency changers; greater attention is now being paid to their design. For instance, it is now being realized that for really satisfactory operation a specially designed oscillator coil should be employed in order that the optimum heterodyne voltage may be obtained over the whole of the tuning scale. In addition to the usual valve data manufacturers are now supplying information concerning the conversion conductance of single valve frequency changers. As this is an innovation it may be worth while to explain briefly what is meant.

First of all we know that the mutual conductance of a valve is a measure of its efficiency and is the ratio of the charge of anode current with charge of grid voltage, the anode voltage remaining constant. As an example, if there was a charge of 4 volts in the grid of the valve and the anode current varied from 3 to 5 milliamps, the mutual conductance in this case would be 0.5 m.a. per volt. This is arrived at by dividing the change in anode current, namely, 2 m.a. by the change in grid voltage which is 4 volts. This gives 0.5, which is an indication of the valve's slope or goodness.

Conversion conductance is somewhat analogous to mutual conductance. In this case, we ascertain the amplification of the intermediate frequency component of the anode current in microamps—not milliamps—and divide by the signal input

in volts. The resulting figure expresses the efficiency of the valve as a frequency changer, and is termed conversion conductance. It has also been ascertained that maximum signal strength and greater efficiency are obtained when a certain fixed value of oscillator voltage is applied between grid and cathode of the first detector.

The Triode Pentode

The triode pentode frequency changing valve operating in conjunction with a well designed oscillator coil appears to have many advantages.

This is one of the latest type of valve for use in superhet receivers. As its name implies, it consists of a pentode triode valve combined within one glass envelope. The oscillator portion possesses a high mutual conductance, enabling anode circuit tuning to be employed with a consequent reduction in harmonics, and the pentode has variable mu characteristics and consequently, as with the pentagrid valve, A.V.C. is possible.

Circuit details of the valve are shown in Fig. 4. In series with the grid of the oscillator portion is a 1,000-ohm resistance; this is employed to reduce oscillator harmonics.

The resistance R and Condenser C are employed in order to keep the heterodyne voltage constant over both wave bands.

You will observe that the decoupling of the anode and screening grid are taken to cathode instead of, as is usual, to earth. It should not be taken direct to earth, otherwise oscillation frequency feed back will occur. Several manufacturers are providing valves of this type and in one instance, a battery version is available.

Useful Tips

HOLDING a key against the centre pole-piece of an energized moving-coil speaker will tell whether the coil is O.K. and it is getting its magnetizing current.

One can start testing a set either from the speaker inwards or from the detector anode outwards, but it usually saves time to work from the speaker inwards, because getting at the detector circuit of other parts of the low frequency may involve the removal of the chassis which may not be necessary, if, for instance, the loud-speaker is the only cause of the trouble.

A brief examination will show where an audible signal can be heard, and it is worth remembering that where high voltages are concerned, such as in the anode circuit of the pentode, it is usually only necessary to put one tag of the headphones on to the circuit to hear a signal. Signals, too, can be heard, for instance, across the primary of a transformer without necessarily cutting wires; always avoid cutting a wire in any set if possible; it is far better to unsolder at an existing soldered joint.

Working back from the loud-speaker we have the coil of the loud-speaker, primary winding and secondary winding of the transformer, across which signals can be heard, although they will be very faint on the coil side. If no signals are heard across the primary winding, but have been located in the detector-anode circuit, it is almost certain that the trouble is somewhere in the pentode circuit, but if signals are heard across the primary winding, it doesn't necessarily mean that the primary winding is all right. When, if the headphones are put across the primary winding, there is a very loud bang in the 'phones, a burnt-out

Practical Pars.

winding is suggested, and its continuity and resistance checked up.

There will also be some sparks flying, especially in the modern type of one-and-a-half-watt output valves. Working back again an audible test can be made between the grid and cathode or grid and filament of the output valve, if nothing is heard in the anode circuit of the valve and something is heard in the grid circuit of the valve, and so on.

Use a High-Bias Voltage

It is always worth while to spend a little time making adjustments to

the bias tappings. It must be borne in mind that if the voltage is increased beyond a certain limit the quality of reproduction will be adversely affected, and so it is a good rule to use the very highest voltage at which satisfactory reproduction can be obtained. *Do not forget that the set must always be switched off before altering the G.B. tappings*; failure to do this will cause very serious damage, both to the valves and to the H.T. supply unit, due to the sudden and tremendous increase in current as the G.B. battery is disconnected.

G.B. batteries are made in exactly the same way as dry high-tension batteries, and though they do not normally supply any current, they do run down in time, due to evaporation of the electrolyte. It is a very good plan to make a practice of renewing the G.B. at the same time as the H.T. battery, or otherwise at intervals of from six to nine months—this is a real economy.

Combined H.T. and G.B. Batteries

A few high-tension batteries include a grid-bias battery, and many listeners like this idea very much. It is simple, neat, and ensures that the G.B. battery is always in as good a condition as the H.T., and that the current consumption from the latter is kept at a minimum. In using a combined battery of this type the G.B.+ plug on the set should be left disconnected because the positive terminal of the grid-bias battery is internally connected to H.T.—.

Capacity of G.B. Battery

For most purposes there is no point in using a super-capacity grid-bias battery, because, as previously explained, no current is drawn from it.

LEARN TO SWIM

by SID G. HEDGES

THIS admirable little booklet by Mr. Sid G. Hedges, the well-known authority on swimming, will prove equally valuable to the novice and the more proficient swimmer. It is illustrated with exceptionally clear diagrams and covers every important aspect of the sport from first bathing hints and water games to the more intricate strokes and dives.

3^d

Obtainable at all Newsagents and Bookstalls, or by post 4^d. from George Newnes, Ltd., 8-11, Southampton St., Strand, London, W.C.2.

A FULL-RANGE TONE CONTROL

A Useful Accessory for the Keen Listener.

IN these days of high-quality transmissions from stations at home and abroad a very high standard of reproduction is called for, and this can only be obtained if a really efficient form of tone control is employed. A study of the diagram will show that the unit is composed of a tapped choke, four condensers, and a potentiometer; the choke, potentiometer and condenser No. 4 being connected across the speaker windings whilst condensers 1, 2 and 3 are inserted in the leads to the speaker. The arrangement is very simple and at the same time very effective, allowing the output required to be selected at will. The most important item for construction is the choke, and this must be to the specification given or the results are quite likely to fall very much below the standard required.

The Choke

The original design was made up by using two chokes connected in series, but experiment proved that a single-tapped choke might be used if the correct point of tapping was found, and it is proposed to use one choke on grounds of both expense and space. For the purpose of winding we will call the windings one and two, each part being dealt with as a separate choke until the finish. Commencing with choke 1, a hole must be drilled on one side of bobbin cheek low down near the tunnel for the commencement of the winding. Pass a short length of flex, with the outer braid covering stripped off, through the hole, clean off the insulation, and solder the end of the 36 S.W.G. enamelled wire to it. Insulate the joint with a small piece of ordinary insulating tape and all is ready for winding.

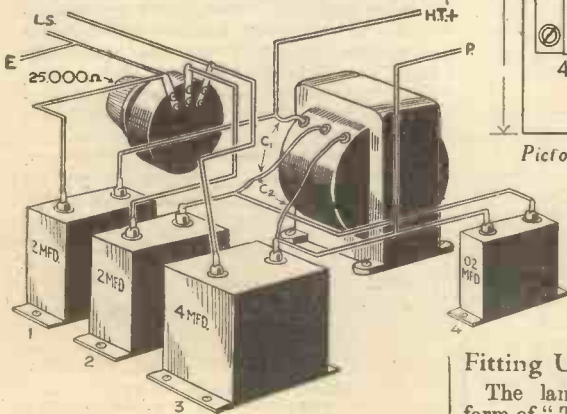

Pictorial diagram and wiring plan of the tone control.

insulating tape to make a good firm job. A word of warning, be quite sure that all winding is done in the same direction, otherwise one choke will be in opposition to the other.

Fitting Up

Wind on to the bobbin as evenly as possible 1,620 turns, and finish off by soldering on a length of flex as for the commencement, and passing through a hole drilled in the same cheek. This hole may be made slightly larger than the hole for the commencement, as we shall pass the lead for the next winding through this, making two leads in one hole. Having completed the winding and made fast the finishing lead, put two layers of greaseproof paper over the winding, followed by a layer of good quality insulating tape, and choke 1 is finished. Choke 2 is wound in exactly the

same manner as choke 1, the lead for the commencement being pushed through the finishing hole of choke 1, and the wire for the winding soldered to it. For choke 2, 3,240 turns are needed, and in winding this amount of wire the windings are apt to get very uneven. Therefore, at the end of every 800 turns cover the winding with a layer of paper as used for the finish of choke 1. Finish as for choke 1, securing the whole of the windings with an extra layer of in-

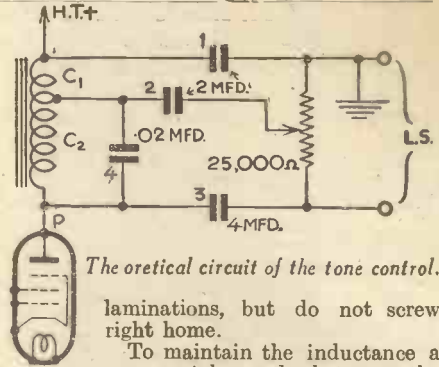

Theoretical circuit of the tone control.

laminations, but do not screw right home.

To maintain the inductance a gap must be made between the "T's" and "U's," the size of this being about the thickness of two sheets of the paper upon which this article is printed. Cut two slips of this paper and place between the ends of the "U's" and the "T" pieces, afterwards closing the laminations up tight and clamping up the feet so that any movement of the laminations is impossible.

The unit may be built into a receiver, and should this be the case the components will be arranged to suit the available space and layout of the remainder of the set, but for existing receivers where a new unit has to be made, a small paxolin panel or even wooden panel can be used to advantage with the potentiometer, and terminals on the front, and the components mounted on a baseboard.

Wiring

The wiring is very simple, and as all the components, with the exception of the choke, will have terminals, these have not been included on the choke, and connections may be made direct to the different points.

When using a separate speaker the unit may be housed in the speaker cabinet, and as one side of the speaker will be at earth potential, as in ordinary choke-capacity coupling, the terminal marked earth may be taken to the nearest earthing point. This is particularly useful when extension leads are being used.

Connections to Receiver

- Terminal No. 1 to L.S. and earth.
- Terminal No. 2 to L.S.
- Terminal No. 3 to H.T.
- Terminal No. 4 to anode of output valve.

LIST OF COMPONENTS.

- Seventy-two No. 30 Laminations.
- One Bobbin to fit.
- Four ounces 36 S.W.G. Enamelled Wire.
- One Set of Feet and Bolts.
- Short length of Flex.
- Insulating Tape.
- One 0.02 Fixed Condenser
- Two 2 mfd. Fixed Condensers } T.C.C.
- One 4 mfd. Fixed Condenser
- One 25,000 ohms Potentiometer—Colvern.
- One Panel, 6in. by 3in. by 1/4in.
- One Baseboard, 6in. by 6in. by 1/4in.
- Four 4 B.A. Terminals; 20 S.W.G. Tinned Copper Wire.
- One and a half dozen Small Screws.

TUNING AND ADJUSTING THE "UBIQUE" ALL-MAINS THREE

Although There are No Tricky Adjustments, the following Notes Will Tell you How to Get the Best From This Novel All-Mains Receiver.

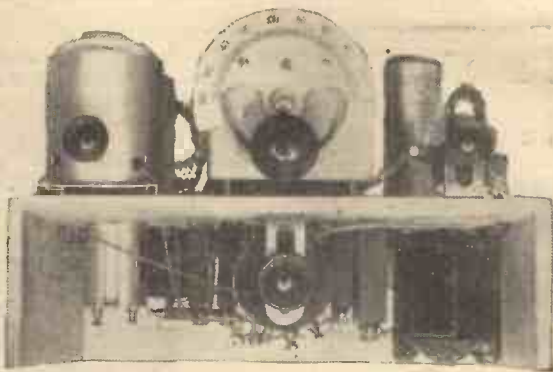

A front view of the "Ubique."

LAST week we dealt very fully with the construction of this new receiver which employs the latest valves designed to operate direct from alternating or direct-current mains without any modification. The principal point to note regarding the connection of the receiver was there emphasized, and to avoid the user overlooking the fact we will repeat the warning to mark the plug if the receiver is to be used on D.C. mains. An examination of



The complete receiver ready for insertion in the cabinet.

the circuit will show that the negative side of the mains (on D.C.) must be joined to the common earth line and, therefore, the plug must be connected to the mains socket so that this requirement is carried out. Unfortunately, the mains sockets in our houses bear no marking to indicate positive and negative as with normal lights, etc., the polarity is not of importance. Therefore, by scratching or otherwise making a sign on the Bulgin plug fitted to the Ubique it is possible to identify the correct position of the plug in the mains socket and no time will be wasted in waiting for signals. The Universal valves take some time to attain maximum temperature, and until this has been reached no sound of any kind will be heard from the loud-speaker. If the plug is inserted in the mains socket so that the positive side is joined to the common earth line no signals will ever be heard, and it is for this reason that the marking is required. If, therefore, after inserting the plug in a D.C. mains socket, no signals or noises can be heard at the expiration of one minute, reverse the mains plug and all should be well. On A.C. mains this is not required, as the rectifier takes care of the polarity after the alternating current has been rectified.

Adjusting Volume

Set the lower knob about half-way round the control, turn the left-hand control

to [the right and connect to the aerial, earth and mains. At the expiration of forty-five seconds a faint hum and rushing noise should be heard from the speaker. If the right-hand control is now rotated in a clockwise direction, oscillation should be heard and you may proceed to tune-in a signal. If no oscillation can be obtained, switch off and examine the wiring to make certain that all is correct. Note particularly that the reaction condenser is insulated from the mounting bracket, and see that the fixing bush is not making contact at the side. If suitable insulating bushes have been fitted there will be no risk of this, but if large washers are employed there will still be a possibility of the condenser shifting sideways and a short being introduced. If reaction operates satisfactorily and a howl can be obtained, turn the control back to zero and carefully rotate the main tuning knob until the local station is heard. With the volume control in a midway position, the volume should be about right for normal reception, provided the station is not too far away and that the aerial and earth system is efficient.

When the tuning point has been found, slacken off the volume control until the station is practically inaudible, and then carefully turn the star wheel at the rear of the gang condenser until the volume is brought to a maximum. Whilst carrying out this adjustment set the small concentric knob on the main tuning control to a midway position. As volume increases, slacken off the volume control to keep the signal always at its weakest, as you are thereby enabled more accurately to judge

the alteration of the tuning setting. When this adjustment has been satisfactorily obtained on the local, turn the dial to a position at the opposite end of the scale and turn up the volume control and endeavour to locate a station somewhere in this part of the scale. It may be necessary to apply a little reaction, but try to keep at the extreme end of the scale. Now see if any modification of the star wheel will increase signals, and if so, use the concentric trimming knob to reduce this alteration to the smallest value. The setting should be made so that the star wheel takes care of the maximum trimming error from 0 to 180 on the scale, and then any station can be tuned in by simply rotating the small central trimming knob. It is not difficult to carry out this part of the trimming, although it takes rather a lot of space to explain. The whole operation should be carried out in five minutes.

Wave-change Switch

The left-hand control will enable you to change over from medium to long waves, and no further alteration of the star wheel should be necessary on long waves. The volume control will give a smooth and gradual control of volume, reducing to complete inaudibility in its minimum position. If it is preferred to have this to operate in a clockwise direction for signal increase, the leads connected to its two outside terminals should be changed round. The central connection should be left as it is. Reaction should only be necessary when listening to a very distant station, and for the majority of the British broadcasting programmes it will not be required. This comprises all the adjustments which are required in this particular receiver, and, therefore, it may be handled by the novice with complete confidence.

LIST OF COMPONENTS

- | | |
|--|--|
| One pair B.P.31 tuning coils (Varley). | One 15,000-ohm Ohmite resistance (Graham Farish). |
| One two-gang .0005 variable condenser and dial (J.B.). | One 400 ditto (Graham Farish). |
| One .00015 mfd. reaction condenser (Polar). | One 200 ditto (Graham Farish). |
| Five Universal chassis-mounting valve-holders (W. B.). | One 10,000 ohm volume control, type CP 158 (Varley). |
| Two .01 mfd. fixed condensers, type 80 (T.C.C.). | One Amplion loud-speaker, type MC22. |
| Two .1 mfd. ditto, type 50 (T.C.C.). | One type C barretter (Philips). |
| Two .0001 mfd. ditto, type S (T.C.C.). | One A. and E. terminal socket strip and plugs (Belling Lee). |
| One .0005 mfd. ditto, type S (T.C.C.). | One fuse plug with .5 amp. fuses (Bulgin). |
| One .005 mfd. ditto, type 40 (T.C.C.). | One H.F. choke, type H.F.10 (Bulgin). |
| One 1.0 mfd. ditto, type 80 (T.C.C.). | One H.F. choke, type H.F. 12 (Bulgin). |
| One 25 mfd. ditto, type 511 (electrolytic) (T.C.C.). | One type 752 mains smoothing choke (Heyberd). |
| Two 8 mfd. ditto, type 902 (electrolytic) (T.C.C.). | One V.P.13A Universal valve (Mullard). |
| One 20,000-ohm Ohmite resistance (Graham Farish). | One S.P.13 ditto (Mullard). |
| One 100,000 ditto (Graham Farish). | One Pen. 26 ditto (Mullard). |
| One 150 ditto (Graham Farish). | One U.R.2 ditto (Mullard). |
| Two 1-megohm ditto (Graham Farish). | One Metaplex chassis (Peto-Scott). |
| One 2-megohm ditto (Graham Farish). | Two (2 1/2 in.) British Radiogram component brackets. |
| Two 250,000 ditto (Graham Farish). | Three Belling Lee grid cap connectors. |
| | Wire, screws, screened lead, etc. |
| | One Peto-Scott Compact Console Cabinet. |

For your Bookshelf

THE WIRELESS CONSTRUCTOR'S ENCYCLOPAEDIA

by F. J. CAMM
(Editor of *Practical Wireless*)

THIRD EDITION

5' - net
by post 5/6

The entire contents, written by the most accomplished designer and writer on the practical side of wireless construction, are presented in a new and attractive manner. The whole field of wireless construction is covered, and the volume is remarkable for the number of practical diagrams used to illustrate the text. Wireless terms and definitions are explained in concise and clear language. A treasury of wireless knowledge.

FIFTY TESTED WIRELESS CIRCUITS

by F. J. CAMM

2'6 net
by post 2/10

Modern circuits of practically every type from crystal to super-het. Diagrams and instructions for assembling and wiring, details of components and notes on operation.

THE MATHEMATICS OF WIRELESS

by RALPH STRANGER

5' - net
by post 5/6

Probably because it seems such a dull subject, this is a side of Wireless that is too often neglected by amateurs. But, none the less, it is of tremendous importance—and this gifted writer deals with it in such a way that there isn't a dull page in the book.

THE ELEMENTS OF WIRELESS

by RALPH STRANGER

3'6 net
by post 3/11

A complete guide to the understanding of modern wireless. The author starts with elementary principles, proceeds to the consideration of their application in practice and theory and finishes with a critical survey of a typical four-valve Receiving Set, tracing its working from aerial to loud-speaker.

From all Booksellers or by post from:—

GEORGE NEWNES LIMITED

8-11, Southampton Street, Strand, London, W.C.2

INDEXING YOUR RADIO LITERATURE

How to Keep an Accurate and Simple Reference to all Your Cuttings, Catalogues, etc.

EVERYONE who has an interest in a particular subject finds that, as time goes on, there is an ever-increasing accumulation of reading matter, collected from all sources, and ranging from periodicals to textbooks, and catalogues to sketches and diagrams. Yet most of this is allowed to remain almost unused because of the difficulties which arise in finding the section required at the time it is wanted. An alphabetical index, when it relates to a bound series of periodicals such as PRACTICAL WIRELESS, is very useful, but it is restricted in its usefulness because it brings totally unrelated subjects together. These difficulties are increased when, as is usual, there are bundles of cuttings and a heterogeneous collection of pencilled notes in addition, and the general result is that a lot of valuable information is shelved simply for the lack of a suitable indexing system.

Decimal Classification

The author has adapted a classification employed by all the big reference libraries. The complete system has the name "The Decimal Classification of Dewey," and is of course, far too extensive for ordinary use. However, the section in which one is interested may be extracted and modified to suit any personal needs. In this case the original numbering has been adhered to as closely as possible, but extensions have been made just when and where desirable.

The system itself will first be described, and then its application to books, cuttings, and notes will be explained.

The subject is, of course, Wireless and is divided under ten general headings, each represented by a code of three numbers.

- 000 Wireless in general.
- 100 Theory and principles.
- 200 Measurements.
- 300 Apparatus and equipment.
- 400 Systems of working.
- 500 Applications of Wireless.
- 600 Stations and their operation.
- 700 Manufacturing processes.
- 800 Associated subjects.
- 900 Miscellaneous.

It will be noticed that each section has 100 possible headings. Taking MEASUREMENTS as an example, we get as sub-heads:—

- 200 Measurements—General.
- 210 Frequency and wavelength measurement.
- 220 Capacity.
- 230 Inductance.
- 240 Resistance.
- 250 Current.
- 260 Voltage.
- 270 Field strength.
- 280 Properties of materials.
- 290 Miscellaneous.

These again are sub-heads which may, in turn, be divided into units and decimal points, if necessary. Usually the "tens" subheads are sufficient, but as each enthusiast has his own pet section, the probability is that that particular section will be as big as several others put together, and thus will need more sub-divisions. A more complete layout is given at the end

By ERNEST G. ROWE

of this article, but it must be borne in mind that the chief beauty of this method is its extreme flexibility so that each user can adapt it to suit his own requirements.

How it is Employed

Now to describe the way to use it. The author found that two looseleaf books were desirable, one to deal with books and cuttings, and the other to hold the notes. For a start a leaf should be allotted to every tens figure from 000 to 900 and each hundred block separated by a card to facilitate easy reference. The front page should have the complete index typed on it. All references to books should be entered up with the name of the article, the name of the book, and the page number. This will enable unbound periodicals to be kept in their piles. All cuttings can be entered up in the same book but with no page reference. For holding cuttings and drawings, large foolscap envelopes are best, each envelope bearing a number describing its contents. Thus envelope No. 100 will hold cuttings relating to the general principles and theory of waves, aerials and valves, etc.

The other notebook should be divided up in a similar manner and the notes relating to any particular part will be written up and filed under that part. Thus, if at any time the experimenter wanted information on, say, field strength measurements, he would turn up 270 in his index which would immediately give him the page numbers of the books having the information and also details of any cuttings he has on the subject; while turning to 270 in the other notebook will give him any notes of his own making.

While there is quite a lot of work entailed in initially preparing this index it will be found more than worth while, because not only will the reader have all his available information for ready reference, but in making up his index he will revise quite a lot of matter that he had forgotten.

Index

- 000 GENERAL. Laws and regulations, Licences, &c.
- 010
- 020
- 030 Encyclopædias.
- 040
- 050 Periodicals—Publishers, price, &c.
- 060 Societies.
- 070
- 080 Tables, data sheets, &c.
- 090 History and biography.
- 100 GENERAL PRINCIPLES AND THEORY.
- 110 Wave motion and wireless waves.
- 120 Aerials and their theory. Earths.
- 130 Valve theory.
- 140 Circuit theory. Resonant circuits.
- 150 High-frequency generators other than valves.
- 160 Receiving apparatus. Theory.
- 170
- 180
- 190 Miscellaneous.

- 200 MEASUREMENTS.
- 210 Frequency and wavelength.
- 220 Capacity.
- 230 Inductance.
- 240 Resistance and damping.
- 250 Current.
- 260 Voltage.
- 270 Field strength.
- 280 Properties of materials.
- 290 Miscellaneous.
- 300 APPARATUS AND EQUIPMENT
- 310
- 320 Aerial and earth design.
- 330 Valve practical design.
- 340 Valve apparatus.
- 350 H.F. Generators — not valve generators.
- 360
- 370 Receiving apparatus other than valves—crystals, recorders.
- 380 COMPONENTS & ACCESSORIES.
- 381 Condensers.
- 382 Coils.
- 383 Resistances.
- 384 Wavemeters.
- 385 Keys, buzzers, and microphones.
- 386 Filters.
- 387 Insulators.
- 388
- 389
- 390
- 400 SYSTEMS OF WORKING.
- 410 Damped and modulated waves.
- 420 Continuous wave systems.
- 430 Atmospheric.
- 440
- 450
- 460 Duplex and multiplex.
- 470 Wired wireless.
- 480
- 490
- 500 APPLICATIONS AND USES.
- 510 Navigation aids.
- 520 Aviation.
- 530 Commercial working.
- 540 Amateurs.
- 550 Broadcast transmission.
- 560 Military and naval.
- 570 Remote control of machinery.
- 580
- 590
- 600 STATIONS. DESIGN, OPERATION AND MANAGEMENT.
- 610 Description of stations.
- 620
- 700 MANUFACTURING PROCESSES.
- 800 NON-RADIO SUBJECTS. GENERAL ELECTRICAL ENGINEERING.
- 900 MISCELLANEOUS.

THE WIRELESS CONSTRUCTOR'S ENCYCLOPEDIA

(2nd Edition)

By F. J. CAMM
(Editor of "Practical Wireless")

THIS invaluable encyclopædia is written in plain language by one of the most accomplished designers and writers on wireless construction.

Obtainable at all Booksellers or by post
5/6 from Geo. Newnes, Ltd., 8-11, Southampton Street, Strand, London, W.C.2.

5/-

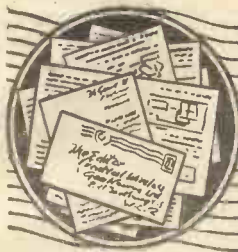

READERS' WRINKLES



An A.C. Voltmeter

THE simple meter illustrated is useful for measuring A.C. voltages and is easily constructed. A curved solenoid (A) is wound with 200 yards No. 48 B.W.G. S.S.C. Eureka resistance wire; B is a piece of hard steel on which the knife-edge (D) rests; C is a piece of soft iron with the same radius of curvature as the centre of A, while P and W are the drawn-glass pointer and adjustable balance weight respectively.

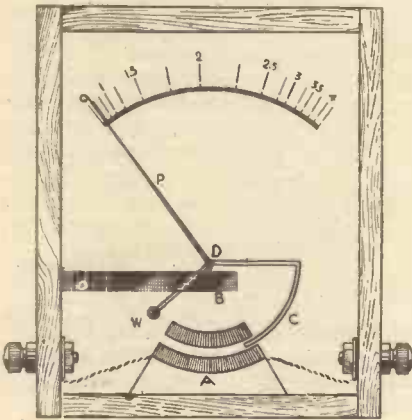

A simple A.C. voltmeter.

Thus, when a current is passed through A, it attracts C, pulling against the weight (W). The meter is best calibrated as follows: a resistance (capable of carrying about 1 amp—an electric iron whose exact resistance is known is suitable) is placed in series with a resistance of $\frac{1}{100}$ of its value, and the meter is connected across the small resistance. The whole is then connected across mains of known voltage and the reading noted; if the mains are, say, 250v., the meter is then reading 2.5v. The same is done with different small resistances, and then a copy can be made of the rough scale, and neatly printed. It is advisable to calibrate on A.C., owing to the inductance of A.—B. SKENFIELD (Troedyrhin).

An Extension Spindle

THE accompanying sketch shows a neat extension spindle which I fitted to a pre-set condenser. The parts required are

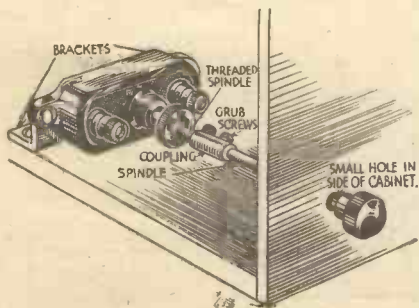

A neat extension spindle arrangement.

THAT DODGE OF YOURS!

Every Reader of "PRACTICAL WIRELESS" must have originated some little dodge which would interest other readers. Why not pass it on to us? We pay £1-10-0 for the best wrinkle submitted, and for every other item published on this page we will pay half-a-guinea. Turn that idea of yours to account by sending it in to us addressed to the Editor, "PRACTICAL WIRELESS," George Newnes, Ltd., 8-11, Southampton Street, Strand, W.C.2. Put your name and address on every item. Please note that every notion sent in must be original. Mark envelopes "Radio Wrinkles." Do NOT enclose Queries with your Wrinkle.

a short spindle and knob, and a small metal or ebonite coupling sleeve with two grub screws. The parts are assembled, as shown, and the end of the spindle, which passes through a hole in the side of the cabinet, is fitted with a small knob.—P. HILL (Manchester).

A Combined Wave-change and L.T. Switch

THE combined wave-change and L.T. on-off switch shown in the sketch, has proved very successful and was made entirely from material taken from the junk box, with a minimum of tools. The materials required are: ebonite boss 2in. by 1½ in., lead-in tube and rod, condenser vanes, rheostat brackets (2), panel bushes (2), nuts and terminals, and a piece of clock

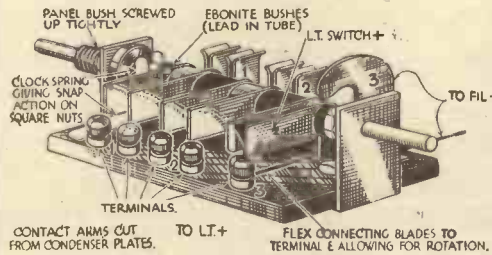

A combined wave-change and L.T. switch.

spring. The illustration shows the construction of the switch clearly, the action being as follows:—

The switch knob turned completely to the left is medium-wave setting, the blades marked 3 being fully engaged. The central position is the long-wave setting, the blades marked 3 being still engaged. When the knob is turned completely to the right, the switch is in the "off" position, the blades marked 3 then being disengaged.

The switch is suitable for two-point switching, and can be constructed for coils requiring three-point switching by adding an extra blade for contacts marked 1 and 2.—S. G. LLOYD (Gosport).

A Dial Magnifier

A CHEAP reading glass can easily be adapted as a dial magnifier, as shown in the accompanying sketch. The metal handle is split and the ends flattened with

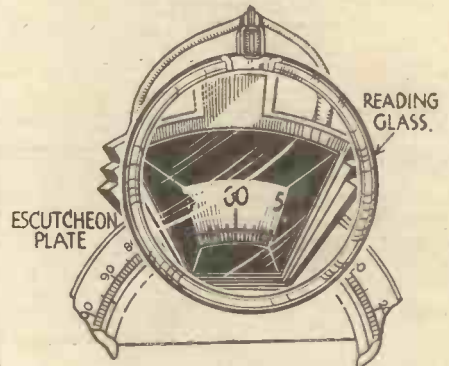

A useful dial magnifier.

a light hammer and bent so that they fit at the back of the escutcheon plate. By means of the hinge usually provided with this type of glass, the magnifier can be raised when not required for use.—F. LAW (Glasgow).

A Novel Needle Indicator

RECENTLY I took to using a pick-up needle that lasted for ten records, but I found it very hard to listen and keep the figure in mind. I therefore constructed the indicator shown in the sketch. Underneath the arm I fitted a catch (as used on shop bells) which was rigid when the tone arm moved on to the record but hung limply on returning. This engaged a ten-toothed wheel, arranged as shown in the sketch and numbered 1 to 10, and when the numeral "10" is indicated, the needle is changed. The indicator is made out of a disc of plywood, with ten small uprights (which engage the catch) glued to it. A little care is necessary to arrange the disc so that the catch engages correctly at each playing.—P. BINGLEY (Esher).

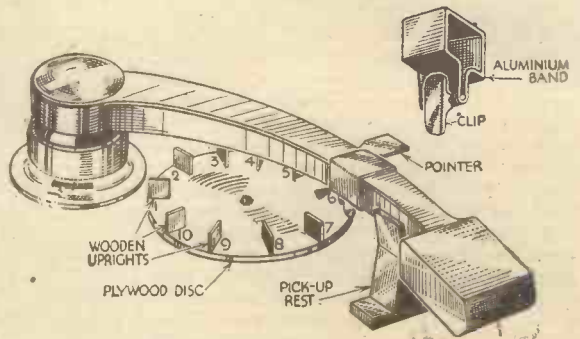

A needle indicator for a radio-gram.

OPERATING A BATTERY SET FROM D.C. MAINS

How to Adapt a Battery Receiver so that Batteries may be Dispensed With.

THESE are still many readers who are not fortunate to have A.C. mains in the house and are compelled to make the best of a battery-operated receiver. But those with D.C. mains available may, for a very small outlay, convert their battery sets to work from the mains, knowing that when a change to A.C. is made, the additional components will be equally suitable.

A comparison of the circuits in Figs. 1 and 2 will show that no alteration to the wiring of the actual receiver is necessary. The alterations commence at the output end with revised loud-speaker arrangements (unless a transformer or choke-capacity output is already incorporated either in the set or with the speaker). A choke-capacity coupled output is illustrated although a transformer would be equally suitable; the object being to isolate the speaker from the high mains voltage.

The only potential remaining to be supplied from a battery is the grid bias.

the total current required by the valve filaments. If it is known that two valves together take 0.25 amp., then a lamp which will pass exactly this current when joined

board holder and wired to be in series with the positive main to the set. The correct choice of lamp resistance is most important as incorrect values may allow excessive filament current to pass through the valves. If the exact lamp resistance is not available use a lower wattage, but never a higher power lamp. For example, if it is calculated that an 80-watt lamp is suitable, two 40-watt lamps may be joined in parallel, but, failing this, a 75-watt lamp would serve the purpose. Most valves specified to work with, say, 0.1 amp., are quite efficient with as little as 0.08 amp.

As this lamp wattage is so important the following table is given covering four possible total current values and the lamp required.

S.G.	Detector	Power	Total	Lamp(s) Required
A—0.15 amp	0.1 amp	0.2 amp	0.4 amp	100 watts or 60, 40 watts.
B—0.15 amp	0.1 amp	0.15 amp	0.35 amp	40, 25, 25 watts
C—	0.1 amp	0.2 amp	0.3 amp	75 watts
D—	0.1 amp	0.15 amp	0.25 amp	60 watts

In case A a three-valve set employing an S.G., detector and a power valve of the P220 or LP2 class is indicated. Some S.G. valves require only 0.1 amp and others 0.2 amp., while a few take 0.18 amp. The exact value should be found from the maker's specification, and the total value of current noted. The lamp wattage should be the one nearest to that calculated. If a 100-watt lamp is not available, a 60 and a 40 watt should be arranged in parallel. Examples B, C, and D cover most of the other possible current values required, and any other arrangement of valves will show current values easily calculated and the lamp wattage determined from the above formula.

As the plate current passed by battery valves is not likely to be very large, the smoothing choke need not be more than

across the mains must be used. If such is the case, a 60-watt lamp designed for 240-volts working is the correct one to use. In making the calculation the formula is

current = $\frac{\text{watts}}{\text{volts}}$, and $\frac{60}{240}$ is $\frac{1}{4}$ or 0.25 amp. The lamp should be mounted in a base-

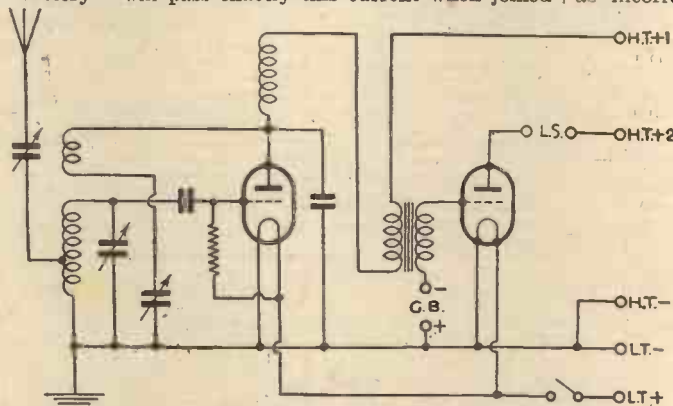

Fig. 1.—Circuit diagram of a 2-valve battery set before conversion.

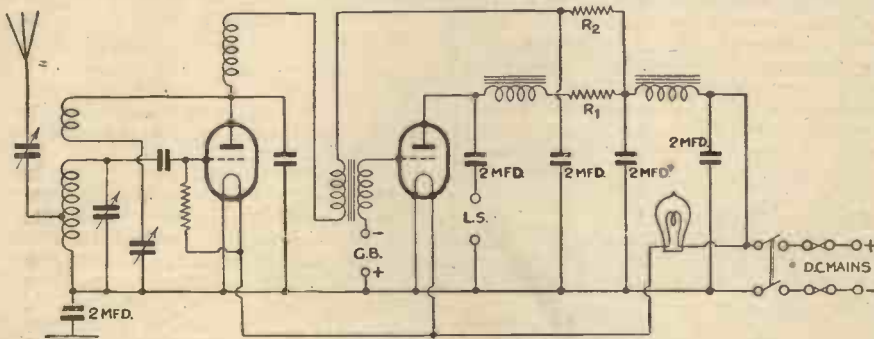

Fig. 2.—Circuit diagram of a 2-valve battery set after conversion.

While this could certainly be arranged, the life of a bias battery is so long that the additional complications are not merited by the indefinite time for which the set may be used before a change is made to all-mains valves. There are no complications in supplying the filament voltage and the H.T. supply is very simply arranged.

Ascertaining the Wattage

The filament current is supplied through an ordinary electric lamp, as this is the most convenient and certain means of securing the correct resistance for "dropping" the mains voltage down to that of the valve filaments. As 2-volt valves are in general use, it will be assumed that we require two volts to heat the filaments. If 4-volt valves are in use, exactly the same lamp values may be taken, as the difference when compared with the mains voltages is very slight. Theoretically we require to drop 240—2 volts across a resistance. Now 238 volts is so nearly the same, in practice, as 240 volts, that our consideration must be

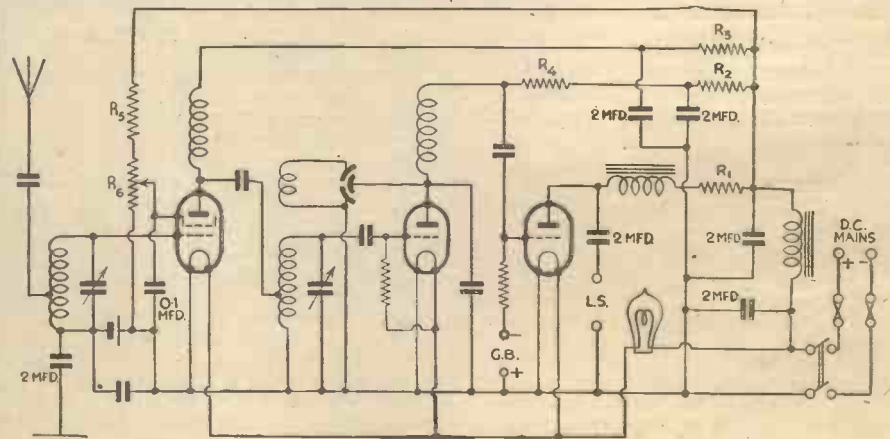

Fig. 3.—Theoretical circuit diagram of an S.G.-3 battery valve set for D.C. mains.

30 henries at up to 30 mA. If it is intended to convert to all-mains valves at a later date, it will be an advantage to have the choke of higher inductance. Both this and the condensers to be used would also be needed in the smoothing arrangements in an all-electric D.C. or A.C. set.

Four 2-mfd. condensers, designed for 240-volts working, will be required for a two-valve circuit, and five if an S.G. Three is to be converted. In the latter case a 0.1 mfd. will be needed from the screen to earth if not already incorporated in the battery circuit. Another 2-mfd. condenser must be used in the choke-capacity output to the speaker as previously mentioned. The condenser in the earth lead is absolutely essential if an earth connection is made to the set, but this is, in many cases, not necessary as one side of the D.C. mains may be earthed at the supply.

Obtaining the Correct H.T.

The plate resistance values will depend entirely upon the type of valves employed. Consider the power valve first so as to determine the value of R1 in Figs. 2 or 3. The maximum permissible voltage to a battery valve must not be more than 150 volts. To be on the safe side we will assume that 140 volts may be applied, hence we must arrange for a drop of 240-140=100 volts across R1. Determine from the valve specification or curves the current passed at maximum volts and the resistance will be calculated from

$$R = \frac{\text{voltage drop}}{\text{valve current}} \times 1,000.$$

A Cossor 215P passes 10 mA. with the grid bias at 7.5 volts. Then

$$R1 = \frac{100}{10} \times 1,000 = 10,000 \text{ ohms. An Osram}$$

P2 passes 19 mA. with grid bias at 10.5 volts.

Then $R1 = \frac{100}{19} \times 1,000 = 5,260$ ohms approximately. In this case a 5,000-ohms resistance may be used as there will be a few volts drop across the output choke which will limit the plate voltage to a safe value.

R2 must be determined in the same manner. Not more than 100 volts are needed for the detector so we must drop 140 volts across R2. For example, an Osram HL2 will pass about 3 mA. at 100 volts as a detector. Then

$$R2 = \frac{140 \times 1,000}{3} = 46,000 \text{ ohms approxi-}$$

mately. In this case R2 may be 50,000 ohms. This applies only to the circuit of Fig. 2. The possible amplification with the higher plate voltage available for the power valve is much greater than with H.T. batteries, hence a trial of resistance coupling may be made. The quality with good volume which results will be a pleasant surprise for many who revert to this method of coupling. The same calculation should be made if para-feed coupling is decided upon.

In the circuit of Fig. 3, make R4 100,000 ohms. If the valve used as detector passes, say, 1 mA., then the total plate resistance should be $\frac{140 \times 1,000}{1} = 140,000$ ohms.

Hence R2 should be 40,000 ohms. If the valve used takes less than 1 mA., then R4 may be increased accordingly.

The plate current passed by the S.G. valve may be about 2 mA., so that R3 in this case should be 50,000 ohms. Incidentally, if this makes the set too sensitive, a higher value of resistance is called for to reduce the S.G. plate voltage. Resistances

R5 and R6 should be 50,000 ohms each, but R6 should be variable so that the best setting of screen voltage may be found by trial. This will also be an aid to control the sensitivity of the set.

The on-off switch should be of the snap-action type as designed for mains operation. As a precaution, fuses limiting the current to 1 amp. should be fitted. The combined fuse and mains plug is a very convenient component for baseboard mounting. When plugging in to the mains, it will be found that the set will only operate with the plug in one position which should be marked for future use. No harm will be done to the set if the mains leads are reversed, and in this connection it may be noted that Dubilier reversible electrolytic 8-mfd. type condensers are suitable for use in the smoothing circuit in place of the 2-mfd. type illustrated.

“THE LAW AND ‘ON APPROVAL’”

Some Legal Advice for the Home Constructor. This Article is Written in Understandable Language.

(Concluded from page 524, July 28th issue)

THE second part of rule (a) provides that the articles become my property and my risk if I do “any other act adopting the transaction.” Briefly, it is mine, and my risk, if I do anything in regard to the article which shows that I have regarded myself as an owner, as opposed to a prospective buyer. In all cases, however, it is a question of fact which has to be decided on the particular facts of the special case under consideration, whether or not what the prospective buyer has done in an act adopting the transaction. It is therefore impossible to lay down any special rule.

The second rule says that the property in the goods (and with it the risk) passes from seller to buyer: (b) “if he (the buyer) does not signify his approval or acceptance to the seller but retains the goods without notice of rejection, then if a time has been fixed for the return of the goods, on the expiration of that time, and if no time has been fixed, on the expiration of a reasonable time. What is a reasonable time is a question of fact.”

From this it will be seen how important it is to take a note of the time within which one has to make up one's mind, and see the goods are returned in the period specified, and in nine cases out of ten it will be found that the sellers provide that goods which are not required have to be returned within so many days. This, of course, is only reasonable and requires no explanation.

As to the second half of the rule (b) the question here is what is a reasonable time, and as the rule says this will have to be decided on the facts of each particular case, obviously one may require a longer time to make a decision with regard to one article than with another.

Lastly it must not be forgotten that the rules provided by the Act are subject to any contrary agreement by the parties and it may be that a firm sending goods on approval will only do so at the risk of the purchaser, and if such is the case, he has to accept them on these terms. Generally, however, one need have no hesitation of receiving goods on approval as, in the ordinary case, the risk of their accidental loss or destruction is not yours until you have done something which would show that you have regarded them as your own property.

Important

Readers please note that the last GIFT TOKEN, No. 4,

(*provided they started collecting from the first announcement of this offer, see below)

for their Presentation

CORONET CAMERA

appears on the back cover of this issue of

“PRACTICAL WIRELESS”

Will readers who are qualifying for this Presentation Camera affix the last Gift Token to their Subscription Voucher; and forward the completed Voucher in accordance with the instructions thereon TO-DAY?

PLEASE DON'T DELAY

There will be an enormous number of cameras to despatch, and it will take some little time to get them all out. All applications will be treated in strict rotation. If you do not receive your camera within 15 days of the despatch of your application—notify by postcard, giving date application was made.

NOTE.—Carefully read instructions on your Subscription Voucher and make sure it is properly filled in before forwarding.

* This will not be your last Gift Token if you did not start collecting until after the first announcement—in which case you continue to collect until you have the necessary four Gift Tokens attached to your Subscription Voucher.

If you have lost any of your Gift Tokens you may send twopence in stamps in lieu of each, and if by chance you have mislaid the Subscription Voucher, you can still obtain your camera by sending four Gift Tokens and a remittance of 4s., with your name and address written plainly on a sheet of paper.

Complete and send in your Subscription Voucher immediately you have affixed the last Gift Token to

“PRACTICAL WIRELESS”

Camera Presentation Department,
22, Tavistock Street,
Covent Garden,
London, W.C.2.

Any query regarding this offer must be accompanied by a stamped addressed envelope for reply.



THE EASY ROAD TO RADIO

THE BEGINNER'S SUPPLEMENT

SWITCHES AND THEIR USE IN RADIO

The Principles Underlying the Design of a Good Switch, and the Correct Type to Use in Various Circuits

ALTHOUGH a switch is simply a device for breaking and making a circuit, there are several principles which have to be considered not only in the design but in the use to which the particular switch is to be put. For instance, in the illustration on the right a number of different types of switch are shown, ranging from a single-pole change-over switch to a quick make-and-break switch of the toggle type. Both will carry out the same ultimate aim, but they are by no means interchangeable. Apart from a study of the purpose for which a switch has to be chosen it is absolutely essential to ascertain the potential which is applied to the leads which are joined to the switch. When the circuit is broken current will cease to flow, but if the applied potential is not removed as the broken ends of the circuit are brought together a distance will be reached (no matter how small) where the current will jump across the remaining gap in order to complete the circuit, and the greater the current the bigger the gap. For this reason for potentials of any appreciable extent a Q.M.B. type of switch must be employed, as the connecting arm jumps from one position to another under the influence of a spring and arcing cannot take place owing to the rapid making and breaking of the circuit. The lower illustrations in the right-hand corner show a switch of this nature in section and in elevation.

High Frequency Circuits

When dealing with high frequency circuits it is essential to take every precaution to prevent the rapidly flowing impulses from taking a quick path to earth, and therefore it is necessary in this case to ensure that the contacts of the switch are either well spaced, or that the intervening space is filled with a very good insulator. The old pattern plug and jack was a good example of this design, and may be seen in the lower left-hand corner of the illustration. It will be seen that the framework of the jack forms one contact, and the small arm at the upper surface is the other contact, layers of insulating material at the end serving to keep them apart.

Filament Circuits

The switch which is employed for switching on and off the filaments of a battery-operated receiver has to be of very good design if noises are to be avoided. The filaments of this type of

receiver heat fairly rapidly, and therefore the moment the circuit is completed the valves will start to emit, and if the connection is immediately broken some slight noise will have been heard in the phones or loud-speaker. Obviously,

therefore, if the contact in the switch is of an intermittent type, noises will be heard and the signal will be interrupted. For this reason a very strong spring is required and cleanliness is absolutely essential. In the illustrations at the upper part of the picture may be seen two typical push-pull switches such as are employed for filament switching, and it is necessary always to make certain that the contacts are clean. By rotating the operating knob a cleaning action will take place, but when the springs become weak, as is evidenced by noises as the knob is turned, a new switch should be obtained.

A Typical Example

All the points enumerated are shown in the circuit diagram in the centre of the illustration where the various switches are shown in theoretical form, and the number at the side of the switch relates to the actual illustration surrounding the circuit.

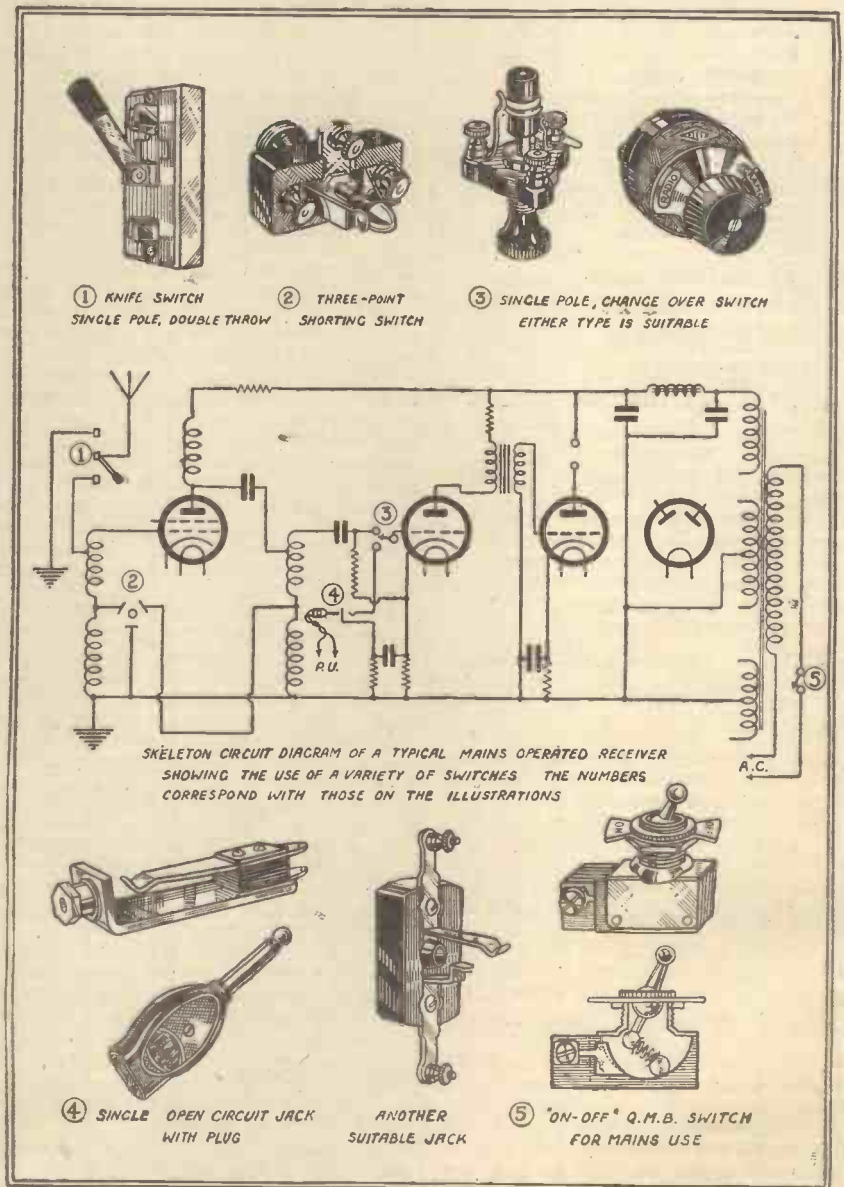

Various types of switches and how they are used in a modern receiver.

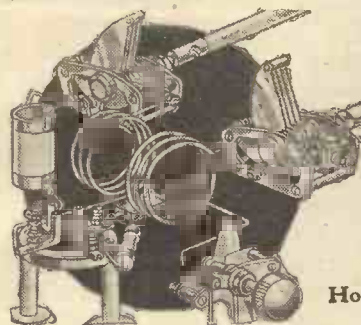

Short Wave Section

REPORTING ON AMATEUR TRANSMISSIONS

How to Inform a Station of Your Reception so as to give Useful Assistance to the Transmitter.

At some time or another every listener on short waves picks up transmissions from amateur stations, either in this country or from abroad, and he is almost certain to want to let the transmitter know that he has been heard, partly with the idea that such reports are useful to the transmitter, and partly to confirm the reception. Such reports may be very useful indeed, but only if they are reasonably detailed and sent with discrimination. In the first place it must be realized that every card acknowledging a report sent out by an amateur transmitter costs money both for postage and printing. Since each contact made is confirmed by card, the amateur will have quite a large postage bill, without any additional expense in acknowledging reports of reception from listeners, and therefore such reports must be of real value if they are to be worth a reply. It therefore behoves the listener to think twice before sending a report, and to use judgment in the matter. There are three points that should be borne in mind. (1) How far off is the transmitter? (2) What is his wavelength? (3) Who is he working?

What Stations to Report

Obviously if the amateur is in the same town as the listener it is very unlikely that a report will be useful, unless it describes some abnormality that might not be noticeable at a greater distance; what is not so obvious is that there are occasions when a transmitter as far away as the United States of America will regard a report from England as too common to be worth answering. One guide to the importance of distance is the wavelength being used. A report on a telephony transmission on 40 metres from a station a hundred miles away is likely to be of little value, but if the same transmission was on 160 metres the report might be quite unusual, since the range of the longer wave is considerably less than that of the short wave, and the power used cannot be more than ten watts, since that is the maximum permitted on 160 metres, although shorter wave stations can, in certain circumstances, obtain permission to use much higher power. But even on 160 metres there is no point in reporting reception to a station who was, at the time the listener heard him, in actual contact with a transmitter in the same neighbourhood as the receiver, because he already knows what strength he is in that region. There is, however, one other factor which may modify all that I have said, and that is the time of day, although this will mostly affect the longer wave stations; on 160 metres at midday even so short a range as 40 miles might be quite good DX and one would therefore be justified in reporting such a reception; so, too, on 80 metres a broad daylight range of 200 miles would be unusual—at any rate on low power. It is

rash to generalize, but one might sum up the foregoing in this way; do not send a report to a 160-metre telephony station who is nearer than about 100 miles off, except in daytime; do not send a report to an 80-metre station in England at all except in daytime; do not send a report to a 40-metre station in Europe at all, or to a 20-metre station nearer than the U.S.A., and then not if he is working an Englishman. In any case a listener should not send a report to stations working with a station in his own locality, or in his own country if they are on 20 metres, unless it seems that the reception is exceptional.

Morse Signals

All the above has been written with telephony transmissions in mind, but it applies with much greater force to continuous wave morse transmissions; the range obtainable with C.W. is immensely greater than on telephony and consequently reports are even less likely to be useful. In fact, it is probably inadvisable to send an unsolicited report on a morse transmission to anyone except perhaps a station in the extreme West of the U.S.A., or Japan, China, or the West Coast of South America; in certain circumstances reports might be sent to South Africa, Australia, and New Zealand, but only experience can show to whom in these countries reports would be useful. Certain New Zealand stations, for example, work British stations daily on schedule; clearly a report of reception in this country will mean little to them. The restrictions apply chiefly to the 40- and 20-metre bands; on 160 metres even C.W. stations would welcome a report from a point 400 or 500 miles away, and although 80 metres is quite a good DX band, many stations operating in it on the East coast of the U.S.A. would find a report from Europe of considerable interest.

There are, however, certain cases when none of the foregoing holds good. The most obvious is when a station is heard actually asking for reports from listeners over the air, or when a similar request has appeared in the radio press; to such by all means report. Lastly, it is pretty safe to report reception of a station heard either on 10 or 5 metres; little is known about these waves, and often quite local reports are valuable.

What to Say

Having now obtained some idea of which stations are likely to appreciate reports, we must discuss what details shall be included in a report, for it is utterly useless to send a card which merely announces that "I heard your speech transmission quite loudly last Sunday." The transmitter wants to know at what time on Sunday, how loudly, on what wavelength, and whether the quality was good or not. The first thing, therefore, to note is the date and exact time, stating whether it is

British Summer Time (B.S.T.) or Greenwich Mean Time (G.M.T.). Then should come the signal strength, in terms of the so-called R code, which is as follows:—

- R1 Faint signals, only just audible and quite unreadable.
- R2 Weak signals, barely readable.
- R3 Weak signals, but can be read when atmospheric and interference permit.
- R4 Fair signals, readable easily.
- R5 Moderately strong signals.
- R6 Good signals.
- R7 Strong signals, readable through atmospheric and interference.
- R8 Very strong signals, audible several feet from the headphones.
- R9 Loud-speaker signals.

The accuracy of a report given in this code cannot be great, but there is sufficient consistency between the individual opinions of good operators as to what constitutes a certain R strength to make it workable. In addition to the R strength there is the QSA readability code; this attempts to define the readability of a transmission as distinct from the audibility or loudness. A moment's thought will show that the two terms are not necessarily interchangeable; one may have a R8 signal that is so badly jammed and is of such bad quality that it is only 60 per cent. readable, whereas a good-quality R3 signal that is free from interference is 100 per cent. readable. The QSA code is:—

- QSA 1 Hardly perceptible; unreadable.
- QSA 2 Weak; readable now and then.
- QSA 3 Fairly good; readable with difficulty.
- QSA 4 Good readable signals.
- QSA 5 Very good; perfectly readable.

Having settled the signal strength and readability, the next thing that requires comment, if the transmission is in telephony, is the speech quality; and in this connection there are several points to notice. Quality is a self-explanatory term; good quality speech is a good reproduction of the human voice; bad quality may sound as if the speaker was gargling! Before condemning any failing in a transmission the listener must make quite sure that the distortion is not due to his own receiver being on the verge of oscillation, or to a heterodyne with a neighbouring transmitter. If it is decided that the transmission is bad, an attempt should be made to explain the cause. Does speech blast, due either to an overloaded microphone or amplifier? Is there too much hum in the carrier wave due to improperly-filtered H.T. supply? Is there a bad cut-off of either upper or lower notes? In connection with this last point it must be remembered that few amateurs aim to retain the extreme top of the scale, but tend to cut off at about 3,000 cycles; this still permits the speech transmitted to be perfectly intelligible, and at the same time considerably reduced interference with neighbouring stations, an important consideration in the restricted amateur bands of wavelengths.

Depth of Modulation

The next thing to report on in a speech transmission is the amount of modulation. This is measured in terms of the ratio of the amplitude of the low-frequency speech current to the amplitude of the high-frequency carrier wave, the ratio being multiplied by a hundred and expressed as a percentage. Thus, if the L.F. current amplitude is the same as the carrier the

transmission will be 100 per cent. modulated; if the ratio is less than one the percentage modulation is less than 100, while a ratio greater than one gives more than 100 per cent., but in this case the transmission will be very bad quality and practically unintelligible, blasting horribly. It is only possible to estimate the percentage modulation at the receiving end, but a good guess may be made by comparing the strength of the carrier wave (heard when the receiver oscillates) with the strength of the actual speech; the higher the percentage modulation up to 100 per cent. the less difference between the two and the louder will be the actual speech. Most ordinary broadcasting stations on the medium-wave band use quite a low percentage of modulation, about 30 to 40, but for amateur work an effort is generally made to get near to the 100 per cent. mark. After a little experience, quite a close estimate of the modulation percentage can be made.

That covers the requirements of a report on speech transmissions; when the transmission has been in continuous wave morse a less elaborate report is possible. In this case, the chief point to notice is the quality of the note, whether it is a pure whistle or is partly modulated by ripple in the H.T. supply, or whether it is very rough owing to the use of unrectified A.C. for H.T.; it is important, also, to note how steady the emitted wave is and whether it is free from "chirps" on keying. In order to facilitate such reports the T code has been devised as below:—

- T1 Poor 25 or 50 cycle A.C. tone.
- T2 Rough 50 cycle A.C. tone.
- T3 Poor, rectified A.C. tone; not filtered.
- T4 Fair, rectified A.C. tone; small filter.
- T5 Nearly D.C. tone; good filter but with key clicks, chirp, etc.
- T6 Nearly D.C. tone; very good filter; keying O.K.
- T7 Pure D.C., but with key clicks, chirp, etc.
- T8 Pure D.C.; not quite as good as T9.
- T9 Best, steady crystal-controlled D.C. tone.

With either speech or morse transmissions mention should be made of fading, if any was noticed, giving the maximum and minimum signal strengths, and of any unsteadiness in the transmitted wave, although in the latter case the listener must be certain that the unsteadiness is not in his own receiver or due to a swinging aerial. Two imaginary reports will serve as examples to illustrate my remarks:—

- (a) To radio G5EF; your 160-metre speech transmission was heard here QSA5 at 11.35 B.S.T. on 13th August, 1933, calling test. Modulation about 70 per cent. Quality very good.
- (b) To radio W7PQR; your 40-metre C.W. signals were heard here QSA3 R3 fading to R2 at 04.30 G.M.T. on 13th August, 1933, calling W6STU. Note T8.

Insufficiently detailed reports sent out indiscriminately are only a nuisance to the recipients and will often go unacknowledged; listeners who send such reports should therefore not condemn all amateur transmitters as an ill-mannered crowd because they get no answer to their cards, but rather should try to make their reports really useful, along the lines suggested above, when they may expect an entirely satisfying number of QSL cards in reply.



ANOTHER fine medley record by Charlie Kunz appears among the August releases of the British Homophone Company. This record, *The "Kunz" Medley—No. 7, parts 1 and 2*, introduces seven of the best loved melodies—old and new—in *If you were the only girl in the world—When Irish eyes are smiling—Beautiful garden of roses—Three o'clock in the morning—I ain't got nobody—If I had you and Time on my hands*. The number of this disc is *Sterno 1453* and it is certainly a fine pianoforte solo. Whilst on this type of record you should certainly hear Adelaide Newman playing *Automne* and *Danse Creole* on *Sterno 1463*. These two beautiful Chaminade numbers receive a perfectly masterly rendition at the hands of this great pianist. The Casani Club Orchestra, directed by Charlie Kunz, record some very fine numbers this month in *Little man, you've had a busy day* and *The beat o' my heart* on *Sterno-1454*, and *Lazim' and Memories of hours spent with you* on *Sterno 1455*. The orchestra give beautifully colourful renderings of these four charming dance tunes and are well worth hearing.

The Masterkeys run the whole gamut in their records this month. The dreaminess of *A place in your heart* and *Moon Country* on *Sterno 1457*, to the sparkling rhythm of *Hot Choc'late Soldier* and *I ain't lazy—I'm just dreaming*, on *Sterno 1458*, adds yet more laurels to their past successes.

The Grosvenor House band, directed by Sydney Lipton, are also in the above Company's lists for this month on *Sterno 1456*. They play two popular tunes in *Goodnight, lovely little lady* and *May I, both tunes being from the film "We're not Dressing."*

Light Music

Tangos played by Mantovani's Orchestra are always worth listening to, and this month they give a splendid performance on *Sterno 1459*. *Tangolita* and *Amargura* are two fine tangos, full of the seductiveness of Southern Europe, and the orchestra give a perfect recording.

Reginald King and his Orchestra, whose appearance in the above Company's lists are all too few, plays a pair of delightful tunes this month in *One life, one love* and *The Frolicsome Hare*, on *Sterno 1461*. The prowess of the conductor as a pianist is particularly brilliant in the *Frolicsome Hare*. Undoubtedly this is a fine double-sided disc.

Poem d'Amour and *Caliph of Bagdad*, played by Joseph Lewis and his Orchestra, on *Sterno 5019*, is another particularly fine record. The first tune is one of the world-renowned waltzes of that master of the ballroom—Strauss, and the other an overture—all too seldom played. Joseph Lewis and his Orchestra have never done anything better.

NOTES AND NOTIONS

Literary Tours

A SHORT series of Literary Tours in the Midlands, in which various parts of the region will be portrayed through scenes in fiction and passages from poetry, will begin with Nottingham district on August 9th. The programme will include Alan-a-Dale's wedding ride from the Robin Hood ballad literature, the journey to the Hemlock Stone in D. H. Lawrence's "Sons and Lovers," Maggie Tulliver's boating trip down Trent in "The Mill on the Floss" (George Eliot), Childe Harold's departure from Newstead (Byron), scenes from James Prior's work "Forest Folk," and Inigo Jollifant's Nottingham experiences from "The Good Companions" (J. B. Priestley). It will be given by different voices, with musical interludes and effects, and produced by Owen Reed, who was recently appointed assistant for special programmes in the Midlands.

Bank Holiday Entertainment

"COSTER CARNIVAL," the Bank Holiday reminiscence written and arranged by Cyril Nash, which is to be broadcast in the National programme on August 6th, is to be a show in the real Bank Holiday spirit. Two or three artists

have yet to be chosen for principal parts; but names of members of the cast already booked give promise of a lively hour's entertainment. They include Eric Lugg, Ivan Samson, Eric Anderson, Laurie Lane, Pascoe Thornton, Ray Wallace, Maurice Soutter, and Bertha Willmott, with Cyril Nash, the author, and Ernest Shannon. Other Bank Holiday programmes, which will be given from the Midland Regional, include two outside broadcasts of interest. First comes a relay from the De Montfort Gardens, Leicester, of the Kitsilano Boys' Band, which arrived in this country in the middle of July for a six weeks' tour.

A Useful Hint

It is often desirable to reduce the G.B. voltage as the high-tension battery runs down. This is because the G.B. and H.T. voltages should bear a definite relationship to each other, and consequently, as the latter falls the former should be adjusted to correspond. If this is not done, the quality will suffer and the great drop in volume level might lead one to suspect that the high-tension battery is completely exhausted, whereas it is probably good for several more weeks' use.

Practical Television

SUPPLEMENT TO PRACTICAL WIRELESS

AUGUST 4th, 1934. Vol. 1. No. 31.

VARIED SCANNING METHODS

By H. J. Barton Chapple, Wh. Sch., B.Sc., A.M.I.E.E.

HAVING occasion to carry out some television investigations recently in connection with different methods of scanning, I was both intrigued and impressed with the large number of schemes which have been proposed and actually tried. Many of these lend themselves to experiments which can be carried out readily by readers of these notes, and the following brief details will act as a

intervals in its length as indicated in Fig. 4. By "stepping" these apertures it is possible to scan completely the area required, this idea being applicable specially to receivers using a flat plate neon lamp.

Mirror Devices

Coming now to scanning methods whereby the source of modulated light is actually reflected on to a viewing screen (back

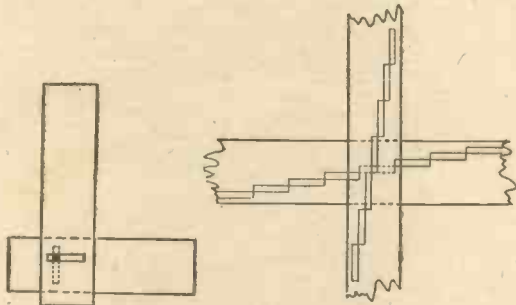

Fig. 1.—Using two oscillating bars with overlapping slots.

Fig. 2.—Continuously moving endless bands with stepped slots.

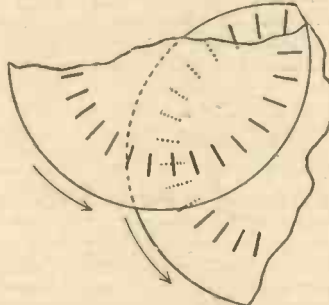

Fig. 3.—Scanning with two discs having radial slits moving at right angles to one another.

basis for this work. Many of the ideas are applicable to an image dissection exceeding the present thirty-line service, but several were abandoned owing to the difficulty of synchronizing. With the increased knowledge now available on this side of the science, however, there is no outstanding reason why some of the ideas should not find favour once more.

First of all, it must be remembered that there is both a vertical and horizontal analysis, and with the present B.B.C. service this can be regarded as the primary and secondary synthesis respectively. With horizontal scanning these primary and secondary analyses are reversed, but in either case the frequencies of the repetitive action are different.

In Fig. 1 is shown a very simple arrangement consisting of two oscillating bars or members having narrow slots at right angles to one another. According to the rates of motion of these bars, so the square shaded area will move over the scene to be analysed in a definite manner. If an oscillatory motion is difficult to reproduce, then the idea can be modified to that of Fig. 2, where two continuously moving endless bands, having slots cut as shown, are moved across one another at right angles.

Yet another arrangement is two discs having radial slits as shown in Fig. 3. The two discs are so mounted that the slit movement in one disc is at right angles to the slit movement in the other, although the direction of rotation of the two discs are the same. At any one instant two of the slits overlap leaving a small area of "observation." Then, again, there is the continuously moving endless band with small square apertures set at regular

projection is nearly always used here), the mirror-drum component is an outstanding and popular example. Several other devices can be used, however, and amongst these there is shown in Fig. 5 a method for employing an oscillating mirror. The

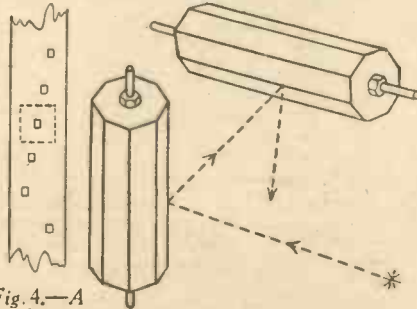

Fig. 4.—A single continuously moving band with stepped square apertures.

Fig. 7.—Employing two polyhedron mirrors rotating on axes at right angles to one another.

mirror is pivoted about its centre axis in bearings having the minimum friction, and at one end is fixed a light spring anchored to a rigid support. At the other end can be mounted any device which will produce

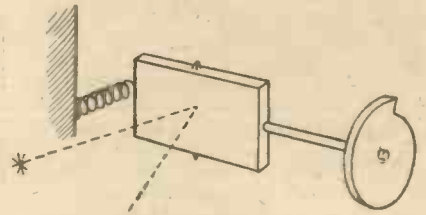

Fig. 5.—Using a pivoted oscillating mirror.

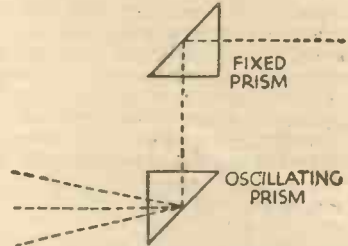

Fig. 6.—Two totally reflecting prisms are used here to give the light beam movement.

an oscillatory motion, but one of the most convenient is a rotating cam. By this means a rocking motion is given to the mirror, and if a modulated beam of light is focused on to this the reflected ray will be moved to and fro continuously over a fixed line. By arranging for this "moving ray" to pass to a second oscillating mirror to swing it at right angles to its original motion, then a complete scanning area will be swept out by these primary and secondary motions.

Cases arise where two totally reflecting prisms can be employed to give the light beam motion. An arrangement of this character is indicated in Fig. 6. Here the top prism is stationary while the lower prism is rocked through a small angle by a cam device (not shown). As in the case of Fig. 5 a duplicate of this scheme is necessary in order to provide the double motion essential for a complete analysis. If preferred, polyhedron mirrors can be mounted so that they rotate on axes at right angles to one another as shown in Fig. 7. When a beam of modulated light is focused on to one of these rotary devices, the ray is reflected as a line on to the second set of mirrors, and finally thrown on to a screen at the front.

As an outstanding example of scanning methods having no actual moving parts in the sense of those just described, the cathode-ray tube can be cited. Speaking generally, the diagram of Fig. 8 gives the essentials for the standard tube, although it is known that in many television schemes using cathode-ray tubes at the receiving end, the electrode assembly is modified considerably to make it specially suitable for the production of the best television images. First of all, there is the cathode or filament acting as the source of electrons

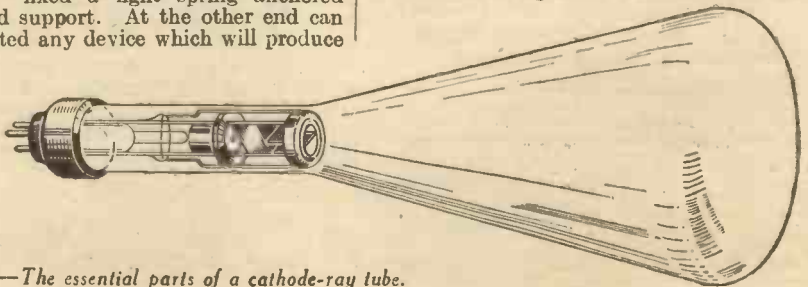

Fig. 8.—The essential parts of a cathode-ray tube.

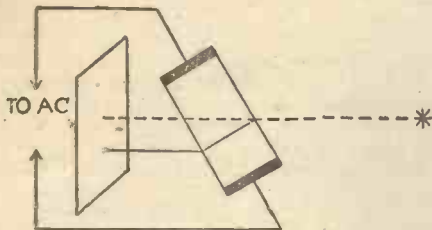

Fig. 9.—Altering the refractive index of a fluid to produce beam motion.

or cathode rays. Surrounding this is a shield or cylinder (known generally as the Wehnelt cylinder) whose function is to modulate the electron beam, and which is given an initial negative bias for focusing purposes. Next in order is the anode—a circular plate with a very small orifice at its centre. This is furnished with a high

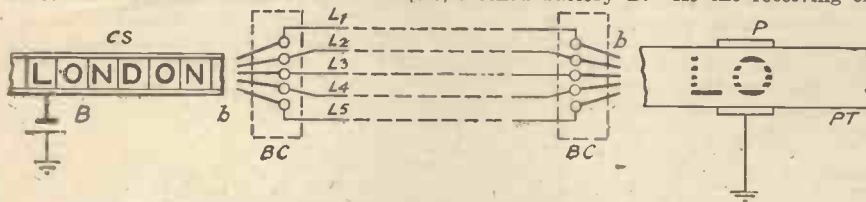

Fig. 10.—Illustrating simply the principles of Bain's early telegraphic apparatus.

positive potential in order to accelerate the electrons towards the front screen.

Last of all in the electrode assembly are the two pairs of "condenser" plates which serve to deflect the beam from its normal straight path. By varying the frequency, phase, and form of the voltages applied to these distinct pairs of plates almost any desired motion can be imparted to the beam. After passing the plates the beam finally impinges on the front portion of the belled out tube, this plate or screen being coated with a fluorescent material, that is, a substance which glows brightly at the area struck by the end of the electron beam.

The cathode-ray tube has certainly passed through many vicissitudes since its use for television was first suggested by Campbell Swinton and Boris Rosing simultaneously, but with high definition working it has many points in its favour. Is there any future application, however, to a scanning method with no moving parts proposed by an inventor named Skapy? His method is shown in simple form in Fig. 9, and consisted of a glass vessel having parallel walls and filled with nitro-benzine. The two end plates of this vessel were connected to an alternating source of voltage. With the variations in electrical pressure the refractive index of the fluid alters in a proportional manner. If a beam of light is therefore focused on to the glass vessel these external changes cause it to move over a screen placed in its path. Two of these devices suitably arranged with respect to one another, one excited from a high-frequency source of voltage and a second from a low-frequency source of voltage, can be made to produce the desired primary and secondary television motions.

HOW OLD IS TELEVISION?

THE other day I came across an article purporting to deal with the subject of television in which the writer recalled the feat achieved in 1930, when some black ink smeared on a card was viewed from a distance of 20,000 miles

through the medium of television. This was hailed as being effected on the eighty-seventh birthday of television, and on looking further into the matter it was discovered that the first man to achieve television was given as Alexander Bain, in the year 1843. This scientist sent designs or words by means of an electro-chemical telegraph, and brief details of the apparatus are furnished in Fig. 10.

A Chemical Process

The message to be transmitted was set up with metallic type in a compositor's composing stick. Five metallic brushes connected to as many line wires were mounted in a brush carriage, BC, and the composing stick with its type was drawn past these at a regular speed, so that the brushes swept over the faces of the type, currents being sent over the line from an earthed battery B. At the receiving end

the lines terminated on a similar set of brushes, which were made to bear on a paper tape, PT, drawn regularly over a metallic platform, P, also connected to earth. The tape, which had previously been soaked in a solution of six parts of water, one part sulphuric acid, and two parts of a saturated

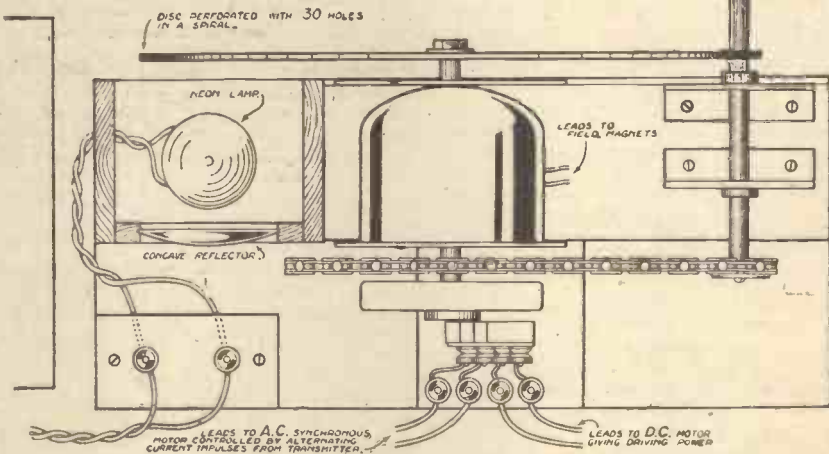

Fig. 11.—A plan view of the original receiving equipment used by Baird for his first demonstration in 1926.

solution of yellow prussiate of potash, permitted the line current to pass through it to earth and a discolouration took place when this occurred. The receiver thus produced a more or less faithful copy of the matter at the originating end.

This was a remarkable achievement, but without in any way detracting from this early work of Bain, surely this process must be regarded as the forerunner of tele-photo or facsimile transmissions? The real interpretation of true television is the reproduction of sight at a distance, and by its aid it is possible to see people or events at the instant they take place.

The writer of the original article had undoubtedly fallen a victim to mixed definitions, and readers of "Practical Television" need hardly be reminded that true television was not accomplished until January, 1926, when Baird gave a demon-

stration to members of the Royal Institution.

In this connection interest is added to Fig. 11, which shows a diagrammatic plan view of the receiving apparatus used by the inventor, the actual equipment itself being housed in the Science Museum, South Kensington. Although crude and cumbersome, it still bears a very close resemblance to present-day disc receivers, and shows that thirty-line images were shown even eight years ago.

ROUND THE WORLD OF WIRELESS.

(Continued from page 542)

British Transformers for the Belgian State Railways

IT is interesting to note that the radio equipments on the Surprise Trains of the Belgian State railways have been fitted with Ferranti audio-transformers. These trains run on Sundays in the most picturesque parts of Belgium, the itinerary being unknown to the passengers. The trains are composed of restaurant cars, and loud-speakers are fitted all along the

cars, providing music and explaining all that is seen along the track: castles, villages, war sites, and other interesting places.

Light Entertainment from the Midland Regional

DURING the week light entertainment includes the Midland Mischief-makers from a studio, and a concert party relay from Leamington, both on August 9. The Mischief-makers' programme has been devised by Richard Spencer to follow the layout of a newspaper, each of the features being "hit off." Stuart Vinden and Dorothy Summers are assisting the Mischief-makers, who are a Wolverhampton combination, for this occasion. The Leamington relay is the first Midland broadcast of "Holiday Fair," presented by K.M. Productions.

Facts and Figures

Components Tested in our Laboratory

BY THE PRACTICAL WIRELESS TECHNICAL STAFF

Radio Exhibition

WITH the approach of the Radio Exhibition at Olympia, many component manufacturers are introducing special new lines. Information is already to hand concerning many of these components, and amongst the descriptions on this page will be found some details relative to these new lines. We would consequently remind readers that some little difficulty may be experienced in obtaining these items from their local suppliers, owing to the fact that full supplies are not yet available, and therefore, unless the items are urgently required, their orders should be postponed until the exhibition is well under way. In the case of an urgent order, the manufacturers themselves should be approached.

Morse Practice Accessories

A VERY large number of our readers are desirous of attaining proficiency in Morse sending and receiving, and many letters received by our queries department are in connection with the purchase of such apparatus. Messrs. Leslie Dixon and Co., of Electradix House, 218 Upper Thames Street, E.C.4, have now printed a special Morse Key List which will appeal especially to readers who desire to have some idea of the prices of this class of apparatus. The list shows keys ranging in price from 4s. 6d. to 30s. For the smaller sum the key is of the "model" practice type. That is to say, it consists of a small moulded base with a stout rocker arm and small moulded knob, with terminals for connection at the rear edge. The Morse code is embossed on the base. For 5s. 6d. a Lucas model is obtainable, and this has a balanced key, tungsten contacts and bakelite panel, the whole firmly mounted on a metal base which may be screwed to a table. To protect the gap a cast aluminium cover is obtainable for 9d. extra. Other models are obtainable at 6s. 6d., 7s., 7s. 6d., 8s. 6d. and 21s., whilst the most expensive model (30s.), of which only a few models are left in stock, consists of the G.P.O. Type A. This has eight platinum double-arm 4-contact points, with side send-receive switch, brass and bevel glass cover and ebonite and teak base. An instrument of this nature is made to sell at a much higher figure than Messrs. Dixon are charging and, therefore, those who are interested should not hesitate to obtain one whilst stocks are available.

Bulgin All-Valve Testing Unit

TO test satisfactorily all types of valve now on the market a most elaborate type of adaptor would appear to be necessary. For instance, we have four-pin, five-pin, seven-pin, eight-pin and probably nine-pin bases to valves, and the arrangement of these pins does not permit of the

building of a single holder into which any type of valve could be plugged to obtain voltages of the correct type at the proper electrodes. Messrs. Bulgin, who have for some time made various types of adaptor, have, however, satisfactorily solved this problem and the finished tester is known as the All-valve Testing Unit, and a photograph of the complete unit is shown on this page. A special base is provided with a nine-way cable and connecting plug, and the valveholder is used in conjunction with the adaptors shown in the group. Every connection in this useful assembly is "split" and thus enables any type of voltage or current reading to be obtained with a minimum of trouble and under exact operating conditions, a point which is of the utmost importance.



The new Bulgin All-Valve Testing Unit, with Adaptors

W/B Stentorian Speaker

AT last year's Radio Exhibition we were agreeably surprised by the strides made in loud-speaker design by the Whiteley Electrical Radio Company, and their Microlode speaker created intense interest. This year Messrs. Whiteley have progressed even more and their new speaker will no doubt be again a source of much interest and discussion at the forthcoming exhibition. As may be seen from the illustration on this page, the design differs from previous ideas, the stand being made much more robust whilst still retaining the microlode selector principle. An entirely new magnetic alloy is responsible for the modification in design, and this gives nearly double the strength of previous magnetic systems at the same cost of material. The chief advantage of this new magnet strength is, of course, increased sensitivity, and when one is enabled to obtain a really powerful magnetic field one can arrange all other matters accordingly and thus obtain better attack, greater signal output and improved response over the entire frequency range. Obviously, too, the air-gap may be increased without detrimental effect, and thus a different type of speech coil may be fitted to the cone, the greater

power of such a speech coil permitting of an increased size of the diaphragm. All these features will be found in the new Stentorian speaker, which costs 42s. for the Senior model, 32s. 6d. for the Standard model, and 22s. 6d. for the Baby model. A full test report will be published at a later date.

A Timber Demand

WHILE we all know to-day that the wireless industry is one of the biggest industries of the country, only a few have any conception of the vast quantities of material which go to make up the receiving sets manufactured each year. Consider for a moment the timber used for the making of cabinets. One firm, the G.E.C., requires a daily supply of approximately 3,250 square feet of timber for this purpose alone. This figure means that a very large number of trees have to be felled, lopped, sawn and prepared for making cabinets in this company's extensive works at Coventry in the course of a year. Quite a small forest, in fact!

Dubiliers' Fire

THE Dubilier Condenser Co. (1925) Ltd., inform us that the outbreak of fire which recently occurred was confined to a portion of the laboratory at Acton, and fortunately as the result of prompt action by the night staff the damage was not extensive, and therefore production will carry on as usual.

"Choosing Components" —Please Note

On page 509 of our issue dated July 21st we showed a sketch of a wireless receiver of the table type which had been drawn by our artist to illustrate a point regarding the choice of a complete receiver. Messrs. Shalless & Evans have pointed out to us that our illustration bears a striking resemblance to one of their well-known receivers. We

wish, therefore, to point out to our readers that no reflection was intended to be cast upon either the cabinet or the components of the receivers manufactured by Messrs. Shalless & Evans, whose products are noted for high-class workmanship and design and are in every way perfectly satisfactory.



The W/B Stentorian Senior Speaker.

PRACTICAL LETTERS FROM READERS

The Editor does not necessarily agree with opinions expressed by his correspondents. All letters must be accompanied by the name and address of the sender (not necessarily for publication).

Progress in Component Design

SIR,—As a keen wireless constructor and experimenter, I view with some apprehension the new types of valve holder and valve bases which have recently been introduced. I have no doubt that they are very efficient, as well as being in many ways convenient to use, but what am I to do if I wish to experiment with some of the new valves in one of my existing receivers? I can see no way of making easy comparisons between the valves at present in use and the new ones which I should very much like to try out.

Surely the new holders must act as a deterrent to many constructors who would like to modernize their receivers during the coming autumn and winter. Besides this, I am by no means convinced that the holders and bases previously employed left very much to be desired, and I seriously wonder if the new types can justify their existence.

The only real point which I can see in favour of the new valves is that the grid, instead of the anode, is taken out to the terminal cap on top of the glass envelope, but why could not this modification have been applied to the plug-and-socket valve bases, so that advantage could have been taken of the feature without the necessity for very largely re-building the set?

Whilst on the subject of progress (?) in component design, I should like to ask why there are still so few manufacturers who supply "stripped" components for home constructors. Such parts can be made far more cheaply, and they would do much to further encourage the making of receivers at home. These "stripped" parts are essential if the home-built set is to compare in price with the ready-made commercial article.—F. JONES (Llandudno).

Television Systems

SIR,—I gather that a conference was called some little time ago to consider the question of future television programmes, but I am still waiting to learn what decision (if any) was made. Now that there are so many television systems which are supposedly very good in their various ways, it is only fair that they should each be given a chance to demonstrate their superiority, but I do think that it would be still more fair to the looker-in if the present 30-line disc system could be continued, if only as a subsidiary to one of the others.

All those amateurs, like myself, who have gone to the expense of buying or building a disc machine would be loth to scrap the present—and expensive—apparatus only to spend a further considerable sum on a new, and possibly less effective, piece of apparatus. In addition to this, I am quite sure that the possibilities of the present system have been by no means fully exploited. May we therefore hope that the B.B.C. will continue to give us at least two programmes a week on the present system.—B. TIMMS (Petworth).

"Local Experts," Please Notice

SIR,—In two articles published in a recent issue of PRACTICAL WIRELESS

mention is made of the "Local expert," and of his being called in to do some job, "probably for nothing." I have had this pointed out to me, and these phrases have also appeared in other papers. I want to ask you if you think it is fair that there should be so many of these experts, many of whom have decent jobs in another calling altogether, and that they should poach, as it were, upon the bread and butter of men who lay themselves out, and spend a lot of money on instruments, tools, etc., to be of service to the general public. I make this appeal to the goodness of these "experts" on behalf of all service men. We don't mind in the least a man looking after his own set, but we don't like this poaching of our legitimate jobs.—A SERVICE MAN (North Shields).

Yankee Dialect

SIR,—With reference to the discussion about the "Yankee dialect," when I was in the States there were three places in which this was objectionable—New York, Chicago, and Los Angeles! In all the rest of the States that I saw, quite a few, the accent was rather subdued and rather pleasant! It was certainly no more objectionable than the English "Blah! Blah," referred to. Personally, however, I do object to being asked, over the radio, if I am litherish between verses in opera. (I am not highbrow!) American broadcasting is too intimate, the B.B.C. too formal. However, there are faults on both sides. I have had every number of your excellent

CUT THIS OUT EACH WEEK.

Do you know

—THAT the Universal valves are fitted with two different types of valve-base—one of which has 8 pins and the other 5.

—THAT radio-gram switching cannot satisfactorily be arranged in a diode circuit.

—THAT the mixing circuit of a superhet receiver may be arranged in the grid, anode, or cathode circuits, as well as within the valve itself.

—THAT the electrodes of a valve are chemically cleaned before being inserted into the glass bulb, and all handling is carried out with rubber gloves to avoid grease, etc.

—THAT wave-change switching is very inadvisable in a short-wave receiver unless very careful design is introduced.

—THAT two loud-speakers of different types will enable a balanced type of reproduction to be obtained.

—THAT for the above arrangement the speakers should be chosen so that one is responsive to high notes and the other to low notes.

The Editor will be pleased to consider articles of a practical nature suitable for publication in PRACTICAL WIRELESS. Such articles should be written on one side of the paper only, and should contain the name and address of the sender. Whilst the Editor does not hold himself responsible for manuscripts, every effort will be made to return them if a stamped and addressed envelope is enclosed. All correspondence intended for the Editor should be addressed: The Editor, PRACTICAL WIRELESS, Geo. Newman, Ltd., 8-11, Southampton Street, Strand, W.C.2.

Owing to the rapid progress in the design of wireless apparatus and to our efforts to keep our readers in touch with the latest developments, we give no warranty that apparatus described in our columns is not the subject of letters patent.

paper since No. 1, and I shall continue to do so. I have made one of your D.C. sets, and it is admired for its marvellous tone.—WALTER M. BUCHANAN (Glasgow).

The Future of Home Construction

SIR,—Having been very keenly interested in wireless for more than twelve years, both as an enthusiastic home constructor and as a transmitter, I deplore the fact that serious home construction appears to be on the wane. I believe that a few years ago there were as many home-built as factory-produced receivers, whereas to-day I am afraid that the proportion of home-made sets is getting less. Why should this be so? The home-constructor is in a far better position than the purchaser of a ready-made set, firstly because he can always modify his receiver to take full advantage of every new development, and secondly because he can effect a considerable saving by modernizing his receiver.

One of the reasons for the decline in home-construction is that there are still many component manufacturers who charge too much for their components, and because these same manufacturers are reluctant to supply "stripped" parts of the kind used by the makers of commercial receivers. There is another reason, which is that home-construction has been simplified to so great an extent that it offers very little scope to the mechanically-minded person who likes to create things. All that the present-day constructor (?) has to do is to assemble a series of parts and connect them together by means of lengths of wire which are, very often, marked or cut to length ready for use. This work leaves little scope for ingenuity and compares unfavourably with the real constructional work with which the enthusiastic amateurs of some ten years ago had to contend.—B. J. S. (Leeds).

[Our correspondent bases his arguments on a false premise. There is no decline in interest in home construction. The constructor has, perhaps, not made so many sets this year as formerly—the chief reason probably being the rapidity with which new developments have been thrust upon him. He has thought, with some justification, that what is new to-day may be out of date in a few weeks. Fortunately, design is now stabilizing.—ED.]

Is Crystal Reception Dead?

SIR,—As a wireless experimenter since the early days of broadcasting, and a reader of PRACTICAL WIRELESS since the first issue, I have noticed that no mention is ever made in your paper of crystal reception. Surely there must be a number of readers who, like myself, would welcome an article occasionally on the possibilities of crystal receivers with present-day high-power broadcasting. In the early days wonderful results were obtainable with a two-valve and crystal reflex set, and there appears to be no reason why equally good results should not be obtainable at the present time, provided that a selective tuning arrangement is used. A periodic tuning, using three basket coils loosely coupled, used to be sufficient for the purpose in the days of 2LO. It would be interesting to know what other readers think on the subject.—R. DAVEY (Watford).

[Our reader apparently overlooks the fact that a simple two-valve receiver of to-day is infinitely superior to any two-valve-and-crystal-reflex circuit which was ever used. We do not think that there is any practical use for the crystal detector to-day, and that is why we have refrained from giving articles on this subject.—ED.]

HOW MUCH H.F.

An Interesting Explanation of Stage Gain and How It May Usefully be

PRACTICALLY all modern receivers employ at least one amplifying stage before the detector. Every listener knows that the object of such a stage is to "boost up" the signals received by the aerial, and, by thus bringing weak and distant signals up to workable strength, to increase the range of the receiver. It is a fair question to ask "What can I expect from a stage of high frequency amplification?" and also "How much high frequency amplification should I use in my set?"

The answers to these queries cannot be given in a single plain statement; they require a certain amount of explanation. The effective degree of amplification, usually called the "stage gain," achieved in any amplifier depends upon two things—the valve and the coupling. Of two valves, that having the larger amplification will give the greater stage-gain, provided both are operated under the most suitable conditions.

Inter-valve Coupling

A complete explanation of how the inter-valve coupling affects the stage gain would require mathematical treatment, and it must suffice to say that the coupling must be considered as a load of high impedance in the anode circuit of the valve, and that the stage gain depends upon the relation between the impedance of the coupling and the impedance of the valve. Within certain practical limits, the higher the load impedance the larger the stage gain. Actually, the stage gain can be calculated from the formula:—Stage gain = Amplification factor of valve $\frac{Re}{Ri + Re}$ where Re = the impedance of the external load, and Ri = the valve impedance.

The curves shown in the graph have been plotted from figures derived from this formula and show the stage gains obtainable with various typical high-frequency valves over a range of load impedance. Some idea of the stage gains to be expected can be gauged from the fact that to-day a tuned coupling having an impedance of 50,000 ohms would be considered poor, and that an impedance of 100,000 ohms is easily obtainable with average components. A very good radio-frequency coupling might have an impedance as high as 250,000 ohms, and this figure is also easily obtained with high-class I.F. transformers in super-het circuits. On the whole, however, it is better to be conservative and to consider that load impedances of between 100,000 and 250,000 ohms represent the limits which the average constructor may hope to achieve.

Referring once more to the graph, it will be observed that with ordinary battery-operated screen-grid valves, a stage gain of between 100 and 200 may be expected; with a mains screen-grid valve, a gain of between 150 and 250, and with the latest mains H.F. pentodes, a gain of between 200 and 550.

The Load Impedance

It will further be noted that the curves for an ordinary screen-grid valve tend to

flatten, which means that the impedances over some 200,000 ohms give very little increase in output. In fact, that in actual practice there can be gained by improving the coupling coils above this mark when using screen-grid valves.

On the other hand, the curve for the H.F. pentode shows a consistent upward trend, which means that valves of this type take full advantage of any and every improvement in coil design.

Having obtained some idea of the stage gains likely to be achieved by high-frequency amplifiers of different types, it now remains to translate these figures into terms of practical performance. To begin

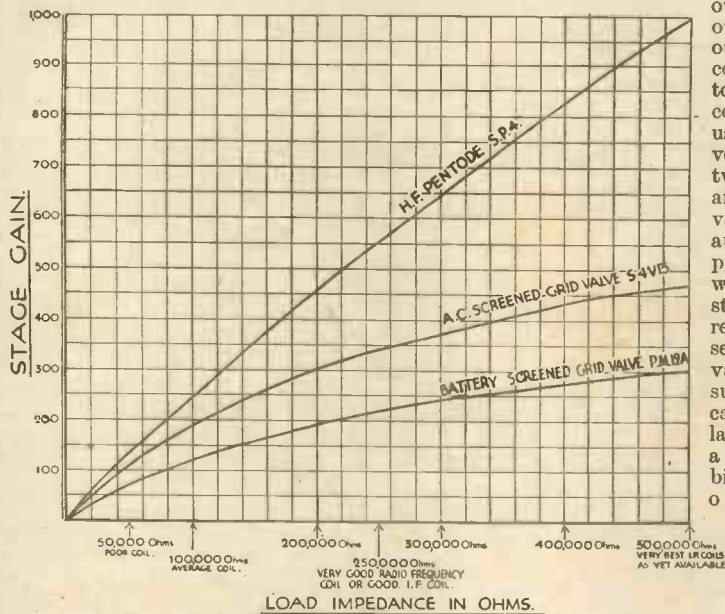

Graph showing relation between stage gain and load impedance for various types of H.F. valves.

with, it is worth remembering that the minimum requirements for satisfactory reception is an output of about 50 milliwatts of audio frequency power with a 30 per cent. modulated signal. With a simple battery set, employing only detector and output pentode, this minimum output can only be obtained from signals having a minimum field strength at the point of reception of about 6,000 micro-volts per metre. But by the use of radio-frequency amplification, stations whose field strengths at the point of reception are much less than the latter figure are easily receivable. For example, if only one H.F. stage were added to a simple detector-pentode battery-operated combination, and assuming a stage gain of 100, which should be easily obtained by the use of a good high-frequency coupling, field strengths of only 60 micro-volts per metre (6,000 divided by 100) should yield satisfactory reception.

Signal Field Strength

With two such radio-frequency stages it would appear that signals of field strengths down to a fraction of a micro-volt per metre

...the ... however, that when employing such a high degree of amplification, it is not usually advisable to employ small pentodes in the output stage if good quality is to be maintained,

owing to the risk of overloading the output valve, with consequent distortion. It is, of course, possible to use some form of volume control between the detector and the output valve to reduce the audio-frequency input to the pentode when powerful stations are being received; or a less sensitive output valve such as a super-power type can be used in the last stage, for such a valve can handle bigger inputs without introducing distortion. With this arrangement, however, the overall sensitivity of the set is reduced somewhat, and, while giving all

that is required from strong signals, the less powerful programmes may not be satisfactorily received.

Variable Sensitivity

A better plan, therefore, is to retain the pentode output valve, and to use multi-mu valves in the high-frequency stages, the gain of which can then be controlled by applying variable grid-bias, so that the valves, while operating at maximum sensitivity for the reception of weak stations, can be made less sensitive to strong signals. This arrangement not only makes it possible to avoid overloading the detector and output stages, but also provides a means of obviating distortion due to overloading the H.F. valves themselves.

With mains-operated equipment the question of overloading becomes even more acute owing to the higher sensitivity of mains S.G. valves and H.F. pentodes, as indicated in the graph.

By a process of working backwards from the audio-frequency grid input voltage necessary to obtain comfortable volume from, say, a mains pentode, it can

(Continued overleaf)

WIRELESS

(previous page)
 e-valve A.C. mains pentode, a triode output stage by a pentode output stage reception with out 200 micro-volts, strengths down to per metre with a good with two S.G. pentodes stages, or a good would give reasonable strengths of only a few per metre, assuming an efficient

It may be of interest to state what is the average field strength of the various types of interference likely to be encountered by the listener. In the country, remote from towns and machinery, the average interference due to atmospherics and the like is of the order of 1 or 2 micro-volts per metre, although, of course, this figure will be greatly exceeded during thundery weather.

In the neighbourhood of towns, the general level of noise rises up to some 10 micro-volts per metre, while in bad cases, in the vicinity of electric lifts, sign flashers and other intermittent machinery, the interference level may rise to as much as 50 micro-volts per metre, or even more, while very near interfering machinery may give rise to a noise level of thousands of micro-volts per metre, which may even drown the local station.

For reasonably pleasurable reception, the programme level must be at least 4 or 5 times greater than the noise level, so that, for country listeners, it is little use to try to receive stations whose field strength is much below 5 to 10 micro-volts per metre, while in towns the minimum receivable signal strength is of the order of 100 micro-volts per metre.

Interference Ratio

The words "reasonable volume" in the previous sentence have been printed in italics advisedly, for, sad to tell, these very weak signals will not be receivable with any amount of pleasure in actual practice. The reason is that the amount of external interference will be so great as to drown the weak signals, or at any rate to spoil their programme value entirely. For the sensitive receiver will amplify the interference just as efficiently as it amplifies the signals.



The man who can analyse these curves and understand what they indicate knows his job. But if they do not convey to him perfectly definite information, it would appear that he needs more training than he has had. He is not competent to fill a responsible position in wireless.

Radio has developed so rapidly throughout the last ten years that it has now greatly outgrown the supply of technically qualified men required for the better posts. Moreover, it continues to develop with such speed that only by knowing the basic principles can pace be kept with it.

The I.C.S. Radio Courses cover every phase of radio work. Our instruction includes American broadcasting as well as British wireless practice. It is a modern education, covering every department of the industry.

OUR COURSES

Included in the I.C.S. range are Courses dealing with the Installing of radio sets and, in particular, with their Servicing, which to-day intimately concerns every wireless dealer and his employees. The Operating Course is vital to mastery of operating and transmitting.

There is also a Course for the Wireless Salesman. This, in addition to inculcating the art of salesmanship, provides that knowledge which enables the salesman to hold his own with the most technical of his customers.

We will be pleased to send you details of any or all of these subjects. Just fill in, and post the coupon, or write in any other way, stating which branch of Wireless interests you—the information you require will be forwarded at once.

International Correspondence Schools, Ltd.,
 Dept. 94, International Buildings,
 Kingsway, London, W.C.2.

Without cost, or obligation, please send me full information about the Courses I have marked X

- COMPLETE RADIO
- RADIO SERVICING
- RADIO EQUIPMENT
- RADIO SERVICING AND SALESMANSHIP
- WIRELESS ENGINEERING
- WIRELESS OPERATORS

Name.....Age.....

Address.....

RADIO CLUBS AND SOCIETIES

Club Reports should not exceed 200 words in length and should be received First Post each Monday morning for publication in the following week's issue.

SLADE RADIO

It was a "Members' Night" at the last meeting of this Society, and as usual there were a large number of questions to be answered, one of the members telegraphing his from a seaside resort. The first question, "Are American valves more efficient and durable than English?" was debated at some length. A number of other questions were then raised and generally debated, the most interesting of them proving to be one concerning developments necessary in wireless receivers in the near future. This brought forward quite a number of suggestions, some of which were of a very interesting nature.

On Sunday, July 15th, three parties from the Society took part in a D.F. test organized by the Rugby club

in conjunction with the Kettering and Leicester clubs, and secured second, third and fifth places out of seven to reach the transmitter. The event proved to be very satisfactory, and a party of about sixty met at the tea and discussed their experiences.—Hon. Sec., 110, Hillaries Road, Gravelley Hill, Birmingham.

INTERNATIONAL SHORT-WAVE CLUB (EXETER CHAPTER)

A special meeting of this club was held in the Y.M.C.A. rooms, High Street, at 8 p.m. on Friday, July 13th. Mr. A. E. Bear, the European representative of the club, who was the guest for the evening, gave a very interesting talk on the aims and objects of the I.S.W.C., and also some sound advice to those who are just starting in the "DX" field. A general discussion followed, and among the topics discussed were sun spots, and the effects of the weather on short-wave radio reception. Many members submitted interesting views on the last-named subject. Further meetings of the Exeter Chapter will be held at the Y.M.C.A. rooms on the second and fourth Fridays of each month at 8 p.m. All readers of PRACTICAL WIRELESS are welcomed.—Hon. Sec., William W. Warner, 56, East Grove Road, St. Leonard's, Exeter.

CATALOGUES RECEIVED

To save readers trouble, we undertake to send on catalogues of any of our advertisers. Merely state, on a postcard, the names of the firms from whom you require catalogues, and address it to "Catalogue," PRACTICAL WIRELESS, Geo. Newnes, Ltd., 8/11, Southampton St., Strand, London, W.C.2. Where advertisers make a charge, or require postage, this should be enclosed with applications for catalogues. No other correspondence whatsoever should be enclosed.

OSBORN RADIO CABINETS

A FINE range of radio cabinets of modern design is displayed in a booklet just issued by Chas. A. Osborn. In addition to table models there are several new designs of radiogram cabinets, some in beautifully figured walnut and others in polished oak. A special line listed comprises radiogram converters consisting of special cabinets capable of accommodating any type of radio receiver and any type of gramophone motor, either electric or spring driven. One of these cabinets has a clock mounted in the top part, and is provided with a storage space for records. Most of the cabinets listed are obtainable as kits of parts ready to assemble, either polished or unpolished. Home constructors looking for high-class cabinets in which to house their sets should obtain a copy of this useful booklet.

MULLARD H.F. PENTODES

LISTENERS contemplating the use of screened (H.F.) pentodes in their next receiver should obtain a copy of a new Mullard leaflet on these valves which has just been issued. The special properties of the screened pentode are fully described, and are followed by full operating data and characteristics, with curves of the two Mullard types—V.P.4 and S.P.4—and practical operating hints for using these valves in modern circuits.

WEARITE COMPONENTS

FOR over fourteen years the firm of "Wearite" has been recognized by expert designers and amateur constructors as makers of wireless components of the highest class. In a well-illustrated booklet, just issued, a full range of "Wearite" components in accordance with the latest practice is described, including "Nucleon" iron-core coils for "straight" circuits, H.F. chokes, "Class B" and Q.P.P. components, and a new smooth-contact potentiometer for volume control, and other purposes. There are also mains transformers, and a useful range of handy and efficient switches for receiving sets and radiograms. Some of the components are fitted with a new type of terminal nut which can be tightened or loosened with fingers, pliers, screwdriver, or spanner. Other components listed are a "Nucleon" iron-core I.F. transformer, Paxolin formers and panels, valve-holders, and frame aeralars. Copies of the booklet can be obtained for threepence from Wright and Wearite, Ltd., 740, High Road, Tottenham, London, N.17.

WATMEL VOLUME CONTROLS

A USEFUL range of variable resistances and potentiometers is given in a list recently issued by Watmel Wireless Coy., Ltd. Wire-wound potentiometers of 5-watt rating suitable for voltage regulation of H.T. supply, screened grid control, etc., are listed, and also a totally enclosed potentiometer with composition element. Two new components consist of totally enclosed metal-cased wire-wound potentiometers, which are obtainable in any values up to 15,000 ohms. One is fitted with a snap-action switch, rated to carry 3 amps at 250 volts. Various types of dual potentiometers, and a new heavy-duty variable resistance are also listed. The latter component, which is specially designed for the control of motors for television and for laboratory use, has the elements wound on two slates, and variation of resistance is obtained by rotation of a contact slider which spans the two resistance formers. Readers contemplating the fitting of an efficient volume control to their sets are advised to write for a copy of this list.

LET OUR TECHNICAL STAFF SOLVE YOUR PROBLEMS

REPLIES TO



If a postal reply is desired, a stamped addressed envelope must be enclosed. Every query and drawing which is sent must bear the name and address of the sender. Send your queries to the Editor, PRACTICAL WIRELESS, Geo. Newnes, Ltd., 8-11, Southampton St., Strand, London, W.C.2.

QUERIES and ENQUIRIES by Our Technical Staff

The coupon on Page iii of cover must be attached to every query

SPECIAL NOTE.

We wish to draw the reader's attention to the fact that the Queries Service is intended only for the solution of problems or difficulties arising from the construction of receivers described in our pages, from articles appearing in our pages, or on general wireless matters. We regret that we cannot, for obvious reasons—

- (1) Supply circuit diagrams of complete multi-valve receivers.
- (2) Suggest alterations or modifications of receivers described in our contemporaries.
- (3) Suggest alterations or modifications to commercial receivers.
- (4) Answer queries over the telephone.

Please note also that all sketches and drawings which are sent to us should bear the name and address of the sender.

Pick-up Volume

"I have a screen-grid three 1930 model battery receiver and a pick-up. I have connected one lead of the pick-up to the grid of V2 and the other lead to 1½-volt grid bias, but the result is very soft with the volume control in the maximum position. Can you tell me why?"—G. T. (West Croydon).

It is quite possible that the output from your pick-up is not sufficient to give you more volume than you are at present getting, although with two L.F. stages there should be sufficient to give comfortable volume. Provided that there is no other component in the grid circuit of the valve to which the pick-up is joined, we can only assume that the valves or coupling components are defective, and a thorough examination is necessary. Make quite certain, however, that there is no other component in the grid circuit as there would quite conceivably exist a short-circuit across the pick-up which would account for the lack of volume.

Making a Piezo-Electric Speaker

"Could you please tell me if it is possible for me to make a piezo-electric loud-speaker? If not, could I buy one? I want it fairly sensitive, and to cover a frequency of about 3,500 cycles to 10,000 or 11,000 cycles."—J. P. (Kilburn).

We do not think you could make a really satisfactory job of a speaker of the type you mention. We would advise you to get into touch with Messrs. Rothermel, of 1A, Willesden Lane, N.W.6, and they may

be able to furnish you with details of speaker movements of the type in question at a reasonable price.

Making I.F. Transformers

"During the latter end of last year you described how to make screened coils. I now wish to make some I.F. transformers for 126 kc/s. How many turns must I wind on 1in. formers, using 36 S.W.G. D.S.C.? For trimming I wish to use .0001 mfd. pre-sets."—H. T. (Bramley).

The actual method of construction should follow that described in the issue in question, and you should use 400 to 450 turns for each winding (primary and secondary).

DATA SHEET No. 90.

Cut this out each week and paste it in a Notebook.

SOLDERING FLUXES.

Material to be Soldered.	Flux to be Used.
Brass	Chloride of zinc, sal-ammoniac, or resin.
Copper	Chloride of zinc, resin, or sal-ammoniac.
Iron	Chloride of zinc, borax, or sal-ammoniac.
Lead (with fine solder)	Tallow and resin.
Lead (with coarse solder)	Tallow.
Pewter	Resin with sweet oil.
Steel	Chloride of zinc, borax, or sal-ammoniac.
Tin	Resin with sweet oil.
Tinned iron	Resin or chloride of zinc.
Zinc (new)	Chloride of zinc.
Zinc (old)	Hydrochloric acid.

When soldering wireless connections non-corrosive fluxes must be employed. In addition to the above fluxes, any of the well-known proprietary preparations may, of course, be used.

Soldering Problem

"I have not been long at the wireless experimenting hobby, and have just recently tried soldering. I find great difficulty in carrying out a clean joint like you see in shop-made sets. I either get a large blob of metal all rough in shape, or else I get a dirty black and greasy mess which won't hold the wire at all. What is the actual secret of getting a little shiny joint?"—T. Y. (Brighton).

Apart from cleanliness the only point is the iron temperature. This may be gauged by holding the iron a few inches from your face. Each time you try the iron, note the distance you hold it, and eventually you will be able to judge almost exactly the correct temperature. The place to be joined must be perfectly clean, and this may be carried out either with a small

file or a sharp penknife. Use the smallest quantity of flux, and also wipe the iron on a piece of emery before applying the solder. You should then find that a small blob of solder will adhere to the end of the iron and when this is placed on the joint it will run off and make a very neat job. Remember the two essentials—cleanliness and temperature.

Metallized Chassis

"I have made up the 'Orbit,' but it does not seem to work correctly. I could not get the metallized wooden chassis, so made one from wood and covered it on both sides with copper foil. I am not certain, however, whether this is correct, or whether only the top should be covered. Can you please explain this point?"—L. S. (Bromley).

Only the upper surface of the chassis is metallized. If you have connected a metal sheet to the underside you will find that the mounting bracket will be connected to earth and thus will be short-circuiting some of the components which are used on the underside, as well as connecting the spindle of the reaction condenser to earth.

Improving the Earth

"I have recently overhauled my aerial and earth, and have found that the earth in my particular case is very dry. I believe this is responsible for the poor results I have been getting lately. I want to improve this part of my equipment and have found that I can get a lot of sweepings from a small workshop nearby where the contents of the rubbish box consist of brass and steel filings, etc. Would it be a good idea to bury a lot of this stuff round the earth plate?"—T. V. F. (Birmingham).

The idea is good up to a point. The presence of the metal will increase the area only if there is connection between all the pieces, and if your earth is naturally dry and the metal is mixed with soil it is obvious that the particles will be isolated. If you can mix with the material some hygroscopic salts, such as sodium theosulphite, rock salt, etc., you will improve the efficiency of the arrangement. Apparently your principal consideration is moisture.

THE QUERIES COUPON APPEARS ON PAGE iii OF COVER

ANOTHER AMAZING ADVANCE



Miscellaneous Advertisements

Advertisements are accepted for these columns at the rate of 3d. per word prepaid—minimum charge 3/- per paragraph—and must reach this office not later than Tuesday for the following week's issue. Radio Components advertised at below list price do not carry manufacturers' guarantee. All communications should be addressed to the Advertisement Manager, "Practical Wireless," 8, Southampton Street, Strand, London.

PREMIER SUPPLY STORES

Offer the Following Manufacturers' Surplus New Goods at a Fraction of the Original Cost; all goods guaranteed perfect, carriage paid over 5/-, under 5/- postage 6d. extra, I.F.S. and abroad, carriage extra. Orders under 5/- cannot be sent C.O.D. PLEASE SEND FOR ILLUSTRATED CATALOGUE POST FREE.

STUPENDOUS Purchase of Set Manufacturers' Stock. Allelectric 3 Valve (S.G. Det. Pen.) Set in Walnut Cabinet with moving-coil speaker 200-250 volt 40-60 cycles. Chassis built. 200-2,000 metres with 4 valves, £4/10/6.

SPECIAL Offer of P.M. and Energised M.C. Speakers. Purchased from well-known gramophone co.

TYPE 10971G. 9in. diameter, 115 ohm field, 120/200 m.a. with power output transformer. Handles 4 watts, 17/6.

TYPE 10971C. 9in. diameter; 2,000 ohm field, 40/70 m.a., Pentode transformer. Handles 4 watts, 17/6.

TYPE 10055E. 9in. diameter, 11,650 ohm field, 20/30 m.a., auditorium type power transformer. Handles 10 watts, 30/-.

TYPE 10055H. 9in. diameter, 115 ohm field, 350/400 m.a., auditorium type Pentode transformer. Handles 10 watts, 30/-.

TYPE 4480. 9in. diameter, permanent magnet. Handles 4 watts, 7 ohms speech coil, 13/6. Multi-ratio transformer, 4/6 extra.

PREMIER SUPPLY STORES announce the Purchase of the Complete Stock of a World Famous Continental Valve Manufacturer; all the following standard mains types, fully guaranteed, 4/6 each, H., H.L., L. power. High, Medium, Low magnification and Variable-Mu Screen Grid. Directly heated Pentodes, 1 watt, 3 watt and 4 watt A.C. outputs. 250v. 60 milliamp, full wave rectifier.

THE Following Type, 5/6 each: 350 v. and 500 v., 120 milliamp full wave rectifiers, 2½ watt indirectly heated pentode.

THE Following American Types at 4/6; 250, 227, 112, 171, 210, 245, 26, 47, 46, 24, 35, 51, 58, 55.

ELIMINATOR Kits, including transformer, choke, Westinghouse metal rectifier, T.C.C. condensers, resistances and diagram, 120v., 20 m.a., 20/-; trickle charger 8/- extra; 150v., 30 milliamps, with 4v., 2-4 amps. C.T., L.T., 25/-; trickle charger 6/6 extra; 250v., 60 milliamps with 4v., 3-5 amps, C.T., L.T., 30/-; 300v. 60 m.a. with 4 volts, 3-5 amps, 37/6; 200v. 100 milliamps, 39/6.

PREMIER chokes, 40 milliamps, 25 hys., 4/-; 65 milliamps, 30 hys., 5/6; 150 milliamps, 30 hys., 10/6; 60 milliamps, 80 hys., 2,500 ohms, 5/6; 25 milliamps, 20 hys., 2/0.

ALL Premier Guaranteed Mains Transformers have Engraved Terminal Strips, with terminal connections, input 200-250v., 40-100 cycles, all windings paper interleaved.

PREMIER H.T.7 Transformer, output 185v. 80 m.a. for voltage doubling, 8/6; 4v. 3-4a., C.T. L.T. 2/- extra; with Westinghouse rectifier giving 200v. 30 m.a., 17/6.

PREMIER H.T.8 and 9 Transformers, 250v., 60 m.a., and 300v. 60 m.a. rectified, with 4v. 3-5a. and 4v. 1-2a. C.T. L.T. and screened primary, 10/-; with Westinghouse rectifier, 18/6.

PREMIER H.T. 10 Transformer, 200v. 100 m.a., rectified with 4v. 3-5a., and 4v. 1-2a. C.T. L.T., and screened primary, 10/-; with Westinghouse rectifier, 19/6.

PREMIER Mains Transformer, output 250-0-250v. 60 m.a., 4v. 3-5 a., 4v. 2-3a., 4v. 1-2a. (all C.T.) with screened primary, 10/-.

PREMIER Auto Transformers, 100-110/200-250v. or vice versa, 100-watt, 10/-.

L.T. Transformers, 4v. 3-5a., 22v. 1a., 8/6 each; 10v. 3a., 14v. 4a., 10/- each.

WESTERN ELECTRIC Mains Transformers, 300-0-300v. 65 m.a., 4v. 1-2a., 4v. 2-3a., 6/6; 500-0-500v. 150 m.a., 4v. 3-5a., 4v. 2-3a., 4v. 2-3a., 4v. 1a. C.T., 4v. 1a. C.T., 19/6; 1,000-0-1,000v. 250 m.a. 4v. 3a. C.T., 4v. 3a. C.T., 49/6; 2,000-0-2,000 150 milliamps, 49/6.

SPECIAL Offer of Mains Transformers, manufactured by Phillips, input 100-120v. or 200-250v., output 180-0-180 volts 40 m.a., 4v. 1 amp., 4v. 3 amps., 4/6; 200-0-200v., 4v. 1a., 4v. 3a., 4/6.

PREMIER L.T. Charger Kits, consisting of Premier transformer and Westinghouse rectifier, input 200-250v., A.C., output 8v. ½ amp., 14/6; 8v. 1 amp., 17/6; 15v. 1 amp., 19/-; 6v. 2 amp., 27/6; 30v. 1 amp., 37/6; 2v. ½ amp., 11/-.

T.H. Trusped Induction Type (A.C. only) Electric Gramophone Motors. 100-250v.; 30/- complete.

SPECIAL Offer B.T.H. Gramophone Motors, A.C. and D.C., 100/250v., 30/-. Listed £3/3/-.

(Continued at top of column three)

1000 RADIO BARGAINS
3d. Stamps only
Secures the Greatest Surplus Lists published in the Radio Industry. THE RADIO "GOLD-MINE" at 3d. is the greatest investment you can make. Send to-day (Dept. C.22)
LONDON EAST CENTRAL TRADING CO.
23, BARTHOLOMEW CLOSE E.C.1. TEL. NAT. 7475



HOME CHARGING!

Charge your own accumulators at home. This is simple and interesting. Just connect your accumulators to a Heayberd Charger and plug into the mains—in a short time they will be fully charged.

MODEL AO2 Charges 2, 4, or 6v. accumulators at ½ amp. **PRICE 35/-.**
MODEL AO3 Charges 2, 6, or 12v. accumulators at 1 amp. **PRICE 50/-.**
Larger models or Kits of Parts for building your own Charger also supplied.

Cut out this ad. and send with 3d. in stamps for 40 pp. booklet describing these Home Battery Chargers.

F. C. HEAYBERD & CO.,
10, FINSBURY STREET, LONDON, E.C.2.

There are many GOOD valves but
NONE BETTER THAN 362
Post Free Dept W. Trade Dept W.T.
362 RADIO VALVE CO. LTD.
STONEHAM RD., LONDON E.5.

H.T. THAT LASTS YEARS
"Extremely satisfactory service for 12 months on 6 valves."—R.N.W., Portsmouth. Install a Standard Wet Battery. Cheap annual replenishment. Saves pounds. 120-v. 12,500 m.a. £2, carr. paid. All Standard H.T. Spares.—Write: Wet H.T. Battery Co., 26, Lisle St., London, W.C.2. Any voltage supplied.

A Guide to Modern Homes in London and the Home Counties

House ownership—the purchase by hundreds of thousands of couples of the homes they occupy—is one of the strongest and most heartening characteristics of the times. "Where to Live" will serve as both a guide and friend in helping you to make a choice with which you will always remain satisfied. Descriptions are given of the districts and best housing estates, also details of transport facilities, season ticket rates and the general amenities of the particular place concerned.

WHERE TO LIVE

Obtainable at all newsagents and bookstalls, or by post 7d. from George Newnes, Ltd., 8-11 Southampton Street, Strand, W.C.2. 6D

(Continued from foot of column one)

COLLARO Gramo. Unit consisting of A.C. motor, 200-250v. high quality pick-up and volume control, 49/-; without volume control, 46/-.

DISON Bell Double Spring Gramophone Motors, complete with turn-table and all fittings, a really sound job, 15/-.

SPECIAL Offer of Wire Wound Resistances, 4 watts, any value up to 50,000 ohms, 1/-; 8 watts, any value up to 15,000 ohms, 1/6; 15 watts, any value up to 50,000 ohms, 2/-; 25 watts, any value up to 50,000 ohms, 2/6.

WIRE Wound Potentiometers, 15,000 ohms, 1/6; 50,000 ohms, 2/-; 500,000 ohms, 3/-; 1,000 ohms wire-wound semi-variable resistances, carry 150m.a., 2/-.

CENTRALAB Potentiometers, 50,000, ½ meg. any value, 2/-; 200 ohms, wire wound, 1/-.

POLAR Star, manufacturers' model, 3-gang condensers, fully screened, 7/6; with trimmers.

AMERICAN Triple Gang 0.0005 Condensers, with trimmers, 4/11; Utility Bakelite 2-gang 0.0005 screened with unknob trimmer, 3/6; Polar Bakelite condensers, complete with knob, 0.00015, 0.00035, 0.0003, 0.0005, 1/-.

ORMOND Condensers, 0.0005 2-gang semi-shielded, 2/6; brass vans, with trimmers, 3/6. British Radiophone 110 kc/s Intermediate, 3/-.

MAGNAVOX D.C. 152, 2,500 ohms, 17/6; D.C. 154, 2,500 ohms, 12/6; D.C. 152 magna, 2,500 ohms, 37/6, all complete with humbucking coils; please state whether power or Pentode required; A.C. conversion kit for above types, 10/-; Magnavox P.M. 7in. cone, 18/6.

RELIABLE Canned Coils with Circuit, accurately matched, dual range, 3/- per coil; ditto, iron-cored, 3/6.

RELIABLE Intervalve Transformers, 2/-; multi ratio output transformers, 4/6.

HELLESEN 8 mf. Electrolytic Condensers, 435 volts working, 2/3; Mershon ditto, 1/9.

POLAR 2-gang Uniknob Condenser with Trimmers and complete Slow motion Dial, 6/-.

WESTERN ELECTRIC Condensers, 250v. working, 2 mf., 1/-.

T.C.C. Electrolytic Condensers, 550v. working, 650v. peak, 8 mf., 4/-; 4 mf. or 8 mf. 440v. working, 3/-; 15 mf. 50v. working, 1/-; 25v. working, 25 mf., 1/3; 6 mf. 50v. working and 2 mf. 100v. working, 6d.

T.C.C. Condensers, 250v. working, 2 mf., 1/9; 2 mf., 1500v. working, 0/-.

H.M.V. Condensers, 400v. working, 4x4x1x1x1x1x1x0.1x0.1x0.1x0.1x0.1, 4/9; 4x2x1x1x1x0.5, 3/9.

DUBILIER Condensers, 8 or 4 mfd. dry electrolytic 450v. working, 3/-.

VARLEY Constant square Peak Coils, hand-pass type BP7, brand new in maker's cartons with instructions and diagrams, 2/4.

VARLEY H.F. Intervalve Coils, BP8, hand pass complete with instructions in original cartons, 2/6.

SCREENED H.F. Chokes by One of the Largest Manufacturers in the Country, 1/9.

PREMIER British-made Meters, moving irons, flush mounting, accurate, 0-10, 0-15, 0-100, 0-250 m.a., 0-1, 0-5 amps. all at 6/-.

LARGE Selection of Pedestal, table and radio-gram cabinets, by best manufacturers, at a fraction of original cost, for callers.

THE Following Lines 6d. Each, or 5/- per dozen.—Chassis valve holders, 5-, 6-, or 7-pin, screened screengrid leads, any value 1-watt wire end resistances, wire end condensers, 0.0001 to 0.1, Eulgin 3-amp-main switches. Cydon capacitors, double trimmers.

PREMIER SUPPLY STORES
20-22, High St., Clapham, S.W.4. Telephone: Macaulay 2188. Nearest Station, Clapham North Underground.

ALL goods advertised in last week's issue still available.

WARD, 2nd floor, 45, Farringdon Street, London, E.C.4. Telephone, Holborn 9703.

VARLEY Constant Square Peak Hand-Pass Coils, type B.P. 5. Complete, all accessories and instructions. New, boxed, 2/4. (List, 15/-)

POLAR 3-gang Star Minor Condenser, full screened, trimmers, new, 7/- (List, 18/9).

ERICSSON 3-1 L.F. Transformers, new and guaranteed, 2/3. (List, 17/6).

COLLARO Electric Gramo Motor A.O. 100-250v. with pick-up and volume control. Auto Start and Stop. Brand new. List price, £4. Our price, 47/6 carr. paid. Bankrupt set maker's stock.

VOLUME Controls, 50,000 ohms, New, 1/3.

CELESTION Energised M.C. Speaker, 2,500 ohms. Model D.C. 2054, with universal transformer. List price, £2/5/0. Our price, 12/6.

PIONEER RADIO MFG. CO., LTD., Coptly Street, London. W.C.1. Museum 9607.

REPAIRS—REWINDING—OVERHAULS. New cones and centres fitted any make M/c chassis, Mc/s rewound. Mains transformers, etc. Receivers converted D.C. to A.C. Write Repair Dept. C.

WEEEDON P.L.R. CO., 80, Lonsdale Avenue, London, E.6 (Grangewood 1837).

"MELFO-RAD" for all Receivers, Kits, Components, etc.—Lowest prices—Cash/C.O.D. or H.P. Quotations and Lists Free—Queen's Place, Hove. (Trade Supplied.)

SOUTHERN RADIO'S Bargains.—Manufacturer's guaranteed surplus.

VARIABLE Condensers.—Lotus. All 0.0005. Complete with dials, escutcheons, knobs. Fully screened with trimmers, 3-gang, 12/6; 2-gang, 8/6; single, 4/9 (List 9/6). Hydra block condenser, 10 mfd. (2x2x6x2x1x1), 1,000v. D.C., 7/- Dribbler 4 mfd. (2x1x1), 1,000v. D.C., 2/9; Utility Midget 2-gang variable condensers, 0.0005 with concentric trimmers, 3/5.

SPEAKERS.—Blue Spot permanent magnet, universal transformer for power, super power, pentode and Class B, 23/- (list 30/6); Celestion Soundex permanent magnet, 15/- (list 27/6).

BLUE Spot, genuine 100U, inductor speaker on chassis; 13/6 (list 30/6).

CRANIC Coils, set of four (1 osc. 2 I.F. with pig-tails, 1 I.F. plain), 12/6 (list 50/-).

LISSEN Super-het. 3 Coils Unit, screened, gauged on base with wave-change and filament switches; type LN5181 for battery or mains, 12/6 (list 30/-).

VARLEY Constant Square Peak Coils, with all accessories, new, boxed; BP5; 2/4 each (list 15/-).

VARLEY H.F. Inter-wave Coils, BP6, 2/3 (list 8/6).

EKCO A.C. Eliminators, each new and boxed, in original sealed cartons, type K25, with trickle charger, 25 milliamps, 39/6 (list 57/6); type A.C.25, 33/6 (list 53/17/6); type K.12 with trickle charger, 37/- (list 53/17/6); Ekco trickle chargers, type T.C.1., for 2-4 and 6-volt accumulators, 20/- (list 42/-).

MAINS Transformers.—Full list of mains transformers and chokes sent free.

MISCELLANEOUS.—Rotorhmi and Radiophone volume controls, all values, 3/- switch, 3/3 (list 10/-). Westinghouse metal rectifiers, H.T. 6, 7, 8, 9/3 each; Ferranti chokes, 20 Henry 60 m.a., 6/9 each.

ALL Goods Guaranteed and Sent Carriage Paid.

BRANCHES at 271-275, High Rd., Willesden Green, N.W.10, and at 46, Lisle St., W.C.2. Please send all post orders to 323, Euston Rd., N.W.1.

SOUTHERN RADIO, 323, Euston Rd., London, N.W.1, (near Warren St., Tube). Phone: Museum 6324.

WOBBURN Radio's New Purchase.—

WESTERN ELECTRIC Microphones, super sensitive, boxed, listed 21/-, 2/6 each, post free. W.R.C. Eliminators, guaranteed 12 months, 150v. 30 m.a. Three positive H.T. Tappings, D.C. 9/6, A.C. 21/-, A.C. with trickle charger 32/6. Trickle chargers (2-v., 4-v., 6-v., 1 amp.) 12/6. Universal A.C./D.C. 21/- (post 1/- extra). **TRADE LIST** now ready. All orders over 5/- carr. free. Let us quote for Kits, components, and valves.

WOBBURN RADIO CO., 9, Sandland Street, 1. W.C. Holborn 7289.

MIDGET Receivers, brand new. Ideal for travellers, etc. Working off both AC and DC Mains 100/130 and 200 240 volts by Universal adaptor supplied. All incorporate M.C. Speaker, provision for gramophone pick-up, L. and M. Wave. Complete with valves. Emerson 5-valve chassis (as above). Sealed cartons £3 15s. 0d., this chassis incorporated in handsome figured walnut cabinet (10 x 7 1/2 x 5 1/2), list 10 gns., at £4 6s. 3d. Also 6 only Spartan '63', 6 valve, 7 stage Superhets, 3-point tone control, A.V.C., Walnut cabinet (12 1/2 x 7 1/2 x 4 1/2), over 70 stations, at £7 5s. 0d. Carr. Paid. Cash with order or C.O.D.—Degallier's, 4/21, Upper Marylebone Street, London, W.1.

ELIMINATORS, 25 m.a., D.C. 10/-, A.C. 21/-; Transformers 3-1, 5-1, 1/9. British-made Valves H.F., L.F. and Deet. 1/9. Power 2/-, S.G. 5/- Carriage Paid Cash with Order.—Radio Electrical Supplies, 233, Camberwell Road, London, S.E.5.

ACCORDEONS, Saxophones, Guitars. Send for Free Catalogues. Easy Terms. Hessay's, 18-20, Manchester Street, Liverpool.

VAUXHALL UTILITIES.

ALL goods advertised in last week's issue still available. Lists free.

VAUXHALL UTILITIES, 163a, Strand, W.C.2. Phone: Temple Bar 9338. (Facing Bush House, over Denny's.)

WANTED, good Modern Wireless Parts, Sets, Eliminators, Meters, Valves, Speakers, etc. Spot Cash waiting. Send or bring. We pay more than any other dealer. Open 9-8.—University Radio, 142, Drummond St., Hampstead Rd., N.W.1.

PEARL & PEARL Bargain List "B" Free. 100, Bishopsgate, London, E.C.2.

YOUNG men trained for all branches of Wireless Profession. Britain's leading College, situated on sea-front. Boarders accepted. Training fee payable after appointment. Prospectus free. The

WIRELESS COLLEGE, COLWYN BAY.

BARGAINS

ATLAS S.G.3 A.C. SET
LIST PRICE £9. 17. 6 OUR PRICE £5. 19. 6

Model 334. Variable-Mu S.G. Detector and Power Valves. Westinghouse Rectifier. Full-vision Illuminated Wavelength Scale. Sockets for Pick-up and extra Speaker. A.C. Mains, 200/250 volts, 40/120 cycles. Complete with Valves, Speaker and Cabinet. Guaranteed BRAND NEW in Manufacturer's Sealed Carton. Ready to play.
or Yours for 11/6 Balance in 11 monthly Payments of 11.6.

ATLAS "LAMBDA" S.G.3 BATTERY RECEIVER
LIST PRICE £9. 15. 0 BARGAIN PRICE £5. 17. 6

Yet another amazing Battery Set Bargain. Variable-Mu S.G. Detector and Parallel-Feed Output Valves. Single-knob Tuning. Variable Selectivity Control. Absolutely complete with Batteries, Accumulator, Moving-Coil Speaker and inlaid two-tone Walnut Cabinet. Guaranteed BRAND NEW.
Carriage Paid. 10/- and 11 monthly payments of 11.6.

7-GUINEA CLASS "B" 4 BATTERY SET FOR 49/6

A splendid PETO-SCOTT product at an unparalleled Bargain Price. Screened-Grid, detector; Class "B" driver and Class "B" output valves; single-knob tuning. Roia Permanent-Magnet Moving-Coil Speaker and modern Walnut Cabinet. Less Valves and Batteries: Cash or C.O.D. Carriage Paid 49/6. If required with 4 B.R.V.M.A. Valves and British-made Batteries. Cash or C.O.D. Carriage Paid £5 : 12 : 6 or 10/6 Deposit and 11 monthly payments of 10/6.

PETO-SCOTT LONG RANGE 3
LIST PRICE £4.4.0 BARGAIN PRICE 29/6

An amazingly efficient Ready-Built Receiver at a great reduction to clear a limited quantity. 3-valve straight circuit: B.A. Speaker in beautiful Console Cabinet. Less Valves and Batteries. If required with B.R.V.M.A. Valves and Hellesen H.T. and Peto-Scott 2-volt Accumulator, Brand New, tested and guaranteed by Peto-Scott. Cash or C.O.D. Carriage Paid, £3,8/9. Or 8/6 deposit and 8 monthly payments of 8/6.

HALSON MIDGET SET
LIST PRICE 12 Gns. OUR PRICE £5

4-valve Super-het circuit. All-electric A.C. or D.C. Mains, 100 to 250 volts. Moving-coil Speaker. Single-knob tuning, 200-500 metres. Size 10 in. by 7 1/2 in. by 6 in. deep. Regional and powerful foreign stations received on ready fitted short aerial.
or Yours for 10/- Balance in 12 monthly payments of 10/3.

PETO-SCOTT Co. Ltd.
77, (Pr. W. 10), CITY ROAD, LONDON, E.C.1
West End Showrooms: 62, High Holborn, London, W.C.1
EST. 1919

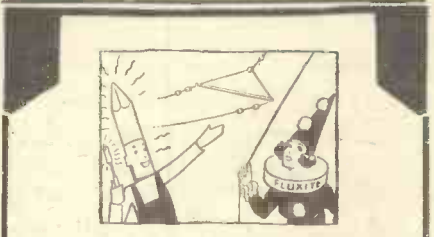

"We're Fluxite and Solder—To make good reception the reliable pair; a foregone conclusion; Famous for Soldering—Use Fluxite and Solder—known everywhere! no fear of 'confusion'!"

See that Fluxite and solder are always by you—in the house—garage—workshop anywhere where simple, speedy soldering is needed.

ALL MECHANICS WILL HAVE FLUXITE

IT SIMPLIFIES ALL SOLDERING

All Ironmongers sell Fluxite in tins: 4d., 8d. 1s. 4d., and 2s. 8d. Ask to see the FLUXITE POCKET SOLDERING SET—complete with full instructions—7s. 6d. Ask also for our leaflet on HARDENING STEEL with Fluxite.

FLUXITE, LTD. (Dept. W.P.)
Dragon Works, Bermondsey Street, S.E.1.

FOR ALL REPAIRS!



Helpful Books for the Practical Man

The Home Mechanics Series

Price 1/- net each by post 1/2 each

SIMPLE ELECTRICAL APPARATUS

Interesting and useful apparatus, easily constructed, with which the student is enabled to test for himself the theory and practice of Electricity as laid down in the text-books.

THE HOME WOODWORKER

The various examples of woodwork described in this Handbook have been designed by practical craftsmen. They are modern in style, and their construction is well within the powers of the average home-worker who follows the instructions given.

MOTOR-CAR OVERHAUL AND UPKEEP

Many, by undertaking their own repairs, can afford to run a Car, and it is the purpose of this handbook to show how the Owner-Driver may carry out most of the adjustments and repairs which every Car sooner or later needs.

25 SIMPLE WORKING MODELS

All the models described in this book can be constructed from the simplest materials and with very modest equipment. None requires lathe-work. 147 illustrations.

ACCUMULATORS

An accumulator (whether for Wireless or the Car) if properly used and cared for, is an extremely reliable piece of apparatus. This book shows how to get the best out of it.

TOY MAKING FOR AMATEURS

Over 200 illustrations. Instructions and diagrams are given for the construction of innumerable toys of all kinds, from the simplest to the more complicated mechanical sorts.

There are 10 books in this Series. Send post-card for List

From all Booksellers, Newsagents, etc., or by post 1s. 2d. each from the Publishers:—

GEO. NEWNES, LTD.
8-11, Southampton Street, Strand, London, W.C.2

50 Tested Wireless Circuits

Edited by F. J. CAMM

Obtainable at all Booksellers, or by post 2/10 from Geo. Newnes, Ltd., 8-11, Southampton Street, Strand, London, W.C.2. 2/6

FREE ADVICE BUREAU COUPON

This coupon is available until August 11th, 1934, and must be attached to all letters containing queries.

PRACTICAL WIRELESS, 4/8/34.

ADVERTISEMENT INDEX

	Page
Cosser, Ltd.	Inside Front Cover
Fluxite, Ltd.	Inside Back Cover
Hayberd, F. C., & Co.	564
I.C.S.	562
Peto-Scott, Ltd.	Inside Back Cover
"362" Radio Valve Co.	564
Wet H.T. Battery Co.	564
Whiteley Electrical Radio Co., Ltd.	563

★ AN IMPORTANT ARTICLE

BORING FOR WATER

THE August issue of this most modern of monthly magazines contains an authoritative article on methods of boring for water. Interesting illustrations show a complete section of the sub-soil and strata of the County of London, and the various methods of finding water are interestingly discussed.



Another specially interesting article is "Twenty Years of Airship Progress." The issue also contains practical articles on Lathe Work, the Automatic Telephone, Mechanics of Side-Show Games, Domestic Refrigerators, Petrol-Driven Model Aeroplanes, Synchronous Electric Clocks, Making a Radio-gram, How Gramophone Records are made, Mechanics of 2,000 Years Ago, History of Locomotives, Mechanical Drawing, the Diesel Oil Engine, Gas Filled Relays, etc.

On sale at all Newsagents and Bookstalls, or by post 7½d from George Newnes, Ltd., 8-11, Southampton St., Strand, London, W.C.2

PRACTICAL MECHANICS

FASCINATING NEW
DISCOVERIES
TOLD IN SIMPLE
LANGUAGE AND
PICTURES

6d

Geo. Newnes, Ltd.

C.4
Sep. 553

Printed in Great Britain by NEWNES & PEARSON PRINTING CO., LTD., Exmoor Street, Ladbroke Grove, W.10, and published by GEORGE NEWNES, LTD., 8-11, Southampton Street, Strand, W.C.2. Sole Agents for Australia and New Zealand: GORDON & GOTCH, LTD. South Africa: CENTRAL NEWS AGENCY, LTD. *Practical Wireless* can be sent to any part of the world, post free, for 17/4 per annum; six months, 8/8. Registered at the General Post Office for Transmission by Canadian Magazine Post.

ALL ABOUT OUR NEW DESIGNS!

15p

Practical Wireless

3^d

Published every Wednesday by
GEORGE NEWNES LTD.

Vol. 4. — No. 99.
August 11th, 1934.

Registered at the G.F.O. as a Newspaper.

AND PRACTICAL TELEVISION
EDITED BY F.J. CAMM



A
NEW Course
FOR THE
Beginner



ALWAYS SPECIFIED
Obtainable from
all Good Dealers.
In cases of difficulty send direct to:
Sole Wholesale Distributors:

BRITISH RADIOGRAMOPHONE CO. LTD.
Pilot House, Church Street, Stoke Newington, London. N.16.

METAPLEX

USED EXCLUSIVELY BY MR. F. J. CAMM

The Metallised Baseboard
that has come to stay.
REFUSE SUBSTITUTES.

BASEBOARDS

THE EVENT OF THE YEAR....



KINGS OF THE AIR

The NEW COSSOR MELODY MAKER

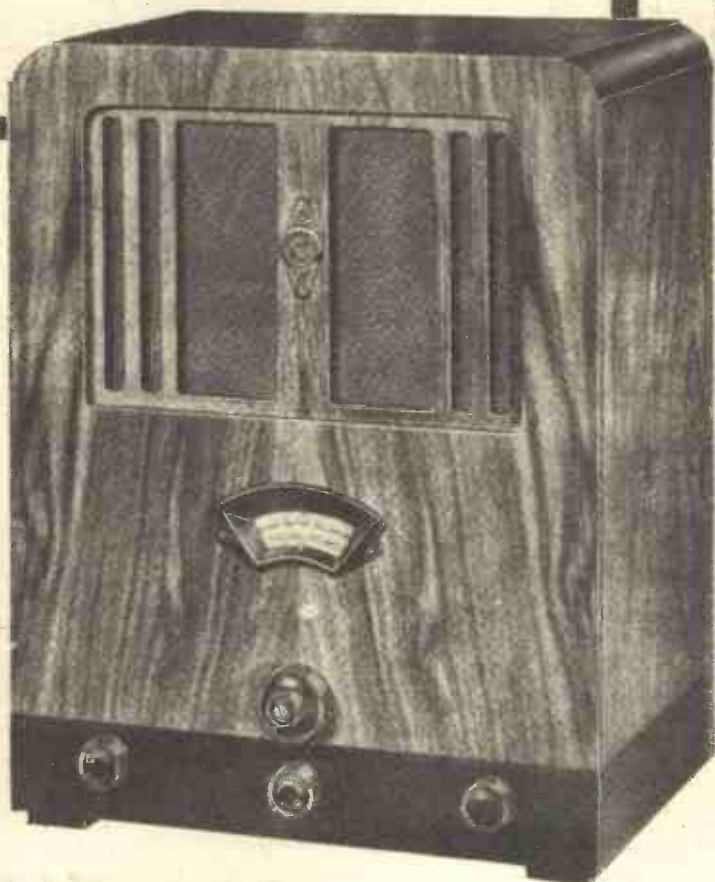

Better than ever—still higher efficiency due to its remarkable new Super-selective Iron Cored Coils. In Model 352 Economy Pentode Output cuts H.T. battery consumption to a minimum. Superb tone—due to its matched Moving Coil Loud Speaker. Save money — use your wireless knowledge — get a better Set for less money. Britain's finest Screened Grid Receiver — at the bare price of the parts.

BATTERY KIT MODEL 352.

3 valves (Variable-mu S.G. — Triode Detector—Pentode Output). Latest type 8" P.M. Moving Coil Loudspeaker. Super-selective Iron Cored Coils. Handsome walnut finish cabinet, 18" high, 14" wide, 9 1/2" deep.

£5.19.0 £7.19.0

(exclusive of batteries).

Hire Purchase Terms—14/- deposit and 10 monthly payments of 12/-.

ALL-ELECTRIC MODEL 357.

4-valves (Variable-mu S.G.—H.F. Pentode Detector—Mains Power Output, Heavy duty rectifier). Super-selective Iron Cored Coils. Mains energised 8" Moving Coil Loudspeaker. Cabinet similar to Model 352. A.C. Mains 200/250 volts, 40/100 cycles.

Hire Purchase Terms — 20/- deposit and 10 monthly payments of 16/-.

Prices do not apply in I.F.S.

SEND COUPON FOR FULL DETAILS

VARIABLE-MU S.G. CIRCUIT

SUPER SELECTIVE IRON-CORED COILS

MOVING COIL LOUDSPEAKER

HANDSOME WALNUT FINISH CABINET

To A. C. COSSOR LTD., Melody Dept.,
Highbury Grove, London, N.5.

Please send me full details of the new Cossor Melody Maker.

State which Model required.....

Name

Address

352 & 357 FRAC. D/B/14.

ORDER NEXT WEEK'S ENLARGED SHOW NUMBER NOW!



EDITOR:
 Vol. IV. No. 99. || F. J. CAMM || Aug. 11th, 1934.
Technical Staff:
 W. J. Delaney,
 H. J. Barton Chapple, Wh.Sch., B.Sc. (Hons.), A.M.I.E.E.
 Frank Preston, F.R.A.

“PRACTICAL WIRELESS” AND THE PRICE QUESTION.

Phenomenal Success of Our Campaign! Component Manufacturers to Supply Stripped Components! Valve Manufacturers Co-operate! By The Editor.

EVER since the publication of No. 1 of PRACTICAL WIRELESS my staff and I have resolutely been at work to provide the home constructor with designs for high-class receivers of guaranteed performance, and at a price which made it possible for a first-class receiver to be built at less than the cost of a commercial receiver. A well-built and well-designed home-constructed receiver is always better than an equivalent commercial receiver, for the simple reason that its builder is able to tune and adjust it, and to avail himself, through our Free Advice Bureau, of the services of the designer free of all charge.

He is also able at small cost to bring his receiver entirely up-to-date as new components are produced without having to go to the expense of buying an entirely new kit. It has been my earnest endeavour by means of our policy of specifying only those components used by the designer (no alternatives) and by our Free Advice Bureau, as well as by our guarantee, to give the home constructor as great a degree of confidence in building a receiver as obtains when he purchases one.

Our editorial policy has been resolutely pursued and we have sought to place in the readers' hands—by means of the Wireless Constructors' Encyclopaedia, the PRACTICAL WIRELESS Free Gift Data Sheets, the Encyclopaedia of Popular Mechanics, our Free Gift Spanners, and our Presentation Tool Kit—all of which have been supplied on Presentation terms—a complete library of technical information and really useful tools which cannot be bought elsewhere, so that they may enjoy radio at its best.

It is common knowledge among home constructors as well as among leading manufacturers, that PRACTICAL WIRELESS is the leading journal to which all discriminating readers regularly subscribe, in order to keep their knowledge entirely up-to-date.

But during the past twelve months the competition of the cheap commercial receiver has been so keen that in many cases it has been found cheaper to buy a receiver than to make one.

As all our regular readers know, I took early steps to safeguard the interests of the home constructor by embarking upon the design of our eminently successful Leader series of receivers which were designed down to a price without sacrificing efficiency. To this end I sought the co-operation of leading manufacturers who generously, and at once, designed and made some efficient stripped components at really competitive prices. The manufacturers of cheap commercial receivers made their answer to this policy by producing even cheaper receivers, some of which were not very efficient but appealed because of their low price.

I again got into touch with all the leading manufacturers of components to see what could be done about producing even cheaper components without sacrificing efficiency. As most of these manufacturers pointed out to me, whereas the set manufacturers could purchase stripped components of lower factor of safety at a low price, such components would lose their appeal if sold as separate units to home constructors. They also pointed out that valves represented quite a large proportion of the total cost of the receiver, and that if I could persuade valve manufacturers to reduce their prices, I should have performed yeoman service to home constructors. Accordingly, it is with extreme pleasure that I note that my recent letter to valve manufacturers has borne fruit in that members of the B.V.A. have now reduced the price of their valves as shown in the appended list.

	Old Price.	New Price.
Detector ..	7/-	now 5/6
Power ..	8/9	now 7/-
Screened Grid ..	15/6	now 12/6
Screened pentode	15/6	now 13/6
Output pentode	16/6	now 13/6

These prices apply to the following firms: A. C. Cossor, Ltd. (Cossor); Edison Swan Electric Co., Ltd. (Mazda); Ferranti, Ltd. (Ferranti); General Electric Co., Ltd. (Osram); Marconiphone Co., Ltd. (Marconi); Mullard Wireless Service Co., Ltd. (Mullard); Philips Lamps, Ltd. (Philips); Six-Sixty Radio Co., Ltd. (Six-Sixty); Standard Telephones and Cables, Ltd. (Micromesh).

These reduced prices mean a great deal to the home constructor. They enable him first of all to put new life into his old receiver. Combined with all of the other manufacturers who have responded to our request for their co-operation and have agreed to supply efficient stripped components at a low price, they mean that the home constructor can make an extremely efficient, selective, long range, and up-to-date receiver of any battery-operated type for a minimum of cost, at a price, in fact, which has never yet obtained in radio. There remains the hope that in the near future mains valves will be similarly reduced. Quite naturally, my staff and I are gratified that our efforts to safeguard the interests

of the home constructor have been so successful. Our new season's receivers, our readers should note, will continue on even more advantageous lines the policy which led to the production of the highly-successful Leader series. The next season will be a home-constructors' year. In conclusion, I desire to thank the many thousands of loyal readers who have contributed to the great success of PRACTICAL WIRELESS, and for their appreciation of our efforts.

THE EDITOR.

MAKE A NOTE OF IT!

Olympia Radio Show

Thursday, Aug. 16th to Saturday, Aug. 25th, 11 a.m. to 10 p.m. (OUR STAND No. 8, GROUND FLOOR)

Two Special Enlarged Numbers

of

Practical Wireless

The Leading Wireless Weekly

Next Week's issue will contain COMPLETE GUIDE TO THE SHOW

A Forecast of the Exhibits, and details of the New Components in At-a-Glance form, with a guide to the show alphabetically arranged

August 25th issue STAND-TO-STAND SHOW REPORT

A comprehensive report on each exhibit by our Technical Staff.

Order These Issues Now!

ROUND the WORLD of WIRELESS (Continued)

B.B.C. Symphony Concerts, 1934-1935

ACCORDING to a recent announcement by the British Broadcasting Corporation, its season of twelve Symphony Concerts at Queen's Hall begins on Wednesday, October 24th, 1934, and will continue until Wednesday, April 10th, 1935, the intermediate dates being Wednesdays, October 31st, November 14th, November 28th, December 12th, January 23rd, February 6th, February 20th, March 6th, March 20th and March 27th.

Light Entertainment from Blackpool

ON August 10th, Blackpool contributes a forty-five minute entertainment to the North Regional programme, this period being equally divided between two concert parties—Tom Vernon's Royal Follies, from the Central Pier, and the Arcadian Follies, from the South Pier.

Band of H.M. 11th Hussars

BY permission of Lieut.-Col. D. MacMurrugh Kavanagh, the Band of H.M. 11th Hussars will be relayed for West Regional listeners from the Barry Horticultural and Horse Show at Romilly Park, Barry, on August 15th.

Variety from the Midland Regional

ON August 14th variety will be relayed to Midland Regional listeners from the Grand Theatre, Derby—the first outside broadcast from this theatre—and cabaret by Orlando and his Band, with guest artist from the Welcombe Hotel, Stratford-on-Avon, on August 18th. Billy Merrin and his Band will be at Derby.

Autumn Talks

IN the autumn talks this year India will have a series to herself and another series by prominent Americans will be relayed from the U.S.A.; the latter may be broadcast on Sunday evenings. Reminiscences, household talks, technical talks, discussions, short story and poetry readings will be included in the syllabus. Morning talks will start at the beginning of September, early evening talks will start in the third week in September and the rest of the general talks and discussion group talks will start in the first week in October. Announcements will be made from time to time as the arrangements for the various talks are completed.

Across the Channel

A PROGRAMME with the title "Across the Channel" will be broadcast to Northern Ireland listeners on August 9th. This will be a record in programme form of the impressions of an Irishman visiting England, Scotland and Wales.

"Picture People"

AT the end of May last a novel broadcast was given consisting of a complete variety programme taken from the soundtrack of recent film successes and films in

INTERESTING and TOPICAL PARAGRAPHS

the making. It was entitled "Picture People" and included Gracie Fields, Eddie Cantor, Florrie Forde and many other foremost film artists. Clayton Hutton, who devised the programme, is now com-

IN A MODERN RADIO FACTORY

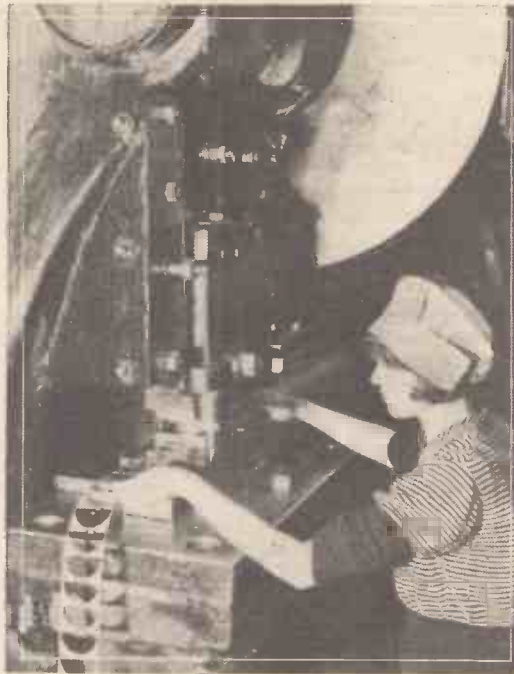

Moving vanes for Cossor variable condensers being stamped out on a 40-ton power press.

piling a second edition for broadcasting on August 8th. Some of the artists to be included will be the following:—Mae West, who may be heard repeating her popular slogan; Paul Robeson; Florence Desmond; Norma Shearer; Bing Crosby; Sophie Tucker; Grace Moore; Elisabeth Bergner; Evelyn Laye and Wallace Beery. Leading film companies will again co-operate in the broadcast and, as on the previous occasion, the reproduction will be so perfect that it will be practically impossible to detect that the artists are not speaking direct into the broadcasting studio microphone.

"Arthur's Cave"

A PLAY for Welsh listeners, entitled "Ogof Arthur" ("Arthur's Cave"), by T. Rowland Hughes, will be given in the West Regional programme on August 15th. This play deals with the old tradition about Arthur's Cave. A group of people who are attending the National Eisteddfod wander up the mountain-side and by accident discover the cave of Arthur and his knights. One of them summons enough courage to sound the huge bell which hangs from the roof and its deep boom breaks the long sleep of Arthur and his knights. The hero converses with the visitors and in the conversation an attempt is made to reveal his character. The complexities of modern civilization are bewildering to him and he returns to his sleep and to his dreams of Camelot.

Variety Entertainment from Belfast

A NON-STOP musical variety programme will be presented in the Belfast studio on August 10th. No less than thirteen acts have been booked to appear in the fifty minutes which the programme will occupy, ranging from a guitar team to a siffleuse. The whole show will be supported by David Curry and his Orchestra.

Two Plays from Midland Regional

TWO plays by H. C. G. Stevens will be acted by the Coventry Repertory Company on August 15th in the Midland Regional programme. A. Gardner Davies will produce plays, which will be relayed from the Opera House. The first, "Sir Herbert is Deeply Touched," concerns a famous actor-manager, and the second, "To Meet the King," is of the mystical type.

Droitwich Spa Orchestra

THE concerts by the Droitwich Spa Orchestra, composed of the Midland Regional Studio Nonet and some members of the City of Birmingham Orchestra, conducted by Victor Hely-Hutchinson, continue to be an attractive Sunday evening feature in the Midland programme. On August 12th the principal work is Schubert's Unfinished Symphony, written in 1822, never heard by the composer, and first played in 1865. George Gibbs, of Wolverhampton, is the baritone vocalist. He will sing the Sword Song, from Elgar's "Caractacus," and "The Song of the Soldiers" and "Adam lay i-bounden," by Hely-Hutchinson.

(Continued on page 569)

SOLVE THIS!

PROBLEM No. 99.

Jackson built a straight-three receiver, employing detector and two I.F. (transformer-coupled) stages. Tuning was carried out by a band-pass circuit made from two commercial coils connected in the orthodox manner, that is, with a fixed condenser joining the lower end of each coil to earth, and with the two-gang condenser joined to the earthed chassis. After some use he decided that he would use a variable-mu valve in place of the existing one and connected a suitable grid-bias battery between the lower end of the aerial coil and earth. When a potentiometer was joined across this battery he found that, in addition to a reduction in signal strength, the potentiometer also introduced serious distortion. Where had he gone wrong? Three books will be awarded for the first three correct solutions opened. Address your attempts to The Editor, PRACTICAL WIRELESS, Geo. Newnes, Ltd., 8-11, Southampton Street, Strand, London, W.C.2. Envelopes must be marked Problem No. 99, and must be posted to reach here not later than the first post, August 13th, 1934.

Solution to Problem No. 98.

When Jarrold inserted the condensers in each 'phone lead he had overlooked the fact that he had interrupted the H.T. supply to the valve and, consequently, it failed to operate. An H.F. choke would have proved satisfactory in removing the H.F. currents and preventing his hand-capacity troubles.

No readers satisfactorily solved Problem No. 97, and therefore no books have been awarded this week.

"PRACTICAL WIRELESS" at RADIOLYMPIA

As our readers will by now be aware, next week will see the opening of the thirteenth Radio Exhibition at Olympia, the exact date being August 16th. This year will again see the vast crowds who every year make their way to the Great Hall in this famous London building in order to see the new developments in wireless receiver and component design. For months now the various manufacturers have been hard at work introducing new models and ideas which annually make their appearance at this time, and which pave the way for receiver modifications for the coming months when radio once again becomes of interest owing to the approach of the radio season.

Radio should, of course, be an all-the-year-round hobby, but the warm days and long nights have a great influence in taking the listener away from his receiver. However, the majority of amateurs want to know what is new in radio and will accordingly make their way to Olympia. A cordial welcome is extended to all our readers, who will find us at the same spot as last year, our Stand also bearing the same number—namely Stand No. 8, on the ground floor. Here will be found copies of all the interesting books on radio which are published by the House of Newnes, including copies of our Encyclopaedias, Data Sheets, and Blueprints, Tool Kits, etc. Those readers who have not already availed themselves of our Free Gift Schemes will thus be enabled to inspect the various items and obtain them for a cash payment. In addition, speci-



Our Stand: No. 8, Ground Floor.

men receivers made up from the published details will also be on view, and will enable readers to check over any small point which they may find is causing them some difficulty.

In addition, members of the Technical Staff will be in attendance daily, and will be prepared to answer any problem which our readers care to bring along, although we should like to take this opportunity of pointing out that at last year's exhibition many readers seemed to have an endless store of questions which could have occupied all day in answering. This hindered others from obtaining assistance, and prevented many visitors from seeing the various items which we had introduced for their inspection. Will readers kindly, therefore, prepare any questions which they require answered, and jot them down on a piece of paper before coming to the Stand? In this way they will be

able to put their problem with the minimum of delay, and be able to pass on and so make way for others. An interesting and instructive part of our show programme is the Free Advice Bureau; last year our staff must have answered some thousands of questions. Remember there is no charge for this service, and that everyone is invited and welcomed at our Stand.

PRACTICAL WIRELESS is recognized throughout the country as the leading paper devoted to the interests of the home constructor, and during the past few months unceasing efforts have been made by us to bring down the prices of the components of wireless receivers. As a result

of the great appeal which we have made, we are pleased to state that the majority of manufacturers have responded in a most ready manner, and in addition to genuine price reductions many cheaper parts have been introduced for the home constructor. In addition, the prices of battery valves have also been reduced, and the home constructor is thus placed in a more favourable position than ever before to experiment and test new ideas which are introduced in the reception of the broadcast programmes.

Television will soon be here, and, as with all other developments, PRACTICAL WIRELESS will be the first to present for the home constructor details concerning the construction of suitable receiving apparatus. In addition, No. 1 of our new monthly, *Practical Television*, will be on sale at Olympia. A special announcement regarding it appears below.

"PRACTICAL TELEVISION" OUR NEW SIXPENNY MONTHLY

THE science of television is on the eve of momentous achievement. Already it has been demonstrated that it has emerged from its development stage and has reached a point where it is commercially practicable, and has excellent entertainment value. Within a few weeks the Television Committee, appointed by the Postmaster-General to report to him as to the present position of television, will issue its findings. As with wireless, so with television, the home constructor will extract the greatest enjoyment from this fascinating yet simple new hobby. It behoves every reader of this journal to make himself *au fait* with this missing link of complete home radio entertainment.

PRACTICAL TELEVISION, our new 6d. monthly, will be published on August 16th, and copies of it will be on sale at Radiolympia at the popular price of 6d. per month.

No. 1 contains interesting articles on "Building a

Home Visor," "Scanning Systems," "History of Television," "The Cathode Ray Oscillograph," "Tele-news and Televews," "Television—a Review of the Various Systems," "Coupling Your Set to a Visor," "Light Cells, their Principles and Uses," "Valves for Television," "Television Tips," etc., etc.

PRACTICAL TELEVISION will accurately present reviews and reports of the latest apparatus and television developments, and test reports of receivers and new apparatus will form regular features. Bring your knowledge of the new science right up to date and be prepared for the new hobby, by ordering a copy of PRACTICAL TELEVISION to be delivered to your door every month. Already the entire print of No. 1 has been taken up by the wholesale newsagents, and to secure your copy it is necessary to place an order now for this latest addition to our series of practical journals.

OUR RADIOLYMPIA RECEIVERS

THE "SUMMIT" AND THE "ARMADA"

Our New Battery and Mains Receivers. Preliminary Details of Two New Receivers which are designed in accordance with Our Recently-introduced Low-price Campaign. Full Constructional Details will be Given Next Week.

WITH the introduction of the Leader series of receivers we endeavoured to show that a receiver could be built at home at a price which was really comparable with that of a commercially-made set. This might not have been any very great achievement a few years ago, but in 1934 it is one of the greatest importance, since the production of factory-made receivers has been reduced to a very fine art and such sets can be produced at extremely low prices. The reason is not that the designers of these instruments are cleverer than those who design home-constructor sets, but that their facilities for obtaining components at extremely low prices are greater than those available to the amateur. Furthermore, in many cases the manufacturer of complete receivers also constructs his own components, and is thus relieved of the necessity of obtaining a greater profit owing to the fact that no distribution charges have to be added. There is also the point that no elaborate case or trimmings have to be added, and no terminals or other connecting devices need to be fitted. Our campaign also resulted in a great reduction in the prices of components offered to the home constructor, and as our readers will have seen, the price of battery valves has also been reduced. Our two new receivers have been designed to still further increase the popularity of home construction, and the prices of these receivers will be found fully to demonstrate that the home constructed receiver can vie with its commercially-produced prototype not only in price but in performance.

High Standard of Performance

Considered from the point of view of performance it might even be said that these receivers are capable of even better results than those of factory-produced articles. The reason for this is simple, and is that the constructor can himself in many ways "hot-up" and otherwise adjust the individual receiver so as to obtain the maximum from the parts which are employed. Such adjustments are not possible in the case of the ready-made set which must, in view of the low price at which it is offered, be made entirely by mass-production methods. These latter, of course, completely rob the receiver of that particular individuality which the home constructor and experimenter always values so highly.

In producing these receivers no attempt has been made to introduce what are generally referred to as stunt features, but instead the aim has been throughout to design sets of thoroughly proven type which are not only easy to make but have that nicety of adjustment and control which is peculiar to the instrument of so-called thoroughbred type. One of these receivers is designed for battery operation,

and the other for mains operation, so that every reader may choose that particular model which in every way meets his individual requirements. The fundamental design of the battery set is such that radio reception is the prime consideration, although arrangements have been incorporated so that it may, when desired, be

RADIOLYMPIA

We shall be At Home to Every Reader on Stand No. 8 (Ground Floor). A Qualified Technical Staff will be in attendance to answer readers' questions FREE OF CHARGE.

For Most Complete Show Guide order NOW next week's Greatly Enlarged Issue of PRACTICAL WIRELESS, dated August 18th, on sale August 15th.

A Complete Stand-to-Stand Report will be given in our Second Greatly Enlarged Show Issue dated August 25th, on sale August 22nd.

TO NEW READERS

PRACTICAL WIRELESS contains a blending of articles on every branch of wireless—practical articles on set-building, television, mains receivers, readers' wrinkles, fault-finding, query service and similar subjects. In addition, as may be seen from the announcements in this issue, a special Beginner's Supplement and a Short-Wave Section also take a prominent place in our issues.

OUR UNRIVALLED READER SERVICE

Our FREE ADVICE BUREAU answers readers' queries promptly and accurately FREE OF CHARGE. Only those parts which are used by the designer are specified for PRACTICAL WIRELESS receivers—no alternatives. Every receiver built according to our instructions *must* do all we claim for it. Hence our Free Advice Guarantee.

OUR LABORATORIES

Our well-equipped Laboratories, staffed by a band of enthusiastic experts, is always tirelessly at work designing the very best receivers for home constructors. PRACTICAL WIRELESS provides an excellent instructional course for the expert. It is THE LEADING HOME CONSTRUCTORS' WEEKLY.

employed for the reproduction from gramophone records. On the other hand, the mains apparatus has been designed as a self-contained radio-gramophone, and it is arranged in a cabinet which contains, in addition to the loud-speaker and wireless apparatus, the gramophone turntable and pick-up. The cabinet is not one of the

cumbrous and inelegant pieces of wood-work which have hitherto received the name of radio-gram. cabinets, but is neat and of such a size that it may conveniently be stood upon any table. In fact, it is very little larger than a console type of radio cabinet, and possesses a similarly attractive appearance. The modern small size radio component has played a large part in the reduction in the overall dimensions of this particular piece of apparatus, and the battery receiver has also been built to take full advantage of this tendency in modern design. When the finished receivers are compared with last year's models the great advantage of this size reduction will become apparent.

In both receivers the number of valves employed has been reduced to three—the minimum which will give good, consistent results in these days, and a combination which has been found to give all that is required for normal home entertainment. The latest type of high-frequency pentode is employed in the preliminary stage in order to ensure that adequate range of reception is secured and that the detector stage is fed with a sufficiently powerful signal from the desired station to enable good quality to be passed on to the output stage. The output stage similarly has been arranged to utilize one of the modern pentodes so that the loud-speaker may be operated at comfortable volume. Since the inauguration of the Lucerne Wavelength Plan we have received countless complaints and requests from readers regarding the reception of foreign stations, due to the difficulty of eliminating some of the interference caused by more powerful stations. Thus, although the Lucerne Plan was intended to simplify the reception of a greater number of stations, it appears from our large correspondence that, in many cases, greater difficulties have been introduced. All the letters which have been received have been very carefully considered by our technical staff, and the difficulties encountered have been tabulated and carefully considered from every angle. As a result of the investigations made in this way we feel sure that we have exactly gauged the requirements of the majority with regard to the degree of selectivity required. The tuning arrangements of both of the new receivers have been designed to incorporate those principles which have been found after considerable experience to fully satisfy the present-day needs so far as selectivity and signal strength are concerned. Because of this, readers will be able to rest assured that by building either of these receivers they will be able to take advantage of the experience and assistance which we have obtained from the analysis of the requirements of listeners in all parts of the country, and also from our own individual experiments, which have consistently been carried out during the past six months.

THE OCTODE FREQUENCY CHANGER

Some Interesting Details of the Latest Type of Multi-electrode Valve

AS we have previously pointed out, the super-het. fell out of favour not so much on account of bad reproduction, but mainly because of troubles associated with the frequency-changing stage.

The whole process of frequency changing depends upon an oscillator and a "mixer," whether these be two separate valves, or whether both functions are performed by one valve, or by two sets of electrodes enclosed in a single bulb. In all previous systems the coupling between the oscillator and mixer elements has been obtained by coils inductively coupled.

In the "electron coupled" frequency changer, however, the heterodyne frequency is generated in one set of electrodes, and the coupling between the oscillator and mixer is obtained through the electron stream, thus avoiding the use of external coupling coils.

Six Separate Grids

Of the various types of electron-coupled frequency changer, the latest is the Mullard octode, which is made in two forms, Type F.C.4 for A.C. mains and Type F.C.13 for universal sets. As its name implies, the octode is an eight-electrode valve; having a cathode, six concentric grids, and an anode. The operation of the octode can be understood by reference to Fig. 1, which shows the electrode system in diagrammatic form, and Fig. 2, which gives the basic circuit arrangements.

The cathode and grids Nos. 1 and 2 form a triode oscillator, of which grid No. 2 is the anode. Grid No. 3 is a screen, carrying a high-tension voltage of some 85 volts. The potential on grid No. 3 accelerates the electrons emitted by the

This illustration shows the electrode assembly of the new valve.

cathode, and a certain proportion of them pass through grid No. 3. Grid No. 4 is the control grid of the mixer portion, and is negatively biased due to the voltage drop across the resistance "R" in the cathode lead (Fig. 2). Due to this negative bias, the electrons passing grid No. 3 are retarded and a cloud of electrons, or

"space charge," pulsating at heterodyne frequency, will occupy the region between grids Nos. 3 and 4, forming what is termed the "virtual cathode" of the mixer portion.

From this "virtual cathode" electrons will be drawn off, due to the high potentials on the auxiliary grid (grid No. 5) and on the anode, and this electron stream, already pulsating at heterodyne frequency, will be modulated by the receiver radio-frequency signal applied to the control grid No. 4. It will be understood, therefore, that the

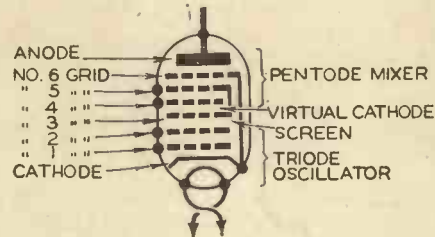

Fig. 1.—Diagram showing the electrode system of the octode frequency changer.

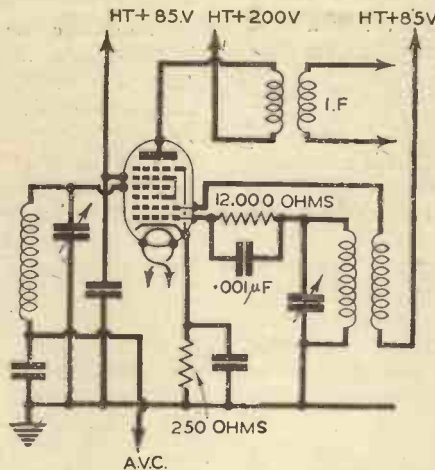

Fig. 2.—The basic circuit of the octode frequency changer.

electron stream now carries a double modulation—heterodyne frequency and signal frequency, and that the mixing of the two produces the required intermediate frequency.

The operation of the octode as so far described resembles that of other electron-coupled frequency changers, such as the hexode or pentagrid. In the octode, however, the sixth grid is introduced, and is connected back to the cathode. The mixer portion of the octode acts, therefore, as a pentode mixer instead of as a tetrode, as in the heptode, and thus possesses all the advantages by way of increased amplification combined with stability which characterize the high-frequency pentode as contrasted with the screen-grid valve.

Moreover, the Mullard octode is so

designed that the mixer portion has variable- μ characteristics, so that the effectiveness of gain control, whether manual or automatic, is greatly enhanced. As an indication of the improvement effected in this direction, it may be stated that, with a grid bias variation of 20 volts, the control is from 1 to 10,000.

A further advantage attaching to the pentode characteristic of the mixer section of the octode is that the auxiliary grid voltage can be obtained by a simple voltage-dropping resistance, thus avoiding the use of an expensive potentiometer for regulating the auxiliary grid voltage.

On the score of re-radiation, the good screening between the oscillator and mixer provided by grid No. 3 prevents the heterodyne oscillation from being superimposed on the control grid, with the result that re-radiation to the aerial is negligible.

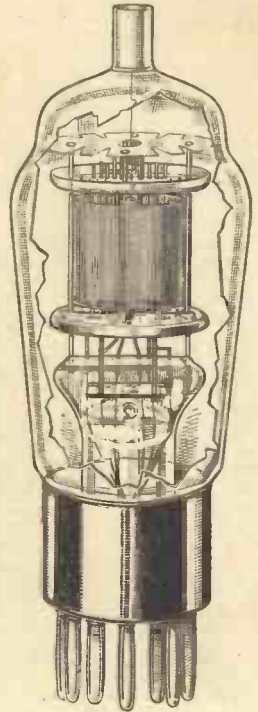

A general view of the new octode valve.

ROUND THE WORLD OF WIRELESS

(Continued from page 566)

Bridgwater Band Festival

THE Nynsbywl Workmen's Silver Prize Band, conducted by C. Hall, will be heard by West Regional listeners in a relay from the Bridgwater Band Festival on August 18th.

Concert by Band of H.M. Royal Marines

JACK COLLINGS (the fisherman bass) will be the vocalist in a concert for West Regional listeners by the Band of H.M. Royal Marines, Plymouth Division, on August 13th.

"Roundabouts and Swings"

THE Scottish Regional Saturday afternoon talk on August 18th will be given by John R. Allan, the well-known Scottish humorist. His subject is "Roundabouts and Swings." John has tasted the pleasures of every type of entertainment to be found in fairs, and the recital of his experiences should be amusing. He tells us that he takes up residence in Glendevon Castle in September, a castle, by the bye, which originally belonged to Archibald Bell the Cat. Naturally the castle is haunted, Glendevon's principal apparition being Green Jean, the daughter of the De'il of Kincardine.

(Continued on page 581)

OUR SECOND COURSE FOR BEGINNERS



INTRODUCING our new course in wireless transmission and reception, written in simple language for the newcomer as well as the old hand.

WE have, of course, previously dealt with the principles of wireless in these pages, and this new series of articles is intended to be a refresher and secondary course for the reader who has already acquired a knowledge of the various points involved, whilst it will also enable the newcomer to understand how it is that the speech and music at the broadcast station or the concert hall may be heard in our own homes situated miles away.

The Sciences Involved

Before it is possible to study the subject it is necessary to point out that for a complete understanding of wireless transmission and reception a knowledge of several subjects is required. Thus, in addition to the main item—electricity, it is also necessary to understand such things as magnetism, chemistry, meteorology, etc. It might seem, therefore, that the study of wireless means a lot of hard work, but actually for our purpose we can take a small portion of each of these and leave the complete study until later on. Perhaps, before going any further, it would be as well to point out where these extra items are introduced to our hobby in order to prevent any possible queries. Magnetism is, of course, the main prop of the loud-speaker and the headphone, whilst some types of microphone also employ a mechanism which relies for its function on a magnet. In our low-frequency transformers and smoothing chokes we also find the question of the magnetic property of iron and steel is introduced, and has some influence on the function of these components. Chemistry is introduced in the design of the valve, the insulation of various accessories, and of recent years it has also come into play in the design of various types of earth connection. In addition, the chemist has to be brought in to solve the problem of certain troubles and difficulties which arise in a wireless receiver due to inter-action between certain metals or other materials, and he has to order the employment of different substances in order to prevent noises which might be introduced through wires being eaten away or similar

difficulties. In order to fully understand the problem of distant reception of low-powered transmitters and the vagaries of short-wave transmissions a knowledge of meteorology must be introduced.

What is Electricity?

Therefore the first subject to receive our attention is electricity, and whole pages would be required to give a thorough explanation of the principles and theories involved. To be brief, however, we may look upon electricity as the movement of particles in a certain direction. To-day everyone knows that all things are composed of atoms or small particles of matter, and these atoms are in themselves composed of smaller particles. These latter particles are of two kinds, known as "electrons" and "protons," and they are best likened to our present solar system. In this we have the sun around which the earth and other planets revolve, and in our atom we have a central nucleus (the sun) which is composed of "protons," and rotating round this nucleus we find what is known as "electrons." An attractive force exists between electrons and protons, and therefore the atom, no matter how many electrons and protons it contains, is held bound together, and in a normal state contains an equal proportion of both electrons and protons, and is therefore in a neutral or uncharged condition. Under certain conditions one or more of the electrons may leave the assembly, and when this happens the atom is left in a "positive" condition owing to the excess of protons which exists. The atom is now in a condition known as "charged," and it will endeavour to attract a negative particle in order to make up its deficiency. Consequently a movement will take place and an attractive force will exist between this positively charged atom and any other normal atom near it, until it is able to restore its original condition.

Our new series is intended to deal with these and similar aspects of radio, and the new reader should carefully study the course as it develops in our pages.

STATIC OR DYNAMIC?

An Interesting Chat About Valve Curves

By H. J. BARTON CHAPPLE, Wh.Sch., B.Sc. (Hons.), A.M.I.E.E.

however, that this curve pre-supposes that the anode voltage remains constant at 125 volts all the time.

If you examine any page of a valve manufacturer's catalogue you will observe a table giving the "characteristics" of the valve; that is, anode impedance, amplification factor, and mutual conductance. This table will be prefaced by a statement that these are the published characteristics of the valve, taken under some special operating conditions—usually anode volts 100, and grid volts zero. Further, there will be "characteristic curves"—usually one or two showing the relation between anode current and grid voltage for various values of anode voltage.

It is generally understood that these characteristics and curves are what is known as "static" characteristics, that is to say, they are derived from test figures taken in the laboratory, and not as a result of measurements made while the valve is operated under reception conditions with a signal applied to the grid and a "load" connected in the anode circuit. On the other hand, it is not commonly known that, under practical working conditions, the values of the characteristics are not so high as the "static" figures.

Why not Dynamic?

The reader may, therefore, quite reasonably ask why "static" characteristics and curves are published by valve makers instead of the more practical "dynamic" characteristics. There are two very good reasons. In the first place, the static characteristics are published merely as an indication of the qualities of various valves, and since all the valve makers publish characteristics taken under the same voltage conditions, these figures serve perfectly well as a standard of comparison between various types and makes of valves.

The second reason requires a rather extended explanation. It is that the "dynamic" characteristics are not constant, but depend upon the actual operating conditions, and more particularly upon the nature and impedance of the "load," that is the type of apparatus connected in the anode circuit of the valve.

An Example

This will be made clear by taking a typical example. Fig. 1 shows the published (static) grid volts/anode current characteristic curves of a typical 2-volt general-purpose valve—the type of valve used as a detector or first low-frequency amplifier. Separate curves are given for anode voltages of 75, 100, 125, and 150 volts. Taking the 125-volt curve—the top curve but one, it shows that, if a pressure of 125 volts was applied to the anode of this valve, and the voltage applied to the grid was varied from zero to 7 volts negative, the anode current would vary from

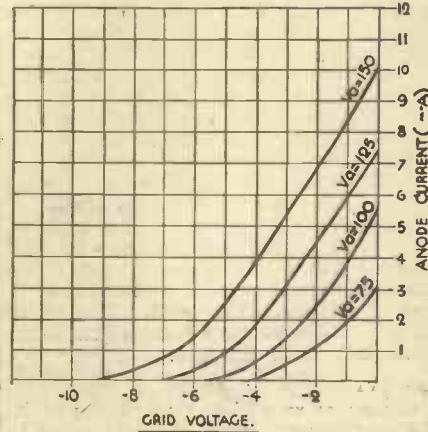

Fig. 1.—Static characteristics of a typical general purpose battery valve.

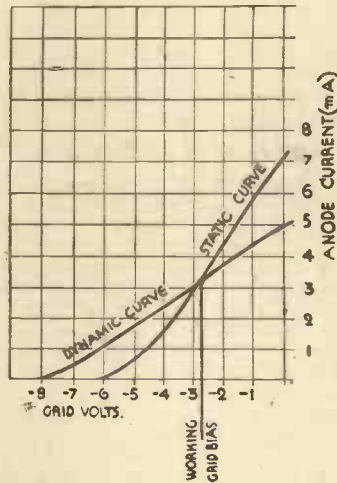

Fig. 2.—Static and dynamic curve forms.

about 7.4 milliamps down to zero, the corresponding values of grid voltage and anode current being represented by points on the curve. It is necessary to realize,

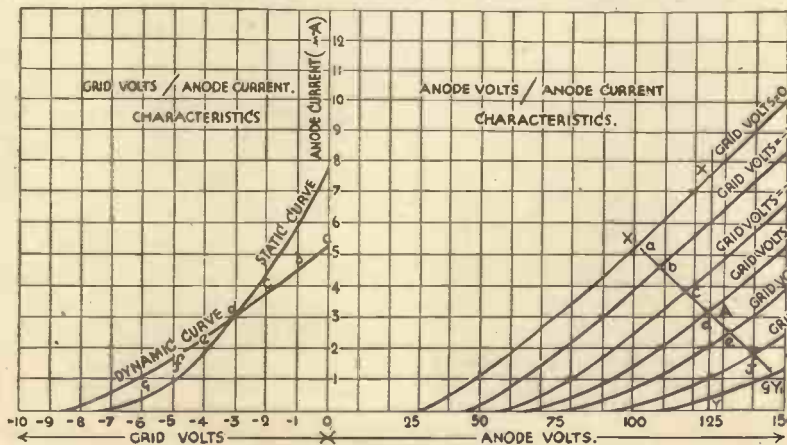

Fig. 3.—Anode volts/anode current curves and derived dynamic curves.

In Practice

Now see what happens in actual practice. To begin with, some piece of apparatus, such as a resistance or a transformer, will be connected in the anode circuit, and if the valve is being employed as a low-frequency amplifier, a negative bias voltage will be applied to the grid. Suppose this negative bias is 3 volts, and that with no signal applied to the grid the actual voltage on the anode is 125. When a signal is applied to the grid, the grid voltage varies above and below the bias value of 3 volts negative. When the grid voltage increases (that is, becomes less negative) the anode current will rise, and when the grid voltage becomes more negative the anode current will decrease.

But when the anode current rises, the voltage drop in the anode load will increase and the actual voltage at the anode will be less than 125. Similarly, during negative half-cycles when the anode current decreases, the voltage drop in the anode load will also decrease, and the actual voltage at the anode will be greater than the nominal figure. Thus, the true values of anode current during positive half-cycles will not be those indicated by the static curve, but will be lower; and the true values of anode current during negative half-cycles will be greater than those found from the curve.

Practical Effects

In other words, the "dynamic" curve of the valve will be "flatter" than the static curve, as though it has been moved round bodily with the point corresponding to the working grid-bias as the pivot, as indicated in Fig. 2. It is easy to understand from this graph, which shows that the dynamic curve has a less steep slope than the static curve, that the practical effect of using a valve under reception conditions results in a reduction of its mutual conductance below the "static" figure.

Another, and still more interesting way of showing the difference between static and dynamic conditions is to derive a dynamic curve from the anode volts/anode current curves of the valve. This method will appeal to those listeners who like to study radio from the theoretical angle, and should also interest those who, so far, have not come across anode volts/anode current curves.

Deriving Other Curves

Referring again to Fig. 1, we can take readings from the curve, showing the anode currents for various grid voltages, as for example 0, -1, -2, -3, and so on. The following table has been compiled from the curves in Fig. 1.

(Continued overleaf)

STATIC OR DYNAMIC ?

(Continued from previous page)

Negative Grid Volts.	Anode Current.			
	75 Volts.	100 Volts.	125 Volts.	150 Volts.
0	3.1	5.25	7.4	10.0
1	1.8	3.9	5.9	8.4
2	0.95	2.4	4.3	6.7
3	0.4	1.4	3.0	5.2
4	0.1	0.65	1.85	3.8
5	0	0.25	1.0	2.4
6		0.05	0.4	1.35
7		0	0.15	0.7
8			0	0.35
9				0.1
10				0

Now take a sheet of graph paper and plot the different values of anode current at zero grid volts against the corresponding anode voltages. You will then obtain a curve similar to that shown at the top in the right-hand half of Fig. 3. Similarly, by plotting the various anode currents for -1 grid volts (second horizontal line of the table) against the respective anode voltages, a second anode volts/anode current curve for grid volts -1 can be plotted. To complete the work a whole "family" of such curves must be drawn.

Now we have considered in our example that at -3 volts grid bias the anode voltage is 125. If the anode voltage remains constant (which, of course, it does not for reasons already explained) a 3-volt (peak) signal on the grid would cause the anode current to vary between the points X and Y, for the grid voltage would vary by 3 volts above and below the bias of -3 volts. Thus, the instantaneous grid voltage will range from zero to -6 volts.

The Effect of Impedance

These conditions would only exist, however, if the "load" in the anode circuit of the valve had no impedance and therefore produced no voltage drop. But the anode load does possess impedance—must, in fact, possess impedance in order that an amplified reflection of the grid input signal shall be developed across it. And because the load possesses impedance, and produces a voltage drop which depends upon the current flowing through it at any instant, the fluctuations in anode current will not be so great as those indicated by the intersections of the line XY with the various anode volts/anode current curves.

Operating Conditions

The operating conditions of the valve will still slide from one curve to another, but along another line, such as $X_1 Y_1$, which represents a load of just over 10,000 ohms, being given by "resistance equals volts divided by amps." The greater the impedance of the load, the less steep will be the slope of $X_1 Y_1$. For the present we will assume that the line so marked in Fig. 3 represents the actual working conditions.

The Dynamic Curve

The working values of anode current at various instantaneous values of grid voltage will therefore be shown by the points at which the line $X_1 Y_1$ cuts the various anode volts/anode current curves, and are marked a, b, c, d, etc., on $X_1 Y_1$ (Fig. 3).

From these values we can now construct a dynamic characteristic curve, as shown at the left-hand side of Fig. 3. In this way the true variations taking place in the valve under actual working conditions can be studied with accuracy.

THE WIRE IN "WIRELESS"

Some Interesting Facts Regarding the Manufacture of Fine Instrument Wires

MANY humorous things have been said about the use of the word "Wireless" to describe that set of phenomena which is now almost universally termed Radio. It is quite true that the actual signals travel from the transmitting aerial to the receiver without conveying wires, but wire plays a most important part in the complete process. For example, on a ship's transmitting apparatus there are about 300 miles of wire in the transformer. Even in our receiving sets the amount of wire employed is considerable.

Few realize the art which is employed in the manufacture of wire. Copper plays, perhaps, the most important part in wire manufacture, but, of course, there are other materials used in the manufacture of special or resistance wires. Copper is shipped to this country in large quantities, principally from America.

Copper

Copper, as we all know, plays its part in the currency, and with gold and silver is recognized as one of the universal equivalents in our exchange system. The price of copper may vary from day to day and for this reason a constant watch has to be kept by the wire manufacturers and electrical firms on this aspect of the case. When the copper bars are to be made into wire, or copper strips as employed in commutator segments, etc., they are placed in a container and put into a crucible and melted at a temperature which makes the copper liquid glow at a white heat.

All round these furnaces are large tubs of water into which the workmen can jump if, as often happens, their overalls catch on fire owing to the heat from the ingots. The latter are about 5ft. in length and 9in. thick, they are grabbed by the operators with long pincers and propelled along the steel floors, thence to be placed between rollers, which shape and flatten the metal to a workable size. If it is to be strip, the whitened metal will be run backwards and forwards until, like a snake from the nether regions, it is 60ft. to 70ft. in length, sliding over the polished steel floor, sending sparks hither and thither during its progress, a most awe-inspiring sight.

When round wire is required the metal is run through different shaped rollers and, owing to the enormous length it reaches, is turned back on itself through adjacent rollers, so that it actually travels through several rollers at a time, with many loops all over the floor. It is during the latter process that men have had their legs trapped in the loops of white-hot metal, with disastrous results. Having obtained a length of copper sufficiently reduced in diameter the next job is to draw it cold, down to the size of wire required, and this is done in easy stages.

Wire Drawing

The first stage sees the copper, the size of a man's wrist, being drawn by a chain, the links of which would do justice to a steam-roller transmission system, through a tapered reducer. When the wire is drawn down to really fine sizes, such as those used for making radio tuning coils or transformers, etc., it is taken through numerous diamond dies, each successive die having a smaller diameter hole than its

predecessor. During the latter process the wire passes through cooling baths. Having reduced the conductor to the requisite size, it now remains to cover it with suitable insulation.

We may have cotton covering, silk, rubber, cellulose compound, in fact there is a galaxy of insulations at our disposal. In radio the commonest forms of insulation are enamel, silk, cotton, cotton and cellulose, cotton and wax, and, of course, oiled cotton sleeving (i.e., systoflex), and V.I.R. (vulcanized india-rubber). To enamel the wire it has to be run through several baths of the insulating material and baked after each bath. The general temperature plays a very important part in this process, as does local climatic conditions.

It is interesting to note that one well-known transformer concern insists on an enamel insulation which will have a "breaking point" beyond that of the wire conductor. This means that when the wire is stretched it will actually break before the enamel surface. One can appreciate the reason for this precaution owing to the number of bends in a length of wire employed in the secondary winding of a transformer and the enormous pressure existing in the internal turns.

Covering the Wire

In cotton covering the wire travels horizontally, and reels of cotton are arranged radially around the conductor. There has to be a correct relationship between the velocity of the wire and the revolutions per minute of the cotton reels which spin round and round in a big circle, lapping the core with the right amount of cotton. D.C.C., or double cotton covered wire, necessitates two sets of reels revolving in opposite directions. In order to impart a braided covering the reels move around a vertically travelling wire. Actually the reels take an eccentric course similar to children playing "in and out the windows."

The famous Litzendraht wire, or Litz as it is known, is composed of three sets of three wires, each set of three being twisted and then the three lots twisted together; this ensures that each conductor shall come to the surface alternately, and since H.F. currents travel on or "near" the surface of conductors, Litz reduces the H.F. resistance as compared with ordinary wire. It is important to note that genuine Litz has each conductor separately insulated either by silk covering or enamel.

Preventing Electrolysis

It very often happens that when a coil is employed in a humid atmosphere a green spot appears on the wire which finally eats it away and causes a breakdown; this is known as electrolysis, and is due to the passage of a steady current through a conductor in a damp environment. Especially did this "green spot" occur in the early "spaghetti" resistances. A cure has been found by winding the wire on a non-absorbing core, sealing the ends and last, but not least, by the employment of a wire free of iron content.

Such is the care exercised in modern wire production that it was found in one factory that breakdowns were due to the peculiar moisture on the skin of the hands of two sisters employed in handling the wire.

The Metal Rectifier *breaks all Records!*

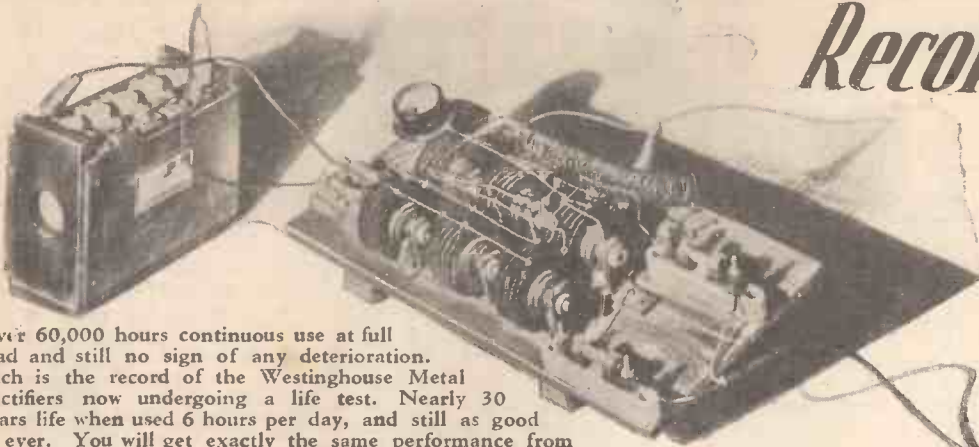

Over 60,000 hours continuous use at full load and still no sign of any deterioration. Such is the record of the Westinghouse Metal Rectifiers now undergoing a life test. Nearly 30 years life when used 6 hours per day, and still as good as ever. You will get exactly the same performance from the Westinghouse Metal Rectifiers you buy. See that there is one in your new A.C. Mains Set or Eliminator, and ensure a constant high tension supply for . . . ever.

WESTINGHOUSE
METAL RECTIFIERS

THE WESTINGHOUSE BRAKE & SAXBY SIGNAL CO., LTD.,
82, YORK ROAD, KING'S CROSS, LONDON, N.1.



STAND 86 RADIOLYMPIA



**FOR THAT
SMOOTH, CLEAN
FEELING
USE**



**PARKE-DAVIS
Shaving Cream**

Send for a sample tube of Parke-Davis Shaving Cream, and for a week your shaving troubles will be things of the past. No more painful scraping! The close, creamy lather of Parke-Davis Shaving Cream makes the razor feel like a finger—and leaves your skin velvety and comfortable. Your chemist sells large tubes for 1/6.

*British made by the makers of
Euthymol Tooth Paste*

If you have not yet tried Parke-Davis Shaving Cream send to Euthymol (Dept. 182/36), 50, Beak Street, London, W.1, for a free 7-day trial sample.

A Guide to Modern Homes in London and the Home Counties

House ownership—the purchase by hundreds of thousands of couples of the homes they occupy—is one of the strongest and most heartening characteristics of the times. "Where to Live" will serve as both a guide and friend in helping you to make a choice with which you will always remain satisfied. Descriptions are given of the districts and best housing estates, also details of transport facilities, season ticket rates, and the general amenities of the particular place concerned.

WHERE TO LIVE

Obtainable at all Newsagents and Bookstalls, or by post 7½d. from George Newnes, Ltd., 8-11, Southampton Street, Strand, London, W.C.2.

6^{pd}



THE EASY ROAD TO RADIO

THE BEGINNER'S SUPPLEMENT

MODIFYING A METER

A Useful Hint for the Listener for Improving a Simple Type of Voltmeter. By W. J. DELANEY.

A LARGE amount of interest attends the publication of an article relating to test meters of various types and the number of suggestions which are received for the Wrinkles section, and which consist of meter modifications or construction, is proof that this part of the listener's apparatus affords the greatest scope for "tinkering" or experimentation. We have already explained in these pages how to use a simple milliammeter for the purpose of making practically every test which is required in constructing or testing a receiver, and the Multimeter forms a very good example of this

ment of this kind is an expensive item, and many listeners who would like to own such an accessory are debarred from making circuit tests owing to lack of incentive to spend the amount required on the necessary meter.

Items of Interest

Apart from the value of quickly being able to trace a fault in a circuit there is much to be learnt from an examination of various components under the influence of voltage applications, and from a study of certain parts of a receiver whilst signals are being received. On various occasions we have explained how the majority of wireless components rely for their function on the fact that they possess what is known as resistance, and when a voltage is applied to the ends of such a component a voltage difference exists between the ends. In the case of a pure resistance, or a component which is designed to operate by virtue of this feature alone, it is obvious that its value is of paramount importance, and a circuit may be made or marred by its inclusion — dependent upon whether its value

is correct or not. It is valuable, therefore, if the listener can measure resistance values, and one object of a multi-

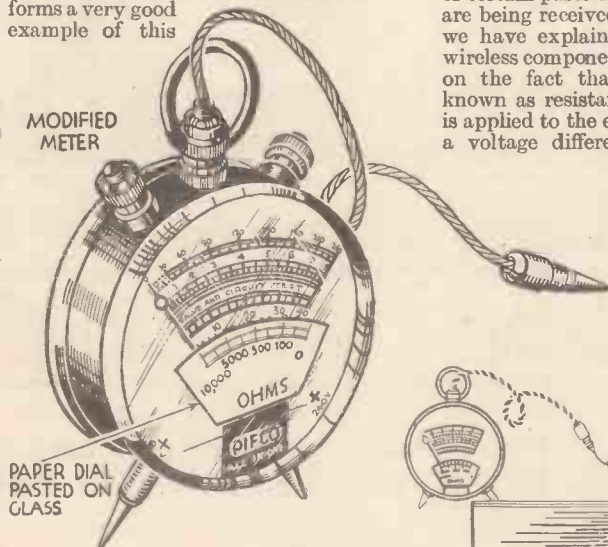

PAPER DIAL PASTED ON GLASS

Figs. 1 and 2.—The modified meter and the method of calibrating in conjunction with a G.B. battery.

purpose meter is to carry out this type of measurement.

A Cheap Meter

Practically every user of a battery receiver has in his possession a meter for the purpose of keeping check on the batteries, and in many cases this consists of a simple type of instrument which probably only cost a few shillings, but which serves admirably for the purpose for which it is used. Fortunately, this type of instrument may be used for the measurement of resistance values without in any way damaging or dismantling the meter, and the following modification will add to the utility of such a meter without any additional expense whatsoever. The illustration accompanying this article shows that the only alteration which has to be made is the attachment of a strip of paper to the glass front of the meter, and this is calibrated in the following manner so that it will carry out the additional function without trouble. As explained previously, when a voltage is applied to the ends of a component possessing resistance a voltage drop takes place across that resistance. Provided, therefore, we know the resistance of the meter, and the value of the voltage applied when testing, we can quickly work out the value of an unknown resistance which is joined in series with the meter and battery. First of all cut a strip of white paper to follow the same curve as the engravings on the face of the meter. Stick this piece of paper just below the scale, using a good adhesive such as Seccotine or Durofix. Whilst this is drying remove the grid bias battery from your receiver, together with two or three resistances having values up to 50,000 ohms. (Unfortunately it is unlikely that the meter will be useful for values higher than this figure.) Connect the meter, one of the resistances and the grid bias battery in series, using the 6 volt or the 7.5 volt tapping on the meter. Under these conditions the pointer of the meter will swing over and will actually be recording the current which is flowing, but ignoring this point make a neat, small line on the paper scale directly above the pointer.

Calibrating the Device

On this line write the value of the resistance which you are using in the test, and then replace the resistance by another of different value. Again make a line above the pointer and write on the value, and proceed in this way with as many resistances as you can obtain. To check the value of the markings, connect various resistances in parallel and series to obtain different values and ascertain if they agree with your markings.

AERIALS. 7.

Outdoor Twin Aerials.



TWIN "L" TYPE AERIAL WITH WOODEN SPREADERS.

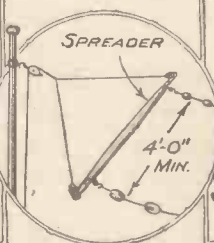

TWIN "T" TYPE AERIAL.

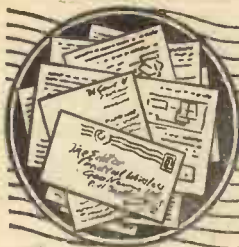

READERS' WRINKLES



A Pre-Set Resistance

A NEAT and handy variable resistance, such as may be used to decouple the screen of an S.G. valve is illustrated in the accompanying sketch. A piece of ebonite (A)

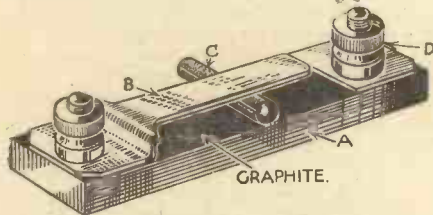

An easily-made variable resistance.

about 1 1/2 in. by 1/2 in. is drilled at each end. One terminal holds a narrow piece of springy brass, such as taken from a flash-lamp battery (B). The surface of the ebonite from terminal to terminal is thickly coated with graphite by means of a soft pencil, and the second terminal holds a square brass plate firmly on this (D) so as to ensure good contact. A fairly thick piece of pencil lead such as used in a draughtsman's compass (C) is inserted under the brass strip, so that by sliding it along the resistance may be varied, while the pressure of the spring keeps it in place. When a suitable value has been found either the whole thing may be immersed in wax to prevent variation, or a spaghetti may be matched to it by means of the well-known meter bridge.—J. H. ROWE (Dublin).

Operating Multiple Toggle Switches

HAVING found it necessary to devise a scheme to operate two or more toggle switches from the panel of my radio set, I hit upon the following idea. Two flat bars, 3/16 in. width, were secured to a couple of metal blocks which were placed upon a common spindle. These blocks were 3/8 in. thick to allow the knobs of the toggle switches to just ride easily inside them in course of their operation. The principle of their coupling may be easily gathered

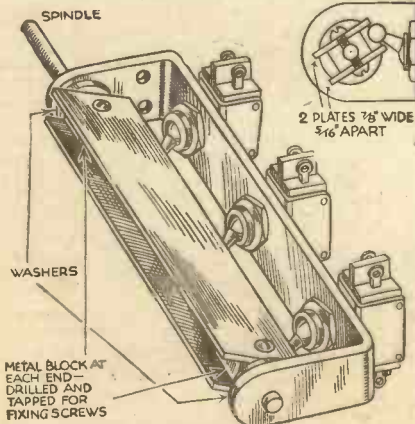

A method of operating multiple toggle switches.

THAT DODGE OF YOURS!

Every Reader of "PRACTICAL WIRELESS" must have originated some little dodge which would interest other readers. Why not pass it on to us? We pay £1-10-0 for the best wrinkle submitted, and for every other item published on this page we will pay half-a-guinea. Turn that idea of yours to account by sending it in to us addressed to the Editor, "PRACTICAL WIRELESS," George Newnes, Ltd., 8-11, Southampton Street, Strand, W.C.2. Put your name and address on every item. Please note that every notion sent in must be original. Mark envelopes "Radio Wrinkles." Do NOT enclose Queries with your Wrinkle.

from the accompanying sketches, and it will be found that the "snap action" is definitely transmitted to the main control knob.—W. H. ARTHUR (Liverpool).

Novel Change-over Switching

I HAVE two receivers in use, one for medium/long-wave reception, and the other for short-wave work. Each has three

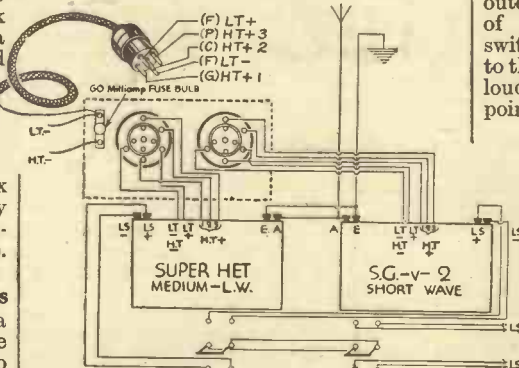

A novel change-over switching arrangement.

H.T.appings, and I got rather tired of changing over from one set to another each time I wanted to listen. There were L.T. + and -, H.T. -, H.T. +1, 2 and 3, A. and E., and loud-speaker to be connected. Eventually I placed the receivers side by side, the aerial and earth permanently joined. (Fortunately, one receiver is built right to left and the other from left to right). Behind the receivers two five-pin valve-holders are mounted on a piece

of 3/4 in. ply wood. The L.T. wiring from one set is taken to the filament points of one valve-holder and the three H.T.appings are taken to end, centre pin, and anode pins. The H.T. negative is connected in the set to L.T. negative, and similarly with the second set and valve-holder. The accumulator is connected to the filament pins of a Bulgin five-pin plug, and the H.T.appings from my eliminator are taken to the end, anode, and centre pins of the plug. The

H.T. negative from the eliminator is taken through a 60-milliamp fuse bulb to the L.T. negative pin of the plug. It is then a simple matter to plug the power on to either set as required. The loud-speaker terminal leads of the two sets are brought out and taken to the end contacts of a D.P.D.T. switch (No. 1). The centre contacts of this switch are led off to a BEVELLED loud-speaker. I desired to operate a loud-speaker in one of two rooms, and to facilitate this I interposed a second D.P. D.T. switch (No. 2), to the centre contacts of which I brought the leads from the centre contacts of the first switch. The outer contacts of the second switch are taken to the respective BEVELLED loud-speaker points.—A. C. LAMB (Dewsbury).

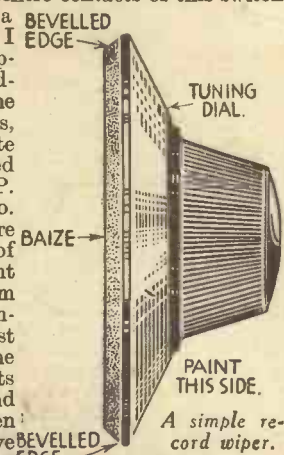

A simple record wiper.

A Simple Record Wiper

AN efficient dust remover for records may be made from a piece of baize and an old tuning dial. Cut a circle of baize the same size as dial, and glue it to the back of it. When dry, bevel the edge of the baize with a pair of scissors.—P. BINGLEY (Esher).

A Novel Wire-stripper

A PIECE of steel cut from an old saw blade, shaped as shown, and attached to a wrist band, makes an excellent wire-stripper for the home constructor. Two slots (E) are cut in each side of the blade, for the strap. The round part of this stripper is about 2 1/2 in. across, and the whole is 4 in. long. A V-shaped notch (B) is cut in the metal and the edges sharpened, as at (D). The steel piece is then bent back on itself, after heating.—J. CROWSHAW (Bolton).

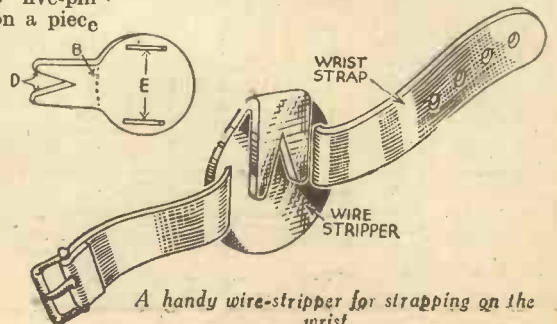

A handy wire-stripper for strapping on the wrist.

R-RANGE AG TWO

Experimenter and His Family.
"ELECTRIX"



broadcast coil with two aerial tap-pings; another switch contained in the base of the latter coil automatically connects the aerial to an appropriate tapping for medium or long-wave reception. When the set is required for operation on the two higher wavebands both windings (grid and reaction) of the two coils are in series, but when listening on short waves the windings of the broadcast coil are short circuited by a 3-point switch. Tuning is by a single knob which operates a .0005 mfd. condenser having a 35 to 1 reduction drive, thus making accurate tuning easy of accomplishment even on the highest frequencies.

Both coils have reaction windings, which are used in conjunction with a variable condenser. A .0001 mfd. reaction condenser is sufficient for

S.W. reception, but for the broadcast bands approximately twice that capacity is necessary. In order to satisfy both these conditions in the most satisfactory manner a .0001 mfd. variable reaction condenser is used and functions independently on S.W. When the 3-point switch is pushed "in," however, a fixed condenser of similar capacity is put in parallel with it. With this very simple arrangement reaction control is delightfully easy on every waveband.

Other Components

Two aerial terminals are provided, one for S.W. work and the other for Broadcast reception. Each is connected to the appropriate coil through a separate pre-set condenser so that the optimum setting can be found and retained for long and short waves. The detector valve (a new one of high amplification) operates on the usual leaky grid system although the values of grid condenser and leak are rather unconventional; values were chosen which proved to be equally satisfactory for each waveband. The grid leak is taken to the slider of a 250 ohm. potentiometer, wired across the filament supply, so that exactly the correct grid voltage can be applied under all conditions. The potentiometer can be left in almost any position for more or less local reception, but it is extremely valuable when carrying out long distance or S.W. reception. The H.F. choke has to deal with all wavelengths, and that chosen is specially designed for this purpose.

Instead of the usual L.F. transformer, a neat "Transcoupler" is employed which combines a high efficiency transformer with a parallel resistance-capacity anode feed circuit. The arrangement makes for "straight line" amplification of all frequencies, besides giving a greater degree of amplification due to the absence of D.C. current in the primary windings. A decoupling resistance and condenser are used to feed the transcoupler, so preventing motor-boating and L.F. feed-back. A

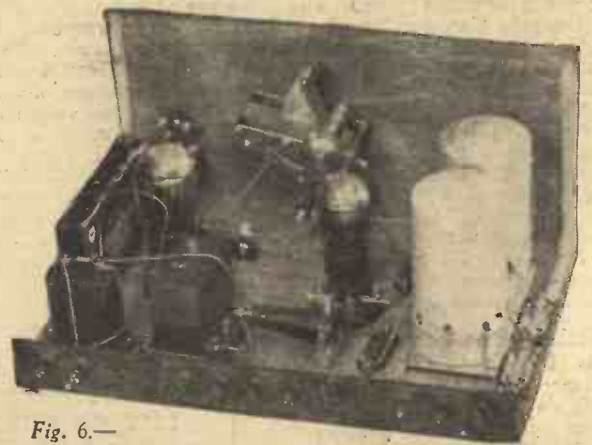

Fig. 6.—
Another view of the finished set, showing the coil screens.

100,000 ohm. non-inductive resistance (actually a metallized one), is inserted in the grid leak of the power valve to prevent the passage of any stray H.F. currents into the amplifier. The power valve chosen is one of the newer high-efficiency types, which gives a very high degree of magnification on a small anode current.

Practical Details

A plywood panel is specified in the list of components, but an ebonite one may be used in its place if desired. The plywood is, of course, cheaper, and is one of the writer's pet fads because it can be finished in such a variety of ways to match cabinets or furniture, and it does not discolour with exposure to sun and bright light. The positions and diameters of the panel holes is given in Fig. 5. Details of the construction and wiring are most easily obtained from the photographs Figs. 1, 3 and 4, and the wiring plan, Fig. 2. All wiring is in "Glazite" insulated wire, which can be attached to the terminals after baring the ends by looping and fitting it under the nuts. It might not be quite clear from the wiring plan that two connections are made to the aluminium baseplate of the coil assembly. These are made by looping the wires round the holding-down screws before tightly screwing down the latter. These two connections simplify slightly the wiring and, of course, serve to "earth"

(Continued overleaf)

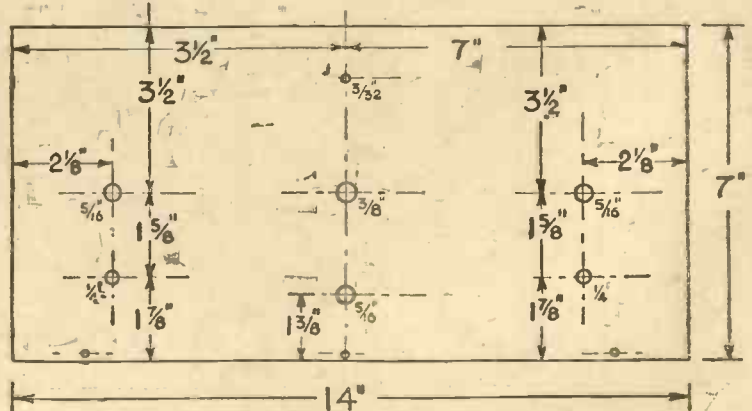
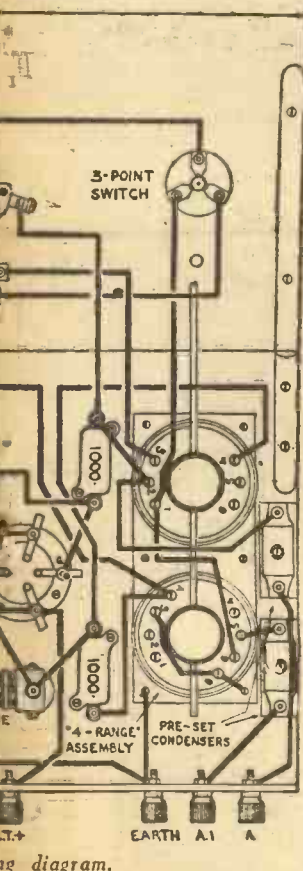

Fig. 5.—The panel layout.

(Continued from previous page)

the entire screening system. The two leads to the grid bias wander plugs are made with flex, so that they can be moved more easily. The spaghetti resistance itself is used to connect the "High" terminal of the transcoupler to the 2 mfd. by-pass condenser. Little need be said of the other wiring, since this is perfectly straightforward. The containing cabinet specified and employed by the writer is made up from a set of "Byldurone" components. Its internal dimensions are 14in. wide by 7in. high by 14in. deep, so it is sufficiently large to accommodate both accumulator and high-tension battery.

Working the Set

It is best to employ a high-tension battery of no less than 100 volts, and with a voltage of about that figure the appropriate grid bias voltage will be 3. With these voltages the total anode current consumption is between 5 and 6 milliamps, so a battery of the smallest capacity is adequate and will give satisfactory service for several months.

When batteries, aerial, earth, and speaker, have been connected, first try the set on broadcasting; this is done by connecting the aerial to terminal A.1 and pushing in the 3-point switch. Set the reaction condenser to its minimum position (anti-clockwise), and pull out the battery switch. Rotate the tuning dial until a station is heard, and then bring it up to required strength by increasing reaction. When searching for weaker or more distant stations, the reaction knob should be set to a position just short of the oscillation point while the tuning dial is rotated. In some cases it might be desirable to manipulate both tuning and reaction knobs simultaneously, but with the original receiver it was found that

once the reaction was set to its best position for one station little alteration was required whilst "searching" was carried out. This applies to both the 200 to 550 metre and 900 to 2,200 metre bands, the former of which is obtained by turning the coil switch to the left and the latter by turning it to the right.

For Short-wave Work

To use the two lowest wavebands connect the aerial to terminal "A" pull out the knob of the 3-point switch and turn the coil switch to left or right for the 18 to 35 metre or 30 to 65 metre band respectively. Searching is done in a manner similar to that just described, but as tuning is much more delicate it must be carried out by using the slow-motion knob only.

Reaction also is more critical and the last fine adjustments are most easily made on the potentiometer. Stations can be received all round the dial, but it is best to use the first half, that is up to 90 or 100 degrees.

So far no mention has been made of the method of setting the two pre-set condensers. There is no difficulty in this; first tune in a station, and then adjust the pre-set condenser associated with the particular waveband in use until the signal is brought to maximum intensity. In doing this the tuning must be adjusted each time the capacity of the pre-set condenser is changed. The most suitable capacity for the pre-set condenser connected to Terminal "A" (S.W.) will depend principally upon the aerial.

LIST OF COMPONENTS FOR THE FOUR-RANGE SUPER-MAG TWO

- | | |
|--|--|
| 1 Plywood Panel, 14in. by 7in. | 1 .0002 mfd. Fixed Condenser (Dubilier type "670"). |
| 1 Baseboard, 14in. by 9in. by ½in. | 1 3 megohm Grid Leak (Dubilier). |
| 1 Pair Panel Angle Brackets (Bulgin). | 1 Grid Leak Holder (Bulgin). |
| 1 Ebonite Terminal Strip, 14in by 1½in. by ½in. (Becol). | 1 .0001 mfd. Fixed Condenser (Dubilier type "670"). |
| 9 Terminals; marked "A," "A.1," "Earth," "L.T.+" "L.T.-," "H.T.-," "H.T.+" "L.S.+" "L.S.-" (Belling Lee type "R"). | 2 Low-Loss Valve Holders ("Eddystone"). |
| 1 .0005 mfd. Variable Condenser with Slow Motion Drive (Jackson Bros. type "D"). | 1 Universal H.F. Choke ("Eddystone"). |
| 1 Dial Indicator (Bulgin). | 1 L.F. Transcoupler (Bulgin). |
| 1 .0001 mfd. Reaction Condenser (Jackson Bros. "Midget"). | 1 30,000 ohm. Spaghetti Resistance (Bulgin). |
| 1 2-spring Battery Switch (Bulgin "Junior"). | 1 2 mfd. Fixed Condenser (Dubilier type "BB"). |
| 1 3-spring Wavechange Switch (Bulgin). | 1 100,000 ohm. Metallized Resistance (Dubilier, 1 watt). |
| 1. 250 ohm Potentiometer (Colvern type "M.T."). | 1 pair G.B. Battery Clips (Bulgin No. 1). |
| 1 set "Four-Range" Coils; supplied complete with Ganged Aligned switches and Base-plate (Colvern "Four-Range"). | 2 Wander Plugs; marked "G.B.+" and "G.B.-" (Belling Lee). |
| 2 .0001 mfd. (max.) Pre-Set Condensers (Colvern). | 2 Coils Glazite, odd lengths flex, ½in. Screws. |
| | Approximate Cost, £4 0 0. |
| | Accessories: |
| | 2 Valves: 1 Mullard P.M.1.H.L. (new type) and 1 Mullard P.M.2 A. |
| | 1 Cabinet (J. J. Eastick and Sons, "Byldurone"). |

WHILST the authorities fully appreciate how the latest developments in the design of portable radio transmitters and receivers will be of assistance to armies in the field in future wars, the question of amplified speech or music for use with armies on the march appears to have been strangely neglected. A considerable sum of money is spent in the training and maintenance of bandmen whose efforts are spectacular and heart-stirring when playing in front of their regiments on the parade ground, but are of little use when regiments are on the march in war-time.

The function of regimental bands, when examined from a practical viewpoint, would appear to be to keep up the spirits of the troops whilst on the march. But only a small proportion of the soldiers are able to hear the efforts of their musical colleagues.

Orders to columns of infantry on the march are passed down the line by the sergeant-majors or sergeants shouting the directions from one to another, so that by the time an order has reached the last sergeant many minutes may have elapsed. When it is necessary to bring a regiment immediately to the halt this time factor may have serious consequences.

Power Amplifiers

The adoption by the War Office of high-power amplifying equipment would pro-

RADIO in the NEXT WAR

Will a Gramophone Record Replace a Thousand Bandmen?

By RICHARD ARBIB

vide greater efficiency and at the same time effect considerable economies.

We can visualise the British armies on the march in future wars, which we sincerely hope will never take place, being preceded by a large van somewhat similar in appearance to the B.B.C. detector vans. It will be painted in khaki or covered with foliage to camouflage it from enemy aircraft. When used on the parade ground or at regimental reviews it may be decorated in the colours of the regiment it precedes.

Mounted on its roof will be two or more high-power loud-speakers. Inside will be a double turntable gramophone unit, suspended in rubber slings, whilst mounted in rubber against the walls will be powerful amplifiers. The troops will be able to march in perfect rhythm to the music reproduced from gramophone records which have been made by an ideal military band.

Transmitting Apparatus

The range of a loud-speaker van would probably be limited to a quarter of a mile, in order that the volume of sound would not be distressing to the troops immediately

following it. The monitor van would, however, be linked up by a small power short-wave transmitting apparatus to other vans at quarter-mile intervals. These would be installed with similar amplifying and loud-speaker apparatus, and thus the whole column of troops would march to the same music.

More powerful loud-speakers, having a greater range, could be used, but this would be inadvisable owing to the time lag of sound which might prevent the soldiers equally distant from two vans hearing the music satisfactorily.

Perhaps the greatest asset in employing these mobile amplifying equipments will be the immediate reception by troops of verbal orders. Instead of the sergeant-majors passing the orders to one another in stentorian voices, the commanding officer will be able to murmur his directions in front of a microphone connected to the monitor van, and his voice will be at once audible over a radius of several miles.

At the Aldershot Tattoo each year the commands to the troops whilst they were in the arena could only just be heard by the audience in the Grand Stand, but when, at the end of the performance, the epilogue, spoken by a well-known actor, is reproduced through the loud-speakers, as are the details of the items, every member of the audience of many thousands present can hear each word distinctly.

Practical Television

SUPPLEMENT TO PRACTICAL WIRELESS

AUGUST 11th, 1934. Vol. 1. No. 32.

TELEVISION RECEIVING CIRCUITS

By H. J. Barton Chapple, Wh. Sch., B.Sc., A.M.I.E.E.

MANY and varied are the number of radio receiving circuits which can be employed in conjunction with television apparatus in order to obtain images which are visually satisfactory. No hard and fast rules can be laid down in this connection owing to the varying distance of constructors from the London National Station which radiates the signals, coupled with questions of local environment which have a marked bearing on the degree of amplification necessary to produce an output signal of adequate strength reasonably free from interference.

Bearing these individual factors in mind, however, it is possible to furnish details of types of circuits which from actual practical experience have given good results. Contrary to popular belief quite a simple "straight" set can be built up which will modulate successfully an ordinary disc television receiver, especially if this machine incorporates a beehive or "letter" neon lamp in lieu of one of the flat plate variety. A well-tried circuit of this nature is shown in Fig. 1 together with component values, and this is satisfactory within approximately thirty miles of the London National station. It is a three-valve battery-operated set with a variable-mu high-frequency pentode stage (this may be replaced with a screen-grid valve of the variable mu or "straight" class if preferred) together with anode bend detector stage coupled to a pentode output valve. For simplicity a straightforward tapped aerial coil is shown, but this can be modified to suit individual tastes provided the circuit is not made too selective. For a simple home-made coil L_1 can consist of 60 turns of No. 24 gauge D.S.C. wire wound tightly on a 3-inch diameter former, a tap being made at the fifteenth turn from the earth end.

The variable-mu feed to V_1 is quite standard practice, but in the anode circuit coils L_2 and L_3 constitute an H.F. transformer arrangement, L_2 consisting of 60 turns of 36-gauge D.S.C. wire wound on a 3-inch diameter former, while L_3 has 60 turns of 24-gauge D.S.C. wire on the same former, the windings being kept close together to give a tight magnetic coupling. If the constructor has some old type two pin plug-in coils available, these can even be used. L_1 then becomes a No. 60 tapped coil, L_2 a No. 40 or 60 coil, and L_3 a No. 60 coil, coils L_2 and L_3 being mounted close together to give the required degree of magnetic coupling.

The detector stage is quite normal, the appropriate negative bias to the grid of V_2 for anode bend rectification being furnished by GB-2. Resistance capacity coupling links V_2 and V_3 and, in order to reduce the total high tension voltage required, the neon lamp (and synchronising

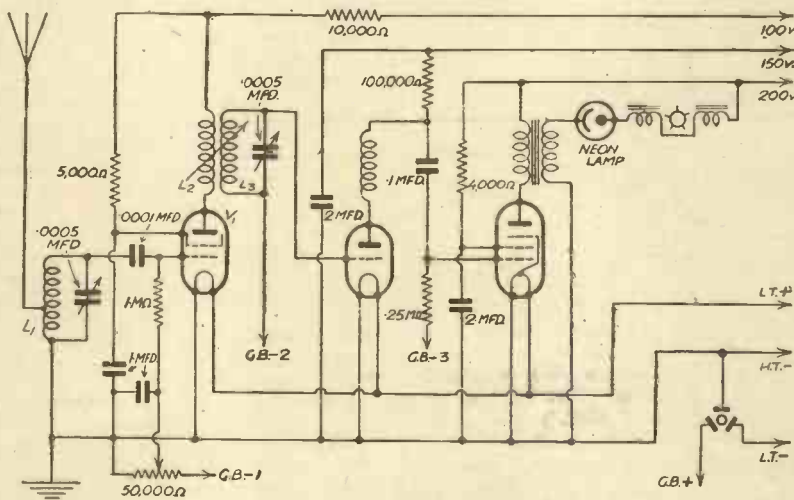

Fig. 1.—A simple three-valve battery circuit suitable for receiving television signals.

coils if included in the receiver) are coupled to the output of V_3 via a 1/1 output transformer.

Standard valves are quite satisfactory for this set, V_1 being of the V.P.2 or 220 VS type, V_2 of the PMILF or L210 type, while V_3 can be either a PM22 or a 220PT. It will be noticed that the coils specified are only for the medium waveband, it being assumed that the set is to be used only for television. If desired, however,

dual range coils may be included, in which case the receiver, in addition to being available for television reception, can serve as a stand-by battery set for home use.

A Mains Receiver

Fig. 2 shows a mains-driven three-valve receiver following on very similar lines to that of Fig. 1. The same valve combination and methods of coupling are used, while a grid bias battery is employed for the anode bend detector stage, it being proved by test that this gives slightly better results than when automatic bias is used. The eliminator side is quite standard and for the valves a choice can be made from AC/SG, MSG/LA, S4VB for V_1 ; MH4, 41 MFH, AC/HL for V_2 ; PM26, 615PT, PT625 for V_3 ; and 460BU, DW4, U14 for V_4 . In the case of the mains rectifying valve it must be arranged that the transformer windings give only a 400-volt feed after rectification as the component values have been calculated on this basis.

A circuit of somewhat greater range and power for disc-type receivers is indicated in Fig. 3. The eliminator side has been omitted here, as this can follow standard lines, while battery bias is shown for simplicity. This latter can be converted to automatic bias if desired. Briefly, the circuit shown consists of a band-pass filter with condenser coupling to give a wide peak separation. V_1 is a standard S.G. valve, but a variable-mu H.F. pentode or S.G. valve can be used if desired. This valve has a choke-grid feed to a power grid-detector valve, followed by an R.C. coupling to the first L.F. valve with two power valves arranged in push-pull in the output stage. No reaction is included in the detector stage, while the neon lamp of the disc television receiver is linked to the extremities of a centre-tapped output choke via two 2 mfd. condensers.

(Continued overleaf)

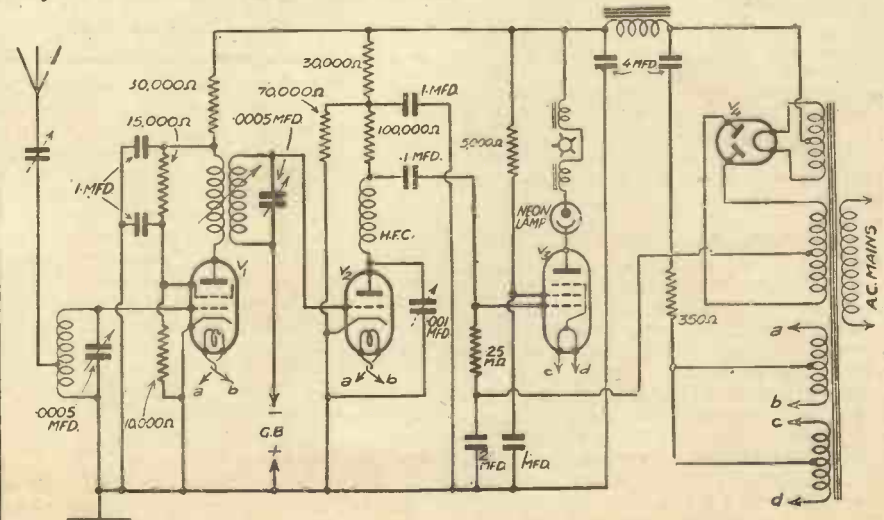

Fig. 2.—A three-valve combination similar to Fig 1, but mains driven.



By Jace

Wireless on Arctic Aeroplane

MR. JOHN GRIERSON, the well-known airman who is now on the first stages of his flight to America, via the Arctic air route, is relying on a special Marconi short-wave aircraft installation for reporting his progress.

This short-wave transmitter, which has been specially developed for the flight, operates on a wavelength of 34 metres, and when in the air hourly messages are transmitted, giving the position and other particulars of progress. The Radio Society of Great Britain has arranged for its members to listen to Mr. Grierson's transmissions throughout his flight, and on his second stage from Londonderry to Iceland several members of the Society successfully received all his messages until the final one notifying his arrival.

In addition to the wireless transmitter, the machine is fitted with a Marconi-Robinson "homing" device which, in the absence of wireless direction-finding facilities on the Arctic route, is of the utmost value to the aviator. It enables him to fly accurately to any wireless station on his route, and it also gives him the facility to check his course during the flight. This is particularly valuable in view of the magnetic conditions in the Arctic which frequently render the ordinary compass unsteady and unreliable.

The "homing" device is extremely simple in operation. A three-way switch indicates to the airman if he is flying on his correct course or if he has veered to the right or to the left of it. On the flight from Londonderry to Iceland the "homing" device worked to perfection and materially assisted Mr. Grierson to accomplish this difficult part of his enterprise without a hitch.

New Teleprinter Service

WE are informed that a private teleprinter service has now been installed between the London office and the Chippenham works of the Westinghouse Brake and Saxby Signal Co., Ltd. The installation at each end includes, of course, a Westinghouse metal rectifier, which is a standard part of A.C. teleprinter equipment.

By Air to Olympia

ARRANGEMENTS have been made by Marconiphone to enable Marconi men in all parts of the British Isles to visit the National Radio Exhibition at Olympia by air. Hillmans Airways, Ltd., will supply a fleet of aeroplanes for the exclusive use of Marconi men throughout the period of the Exhibition. The service will be on similar lines to that in operation last year, but with vastly improved facilities in comfort, convenience and speed.

A daily service will be established from

all the principal airports in the British Isles to Heston and from there conveyance will be arranged to Olympia. Dealers are invited to notify the Marconiphone Publicity Department as early as possible as to the date on which they wish to travel to Olympia and also the return journey. (Only return passages booked.)

The daily service will be subject to enquiries received and calls will only be made at those airports from which bookings have been arranged. The cost is 3d. per mile each passenger, taking mileage as on a direct line between the airport and Heston Aerodrome. This includes conveyance from Heston to Radio Exhibition and a visit to Hayes may be included at the dealer's special request. All bookings must be made not later than August 11th, but in order to facilitate organization, dealers are requested to write as early as possible. Where large parties are travelling together, reduction may be made in the cost.

The following are some typical return fares:—

Bristol	£2 15 0
Birmingham	3 0 0
Bradford	5 0 0
Glasgow	10 0 0
Hull	4 0 0
Leicester	2 15 0
Liverpool	5 0 0
Manchester	5 0 0
Newcastle	7 5 0
Sheffield	4 5 0

Twelve airplanes will be available, and six are of the very latest type, being the new De Haviland Dragon Pullman planes to seat six passengers. They are most luxuriously fitted and are capable of an air speed of 150 miles per hour.

Outside Broadcasts

CONCERT-PARTY relays from Bellevue Gardens are now appearing fairly regularly in the Belfast programmes. The bandstand at Bellevue is an open one and the exposed nature of the plateau on which it stands occasionally leads to trouble for the engineers if a high wind is blowing. Special shields for the microphones have had to be made. Up to the present all the relays have been carried out in fine weather and before enthusiastic audiences.

Group Listeners

IN a booklet issued by the B.B.C. entitled "Broadcast Education in Great Britain—1922-1934," it is stated that, considered in relation to the total number of licence-holders, the number of group listeners is unimpressive; but considered as the first fruits of an experiment with a new medium, it is more interesting, especially to those who are familiar with the difficulties and, above all, with the apathy which meets formal adult education. Moreover, the groups have a significance quite unrelated to their numbers. They are the living evidence that a number of listeners have realized their own responsibility for seeing that broadcasting plays a part in the cultural life of the community and have shown their readiness to co-operate with the B.B.C. to that end.

ROUND THE WORLD OF WIRELESS

(Continued from page 569)

Shrewsbury Floral Fête

DURING the evening of August 12th the Mayor of Shrewsbury (Mr. Richard Mansell) will give Midland Regional listeners his recollections of the Shrewsbury Floral Fête over the past fifty years. The show was founded in 1875, and since 1882 has had a performance of the Massed Guards' Bands as its principal musical feature. The three bands this year are those of the Coldstream Guards, Scots Guards, and Welsh Guards, and they will be relayed on Thursday, August 16th, the second and closing day of the famous Flower Show. With the exception of Shrewsbury, Massed Guards' Bands are not heard out of London. The three conductors are: Major Andrew Harris, the Senior Director of Music in the Brigade of Guards; Lieutenant J. Causley Windram; and Lieutenant H. E. Dowell.

Golf Broadcast

THE Men's International Golf Matches finish at the Royal Porthcawl Golf Club on August 17th, and at 22.00 on that day Bernard Darwin will give an eye-witness account of the matches for West Regional listeners.

Works of F. A. Nichols

FRANK A. NICHOLS has been associated with Northern broadcasting since the spring of 1927, and in honour of his fiftieth birthday, on August 9th, a special "Jubilee" programme of his works will be broadcast from Manchester. It will consist of excerpts from some of the 322 radio plays and sketches in which Mr. Nichols has taken part. Although he is well-known to-day in the rôle of Bill Brown of Owdham, some listeners may be too young to remember him as Newnan Hyde, the Lancashire comedian (his only solo rôle), or his more recent appearances as Griffith Griffiths, of the Professor Zweistein and Mr. Griffith Griffiths sketches.

Variety Programme for National Listeners

BURNS AND ALLEN, the talented broadcasters and film actors, who recently arrived in Europe from New York, are to appear at the top of a variety programme for National listeners on August 11th. They will have several British broadcasting "stars" to keep them company; for example, Norman Long, Harry Hemsley, and Robb Wilton (in "The Fireman," assisted by Iris Parnell). Kneale Kelley will be back from his holidays to conduct the B.B.C. Theatre Orchestra on this occasion.

Light Entertainment from the Scottish Regional

THE Motherwell and Wishaw Town Band, conducted by Jack Remington, with Mae Johnston (soprano) and William McCulloch (entertainer), will provide an entertainment for Scottish Regional listeners on August 13th.

On August 15th the Sunshine Follies will present a new programme in the Pavilion Theatre, Perth, which will be relayed to Scottish Regional listeners. The cast includes George Doonan, Elsie Prince, Jimmy Jerome, Muriel Farquhar, Six Sunshine Girls, and the Rhythm King's Band.

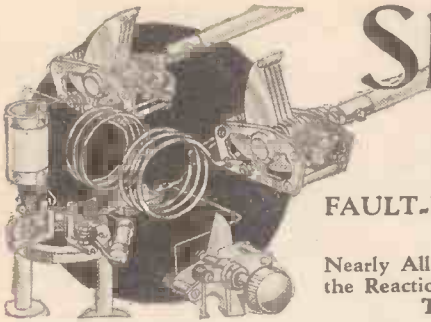

Short Wave Section

FAULT-FINDING IN A SHORT-WAVER
By FRANK PRESTON.

Nearly All S.W. Troubles Occur in Connection With the Reaction Circuit, and the Methods of Overcoming Them are Described on This Page.

GENERALLY speaking, the principal forms of trouble which occur in a short-wave receiver are the same as those in a normal broadcast set, and can be traced and cured in the same way. There are, however, additional faults which are peculiar to short-wave instruments, and the newcomer to S.W. work may find a good deal of difficulty in interpreting the symptoms.

The most widespread fault in the average type of simple short-waver, particularly one of the Det.-L.F. variety, is poor reaction control. Sometimes this manifests itself in the inability to obtain reaction (and generally, therefore, reception) below a certain wavelength, but quite often it is found that feed-back is steady and normal at some parts of the tuning dial, and "ploppy" or even unobtainable at other dial settings. The latter difficulty is usually described by saying that there are "dead-spots" in the tuning range.

Incorrect Values

When it is found that the set refuses to oscillate below a certain wavelength, although it functions normally at higher condenser settings it is frequently a sign that the component values are incorrect, or that there is too much capacity between components or wiring. The former point cannot be dealt with at any length, because the actual values required depend so much upon the particular circuit employed, whilst if the receiver has been made to some published circuit the difficulty should not arise. In general, however, it may be said that

the values of all condensers should not exceed about one-third of the equivalent ones in a set intended for medium-wave work. For example, a .0005-mfd. tuning

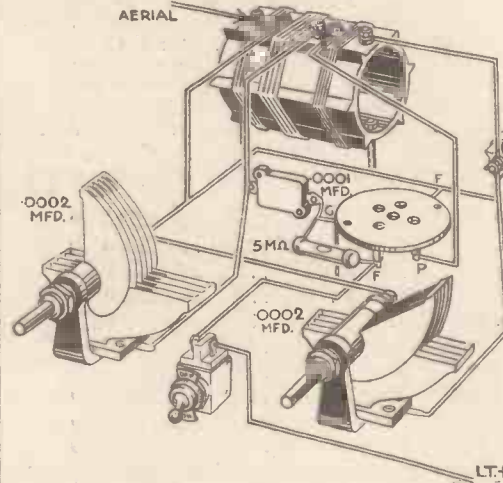

Fig. 2.—Theoretical and pictorial diagrams of throttle controlled reaction.

condenser should be replaced by one of .00015 mfd., a .0001-mfd. reaction condenser would be employed in place of the more customary .0003 mfd., and so on.

It has been mentioned so often in

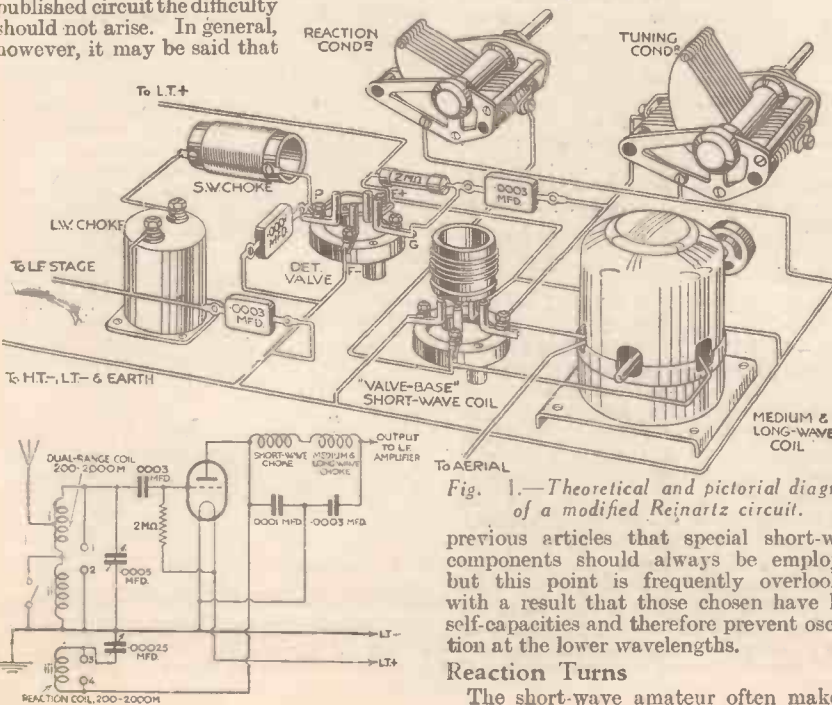

Fig. 1.—Theoretical and pictorial diagrams of a modified Rejnartz circuit.

previous articles that special short-wave components should always be employed, but this point is frequently overlooked, with a result that those chosen have high self-capacities and therefore prevent oscillation at the lower wavelengths.

Reaction Turns

The short-wave amateur often makes a

mistake in connection with the reaction coil for, when he finds that oscillation cannot be induced below, say, 30 metres, he immediately adds more turns to the reaction winding. In nine cases out of ten this has no good effect at all, and probably makes reception more difficult even higher up the tuning range. The fact of the matter is that the larger winding often produces a pronounced damping effect, and thereby "kills" reaction over a large portion of the tuning scale. The point to remember is that there is a fairly critical relation between the optimum size of the reaction

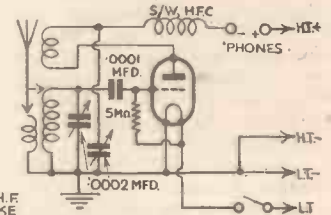

winding, the size of the tuning winding and the capacity of the reaction condenser. There are some experimenters who prefer to use a reaction

winding having a larger number of turns than the tuned winding in conjunction with a reaction condenser of comparatively low capacity, whilst others would rather employ a smaller reaction winding along with a condenser of rather large capacity. Both systems have their advantages in different circuits, but the experimenter

who is not very accustomed to short-wave work will nearly always find it preferable to adopt the latter plan. The reason is that the large coil and small condenser are more liable to form a resonant circuit and to "take charge" of the tuning. In other words, the circuit tunes to stations on the waveband covered by the aerial coil, and makes it impossible to receive signals on wavelengths lower than those covered by the reaction circuit.

For most purposes it will be found satisfactory to employ a reaction winding having approximately 80 per cent. of the number of turns used for the aerial or grid winding. For example, when the grid winding consists of four turns (this number on a 2 1/2 in. diameter former should cover a wavelength range of about 18 to 30 metres) the reaction coil should have about three turns. With an 18-turn grid coil (50 to 110 metres) a reaction winding of thirteen or fourteen turns. In the case of tuning coils having more than about twelve turns, however, it is often possible, and better, to make the reaction winding only about half the size of the other one. It is always worth while to experiment with the number of reaction turns, in order to find the smallest winding which will produce oscillation over the complete waveband in conjunction with the particular value of reaction condenser chosen.

Dead-Spots

Dead-spots in the turning range are sometimes due to a bad choice of reaction-circuit values, but more frequently to the use of an unsuitable type of aerial coupling or to the employment of an H.F. choke of poor or unsuitable design. There are three

main methods of aerial coupling, all of which are well known, and are used for other than short-wave reception. In the first, the aerial is connected through a fixed or variable condenser to the "top" of the grid coil, in the second the aerial goes to a tapping on the grid winding, and in the third a separate, loosely-coupled aerial winding is made use of. It is scarcely possible to say definitely that any one is better than the others, since all have their uses in different circumstances. The beginner is, therefore, advised to try them all, and in doing so different sizes of loose-coupled aerial windings and different tapping points on the grid winding (which amounts to the same thing) should be tried. A considerable amount of interesting experiment can be carried out along these lines, and the result will fully justify the time spent.

Aerial-Reaction Coupling

There is another form of coupling which, although not a very well known one, is worth a trial. This consists of coupling the aerial to the reaction coil, either by means of a loose-coupled winding or by connecting it to a centre tap—preferably through a small variable condenser. Very often when all other methods of removing "dead-spots" have failed this will prove successful.

Although there are various alternative methods of applying reaction, the modified Reinartz system illustrated in Fig. 1 is nearly always employed. It has its advantages, of course, but the "throttle" control circuit shown in Fig. 2 will often be found better in giving a smoother variation of feed-back. Besides this, the Fig. 2 method is less inclined to affect the tuning circuit. The pictorial circuit is self-explanatory, and it need only be said that it is preferable that the reaction condenser should be provided with a fairly long extension spindle in order that hand-capacity effects may be avoided as far as possible.

The old "swinging-coil" method of reaction control is worth a trial, despite the criticisms that have been levelled against it. Provided that a really smooth and even movement can be imparted to the moving-coil the method is almost ideal. This delicate and accurate movement can best be obtained by mounting the coil on a spindle rotated by means of a slow-motion condenser drive. The principal objection is that coil-changing would be inconvenient where this method was employed; it is, therefore, preferable that it should only be applied to sets intended for one particular short-wave range or to those in which a multi-range tuner is fitted.

**THEY ALL
MAKE SURE
AND USE...**

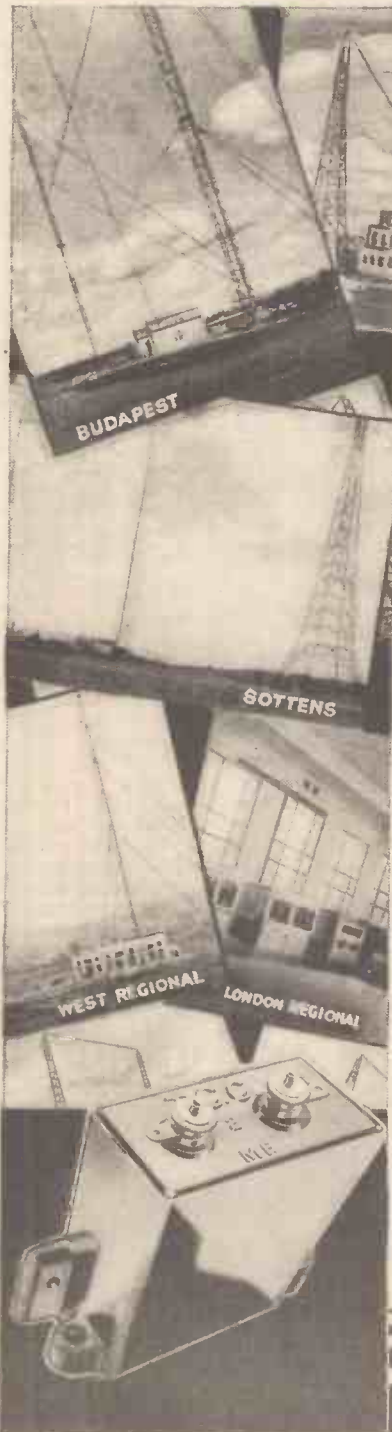

**T.C.C.
ALL-BRITISH
CONDENSERS**

BUDAPEST, Sottens, West and London Regionals, Kalundborg, the Empire transmitter, and a score of others... they all rely on T.C.C. Condensers when they are sending you programmes. The Service they give demands continuous dependability, that is why their choice is T.C.C. Condensers.

At your end... your receiver—little use these stations giving you of their best if your set is out of commission because "a little something" has gone wrong.

* * *

To you the smallest fixed condenser in your set is as vital as the biggest condenser in the transmitter. Keep the chain complete, see that your set is fitted with T.C.C. Condensers, an assurance that you will not miss a programme because of a faulty condenser. T.C.C. experience and "repeated test" methods are your guarantee.

The illustration is of a 2 mfd. Type 50 NON-INDUCTIVE T.C.C. Condenser for 200v. D.C. Working, tested to 400v. D.C. Price 3s. 6d.

The Telegraph Condenser Co., Ltd.,
Wales Farm Rd., N. Acton, London, W.3

**THE WIRELESS
CONSTRUCTOR'S
ENCYCLOPÆDIA**

(2nd Edition)

By **F. J. CAMM**

(Editor of "Practical Wireless")

THIS invaluable encyclopædia is written in plain language by one of the most accomplished designers and writers on wireless construction.

Obtainable at all Booksellers or by post 5/6 from Geo. Newnes, Ltd., 8-11, Southampton Street, Strand, London, W.C.2. **5/-**

Facts and Figures

Components Tested in our Laboratory

BY THE PRACTICAL WIRELESS TECHNICAL STAFF

Radio Exhibition

WITH the approach of the Radio Exhibition at Olympia, many component manufacturers are introducing special new lines. Information is already to hand concerning many of these components, and amongst the descriptions on this page will be found some details relative to these new lines. We would consequently remind readers that some little difficulty may be experienced in obtaining these items from their local suppliers, owing to the fact that full supplies are not yet available, and therefore, unless the items are urgently required, their orders should be postponed until the exhibition is well under way. In the case of an urgent order, the manufacturers themselves should be approached.

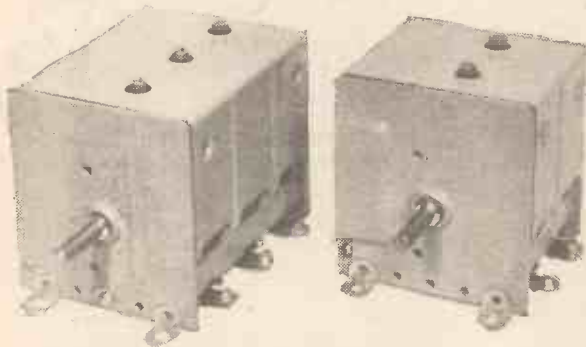

A two-gang and three-gang condenser from the new season's Polar range.

New Polar Condensers

IN accordance with the present-day scheme of reducing the size of components, Messrs. Wingrove and Rogers, manufacturers of the popular Polar accessories, have introduced for the new season some neat and compact ganged condensers, two samples of which are illustrated above. The overall size of these may be judged by noting the proportions of the control spindle, which is of the standard $\frac{1}{2}$ in. section and is 1 in. in length. These condensers are known as Polar Midget Gang Condensers, and are constructed with stout steel frames and cover, and the rotor section is mounted in ball bearings to remove all friction and at the same time to provide a really smooth movement which is fully controllable by means of a slow-motion drive. There are, of course, a number of ganged condensers at present on the market which prove so stiff in the bearings that when a slow-motion drive is attached the pointer is continually slipping and accurate readings are not possible. A further improvement in these ganged condensers is to be found in the trimmers which are situated at the top

and which are non-slipping and retain their setting most accurately. The adjusting screw projects from the dust cover and reduces the risk of short-circuits should a metal screw-driver be employed for the trimming adjustment. Connection to the fixed sections is made through the medium of a stout brass arm and a screw, with an alternative arm for a soldered joint if that is preferred. The finish is in grey cellulose, and the whole instrument has a most workmanlike appearance. The two-gang condenser costs 11s., and the three-gang (for straight or super-het. circuits) costs 16s. 6d.

Atlas Mains Unit

THE illustration at the foot of this page shows the new Atlas Type T.10/30 Mains unit, which is an addition to the present range of mains apparatus manufactured by Messrs. H. Clarke and Co. (M/cr) Ltd. This is designed for connection to any A.C. supply from 200 to 250 volts having a periodicity between 40 and 120 cycles and the output is suitable for battery receivers employing "straight" or Q.P.P. outputs consuming up to 30 mA. Three positive H.T. tapings are provided, the first giving 60 to 80 volts at minimum and maximum positions, and the second giving 50 to 90 volts in three positions—minimum, medium and maximum. The

high voltage output is rated at 120 or 150 volts, the alternative values in each case being obtained by inserting the appropriate plug into the socket carrying the desired marking. A small panel at the lower edge of the case is provided with three sockets marked 10, 20 and 30 mA, and a plug may be



The Atlas type T.10/30 mains unit.

inserted into the socket showing the output which it is desired to employ in the maximum tapping position. To the left of this panel is a small tumbler switch which brings into circuit a trickle charger for the L.T. accumulator and provides a charging current of .5 amps. Rectification is carried out by means of a Westinghouse rectifier, and the regulation provided is of a high order. The Unit may be thoroughly recommended. The price is 69s. 6d. cash, but is also obtainable on hire purchase terms of 10s. deposit and eight monthly payments of 8s. 6d. each.

Elex Duplex Coil Price Reductions

A SUBSTANTIAL decrease in the price of the popular Duplex Short Wave Coil and its base is announced by Messrs. J. J. Eastick and Sons. In future the coil will cost only 2s. 6d. and the base 1s. 6d. Readers will remember that previously the coil has cost 5s. and the base 2s. 6d. This handy combination will enable anyone to build a short-wave receiver, converter or adaptor, and provides a ready method of changing the range over the bands from 15 to 30 and from 28 to 60 metres.

Everett, Edgumbe and Radiolab

WE recently reported on the interesting Radiolab products and we now understand that the well-known firm of Everett, Edgumbe and Co., Ltd., makers of the well-known Meggers and other electrical instruments, have taken over the manufacture of the Radiolab products and are extending the range of radio instruments to include the smaller Everett electrical meters.

Milnes Radio Speakers

MILNES RADIO CO, LTD., of Bingley, Yorks, have previously been known only for the ingenious H.T. battery which they have marketed for some years and which, as our readers know, possesses the novel feature of being rechargeable from a 6-volt accumulator. They now intend to enter other branches of the radio field and are producing a permanent magnet moving coil speaker in two models, one at 32s. 6d. and one at 43s. 6d. These may be obtained in cabinets at a slightly increased cost. A special two-claw magnet is used, possessing unusually high flux density and gives splendid results. The Input transformer is of the Universal type and thus enables any output valve to be matched satisfactorily.

A further line which will be shortly introduced by Messrs. Milnes will consist of a superheterodyne receiver. This has been designed for use with the special Milnes H.T. supply unit and employs 5 valves incorporating 8 stages and 9 separate tuned circuits.

Every modern feature has been included in this receiver, further details of which will be given at a later date.

PRACTICAL LETTERS FROM READERS

The Editor does not necessarily agree with opinions expressed by his correspondents. All letters must be accompanied by the name and address of the sender (not necessarily for publication).

Five-valve Superhet Wanted

SIR,—Superheterodynes are becoming very popular with the manufacturers, and I believe they have come to stay. I appreciated the article by Frank Preston in PRACTICAL WIRELESS, June 23rd, 1934, entitled "Some Superhet Pointers."

Personally speaking, I want to see more articles about superhets, and what I would like to see more than anything else is a good five-valve superhet for the home-constructor, with either class B or pentode output A.V.C. and single-knob tuning. Can we look forward to such a set in the very near future?—W. R. GIRVAN (Monaghan, I.F.S.).

[We have Mr. Girvan's suggestion under consideration and hope to publish in due course particulars of a set on the lines of that mentioned above.—ED.]

A South African Reader's Thanks

SIR,—I have received my copy of "Everyman's Wireless Book," for which many thanks. It certainly is a very instructive and helpful book, and has helped me considerably in clearing up many of the "snags" connected with wireless. I have taken PRACTICAL WIRELESS since July last, but this is the first gift offer I have taken advantage of, and I must congratulate you on the production of so helpful a book.—J. E. KAY (East London, South Africa).

Steam-Roller Radio

SIR,—Yet again Dr. Hackenoff speaks! As he has already stated, certain secret seeds were sown—planted among men at the Institution—some time ago, in hope that "wireless for steam-rollers" might crop-up and stay up—and now, we gather, from Hack's own hamper here, that all his hush-hush husbandry—cum-careful cultivation—has frothed fruit enough to crown him "High Hat in the Canned-Goods Game!" Some will say: "Hack's a hop-head, and this is the aftermath of a session with the Pipe." Others will tell you it's all a trick, done with concealed wires—but we ourselves would rather say: "Well, Hack's at the 'Inst.', ain't it?"

"I got this idea," he tells, rather than informs us, "from watching a steam-roller climb the mast at Rugby, and from playing 'Old Man River' on my 'Radio-Chauffutter' with a set of magnetic hay-forks." And, strangely enough, we find ourselves believing him! "Don't erect any new sets or statues in my honour until you've destroyed the others," he adds, with the same delightful touch that put him where he is to-day. "And be sure to tell the kiddies their old Uncle Gas. will be playing his 'Lattice-Leztoletto'—with the Lynchem Rope Quartet—as per usual, despite the time taken up by gloating over his latest lawless lay-out."

"Tum on, den," we say, in our Bowery-Ghetto guttural. "Show dese guys dat 'Steam-Roller Reddio' is out of de Wood at last! Chute de woysks!" And here's what Hack. shot at us, folks—the "works" with both barrels:—

SIR,—Realizing steam-rollonauts—despite their disarming appearance—have, when roused, a nasty habit of taking those who upset them for a "ride"—which either ends up at the top of a tree, in custody, or in the unfortunate victim being "bumped off" and rolled-out—I knew my promise of "Radio for Rollonauts" (June 22nd) would have to be made good or else—well, even inventors like living (although they're not really supposed to!). Fearing the worst, I decided to do my best—to give to steam-rollonauts the set of their lives, and something they really wanted. After luring two of the dusky dare-devils to the Institution, and observing their reactions to certain treatment, I soon discovered the style of set they were set-on, and sent for my constructors.

Receiving certain whispered instructions from myself, and being handed certain mysterious crates, cartons, crockery and sundry divers equipment, those gallant and eager young yeomen—"The Constructors"—were each given a puff at my mighty "Inspirator" and locked away—in our "D.X-perimental Pent-house"—with my thoughts and theirs for the best. . . . Whatever really happened inside, I know not—but, as a result of what must have happened, the apparatus was wired and waiting when I lifted the latch of the pent-house door. (Washed-out though they were, the boys were able to exclaim: "There tish, Doc.—we done it on Shell!") And so—almost overnight—was born

CUT THIS OUT, EACH WEEK

Do you know

—THAT the latest valve has no less than five separate grids in addition to an anode, cathode and heaters.

—THAT some novel cabinet designs will be seen at the forthcoming radio exhibition.

—THAT a valve will also be seen in which two separate valves are included in a single glass bulb—the two sections comprising an H.F. pentode and a triode.

—THAT a severe shock can often be obtained simply by touching a control knob on a mains-operated receiver, due to the grub screw projecting from the control knob.

—THAT a dab of sealing wax or Chatterton's Compound will prevent the above trouble.

—THAT if an A.C. mains receiver is connected to a D.C. mains supply it will probably be damaged owing to the mains transformer burning out.

—THAT care should be exercised when choosing a "block" condenser for use in a receiver employing a metal rectifier in a voltage doubler circuit.

The Editor will be pleased to consider articles of a practical nature suitable for publication in PRACTICAL WIRELESS. Such articles should be written on one side of the paper only, and should contain the name and address of the sender. Whilst the Editor does not hold himself responsible for manuscripts, every effort will be made to return them if a stamped and addressed envelope is enclosed. All correspondence intended for the Editor should be addressed: The Editor, PRACTICAL WIRELESS, Geo. Neveles, Ltd., 8-11, Southampton Street, Strand, W.C.2.

Owing to the rapid progress in the design of wireless apparatus and to our efforts to keep our readers in touch with the latest developments, we give no warranty that apparatus described in our columns is not the subject of letters patent.

"Steam-Roller Radio"—our greatest gesture; our super-salute—our superb salaam to safety—to pre-Victorian uniformity! With rollonauts appeared, my cup was full; my face, red. . . .

The wonderful apparatus was designed by our own draughtsman, Dr. Hooey (who is, alas! only a poor man). From his daringly-drawn draughtwork—on the Hooey 1500-line system—any owner of a PRACTICAL WIRELESS "Discovisor" (or my own "Televistor") will be able to construct a similar apparatus for himself; but, for those who have not this apparatus handy, I will give an old man's description:

In the top left-hand corner of the set is a sturdily-built Malster-Hopwood "Storage-generator"—Maltese-cross model, roller-top fixing; from this to the set runs the X main lead. In the centre of the set is the input socket and hold-up; middle, cidental time and gravity-indicators; top, co-crystal combinator—with getutite-hilite rare earths, and the cuddlesome Barmann-Pullem controls; right, high-frequency "quencher" coils, output platform and canning apparatus.

But, as Dr. Hooey has now consented to take all the credit, and draw all the necessary plans, I think it only right to add his words: "Allt der kredit mit this give me—'Dampf-Rollen Rundfunk' ist wunderbar!" . . . (More later.)—DR. GASPARD HACKENOFF (Institution for Eccentric Engineers, Univ. of Timbuctu).

RADIO CLUBS AND SOCIETIES

Club Reports should not exceed 200 words in length and should be received First Post each Monday morning for publication in the following week's issue.

SLADE RADIO

"Electrical ignition equipment" was the title of a lantern lecture given by Mr. J. E. Miller at a recent meeting of this society. Commencing with a slide showing the ignition system in use at the beginning of the century, a brief description was given of the progress which has been made up to the present time. Full details were then given of the systems now in use, and special details given of coils, flux density, condensers, magnetic fields and special magnets of various materials. Slides were also shown depicting the winding of condensers, testing of magdynos, and high tension testing of mouldings.

A demonstration was given with a specially constructed running board with a complete ignition system, and the effect of various engine speeds was shown. The lecture proved one of considerable interest, and at the conclusion a large number of questions were raised.—Hon. Sec., 110, Hillaries Road, Gravelly Hill, Birmingham.

SHORT-WAVE CLUB FOR PLYMOUTH

It is proposed to form a chapter of the International Short-Wave Club in Plymouth, and readers of PRACTICAL WIRELESS who are interested in short-wave work are invited to write to Mr. F. Ward, 37, Embankment Road, Plymouth, for further particulars.

INTERNATIONAL SHORT-WAVE CLUB (LONDON)

There was a very large attendance at the meeting of the London Chapter, held on Friday, July 20th, which indicates the increasing interest in short-wave reception. At this meeting a member, who is an authority on short-wave propagation, gave an illustrated lecture on frequency changers, and described and demonstrated a new A.C. short-wave superhet which members agreed to be one of the most efficient receivers ever demonstrated at the Chapter. Full details of this receiver will be sent to anyone enclosing return postage. At the meeting of this Chapter held on Friday, July 27th, Mr. G. Hayes, one of the Chapter's technical advisers, described and demonstrated an autolyne short-wave converter of his own design and construction. This converter, which is operated from A.C. mains, was used in front of a Ferranti superhet, Gloria model. It had several special features, and very good reception was obtained from W2XAD, 19.56 metres, W8XK, 19.72 metres, and W8XK, 25.27 metres. Membership of the club costs 4s. 6d. per year, which includes a handy little monthly magazine, the official organ of the society.—A. E. Bear, Secretary, 10, St. Mary's Place, Rotherhithe, London, S.E.16.



AMONGST the August Decca releases an excellent standard has been attained. The following selected records in the Polydor and Brunswick category should certainly be heard.

Decca

It is a long time since we heard a record from Greta Keller, the charming Viennese singer, who made so many friends with her broadcasts from the B.B.C. a few years ago—apart from her records. In "Easy come, Easy go," and "Don't let It Happen Again" (F5078) she gives us her best. Since then she has been in America, sometimes singing and broadcasting alone, and sometimes with that well-known pair, Ross and Sargent. (In private life she is Mrs. Joe Sargent.)

The issue of this new record is, therefore, of especial interest since Greta Keller will be paying us a flying visit in September, when she will be heard once more from the B.B.C.

The recording was done, of course, in the Brunswick Studios in New York.

A Successor to De Groot

The Alfredo Campoli Grand Orchestra (K734): "Operantics," and (F5075): "Evergreen" Selection. I wonder if everyone fully realizes the amazing versatility of Campoli. The above orchestra is his fifth recording unit selling on records to-day. Campoli as a violinist; his Salon Orchestra; his Novelty Orchestra; his Trio; and now his Grand Orchestra. With these activities he combines regular broadcasting, concerts, cinema stage appearances on the big circuits, and accompanying work on recording sessions.

For a long time now he has been acclaimed as the worthy successor to De Groot. His two records issued this month are particularly interesting for their arrangements and orchestrations. I think that the "Evergreen" Selection will be found especially acceptable.

Billy Reid and his London Piano-Accordion Band (F5116): "Madonna Mine" and "Grinzing" (In Grinzing back with you).

Billy Reid's Accordion Band have a long time been one of the big sellers on records.

You will be invited to listen to many recorded versions of "Madonna Mine," but I venture to think that Billy Reid's performance on Decca F5116 is one of the finest that will come into your possession.

Oskar Joost Dance Orchestra (F5091): "Souvenir Tango" and "Talk to Me of Love, Mariu." The above name will be new to you—for a short time. It is a German orchestra, newly formed, and it already ranks as "The Jack Hylton Dance Band of Germany." No vocal refrains will appear on any of these records, and they will be individual in that the Continental

style predominates, as the American and English styles predominate in American and English recordings. In Germany they are a phenomenal success, and their records in England will appear exclusively on Decca.

Don Barreto and his Cuban Orchestra (F5084): "Jungle Drums." I have written many times of this beautiful Cuban Orchestra now playing in Paris. Their playing is to me a joy, and I personally am delighted to find a new record from them in the August List.

Roy Fox and his Band (F5081): "Over My Shoulder." The first thing that always strikes me about anything Roy Fox does is his efficiency. Even the smallest detail is handled with meticulous care.

I was present at the recording of the above, and I was much struck by the care Fox took, and the experiments he made in order to get a true balance and a vitality of performance. He appears to be trying to get every ounce of personality into his records, and he has been specially rewarded in his version of "Over My Shoulder."

Brunswick

Connie Boswell (01816): "All I Do is Dream of You." What a perfect artist Connie Boswell is! She always manages to find a different interpretation to a song, after hearing which others sound commonplace. At least, that is how I feel. Whenever a new "hit" is born I at once make enquiries as to whether Connie Boswell is going to record it. One only has to look through a Brunswick catalogue to find such classics as "Time on My Hands," "I Cover the Waterfront," "It's the Talk of the Town," "Dinner at Eight," "Emperor Jones," "Where, I Wonder Where," etc., etc., to find that her recording of these numbers is superb. They stand alone. She is, to me, the perfect "Blues" singer—an expression I don't care for, but it seems to be the accepted term.

Again she has surpassed herself in "All I do is Dream of You," although I do not, frankly, care for the other side, "Little Man, You've Had a Busy Day." I understand, however, that such touches are popular in America.

But in spite of this first fall from grace, the other side more than makes amends for it. Please hear it.

A Calloway Concatenation

Cab Calloway and his Orchestra (01792): "Sweet Georgia Brown." Another record for the hot fans, played in characteristic Calloway style.

Casa Loma Orchestra (01793): "Love Me." "Love Me" is a sweet number written by that prolific writer, Victor Young, who is, incidentally, the musical director of Brunswick Company. The

Casa Loma Orchestra, apart from the beauty of its playing, is quickly identified by the vocal refrains of Kenny Sargent, who is rather like Jack Teagarden in style. They both have that "sleepy" style of the negro singers, which is ideally suited to vocal refrains. The band is acknowledged to be one of the greatest in the world, and is composed of ex-college boys, working on a co-operative basis. They are, at the moment, playing at Glen Island Casino, on Long Island, one of the smartest country clubs for the rich New Yorkers.

Decca-Polydor

The Decca-Polydor List does not contain anything that is particularly exciting for the thoroughly initiated music-lover. A popular list has been drawn up in order to attempt to cater for those less experienced in standard music—those who like good music for entertainment rather than for intellectual exercise.

Erna Berger (Soprano) (PO5100): "My Dear Marquis" and "I'll Play the Innocent Country Maid." I would draw attention to the exquisite record of Erna Berger of two songs from the Johann Strauss opera, "The Bat."

Alexander Brailowsky (Pianist) (DE7029): "Polonaise in A Flat Major, Op. 53" (Chopin). Brailowsky, one of the greatest pianists of our time, has not appeared lately in our lists, and his return will be cordially welcomed. He plays the very famous "Polonaise in A Flat Major." This is also a record to which I venture to draw your attention.

The Glorious "Fifth"

—Symphony, that is, by Beethoven. It would be, I think, safe to wager that if a hundred musically cultured folk were told they could take only one piece to the postulated desert island—this would be chosen by the majority.

Now there is one factor which militates against universal popularity of many of the great symphonies and sonatas—one which our more astute modern composers would be wise to avoid whenever possible. This factor is the unfortunate titling of this or that symphony as No. 2 in A flat Major (Opus 99). If only this feast prepared for us by Beethoven could have been first given a title which envisaged the "plot" behind the music (for Beethoven drew his ideas from the most natural and commonplace sources) we may safely say that tens of thousands would revel in, say, "Life," where "Symphony No. 5 in C Minor" remains unheard. It should be pointed out that it was written during an ardent love affair, and we are told that a commentator sees in it a portrait of the composer and his fiancée. Hear it for yourself and you will find that perhaps you yourself are just as strongly drawn. There are four records in this new recording—Columbia DX516-519—and the very beautiful interpretation is by the London Philharmonic Orchestra under Weingartner. I mentioned above the omnipresence of a vital message in this symphony. What is it? This can be interpreted only by the listener, but once a concept has been formed, nothing will shake a belief in what will have become one of the eternal verities to that listener. At any rate, here is beauty of the rare, stirring, simple kind, which everyone may dress as he chooses to his lasting spiritual benefit. Hear, then, Beethoven's "Fifth," and re-title it for yourself.

LET OUR TECHNICAL STAFF SOLVE YOUR PROBLEMS

REPLIES TO



If a postal reply is desired, a stamped addressed envelope must be enclosed. Every query and drawing which is sent must bear the name and address of the sender. Send your queries to the Editor, PRACTICAL WIRELESS, Geo. Newnes, Ltd., 8-11, Southampton St., Strand, London, W.C.2.

QUERIES and ENQUIRIES by Our Technical Staff

The coupon on Page iii of cover must be attached to every query

SPECIAL NOTE

We wish to draw the reader's attention to the fact that the Queries Service is intended only for the solution of problems or difficulties arising from the construction of receivers described in our pages, from articles appearing in our pages, or on general wireless matters. We regret that we cannot, for obvious reasons—

- (1) Supply circuit diagrams of complete multi-valve receivers.
- (2) Suggest alterations or modifications of receivers described in our contemporaries.
- (3) Suggest alterations or modifications to commercial receivers.
- (4) Answer queries over the telephone.

Please note also that all sketches and drawings which are sent to us should bear the name and address of the sender.

Voltage Dropping Resistances

"I have built a three-valve set using 2-volt valves and wish to operate this from a D.C. eliminator giving 60-80 for screen; 60 volts for detector and 120-150 volts at 19 mA. I should be obliged if you could let me know what type and value of resistances I should have to use to give me the correct H.T. at the anodes of the valves, and whether the resistances could be incorporated in the set to act as decoupling resistances at the same time."—A. H. B. (Coatbridge).

Theoretically there should be no necessity to use voltage dropping resistances with this combination, as the outputs from the various terminals will suit the receiver. Thus the 60-80 tapping should be joined to the screening grid, the 60-volt to the detector anode, and the 120-150 volt tapping to the anodes of the H.F. and output valves. In the event, however, of any instability arising and decoupling being necessary, a value of 5,000 ohms for the H.F. anode should be found quite satisfactory, and it may be found better to use a 50,000-ohm resistance in the anode circuit of the detector valve and join this to the maximum tapping instead of to the 60-volt tapping. The customary fixed condensers must also be used in conjunction with the resistances.

Increasing D.C. Mains Output

"I have a small battery set operated from a D.C. mains eliminator. This gives an output of 120 volts, but I wish to use mains valves, taking 150 to 200 volts. I have

arranged for the heater supply, but am not certain how to increase the H.T. output. Could I connect an H.T. battery in series with the eliminator to step up the H.T. only?"—R. F. G. (Staines).

The idea is quite workable, but as the valves to be used are mains valves they will presumably operate with 200 volts H.T., and if your mains are higher than this you only require a small resistance to reduce the voltage to 200. You could then use a simple smoothing circuit, and do away with the eliminator. However, if you wish to retain this, an 80-volt battery connected in series with the positive lead to the eliminator will be quite satisfactory.

DATA SHEET NO. 87

Cut this out each week and paste it in a notebook.

COMPARATIVE TABLE OF WIRE GAUGES

Number.	British Standard Gauge (S. W. G.)	American Gauge (A.W.G. or B. & S.)
21	0.020	0.025
22	0.020	0.025
23	0.020	0.025
24	0.020	0.025
25	0.020	0.025
26	0.020	0.025
27	0.020	0.025
28	0.020	0.025
29	0.020	0.025
30	0.020	0.025
31	0.020	0.025
32	0.020	0.025
33	0.020	0.025
34	0.020	0.025
35	0.020	0.025
36	0.020	0.025
37	0.020	0.025
38	0.020	0.025
39	0.020	0.025
40	0.020	0.025

The above is a corrected table and should take the place of Data Sheet No. 87 which was recently given on this page.

The A.C. Selectone

"Will you please tell me whether you can supply me with a copy of 'Practical Wireless' dated April 29th, 1933, No. 32, Vol. 2. I understand a wiring diagram was given in that issue of a two-valver. Could you also tell me whether arrangements were made in that circuit for biasing the detector valve when used for gramophone-record reproduction."—L. G. R. (Rugby).

A copy of the back number in question may be obtained from our Back Number Department, price 4d. post free. The detector valve was so designed that when

switched over to gramophone reproduction the necessary biasing resistance was included in the cathode circuit. The output valve of this receiver was a Mazda AC/P, the output of which is rated at 650 milliwatts.

An All-Power Eliminator

"Please let me know whether you can supply a plan for an eliminator which provides H.T., G.B., and L.F. I want to do away with the batteries for good and plug into the A.C. mains."—G. G. A. C. (Southampton).

In PRACTICAL WIRELESS No. 5 we published a detailed constructional article of an all-power mains unit which should meet your requirements. This did not provide grid-bias voltages, as these are generally obtained by inserting a suitable resistance in the cathode of the valve which requires negative bias. Various articles have been published by us showing how to ascertain the value of the required resistance, and you should find no difficulty in converting your receiver.

A Misunderstanding

"A few days ago I was reading a valve book on the subject of pentode valves, and it said that in no circumstances should a pentode valve be coupled directly with the speaker, that is, the speaker should not be coupled between anode and H.T. positive, but choke or transformer coupling should be used. Will you please tell me why it is that in the Master Midget and the Pentode one-valver the pentode is coupled in the way that the book says is injurious to the valve?"—J. C. G. H. (Kew, Surrey).

We think you have misunderstood the book. The point which is probably stressed is that the anode circuit of a pentode valve should not be broken whilst the filament is glowing and, therefore, as there is a possibility that a speaker might be disconnected for experimental purposes, the inclusion of a choke or transformer acts as a safeguard. Further, the correct working of a pentode valve necessitates a rather high optimum load, and to obtain this a choke or special pentode output-matching transformer is more suitable than a speaker. The speakers employed in the receivers you mention were specially chosen for pentode matching.

THE QUERIES COUPON APPEARS ON PAGE iii OF COVER.



Miscellaneous Advertisements

Advertisements are accepted for these columns at the rate of 3d. per word prepaid - minimum charge 3/- per paragraph - and must reach this office not later than Tuesday for the following week's issue.

PREMIER SUPPLY STORES

Offer the Following Manufacturers' Surplus New Goods at a Fraction of the Original Cost; all goods guaranteed perfect, carriage paid over 5/-, under 5/- postage 6d. extra, I.F.S. and abroad, carriage extra. Orders under 5/- cannot be sent C.O.D. PLEASE SEND FOR ILLUSTRATED CATALOGUE POST FREE.

STUPENDOUS Purchase of Set Manufacturers' Stock. All-electric 3 Valve (S.G. Det. Pen.) Set in Walnut Cabinet with moving-coil speaker 200-250 volt 40-60 cycles. Chassis built. 200-2,000 metres with 4 valves, £4/19/6.

SPECIAL Offer of P.M. and Energised M.C. Speakers. Purchased from well-known gramophone co.

TYPE 10971G. 9in. diameter, 115 ohm field, 120/200 m.a. with power output transformer. Handles 4 watts, 17/6.

TYPE 10971C. 9in. diameter, 2,000 ohm field, 40/70 m.a., Pentode transformer. Handles 4 watts, 17/6.

TYPE 10955F. 9in. diameter, 11,650 ohm field, 20/30 m.a., auditorium type power transformer. Handles 10 watts, 30/-.

TYPE 10955H. 9in. diameter, 115 ohm field, 350/400 m.a., auditorium type Pentode transformer. Handles 10 watts, 30/-.

TYPE 4480. 9in. diameter, permanent magnet. Handles 4 watts, 7 ohms speech coil, 13/6. Multi-ratio transformer, 4/6 extra.

PREMIER SUPPLY STORES Announce the Purchase of the Complete Stock of a World Famous Continental Valve Manufacturer; all the following standard mains types, fully guaranteed, 4/6 each. H., H.L., L. power. High, Medium, Low magnification and Variable-Mu Screen Grid. Directly heated Pentodes, 1 watt, 3 watt and 4 watt A.C. outputs. 250v. 60 milliamp full wave rectifier.

THE Following Type, 5/6 each: 350 v. and 500 v., 120 milliamp full wave rectifiers, 2 1/2 watt indirectly heated pentode.

THE Following American Types at 4/6; 250, 227, 112, 171, 210, 245, 26, 47, 46, 24, 35, 51, 58, 55.

ELIMINATOR Kits, including transformer, choke, Westinghouse metal rectifier, T.C.C. condensers, resistances and diagram, 120v., 20 m.a., 20/-; trickle charger 8/- extra; 150v., 30 milliamps, with 4v., 2-4 amps. C.T., I.T., 25/-; trickle charger 6/6 extra; 250v., 60 milliamps with 4v., 3-5 amps, C.T., I.T., 30/-; 300v. 60 m.a. with 4 v. volts, 3-5 amps, 37/6; 200v. 100 milliamps, 39/6.

PREMIER chokes, 40 milliamps, 25 hrs., 4/-; 65 milliamps, 30 hrs., 5/6; 150 milliamps, 30 hrs., 10/6; 60 milliamps, 60 hrs., 2,500 ohms, 5/6; 25 milliamps, 20 hrs., 2/9.

ALL Premier Guaranteed Mains Transformers have Engraved Terminal Strips, with terminal connections, input 200-250v., 40-100 cycles, all windings paper interleaved.

PREMIER H.T.7 Transformer, output 135v. 80 m.a. for voltage doubling, 8/6; 4v. 3-4a., C.T. L.T. 2/- extra; with Westinghouse rectifier giving 200v. 30 m.a., 17/6.

PREMIER H.T.8 and 9 Transformers, 250v., 60 m.a., and 300v. 60 m.a. rectified, with 4v. 3-5a. and 4v. 1-2a. C.T. L.T. and screened primary, 10/-; with Westinghouse rectifier, 18/6.

PREMIER H.T. 10 Transformer, 200v. 100 m.a., rectified with 4v. 3-5a., and 4v. 1-2a. C.T. L.T., and screened primary, 10/-; with Westinghouse rectifier, 19/6.

PREMIER Mains Transformer, output 250-0-250v. 60 m.a., 4v. 3-5 a., 4v. 2-3a., 4v. 1-2a. (all C.T.) with screened primary, 10/-.

PREMIER Auto Transformers, 100-110/200-250v. or vice versa, 100-watt, 10/-.

L.T. Transformers, 4v. 3-5a., 22v. 1a., 8/6 each; 10v. 3a., 14v. 4a., 10/- each.

WESTERN ELECTRIC Mains Transformers, 300-0-300v. 65 m.a., 4v. 1-2a., 4v. 2-3a., 6/6; 500-0-500v. 150 m.a., 4v. 3-5a., 4v. 2-3a., 4v. 2-3a., 4v. 1a. C.T., 4v. 1a. C.T., 19/6; 1,000-0-1,000v. 250 m.a. 4v. 3a. C.T., 4v. 3a., 49/6; 2,000-0-2,000 150 milliamps, 49/6.

SPECIAL Offer of Mains Transformers, manufactured by Phillips, input 100-120v. or 200-250v., output 180-0-180 volts 40 m.a., 4v. 1 amp., 4v. 3 amps., 4/6; 200-0-200v., 4v. 1a., 4v. 3a., 4/6.

PREMIER L.T. Charger Kits, consisting of Premier transformer and Westinghouse rectifier, input 200-250v., A.C., output 8v. 1 amp., 14/6; 8v. 1 amp., 17/6; 15v. 1 amp., 19/-; 0v. 2 amp., 27/6; 30v. 1 amp., 37/6; 2v. 1 amp., 11/-.

B.T.H. Truspeed Induction Type (A.C. only) Electric Gramophone Motors. 100-250v.; 30/- complete. SPECIAL Offer B.T.H. Gramophone Motors, A.C. and D.C., 100/250v., 30/-.

(Continued at top of column three)

PETO-SCOTT



Originators of Kits of Parts in 1919, we supply all your Radio Needs CASH, C.O.D., or EASIWAY. Our Customers are invited to take advantage of our FREE Technical Service or call for Demonstration at our Showrooms 77, City Road, London, E.C.1, or 62, High Holborn, London, W.C.2.

IMMEDIATE DELIVERY

PETO-SCOTT HAS IT FIRST

... send to Peto-Scott for the latest in Radio.

Everything new at OLYMPIA for CASH C.O.D or EASIWAY

PETO-SCOTT CO. LTD, 77, PR. W. 21, CITY ROAD, LONDON, E.C.1. Telephone: Clerkenwell, 9406/7. West End Showrooms: 62, High Holborn, London, W.C.1. EST. 1919

EASY PAYMENTS

"There's no place like HOLMES." The first firm to supply Wireless parts on easy payments. Nine years advertiser in Wireless Press. Thousands of satisfied customers.

Table with columns: Item Name, Price, Deposit, Monthly Payments. Includes items like TELSEN Latest 323 Kit, EXIDE H.T. Accum., BLUE SPOT 25PM, ATLAS ELIMINATOR, No. OA25, B.T.H. Pick-up, EPOCH 20th O. P.M.

New Goods Obtained for Every Order. Send us a list of the parts you require and the payments that will suit your convenience, and we will send you a definite quotation. Anything Wireless.

H. W. HOLMES, 29, FOLEY STREET, Great Portland Street, London, W.1. Phone: Museum 1414.

TESTING AND TESTING!

There are degrees of accuracy. Specify SIFAM Meters and be certain of complete accuracy in your radio tests. MOVING COIL METERS. New dials make readings simple. Knife-edge pointers give greater accuracy. Mechanism perfectly balanced and tested. From 27/6.

MAGNETIC CONTROLLED METERS. Recommended by leading technicians for general radio and charging purposes. Guaranteed accuracy. In moulded cases, 2 1/2in. overall, 2in. hole in panel. From 7/6.

SIFAM METERS SIFAM ELECTRICAL INSTRUMENT CO., LTD., York Works, Browning St., S.E.17. Tel. Rodney 3573

(Continued from foot of column one)

COLLARO Gramo. Unit consisting of A.C. motor, 200-250v. high quality pick-up and volume control, 49/-; without volume control, 46/-.

EDISON Bell Double Spring Gramophone Motors, complete with turn-table and all fittings, a really sound job, 15/-.

SPECIAL Offer of Wire Wound Resistances, 4 watts, any value up to 50,000 ohms, 1/-; 8 watts, any value up to 15,000 ohms, 1/6; 15 watts, any value up to 50,000 ohms, 2/-; 25 watts, any value up to 50,000 ohms, 2/6.

WIRE Wound Potentiometers, 15,000 ohms, 1/6; 50,000 ohms, 2/-; 500,000 ohms, 3/-; 1,000 ohms wire-wound semi-variable resistances, carry 150m.a., 2/-.

CENTRALAB Potentiometers, 50,000, 1 meg. any value, 2/-; 200 ohms, wire wound, 1/-.

POLAR Star, manufacturers' model, 3-gang condensers, fully screened, 7/6; with trimmers. AMERICAN Triple Gang 0.0005 Condensers, with trimmers, 4/11; Utility Bakelite 2-gang 0.0005 screened with unknob trimmer, 3/6; Polar Bakelite condensers, complete with knob, 0.00015, 0.00035, 0.0003, 0.0005, 1/-.

ORMOND Condensers, 0.0005 2-gang semi-shielded, 2/6; brass vanes, with trimmers, 3/6. British Radiophone 110 kc/s Intermediate, 3/-.

MAGNAVOX D.C. 152, 2,500 ohms, 17/6; D.C.154, 2,500 ohms, 12/6; D.C.152 magna, 2,500 ohms, 37/6, all complete with humbucking coils; please state whether power or Pentode required; A.C. conversion kit for above types, 10/-; Magnavox P.M. 7in. cone, 18/6.

RELIABLE Canned Coils with Circuit, accurately matched, dual gauge, 3/- per coil; ditto, iron-cored, 3/6.

RELIABLE Intervalve Transformers, 2/-; multi ratio output transformers, 4/6.

HELLESEN 8 mf. Electrolytic Condensers, 435 volts working, 2/3; Mershon ditto, 1/9.

POLAR 2-gang Unknob Condenser with Trimmers and complete Slow motion Dial, 6/-.

WESTERN ELECTRIC Condensers, 250v. working, 2 mf., 1/-.

T.C.C. Electrolytic Condensers, 550v. working, 650v. peak, 8 mf., 4/-; 4 mf. or 8 mf. 440v. working, 3/-; 15 mf. 50v. working, 1/-; 25v. working, 25 mf., 1/3; 6 mf. 50v. working and 2 mf. 100v. working, 6d.

PREMIER SUPPLY STORES 20-22, High St., Clapham, S.W.4. Telephone: Macaulay 2188. Nearest Station, Clapham North Underground.

WOBURN Radio's New Purchase: - WESTERN ELECTRIC Microphones, super sensitive, boxed, listed 21/-, 2/6 each, post free. W.R.C. Eliminators, guaranteed 12 months, 150v. 30 m.a. Three positive H.T. Tappings, D.C. 9/6, A.C. 21/-, A.C. with trickle charger 32/6, Trickle chargers (2-v., 4-v., 6-v., 1 amp.) 12/6. Universal A.C./D.C. 21/- (post 1/- extra). TRADE LIST now ready. All orders over 5/- carr. free. Let us quote for Kits, components, and valves: WOBURN RADIO CO., 9, Sandland Street, W.C.1 Holborn 7289.

PEARL & PEARL 190, Bishopsgate, London, E.C.2. All the following bargains guaranteed new goods. Cash or C.O.D. Carriage Paid. SOVEREIGN Iron Cored Coils, with circuits, 2/11 each. GRANIC Pentode tapped Choke, provides tappings from 1-1 to 6-1. List 7/6; our price 3/11. TRIOTRON 4-pole balanced armature speaker units, type "B"; sensitive, beautiful tone; list 22/6, our price 6/11.

200 MARCONIPHONE 2-Valve Receivers with Speaker and Marconi valves, in handsome oak cabinet; 28/11 Carriage Forward. All Mail Orders Direct to PEARL & PEARL, 190, Bishopsgate, London, E.C.2. Tele: Bishopsgate 1212.

VAUXHALL - Magnavox Permanent Magnet Loudspeakers, universal, suitable for Class B power of pentode; 5in. cone, 15/6; 7in. cone, 17/6; 10in. cone, 23/-; Energised 2,500 or 6,500, 10in. cone, 22/-; 7in. cone, 15/3. All new with humbucking coils.

VAUXHALL - Radiophone Radiopaks, Band-pass or R.F. superhet., with Lucerne wavelength station-named scales, medium and long, complete, 32/6.

VAUXHALL - Radiophone I.L. transformers, with terminals, 6/-; Radiophone volume controls, with switch, 3/6.

VAUXHALL - Coils, set of three on base with switch, 16/6. Three-gang condensers, with covers - superhet 14/6, ordinary type 12/6. Disc drives, complete, 4/9.

VAUXHALL - Pick-ups, 8/--£2. Write for quotation. State make, B.T.H. Collaro Motors, 32/6. Gramophone switches, 3/6.

VAUXHALL - Valve-holders, chassis type, 5-pin W.B., 4 1/2d., Chix 7-pin, 7d.; resistors, Dubilier, 1 watt, 7d.; fixed condensers, T.C.C., 0.002, 8d.; Ormond, 0.001, 7d.; 0.01, 1/-.

CASH with Order, post paid over 2/6, or c.o.d.; all goods unused manufacturers' surplus; guaranteed perfect. Lists free.

VAUXHALL UTILITIES, 163a, Strand, W.C.2. Phone: Temple Bar 9338 (Facing Bush House, over Denny's.)

SOUTHERN RADIO'S Bargains.—Manufacturer's guaranteed surplus.

VARIABLE Condensers.—Lotus. All 0.0005. Complete with dials, escutcheons, knobs. Fully screened with trimmers. 3-gang, 12/6; 2-gang, 8/6; single, 4/6. (List 9/6.) Hydra block condenser, 16 mfd. (2x2x8x2x1x1), 1,000v. D.C. 7/-. Dubilier 4 mfd. (2x1x1), 1,000v. D.C. 2/9; Utility Midget 2-gang, variable condensers, 0.0005, with concentric trimmers, 3/5.

SPEAKERS.—Blue Spot permanent magnet, universal transformer for power, super power, pentode and Class B, 23/- (list 39/6); Celestion Soundex permanent magnet, 15/- (list 27/6).

BLUE Spot, genuine 100U, inductor speaker on chassis; 13/6 (list 39/6).

IGRANIC Coils, set of four (1 osc., 2 I.F. with pig-tails, 1 I.F. plain), 12/6 (list 50/-).

IGRANIC Band Pass, 3 Coils Unit iron-cored, screened on base, with switch; 14/- (list 33/-).

ISSEN Super-het. 3 Coils Unit, screened, ganged on base with wave-change and filament switches; type LN5181 for battery or mains, 12/6 (list 30/-).

VARLEY Constant Square Peak Coils, with all accessories, new, boxed; BP5; 2/4 each (list 15/-).

VARLEY H.F. Inter-valve Coils, BP6, 2/3 (list 8/6).

5-VALVE Class B Superhet, Chassis by Plessey, wired ready for use, with 5 Mullard valves, new, in sealed cartons, £3/17/6; (list £12/12); valves alone are priced £3.

EKO A.C. Eliminators, each new and boxed in original sealed cartons, type K25, with trickle charger, 25 millamps, 39/6 (list £5/7/6); type A.C.25, 33/6 (list £3/17/6); type K.12 with trickle charger, 37/- (list £3/17/6); Ekco trickle chargers, type T.C.I., for 2-4 and 6-volt accumulators, 20/- (list 42/-).

ISSEN Base Revolving Turntables, 1/6 (list 5/-).

SPECIAL Offer of Leweos Spaghetti Resistances, all sizes, in original sealed boxes, 4/- per dozen, assorted.

MAINS Transformers.—Full list of mains transformers and chokes sent free; specials can be supplied in 3 days; transformers and chokes guaranteed 12 months.

MISCELLANEOUS.—Rotorohm and Radiophone volume controls, all values, 3/- switch, 3/3 (list 10/6); Westinghouse metal rectifiers, H.T. 6, 7, 8, 9/3 each; Ferranti chokes, 20 henry 60 m.a., 6/9 each. All Goods Guaranteed and Sent Carriage Paid.

BRANCHES at 271-275, High Rd., Willesden Green, N.W.10, and at 46, Lisle St., W.C.2. Please send all post orders to 323, Euston Rd., N.W.1.

SOUTHERN RADIO, 323, Euston Rd., London, N.W.1 (near Warren St. Tube). Phone: Museum 6324.

MORE AMAZING BARGAINS BY OLYMPIA RADIO LIMITED.

EKO 1934 Model K.25 A.C. Eliminator. 25 m/a Output. Variable S.G. Tapping, complete with Trickle Charger, for 2, 4 or 6-volt Accumulator. List price £5 7s. 6d. Our price 45/-. Our price 45/-.

CELESTION Soundex P.M. Moving Coil Loudspeaker. List price 27/6. Our price 12/9.

CELESTION P.P.M/W. List price 45/-. Our price 17/6.

GRAMPIAN Nipper P.M. Loudspeakers. List price 27/6. Our price 17/6.

GRAMPIAN P.M. Dual "Owl" Loudspeakers, complete with Baffle. List price 55/-.

AMPLION A.R.19 Horn Loudspeakers with Wooden Flare. Original list price 105/-. Our price 9/11. Ideal for Extension Loudspeaker.

REVO Horn Loudspeakers—Metal Flare. Original list price 65/-. Our price 6/11. Suitable for Extension Speaker.

UNIVERSE Pickup and Tone Arm complete with Volume Control. List price 22/6. Our price 12/11.

IGRANIC 2 Gang Condensers, complete with cover (plain boxes). List price 12/6. Our price 6/9.

IGRANIC 3 Gang Condensers. List price 17/6. Our price 8/11.

WONDER Microphones. List price 7/6 each. Our price 4/9.

TRIOTRON Class "B" Amplifier with Tone Control but without Valves. List price 25/6. Our price 10/6 each.

MILLGATE A.C. Trickle Charger, fitted with Westinghouse Metal Rectifier, for 2, 4, or 6 volt. List price 27/6. Our price 17/6.

WE also have a large number of amazing bargains in **BATTERY & A.C. RECEIVERS**—Repossession and Decontrolled Models—Lists on application. Also other numerous bargains in various lines in Components.

TERMS—Cash with Order, or C.O.D. All Goods Carriage Paid. Everything Guaranteed. No Money refunded if not satisfactory. Please mention this paper when replying.

OLYMPIA RADIO LTD., Mail Order Department, 49a, Shudehill, MANCHESTER.

BRANCHES in all Principal Towns.

HIGHEST possible allowance made on used wireless sets or parts in exchange for any new set, kit or parts. Peto-Scott kits supplied. Goods bought for cash.—R. Wigfield, Furlong Road, Goldthorpe, Yorks.



MAINS POWER

If you are interested in running your radio from the mains, be sure to visit the Radio Show at Olympia—Stand 24. This will be the home of HEAYBERD the MAINS SPECIALISTS. There you will be able to inspect the new range of Heavy Duty Transformers, Portable Battery Chargers, Amplifiers, Mains Units and new mains apparatus of all description.

If you cannot come to Olympia, send your name and address attaching this advertisement and 3d. in stamps, and we will forward you a copy of our NEW 1935 Radio Handbook.



10, FINSBURY ST., LONDON, E.C.2.
Tel.: Met. 7516/8.

ELECTRADIX

Home Broadcasting Microphones

No. 11. Home Mike for wireless. A complete solo Microphone for hand or stand in fine bakelite case, with back terminals, front metal grille. Finely finished. Only 5/6.

PARTS FOR HOME CONSTRUCTORS. Microphone Carbon Granules, in glass capsule, enough for four buttons. Grade No. 1, 8d.; No. 2, Medium, 1/-; No. 3, Fine, 1/6; Carbon, solid back, blocks, 3d. Mouthpieces, curved or straight, 10d. Carbon diaphragm, 35 m/m, 4d. Panel Brackets, pivoted, 5/-; Reed Receiver Unit, for amplifier making, 3/-. Headphones, 2/9 pair. For 1,000 other bargains, send 1/4d. stamp for New Illustrated Sale List "N." State your requirements.

ELECTRADIX RADIOS,
218, UPPER THAMES STREET, E.C.4.
Telephone: Central 4611

SEND TO FOYLES FOR BOOKS!

New and second-hand books on Wireless and all other subjects. Over two million volumes in stock. Catalogues free on mentioning your interests.
119-125, CHARING CROSS RD., LONDON, W.C.2.
Telephone: Gerrard 6660 (7 lines).

There are many GOOD valves but ONE BETTER THAN 362!!!

Post Free Dept W. Trade Dept W.T.
362 RADIO VALVE CO. LTD.
STONEHAM RD., LONDON E.5.

H.T. THAT LASTS YEARS
"14 months' going every day on a 3v. set and still kicks up 80v."—E. K., Reading. Install a Standard Wet Battery. Replenish at long intervals—that's all. All Standard Battery Spares, 120v., 2,600 m.a. £2 complete. Carr. paid.—Write Wet H.T. Battery Co., 26, Lisle Street, London, W.C.2.

THE following unused Set Manufacturers' Surplus; all goods guaranteed perfect; immediate delivery.

FERRUCART coils, G1, G2, G3, or G1, G2, G8 with switch, 27/6. G10, G11, G12, G13, with switch, 34/-. Colverdynes (Ferrucart), 7/6.

DUBILIER or Eric resistors, 1 watt type, 7d., 2 watt type, 1/2. Marconi K19 pick-ups, 22/6. Radiophone IF transformers, 110KC or 117.5KC, 6/6.

WESTINGHOUSE rectifiers, HTS, 9/6, HT9, HT10, LT4, LT5, 11/-. Regentone transformers for HTS or HT9 with 4v-1a LT winding, 7/6.

MAINS transformers, 350-0-350v., 60ma., 4-4a, 4v-2a, 12/6. Eliminators, outputs, 150v. 25ma, S.G. and detector. A.C. type with Westinghouse rectifier, 25/-. D.C. type, 12/6. Collaro gramophone motors, 100-250v. A.C., 34/-.

DUBILIER dry electrolytic condensers, 8mf. or 4mf, 500v. working, 50v, 50 mf, 3/6.

ROTOROHM volume controls, with switch, 2/6. BTH pick-up tone arms, 3/-.

ALL types of brand new American valves in stock, first-class makes, guaranteed. 247, 235, 551, 89, 18, 19, 46, 59, 6A7, 15, 42, 41, 38, 39, 78, 75, 57, 58, 24, 44, 36, 43, 12/-.

UX171A, UX199, UX280, UX245, UX226, UY227, 8/-. UX250, UX281, UX210, 18/-.

BTH-RK speakers, 6v field, suitable for P.A. work, 27/6. A.C. type with field rectifier, £2/7/6.

MAGNAVOX speakers, complete with hum-bucking coils, output transformers, etc., 152 (9in. cone), 22/6. 154 (7in. cone), 15/9. Rola F6 (7in. cone), 17/6, with all 2,500 or 6,500 ohm fields. Magnavox PM254, 18/-.

WARD, 2nd floor, 45, Farringdon Street, London, E.C.4. Telephone, Holborn, 9703.

VARLEY Constant Square Peak Band-Pass Coils, type B.P. 5. Complete, all accessories and instructions. New, boxed, 2/4. (List, 15/-).

POLAR 3-gang Star Minor Condenser, full screened, trimmers, new, 7/-.

ERICSSON 3-1 L.F. Transformers, new and guaranteed, 2/3. (List, 17/6.)

COLLARO Electric Gramo Motor A.C. 100-250v. with pick-up and volume control. Auto Start and Stop. Brand new. List price, £4. Our price, 47/6 carr. paid. Bankrupt set maker's stock.

VOLUME Controls, 50,000 ohms, New, 1/3.

CELESTION Energised M.C. Speaker, 2,500 ohms. Model D.C. 2054, with universal transformer. List price, £2/5/0. Our price, 12/6.

PIONEER RADIO MFG. CO., LTD., Coptic Street, London, W.C.1. Museum 9607.

REPAIRS—REWINDING—OVERHAULS. NEW cones and centres fitted any make M/c chassis, Mc/s rewound. Mains transformers, etc. Receivers converted D.C. to A.C. Write Repair Dept. C.

WEEDON P.L.R. Co., 80, Lonsdale Avenue, London, E.6 (Grange Wood 1837)

"MELFO-RAD" for all Receivers, Kits, Components, etc.—Lowest prices—Cash/C.O.D. or H.P. Quotations and Lists Free.—Queen's Place, Hove. (Trade Supplied.)

WANTED, good Modern Wireless Parts, Sets, Eliminators, Meters, Valves, Speakers, etc., Spot Cash waiting. Send or bring. We pay more than any other dealer. Open 9-8.—University Radio, 142, Drummond St., Hampstead Rd., N.W.1.

YOUNG men trained for all branches of Wireless Profession. Britain's leading College, situated on sea-front. Boarders accepted. Training fee payable after appointment. Prospectus free. The **WIRELESS COLLEGE, COLWYN BAY.**

ELIMINATORS, 25 m.a., D.C. 10/-, A.C. 21/-; Transformers 3-1, 5-1, 1/9. British-made valves, H.F., L.F., and Dect., 1/9. Power 2/-.

S.G. 5/-. Carriage Paid Cash with Order.—Radio Electrical Supplies, 237, Camberwell Road, London, S.E.5.

ACCORDEONS, Saxophones, Guitars. Send for Free Catalogues. Easy Terms. Hussy's, 18-20, Manchester Street, Liverpool.

FREE ADVICE BUREAU COUPON

This coupon is available until August 18th, 1934, and must be attached to all letters containing queries.

PRACTICAL WIRELESS, 11/3/34.

ADVERTISEMENT INDEX

	Page
Cossor, A. C., Ltd.	Inside Front Cover
Electradix Radios	Inside Back Cover
Foyles	Inside Back Cover
Heayberd, F. C. & Co.	Inside Back Cover
Holmes, H. W.	588
Parke-Davis	573
Peto-Scott, Ltd.	Front Cover Strip; 588
Sifam Electrical Instruments, Ltd.	588
362 Radio Valve Co., Ltd.	Inside Back Cover
Telegraph Condenser Co., Ltd.	583
Westinghouse Brake & Saxby Signal Co., Ltd.	573
Wet H.T. Battery Co.	Inside Back Cover
Whiteley Electrical Radio Co., Ltd.	587

FREE—

IF YOU'RE KEEN ON PHOTOGRAPHY!

NO matter whether you use a cheap box-camera or a costly Reflex ; whether you have your "snaps" developed and printed by the local Chemist or do all the work yourself you will be able to make better pictures and cut down needless expenditure if you read "The Home Photographer."

To prove our statement, we will send you a copy of this beautifully produced sixpenny monthly entirely free of cost and obligation, if you will use the form below. You will find its many illustrations, articles and hints both helpful and inspiring . . . will learn from it (as by no other means) how to use your camera to the best advantage and how to reduce waste and disappointment to a minimum. Worth it, don't you think ? Then, write to-day !

It won't cost you a Penny!

CUT out the label alongside, as indicated, and paste it securely on the front of an unstamped post-card or other card suitable for transmission under Post Office regulations. Then write on the back of the card your name and address in plain block letters, and put it in the post. On receipt, we will pay postage, and send you a copy of "The Home Photographer" post free, so that you may judge its merits for yourself. If you like it (and we think you will!) we hope you will order it regularly from your Newsagent—but you'll be under no obligation.

CUT HERE

POSTAGE WILL BE PAID BY GEO. NEWNES, LIMITED.	BUSINESS REPLY LABEL Licence No. 11568	NO POSTAGE STAMP NECESSARY IF POSTED IN GT. BRITAIN OR NORTHERN IRELAND.
---	---	--

CUT HERE

The Publisher,
HOME PHOTOGRAPHER,
(Geo. Newnes, Ltd.)
8-11, Southampton Street, Strand,
London, W.C.2.

C.5

FIRST GREATLY ENLARGED RADIOLYMPIA NUMBER!

Practical Wireless

3^D

Published every Wednesday by
**GEORGE
NEWNES
LTD.**

Vol. 4. — — — No. 100.
August 18th, 1934.

Registered at the G.P.O. as a Newspaper

Edited by F. J. CAMM.

OLYMPIA

NATIONAL
RADIO
EXHIBITION

COMPLETE GUIDE to the SHOW

our Stand **No. 8**
GROUND FLOOR

PETO-SCOTT 75/- DISC TELEVISION KIT

ASSEMBLED IN 30 MINUTES

NO SPECIAL TOOLS REQUIRED

PETO-SCOTT, Pioneers in Television since 1927, have, after considerable research, produced this "up-to-the-minute" Disc Television Receiver Kit, of which Efficiency and Economy are the keynotes.

Designed to work from almost any 3-valve battery or mains set, the Peto-Scott 75/- Disc Television Receiver is supplied in Kit form, and comprises Peto-Scott Universal Television Motor and Stand; control-

ling resistances; laminated and ready assembled chassis; Stroboscopic 16in. scanning disc; Lens and lensholder; Neon Lamp and holder, together with sundry small parts. It is absolutely complete down to the last screw and piece of wire. Full-size Blueprint with assembly, wiring and operating instructions included with every kit. Cash or C.O.D., Carriage Paid, 75/-, or yours for 15/- and 11 monthly payments of 6/3.



YOURS FOR
15/-

PETO-SCOTT CO. LTD. 77, CITY ROAD, LONDON, E.C.1.

The METAL RECTIFIER BREAKS ALL RECORDS

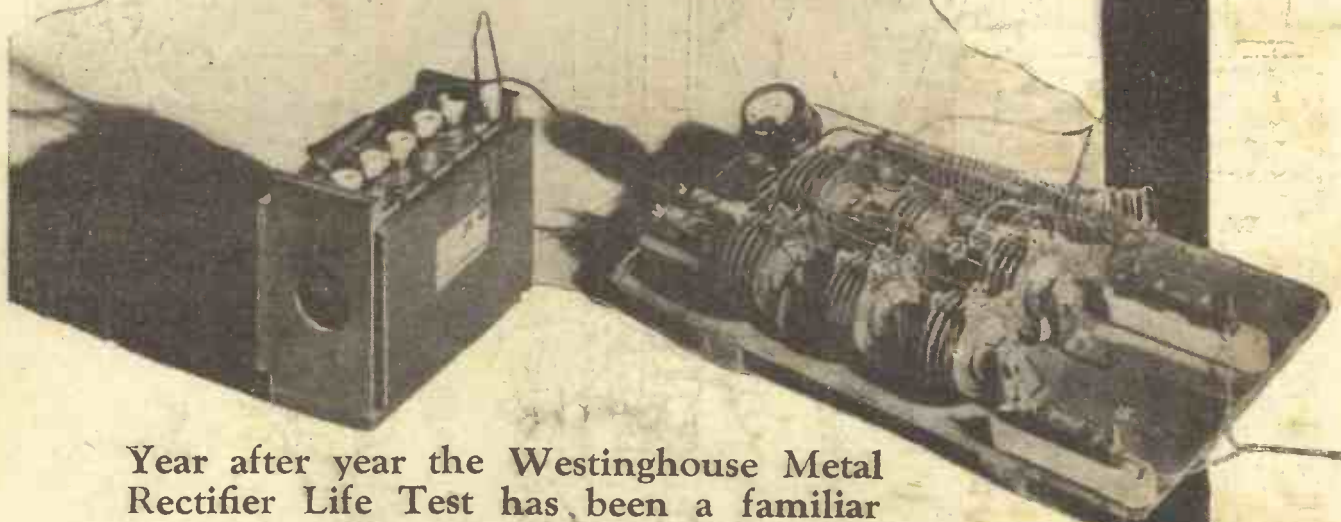

Year after year the Westinghouse Metal Rectifier Life Test has been a familiar feature to visitors at the Radio Exhibitions. And at each successive Exhibition the rectifiers appear to be just as good as they were the year before.

Radiolympia 1934 will prove no exception. And . . . for that matter, there is no reason why 1935, 1936, 1937 . . . should either. Over 60,000 hours continuous use at full load, and still no sign of any deterioration, is the record to date. Nearly 30 years' life when used 6 hours per day, and still as good as ever.

You will get exactly the same performance from the



METAL RECTIFIERS

you buy.

See that there is one in your new A.C. Mains Set or Eliminator and ensure a constant high tension supply for . . . ever.

WESTINGHOUSE BRAKE & SAXBY SIGNAL CO., LTD., 82, YORK ROAD, KING'S CROSS, LONDON, N.1.

STAND
No
86



**THE FOCUS
OF ATTENTION
AT
RADIOLYMPIA**

**G.E.C.
RADIO**



MADE IN ENGLAND

Sold by all Radio Dealers.

The General Electric Co. Ltd. ("G.E.C.")—the largest British electrical manufacturing organisation in the Empire—has produced a magnificent range of receivers to meet every demand. The G.E.C. "A.C./D.C. Mains 3," typical of the new sets, is the finest radio value offered to-day. Insist upon your dealer demonstrating its remarkable performance and quality of reproduction.

WRITE for folder No. BC6922 which describes the complete range of G.E.C. Radio receivers and loudspeakers. Sent **POST-FREE** on request.

G.E.C.

A.C./D.C. MAINS 3

A "universal" mains receiver for both A.C. and D.C. supplies, providing exceptional quality and power with reasonable range and flexibility of operation. Built-in energised moving coil speaker with 2-watts output. Illuminated tuning dial. Connections for low-impedance extension speaker. Lustrous moulded Bakelite cabinet. BC3520 for A.C. mains 200/250 volts, 40/100 cycles, and D.C. mains 200/250 volts.
PRICE, including OSRAM Valves **£7.15.0**

HIRE PURCHASE TERMS

Deposit **13/-** and twelve monthly payments of **13/-**

BC3521—25 cycle model
 Cash Price 5/- extra.

**SEE THE COMPLETE NEW
RANGE AT RADIOLYMPIA**

G.E.C. THE SETS WITH THE BIG NAME BEHIND THEM

Advt. of The General Electric Co. Ltd., Head Office and Public Showrooms : Magnet House, Kingsway, London, W.C.2.

For your Bookshelf

THE WIRELESS CONSTRUCTOR'S ENCYCLOPAEDIA

by F. J. CAMM
(Editor of *Practical Wireless*)

THIRD EDITION

5'- net

by post 5/6

The entire contents, written by the most accomplished designer and writer on the practical side of wireless construction, are presented in a new and attractive manner. The whole field of wireless construction is covered, and the volume is remarkable for the number of practical diagrams used to illustrate the text. Wireless terms and definitions are explained in concise and clear language. A treasury of wireless knowledge.

FIFTY TESTED WIRELESS CIRCUITS

by F. J. CAMM

2'6 net

by post 2/10

Modern circuits of practically every type from crystal to super-het. Diagrams and instructions for assembling and wiring, details of components and notes on operation.

THE MATHEMATICS OF WIRELESS

by RALPH STRANGER

5'- net

by post 5/6

Probably because it seems such a dull subject, this is a side of Wireless that is too often neglected by amateurs. But, none the less, it is of tremendous importance—and this gifted writer deals with it in such a way that there isn't a dull page in the book.

THE ELEMENTS OF WIRELESS

by RALPH STRANGER

3'6 net

by post 3/11

A complete guide to the understanding of modern wireless. The author starts with elementary principles, proceeds to the consideration of their application in practice and theory and finishes with a critical survey of a typical four-valve Receiving Set, tracing its working from aerial to loud-speaker.

From all Booksellers or by post from:—

GEORGE NEWNES LIMITED
8-11, Southampton Street, Strand, London, W.C.2

RADIOLYMPIA

G.E.C. STAND

See the full range of G.E.C. Batteries on Stand No. 225, Grand Hall Gallery.



The battery that
is especially
made to give
**BETTER
RADIO**

PRICES:
60v : 5/6. 99v : 9/-. 108v : 10/-. 120v : 11/-. 124½v : 11/6.
139v : 12/9. 150v : 14/-. Also Triple Capacity 60v : 8/6.
120v : 17/6.

- Made by modern machinery in a modern factory
- Multi-tested to ensure uniform performance and longer life

GUARANTEED 120 VOLT. 144,000 MILLIWATT HOURS

MADE IN ENGLAND

Sold by all Radio Dealers

G.E.C.H.T.

A TRIAL MEANS YOU'LL ALWAYS USE GEC HT

Advt. of The General Electric Co. Ltd., Magnet House, Kingsway, London, W.C.2

POLAR

CONDENSERS & DRIVES

See them all on
STAND 87
RADIOLYMPIA

**SEND FOR
NEW POLAR
CATALOGUE**

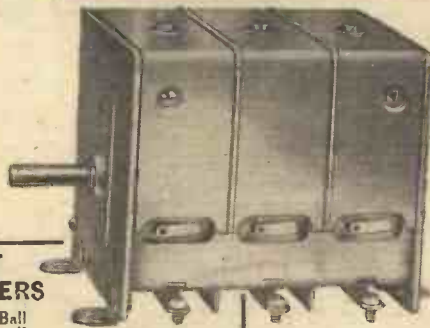

POLAR MIDGET GANG CONDENSERS

Steel frame and cover. Ball bearing shaft. Small over-all dimensions. Trimmers operated from top. Matched within 1/2% or 1 mmfd., whichever is the greater.

2 GANG 11/-
* 3 GANG (or Superhet) .. 16/6

★ SPECIFIED FOR THE
"ARMADA THREE"
ONE Midget 3 gang Condenser 16/6
ONE "Arcuate" S.M. Drive... 5/9

POLAR ARCULATE DRIVE

Slow Motion Drive.
Bevelled Scale.
Moulded Escutcheon.
Lampholders.

★ Price 5/9



POLAR VERTICAL C.K. DRIVE

Slow motion drive. Horizontal pointer. Lampholders provided.

Price 6/6

WINGROVE & ROGERS, LTD.,
188/189, Strand, London, W.C.2

'Phone: Temple Bar 2244.

Works: Old Swan, Liverpool



BULGIN

QUALITY
RADIO COMPONENTS

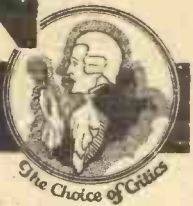

OLYMPIA STAND 121

Do not fail to call and examine the numerous brand new BULGIN Components now available, all designed in accordance with the latest research and practice. Prices have been reduced to the lowest level consistent with the high quality of material and workmanship for which BULGIN PRODUCTS are justly famed.

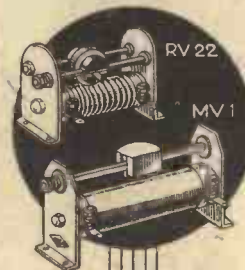

NEW RESISTANCES

Additions to the present large range of wire wound resistances include 10 watt and 60 watt continuously variable and 40 watt semi variable. Many types reduced in price.

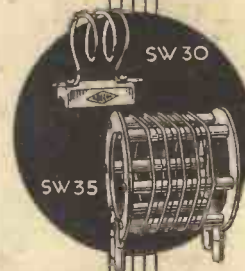

SHORT WAVE UNITS

Considerable progress in this direction. New Ultra Short Wave Multiple and Plug-in Tuners from 5 metres upwards. Ceramic Valveholders 5 and 7 pin with special low loss properties, etc., etc.

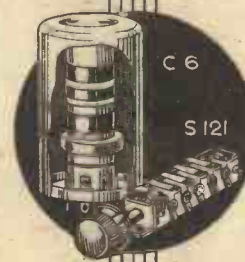

NEW TUNING COILS

Complete range of compact modern design screened coils to suit present-day conditions. New quick-make-and-break wiping contact wavechange switches.

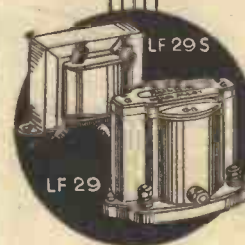

NEW TRANSFORMERS

Specially designed high gain Q.P.P. Transformers suitable for use with latest Double Output Pentode Valves. Skeleton and Bakelite cased types available giving wonderful performance.

300
ILLUSTRATIONS

Please send me, post free, a copy of the New Bulgin Catalogue, No. 154 "N," for which I enclose threepence in stamps.

NAME

ADDRESS
(BLOCK LETTERS PLEASE)

A. F. BULGIN & CO. LTD.,
Abbey Road, Barking, Essex.

50
NEW LINES

2 NEW KB

SUCCESSSES!

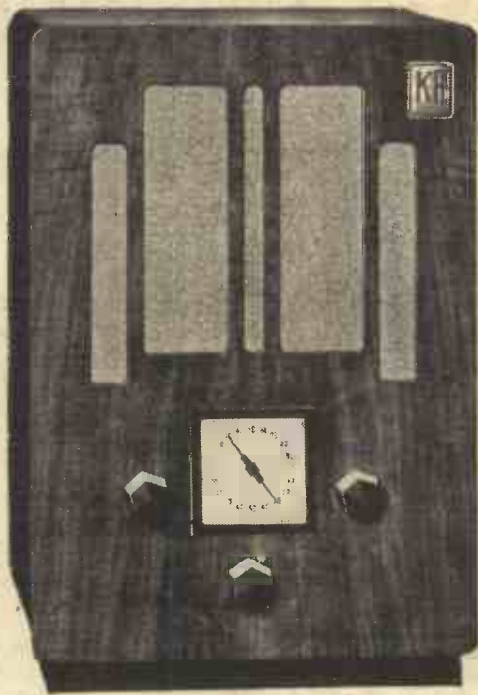

KB 'NEW PUP'

3 VALVES. MOVING COIL SPEAKER

£5.15

OR 10/- A MONTH

Here's one of the high-lights of the Show! Do you remember the original KB 'Pup'? More than 200,000 listeners have owned one. Now comes its successor—the 'New Pup' of 1935. We have aimed wholly and solely at giving the most and the best that we can for the money—really satisfying reception, and handsome cabinets.

fine volume and pure tone. It has full vision dial with names of principal stations. Four aerial tappings provide alternative selectivity.

The 'New Pup' brings in a good range of British and Continental stations with

You must see this set for yourself, hear it, compare it. Then we believe you'll agree the value is unique.

KB 'New Pup' 3-valve Battery model. Oak cabinet. £5. 15 or first payment of 12/- (including 2/- insurance) and 12 monthly payments of 10/-

KB 'NEW PUP' 3-valve A.C. Model **£6-17-6**

FINE WALNUT FINISHED CABINET

or first payment of 14/- (including 2/- insurance) and twelve monthly payments of 12/-

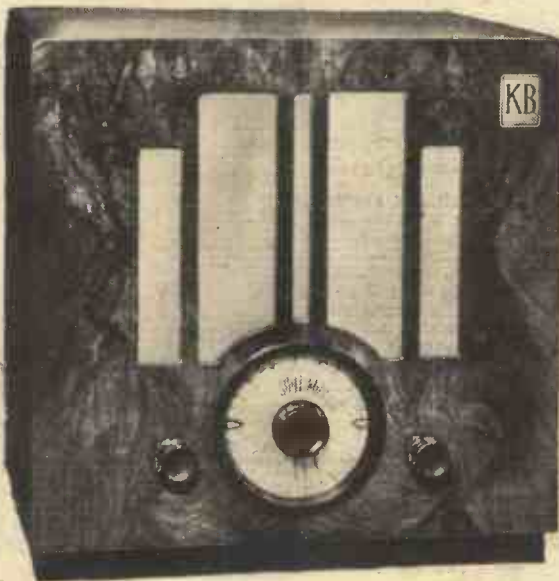

KB '381' SUPERHET

with delayed automatic volume control

5 VALVES. A.C. or D.C.

£10.10

OR 18/- A MONTH

Are you looking for radio that will bring you—and go on bringing you—first class entertainment without trouble? Here it is. Never has a receiver undergone such searching tests as this new superhet. It was 'taken for a ride' all over England, and stood up to the severest trials. It can never meet, in normal use, demands it has not already met.

Now 18 months' hard work is done and the sets are ready for you to hear and compare.

The '381' is a clean, clever job. Every component has earned its place. Every essential is there. We wanted extra robust valves, and had them made specially. We wanted high selectivity—and you'll find we got it.

The '381' has five valves, including rectifier. Operates on any A.C. or D.C. supply, 200-250 volts. Full vision dial marked with station names and wavelengths. Designed for KB Rejectostat system. Handsome walnut cabinet.

10 GUINEAS or first payment of 28/- (including 3/- insurance) and twelve monthly payments of 18/-

KB RADIO from £5.15 to 65 gns.

See all the new KB models at
STAND 84 RADIOLYMPIA

SEND FOR NEW KB CATALOGUE

Post in unsealed envelope using 3d. stamp to
KOLSTER-BRANDES LTD., CRAY WORKS, SIDCUP, KENT.

Please send me full particulars of the new KB Receivers.

Name

Address

Pract. W. 18/8/34

NEW LINES

By **BELLING-LEE** OLYMPIA, STAND No. 41

Standard Disturbance Suppressor 1118

 This is all that is required in 80% of cases.
 Type 1118 .. 10/6

For Small unearthed electric motors.

 Type 1711 .. 8/6

Flashing Sign Suppressor

 Type 1172 11/6

Neon Sign Suppressor

 Type 1142 .. £3 15

D.C. Ripple Suppressor

 For use when 'hum' on D.C. mains is troublesome, such as when fed from Mercury Arc Rectifiers. Type 1140 £3 7 6

Car Radio Interference Suppression Kit

 6 cylinder 20/-
 4 cylinder 15/6

CONTACT SUPPRESSOR

 Type 1144 2/6

VOLTAGE DROPPER.

 Use practically any make or combination of universal valves on any mains supply without the use of additional resistances. Type 1173. 17/6

PLUG TOP VALVE Connectors

 Type 1175 .. 1d.
 Type 1167 .. 2d.
 Type 1156 .. 4d. (shrouded)
 Type 1166 .. 8d. (shielded).

PICK-UP. Model D.

 Without volume control .. 30/-

AIR FORCE Wanderplug

 will not come out
 Type 1157 each 1/-

TELEVISION LETTERINGS

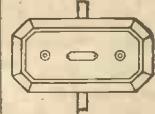
 Syn. Mod. Anode GN. X1, X2, Y1, Y2, A1, A2, B1, B2

VALVE HOLDERS

 Type 1163 8d.
 " 1164 10d.
 Type 1135-S 4 way .. 4d.
 Type 1136-S 5 way .. 4d.
 Type 1138 7 way .. 5d.
 Type 1137 9 way .. 6d.

Double Choke and Condenser Unit

 3 to 30 amps.
 From £3 10

Better 1935 radio means using 1935 COLVERN components



The latest type Ferrocort coils, 12/6 each

Constant research and continuous experiment have resulted in the new Ferrocort coils and "Colpak" illustrated—even further advanced and in efficiency, prevision and design than last year. Only by fitting Colvern components in your set can you be assured of the most brilliant reception. Make a special point of seeing them at Stand 38, Olympia. Made under licence from patentee, Hans Vogt.



The New Colpak tuning unit, 57/6

A description of the method evolved by the post office and by engineers throughout the world for the suppression of electrical interferences with Radio reception and including results of research work conducted by Belling & Lee, Ltd., with 37 illustrations. From your Radio dealer price 6d. or post free 6d. by sending the coupon.

WRITE FOR BOOKS

BELLING & LEE LTD.
 Cambridge Arterial Road, Enfield, Middx.

Please send a Free Catalogue, b 6d. Book. Stamps enclosed.

Name

Address

P.W.18/8/34

STAND 38 OLYMPIA

FREE Blueprints of splendid specially designed "up to the minute" sets.

To COLVERN, Ltd., Romford, Essex. Please send me full details and Blueprint of the } COLPAK CLASS B
 Strike out name of blueprint not required. } A.C. MAINS SET

Stamps value 3d. to cover postage are enclosed.

NAME

ADDRESS

If you would like a copy of our Ferrocort Booklet, please put a X here.....



In the days when receiving "a foreign station" was a matter for congratulation—when reception of any description was always rather a question of fortune—in those days Celestion was the Foremost Name in Sound Reproduction.

To-day, with a long list of achievements to its credit, the name of Celestion on a Loud Speaker means the same as the hall-mark on gold. Throughout ten long years Celestion engineers have striven always onwards to achieve their aim of perfect sound reproduction. That is why Celestion is still to-day the choice of those who know.

There is a Celestion Loud Speaker for every purpose at prices ranging from 17s. 6d. to 18 gns. Write for complete list and technical data to Celestion Ltd., London Road, Kingston-on-Thames. Telephone: Kingston 5656-7-8-9.

CELESTION
The Very Soul of Music

was the foremost name
in sound reproduction

Duckingham

362
VALVES

OLYMPIA
STAND 244

An invitation to all radio enthusiasts; Call at our stand, and learn for yourself how 362 valves have solved the problem of "better—yet—cheaper" radio. Compare price and performance (study the characteristics) with any other make of valves.

362 BATTERY VALVES. H HL & L, 3/6. Power, 4/- Super Power, 4/6. SG & VS, 7/6. Pentode Type, 10/- BA & BX, 9/-.
362 AC MAINS. HL4, 7/6. PX4, 9/- SG4 & VS4, 12/6. ME & HM, 13/- RB41, 7/6. RB42, 10/- DC MAINS at SAME PRICES as AC MAINS.
Should your dealer not stock, send P.O. to Dept. 44.

362 RADIO VALVE CO., LTD.,
STONEHAM RD., LONDON, E.5.

TELEPHONE: CLISSOLD 1206

CAREW WILSON

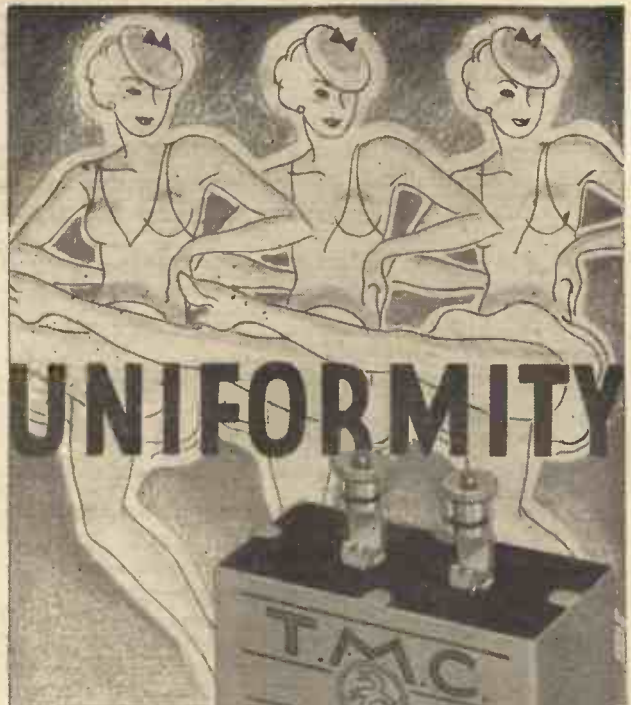

The perfect uniformity of movement in a well-trained chorus is not as easy to achieve as it looks. It calls for experience, endless practice and endless patience. So it is with T.M.C.-HYDRA condensers. Patient and careful checking is carried out at every stage in their manufacture. Stringent tests are applied to ensure uniform accuracy within the narrowest of limits. And so you know that every T.M.C.-HYDRA condenser you buy is absolutely reliable.

SEE OUR STAND No. 105, RADIOLYMPIA

T.M.C.
BRITISH MADE
HYDRA
CONDENSERS



The special method of sealing T.M.C.-HYDRA condensers definitely prevents the penetration of moisture and so preserves the high electrical properties of the condensers. T.M.C.-HYDRA condensers of all types are sold by your radio dealer, but if you have any difficulty in obtaining supplies, write to the Sole Distributors:

T.M.C.-HARWELL (SALES) LTD
Britannia House, 233 Shaftesbury Avenue
London, W.C.2. (A few doors from New Oxford Street)

Telephone: Temple Bar 0055 (3 lines)

Made by TELEPHONE MANUFACTURING Co.Ltd.

AGAIN

Regd. Trade Mark.

WEARITE
are specified.

NOW FOR THE
"SUMMIT 3"

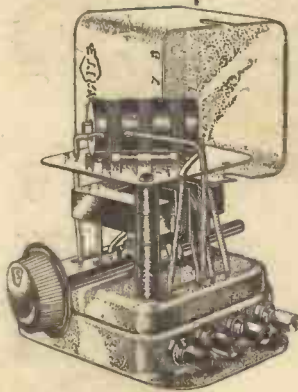

**THE WEARITE
"NUCLEON"
IRON CORE
COILS**

The outcome of many months intensive research work, these coils are again the choice of a leading Set designer. For your "Summit Three" you will need the following:

- ONE WEARITE A.D. Coil (Aerial) 12/6
- ONE WEARITE T.G. Coil (H.F.) 12/6

Here is the famous
**SCREENED
UNIVERSAL
COIL**

Tunes 180-550 and 850-1950 metres. This coil is Universal in that it is equally suitable for Aerial, H.F. or Band - Pass Tuning.
5/-
Price per coil

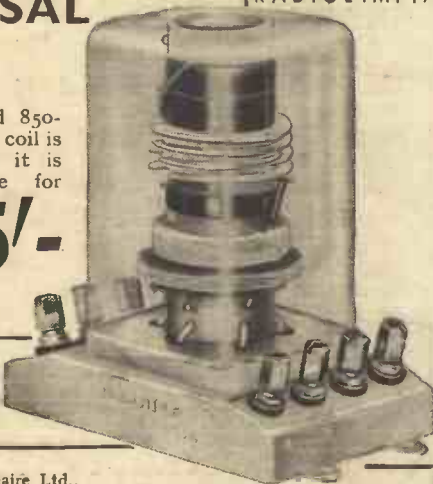

SEE THE COMPLETE RANGE OF NEW COMPONENTS ON STAND No. 1 RADIOLYMPIA

ASK AT THE STAND FOR NEW BOOKLET or POST THIS COUPON

COUPON

To Messrs. Wright & Weaire, Ltd.,
740, High Road, Tottenham, N.17.

Please send me a copy of your latest Booklet No. S.834, together with details of your Universal Coils and L.P. (Lucerne Plan) Circuits, particulars of your Class "B" Components (and circuits) and also H.T. Power Packs with Circuits.

NAME

ADDRESS
PRAC. 18/8/34. PLEASE WRITE IN BLOCK LETTERS.

**HEAR BLUE SPOT
FIRST**

Blue Spot's reputation for quality in Loudspeaker design and performance is almost as old as broadcasting. The new Blue Spot "Star" Speakers represent the greatest advance in the science of loudspeaker reproduction. Your old friends 89PM and 45PM and their cabinet models are also being continued.

**OLYMPIA
STAND 90**

BLUE SPOT "STAR JUNIOR"

This is an exceptionally fine speaker at a very attractive price. The "Star Junior" gives a very high frequency response and the reproduction is amazingly natural and vivid in every detail of speech, song, or instrumental music.



FEATURES.

New Magnet design. Die cast chassis. No leakage of magnetism. Transformer with 12 point matching to suit all usual output stages or for use as extension speaker.

PRICE

35/-

Cabinet model in oak and chromium 48/6.

BLUE SPOT PICK-UP

This new model presents many attractive features. Tracking error is reduced to the minimum. The head lifts back for needle changing, eliminating risk of damage to records. Perfect reproduction of all frequencies without overloading. Screened leads. An earth connection provided. Special Volume Control giving silent and distortionless adjustment. Price £1 7s. 6d., or without Volume Control £1 1s. 6d.

BLUE SPOT "STAR"

A really outstanding speaker giving a degree of naturalness in reproduction never before achieved. It has a special magnet, die cast chassis, novel exterior suspension, independent on/off switch and many other features. Price: 70s. Cabinet Model in walnut and chromium 98s.

REMOTE VOLUME CONTROL

for use only with the Blue Spot "Star." It replaces the standard on/off switch and only controls the speaker to which it is attached. May be used free or fixed. Price: 10s. 6d.

SEND FOR SEASON'S CATALOGUE FREE. It describes in detail all the newest Blue Spot Models.



THE BRITISH BLUE SPOT COMPANY, LTD., Blue Spot House, 94/96, Rosoman Street, Rosebery Avenue, London, E.C.1.
Distributors for Northern England, Scotland, and Wales - H. C. RAWSON (Sheffield and London), Ltd., Sheffield: 22, St. Mary's Parsonage, Manchester; 177, Westgate Road, Newcastle-on-Tyne; 37, 38, 39, Clyde Place, Glasgow; 45, Springbank, Hull.

IT STANDS ALONE

10, 20 or 30 m/A
at either
120 or 150
volts.



69/6
CASH
or 10/- DEPOSIT
and 8 monthly
payments of 8/6.

THIS NEW "ATLAS" UNIT HAS 6 OUTPUTS & GIVES THE MOST POWER at the LOWEST COST

A MODEL FOR EVERY SET.
TRY ONE FREE ON YOURS.

There is an "ATLAS" Unit to make any Battery Receiver Mains-operated without alteration to set or valves; giving vastly improved performance for one-fiftieth the running cost of dry batteries. Prices from 39/6d. cash, or 10/- deposit.

The new "ATLAS" Model T10/30 is the last word in Mains Unit design. In power, output and value, it surpasses any mains unit ever made. No other unit in the world provides tapped alternative outputs of 10, 20 or 30 milliamps with alternative voltages of 120 or 150 for only 69/6 cash.

WHAT THIS MEANS TO YOU.

You can run your battery radio set of any type or size from the mains and cut running costs from 60/- a year to less than ONE SHILLING A YEAR. Moreover, it means that no matter what battery set you may buy or construct in future years, you are assured of the correct voltages and outputs you require. If you buy the "ATLAS" T10/30 and insist on it, you put an end for ever to the expenses and annoyances of Battery replacements, and accumulator charging.

SPECIFICATION.

H.T. Tappings, 60/80 v. (min. and max.), 50/90 v. (min., med. and max.), 120 v. and 150 v.

H.T. Outputs, 10, 20 or 30 m/A at either 120 or 150 v.

L.T. Trickle Charger, 2 v. at 0.5 A. For A.C. Mains 100/125 or 200/250 v. 40/120 cycles. Model for 25 cycle mains at same price.

Guaranteed for 12 months. Westinghouse Rectifiers.

NO OTHER UNIT GIVES SO MUCH FOR SO LITTLE.

Ask your dealer for a FREE demonstration to-day.

POST THIS COUPON NOW!

Messrs. H. Clarke & Co. (M/cr.), Ltd., Patricroft, Manchester.

Please send me full details of the unique new T10/30 and other "ATLAS" Mains Units.

Name

Address

7/65

ATLAS

MAINS UNITS 

H. CLARKE & CO. (M/cr.), LTD., PATRICROFT, MANCHESTER.

London: Bush House, W.C.2.

Glasgow: G. E. S. Co., Ltd., 38, Oswald St.

THE RADIO OF THE FUTURE IS AVAILABLE NOW!



It does not matter how much or how little you have in mind to spend, you will find, in the "His Master's Voice" range, the set that is *exactly* what you want. "His Master's Voice" instruments range from £7. 19. 6 upwards, and each, at its price, is the finest set you can get for your money anywhere. Come and see the new models "His Master's Voice" are showing at Olympia. Very *cudibly* are they in advance of their time.

SEE THE NEW "HIS MASTER'S VOICE" MODELS AT OLYMPIA

A set for every purpose—to flatter every purse

STAND Nos. 61 & 33, THE RADIO EXHIBITION,

OLYMPIA, AUGUST 16th—AUGUST 25th



"HIS MASTER'S VOICE"

THE GRAMOPHONE CO. LTD.. 98-108, CLERKENWELL ROAD, LONDON, E.C.1

THE "SUMMIT" (BATTERY) AND "ARMADA" (MAINS)

See Pages 602 & 612.

1st SPECIAL SHOW NUMBER



Practical Wireless

Technical Staff:
 W. J. Delaney,
 Frank Preston,
 H. J. Barton,
 Chapple,
 Wh. Sch., B. Sc.,
 A.M.I.E.E.

VOL. IV No. 100 Editor F. J. GAMM Aug. 18th, 1934

Welcome to Stand No. 8, Ground Floor!

READERS visiting Radiolympia should make a point of visiting our stand, which is No. 8, Ground Floor. Our technical staff will be in attendance to answer readers' queries and to offer advice. Readers will also be able to inspect the latest literature dealing with all aspects of wireless.

Our Show Guide

ELSEWHERE in this issue we give a full forecast of the exhibits arranged in alphabetical order. This forecast may also be used as a complete guide to the Show.

Getting to the Show

FOR the convenience of readers we show on page 635 a map giving the bus and Underground routes to and from Radiolympia. If you are a provincial reader (or even a London reader!) you will find this map of great use.

A Complete List of Exhibitors

ON page 644 appears a complete list of exhibitors arranged in alphabetical order, the Stand No. of each exhibitor appearing against each entry.

Next Week's Complete Show Report

NEXT week's issue, our second greatly enlarged Radiolympia number, will contain a comprehensive stand-to-stand report of all the exhibits. There is always a colossal demand for our special Show issues and it is necessary for you to order next week's issue in advance.

The "Summit" and the "Armada" —our Special Show Receivers

OUR special Show receivers cater for both the battery and the mains user. The "Summit" represents the peak of performance at a really competitive price, and we enthusiastically recommend it to every reader who wishes to make an extremely selective, sensitive, and powerful receiver at low cost. The "Armada" is a small, mains-operated tablegram—small in size, and, therefore, ideal for a small room. As

its title, with subtle allusion to a different sort of mains, suggests, it will enable the reader to roam the mains of the ether. Both are backed by our guarantee.

Scottish Radio Exhibition

AN important event, from the wireless listeners' point of view, will be the opening of the Radio Exhibition, Kelvin Hall, Glasgow, which is being held under the auspices of the Radio Manufacturers' Association. The opening speeches will

SPECIAL FEATURES IN THIS ISSUE

	Page
A Message to New Readers...	601
The "Summit" Three ...	602
The New Valves ...	605
The Trend of Design...	606
Circuit Developments ...	607
Television is Imminent ...	608
Readers' Wrinkles ...	611
The "Armada" Mains Three	612
Loud-speaker Progress ...	617
Special Free-for-all Competition ...	618
Guide to the Show ...	621
Floor Plan of the Exhibition	624
List of Exhibitors ...	644
Practical Television...	648

be relayed in the Scottish Regional programme on August 31st. In the following week there will be three relays from the concert hall. The exhibition will be practically a replica of Radiolympia, London.

Our NEW monthly Magazine
PRACTICAL TELEVISION
 6D. EVERY MONTH

Entertainment from Blackpool

ON August 24th another Blackpool Night's Entertainment will be broadcast from the North Regional. This will include organ music by Reginald Dixon from the Tower Ballroom; a sound picture of the crowds on the Pleasure Beach; dance music by Will Hurst's Band from the Palace Ballroom; variety from the Palace Theatre; dance music by Bertini's Band from the Winter Gardens; shows by the Arcadian Follies from the South Pier, and by Tom Vernon's Royal Follies from the Central Pier, and a visit to the Tower Circus.

Dominoes Dance Band from Newquay

WEST Regional listeners will hear Sutherland Felce (raconteur) and Philip Brown's Dominoes Dance Band relayed from the Headland Hotel, Newquay, on August 25th. The band, which consists of four players, was formed in 1925, and has broadcast on more than 120 occasions. A chance offering of a cabaret engagement whilst in the South of France decided the future career of Sutherland Felce, and he set out to create a style that was different.

Three Choirs Festival

IN the Regional programmes on September 4th a relay will be given from the Three Choirs Festival, which takes place at Gloucester. The relay consists of the Mozart Requiem Mass, and the three cathedral choirs of Worcester, Hereford, and Gloucester will be heard with the London Symphony Orchestra and with Isobel Baillie, Mary James, Trefor Jones, and Keith Falkner as soloists. Dr. Percy Hull, organist at Hereford Cathedral, will be the conductor. The conductor of the whole Festival is Herbert W. Sumson, who succeeds the late Sir Herbert Brewer as organist of Gloucester Cathedral. There are 350 voices in the Festival Choir.

Silver Band Concert from Bodmin

THE St. Dennis Silver Band, conducted by A. G. Richards will give a concert for West Regional listeners from the Foster Hall, Bodmin, on September 1st. Jack Collings, the fisherman bass, will be the artist.

ROUND the WORLD of WIRELESS (Continued)

Variety Performances from Olympia
THE B.B.C. announces that during the Radio Exhibition at Olympia (August 16th to 25th) three variety performances will be given daily in the theatre. The bill will be changed three times in the course of the Exhibition, each bill running for three consecutive days. Excerpts from performances are to be relayed in the National programme on August 16th, 20th and 25th, and in the Regional programme on August 18th and 22nd.

The following artists will appear: Claude

RADIO IN THE OPEN



A small picnic party using a Ferranti Lancastria Battery Portable.

Dampier and Billie Carlyle, comparative newcomers to the microphone; Ann Penn, whose impersonations have been a popular feature of B.B.C. programmes since February, 1929; Collinson and Dean, comedians; Phyllis Robins; Bertha Willmott, the "comedy girl with a voice"; and Clapham and Dwyer, who need no introduction to the public, Jass and Jessie, Arthur Prince and "Jim." Lily Morris, and the Carlyle Cousins, syn-copated singers, will also appear at Radiolympia. In addition there will be Stanelli and his Hornchestra; Stainless Stephen, who invented the "punctuation" style of broadcast humour; Alec McGill and Gwen Vaughan, the Cheerful Chatterers; Anona Winn, one of broadcasting's most versatile artists; and Hermione Gingold.

Broadcasts by Miscellaneous Bands

DURING the absence from the studio of the B.B.C. Dance Orchestra, directed by Henry Hall, who will be on the stage at the Radio Exhibition at Olympia from August 16th to 25th, Will Hanson, organizer of dance-band broadcasting, will carry into effect his policy of giving lesser-known combinations a turn at the microphone. The bands which listeners are to hear during the middle weeks of August are all extremely capable and able to put up an excellent show. In the first week, starting on August 13th, the 17.15-18.00 (5.15-6.0 p.m.) period will be filled on successive days by Percival Mackey and his Band, Reginald Foresythe and his New Music, The Barnstormers, Harry Leader and his Band, and Joe Loss and his Kit-Cat

INTERESTING and TOPICAL PARAGRAPHS

Band. The midday period on August 17th will be filled by Tommy Kinsman and his Band.

Band Music During the Second Week of the Show

THE 17.15-18.00 period of the second week of Henry Hall's absence at Radiolympia opens with Billy Mason and his Dance Orchestra (August 20th), followed by Terry Mack and his Serenaders, Dare Lea and his Band, Rudolph Dunbar and his Coloured Orchestra, and Don Sesta and his Gaucho Orchestra in the order named. For the midday period on August 24th, Henry Hall and the B.B.C. Dance Orchestra will make a temporary return to the studio.

Another Outside Broadcast

ANOTHER North Wales Night's Entertainment has been arranged for Northern listeners on August 15th. Although the programme will be an entirely new one, it will be supplied by the same artists, these being the "1934 Evening Follies" from Arcadia, Llandudno, the Colwyn Follies from the Pier Pavilion, Colwyn Bay, and the Rhyll Municipal Silver Prize Band.

"Tangos"

FRANK CANTELL is to direct the Midland Studio Orchestra on August 21st in "Tangos." Thomas O'Hara, who has often broadcast with his piano accordion, will play with the Orchestra.

Concert by 2nd Battalion Black Watch

THE principal feature for Midland Regional listeners on August 22nd will be a relay from the Arboretum, Derby, where the Band of the 2nd Battalion Black Watch, conducted by Mr. F. G. Lewis, is to give a popular programme, including a Sullivan Selection and a Scottish Fantasia. It will close with the Regimental Slow March, "The Garb of Old Gaul." This band played at Helsingfors last September in the British Week there, and this year it took an important part in the Black Watch Historical Pageant at the Royal Tournament.

"Saturday Afternoon" Series

R. N. BILES will contribute to the Scottish Regional "Saturday Afternoon" series on August 25th, when he will discourse on "Pottering About the Garden." The majority of listeners have done this sort of thing themselves, and it should be

interesting to hear whether Mr. Biles has discovered a new way of killing time.

"Bitter Brevities"

HALBERT TATLOCK has devised another set of "Bitter Brevities" which will be broadcast on August 22nd in the Scottish Regional programme. He will be followed by a programme of "Tunes we Remember"—old tunes, gay tunes, new tunes, blue tunes. These gramophone records have been specially selected by Douglas Moodie.

Welsh Concert Orchestra

THIS orchestra, conducted by Ronald Harding, will give a concert from the studio for West Regional listeners on August 19th. This orchestra is composed of keen professional unemployed musicians, both men and women, who have no outlet for their talents and capabilities owing to the lack of vacancies in existing orchestras. Tudor Davies (tenor) will be the soloist.

Light Entertainment from Portrush

THE Society Entertainers and Sibbald Treacy and his Rhythm Kings will be broadcasting from Portrush on the night of August 22nd-23rd; but they will not be heard by Northern Ireland listeners. Their audience on this occasion will be a vast one, spread over the Empire, for the transmission, which starts at midnight, is being radiated by the Empire station.

For Scottish Regional Listeners

THAT popular combination, the John MacArthur Quintet, are in the Scottish Regional programme on August 19th. The items will include Der Vogelhandler, by Bauckner, a Gavotte by Bolzoni, Bourrée and Gigue by German, and a selection from "The Gondoliers" by Sullivan. The Scottish Military Band, conducted by John A. McIvor, will present a popular programme on August 20th. Laurence Morgan, tenor, will be the soloist.

(Continued at foot of facing page.)

SOLVE THIS!

PROBLEM No. 100.

Martinson had an old three-valve mains set employing a detector and two L.F. transformer-coupled stages. He decided to bring this up to date, and accordingly fitted iron-cored tuning coils and new ganged condensers with good results. As the set seemed now in good condition he decided to fit an R.C. coupled stage in place of one of the transformer-coupled stages, and therefore fitted this in place of the first stage, thus making the detector R.C. coupled to the first L.F. valve. He chose the values of the two resistances and condenser from the valve-maker's instruction sheet, but found that not only was the volume seriously reduced, but he could obtain no reaction. Why? Three books will be awarded for the first three correct solutions opened. Address your attempts to The Editor, PRACTICAL WIRELESS, Geo. Newnes, Ltd., 8-11, Southampton Street, Strand, London, W.C.2. Envelopes must be marked Problem No. 100, and must be posted to reach this office not later than the first post Monday, August 20th, 1934.

Solution to Problem No. 99.

When Jackson made his change he overlooked the fact that he was not employing an H.F. stage, and consequently he affected the rectification properties of the valve as he applied the negative bias.

The following three readers successfully solved Problem No. 98, and books have accordingly been forwarded to them:—

H. Smith, 6, Marshfield Road, Settle.
 D. G. Adams, 228, Robin Hood Lane, Hall Green, Birmingham.
 J. A. Pangborn, 24, North Birkbeck Road, Leytonstone, E.11.

A MESSAGE TO NEW READERS

By The Editor



THE annual Radio Exhibition at Olympia is the period when thousands turn their attention to radio for the first time. A great proportion of this new generation of home-constructors become regular readers of PRACTICAL WIRELESS, and it is to them that this message is addressed.

This is not a normal issue, and for the benefit of new readers, who are making their acquaintance with PRACTICAL WIRELESS for the first time, I wish to reaffirm our objects and our policy. Quite naturally, the importance of the Wireless Exhibition has justifiably claimed a large proportion of our space, and to accommodate the Guide to the Show and announcements regarding manufacturers' new season's programmes, many regular features and articles have necessarily been held over.

Normal issues of PRACTICAL WIRELESS contain a fair blending of everything of interest to the wireless constructor, expert or amateur. There are practical articles on set-building, television, readers' ideas, coil-making, test reports on the latest components, fault-tracking, our experts' replies to readers' questions, and many other interesting features written in everyday language and attractively illustrated by means of PRACTICAL WIRELESS copyright illustrations.

The Beginner's Supplement

We regularly feature a special supplement for the absolute beginner, and a new course for beginners commences in next week's issue. This course starts from first principles and proceeds through all of the varied aspects of radio and home construction. It is written in non-technical language and illustrated by means of non-technical diagrams. Even experts will find it an interesting refresher course: Those who have just taken up the hobby should follow this series week by week.

For the Short-Wave Enthusiast

For the short-wave enthusiast there is our regular short-wave section, which deals with the latest designs for short-wave receivers, methods of operation, the latest short-wave components, and all other avenues of this interesting branch of radio, including the ultra short waves. This also is a weekly feature.

Half Guineas for Readers' Ideas

Our readers' wrinkles pages give each week a selection of the best ideas received from our readers. We pay 10s. 6d. for every

item so published. These wrinkles cover interesting and ingenious gadgets, components, and methods which considerably add to the enjoyment and the efficiency of home-built receivers.

We award a special prize each week of one and a half guineas for the best wrinkle submitted. This feature affords you an interesting means of earning sufficient money to pay for your wireless components. Every reader stands an equal chance of winning these cash prizes.

The Free Advice Bureau

For the reader requiring technical advice, there is our Free Advice Bureau, which answers readers' questions promptly and accurately free of charge.

"Practical Television"

Our Television Supplement presents the latest news about persons, programmes, and apparatus relating to television. You will find all the news about the radio screen in this regular weekly feature, and in our companion journal, "Practical Television"—6d. Monthly.

Our Policy

Our receivers are designed for cheapness of construction and efficiency and ease of operation, and PRACTICAL WIRELESS has played a great part in bringing about the present low prices of components and valves. We only specify the parts actually used by our designers—no alternatives. Every receiver of PRACTICAL WIRELESS design must function in the manner which we claim it to do, and readers who encounter a difficulty may freely avail themselves of the technical advice of the designer.

Our Laboratories

The PRACTICAL WIRELESS well-equipped laboratories are staffed by enthusiastic experts, who are always tirelessly at work designing the very best receivers for home constructors. Other contributions deal in a fascinating way with this most modern of all sciences, and as a new reader you will appreciate that PRACTICAL WIRELESS does a great deal more to deserve your patronage than normally comes within the province of a journal. In nailing your flag to its mast you have secured not only the best technical information and the services of trained experts; you are ensuring that you are obtaining from your receiver the maximum of efficiency for the money you spend and the most palatable presentation of technical knowledge.



The Editor.



Mr. W. J. Delaney.



Mr. Frank Preston.



Mr. H. J. Barton Chapple,
Wh. Sch., B.Sc.,
A.M.I.E.E.

ROUND THE WORLD OF WIRELESS

(Continued from facing page)

"Schemes"

A NEW series of talks, entitled "Schemes," commences in the North Regional programme on August 17th. The projects selected are all either Northern in origin or liable to have a marked effect on the life of the North; none of them has a purely commercial object; and they have been chosen largely for their "news value" irrespective of whether they are

yet practicable. Mr. Kenneth Spence, Honorary Secretary of the recently-formed Lake District National Reserve Association (better known as the "Friends of the Lake District") will initiate the series on August 17 with a talk about "The Future of the Lake District." In this he will outline the scheme which is on foot (sponsored by the "Friends" and kindred organisations) for preserving the beauty of the Lakes by regulating all forms of building development in the district, sometimes going so far as to buy stretches of country for the National Trust.

Radio Folk for Belgium

THE L.N.E.R. are arranging two special trains and special steamers for two parties, totalling 470 passengers, under the auspices of the Philco Radio and Television Corporation of Great Britain, Ltd., to visit Zeebrugge and the Belgian Coast.

The first party will leave Liverpool Street Station on Friday, August 10th, at 8.35 p.m., returning from Zeebrugge on Sunday night, August 12th; the second party will leave at 8.30 p.m. on Friday, August 17th, and return on Sunday, August 19th.

BUILDING

Our Latest Battery Receiver—
at a Really Competitive Price



Here is the "Summit" ready for insertion into its cabinet.

THE "Summit" can truly be described as one of the very best battery receivers that has been designed in the PRACTICAL WIRELESS laboratories. Regular readers know what this means, and that it would be difficult to give greater praise to any set. There is, therefore, no necessity to emphasize the extreme efficiency of the receiver, nor even to say that it is probably more effective than any simple three-valve battery set that could be made at a reasonable price. Another point of great interest is that the

make for better reception, or which might in any way simplify the operation. There are two tuned circuits, both of which may be controlled by means of a single knob, although an accessible trimmer is provided, and this takes the form of a second tuning knob concentric with the first. By this means the very distant stations which would never be received in the normal way can be brought in with ease; all the advantages of separate tuning condensers are thus secured without the attendant disadvantages.

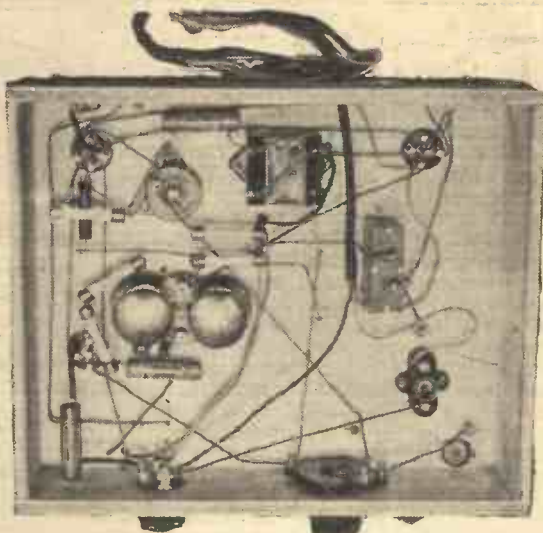

This under-surface view of the "Summit" shows the wiring and will assist you in connecting up.



A three-quarter rear view of the complete receiver.

Variable Selectivity

It has been said that the sharpness of tuning is ample, and this statement might be amplified by stating that the London stations, when only about ten miles away, occupy no more than one degree of the tuning scale, even when the aerial is connected to the least selective tapping on the first coil. Moreover, either of these transmissions can be eliminated merely by

rotating the knob of the trimmer condenser through a small angle; this is true proof of the correct matching of the two coils and their associated circuits. Reaction is provided, but this is required only when distant stations are being received, or when extreme selectivity is called for, such as, for instance, when the set is being used within two or three miles of the local station. Both coils, and also the tuning condenser, are adequately screened so that there is no danger of "break-through" occurring.

It will be evident from the illustrations on this page that the set is entirely self-contained, the batteries and loud-speaker being all accommodated neatly within the

set has been designed on strictly economical lines; every unnecessary component has rigorously been obviated, and nothing except real essentials has been retained. This does not mean that those valuable refinements which are so popular on present-day sets have been omitted, for the set has every feature which is generally wanted by the average listener. For example, there is a remarkably smooth-working volume control which operates on the first (variable-mu pentode) valve, whilst iron-cored tuning coils are used in both tuned circuits. The "Summit" is selective enough for all requirements, but in addition there is ample provision for modifying the actual degree of selectivity to suit any particular set of conditions.

A Handsome Design

The special cabinet chosen is of very handsome design, and can be bought either as a plain table consolette, or with a set of legs so that the receiver may form a complete piece of furniture and may be stood on the floor. The controls are few in number, but nothing has been omitted which might

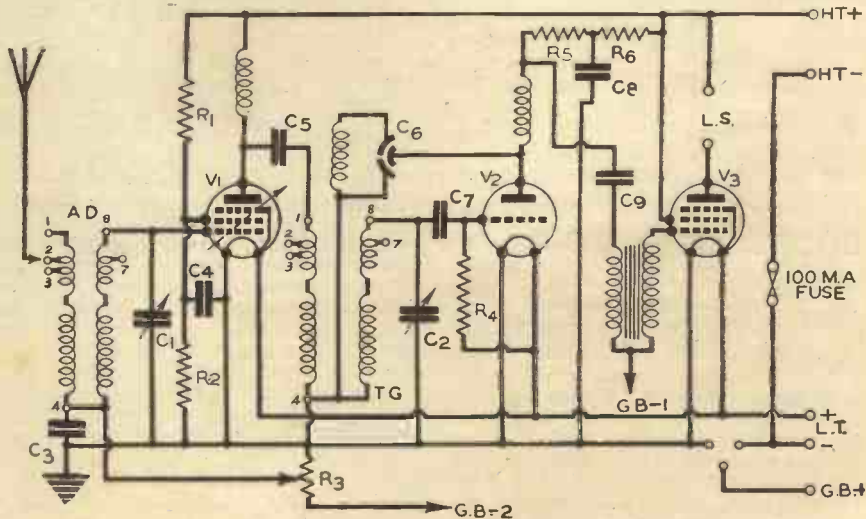

Theoretical circuit of the "Summit."

THE "SUMMIT"

The Peak of Performance
Selectivity, Sensitivity and Power

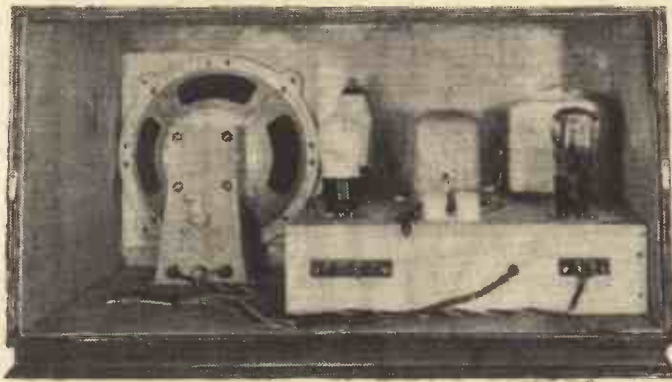

This view shows the "Summit" in its cabinet. The batteries are accommodated behind the speaker.

gang tuning condenser is fitted by means of the three bolts which are supplied with it. A word of warning is called for in connection with this component, especially since two of the bolts are used on the underside of the chassis for taking earth-return connections. Because of this the bolts must necessarily be screwed up tightly, and in doing this there is some danger of

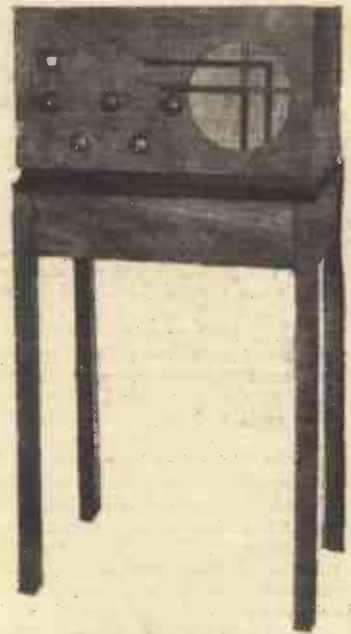

The finished receiver in its cabinet, and mounted on the neat pedestal.

popular type of horizontal cabinet, specified. Incidentally, the loud-speaker unit is of an entirely new pattern just released by Messrs. Whiteley Electrical, Ltd.; its name—the "Stentorian"—is truly descriptive of the unit, for the volume which it delivers is truly remarkable, so much so, in fact, that it is hard to believe that Class B amplification is not employed.

The "Summit" Is Easy To Build

The whole of the constructional work is of the simplest possible nature, and can safely be undertaken by the beginner, even if he has never before attempted home construction. The chassis, which is of the metallized-wood type, is supplied in ready-made form by Messrs. Peto-Scott, and it is a perfectly simple matter to mount the necessary components. The positions of all the parts can readily be determined by making reference to the wiring plans and also to the photographs. Most of the components are attached by means of $\frac{3}{16}$ in. and $\frac{1}{4}$ in. wood screws, but the two-

the tubular "legs" on top of the chassis breaking through the metallized surface, so that they do not make proper electrical contact with it. This eventuality can be avoided in one of two ways; one is to place washers between the feet and the chassis surface, and the other is to avoid tightening the bolts unduly.

The twin-screened high-frequency choke is mounted by means of a $\frac{3}{16}$ in. bolt, the latter passing through the metal lug which is joined to the screening cases. By adopting this form of mounting the screen is properly earth-connected to the chassis by means of the bolt head.

Constructional Pointers

Terminal socket strips are used for making connection to the aerial and earth leads, and also to the loud-speaker, and these are mounted by means of wood screws after making two series of $\frac{3}{16}$ in. holes through which

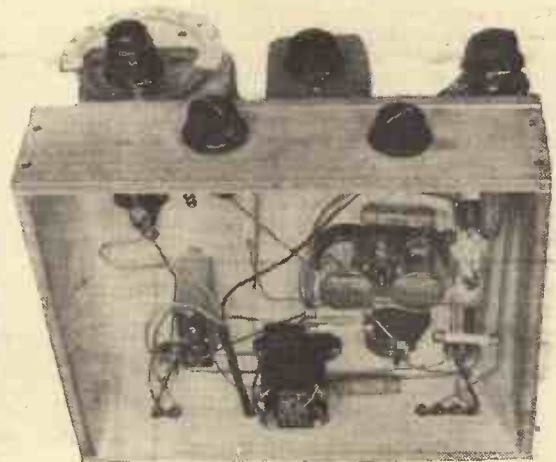

Another view of the "Summit" which will help you in assembly.

the metal sockets may pass. It will be found that the screw terminals on the back of the sockets are not at first accessible since they are adjacent to the baseboard instead of facing the bottom of the chassis. They can easily be reversed, before fixing, however, by gripping them with a pair of pliers.

The reaction condenser and on-off switch, it will be noted, are mounted on the three-ply front strip of the chassis, the latter having two 5-16 in. holes for the purpose. The rest of the assembly is perfectly straightforward and calls for no comment.

Straightforward Wiring

Little explanation is called for in respect of the wiring since this can readily be followed by referring to the large-scale wiring plans provided. Most of the connections are made by means of insulated connecting wire, and only a few of them require to be soldered. Those which are soldered are the connections to the volume control potentiometer and to the 1-mfd. fixed condenser. As can be seen from the various illustrations, the fixed resistances

(Continued on next page)

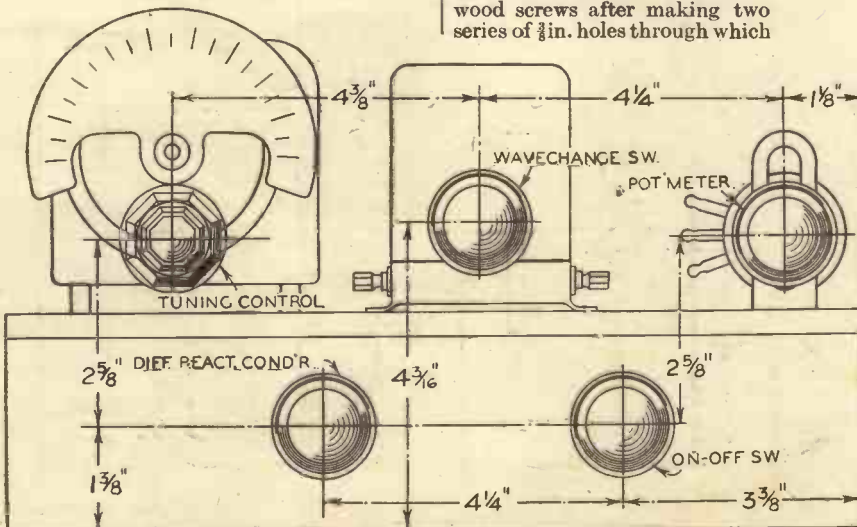

Use the dimensions shown here when drilling the cabinet front.

BUILDING THE "SUMMIT" BATTERY THREE

(Continued from previous page)

and tubular fixed condensers are attached to the various components by means of their own connecting wires, and these components have been placed in such positions that the wires do not need to be extended or even cut off short.

Battery Connections

There are three flexible leads, these being for the grid-bias battery connections, and these are passed through a hole made through the baseboard of the chassis near to the G.B. battery clip. The only other flexible leads are those which comprise the battery-cord assembly, and these are attached to the terminals by forming loops in their ends which fit over the terminal shanks.

After the wiring has been completed, and before the set is fitted into its cabinet, it will be advisable to give it a preliminary trial and to set the trimmer on the rear half of the gang condenser. This little matter will be fully dealt with next week, when full operating details will be given.

We shall also deal next week with fine adjustments, how to connect up the "Summit" for use as a radiogram, and, in fact, with how to extract the last ounce from this, our latest battery receiver which continues the policy of designing efficient receivers on a competitive price basis, which policy we inaugurated early this year with the "Leader Three." Readers who would care to inspect our experimental model of the "Summit" may do so on Stand No. 8 of the Ground Floor at Radiolympia. Our Technical Staff will also be delighted to answer any queries which intending builders care to ask, either at the Show itself or through the post.

WIRING DIAGRAMS OF THE "SUMMIT"

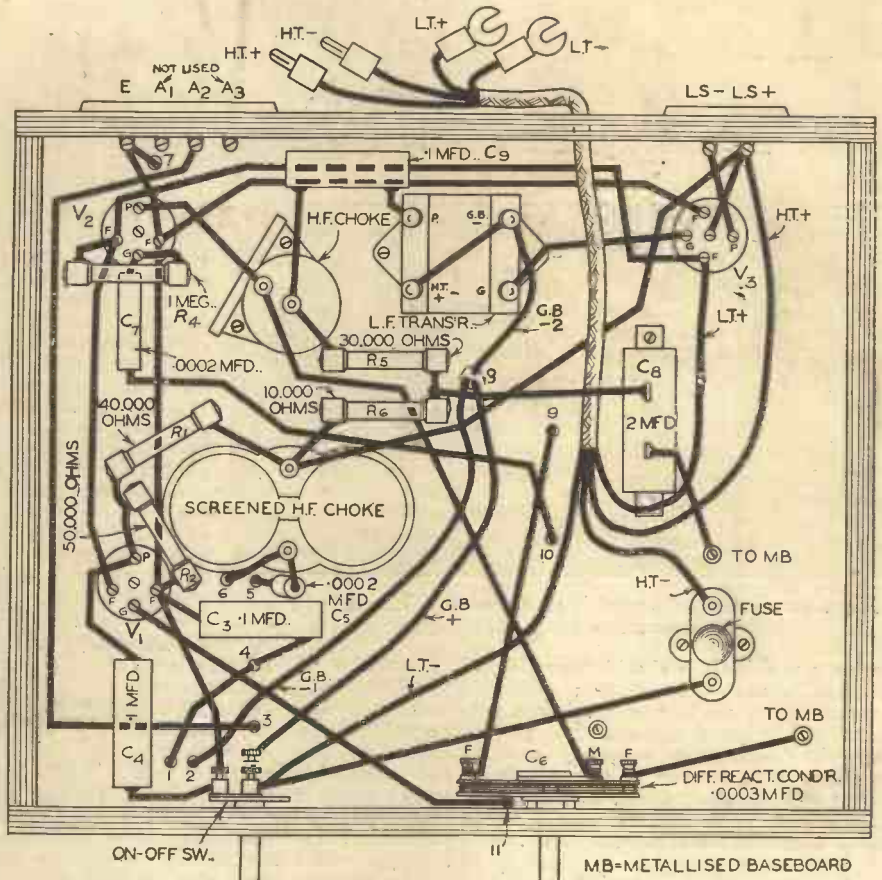

List of Components

- Two dual-range coils, types A.D. and T.G. (Wearite).
- One two-ganged condenser (C1 and C2) (J.B. "Unitune").
- One .0003 mfd. differential reaction condenser (C6) (Graham Farish).
- One 50,000-ohm potentiometer (R3) (Ferranti).
- Five resistances: 10,000 ohms, 30,000 ohms, 40,000 ohms, 50,000 ohms, 1 megohm. (R6, R5, R1, R2 and R4) (Dubilier, 1 watt).
- Three .1 mfd. fixed tubular condensers (C3, C4 and C9) (Graham Farish).
- Two .0002 mfd. tubular condensers (C5 and C7) (T.M.C.).
- One 1 mfd. fixed condenser (C8) (T.M.C.).
- One 3pt. on-off switch (Snap Switches)
- One 5.1 Niclet L.F. transformer (Varley).
- Three valveholders: 2, 4-pin and 1, 5-pin (Clix).
- One "L.M.S." screened H.F. choke (Graham Farish).
- One "Snap" H.F. choke (Graham Farish).
- One 100 m.a. fuse and holder (Bulgin type F.5).
- Three wander plugs, GB-1, GB-2, GB+ (Belling Lee).
- Two component brackets (B.R.G.).
- One "Summit" cabinet (Peto-Scott).
- One Metaplex chassis, 12in. x 10in. x 3in. (Peto-Scott).
- One four-way battery cord (Belling Lee).
- Two terminal socket strips: 1, A and E, and 1, L.S. (Belling Lee).
- One G.B. battery clip (Bulgin No. 1).
- One coil connecting wire; screws, etc. (B.R.G.).
- One "Stentorian" Standard M.C. speaker unit (W.B.).
- One 120-volt H.T. battery.
- One 9-volt G.B. battery.
- Three valves: 1, V.P.210; 1, H.L.210 and 1, H.P.T.220 (Cossor).

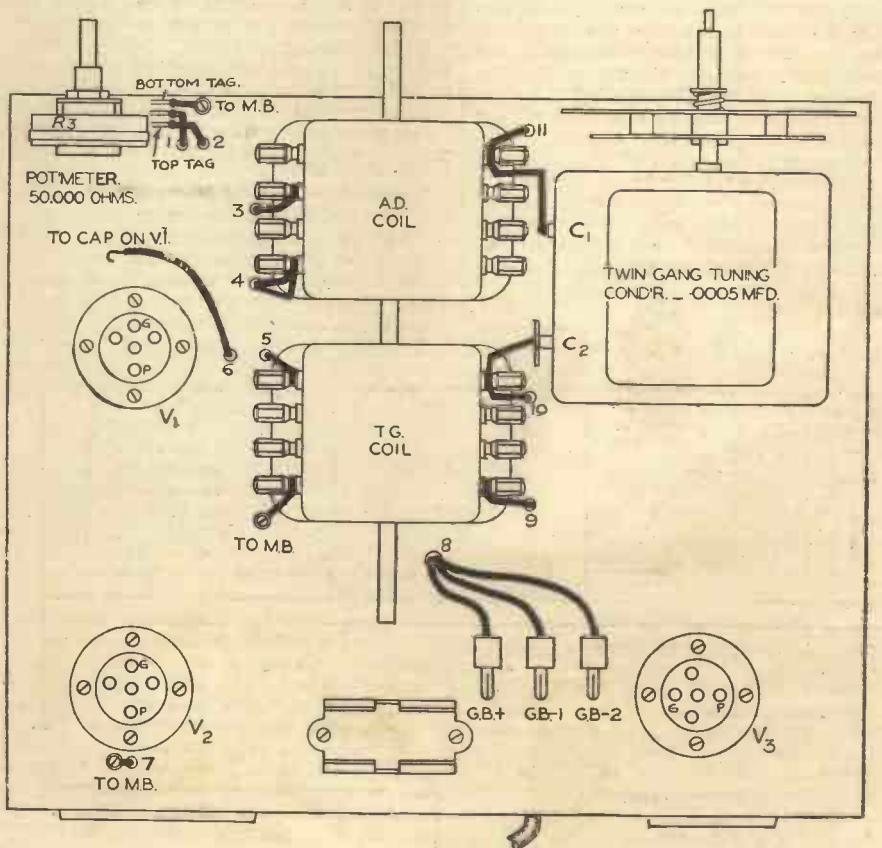



The New Valves

A RAPID SURVEY OF THE YEAR'S VALVE DEVELOPMENTS

Being a Summary of the Many Valuable Improvements which Have Been Made in Valve Design.

By BERNARD DUNN

IN a way, it might be said that there have not been so many changes in valve design during the past year, it being argued that there have been fewer new types introduced to the public. It is true that there have been no such startling novelties as Class B valves, variable- μ 's or high-frequency pentodes, but nevertheless considerable improvements have been made, and valve design has certainly not lagged behind developments in other directions.

The H.F. pentode has been well-nigh perfected; Class B has settled down and taken its proper place in battery-operated receivers; a successful double-pentode for Q.P.P. amplification has been placed on the market, and a variety of new multi-electrode valves have been introduced. It is perhaps the latter kinds of valves which have made the greatest "stir," for they have undoubtedly placed the modern superheterodyne on an entirely new plane. Such ingenious and rather complicated valves as the heptode, pentagrid, and octode have enormously simplified the design of a really effective frequency changer, besides bringing this portion of the superheterodyne many stages nearer to perfection.

Additional Electrodes

Whether or not it is entirely desirable that so many new valves which have upwards of ten electrodes should be introduced is rather a matter of opinion, but the fact that such valves can be made to be satisfactory in every way is a glowing tribute to the skill of the valve manufacturer. A testimony to the efficiency of these valves of advanced design is provided by the makers of complete receivers who have thought fit to incorporate them in their latest products. Moreover, the use of the valves has not, so far as one can judge, had any deleterious effect upon the "service" side of the manufacturers' activities; this is definite proof of complete reliability.

Whilst speaking of the newer types of valve, mention should be made of the improvements which have been made to the diode-triodes and similar valves which were first in evidence about a year ago. At that time they were looked upon as rather experimental, but to-day they are regarded as commonplace, since they have been thoroughly tried and tested. One no longer looks upon them as "stunts," but purely as reliable component parts of modern superheterodyne receivers.

Reductions in Size

Another direction in which valve

designers have demonstrated their skill has been in the production of reliable valves of much smaller physical dimensions. The miniature or midget valves have characteristics practically identical with those of their larger brethren, and the reduction in size has been brought about without any consequent loss in other directions. These small valves will probably become increasingly popular as time goes on, since there is already a large demand for midget components and accessories of every kind. This is all to the good, especially in so far as portable receivers are concerned, for most of those on the market, and all except one (the PRACTICAL WIRELESS "Atom") which have been designed for home construction, are much too large and too heavy for true portability.

Until fairly recently the British valve manufacturers left the production of universal (A.C. or D.C.) valves almost entirely in the hands of foreign makers, but it is interesting to note that things are now changing in this respect. Those (as yet few) universal valves which have been made by British firms are extremely good and truly reliable; they are, in fact, just as effective as the more usual battery and mains valves of standard pattern.

Constructional Improvements

Quite apart from the new types of valves which have come into existence during the past twelve months, there have been several important developments concerning the constructional details. Although not spectacular, these items are of great importance, firstly because they make for better reception, and secondly because they are designed to ensure longer valve life. One of the most noticeable changes in construction is in respect of the shape of the glass envelope; instead of the older plain glass bulb, an electrode container rather similar in shape to a pear has come into favour. In all fairness, it should be pointed out that what was probably the first valve to be made in this way was the Cossor 220B (a 1-watt Class B valve) which was introduced at the very end of last season. The shape of the envelope is a very important aspect, since the narrowing-off at the top makes it possible to insert a special form of mica washer which fits over the electrode assembly and rigidly supports this in the centre. The rigidity so obtained entirely overcomes the old trouble of microphony caused by the electrodes vibrating mechanically, besides making it practically impossible for the characteristics of the valve to be changed accidentally due to jolts.

Valve-Base Modifications

Another important change which has been made in regard to the construction is in connection with the base connector. For something like fourteen years it had been standard to fit the base with pins of some kind or other which fitted into corresponding sockets in the holder. It was known that this method was not entirely satisfactory because it necessarily introduced unwanted capacity between the various electrodes, but it proved to be difficult to devise any better form of mounting. As the number of electrodes was increased, however, it became absolutely essential to invent some method of cutting down capacity, and the first idea (introduced some years ago) was to fit a terminal to the top of the glass envelope or to the cap, and to use this for making connection with one of the electrodes. The practical limit was set at one such connection, however, and the latest type of valve is provided with side contacts on the base cap and these make connection with spring contacts in a new type of holder. This holder, which has recently been illustrated in these pages, takes the form of a ring into which the base fits. In consequence there is no solid dielectric material between the various contacts or terminals, and the capacity is cut down to negligible proportions. Additionally, the new form of construction ensures that there shall be better contact between the valve and holder, so that many practical difficulties are at once solved.

The idea of joining one of the electrodes to a connector on top of the glass bulb has been retained, but the connector is now of different form. When an ordinary screw-down terminal was employed it frequently happened that the cap to which it was attached, and also the wire connecting the particular electrode to the terminal, became loose and broken due to the fact that the over-zealous user attempted to tighten the terminal unnecessarily. This trouble has been entirely overcome by replacing the terminal by a small closed metal cylinder to which contact is made by means of a spring clip. A further practical improvement has also been effected by using the top connector for the grid instead of the anode. This means that there is far less liability to short-circuit the H.T. supply (which is between the anode and the metal-covered bulb), and also that the capacity of the wiring is considerably reduced, whilst a more direct connection can be made between the grid and the corresponding tuning coil.

After what has been said there is no need to emphasize that the 1933-34 season has witnessed many notable improvements.

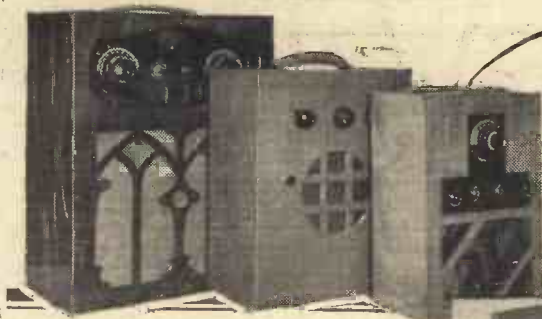

The TREND of DESIGN

WHAT changes have been made in the design of receivers since the 1933 Radiolympia? What changes will be made between now and the Radio Exhibition of 1935? These are two questions which the enthusiast might well ask himself, and from the consideration of which he might derive considerable mental entertainment.

Thinking over the changes during the past few months, perhaps the first impression which one gets is that receivers have been considerably reduced in size, as well as in price, despite their undoubted increase in the way of performance. The smaller dimensions have been secured by the use of modern components which the constructor has demanded should be less bulky and more efficient than their prototypes. There has been another strong influence at work, however, which is the rapidly-growing popularity of radio receivers for use in the car. It is obviously essential that a car receiver shall be extremely compact, and experiment very soon proved that it was possible to make a really compact instrument which was just as effective in every way as the larger ones which have become practically standardized during the past few years. As soon as it was generally realized that compactness could go hand-in-hand with efficiency, the public claimed that their wireless receivers should be reduced in size. After all, a small set is far less obtrusive, and can be placed in the drawing-room without making the latter look like a glorified laboratory, and it is easier to make the small instrument harmonize with the furnishings.

In spite of the pruning-down which has been done it is rather surprising to find that the external appearance of receivers has changed very little. There is still a fret, behind which is placed a loud-speaker unit, and the tuning dial—although altered in detail—still takes pride of place. It is true that the number of control knobs has been reduced, and this is certainly a move in the right direction, which is directed towards making a wireless set look like a piece of furniture and less reminiscent of the laboratory.

Automatic Tuning

Contrary to general expectations there has apparently been little attempt to camouflage the loud-speaker opening, and still less to dispense entirely with such a fretted hole in the cabinet. A couple of years ago there seemed to be a determined effort to produce a set with automatic tuning, and by means of which any one of a number of stations which happened to be wanted could be received merely by pressing an appropriate button. Moreover, a receiver of this type was actually made, but, although it appeared to be quite satisfactory on the whole, it is regrettable to find that the makers have found



The Changes Which Have Taken Place During Recent Times are Summarized in This Article, and Probable Future Developments are Indicated

By FRANK PRESTON

it necessary to go out of business. This must have been a case in proof of the fact that the public will not readily accept any device, however clever, which differs materially from others with which it is familiar. Let us hope (for the sake of non-technical listeners) that the automatically-tuned receiver will again be given a trial, and that it will prove as popular as it deserves to be.

Low-Priced Efficiency

Despite what has just been written, the home constructor has probably no

ceivers which can be made cheaply. The "Leader Three" battery and mains models were the first up-to-date, low-priced sets designed to demonstrate to the constructor that low price and extreme efficiency can be combined. An additional proof of the bold policy of "the best home-constructor receivers at the lowest cost" is given by the remarkable performance of the two "Olympia" sets described in this issue.

Chassis Construction.

Rather more than a year ago there were two schools of thought on the question of receiver chassis; one required a metal chassis which would give rigidity and ample screening; the other was in favour of a wooden one which was much easier for the average constructor to deal with. PRACTICAL WIRELESS solved the problem by standardizing the metal-sprayed wooden chassis. This has since been employed for every important PRACTICAL WIRELESS receiver and—significantly enough—the idea has been widely copied by other designers, including those who previously pinned their faith to the flat-baseboard form of construction. Yet another instance of "We lead—others follow!"

Generally speaking, the form of construction adopted has not changed very much during the year, and this is in agreement with the views which we expressed a year ago. This does not mean that design, or even home-construction, has become stagnant, but merely the constructional methods used by PRACTICAL WIRELESS a year ago were ahead of their time and were so sound that they could not be materially improved upon.

One could not leave the subject of this article without making reference to a tendency in design which was demonstrated a few months ago by the introduction of the "Atom Lightweight" portable receiver by this journal. This was, and still is, the smallest and lightest portable receiver of its kind ever placed before the home constructor. It will undoubtedly be copied, but it does point to the direction in which design is leading.

What of the Future?

Looking to the future one may justly wonder whether any very great improvements or modifications could be made to existing receivers, such is the height of their efficiency. They will certainly become smaller; more of them will be of the mains-operated type; automatic tuning will come; knobs and dials will disappear; loud-speakers will probably be separate from the receiver, and the number of valves will be reduced.

One other direction in which design will probably lead is in connection with the construction of a receiver of the semi-portable kind which can be used equally well in the car as in the home.

ITEMS OF NOTE AT THE SHOW.

Flood-light Tuning—

A novel system of tuning indication in which a column of light rises and falls in a thin glass tube. Seen on Marconiphone, H.M.V. and Columbia receivers.

Automatic Record Changer—

An ingenious device which plays thirty records, turning each one over and playing both sides. Seen on Autotrope receivers.

Spectrum Tuning—

A device which illuminates the tuning dial with red and green lights for each waveband and so renders only the appropriate station names visible. Seen on Atlas receivers.

Pointograph Tuning—

A device which renders accurate tuning possible by means of a moving pointer. This is normally at an angle, but when accurately tuned the pointer becomes vertical.

desire for a set which removes all necessity for delicate adjustments which allow him to employ the skill he has acquired by long experience. What he wants is a type of receiver which will give results equal to those obtainable from an expensive commercial receiver, but at a fraction of the cost. Design has been all in his favour during recent months, and one may be excused for emphasizing the success which has attended the policy recently introduced by PRACTICAL WIRELESS of designing home-constructor re-

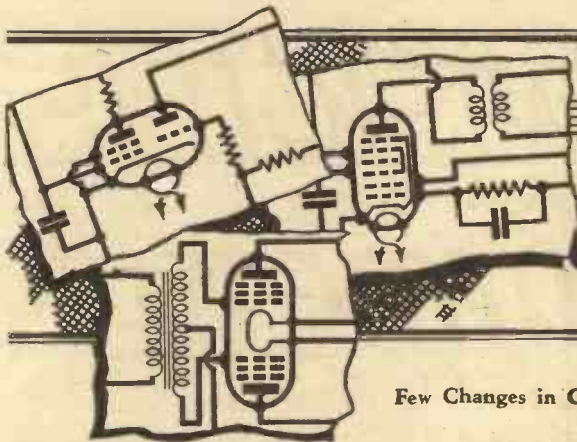

Circuit Developments

Few Changes in Circuit Arrangements Have Occurred during the Last Year, but Those of Importance Are Reviewed on this Page.

TO the more technical of wireless amateurs and experimenters "the circuit is the thing." The circuit arrangement comes first and foremost; it is the nucleus around which the whole set is designed, and the basis of all experiment. On other pages in this issue it is shown how the whole science of wireless has moved forward during the past year or so, and in summarizing the position one cannot help referring to the circuit alterations which have eventuated.

So far as ready-made receivers are concerned, it has been a very definite superheterodyne year, and a large number of the circuit improvements and modifications concern this type of valve arrangement. Looking back over the last five years one quickly realizes that superhets. have made wonderful progress. Only a very short time ago a superhet. had upwards of seven valves, these being arranged as: first detector, oscillator, three intermediate-frequency stages, second detector and low-frequency output valve. To-day it is possible to construct a reliable superhet. by using only three valves. The first of these is a combined first-detector oscillator, the second is a highly-efficient variable-mu pentode I.F. amplifier, and the third is a diode-pentode which performs the functions of second detector, L.F. amplifier and automatic volume control.

Improved A.V.C.

A very notable circuit improvement which has taken place during the last year or so concerns the provision of really effective automatic volume control. Whereas with the older receivers distant stations were useless for entertainment purposes due to the fact that their received signals varied in intensity as a result of the inevitable fading, these stations can to-day provide good, enjoyable programmes. The change is due entirely to the provision of effective A.V.C. whereby the signal voltages applied to the detector (second detector in a superhet.) are used to bias a preceding variable-mu stage. Thus, as the signal voltage applied to the detector increases, so the negative grid-bias voltage fed back to the H.F. amplifier increases, thereby reducing the effective degree of H.F. amplification. When the signal voltages are at a minimum the bias voltage is reduced and the H.F. amplification is thereby increased.

At first it was considered that A.V.C. could be applied only to superheterodynes or receivers having a minimum of two H.F. stages, but the simple three-valve receiver introduced by PRACTICAL WIRELESS last October proved that this was not the case. It was not claimed that this set

would reproduce all stations at uniform volume level, but those who made it did find that it very largely overcame the fading which was normally experienced when listening to certain stations.

H.T. Economisers

Another circuit improvement which has been effected, and which is somewhat similar in principle to A.V.C. is the provision of a means for cutting-down the consumption of high-tension current by a battery valve of the high-power L.F. type. This improvement was incorporated in the "1934 Fury Four Super," and consists of a means of varying the grid-bias voltage to the output valve according to the intensity of the signal voltages being handled. The economiser unit consists essentially of a high-frequency metal rectifier, connected in series with a fixed condenser, between the anode of the last valve and earth. A fixed potentiometer is connected in parallel with the rectifier, and the tapping is connected to grid bias positive, whilst the negative G.B. lead goes to the grid of the valve in the usual manner. Normally the G.B. voltage is set to a much higher value than that actually required by the valve, but a small percentage of the signal voltages appearing at the anode are rectified and tend to make the positive G.B. point more negative. In other words, the rectified voltage acts

in opposition to the G.B. battery, with a result that the negative voltage applied to the grid of the valve is reduced. It will be seen that as the signal voltages increase the G.B. voltage is reduced. Consequently, when the valve is fully loaded it receives its rated G.B. voltage, but when the signal intensity is low it is over-biased, so that it consumes less H.T. current. As the valve is fully loaded for only a very small proportion of its "working" time the saving in current is considerable.

Paraphase Amplification

A circuit development which has taken place on the low-frequency side concerns what is known as paraphase amplification. The chief advantage conferred by paraphase is that harmonic distortion is almost entirely overcome, and reproduction is made more "natural." This form of amplification has not yet become very widely known, nor is it yet employed at all extensively, because the "characteristic" requirements of the special L.F. transformer are somewhat critical and depend upon the valves employed and other parts of the circuit. This means that the transformers have to be made separately and specially chosen to match the rest of the circuit; this involves a certain additional expense to which most constructors are not prepared to go. A slight modification of the original paraphase arrangement consists of using two similar valves in the output stage, the primary winding of the output transformer being connected between the anode of the first valve and the grid of the second.

Band-pass Arrangements

A circuit modification which has this year come into great favour, although it was certainly employed as long as two years ago, is the use of a band-pass filter between the H.F. and detector valves instead of in the input circuit to the first valve. In the simpler types of three-valve H.F.-det.-pen. circuit this idea has proved very valuable. By its adoption even greater selectivity has been obtained than with the form of coupling previously in use, and greater efficiency on the H.F. side has been secured. Apart from this modification, band-pass coupling has not been so popular during the past year as it was in the two preceding years. The reason is probably to be found in the better selectivity to be secured by the use of up-to-date coils, and the fact that those who employ a simple receiver do not now feel so anxious to receive a number of foreign stations as to obtain really good quality reproduction from the "locals."

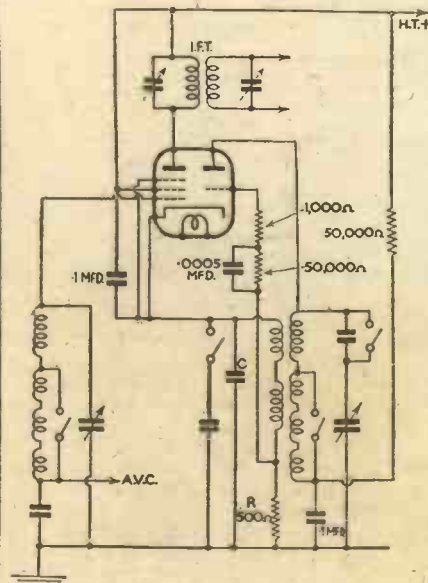

Circuit diagram of triode-pentode oscillator combination—one recent circuit development.

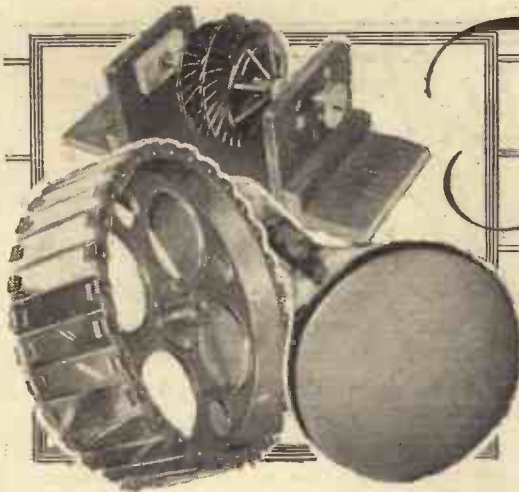

Television is Imminent!

Why You Should Prepare for the Forthcoming Addition
to Home Entertainment. By W. J. DELANEY

A PART from the fact that scientists and technical research experts must endeavour to develop television as an art, it is essential that, in order to complete our broadcast entertainments, this branch of wireless must be added to that which we already possess. There are, of course, many sceptics who hold that it can never come in our day, but they, presumably, are content to sit at home during a broadcast relay, and whilst they listen (?) to the loud-speaker, read a book, or sit and look out of a window at the passing traffic, or in some other manner divide their attention. Surely no one can hold that they are getting even 50 per cent. from the transmission. Experts have even written in various places stating that for the full enjoyment of a programme it is necessary to darken the room—or in other words prevent the attention from being distracted. It needs very little imagination to visualize the great advantage which would accrue to the listener who could not only hear, but also see, the various items which are performed for his benefit. It is quite true that little would be gained by seeing a violinist play his instrument, or even a singer rendering a song. But there are numerous items which would not only be improved by a vision accompaniment, but which are definitely of little value without such.

We are sure the majority of listeners will agree that television must soon be made practicable, and the various demonstrations which we have witnessed bear ample proof that it is now only a matter of a little time before the listener will be enabled to look in and obtain even greater pleasure from his pastime. So convinced are we that the day is near at hand that, as readers will no doubt already have noticed, we are launching a new monthly—*Practical Television*—in which articles relating to the subject will be given and constructional details of home-receiving apparatus will appear.

Comparison with the Films

Many people endeavour to try and compare broadcasting with the films and liken the present type of transmission to the original silent films, which gave entertainment for many years. But this is hardly a fair comparison. In the silent days, we were able to see just what was done by the gesticulations of the actor, and if some point needed stressing which was not exactly related to the scene being depicted, a caption was thrown on the screen. With the broadcast performance, however, we can-

not have someone interpolating "He now walks across the room," to tell you that some stormy scene is about to be witnessed between two people. True, the all-important Effects Department have spent much time in developing "noises off," and a good imitation of someone walking across a room can be broadcast. But on probably the majority of receivers this might also sound as though someone were knocking at a door, or beating time to something. Thus, the type of the broadcast has to be arranged to suit the invisible manner of the audience and much of the quality of a transmission is thereby lost. There are hundreds of artists who cannot at present appear in the home owing to the

do not like this type of entertainment. As we have pointed out, television must come and all our readers should hasten to acquaint themselves with the principles involved and commence to take advantage of the present limited transmissions in order to see for themselves how far the art has at present progressed and to join in the general development of a new science.

Television Images Seen in Country

Although to many the 11 a.m. television transmission furnished by the B.B.C. every Friday morning is inconvenient, there are no doubt many readers free at that time who take advantage of the signals to carry out tests. It may not have occurred to these that with the holiday periods, and fine days available, the opportunity presents itself to take a trip into the country by car and watch the images under a new set of conditions. The receiving equipment, especially if it is of the transportable nature, can easily be accommodated in a car together with any batteries. Then when actually undertaking the reception tests it is quite useful to have the receiver on the running board. The television set can be of the portable disc type, while the radio receiver can also be of a simple type for this purpose. If any trouble is experienced from the daylight, then a temporary stiff paper observation tunnel can be mounted over the image screen aperture. Open-air experiments of this nature will prove invaluable.

**OUR NEW MONTHLY JOURNAL
PRACTICAL TELEVISION
6d. MONTHLY
No. 1 NOW ON SALE AT ALL NEWSAGENTS**

fact that their abilities lie in their actions or skill in some particular direction, and anyone who has already seen the television programmes will know that the acrobatic performers form a most pleasing object for broadcasting. No sound whatever is needed for this type of broadcast, except perhaps a quiet musical background, and yet there must be very few members of the public who



Pack your television receiving apparatus in a car and go into the country to watch the B.B.C. morning transmission.



KINGS OF THE AIR

WIDEN YOUR CHOICE OF PROGRAMMES

No matter what type of Receiver you use—Battery or All-Electric (A.C. or D.C.)—there is a Cossor Screened Grid Valve to suit it. By fitting one of these highly efficient valves you can considerably widen your choice of programmes.

Because Cossor S.G. Valves have negligible inter-electrode capacity they permit exceptionally high effective amplification, and this means increased range. To fit a Cossor Screened Grid Valve, therefore, is a simple way of improving performance.



COSSOR SCREENED GRID VALVES

Cossor 2-volt Screened Grid Valves

Type	Fila-ment Amps.	Anode Volts	Imped.	Amp. Factor	Mutual Conduc-tance m.a./v.	Price
*215 S.G.	.15	120-150	300,000	330	1.10	12/6
*220 S.G.	.2	120-150	200,000	320	1.60	13/6
*220 V.S.G.	.2	120-150	110,000	—	1.60	13/6
*220 V.S.	.2	120-150	400,000	—	1.60	12/6

Cossor A.C. Mains Screened Grid Valves

Type	Purpose	Imped.	Amp. Factor	Mutual Conduc-tance m.a./v.	Price
*†MSG-HA	Super H.F. Amp'n.	500,000	1,000	2.0	17/6
*41 MSG	Super H.F. Amp'n.	400,000	1,000	2.5	17/6
*†MSG-LA	Super H.F. Amp'n.	200,000	750	3.75	17/6
*†MVSG	Variable-Mu S.G.	200,000	—	2.5	17/6

The above Valves have Indirectly Heated Cathode, 4 Volts, 1 Amp

Cossor D.C. Mains Screened Grid Valve

*†DVSG	Variable-Mu S.G.	—	—	2.5	17/6
--------	------------------	---	---	-----	------

The above Valves have Indirectly Heated Cathode, 16 Volts, 0.25 Amp.
* These Valves available with or without Metallised Bulbs.

† Characteristics measured at -1.5 grid volts
* * Stocked with Metallised Bulb only

SEE THE COMPLETE RANGE OF COSSOR PRODUCTS ON STAND 73 RADIOLYMPIA

USE THE COUPON

To A. C. COSSOR LTD.,
Melody Dept., Highbury
Grove, London, N.5.

Name

Please send me free of charge,
a copy of the Cossor 72-page
Wireless Book

Address.....

B.V.33

PRAC. 19/8/34

ON TOP AT OLYMPIA

SEE THE
RANGE
OF
OSRAM
VALVES
ON
STAND
NO.
34

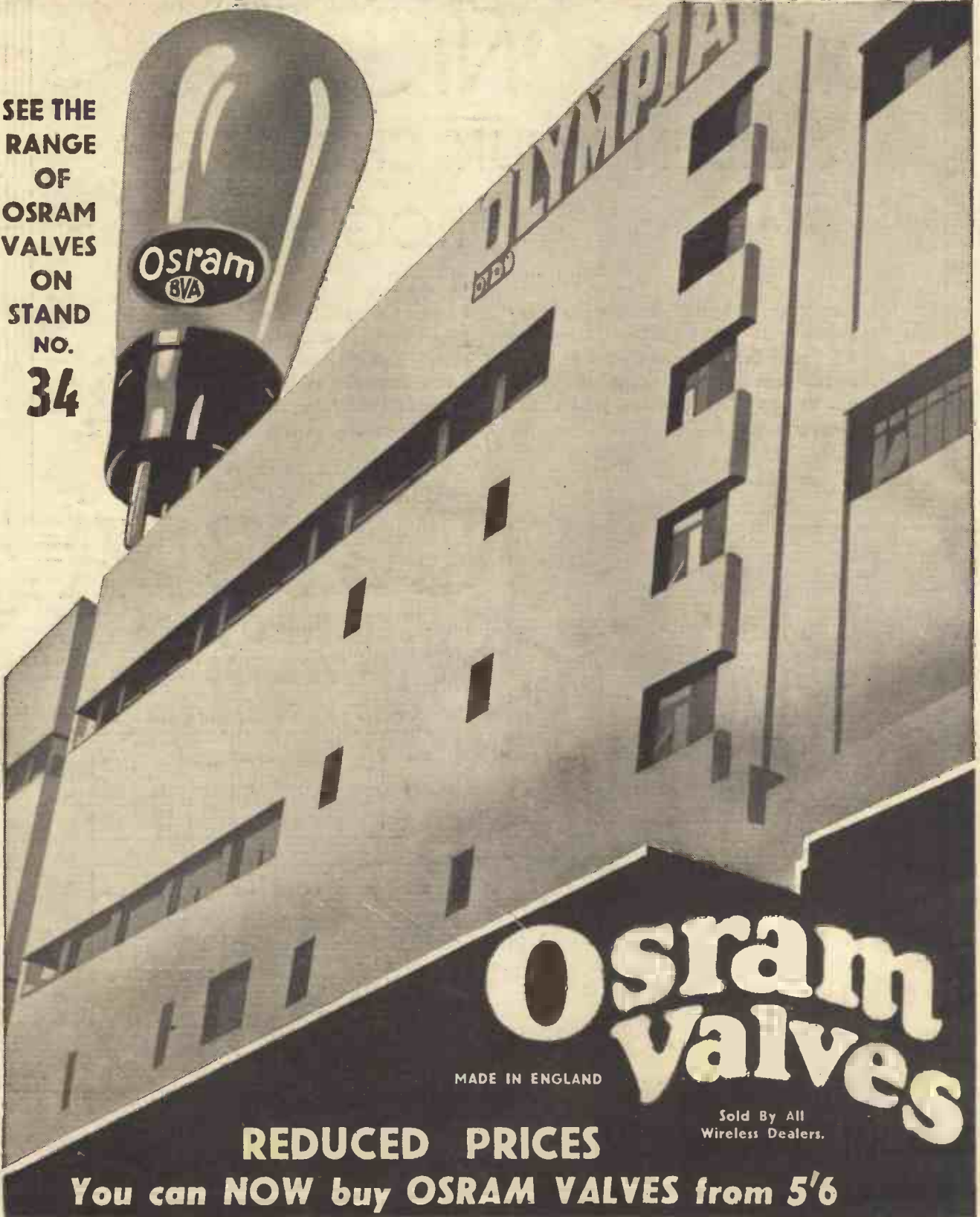

Osram valves

MADE IN ENGLAND

Sold By All
Wireless Dealers.

REDUCED PRICES

You can NOW buy OSRAM VALVES from 5'6

Advt. of The General Electric Co., Ltd., Magnet House, Kingsway, London, W.C.2.

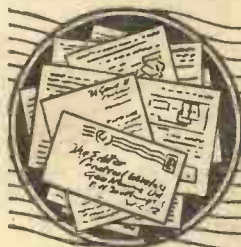

READERS' WRINKLES



Charging a Portable-Set Accumulator
FOR those who are in the habit of using portable sets with their cars, the following dodge will eliminate the possibility of a run-down accumulator. The requirements are as follows: A miniature on-off switch, batten mounting bulb-holder, tail-lamp bulb, length of twin flex, inspection-lamp plug (or two single plugs of the Clix type). One lead from the plug is wired in series with the lamp-holder

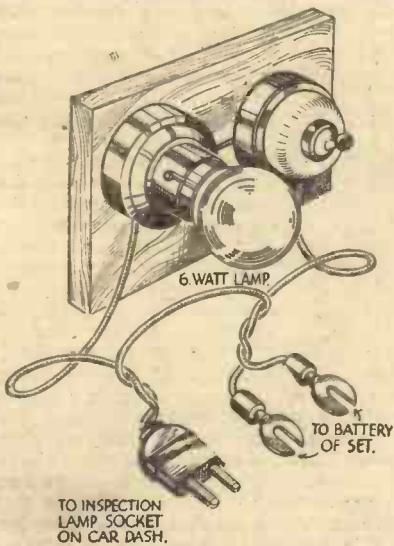

Charging a portable-set accumulator.

and switch, and is taken to one terminal of the set battery. The other lead from the plug is taken straight to the set battery. With the plug and lamp in position we thus have a simple charging plant taking half an ampere from the car battery. It is important that the plug be inserted the correct way so as to charge the battery. To determine this position reverse the plug once or twice. The position in which the lamp shows the least light is the correct one, and the plug should be marked accordingly. The accumulator can be charged while the set is in operation or otherwise. The drain on the car battery is insignificant, but sufficient to keep the L.T. up to the mark.—R. LIDDINGTON (Hull).

S.W. Reception with Novel Equipment

EXPERIMENTS reveal that short-wave signals can be received satisfactorily on either elaborate or simple aerial-earth equipment, and often without an earth or an aerial. A new way, simple yet effective, is to use two earths, one as usual, the other replacing the aerial. This novel "signal-collecting" method is particularly interesting to the man who takes the short-wave set outdoors, and the simple equipment illustrated is for this purpose. Briefly, two 9in. lengths are cut

THAT DODGE OF YOURS!

Every Reader of "PRACTICAL WIRELESS" must have originated some little dodge which would interest other readers. Why not pass it on to us? We pay £1.10.0 for the best wrinkle submitted, and for every other item published on this page we will pay half-a-guinea. Turn that idea of yours to account by sending it in to us addressed to the Editor, "PRACTICAL WIRELESS," George Newnes, Ltd., 8-11, Southampton Street, Strand, W.C.2. Put your name and address on every item. Please note that every notion sent in must be original. Mark envelopes "Radio Wrinkles." Do NOT enclose Queries with your Wrinkle.

from carpet or curtain-rod of small diameter. De-headed nails are then pushed up the stems—allowing about 1in. protrusion—and are soldered in, and the tube-ends filed to same level. The opposite ends are soldered up, and on the side nearby are soldered leads of thin flex or stranded wire, ending in a small spade. The container, an old cycle pump, cut down and fitted with a cork—allows the equipment to be neatly packed, and carried in an inside pocket.

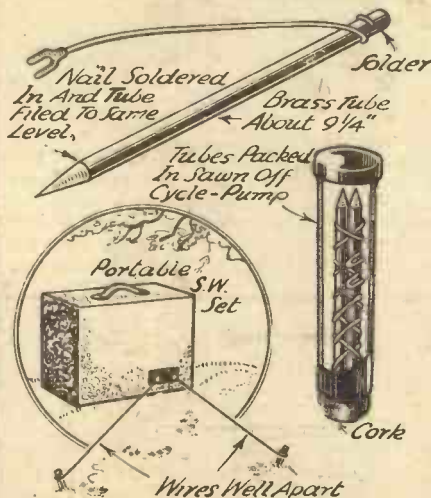

A novel aerial and earth arrangement for S.W. reception.

In use, the tubes are kept well apart, and the lead length determined by actual experiment.—F. J. GOUGH (Ellesmere).

Plug-in Adaptors for Accumulators

ALTHOUGH it is usual to fit the ends of an accumulator leads with spade terminals, it may sometimes be found necessary to make connection to the accumulator by the plug-and-socket method. For instance, in some short-wave adaptors where connections from L.T.+ , L.T.— and H.T.+ arc made by plugging into the detector valve-holder, it may be required to use the set separately with 'phones, and plug-in adaptors will then be found very handy.

Two types can be made up quite simply. Type A being merely a short strip of lead, bent round at the ends to take the plug as

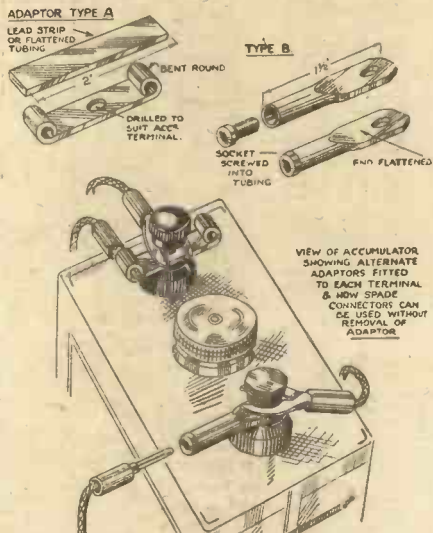

Handy plug-in adaptors for accumulators.

shown in sketch. Type B is made from a short length of ordinary lead casing from electric-lighting wire. One end is flattened and the other receives a socket (such as Clix) which is screwed in and the casing pinched round as shown.—R. L. GRAPER (St. Albans).

An Adjustable Workshop Light

IHAVE found the following idea very useful in my workshop where I had no portable light. I fixed a cheap curtain spring about 1/2 in. in diam. and 8ft. long, on two cup hooks in the ceiling (about 10ft. apart), and threaded on this one of the "egg" type aerial insulators, as shown in the sketch. Through the other hole in the insulator I threaded the flex from the ceiling rose. With this arrangement I have a handy electric light, which can easily be moved to any position over the bench.—A. HAWKINS (Needham Market).

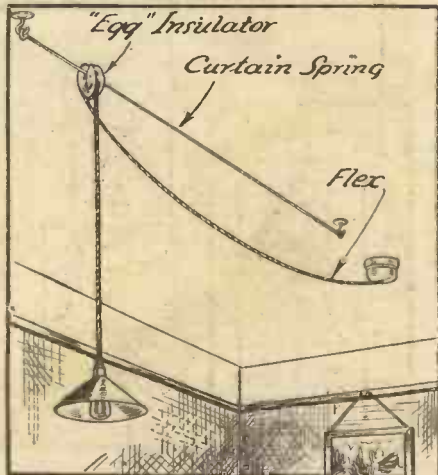

A simple adjustable workshop light.

THE "ARMADA"

An Efficient Low-priced Radiogram, Satisfy the Most Exacting Require-



This view shows the completed radiogram in its neat cabinet.

THE builder of a modern mains-operated receiver desires that it shall be operative for the reproduction of gramophone records in addition to the radio programmes, and the reason is to be found in the fact that, generally speaking, the mains receiver is capable of a much greater output of volume than a battery receiver and, consequently, it will be used on many occasions for dancing purposes. So far, however, the radio-gramophone has been looked upon as an ornate piece of cabinet work, and has generally been designed and built to resemble the cabinet gramophone of two or three years ago. The term "radio-gramophone cabinet" in fact, on glancing through any cabinet catalogue, will be found to include pedestal items ranging in

size from one just sufficient to incorporate a gramophone mechanism and a radio set to an elaborate piece of furniture housing a complete library or cocktail cabinet. Portable and table-model gramophones have for a long time been on the market, and there is obviously a need for a radiogramophone which will take up no more room than a moderately-sized table gramophone.

will provide the full entertainment which is obtainable from the combination of radio and gramophone records. It does not, unfortunately, house the records, but a suitable small cabinet could be obtained for that purpose and built to form the lower section in place of the table or stool, or, alternatively, one of the many commercial portable record-carrying cases could be utilized and would take up very little space.

The Layout

An examination of the complete apparatus will reveal that it has been divided into three completely separate sections—the receiver proper on the lower part of the cabinet, the mains section or power pack on the centre section, and the gramophone motor and pick-up on the upper portion immediately beneath the lid. This method of sub-division is not necessarily carried out on account of the smallness of the cabinet, but greatly facilitates construction from the point of view of the home constructor, and will also assist in testing and in the location of any faults which might develop during

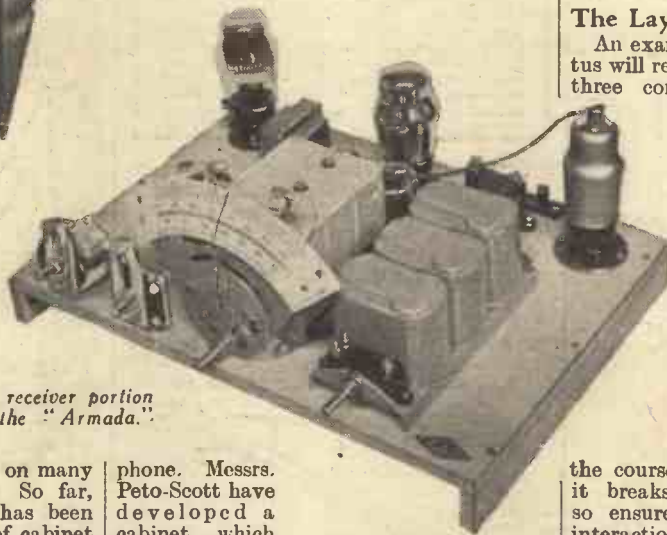

The receiver portion of the "Armada."

phone. Messrs. Peto-Scott have developed a cabinet which follows these lines, and the "Armada" has been designed to be incorporated in this cabinet. Accordingly, it may be stood on a table, or on a small low stool or pedestal, and although taking up no more room than an orthodox radio set,

it breaks up the various circuits and so ensures stability and freedom from interaction from the various parts should they be clumsily associated. Thus even the new-comer to home construction may safely undertake the assembly of a receiver of this nature, as he is freed from all anxiety concerning the results of his handiwork.

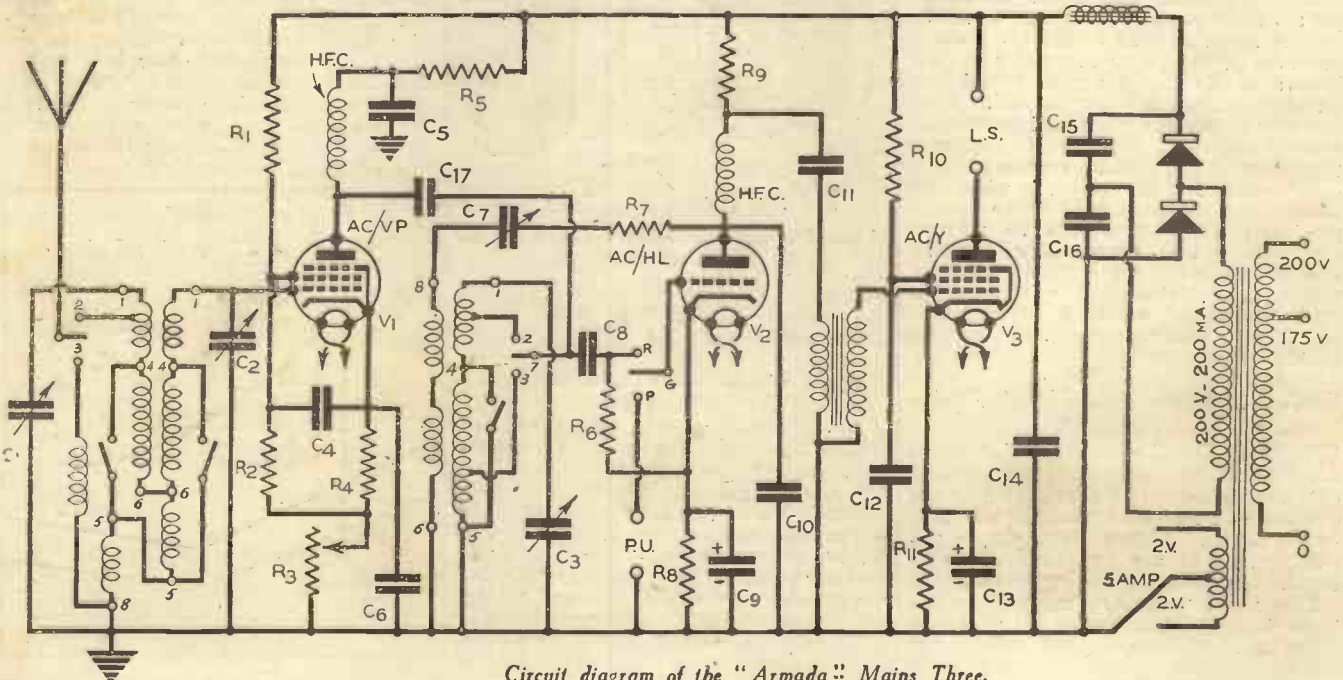

Circuit diagram of the "Armada" Mains Three.

MAINS THREE

the Performance of which will
ments. Simple and Cheap to Build.

The Circuit

The circuit of the complete receiver is shown in Fig. 1, and it will be seen that the more or less standard arrangement of H.F. stage followed by a detector and a pentode-output stage is employed. The H.F. valve is one of the new variable- μ H.F. pentodes, and is fed from the aerial system through the medium of a band-pass tuner, which, together with the H.F. coupling coil, is one

valves. It will be noticed that no fuses are included in the actual apparatus, and safety is assured by the utilization of a special plug which includes two fuses. This is attached to the mains flex and is used for connecting the apparatus to the nearest mains socket. Although of the two-pin type, it is possible, when desired, to connect this to an ordinary lamp socket by using one of the special Goltone converter plugs. Before doing this, however, you should make certain that your local electricity supply does not prohibit the use of a radio-gramophone on the lighting circuit. To ensure hum-free operation electrolytic condensers have been used in the L.F. biasing circuits, and ample decoupling is provided at every point.

Construction

The actual construction may be divided up into three sections, as mentioned above, and the receiver proper will receive our first attention. The chassis will be found to be ready metallized and cut to size, and before mounting any components it is preferable to drill holes at the points marked "M.B." and to insert in these holes short



The receiver portion of the "Armada" in its cabinet. The mains unit shown on the left stands on the upper shelf.



The mains section and the loud-speaker.

of the latest iron-core assemblies, a Colvern "G" combination. This coil assembly includes on its base-plate two other components, also operated by the coil wave-change switch. These are the radio-gramophone switch and the mains on-off switch. The former is of the single-pole change-over type and completely isolates the radio side when the receiver is used for gramophone reproduction. The latter is of the single on-off Q.M.B. type, and breaks the lead between the mains and the mains transformer. A four-position indicating control knob is fitted to the coil, and thus in one position the receiver is completely dead, or "off," and as it is rotated through its complete movement it brings the receiver into working condition on the medium and the long waves, and finally brings the pick-up into circuit. The actual settings are clearly indicated by letters embossed on the control knob. The detector valve is resistance-transformer coupled to the output pentode; and this is one of the latest valves designed to provide an output, when fully loaded, of over three watts. From gramophone records or a powerful local station, therefore, it will provide sufficient volume for dancing in a small hall. The loud-speaker is one of the latest types, the R. and A. Multima, and this is easily capable of handling the output without distress and with really admirable quality. The H.T. supply is obtained from a Westinghouse metal rectifier, and a separate winding on the mains transformer feeds the heaters of the

bolts, under the heads of which soldering tags should be fitted. These provide earth-anchoring points for various wires, as shown in the wiring diagram. Next cut the slots, or drill separate holes, to accommodate the leads from the coil unit. With the maker's

(Continued overleaf)

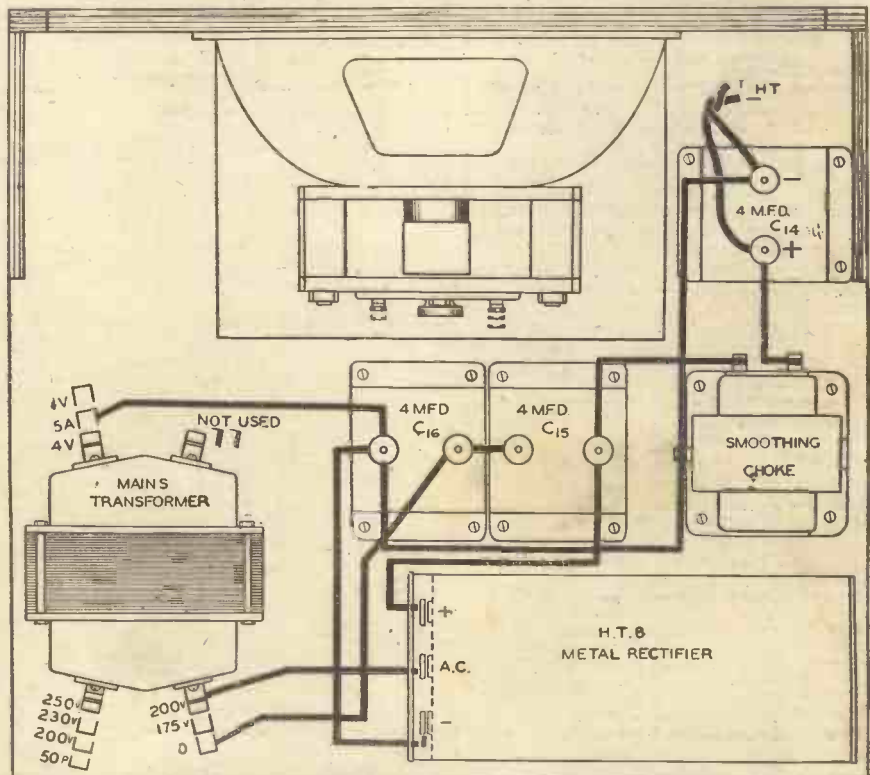

Wiring diagram of the mains section of the "Armada."

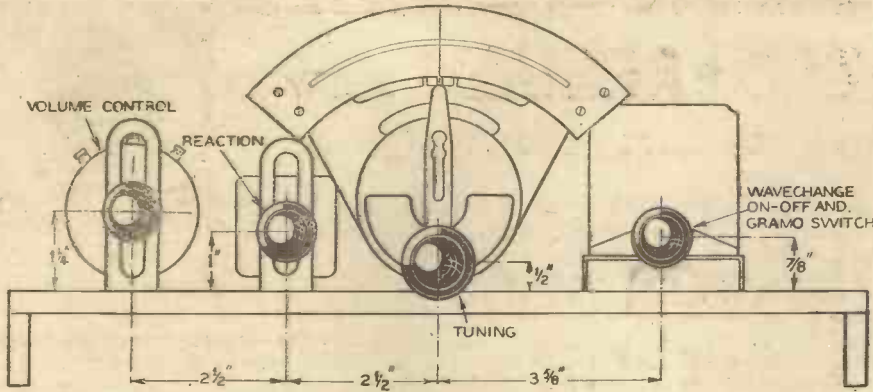

Dimensioned diagram of the controls of the "Armada."

(Continued from previous page)

template, drill holes to accommodate the fixing bolts of the three-gang condenser, and finally drill the holes to take the aerial and earth terminal strip. The various holes for the inter-connecting wires should next be drilled, after marking their position, by placing the various components temporarily in position, using the photographs and the wiring diagram as a guide. When this has been done the parts may all be mounted, leaving the condenser and coil unit until last to avoid the awkwardness of the complete assembly. Wiring is carried out

LIST OF COMPONENTS FOR THE "ARMADA" MAINS THREE.

- One set Ferrocart coils, types G1, G2 and G3, with mains on/off switch (Colvern).
- One three-gang Midget condenser (C1, C2 and C3) Polar.
- One Arcuate slow-motion drive (Polar).
- One .00015 mfd. differential condenser (C7) (Polar).
- One 30,000-ohm 1 watt resistance (R9) (Ferranti).
- One 20,000-ohm 1 watt resistance (R2) (Ferranti).
- One 15,000-ohm 1 watt resistance (R1) (Ferranti).
- Two 5,000-ohm 1 watt resistances (R10 and R5) (Ferranti).
- Three 500-ohm 1 watt resistances (R7, R8 and R11) (Ferranti).
- One 300-ohm 1 watt resistance (R4) (Ferranti).
- One 1 megohm grid leak (R6) (Ferranti).
- One .0005 mfd. tubular condenser (C17) (T.M.C.).
- One .0002 mfd. tubular condenser (C10) (T.M.C.).
- One .0001 mfd. tubular condenser (C8) (T.M.C.).
- One .1 mfd. type 250 condenser (C4) (T.C.C.).
- One .5 mfd. type 80 do. (C11) (T.C.C.).
- Two 1 mfd. type 80 do. (C5 and C6) (T.C.C.).
- One 2 mfd. type 80 do. (C12) (T.C.C.).
- One 50 mfd. electrolytic type 501 (C9) (T.C.C.).
- One 50 mfd. electrolytic type 521 (C13) (T.C.C.).
- Three .4 mfd. type 80 (C14, C15 and C16) (T.C.C.).
- Two 5-pin valveholders (Clix).
- One 7-pin valveholders (Clix).
- One screened H.F. choke (binocular) (Telsen).
- One screened H.F. choke (standard) (Telsen).
- One mains choke (Telsen).
- One 5/1 pip transformer (Graham Farish).
- One type W.31 mains transformer (Heyberd).
- One type H.T.8 metal rectifier (Westinghouse).
- One "Multimu" speaker (R. and A.).
- One tablegram cabinet (Peto-Scott).
- One Blue Spot pick-up and volume control (Blue Spot).
- One 5,000-ohm volume control (C.P.157) (Varley).
- One "Trusped" electric gramophone motor (B.T.H.).
- One A.C./V.P., one A.C./H.L., and one A.C./Y valve (Hivac).
- Aerial and earth terminal strip (Belling Lee).
- Two component brackets (B.R.G.).
- One Bulgin fuse plug (with fuses).
- One Metaplex chassis to fit tablegram cabinet.
- Wire, flex, screws, etc.

with coloured connecting wire, soldering being resorted to at the common connecting points. Make certain that the insulating washers are included when mounting the volume control, or this component will not function. The reaction condenser is provided with an insulated spindle and bush, and therefore this necessity for precaution does not arise. When this has been completely wired the mains unit should receive attention, and it will be noticed that the speaker is mounted on the baseboard with these parts. Wiring may be completed from the wiring diagram, and it then only remains to connect the two parts and the gramophone section, and details concerning the completion of the apparatus will be given in next week's issue, together with operating instructions.

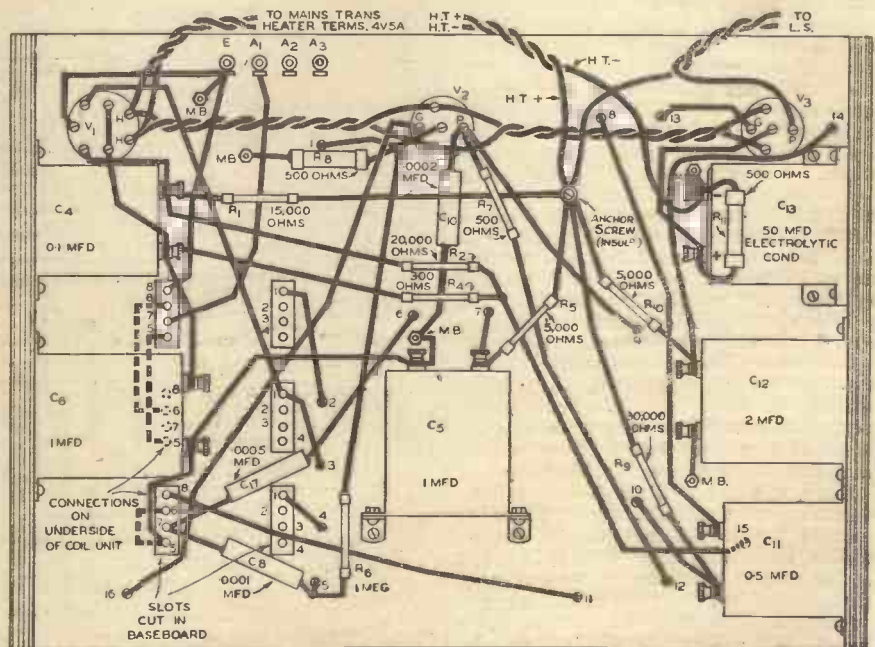
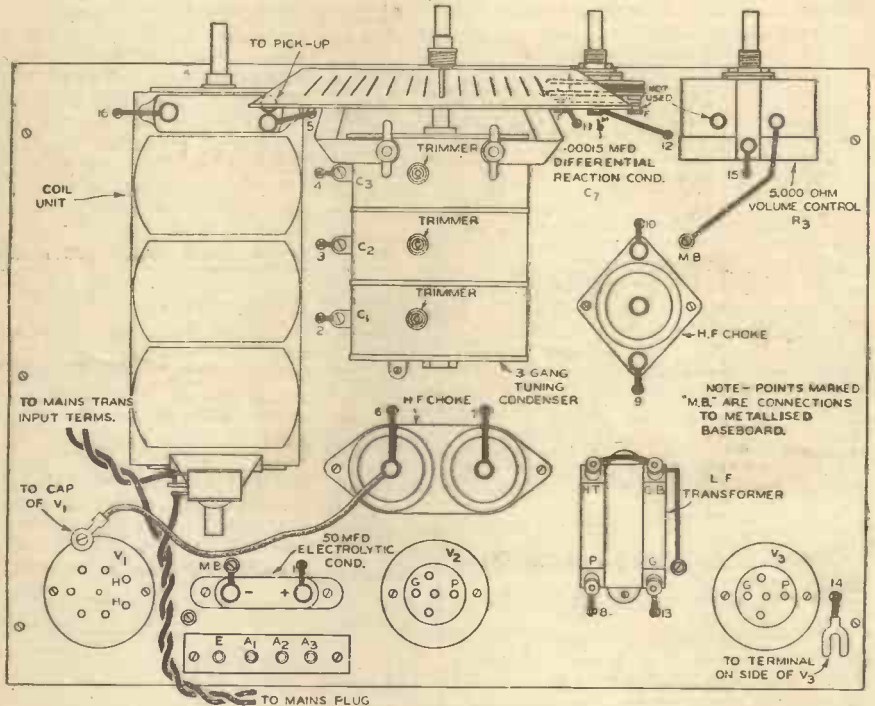

WIRING DIAGRAM OF THE "ARMADA" THREE.



SUMMIT 3 • ARMADA MAINS 3

NEW SPEAKERS—ELIMINATORS—KITS



PILOT AUTHOR KIT EXACT TO SPECIFICATION

The Pilot Kit SERVICE was founded in 1919.

See the PILOT on the carton. It's a real guarantee.

● Originators of Kits of Parts in 1919, we supply all your Radio needs CASH, C.O.D. or EASIWAY. Our Customers are invited to take advantage of our FREE Technical Service or call for Demonstration at our Showrooms—77, City Road, London, E.C.1, or 62, High Holborn, London, W.C.1.



NEW Manufacturers' KITS in Sealed Cartons

NEW LISSEN SKYSCRAPER THREE. Chassis model with Detector and Pentode Valves. Cash or C.O.D. Carriage Paid, £3/17/6. Send **7/-** only

Balance in 11 monthly payments of 7/-.
NEW LISSEN SKYSCRAPER FOUR ALL-WAVE CHASSIS MODEL. Complete Kit comprises all components, including set of Lissen Valves. Cash or C.O.D. Carriage Paid, £5/12/6. Send **10/3** only

Balance in 11 monthly payments of 10/3.
NEW LISSEN BAND-PASS SKYSCRAPER THREE. Complete Kit comprises all components, including set of Lissen Valves. Cash or C.O.D., Carriage Paid, £5/0/0. Send **9/3** only

Balance in 11 monthly payments of 9/3.
GRAHAM-FARISH SKYRAIDER THREE. Complete Kit for building, includes valves and modern walnut cabinet. Cash or C.O.D. Carriage Paid, £6/4/0. Send **11/3** only

Balance in 11 monthly payments of 11/3.

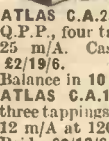

NEW ELIMINATORS

ATLAS C.A.25, for Mains, Class "B" and Q.P.P., four tappings; 60/80, 50/90, 120, 160 25 m/A. Cash or C.O.D. Carriage Paid, £2/19/6. Send **6/-** only

Balance in 10 monthly payments of 6/-.
ATLAS C.A.12, for A.C. Mains, 100/250v. three tappings; 60/80 v., 90/100 v., 120/150 v. 12 m/A at 120 v. Cash or C.O.D. Carriage Paid, £2/12/6. Send **5/9** only

Balance in 9 monthly payments of 5/9



NEW SPEAKERS

W.B. STENTORIAN SENIOR, Permanent Magnet M.C. SPEAKER. For Power, Pentode and Class "B." Cash or C.O.D. Carriage Paid, £2/2/0. Send **5/9** only

Balance in 7 monthly payments of 5/9.
W.B. STENTORIAN STANDARD Permanent Magnet M.C. SPEAKER. For Power, Pentode and Class "B." Cash or C.O.D. Carriage Paid, £1/12/6. Send **5/-** only

Balance in 6 monthly payments of 5/-.
BLUE SPOT "STAR" MOVING-COIL SPEAKER. Complete with Universal matching transformer. Cash or C.O.D. Carriage Paid, £3/10/0. Send **6/6** only

Balance in 11 monthly payments of 6/6



Peto-Scott PERMANENT MAGNET MOVING COIL SPEAKER

Not a Midget—FULL SIZE CONE Power or Pentode. Cash or C.O.D. Complete with input transformer. Send 19/6 Carr. Paid. Balance in 5 monthly payments of 4/-.
Class B Model, Cash or C.O.D. Carr. Paid, **2/6** DOWN

SUMMIT 3

KIT "A" Author's Kit of First Specified Parts, less Valves and Cabinet. Cash or C.O.D. Carriage Paid £4/6/0. Yours for **7/9** and 11 monthly payments of 7/9

KIT "B" as for Kit "A" but with set of specified Valves, less Cabinet. Cash or C.O.D. Carriage Paid, £5/18/6. Or 12 monthly payments of 10/9.

KIT "C" as for Kit "A" but with set of specified Valves, and Peto-Scott Summit Cabinet. Cash or C.O.D. Carriage Paid, £6/18/0. Or 12 monthly payments of 12/6.

These are the Parts the Author Used

	£	s.	d.
1 Peto-Scott Metaplex chassis, 12 x 10 x 3 in. Ready Drilled	3	0	0
2 Wearite dual range coils, A.D. & T.G.	1	5	0
1 J.B. 2-gang Unitune. .0005 mfd.	17	6	
1 Graham-Farish .0003 mfd. diff. reaction	2	0	
1 Ferranti 50,000 ohm potentiometer	4	6	
5 Dubilier 1 watt resistances, values—10,000, 30,000, 40,000, 50,000 ohms and 1 megohm	5	0	
3 Graham-Farish fixed tubular condensers, .1 mfd.	4	6	
2 T.M.C. .0002 mfd. tubular condensers	1	0	
1 T.M.C. 1 mfd. condenser, type 25	2	3	
1 Graham-Farish Snap 3 point on/off switch	1	0	
1 Varley 5.1 L.F. Niclet transformer	7	6	
3 Clix sub-baseboard valveholders, 2, 4 and 5 pin	2	1	
1 Graham-Farish L.M.S. H.F. Choke	4	6	
1 Graham-Farish Snap H.F. Choke	2	0	
1 Bulgin 100 m/A fuse and holder, type F.15	1	0	
5 Belling Lee wander plugs—G.B.+1, G.B.+2, G.B.—, H.T.+ , H.T.—	7	3	
2 B.R.G. 2 1/2 component brackets	8		
Wire, screws, flex, etc.	2	0	
KIT "A" Cash or C.O.D.	£4	6	0
VALVES: Set of 3 Specified Valves	1	12	6

EXCLUSIVELY SPECIFIED PETO-SCOTT Walnut CABINET 19/6

Specially designed at the request of PRACTICAL WIRELESS for the Summit 3. In exquisite walnut, a superb example of cabinet craftsmanship. Internal Dimensions 20" wide; 10" high; 12" deep. Carriage Paid. *A strongly-built Walnut Stool, 28in. high, for the Summit 3 Cabinet. 27/6 Carriage Paid.*

IMMEDIATE DELIVERY

PETO-SCOTT HAS IT FIRST

... send to Peto-Scott for the latest in Radio. Everything new at **OLYMPIA for CASH C.O.D or EASIWAY**

● Send for Latest Easiway Lists.

ARMADA Mains 3

KIT "A" Author's Kit of First Specified Parts, less valves and cabinet. Cash or C.O.D. Carriage Paid £10/9/6. Yours for **19/3** and 11 monthly payments of 19/3

KIT "B" as Kit "A" but with set of specified valves. Cash or C.O.D. Carriage Paid £12/8/0. Or 12 monthly payments of 22/9.

KIT "C" as Kit "A" but with set of specified valves and Peto-Scott Tablegram Cabinet. Cash or C.O.D. Carriage Paid £14/13/0. Or 12 monthly payments of 26/6.

EXCLUSIVELY SPECIFIED PETO-SCOTT TABLEGRAM CABINET

Another magnificent Peto-Scott cabinet, specially designed for the Armada Mains 3. In beautifully grained woods, faultlessly constructed and hand french polished. In Oak or Mahogany to choice, no extra. State which when ordering. **45/-**

ANY ITEM SUPPLIED SEPARATELY—ORDERS OVER 10/.

SENT C.O.D. CARRIAGE AND POST CHARGES PAID

IMPORTANT. Miscellaneous Components, Parts, Kits, Finished Receivers or Accessories for Cash, C.O.D. or H.P. on our own system of easy payments. Send us a list of your wants. We will quote you by return. C.O.D. orders value over 10s. sent carriage and post charge paid (GREAT BRITAIN ONLY). OVERSEAS CUSTOMERS CAN SEND TO US WITH CONFIDENCE. We carry a special export staff and save all delay. We pay half carriage—packed free. Send full value plus sufficient for half carriage. Any surplus refunded. Hire Purchase Terms are NOT available to Irish or Overseas customers.

PETO-SCOTT CO. LTD., 77, CITY RD., LONDON, E.C.1 Tel.: Clerkenwell 9405/7. West End Showrooms: 62, High Holborn, London, W.C.2. Tel.: Holborn 3248.

Dear Sirs,—Please send me CASH/C.O.D. H.P. for which I enclose £.....d. CASH/H.P. Deposit.

NAME

ADDRESS

Pr.W. 18/8/34.

Buy by Post—its Quicker—CASH—C.O.D.—EASIWAY

**“Yes, I’m fully charged
Look at my indicator”**



I am the Exide “Indicator” Battery. When I say “Full” I *am* full—and that’s that. When my hand approaches “Empty” it is time to get me recharged—and that’s *that*. The point is that with me you always know where you stand. I put an end to uncertainty. I put an end to the risk of being let down by a run-down battery.

★ The Exide Batteries already equipped with this invention are the “D” types listed below.

Exide

PRICES WITH ‘INDICATORS’

Type DTG-C 2 volt 20 a.h. 5/-
Type DFG-C 2 volt 45 a.h. 9/-

★ These prices do not apply to the Irish Free State.

“INDICATOR” BATTERY

For wireless H.T. get

Drydex

the Exide dry battery

Exide Batteries are obtainable in sizes to suit every set from Exide Service Stations and all reputable dealers. Exide Service Stations give service on every make of battery. ● EXIDE BATTERIES, Exide Works, Clifton Junction, near Manchester. Branches: London, Manchester, Birmingham, Bristol, Glasgow, Dublin, Belfast.

R.70.

‘STILL KEEPS GOING WHEN THE REST HAVE STOPPED’

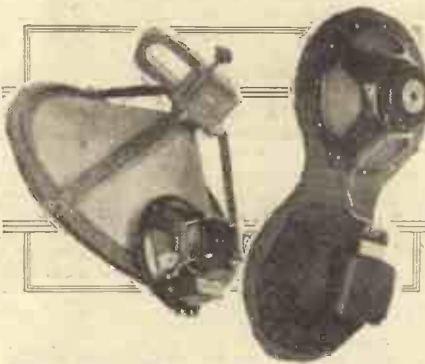

SPEAKER PROGRESS

How the Loud-speaker Has Developed During the Past Season

AT last year's exhibition a number of interesting changes was witnessed in the design and construction of loud-speakers, and one of the most interesting, and one which undoubtedly attracted the greatest amount of attention, was the Microlode principle incorporated in the W/B speaker. As our readers are by now aware, this was an ingenious tapped matching transformer, fitted with selector arms, so that by a combination of the setting of the two arms it was possible to match the impedance of any type of output valve and so obtain optimum results from the speaker.

Class B

In addition to this we saw for the first time various Class B speakers in which a complete Class B stage was fitted. At this year's exhibition we cannot expect to see such radical departures from existing design, and it is quite safe to say that the loud-speaker of to-day, so far as quality is concerned, is practically perfect and will deal satisfactorily with the range of frequencies at present transmitted by the B.B.C. There is, however, room for improvement in the range which can be handled, and this will be dealt with later on.

W/B Again

At this year's exhibition the great surprise is again promised by Whiteley Electrical. As with last year's surprise, so this year they have developed something new, but instead of a departure from existing design, the improvement is to be found in the magnet system. A new alloy has been found which has resulted in greatly increased magnetism, and thus for a given size of magnet a much stronger gap strength has been obtained. This has far-reaching results, as may be seen from the following. The experimenter knows that the speech coil of an M.C. speaker is included in a small gap which is part of a magnetic system,

and consequently the speech or music current fluctuations through the speech coil intersect the magnetic lines existing in this small gap, and this gives rise to the movement of the speech coil which, as it is part of the diaphragm, causes this to move and so reproduce the sounds. Obviously, therefore, if the magnetic lines are weak, the movement of the speech coil will also be weak.

Gap Size

To maintain a sufficient and reasonably strong field across the gap this is reduced to extremely small dimensions, and consequently the speech coil must be very small, and to enable the diaphragm to be given a substantial movement it must be made

definitely does not extend into the range of the higher harmonics, and although it gives splendid results when well designed, it cannot be said that it reproduces faithfully any sound which is rich in these harmonics. In America a speaker has been developed which is remarkably good in this latter respect, and it utilizes a movement which arises from the effect of electrical currents on a crystal of rochelle salt, or, as it is more commonly known, a piezo crystal. Unfortunately, as with practically everything in this life, nothing is perfect, and the ability to deal so faithfully with the upper frequencies is met in this system with a failure to go right to the other end of the scale. Consequently, to obtain a true overall response, in which the lowest and the very highest frequencies are handled faithfully, it is necessary to combine a piezo-crystal speaker with a moving-coil speaker and this combination will be seen for the first time this year on the Rothermel stand. It is interesting to note that the piezo crystal has also been utilized by this firm in the production of gramophone pick-ups and microphones.

OUR NEW MONTHLY

Practical Television

6^D. FROM ALL NEWSAGENTS

Television Frequencies

These two instances represent probably the only radical "introductions" at this year's exhibitions, but before closing these notes perhaps it would be well to point out that with the introduction of television transmissions, and the consequent necessity of greatly extending the frequency range at present utilized, a demand will arise for improved design in both broadcast amplifiers and loud-speakers, as the probability is that the amateur will build a high-class receiver to which to connect his vision apparatus and will, at other times, utilize that amplifier for broadcast reception. With the natural progress which will result from the increased frequency response it is only natural to expect some change in quality of sound output, and thus speaker design may need modification before the next exhibition arrives.

light in weight. With the new magnet it is found possible to use a much larger gap, and consequently the speech coil may be made more substantial, leading to the introduction of a larger cone and so, throughout all the parts that matter, introducing improvements. Great things may thus be expected of this new arrangement.



The Beethoven S.G.A. Battery Model No. 54.



The Rola F7 P.M. Speaker.

The Piezo Speaker

A failing of the cone type of speaker has always been the poor high-note response. By this is not meant that the cone type of speaker is no good for high notes, but it



The Beethoven Minor Portable Model P75.

What is Your Favourite Circuit?

OUR SPECIAL RADIOLYMPIA COMPETITION

PRIZES: FIFTY W.B. STENTORIAN SPEAKERS IN SIMPLE FREE-FOR-ALL COMPETITION

Fifty of these splendid new W.B. Stentorian speakers, which incorporate an ingenious new principle in speaker construction, providing greater output for a given input, and vastly improved quality are offered in a simple competition in accordance with the Rules and Conditions given below. These speakers cost 42/- each, and are renowned for the brilliance of their reproduction and extreme sensitivity. A switch-arm is incorporated at the back which enables matching to be carried out without having to disconnect the speaker—in fact whilst the speaker is in operation.



Here is one of the 50 New W.B. Stentorian Speakers offered as Prizes in this Simple Competition.

ENTER NOW for this simple competition in which every reader—expert and amateur alike—has an equal chance! Here is a golden opportunity to win the very latest in loud-speakers, and an excellent chance of obtaining an important part of your new season's equipment. There is no entrance fee, and you may send in as many attempts as you like. The competition will be judged quickly so that you will not be kept waiting for the result.

STUDY THESE RULES CAREFULLY!

1. In the centre column appears a list of nine features of design. What you have to do is to answer the various questions in the space provided. The fifty senders of coupons most nearly agreeing with the popular vote will each receive one of the W.B. Stentorian speakers.
2. After filling in the coupon in this way, fill in your name and address in block letters at the foot of the coupon, and post, in a sealed envelope, addressed to The Editor, "Practical Wireless," Geo. Newnes, Ltd., 8-11, Southampton Street, Strand, London, W.C.2.
3. Mark the word COMPETITION in the top left-

WHICH IS YOUR FAVOURITE CIRCUIT ?	
Battery or Mains ?	
All-Wave, Broadcast, or Short-Wave Bands ?	
Superhet or Straight Circuit ?	
Power Output over or under 2 Watts ?	
Self-contained or External Speaker ?	
Table or Console Cabinet ?	
Combined or Separate Controls ?	
Radiogram or Provision for Pick-up ?	
Self-contained or External Aerial ?	
Name	
Address	

hand corner of the envelope. Post to reach us not later than August 31st.

4. Readers may send in as many attempts as they like in one envelope, provided that each attempt is written on a separate coupon, each of which must bear the full name and address of the sender.
5. Only one speaker can be awarded to each reader.
6. The result will be published in our issue dated September 15th.
7. The Editor's decision is final and legally binding, and this is an express condition of entry. No correspondence whatever can be entered into regarding this competition.

REPUTATION

The **AMPLION** reputation for producing speakers giving life-like reproduction, fine tonal balance, sensitivity and the ability to handle heavy input without the slightest signs of distortion, is faithfully upheld in this 1935 "LION."

Perfect Matching to every class of output is obtained through the **Universal Transformer** covering from 1 to 20 ohms and from 2,000 right up to 40,000 ohms; normal or centre tapped.

Refinements include, terminals for connecting up an extension speaker. Sockets to which can be connected leads for volume or tone control. The terminal strip is clearly engraved so that it is a simple matter to secure exact and perfect matching with any receiver which you may acquire.

Sealed Magnetic Gap. Every AMPLION "LION" Speaker can be relied upon to indefinitely maintain its perfection of reproduction, because all incorporate the new "Sealed Magnetic Gap."

AMPLION "LION"

PERMANENT MAGNETIC MOVING COIL SPEAKER

Universal Transformer. Cone diameter, 7 inches. Magnet of new design. Exceptionally heavy and provides extremely high sensitivity. **47/6**

AMPLION "LION SUPER" 10-INCH CONE, 55/-

AMPLION (1932) LTD.

82-84 Rosoman Street, London, E.C.1



OLYMPIA—STAND 63

See & hear the amazing new

LOTUS

at
11, HAMMERSMITH ROAD
FACING OLYMPIA **AUGUST 16th to 25th**

The LOTUS

DOUBLE PENTODE

- SCREENED PENTODE DETECTOR AND PENTODE OUTPUT.
- MAINS ENERGISED MOVING COIL SPEAKER.
- WORKS ON ANY ELECTRIC MAINS (A.C. or D.C.) 150 to 250 volts.

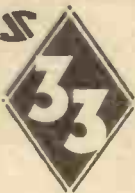

This amazing new set has been designed to give the very finest possible reproduction. It is selective, easy to tune and of handsome appearance.

PRICE COMPLETE

£4.17.6

The LOTUS



TRIPLE PENTODE

Variable Mu H.F. pentode. E.F. pentode detector. Output pentode. Mains energised moving coil speaker. Provision for gramophone pick-up. Works on any electric mains (A.C. or D.C.) of 150 to 250 volts. Handsome insid modern cabinet in walnut and sycamore.

Price complete: £7.19.6

Also two other splendid new LOTUS models as follows

The LOTUS



TRIPLE-TUNED A.C.

Matched triple-tuned dual range tuning inductances. Variable Mu H.F. Pentode amplifier. Screened pentode detector. 9-watt output valve. Energised moving coil loudspeaker. Handsome walnut cabinet with full vision scale. Ultra selectivity and long range. 31 watts output.

Price complete £10.10.0

MODEL "33"
AC/DC UNIVERSAL
DOUBLE PENTODE

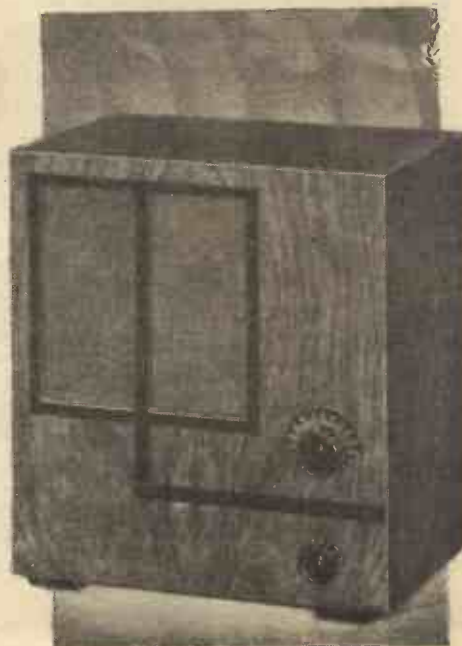

★ **WRITE FOR FREE ILLUSTRATED BROCHURE**
LOTUS RADIO (1933) LIMITED,
105, Judd Street, King's Cross, London, W.C.1.

OLD FRIENDS AND NEW.....



TRANSFORMERS

1 which make any set a better set. The AF5 illustrated here, price 30/- is the choice of engineers and musicians—specified wherever high amplification and nearly perfect reproduction are essential. (Ratio 1/3.5, Inductance 260/80 henrys, 0/10 m/A).

AT OLYMPIA

At Stand No. 70 you will see some old friends. The AF3 and AF5 will be there for instance, because after years of service, these transformers have proved their title to supremacy. But the many new friends will prove to be of interest to the Radio man whose watchword is "Quality." The AF9cs; the new Resistances; the Volume controls; the Electrolytic Condensers, and above all, the comprehensive range of Ferranti Valves. The new season's range of constructor's sets alone is worthy of the closest inspection. A display of Radio at its very best. A Wireless Exhibition in itself.

FERRANTI NEW RESISTANCES

Types G·5, GH·5, G·1 and GH·1

2 Accurate to within 5% of their rated values, non-varying and maintaining the stated value even when working at full rate for long periods. Inductance and capacity negligible. From 300 ohms to 2 megohms. Price 1/- and 1/6 each. Without holder 6d. each less.



POTENTIOMETERS

3 Ferranti Potentiometers are constant in value and silky in action. Although not usually required to carry appreciable current they will dissipate 0.25 watt continuously. They have a slight negative temperature coefficient. Standard values: 50,000 ohms, 100,000 ohms, 250,000 ohms, 500,000 ohms, 1 megohm. Type P with knob as illustrated, Price 3/9 Type PS with knob and mains switch 4/6 Logarithmically graded types, 1/- each extra.

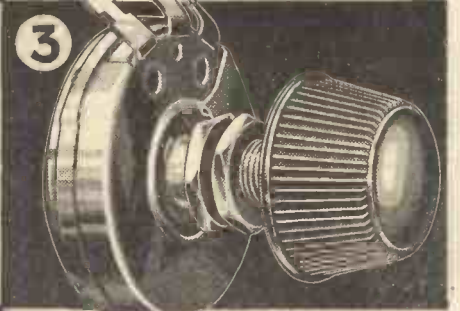

THE HEPTODE

4 The Ferranti VHT4 combines in one valve the function of both oscillator and modulator, and, in addition, is a variable Mu type, enabling full A.V.C. to be obtained in sets with only one I.F. stage. Price 20/- 2-volt Battery Heptode VHT2 also available Price 18/6



CONDENSERS

5 Ferranti (the lowest price quality condensers on the market) are made with extreme care to work efficiently and without possibility of breakdown. They are designed and made by engineers whose experience includes the building of condensers for working pressures of more than 1,000,000 volts. Prices from 1/-

STAND No. 70



M.1. SUPER SPEAKER

After being unsurpassed for years the M.1. speaker is now available in a still better form. A new suspension better and freer than before and a remarkable magnet of aluminium steel with a gap half-inch deep, are now incorporated.

Write for leaflets to FERRANTI LTD., HOLLINWOOD, LANCASHIRE.

The Practical Wireless COMPLETE GUIDE TO THE NATIONAL RADIO EXHIBITION



AT
OLYMPIA
FROM
THURS. AUG. 16th TO SAT. AUG. 25th 1934
10 A.M. TO 10.0 P.M. DAILY
ADMISSION 1/6

ACE RADIO, 2a, West Harbour Street, E.1. Stand No. 19.

ADEY PORTABLE RADIO, 99, Mortimer Street, London, W.1. Stand No. 115.

A **UNIQUE** portable will be seen on this stand, together with a valve which has been designed by Mr. Adey to simplify the construction of a neat portable of the type which he has so successfully produced. Some novel features are included in this portable which is one of the smallest receivers made commercially. Four valves are employed, and the total weight of the receiver, with batteries, is only about 12½ lbs. The price has been reduced to £7 10s.

AERIALITE, LTD., Junction Mills, Ashton-U-Lyne. Stand No. 253.

NOVELTIES in aerial and earth equipment will form the basis of the exhibits by this firm, and amongst these may be mentioned "Quikfix," some ingenious Aerial brackets designed to simplify the erection of an aerial; "Levenstrand," a new type of aerial wire; "Percolite," an all-copper earth tube, and a complete Aerial and Earth Kit, incorporating some of the above parts.

AERODYNE RADIO, LTD., Aerodyne Works, Walthamstow, E.17. Stand No. 68.

A **FULL** range of 1935 "Aerodyne" receivers will be exhibited on this stand. The range will include some of the sets which were popular last year, but these will be exhibited in new and up-to-date form.



The novel and compact Adey portable receiver which employs the Adey self-coupling valves.

AUTOMATIC COIL WINDER AND ELECTRICAL EQUIPMENT CO., LTD., Winder House, Douglas Street, London, S.W.1. Stand No. 2.

THE Avometer is now well known, and the makers of this ingenious testing instrument will be showing this fine meter as well as some entirely new lines developed this season. The Avodaptor is now brought up to date by the inclusion of a seven-pin adaptor. Also on show will be a Universal Avometer having a fully-jewelled movement with cobalt-steel magnets and a 5in. untarnishable anti-parallax dial; a D.C. Avometer providing thirteen different ranges; the Avominor—a small edition of the D.C. Avometer with eleven ranges; and the Avo-oscillator.

AUTOMATIC RADIO GRAMOPHONE Co., Ltd., Crown Street Hall, Brighton. Stand No. 110.

BAKERS SELHURST RADIO, LTD., 75, and 77, Sussex Road, Croydon, Surrey. Stand No. 242.

ALTHOUGH manufacturers of high-quality loud-speakers which will form the centre of interest on this stand, for the first time a complete receiver will take a position at the show. This has been designed for Car Radio purposes, and consists of a 4-valve receiver designed for H.T. battery-operation. Steering column control is fitted, and the circuit utilizes iron-core coils, R.C. coupling and a moving-coil loud-speaker. Extension loud-speakers will also be on show, together with the new Justone speaker, which incorporates a novel output matching device.

BALCOMBE, A. J., LTD., 52-58, Tabernacle Street, London, E.C.2. Stand No. 32.

THE well-known Alba receivers will appear on this stand, and these include table models as well as radiograms. Battery receivers and A.C. mains apparatus will be shown, and the circuits incorporated include bandpass tuning as well as the modern superheterodyne feature.



A very useful and inexpensive test meter—the Avominor, which is made by the Automatic Coil Winder and Electrical Equipment Co., Ltd.

FOR FLOOR PLAN

See page 624.

ALLWAVE INTERNATIONAL RADIO AND TELEVISION, LTD., 4a, Wimbledon Hill Road, S.W. Stand No. 113.

UNIVERSAL AC/DC all-wave receivers will be featured on this stand, and the models include a chassis which covers from 15 to 2,000 metres in four bands, each band calibrated on separate scales visible through one opening, the appropriate scale being illuminated for each switch position. A fully

SPECIAL NOTICE.

This guide is arranged in alphabetical order, and gives details of all the new season's programmes released up to the moment of going to press.

NEXT WEEK'S SECOND ENLARGED SHOW NUMBER.

Next week's issue will contain a comprehensive stand to stand report of the exhibits. Order your copy to-day.

AN INVITATION.

A cordial invitation is extended to every reader to call at our stand, No. 8, ground floor, if in need of information, advice or assistance regarding any radio or kindred subject.

variable tone control is also fitted, and the speaker is of the M.C. type with a 15-watt excited field.

AMALGAMATED PRESS, Fleatway House, Farringdon Street, London, E.C. Stand No. 12.

AMPLION (1932) Ltd., 52, Rosoman Street, E.C. Stand No. 63.

ANSON AND HOPWOOD, LTD., 41, Cheval Place, S.W.3. Stand No. 108.

LUXE receivers incorporating self-changing mechanism for gramophone records will be seen here, and the capacity of the mechanism is thirty records, all automatically changed and turned over. Known as the Autotrope, this apparatus sets a new standard for home reproduction, and visitors will find the exhibit most interesting.

HOW TO GET THERE.

See page 635.

Practical Wireless GUIDE TO THE SHOW

BELLING AND LEE, LTD., Cambridge Arterial Road, Enfield, Mdx. Stand No. 41.

THIS firm needs no introduction as the manufacturers of small radio accessories. In addition to already popular items such as terminals, connectors, etc., some new and ingenious interference eliminating units will be on show. These are designed for use with all

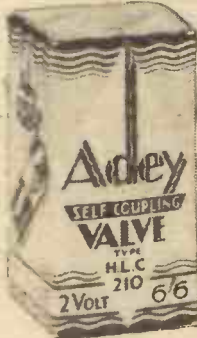

The unusual Adey Self-coupling Valve, which has an inductance wound around its base.

types of apparatus, from sewing machine motors to flashing electric signs. Car-radio suppressors will also be featured, and the smaller items, such as valveholders, connectors, terminal strips, etc., will provide the home constructor with much interesting material.

BEETHOVEN RADIO, LTD., Beethoven Works, Great College Street, Camden Town, London, N.W.1. Stand No. 57.

A TWIN-speaker G-valve A.C. mains superhet; an S.G.4 Portable, and an S.G.3 battery receiver will be seen on this stand together with some other receivers embodying the latest principles. Full-vision tuning scales and modern work in birdseye maple are features which will give some indication of the modern style of these receivers.

BENJAMIN ELECTRIC, LTD., Brantwood Works, Tarriff Road, Tottenham, London, N.17. Stand No. 42.

THE exhibits on this stand will consist of small components and the famous Magnavox loud-speakers. Among the smaller items may be mentioned valveholders, battery-switches, chokes, battery economizing unit, and transformers. The



A useful testing instrument for the experimenter, the Avo-Oscillator.

speakers include the new Double Six speaker intended specially for sets and radio-gramophones of the highest quality.

BERNARD JONES PUBLICATIONS, LTD., 58, Fetter Lane, E.C.4. Stand No. 10.

BIRMINGHAM SOUND REPRODUCERS, LTD., Claremont Works, Claremont Street, Old Hill, Staffs. Stand No. 235.

ON this stand will be seen a most comprehensive range of goods, including amplifiers, radio chassis and H.F. amplifier units, turntables, speakers, baffles, microphones, radio receivers and gramophones, oscillators and valve voltmeters. The amplifiers cover various purposes and have outputs from 12 watts to 80 watts, whilst the microphones are suitable for speech or music, and may be obtained complete with table stand or floor stand. The speakers range in price from £5 5s. to £22 2s., the latter having two horns and a "Y" connector, together with a substantial reproducing unit.



employing an exclusive magnet of nickel aluminium alloy and an impedance-matching panel fitted with a simple wander plug. This costs 70/-. Other exhibits will include a remote control and a pick-up, the latter having a lifting head and a re-designed arm reducing tracking error to the lowest possible

minimum. A special volume control is incorporated, and the price, with volume control, is £1 7s. 6d. Without the control the pick-up only costs only £1 1s. 6d.

This is the self-contained battery-operated car radio equipment made by Messrs Bakers (Selhurst) Radio, Ltd.



BRITISH BROADCASTING CORPORATION PUBLICATIONS, Broadcasting House, W.1. Stand No. 88.

BRITISH G.W.Z. BATTERY, CO., 205, Bedford Avenue, Trading Estate, Slough, Bucks. Stand No. 206.

BRITISH PERMEL ENAMELLED WIRE, LTD., Charlton, S.E.7. Stand No. 21.

BRITISH PIX CO., LTD., 118, Southwark Street, London, S.E.1. Stand No. 237.

HERE will be seen Pix valves, the Pix Invisible Aerial, the Modula armchair control and similar small but useful items for the listener. For the improvement of the earth connection a new material known as "Hydrolyte" has been introduced by Messrs. Pix, and this is obtainable in a bottle at 1s. or included in a special canister ready for burial in the earth at 2s. The armchair control has already been reviewed in our pages.

BLOCK BATTERIES, LTD., By-Pass Road, Barking, Essex. Stand 31.

IMPORTANT recent additions now make available a complete range of Block plateless accumulators for every radio purpose. The three main varieties are the original cylindrical 80 a.h. type L.T., a new range of square-shaped L.T.'s of



The "Atlas" new-model receiver. This set embodies what is known as spectrum tuning whilst, as can be seen, the loud-speaker baffle board is arranged at an unusual angle.

smaller capacity, and H.T. accumulators.

The new square-shaped L.T. accumulators are specially designed for use in radio sets, and all varieties are plateless, thus providing maximum capacity for minimum space and weight, together with greater endurance and ability to hold full charge for long periods when inactive. All are enclosed in coloured mottled bakelite cases.



A new pick-up, with built-in volume control, by the British Blue Spot Co., Ltd.

BRIDGER AND CO., LTD., 4 Factory, Shelford Place, Church Street, Stoke Newington, London, N. 16. Stand No. 216.

BRITANNIA BATTERIES, LTD., Union Street, Redditch, Worcs. Stand No. 94.

A REPLACEMENT battery for any receiver is the keynote of the Britannia factory, and a comprehensive range of batteries for all purposes will be seen on this stand. In addition, accumulators and grid-bias batteries will also be displayed and some old friends will be seen in newly-designed and improved containers.

BRITISH BLUE SPOT CO., LTD., 94/96, Rosoman Street, Rosebery Avenue, London, E.C.1. Stand No. 90.

NEW models to be introduced by the well-known makers of the Blue Spot speakers will include a novel magnet principle which results in greatly improved performances. The Super Dual, costing £11 11s. with permanent magnet and £8 8s. with energized magnet, represents a most attractive type of speaker which is suitable for the home or the theatre. The Blue Spot Star is a new model



This interesting-looking instrument is an excellent modulated oscillator which is produced by Messrs. W. F. Brown Radio Co.

Practical Wireless GUIDE TO THE SHOW

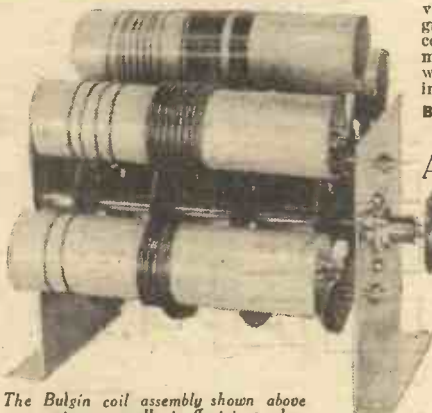

The Bulgin coil assembly shown above represents an excellent effort to produce a really satisfactory all-wave tuner. It is the result of several years' experiment.

BROADCASTER, 29, Bedford Street, Strand, London, W.C.2. Stand T27.

BROWN BROS., LTD., Great Eastern Street, E.C.2. Stand No. T20.

WM. F. BROWN RADIO CO., Oscillo Works, Brierly Hill, Staffs. Stand No. 229.

THIS firm will be showing a wide range of wave meters, calibrated oscillators of both the radio- and audio-frequency types. These will be of especial interest to the more advanced experimenter and to those members of the trade who are interested in the calibration of various components. There will be a number of various types on view, and these will range in price from £14 for a radio-frequency oscillator to £35 for an audio-frequency unit. An extremely accurate pattern of valve voltmeter will also be shown.

BULGIN AND CO., A. F., LTD., Abbey Road, Barking, Essex. Stand No. 121.

IN addition to many existing and popular lines, Messrs. Bulgin will be showing a number of new components which will still further add to the long list of useful parts which have been produced during the past years. From the smallest switch to the new short-wave coils the components are of very high merit, and visitors will be able to spend an interesting time at this stand. Among the new items may be mentioned the multiple short-wave 5-range coil chassis; the all-wave testing unit; a new decorative signal lamp, and some short-wave tele-

vision coils. A further point of great interest to the home constructor is the announcement that many existing lines will be substantially reduced in price.

BURGOYNE WIRELESS (1930), LTD., Great West Road, Brentford. Stand No. 102.

A RANGE of receivers at competitive prices will be shown, all of which are provided with a new form of tuning scale which is on the "clock-face" principle; it is called by the makers "one-glance tuning." The range covers battery receivers of all types, including three different portable models and one instrument fitted with dual loud-speakers and having a Class B output stage.

BURDEPT, LTD., Light Gun Factory, Erith, Kent, 81.

BURTON, C. F., and H., Progress Works, Bernard Street, Walsall, 3.

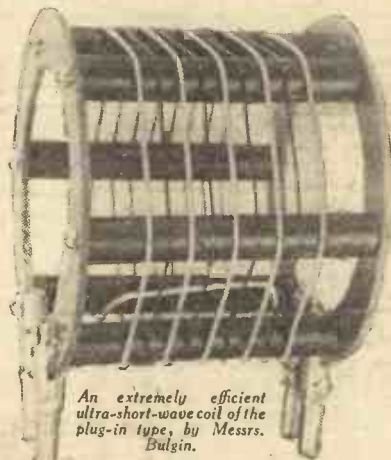

An extremely efficient ultra-short-wave coil of the plug-in type, by Messrs. Bulgin.

BUSH RADIO, LTD., Woodger Road, Shepherds Bush, W.12, 82.

CADISH AND SONS, 5-6, Red Lion Square, W.C. Stand No. T7.

A REPRESENTATIVE selection of commercial apparatus will be seen on this stand, Messrs. Cadish being wholesalers only.

CELESTION, LTD., London Road, Kingston-on-Thames. Stand No. 28.

A S representative of loud-speakers, this stand will be devoted to reproducers of various types. From the small single permanent-magnet type of speaker to the large double-energized balanced units every taste is catered for by the Celestion Company. The Auditorium speaker, for instance, costing £18 18s., and weighing 74½lbs., represents one of the larger models, whilst the E.5, costing 17s. 6d. and weighing only 11b. 4ozs., represents the other extreme. In addition, the P.2 pick-up will also be seen, and this embodies all the latest features in modern pick-up technique.



A new series of efficient and low-priced coils of the "stripped" type, which has just been introduced by Messrs. Bulgin as a reply to the "Practical Wireless" Low-price-with-efficiency Campaign.

CENTRAL EQUIPMENT, LTD., 188, London Road, Liverpool. Stand No. 4.

SOME novel aerial and earth accessories will be seen on this stand, including the No-Mast Aerial and Siltit. The former is a novel arrangement of stout copper wires built into an insulator and designed for vertical erection against the side of a house, whilst the latter is a similar arrangement incorporated with a special hygro-metallic compound for improving the efficiency of the earth connection.

CHLORIDE STORAGE AND BATTERY, CO., 231, Shaftesbury Avenue, London, W.C.2. Stand No. 254.

A FULL range of Exide and Drydex batteries will be seen on this interesting stand in the Grand Hall Gallery. A feature of the exhibit will be the "D"-type cells fitted with the indicator which created so much interest on its recent introduction. The indicator consists of a dial over which moves a needle between positions marked "full," "half," and "empty," giving a correct indication as to the state of the cell and affording an accurate idea of the time it can be expected to last before re-charging is necessary. Examples of all types of Exide high-tension batteries include the specially-designed polished wood crates to hold Exide 60-volt batteries. It will be noticed that the range of Drydex dry batteries has been extended, a number of special batteries having been developed for the latest and most recently-designed battery operated receivers.

CHURCHMAN'S LTD., 79, Maidenburgh Street, Colchester. T23a.

CITY ACCUMULATOR CO., LTD., 18-20, Norman's Buildings, Central Street, London, E.C.1. Stand No. 89.

THE "Austin" Receivers will attract a great deal of attention on this stand. The manufacturers point out that the exhibits here will consist of receivers, amplifiers and tuning packs, designed and sold many months prior to the exhibition, and not some items hastily thrown together at the last moment. The Superpak Tuning Unit is a superhet tuning pack specially designed for the Heptode Frequency Changer, and is complete with 3 coils 3-gang condenser, padding condenser and 25,000-ohm tone-control potentiometer. This sells at £2 12s. 6d.



One of the permanent-magnet moving-coil speaker units from the British Rola range.

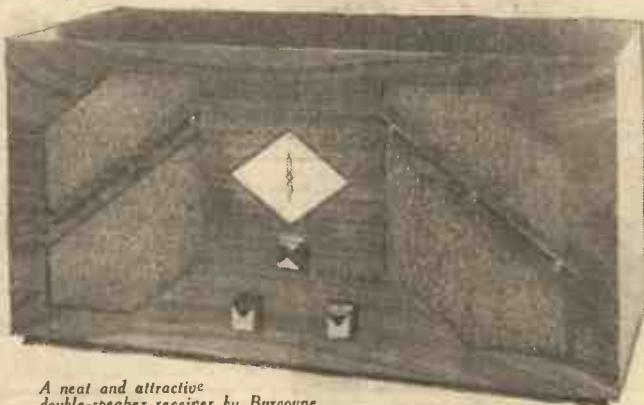

A neat and attractive double-speaker receiver by Burgoyne Wireless, Ltd. It has an attractive form of "clock-face" tuning.

Practical Wireless GUIDE TO THE SHOW

GRAND HALL - FLOOR PLAN

"PRACTICAL WIRELESS" THE LEADING WIRELESS WEEKLY

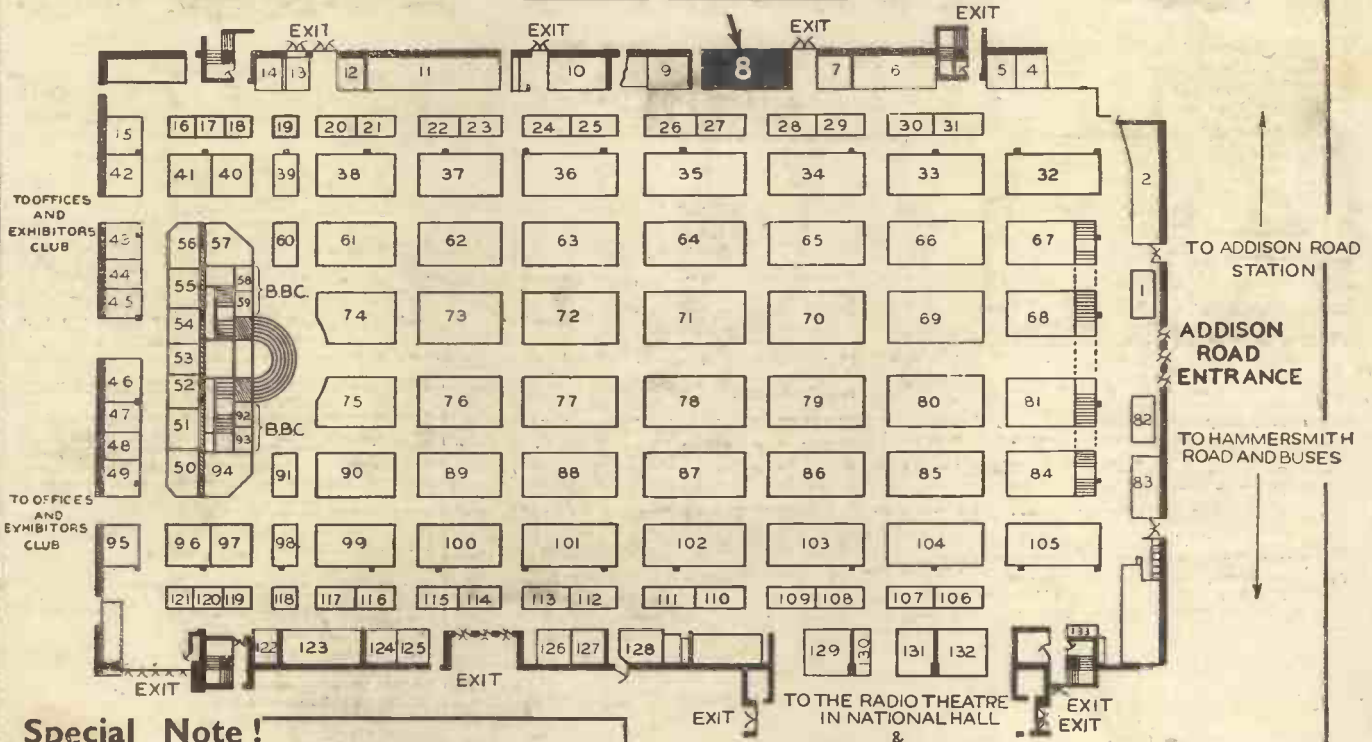

Special Note!

Stands Nos. 1 to 133 are on the Ground Floor; Stands 201 to 272 and T1 to T32 are in the Gallery.

ENTRANCES IN HAMMERSMITH RD

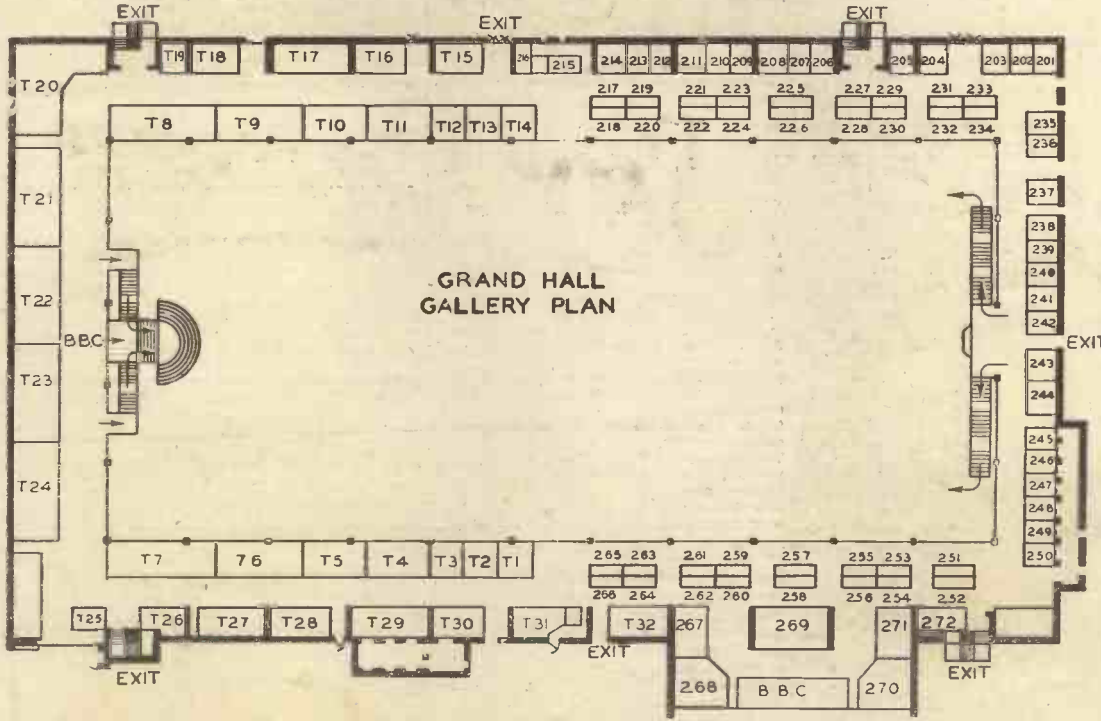

For Details of 'Bus and Underground Routes to and from Olympia See Page 635.

A Detailed Stand to Stand Report of the Exhibits will appear in Next Week's Second Enlarged Show Number! Order your Copy Now!

Graham Farish presents

The finest Radio Magazine ever published

"RADIO CONTACT"

Magazine ever published

Packed from cover to cover with Interest, and Instructions for building 3 magnificent new Battery Sets

out Today



SKY RAIDER

The most advanced set of our time. NEW-type Coils, NEW-type Valves, NEW-type Speaker . . . AND results that will amaze you.

SKY RAIDER IS THE SET TO BUILD!
Fully described in this issue with full-size Blue Print FREE

Also instructions for building two other interesting modern circuits

Wonderful new BATTERY VALVE developments

Host of new ideas for your present set

"CONTACT" World-wide Station-finder

Intimate News and Views from your favourite Station abroad, etc., etc.

HERE IS THE MAG. YOU'VE WANTED!

Don't be too late, get your copy from your Dealer *now*. If any difficulty in obtaining send 3d. in stamps to **GRAHAM FARISH, LTD.**, Bromley, Kent, or call at our Stand No. 59 Radiolympia for a copy.

STAND TO! AT

SEE THESE
TWO FOREMOST

Stand 2

Radio Fault - Tracers



Testing made Easy—Accurate—Simple!

A Sensational New UNIVERSAL (A.C.&D.C.) AvoMINOR

REG. TRADE MARK.

Here — for everyone — is a younger brother of the famous Universal Avometer. This new meter makes both A.C. and D.C. tests. It gives you a wonderful new ability to trace faults accurately — quickly — easily — with all the assurance of the technical engineer. Entirely new testing facilities are combined with famous AvoMinor precision and simplicity.

22 METERS IN ONE	
D.C. VOLTS	A.C. VOLTS
0-75 millivolts	0-5 volts
0-5 volts	0-25 "
0-25 "	0-100 "
0-100 "	0-250 "
0-250 "	0-500 "
0-500 "	
MILLIAMPS	RESISTANCE
0-2.5 milliamps	0-20,000 ohms
0-5 "	0-100,000 "
0-25 "	0-500,000 "
0-100 "	0-2 megohms
0-500 "	0-5 "
	0-10 "

- The newest and best of inexpensive A.C. and D.C. meters.
- Entirely self-contained. Dimensions: 4½" x 3½" x 1½".
- 3" accurately marked scale.
- Simple range selection.
- Simple switch determines A.C. or D.C.

£5

Deferred Terms if desired.

See the Universal AvoMinor at Olympia, or write for descriptive folder.

The Famous D.C. AvoMINOR

REG. TRADE MARK.

Ten ACCURATE Meters in One

A NEW AID Radio Servicing Simplified

This invaluable new Book gives a complete survey of radio testing in non-technical language. The testing of modern valves, and every phase of fault-finding are explained in easy phraseology. Numerous diagrams. A book compiled for both the amateur and engineer.

2/6 Post free 2/9

Radio's triumphant little helpmate. Testing is simple, easy and accurate with this instrument. It tracks the slightest defect, traces the most baffling fault. Ten precision meters are combined in one. You can test your set like an expert. No other small D.C. meter has the same accuracy.

See it at Stand 2 and see how it can win you a valuable cash prize.



THE AUTOMATIC COIL WINDER & ELECTRICAL EQUIPMENT CO., LTD.
WINDER HOUSE · DOUGLAS STREET · LONDON · S.W.1 · TELEPHONE · VICTORIA 3404/7

Practical Wireless GUIDE TO THE SHOW

CLARKE, H., AND CO. (M/c), LTD., Atlas Works, George Street, Patricroft, Manchester. Stand No. 85.

AS makers of the popular "Atlas" branch of wireless apparatus, this firm is already well known. The popular Atlas Mains units will also be shown on this firm's stand, and the range has been increased this year by the addition of model T.10/30. All previous models of receivers have been discontinued, and one new model is being marketed, in table and console types. These are known as the 7-5-8, the figures representing seven tuned circuits, five valves and eight separate functions. In addition, a novel form of tuning dial is employed in which the colour of the illumination changes for each waveband and only the names of the stations on the appropriate waveband may be seen.



This is a set of the latest type of Colvern G-type coils, the cores of which are now self-supporting, no wax being used in their assembly.

CLIMAX RADIO ELECTRIC, LTD., Haverstock Works, Parkhill Road, Hampstead, N.W.3. Stand No. 56.

AMONGST the receivers to be seen on this stand is the S5/W, employing the latest Octode frequency changing circuit, variable H.F. pentode, etc. The radiogram BG/S5 employs the latest Collaro Induction motor with fully automatic stop and a pick-up designed to accurately match the remainder of the circuit constants. A 4-valve Class B receiver and a 3-valve S.G. battery receiver in either horizontal or upright cabinet are also included in the range.

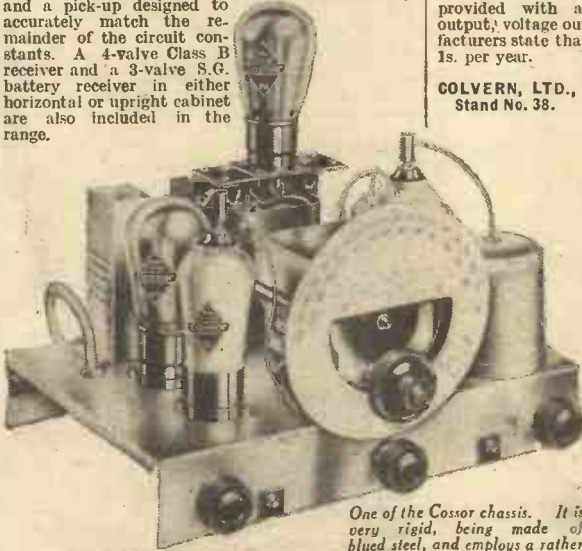

One of the Cossor chassis. It is very rigid, being made of blue steel, and employs a rather unusual form of mounting for the rectifying valve.

noise and interference between stations. Fully delayed A.V.C. (amplified) will also be featured. In addition, the well-known power units, in some of which provision for trickle-charging is made will also be seen. Each of the new Ekco units is provided with adjustable tappings for current output, voltage output and S.G. supply. The manufacturers state that running costs are approximately 1s. per year.

COLVERN, LTD., Mawneys Road, Romford, Essex. Stand No. 38.

VARIOUS types of iron-core (Ferrocarb) coil will be seen on this stand, and it will be noticed that the method of assembling the bakelite casing on these coils has been modified and is now practically perfect. The coils themselves are still designed to have the same characteristics and it is only in the mouldings that the modifications have been made and the new cases provide greater mechanical strength and durability. A coil for every purpose may be seen here.

CONCORDIA ELECTRIC WIRE CO., LTD., New Sawley, near Manchester. Stand No. 238.

CONSOLIDATED RADIO CO., LTD., Warple Way, Acton, London, W.3. Stand No. 20.

THE "Ranger" series of receivers will be seen on this stand, and they cover transportable, and table types of receivers designed for battery

E. K. COLE, LTD., Ekco Works, Southend-on-Sea. Stand No. 72.

THE popular bakelite-cased receivers will form a wonderful setting on this stand, and the extremely modern design of some of the cabinets will strike a new note. The modification of the tuning scale which Messrs. Ekco have introduced will go a long way to popularising their receivers owing to the simplification of tuning which is provided. Among the new circuit features incorporated in the receivers may be mentioned the station pre-selector and noise suppressor which enables the super-heterodyne circuit to be rendered insensitive only to a pre-selected number of high-quality stations and at the same time entirely suppresses all

and mains operation. There is a screen-grid four-battery-operated at £8 10s. 6d.; an All-wave Universal Mains Band-pass four at 11 guineas; a de luxe battery superhet at



The large and easily-read tuning dial is an interesting feature of this Ekco consolette.



The "No-Mast" aerial which has become so popular since its recent introduction.

18 guineas, and other similar types of apparatus. Full vision scales are fitted to all the receivers and the circuit details are fully modern and will be found to satisfy all modern requirements.

COSSOR, LTD., Cossor Works, Highbury Grove, London, N.5. Stand No. 73.

IN addition to the exhaustive range of wireless valves some other interesting equipment will be seen here. Cathode ray tubes and associated apparatus; neon tuning devices; complete receivers and kit-sets will share a place on the stand. The popular Melody Maker Kit will again be seen, and this incorporates the screened H.F. pentode in A.C. models together with an all-metal chassis ready drilled and all nuts bolts and screws supplied ready for assembly.

DALLAS AND SONS, LTD., 6-10, Betterton Street, London, W.C. Stand No. 112.

AS wholesalers a representative selection of commercial apparatus will be on show at this stand.



A console radiogram from the extensive Cossor range of 1935 receivers.

DARWINS, LTD., Fitzwilliam Works, Sheffield. Stand No. 40.

MAGNETS for all purposes are manufactured by Messrs. Darwins and consequently this stand will be devoted to an exhibition of this type of article.

DE LA RUE CO., LTD., Shern Hall Street, Wattham-stow. Stand No. 5.



Another Ekco set of attractive and unusual design.

Practical Wireless GUIDE TO THE SHOW



The well-made public address "mixer" which has been introduced by Messrs. R. H. Dent, makers of the "Ardente" deaf-aid devices.

DENT, R. H. (ARDEnte), 300, Oxford Street, London, W.1. Stand No. 45.

SPECIAL apparatus for the use of deaf persons will be the principal feature on this stand, and such items as microphones, loud-speakers and cinema apparatus to enable deaf persons to hear the performances will also be exhibited. Some Public Address amplifiers will also be shown in types ranging from £24 to £35, as well as a special Mixing Unit for use with the amplifiers.

DEW AND CO., A. J., LTD., Rathbone Place, Oxford Street, London, W.1. Stand No. T22.

AS wholesale suppliers, Messrs. Dew will have on show receivers and components of every description, and by nearly all the well-known manufacturer.

DIBBEM, LTD., 34, Carlton Crescent, Southampton. Stand No. T21.

AS factors, this firm will confine its exhibits to items selected from various sources.

DIGGLE, A., CO., Reliance Works, Jane Street, Rochdale, Lancs. Stand No. 13.

CHARGING Plant will form the basis of this firm's exhibit, and various instruments from £33 will be shown. These items are designed to operate in a most efficient manner, and are low in running costs and easy of maintenance. They are obtainable on hire-purchase terms.

DUBILIER CONDENSER CO. (1925), LTD., Ducon Works, Victoria Road, North Acton, London, W.3. Stand No. 96.

AS manufacturers of condensers, this firm will obviously devote its exhibits to various types of capacitors. From the minute mica condenser, no larger than a penny, to the large transmitting condensers which are used in commercial stations, there is practically no type of condenser which Messrs. Dubilier do not make. Among the new items will be seen some novel electrolytics in metal cases, where the polarity may be reversed without damage. A "block" type of electrolytic in metal case will also be seen. Mica, paper, and dry electrolytic condensers are also on view in

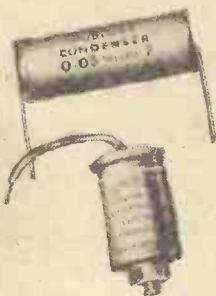
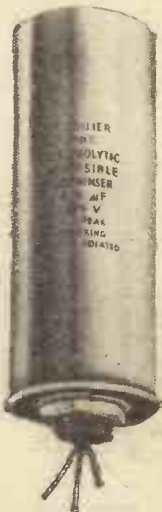

A variety of the well-known Dubilier electrolytic and tubular condensers.

various types and sizes, whilst resistances, anti-interference devices, and static condensers will also be included on the stand.

DULCETTO-POLYPHON, LTD., 2-3, Newman Street, Oxford Street, London, W.1. Stand No. T16.

MESSRS. DULCETTO intend to give a general wholesale display of most of the manufacturers exhibiting. All provincial representatives will be in attendance, and special facilities for trade customers to review the exhibition in miniature, and under comfortable conditions, will be provided.

DYSON AND CO., J., LTD., 5, Godwin Street, Bradford. Stand No. T4.

THE principal exhibits on this stand will be the range of accessories and receivers for which they are wholesalers. In addition, there will be a number of H.T. units, transformers, chokes, and rectifiers of which they are the makers.

EARL MANUFACTURING CO., LTD., Avenue Works, Hanover Park, London, S.E.15. Stand No. 240.

A WIDE range of the well-known Earl reproducers will be shown, and ample technical details regarding these will be available to the intending purchaser.

EASTICK, J. J. AND SONS, 118, Bunhill Row, E.C. Stand No. T23.

A SELECTION from commercial ranges will form the exhibit of this firm of wholesalers.

EAST LONDON RUBBER COMPANY, LTD., 29, Great Eastern Street, London, E.C. Stand No. T18.

AS wholesalers, this firm will confine its exhibits to a representative selection of commercial products.

ECONASIGN CO., LTD., 92, Victoria Street, London, S.W.1. Stand No. 227.

THE exhibits on this stand will be of interest particularly to the wireless retailer, and will not be planned for the amateur.

EDGE RADIO, LTD., Dolly Blue Works, Raphael Street, Bolton. Stand No. 91.

EDISON SWAN ELECTRIC CO., LTD., 155, Charing Cross Road, London, W.C.2. Stand Nos. 18 and 58.

AS in previous years, this firm will be showing a range of the famous R.K. loud-speakers, the B.T.H. Needle Armature Pick-Up and Tone-Arm, at 40s., the B.T.H. Minor Pick-Up and Tone-Arm, and the full range of Mazda valves. A special display will be made of the Senior R.K. speakers in both A.C. and D.C. types, the prices of the two being, £7 15s. and £5 17s. 6d., respectively.

ELDECO RADIO, LTD., 62, Conduit Street, London, W.1. Stand No. 93.

AMONG the receivers to be seen on this stand, will be some radio-gramophones, incorporating the Stenode principle. In addition, a 5-valve battery superhet, incorporating a quiescent output stage will attract attention. The largest model, a 9-valve radiogram, with automatic record changer, incorporates every modern refinement, including silent and visual tuning. The output is 8 watts, obtained from a powerful push-pull stage.

ELECTRO DYNAMIC CONSTRUCTION CO., Devonshire Grove, S.E. Stand No. 117.

ON this stand will be seen the well-known Electro Dynamic Interference free-rotary converter, and other types of anode converter and alternator. In addition, a new line in the form of a petrol-driven alternator, consisting of a neat and compact self-contained petrol engine, tank and silencer coupled to a self-exciting alternator will be seen.

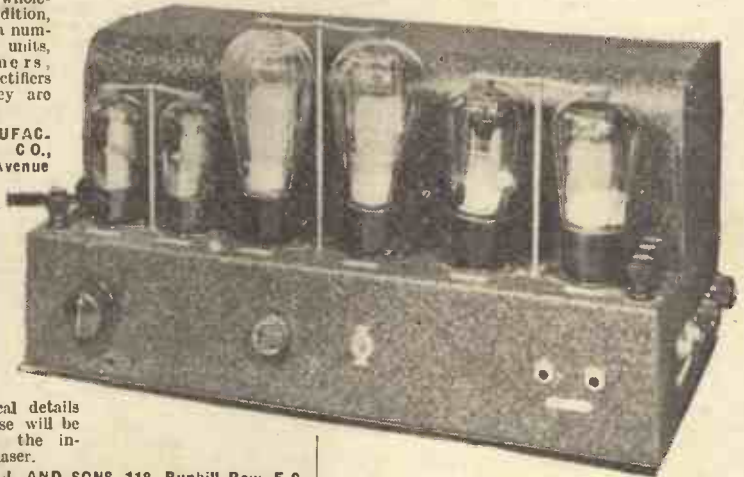

The power amplifier, intended for public-address work, shown above is being exhibited by the "Ardente" people.

ENSIGN, LTD., Ensign House, 88-89, High Holborn, London, W.C.1. Stand No. T5.

AS wholesalers, this firm will devote its exhibits to a representative collection of receivers and accessories chosen to provide dealers and others with a combined selection arranged under one group.



The Beethoven S.G.4 Major Portable Model P.85.

Practical Wireless GUIDE TO THE SHOW

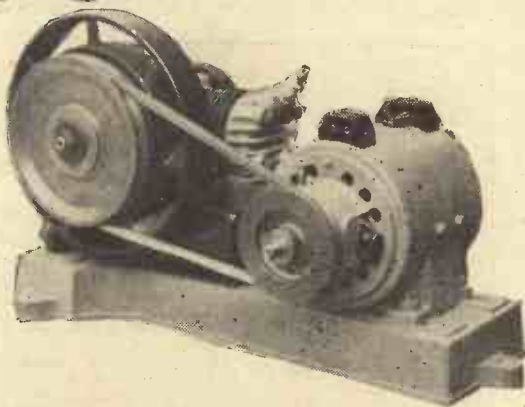

A petrol-driven battery-charging plant made by the Electro Dynamic Construction Co.

EVERETT, EDGUMBE AND CO., Colindale Works, Hendon, London, N.W.9. Stand No. 212.

THIS firm is well known as manufacturers of high-grade testing and measuring instruments, and this year they have added to their range by taking over the Radiolab products. Thus the stand will be devoted to an exhibition of instruments suitable for all testing purposes, and will range from midjet meters suitable for panel-mounting purposes to large apparatus suitable for laboratory use.

THE EVER READY CO. (GT. BRITAIN), LTD. Hercules Place, Holloway, London, N.7. Stand No. 83.

THE whole Ever Ready range of over sixty different types of high tension and grid bias batteries will be featured on this stand. This range permits the selection of the exact battery and voltage for every requirement. Ever Ready batteries are contained in dust—and short-circuit proof covers.

The Ever Ready high tension batteries are divided into eight groups:—The Winner series (in dark blue board containers); The Popular series (in brown containers); The Popular Portable series (also in brown leather board containers); The Popular "Power" series (in brown leather board containers); The Ever Ready "Standard" series (in blue containers); The Ever Ready Power series (in blue containers); The High Power "60" battery (in blue and orange leather board containers), and Super Capacity batteries.

A range of Ever Ready and Winner grid-bias batteries will also be shown. These have a voltage range of 6 to 22½ volts.

Another feature of the display on this stand will be the Ever Ready accumulators which have been a speciality of the firm for the past 30 years.

ELECTRICO, 97, George Street, Croydon. Stand No. 246.

FERRANTI, LTD., Hollinwood, Lancashire. Stand No. 70.

IN addition to the extensive range of high-class radio receivers and gramophones, a number of small components will be seen on Messrs. Ferranti's stand. These will include transformers (audio and output), chokes, condensers, resistances, potentiometers, valves, and various types of multi-range testing instruments. For the first time a Universal receiver will also be seen on this stand, and this incorporates five valves and a barretter, one of the valves being a heptode. No gramophone pick-up connection is provided in this particular receiver.



Some new Formo lines: on the left is an iron-core coil; above are some screened tubular paper condensers for easy mounting, and on the right is a cleverly-designed single tuning condenser with attractive scale.

FILM INDUSTRIES, LTD., 60, Paddington Street, London, W.1. Stand No. 207.

PUBLIC address loud-speakers and allied equipment will be featured on this stand. The speakers will be of several types, all of which are fitted with horns, generally of the exponential pattern. In each case the units are of the moving-coil type, and are fitted with cobalt-steel permanent magnets. Another interesting line is a new moving-coil microphone specially designed for P.A. work. A third item which is sure to have a wide appeal is the F.I. Junior Address Equipment, which is supplied complete with a small microphone, gramophone turntable, and power amplifier, the whole being accommodated in a stout wooden container which is readily transportable.

FLINDERS (WHOLESALE), LTD., Shaftesbury House, Colchester. Stand T10.

SELECTED items from various ranges will be displayed by this firm of wholesalers.

FULLER ACCUMULATOR CO. (1926), LTD., Woodland Works, Chadwell Heath, Essex. Stand No. 124.

IN addition to the already popular accumulators manufactured by this firm will be seen a new high tension accumulator, type S/DMHG, which will be similar in size and voltage to their type DMHG, but will have raised intercell connectors protected by a grease barrier, which not only prevents corrosion and cell-to-cell leakage, but also enables intermediate tappings to be taken by means of the usual type of wander plug. A new range of accumulators, known as "Standard de Luxe" plate types, will also be seen. The H.T. batteries will be found to have been modified in several respects and now bear identifications consisting of coloured circles. Thus the Green Circle batteries take the place of the previous "Sparta" batteries, whilst the Blue Circle batteries take the place of "Super" batteries. Price modifications and size adjustments have also been made in these batteries, while one or two of the smaller batteries have been completely discontinued.

GARRARD ENGINEERING AND MANUFACTURING CO., LTD., Swindon, Wilts. Stand No. 54.

A FEW items in the vast Garrard range will include a Universal Gramophone Motor, designed for operation from A.C. or D.C. mains. This is fitted with speed regulator, automatic stop, etc. A new radiogram. unit will also be seen, in which the over-



all dimensions have been reduced to enable a complete unit to be included in a smaller cabinet than was hitherto possible. This is complete with pick-up, etc. The Garrard Pick-up, Volume-control, and Record Changing Units will also be exhibited.

GENERAL ELECTRIC CO., LTD., Magnet House, Kingsway, W.C.2. Stands Nos. 34, 66 and 225.

THERE are two battery-operated receivers figuring in this season's programme. One of these is called the "Compact 3," a powerful and well-built three-valve set in a handsome bakelite cabinet, which houses a moving-coil speaker as well as the accumulator and battery. It has single-tuning control, an illuminated scale, and separate selectivity and volume controls. The other battery set, which has "Class B" output, is a four-valver with the power of a mains receiver, giving a wide range of stations with exceptional quality.

GEORGE NEWNES, LTD., 8-11, Southampton Street, Strand, London, W.C.2 (see Newnes, Ltd., George).

GILBERT & CO., LTD., 73, Arundel Street, Sheffield. Stand No. T9.

A SELECTION of Trade items will form the basis of this exhibit.

GOODMAN, J., 28-30, Drysdale Street, London, N.1. Stand No. 217.

AT the time of going to press no details have been released concerning this exhibit.

GOODMANS (CLERKENWELL), LTD., Turnmill Street, Clerkenwell, London, E.C.1. Stand No. 125.

LOUD-SPEAKERS will form nearly the whole of the display on this stand, no less than seven entirely different models being exhibited. These

will range from a 25-watt public address instrument with 13in. cone to a truly midjet model—the P.M.6—which is only 6½in. diameter and costs 27s. 6d. The other models to be shown are of various sizes and power-handling capacity, and the range includes both permanent-magnet and energized types. Exhibits other than speakers will include displays of coil winding, turned parts, transformers, chokes, etc.



An energized moving-coil speaker from the wide range being shown by Goodmans (Clerkenwell), Ltd.

GRAHAM FARISH, LTD., 153, Masons Hill, Bromley, Kent. Stand No. 59.

ON this stand will be seen many small items of particular appeal to the listener. Such items as fixed condensers, chokes, tuning condensers, resistances, valveholders, earth and aerial accessories, and transformers all find a place in the exhibits, and, in addition, some of the Formo 1935 components will be seen.

GRAMOPHONE CO. (H.M.V.), LTD., 98-108, Clerkenwell Road, London, E.C. Stands Nos. 33 and 61.

ON the stands of this company will be found eleven different types of receiver, ranging from small battery models to elaborate radio-gramophones with automatic record-changing devices.

The stands themselves should be one of the sensations of Olympia, for they will present the instruments in a way which has never been seen at any exhibition before.

Special apparatus from the "His Master's Voice" research laboratories and factories will also illustrate the painstaking care that is taken in the construction of modern radio instruments. A life-testing machine will demonstrate how the mechanical parts of instruments are tested for wear, whilst



Another Formo component, a double-gang tuning condenser, which is fitted with a new and unusual form of tuning dial.

Practical Wireless GUIDE TO THE SHOW



The "Halcyon" receiver shown on the left is a good example of the present tendency to combine the radio set with a useful piece of furniture. The instrument on the right is an attractive "Halcyon" console model.



transformers and coils will be seen in humidity chambers which reproduce any temperature from the Arctic to the Tropics. Another ingenious apparatus to be shown is an "artificial train," which subjects apparatus to severe shaking and ensures that production instruments can withstand the roughest handling.

Fluid-light tuning is incorporated in some of the receivers, the super-heterodyne circuit will be used in most of the receivers, and every model will include a moving-coil loud-speaker. Among the accessories will be the H.M.V. Pick-up, Volume Control and connecting leads which costs 32s. 6d., the Model 178 loud-speaker and the Model 180 speaker.

GROSVENOR ELECTRIC BATTERIES, LTD., 2-3, White Street, Moorgate, London, E.C.2. Stand No. 104.

In addition to batteries of all types, some novel electric torches will be seen on this stand. The batteries are made in various sizes, and a number of special batteries are designed for special commercial receivers. In addition, smaller batteries for torches, etc., will be found. Some new accumulators, with both jelly and free acid will also be seen on the stand this year, and some specially developed cells for medical apparatus and similar articles will be shown.

HACKER H., AND SONS, Perfecta Works, Ray Lea Road, Maidenhead. Stand No. 116.

High standard "hand-made" quality receivers, will again be seen on this stand, and again the utilization of straight circuits employing several tuned stages with iron-core coils will be seen in preference to the superhet type of circuit. In addition, a novel variable neon searchlight tuner will cause interest. An all-wave radio-gramophone will also prove an attraction.

HALCYON RADIO, LTD., 83a, Valetta Road, Acton, London, W.3. Stand No. 36.

This well-known firm of receiver manufacturers are showing a comprehensive range of modern sets, which include both battery and mains-operated types. The battery sets are of three- and four-valve types, and are of particularly up-to-date design. A 9-stage 7-valve superheterodyne for A.C. operation will be a particular attraction embodying, as it does, such features as automatic volume control, visual tuning, tone control, provision for extension speakers, etc. Another extremely interesting line is a superheterodyne for either A.C. or D.C. operation. This set has seven tuned stages and a similar specification to that of the A.C. model above referred to. Both models are available in either table or console cabinets, the respective prices for the A.C. model being 10 guineas and 22 guineas.

HARNER & SIMMONS, LTD., 223, Hoe Street, Walthamstow, E.17. Stand No. 209.

No details are available at the time of going to press concerning this firm's exhibits.

HARTLEY TURNER RADIO, LTD., Thornbury Road, Isleworth, Middlesex. Stand No. 119.

High-quality apparatus will be seen here, including receivers, kit sets, amp-

lifiers, and loud-speakers. The latter are high-class pieces of apparatus costing £7 7s. for a D.C. model and £9 9s. for an A.C. model with 40-watt rectifier for the field supply. In addition some small accessories, including the Hartley-Turner A.F. Coupling Unit, will be seen. This is available for use with triodes used singly or in push-pull, and is priced 30s. Power and smoothing chokes will also be on show.

HAYNES RADIO, 57, Hatton Garden, E.C.1. Stand No. 9.

HEAYBERD AND CO., F. C., 10, Finsbury Street, London, E.C.2. Stand No. 24.

A comprehensive range of mains apparatus and equipment will be exhibited on this stand. The range includes mains transformers, chokes, and condensers suitable for inclusion in a home-made unit or receiver, and the complete equipment consists of chargers, etc. The chargers are suitable for either home or garage use and provide charging currents from .5 amp. upwards. An interesting addition to the range of mains accessories is the auto-transformers for stepping up or down the mains voltage to suit various types of apparatus which is now obtainable.

HELLESENS, LTD., Hellesen Works, Morden Road, South Wimbledon, S.W.19. Stand No. 78.

A most comprehensive range of batteries will be seen on this stand, and they are obtainable for flash lamps, etc. The H.T. batteries are manufactured in many types for normal use as well as for special commercial receivers, where the dimensions have been modified in order to accommodate a certain type of battery. Grid-bias batteries and cycle-lamp batteries will also be included in the exhibits.

HENLEY'S TELEGRAPH WORKS CO., W. T., LTD., Holborn Viaduct, London, E.C.1. Stand No. 109.

The display on this stand will comprise two ranges of the many products of the firm—namely, electric soldering irons and radio wires and cables. The irons will be found in several styles, suitable for ordinary domestic purposes or for factory use. Another interesting exhibit is Solon resin-cored solder, which consists of a tube of alloy (lead and tin in equal parts) with a pure resin filling. All types of wire will also be seen.

THE HIGH VACUUM VALVE CO., LTD., 113-117 Farringdon Road, London, E.C.1. Stand No. 27.

A complete range of battery and mains valves will be seen here. In addition to existing types the new A.C. mains valves will be on view for

the first time and these include H.F. pentodes, a General Purpose Triode and a 3½ watt output pentode. A full-wave rectifier will also be shown and all these valves are characterized by the high performance and low price, the output pentode, for instance, costing only 10s. 6d.

HENDERSON'S WHOLESALE ELECTRICAL AND RADIO, LTD., Queen's Rd., Brighton. Stand No. T2.

HILLMAN BROS., 123, Albion Street, Leeds. Stand No. T3.

HOBDDAY BROS., LTD., Great Eastern Street, London, E.C.2. Stand No. T17.

RECEIVERS and components by all the leading manufacturers will be displayed on this stand.

ILIFFE AND SONS, LTD., Dorset House, Stamford Street, S.E. Stand No. 6.

As publishers of various books, the main items on this stand will consist of various specimens selected from their range.

ITONIA, LTD., Itonia House, 59, City Road, London, W.C.1. Stand No. T6.

As in previous years, the exhibits on this stand will consist of receivers manufactured by those firms who are signatories to the F.T.A.



The HiVac valve shown above has only just been released—it is the mains-operated H.F. pentode.



Messrs. Heayberd are again showing a comprehensive range of mains transformers specially designed for the home constructor, and a few of these are shown above.

Our NEW Sixpenny
MONTHLY
MAGAZINE
"Practical Television"

may be purchased from Stand
No. 8, Ground Floor.

- **NEW MAGNET PROVIDES TWICE THE VOLUME.**
An extraordinary new magnetic material, exclusive to W.B. Stentorian Speakers, gives double the strength of an ordinary magnet at the same cost.
- **NEW SPEECH COIL BRINGS AMAZING REALISM.**
Previously used only on W.B. public address models, the Whiteley Speech Coil becomes usable on Stentorians because of the new magnet's enormous strength. It gives crisper attack and better definition.
- **INNUMERABLE ADDED REFINEMENTS COMPLETE A BRILLIANT DESIGN.**
Improved "Microlode" feature gives accurate matching to any output as principal speaker or extension. Complete dust protection at back, front, and sides of air gap. Oversize cone on Senior Model and many other improvements in detail.

AN AMAZING ADVANCE



WE ARE EXHIBITING AT



Stentorian Senior (PMS1) ...	42/-
Stentorian Standard (PMS2) ...	32/6
Stentorian Baby (PMS6) ...	22/6

Write for the new W.B. Stentorian leaflet.

See them at Stand No. 98

STENTORIAN

A W.B. Speaker is specified exclusively or as author's first choice in every prominent journal's "Star" Exhibition receiver

WHITELEY ELECTRICAL RADIO CO., LTD. (Dept. D.), Radio Works, Mansfield, Notts.
Sole Agents in Scotland: RADIOVISION, Ltd., 233, St. Vincent St., Glasgow, C.2. Sole Agents in I.F.S.: KELLY & SHIEL, Ltd., 47, Fleet St., Dublin.

TELSEN COMPONENTS

specified
for the
'Armada 3'

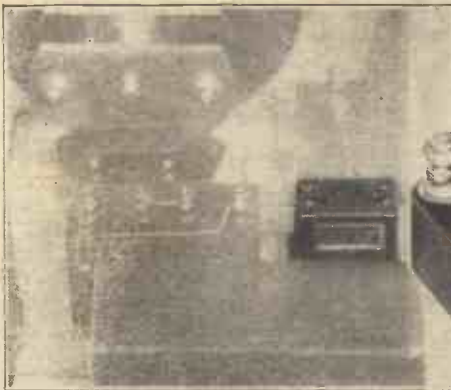

View of the mains output section, showing the position of the Telsens L.F. Smoothing Choke.



View of set showing the position of the Telsens Standard and Binocular Screened H.F. Chokes.



TELSEN L.F. SMOOTHING CHOKE

Fulfills every high-efficiency requirement when used in the rectified mains output circuit of a receiver. The maximum permissible current is 50 m.a., D.C. resistance 1,000 ohms and inductance is 28 henries at 25 m.a. Presented in an attractive black bakelite moulded case, with easily accessible terminals and fixing holes.

12/6

TELSEN STANDARD SCREENED H.F. CHOKE

For wavelengths between 100 and 2,000 metres, such as are covered by the ordinary radio receiver. Carefully designed and constructed in accordance with the latest technique, it provides consistently high efficiency over the whole of its wave range, interaction with other components being eliminated by the earthed metal screen.

3/6

TELSEN SCREENED BINOCULAR H.F. CHOKE

Designed and constructed to ensure consistently high efficiency over the entire waveband for which it is intended, viz., 10 to 2,000 metres. Small and compact, it occupies the minimum of baseboard space, while the metal screen, which is connected to an earthing terminal, entirely prevents interaction with other components.

5/6

VISIT STANDS NOS. 75 AND 101 AT RADIOLYMPIA

Announcement of THE TELSEN ELECTRIC COMPANY LIMITED, ASTON, BIRMINGHAM

Practical Wireless GUIDE TO THE SHOW

JACKSON BROS. (LONDON), LTD., 72, St. Thomas Street, London Bridge, S.E.1. Stand No. 114.

GANGED condensers, disc drives, and complete tuning packs will form the main attractions on this stand. These items need no introduction

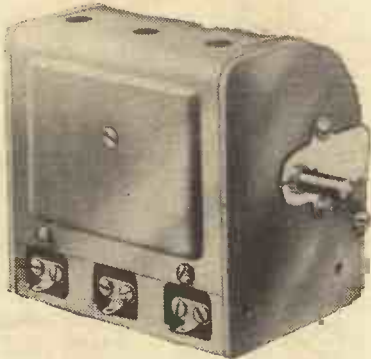

The latest type of Jackson Bros. all-enclosed three-gang condenser.

to the home-constructor as they have already been extensively used by us in the construction of some of our receivers. Small modifications in design and alterations in the prices of some of the components will add interest to the exhibits.

JOHNSON TALKING MACHINE CO., 96, Clerkenwell Road, London, E.C. Stand T13.

A SELECTION of various commercial products will be seen on this wholesale stand, and will include some of the highlights from the exhibition.

KINGSWAY RADIO, LTD., 3-9, Dane Street, High Holborn, W.C.1. Stand No. 44.

THIS firm will exhibit all types of transformers as well as a comprehensive range of L.F. transformers, chokes, tuning coils, microphone transformers, mains transformers, and other components. As sole licensees for the manufacture and sale of the "Simpson Electric Turntable," these will also appear on the stand.

The "Bowl" loud-speakers, containing a specially designed 35 per cent. Cobalt steel magnet, and finished in pastel shades to customers' requirements, will also be shown. About eight shades will be on the market.



A particularly handsome radiogramophone which is being shown by Kolster Brandes.

The Simpsons Electric Turntable will again be shown on this stand, and the price has now been fixed at two guineas, in either 10 or 12in. sizes. The turntable is suitable for 200-250 volts or 100-150 volts 50-cycle mains.

KOLSTER BRANDES, LTD., Cray Works, Sidcup Kent. Stand No. 84.

THE design of the cabinets used for the K.B. receivers will prove a great attraction, and the various circuit details will interest many. The Selectrola, a 7-valve superhet at 19 guineas is a very attractive model, and the 8-valve A.C. radiogramophone is a luxury instrument, in which the cabinet has provision for storing records. Two output pentodes in push-pull deliver ample volume for dancing in a small hall.



This illustration is of the Lampex "Unifoc" receiver. Above it is the Lampex "Unifive" de luxe radiogram; a very attractive console receiver of the de luxe type.

LAMPEx RADIO AND ELECTRIC CO., Phantom House, Brewery Road, London, N.7. Stand No. 22.

VARIOUS receivers ranging from a straight-three battery set to a Universal Radiogram will be seen here. The latter employs a Universal A.C./D.C. motor, pick-up and dual balanced mains-energized loud-speaker, and is housed in a full-size walnut radiogram cabinet inlaid with bird's-eye maple.

LECTROLINX, LTD., 79a, Rochester Row, London, S.W.1. Stand No. 218.

THIS firm will again be showing a variety of wireless connecting devices which are well known to all readers under the trade name of Clix. Chassis-mounting valve-holders of every type, including Continental and American patterns, and those suitable for use with the new 9-pin valves. There will also be a thimble connector for use with the

recently introduced H.F. pentodes which have thimble connectors. Terminals, wander plugs, socket connectors, etc., will be shown as last year.

L. E. S. DISTRIBUTORS, LTD., 15-16, Alfred Place, Tottenham Court Road, London, W.C.1. Stand No. T25.

A REPRESENTATIVE range of new season's receivers and components will be seen on this stand, Messrs. L. E. S. Distributors being wholesalers only.

LISSEN, LTD., Lissenum Works, Isleworth, Middlesex. Stand No. 83.

A COMPREHENSIVE range of battery, A.C. and D.C. mains receivers will be shown by Messrs. Lissen, and these will range in price from £4 10s. to £9 9s. In addition, some interesting Kits of Parts will be on view, including the now famous Sky-scraper series. Also, a complete range of H.T. and G.B. batteries will be seen, together with some L.T. accumulators. Car radio will be represented, and radio enthusiasts should make a point of seeing the excellent Lissen developments in this branch of radio.

LONDON AND PROVINCIAL FACTORS, 146, Theobald's Road, London, W.C.1. Stand No. T.26.

LUGTON AND CO., LTD., 203, Old Street, London, E.C.1. Stand No. T1.

THIS firm supplies at wholesale rates only, and the exhibits on the stand will comprise the popular ranges of receivers by all the well-known makers.

MAINS POWER RADIO, LTD., Broadway Works, Eastern Road, Romford. Stand No. 230.

MAINS Units and apparatus of various kinds will be found on this stand. Units for incorporation in battery-operated receivers and units for the building of complete mains sets will form an attractive display.

MANUFACTURERS ACCESSORIES CO., LTD., 85, Great Eastern Street, London, E.C. Stand No. T.24.

REPRESENTATIVE items from various manufacturers' lines will be seen here.

MARCONIPHONE COMPANY, LTD., 210-212, Tottenham Court Road, London, W.1. Stand No. 76.

EVERY type of receiver, from the simple battery-operated three-valver to the 9-valve super-heterodyne auto-radiogram, may be seen on Stand No. 76. This will probably prove the most comprehensive range of receivers ever exhibited on a single stand, and here will be found a receiver to suit any individual need. In addition, the popular pick-up will also be seen, together with loud-speakers and batteries suitable for the operation of the battery receivers. The Marconiphone receivers present a number of novel features, and such items as tone correction, simplification of control, and clearly-marked tuning scales have received the full attention of the firm's designers, so that no exception can be raised to any detail.



The Lissen B.P. receiver—an attractive little set at a competitive price.

Practical Wireless GUIDE TO THE SHOW



A distinctive note is struck by this latest Marconiphone console receiver. It is a set for the connoisseur.

McMICHAEL RADIO, LTD., Slough, Bucks. Stand No. 60.

THE exhibits on this stand will comprise a still wider range of McMichael complete receivers. The suitcase portable which has been a popular favourite for a number of years will again be in evidence and is this year priced at 15 guineas. Other receivers on show will be a powerful mains superhet at 16 guineas, a twin-speaker superhet (for A.C. mains) at 18 guineas, a mains transportable superhet, at 16 guineas, and the "Duplex" battery transportable, which has Class B output, at 14 guineas. The twin-speaker superhet is a very advanced model employing fully delayed automatic volume control in conjunction with an inter-station noise suppressor and automatic tone control. The mains transportable is capable of supplying an undistorted output up to 3 watts.

MICHELL AND BROWN, 153, Turney Road, Dulwich, London, S.E.21. Stand No. 210.

THE item of outstanding interest on this stand will be a new loud-speaker to be known as the "Mastersinger." This is based upon a novel idea in sound-projection which has been found to produce excellent results. The speaker is mounted close to the ceiling, the sound being projected upwards and then reflected down again. An electric-light shade is suspended below the speaker, and this helps to produce the combined speaker and light shade. The price of the standard model "Mastersinger" speaker has been fixed at 12 guineas, including shade, whilst a senior model is available at 25 guineas.

MULLARD WIRELESS SERVICE CO., LTD., Mullard House, Charing Cross Road, London, W.C.2. Stand No. 65.

YEAR by year the radio enthusiast and the professional radio engineer expect to see on the stand of the Mullard Wireless Service Co. something which represents a notable, if not startling, advance in radio valve technique. They have never been disappointed, and they will certainly not be disappointed this year.

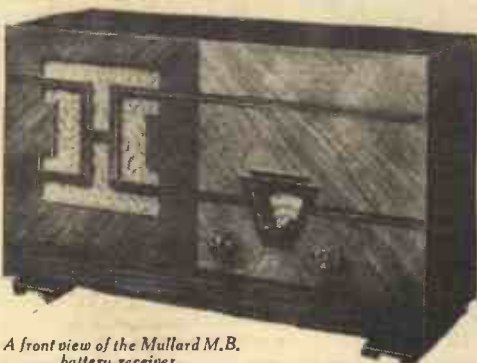

A front view of the Mullard M.B. battery receiver.



An old favourite in its latest form, the McMichael "Duplex" portable.



This is another smart receiver which is being exhibited by McMichael. It is an A.C. superhet.

MILNES RADIO CO., LTD., Victoria Works, Bingley, Yorks. Stand No. 249.

AS manufacturers of the ingenious H.T. supply unit, which, as our readers are aware, may be charged from a 6-volt accumulator, this item will prove the centre-piece of the



A useful piece of apparatus produced by Multitone Electric.

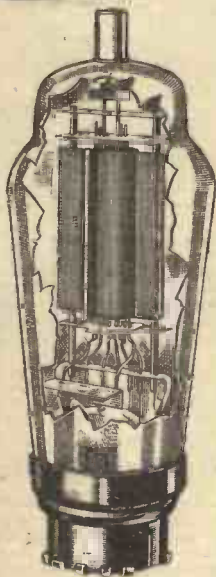

The latest Marconiphone pick-up, which is noted for its excellent response.

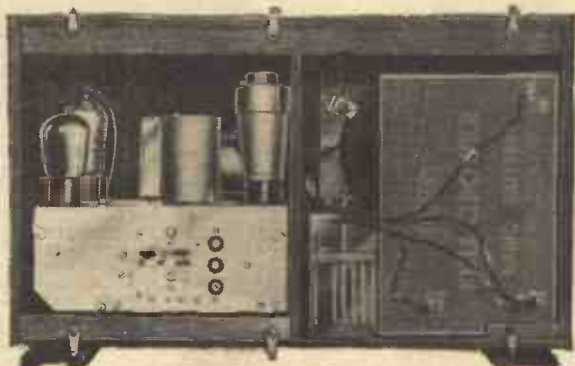

One of the new Mullard universal valves, which is fitted with a new type of base. This picture shows the neat internal arrangement of the Mullard M.B. 3 receiver.

Practical Wireless GUIDE TO THE SHOW

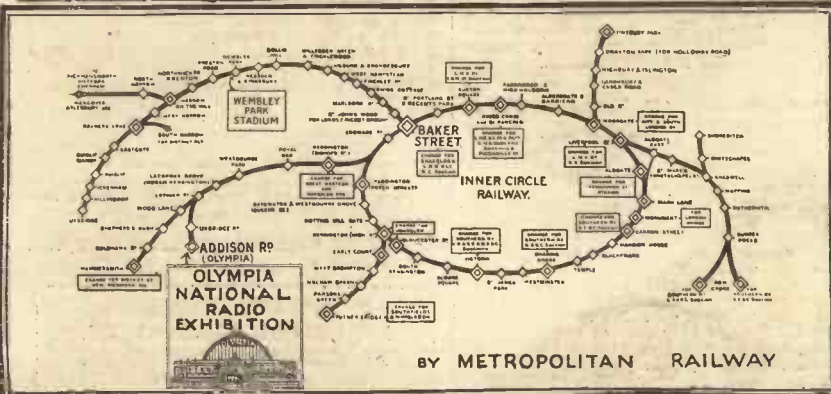
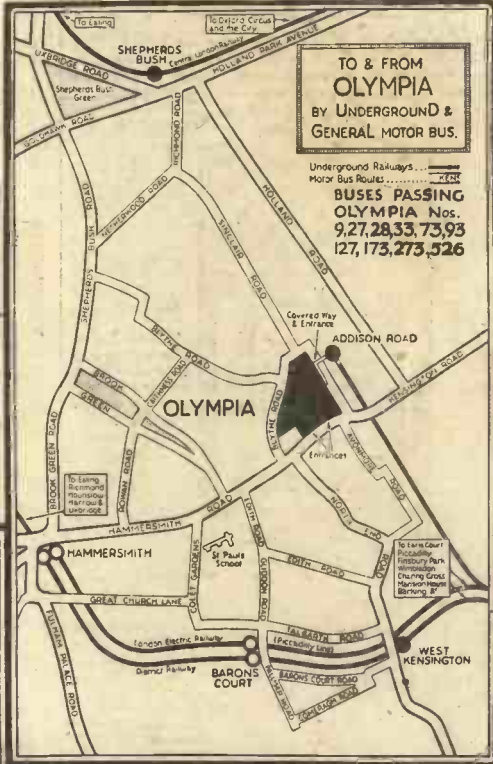

NEW LONDON ELECTRON WORKS, LTD., East Ham, London. Stand No. 39.
BESIDES showing the lines which were sold last year the New London Electron Works will have on view a new aerial which has recently been patented, and which is to be sold as the "Electron Globe Aerial." Details of this are not available at the time of going to press.

NEWNES, GEO., LTD., 8-11, Southampton Street, W.C.2. Stand No. 8.
 Largest publishers of wireless books and publications in the world. Publishers of "The Radio Times," and "The Listener" (for the B.B.C.), "Practical Television," "Practical Mechanics," "Practical Motorist," "Practical Wireless," the leading weekly journal for home-constructors, and "Radio Magazine"—the listeners' pictorial monthly. A full range of blue-prints for "Practical Wireless" receivers will be on sale, and practical hand-books on every branch of radio. Other volumes on show will include "The Wireless Constructors' Encyclopaedia," "Encyclopaedia of Popular Mechanics."

In every class of valve—battery-operated, A.C. Mains and "Universal"—the Mullard Wireless Service Co. offer types which are certain to have a

pronounced influence on set design during the coming season, and to result in enhanced efficiency of reception.

Among the new battery valves will be found the new 2-volt H.F. pentodes, of variable-mu and ordinary characteristics. In addition, a double-diode-triode will be seen, together with output pentodes and general-purpose valves such as the ever-popular P.M.2.D.X. The P.M.2.B.A.—a Class B valve designed for operation with a small negative bias—will also attract attention.

In the mains class will be seen the new octode, double-diode-triode, separate double-diode, H.F. pentodes and output pentodes, together with their counterparts in the universal type of valve.

An addition to the Mullard range will be the inclusion of a complete receiver, known as the M.B.3. This is a battery receiver employing three pentodes, and is completely self-contained.

MULTITONE ELECTRIC CO., LTD., 95-98, White Lion Street, Islington, London, N.1. Stand No. 51.

TRANSFORMERS designed to permit of tone control will be seen here. In addition, a special tone control transformer for use in Q.P.P. circuits has been developed and will be on view. A Class B Driver transformer and output chokes, together with a Class B converter will be exhibited, and a Deaf Aid Set which has been adopted at the leading private school for deaf children will prove of interest.

NATIONAL ACCUMULATOR CO., LTD., 50, Grosvenor Gardens, S.W. Stand No. 226.

NATIONAL RADIO SERVICE CO., 15-16, Alfred Place, Tottenham Court Road, London, W.C.1. Stand No. 215.

THIS firm specializes in the repair and servicing of receivers and components, and they will have a special display featuring the repairs which they are able to effect at attractive prices. Additionally, they will have on show a motor-boat radio kit.

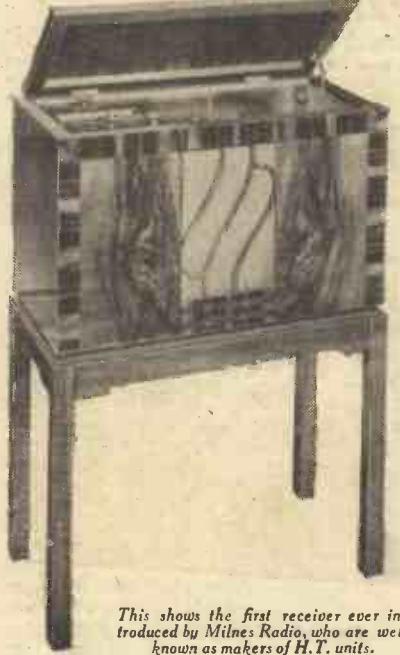

This shows the first receiver ever introduced by Milnes Radio, who are well known as makers of H.T. units.



The Milnes universal permanent-magnet loud-speaker.

Practical Wireless GUIDE TO THE SHOW

NOVO RADIO-ELECTRIC, LTD., Novo House, 34, Lovaine Place, Newcastle-on-Tyne. Stand No. 17.

THE items displayed on this stand will include the "Northumbria Five-Six," a four-pentode set built round three iron-core coils of special construction, giving great selectivity without loss of sensitivity or of the quality of reproduction. A feature of the "Northumbria Five-Six" is the



A Novo Radio-Electric receiver which is designed on strictly modern lines.

application of delayed A.V.C. across the two variable-mu H.F. pentode valves by the operation of a separate diode valve resulting in complete elimination of any A.V.C. service trouble. A variable selectivity and tone control, operated from a panel control, enables adjustment to be made to suit individual localities and tastes. A nine-kilocycle frequency separation is guaranteed. The latest type energized moving-coil type speaker is specially matched to the set. Gramophone P.U. and additional speaker connections are provided.

NUVOLION ELECTRICS, LTD., Meredith Works, Park Crescent, London, S.W.4. Stand No. 236.

ON this stand will be seen an oscillographic demonstration of Patent Grid Compensated Relay and Public Address Equipment giving 50-watt output with 5 per cent. distortion from two DA 60 valves, with uniform response to 10,000 cycles per second. Also a 20-watt high-fidelity Public Address loud-speaker. In addition, large distortionless output transformers, and domestic moving-coil loud-speakers, will also be shown.

ORMOND ENGINEERING CO., LTD., Ormond House, Rosebery Avenue, London, E.C.1. Stand No. 100.

ALL the existing lines which have proved so popular in the past will appear on this stand. Tuning dials, condensers, loud-speakers and loud-speaker units, transformers, volume controls, and cone chassis will be seen in a variety of types and ranges.

ORR RADIO LTD., 79a, Parkhurst Road, N.7. Stand No. 64.

OSSICAIDE, LTD., 447, Oxford Street, London, W.1. Stand No. 211.

A REPRESENTATIVE range of amplifiers, microphones, etc., both of the portable and permanent installation models will be on show at this stand. There will also be various types of amplifiers and equipment for use in cinemas, churches, etc., to enable deaf persons to follow the service, etc.

A new and improved model microphone for high-quality reproduction of speech and music has been produced and will be on show at the Exhibition.

There will also be shown a new Universal Amplifier in the portable range, giving an output of 6 watts undistorted speech. The amplifier will work off both A.C. and D.C. mains supplies of 200/250 volts, and should prove very popular with dance bands.

Another new exhibit will be a very small portable and self-contained amplifier designed to aid the deaf and persons hard of hearing. It is a three-stage amplifier employing the new midget valves. Means

are provided for adjusting the frequency response of the amplifier to suit different types of deafness, and also to correct for the differences in acoustic properties of the various situations where the aid may be in use.

PARTRIDGE, WILSON AND CO., LTD., Davenset Works, Evington Valley Road, Leicester. Stand No. 29.

THIS stand will be occupied principally by a variety of battery-charging plants, which are marketed under the trade name of "Davenset."



The "Ossicaide" portable deaf-aid unit.

The units are extremely well made, being steel-constructed and fitted with automatic overload switches. A "Davenset" electric shop window display sign will also be on view, as well as a number of mains transformers and power chokes.

PHILIPS LAMPS, LTD., 145, Charing Cross Road, London, W.C.1. Stand No. 62.

AN extremely wide range of receivers, one of which is suitable for every requirement, will be displayed by Messrs. Philips. Every receiver is an entirely new model, although several of them employ the Philips superinductance principle which was such a popular feature in the last year's sets. Of the eight sets to be shown, four are for A.C. operation, two are universal in regard to their current requirements, whilst two are battery-fed. All except one of the A.C. models employ the superinductance principle, but another A.C. model, and also one of the universal sets, are superheterodynes. The two battery sets have six and five valves respectively, and are priced at 11 and 10 guineas. The mains receivers vary in price from 9 to 23 guineas.



A new Philips radiogram.

PLEW TELEVISION, LTD., Waddon, Croydon. Stand No. 11.

TELEVISION apparatus of various types will be shown by this company, and in addition to a simple model designed to be coupled to an existing radio receiver will be seen a



This console receiver is being produced and shown by Orr Radio.

complete long-range television receiver fitted with microscopic adjustment. Picture reproduction from discs resembling gramophone records, combined with sound reproduction from the same disc, is also a feature of apparatus manufactured by this company, and a model will be seen on the stand.

PORTADYNE RADIO, Gorst Road, North Acton, London, N.W.10. Stand No. 71.

PORTADYNE receivers, which have been so popular for a number of years past will be shown in their latest form. The largest model will be a 6-valve transportable superheterodyne listed at 14½ guineas. This receiver employs a variable-mu pentode signal-frequency amplifier, followed by a frequency changer and I.F. amplifier; a double diode-triode functions as second detector, first I.F. and A.V.C., whilst a power pentode is employed in the output stage. The receiver has an output of 2½ watts, and is fitted with a suppressor switch for quiet A.V.C. Another set of similar up-to-date design, but for battery operation will be shown, as well as four other models, down to a 4-valve battery receiver at 10 guineas.

POWERTONE PRODUCTS, 102, Cromer Street, W.C. Stand No. 15.

**PRACTICAL WIRELESS.
PRACTICAL MECHANICS.
PRACTICAL TELEVISION.
PRACTICAL MOTORIST.**

Published by **GEORGE NEWNES,** Stand No. 8, Ground Floor.

PROVINCIAL INCANDESCENT FITTINGS, CO., LTD., Pitco House, High Street, Manchester. Stand No. 111.

THE popular Pifeo testing instruments will be seen on this stand, and two new models will be seen for the first time. One of these is a deluxe Rotameter, and the other an A.C.-D.C. Radiometer. This latter instrument costs only 12s. 6d.,



The new Plew disc-type television receiver, which has a built-in power amplifier.



Diameter 8½"
Height 8½"
Depth 4½"

The revolutionary "MULTIMU" gives instantaneous matching from 1 to 40,000 ohms. This reproducer is therefore ideal for every purpose—principal or extension instrument; any type of valve or circuit without exception.

The 1935 range of R & A Permanent Magnet and Mains Energised Reproducers includes models from 21/- to 55/-.

Unsurpassed reproduction and fidelity in each class. It will pay you to hear the new R & A models before making a purchase.

Send us a postcard for full details.

OLYMPIA—STAND 53

REPRODUCERS & AMPLIFIERS, LTD.,
WOLVERHAMPTON

"Impedance Tuning" solves this problem—

what is the correct
transformer ratio
to give perfect
reproduction?

R & A "MULTIMU"
gives instantaneous
matching with any
valve or circuit

The R & A Multimu not only sets a higher standard of reproduction, but also instantly solves the 'matching' problem! It is now a matter of ease and precision to accurately match the speech coil impedance with that of any and every known type of output valve, and it can be used with every circuit in present or future use.

Furthermore the 'Multimu' with its entirely new and amazingly efficient magnet system has a sensitivity greater than ordinary P.M. Speakers—it is even more sensitive than the average mains energised speaker.

Get a 'Multimu' Reproducer. Use it as principal speaker, as an extension speaker, or in conjunction with any other speaker. Its use is universal and its performance a revolution in vividness of sound.

42/-

The **R & A**
"MULTIMU"
P.M.M.C. REPRODUCER

Practical Wireless GUIDE TO THE SHOW

and thus enable listeners for a really low price to obtain a test instrument which will measure both D.C. and A.C. supplies. The de luxe Rotameter costs 42s. and is a most elaborate instrument incorporating nine separating test scales, each brought into use by the range switch.



This useful and neat testing instrument is the Pifco "Rotameter."



One of the new Regentone receivers.



Another excellent test meter which is made by Pifco; the "Rotameter."

18s. 6d., and for a 6-cylinder, 24s. 6d.

RADIO SOCIETY OF GREAT BRITAIN, 53, Victoria St., London, S.W.1, Stand No. 204.

A TEX-WATT C.W. and telephony transmitter, a two-valve receiver, a dual-range frequency meter with 100 Kc. Quartz Bar calibration, and a one-valve transmitter will form features on this stand. The exhibits will also include apparatus made

PYE RADIO, LTD., Africa House, Kingsway, London, W.C.2, Stand No. 69.

THIS well-known firm of receiver manufacturers will this year have an even wider and more comprehensive range than heretofore. There are several new models, one of the most interesting of which is the "Cambridge" radiogramophone which is priced at 50 guineas for either A.C. or D.C. use. This price includes an automatic record changer, but either model can be obtained without the changing device, the prices then being 40 guineas and 43 guineas for A.C. and D.C. respectively. There is also an extremely attractive table model superhet fitted with A.V.C., tone control, and a cabinet of very modern and pleasing design. This can be obtained for either battery or mains operation, the prices being 16 guineas and 15 guineas respectively. A particular feature of many of the new Pye receivers is the concealment of the controls, these being placed underneath the hinged lid.

RADIO GRAMOPHONE DEVELOPMENT COMPANY, 18, Frederick Street, Birmingham. Stand No. 74.

RECEIVERS and radiogramophones in the luxury class will be seen on Stand No. 74. Among the larger pieces of apparatus the model 1203 will be found to employ all that modern science has introduced in the musical home-reproducer. A 12-valve superheterodyne forms the basis of the apparatus, and automatic record changing mechanism is fitted. The cabinet work is outstanding for design and workmanship, and the quality and volume of the output leave nothing to be desired.

RADIO INSTRUMENTS, LTD., Purley Way, Croydon, Surrey. Stand No. 80.

RADIO RESISTOR CO., LTD., 1, Golden Square, Piccadilly, London, W.1. Stand No. 14.

ERIE Resistors are the most important of the exhibits on this stand. In addition to the well-known range of rod resistors which have been made for a few years past, there will also be a series

of carbon resistors retailing at 1s. per watt and some well-made wire-wound components with ratings up to 100 watts. Another useful packing for the service man is a set of replacement resistors in various sizes and ratings. There will also be a range of volume controls in all resistance ratings, with and without snap-action switches. The price without switch is 8s. 6d., and with double-pole switch, 5s. A new line will take the form of

by members of the society.

REGENTONE, LTD., Regentone Works, Worton Road, Isleworth, Middlesex. Stand No. 99.

THE main feature of interest on this stand will probably be an entirely new receiver—the AS/35—which, although it employs only four valves, comprises eight stages and the functions of seven valves. The latest types of multiple valves are used throughout, and such features as automatic volume control, noise suppression, a continuously-variable tone control and a "sound reflector" cabinet. A full-vision tuning scale is fitted and this is clearly marked with station names. The price of the new set is 12 guineas.

REPRODUCERS AND AMPLIFIERS, LTD., Frederick Street, Wolverhampton. Stand No. 53.

ONLY two instruments are carried over from last season, the rest being entirely new models. These are the Type 60, a 12in. 4-pole differential armature reproducer retailing at 21s., and the "Multex," an 8in. permanent-magnet moving-coil reproducer which has been considerably improved in performance by fitting an entirely new magnet system, and which has been increased in price from 30s. to 32s. 6d. This instrument is fitted with a transformer offering 30 ratios and is suitable for use with any type of output valve.

The latest, and probably the most interesting, addition to the "R. and A." range is the new "Multimu," in which a new system of "impedance tuning" has been incorporated and which enables instantaneous matching of any impedance between 1 ohm to 40,000 ohms.

An entirely new model is the E.85, which is a mains-energised unit retailing at 27s. 6d. There will also be a new output transformer—the O.P.58—which will produce 58 ratios and is priced at 18s. 6d.



The Pye "Cambridge" receiver, which has concealed tuning controls.

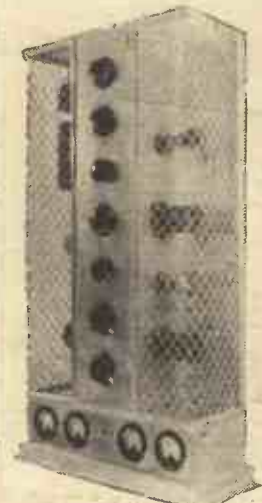

This modern wireless transmitter will be on view on the stand of The Radio Society of Great Britain.



A truly de-luxe receiver by the Radio Gramophone Development Co.

complete suppressor kits for car-radio equipments; a kit for a 4-cylinder car costs



Two new lines by Messrs. Reproducers and Amplifiers; a universal output transformer (left) and the "Multimu" speaker (right). The latter is being used in the "Practical Wireless" "Armada" receiver.



Practical Wireless GUIDE TO THE SHOW

A. RIST (1927), LTD., Wavency Works, Lowestoft. Stand No. 233.

THE products exhibited on this stand, No. 233, will be representative samples of all wires, flexibles and conductors used for wireless, including lead-in wire, battery cords, crocodile clips, loud-speaker cords, headphone cords, aerial wires, connecting wires, screened tubing, screened flexible tubing, and also mains leads.

SELECTA GRAMOPHONES, LTD., 81, Southwark Street, London, S.E.1. Stand No. T11.

AS wholesalers, this firm will be showing a variety of receivers and components by all the well-known makers.

SIEMENS ELECTRIC LAMPS AND SUPPLIES, LTD., 39, Upper Thames Street, London, E.C.4. Stand No. 77.

NO details have yet been received concerning the exhibits on this stand.

SINCLAIR SPEAKERS, LTD., 13, Vale Royal, N.7. Stand 232.

SMITH AND SONS (M/A), LTD., Cricklewood Works, London, N.W.2. Stand No. 47.

NO details have been received at the time of going to press concerning the exhibits of this firm.

SONOCHORDE REPRODUCERS, LTD., Rothermel House, Canterbury Road, N.W.6. Stand No. 43.

THE main features of the display on this stand will consist of the well-known loud-speakers having both permanent magnet and energized field magnet systems. The range consists of the Midget, Junior, Standard, Senior, and De Luxe Models, and some special models designed for manufacturers' use will also be seen. The new piezo-electric speakers, pick-ups and microphones will also be shown.

SOUND SALES, LTD., Tremlett Grove Works, Junction Road, London, N.19. Stand No. 203.

THERE will be one or two interesting power amplifiers showing on this stand as well as a special double time base for 30-line and 120-line cathode-ray television. In addition to these items there will be a special battery charger for use with car batteries which are normally overloaded due to the extra drain imposed upon them by car-radio equipment. The "Sound" moving-coil loud-speaker which proved so popular at last year's Show will again be exhibited, in conjunction with an extensive range of mains transformers, chokes, and Class B Equipment. An entirely new line will be a range of paper condensers designed particularly for use in smoothing circuits. These will be available in capacities of from 1-mfd. to 8-mfd., and with working voltages from 250 to 1,500.

STRATTON & CO., LTD., Eddystone Works, Bromsgrove Street, Birmingham. Stand No. 30.

MESSRS. STRATTON will be showing a range of short-wave receivers designed essentially for overseas requirements, including the All-World Four for battery and A.C. all-mains operation, a super-heterodyne instrument using switched coils in a cabinet with self-contained loud-speaker for A.C. all-mains working, and the Overseas Four model for battery and A.C. mains operation, in cabinet with self-contained loudspeaker. A wide range of short-wave components will also be on view.

SUNBEAM ELECTRIC, LTD., Park Royal Road, North Acton, London, N.W.10. Stand No. 35.

FOUR receivers will be seen on this stand, two four-valve universal mains super-hets, and two five-valve receivers, one a universal mains set and the other a car-radio receiver. Shadow tuning is incorporated in two of these receivers, and all circuits embody the latest devices such as A.V.C., etc. The car-radio receiver has no cable drive to the remote control, so that back-lash is avoided. The output is 3 watts undistorted with a total consumption of less than 3 amps. from the car battery.

SUN ELECTRICAL CO., LTD., 118 & 120, Charing Cross Road, W.C.2. Stand No. T19.

THIS exhibit will consist mainly of items selected from various manufacturers' ranges and will prove of great interest to the dealer.

SWIFT LEVICK & SONS, LTD., Clarence Steel Works, Sheffield, 4. Stand No. 118.

HERE will be seen a comprehensive display of permanent magnets used by loud-

speaker manufacturers. The cross and link type permanent magnets for loud-speakers in chrome and cobalt steels will again be on view as these have proved to be most efficient and are still being used in large quantities for moving-coil loud-speakers. The new nickel aluminium steel will be employed in magnets of various attractive designs combined with a beauty of finish not previously obtained and will doubtless appeal to those who are in the market for the last word in loud-speaker magnets. The largest and smallest moving-coil speaker magnets in the world will also be exhibited.

TANNOY PRODUCTS, Canterbury Grove, West Norwood, London S.E.27. Stand No. 95.

IN addition to existing types of public address amplifiers and associated equipment, Messrs. Tannoy will be exhibiting some new lines consisting of portable band amplifiers; mobile amplifiers; projection speakers and a new radio-gramophone. Amplifiers for any output from 6 to 120 watts will be seen, and some of the equipment will well repay inspection.



The Sunbeam Universal Midget receiver which had attained considerable popularity.

TELEGRAPH CONDENSER CO., LTD., Wales Farm Road, North Acton, London, W.3. Stand No. 37.

AS all readers are well aware, Messrs. T.C.C. are one of the largest firms of condenser manufacturers. They will be showing their extensive range at Olympia, including one or two new lines such as the No. 2 Interference Suppressor. A new type of condenser, designated the type 87, and having a working voltage of 450, will be in evidence. This latter component has a paper dielectric, but it has been specially designed to withstand a peak, or surge, voltage up to 650. A variety of dry and aqueous electrolytic condensers in all working voltages will be exhibited, as well as several high-voltage components designed for use in transmitting sets. The new type of interference suppressor is somewhat larger than the previous model (which



A new Telsen intermediate-frequency transformer, which is of neat design.

Two popular T.C.C. components; on the left is the No. 2 Interference Suppressor, and on the right is a unit from the comprehensive range of fixed condensers.



is still being sold in very large numbers) and has two 4-mfd. condensers in place of the 2-mfd. components used in the smaller unit. It is thus particularly suitable for use in difficult circumstances.

TELEGRAPH CONSTRUCTION AND MAINTENANCE CO., LTD., Telcon Works, East Greenwich, S.E.10. Stand No. 112.

NO details have been received concerning the exhibits of this company.

TELEPHONE MANUFACTURING COMPANY, LTD., Hollingsworth Works, Martell Road, West Dulwich, S.E.21. Stand No. 105.

THE display will consist principally of "T.M.C. HYDRA" paper dielectric condenser. These condensers are based on the specifications of the famous "HYDRA" condensers and are manufactured in England by an entirely British Company in a plant of the most up-to-date description, under the supervision of experts whose experience of condenser design and manufacture extends over many years. A range of five types of "T.M.C. HYDRA" paper condensers in metal cases, for working voltages of 250-750 V.D.C., as well as non-inductive tubular paper condensers of varying capacities and tested at 2,000 V.D.C., will form the main exhibit. There will also be shown a selection of sub-divided block condensers, typical specimens of the kind supplied to manufacturers for inclusion in receivers. T.M.C. HYDRA condensers for power-factor correction of Neon signs will be represented by a selection of the sizes most generally in demand. Finally a collection of moulded bakelite switches and connectors will complete the exhibit.



Made by Telsen, the above is a modern pedestal receiver.

THE NEW "J.B." UNIVERSAL **LINACORE**

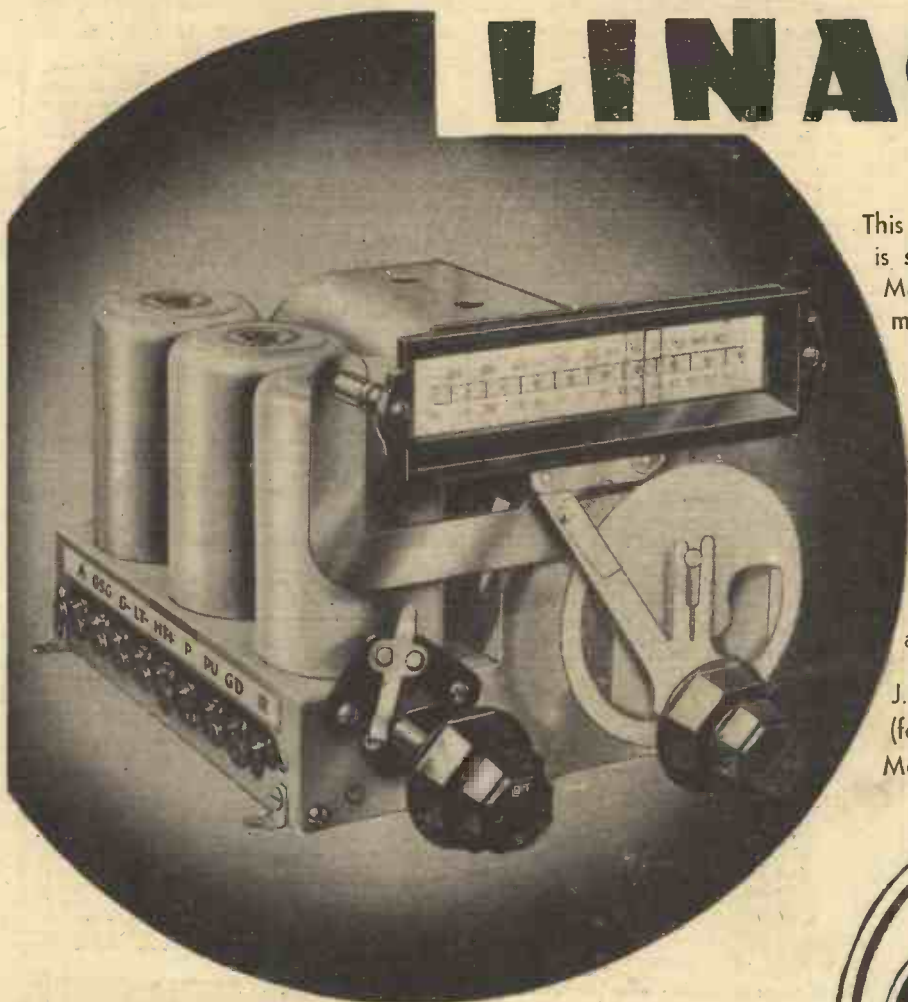

This new J.B. Universal "Linacore" Tuner is suitable for use with either Battery or Mains valves. It has been designed to make possible the construction of really efficient receivers with the minimum possible complication and the maximum certainty of success. It simplifies set building considerably—and is far more efficient and compact than if home assembled. Complete with volume and reaction controls and all switching. Use this new Universal "Linacore" and get performance like a superhet!

J.B. "LINACORE" UNIVERSAL TUNER
(for use with Battery or Mains valves)
Model B.P.U. (Cat. No. 2129) **65/-**



TO HELP YOU INCORPORATE
THE "LINACORE" IN YOUR SET

We are offering you—for only 3d. (4d. Post Free)—a large broadsheet "Vivid Radio" containing three full-size blue-prints and full wiring instructions for incorporating a "Linacore" in your set. Post the coupon today, and be sure of getting your broadsheet before they are out of print!

**FILL IN COUPON
AND POST TO-DAY**

See the "LINACORE" at
Stand No. 114, Radiolympia.



COUPON

To Jackson Brothers (London) Ltd.,
72 St. Thomas' Street, London, S.E.1.

Please send me "Vivid Radio." I
enclose 4d. in stamps to cover postage, etc.

Name.....

Address.....

.....
.....

Practical Wireless GUIDE TO THE SHOW

TELSEN ELECTRIC CO., LTD., Aston, Birmingham.
Stands Nos. 75 and 101.

In addition to complete receivers, Messrs. Telsen will also be exhibiting a complete range of their smaller components designed for home construction purposes. The complete receivers incorporate some novel features, including the "Pointograph" tuning dial which utilizes a pointer traversing a large screen at an angle, and which straightens as the exact tuning point is reached. This enables a station to be tuned in with the volume control set to inaudibility. The S.G.3 and 323 Kit sets will also be seen.

THE 362 RADIO VALVE CO., LTD., Stoneham Works, Stoneham Road, Northwood Road, Upper Clapton, London, E.5. Stand No. 244.

As valve manufacturers, this firm will confine its exhibits to valves of all types—battery, A.C., D.C. and Universal mains. In addition, the appearance of the stand will be enhanced by a large sectional model of the cathode which is employed in 362 A.C. mains valves, as well as a mechanical device demonstrating the process of manufacture of this type of valve.

THOMSON, DIAMOND AND BUTCHER, 34, Farringdon Road, E.C. Stand T.8.

As wholesalers, this firm's exhibit will consist of selected items from various firms.

ULTRA ELECTRIC, LTD., Erskine Road, Chalk Farm, London, N.W.3. Stand No. 67.

CLOCK-FACE tuning forms the principal feature of the Ultra receivers, but the cabinet work and circuit details have received just as much attention as the design of the tuning indicator, and the receivers embody all that is modern in workmanship and design. Models for A.C., D.C. and Universal mains will be on show, and range from the most simple type of receiver to the elaborate radiogram.

VANDERVELL, C. A., LTD., Well Street, Birmingham. Stand No. 234.

On this stand will be seen a full range of L.T. accumulators in glass and celluloid cases, all the former with ball discharge indicating devices. In addition jelly acid non-spillable cells will be seen together with free acid non-spillable cells developed in accordance with the desires of one or two manufacturers. Some new mass plate L.T. cells with two positive plates enclosed by two negatives all of the same thickness will also be shown. In addition, dry batteries and rechargeable H.T. accumulators will take a place on the stand.

VARLEY, Bloomfield Road, Woolwich, London, S.E.18. Stand No. 103.

NEW items to be seen on this stand will include the Duo-nicore tuning coils. These are not fitted with switches and so permit of individual design and layout. A new type of core is employed and special attention has been paid to the reduction of medium-wave breakthrough. In addition to standard types of coil, Superhet coils and I.F. transformers are also obtainable in this particular range.

The Permeability Tuner will also be shown, together with a new Power Transformer delivering outputs of 325 volts at 50 mA. (Centre-tapped), 4 volts 2.5 amps and 4 volts 4 amps. This retails at 22s. 6d. Other items will consist of the Power Puncher—a battery economiser, the A.V.C. Unit and the already popular Nicore range of tuning coils.

VEE CEE DRY CELL CO. (1927), LTD., Northwood Road, Stoke Newington, London, N. Stand No. 126.

ARANGE of batteries will be seen on this stand for the first time, including standard sizes suitable for discharge up to 12 mA and super capacities suitable for discharge currents up to 25 mA. The No. 2 range, known as Plumax Standard Energy batteries are suitable for discharge currents up to 8 mA, and in the super-capacity type up to 12 to 20 mA.

VOIGT PATENTS LTD., The Courts, Silverdale, London, S.E.26. Stand No. 255.

MESSRS. VOIGT will be showing a protected unit which is intended to withstand the rough handling inseparable from many P.A. jobs. This unit is arranged so as to be shower-proof, and when the developments now taking place are complete it will be capable of handling a sound output estimated at 4×10^7 ergs. They will also show a bent 4ft. mouth horn encased so as to be suitable for domestic use. The price of the bent horn without its case is £10 0s. 0d. The cost of the case will depend upon the style of finish selected. The excellent quality for which the Voigt loud-speaker is known will therefore be available to the connoisseur without objection from the womenfolk. Reflector type encased horns will also be shown.

WESTINGHOUSE BRAKE AND SAXBY SIGNAL COMPANY, LTD., 82, York Road, King's Cross, London, N.1. Stand No. 86.

METAL rectifiers in various types suitable for H.F. and other purposes will form the basis of the exhibit of this firm. Rectifiers suitable for H.T. mains units, or chargers for various ratings, as well as larger units suitable for commercial use will be found, and the special H.F. units which have rendered the H.T. economiser and other accessories possible will well repay examination.

WESTERN ELECTRIC INSTRUMENT CO., LTD., Kingston Bypass, Surbiton, Surrey. Stand No. 239.

WHARFEDALE WIRELESS WORKS, 62, Leeds Road, Bradford. Stand No. 205.

WHITELEY ELECTRICAL RADIO CO., LTD., Radio Works, Victoria Street, Mansfield, Notts. Stand No. 98.

SOME startling new types of speaker known as the Stentorians will be seen on the W.B. stand and these will attract considerable attention. Possessing new magnet systems, these speakers have made reproduction a much more realistic thing than



One of the new Ultra table console receivers.

hitherto. Smaller air-gaps, larger diaphragms, greater field strength and such factors have contributed to the strides which have been made, and no doubt this will prove one of the highlights of the show.

WINGROVE AND ROGERS, LTD., 188-189, Strand, London, W.C.2. Stand No. 87.

ALL the existing popular lines such as the Polar Minor Gang condensers, the Polar Uniknob, the Polar Drives, pre-set condensers, etc., will be seen on this stand, and in addition, the new Midget Gang condensers will be shown together with two new full-vision scales. In addition, the Polar-N.S.F. components will be included in the exhibit. These include volume controls, resistors, tubular condensers and semi-dry electrolytics, all of which will, in future, be obtainable only through Messrs. Wingrove and Rogers. The N.S.F. components have, of course, been well known for a considerable time and have been standardised by a number of set manufacturers for some years.

WIRELESS AND GRAMOPHONE TRADER, Dorset House, Stamford Street, S.E.1. Stand T.14.

WIRELESS LEAGUE, 12, Grosvenor Crescent, London, S.W.1. Stands Nos. 248 and 251.

HIGHLY qualified technical advisers will be on these stands to answer questions regarding exhibits and other details. Arrangements will be made to have someone always at hand.

WIRELESS RETAILERS ASSOCIATION, 316, First Avenue House, High Holborn, W.C. Stand No. 231.

NO details are yet available concerning the exhibits on this stand.

WOLSEY WHOLESALE LTD., 54, Lambs Conduit Street, London, W.C.1. Stand No. T.15.

THE exhibits here will consist of selected items from various manufacturers and the exhibits will thus be principally Trade items. In addition, a new Television Kit, consisting of a standard disc apparatus, will be introduced to enable experimenters who so desire to take up this new hobby.

WORLD RADIO RESEARCH LEAGUE, Broadcasting House, London, W.1. Stand No. 88.

WRIGHT AND WEARE, LTD., 740, High Road, Tottenham, London, N.17. Stand No. 1.

ALL the lines which proved so popular last year are being continued and will be exhibited in conjunction with several new and interesting components. One of the latter is the General Purpose Iron Core Coil which is similar in many respects to the Universal coils that were used with such outstanding success in the "Practical Wireless" "Leader Three." There will also be a range of new short-wave components, all of which use "Mycalex" as the insulating medium; this material is non-hygroscopic and has extremely good insulating properties. A new oscillator coil which has been designed for use in conjunction with the Universal coils, and which is priced at only 5s. will also be in evidence.

**FOR COMPLETE
STAND TO STAND
REPORT
see
NEXT WEEK'S
2nd ENLARGED
RADIOLYMPIA
NUMBER**



This is the W.B. "Stentorian Standard" speaker which is specified for the "Practical Wireless" "Summit" three-valve battery receiver.

IMPRESSIONS ON THE WAX

THE "His Master's Voice" record of the month has again been produced by Richard Crooks, with two English ballads, "A dream of Paradise" and "Oh song divine," on H.M.V. DA1368. In many ways this artist is the world's most remarkable tenor. The music of these two songs was, in fact, sent to America for him to record especially for H.M.V. Although a singer of great capabilities and a favourite of the Metropolitan Opera House, New York, he specializes in records of ballads and light songs. On H.M.V. DA1368, his latest contribution, are two of the best recordings he has ever made.

Good Orchestral Discs

Practically all the ordinary records of the latest "His Master's Voice" lists are of a light nature. Marek Weber and his Orchestra have made the most polished orchestral record that has been issued for many months with a selection of those entrancing airs from "Lilac Time" on H.M.V. C2673. This should be especially popular, for these tunes will be heard in the new film about the life of Schubert which is to be released shortly.

Two other orchestral records of note are "Kiss me again" and "Echoes from the Puszta," by the London Palladium Orchestra on H.M.V. B8189, and a selection of celebrated love songs arranged by Henry Hall, called "Love Tales," by the New Mayfair Orchestra, on H.M.V. C2674. The pieces by the Palladium Orchestra were popular items during the recent Crazy season at this well-known music-hall. The tender intimacy of "Speak to me of Love," the carefree philandering of "A Bachelor Gay," the passionate intensity of Grieg's "Ich liebe dich," the quiet fervour of "Drink to me only," the longing of "God send you back to me," and the wartime memories of "If you were the only Girl," are all admirably played in this selection.

Another medley is entitled "On the March," and is played by the premier English Military Band, that of H.M. Coldstream Guards, conducted by Lieut. J. C. Windram on H.M.V. B8187. It is interesting to compare this performance with the "Zampa Overture," played by the American Legion Official Band on H.M.V. C2680.

Stirring Songs by Peter Dawson

From stirring music we pass to stirring songs, where Peter Dawson can be heard singing "The Devout Lover" and "The Tramp's Song," on H.M.V. B8191. This popular Australian singer probably holds the record for having made the most gramophone recordings. He must be nearly approaching his thousandth title.

Two essentially English songs are "The Fiddler" and "Come to the Fair," which are admirably sung by Stuart Robertson on H.M.V. B8194, whilst lovers of organ music will recognize "Moonlight and Roses," which Walter Glynn sings with "The World is waiting for the sunrise" on H.M.V. B8195, as being the motif of Lemare's organ piece "Andantino."

Paul Robeson seems to have been specializing in songs about children during the last few months, and his admirers will learn with interest that he has now recorded "Little man you've had a busy day" on H.M.V. B8202, coupled with "I ain't lazy, I'm just dreamin'."



1 Watt 1/2
2 Watt 2
3 Watt 3

These **11** facts
spell **DUBILIER**
superiority

SEALED IN CERAMIC TUBES—MOISTURE PROOF

USED EXCLUSIVELY BY LEADING RADIO MANUFACTURERS

PERMANENCY OF CHARACTERISTICS

EXPERTS CONTINUALLY SPECIFY

RELIABILITY UNSURPASSED

INDEPENDENTLY TESTED

OVER TWENTY MILLIONS IN USE THROUGHOUT THE WORLD

REASONABLY PRICED—1/- PER WATT

INDIVIDUALLY PACKED

TREMENDOUS MECHANICAL STRENGTH

YET THE GREATEST REASON OF ALL IS —THEY BEAR THE NAME **DUBILIER**

DUBILIER
RESISTANCES

Write for free NEW 1934 Illustrated Booklet

DUBILIER CONDENSER CO. (1925) LTD., DUCON WORKS, VICTORIA RD., N. ACTON, W.3.

"Evergreen" Hits

Jessie Matthews' memorable performance in "The Good Companions" has now been eclipsed by her work in "Evergreen," her latest picture. The story of the film (which is based on the play) centres on the daughter of an actress impersonating her mother, and goes back from the present day over a period of twenty-eight years. Miss Matthews plays the daughter, and, as is natural in so kaleidoscopic a rôle, she has a good many songs to sing. "Just By Your Example," "When You've Got a Little Springtime," "Tinkle, Tinkle," "Over My Shoulder," and, of course, "Dancing on the Ceiling"—these are the principal ones, and these hits Jessie Matthews has recorded for Columbia on two records in her own inimitable manner (DB1403-4).

"Butterfly"

"Butterfly" contains some great music, which runs with the gamut of every phase of conduct or emotion as the pitiful tale unfolds. The sublime, childlike faith of Butterfly in *One Fine Day*, gloriously sung by Rosa Pampanini; the Love Duet in Act I—emotion lit with perfect music; the cruel disillusionment (*E Questo?*), despair in poignant melody—all unforgettable experiences for the hearer. There are, in fact, few operas whose music tells the tale so faithfully as this. Well, this is "Butterfly." You must decide if you are able to cope with a strange tongue, and whether tragedy may be sung to you or not. But perseverance is worth while in hearing this opera; it will penetrate the consciousness from the first moment.

(Continued on page 647)

AN ALPHABETICAL



NAME.	ADDRESS.	STAND No.	NAME.	ADDRESS.	STAND No.
Ace Radio, 2a, West Arbour St., E.1		19	Dibben, Ltd., Horace, 34, Carlton Crescent, Southampton		T21
Adey Portable Radio, 99, Mortimer St., W.1		115	Diggle & Co., Ltd., Jane St., Rochdale, Lancs.		13
Aerialite, Ltd., Junction Mills, Welbeck St., Ashton-under-Lyne		253	Dubilier Condenser Co. (1925), Ltd., Ducon Works, Victoria Road, North Acton, W.3		T16
Aerodyne *Radio, Ltd., Aerodyne Works, Walthamstow, E.17		68	Dulcetto-Polyphon, Ltd., 2-3, Newman St., W.1		T4
Allwave International Radio & Television, Ltd., 4a, Wimbledon Hill Rd., S.W.		113	Dyson & Co., Ltd., J., 5, Godwin St., Bradford		T4
Amalgamated Press, Ltd., Fleetway House, Farringdon St., E.C.4		12	Earl Mig., Co., Ltd., Avenue Works, Hanover Park, S.E.15		240
Amplion (1932), Ltd., 82, Rosoman St., E.C.		63	East London Rubber Co., Ltd., 29, Great Eastern St., E.C.		T18
Anson & Hopwood, Ltd., 41, Cheval Place, S.W.3		108	Eastick & Sons, J. J., 118, Bunhill Row, E.C.		T23
Automatic Radio Gramophone Co., Ltd., Crown St. Hall, Brighton		110	Econasign Co., Ltd., 92, Victoria St., S.W.		227
Automatic Coil Winder & Elec. Equip. Co., Ltd., Winder House, Douglas St., S.W.		2	Edge Radio, Ltd., Dolly Blue Works, Raphael St., Bolton		91
Bakers Selhurst Radio, Croydon, Surrey		242	Edison Swan Electric Co., Ltd., 155, Charing Cross Rd., W.C.		18 and 58
Balcombe, Ltd., A. J., 52, Tabernacle Street, E.C.		32	Eldeco Radio, Ltd., 62, Conduit St., W.1		93
Beethoven Radio, Ltd., Beethoven Works, Gt. College St., N.W.		57	Electrico, 97, George St., Croydon		246
Belling & Lee, Ltd., Cambridge Arterial Rd., Enfield, Middx.		41	Electro Dynamic Construction Co., Ltd., Devonshire Grove, S.E.15		117
Benjamin Electric, Ltd., Brantwood Works, Tariff Road, N.17		42	Ensign, Ltd., 88, High Holborn, W.C.		T5
Bernard Jones Publications, Ltd., 58, Fetter Lane, E.C.4		10	Erie Resistor, Ltd., Cricklewood, N.W.		14
Birmingham Sound Reproducers, Ltd., Clarendon Works, Clarendon St., Oldhill, Staffs.		235	Everett Edgcombe, Ltd., Hendon, N.W.		212
Block Batteries, Ltd., By-Pass Rd., Barking, Essex		31	Ever Ready Co. (G.B.), Ltd., Hercules Place, Holloway, N.7		83
Bridger & Co., Ltd., R. O., 4, Factory, Shelford Place, Church St., Stoke Newington, N.16		216	Ferranti, Ltd., Hollinwood, Lancs.		70
Britannia Batteries, Ltd., Union St., Redditch, Worcs.		94	Film Industries, Ltd., 60, Paddington St., W.1		207
British Blue Spot Co., Ltd., 94, Rosoman St., E.C.		90	Flinners (Wholesale), Ltd., Shaftesbury House, Colchester		T10
British Broadcasting Corporation Publications, London, W.1		88	Fuller Accumulator Co. (1926), Ltd., Woodland Works, Chadwell Heath, Essex		124
British G.W.Z. Battery Co., 205, Bedford Avenue, Trading Estate, Slough, Bucks.		206	Garrard Engineering & Mig. Co., Ltd., Newcastle St., Swindon, Wilts.		54
British Permel Enamelled Wire, Ltd., Charlton, S.E.7		21	General Electric Co., Ltd., Magnet House, Kingsway, W.C.2		225
British Pix Co., 118, Southwark Street, S.E.		237	Gilbert & Co., Ltd., C., 73, Arundel St., Sheffield		T9
British Radiophone, Ltd., Aldwych House, Aldwych, W.C.2		97	Goodman, J., 28-30, Drysdale St., N.1		217
British Rola Co., Minerva Rd., Park Royal, N.W. Broadcaster, 20, Bedford St., Strand, W.C.		48	Goodmans (Clerkenwell), Ltd., Broadyard Works, Turnmill St., E.C.		125
Brown Bros., Ltd., Great Eastern St., E.C.2		T27	Graham Farish, Ltd., Bromley, Kent		59
Brown, Wm. F., Ossillo Works, High St., Brierley Hill, Staffs.		229	Gramophone Co., Ltd. (H.M.V.), 108, Clerkenwell Road, E.C.		33 and 61
Bulgin & Co., Ltd., A. F., Abbey Rd., Barking, Essex		121	Grosvenor Electric Batteries, Ltd., 2-3, White St., Moorgate, E.C.		104
Burgoyne Wireless, Ltd., Great West Rd., Brentford		102	Hacker & Sons, H., Perfecta Works, Ray Lea Rd., Maidenhead		116
Burndett, Ltd., Light Gun Factory, Erith, Kent		81	Haleyson Radio, Ltd., 83a, Valetta Rd., Acton, W.3		36
Burton, C. F. & H., Bernard St., Walsall		3	Harmer & Simmons, Ltd., 223, Hoe St., Walthamstow, E.17		209
Bush Radio, Ltd., Woodger Rd., Shepherd's Bush, W.12		82	Hartley Turner Radio, Ltd., Thornbury Rd., Isleworth, Middx.		119
Cadisch & Sons, R., 5-6, Red Lion Square, W.C.		T7	Haynes Radio, 57, Hatton Garden, E.C.		9
Celestion, Ltd., London Rd., Kingston-on-Thames		28	Hayberd & Co., F. C., 10, Finsbury St., E.C.		24
Central Equipment, Ltd., 188, London Rd., Liverpool		4	Hellesens, Ltd., Morden Rd., Wimbledon, S.W.		78
Chloride Electrical Storage Co., Ltd., 231, Shaftesbury Avenue, W.C.2		254	Hendersons Wholesale Electrical & Radio, Ltd., Electric House, Queen's Rd., Brighton		T2
Churchmans, Ltd., 79, Maidenburgh St., Colchester		T23A	Henleys Telegraph Works, Ltd., Holborn Viaduct, E.C.		100
City Accumulator Co., Ltd., 18, Normans Bldgs., Central St., E.C.		89	High Vacuum Valve Co., Ltd., 113, Farringdon Rd., E.C.		27
Clarke & Co., Ltd. (M/C) H., Atlas Works, George St., Patricroft, Manchester		85	Hillman Brothers, 123, Albion St., Leeds		T3
Climax Radio Electric, Ltd., Haverstock Works, Parkhill Rd., Hampstead, N.W.3		56	Hobday Bros., Ltd., 21, Great Eastern St., E.C.		T17
Cole, Ltd., E. K., Ekco Works, Southend-on-Sea		72	Hiffe & Sons, Ltd., Dorset House, Stamford St., S.E.		6
Colvern, Ltd., Mawneys Rd., Romford, Essex		38	Itonia, Ltd., 58, City Rd., E.C.		T6
Concordia Electric Wire Co., New Sawley, nr. Nottingham		238	Jackson Bros. (London), Ltd., 72, St. Thomas St., S.E.		114
Consolidated Radio, Ltd., Warple Way, Acton, W.3		20	Johnson & Phillips, Ltd., Charlton, S.E.7		21
Cosson, Ltd., A. C., Cosson House, Highbury Grove, N.5		73	Johnson Talking Machine Co., 96, Clerkenwell Rd., E.C.		T13
Dallas & Sons, Ltd., John E., 6-10, Betterton St., W.C.		T12	Kingsway Radio, Ltd., 3-9, Dane St., W.C.1		44
Darwins, Ltd., Fitzwilliam Works, Sheffield		40	Kolster-Brandes, Ltd., Sidcup, Kent		84
De La Rue & Co., Ltd., Thos., 90, Sherrhall St., E.17		5	Lampex Radio & Electric Co., 62, Brewery Rd., N.7		22
Dent, R. H. (Ardente), 309, Oxford St., W.1		45	Lectrolin, Ltd., 79a, Rochester Row, S.W.1		218
Dew & Co., Ltd., A. J., 33, Rathbone Place, W.1		T22	L.E.S. Distributors, Ltd., 15-16, Alfred Place, W.C.		T25
			Lissen, Ltd., Worpole Rd., Isleworth		83
			Loudon & Provincial Factors, Ltd., 140, Theobalds Rd., W.C.		T26
			Lugton & Co., Ltd., 203, Old St., E.C.		T1
			Mains Power Radio, Ltd., Broadway Works, Eastern Rd., Romford		230
			Manufacturers Accessories Co. (1926), Ltd., 85, Great Eastern St., E.C.		T24
			Marcronphone Co., Ltd., 210, Tottenham Court Rd., W.1		76
			McMichael Radio, Ltd., Wexham Rd., Slough, Bucks		60
			Michell & Brown, 153, Turney Rd., Dulwich, S.E.21		210
			Milnes Radio Co., Ltd., Bingley, Yorks.		249
			Mullard Radio Valve Co., Ltd., Mullard House, Charing Cross Rd., W.C.		65
			Multitone Electric, Ltd., 95, White Lion St., N.1		51
			National Accumulator Co., Ltd., 50, Grosvenor Gardens, S.W.		226
			National Radio Service, Ltd., 15, Alfred Place, W.C.1		215
			New London Electron Works, East Ham, E.6.		39
			Newnes, Ltd., George, 8-11, Southampton St., W.C.		8
			Novo Radio Electric, Ltd., 34, Lovaine Place, Newcastle-on-Tyne		17
			Nuvolon Electric, Ltd., Meredith Works, Park Crescent, Clapham Park Rd., S.W.4		236
			Ormond Engineering Co., Ltd., Ormond House, Rosebery Avenue, E.C.		100
			Orr Radio, Ltd., 79a, Parkhurst Rd., N.7		64
			Ossicaide, Ltd., 447, Oxford St., W.1		211
			Partridge Wilson & Co., Ltd., Leicester		29
			Philips Lamps, Ltd., 145, Charing Cross Rd., W.C.		62
			Plew Television, Ltd., Waddon, Croydon		11
			Portadyne Radio, Gorst Rd., North Acton, N.W.7		71
			Powertone Products, 102, Cromer St., W.C.		15
			Provincial Incandescent Fittings Co., Ltd., Pifco House, High St., Manchester		111
			Pye Radio, Ltd., Africa House, Kingsway, W.C.2		69
			Radio Gramophone Dev. Co., Ltd., 18, Frederick St., Birmingham		74
			Radio Instruments, Ltd., Croydon, Surrey		80
			Radio Society of Gt. Britain, 53, Victoria St., S.W.		204
			Regentone, Ltd., Worton Rd., Isleworth, Middx.		99
			Reproducers & Amplifiers, Ltd., Frederick St., Wolverhampton		53
			Rist (1927), Ltd., A., Freenant Rd., Lowestoft		233
			Selecta Gramophones, Ltd., 81, Southwark St., S.E.1		T11
			Siemens Electric Lamps & Supplies, Ltd., 39, Upper Thames St., E.C.4		77
			Sinclair Speakers, Ltd., 13, Vale Royal, N.7		232
			Smith & Sons (M/A), Ltd., S., N.W.2		47
			Sonochorde Reproducers, Ltd., 1, Willesden Lane, N.W.		43
			Sound Sales, Ltd., Tremlett Grove Works, Junction Road, Highgate, N.19		203
			Stratton & Co., Ltd., Eddystone Works, Bromsgrove St., Birmingham		30
			Sunbeam Electric, Ltd., North Acton, N.W.		35
			Sun Electrical Co., Ltd., 118, Charing Cross Rd.		T19
			Swift, Levick & Sons, Ltd., Clarence Steel Works, Sheffield		118
			Tannoy Products, Canterbury Grove, S.E.27		95
			Telegraph Condenser Co., Ltd., Acton, W.3		37
			Telegraph Construction & Maintenance Co., Ltd., Telcon Works, East Greenwich, S.E.10		112
			Telephone Mfg. Co., Ltd., Martell Rd., S.E.		105
			Telsen Electric Co., Ltd., Aston, Birmingham 75 and 101		244
			The 362 Radio Valve Co., Ltd., Stoneham Rd., Upper Clapton, E.		244
			Thompson, Diamond & Butcher, 34, Farringdon Rd., E.C.		T3
			Ultra Electric, Ltd., Erskine Rd., N.W.3		67
			Vandervell, Ltd., C. A., 319, Regent St., W.1		234
			Varley Co., 103, Kingsway, W.C.2		103
			Vee Cee Dry Cell Co. (1927), Ltd., Northwold Rd., Stoke Newington, N.		126
			Voigt Patents, Ltd., Silverdale, S.E.26		255
			Westinghouse Brake & Saxby Signal Co., Ltd., 82, York Rd., King's Cross, N.		86
			Weston Elec. Instrument Co., Ltd., Kingston By-pass, Surbiton, Surrey		239
			Wharfedale Wireless Works, Bradford		205
			Whiteley Electrical Radio Co., Victoria St., Mansfield, Notts.		98
			Wingrove & Rogers, Ltd., 188, Strand, W.C.2		87
			Wireless & Gramophone Trader, Dorset House, Stamford St., S.E.		T14
			Wireless League, 12, Grosvenor Crescent, S.W. 248 and 251		231
			Wireless Retailers Association, 316, First Avenue House, High Holborn, W.C.		231
			Wolsey (Radio & Allied Trades) Wholesale, Ltd., 54, Lamb's Conduit St., W.C.		T15
			World Radio Research League, Broadcasting House, W.1		83
			Wright & Wearle, Ltd., Tottenham, N.17		1

RANDOM JOTTINGS

By the Editor

B.B.C. Educational Talks

SINCE the autumn of 1924 the B.B.C. has set aside part of the evening programme for adult education, and during last winter some 1,100 discussion groups met regularly to follow the series of talks, and they comprised, approximately, 13,200 listeners, although the number of listeners to broadcast talks is certainly infinitely larger. The growing public interest, as shown in the public demand for the printed programmes of talks (of which 200,000 copies are now distributed three times a year), implies that there exists a large audience which listens to talks individually and perhaps spasmodically. The results of such listening cannot be scientifically traced, but that they are considerable is shown periodically by the effect on public opinion of some of the more important series. Experience has shown that adult education talks should last for not less than twenty minutes or more than thirty minutes, and should be delivered between 19.30 and 21.00 (7.30 and 9 p.m.).

Good-bye, Poldhu

ACCORDING to a recent report, Poldhu (MPD) is closing down. This station will always be remembered as the first one to span the Atlantic. In the old days, Poldhu meant a great deal to home-ward-bound seamen, and many wireless operators will remember the thrill of switching up to the long wave when within the two-thousand-miles radius on the off-chance of picking up a few dots and dashes of MPD's note—the first sign of home after months of absence in foreign waters. Poldhu, which did such good service in the early days, was eventually eclipsed by the big strides made in wireless development in recent years. Operators who used to listen regularly for its note began to miss it, and then learned that experimental work was the cause of its desertion of ships at sea.

New Broadcasting Station for Palestine

IT is interesting to note that the Palestine authorities have decided to provide a broadcasting service for the Holy Land. Plans for the new service are already well advanced and a site for the broadcasting station has been selected about seven miles north of Jerusalem.

The work of constructing and installing the new station has been entrusted by the Palestine Department of Posts and Telegraphs to the Marconi Company, and work on the manufacture of the equipment has started at the Company's Works at Chelmsford, Essex.

The power of the new station is 20 kilowatts unmodulated aerial energy, and broadcasting will take place on a wavelength of 449.1 metres. The transmitter is, however, adjustable from 200 to 545 metres, so that a change of wavelength can easily be effected should this be desired at a future date.

(Continued overleaf)

These NEW Products TRANSFORM TRANSFORMER VALUES



MAX TRANSFORMER
PARALLEL FEED

4'6

One of the most astounding Graham Farish contributions to better and lower priced 1935 radio. Alternative ratios of 1-1, 1-2, 1-3, 1-4, 1-5, 1-6 and 1-7½ are obtainable with the same transformer. Fitted with the new type of terminal developed by Graham Farish for the home constructor. Without doubt the greatest value in radio to-day. Price 4'6d.

QUIP TRANSFORMER

Suitable for the new Q.P.P. double Pentode valves or any push-pull circuit requiring a high step-up ratio, parallel fed. It has a high primary inductance of 60-70 henries and straight line amplification over 50 to 9,000 cycles and a full step-up ratio of 1/8. Extremely low capacity windings and minimum flux leakage. Price **10'6**



and a NEW Ohmite Volume Control for only 2/9

Yet another striking example of Graham Farish value. Element of extra high current-carrying capacity. Spring wiper operating through a cylindrical sleeve ensures a firm but positive point contact. Finished in black bakelite with dreadnought grey metal cover, complete with control knob. All standard values. Price **2'9**



Visit our Stand No. 59 at Radiolympia.
August 16—August 25.

GRAHAM FARISH LTD., BROMLEY, KENT

Indispensable to Every Wireless Enthusiast

MR. RALPH STRANGER, who is a master of lucidity, has produced in this book a valuable and fully explained synopsis of technical terms that everybody can understand. It will prove indispensable to everybody who reads technical books and journals. Fully illustrated throughout.

DICTIONARY OF WIRELESS TERMS

By RALPH STRANGER

Obtainable at all Bookstalls, or by post 2/10 from George Newnes, Ltd., 8-11, Southampton St., Strand, London, W.C.2. **2'6**

Do You Know What This Graph Means?

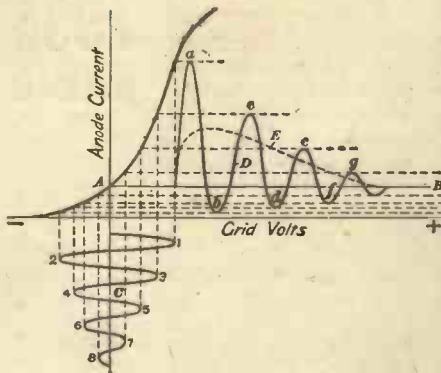

The man who can analyse these curves and understand what they indicate knows his job. But if they do not convey to him perfectly definite information, it would appear that he needs more training than he has had. He is not competent to fill a responsible position in wireless.

Radio has developed so rapidly throughout the last ten years that it has now greatly outgrown the supply of technically qualified men required for the better posts. Moreover, it continues to develop with such speed that only by knowing the basic principles can pace be kept with it.

The I.C.S. Radio Courses cover every phase of radio work. Our instruction includes American broadcasting as well as British wireless practice. It is a modern education, covering every department of the industry.

OUR COURSES

Included in the I.C.S. range are Courses dealing with the Installing of radio sets and, in particular, with their Servicing, which to-day intimately concerns every wireless dealer and his employees. The Operating Course is vital to mastery of operating and transmitting.

There is also a Course for the Wireless Salesman. This, in addition to inculcating the art of salesmanship, provides that knowledge which enables the salesman to hold his own with the most technical of his customers.

Then there are preparatory courses for the City and Guilds and I.W.T. Exams.

We will be pleased to send you details of any or all of these subjects. Just fill in, and post the coupon, or write in any other way.

International Correspondence Schools, Ltd.,
Dept. 94, International Buildings,
Kingsway, London, W.C.2.

Without cost, or obligation, please send me full information about the Courses I have marked X

- COMPLETE RADIO
- RADIO SERVICING
- RADIO EQUIPMENT
- RADIO SERVICING AND SALESMANSHIP
- WIRELESS ENGINEERING
- WIRELESS OPERATORS
- EXAMINATION (state which)

Name Age.....

Address

(Continued from previous page)

Transmitter Design

THE transmitter consists of a number of aluminium panels placed in line, on which the controls and measuring instruments are mounted. The transmitting valves, with their associated wireless circuits, are behind the panels with safety gates on both sides to prevent unauthorized access. A control desk placed in front of the panels is used for the supervision of the power supply and other circuits. The switchboard and the control desk are finished in grey cellulose enamel with highly-polished aluminium borders, which give a distinctive appearance to the equipment.

A high precision quartz-crystal oscillator for stabilizing purposes is provided. Its constancy is five in one million and thus fully ensures that the transmitter will adhere with great accuracy to its allotted frequency.

Aerial

AN inverted quarter-wave aerial of the "T" type, suspended between two lattice-steel masts, is to be used. The masts are 100 metres in height, and they are insulated and stayed. Following modern practice the energy for the transmitter is conveyed to the aerial by means of a two-wire feeder line, which terminates in a small building at the lower end of the aerial, where appropriate coupling circuits ensure the correct transfer of energy from the feeder to the aerial.

RADIO CLUBS AND SOCIETIES

Club Reports should not exceed 200 words in length and should be received First Post each Monday morning for publication in the following week's issue.

SLADE RADIO

There was a lecture on "Ohm's Law," by Mr. N. B. Simmonds at the last meeting of this society. After giving the formula, he went on to explain how it could be applied and gave a number of illustrations. At the end of the lecture there was a short talk by Mr. L. Griffiths, and a demonstration of the 1935 Ekco A.C. 85 superhet receiver, a 6-valver including rectifier and incorporating a disturbance suppressor. The demonstration showed that, using the suppressor, all stations both medium and long wave, shown on the dial, which were working could be received at good strength without any trace of interference. Switching out the suppressor, a number of other stations could be received, but the background noise became very noticeable.—Hon Sec., 110, Hillaries Road, Gravelly Hill, Birmingham.

THORNTON-HEATH RADIO SOCIETY

A meeting of this society was held at St. Paul's Hall, Norfolk Road, on Tuesday, July 24th, presided over by Mr. S. J. Meares.

By the courtesy of the G.P.O. Mr. R. E. Dabbs (2BUS) was enabled to give a demonstration of his short-wave transmitter. He briefly described the working of a transmitter, and then outlined the two methods in use, namely the self-controlled and the crystal-controlled, the latter being the more modern. Mr. Dabbs explained in detail the various stages of the transmitter and amplifier which he illustrated on the blackboard, and then dealt with the question of modulation.

Full particulars of future programmes can be obtained from the Hon. Sec., Mr. Jas. T. Webber, 368, Brigstock Road, Thornton Heath.

THE WIRELESS CONSTRUCTOR'S ENCYCLOPAEDIA

(2nd Edition)

By F. J. CAMM

(Editor of "Practical Wireless")

THIS invaluable encyclopaedia is written in plain language by one of the most accomplished designers and writers on wireless construction.

Obtainable at all Booksellers or by post 5/6 from Geo. Newnes, Ltd., 8-11, Southampton Street, Strand, London, W.C.2. **5/-**

WHEN the history of Radio progress is written, these two books will be given the most prominent place:

TELEVISION FOR THE AMATEUR CONSTRUCTOR

By H. J. BARTON CHAPPLE, Wh.Sch., B.Sc. (Hons.), etc.

THE NEW Second Edition of this firmly established book for radio workers will be ready immediately. The full revision includes the latest developments, enabling the home constructor to follow clear directions for the building of sets capable of receiving any new Television services incorporating "high definition."

290 pp. 12s. 6d. net. Cloth.

TELEVISION TO-DAY AND TO-MORROW

By SYDNEY A. MOSELEY and H. J. BARTON CHAPPLE.

NOW IN its Fourth Revised Edition, this standard book on Television, detailing its origin, development, and present-day methods, should be read by all radio enthusiasts. It gives a complete insight into the principles and the transmitting and receiving apparatus, and presents one of the most fascinating "stories" of this scientific age.

230 pp. 7s. 6d. net. Cloth.

ORDER from a bookseller, or send remittance (including postage) direct to the Publishers. Details post free.

PITMAN

PARKER ST., KINGSWAY, W.C.2

Amazing New
**ROLA
MODELS**

with
New Dust Proof Filter Assembly

Radically New Spider Construction

Domed Centre Cap in Apex of Cone



*You Must see
them at Olympia*
STAND 48

Here at last is a completely dust proof unit—a speaker that sets up new standards of efficiency—a model which will give as fine a performance in ten years' time as it does to-day. Dust and dirt are completely excluded from air-gap and voice-coil—a special corrugated diaphragm type centring member secures perfect alignment—once again Rola has set an entirely new standard of maintained performance supremacy. Inspect the new Rola models for yourself at Olympia. Then ask your dealer to demonstrate and note their unequalled fidelity and volume.

Write to-day for the Rola Folder.

ROLA
the World's Finest Reproducers

**THE
BRITISH ROLA
CO., LTD.**
Minerva Road,
Park Royal, N.W. 10

Phone:
Willesden 4322-3-4-5-6

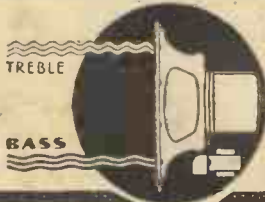

IMPRESSIONS ON THE WAX

(Continued from page 643)

Brilliant Harp Recording

An unusual instrumental record is a harp medley of National Airs played by Mario Lorenzi, coupled with Lincke's "Glow Worm Idyll." This record conveys very faithfully the fullness of tone or range of expression of which the harp is capable in the hands of a master.

Raie da Costa's rhythmic piano playing is as brilliant as ever in her arrangements of "Just by your example" and "Ridin' around in the rain" on H.M.V. B8206, whilst Derickson and Brown are heard singing "Lazin'" and "All I do is dream of you," on H.M.V. B8204 in their own inimitable style.

Ray Noble's New Dance Successes

Amongst the new dance records Ray Noble is again the star. He has recently been using a new arrangement for recording in the studios whereby he conducts his orchestra from a soundproof box and hears their performance through a loud-speaker at his side. He is thus able to determine exactly how the finished performance will sound and ensures that all the instruments of his orchestra are recorded in their proper perspective. On H.M.V. B6507 he conducts his band playing one of America's newest hits, "Moon Country" and a cheery one-step, "Happy," whilst on B6504 he treats two fox-trots, "When you've got a little springtime" and "Over my shoulder" with polish and originality of style.

Eddie Duchin and his Orchestra, who are now causing such a furore in America, have recorded "Ill Wind" and "As long as I live," on H.M.V. B6501, whilst a new American band, Raymond Paige and his Orchestra, give a novel performance of the popular hit of the moment, "Love thy neighbour," coupled with Isham Jones's Orchestra playing "Ridin' around in the rain," on H.M.V. B6505.

We are now able to hear film orchestras playing their hits on records in exactly the same way as they do for the screen performances. The R.K.O. Studio Orchestra play "Carioca Rumba" from the film "Flying Down to Rio" on H.M.V. B6506, with Rudy Vallee and His Connecticut Yankees version of "Sleepy Head" on the other side.

The hot rhythm record of the month is Hoagy Carmichael playing his own composition, "Lazy River," coupled with Henry Allen Jr. and His Orchestra giving an exhilarating performance of "Swing Out."

New Columbia Records

Albert Sandler and his Orchestra have provided in the August Columbia supplement "Maruschka" and "Cuban Serenade," two dreamy, wistful pieces of Continental origin. These records, with their melody and lilting rhythm, are certain of widespread appeal (DB1406).

Radiolympia Signature Tune

The theme tune of Radiolympia this year is "Tune In," and Henry Hall and the B.B.C. Dance Orchestra, who will play throughout the run of the exhibition, will be responsible for introducing it to the huge audiences that will throng the great radio show. As was to be expected, Mr. Hall and our national dance orchestra have recorded the signature tune on Columbia, with "Night on the Desert" on the reverse (CB766).

EASY TERMS

Every Radio requirement, however extravagant or modest, is supplied by us on the most convenient terms and with the utmost expedition and courtesy. Continuously established since 1925, we maintain a service upon which increasing numbers rely. We deal with you direct and all transactions are strictly private. May we have your orders and inquiries?

New Blue Spot STAR Unit. Cash Price £3-10-0, or 6/5 with order and 11 monthly payments of 6/5.

Blue Spot Moving-Coil Chassis 45PM 5/- with order and 9 monthly payments of 5/-.

99PM 5/- with order and 11 monthly payments of 5/6.

Atlas C.A. 25. Cash Price £2-19-6, or 5/- with order and 11 monthly payments of 5/6.

AvoMinor Universal Testing Meter. Cash Price 40/-, or 5/- with order and 7 monthly payments of 5/6.

All Carriage Paid.

To avoid delay, will customers kindly send first payment with order

Estd. 1925 **THE** PHONE NATIONAL 1977

LONDON RADIO SUPPLY COMPANY

11, OAT LANE, NOBLE STREET, LONDON, E.C.2

Soldered contacts are better

See Stand No. 109 Radiolympia.



contacts are better
**ELECTRICALLY
SOLDERED
ARE BEST**

Switch on a Solon Electric Soldering Iron and in three minutes it is ready for use. It plugs into a lampholder. Use a

SOLON
TRADE MARK
**ELECTRIC
SOLDERING
IRON**

7/6

65 watts 7/6
125 " 22/6
240 (1lb. 10oz.)
(2lbs.) 37/6

If unable to obtain, send us the name of your nearest dealer.

W. T. HENLEY'S TELEGRAPH WORKS COMPANY LTD.
Y.O.15, Dept. — HOLBORN VIADUCT — LONDON — E.C.1

MADE IN ENGLAND

SUPPLEMENT TO PRACTICAL WIRELESS

TELEVISION REVIEW

CHANGING FASHIONS

By H. J. Barton Chapple, Wh. Sch., B.Sc., A.M.I.E.E.

WE are all familiar with the changing fashions in radio both at the transmitting and receiving ends, but few have given thought to the radical

enormous transmitter used by Mr. Baird for some of his early attempts at scanning large scenes. On the left are the two discs having overlapping slots to produce the

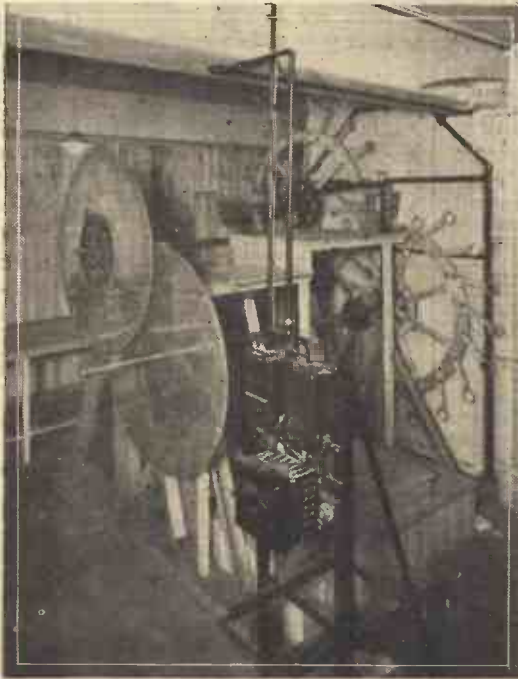

Fig. 1.—The large double-scanning transmitter used by Mr. Baird in some of his early efforts to scan big scenes.



Fig. 2.—One of the first forms of portable Baird television transmitter, which has now been superseded.

differences in design in television transmitting equipment.

In Fig. 1 is shown the complicated and



Fig. 3.—The first portable mirror-drum transmitter. This machine was the forerunner of that now used by the B.B.C. for its present television service.

scanning effect as shown in a recent note in these columns. Coupled with this are the large metal wheels with radial arms terminating in lenses. With equipment of this character a very powerful driving motor was essential and this, coupled with the cumbersome nature of the machine, led to its final abandonment.

The next step was the straightforward apertured disc transmitter which ultimately took the form of a very simple disc machine of a portable type. This is shown in Fig. 2, and was developed for the first transmissions made from the old Savoy Hill headquarters of the B.B.C. some three years ago. The revolving disc, driving motor and arc lamp are supported on a small revolving turntable which in turn is secured to a three-legged stand with large wheels. In front of the circular case housing the disc is a sector-shaped arm hold-

ing two lenses. Either of these could be brought into use at will and were included to give a focussed light spot scanning field for close-up or semi-extended images.

In the search for a more intense spot of light this machine was also abandoned in favour of the mirror-drum light spot transmitter, and the first design for this machine is illustrated in Fig. 3. The top cover is removed to show the mirror drum itself. Immediately below the drum is the arc light housing the resultant light beam passing along the tubular section, to be reflected back on to the drum mirrors, and finally reflected from these mirrors as an intense spot of light tracing out the scanning light strips. The tubular framework support allowed the scanning beam to be moved to left or to right on a back runner. From the experience gained from this model the ingenious mirror-drum transmitter installed in the B.B.C. studio at No. 16 Portland Place was evolved. This machine is shown in Fig. 4, and it has been in constant use now for nearly two years, and, for the thirty line service, gives outstandingly good results.

Watching the Image

ONE of the recent morning transmissions by the B.B.C. Television Department included Signor Podrecca's marionettes. As these figures move about within a relatively small compass it is possible to arrange the travelling light spot area to close-up dimensions, and the effects produced are really remarkable. Drama, melodrama, comedy, and ballet are performed by the puppets, the movements and actions being controlled by a veritable maze of strings. Transmissions of this character have been a great favourite in the past, and in Fig. 4 is shown one of the original acts of the London Marionettes in progress. The photo-electric cells were fixed in a box above the aperture cut in the wall dividing the studio from the control room. This can be seen clearly and also the special scenery painted for television work, while the strings supporting the "performers" on the front of the stage are quite visible.

The "Televisor" employed by the B.B.C. for Press and public demonstration is a particularly interesting machine standing about 5ft. high. The image screen size is 14in. by 6in., while the screen itself

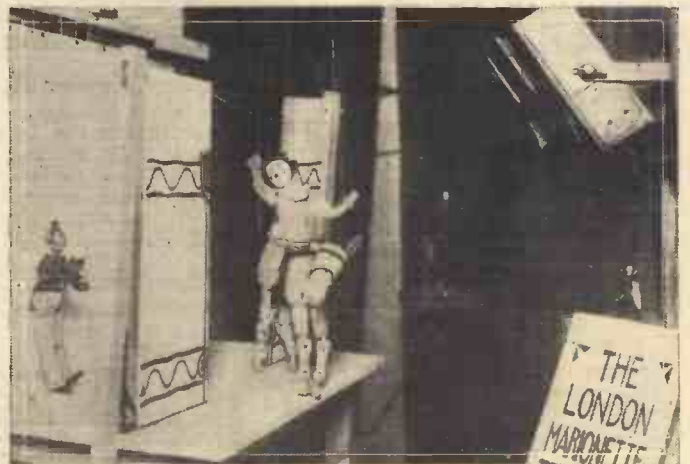

Fig. 4.—Indicating how the first marionette shows were produced for television. The photo-electric cells are housed in the rectangular apertured box on the right.

is made from thin frosted glass. This is shown in Fig. 5, together with the machine controls which are grouped round the screen for convenience of adjustment. The question of automatic synchronizing by means of the picture signal does not arise, for since the mirror drum of the television transmitter is driven by a synchronous motor, then it is only necessary to employ a similar synchronous motor in the receiving "televisor" and feed this from the same mains supply. The two switches at the top of the left and right panels are the main on-off switch and motor start-run switch. Initially both these switches are snapped down, this feeding the mains supply to the independent running winding and furnishing a starting voltage of 300. When the motor pulls into its synchronous speed the right switch is moved up to give the running voltage of 110 volts, while the hood over the switch knob of the left-hand switch is released and springs back to its initial position.

For tuning-in the 261-metre transmission,

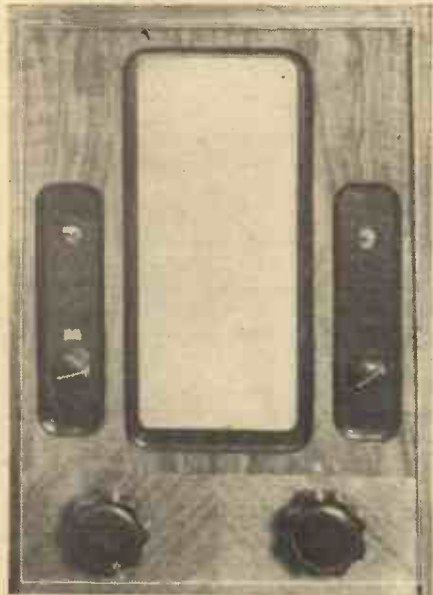

Fig. 5.—A close-up view of the image screen and controls contained in the B.B.C. Televisor situated in the listening room at Broadcasting House.

the left-hand arrowed knob is turned, the small aperture above this indicating the wavelength. The actual image reception is effected by a grid cell working in conjunction with a thirty-mirrored drum, so to control the bias voltage on the cell and thus alter the brilliance of the image to suit individual taste, a potentiometer is adjusted by means of the right-hand arrowed knob. The large right-hand knob is a volume control operating on the radio receiver proper so that the signal strength may be altered to the required value. Finally, there is the left-hand large knob for a combined image phasing and framing adjustment. This is brought about by a relative movement between the rotor and stator of the motor itself and locates the image exactly in frame within the translucent screen.

Order Next Week's

2nd Enlarged Show Issue Now!



for the most complete range of NON-INDUCTIVE PAPER CONDENSERS • MICA CONDENSERS TUBULAR CONDENSERS • ELECTROLYTIC CONDENSERS • AND TRANSMITTING CONDENSERS

VISIT STAND 37

... and IF YOU ARE GETTING INTERFERENCE FROM NEON SIGNS, 'DIRTY' MAINS, OR MOTORS, ETC.

special arrangements have been made at the T.C.C. Stand to give you advice, how your own individual difficulty can be overcome with the T.C.C. Interference Suppressor.

The Telegraph Condenser Co. Ltd., Wales Farm Road, N. Acton, W.3.

T.C.C.

ALL-BRITISH

CONDENSERS



**BUY YOUR COPY
OF NO. 1 TO-DAY.**

*On sale at all Newsagents and
Bookstalls, or by post 7½d.
from George Newnes, Ltd.,
8-11, Southampton Street,
Strand, London, W.C.2.*

THE time cannot be far distant when we look in as well as listen in...

BRING YOUR KNOWLEDGE OF TELEVISION RIGHT UP-TO-DATE BY STUDYING THE PAGES OF THIS NEW MAGAZINE.

Read all about the various systems, how your set may be adapted to receive television, how to make a receiver at small cost, how pictures are transmitted, the latest television news, and many other aspects of this most modern and intriguing of sciences.

"PRACTICAL TELEVISION" WILL TELL YOU ALL ABOUT THE NEW HOBBY IN EVERYDAY LANGUAGE, PRACTICAL DIAGRAMS AND PHOTOGRAPHS.

PRACTICAL TELEVISION

CATALOGUES RECEIVED

To save readers trouble, we undertake to send on catalogues of any of our advertisers. Merely state, on a postcard, the names of the firms from whom you require catalogues, and address it to "Catalogue," PRACTICAL WIRELESS, Geo. Newnes, Ltd., 8/11, Southampton St., Strand, London, W.C.2. Where advertisers make a charge, or require postage, this should be enclosed with applications for catalogues. No other correspondence whatsoever should be enclosed.

"FIGHTING FACTS"

A VERY attractive folder bearing the above title has just been issued by E. K. Cole, Ltd., which tells an interesting story of this firm's ten years' progress in the radio industry. This folder, copies of which are being distributed to all Ekco dealers, points out that this well-known firm are launching another new radio programme which should make the season 1934/5 an even greater Ekco year. New sets are to be introduced which will enhance the range of popular Ekco models. The folder is particularly topical in view of the approaching Radio Exhibition.

FERRANTI ELECTROSTATIC VOLTMETERS

MESSRS. FERRANTI, LTD., have recently marketed two new electrostatic voltmeters. One is a 150 v. instrument, spring mounted in a cast-iron case, and arranged for measurements to be taken with the dial in a horizontal position. The other model is a 12 kv. instrument, with an upright dial, and is fitted in a polished wood case. A leaflet (Wh. 526/1) gives further particulars of these meters, and also details regarding a new 2½ in. A.C. and D.C. instrument, which may be used as the basis of an elaborate testing equipment by those who desire to construct such apparatus themselves. With this instrument, A.C. and D.C. readings can be made at choice by the operation of a switch at the top of the instrument. The full scale readings are 5 v. A.C. and 50 Mv. D.C. Both these ranges have a resistance of 1,000 ohms per volt, giving additional ranges of 0.1 mA. A.C. and 0.1 mA. D.C. Copies of the leaflet can be obtained on application to Ferranti, Limited, Hollinwood, Lancashire.

"GOLSTONE" RADIO COMPONENTS

MANY useful components and radio accessories for the set constructor are shown in the new season's list issued by Ward and Goldstone, Ltd. There is a fine range of H.F. chokes including some heavy duty types suitable for A.C. or D.C. sets. Iron-cored tuning coils, H.F. coupling units, screened dual-range coils, a switch unit chassis, condensers in metal or bakelite cases, compression type condensers, and switches of different types are also listed. Among the other material given in this comprehensive list are instrument wire in all gauges, rubber and flex covered wires, voltmeters and ammeters, the "Goltone" screened down-lead, accumulator charging boards, and a range of bakelite moulded adaptors and lamp holders. There are also several other useful accessories, too numerous to mention, and every set constructor is advised to write for a copy of this invaluable list.

BELLING-LEE PRODUCTS

THIS well-known firm have recently issued a loose-leaf catalogue setting forth their latest components. Noticeable amongst these are single and double choke units, in cases, for electrical disturbance suppression. The double choke unit consists of two H.F. mains chokes and condensers housed in a cast aluminium case. They can be adjusted for A.C. or D.C. and to provide several different filter circuits. In addition there are a D.C. ripple suppressor, and a car radio interference suppression kit. The popular Belling-Lee indicator and other terminals, fuseholders, and connectors, are also listed, together with the Belling-Lee spares kit, a handy little box of small parts and pilot bulbs for the home constructor or service man.

ROTHERMEL SPEAKERS

A FINE range of moving coil speakers, including a new Piezo Electric Speaker, is displayed in an attractive leaflet issued by R. A. Rothermel, Ltd. This new speaker is characterized by its unusual frequency response and sensitivity. Among the other models listed are two midget speakers suitable for portable or car receivers, one a D.C. type and the other P.M. type. Both are available with power or pentode transformers, and the P.M. model is also obtainable with a Class "B" transformer. Another interesting item is the Microvox, which is admirably suited for use as an extension speaker, provision being made for either high or low impedance by terminals located at the bottom of its cabinet. Also included in the range are Junior, Standard, Senior and De Luxe models at prices ranging from 25s. to 65s.

50 Tested Wireless Circuits

By F. J. Camm (Editor of "Practical Wireless")

This handbook contains every modern circuit, complete with instructions for assembling, component values and notes on operation.

Obtainable at all Booksellers, or by post 2/9 from Geo. Newnes, 2/6 Ltd., 8-11, Southampton Street, Strand, London, W.C.2.

CONSISTENT PERFORMANCE

HIVAC

THE SCIENTIFIC VALVE

BRITISH MADE



BRITISH MADE by

High Vacuum Valve Co., Ltd., 113-117, Farringdon Road, London, E.C.1

The Hivac design and method of Cathode construction adds to the working life of the valve because it eliminates Heater to Cathode shorting caused by friction to heater element.

Non-warping special drawn nickel outer tube. Ceramic Insulator slides into outer tube. Tungsten hairpin Heater Element slides into Ceramic Insulator which protects it from damage by friction during expansion and contraction.

HIVAC SPECIFIED FOR THE "ARMADA MAINS THREE"

AC/VP	13/6
AC/HL	9/6
AC/Y	15/6

Obtainable from all Curry's branches and high-class dealers.

BATTERY TYPES FROM 4/6

MAINS TYPES FROM 9/6

HIVAC 1935 VALVE GUIDE AND COMPARATIVE TABLE "N" FREE ON REQUEST.

STAND 27 OLYMPIA

PROLONGED LIFE

An Invaluable Handbook

ACCUMULATORS

An up-to-date practical handbook dealing with every type of accumulator, methods of charging them at home, care and maintenance. Also explains how to erect a charging station.

This is one of NEWNES'

HOME MECHANIC BOOKS

Ask your Newsagent to show you other Titles in This Helpful Series.

Obtainable at all Booksellers, or by post 1/2 each from George Newnes, Ltd., 8-11, Southampton Street, Strand, London, W.C.2

1/- EACH

PRACTICAL LETTERS FROM READERS

The Editor does not necessarily agree with opinions expressed by his correspondents. All letters must be accompanied by the name and address of the sender (not necessarily for publication).

Test Match Broadcasts in Australia

SIR,—Now that the Test matches are on I think it would be of interest to your many readers to know how the play is broadcast out here in Australia. The play starts at 8 p.m. (our time) and finishes at about 3.30 a.m. The whole broadcast is carried out by cables which come here after every over. These cables, which contain about twelve words, contain all the details of the preceding over. The announcer, together with some of his own patter about the cable, talks till the next cable arrives which is generally in about three minutes. In conjunction with the announcer is a gramophone record taken at some previous Test match of a crowd cheering. The volume of this record which is being played all the time is increased when something startling happens such as a 4, 6, a catch, or a man going out. At first many Australians thought that the announcer was at Trent Bridge seeing the actual cricket.

The tests are very popular out here in Australia. For instance, I stay up until about 4 a.m. each morning listening to the tests. I might also add that I do not begrudge the time thus spent as it affords me a great deal of pleasure, especially for short-wave testing.

In conclusion, I should be very pleased to correspond with someone in England if an enthusiast would please forward his address through the Editor.—Mr. ROTH JONES (Bendigo, Victoria, Australia).

Using Cheap Voltmeters

SIR,—The advice given in the July 28th issue of PRACTICAL WIRELESS on the use of cheap voltmeters is only too correct as I once found out for myself. About nine months ago I made a D.C. H.T. unit described in the PRACTICAL WIRELESS Encyclopædia. After connecting to the mains, I tested the readings with a cheap voltmeter, the 150-volt tap read 30 volts only, the 80-volt tap just made a slight flicker on the needle. At first I thought the unit was at fault, but I found this was not so when I made a quick short circuit between the H.T.— and H.T.+ tap. Thinking the meter was broken, I put a "Pifco" meter on test, and a correct reading of 80 volt and 150 volt was obtained. I tested an H.T. battery with the cheap meter, and this read correctly. I at once came to the conclusion that the cheap meter was taking more milliamps than the H.T. unit would give out. I tested this cheap voltmeter, in series, with a good milliammeter and found that it was taking not less than 30 milliamps, in fact, the needle went bang over to 30 milliamps; it might have gone more but for the fact that the meter was rated from 0 to 30 m.a. The moral, of course, is never use cheap meters when testing H.T. batteries, etc.—G. C. SURRIDGE (Crawley).

"Fury III" and Double-Diode-Triode

SIR,—Last year I suggested to you that "Fury III" should include a double-diode-triode, but you do not seem to have carried the matter any further. Perhaps the new Mullard is a suitable valve.

One often reads that the selectivity of the straight set cannot equal that of the superhet. I have not seen the following tried:—Aerial into a Band Pass unit with 2-gang condenser. (Probably an extra preset would be necessary because of the aerial.) The 2 H.F. coils to be controlled by a second 2-gang condenser. As, presumably, reaction would not be included, there can be no objection to two tuning controls.—H. M. SMITH (Westward Ho).

"Hush Hush Mixture"

SIR,—I have got an Ecko transverse microphone, but there is a lot of background noise and it won't pick up sound within a distance of two to three feet. The background noise is too loud. Do you sell that "hush hush mixture" that makes the silent background quality?

[The above letter was recently received by one of our advertisers, Messrs. Electradix Radios, apparently from one of their customers.—Ed.]

S.W. Stations and Postal Addresses

SIR,—With reference to my article entitled as above, published in the July 28th issue, I notice that the address given for reports of the German transmissions is the old one, which was correct when the article was written. In order that PRACTICAL WIRELESS readers, especially new ones, will not be misled, it may be pointed out the new address was given on the Practical Letters page of the January 27th issue. It is as follows: German Short Wave Station, Broadcasting House, Berlin, Germany.—THE AUTHOR.

CUT THIS OUT EACH WEEK.

Do you know

—THAT some novel tuning devices will be seen at the show in which accurate tuning settings are definitely located.

—THAT the reason for the above devices is to be found in the employment of A.V.C. circuits and side-band cut-off resulting in poor quality.

—THAT some new types of speaker will be seen during the coming season and will considerably modify current ideas concerning reproduction.

—THAT in a new recording system for gramophone records the conductor of a band stands in a sound-proof cabinet and hears the band playing through the medium of phones.

—THAT the grid-bias battery must be disconnected in a receiver employing a variable-mu-stage, or the battery will discharge itself through the control potentiometer.

—THAT the tuning condenser employed with iron-cored coils must be of good quality or the benefit of the coils will be lost.

The Editor will be pleased to consider articles of a practical nature suitable for publication in PRACTICAL WIRELESS. Such articles should be written on one side of the paper only, and should contain the name and address of the sender. Whilst the Editor does not hold himself responsible for manuscripts, every effort will be made to return them if a stamped and addressed envelope is enclosed. All correspondence intended for the Editor should be addressed: The Editor, PRACTICAL WIRELESS, Geo. Newnes, Ltd., 8-11, Southampton Street, Strand, W.C.2.

Owing to the rapid progress in the design of wireless apparatus and to our efforts to keep our readers in touch with the latest developments, we give no warranty that apparatus described in our columns is not the subject of letters patent.

TELEVISION—A SUGGESTION

CHANCING to come across a recent copy of an Australian radio journal, it was most interesting to note an expression of opinion in regard to that country's outlook on television. After pointing out the difficulties with which nearly everyone is now familiar, the writer went on to say that many of those closely associated with actual television activities hold the view that the public to-day will only accept television when it is given to them in a form comparable with the standard of picture possessing an entertainment value similar to the moving and talking pictures of to-day. He also said that as radio has developed to a very fine art, and the reproduction of music, etc., in the home is accomplished in a most satisfactory manner, the public will also demand a similar standard from television. Without entirely disagreeing with this point of view, it is suggested that television will best be introduced to the public on lines similar to the manner in which radio and other industries have been developed. There is no doubt that the public always pay either directly or indirectly for all developments and progress. Even motor-cars were not developed in the laboratory or on the testing grounds of the manufacturers, but rather in the hands of the public along the highways of the various countries and, in the initial stages, under conditions of bad roads, solid tyres, faulty engines, badly designed bodies, and other innumerable difficulties; but to-day we find the motor-car developed to a high degree of efficiency in every direction. The same applies to the radio receiver.

Now, if a television transmitting station is erected in any particular capital city, and even elementary signals, for instance, large words, black and white pictures, and other simple visionary objects are televised, it would create a large demand for television components, and the large number of existing listeners could be encouraged to buy these parts and achieve results with their own hands. This would not in any way interfere with the sale of complete broadcast receivers, but would rather tend to increase the public demand, as television transmissions would be linked up with some broadcasting station, thus requiring two receivers—one to reproduce the object, and the other to reproduce the sound. Those of us who have been associated with radio for the last fifteen years are apt to forget that there is another generation growing up, and that the youth between the ages of 12 and 20 is a definite candidate for the purchase of parts to experiment with.

Undoubtedly this is a very sound argument, and one which could very well be given serious consideration by the authorities concerned.

THE "SUMMIT"

(Battery)

AND

THE "ARMADA"

(Mains)

Our Special Radio Show Receivers!

LOW PRICE AND
HIGH PERFORMANCE.

Full Details on pages 602 and 612.

MULTITONE

PUT TONE CONTROL ON THE MAP

THE Multitone Tone Control Transformers. Types Toco and Puco (for Q.P.P.) are still the simplest and the most efficient means of ensuring the best possible reproduction under all working conditions.

Multitone were the pioneers of Class B components.

STAND 51 AT RADIOLYMPIA

Write for the free Multitone handbook and guides to Class B and Push-Push (Q.P.P.) to Multitone Electric Co., Ltd., Dept. 8, 95-98, White Lion Street, London, N.1.

MULTITONE
ELECTRIC COMPANY LIMITED
95-98, White Lion Street, London, N.1. Terminus 5474/5

C.R.C.87

FREE £500 CASH

FOR WIRELESS LICENCE HOLDERS

See if your number is in this week's

TIT-BITS TWOPENCE

On sale everywhere

Geo. Newnes, Ltd.

ELECTRADIX MICROPHONES

WE HAVE THE VERY BEST.

A Range of Models to suit Every Purpose.

20 designs to select from, each suitable for its particular job. All tested in our own Lab. before despatch and guaranteed. Complete makes from 5/6. Send for special illustrated list "P."

HOME RADIO MIKES.

New Designs for Home Broadcasting on your Radio. Bakelite cases, metal grille. No. 11 Solo. 5/6 Type No. "N.W." 11 Table, with high ratio transformer in case 15/-

GENUINE EISEL MICROPHONES at Bargain Prices.

A 25 Microphone of incomparable quality and wide frequency response range at sacrifice price of 55/-. Special cushion mounting in this make only. Limited number at 55/-.

Handsome Stand for table P.A., 10/-. Matched Transformer, 7/6. MICROPHONE BUTTONS for all purposes, 1/- Volume Controls, 6d. Announcers' No. 11 Mikes, 5/6 and 7/6; Pedestal type, 18/6. Microphone Carbon Granules. In glass capsule, enough for four buttons. Grade No. 1, 8d.; No. 2, Medium, 1/-; No. 3, Fine, 1/6; Carbon, solid back, blocks, 3d. Mouthpieces, curved or straight, 10d. Carbon diaphragm, 55 m/m., 4d. Panel Brackets, pivoted, 5/-. Reed Receiver Unit for Amplifier making, 3/-. Headphones, 2/9 pair. Vocoder 10,000 Counters, 1/3.

Send stamped addressed envelope for Special Exhibition Sale List.

ELECTRADIX RADIOS,

218, UPPER THAMES ST., LONDON, E.C.4

10,000 MOTORS: Spring and Electric, for RADIOGRAMS or GRAMOPHONES in stock.

Thousands of components; Tone arms, soundboxes, pick-ups, all types horns, pedestal-portable cabinets, fittings, hinges, h/dists, springs for all motors, gears, repairs, accessories. Portable Gramos from 12/6. Violins, strings for all instruments. Big trade discount. Radio goods to order. List free. 64 page Catal. "How to make them," 2d. Establ. 30 yrs. THE REGENT FITTINGS CO. (D.286), 120, Old St., London, E.C.1.



"We're Fluxite and Solder—the reliable pair: Famous for Soldering—known everywhere!"

As a Wireless Constructor—there isn't a doubt; You can't go far wrong—if WE are about!"

See that Fluxite and solder are always by you—in the house—garage—workshop anywhere where simple, speedy soldering is needed.

ALL MECHANICS WILL HAVE

FLUXITE

IT SIMPLIFIES ALL SOLDERING

All Ironmongers sell Fluxite in tins: 4d., 8d., 1s. 4d., and 2s. 8d. Ask to see the FLUXITE POCKET SOLDERING SET—complete with full instructions—7s. 6d. Ask also for our leaflet on HARDENING STEEL with Fluxite.

FLUXITE, LTD. (Dept. W.P.),

Dragon Works, Bermondsey Street, S.E.1.

FOR ALL REPAIRS!



WHEN BUYING SILVER YOU LOOK FOR THE HALLMARK



WHEN BUYING A RECEIVER LOOK AT THE VALVEHOLDERS

When they're "Clix" it's a sure sign that the designers include quality components throughout. That's a guarantee of good performance.

CLIX SPECIFIED FOR "SUMMIT THREE" AND "ARMADA MAINS THREE."

See all Clix contacts on STAND 218 OLYMPIA.



CLIX

LECTRO LINX, LTD.,
79A ROCHESTER ROW LONDON S.W.1

REPLIES TO

LET OUR TECHNICAL STAFF SOLVE
YOUR PROBLEMSQUERIES and
ENQUIRIES

The coupon on Page iii of cover must be attached to every query

by Our Technical Staff

If a postal reply is desired, a stamped addressed envelope must be enclosed. Every query and drawing which is sent must bear the name and address of the sender. Send your queries to the Editor, PRACTICAL WIRELESS, Geo. Newnes, Ltd., 8-11, Southampton St., Strand, London, W.C.2.

SPECIAL NOTE.

We wish to draw the reader's attention to the fact that the Queries Service is intended only for the solution of problems or difficulties arising from the construction of receivers described in our pages, or on general wireless matters. We regret that we cannot, for obvious reasons—

- (1) Supply circuit diagrams of complete multi-valve receivers.
- (2) Suggest alterations or modifications of receivers described in our contemporaries.
- (3) Suggest alterations or modifications to commercial receivers.
- (4) Answer queries over the telephone.

Please note also that all sketches and drawings which are sent to us should bear the name and address of the sender.

Matching a Speaker

"I am using a Mullard PM.2B (with 150 volts on the plate) in conjunction with the M.C. speaker having a speech coil of 11 ohms. I wish to know the correct ratio of the output transformer to use. I remember seeing an article on this subject, but cannot trace it."—E. A. P. (Catford, S.E.6.)

The formula for ascertaining the correct transformer ratio is

$$\text{Ratio} = \sqrt{\frac{\text{Optimum Load of Valve}}{\text{Impedance of Speaker}}}$$

The optimum load of the valve you are using is 14,000 ohms, and the impedance of the speaker is 11 ohms. If, however, the figure which you give is the D.C. resistance of the speech coil, and not its impedance, you should multiply that figure by 1½. That is to say, the impedance of an 11-ohm speech coil may be taken as 13.75 ohms. The ratio of the transformer will be found to be 45 to 1, this being the nearest commercial value obtainable.

Short-Wave Circuit Wanted

"I am on the look-out for a two or three valve short-wave circuit. It must be cheap and

fairly simple to construct. Have you published anything which would be suitable for me?"—D. R. H. (Streatham).

The Empire Short-Wave Three might prove of use to you, or the All-Wave Two. The former utilized a detector and two L.F. stages, together with a special type of short-wave coil manufactured by Radio Instruments. The latter employed iron-cored coils to cover short, medium and long waves. Blue Print No. 7 is obtainable in respect of the Empire Short-Wave Three and No. 28 in respect of the All-Wave Two.

A Microphonic Valve

"I have a valve which has been used in many circuits and it makes an unpleasant microphonic howl. This is very annoying when trying to tune in a station and someone walks across the floor. I have tried wrapping it in cotton wool, and also using various types of spring valveholder. Can you help me? I am also interested to know what makes it microphonic."—T. G. (Stoke Newington).

The noise is caused by the vibration of the electrodes and, therefore, you must arrange to prevent these from being set in vibration. A sprung valveholder will prevent jolts from being transmitted to the valve, but you will also find it necessary to cover the glass and preferably damp the glass by using lumps of plasticine or similar material under the wrapping. A tin or other type of cover over the valve, with some felt or other thick material round the valve so as to fit the cover, should prove effective.

A Ford Coil Query

"I am interested in the A.C. rectifier hint which you recently published, but am in doubt regarding one point. Your Ford coil seems to be the same as mine, opening with a sliding panel to the right. I have opened my coil and taken as much pitch as

possible away, but I cannot find the primary negative to the second negative—only the leads to the condenser. Could you please help me in any way?"—W. A. C. (York).

The two leads in question will be found attached to the brass contact stud on the side of the case.

Finding the Capacity

"Will you kindly explain to me how to find the value in mfd. of any variable or reaction condenser when they are not marked?"—D. D. (Weston-super-Mare).

The capacity depends upon the dielectric, the area of overlap of the plates and the thickness of the dielectric. You will find it rather difficult to calculate these factors from most condensers and, therefore, think the most satisfactory method would be to take the particular components to a local dealer and have them compared with similar items.

Fuse Position

"I have had an argument concerning the position of a fuse in a simple battery receiver. Can you please state definitely the correct position for the fuse so as to prevent the valves burning out?"—T. H. (Pinner).

If you examine a standard circuit you will see that H.T.—and L.T.—are joined together and to earth, and thus one side of the H.T. battery is already joined to the filaments. Consequently, you must arrange matters so that should the positive H.T. lead be joined to the filaments the entire H.T. supply will not be thrown across this part of the circuit and, therefore, the most obvious position for the fuse is in the H.T. negative lead. Use a fuseholder with two terminals, connecting one terminal to H.T.—and the other to L.T.—and to the filaments.

The Queries Coupon appears on Page iii of cover.

OSTAR-GANZ

UNIVERSAL HIGH VOLTAGE MAINS VALVES (MADE IN VIENNA)

are the only Universal Valves that can be wired in Parallel. There's no wider, finer or more up-to-date range available. They work equally as well on either D.C. or A.C. supply without alteration of the full Mains Voltage and they do not require Transformers, Barretters or Breakdown Resistances. Because of their remarkable efficiency they have been specified and are fully recommended by "Wireless Press."

KITS SUPPLIED FOR ALL TYPES OF RECEIVERS—RADIOGRAMS—AMPLIFIERS.

It is simple to CONVERT Battery or any mains set to Universal AC/DC with Ostar-Ganz valves. Write now for full details of the range. Free technical assistance.

EUGEN J. FORBAT, 28-29, Southampton St., Strand, London, W.C.2. Tel.: Temple Bar 8608.

MISSING AT OLYMPIA!

The Finest range of "Universal" AC/DC All-Wave Receivers. They operate on either AC or DC Mains from 100 to 250 volts.

ALL models except the "Miniature" cover Ultra Short Bands as well as medium and long wavebands.

ALL models are available as RADIOGRAMS in modern and compact cabinets.

ALL models are extremely economical in operation as no barretters or dropping resistances are employed and the filaments are connected directly across the mains.

ALL models owing to the use of Ostar-Ganz Super Power output valves give a greater undistorted output than corresponding sets on the market.

ALL models are completely hum-free on A.C. or D.C. mains!

UNIVERSAL HIGH VOLTAGE RADIO, LTD., 28-29, SOUTHAMPTON ST., LONDON, W.C.2.



Write at once for full details and prices.

Telephone: Temple Bar 4985.

Miscellaneous Advertisements

Advertisements are accepted for these columns at the rate of 3d. per word prepaid - minimum charge 3/- per paragraph - and must reach this office not later than Tuesday for the following week's issue. Radio Components advertised at below list price do not carry manufacturers' guarantee. All communications should be addressed to the Advertisement Manager, "Practical Wireless," 8, Southampton Street, Strand, London.

PREMIER SUPPLY STORES

Offer the Following Manufacturers' Surplus New Goods at a Fraction of the Original Cost; all goods guaranteed perfect, carriage paid over 5/-, under 5/- postage 6d. extra, I.F.S. and abroad, carriage extra. Orders under 5/- cannot be sent C.O.D. PLEASE SEND FOR ILLUSTRATED CATALOGUE POST FREE.

STUPENDOUS Purchase of Set Manufacturers' Stock. All electric 3 Valve (S.G. Det. Pen.) Set in Walnut Cabinet with moving-coil speaker 200-250 volt 40-60 cycles. Chassis built. 200-2,000 metres with 4 valves, £4/19/6.

SPECIAL Offer of P.M. and Energised M.C. Speakers. Purchased from well-known gramophone co.

TYPE 10971G. 9in. diameter, 115 ohm field, 120/200 m.a. with power output transformer. Handles 4 watts, 17/6.

TYPE 10971C. 9in. diameter, 2,000 ohm field, 40/70 m.a., Pentode transformer. Handles 4 watts, 17/6.

TYPE 10955F. 9in. diameter, 11,650 ohm field, 20/30 m.a., auditorium type power transformer. Handles 10 watts, 30/-.

TYPE 10955H. 9in. diameter, 115 ohm field, 350/400 m.a., auditorium type Pentode transformer. Handles 10 watts, 30/-.

TYPE 4480. 9in. diameter, permanent magnet. Handles 4 watts. 7 ohms speech coil, 13/6. Multi-ratio transformer, 4/6 extra.

PREMIER SUPPLY STORES Announce the Purchase of the Complete Stock of a World Famous Continental Valve Manufacturer; all the following standard mains types, fully guaranteed, 4/6 each, H. H.L. power, High, Medium, Low magnification and Variable-Mu Screen Grid. Directly heated Pentodes, 1 watt, 3 watt and 4 watt A.C. outputs. 250v. 60 milliamp, full wave rectifier.

THE following Type, 5/6 each; 350 v. and 500 v., 120 milliamp full wave rectifiers, 2/4 watt indirectly heated pentode.

THE Following American Types at 4/6; 250, 227, 112, 171, 210, 245, 26, 47, 24, 35, 51, 58, 55.

ELIMINATOR Kits, including transformer, choke, Westinghouse metal rectifier, T.C.C. condensers, resistances and diagram, 120v., 20 m.a., 20/-; trickle charger 8/- extra; 150v., 30 milliamps, with 4v., 2-4 amps. C.T., L.T., 25/-; trickle charger, 6/6 extra; 250v., 60 milliamps with 4v., 3-5 amps, C.T., L.T., 30/-; 300v. 60 m.a. with 4 volts, 3-5 amps., 37/6; 200v. 100 milliamps, 39/6.

PREMIER chokes, 40 milliamps, 25 hys., 4/-; 65 milliamps, 30 hys., 5/6; 150 milliamps, 30 hys., 10/6; 60 milliamps, 80 hys., 2,500 ohms, 5/6; 25 milliamps, 20 hys., 2/0.

ALL Premier Guaranteed Mains Transformers have Engraved Terminal Strips, with terminal connections, input 200-250v., 40-100 cycles, all windings paper interleaved.

PREMIER H.T.7 Transformer, output 135v. 80 m.a. for voltage doubling, 8/6; 4v. 3-4a., C.T. L.T. 2/- extra; with Westinghouse rectifier giving 200v. 30 m.a., 17/6.

PREMIER H.T.8 and 9 Transformers, 250v., 60 m.a., and 300v. 60 m.a. rectified, with 4v. 3-5a. and 4v. 1-2a, C.T. L.T. and screened primary, 10/-; with Westinghouse rectifier, 18/6.

PREMIER H.T. 10 Transformer, 200v. 100 m.a., rectified with 4v. 3-5a., and 4v. 1-2a. C.T. L.T., and screened primary, 10/-; with Westinghouse rectifier, 19/6.

PREMIER Mains Transformer, output 250-0-250v. 60 m.a., 4v. 3-5a., 4 v. 2-3a., 4v. 1-2a. (all C.T.) with screened primary, 10/-.

PREMIER Auto Transformers, 100-110/200-250v. or vice versa, 100-watt, 10/-.

WESTERN ELECTRIC Mains Transformers, 300-0-300v. 65 m.a., 4v. 1-2a., 4v. 2-3a., 6/6; 500-0-500v. 150 m.a., 4v. 3-5a., 4v. 2-3a., 4v. 2-3a., 4v. 1a. C.T., 4v. 1a. C.T., 19/6; 1,000-0-1,000v. 250 m.a. 4v. 3a. C.T., 4v. 3a. C.T., 49/6; 2,000-0-2,000v. 150 milliamps, 49/6.

SPECIAL Offer of Mains Transformers, manufactured by Philips, input 100-200v. or 200-250v., output 180-0-180 volts 40 m.a., 4v. 1 amp., 4v. 3 amps., 4/6; 200-0-200v., 4v. 1a., 4v. 3a., 4/6.

PREMIER L.T. Charger Kits, consisting of Premier transformer and Westinghouse rectifier, input 200-250v., A.C., output 8v. 1 amp., 14/6; 8v. 1 amp., 17/6; 15v. 1 amp., 19/-; 6v. 2 amp., 27/6; 30v. 1 amp., 37/6; 2v. 1/2 amp., 11/-.

B.T.H. Trussed Induction Type (A.C. only) Electric Gramophone Motors. 100-250v.; 30/- complete.

COLLARO Gramo. Unit consisting of A.C. motor, 200-250v., high quality pick-up and volume control, 49/-; without volume control, 40/-.

Continued at top of column three

Easy Terms

Why wait weeks for that new Radio accessory? You'll get it quicker from N.T.S. Any items advertised in this journal on Easy Terms. Strict Privacy Guaranteed. Cash or C.O.D. if preferred. Orders over 10s. Carriage and C.O.D. Charges Paid. SEND FOR QUOTATION FOR ANYTHING IN RADIO YOU ARE NEEDING.

W.B. STENTORIAN SENIOR P.M. MOVING-COIL SPEAKER

SENT ON 7 DAYS' TRIAL.

5/9 DOWN

Type PMS1. For Power, Pentode, and Class "B". Send only 5/9 for 7 days' trial. If approved, balance in 7 monthly payments of 5/9. Cash or C.O.D. Carriage Paid £2/2/0.



TELSEN S.G.3 KIT

Complete kit of parts for building. Send only 2/6, balance in 8 monthly payments of 5/-. Cash or C.O.D. Carriage Paid, £1/19/6.

2/6 DOWN

If valves required, add £1/11/6 to Cash Price or 2/6 deposit and 6 monthly payments of 5/-.



BLUE SPOT "STAR" MOVING-COIL SPEAKER

SENT ON 7 DAYS' TRIAL.

5/- DOWN

Complete with universal matching transformer. Send only 5/- for 7 days' trial. If approved, balance in 11 monthly payments of 6/8. Cash or C.O.D. Carriage Paid, £3/10/0.



BLUE SPOT "STAR" JUNIOR Permanent-Magnet Moving-Coil Speaker with 12pt. matching transformer suitable for all outputs. Send only 2/6 for 7 days' trial. If approved, balance in 7 monthly payments of 5/-. Cash or C.O.D. Carriage Paid, £1/15/0.

N.T.S. CLASS 'B' SPEAKER-AMPLIFIER

"JUST PLUGS-IN."

GIVES SEVEN TIMES THE VOLUME, READY ASSEMBLED WITH CLASS B VALVE.

5/- DOWN

Send only 5/- and instantly convert your present set to Class "B" output. Balance in 10 monthly payments of 5/-. Cash or C.O.D. Carriage Paid, £2/10/0.



ATLAS ELIMINATOR

SENT ON 7 DAYS' TRIAL.

3/6 DOWN

Model C.A.25. Suitable for all outputs, including Class B and Q.F.P. 100/250 volts A.C. Send only 3/6 for 7 days' trial. If approved, balance payable in 11 monthly payments of 5/6 (or cash in 7 days £2/19/6). D.C. Model 16/25 B. Cash or C.O.D. Carriage Paid, £1/19/6, or 2/6 down and 8 monthly payments of 5/-.



New Times Sales Co.

56, LUDGATE HILL, LONDON, E.C.4.

Dear Sirs:

(a) Please send me.....

(b) I enclose Cash/Deposit.....

NAME.....

ADDRESS.....

Pr. W. 18/8/34.

FIRST WITH EASY TERMS IN 1924

(Continued from foot of column one.)

SPECIAL Offer B.T.H. Gramophone Motors, A.C. and D.C., 100/250v., 30/-. Listed £3/3/-. EDISON Bell Double Spring Gramophone Motors, complete with turn-table and all fittings, a really sound job, 15/-.

SPECIAL Offer of Wire Wound Resistances, 4 watts, any value up to 50,000 ohms, 1/-; 8 watts, any value up to 15,000 ohms, 1/6; 15 watts, any value up to 50,000 ohms, 2/-; 25 watts, any value up to 50,000 ohms, 2/6.

WIRE Wound Potentiometers, 15,000 ohms, 1/6; 50,000 ohms 2/-; 500,000 ohms, 3/-; 1,000 ohms wire-wound semi-variable resistances, carry 150m.a., 2/-.

CENTRALAB Potentiometers, 50,000, 1 meg. any value, 2/-; 200 ohms, wire wound, 1/-.

POLAR Star, manufacturers' model, 3-gang condensers, fully screened, 7/6; with trimmers.

AMERICAN Triple Gang 0.0005 Condensers, with trimmers, 4/11; Utility Bakelite 2-gang 0.0005 screened with uniknob trimmer, 3/6; Polar Bakelite condensers, complete with knob, 0.00015, 0.00035, 0.0003, 0.0005, 1/-.

ORMOND Condensers, 0.0005 2-gang semi-shielded, 2/6; brass vanes, with trimmers, 3/6. British Radiophone 110 k/s Intermediate, 3/-.

MAGNAVOX D.C. 152, 2,500 ohms, 17/6; D.C.154, 2,500 ohms, 12/6; D.C.152 magna, 2,500 ohms, 37/6, all complete with humbucking coils; please state whether power or Pentode required; A.C. conversion kit for above types, 10/-; Magnavox P.M. 7in. cone, 18/6.

RELIABLE Canned Coils with Circuit, accurately matched, dual range, 3/- per coil; ditto, iron-cored, 3/6.

RELIABLE Interval Transformers, 2/-; multi-ratio output transformers, 4/6.

HELLESEN 8 mf. Electrolytic Condensers, 435 volts working, 2/3; Mershon ditto, 1/9.

POLAR 2-gang Uniknob Condenser with Trimmers and complete slow-motion Dial, 6/-.

WESTERN ELECTRIC Condensers, 250v. working, 2 mf., 1/-.

T.C.C. Electrolytic Condensers, 550v. working, 650v. peak, 8 mf., 4/-; 4 mf. or 8 mf. 440v. working, 3/-; 15 mf. 50v. working, 1/-; 25v. working, 25 mf., 1/3; 6 mf. 50v. working and 2 mf. 100v. working, 6d.

T.C.C. Condensers, 250v. working, 2 mf., 1/9; 2 mf. 1,500v. working, 6/-.

M.V. Condensers, 400v. working, 4 x 4 x 1 x 1 x 1 x 1 x 0.1 x 0.1 x 0.1, 4/9; 4 x 2 x 1 x 1 x 1 x 1 x 0.5, 3/9.

UBILIER Condensers, 8 or 4 mfd. dry electrolytic 450v. working, 3/-.

VARLEY Constant square Peak Coils, band-pass type BP7, brand new in maker's cartons with instructions and diagrams, 2/4.

VARLEY H.F. Interval Coils, BP8, band-pass complete with instructions in original cartons, 2/6.

SCREENED H.F. Chokes by One of the Largest Manufacturers in the Country, 1/6.

PREMIER British-made Meters, moving Irons, flush mounting, accurate, 0-10, 0-15, 0-100, 0-250 m.a., 0-1, 0-5 amps, all at 6/-.

LARGE Selection of Pedestal, table and radio-gram. cabinets, by best manufacturers, at a fraction of original cost, for callers.

THE Following Lines 6d. Each, or 5/- per dozen.—Chassis valve holders, 5-, 6-, or 7-pin, screened screengrid leads, any value 1-watt wire end resistances, wire end condensers, 0.0001 to 0.1 Bublein 3-amp. main switches. Cylcon capacitors, dougtr trimmers.

PREMIER SUPPLY STORES

20-22, High St., Clapham, S.W.4. Telephone: Macaulay 2188. Nearest Station, Clapham North Underground.

VARLEY Constant Square Peak Band-Pass Coils, type B.P. 6. Complete, all accessories and instructions. New, boxed, 2/4. (List, 15/-)

POLAR 3-gang Star Minor Condenser, full screened, trimmers, new, 7/- (List, 18/9)

ERICSSON 3-1 L.F. Transformers, new and guaranteed, 2/3. (List, 17/6)

COLLARO Electric Gramo Motor A.C. 100-250v. with pick-up and volume control. Auto Start and Stop. Brand new. List price, £4. Our price, 47/6 carr. paid. Bankrupt set maker's stock.

VOLUME Controls, 60,000 ohms, New, 1/3.

CELESTON Energised M.C. Speaker, 2,500 ohms. Model D.C. 2054, with universal transformer. List price, £2/5/0. Our price, 12/6.

PIONEER RADIO MFG. CO., LTD., Coptic Street, London, W.C.1. Museum 9607.

ELIMINATORS, 25 m.a., D.C. 10/-, A.C. 21/-; Transformers 3-1, 5-1, 1/9. British-made valves, H.F., L.F., and Decat., 1/9. Power 2/- S.G. 5/- Carriage Paid Cash with Order.—Radio Electrical Supplies, 237, Camberwell Road, London, S.E.5.

"MELFO-RAD" for all Receivers, Kits, Components, etc.—Lowest prices—Cash/C.O.D. or H.P. Quotations and Lists Free.—Queen's Place, Hove. (Trade Supplied.)

WANTED, good Modern Wireless Parts, Sets, Eliminators, Meters, Valves, Speakers, etc., Spot Cash waiting. Send or bring. We pay more than any other dealer. Open 9-8.—University Radio, 142, Drummond St., Hampstead Rd., N.W.1.

MORE AMAZING BARGAINS BY OLYMPIA RADIO LIMITED

1934 Model EKCO K.25 A.C. Eliminator. 25 m/a output. Variable S.G., Tapping. Complete with Trickle Charger, for 2, 4 or 6-volt Accumulator. List price £5/7/6. Our price 45/-.

CELESTION Soundex P.M. Moving Coil Loud-speaker. List price 27/6. Our price 12/9.

CELESTION P.P.M./W. List price 45/- Our price 17/6.

RAMPIAN Nipper P.M. Loudspeakers. List price 27/6. Our price 17/6.

RAMPIAN P.M. Dual "Owl" Loudspeakers, complete with Baffle. List price 55/- Our price 27/6.

AMPLION A.R.19 Horn Loudspeakers with Wooden Flare. Original List price 105/. Our price 9/11. Ideal for Extension Loudspeaker.

REVO Horn Loudspeakers—Metal Flare. Original list price 65/. Our price 6/11. Suitable for Extension Speaker.

UNIVERSE Pickup and Tone-arm complete with Volume Control. List price 22/6. Our price 12/11.

IGRANIC 2 Gang Condensers complete with cover. (plain boxes). List price 12/6. Our price 6/9.

IGRANIC 3 Gang Condensers. List price 17/6. Our price 8/11.

IGRANIC Transformers—3-1 and 5-1. List price 10/6. Our price 3/6 each.

IGRANIC Intermediate Frequency Superhet Transformer Unit. List price 10/6. Our price 3/9 each.

IGRANIC Oscillator Coils for same. List price 10/6. Our price 3/9.

IGRANIC Shortwave H.F. Chokes. List price 2/- Our price 1/3.

WE also have a large number of amazing bargains in **BATTERY and A.C. RECEIVERS**—Repossession and Decontrolled Models. Lists on application.

ALSO other numerous bargains in various lines in Components. Please mention this paper when replying. **TERMS**—Cash with order or C.O.D.

ALL Goods Carriage Paid.

EVERYTHING guaranteed O.K.

MONEY refunded if not satisfactory.

OLYMPIA RADIO LTD., Mail Order Department, 49a, Shudehill, MANCHESTER. BRANCHES in all Principal Towns.

334-35 SENSATION! Everybody can keep their 2-volt Accumulators in perfect condition and fully charged for 8/3 per annum. Ideal for remote districts, where there are no mains. Chargers from 7/- Full particulars, stamp—"Tonic" Chargers, Stourbridge Road, Halesowen, Birmingham.

VAUXHALL—Magnavox permanent magnets, universal, suitable for Class "B" power or pentode, 6in. cone, 15/6; 7in. cone, 17/6; 10in. cone, 23/-; mains energised 2,500 or 6,500, 10in. cone, 23/-; 7in. cone, 15/3; brand new, with humbucking coils; state power or pentode transformer; unused manufacturers' stock; immediate delivery.

VAUXHALL—Westectors, W.4, 5/9. Rectifiers H.T.8, 9/6; H.T.9, 10/9. B.T.H. True Speed and Collaro Motors, 32/6, with pick-ups, 49/- complete.

VAUXHALL—Radiophone, Radiopaks, complete with volume control and Lucerne station named scale and esutcheon, state type, 32/6; intermediate transformers for above, with terminals, 6/-; coils set of 3 on base with switch and terminals, 16/6; 3-gang condensers, super-het., 14/6; ordinary type, 12/6; disc drives, complete, 4/9.

VAUXHALL—Pick-ups from 8/- to £2; state make for quotation; volume controls, all values, with switch and knob, 3/6; gramophone switches, 3/6.

VAUXHALL—Benjamin, Class B, transformers, 1-1 1/2 to 1, 6/6; Radiophone, Class B, 10/-; L.F. transformers, 3/-.

VAUXHALL—Resistors; Dubilier, 1-watt, 7d.; tubular condensers, all values, from 4d.; Clix valve holders, 4.5 pin terminal, 7d.; 7-pin chassis type, 7d.; W.B. ditto, 4.5 pin, 4 1/2d.

FREE Service—Home constructors' queries; write details fully; send postcard for lists. Valves, Etc., Cash with Order or C.O.D. Post Paid 2/6 or over.

VAUXHALL UTILITIES, 163a, Strand, W.C.2 (facing Bush House, S.E. Wing). Temple Bar 9338.

RADIALADDIN (Disposals), Ltd., exchange your old set for any new model, balance cash or H.P. Write for free booklet and quotation to largest radio exchange in U.K. Also clearance sale of reconditioned sets and radiograms at gift prices £1 to £10.—46, Brewer Street, Piccadilly Circus, W.1. Ger. 4055.

FREE No. 1 Wireless List now ready. Knockout Prices. Exchanges arranged. Exchange Mart, 67, Porter St., Hull.

PIANO Accordeons, Saxophones, Guitars. Send for Free Catalogues. Easy Terms.—Hessys', 18/20, Manchester Street, Liverpool.

YOUNG men trained for all branches of Wireless Profession. Britain's leading College, situated on sea-front. Boarders accepted. Training fee payable after appointment. Prospectus free. The

WIRELESS COLLEGE, COLWYN BAY.

ENGINEERS—IMPORTANT OFFER

As the leading Institute of its kind in the World, we offer to prepare you at home for the A.M.I.Mech.E., A.M.I.E.E., A.M.I.A.E., or similar qualification, on the distinct understanding that if you fail your Examination your tuition fee will be returned to you in full. Realise what a difference a few letters after your name will mean to you, and you will realise the value of our extraordinary offer to prepare you on "NO PASS—NO FEE" terms.

Our record in the above Examinations is over 95% successes.

Whatever your age or experience you should apply immediately for a copy of our hand-book "ENGINEERING OPPORTUNITIES," giving details of all leading Engineering Examinations, and over 100 Courses in all branches of Civil, Mech., Elec., Motor, Radio and Aero. Engineering. This book is sent free and without obligation.

BRITISH INSTITUTE OF ENGINEERING TECHNOLOGY, 390, SHAKESPEARE HOUSE, 29/31, OXFORD STREET, LONDON.

Write for Illustrated Catalogue of RADIO-GRAMOPHONE CABINETS

of exclusive modern design, made by craftsmen, in highly figured Oak, Walnut or Mahogany, post free.

REMARKABLE VALUES. Cabinets made to order a speciality.

Maker, under license, of the **HOWE BOX BAFFLE.**

Recommended by the B.B.C. Full details on request.

GILBERT Cabinet Maker - SWINDON Estimates Free Est. 1866.



NEVER AGAIN WILL YOU BE ABLE TO BUY OSBORN CABINETS

AT 50% OFF LIST PRICE.

TO MAKE ROOM FOR OUR EXHIBITION MODELS, A CATALOGUE OF WHICH IS NOW READY, POST FREE,

THIS IS OUR SENSATIONAL OFFER. ONLY 600 TO BE SOLD.

Call at our showrooms:

21, Essex Road, ISLINGTON. (Adjoining Collins' Music Hall.)

PERMANENT L.T.

Get permanent L.T. with WATES L.T. BATTERY. Supplies abundant current for average receiver for one year. No bother. Compact. Very low upkeep cost. A real investment. No troublesome accumulator charging. £1. Carriage paid. Standard Wet H.T. Battery. 120 v. 12,500 m.a. Lasts years. Saves pounds. £2. carriage paid. Wet H.T. Battery Co., 26, Lisie Street, London, W.C.2.

PATENTS AND TRADE MARKS. KING'S PATENT AGENCY, LTD., 146b, Qn. Victoria Street, E.C.4, offer "Advice Handbook" and Consultations free. 49 years' references. Write, call, or phone. Phone: City 6161. Director, B. T. King, C.I.M.E., Reg. Patent Agent, G.B., U.S.A., and Canada.

RADIO SUPPLIES

Send your list of Radio needs for our quotation, Kits, Parts, Sets, etc. Everything in Radio stocked, prompt delivery. 7 days' approval. Catalogue free. Taylex & Standard Wet H.T. replacements stocked. N. TAYLOR, 9, GROVE RD., BALHAM, S.W.12.

FREE ADVICE BUREAU COUPON

This coupon is available until August 25th, 1934, and must be attached to all letters containing queries. PRACTICAL WIRELESS, 18/8/34.

SOUTHERN RADIO'S Bargains.—Manufacturer's guaranteed surplus.

VARIABLE Condensers.—Lotus. All 0.0005. Complete with dials, escutcheons, knobs. Fully screened with trimmers. 3-gang, 12/6; 2-gang, 8/6; single, 4/9. (List 9/6.) Hydra block condenser, 16 mfd. (2x2x8x2x1x1), 1,000v. D.C., 7/- Dubilier 4 mfd. (2x1x1), 1,000v. D.C., 2/9; Utility Midget 2-gang, variable condensers, 0.0005, with concentric trimmers, 3/5.

SPEAKERS.—Blue Spot permanent magnet, universal transformer for power, super power, pentode and Class B, 23/- (list 39/6); Celestion Soundex permanent magnet, 15/- (list 27/6).

BLUE Spot, genuine 100U, inductor speaker on B chassis; 13/6 (list 39/6).

IGRANIC Coils, set of four (1 osc., 2 I.F. with pig-tails, 1 I.F. plain), 12/6 (list 50/-).

IGRANIC Band Pass, 3 Coils Unit iron-core, screened on base, with switch; 14/- (list 33/-).

LSSEN Super-het. 3 Coils Unit, screened, ganged on base with wave-change and filament switches; type LN5181 for battery or mains, 12/6 (list 30/-).

VARIABLE Constant Square Peak Coils, with all accessories, new, boxed; BP5; 2/4 each (list 15/-).

VARIABLE H.F. Inter-valve Coils, BP6, 2/3 (list, 8/6).

5-VALVE Class B Superhet, Chassis by Plessey, 5-wired ready for use, with 5 Mullard valves, new, in sealed cartons, £3/17/6; (list £12/12); valves alone are priced £3.

EKCO A.C. Eliminators, each new and boxed in original sealed cartons, type K25, with trickle charger, 25 milliamps, 39/6 (list £5/7/6); type A.C.25, 33/6 (list £3/17/6); type K.12 with trickle charger, 37/- (list £3/17/6); Ekco trickle chargers, type T.C.1., for 2-4 and 6-volt accumulators, 20/- (list 42/-).

LSSEN Base Revolving Turntables, 1/6 (list 5/-).

SPECIAL Offer of Lewcos Spaghetti Resistances, all sizes, in original sealed boxes, 4/- per dozen, assorted.

MAINS Transformers.—Full list of mains transformers and chokes sent free; specials can be supplied in 3 days; transformers and chokes guaranteed 12 months.

MISCELLANEOUS.—Rotorohm and Radiophone volume controls, all values, 3/- switch, 3/3 (list 10/6); Westinghouse metal rectifiers, H.T. 6, 7, 8, 9/3 each; Ferranti chokes, 20 henry 60 m.a., 6/9 each.

ALL Goods Guaranteed and Sent Carriage Paid. BRANCHES at 271-275, High Rd., Willesden Green, N.W.10, and at 46, Lisie St., W.C.2. Please send all post orders to 323, Euston Rd., N.W.1. SOUTHERN RADIO, 323, Euston Rd., London, S.N.W.1 (near Warren St. Tube). Phone: Museum 6324.

ALL goods advertised in last week's issue still available. WARD, 2nd floor, 45, Farringdon Street, London, E.C.4. Telephone: Holborn 9703.

WOBURN RADIO'S New purchase of Resistances, etc.

RESISTANCES: Bargain parcels of resistances: Parcel "A" containing 13 resistors, all 1 1/2 watt, wire wound accurate to 1%, comprising one of each: 100, 400, 500, 1,000, 2,500, 5,000, 10,000, 15,000, 20,000, 25,000, 40,000, 50,000, 100,000, every one guaranteed perfect. 3/9 lot, post 3d. Parcel B, containing 26 resistors, including all the above and thirteen additional useful values, including several 2 watt, 7/6 post free.

WESTERN ELECTRIC MICROPHONES, boxed, very sensitive at 2/6 each, also transformers for use with above (ratio 85/1), 2/6.

WESTINGHOUSE rectifiers: Special offer 6v. 1 amp, 5/8. 6 v. 1 amp, 4/8. H.T. 8 and 9, 9/6. Dubilier Condensers, 2 mfd, 1,000 v. test, 1/4. Dubilier dry electrolytics, 4 mfd., 500 v. and 8 mfd. 450 v., 3/-. Wego Condensers, 750 v. test, 1 mfd., 1/- 2 mfd., 1/2. 4 mfd., 2/3. Tubulars: .02, .01 and 1, 6d. S.W. H.F. Chokes, 10d. Radiophone Straight Line Dials, with esutcheon (list, 8/6), 3/9. Toggles, 6d.

W.R.C. Eliminators, all guaranteed 12 months. 150 v. 30 m.a. D.C. Model, 9/6. A.C. Model, 21/-. Universal AC/DC model, 21/-. A.C. Model with trickle charger (2 v., 4 v., 6 v., 1 amp.), 32/6. Carr. 1/- extra.

VALVES.—Let us quote for your valve and component requirements. WOBURN RADIO CO., 9, Sandland Street, W.C.1. Holborn 7280.

REPAIRS—REWINDING—OVERHAULS. English and American receivers, Conversions D.C. to A.C. New Cones and coils fitted to moving coil speakers. Chokes, L.F. and mains transformers and eliminators. All repairs guaranteed laboratory tested with quick service. Trade discount. Write REPAIR DEPT. A.

WEDDON POWER LINK RADIO CO., 80, Lonsdale Avenue, London, E.6. (Grangewood, 1837.)

OUR new lists, which are packed with useful information, are ready. Constructors of chokes, Transformers, and Coils should apply immediately.—Lumen Electric Coy, 9, Scarisbrick Ave., Litherland, Liverpool 21.

HUGE RADIO CLEARANCE!

COMPLETE AUGUST LISTS NOW AVAILABLE. ENCLOSE 3d. STAMPS FOR "THE RADIO GOLD-MINE" TO-DAY.

- 27/6 CLASS B A.C. ELIMINATOR KITS with full assembly instructions.
- 22/6 CL. B. III SEALED KITS. An unprecedented bargain.
- 18/6 S.G. III KITS. Complete in sealed cartons. Full diagrams.
- 17/6 A.C. ELIMINATOR KITS, 25 ma. State mains voltage.
- 14/6 ORMOND PERMANENT MAGNET. P.M. SPEAKERS (list 27/6).
- 12/6 SHORT-WAVE III VALVE KITS. Will tune in the world.
- 10/6 CLASS B CONVERSION KITS. Complete in sealed cartons.
- 10/6 STRAIGHT III KITS. In sealed cartons, with full instructions.
- 10/- SAMPLE BARGAIN COMPONENTS Parcel. Guaranteed value, 30/-—40/-.
- 8/6 SHORT WAVE ADAPTOR KITS, complete to last screw. Full instructions.
- 6/10 BLUE SPOT 66K SPEAKER UNITS. List 15/-.
- 6/6 D.C. ELIMINATOR KITS, with full instructions and sundries. Sealed.
- 6/6 WESTERN ELECTRIC PENDANT MIKES (list 15/6), a real quality microphone.
- 5/11 ORMOND TWIN GANG condensers with S.M. disc drive (list 12/6).
- 5/11 BALDWIN UNITS, for horns. Public addresses, etc. (list 21/-).
- 5/- SAMPLE BARGAIN SUNDRIES PARCEL. Guaranteed value, 15/-—20/-.
- 4/11 A.V.C. UNITS (list 10/-), with full instructions for any battery receiver.
- 4/11 WESTINGHOUSE H.T.5; H.T.6; H.T.7; rectifiers.
- 4/11 H.T.8; H.T.9 MAINS TRANSFORMERS, boxed.
- 3/11 LISSON OUTPUT TRANSFORMERS—1:1; 3:1; 8:1; 23:1. (list 17/6).
- 3/11 WESTINGHOUSE L.T. RECTIFIERS, 4-amp. 4 volt; 6 volt.
- 3/3 IGRANICORE, iron core coils (list 10/6).
- 3/3 FAST AND SLOW MOTION, air-spaced variable condensers.
- 2/11 Dr. NESPER, 4-pole bal armature units (list 10/6).



HEAYBERD MAINS APPARATUS ON STAND 24

Visit Stand 24 at Olympia and inspect the wide range of Mains Units, Transformers, Battery Chargers, Amplifiers and Chokes, etc. The Mains Unit, illustrated above, is the NEW model 15/50. Below are four interesting points about this Unit.

- 1 The Voltage regulation remains practically constant throughout the whole range of 15-50 ma.
 - 2 Can be used with extremely satisfactory results for Class "B" operation.
 - 3 Excellent smoothing. Absolutely free from all hum and background.
 - 4 GUARANTEED THREE YEARS.
- The 15/50 is housed in a neat metal case with bakelite panel carrying controls. MODEL 15/50—Output 150v. at 15-50 ma. H.T.1 variable 40-110 v. H.T.2 variable 60-130v. H.T.3 fixed 150v.

PRICE 89/6.



Heayberd Mains Transformers are constructed from the finest quality

BRITISH materials, and made by British craftsmen. When you require a transformer—Remember Heayberd are Mains Specialists and their products are constantly being specified by the leading set designers. IF YOU CANNOT VISIT THE SHOW, cut out this advt. and send, with 3d. in stamps, for New 1935 Radio Handbook.

Mr.

PRA

F.G. HEAYBERD & CO.,
10, Finsbury St.,
LONDON, E.C.2.



MONARCH OF THE MAINS.

PEARL & PEARL

190, Bishopsgate, London, E.C.2. All the following bargains guaranteed new goods. Cash or C.O.D. Carriage Paid.

- SOVEREIGN Iron Cored Coils, with circuits, 2/11 each.
- IGRANIC Pentode tapped Choke, provides tappings from 1-1 to 8-1. List 7/6; our price 3/11.
- TRIOTRON 4-pole, balanced armature speaker units, type "B"; sensitive, beautiful tone; list 22/6, our price 6/11.
- MARCONIPHONE 2-Valve Receivers with Speaker and Marconi valves, in handsome oak cabinet. 28/11 Carriage Forward.
- All Mail Orders Direct to PEARL & PEARL, 190, Bishopsgate, London, E.C.2. Tele: Bishopsgate 1212.
- BANKRUPT Bargains. New list free. Part exchange. All the clearance lines. Burgoyne Class B 3v complete 24. Lotus AC 8G, Det and Pentode, MC bandpass 26.
- Regentone WIA 30 ma eliminators 32/6. Dulci DC 9/6. Celestion Soundex 11/-, ditto PPM/W 16/-.
- Ormond PM 16/-.
- Triotron Class B 30/-.
- Lissen Super transformers 3/3. Ditto LF chokes 3/3.
- Lissen HFC 1/-.
- Lissen diffs 1/-.
- Igranitic Midget transformers 2/3.
- Ditto Resistance fed 3/-.
- Bakelite transformers 1/6.
- VALVES, condensers, eliminators, sets, etc., all at lowest prices. Butlin, 143B, Preston Road, Brighton.

The "DAILY MAIL" says:—"I recommend 'SUDDEN' with enthusiasm."

SUDDEN
By OLIVER STRANGE

An adventure of "Sudden," the famous outlaw and gunman, at his best. Love, —murder—mystery—humour—all are to be found in this well-drawn picture of the Wild West in its worst days. In an atmosphere redolent of romance, thrill succeeds thrill as the story moves swiftly and surely to a fine dramatic climax.

Obtainable at all Booksellers, or by post 2/10 from Geo. Newnes, Ltd., 8-11, Southampton Street, Strand London, W.C.2.

2/6

ADVERTISEMENT INDEX

	Page
Amplion (1932) Ltd.	619
Automatic Coil Winder and Electrical Equipment Co., Ltd.	626
Belling & Lee	594
British Blue Spot Co., Ltd.	596
British Institute of Engineering Technology	652
British Rola Co., Ltd.	647
Bulgin, A. F., & Co., Ltd.	592
Celestion, Ltd.	595
Clarke, H. & Co. (M/cr.), Ltd.	597
Colvern, Ltd.	594
Cossor, A. C. Ltd.	609
Dubilier Condenser Co., Ltd.	643
Electradix Radios	653
Eugen Forbat	654
Exide	616
Ferranti, Ltd.	620
Fluxite, Ltd.	653
Formo Products, Ltd.	637
General Electric Co., Ltd.	589, 591, 610
Gilbert	652
Graham Farish, Ltd.	625, 645
Heayberd, F. C., & Co.	Inside Back Cover
High Vacuum Valve Co., Ltd.	651
International Correspondence Schools	646
Jackson Bros. (London), Ltd.	641
King's Patent Agency	652
Kolster Brandes	593
Lectro Linx, Ltd.	653
London Radio Supply Co.	647
Lotus Radio (1933) Ltd.	619
Multitone Electric Co., Ltd.	653
New Times Sales Co.	655
Osborn, Chas. A.	615
Peto Scott, Ltd.	Front Cover Strip 615
Pitmans	646
Practical Television	650
Regent Fittings Co.	653
Reproducers & Amplifiers, Ltd.	638
Taylor, N.	652
Telegraph Condenser Co., Ltd.	Page ii Television Supp.
Telephone Mfg. Co., Ltd.	595
Telsen Electric Co., Ltd.	632
The Gramophone Co., Ltd.	598
362 Radio Valve Co., Ltd.	595
Varley, Ltd.	Back Cover
W. T. Henley's Telegraph Works Co., Ltd.	647
Wet H.T. Battery Co.	652
Westinghouse Brake & Saxby Signal Co., Ltd.	Inside Front Cover
Whiteley Electrical Radio Co., Ltd.	631
Wingrave & Rogers	592
Wright & Weaire	596

THE 'GOLD-MINE' CHAIN STORES
BRANCH No. 1 NOW OPEN
For the use of all personal callers. Open Mondays —
Fridays 8.0 a.m. — 6.0 p.m. Saturdays — 1 p.m.
(2 minutes from London U.P.O.)
The 'GOLD-MINE' STORES (phone National 7473
private branch exchange)
24, ALDERSGATE, LONDON, E.C.1.

- 2/11 BRITISH RADIOPHONE VOLUME CONTROLS, 10, 20, 50, 100,000 ohms. 4, 4 megs.
- 2/11 BRITISH RADIOPHONE FULL straight line, dial and knob.
- 2/11 COLUMBIA L.F. TRANSFORMER, 3 : 1, 5 : 1 (list 10/6).
- 2/6 IRON CORED DUAL RANGE COILS, with diagrams.
- 2/3 VARLEY SQUARE PEAK DUAL RANGE COILS (list 15/-), boxed with full diagrams.
- 1/11 L.F. CHOKES, 20 hen., 30 hen. Worth 5/6.
- 1/11 SCREENED DUAL RANGE COILS with 6-terminal base.
- 1/11 MICROPHONE TRANSFORMERS. 100:1. Worth treble.
- 1/2 READY RADIO SHORT-WAVE COILS, 6-terminal base (list 6/6).
- 1/2 ASTRA DIFFERENTIALS, .0001, .00015, .0003, 20 hen. Chokes (list 8/6), 1/11d.
- 1/- POLAR MICA DIELECTRIC Variable Condensers. .0003, .0005.
- 11d. BROWNIE DUAL-RANGE COILS, with reaction. Helsby 2-mfd. condensers, 11d.
- 9d. S-WAVE H.F. CHOKES. Mel. and long wave. 10d. Glazite 3d. 10ft. roll.
- 7d. MICROPHONE BUTTONS, very sensitive, worth 3/-. V holders, 4, 5 pin, 3d.; 7 pin, Gd.
- 6d. ERIE 1 WATT. RESISTANCES, all sizes, 100 ohms—500,000 ohms. 5/- doz.
- 4d. 1 WATT RESISTANCES, all sizes, 250-100,000 ohms, 1-5 megs. 2 watt. 3d.
- 4d. SPECIAL OFFER SPAGHETTI RESISTANCES. All sizes 1000-70,000 ohms. Or 3/- doz. each. FIXED CONDENSERS. .0005, .005, .001, .0004, .001—006; 1, 2 cd.
- 3d. ONLY POST FREE.—Enclose 3d. stamps to-day, for your August number of THE "RADIO GOLD-MINE." By far the most comprehensive lists of up-to-date surplus goods (Kits, components and accessories) yet produced, with a general price level lower than ever before. Avoid delay. Send (enclosing 3d. stamps) to-day.

LONDON EAST CENTRAL TRADING COMPANY (Dept. M.122), 23, Bartholomew Close, London, E.C.1. (Telephone: NATIONAL 7473). Immediate delivery. 24 hour service. Cash or C.O.D.
"The Radio Gold-Mine" 3d. post free to-day from THE 'GOLD-MINE' STORES

PERMEABILITY TUNER

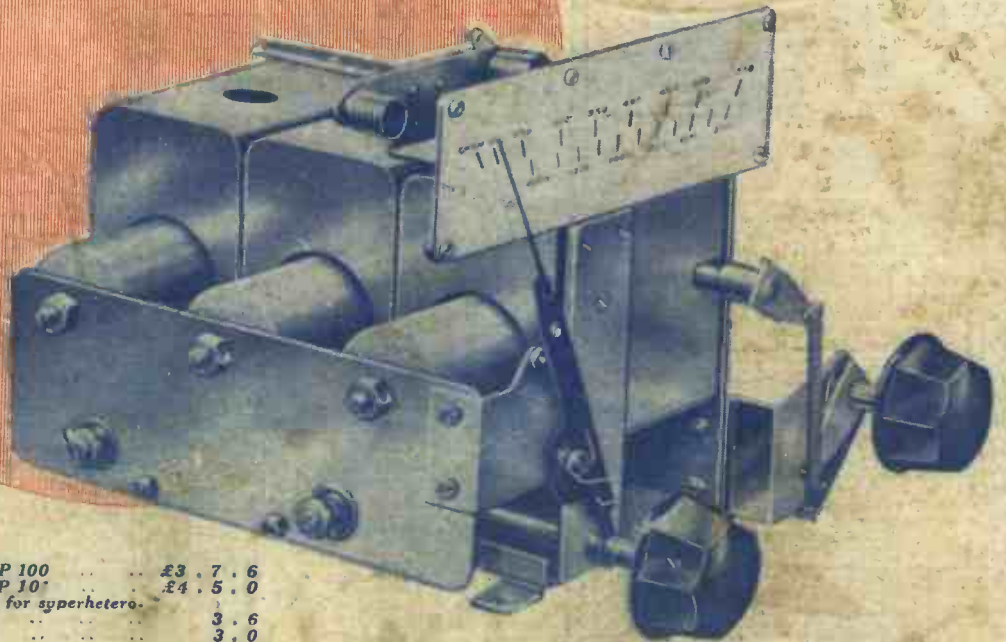

Permeability Tuner (3 gang) BP 100	£3 . 7 . 6
Permeability Tuner (4 gang) BP 107	£4 . 5 . 0
Padding Coil (to convert tuners for superheterodyne use) (110K.C.)	3 . 6
Gramophone Switch attachment	3 . 0

Visit Our
Stand
No. 103
Radiolympia

Both selectivity and quality remain constant over the *whole* of both wavebands ● The inductance of the coil is varied by sliding a powdered iron core into and around the coil ● It is the perfect tuning unit; making possible the design of a receiver giving good quality at all wavelengths—quality obtainable being limited only by station separation and reception conditions ● Both 3- and 4-gang units available. "3-gangs" can be used as a band-pass filter, followed by single intervalve circuit, or as three single tuned circuits. "4-gang" can be used as TWO band-pass filters or as band-pass filter and two single tuned circuits ● Perfect tracking of aerial circuit ● Initial matching of circuits is maintained.

Varley

PROPRIETORS:- OLIVER PELL CONTROL LTD.

FOREMOST AS PIONEERS

Advertisement of Varley (Oliver Pell Control Ltd.), Bloomfield Road, Woolwich, S.E.18.

Telephone: Woolwich 2345

C.6

Printed in Great Britain by NEWNES & PEARSON PRINTING CO., LTD., Exmoor Street, Ladbroke Grove, W.10, and published by GEORGE NEWNES, LTD., 8-11, Southampton Street, Strand, W.C.2. Sole Agents for Australia and New Zealand: GORDON & GOTCH, LTD., South Africa: CENTRAL NEWS AGENCY, LTD. *Practical Wireless* can be sent to any part of the world, post free, for 17/4 per annum; six months, 8/8. Registered at the General Post Office for Transmission by Canadian Magazine Post.

SECOND ENLARGED RADIOLYMPIA NUMBER

Practical Wireless

3^d

Published every Wednesday by
GEORGE NEWNES LTD.
Vol. 4.—No. 101.
August 25th, 1934.
Registered at the G.P.O. as a Newspaper.

AND TELEVISION REVIEW

Edited by F.J.CAMM

COMPLETE SHOW REPORT

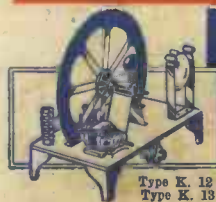

B.T.S. INDIRECT DRIVE DISC TELEVISION RECEIVER KIT

Type K. 12 for A.C. Mains (40-60 cycles) and D.C. Mains 84/-
Type K. 13 for 6-volt Battery 78/-
(If required with B.T.S. Synchronising Gear, 37/6 extra.)

OBTAINABLE from all **FIRST-CLASS RADIO DEALERS**

84

TELEVISION is here! B.T.S., leading the way in this revolutionary new mode of entertainment, make the efficient reception of televised programmes in your home as practical and inexpensive a proposition as ordinary Radio. Works from any Mains Set or Battery Set (of 3 or more Valves); easily assembled by the least experienced in half-an-hour.

requiring no special tools or technical knowledge. Enjoy televised programmes in your home within an hour of purchasing the B.T.S. INDIRECT DRIVE DISC TELEVISION RECEIVER Kit from your local Radio Dealer. Send for Leaflet.

With **FULL-SIZE BLUEPRINT and Assembly instructions.**

BRITISH TELEVISION SUPPLIES, LTD. BUSH HOUSE, LONDON, W.C.2.

ADVT.

Olympia's finest components are on **Stand 38**

Year in, year out, Colvern are constantly experimenting and conducting researches so that their products will keep ever ahead and provide the maximum possible results. And now—the new Colvern components are here—even further advanced in efficiency, precision and design! These improved components will set an entirely new standard in reception—only by fitting them in your set can you be assured of the most brilliant results possible. Do not fail to visit the Colvern Stand at Olympia—No. 38.

Made under licence from patentee, Hans Vagt.

COLVERN

COLVERN LTD., ROMFORD, ESSEX

free BLUEPRINTS OF SPLENDID SPECIALLY DESIGNED "UP TO THE MINUTE" SETS

To COLVERN Ltd., Romford, Essex. Please send me full details and Blueprint of the COLPAK CLASS B A.C. MAINS SET ★
Stamps value 3d. to cover postage are enclosed.

* Strike out name of blueprint not required.

NAME.....

ADDRESS.....

If you would like a copy of our Ferrocart Booklet, please put a X here . . .



Above—The latest type Ferrocart coils, with greater efficiency and more advanced design. Each **12/6**

Below—The New Colpak Tuning Unit, incorporating Ferrocart coils Price complete **57/6**

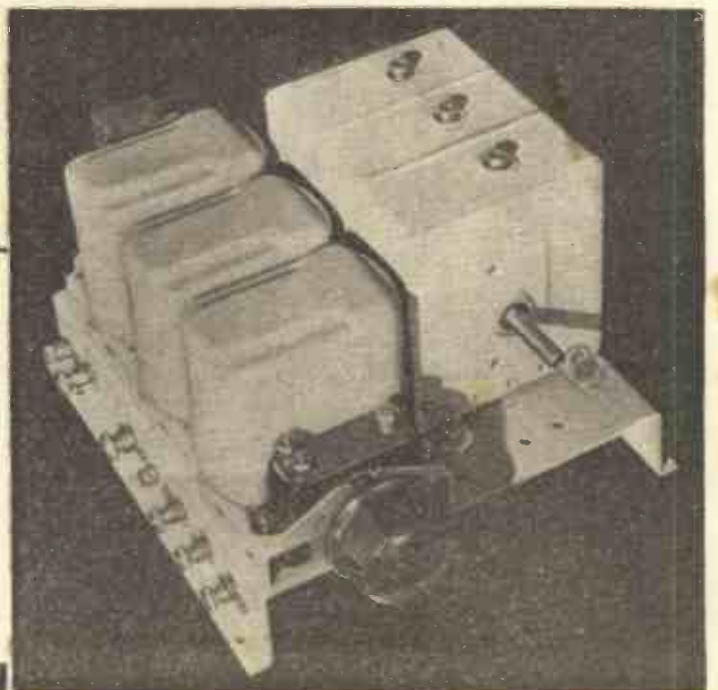

CUT THE CRACKLE OUT OF RADIO

In 80 to 90 per cent. of cases the Belling-Lee Standard Suppressor 1118 is all that is required, fitted preferably at the source of trouble or at the listener's end.

In 10 to 20 per cent. cases chokes are necessary in addition, or one of the other Belling-Lee devices. Accepted methods fully described in new 6d. Book.

See coupon below.



Belling-Lee Standard Condenser Suppressor, No. 1118 ... 10/6



For Small un-earthed electric motors.
Type 1711 .. 8/6



Flashing Sign Suppressor
Type 1172 11/6



Car Radio Interference Suppression Kit
6 cylinder 20/-
4 cylinder 15/6



D.C. Ripple Suppressor
For use when 'hum' on D.C. mains is troublesome, such as when fed from Mercury Arc Rectifiers. Type 1140 £3 7 6



Neon Sign Suppressor
Type 1142 .. £3 15



CONTACT SUPPRESSOR
Type 1144 2/6

Write for NEW Book

A description of the method evolved by the post office and by engineers throughout the world for the suppression of electrical interferences with Radio reception and including results of research work conducted by Belling & Lee, Ltd., with 37 illustrations. From your Radio Dealer price 6d., or post free 6d. by sending the coupon.

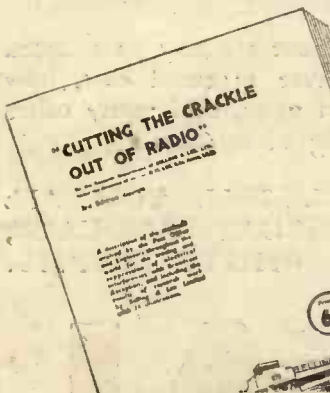

BELLING & LEE LTD
CAMBRIDGE ARTERIAL ROAD, ENFIELD, MIDD.

Please forward your new Book on Disturbance Suppression. Enclosed is 6d. in stamps.

Name

Address

.....Prac. 25.8

SEND
6d.
NOW

THE NEW "J.B." UNIVERSAL "LINACORE"



This new J.B. Universal "Linacore" Tuner is suitable for use with either Battery or Mains valves. It has been designed to make possible the construction of really efficient receivers with the minimum possible complication and the maximum certainty of success. It simplifies set building considerably—and is far more efficient and compact than if home assembled. Complete with volume and reaction controls and all switching. Use this new Universal "Linacore" and get performance like a superhet!

J.B. "LINACORE" UNIVERSAL TUNER (FOR USE WITH BATTERY OR MAINS VALVES) Model B.P.U. (Cat. No. 2129) 65/-

SEE THE NEW "LINACORE" AT STAND 114—RADIOLYMPIA

TO HELP YOU INCORPORATE THE "LINACORE" IN YOUR SET

We are offering you—for only 3d., [4d., post free]—a large broadsheet, "Vivid Radio," containing three full-size blue prints and full wiring instructions for incorporating a "Linacore" in your set. Post the coupon to-day, and be sure of getting **your** broadsheet before they are out of print!

FILL IN THE COUPON AND POST IT TO-DAY



COUPON

To Jackson Brothers (London) Ltd., 72, St. Thomas St. S.E.1

Please send me "Vivid Radio." I enclose 4d. in stamps to cover postage, etc.

NAME

ADDRESS

PRACTICAL TELEVISION



ADAPTING
YOUR SET
FOR
TELEVISION

**NOW
ON
SALE**

6^d

**BUY YOUR COPY
OF NO. 1 TO-DAY.**

*On sale at all Newsagents and
Bookstalls, or by post 7½d.
from George Newnes, Ltd.;
8-11, Southampton Street,
Strand, London, W.C.2.*

THE time cannot be far distant when we look in as well as listen in...

BRING YOUR KNOWLEDGE OF TELEVISION RIGHT UP-TO-DATE BY STUDYING THE PAGES OF THIS NEW MAGAZINE.

Read all about the various systems, how your set may be adapted to receive television, how to make a receiver at small cost, how pictures are transmitted, the latest television news, and many other aspects of this most modern and intriguing of sciences.

"PRACTICAL TELEVISION" WILL TELL YOU ALL ABOUT THE NEW HOBBY IN EVERYDAY LANGUAGE; PRACTICAL DIAGRAMS AND PHOTOGRAPHS.

PRACTICAL TELEVISION



Day in day out, year in year out, the lighthouse carries on with unfaltering reliability . . . guiding and safeguarding the ships that pass. And though their jobs are so vastly different, a condenser has perhaps one thing in common with a lighthouse . . . the need for absolute reliability. That is why so many set-builders are turning to T.M.C.-HYDRA condensers. By doing so they know not only that the condensers will be accurate to start with, but also that they will stay accurate in use. Equip your next set with T.M.C.-HYDRA condensers.

SEE OUR STAND No. 105, RADIOLYMPIA

T.M.C.
BRITISH MADE
HYDRA
CONDENSERS



Strict scientific control of every manufacturing process ensures the accurate rating of every T.M.C.-HYDRA condenser, while a special method of sealing prevents the penetration of moisture, so maintaining the high electrical properties of the condenser. T.M.C.-HYDRA condensers are sold by your radio dealer, but if you have any difficulty in obtaining supplies, write to the Sole Distributors:

T.M.C.-HARWELL (SALES) LTD
Britannia House, 233 Shaffesbury Avenue
London, W.C.2. (A few doors from New Oxford Street)
Telephone: Temple Bar 0055 (3 lines)

Made by TELEPHONE MANUFACTURING Co.Ltd.

AMPLION

"RADIOLUX" ALL-ELECTRIC SUPER-HET

AUTOMATIC VOLUME CONTROL ensuring an even volume being maintained on all stations.

NEON LIGHT VISUAL TUNING.

ILLUMINATED FULL VISION SCALE calibrated in metres and degrees.



ENERGISED MOVING COIL SPEAKER.
GRAMOPHONE PICK-UP CONNECTION.
EXTERNAL SPEAKER CONNECTION.

TWO TONE WALNUT CABINET. Matt finish.
Gold silk grille with ebonite black surround panel. Handsome. Artistic.

The "Radiolux" Super-het
5-valve
(including rectifier)

For A.C. Mains. 200/250 volts and
110 volts (40/100 cycles.)
For D.C. Mains. 200/250 volts. 14 Gns.

14 GNS.

H.P. Terms available.

"RADIOLUX" RADIOGRAM (5-valve A.V.C.) 24 Gns.

"RADIOLUX" AUTOGRAM with 10" Auditorium
M/C Speaker. British Capehart Automatic Record Changer.

SEE THEM ON STAND 63 OLYMPIA
AMPLION (1932) LTD.

82-84 Rosoman Street

London, E.C.1.



KEEPING AHEAD



For nearly forty years "His Master's Voice" have kept ahead by continual development in the science of sound reproduction. When radio came into being, the radio instruments made by "His Master's Voice" immediately took their place in the top rank—not merely because of the research that lay behind them and the brilliance of their design, but because of the unrivalled methods used in their manufacture. The new "His Master's Voice" models, now on exhibition at Olympia, provide what is probably the most sensational proof of the supremacy of "His Master's

Voice" instruments that has yet been seen. It is not possible to describe in detail all the many outstanding improvements that have been made, but the most important are listed below.

- DUO-DIFFUSION SPEAKER
- CONTRAST AMPLIFICATION
- NOISELESS TUNING
- SOUND-TRANSPARENT GRILLE
- ANTI-STATIC "SUPPRESSOR"
- TONE-COMPENSATED VOLUME CONTROL
- VARIABLE BAND-WIDTH

STAND Nos.
61 and 33.

SEE THE NEW "HIS MASTER'S VOICE" MODELS AT OLYMPIA

"His Master's Voice" radio sets range from £7.19.6 upwards. They stand in a class apart! An illustrated list giving full particulars of all the outstanding features is obtainable free from any "His Master's Voice" dealer.

"His Master's Voice"

THE
RADIO
EXHIBITION
OLYMPIA
August 16-25

The Gramophone Company, Limited, 98-108 Clerkenwell Road, London, E.C.1. (Prices do not apply in I.F.S.)

2nd SPECIAL SHOW NUMBER



Practical Wireless

Technical Staff:

W. J. Delaney.

Frank Preston.

H. J. Barton.

Chapple.

Wh. Sch., B. Sc.,

A.M.I.E.E.

VOL. IV No. 101

Editor: F. J. CANN

Aug. 25th, 1934

Military Band Concert from Portrush

A MILITARY Band concert is to be relayed from the Promenade, Portrush, on August 22nd. These concerts are a feature of the season in Portrush, but this is the first to be broadcast this year. The band, which will be conducted by Mr. George Dean (late bandmaster 1st Norfolk Regiment), will be the Belfast Military Band.

Craigantlet Hill Climb

ANOTHER of the annual sporting events in Northern Ireland about which listeners like to hear is the Craigantlet Hill Climb, which takes place this year on August 25th. An eye-witness account will be given early on that evening by Peter Holmes.

Talk on Caravanning

A MIDLAND Regional talk on caravanning will be broadcast by Major Vernon Brook, who is well known to listeners as the commentator on the T.T. Races and Shelsley Walsh hill-climb. Major Brook, whose talk is to be given on August 30th, is hon-secretary of the Caravan Section of the Camping Club. Recently he organized a record meet in Warwick Castle Park, where there were fifty-two caravans.

Southport Flower Show

H. FAIRBANK, of the Cheshire School of Agriculture, will broadcast an eye-witness account of the Southport Flower Show for North Regional listeners on August 22nd. This show is one of the most important events of its kind in the country.

"Ship Ahoy"

THIS is the title of a programme which West Regional listeners will hear on August 23rd. One hundred and seventy Merchant Navy captains have been traced as residing in the county of Caernarvon, and the programme is a relay of the proceedings at their reunion in the Assembly Rooms, Pwllheli. Stirring encounters will be recalled by those whose own experience enables them to appreciate the reminiscences, and several popular sea shanties will be sung.

Oriental Night

THIS is the title of a special feature of the West Country Club on August 28th. It is described as a gala evening in honour of a visit by an Oriental potentate.

Sheep Dog Trials Broadcast

THE National Sheep Dog Trials are being held on September 1st at Denton Park, Ilkley, Yorkshire, for the second year in succession. George Aitchison (who recently described the Rydal Trials) will broadcast a running commentary for North Regional listeners.

Variety from Scottish Regional

ANOTHER excerpt from Harry Kemp's Summer Show will be relayed to Scottish Regional listeners from the Barrfields Pavilion, Largs, on August 31st. The

PRACTICAL TELEVISION

Our New Monthly Magazine

6th EVERY MONTH

IS NOW ON SALE

DON'T MISS IT

artists will be: George West, Jack E. Raymond, The Jee Boys, The Clayton Sisters, Gladys Watson, Harry Carmichael and his Band.

Organ Recital from Caird Hall, Dundee

DR. W. B. ROSS will give an organ recital for Scottish Regional listeners in the Caird Hall, Dundee, on August 28th. Dr. Ross is one of the best-known organists in Scotland and was the first to broadcast an organ recital. He was the founder of the Edinburgh Organists' Society and was its first president.

A Caruso Concert from Blackpool

ENRICO CARUSO'S concert at the Winter Gardens, Blackpool, in the summer of 1909 is being reconstructed by G. H. Dayne, and will form the theme of a special North Regional programme to be broadcast on August 29th—exactly twenty-five years after the original concert took place. Caruso's voice will be heard again by means of gramophone records, and the scene will be described in a running commentary, attention being drawn, for instance, to the presence in the audience of Mr. Eugene Sandow and Mr. George Robey.

Second "Schemes" Talk

THE second of the "Schemes" to be represented in the North Regional talks series of that name is Mr. Walton Maughan's project for a Tyne-Solway Canal. Mr. Maughan, who will outline this scheme on August 24th, is an engineer now resident at Holmfirth, Yorkshire. His canal would link up two of Britain's largest coalfields, and would be wide enough to accommodate battleships; it would, moreover, provide the Air Force with an excellent base. Traversing a high "catchment" area in a district of heavy rainfall, the canal could tap a great source of hydraulic power for the operation of the great vertical-lift locks which would be necessary.

Oboe Recital from Midland Regional

LUCY VINCENT, who will give a recital for Midland Regional listeners with Arthur Roberts (piano) on August 28, was the first woman wind-instrument player in the country to be engaged with a symphony orchestra. She will play Handel's oboe concerto in C minor; three pieces by Sir Hamilton Harty, and, on the cor anglais, an Irish air, "The Bard's Legacy."

A Tennyson Song-cycle

TENNYSON'S "Maud," like his "Locksley Hall" had a Lincolnshire scene, so a broadcast of the song-cycle composed by Arthur Somervell to its words has a Regional appeal. Arthur Cranmer (baritone) is the vocalist who will be heard in this song-cycle on August 29th. Somervell's setting of "A Shropshire Lad" was recently given from Birmingham.

ROUND the WORLD of WIRELESS (Continued)

Novel Broadcast Play from Manchester

PROMETHEUS: a tragedy of ransom and new power" is the title of D. G. Bridson's new modern industrial tragedy in the Greek manner, which will be broadcast from Manchester on August 27th. Although he follows the main lines of the story dramatized by Æschylus in "Prometheus Bound," Mr. Bridson has modernized the characters. Thus Prometheus figures not as a demi-god, but as an engineer in a Northern works; Mankind is represented by the factory workers, and the Gods of Olympus by the Board of Directors. The play is, however, strictly classical in form, embodying a chorus and antiphonal speech.

The Roosters

ON August 30th a relay will be taken for West Regional listeners of an entertainment by the Roosters, the famous wartime all-male concert party, from the Victoria Pavilion, Ilfracombe. There were many War-time concert parties, and the Roosters was one of the few to survive. The party sprang from a scratch show given in the Balkans early in 1917, the personnel being attached to the 60th Division, which was afterwards moved to Palestine.

A Broadcast About Hop Pickers

A **CHEERFUL** radio picture of hopping and the hopping season is to be embodied in a programme entitled "Opping 'Oiday," which Laurence Gilliam and Pat Forrest are preparing for listeners on September 15th. Laurence Gilliam is a B.B.C. producer; Pat Forrest has had a varied career as miner, tramp, farmhand, newspaper reporter, editor, and advertising man. The programme which Gilliam will produce is in four phases. The first will be a shot of hop-pickers leaving London Bridge Station at five o'clock in the morning on the "Hop-pickers' Special." The London Bridge Station sound portion will be followed by a short talk, to be given by an authority on the subject, contrasting hopping of fifty years ago with that of to-day. The third phase will consist of a series of such things as the hiring of hop-pickers, allocation to various living huts, interview with a farm manager, and a description of hopping in progress. The whole of this will be done by an actual relay from a hop farm.

"The Sincerest Form"

NINE London radio stars, including Stanley Holloway, Mabel Constanduros, and Mrs. Feather, will be imitated by Midland contemporaries in a programme on August 28th. The title is "The Sincerest Form." Harold Pollard and Gerald Martin; Alma Vane; Alex Penney and Janet Joye are the vocalists, while Jack Wilson and Jack Hill will represent Harry Pepper and Doris Arnold at the piano. Martyn Webster, the Regional producer, has worked in London with eight of the nine stars to be imitated.

INTERESTING and TOPICAL PARAGRAPHS

Scottish Band Concerts

IN a concert to be given by the Scottish Studio Orchestra, directed by Guy Daines, on August 29th, Alexander Fortune (tenor) will sing a number of popular Scottish songs. The concert will be followed by a gramophone programme entitled "Holidays on Record." This will

NEW MICRO-WAVE ACHIEVEMENT



The Marconi micro-wave beacon receiving equipment installed on the steam yacht "Elettra" for the demonstration recently when the yacht was successfully steered "blind" between two buoys 20 yards apart. Marchese and Marchesa Marconi are seen standing on the bridge in the foreground.

include past and present holiday tunes. The programme has been arranged by Gordon Gildard, dramatic producer to the B.B.C. in Scotland, and the items will be introduced by Pearl Elliott and R. F. Pearson.

Another Scottish Regional band concert will be broadcast on August 29th. The Bonnybridge and District Prize Band will be conducted by Gregor J. Grant. They will play overture, "Raymond," an excerpt from "Tannhauser," and a selection entitled "Sweethearts of Yesterday."

Droitwich Spa Orchestra

IN the sixth of the Sunday evening concerts by the Droitwich Spa Orchestra, the violinist will be Eda Kersey. On August 26th she is to play, with orchestral accompaniment, Max Bruch's concerto in C minor, and, as a solo, "Baal Shem," in which Ernest Bloch gives pictures of Jewish life.

"Road to Ireland"

FILSON YOUNG'S "Road to Ireland" programme will be broadcast on September 3rd in the National programme. This is in commemoration of Thomas Telford, the famous Scottish roadmaker, who died on September 2nd, 1834. The programme is described as "a romantic journey of yesterday and to-day from London to Holyhead."

The characters to be heard are a romantic traveller, a Welsh patriot, a railway porter,

a seaman, etc. There will also be the ghosts of Thomas Telford, a stage coachman, an Irish M.P., and others. In this broadcast listeners will follow Filson Young in a journey through England and Wales to the port for Ireland. That is the road that Telford built over a hundred years ago. It has seen much history since the days of the stage coach which took twenty-seven hours between London and Holyhead. Telford was a constructional genius, who most worthily expressed himself in terms of roads, bridges, and canals.

"Humoresque"

THIS is the title of a programme of amusing pieces which Victor Hely-Hutchinson has chosen for the Midland Studio Orchestra and two pianos on September 1st. The pianists are Margaret Ablethorpe and Maurice Udloff. Gounod's "Funeral March of a Marionette" and Pierné's "March of the Little Leaden Soldiers" will be followed by Bucalossi's "The Grasshopper's Dance" and Bidgood's "A Motor Ride"; while "Le Carnaval des Animaux" by Saint-Saëns will complete the programme.

Shakespeare Plays from Midland Regional

DURING the evening of August 30th a Midland Regional relay of the Coventry Repertory Company's performance of three scenes from Shakespeare will be broadcast. This will also be heard by Empire listeners. The scenes chosen are the Balcony Scene from "Romeo and Juliet" and two scenes from

"Twelfth Night"—the drinking scene, and that between Viola and the Duke, which precedes it. A. Gardner Davies is the producer.

SOLVE THIS!

PROBLEM No. 101.

Jackson found that his reception with a new three valve set was spoiled on account of interference from a nearby power station, and accordingly decided that it would be necessary to screen his receiver. He accordingly lined the cabinet with aluminium foil and earthed this, but as the noise still persisted he used a screened earth and aerial lead, with the screening earthed. The noise was substantially reduced, but in an endeavour to still further eliminate the trouble he replaced the actual aerial with the screened wire and connected the screening to earth. He found then that he received no interference and no signals. Even with reaction pushed to the limit the local station was inaudible. Why? Three books will be awarded for the first three correct solutions opened. Address your envelopes to The Editor, PRACTICAL WIRELESS, Geo. Newnes, Ltd., 8-11, Southampton Street, Strand, London, W.C.2. Entries must be received not later than the first post Monday, August 27th, 1934, and the envelopes must be marked Problem No. 101.

Solution to Problem No. 100.

Martinson overlooked the fact that a resistance of high value was taking the place of a transformer primary of low resistance, and accordingly he should have increased the H.T. applied to the detector valve, in order to make up for the increased voltage drop. One reader appreciated the fact that in Problem No. 99 the S.G. valve was replaced as a detector and that this accounted for the majority of the troubles. A book has therefore been forwarded to W. A. Hogg, 12, Ashover Avenue, Knotty Ash, Liverpool.

ADJUSTING- AND OPERATING THE "SUMMIT"

This Week the Method of Obtaining the Optimum Performance from this Extremely Successful Receiver is Fully and Clearly Explained

SINCE reading the constructional article last week many readers will no doubt have commenced the construction of this most efficient battery-operated receiver. It is unlikely that any difficulties will have been encountered due to the fact that the work entailed is of a particularly simple nature. There is just one point which was not stressed last week, and which should clearly be borne in mind, which is that the spindle and, hence, the mounting bush of the reaction condenser must be insulated from the metalized chassis. This does not present any difficulty, nor does it entail the use of special insulating washers, since it is only necessary to scrape away a little of the metallic surface from the three-ply front member of the chassis immediately round the mounting hole. This can be done quite easily by using the blade of a pocket knife or by means of a strip of glasspaper. Another, and rather neater, method is to remove the surface before drilling the hole; this is done by means of a centre-bit held in the brace.

Setting the Trimmer

There are very few preliminary adjustments to be made, chiefly because of the fact that the tuning condenser is provided with an external trimmer, but it is best to set the star wheel of the other trimmer to about its midway (half-in) position. When this has been carried out it should be found that the external trimmer is somewhere near its midway setting when any station is tuned in. If this state does not obtain, a further slight alteration can, with advantage, be made to the star wheel.

For the benefit of beginners, it might be preferable to explain briefly the battery connections. Dealing first with the battery-cord assembly, the two spade terminals should be joined to the corresponding (red and black, or positive and negative) terminals on the accumulator respectively. The high-tension negative wander plug should be inserted in the negative socket of the H.T. battery, whilst the positive plug

should be given a voltage of 100 to 120, according to the exact battery employed. In any case, the higher voltage is to be preferred on the score of optimum performance.

Grid Bias Voltages

The grid-bias battery fits into the clip provided on top of the chassis, and the G.B. + plug should be inserted into the + socket, whilst the G.B.—2 plug is inserted into the 9-volt socket. The best position for the G.B.—1 wander plug depends upon the

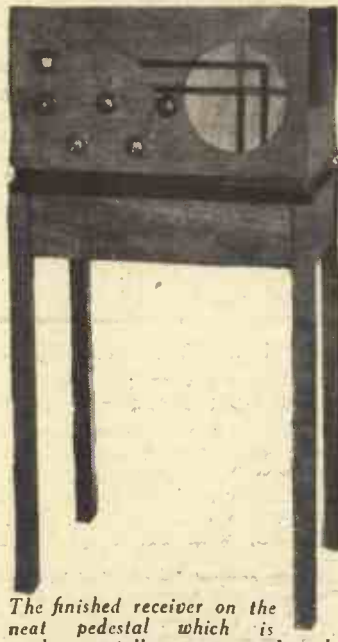

The finished receiver on the neat pedestal which is made especially to accommodate the "Summit" cabinet.

actual voltage of the H.T. battery, but assuming this to be of the voltage recommended, the plug should be placed in the 4½- or 6-volt socket; if the battery is only of about 100 volts, however, this plug should be given from 3 to 4½ volts. No matter which battery is used, it will be worth while to try different positions for the plug, choosing the highest one at which good quality of reproduction is secured. It is important to note that no alteration should be made to the G.B. voltages while the set is switched on; switch off every time an adjustment is to be made.

It is scarcely necessary to point out that the two plugs provided with the L.S. terminal sockets should be connected to the two "outside" terminals on the loud-speaker through a short length of

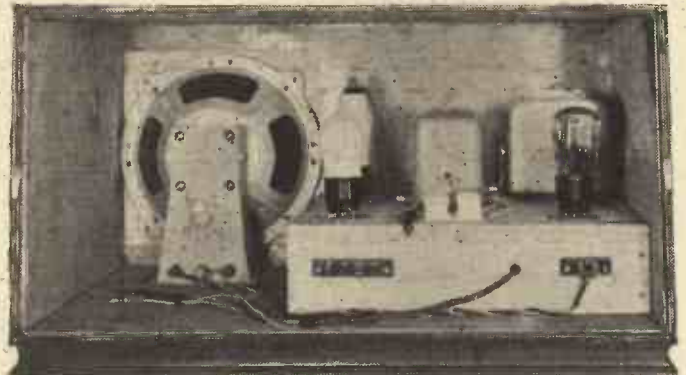

This rear view of the "Summit" illustrates the simplicity of lay-out and the ample battery space.

twin flex. The earth lead should be attached to the plug marked E, whilst the aerial down-lead must be connected to the second plug, this being inserted into the socket marked A2.

When all these connections have been made set the reaction condenser to zero and turn the volume control to the full-on (clock-wise rotation) position. Turn the wave-change switch to the left or right respectively, according to whether medium- or long-wave reception is required. Then switch on and tune to the desired station by rotating the larger knob on the gang condenser. When signals are heard, the smaller (trimmer) knob can be adjusted until maximum volume is obtained. A reduction in volume can then be secured by movement of the right-hand knob.

It will have been observed in studying the circuit diagram that both tuners are fitted with primary windings having two tappings by means of which different degrees of selectivity can be obtained. When testing out the original "Summit" receivers, however, it was found that ample selectivity for all purposes could be obtained by connecting the aerial to the first tapping—that is, to terminal 2—on the type A.D. coil, and by connecting the H.F. coupling condenser direct to the end of the primary winding (terminal 1) on the T.G. coil. Should it ever be found that additional selectivity is required, for instance, when the set is being used "under the aerial" of a powerful transmitter, the aerial lead may conveniently be transferred to terminal 3. Alternatively, leads can be taken from terminals 1, 2, and 3 to the sockets marked A1, A2, and A3 respectively on the chassis terminal strip. Additionally, the lead from the tubular condenser which is shown as being connected to terminal L on the T.G. coil can be transferred to terminal 2 or 3.



It can be seen from this illustration that the top of the chassis is almost free from wiring.



The Lissen New Process H.T. battery which is recommended for the "Summit."

MODERNIZING YOUR RECEIVER

In this Article the Author Describes Several Improvements that Can Easily be Made to the Battery Receiver. By J. EVANS

It is often argued nowadays that home construction of receivers is not worth while, as commercial sets can be obtained so cheaply. The great advantage derived from home construction does not lie in the initial saving, however, but in the fact that the circuit arrangement of the receiver is known to the owner, thereby enabling him to effect modifications with confidence when more efficient valves and components are placed on the market. The three-valve receiver employing screened H.F. valve, detector, and pentode is still the most serviceable and the most popular type for the average listener. The superhet is, of course, more selective, but it has its inherent disadvantages, and as yet does not compare favourably with the well-tried S.G. three. In this article it is, therefore, proposed to suggest certain

for the S.G. screen voltage and an anode feed for the detector valve, but in conjunction with the 2 mfd. condenser it also effectively decouples the detector anode circuit, and therefore helps to stabilize the receiver.

Fitting a Diode Detector

It is a well-known fact that the ordinary leaky grid detector valve introduces a certain amount of distortion, because it acts as a rectifier and as an amplifier, and, owing to the fact that for effective rectification the valve has to be worked on the bend of its curve, undistorted amplification cannot be obtained. In the interests of quality reproduction it is therefore advisable to use a rectifier that will not amplify; the modern Westinghouse WX Westector fulfils this purpose admirably. The ordinary triode detector valve may then be used to

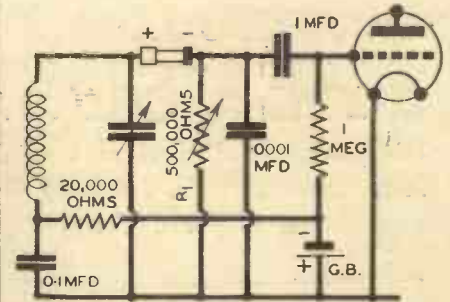

Fig. 2.—Theoretical circuit diagram showing how a WX Westector may be fitted.

If only one S.G. stage is used, the Westector should be biased to a point of optimum rectification; $-1\frac{1}{2}$ volts is generally found adequate. The value of resistance R1 is critical, and although a 250,000 fixed resistance gives good results, it is advisable to use a 500,000 variable potentiometer, in this position. The L.F. coupling shown in Fig. 1 can still be retained if an H.F.-L.F. control is desired. If slightly greater volume is required, a 2 or 3/1 transformer connected as shown in Fig. 3 may be used, but, owing to the high impedance of the detector stage, it is not advisable to use straight transformer coupling.

Variable Bias Coupling for the Output Valve

When a dry battery is used for supplying H.T. voltage, H.T. current economy is of paramount importance. Several economical stages have been designed recently (viz., Class B, Q.P.P., single economized pentode), but although these give very good results when the H.T. battery is supplying maximum voltage, a definite deterioration of quality is experienced as the battery runs down, and therefore frequent battery renewals are necessary.

To the average listener, the variable bias circuit shown in Fig. 4 is much more suitable. R1 is a variable potentiometer of 50,000 ohms, R2 a fixed resistance of the same value, and the bias battery should have a voltage of approximately double that specified for the valve used. When the arm of the potentiometer is at maximum setting, a bias of half the G.B. battery voltage will be applied to the valve (i.e., normal bias for maximum undistorted output), but as the potentiometer arm is moved towards zero setting, the bias voltage is gradually increased, and the output valve current consumption is consequently reduced. It will be advisable to use a three-point on-off switch with this control, having the third contact connected to G.B.—, in order that the bias circuit may be broken when the set is not in use.

This control will be found a very useful addition to any battery operated receiver, as a power pentode valve (e.g., Pen. 220A, PM 22, Z 220) may then be used to advantage. There are numerous items in the evening's programme that can be pleasingly reproduced with the output valve operating well below its optimum output, and therefore the bias control may be set near minimum setting.

Satisfactory reproduction of talks, commentaries, and light music may be obtained with the valve consuming a mere 3 to 4 m/a. When good reproduction of a symphony orchestration, piano recital, or organ recital is desired, however, the control may be set at maximum in order that maximum undistorted output may be obtained from the valve.

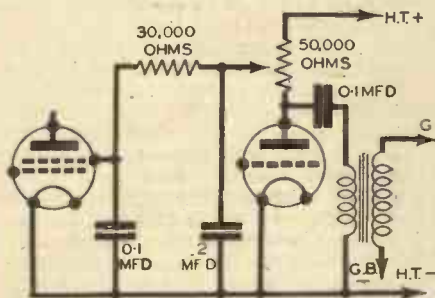

Fig. 1.—Theoretical circuit showing combined H.F.-L.F. control.

modern improvements that can be easily effected in the latter type of receiver.

Combined Radio-Gram Volume Control

When an eliminator without a variable S.G. screen voltage control, or 60-volt wet H.T. batteries are used, it is advantageous to fit a variable control in order that optimum amplification may be obtained from the H.F. valve. It is common practice to fit a potentiometer across H.T.+ and H.T.— terminals, with the S.G. screening grid terminal connected to the centre tap, but this potentiometer has the disadvantage of consuming approximately 1 to 2 m/a. when the set is in operation. A series resistance, on the other hand, is not very reliable for dropping the voltage to the required value owing to the very low current taken by the screening grid. In Fig. 1 a control is shown which effectively controls the S.G. screen voltage, and may, if desired, be used as a combined H.F.-L.F. volume control when on radio, and as an L.F. control when on gram. The resistances should be chosen to suit the valves in use, but the necessary values are by no means critical; using an S.G. valve having an impedance of approximately 400,000, and an HL or GP valve as detector, the values shown on the diagram will be quite suitable. A study of the circuit arrangement will indicate that the variable potentiometer not only acts as a control

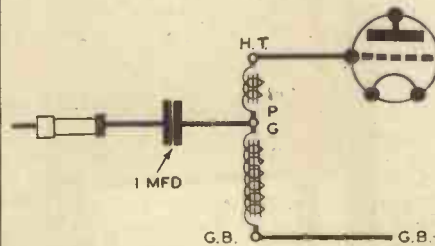

Fig. 3.—A transformer coupling is here shown.

good advantage as an L.F. amplifying valve following the Westector, and it has been found that a three-valve design of this type (S.G., Westector, L.F., Pen.) gives a slightly higher degree of amplification than the ordinary S.G., Det., Pen. combination, with better quality reproduction.

Reaction cannot be applied in the usual way when a Westector is used, of course, but the S.G. valve can easily be made to oscillate by connecting a very small condenser between anode and grid terminals, or by connecting a loop of wire from the anode of the S.G. around the preceding grid coil; oscillation may then be controlled by means of the normal variable mu potentiometer bias control, or by the screening-grid voltage control.

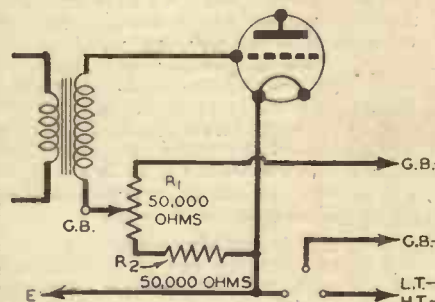

Fig. 4.—Variable output valve bias circuit using a potentiometer and a fixed resistance.



Items of Special Interest

AT RADIOLYMPIA

Particulars of Some of the Arrangements and Items which Are Attracting Great Attention at Olympia.

AN examination of the exhibits at Olympia reveals the fact that there are certain components or pieces of apparatus which possess what might be termed "novelty" and which are undoubtedly attracting the attention of visitors. These novelties may be divided into groups, and some further details are given below concerning them.

Tuning Dials

The tuning dial has undergone remarkable changes during the past few months. It



One of the new R. & A. speakers in which a special matching transformer is fitted.

is now the exception, rather than the rule, to find on a commercial receiver a small hole behind which rotates an ivorine scale bearing some arbitrary figures. Station-named dials are fitted to practically every receiver, and to simplify tuning the dial is now of the full-vision type, in either a straight, arcuate, or square pattern. The latter is now seen on three or four manufacturers' products, and the station names are arranged in a circle after the manner of the hour markings on a clock. For indicating purposes, two pointers are provided, and as the tuning control is operated these pointers travel round the "clock face" and indicate the setting. In addition to the easy visibility of this type of dial there is also the added advantage that no doubt exists in the mind of the user concerning which way to turn the control for any desired station, and the mind automatically registers "clockwise" and "anti-clockwise."

The automatic type of dial which, in addition to showing the tuning setting,

also gives an indication of other things is also becoming popular. Messrs. Ferranti, for instance, include on the dial a separate pointer, showing the setting of the tone control; one showing the wave-range; one showing the A.V.C. setting, and so on. True, at first it may seem unnecessary to include so much on a scale, but when the receiver has been in use for a short time the advantage of having all doubts removed concerning the various adjustments is found to be quite useful. Similarly, the indication concerning the tuning range, that is, long or medium waves, is an advantage on a tuning dial. Generally it is necessary to peer rather close to the panel to ascertain where the wave range control is adjusted, but separate scales, brought into action by the wave-change switch, coloured names illuminated by appropriate coloured lamps, and separate scales and pointers are found on this year's commercial receivers.

In addition to the above-mentioned indications some novel means of showing the exact tuning point in receivers fitted with A.V.C. are seen. The H.M.V., Columbia, and Marconiphone receivers utilize a device which gives the effect of a column of light rising and falling in a short tube. The Telsen's "Pointograph" dial is designed with a pointer which indicates the wavelength setting of the tuning control as well as one which, as resonance is reached, gives an indication as a separate scale. Tuning is carried out for the horizontal position of the pointer. Other devices include rays of light or shadows which vary in width with the tuning adjustment, and all enable the volume control to be set to a silent point whilst a station is accurately-tuned-in, and then the volume may be brought up to the desired level, thus avoiding all the noises of inter-station tuning, etc. The home-constructor may, of course,

fit a device of this nature to his receiver by purchasing the new Cossor Neon Indicator.

Loud-speakers

The majority of loud-speakers this year possess the special tapped transformer arranged so that practically any ratio



A novel type of speaker which incorporates an electric-light fitting.

may easily be obtained and thus accurately match the output valve. At last year's exhibition Messrs. Whiteley Electrical introduced this arrangement in their Micro-lode, and now various modifications of the scheme may be seen. In some models a row of sockets is provided, and by choosing any pair it is possible to obtain any ratio. In others switches are provided for the purpose of selecting the desired tapping. Better quality and greater volume is, of course, obtainable when the speaker is exactly matched to the output valve, so that this improvement in speaker design is greatly to be appreciated. Modifications in magnet design are also to be seen this year, the Blue Spot utilizing a novel form of "bolted-up" magnet in place of the more commonplace "Claw" arrangement, and the W/B speaker, although very little different in appearance, embodies a new alloy which gives greatly increased field strength and consequently increased volume and better quality, owing to the ability to modify the cone and speech coil proportions. The speaker designed especially for use with a receiver which has a built-in reproducer is also becoming popular, and is provided with a special transformer, so that it may be included in circuit without affecting the quality of response of the built-in speaker. It will be appreciated that this is a vital point,

(Continued from page 668)



This illustration (an Ekco receiver) shows how the question of the tuning dial has been tackled.

TUNING - CIRCUIT CHANGES

The Improvements and Modifications which Have Been Made in Connection with Tuning Coils and Variable Condensers are Described in this Interesting Article. By FRANK PRESTON

AT least a year ago a number of serious attempts had been made to perfect a system of tuning which is quite different from that which has been employed continuously ever since wireless receivers were first made. The old, and still universal, method of tuning by means of a coil and condenser is known to possess a number of undesirable features, the most important of which is its varying sensitivity

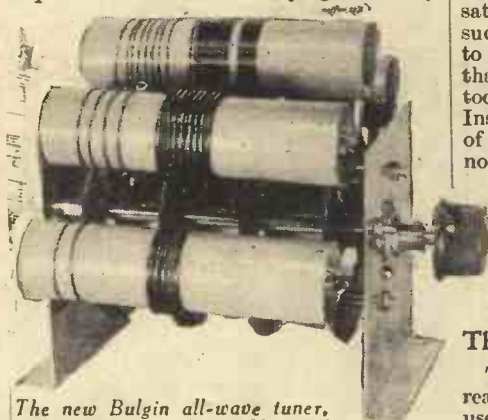

The new Bulgin all-wave tuner, which has interchangeable coil units.

and selectivity over even a narrow band of frequencies.

What of Permeability?

When iron-core coils were perfected (if one may use such a word in connection with radio) it appeared only a short step to the introduction of permeability tuning. In fact, more than one so-called permeability tuner was placed on the market, but its debut proved to be premature; this form of tuning had by no means reached a truly practical stage, but there is now, at last, an efficient, ganged permeability tuner available; it is made by Varley. As is by now fairly well known, the idea of permeability tuning is that the natural frequency (wavelength to which it will tune) of a coil is varied by moving a core of ferrous material nearer to, or farther away from, the turns of wire. It was not difficult to obtain a suitable wavelength variation in this way, and the principal obstacle appeared when it was attempted to make the tuner follow some definite "law." That is, it was not found by any means an easy matter to so arrange the core and its operating mechanism that an even separation of wavelengths or frequencies could be obtained. Thus, it was found that, at certain parts of the tuning range, several stations were crowded together, while at other parts they were separated by undue amounts.

Iron-Core Popularity

It is only about a year ago that iron-core coils became really popular, and at that time it was considered by many that in a very few months they would entirely oust

the ordinary type of air-core inductance. This opinion was, in fact, very freely expressed, but it is of interest to note that the forecast has by no means been fulfilled. There have been numerous factors which have acted against the iron-core coil, one of which has been that this kind of tuner has been produced in large quantities by several small firms who were without the necessary experience to produce a really satisfactory article, and because many such firms have been so unscrupulous as to use a core material vastly different from that which the inventor of ferrous cores took so much trouble and time to perfect. Instances have actually come to our notice of so-called iron-core coils which had nothing better than a block of hard wax for their cores! Happily, such deception has been practised by only a very few "back-street" manufacturers, and the purchaser who has been "bitten" can only blame himself for not dealing with a well-known and reputable firm.

The Effect of the Superhet.

There is another, perhaps more important, reason why iron-core coils have not been used in such large numbers as was anticipated; this is because superheterodyne receivers have rapidly increased in popularity. The inference might not seem quite clear, but, as has been mentioned in PRACTICAL WIRELESS, the inherent selectivity of the superhet. is extremely high, and therefore the advantages of ferrous-cored coils in this direction are not nearly

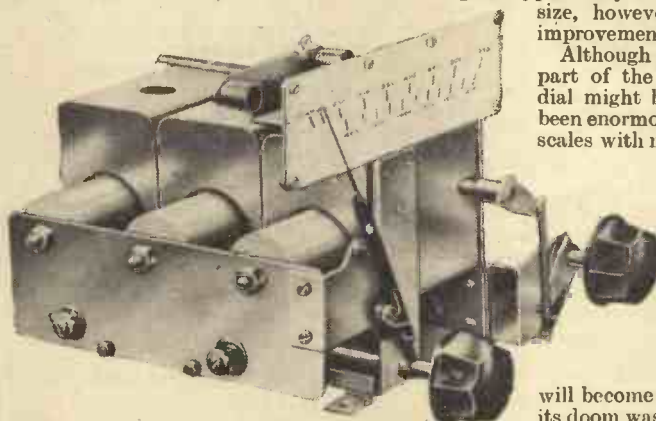

The 1935-model Varley permeability tuner.

so marked. In this respect it is significant to remark that the majority of receiver manufacturers employ ordinary air-core tuners in their superhets, with praiseworthy results. It should not be gathered from the above remarks that iron-core coils are dead, for that is by no means the case; it is probable that they will become even more popular, especially as they are gradually being reduced in price.

Reductions in Size

Even if they had done nothing else, iron-core coils have proved extremely valuable in pointing the way in the reduction in size. They proved that coils could be made which were only a fraction of the size of those which had previously been employed, and this set designers thinking, with a result that even air-core coils have since been made considerably smaller. It is a fact that many of the air-core coils now available are very little larger than several of the earlier ones having iron cores. The efficiency of the newer coils also stimulated designers into improving the performance of air-core coils, so that to-day these have reached a high degree of efficiency.

A Coil That is Wanted

There have been few entirely new types of coils, because these have not been found necessary. Slight modifications have been made in some instances so as to make the coils suitable for use with the special superheterodyne frequency-changing valves, such as the pentagrid, heptode, octode, etc., but it has not been found necessary to make any major alterations. There is, however, one new type of coil which the constructor would like to see. Reference is made to an oscillator coil for use in conjunction with a battery-operated pentagrid frequency-changer; a coil of this nature is used by one manufacturer of commercial receivers, but nothing of the kind intended for the home constructor has been brought to our notice.

Condenser Improvements

There have been no revolutionary changes in variable condensers, but some of the minor modifications are worthy of note. For example, condensers have been vastly improved mechanically, with a result that they are now more rigid and their trimmers provide a more uniform variation over the movement of the adjusting device. Additionally, the present-day variable condenser is considerably smaller than its prototype of a year ago; the reduction in size, however, is accompanied by improvements in details of design.

Although not being an integral part of the condenser, the tuning dial might be referred to as having been enormously improved. Larger scales with more "open" markings are notable, and full-visibility scales (on which the full range can always be seen) have become almost standardized.

In looking to the future one cannot help wondering whether or not the variable condenser will become obsolete. A year ago its doom was predicted when permeability tuning was mooted, and quite recently a form of tuning has been experimented with in which the variable condenser is replaced by a variable resistance. Although the idea has not yet passed outside the laboratory, it is claimed that it gives almost uniform response over any complete tuning range. We shall see!

PRACTICAL TELEVISION
6d. EVERY MONTH

READERS' WRINKLES

THE HALF-GUINEA PAGE

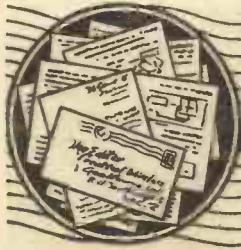

A Novel Tone Compensator for a Pick-up

It is well known that the amplitude of the bass notes on a gramophone record below 250 c.p.s. are attenuated for recording purposes, and to get true reproduction a compensating circuit of some sort is necessary. Here is a description of a novel circuit I have evolved for use with my

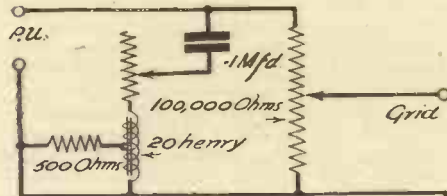

Theoretical diagram of tone compensator for a pick-up.

pick-up. The values may vary for different pick-ups. It consists of a 20-henry choke, centre-tapped, a 20,000-ohm variable resistance, and a .1 mfd. condenser in series across the pick-up terminals, one half of the choke being short circuited with a 500-ohm resistance. This is the novel part of the circuit, as without this resistance no compensation takes place. Varying the resistance varies the amount of compensation—minimum resistance, maximum bass notes. Actually this circuit absorbs the upper register, but as most pick-ups are not worked "flat out" this does not matter, and can be allowed for by advancing the volume-control.—R. V. PARSONS (Longleavens).

Using Up Odd Pieces of Solder

MANY wireless constructors will have on hand odd pieces of solder which are too small to hold except with pliers; the accompanying sketch shows a method of making use of them. Take an old table-spoon and punch or drill a small hole near the rim. Place in the spoon the odd bits of solder, hold over a gas-ring till molten, and then run out quickly into long strips, the size of which will be governed by the hole in the spoon.—R. DOWNY (Acomb).

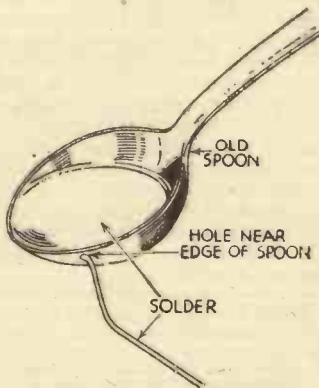

Using up odd pieces of solder.

THAT DODGE OF YOURS!

Every Reader of "PRACTICAL WIRELESS" must have originated some little dodge which would interest other readers. Why not pass it on to us? We pay £1-10-0 for the best wrinkle submitted, and for every other item published on this page we will pay half-a-guinea. Turn that idea of yours to account by sending it in to us addressed to the Editor, "PRACTICAL WIRELESS," George Newnes, Ltd., 8-11, Southampton Street, Strand, W.C.2. Put your name and address on every item. Please note that every notion sent in must be original. Mark envelopes "Radio Wrinkles." Do NOT enclose Queries with your Wrinkle.

A Trimming Dodge

WHEN modernizing an old set with twin ganged condensers I was in difficulties as trimmers were unknown when the set was originally constructed. The following dodge, however, answers the purpose very well. A piece of copper foil (1½ ins. by ½ in.) was wrapped with gummed paper (1½ ins. by 1½ ins.) to within ½ in. of one end and just overlapping at the other. Round this was bent another piece of copper foil (1½ ins. by 1½ ins.) pressed together so that the wrapped piece slid inside. A piece of 18 S.W.G. wire is soldered to the outer foil, and a piece of flex to the slider. The pieces of 18 gauge wire are soldered to the earth side of the condenser, and the flex

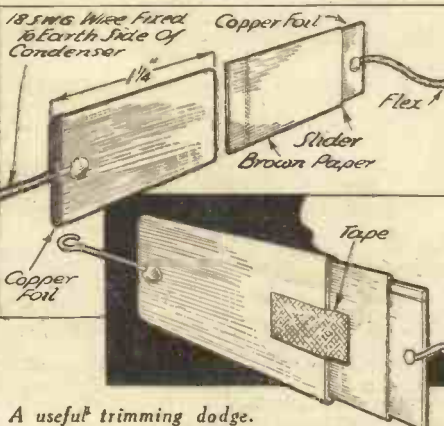

A useful trimming dodge.

to the other. Adjust by tapping the slider in or out. After the necessary adjustment was made, a bit of surgical or other adhesive tape was fixed on, as shown in the accompanying sketch.—S. R. GIBBON (Cardiff.)

Protecting Aerial Pulleys from Rust

PULLEYS at the top of an aerial-mast are liable to rust and become jammed. The following dodge will prevent this annoyance. Obtain a large size Colman's mustard-tin and fix the lid and pulley to the mast (as in sketch). In the other part of the tin two holes are bored to correspond with the lanyard and the aerial. The lanyard is threaded through the aerial hole over the pulley and through the lanyard hole. The lid can be soldered to the tin and the whole can then be painted.—R. LANDELS (Hendon).

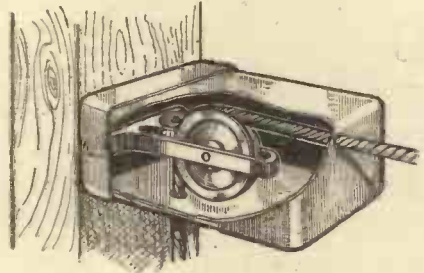

Method of protecting aerial pulleys from rust.

A Novel Multi-pole Switch

THIS multi-pole switch converts the usual panel-controlled push-pull action into a lateral movement by means of two cams secured to the main operating shaft. The fixed contacts are arranged (to suit the actual circuit conditions) upon two ebonite blocks secured directly to the baseboard, whilst the moving (or operating) contacts are suitably arranged upon another block which slides between the two fixed blocks. The moving block is drilled to allow free lateral movement along the two guide rods, as shown in the sketch, and four vertical pins, bearing upon the cams on the shaft, are fixed firmly into the block, thus causing the advancing or receding shaft to move the "switching" contacts from side to side. Two points of importance must be noted—stops must be provided to prevent overriding the cams, and the slope upon the cams must not be excessive; this should not exceed 30 degrees.—WM. A. HARRISON (Aintree).

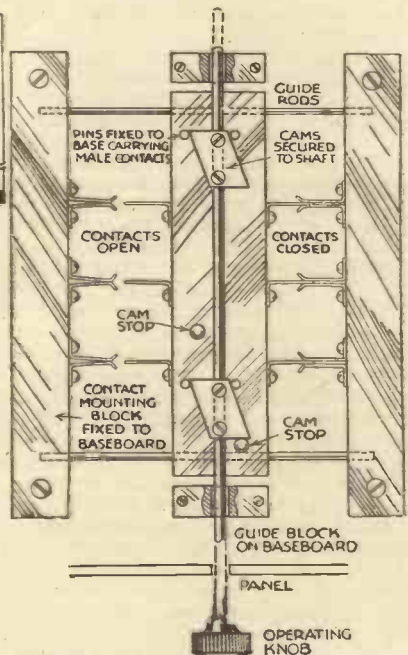

A novel multi-pole switch.

SUPERHET IMPROVEMENTS

How This Circuit has Developed During the Past Year.

By W. J. DELANEY.

DURING the past year the superheterodyne receiver has made enormous strides, and is now probably one of the most popular of circuits. That this is definitely so may be ascertained by examining the complete receivers which will appear at the Exhibition this year. The majority are undoubtedly superhets, and the number of valves employed has now dropped to three or four, whilst still maintaining the selectivity and other features for which this type of circuit is noted. The great strides which have been made are probably due, in the main, to the development of the multi-electrode valves which are used for the frequency-changer. In the original type of superhet it was necessary to utilise an H.F. valve for providing selectivity (by the addition of a tuned circuit), following this by the first detector with a separate valve as oscillator. To-day the pentagrid, the heptode, and the octode combine in one bulb the functions of the first detector and oscillator with greatly increased efficiency, and the higher magnification of this type of valve also enables the signal H.E. stage to be dispensed with. In addition to this, the stability of this stage is greatly improved owing to the additional grids which are included in the valve, and although, theoretically, the superhet should need only the very minimum of decoupling (owing to the fact that each stage operates at a different frequency), no decoupling is really required when the modern assembly is employed.

The Intermediate Frequency

Probably one of the greatest drawbacks of the superhet receiver, as it appeared on our market a year ago, was the whistles which arose from what is known as second-channel interference. In addition to this, the tremendous amplification which has been employed (owing to the large number of valves which were used) led to annoying background noises, valve hiss, and similar faults, which in many cases proved louder than the actual signal which was being received. Obviously, therefore, a reduction in the number of valves will result in a reduction of these stray noises, and give improved quality. The question of the intermediate frequency has received careful attention, and although last year the English manufacturer used a different frequency from that employed in American receivers (due to the fact that we need to tune in to the long-wave band), a still further modification has now been made by some manufacturers with the result that the second channel whistle has been removed. This has in its turn led to the removal of the necessity of using a band-pass tuning circuit in the first stage, and a single circuit tuner may now be used without the losses usually associated with a band-pass tuner.

The only point which has to be guarded against when using the new (higher) frequency is that losses in the necessary tuning circuits must be kept low and slightly greater care is called for in the design and construction of the coils and condensers. Several firms are now prepared to supply ganged condensers having the oscillator section shaped to provide accurate tuning with the new intermediate frequency, and although at the moment no details have been received concerning the supply of I.F. transformers for the home constructor, no doubt these will appear shortly.

A.V.C.

The automatic control of volume has now been perfected, and the modern superhet incorporates this as a matter of course. The intermediate amplifying stage or stages is controlled, together with the first detector-oscillator stage, generally through the medium of one of the double-diode triode or similar multi-electrode valves, the second diode being used for second detector. Thus, not only has the number



Employing only 5 valves, this superhet has 7 tuned stages and the valves perform 8 separate functions.

of valves been reduced, with a consequent reduction in size and price of the finished receiver, but efficiency is much higher, whether efficiency is judged by performance or quality of output.

We have been carrying out a number of experiments for a considerable time in order to develop a superheterodyne receiver which could aptly be described as the last word for the home constructor. It must be realized that the manufacturer can turn out this type of receiver by mass production means to conform to a certain standard, but the home constructor asks that this standard should be improved upon, whilst at the same time the difficulties usually associated with the home construction of a superhet are avoided. At least two I.F. transformers are required, and in the modern component of quality both primary and secondary are tuned. Stray circuit capacities render it impossible to supply these transformers with the circuits definitely tuned, and therefore some



This modern superhet represents one of the smallest receivers employing this principle.

form of tuning must be permitted to the constructor. With two I.F. transformers this gives four adjustments, and as the oscillator tuning condenser must be accurately adjusted with the main tuning condenser, this adds at least two more adjustments, and the permutations of six adjustments makes it possible to spend weeks in endeavouring to obtain the correct setting for each adjustment. We are slowly overcoming these defects, and if it is found possible to combine all the best features of the modern components with the ease of construction of a one-valve set, we shall publish full constructional details in these pages. In accordance with our policy, however, we shall not do this until the circuit has been perfected, but the notes given above will enable the newcomer and the interested amateur to see how this important circuit has progressed from a theoretical perfection to a practical proposition, and it is quite conceivable that before long the "straight" or simple circuit will become obsolete.

ITEMS OF SPECIAL INTEREST

(Continued from page 665)

and the special tapped transformer enables the adjustment to be carried out without any doubts arising as to whether an improvement could be effected by some other ratio of transformer.

Components

A general reduction in size of components, including valves, has obviously taken place during the past year, and the three-gang condenser, for instance, now occupies no more space than a single condenser of just over a year ago. The introduction of the iron-core coil enabled a reduction in size to be obtained last year, and improvements have naturally been made in this component with the result that it is still more compact, and generally provided with a self-contained wave-change switch designed to operate some other component, such as an on/off switch at the same time. The valve, in addition to the incorporation of more electrodes inside the bulb, has been reduced in size and slightly modified in shape, so that now it not only takes up less room, but is free from microphony and gives much better results.

50 Tested Wireless Circuits

By F. J. Camm (Editor of "Practical Wireless.")

This handbook contains every modern circuit, complete with instructions for assembling, component values and notes on operation.

Obtainable at all Booksellers or by post 2/6 from Geo. Nemes, Ltd., 8-11, Southampton Street, Strand, London, W.C.2. 2/6

THE "ARMADA" MAINS THREE

Building the Gramophone Section and Connecting Up This New All-mains Three-valve Set

BEFORE this novel instrument is completed it will be necessary to mount the gramophone motor and the pick-up on the upper part of the cabinet. The makers of the motor supply a very complete drilling template and instructions for this purpose, and it will be necessary first of all to find the centre of the motor board, which is the name given

up in its correct position so that accurate tracking is ensured, and the template supplied with the pick-up should be used for this purpose. Carefully follow the maker's instructions, placing the template on the motor board in the required position and marking the hole for the passage of the pick-up leads. It will be noticed that an earthing lead is included on the pick-up, and this should be joined to one of the motor retaining bolts, and this in turn joined to the H.T. negative terminal on condenser C.14 on the mains pack when this is inserted in its position. Now screw the motor into position, and attach the connection link on the motor to the correct pair of terminals as denoted on the template, and which adapt the motor for the voltage of the mains with which it is to be employed. A length of twin flex is next attached to the two terminals (see the template), and these leads are taken down and attached to the primary terminals on the mains transformer bearing a voltage marking corresponding to that with which the receiver is to be used. The two leads which are attached to the mains plug (and one of which passes via the on-off switch on the coil unit) are also attached to this pair of terminals on the mains transformer, and in this position both the receiver and the gramophone motor are rendered "alive," although the latter will not revolve until the pick-up arm is brought into the playing position. This operates a mechanical brake as well as an electrical switch, and thus avoids the necessity of fitting a separate motor switch.

Connecting Up

Connect the heater flex to the two 4-volt terminals on the mains transformer and the H.T. + and H.T. — leads to the terminals on condenser C.14. Preferably, whilst the receiver is being ganged and adjusted, it would be better to leave

the gramophone motor and pick-up disconnected, and to connect the mains unit and receiver together whilst they are standing on a table, inserting them into the cabinet when finally adjusted. The L.S. leads should be joined to the correct pair of terminals on the Multimu speaker, again following the maker's instructions regarding the optimum load of the output pentode. Attach the aerial to the small aerial plug and the earth to the earth plug, and insert these in their respective sockets. The mains plug is of the two-pin type, and should therefore be inserted into a two-pin socket; but as this type of socket is generally fitted on the power circuit of the house wiring, it may be found that rather long leads are required in order to reach

the nearest point. If desired, therefore, the plug may be used with an ordinary lighting socket, by obtaining one of the popular combination plugs which converts a lamp socket into a two-pin socket. Before doing this, however, make quite certain that your local supply company does not prohibit the use of a radio-gramophone on the lighting circuit. In some parts of the country there is a by-law to this effect. The control knob on the coil unit has four positions, each of which is indicated by letters engraved on the knob. When turned as far as possible anti-clockwise the receiver is switched off. A quarter of a turn to the right (in a clockwise direction) brings the medium-wave band into circuit, a further quarter of a turn brings the long-wave band into circuit, and a final movement switches out the radio side of the receiver and brings the pick-up into action. The control must then be turned in the reverse direction to switch off.

Operation

Turn the left-hand control (volume control) to a midway position and set the pointer of the tuning scale somewhere near the wavelength of your nearest station, and switch on. After a short interval a faint hum should be heard from the loud-speaker, and if all is well faint signals should also be heard. Turn the volume control until the signals are at their faintest, and then carefully adjust the trimming controls on top of the condenser assembly. As signals become louder, reduce them on the volume control until the maximum position is found for the trimmers. Carry out the trimming operation at both ends of the waveband, and use that position which gives the correct over-all balance. The receiver is then ganged, and may be placed in its cabinet and the motor and pick-up connected. The latter has one lead joined to the vacant terminal on the switch on the coil unit, and the other lead is joined to earth.



The receiver portion of the "Armada" in its cabinet. The mains unit shown on the right stands on the upper shelf.

to the upper surface of the cabinet immediately below the lid. Remove the four screws which hold this board in position, as well as the two screws retaining the lower part of the cabinet lid-stay. Lay the motor board on a flat surface, and when the centre point has been found (by lightly marking the two diagonals), place the motor template on the board with the point marked "Turntable Centre" exactly over the centre point on the board. With a sharp-pointed pencil trace round the heavy black line on the template and with a sharp point mark the positions of the retaining screws 1, 2, 3, and 4. Remove the template, and with a fretsaw or coping saw cut out the section enclosed by the black line and drill holes at the fixing screw points. It is preferable to use 6 or 8 B.A. bolts to hold the motor in position, although if thought sufficiently secure ordinary wood screws could be used for the purpose.

Mounting the Pick-up

It is now necessary to fit the pick-



The mains section and the loud-speaker.

INTERFERENCE SUPPRESSION

A Brief Description of Most of the Devices which are Now Available for Combating All Kinds of Electrical Interference with Wireless Reception. By FRANK PRESTON

THE interference with radio reception caused by various types of electrical apparatus has presented a difficult and important problem for some years, but, far from automatically solving itself, it has gradually become worse.



The T.C.C. No. 2 interference suppressor.

Although this form of interference is as old as wireless itself, it is rather surprising to note that it was not considered at all seriously until about three years ago. Prior to that it had been looked upon as inevitable, in addition to which it was not generally so trouble-

some, due to the fact that the receivers in common use were considerably less sensitive than they have become of recent years.

That electrical interference—which evidences itself as a series of crackles, bangs, or scratching noises—can now satisfactorily be overcome is a definite fact, although this may come somewhat as a surprise to those who have not kept in close touch with radio developments during the past months and who, quite probably, gave up all thoughts of ever securing really enjoyable, trouble-free, and interference-free, reception on account of the local conditions. Right up to the summer of 1934 it has not been possible to guarantee that all forms of electrical interference could definitely be overcome without tackling the trouble right at its source; very often an impossibility. The listener is now able, in something like 90 per cent. of cases, to overcome the trouble without making any modifications outside of his own apparatus. In the other few instances a compromise can generally be made by making slight alterations to the receiving equipment and by persuading the owner of the offending apparatus to make a simple addition to his plant.

Post-office Assistance

Before going on to detail the various types of interference suppressor which are available it would be well to point out (principally for the benefit of new readers) that in all cases of difficulty the Post Office engineers are very willing to render whatever assistance they can, and without charge. All that the listener has to do is to obtain an appropriate Form from the Post Office from which he obtained his licence, fill it in and return to the address given on it. Very soon qualified engineers will look into the matter and advise upon the steps which should be taken. If the source of trouble happens to be a fan, electric vacuum cleaner, hair drier, or similar

machine used upon the listener's own premises, or if it is in the electric supply wires or switches, the engineers will suggest a remedy and offer to put this into effect for a nominal charge; if the source is external to the listener's premises they will suggest remedies to the owner of the plant concerned. Unfortunately there is no law which prescribes that devices should be fitted to electrical equipment so as to render them non-radiating, although such legislation is in force in some of the Continental countries. In any case such laws will probably never be required, especially when one bears in mind the efficacy of the suppression devices which are available at low cost.

There are two principal forms of suppressor device, one of which is intended for connection to the apparatus which is the cause of trouble, and the other which is designed essentially for use in conjunction



Anti-interference (or impedance-matching aerial) device manufactured by Messrs. Ward and Goldstone.

with the receiver. The first type of device consists essentially of two fixed condensers, connected in series, and two safety fuses. The "free" terminal of each condenser is connected, through one of the fuses, to one terminal of the apparatus (or to one of the brushes in the case of an electric motor) whilst the series connection is joined to a convenient earthing point.

The Suppressor Units Available

A number of these excellent suppressor units are on the market, four well-known ones being made by Messrs. Belling & Lee, Messrs. T. C. C., Messrs. Dubilier, and Messrs. Ward & Goldstone. The first-mentioned firm have two chief models, one of which was introduced a year ago and costs 10s. 6d.,

the other being a newcomer of smaller type and designed especially for use in conjunction with small electrical machines and costing 8s. 6d. Messrs. T.C.C. introduced their No. 1 model some time ago, and this, selling at 10s. 6d., employs a pair of 2-mfd. condensers. Their new model, however, which is described as model No. 2, contains two 4-mfd. condensers and is intended for use in extremely difficult circumstances, or where the smaller model does not provide a complete cure; it is priced at 12s. 6d. The other two firms mentioned above have several different models, one of which is suitable for any particular requirement.

All the manufacturers referred to undertake to advise any intending purchaser regarding the type of unit most suited to his own particular circumstances, whilst Messrs. Belling & Lee provide a questionnaire, and from the answers supplied to the various questions they will give free advice regarding the steps which should be taken in order to overcome the interference.

Despite the fact that the condenser units described are intended principally for connection to electric motors and similar pieces of machinery, they can always be connected across the mains supply leads to the (mains) receiver, in which position they will considerably lessen nearly every form of interference.

Screened Aerial Devices

When the interference nuisance cannot be completely obviated by using one of the suppressors referred to above, and it is known that the trouble is from some outside source, it becomes necessary to employ a screened down lead from the aerial, and special screening material (which has the essential feature of low capacity) for this purpose is made by Messrs. British Radiophone, Messrs. Ward and Goldstone, and others. So long as the aerial is fairly high the provision of the screened down lead will almost invariably eliminate the trouble, but it is occasionally necessary to go to still further trouble by moving the aerial to a point outside the field of interference. This might entail the use of a down lead fifty, or even a few hundred, feet in length and the capacity of the screening would then be too great to permit of the aerial functioning correctly. Even this difficulty has been foreseen, however, and special lead-in devices are on the market. The principles upon which these work have previously been dealt with in these pages, and it is briefly as follows: A step-down high-frequency transformer is inserted between the aerial proper and the end of the lead-in which is normally connected to it. At the "set" end of the lead-in there is a step-up transformer exactly matched with the first one. Because of the comparatively low H.F. voltage which passes through the screened wire the capacity has little or no effect.

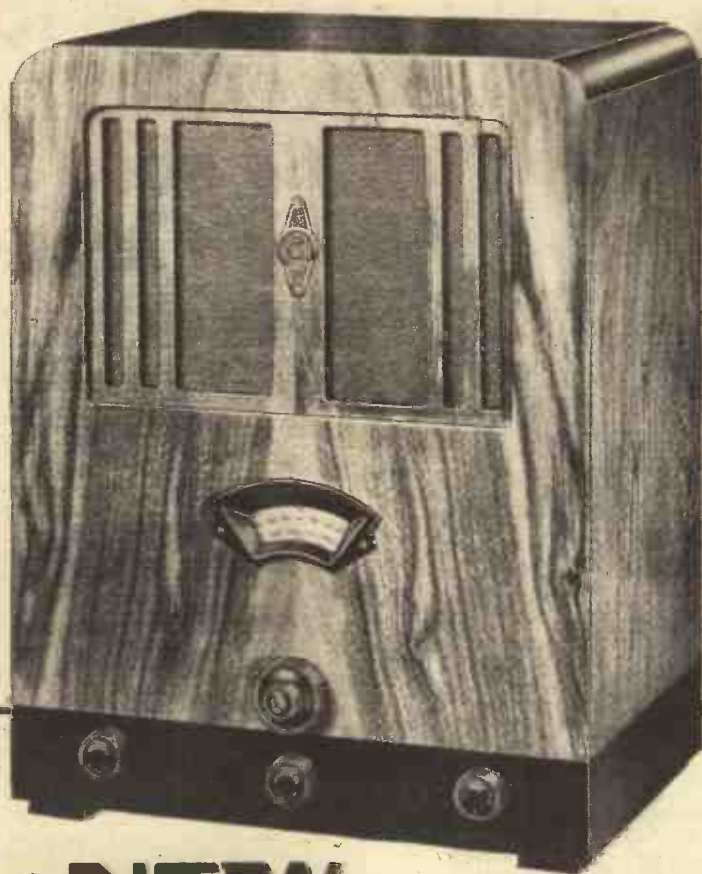

VARIABLE-MU S.G. CIRCUIT

SUPER-SELECTIVE IRON-CORED COILS

MOVING-COIL LOUDSPEAKER

TWO MAGNIFICENT MODELS

BATTERY MODEL 352

Complete Kit of parts includes Cossor Variable-Mu Screened Grid Triode Detector and Economy Pentode Output Valves, fully screened Super-Selective Iron-cored Coils, combined On/Off, Wavelength and Gramophone Switch and all the parts for simple home assembly. Handsome walnut finished cabinet 18" high, 14" wide, 9½" deep. Permanent Magnet Moving Coil Speaker. Terminals for Gramophone Pick-up, Plug and Sockets for Extension Loud-speaker. Price **£5.19.0**

(excluding batteries).

Hire Purchase Terms: 1/- deposit and 10 monthly payments of 12/-.

ALL-ELECTRIC MODEL 357

Complete Kit of parts similar to Model 352 but with Cossor Mains Variable-Mu Screened Grid, Mains H.F. Screened Pentode Detector, Mains Power Output and Rectifier Valves. Mains Energised Moving Coil Loudspeaker. For A.C. Mains only 200/250 volts (adjustable) 40/100 cycles. Price **£7.19.0**

Hire Purchase Terms: 20/- deposit and 10 monthly payments of 16/-

Prices do not apply in I.F.S.

5428

The NEW COSSOR MELODY MAKER

Every worth-while development in up-to-date Screened Grid Radio is incorporated in the new Cossor Melody Maker—Variable Mu S.G. Circuit—Super-selective Iron-cored Coils—Moving Coil Loud Speaker, etc. Because of its advanced design its performance is remarkable—better even than that of its famous predecessors. Send at once for full particulars—the coupon below brings you full-size constructional chart.

SEND THIS COUPON FOR FULL DETAILS

To A. C. COSSOR LTD., Melody Dept., Highbury Grove, London, N.5

Please send me full size constructional chart which tells me how to build the new Cossor Melody Maker Model.....*

* Insert Model No. required.

Name.....

Address.....

PRAC. 25/334



"Good...that's found the fault... what a good thing I bought myself a PIFCO ROTAMETER"

A whole night's job becomes but a few minutes' work with the Pifco ROTAMETER.

The new De-Luxe moving coil model is amazingly accurate—it has a resistance of 200,000 ohms. The voltage scale registers up to 400 volts. In fact the ROTAMETER is a complete testing set in one handy-sized bakelite case.

Ask your dealer to show you one now, or write for fuller details to PIFCO LTD., Shudehill, Manchester, or 150, Charing Cross Road, London, W.C.2.



9 SEPARATE METERS IN ONE ROTAMETER-DE-LUXE

- 1 —0.5 volts.
- 2 —0.20 volts.
- 3 —0.100 volts.
- 4 —0.400 volts.
- 5 —0.10 milliamperes.
- 6 —0.50 milliamperes.
- 7 —0.250 milliamperes.
- 8 —Resist/valve test.
- 9 —Plug-in test for valves.

Without question the finest radio testing instrument in the world to-day. Entirely self-contained, it is a complete testing and radio research laboratory in miniature. Every conceivable test can be made with this amazing instrument. Size of each dial 1 1/2" x 9/16". Finished in black bakelite, complete with leads and fitted in handsome velvet-lined case.

42/-

Adapter sockets for use in testing 7 and 9 pin valves are now available. Price **3/-**

ROTAMETER

- 1 —0.8 volts. For low-tension voltage test.
- 2 —0.30 volts. For grid-bias voltage test.
- 3 —0.250 volts. For high-tension voltage test.
- 4 —BATTERY TEST.
- 5 —0.20 M.A. For individual valve test.
- 6 —0.100 M.A. } For testing current taken by total valves in set.
- 7 —0.250 M.A. }
- 8 —FILAMENT AND RESISTANCE TEST (4,000 ohms.) For D.C. and rectified A.C.
- 9 —Plug-in test for valves.



Radio testing is made easier, quicker and more accurate by the Pifco ROTAMETER. Any one of eight dials are brought into view by turning the octagonal knob at the side of the instrument. Size of each dial 1 1/2" x 1". Convenient in size and of amazing accuracy. Finished in black bakelite, complete with leads, in velvet-lined case.

29/6

PIFCO

ROTAMETERS

PIFCO ON THE SPOT WILL TRACE YOUR TROUBLES LIKE A SHOT

STAND TO STAND REPORT OF RADIOLYMPIA

FOR REAL READER
SERVICE BUY
Practical Wireless
3^d EVERY WEDNESDAY

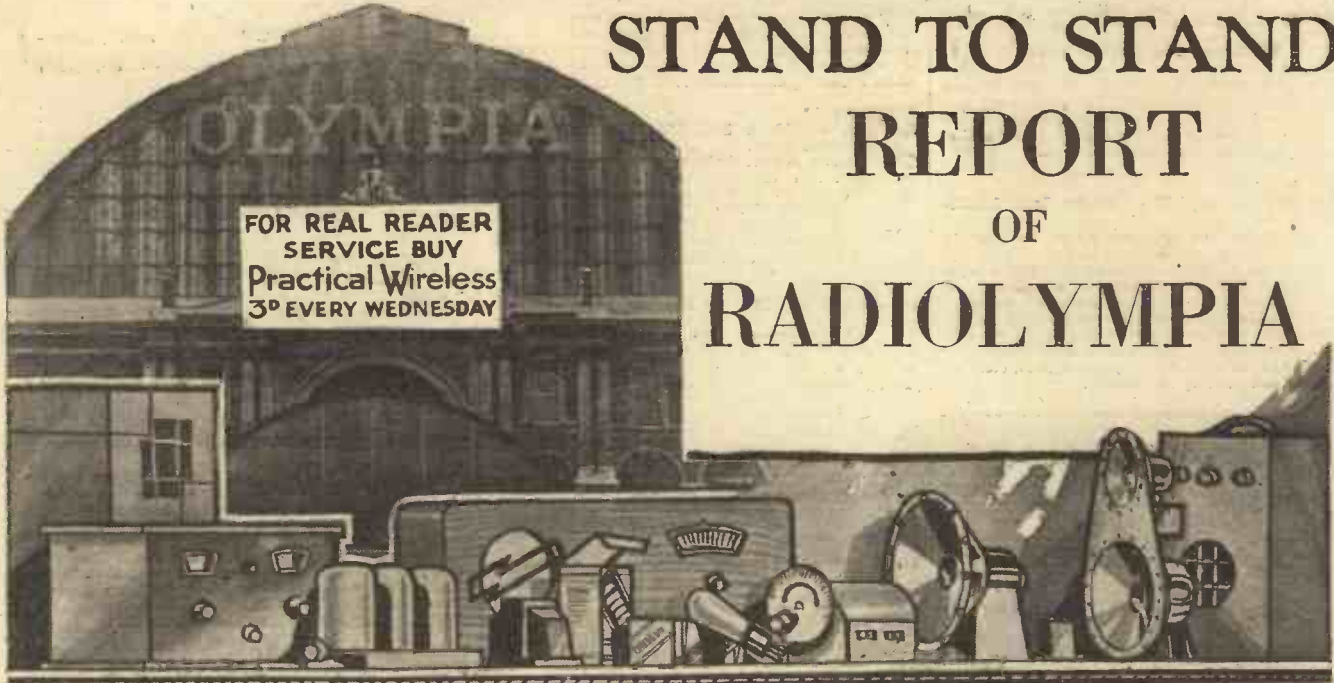

DETAILS OF EXHIBITS OF OUTSTANDING INTEREST ON EACH STAND — BY THE TECHNICAL STAFF.

STAND No. 1
WRIGHT & WEAIRE, LTD., 740, High Road,
Tottenham, London, N.17.

THE range of coils shown by Messrs. Wright & Weaire seems to form the centre of attraction on this stand. The vast range which is covered by these coils, from the simple air-core dual-range coil to the latest iron-core suitable for use with the new octode and similar types of frequency-changer, enables the constructor to choose a coil to suit any type of circuit. In addition, the new I.F. transformers and other components, in which the new insulating material "Mycalex" is employed, also gives the constructor a new hope for experiment during the coming months. In addition to the coils, all the other accessories shown



A useful testing instrument which has been added to the range of Avo-Instruments.

on this stand give a good idea of the resources of Messrs. Wright & Weaire in designing and manufacturing high-class components for the home constructor who wishes to make up a receiver to give really high efficiency at a minimum of expense.

STAND No. 2
AUTOMATIC COIL WINDER & ELECTRICAL EQUIPMENT CO., LTD., Winder House, Douglas Street,
London, S.W.1.

THE novel testing instruments, the Avometer, the Avometer, and others form a novel setting, and by the crowds which always surround the stand it would appear that at last the home constructor has realised the necessity for obtaining really good testing instruments if he wishes to carry out tests and experiments which are of prove of value to him. The novel Avodapter, which enables the various voltages and currents to be measured whilst a valve is function-

ing in a circuit, also attracts attention, and the new pattern, designed for use with 7-pin valves, shows how the need has arisen for an extension of the range of this type of accessory. In addition, the coil winding apparatus, principally of interest to the manufacturer, gives the visitor some idea of the work which is involved in the manufacture of the simple tuning coil.

STAND No. 3
C. F. & H. BURTON, Progress Works, Bernard Street, Walsall.

THIS stand also devotes the majority of its space to an exhibition of components especially designed for the use of the home constructor. Some ingenious accessories may be seen, and the interest evinced in some of the items shows that the home constructor is becoming still keener in his knowledge regarding the why and the wherefore of the various parts which he utilizes.

STAND No. 4
CENTRAL EQUIPMENT LTD., 188, London Road,
Liverpool.

THE ingenious no-mast aerial no doubt causes many listeners to wonder whether it is still worth while putting up with the unsightly prop at the bottom of the garden. In addition, the earth device and the interest which everyone seems to show in these accessories speaks well for the results which will be obtained in the coming months if the majority decide to overhaul the aerial and earth system.

STAND No. 5
DE LA RUE & CO., 90, Shernhall Street, London,
E.17.

THE interesting range of mouldings, etc., which are shown on this stand give the visitor some idea of the extensive branches which are covered in the manufacture of radio apparatus.

STAND No. 8
GEO. NEWNES, LTD., 8-11, Southampton Street,
Strand, London, W.C.2.

MANY old friends called upon us at Stand No. 8 during the week, and we also made many new friends. It was surprising how many readers seemed to find the time to call and thank us for the various hints or knowledge which they had acquired from our publications, and many stated that they had only come to the exhibition in order to make our acquaintance. Great interest was shown in the model receivers which were on show, and the staff were kept very busy answering technical queries. We received dozens of requests for articles of various types, and careful note has been made of all the desires of our readers, and we shall endeavour to please everybody during the coming year by catering for them in the manner they desire. We must thank those readers who we were unable to see for their good wishes.

STAND No. 9
HAYNES RADIO, 57, Hatton Garden, E.C.

SOME high-class examples of receivers and amplifiers are shown on this stand, and the kits which are made up for the home constructor, in which special tool-cut metal chassis are employed, enables the constructor to build up a unit having the

appearance of the commercial product, but with the added advantage of the "hotting-up" which only the individual touch can produce.

STAND No. 11
PLEW TELEVISION, LTD., Waddon, Croydon.

HERE at last is the home-television receiver, and by the enormous interest which is displayed it is obvious that the public is definitely television-minded. The receivers produced by this company have shown that it is possible to obtain a satisfactory television apparatus at a really competitive price and a number of novel features have been included in the receivers. A new type of lamp, simple "focusing" adjustments, and a perfect synchronizing gear render the reception of a picture as simple as the tuning in of a modern broadcast station. In addition, the provision for the reproduction of a "bottled" television transmission from a gramophone record will enable some interesting experiments to be carried out by the home constructor who is, for any reason, unable to make use of the normal television transmissions.

STAND No. 13
A. DIGGLE & CO., Reliance Works, Jane Street,
Rochdale, Lancs.

ALTHOUGH primarily of interest to the shop-keeper or service agent, the various types of charging plant which are seen on this stand interested

For the flat-dweller this type of aerial has many advantages to offer. This model is manufactured by the Central Equipment Ltd., and is known as the No-Mast Aerial.



STAND TO STAND SHOW REPORT

(Continued from previous page)

the home constructor who is unable to charge his own accumulator. It is interesting to be able to see how it is done, and the plant gives some indication of the care which can be exercised in such a small matter as recharging a simple 2-volt accumulator.

STAND No. 14
ERIE RESISTOR CO., LTD., Waterloo Road, Cricklewood, N.W.

IN addition to the resistors which are already well known, a number of new components are seen on this stand. The new potentiometer or volume control shows that the problem of a noiseless and accurate control had been seriously tackled and overcome. In addition, the suppressors designed for use with car-radio equipment shows that this branch of radio is now becoming popular, and that the difficulty of eliminating the noise from plugs, magneto, etc., has been overcome. A very fine exhibit.



This Television receiver, made by Plew Television, brings the low-priced television instrument to the listener.

STAND No. 17
NOVO RADIO-ELECTRIC, LTD., Novo House, 34, Lovaine Place, Newcastle-on-Tyne.

THE novel receivers shown on this stand prove attractive to the visitor who is looking for originality. The circuits employed in the receivers are entirely up to date, and the cabinet work and general design reaches a high degree of workmanship and strikes a novel note in many directions.

STAND No. 18
EDISON SWAN ELECTRIC, LTD., 155, Charing Cross Road, W.C.2.

A REAL mine of knowledge is stored away on this stand, and the visitor finds much to interest him. From the smaller accessories, including the well-known B.T.H. pick-up, to the large cathode-ray apparatus there is something for everybody to be seen. Batteries, the well-known Mazda valves, the popular Reisz Kellogg loud-speakers, and other items are introduced to many for the first time, but to the older experimenter these show that there had been little modification in design and that these items still hold their supreme position in the various fields which they represent.

STAND No. 19
ACE RADIO, 2a, West Arbour Street, London, E.1.

THE range of universal (A.C.-D.C.) receivers exhibited on this stand give an indication of the manner in which the problem of the two types of supply has been overcome. These receivers may be plugged into either A.C. or D.C. mains, and they function efficiently on each supply without any modification. All risks of a change-over are therefore removed, and the traveller or the resident in a district which might be changed at any moment may thus purchase one of these receivers without any worry.

STAND No. 20
CONSOLIDATED RADIO CO., LTD., Warple Way, Acton, W.3.

BEARING the identification term "Ranger," the receivers seen on this stand may be safely held to range throughout the ether. There is a type for everyone, from the simple battery receiver to the elaborate radio-gramophone.

STAND No. 21
BRITISH PERMEL ENAMELLED WIRE, LTD., Charlton, S.E.

THE various types of wire which are used in "wireless" are seen to advantage on this stand, and attract considerable interest. Nowa-

days so many components are hidden away beneath screening cans that the listener does not give much thought to the various types of instrument wire which are employed in the components, and therefore this stand attracts quite a considerable amount of interest.

STAND No. 22
LAMPEX RADIO & ELECTRIC CO., 62, Brewery Road, London, N.7.

SOME novel cabinet designs are to be seen on this stand, and the receivers exhibit range from simple circuits to right up-to-the-minute superhets. The very modern bird's-eye maple is seen in some of the cabinets on this stand, and there is no doubt that this type of wood will become very popular in the future, owing to its clean and intriguing appearance.

STAND No. 24
HEYBERD & CO., 10, Finsbury Street, London, E.C.

MAINS apparatus sums up the exhibits on this stand, although the range which is covered is really marvellous. From the simple by-passing condenser to the most elaborate charging plant, Messrs. Heyberd can supply practically any item required for use on the mains. Transformers, chokes, complete mains eliminators, trickle chargers, rectifying units, etc., all form a most interesting display, and the interesting circuit details which are obtainable from this firm will enable many to modify their receivers so as to take full advantage of the mains supply.

STANDS Nos. 25 and 26
THE EVER READY CO. (GT. BRITAIN), LTD., Hercules Place, Holloway, London, N.7.

BATTERIES for all purposes, from the small flash-lamp cell to the super-capacity H.T. battery, and accumulators of various types are seen on this stand. The name of Ever Ready is, of course, well known in this connection, and the exhibit attracts considerable attention and interest.

STAND No. 27
HIGH VACUUM VALVE CO., 113, Farringdon Road, London, E.C.

THE new A.C. mains valves attract many visitors to this stand, and the complete range of Hivac valves, at modest prices, leads many to decide to replace their old valves with more up-to-date ones and thus obtain a new lease of life from their receivers. The novel Class B plus driver valve will no doubt also introduce to many the advantages of this type of output for a battery receiver and so lead to improved results.

STAND No. 28
CELESTION, LTD., London Road, Kingston-on-Thames.

THE range of loud-speakers shown here proves very attractive, and in addition to the neat cabinet types of reproducer, the large auditorium speaker and the pick-up also receives much attention from visitors. The dual-balanced units are also the subject of many comments by the "quality" fans, and it is quite interesting to hear the remarks of these visitors regarding the utility of a dual speaker.

STAND No. 29
PARTRIDGE, WILSON & CO., Davenset Works, Evington Valley Road, Leicester.

THE range of battery chargers forms a most interesting exhibit, and the ingenious manner in which compactness has been combined with utility, and the safety device incorporating the automatic overload switches proves quite attractive. In addition, the complete range of Davenset plants, electric shop signs and other accessories form an attractive setting. The constructor will find much to interest him in the range of mains transformer and smoothing chokes.



This Lampex "Unifive" receiver possesses novel features in circuit and cabinet design.

STAND No. 30
STRATTON & CO., LTD., Eddystone Works, Bromsgrove Street, Birmingham.

THE short-wave listener is attracted to this stand and finds a great deal to interest him. Apart from the complete range of short-wave apparatus, such as coils, tuning condensers, insulators, etc., the complete receivers are highly interesting. The cabinet construction, which is designed to withstand tropical climates, shows how the manufacturer has to contend with severe changes in temperature and also demonstrates that the English manufacturer has not overlooked the advantages of the colonial markets. A fine exhibit.

STAND No. 32
A. J. BALCOMBE, LTD., 52-58, Tabernacle Street, E.C.2.

THE fine range of Alba receivers on this stand well repays an examination. From the simple battery receiver to the most elaborate mains radio-gramophone, the cabinet work as well as the circuit designs have obviously been the result of much experimental research.

STAND No. 34
GENERAL ELECTRIC COMPANY, Magnet House, Kingsway.

THE G.E.C. trade mark is sufficient indication of the type of apparatus which is seen on this stand, and the range of receivers and loud-speakers is very attractive. Some interesting circuits are revealed in some of the receivers, and the cabinet work strikes a novel note in many respects. In addition to the complete receivers the loudspeakers, the A.C./D.C. conversion units, the home broadcaster, the gramophone, motors, and the H.T., G.B., and L.T. batteries also make a splendid display on the G.E.C. stand.

STAND No. 35
SUNBEAM ELECTRIC, LTD., Park Royal Road, North Acton, N.W.10.

UNDOUBTEDLY the centre of attraction on this stand is the Midget receiver. All the receivers (except car radio) manufactured by this company employ the universal mains circuit suitable for A.C. or D.C. without alteration, and in the Midget they have included a most elaborate receiver in the smallest space possible. We do not doubt but that this type of receiver will be very popular in the coming year.

STAND No. 36
HALCYON RADIO, LTD., 83a, Valetta Road, Acton W.3.

PRODUCTS of really high class appear on this stand, and include three- and four-valve battery receivers, a nine-stage seven-valve A.C. radio-gramophone and some novel universal receivers and radiograms. The "bureau" lines of the 7-valve superhet attract a considerable amount of attention, and the two tuning controls form a novel departure from the usual style of receiver.

STAND No. 37
TELEGRAPH CONDENSER COMPANY, LTD., Wales Farm Road, North Acton, W.3.

THE green-cased condensers reveal the identity of this stand at a glance and the home-Constructor is already very familiar with the high grade of component which bears the T.C.C. trade mark. The exhibit is tastefully arranged, and in addition to the smaller condensers with which the home constructor is so familiar, the large transmitting and high-voltage condensers, which are tested up to 80,000 volts, and which are employed in broadcasting stations in many

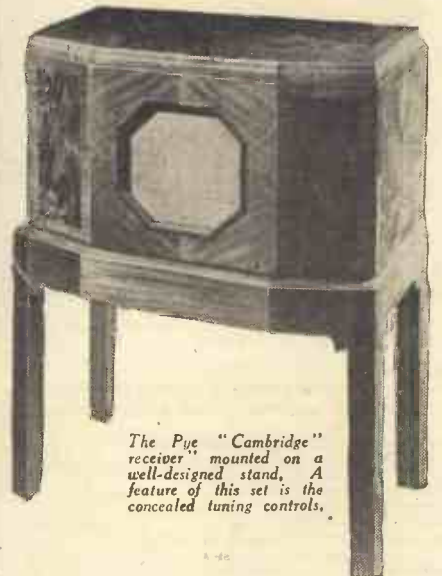

The Pye "Cambridge" receiver, mounted on a well-designed stand. A feature of this set is the concealed tuning controls.

STAND TO STAND SHOW REPORT

(Continued from previous page)

countries, are good examples of the range of products which this firm manufactures. The interference suppressor is a component which is coming in for a good



In this splendid piece of cabinet work—a Halcyon product—the sloping baffle and bookcase form interesting departures from normal design.

deal of interest at the present time, and the T.C.C. component is a most useful accessory for this purpose. A new model is seen on the stand which retails at 18/6, and no doubt will find a large sale during the coming season.

STAND No. 38. COLVERN, LTD., Mawneys Road, Romford, Essex. A FINE display of the Ferrocart components shows how this type of powder-iron core coil has been developed. In its latest form the bakelite housing has been considerably modified, and although the actual coil windings are unaltered, the new moulding renders the coils more robust and they may even be employed in tropical receivers without any risk of changing characteristics. The I.F. transformers and the complete range of coils and tuning pack, complete with variable condensers, make a very fine display.

STAND No. 39. THE NEW LONDON ELECTRON WORKS, East Ham, London. THE new Globe aerial attracts a considerable amount of attention on this stand and the claims of the manufacturers show that it might have great possibilities. In addition to many other interesting lines, such as the Electron wire, the insulator pins, and so on, formed a very novel and instructive display.

STAND No. 40. DARWINS, LTD., Fitzwilliam Works, Sheffield. THE large range of magnets which are used for the construction of loud-speakers forms a most interesting display. The various patterns in which these magnets are obtainable and the sections showing their construction enables many visitors to gain some idea of the work which is involved in this type of accessory.

STAND No. 41. BELLING & LEE, LTD., Cambridge Arterial Road, Enfield. THE many new lines which Messrs. Belling-Lee have to exhibit attract the thousands of home-constructors who visit the exhibition. Not the least interesting feature of the exhibit is the announcement that many lines have been reduced in price, and from the smallest wauder plug to the various types of interference suppressor, a most interesting collection of components is on view. The arrival of the new universal valves has led to a demand for new valve-holders and new types of connector for the top cap, and these have obviously been added to the Belling-Lee range.

STAND No. 42. THE BENJAMIN ELECTRIC, LTD., Brantwood Works, Tarrif Road, Tottenham, N.17. THE Magnavox speakers form the centre-piece of this display, and the new Double Six gives a very good impression. It is, of course, unfortunate in one respect that the broadcast programme cannot be tuned in, but the relayed music enables one to form a very favourable impression of the response of this model. The provision of the silk-fronted dust-bags, which enables the Magnavox speakers to be mounted direct on a baffle without any further silk backing, makes a novel feature of these speakers. The smaller accessories, such as the valve-holders, transformers, etc., also repay examination.

STAND No. 43. SONOCHORDE REPRODUCERS, LTD., Rohermel House, Canterbury Road, N.W.6. THE peculiar appearance of the piezo-crystal and ordinary moving-coil balanced pairs attracts many to this stand, and the large range of loud-speakers well repays examination. In addition there may be seen here some new pick-ups and microphones in which the Rochelle salt principle is utilized. The Sonochorde speakers are seen in many sizes, from the interesting little midgets to the large auditorium models suitable for public-address work.

STAND No. 44. KINGSWAY RADIO, LTD., 3 to 9, Dane Street, High Holborn, W.C.1. THE Simpsons electric turntable appears on this stand, and many constructors were pleased to note that this accessory has not disappeared from the market. The advantage of the one-hole fixing, and the avoidance of any form of speed regulating device, makes this turntable a useful accessory for the home constructor.

STAND No. 45. R. H. DENT (ARDENTE), Oxford Street, London, W.1. THIS is Messrs. Dent's first appearance at the Radio Exhibition, and although known principally for the deaf aids, they have some other apparatus to exhibit. Their experience in the design of this type of apparatus has enabled them to develop some useful public-address apparatus and amplifiers, and they have also fitted a large number of cinemas with reproducing apparatus to enable deaf persons to obtain the benefit of the "talkies."

STAND No. 47. S. SMITH & SONS (M.A.), LTD., Cricklewood Works, London, N.W.2. THIS attractive stand is devoted to a novel display of accumulators and the well-known Anodex batteries. They are very attractively displayed and it



A dual pair of Rola speakers designed to give a full overall response.

is noted that a new range of improved batteries has appeared for the first time. Batteries for all purposes and at prices to suit every pocket are to be seen and the complete range is very exhaustive.

STAND No. 48. THE BRITISH ROLA COMPANY, LTD., Minerva Road, Park Royal, London, N.W.10. THE new features in the Rola speakers, by means of which dust is definitely excluded from the gap, and the new corrugated diaphragm prove very interesting. This is a fine exhibit, and a most interesting range of models may be seen, extending from the midget permanent magnet type to some very fine cabinet models. The dual balanced pairs are a novel

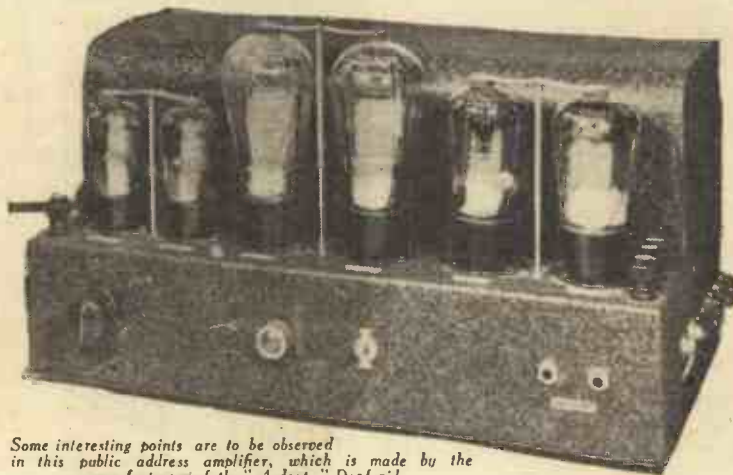

Some interesting points are to be observed in this public address amplifier, which is made by the manufacturers of the "Ardenite" Deaf-aid.

feature in the Rola range and eight separate types are listed.

STAND No. 49. THE BRITISH N.S.F., 188-189, Strand, London, W.C.2. THESE components have appeared for the first time, and are now being handled by Messrs. Wingrove and Rogers. They cover a most exhaustive range and have been used for many years by complete receiver manufacturers. Fixed condensers, tubular condensers, volume controls, etc., provide a further range of components from which the home constructor can choose his accessories.

STAND No. 51. MULTITONE ELECTRIC CO., LTD., 95-98, White Lion Street, London, N.1. IN addition to the tone-control transformers which have been made famous by Messrs. Multitone, the deaf-aid set proves very instructive. This has been developed to such an extent that it is being used in many institutions and schools for the deaf and it is a very valuable aid. The control of the higher frequencies in this, after the manner of the control on the ordinary transformers which Messrs. Multitone have introduced, forms the basis of the aid to the deaf and it is most effective in its operation. In addition, the Q.P.P. transformers (with tone control), the Class B transformers and converter are also the subjects of much interest.

STAND No. 53. REPRODUCERS & AMPLIFIERS, LTD., Frederick Street, Wolverhampton. THE fine range of loud-speakers forms a most attractive setting, and it will be seen that there are some new lines being shown for the first time. Amongst these is the Multimu, which is, of course, used in our Armada receiver, and this speaker enables any output valve to be accurately matched. There are only two models to be seen from last year's list and all the remainder are entirely new lines. A number of interesting features are included in these speakers, and they are most robust and reliable in every way.

STAND No. 54. GARRARD ENGINEERING & MANUFACTURING CO., LTD., Swindon, Wilts. THE gramophone motor appears on this stand in many forms. Ordinary clockwork mechanism is still required for many purposes, but in addition to this type of motor, Messrs. Garrard have also produced some very efficient electric motors, together with complete playing tables, including a pick-up which enables a radio-gramophone to be quickly constructed. The automatic record-changer is also a feature which will undoubtedly become increasingly popular.

STAND No. 56. CLIMAX RADIO ELECTRIC, LTD., Haverstock Works, Parkhill Road, Hampstead, N.W.3. A VERY complete range of receivers is shown by Messrs. Climax, and in both circuit design and cabinet work they are extremely up to date. The double tuning escutcheon on some of the models strikes a new note, and the 4-valve Class B receiver attracts the battery-user, and shows that the battery set can still be made a most useful proposition.

STAND No. 57. BEETHOVEN RADIO, LTD., Beethoven Works, Great College Street, Camden Town, N.W.1. COMPLETE receivers in many types are shown here, and great interest is evinced in the battery models in which the very latest circuits are utilized. The portables for which Messrs. Beethoven have become noted have been re-designed and brought up to date and still prove very popular.

STAND TO STAND SHOW REPORT

(Continued from previous page)



A neat example of a compact superhet. The Beethoven Model 56.

STAND No. 59 GRAHAM FARISH, LTD., Masons Hill, Bromley, Kent.

THE once-famous Formo products appear again at the exhibition, and these are now being manufactured by the New Formo Company—a branch of Graham Farish. It is interesting to note that all the items which are manufactured by this company are produced for the home constructor only, and are not even available for set manufacturers. Thus, these components are developed especially for their high efficiency and their suitability for home constructors, and they function in a most admirable manner. The original Formodensator is still foremost as a pre-set condenser, and in addition there are the new transformers, chokes, condensers, tuning coils, and other items too numerous to mention.

STAND No. 60 McMICHAEL RADIO, LTD., Slough, Bucks.

IN addition to the famous Duplex Transportable, there are a number of other old friends on this stand. The portable has still further been improved, and the twin-speaker console receiver is also a most interesting item on this stand. In both cabinet work and circuit design these receivers are entirely up to date.

STAND No. 61 GRAMOPHONE CO., LTD., Hayes, Middlesex.

IN addition to the elaborate radio-gramophones in which the H.M.V. company have produced, there is an extensive range of smaller receivers, in which the fluid-light tuning device forms quite an interesting factor. The popular pick-up is also seen on this stand, and the chassis of some of the receivers gives visitors a good idea of the work which is involved in building up sets of this nature, whilst the average listener would no doubt hesitate to try to locate a fault in the maze of wiring which is included in these receivers. The method of colour coding the wires, however, enables the circuits to be easily traced out when once understood.

STAND No. 62 PHILIPS LAMPS, LTD., Charing Cross Road, London, W.C.2.

SOME very fine examples of complete receivers are shown on this stand, and it is interesting to note that in at least one case Messrs. Philips have utilized the superhet circuit. Hitherto, this firm has specialized in the use of multi-tuned circuits in preference to the superhet feature, and the super-inductance feature, as it is called, still forms the basis of the major part of their equipment.

STAND No. 63 AMPLION (1932), LTD., 82, Rosoman Street, E.C.

THE all-electric table model superhet, in which all the latest circuit improvements, such as the octode frequency changer, etc., have been incorporated, forms the centre of attraction on this stand, and the new loud-speakers, such as the Lion also attract interest. The Lion, which is the latest addition to the Amplion range, is one of the modern speakers, designed in the full light of modern technical knowledge, and gives promise of a very popular life.

STAND No. 64 ORR RADIO, LTD., 79a, Parkhurst Road, N.7.

A VERY fine range of receivers forms the basis of this exhibit. Circuits of the latest type, cabinets and layout designed in the most modern fashion, and certain items of novelty attract much attention. The "Fisherman's" set, designed primarily for use on trawlers and yachts, shows that attention has been given to markets which as yet have not received the attention they deserve, and the wave-band covered, namely 100 to 200 metres offers a number of interesting transmissions.

STAND No. 65 MULLARD RADIO VALVE CO., Mullard House, Charing Cross Road, London, W.C.2.

THE usual Mullard stand is easily picked out in the Exhibition, and in addition to the vast display of valves, the large models have a story to tell. Obviously the very latest valves attract the major part of the visitor's attention, especially the octode with its six grids, all arranged one above the other. In addition to this part of the exhibit, however, the new receiver, the M.B.3, proves a popular item. This is the first receiver to be manufactured by the Mullard people, and it employs three pentodes in the popular S.G., detector, and L.F. circuit. Reaction has been eliminated, and thus there are only two controls—a tuning control and a volume control—the latter combining the function of an on/off switch. As this receiver is designed for the battery user it should prove a very popular item during the coming season.

STAND No. 66 GENERAL ELECTRIC CO. LTD., Magnet House, Kingsway, London, W.C.2.

A FURTHER display of G.E.C. apparatus is seen on this stand, and proves as attractive as the exhibits on this company's other two stands.



Two interesting components which have been added to the Graham Farish range. The "Max" and the "Quip" Transformers.



STAND No. 67 ULTRA ELECTRIC LTD., Erskine Road, Chalk Farm, N.W.3.

THE popular clock-dial tuning scales which were introduced by the Ultra firm, and which have been extensively copied, give the receivers on this stand a very pleasing appearance. The circuits employed in the receivers, as well as the general arrangement of the cabinet, etc., fully meets modern day requirements, and the prices, too, are well in keeping with the present tendency.



STAND No. 68 AERODYNE RADIO LTD., Aerodyne Works, Walthamstow, E.17.

SEVEN different models, from the 3-valve battery receiver to the 4-valve Universal A.C./D.C. are to be seen on this stand and cover all types of design. A 4-valve Class B receiver, a 4-valve A.C. mains band-pass receiver, a 5-valve superhet, and others are built entirely on the modern style with H.F. pentodes, heptodes, and other improvements which have been introduced during the last season.

STAND No. 69 PYE RADIO LTD., Granta Works, Cambridge.

RADIO receivers and radio-grams in ultra-modern cabinets, in which no controls or external switches of any kind are visible, strikes an entirely novel note on this stand. The wireless set is completely disguised, and no doubt to many listeners this style of receiver represents perfection in home broadcast equipment.

STAND No. 70 FERRANTI LTD., Hollinwood, Lancs.

IN addition to the many receivers which Messrs. Ferranti have to exhibit are to be seen a number of new components produced especially for the home constructor. The L.F. transformers, mains transformers, chokes, and similar items have been, for many years, very popular items among home constructors, but Messrs. Ferranti have now added to the component range by including smaller items, such as fixed condensers, electrolytic condensers, resistances of the moulded type, variable resistances, and volume controls, etc., and the stand attracts many constructors who are undoubtedly pleased to note this increase in the products available for their use.

STAND No. 71 PORTADYNE RADIO, Gorst Road, North Acton, N.W.10.

THE 6-valve transportable superhet attracts considerable attention to this stand, and the display of receivers is very tastefully arranged. The range of battery-receivers shows that this type of apparatus is still finding a ready market in spite of the low price at which some mains receivers may be obtained.

STAND No. 72 E. K. COLE LTD., Southend-on-Sea.

THE perfection which has been obtained in the design of moulded bakelite cabinets has enabled Messrs. Cole to produce some really elaborate cabinets for their receivers, and the latest model, in which the cabinet takes on a round shape, with the tuning dial occupying the whole of the upper half, is probably the most unusual exhibit at Olympia. Greatly improved ease of tuning is obtained in this model, and the tuning scale has certainly received a great deal of attention from the Cole engineers. The entire range of mains units, too, attracts a considerable amount of attention, and the home constructor and listener who wishes to operate a battery receiver from the mains can find a unit to suit his requirements from the Ekco range.

STAND No. 73 A. C. COSSOR LTD., Cossor Works, Highbury Grove, London, N.5.

THE display of valves seems to occupy the attention of visitors as much as the complete receivers, and it is certain that the entire display is of a most interesting nature. Apart from these parts the cathode-ray apparatus also proves interesting, the novel neon tuning indicator provides another useful accessory to add to receivers where A.V.C. is fitted, and will still further increase the interest of the experimenter. Television with the aid of the Cossor cathode-ray apparatus also appears to find many adherents.

(Continued on page 679)



The novel Amplion Lion loud-speaker, and a new receiver which has many novel points.

See & hear the amazing new

LOTUS

at
11, HAMMERSMITH ROAD
 FACING OLYMPIA **AUGUST 16th to 25th**

The **LOTUS**

- **DOUBLE PENTODE**
- **SCREENED PENTODE DETECTOR AND PENTODE OUTPUT.**
- **MAINS ENERGISED MOVING COIL SPEAKER.**
- **WORKS ON ANY ELECTRIC MAINS (A.C. or D.C.) 150 to 250 volts without adjustment.**



This amazing new set has been designed to give the very finest possible reproduction. It is selective, easy to tune and of handsome appearance.

PRICE COMPLETE
£4.17.6

The LOTUS **44** Also two other splendid new LOTUS models as follows:—

The LOTUS **44**

TRIPLE PENTODE

Variable Mu H.F. pentode. H.F. pentode detector. Output pentode. Mains energised moving coil speaker. Provision for gramophone pick-up. Works on any electric mains (A.C. or D.C.) of 150 to 250 volts. Handsome inlaid modern cabinet in walnut and avodiré.

Price complete: **£7.19.6**

The LOTUS **55**

TRIPLE-TUNED A.C.

Matched triple-tuned dual range tuning inductances. Variable Mu H.F. pentode amplifier. Screened pentode detector. 9-watt output valve. Energised moving coil loudspeaker. Handsome walnut cabinet with full vision scale. Ultra selectivity and long range. 3½ watts output.

Price complete **£10.10.0**

★ **WRITE FOR FREE ILLUSTRATED BROCHURE**
 LOTUS RADIO (1933) LIMITED,
 105, Judd Street, King's Cross, London, W.C.1.

MODEL "33"
AC/DC UNIVERSAL
DOUBLE PENTODE



STAND TO-AT
Stand **2**

if you do not visit Olympia, send for descriptive Folder and Free Competition Entry Form.



- CURRENT MILLIAMPS**
 0-6 millamps
 0-30 "
 0-120 "
- VOLTAGE VOLTS**
 0-6 volts
 0-120 "
 0-300 "
- RESISTANCE OHMS**
 0-10,000 ohms
 0-60,000 "
 0-1,200,000 "
 0-3 megohms

FOR GOOD-RADIO'S SAKE
 don't miss the

AVOMINOR

REGD. TRADE MARK

THE INSTRUMENT FOR ACCURATE TESTING

No other small D.C. meter gives the same testing accuracy as the famous AvoMinor. It tracks the slightest defect, traces the most baffling fault with ease. Circuits, valves, components, batteries and power units can be tested quickly and accurately. See the AvoMinor at Radiolympia—see how invaluable—simple—and accurate it is—and see how it can win you a valuable prize!

See also the New
UNIVERSAL AVOMINOR

This new combination meter makes both A.C. and D.C. tests. It is 22 meters in one—gives wonderful new testing facilities. Illustrated Folder post free.

£120 CASH PRIZES
 waiting to be won in the
AVOMINOR
COMPETITION

Closing Date for entries extended until Sept. 15th. Get Free Entry Forms at Stand No. 2, Radiolympia.

A Boon—Just Published
RADIO SERVICING SIMPLIFIED
 Every phase of radio testing is explained in easy language. This new book enables everyone to test with ease and success.

2/6
 Post Free
2/9

THE AUTOMATIC COIL WINDER & ELECTRICAL EQUIPMENT CO., LTD.
 Winder House, Douglas Street, London, S.W.1. **Tele. : Victoria 3404/7**

Immediate Technical Recognition—

Solely specified by
the designer of
The "ARMADA"
Mains Three

described in last week's issue



The R & A "MULTIMU"

has been selected because of its amazing performance, due to the incorporation of 'Impedance Tuning,' and an entirely new magnet system.

Be guided by this and make the MULTIMU your choice, the best of its class and 12 months ahead of competitors—as usual!

- ★ New Magnet System gives amazing Sensitivity
- ★ Exceptional Brilliance and Attack in Reproduction

THE R & A MULTIMU gives instantaneous matching from 1 to 40,000 ohms, the unique 'Impedance Tuning,' enabling the reproducer to be instantaneously and permanently tuned to the receiver as accurately and simply as the receiver is to the broadcast station, regardless of make or type of output.

The MULTIMU magnet system is entirely new, and the sensitivity is even greater than many field excited moving coil models, giving unequalled brilliance and attack in reproduction.

Whatever type of receiver you own or may ever own—the MULTIMU as principal or extension reproducer will give you a brilliance of performance which must be heard to be believed, whilst ownership will compel a pride in possession never before experienced.

42/-

Your dealer can supply. *Insist on R & A MULTIMU.* There is no substitute.

Send postcard for details of complete range from 21/- to 55/-

R & A

BRITAIN'S FOREMOST REPRODUCERS

REPRODUCERS & AMPLIFIERS LTD., WOLVERHAMPTON



PERFECT
RECEPTION
BETWEEN
THEM!

NO-MAST and SILTIT PATENT OUTDOOR AERIAL and EVER-MOIST EARTH

Neater, and far more efficient than the old-fashioned, ugly pole aerial. Enables you to tune in stations never heard before on your set, increasing volume and reducing interference. Is non-directional, designed for modern congested wave-lengths. Especially valuable to flat-dwellers.

The ever-moist 'earth' with maximum contact area through patent spreading antennae. No metal terminals to corrode or break away—the 8ft. lead-in is an integral part of every "Siltit" earth. Completely efficient in any soil and any climate.

COMPLETE WITH 10/6 3/9 COMPLETE WITH 8 FT. LEAD-IN WIRE ALL FITTINGS

See them at **RADIOLYMPIA**
NATIONAL RADIO EXHIBITION, OLYMPIA 1934
STAND No 4 Ground Floor

Sole Concessionaires:

CENTRAL EQUIPMENT LTD., 188/192, London Road., LIVERPOOL

Forbes Keir Advertising

Start the day Smoothly

A comfortable shave means a good start to the day. If you find shaving a bore in the morning, give Parke-Davis Shaving Cream a trial. It really does soften the beard quickly and effectively, and yet protects the skin from irritation. The liberal seven-shave tube which we offer you free will confirm our claims.

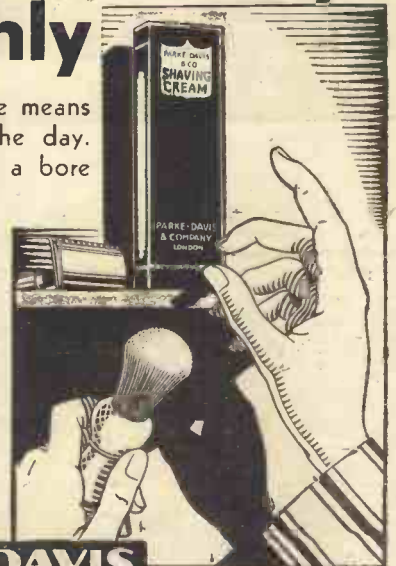

PARKE-DAVIS Shaving Cream

Large tube 1/6 from all Chemists.

FREE OFFER

Write to Box 182/38, Euthymol, 50, Beak Street, London, W.1, for a free 7-day sample of Parke-Davis Shaving Cream.



STAND TO STAND SHOW REPORT

(Continued from page 676)

STAND No. 74
RADIO GRAMOPHONE DEVELOPMENT CO. LTD.,
 18, Frederick Street, Birmingham.

ELABORATE Radio-gramophones, designed round the highest quality circuit arrangements, are to be seen on this stand. Apart from the interesting cabinets, and the utilisation of twin speakers it will be noted that at least one model employs no less than 12 valves. In one model a two-stage paraphase coupled push-pull amplifier is employed to deliver an output of 6 watts.

STAND No. 75
TELSEN ELECTRIC CO. LTD., Aston, Birmingham.

THE name of Telsen has for long been associated with components and complete receivers, and a very fine display is seen on this stand. The range of

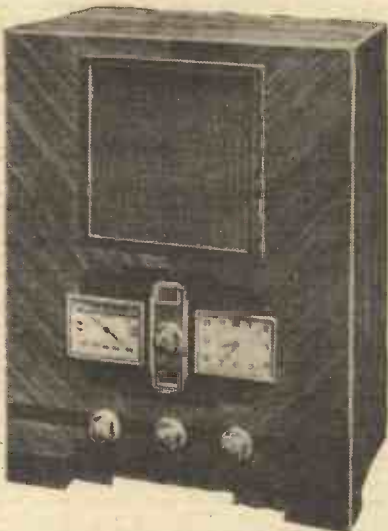

The novel appearance of the clock and the tuning dial strike a new note in this Aerodyne receiver.

components is almost too numerous to describe, and includes such items as L.F. transformers, mains transformers smoothing chokes, H.F. chokes, tuning coils, superhet accessories, reaction and tuning condensers, and so on. In the complete receiver line some novel features are to be seen, in particular the ingenious tuning dial which employs an accurate tuning indicator.

STAND No. 76
MARCONIPHONE CO., LTD., 210-212, Tottenham Court Road, London, W.1.

THERE is on this stand literally a set for every purpose, and no person, whatever his or her circumstances, need be without one.

There are three different types of battery receiver, one 3-valve, one 5-valve, and one 6-valve, which are capable of giving the most excellent performance in any part of the British Isles. There are five table mains superheterodyne receivers and no less than seven radio-gramophones, four of which are fitted with automatic record-changing mechanism.

There are actually two absolutely new instruments which are being introduced for the first time at Olympia, i.e., the 239 A.C., which is a 5-valve superheterodyne radio-gramophone, with automatic record changing mechanism, and the 292 A.C., which is a 9-valve superheterodyne, with automatic record changing mechanism. These two instruments contain many refinements—incorporating modern ideas, and altogether, with the other instruments, complete a range which is absolutely second to none.

There are also the well-known Marconiphone loudspeakers and pick-up on view at this stand.

STAND No. 77
SIEMENS ELECTRIC LAMPS & SUPPLIES, LTD.,
 38-39, Upper Thames Street, London, E.C.4.

AS might be expected, the exhibits on this stand are principally dry batteries of every conceivable type and capacity. There is a range of replacement batteries for every make and type of well-known commercial receiver, besides very many more of general application. An item of especial interest just now, when television is coming very much to the fore, is a special 300-volt dry battery for cathode-ray tube operation.

In addition to the dry batteries, Messrs. Siemens are showing a representative selection of accumulators.

STAND No. 78
HELLESENS, LTD., Morden Road, South Wimbledon, London, S.W.9.

THIS stand is devoted entirely to the well-known HelleSENS' dry batteries, which are available for almost every purpose. Of chief interest will be

those types which are for H.T. purposes, and in this class there are replacement units suitable for use in any and every type of receiver, either commercial or home-made.

STAND No. 80
RADIO INSTRUMENTS, Purley Way, Croydon.

A COMPLETE 3-gang superhet pre-selector and oscillator tuning chassis, using "Micrion" coils, is a special feature here. A new "Micrion" H.F. transformer, similar in appearance to the well-known adjustable inductance coil, is also being shown in conjunction with a "Micrion" H.F. choke, a new L.F. transformer with bi-ferous core, the usual range of short-wave converters, etc. No less than seven different models of the popular R.I. receivers are to be seen, among which are the following: "Ritz" twin-speaker, 5-valve, A.C. superhet; "Ritz" 9-stage, 5-valve superhet; "Ritz" 8-stage, 4-valve battery superhet, and the R.I. "Micrion" Battery Three.

STAND No. 81
BURNDIPT, LTD., Light Gun Factory, Erith, Kent.

THE exhibits on this stand consist of receivers of particularly high grade. There is a wide range, from an A.C. mains superhet, at 18 guineas, to a magnificent A.C. or D.C. radiogram at 32 guineas. The latter is not the only universal model, however, and it is interesting to find several receivers of this modern type. All the Burndept receivers are designed to give reproduction of a particularly "true" nature, and with this object in view every model is fitted with dual speakers mounted at appropriate angles so as to give a correct "floodlighting" effect, instead of a narrow "beam" of sound.

STAND No. 82
BUSH RADIO, LTD., Film House, Wardour Street, London, W.1.

THERE are four different superheterodyne models to be seen on this stand, including one for battery operation. They range in price from £10 19s. 6d. to £16.



The new Electron globe aerial.

STAND No. 83
LISSEN, LTD., Worpje Road, Isewirth, Moss.

THIS year Messrs. Lissen's exhibits are confined chiefly to receivers of the medium and low-price types. A new model which will be of especial interest is a new three-valve band-pass set. It is available for either A.C. or battery operation, the prices being £9 15s. and £8 10s. respectively. Another item which will appeal strongly to home constructors is the latest "Skyscraper" kit; this is available in various forms, all of which are eminently modern. The kit chassis for the "Skyscraper" 3 costs only 77s. 6d., whilst



the price of the A.C. version is £6 10s. Car-radio receivers are prominently displayed on this stand, and these are sure to evoke considerable interest, for they are particularly advanced design and have already achieved a considerable amount of popularity. In addition to complete receivers and

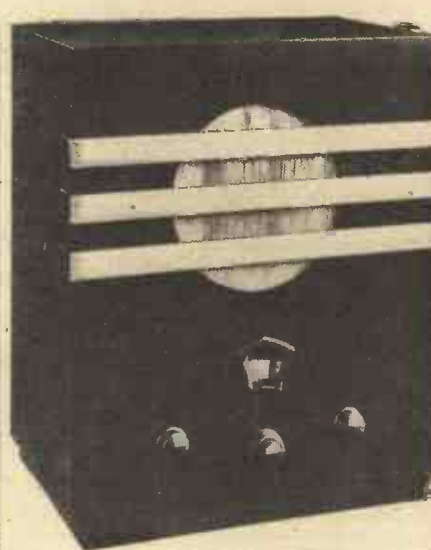

A new note in cabinet design. Another Lissen product.

kits, there is also a wide range of Lissen components, which have been popular favourites for very many years. Altogether, Lissen's exhibits will appeal strongly to the constructor and to every wireless enthusiast.

STAND No. 84
KOLSTER-BRANDES, LTD., Sidcup, Kent.

RECEIVERS of every type and for every purpose and at every price is truly descriptive of the excellent range displayed on this stand. There is a three-valve "New Pup" with many interesting features and having a tuning range from 200-600, and from 1,000-2,000 metres, at £5 15s. complete, to a remarkable 8-valve A.C. superheterodyne radiogram at 65 guineas. The latter is fitted with dual speakers, and has full automatic volume control, noise suppression, neon tuning, automatic record changer, illuminated wavelength-calibrated tuning dials, and an output of no less than 51 watts. Additionally, provision is made for the connection of the K.B. short-wave converter for reception on wavelengths from 14 to 80 metres.

STAND No. 85
H. CLARKE & CO. (M/CR), LTD., Atlas Works, Old Trafford, Manchester.

THE new "Atlas" receivers—designated the "7-5-8" superhets—are the chief features here. Incidentally, it should be pointed out that the figures indicate: seven tuned circuits, five valves, and eight separate functions. This is a rather unusual way of describing the sets, but it has the advantage that it is descriptive and far more informative than a single figure which simply refers to the number of valves. As was pointed out in these pages last week, "spectrum tuning" is one of the main features of the 1935 "Atlas" receivers; the idea is that the wavechange switch serves, in addition to its usual function, to illuminate the station names on either wavelength in red or green, so that no confusion can arise as to the waveband actually in use.

Besides the attractive sets there is a new range of mains units, for which Messrs. Clarke are justly famous. It would be difficult to detail every one of these, but it is sufficient to say that there is a type for every kind of receiver, and for use on either A.C. or D.C. mains.



The Lissen three-valve band-pass receiver, showing the neat design and layout.

STAND TO STAND SHOW REPORT

(Continued from previous page)

The latest unit is the T.1030 and this gives an output of 120 to 150 volts at 30 milliamperes, and is suitable for use with power, class B, or Q.P.P. output. It is provided with three different voltage tapings and is also fitted with a trickle charger capable of charging a 2-volt accumulator at .5 amp.

STAND No. 86

WESTINGHOUSE BRAKE & SAXBY SIGNAL CO., LTD., 32, York Road, King's Cross, London, N.1.

THIS year the new WX6 Westector makes its first appearance at a Radio Exhibition. This Westector is suitable for use in "straight" sets, or as the first detector in superheterodyne circuits, when any form of automatic volume control may be obtained.

The range of H.T. and L.T. units is now so complete that constructors will find a unit to meet their particular requirements for any type of mains receiver, battery eliminator, trickle charger, or moving-coil loud-speaker.

An example of a typical constructors' type combined H.T. eliminator and L.T. trickle charger is shown, and the life test, a familiar feature to visitors at previous Exhibitions, is also being demonstrated. The rectifiers on test have now been operating continuously at full load for over 60,000 hours, and show no falling off in output. As far as can be ascertained, they will continue to give efficient rectification for at least another 60,000 hours.

High-voltage rectifiers for cathode-ray tube supply and various instrument-type rectifiers are also on view.

Traders and owners of battery charging stations will find interest in the display of charging sets. These include the new "hush-hush" RGO 9 charger, which has been produced to meet the needs of all but the larger type of charging station, and at a strictly competitive price. Traders should make a point of seeing this new model.

STAND No. 87

WINGROVE & ROGERS, LTD., 188-9, Strand, London, W.C.2.

HERE is an exhibit of especial interest to the home constructor. For in addition to several of the lines (such as Polar Minor gang condenser, Polar condenser drives, pre-set condensers and the like) which are being continued from last year, there are some excellent new mid-gang condensers of particularly robust construction and some new and improved full-vision tuning scales. Besides these, there are a number of Polar N.S.F. lines, including tubular electrolytic condensers, mid-gang resistors, volume controls, etc. These latter components are of very attractive form, and will probably be used in large quantities by home constructors during the coming seasons.

STAND No. 89

CITY ACCUMULATOR CO., LTD., 18-20, Norman's Buildings, Central St., London, E.C.1.

THE C.A.C. receivers shown on this stand are a combination of well-made modern and attractive cabinet work with the very latest designs in radio receivers. The enthusiast will probably be most interested, however, in the "Superpak" tuning unit which contains three coils, a three-gang condenser, padding condenser, and 25,000 ohm volume control. The unit is designed for use in superhets in conjunction with the heptode frequency changer; it is soundly designed and guaranteed to have circuits which are matched to within one half of one per cent. The price is £2 12s. 6d. Another interesting item is a complete A.C. short-wave adaptor, consisting of two valves, plus rectifier, and covering a range from 12 to 96 metres.

STAND No. 90

BRITISH BLUE SPOT Co., Ltd., 94/96, Rosoman Street, Rosebery Avenue, London, E.C.1.

AS in previous years, there is on this stand a very complete range of loud-speakers in every type required by the average listener, in addition to some pick-ups of advanced design. For those who are in search of perfection of reproduction the new "Super Dual" is of especial appeal. This speaker actually consists of two separate units mounted concentrically with each other. The larger one is designed to handle the lower and middle frequencies, whilst the smaller one deals with the higher frequencies only. To enable it to do this efficiently the cone is extremely light and the windings are of aluminium wire. Special input transformers are fitted to filter the audio frequencies and to keep all except the high notes out of the smaller unit. Visitors can judge the excellence of this latest product for themselves. A smaller speaker which has much to recommend it is the Blue Spot "Star Junior" which sells at 35s. It is of the permanent-magnet pattern, is provided with a transformer which gives 12-point matching, and has a special double cone to ensure a uniform output at all frequencies.

STAND No. 91

EDGE RADIO, Ltd., Bolton, Lancs.

"DRUMMER" receivers are featured on this stand, and although these achieved considerable popularity last year they should be even more in favour now. The range has been considerably widened and includes low-priced battery models and some very interesting mains superhets.

STAND No. 93

ELDEGO RADIO, LTD., 62, Conduit Street, London, W.1.

FIVE different receivers are displayed on this stand, the largest and most interesting from a technical point of view being a 9-valve Stenode radiogram. This gives a frequency separation of 5 kilocycles, is provided with amplified delayed A.V.C., has visual tuning, and supplies an output of 8 watts undistorted to a large Magnavox "Double Six" loud speaker. There are two other and smaller Stenode receivers in the range, as well as two 5-valve battery-operated superhets with Q.P.P. output.

STAND No. 94

BRITANNIA BATTERIES, LTD., Union Street, Redditch, Worcs.

"PERTRIX" batteries are too well known to require any introduction to readers, and visitors will find them displayed on this stand. In addition to the range which was available last year, and included replacement models for all types of commercial receivers, there is on show an entirely new "power" series which are marked with blue labels. These batteries are especially designed for use in modern receivers having up to four or five valves, and have a safe discharge rate of 10-12 milliamperes. Most of them are provided with G.B. tapings in addition to those normally used for H.T. Those readers who require batteries for outputs of 20 milliamperes or so will find the Pertrix super power (maroon carton) batteries entirely suitable for their requirements.



The sloping control panel of this Kolster Brandes set gives it a neat appearance and facilitates tuning.

STAND No. 95

TANNOY PRODUCTS, Canterbury Grove, West Norwood, London, S.E.27.

THE above firm has become very well known during recent years in connection with their excellent public-address outfits, and these are the chief features of interest. In addition to the complete equipments there are a number of special power amplifiers having outputs up to 120 watts, and also some portable amplifiers of various types. There is also a range of projection speakers for outdoor work as well as a variety of microphones. Another brand new item is the Tannoy radio gramophone, which has been designed particularly for the use of those to whom perfect reproduction is the main requirement.

STAND No. 96

DUBILIER CONDENSER CO. (1925) LTD., Victoria Road, North Acton, London, W.3.

AS was naturally expected, Messrs. Dubilier are showing fixed condensers and resistances in almost every conceivable pattern. All the lines which have been so popular during the past few years are being continued and are again exhibited. Additionally, however, there are several new items, among which mention should be made of the reversible dry electrolytic condensers, which have been developed principally for use in D.C. and universal receivers, although they are equally suitable for use in any other type of set. Other interesting lines are the double electrolytic condensers which are fitted into cylindrical aluminium containers (as are the standard types), but have flexible leads for the positive connections. An 8-plus-8 mfd. condenser of this type, for 500 volt D.C. peak working, costs 9s. 6d.

STAND No. 97

BRITISH RADIOPHONE LTD., Aldwych House, London, W.C.2.

THE items of chief interest on this stand are the 8-valve all-wave receivers. These cover the wavelength ranges from 15-55, 190-560, and 800-2,000 metres, excepting in the Empire model, in which the long-wave range is omitted. The receivers are very thoroughly made to proven designs and are just as suitable for use in tropical climates as they are in this country. As an example of the care which has been expended in their design, it might be mentioned that the containing cases of the Empire models are made of teak, the pieces being pinned together with brass fastenings. Special insulating material—frequentite—is employed, and this will retain its almost perfect insulating properties when subjected to heat and humidity. All the aluminium parts are anodized to resist corrosion, and the ganged condensers have separate sections for the long and short-wave ranges. Other items of topical interest on this stand are those forming a very complete range of interference suppressors for use both in conjunction with electrical machinery and with the receiver itself. Messrs. British Radiophone have produced a very useful booklet dealing with interference suppression from various angles and this is being distributed from the stand.

STAND No. 98

WHITELEY ELECTRICAL RADIO CO., LTD., Mansfield, Notts.

THE chief feature of the stand is the new "Stentorian" range of speakers embodying a patented new magnetic material, and an exclusive method of speech coil assembly. The manufacturers claim that its new design brings a very marked improvement in reproduction, and volume approximately double that of previous models at a similar price.

The chief of these, Stentorian Senior (Model PMS1) is displayed in two strongly illuminated boxes at the entrance of the stand, and is also prominently featured in other positions. An oversize cone is incorporated and the price is 42s. retail. This model is now the dearest in the W.B. range, models at £3 19s. 6d., and £6 0s. 6d. having been deleted as being now unnecessary.

The Stentorian Standard, priced at 32s. 6d., employs similar features to the Senior model, but has a smaller magnet and a standard 8in. cone. Like the Senior, it is provided with an improved version of the well-known W.B. Microdole device giving multiple ratios for matching to any output and incorporating the additional feature that, by the turn of a button, the speaker may be adapted for use as an extra speaker on any set on the market.

Both the above models have a number of further detail improvements. The air gap is fully protected from dust at front, back, and sides, and a new non-resonant casting is used for the chassis construction.

Also displayed is the Stentorian Baby—a mid-gang loud-speaker, having the same features as to magnet and speech coil as the larger models but provided with ordinary tapped transformer for matching to power, pentode, or Q.P.P. output.

The well-known W.B. range of components is on display with the addition of new valve-holders for the new B.V.A. bases in both skeleton and baseboard forms. A most interesting addition is the two-way tone control, a unique component which will emphasize either bass or treble at the turn of a single knob. It may be used across the loud-speaker terminals or in any suitable part of the receiver circuit and is sufficiently robust to stand up to large potential differences if necessary. The price is 7s. 6d.

The display is completed by a range of energized and public-address models containing sufficiently interesting new features.

STAND No. 99

REGENTONE, LTD., Worton Road, Isleworth, Middlesex.

REGENTONE mains units have been in great demand for some years past, and the latest model will probably prove to be even more popular than its predecessors. It is styled the V.P.30, and is for A.C. use, and has an output of 30 milliamperes at 120-150 volts; this can be reduced to 10-20 milliamperes when desired, however, by means of the special output regulator which is fitted. In addition to the H.T. supply mentioned this unit has a trickle charger with an output of .5 amp. All the other well-known Regentone eliminators are also being shown.

Another entirely new line is the AS/35 receiver, which has been introduced at Olympia. It is a modern eight-stage superhet having four multiple valves and embodying super-efficient litz-wound coils. Automatic volume control, noise suppression, fully variable tone control, and a novel "sound reflector" cabinet are some of its many features. The price is 12 guineas.

STAND No. 100

ORMOND ENGINEERING CO., LTD., Ormond House, Rosebery Avenue, London, E.C.1.

HERE there is a splendid range of components and accessories, which are of especial interest to the home constructor. All the tuning condensers, dials, L.F. transformers, speaker units, etc., which have been so popular for many years are to be seen.

(Continued on page 682)

"You have surpassed yourselves"

Says Mr. F. J. Camm!

(editor "Practical Wireless")



"You have surpassed yourselves with this new 'Stentorian' speaker. I thought you had reached the apogee when you introduced the 'Microlode' last year; but to this present speaker, which I have submitted to test, I unhesitatingly accord full marks for a rich and entrancing quality in tone, and for an even greater sensitivity for a given input than was obtainable from your past high standard of speaker.

I feel that your Engineers must always be at work striving after the apparently unattainable and attaining it!"

Such an opinion from one of the foremost designers of to-day is not lightly given. To a technician of Mr. Camm's experience a list of interesting technical features alone is not sufficient—he requires results to prove the value of any revised design or new discovery. In the W.B. "Stentorian" Mr. Camm found them.

A W.B. "Stentorian" will bring an unbelievable improvement to your set.

You will hear a considerable increase in volume, due to the exclusive "Nital" magnet which at the same cost provides an enormous strength never

before obtainable with a "commercial" material. Due to a new method of speech coil assembly you will find in your reproduction crisper "attack," and fuller natural bass, and a new "realism" which will astonish you.

You must not fail to hear a "Stentorian" on your set. You will be amazed at the difference. If you visit Radiolympia

SEE IT AT STAND NO. 98

- Stentorian Senior (PMS1) - - - 42/-
100% dust protection. Oversize cone
- Stentorian Standard (PMS2) - - - 32/6
- Stentorian Baby (PMS6) - - - 22/6

Write for the new W.B. Stentorian Leaflet



Model PMS1



STENTORIAN

Whiteley Electrical Radio Co., Ltd. (Dept. D), Radio Works, Mansfield, Notts.
Sole Agents in Scotland: Radiovision Ltd., 233, St. Vincent Street, Glasgow, C.2. Sole Agents in I.F.S.: Kelly and Shiel, Ltd., 47, Fleet Street, Dublin

STAND TO STAND SHOW REPORT

(Continued from page 680)

STAND No. 102
BURGOYNE WIRELESS (1930) LTD., Great West Road, Brentford.

IN addition to the many receiver models which were mentioned in these pages last week, Messrs. Burgoyne are showing two entirely new models, one of which is a two-pentode three-valver, and the other a screened-grid "four." The former employs a screened H.F. pentode in the first stage and a power pentode output and is wavelength calibrated. The latter is a suitcase portable of neat and simple design. Both receivers, like others in the Burgoyne range, have "one-glance" tuning and other interesting features.

STAND No. 103
VARLEY (OLIVER BELL CONTROL, LTD.), Bloomfield Road, Woolwich, London, S.E.18.

ONE of the most interesting exhibits on this stand is the latest Varley ganged permeability tuner, which is shown in 3-gang and 4-gang types. This is attracting considerable attention due to its neat and novel design and bids fair to become very popular during the coming season. Another new line is the Duo-Nicore I.F. transformer, which has adjustable coupling so that the band-width which it covers can be varied over wide limits according to the degree of selectivity required at any time. Nicore coils in all types are also on view, along with the well-known Varley "Power Puncher," A.V.C. unit, etc. Power transformers, L.F. transformers, chokes, and, in fact, everything which the discerning constructor requires is to be seen and can be inspected at close quarters. No constructor can afford to miss the Varley stand.

STAND No. 104
GROSVENOR ELECTRIC BATTERIES LTD., 2-3, White Street, Moorgate, London, E.C.2.

THE popular Grosvenor mercury dry batteries are the centre of interest on this stand, and a particularly wide range is to be seen. Batteries of every required voltage and current rating are shown for both high tension, grid bias, and low tension. In addition a variety of Grosvenor Miscantile electric torches are being exhibited. Although not quite so well known as the dry H.T. batteries, the Grosvenor high-tension accumulators are attracting much attention by those who require a heavy H.T. current over long periods.

STAND No. 105
TELEPHONE MANUFACTURING CO., LTD., Hollingsworth Works, Martell Road, West Dulwich, London, S.E.21.

THERE is here a very extensive range of the popular T.M.C. Hydra condensers which have recently been specified in a number of PRACTICAL WIRELESS designs. These condensers are well known because of the modern principles adopted in their construction. One special feature is that the "business" portions of all the tin-cased models are contained in transparent paper bags, with a result that the operator can see at a glance that the unit is completely covered with wax; this ensures that there shall be no air bubbles which are likely to cause premature breakdown. The tubular fixed condensers are particularly interesting components and, although introduced only within the last year, they are already being used very extensively. In addition to the usual types of condenser, there are several of the multiple, or block, units.

STANDS Nos. 106 and 107
VIDOR BATTERIES, LTD., Erith, Kent.

VIDOR batteries are of recent introduction, but are made in a variety of types and sizes which are useful for either home-made or commercial receivers. They are well displayed, and their special features are clearly demonstrated. The batteries are reasonably priced and are claimed to have a long, useful life.



The new pattern of the J.B. ganged condenser.

STAND No. 108
ANSON & HOPWOOD, LTD., 41, Cheval Place, London, S.W.

THE exhibits here will strongly appeal to those who are interested in the most modern developments, and who want the best and latest form of radio equipment. An entirely new automatic record changer is one of the principal exhibits, this being remarkable in that it not only changes from one record to another in the desired sequence, but also turns the records over so that both sides are played. Its capacity is thirty double-sided records; in other words, from three to four and a half hours' continuous programme. A complete and ultra modern radio-gramophone is also being shown, which is fitted with the "Autotrope" automatic record changer. This is a real "quality" outfit which comprises a highly-efficient superhet receiver, a high-power amplifier, and three separate rectifying valves; of the latter one feeds the receiver, another the amplifier, and the third, the field windings of the energized moving-coil speakers. The price of the complete radiogram is £150.

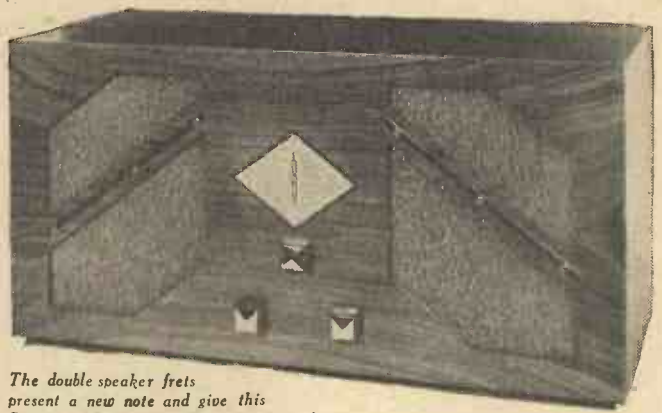

The double speaker frets present a new note and give this Burgoyne receiver an attractive appearance.

being no less than 200,000 ohms. The price of this multi-range meter is only 42s. Another meter which will be found of interest is the "Pifco" A.C.-D.C. "Radiometer." This is an improved model of the well-known "All-in-One" test meter, and can be used for all the tests for which the earlier model was suitable, in addition to being applicable to both A.C. and D.C. supplies. It is modestly priced at 12s. 6d.

STAND No. 112
TELEGRAPH CONSTRUCTION & MAINTENANCE CO., LTD., Telcon Works, East Greenwich, S.E.10

THE exhibits on this stand consist principally of alloys intended for a variety of wireless components and accessories. Two alloys which are suitable for cores in transformers, chokes, etc., as well as for various forms of magnetic screens are known as "Numetal" and "Radiometal." Another special alloy is known as "Calomic," and this is a new form of resistance material which can be drawn down to very fine gauge; its special use is in the construction of wire-wound resistors, potentiometers, and the like.

STAND No. 113
ALLWAVE INTERNATIONAL RADIO AND TELEVISION, LTD., 242, High Street, Bromley, Kent.

THE main item on this stand is an all-wave universal (A.C.-D.C.) superheterodyne receiver chassis having an octode frequency changer double-diode detector, providing A.V.C. and a variable- μ pentode L.F. amplifier. This chassis is of very modern design and has a wavelength range from 15 to 2,000 metres in four separate bands. A complete radio-gramophone is also shown in which the above chassis is fitted along with a pillar-box automatic record player.

STAND No. 114
JACKSON BROS. (LONDON), LTD., 72, St. Thomas' Street, London Bridge, London, S.E.1.

SO popular have all the last year's lines in the J.B. range proved that they are being retained for the coming season, although slight price modifications have in some instances been made. New lines which are being shown include some new midget, fully-screened gang condensers in both plain and superhet patterns, a universal model of the popular "Linacore" tuning assembly, some new full-vision drives and dials, and a baseboard-mounting disc drive. Messrs. Jackson Bros. are certainly living up to the slogan, "Precision Condensers."

STAND No. 115
ADEY PORTABLE RADIO, 99, Mortimer Street, London, W.1.

SO far as we are aware, the Adey portable is the smallest on the market, for it embodies some interesting new methods of construction in addition to the ingenious Adey self-coupling valves, which have inductances wound in slots formed in their bases. The "Baby" four-valve portable costs £7 10s. 6d. complete and weighs no more than 12½ pounds. Other models include a three-valve hikers' receiver and a one-valve portable of interesting design. The remarkable valves are also being exhibited in a number of different types.

STAND No. 116
H. HACKER & SONS, Perfecta Works, Ray Lea Road, Maidenhead.

"DYNATRON" receivers in various types are here to be seen. Contrary to what has become common practice, these sets do not employ the superheterodyne circuit, but have a highly selective arrangement of Ferrocart coils which the makers claim give selectivity equal to that of any superhet, and at the same time produce better quality. One of the special features of "Dynatron" receivers is the "searchlight" tuning which Messrs. Hacker have lately introduced. In addition to receivers and radiograms, there is a short-wave unit which can be used in conjunction with any of the "Dynatron" receivers.

(Continued on page 684)

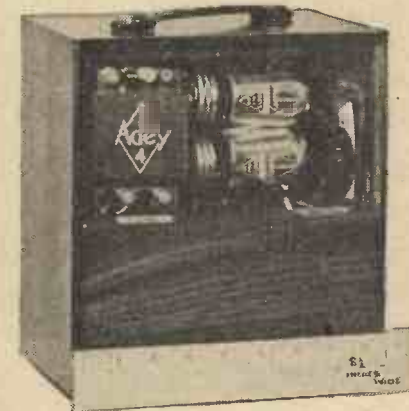

A compact portable. This is the Adey, and employs the special Adey coupling valve.

STAND No. 109
W. T. HENLEY'S TELEGRAPH WORKS CO., LTD., Holborn Vjeduct, London, E.C.1.

THE display on Henley's stand comprises two ranges of the many products of this company, viz., electric soldering irons and radio wires and cables. A range of soldering irons is being demonstrated, including Solons suitable for the amateur wireless constructor or handyman as well as heavier models for radio manufacturers. Recently the design of the domestic model has been modified, although the price of 7s. 6d. remains the same. A tinned copper bit is now fitted which is oval in shape and facilitates work where space is limited. This Solon is fitted with a 6ft. length of Henley brown glass cotton-covered twin flexible together with a standard bakelite lamp-holder adaptor, and is available for two voltage ranges, 200/220v. and 230/250v. The consumption is 65 watts. Other items of interest are Henley's resin-cored solder, a variety of radio connecting wires of all kinds, and Henley's slide-back wire which is useful for set wiring and other purposes. The chief feature of the slide-back material is that it is unnecessary to strip the insulation in any way, since it can simply be slipped back by means of the finger and thumb.

STAND No. 110
AUTOMATIC RADIO GRAM. CO., LTD., Crown Street Hall, Brighton

STAND No. 111
PROVINCIAL INCANDESCENT FITTINGS CO., LTD., Pifco House, High Street, Manchester.

THIS stand is devoted largely to the exhibition of the well-known "Pifco" test meters, which are available in several forms. The meters which have been popular for several years past are again being shown, but there are also some new models which are ideal for the experimenter who desires to have a combination instrument upon which he can rely for all his experiments. One of these is a de-luxe edition of the "Rotameter"; this has a maximum voltage scale reading of 400 volts, and has the commendably high resistance of 500 ohms per volt, the total resistance

RECEIVER DESIGNS SEEN AT THE SHOW



The large and easily-read tuning dial is an interesting feature of this Ekco console.



The Aerodyne Wren.



One of the Lissen models.



The Beethoven S.G. three.



A distinctive note is struck by this latest Marconiphone console receiver.



The Halcyon console model.



The Multitone receiver with deaf-aid equipment.



A console radiogram from the extensive Cossor range of 1935 receivers.

STAND TO STAND SHOW REPORT

(Continued from page 682)

STAND No. 117
ELECTRO DYNAMIC CONSTRUCTION CO., LTD.,
733b, Old Kent Road, London, S.E.15.

HERE there is an interesting display of converters and battery chargers of various types. The best-known converter in the series is one for converting D.C. to A.C. and is intended for the operation of power amplifiers, A.C. receivers, etc. The input may be taken from D.C. mains, private house-lighting plants, or from L.T. accumulators, whilst an important point is that the unit is interference-free. Other lines are



The new Plumax dry battery, manufactured by the Vee Cee Dry Battery Co.

alternators for supplying public address outfits; these may be driven from the engine of a car, or may be obtained complete with a petrol engine. In addition, there are several accumulator-charging plants and an H.T. converter for use with car-radio receivers.

STAND No. 118
SWIFT, LEVICK & SONS, Clarence Steel Works, Sheffield, 4.

THE exhibits here consist of a very extensive range of various types of permanent magnets, most of which are designed for use in the construction of permanent-magnet moving-coil loud-speakers.

STAND No. 119
HARTLEY TURNER RADIO, LTD., Thornbury Road, Isleworth, Middlesex.

THIS firm, as many readers will be aware, specialize in the production of "quality" receivers, power amplifiers, and loud-speakers, and a comprehensive array of such apparatus is to be seen on the stand. The receivers are intended more for the perfect reception of the local stations than as long-range instruments. There are four principal models, styled the M.7, M.12, S.7 and S.12, respectively; the "M" indicates that the receivers are ready-made, whilst the "S" indicates that the necessary parts are supplied as a kit; the figures "7" and "12" indicate the approximate undistorted outputs in watts. The Hartley-Turner loud-speakers are shown in three models, the first of which is for D.C., the second is for A.C. and is provided with a 20-watt rectifier for field energization, and the third is also for A.C. but has a 40-watt rectifier. The prices of the three models are 7, 8 and 9 guineas respectively.

A small number of special high-grade components, such as L.F. coupling units, mains transformers, smoothing chokes, etc., are also on view.

STAND No. 121
BULGIN RADIO, LTD., Abbey Road, Barking, Essex.

THIS stand will probably prove of greater interest to the home constructor than any other at the exhibition, for it contains an extremely wide range of components of every type required for the construction of a high-grade receiver. All the lines which have been in such great demand during the last few years are again on view, but the range of accessories has been greatly extended, and is even wider than it has ever been before. Of the brand new lines which are being shown for the first time particular mention should be made of the all-wave tuner, which has a number of interchangeable coil units, so that any combination of wavelength ranges can readily be obtained. The coil assembly is fitted with an entirely new type of positive-contact multiple switch, which is also available separately. Other new lines include a complete range of stripped screened coils which are especially designed for chassis mounting, and which have soldering-tag contacts and are priced at the extremely low figure of 5s. each. Ultra-short-wave coils for television and other receivers are also newcomers which are being displayed. Other additions to the previously wide range are a new decorative signal lamp of improved design, some 60-watt variable resistances, a Q.P.P. low-frequency transformer, an all-valve testing unit,



Three Fuller products—an H.T. accumulator unit, an L.T. accumulator and a dry battery.

and a neat assembly comprising a series of fixed condensers and resistances and the necessary soldering contacts. The object of this unit is to simplify receiver construction by grouping together the similar components.

STAND No. 124
FULLER ACCUMULATOR CO. (1926), LTD., Woodland Works, Chadwell Heath, Essex.

THIS well-known firm is again showing a variety of accumulators and high-tension batteries of several types. Among the L.T. accumulators there are three principal types known as the "Standard De-Luxe," these having capacities of 40, 60, and 80 ampere-hours respectively, at the 100-hour rate. The new H.T. accumulator is supplied in 10-volt units, and this has a number of special features, such as intercell connectors sunk into a grease barrier to prevent corrosion, and adaptors fitted to the terminals to enable ordinary wander plugs to be used for connecting purposes. A high-tension battery which will be of especial value to tropical wireless users is of the inert type. This can be stored for an indefinite period without any ill effects and it only becomes active when it has been filled with water. The H.T. batteries of normal type are intended principally for use with receivers which consume more than the average H.T. current, since they are of the heavy-duty pattern.

STAND No. 125
GOODMANS (CLERKENWELL), LTD., Clerkenwell, E.C.1.

THE exhibits on this stand included their new Grille P.M. speaker—a de luxe instrument designed to give the most faithful reproduction possible with an 8in. speaker. The periphery of the diaphragm is supported between resilient pads, providing a "dead" suspension and ensuring the fullest bass response without boominess.

The transformer is of the multi-load type, providing ratios for most output valves. It costs 45s., or, fitted, with special extension transformer providing four low resistance tapings, four push-pull and eight high-resistance tapings, the ratios being selected by a selector switch, 52s. 6d.

The "12 watt" moving-coil speaker, with an 11in. diaphragm model, has a response range from 40 to



A neat portable deaf-aid. This is the "Ossicaide."

10,000 cps. free from audible peaks or dips. Its sensitivity enables sufficient volume for a small dance hall to be obtained from a fully loaded 2-watt Class B battery valve, whilst an output of 12 watts undistorted can be handled without distress.

The permanent magnet model costs £4 17s. 6d. Other models shown included the "12 watt" energized model at £4 10s., a public address speaker. The P.M.8., at 42s. 6d., the E.8., at 35s., and the P.M.6., at 27s. 6d.

Other exhibit included displays of coil winding, stampings, turned parts, transformers, chokes, and other manufacturing components for the trade.

STAND No. 126
THE VEE CEE DRY CELL CO. (1927), LTD., Stoke Newington, London, N.16.

THIS Company, manufacturers of high-tension batteries, introduced for the first time at this year's Exhibition a new range of batteries suitable for discharge current up to 12 m/A, and super-capacity sizes suitable for discharge up to 25 m/A. A second range, known as the Plumax Standard Energy, are suitable for discharge current up to

8 m/A, super-capacity sizes in this range being suitable for discharge up to 12 to 20 m/A. All of them are reasonable in price.

STAND No. 203
SOUND SALES, LTD., Junction Road, Highgate, N.19.

AN interesting exhibit on this stand is a special double time base for 30- and 120-line transmissions in television. This is in the form of a totally enclosed unit and may be used in conjunction with existing receivers for the reception of both 30- and 120-line transmissions, the alteration being effected by throwing over suitable switches on the control panel. Finished in a black crystalline metal case, the price complete is £12 10s. Other interesting items include a special high voltage eliminator employing a universal transformer suitable for A.C. voltages from 200 to 250, and incorporating a special smoothing circuit costing £7 10s. complete; a special cathode-ray exciter unit incorporating smoothing with focus and voltage control, universal transformer, and suitable switching arrangement to enable the cathode-ray tube heater to be fed from raw A.C. or battery—total price with valves being £7 15s., a complete series of mains transformers for television apparatus giving outputs of 1,000 to 1,500 volts especially designed for cathode-ray work, and specially designed equal ratio transformers for use in the output circuit where phase reversal is necessary owing to the picture appearing inverted. Two models are released, one for battery receivers at 10s. 6d. and another for use with mains output valves at 16s. This firm is also showing a self-contained portable charger which can be instantly connected to the car battery in order to re-charge over-night. Known as the Auto-charger, it sells at £3 12s. 6d. The Sound moving-coil speaker has been altered only in minor details, complete with transformer it costs £2, or a special matched pair of speakers without output transformer at £5.

Auto transformers were also exhibited for voltage conversion for those who wish to work 110 apparatus from 230 volt mains.

STAND No. 204
RADIO SOCIETY OF GREAT BRITAIN, 53, Victoria Street, London, S.W.1.

STAND No. 205
WHARFEDALE WIRELESS WORKS, 62, Leeds Road, Bradford.

THIS well-known firm exhibits their range of speakers from 32s. 6d. to 110s. in price. The Junior Model at 32s. 6d. is an excellent general-purpose speaker fitted with a new type of cone, and will handle 3 to 4 watts undistorted output and can be matched to any output valve or set. The new bronze model at 42s. 6d. was introduced two years ago and is ideal for public address work. It will handle 5 watts undistorted output. Other models are the Golden at 58s. 6d., the Auditorium at 110s., the D.C. Standard at 32s. 6d., the Rexine Junior extension speaker in cabinet at 38s. 6d., the Bijou extension in cabinet at 45s. 6d., and the Bronzoid, de Luxe, and Nubian at 65s. 6d., 92s. 6d. and 75s. 6d. respectively; transformers are available to suit most requirements.

STAND No. 206
BRITISH G.W.Z. BATTERY COMPANY, Trading Estate, Slough, Bucks.

A FULL range of high-tension batteries and grid-bias batteries at reasonable price form the main feature of this exhibit.

STAND No. 207
FILM INDUSTRIES, LTD., 60, Paddington Street, London, W.1.

THIS firm manufactures small public-address outfits, notably the Junior at £48 10s. and the Baby at £32 10s., the latter clearly reproduces speech at a range of 500 yards and the former within a range of 800 yards. This firm also exhibited their P1 Pedestal moving-coil microphone at £7 7s. (stand £1 1s. extra) and their full range of loud-speaker units and horns.

STAND No. 209
HARMER & SIMMONS, LTD., 223, Hoe Street, Walthamstow.

THIS firm specializes in work for electrical undertakings in converting from D.C. to A.C. Their speciality is rectifiers for all purposes, and they also undertake to convert all A.C. mains receivers.

(Continued on page 687)





SUMMIT 3 • ARMADA MAINS 3 NEW SPEAKERS—ELIMINATORS—KITS



The Pilot Kit SERVICE was founded in 1919.

PILOT AUTHOR KIT EXACT TO SPECIFICATION

See the PILOT on the carton. It's a real guarantee.

IMPORTANT

Miscellaneous Components, Parts, Kits, Finished Receivers or Accessories for Cash or C.O.D. or H.P. on our own system of Easy Payments. Send us a list of your wants. We will quote you by return. C.O.D. orders value over 10/- sent carriage and post charges paid (GREAT BRITAIN ONLY). OVERSEAS CUSTOMERS CAN SEND TO US WITH CONFIDENCE. We carry a special export staff and save all delay. We pay half carriage—packed free. Send full value plus sufficient for half carriage. Any surplus refunded immediately. Hire purchase Terms are NOT available to Irish and Overseas customers.

SUMMIT 3

KIT "A" Author's Kit of First Specified Parts, less Valves and Cabinet. Cash or C.O.D. Carriage Paid **£4/6/0.** Yours for **7/9** and 11 monthly payments of 7/9

KIT "B" as for Kit "A" but with set of specified Valves, less Cabinet. Cash or C.O.D. Carriage Paid, **£5/18/6.** Or 12 monthly payments of 10/9.

KIT "C" as for Kit "A" but with set of Specified Valves, and Peto-Scott Summit Cabinet. Cash or C.O.D. Carriage Paid, **£6/18/0.** Or 12 monthly payments of 12/6.

GARRARD AUTOMATIC RECORD CHANGER UNIT. Universal A.C. or D.C. 100-250 volts. Plug pack of 8 10" or 12" records. Cash or C.O.D. Carriage Paid, **£10/17/6.** Balance in 11 monthly payments of 20/-.



NEW SPEAKERS

W.B. STENTORIAN BABY Permanent-Magnet M.C. SPEAKER. With matching Transformer, suitable for Power, Pentode, Class B or Q.P.P. Cash or C.O.D. Carriage Paid. **£12/6/0.** Balance in 5 monthly payments of 4/3.

BLUE SPOT STAR JUNIOR Permanent-Magnet M.C. SPEAKER with 12 point matching transformer suitable for all outputs. Cash or C.O.D. Carriage Paid. **£11/5/0.** Balance in 6 monthly payments of 5/6.

CELESTION P.P.M.6 Permanent-Magnet M.C. SPEAKER. For Power or Pentode. Cash or C.O.D. Carriage Paid. **£17/7/6.** Balance in 5 monthly payments of 5/-.

EXCLUSIVELY SPECIFIED PETO-SCOTT Walnut CABINET 19/6

Specially designed at the request of PRACTICAL WIRELESS for the Summit 3. In exquisite walnut, a superb example of cabinet craftsmanship. Internal Dimensions 20" wide; 10" high; 12" deep. Carriage Paid.

A strongly-built Walnut Stool, 28in. high, for the Summit 3 Cabinet. 27/6 Carriage Paid.

"Simply Plug-In" 1935 PILOT CLASS 'B' SPEAKER-AMPLIFIER KIT

GIVE A NEW LEASE OF LIFE TO YOUR PRESENT BATTERY SET. This amazing unit will give seven times the volume with mains quality from your existing battery set. B.V.A. Class B Valve, 1935 Peto-Scott Permanent-Magnet Moving-Coil Speaker, B.H.G. Driver Transformer and 7-pin Valve Holder. Peto-Scott Baffle and Baseboard Assembly, all Wires and Screws. With full-size Diagrams and Assembly Instructions. Complete Kit as illustrated. Cash or C.O.D. Carriage Paid. Or send only 5/-.

Balance in 9 monthly payments of 5/-.

ANY BATTERY SET 45/-



NEW ELIMINATORS

ATLAS C.A.25, for A.C. Mains, Class B and Q.P.P., four tappings: 60/80, 50/90, 120, 150 volt, 25 m.a. Cash or C.O.D. Carriage Paid. **£2/19/6.** Balance in 10 monthly payments of 6/-.

ATLAS C.A.12, for A.C. Mains, 100/250v. three tappings: 60/80, 90/100, 120/150v., 12 m.a. at 120v. Cash or C.O.D. Carriage Paid. **£2/12/6.** Balance in 9 monthly payments of 5/9.

NEW REGENTONE UNIT, V.P.30 for A.C. Mains. 100/130 v., three tappings: 10, 20, 30 m.a. With L.T. Charger 2 v., 5 amp. Cash or C.O.D. Carriage Paid. **£2/12/6.** Balance in 9 monthly payments of 5/9.

ARMADA Mains 3

KIT "A" Author's Kit of First Specified Parts, less valves and cabinet. Cash or C.O.D. Carriage Paid **£10/9/6.** Yours for **19/3** and 11 monthly payments of 19/3

KIT "B" as Kit "A" but with set of specified valves. Cash or C.O.D. Carriage Paid **£12/8/0.** Or 12 monthly payments of 22/9.

KIT "C" as Kit "A" but with set of specified valves and Peto-Scott Tablegram Cabinet. Cash or C.O.D. Carriage Paid **£14/13/0.** Or 12 monthly payments of 26/9.

EXCLUSIVELY SPECIFIED PETO-SCOTT TABLEGRAM CABINET

Another magnificent Peto-Scott cabinet, specially designed for the Armada Mains 3. In beautifully grained woods, faultlessly constructed and hand french polished. In Oak or Mahogany to choice, no extra. State which when ordering. **45/-**

1935 ADAPTAGRAM

Convert Your Present Set to a Magnificent Radiogram.



Here is the ideal Cabinet for converting your present set to a magnificent Radiogram. Hand French Polished by leading experts of London's piano trade. Chromium fret surround. All joints mortised and tenoned. Ready to take your set, speaker, power equipment and your own gram fittings. With ready-fitted motor board. Plain front or vignette to take any panel up to 18ins. by 8ins. or specially drilled to your own dimensioned sketch at slight extra cost.

YOURS FOR 8/3

Overall Dimensions: 36 1/2 ins. high by 22 1/2 ins. by 17 1/2 ins. deep.

MODEL "A" as illustrated, Cash or C.O.D. 63/- Carriage and Packing 2/6 extra. Engraving or Wires: Yours for 8/3 and 11 monthly payments of 5/9. Baffle Board 3/6 extra.

WALNUT, OAK or MAHOGANY to choice. **63/-**

SEND FOR CABINET LISTS



NEW Manufacturers' KITS in Sealed Cartons

GRAHAM-FARISH STENTORIAN. Complete Kit for building less Valves and Cabinet. Cash or C.O.D. Carriage Paid, **£1/17/6.** Balance in 7 monthly payments of 5/-.

If required complete with valves and specified B.R.G. Cabinet. Cash or C.O.D. Carriage Paid **£3/15/6** or 12 monthly payments of 7/-.

LISSEN A.C. SKYSCRAPER. Complete Kit comprises all components, including set of Lissen Valves. Cash or C.O.D. Carriage Paid. **£6/10/0.** Balance in 11 monthly payments of 12/-.

TELSEN S.G.3 KIT, less Valves. Cash or C.O.D. Carriage Paid. **£1/19/6.** Balance in 7 monthly payments of 5/3.

If valves required, add **£1/11/6** to Cash Price: H.P., 12 monthly payments of 6/6.

COSSOR 352. Three-valve Battery. Complete Kit with all components, Cabinet and Moving-Coil Speaker. Cash or C.O.D. Carriage Paid **£5/19/0.** Balance in 11 monthly payments of 11/-.

Peto-Scott 1935 SPEAKERS TONE AND QUALITY AS NEVER BEFORE



Type S.I. PERMANENT MAGNET MOVING-COIL SPEAKER—Not a Midset—FULL SIZE CONE. Power or Pentode. Complete with Input Transformer. Send 2/6 with order; balance in 5 monthly payments of 4/-.

Cash or C.O.D. Carriage Paid 19/6.



Type S3. DE LUXE P.M. 1935 MOVING-COIL SPEAKER. For Power or Pentode. A superb permanent-magnet moving-coil speaker with 7 1/2 in. cone. Gives exquisite tone. Send only 2/8; balance in 7 monthly payments of 5/-.

Cash or C.O.D. Carriage Paid 11/5/0.

PETO-SCOTT CO. LTD., 77, CITY RD., LONDON, E.C.1.
West End Showrooms: 62, High Holborn, London, W.C.2. Tel. Clerkenwell 9405/7. Tel. Holborn 3248.

Dear Sirs,—Please send me CASH/C.O.D. H.P. _____

for which I enclose £_____ d. CASH/H.P. Deposit.

NAME _____

ADDRESS _____

Pr.W. 25/8/34.

Buy by Post—its Quicker—CASH—C.O.D.—EASIER

THE BIG SUCCESS OF RADIOLYMPIA

G.E.C. RADIO

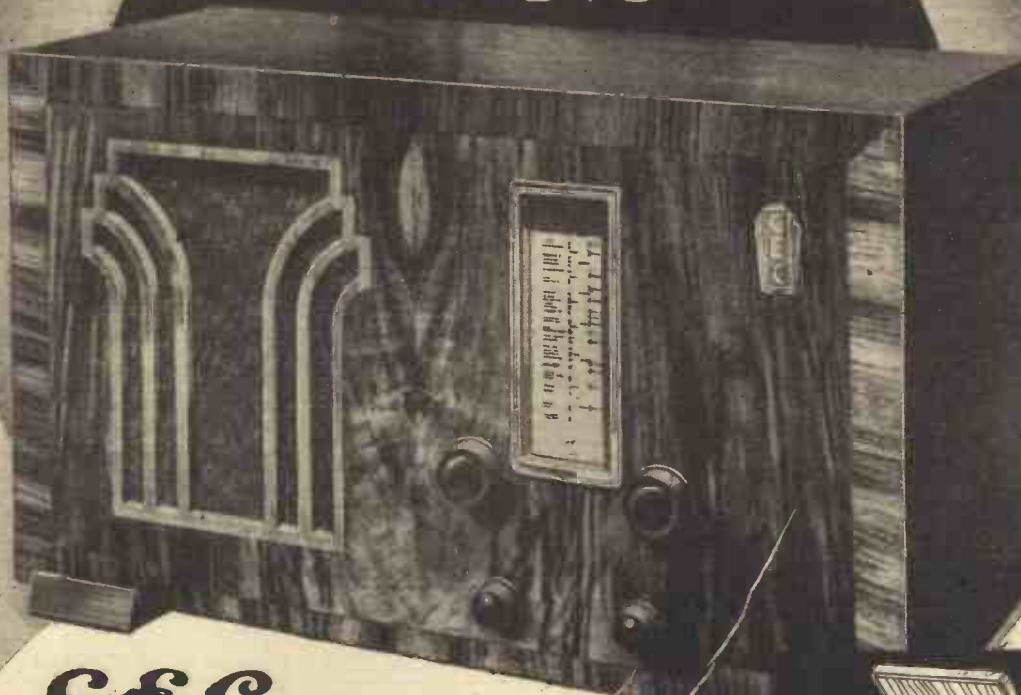

G.E.C. SUPERHET A.V.C. 5 for A.C. mains

The G.E.C. "Automatic Volume Control" series of receivers for A.C. mains is without equal in performance and value. The table model, illustrated above, is a masterpiece—not only in its graceful beauty of appearance, but in its remarkably brilliant performance and quality of reproduction. The specification reaches that very high technical standard to be expected of a product of The General Electric Co. Ltd.

Large energised moving-coil speaker. 3 watts output. Luminous station name indicator. Delayed and amplified A.V.C. Noise suppression and tone controls. Extension speaker connections. Internal speaker-silencing key. Pick-up connections. Internal aerial. Inlaid walnut cabinet. Voltage range: 190/250 volts, 40/100 cycles. (Radiogram 40/60 cycles only.)

PRICE including OSRAM Valves **14 GNS.**

HIRE PURCHASE TERMS: Deposit £1.5.0 and 12 monthly payments of £1.5.0.

WRITE for folder No. BC6922 which describes the complete range of G.E.C. Radio receivers and loudspeakers. Sent **POST FREE** on request.

MADE IN ENGLAND
Sold by all Radio Dealers



RADIOGRAM MODEL. Price including Osram Valves 22 gns. or Deposit £2 and 12 monthly payments of £2, or £1.1.0



CONSOLE MODEL. Price including Osram Valves 17 gns. or Deposit 30/- and 12 monthly payments of 30/-

G.E.C. THE SETS WITH THE BIG NAME BEHIND THEM

Advt. of The General Electric Co. Ltd., Head Office and Public Showrooms: Magnet House, Kingsway, London, W.C.2

STAND TO STAND SHOW REPORT

(Continued from page 684)

STAND No. 210
MITCHELL & BROWN, Turney Road, Dulwich, S.E.21.
 THE most interesting exhibit on this stand was the new Master Singer speaker illustrated on another page of this issue. The speaker is mounted close to the ceiling, the sound being reflected downwards by the latter. An electric light shade is suspended below the speaker, which is supplied in this combined form. The price of the Standard model Master Speaker is £12 12s. including shade, whilst the Junior model is 25 guineas.

STAND No. 211
OSSICAIDE, 447, Oxford Street, London, W.1.
 THIS firm exhibits a full range of amplifiers and microphones for both portable and permanent installation, and for use in cinemas and churches, etc., to enable the deaf to hear. Enormous interest was evinced in their new microphone and in their new universal portable amplifier, giving an undistorted output of 6 watts. The amplifier will work off both A.C. and D.C. mains of 200 to 250 volts.



A useful testing unit—the Radiolab which is now marketed by Messrs. Everett, Edgcombe and Co., Ltd.

STAND No. 212
EVERETT, EDGUMBE & CO., LTD., Hendon, N.W.9.
 THIS company exhibits a complete range of radio instruments in 2in., 2½in. and 3½in. dial sizes. These small light precision instruments are especially suitable for radio work and are available in flush or panel mounting cases of metal or bakelite.

The Radiolab valve and set tester, an instrument which has become very popular among service engineers and dealers and is manufactured by Everett Edgcombe, will also be exhibited at Radiolympia. The design of this instrument has proved so satisfactory and flexible that changes are considered unnecessary. The new 9-pin valves are easily accommodated by means of a pair of adaptors.

There were also a wide range of portable signal generators, ohm-meters, power output meters and other equipment essential to the testing and servicing departments of radio manufacturers and dealers. The firm also manufactures special meters and test gear to the customers' own requirements and invites inquiries of this nature from design and production engineers. The Colindale Works at Hendon are among the largest and best equipped in the country devoted exclusively to the manufacture of electrical measuring instruments.

STAND No. 215
NATIONAL RADIO SERVICE COMPANY, Tottenham Court Road, W.C.1.

THIS firm specializes in repair service, comprising overhauling and repairing of any type or make of radio apparatus of British or foreign manufacture. Spares are carried for all standard makes for five years back. They also specialize in motor-car radio and motor-boat radio, as well as deaf aid service and repairs.

STAND No. 216
BRIDGER & COMPANY, Church Street, N.16.

MAKERS of the well-known Granfona components, and a speciality on their stand is their seamless moulded cone in black linen, kraft, manilla, and mixtures of these substances. As specialists in diaphragms and cones this firm largely caters for the trade.

STAND No. 217
J. GOODMAN, 20/30, Drysdale Street, N.1.

VENEREED panels in all woods, attractively finished in quarterings and art wood veneers, are the features of this exhibit.

STAND No. 218
LECTROLINX, LTD., 79a, Rochester Row, London, S.W.1.

THE components manufactured by this firm, which have been featured in almost every PRACTICAL WIRELESS receiver, include connections, valve-holders,

and terminals for every electrical purpose. New lines included American chassis-mounting valve-holders for soldered connections in four, five, and six-pin types, at 7d., 8d., and 9d. each; seven-pin continental chassis-mounting valve-holders, including a screened model for use with Ostar Ganz valves, as well as an unscreened model, a nine-pin chassis-mounting valve-holder and a new valve cap connector. All of their connections and terminals provide a smooth and positive grip contact.

STAND No. 225
GENERAL ELECTRIC CO., LTD., Magnet House, Kingsway, W.C.2. (See Stand No. 33).

STAND No. 226
NATIONAL ACCUMULATOR CO., 50, Grosvenor Gardens, S.W.

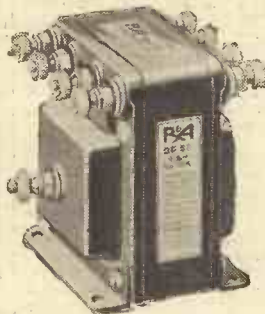

A new Universal output transformer which has been produced by Messrs. Reproducers & Amplifiers.

STAND No. 227
ECONASIGN LTD., Victoria Street, London, S.W.1.

STAND No. 229
WILLIAM F. BROWN RADIO CO., Oscillo Radio Works, Brierley Hill, Staffs.

INTERESTING exhibits on this stand include a modulated R.F. Oscillator for operation from A.C. mains 200 to 250 volts, 40 c.p.s. to 60 c.p.s. Only one tube is used thus making possible comparatively low price and replacement cost. The ranges are 1,500 k/c to 550 k/c, 300 k/c to 150 k/c and 140 k/c to 95 k/c, all on fundamentals. It can be supplied either with direct drive or calibration or a slow motion drive, readings being taken from a colour coded graph. Other types are the M.I.U. which is similar to M.I. except that it is designed for operation on either A.C. or D.C. 200 to 250 volts without alteration.

STAND No. 230
MAINS POWER RADIO CO., Romford, Essex.
 ELIMINATORS and power packs for all purposes form the main feature of this exhibit.

STAND No. 231
WIRELESS RETAILERS ASSOCIATION, High Holborn, W.C.1.

STAND No. 232
SINCLAIR SPEAKERS, Vale Royal, N.7.

STAND No. 233
RIST, 1927, LTD., Lowestoft.
 SAMPLES of every type of wire, battery cords, crocodile clips, speaker and 'phone cords, aerial wires are shown on this stand.

STAND No. 234
C. A. VANDERVELL, LTD., Birmingham.

THIS well-known firm exhibits an attractive range of L.T. accumulators, in glass and celluloid cases, all the former with ball discharge indicator devices. Further to this a complete range of jelly-acid, non-spillable cell, as standard by many of the manufacturers of popular receivers are exhibited. An interesting introduction, however, is the new type of free acid semi-non-spillable cells, developed to suit particular makes such as Murphy. Another interesting assembly shown is their new type of mass plate L.T. cell having two positive plates enclosed by two negatives all of the same thickness. There is, of course, on exhibit also a complete range of C.A.V. dry batteries and rechargeable H.T. accumulators.

STAND No. 235
BIRMINGHAM SOUND REPRODUCERS, LTD., Old Hill, Staffs.

THE basis of this exhibit is the well-known B.S.R. amplifiers from 12 watt to 60 watt, pre-staged microphone amplifiers, their ampligram, a neat radio chassis and high-frequency amplifier, turntables, with record changing unit, mixer control panels, twin-turntable equipments, their well-known high-class permanent-magnet speaker chassis, also complete with rectifier unit and valve for A.C. working, auditorium speakers, baffles, microphones, radio-gramophones, oscillators, and valve voltmeters. The B.S.R. 1934

five-valve receiver is constructed on a steel chassis with cadmium plated finish and lacquered. It includes a mains transformer, tapped from 190/250 volts, 50 cycles, used in conjunction with a full wave rectifier. A suitable converter is supplied for D.C. mains operation. All of the equipment supplied by this firm is of distinct and appealing quality.

STAND No. 236
NUVOLION LTD., Park Crescent, S.W.4.
 PUBLIC address equipment is on show here. Plants are supplied with 20, 50 and 100 watts guaranteed output. This firm caters for relay as well as ordinary public address installations.

STAND No. 237
BRITISH PIX CO., LTD., 118, Southwark Street, London, S.E.1.

THE exhibits on this stand are too well known to need description. They include the Pix Lightning Arrestor with its £1,000 guarantee; the Pix metallized earth, the modula armchair control, the Pix invisible aerial, Pix valves, and, of course, the famous Pix.

STAND No. 238
CONCORDIA ELECTRIC WIRE CO., New Sawley, Nr. Manchester.

WIRES for every electrical purpose are shown here in great abundance.

STAND No. 239
WESTON ELECTRIC INSTRUMENTS CO., Surbiton.
 HIGH class instruments for every purpose are open to inspection on this stand. The name of Weston has always been synonymous with high-class instruments, and although nothing radically new is exhibited it would indeed seem that there is little room for improvement in any of their well known products.

STAND No. 240
EARL MANUFACTURING CO., Hanover Park, London, S.E.15.
 SOME really ingenious, well-made, and compact reproducers are here exhibited.

STAND No. 242
BAKERS SELHURST RADIO LTD., Croydon, Surrey.
 A PART from the well-known range of excellent speakers marketed by this concern, they exhibit an entirely new model the "Fydelitone." This speaker is an extension speaker supplied in a bakelite cabinet, and can be obtained in two models, the "Fydelitone Major" at 45/-, and the "Fydelitone Minor" at 35/-, or without transformer for low resistance outputs at 37/6 and 29/6 respectively. These new speakers are complete in a very attractively finished bakelite cabinet, which can be obtained in various shades and colours to match the furniture of any room, including black and chromium plated. The overall size is 8½in. x 8½in. x 3½in., which makes it convenient for use on a mantelpiece. Although small in size, this new speaker is definitely not of the midget type, as it contains a 6½in. cone and extremely large output transformer, and a highly-efficient permanent magnet of entirely new design. Each speaker is fitted with an output arrangement so that any existing receiver can be matched immediately. In addition to the above, this firm is continuing all existing models including the Permag and Justone. Prices will remain the same, although improvements and modifications have been made. Their new car radio receiver is exhibited for the first time. The accompanying illustration shows this receiver, together with its neat steering-column control. All the necessary features, such as noise suppression, etc., have been incorporated, and the receiver is capable of a really fine performance.

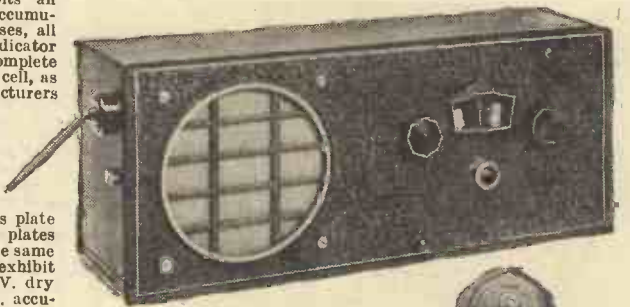

Car radio is the new branch of wireless research which is represented in this new Bakers' receiver.

Our NEW monthly Magazine
PRACTICAL TELEVISION
 6D. EVERY MONTH

STAND TO STAND SHOW REPORT
(Continued from previous page)



A new product by Messrs. Milnes—a universal speaker.



One of the new Ultra table console receivers.

Our **NEW** monthly Magazine
PRACTICAL TELEVISION
6D. EVERY MONTH



Specially produced for Television purposes, this Siemens battery has a voltage of 300.

STAND No. 244
THE 302 RADIO VALVE CO., Upper Clapton, London, E.5.

ON show here are all types of battery valves, A.C. and D.C. mains valves, universal mains valves, and an interesting mechanical device demonstrating the process of manufacture of the 302 A.C. mains valves. Interesting models which may be seen here are large specimens of their Battery S.G. and A.C. Mains Power Valve, and an enlarged sectional model of the 302 A.C. Mains Cathode.

STAND No. 246
ELECTRICO, 97, George Street, Croydon, Surrey.

STAND No. 248.
THE WIRELESS LEAGUE, 12, Grosvenor Crescent, S.W.

STAND No. 249
MILNES RADIO CO., LTD., Bingley, Yorks.

WHEREAS in previous years this concern has marketed only the Milnes H.T. Supply Unit, they are this year entering other branches of the radio field, as mentioned in last week's issue. The Milnes H.T. Supply Unit is, of course, so well known that it would be sheer waste of space to give information concerning it. Their new lines consist of a new permanent magnet moving-coil speaker in which two models are available—a cheaper model with a two-claw magnet and the de Luxe model employing a special magnet of the new nickel aluminium alloy. Both models are fitted with universal transformers which permit of matching to any output valve or the existing speaker. In chassis form it costs 32s. 6d., the de Luxe chassis costs 43s. 6d., and in walnut cabinets cost 47s. 6d. and 67s. 6d., respectively. Their surprise item is the Milne superheterodyne receiver. This is a special battery-driven receiver incorporating the Milnes Speaker and designed for use with Milnes H.T. Supply Unit. The actual set employs five valves with Pentode output incorporating eight stages and nine tuned circuits. Provision is made for gramophone pick-up and for extension speaker leads. The controls consist of a combined on off wave change and gramo switch, tuning control, volume control, tone control and a change-over switch for speaker in set and extension speaker. Delayed A.V.C. is incorporated. The cabinet is a splendid example of modern design in figured walnut and lalaid macassar ebony. There are compartments for a Milnes H.T. Supply Unit 150 volt, and for the necessary L.T. accumulators for re-charging and filament supply. A special type of lever switch has been evolved so that the unit switch can be turned without reaching inside the cabinet.

STAND No. 251
COSMOCORD, LTD., Cambridge Arterial Road, Enfield.

THE principal item of interest to the home constructor is the newly-designed pick-up which, complete with a rest and carrier arm of the swivel type, only costs 15s. This novel pick-up is also included in the complete unit which Messrs. Cosmocord have to show, and which includes gramophone motor, for A.C. mains, complete with automatic stop, speed and volume controls, and which costs only 55s. For users of complete receivers who wish to convert their apparatus to a radio-gram, the playing desk which incorporates the motor, pick-up and other accessories mentioned above, all in a polished walnut cabinet, will have a great appeal, and costs only 75s.

STAND No. 253
AERIALITE, LTD., Ashton-under-Lyne.

IN addition to the Aerialite aerial and earth equipment and automobile aeriads, this firm is exhibiting several new lines including their Quikfix aerial brackets at 2s. 6d. per pair, their Levenstrand super aerial with a £200 lightning assurance, 50ft. costing 1s. 9d., a neat compendium of aerial and earth equipment at 0s. 3d. and 4s. 9d. respectively, their Aerilite universal-fitting bracket for lead-in suspension, copper aerial wire and coils of flex.

STAND No. 254
CHLORIDE ELECTRICAL STORAGE CO., Clifton Junction, Nr. Manchester.

A FEATURE of this exhibit is the D type cells fitted with the charge indicator. The indicator consists of a dial over which moves a needle, the extreme range of movement embracing full charge, half charge and empty. The reader may here inspect an absolutely comprehensive range of Exide and Drydex batteries and accumulators.

STAND No. 255
VOIGT PATENTS LTD., Silverdale, London, S.E.26.

AS explained last week the main exhibit on this stand is the well-known loud-speaker units with standard and twin diaphragms.

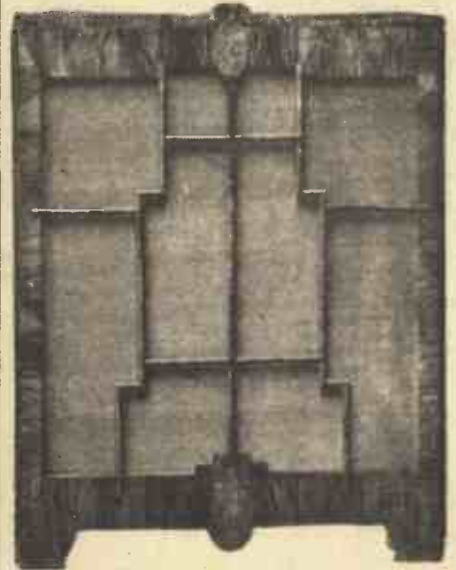

A horn loud-speaker built into a neat corner cabinet. The Voigt four-foot horn.



A modern pedestal receiver by Telsen.



A universal A.C.-D.C. test-meter produced by Pifco.

SUPPLEMENT TO "PRACTICAL WIRELESS"

TELEVISION NOTES

THE TELEVISION RADIO RECEIVER. PART 1.

By H. J. BARTON CHAPPLE, Wh.Sch., B.Sc. (Hons),
A.C.G.I., D.I.C., A.M.I.E.E.

A Practical Article Pointing Out the Requirements of
Modern Television Receivers, and How These Require-
ments Can Best Be Met.

FROM the point of view of the television amateur, a television radio receiver (as distinct from the actual "viewing apparatus") comprises two sections: first, the receiver proper, that is, the radio frequency amplifier and detector stages, and, second, the low-frequency amplifier. This division may be considered arbitrary, but is very convenient for several reasons. For example, results of some sort are possible by using the radio frequency portion of almost any good set, but the low-frequency amplifying arrangements of the average domestic receiver are seldom the best for television work, for reasons which will be given later.

It therefore often happens that a television enthusiast conducts the initial experiments with his ordinary broadcast receiver, using, perhaps, a special low-frequency amplifier as he becomes more and more fascinated by his new hobby. Then, later on, he may consider the building of a radio frequency receiver specially for television work, and, of course, such a set is really essential if serious television experiments are to be carried out and the best images are desired. Two sets are also necessary for the simultaneous reception of sound and vision on the present service of medium-wave television broadcasts.

Fidelity

It is proposed, therefore, to discuss the requirements of television receivers and to show how these requirements can best be met; the present article deals with the radio frequency side, leaving the low-frequency amplifier to be described in the second article. It will be assumed that the reader already possesses some knowledge of the principles of set design and construction, and that it is therefore not necessary to give extended explanations of basic facts.

To begin with, then, a very much higher standard of fidelity is essential for television than for sound reception, because a very considerable degree of distortion can be tolerated by the ear without annoyance, whereas comparatively slight distortion mars the image transmitted by television.

Care must be taken, therefore, in the early stages not to introduce distortion. Now, although it is not so generally recognised as it should be, there are other methods by which distortion can more easily creep into the high-frequency and detector stages of a receiver than into the low-frequency amplifier.

The most obvious form of distortion is that due to interference from a programme on a neighbouring wavelength. A reasonable degree of selectivity is therefore essential, and it is often found desirable to incorporate at least three tuned circuits. A tuned aerial circuit and band-pass coupling between the high-frequency valve and detector will give adequate selectivity, or if two H.F. stages are employed, single tuned circuits between each should be

sufficient. At the same time, selectivity must not be pushed to the limit or the image will lack definition and detail, due to the cutting of the side-bands, with consequent loss of the higher frequencies.

By the way, although carefully ganged condensers and matched coils are essential for sound reception, where the receiver has to be capable of easy and rapid tuning to a large number of stations, this is not so

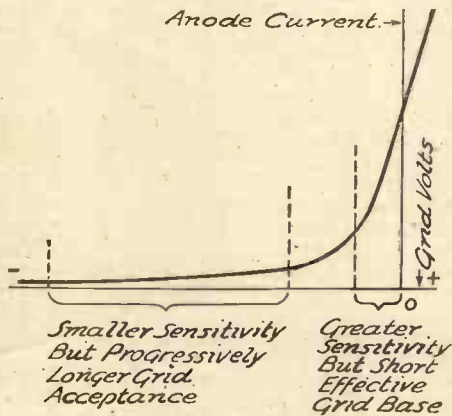

Fig. 1.—Graph illustrating the advantage of a variable-mu H.F. valve.

essential in a television receiver designed to receive the images radiated from one station only. It is quite sufficient, therefore, in many instances, to make use of components already on hand, and separate tuning condensers may be employed if desired, since it will only be necessary to calibrate the set once and for all.

Another Cause of Distortion

The next cause of distortion which must be guarded against is the overloading of one or more of the high-frequency valves. Because valves in these stages are primarily intended for handling and amplifying weak signals, they have a limited "acceptance," and thus can produce serious distortion if called upon to handle large signal voltages from powerful or nearby stations. For this reason it is strongly recommended that variable-mu valves be employed in the high-frequency stages; for although their maximum sensitivity when used with minimum grid bias is fully equal to that of a popularly called "straight" H.F. amplifier, they will handle without distortion very much larger signals when increased bias is applied; and the fact that the overall amplification is reduced is immaterial, because the initial signal is stronger. This is clearly indicated in the explanatory diagram of Fig. 1.

The degree of high-frequency amplification to be provided depends upon two main points: first, the distance between the receiving set and the television transmitter, and, second, the type of detector valve used. It is clear that a receiver

installed within a few dozen miles of the transmitter would need less amplification than one situated several hundred miles away. Then a sensitive leaky grid detector generally will be found to give better results with comparatively small signals than an anode bend detector, which is at its best when fed with a really strong input voltage. Again, any type of triode detector gives a certain degree of amplification as well as rectification, whereas a diode detector does not amplify, but will handle without distortion very much bigger input signal voltages.

Bearing all these points in mind, therefore, the ideal television receiver would probably be one having two high-frequency stages, each employing a variable-mu H.F. pentode, and with single tuned circuits in the aerial and in both H.F. couplings. Such an arrangement would be adequate for television reception anywhere in the British Isles from the points of view of both sensitivity and selectivity, and the variable-mu characteristics of the valves would enable steps to be taken to avoid distortion through overloading. Again, the large amount of high-frequency amplification thus available would render the use of reaction quite unnecessary, thus eliminating yet another fruitful cause of image distortion.

The Detector Stage

The next point for discussion is the detector stage. There are three main alternatives from which to choose. First of all there is the familiar leaky grid system, which, as every listener knows, is a most sensitive detector. But it is hardly sufficiently free from distortion for television reception, and is preferably avoided whenever possible.

Even the modified form of leaky grid detection known as "power grid" is scarcely good enough for the purpose, and it is better to turn to the second alternative, namely, the anode-bend detector. Provided the incoming signal can be built up by the high-frequency amplifier to really good strength, an anode-bend detector is almost, if not quite, the most satisfactory arrangement. In both cases it must be understood that triode valves only have been considered.

Now it is quite possible to use screen-grid valves, and also high-frequency pentodes, as detectors, both on the leaky-grid and anode-bend systems, but they are not the best for television detectors. Their merit, for sound reception, is that they will operate satisfactorily with quite small inputs, but for television, where a considerable amount of H.F. amplification, if not essential, is incidental to methods for obtaining adequate sen-

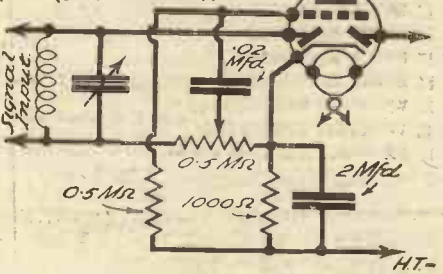
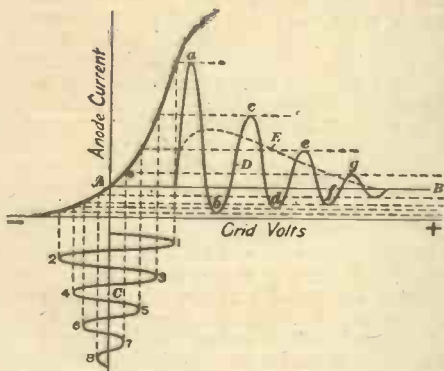

Fig. 2.—A suggested scheme for using a double-diode-triode as a combined half-wave rectifier and L.F. amplifier.

Do You Know What This Graph Means?



The man who can analyse these curves and understand what they indicate knows his job. But if they do not convey to him perfectly definite information, it would appear that he needs more training than he has had. He is not competent to fill a responsible position in wireless.

Radio has developed so rapidly throughout the last ten years that it has now greatly outgrown the supply of technically qualified men required for the better posts. Moreover, it continues to develop with such speed that only by knowing the basic principles can pace be kept with it.

The I.C.S. Radio Courses cover every phase of radio work. Our instruction includes American broadcasting as well as British wireless practice. It is a modern education, covering every department of the industry.

OUR COURSES

Included in the I.C.S. range are Courses dealing with the installing of radio sets and, in particular, with their Servicing, which to-day intimately concerns every wireless dealer and his employees. The Operating Course is vital to mastery of operating and transmitting.

There is also a Course for the Wireless Salesman. This, in addition to inculcating the art of salesmanship, provides that knowledge which enables the salesman to hold his own with the most technical of his customers.

Then there are preparatory courses for the City and Guilds and I.W.T. Exams.

We will be pleased to send you details of any or all of these subjects. Just fill in, and post the coupon, or write in any other way.

International Correspondence Schools, Ltd.,
Dept. 94, International Buildings,
Kingsway, London, W.C.2.

Without cost, or obligation, please send me full information about the Courses I have marked X

- COMPLETE RADIO
- RADIO SERVICING
- RADIO EQUIPMENT
- RADIO SERVICING AND SALESMANSHIP
- WIRELESS ENGINEERING
- WIRELESS OPERATORS
- EXAMINATION (state which)

Name Age

Address

(Continued from previous page)

sitivity, the screen-grid or pentode detector, with its small working grid base is not really a workable proposition.

There is, however, a third type of detector which has interesting possibilities for television, namely, the diode detector. A properly-designed diode detector device will handle very powerful inputs without introducing distortion. It is true that, as has already been pointed out, such a valve possesses no amplifying power, but it is a simple matter to introduce additional low-frequency amplification to compensate for this.

Three methods whereby diode detection may be arranged are available. As a makeshift, or for experimental purposes, any ordinary three-electrode valve may be employed, the grid being used as the diode anode, or the grid and anode may be strapped together.

If no suitable triode is available, diode detection can be obtained by a double-diode-triode, of which types are available for battery or mains operation. Since it is scarcely necessary to consider automatic volume control in connection with a television set, it would be permissible to employ the two diodes of a double-diode-triode as full-wave rectifier, or one diode of the pair only need be employed. The use of this valve as a full-wave rectifier, plus amplifier, is not really practicable, however, unless special balanced condensers are used. The capacity of the ordinary condenser to earth renders it impossible to obtain a true electrical centre of the tuned circuit.

When employing one diode, however, the triode portion of the valve will serve as the first low-frequency amplifying stage, and, as in all the makes of double-diode-triode the triode portion is quite suitable for resistance capacity coupling, the valve falls naturally into line with modern television practice. One scheme of this character is shown in Fig. 2, where the 500,000-ohm potentiometer forms the diode load and volume control. The two diode anodes may be connected together, if desired. The audio-frequency signals reach the triode grid via the .02 mfd. condenser, while the 1,000-ohm resistor biases the triode amplifier.

One of the disadvantages of the double-diode-triode is that the triode amplifying element does tie the set-builder down to one definite form of valve. More recently, however, double-diodes without the amplifying section have been introduced, and while possessing still better signal handling capabilities, permit the constructor or designer to use practically any form of low-frequency amplifying valve he desires. These double-diodes are at present only available for mains operation; they are, however, considerably cheaper than even a triode and would appear to have quite interesting possibilities for the television receiver.

(To be concluded)

RECORDING TELEVISION

VARIOUS details have been published in some of the daily papers lately about the recording of television signals on gramophone records, inferring

that this was an entirely new development as far as television is concerned. This, of course, is not strictly true, for Mr. Baird, as far back as the middle of 1928 carried out his original experiments on this "by-product" of television and produced the first phonovision records.

The gramophone recording machine was a very early model employing cylindrical records, while the amplifier rack was of very ancient vintage. Anyway, the equipment served to establish the principles involved, and it was subsequent to this that improvements were effected and disc type records used to replace the initial ones.

Method of Operation

The scheme is really quite a straightforward one, its complete development being held up owing to incidental problems connected with the recording and playing pick-ups employed and not to any incorrect principles being involved. First of all, the



Fig. 3—Playing back a television record, and showing the image on a mirror standing over the rectangular aperture.

subject to be recorded is scanned by the spot-light method, the resultant light variations being converted to equivalent voltage variations by the usual banks of photo-electric cells. After amplification these signals are transferred to a recording pick-up which indents the wax record. Concurrent with this, the accompanying sound is picked up by a microphone in the same studio, converted to an electrical signal and recorded either on a second record synchronized with the vision record, or alternatively recorded on a second track running concentrically with the vision track on one record.

These records or record are then played back with double pick-ups—one for vision and one for sound. From the sound track the signals are fed to a loud-speaker, while the vision signals are transferred to a television receiver which can be distinct from, or a part of, the gramophone turntable equipment. This latter form is shown in the accompanying illustration, Fig. 4, the image being projected on to a mirror standing over an aperture cut in the box top, as shown. The motor drive for the record turntable is suitably geared to revolve the scanning disc for this purpose, this method lending itself better to the problem of synchronizing.

The electrical pick-up used for "playing" on the vision record has to be capable of passing a wider band of frequencies than is required for sound purposes, otherwise the image seen will be sadly lacking in quality owing to the absence of the higher frequencies so essential to detail.

Graham Farish *presents*

The finest Radio Magazine ever published

"RADIO CONTACT"

Out Today

Packed from cover to cover with Interest, and Instructions for building 3 magnificent new Battery Sets



PRICE
3D

SKY RAIDER

The most advanced set of our time. NEW-type Coils, NEW-type Valves, NEW-type Speaker . . . AND results that will amaze you.

SKY RAIDER IS THE SET TO BUILD!
Fully described in this issue with full-size Blue Print FREE

Also instructions for building two other interesting modern circuits

Wonderful new BATTERY VALVE developments

Host of new ideas for your present set

"CONTACT" World-wide Station-finder

Intimate News and Views from your favourite Station abroad, etc., etc.

HERE IS THE MAG. YOU'VE WANTED!

Don't be too late, get your copy from your Dealer *now*. If any difficulty in obtaining send 3d. in stamps to GRAHAM FARISH, LTD., Bromley, Kent, or call at our Stand No. 59 Radiolympia for a copy.

Just released

LISSEN

"SKYSCRAPER"

THE NEW

BAND-PASS 3

*Magnetically coupled Band-Pass Tuning
Variable-Mu Screened Grid H.F. Valve • Power
Detector • Economy Power Pentode Output*



SEPARATION WITH PERFECT REPRODUCTION

With present-day valves and circuits it is a comparatively easy matter to design a receiver to pull in dozens and dozens of stations, but such a set would be practically useless for the present congested state of the ether. A receiver with so-called "knife edged"

selectivity or "hair line" tuning is not actually "programme selective." Incredibly fine tuning causes considerable distortion. To be selective while retaining all the essentials for good quality reproduction, each programme must be picked out boldly from the surrounding chaos. That is exactly what this new Lissen Band-Pass 3 does. Programmes hitherto spoilt by overlapping stations, now received clean and bright by reason of the three tuned circuits—programmes spoilt by excessive side-band cutting, now received full of depth and detail by reason of the band-pass circuit and the Power Pentode Output coupled to the fine moving-coil loud-speaker. No other receiver can possibly give you a greater sense of complete satisfaction.

KIT COMPLETE WITH VALVES

Cabinet and Moving Coil Loudspeaker 45/-

Gradual payments can be arranged

99'6

**GET THIS 1/-
CONSTRUCTIONAL**

**CHART
FREE!**

LISSEN BAND-PASS 3

SKYSCRAPER KIT

Insert the coupon below in a 3d. envelope and address to Publicity Dept., Lissen, Ltd., Isleworth, Middx. 

Ask for details of other Lissen Skyscraper Kits.

The All-World All-Wave 4 £5 12 6

The A.C. Safety Skyscraper, NOW £6 10 0

The Skyscraper 3, NOW £3 17 6

CUT THIS OUT

Please send me a free copy of the 1/- Constructional Chart giving full details of the Lissen Skyscraper Band-Pass 3 Kit:—

NAME.....

ADDRESS.....

..... Pr.W. 25/8/34

LISSEN LIMITED : WORPLE ROAD : ISLEWORTH : MIDDLESEX

Mention of "Practical Wireless" to Advertisers will Ensure Prompt Attention

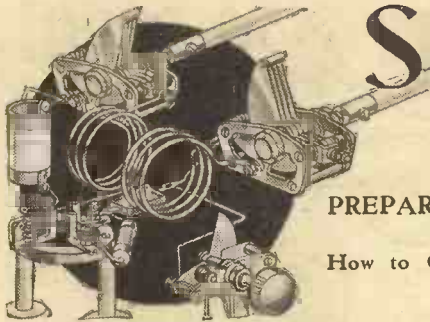

Short Wave Section

PREPARING FOR THE WINTER ON SHORT WAVES.

How to Overhaul and Test a Receiver to Ensure Maximum Results.

By K. E. BRIAN JAY.

THERE are some people who think that because a wireless set has few moving parts there is nothing that can go wrong, but this, of course, is a mistake; dust can creep in, nuts can get slack, the slight jars unavoidable when dusting may shake connections loose, and all these things cause the receiver to become noisy, and lose its efficiency. Any receiver will suffer in this way, but the effects will be most noticeable on short waves, where slight rubbing between metal and metal, or dust, in bearings and joints will cause bad noises in the headphones, and it is therefore very desirable that the receiver should be overhauled and its defects repaired before the winter season, when with the return of dark evenings it is likely to be much used.

In the search for sources of noise first examine the filament circuits; look for dirty joints and especially test the switch, which can be a potent noise producer; clean its contacts and bend them a little so that they press more firmly on the plunger. If it still makes a noise in the 'phones when the knob is wriggled it should be replaced, preferably by one of the Q.M.B. snap type, which is much less likely to develop a bad contact. When indirectly heated valves are used, test the resistance of the heater leads; a high resistance here will cause a bad drop in the voltage at the heater terminals.

Testing the Wiring

Next test the whole of the wiring of the set. If the joints are soldered pull each one sharply to see that it is sound; if it seems at all loose, even although the wires do not come apart, resolder it: indifferent connections are responsible for more noise than any other single item. If the connections are made simply by means of the terminals on the components they should all be screwed tight and tested by pulling. Pay particular attention to terminals which carry flexes; often turning the screw causes the strands of the flex to spread with the result that contact depends on only two or three strands, and the remaining strands are free to rub on the terminal and so create irritating noises. In sets which are screened the screens must be examined to see that they are making good contact with the earth return and that any bolts that hold them together, such as are sometimes used in screening boxes, are screwed up tightly. Make sure also that wires that ought to be in the air are not rubbing against a screen or on a metallized base-board.

Tuning Condensers

Now turn your attention to the tuning condensers. With the receiver switched on turn the dial slowly and listen for noises. If you hear any, as you are very likely to do, remove the condenser and clean it; a pipe-cleaner or feather can be used to remove the dust between the vanes and a small paint brush will be a help in dealing

with the bearings. Should there be any slackness in the bearings it can be taken up by means of the adjusting screw in the bottom plate, but this is an operation that requires care or the plates will be put out of alignment and will rub on one another. A tiny drop of very thin oil can be applied to the bearings when they are clean. Do not forget to look to the pigtail connections on variable condensers; the noisiest short-wave receiver I ever heard of owed all its trouble to a defective pigtail in the reaction condenser. The spirals of the pigtail must not touch one another as the moving vanes are turned nor must they rub against the spindle or bearing. See also that there is no break or weakness in the pigtail, especially if it is made of thin metal foil: While you are treating the condensers do not neglect the slow-motion dial; remove the dust from it and apply a little oil to the bearings.

Examine the Coils

After the condensers the coils. If they are plug-in coils examine the pins and clean and spread them apart a little with a pen-knife so that they make good contact with the sockets. Return any wandering turns to their proper place, and if necessary keep them there with a spot of shellac varnish or Durofix for coils wound with very thick wire. Coils wound on valve bases suffer particularly from handling, and it is sometimes best to rewind them, quite a simple job; make sure you put on the same number of turns though, or the calibration of the receiver will be thrown far out. It will be disturbed in any case if the coils are rewound, but not very much if the same wire and number of turns are used on the original former. In receivers fitted with dual range coils the wave-change switches must be

examined and cleaned or even renewed if they are very noisy. In some home-constructed sets the wave-changing is done by means of a plug on a flex; in such a case it will probably be worth while changing the flex for a new piece. The plug and sockets must, of course, be cleaned.

When the whole of the internal wiring is checked and the components cleaned and dusted, attend to the external wires to the batteries. Examine the L.T. leads for signs of corrosion at the accumulator end and also for broken strands at both ends; cutting off the dirty ends and cleaning a fresh part of the flex will be enough if screw type spade tags are used, but if the tags are soldered on it may be necessary to replace them with new ones. The H.T. and G.B. wander plugs must be cleaned and spread out and the connections to them tightened up [and, of course, the telephone leads must not be forgotten; if there is a great deal of noise when they are shaken there is probably an internal break and they must be replaced.

Lastly, the valve pins are cleaned and spread with a pen-knife if they fit badly. If there is any bad noise left now it almost certainly arises from a defect in some component such as a H.F. choke, L.F. transformer, resistance or grid leak, and in that case each component must be systematically tested in the way that has been described in these pages before.

Checking the Batteries and Valves

There may still be a falling off in efficiency, and to prevent this the batteries and valves are checked. Measure the H.T. voltage when the set is first switched on and then after it has been in operation for three hours or so. Any great difference between the two readings indicates that a new battery is needed. Check the voltage of the grid bias battery, and if necessary renew it; renew it in any case if it has been in use more than a year. It is assumed that the L.T. accumulator has been properly looked after all through the summer, and therefore will not be in need of special attention now.

It is a good plan to measure the plate current of the valves and compare it with the value given in the maker's curves; a wide divergence indicates a defective valve that is probably working far below maximum efficiency, and may be noisy. If a milliammeter is not available you may be

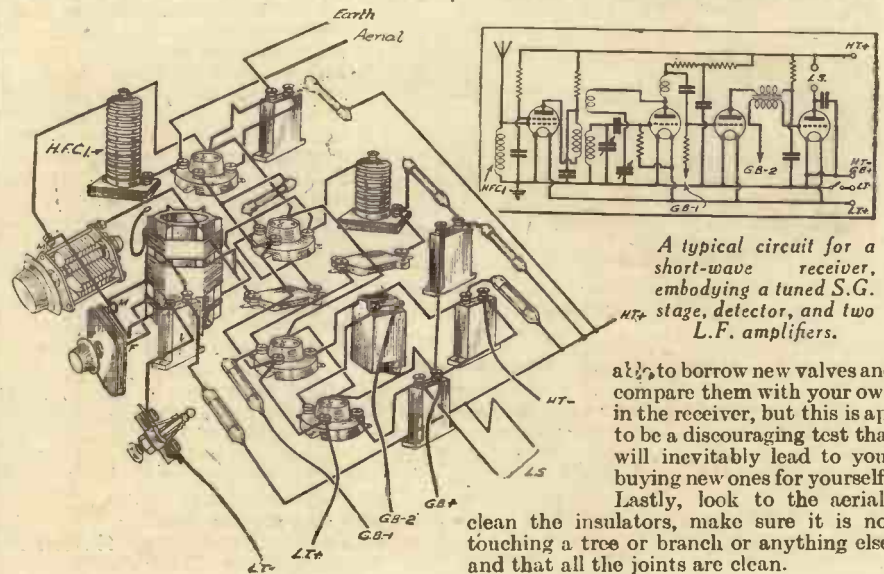

A typical circuit for a short-wave receiver, embodying a tuned S.G. stage, detector, and two L.F. amplifiers.

able to borrow new valves and compare them with your own in the receiver, but this is apt to be a discouraging test that will inevitably lead to your buying new ones for yourself! Lastly, look to the aerial: clean the insulators, make sure it is not touching a tree or anything else, and that all the joints are clean.

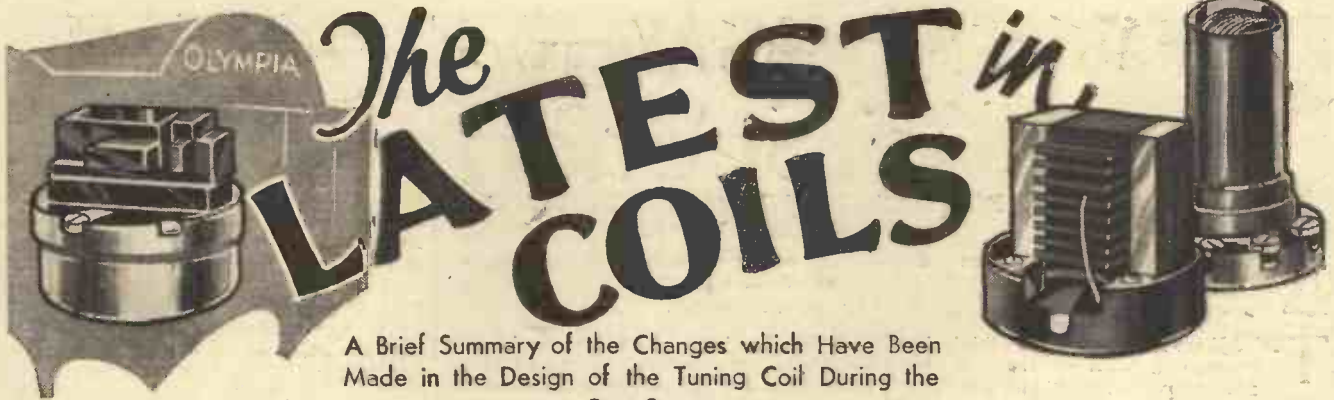

A Brief Summary of the Changes which Have Been Made in the Design of the Tuning Coil During the Past Season.

AT the time of last year's exhibition at Olympia it was possible to describe most comprehensive modifications which had been introduced in the design of the tuning coil during that year. Since that date, however, no such detailed changes have been seen, although there have been several interesting developments in this important section of the broadcast receiver. The introduction of the powder-iron core enabled the size of the tuning coil to be greatly reduced and also enabled Litz wire to be used with decreased H.F. resistance, and further enabled the screening of these coils to be carried out without in any way losing efficiency. Thus it might have been said that the coil was well nigh perfected. Since last year's exhibition, however, the Lucerne Plan has become effective, and this has necessitated some important modifications in the design of the coil to suit modern needs, and with the forthcoming introduction of the Droitwich transmitter (October 7th) it is highly probable that some still further alteration will have to be made.

Wavelength Range

A year ago it was customary for the coil to cover bands of 200 to 600 metres, and about 850 to 2,000 on the long waves. Under the conditions existing with the Lucerne Plan it is necessary to modify this range to include certain stations which are easily receivable in this country



A good example of the compactness obtained with modern iron-core coil assemblies. This is the Colvern assembly.

on small receivers. For instance, Fécamp is a very good station, and unless the tuning coil has a minimum tuning point some way below 200 metres it cannot be satisfactorily tuned in. The new Droitwich station will probably render it necessary to modify the long-wave range in order to take full advantage of this station and other stations in this portion of the band, bearing in mind the fact that the power of this new station will be probably in the region

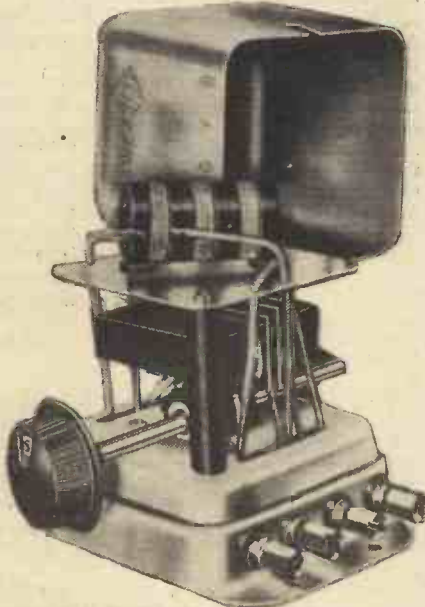

An iron-core coil—this is the Wearite. Note the novel arrangement of the medium and long-wave windings.

of 150 to 200 kilowatts. The London National will cease to function when Droitwich comes into play, and thus the medium-wave band will offer more programmes to southern listeners. The demand for selectivity does not arise in every part of the country, and with the increased efficiency of the modern valve and other components it is now possible to construct a receiver in which a really efficient air-core coil will offer adequate selectivity if used in the correct manner, and accordingly several makers have, during the past few months, re-introduced this type of coil as an addition to their range of iron-cored coils. The Wearite Universal coil is a good sample

of this new method of construction, and the efficiency of the coil was demonstrated in the Leader series of receivers which we recently described. Other coils designed on these lines, that is, with air-cores but carefully designed selective windings, may be found in the Bulgin, Burne-Jones and other catalogues. They

employ metal screening cans and offer adequate selectivity for modern needs in most parts of the country. Obviously in the London area, with a large external aerial, it may be found difficult to provide sufficient selectivity to receive stations separated by only a few channels from the London stations, and it is then that the iron-core coil with probably the addition of a further H.F. stage will be found necessary.

The Superheterodyne

With the increased popularity of the superheterodyne circuit the necessary coils have also become popular, and now practically every manufacturer who includes coils in his range of components can supply the coils necessary for this type of circuit. The introduction of the special frequency-changer valves has led to the development of oscillator coils having characteristics suitable for the pentagrid, heptode and octode valves, and thus render the construction of the superhet much simpler.

Beyond these few changes there has been nothing which is of importance to the home constructor, and Messrs. Varley are still the only firm who are marketing a complete permeability tuner in which the variation in inductance is carried out by a movement of the powder-iron core instead of the more usual parallel tuning capacity. Great things were expected of permeability tuning at last year's exhibition, but for some reason or other they have not matured during the season. It is difficult to account for this, as it is obviously a much better system of tuning than is obtained by the parallel capacity method now in use, and the losses are certainly likely to be much lower. In a way, too, it is the more logical method of tuning, but we must wait and see whether it will become the universal tuning system of the future.



Air-core coils can also be efficient, and here is a group of Bulgin coils, with screens.

SEE VARLEY'S GREAT NEW PRODUCTS AT STAND No. 103 RADIOLYMPIA

PERMEABILITY TUNER

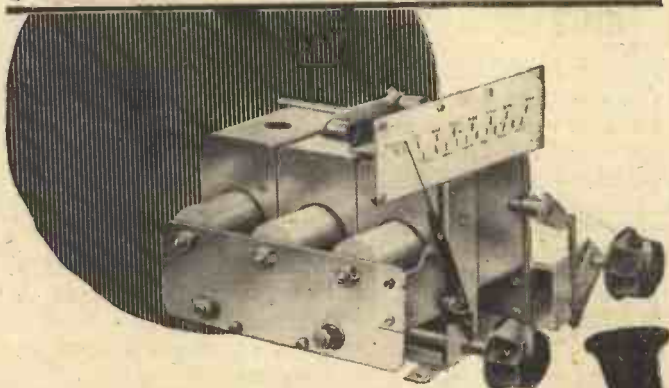

The perfect tuning Unit, making possible the design of a receiver giving good quality at all wavelengths. Both 3- and 4-gang units available. Perfect tracking of aerial circuit. Initial matching is maintained.

Permeability Tuner (3-gang) BP 100 - £3.7.6
" " (4-gang) BP 101 - £4.5.0

is only one of the remarkable range of NEW COMPONENTS that will profoundly interest you. Others are :-

- EP 36 Power Transformer
Semi-shrouded for popular circuits - 22'6
- EP 37 ditto. for Westinghouse Rectifiers - 25'6
- EP 38 ditto. for Valve Rectifiers - 50'
- DP 45 Improved Power Puncher - 15'6
- AVC unit BP 28 - Improved type - 15'6
- Three NEW NICORE oscillator coils
BP 45, 46 and 47 - 10'6
- Wonderful new range of NICORE FLAT-GANG
UNITS smaller than before - in any
combination. 22' to 44'

Varley

FOREMOST AS PIONEERS

Advertisement of Varley (Oliver Pell Control Ltd.), Bloomfield Road, Woolwich, S.E.18.

Telephone: Woolwich 2345.

362

VALVES

OLYMPIA STAND 244

An invitation to all radio enthusiasts; Call at our stand, and learn for yourself how 362 valves have solved the problem of "better—yet—cheaper" radio. Compare price and performance (study the characteristics) with any other make of valves.

362 BATTERY VALVES. H HL & L, 3/6. Power, 4/-. Super Power, 4/6. SG & VS, 7/6. Pentode Type, 10/-. BA & BX, 9/-.
362 AC MAINS. HL4, 7/6. PX4, 9/-. SG4 & VS4, 12/6. ME & HM, 13/-. RB41, 7/6. RB42, 10/-. DC MAINS at SAME PRICES as AC MAINS.
Should your dealer not stock, send P.O. to Dept. 44.

NEW!

Actual Size
5" diameter

NEVER BEFORE SUCH A POWERFUL AERIAL

Most wireless receiving Sets to-day are so highly sensitive that only very short aeriels are generally necessary, but this sacrifices stability. When the Aerial is a short one, your Set will be more selective, but it may be unbalanced, on the verge of oscillation, and hard to control. The new ELECTRON GLOBE AERIAL remedies this and restores balance to the set, corrects fading and stops 'blasting,' as the set is so easily controlled and maintains selectivity at a higher efficiency. The ELECTRON GLOBE AERIAL gives brilliance and sparkle to the duldest transmission, greatly improving the tone and volume. It has special insulated clamps so that it can be easily fixed to any type or size of steel or wooden mast. Its splendid on water pipes near the window for accessibility, or can be screwed to any wall or flat surface, roof, etc. A handsome ornament to the gable, or as a most efficient indoor aerial.

Standard Model .. 15/- (Copper) || De Luxe Model .. 21/- (Chromium Plated)
Carr. Paid. Carr. Paid

Obtainable from wireless dealers everywhere or send remittance direct to:
The NEW LONDON ELECTRON WORKS Ltd.
EAST HAM LONDON.E.6

**362 RADIO VALVE CO., LTD.,
STONEHAM RD., LONDON, E.5.**

TELEPHONE: CLISSOLD 1296

CAREW WILSON

12 GUINEAS

buys a modern
A.C. Mains Receiver

... but, you get

EXTRA VALUE

for the same money
if it is equipped with

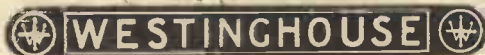

METAL RECTIFIERS

Extra value in that the expenditure you would normally make on rectifier replacements is entirely eliminated.

Gone, too, is the worry that your set will let you down just when you want to show it off to your friends.

Westinghouse Metal Rectifiers are undergoing a continuous life test at full load, to find out exactly how long they will last. So far they have been on duty for over 60,000 hours and still show no sign of a falling off in output.

60,000 hours is 30 years when used six hours a day (the average use of a Wireless Set), and you will get exactly the same performance from the metal rectifiers in the A.C. Mains Receiver you buy.

Remember, Westinghouse Metal Rectifiers never let you down, but, if you would like more detailed information as to their merits, send 3d. in stamps to Dept. Pr. W. for a copy of the new 1935 edition of "The All Metal Way."



THE WESTINGHOUSE
BRAKE & SAXBY
SIGNAL CO., LTD.,
32, YORK ROAD,
KING'S CROSS,
LONDON, N.1

BULGIN

QUALITY
RADIO COMPONENTS



OLYMPIA, STAND 121.

Do not fail to call and examine the numerous brand new BULGIN Components now available, all designed in accordance with the latest research and practice. Prices have been reduced to the lowest level consistent with the high quality of material and workmanship for which BULGIN PRODUCTS are justly famed.

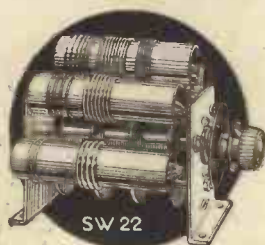

NEW S.W. TUNER.

A specially designed 5 range low loss switch assembly made to accommodate plug-in coils units covering wavebands from 10 up to 2,000 metres.

Numerous new short wave components.



NEW CONTROLS.

Tone Controls of unique construction giving improved top note, and bass response. Improved types of wire and chemical composition volume controls, with and without switches.

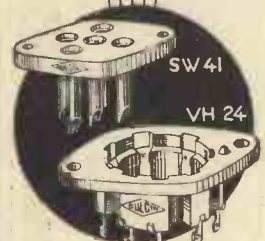

NEW VALVEHOLDERS.

5, 7 and 9 pin chassis and base-board. Bakelite or "Ceramic" low loss insulation. Two new models for the 5 and 8 pin side contact valves.

A type for every purpose.

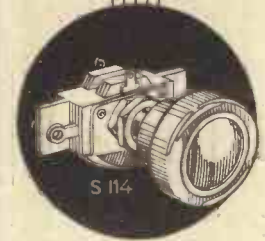

NEW SWITCHES.

More additions to the famous range of BULGIN switches, including new Rotary, Toggle and the latest quick-make-and-break wavechange switches.

300 ILLUSTRATIONS

COUPON.

Please send me, post free, a copy of the New Bulgin Catalogue No. 154 "N," for which I enclose threepence in stamps.

NAME.....

ADDRESS.....

(BLOCK LETTERS, PLEASE)

A. F. BULGIN & CO., LTD.
Abbey Road, Barking, Essex.

50 NEW LINES



THE EASY ROAD TO RADIO.
THE BEGINNER'S SUPPLEMENT

OUR NEW COURSE FOR BEGINNERS.

In This Article the General Principle of Broadcast Transmission is Simply Explained.

BEFORE we can fully appreciate the varied principles which are involved in modern wireless transmission and reception it is necessary to understand the simpler method of sound propagation. Broadcasting is simply a method of transferring sound from one place to another without the intervention of any sort of wire. Sound may be described as the effect upon our ears of air vibrations produced by the vibration of an instrument emitting that sound. When a musical string is plucked or bowed we hear a sound but actually the vibration from the string does not become sound until it reaches our ear. As the string vibrates, or moves backwards and forwards very rapidly, it alternately pushes and releases a small quantity of the air in its immediate neighbourhood and this small movement is imparted to the particles of air nearby and so on, the movement spreading outwards very rapidly in all directions. The jostling and moving which takes place in the particles of air eventually reach our ear, and the very thin membrane inside our ear is, in effect, struck by the moving air waves and so caused to move in sympathy with the air movements, and in this way the original sound is "re-created" and we become aware of the noise.



An illustration of a high-power broadcast transmitter, showing the large valves and other accessories.



A modern broadcasting studio, with two microphones.

The Telephone

The instrument invented by Bell was the first satisfactory solution to the problem of conveying the sound waves from one place to another beyond the normal range of our hearing, and in this instrument a device known as a microphone is employed and the sound waves are directed so that they impinge on the diaphragm of this microphone. By means which will later be described the movement of the diaphragm (which would correspond to the movement of the drum of the ear) sets up varying electric currents in a pair of wires, and these wires are led to a somewhat similar device at the other end. Here, the varying currents flow

through a magnet and so cause another diaphragm to be varied exactly in sympathy with the original diaphragm's movements and this reproduces the sound. For wireless broadcasting exactly the same principle is utilized, but, instead of employing the wires connecting microphone and reproducer, a further change is made and the vibrations are distributed through space by means of a radio wave which travels in a manner very similar to light, at a speed of 186,000 miles per second. So far as is at present known, this radio wave is incapable of affecting any of the normal human senses, and, therefore, it is impossible to hear any broadcast matter without the aid of a wireless set.

THE WIRELESS CONSTRUCTOR'S ENCYCLOPEDIA

By F. J. CAMM
 (Editor of "Practical Wireless")

Third Edition.

5' net.

Wireless Terms and Definitions stated and explained in concise, clear language.
 From all Booksellers, or by post 5/6 from Geo. Newnes, Ltd., Southampton St., London, W.C.2

EASY TERMS

Every Radio requirement, however extravagant or modest, is supplied by us on the most convenient terms and with the utmost expedition and courtesy. Continuously established since 1925, we maintain a service upon which increasing numbers rely. We deal with you direct and all transactions are strictly private. May we have your orders and inquiries?

New Cossor 3-V. Battery Receiver. Model 350. In cabinet, complete with valves and built-in speaker. Cash Price £5-12-6, or 10/- with order and 11 monthly payments of 10/4.

New Blue Spot STAR JUNIOR L.S. Unit. Cash Price £1-15-0, or 5/- with order and 7 monthly payments of 4/7.

New R. & A. "Multimu" L.S. Unit. Cash Price £2-2-0, or 5/- with order and 3 monthly payments of 5/1.

Atlas C.A.25 H.T. unit, 6 tappings, 25 milliamps. Cash Price, £2-19-6, or 5/- with order and 11 monthly payments of 5/3.

New W.B. Stentorian Standard L.S. Unit. Cash Price, £1-12-6, or 5/- with order and 6 monthly payments of 5/-.

All the new valves supplied on the lowest terms. Please state requirements and we will be pleased to quote you.

Full Specification and illustrated list of any of the above will be sent with pleasure.

Everything you see at Radiolympia can be supplied by us on the most convenient terms. Quotations by return of post.

All Carriage Paid.

To avoid delay, will customers kindly send first payment with order.

Estd. 1925 THE **PHONE: NATIONAL 1977**

LONDON RADIO SUPPLY COMPANY

11, OAT LANE, NOBLE STREET, LONDON, E.C.2

WHEN BUYING
AN UMBRELLA
YOU LOOK AT
THE FRAME



WHEN BUYING
A RECEIVER
LOOK AT THE
VALVEHOLDERS

Ask the Salesman what make of Valveholders are used in the receiver you look at. If he says CLIX, and nine out of ten do say CLIX, then you can be satisfied that the receiver is modern and built throughout of quality components.

CLIX SPECIFIED FOR
"THE SUMMIT THREE"

AND
"ARMADA MAINS THREE"

Get our new 1933 Folder "N" Free.

STAND 218 OLYMPIA



CLIX

LECTRO LINX, LTD.,
79, ROCHESTER ROW, LONDON S.W.1

READY MADE OR HOME MADE?

Is it Better to Make Your Receiver or to Purchase One Ready Made?
Some Important Details Which Answer This Question

AT the present time there are a number of really cheap wireless receivers on the market, and this has led to the belief that it does not pay in these days to make a wireless set at home. It is probably safe to say that it is impossible to build a receiver at home at the price of a similar type of commercial receiver, but it is necessary to go rather deeper than this in order to ascertain whether or not it is worth while to build your own. Dealing first with price, it will probably be found that this season it is quite a simple matter to obtain components which will not cost more than the commercial receiver which contains the same number and types of parts. Hitherto, it has been the custom in the component industry to sell parts which have been fitted with ornate cases or which have been made up to sell simply as a separate component, and consequently the price has been higher than was desirable. In an endeavour to obtain a really cheap set the manufacturers of complete receivers set out to utilize components which were stripped of all unnecessary decoration, and also, in many cases, which only just served for the purpose for which they desired to use it. Thus, in the case of a smoothing choke, for instance, this was designed to use the minimum size of core, the thinnest wire, and the smallest number of turns so that it smoothed the particular supply in a cheap receiver. The cheapest choke in the component market would undoubtedly be found to be housed in a bakelite case—not for appearance necessarily, but so that it was amply protected and would not give rise to shocks when handled by the constructor. The wire would also be found to be much heavier than was really essential, and the rating would probably be found to be stated in the catalogue as suitable for "20 to 60 milliamps"—in other words, it was more of a general purpose instrument. Obviously, therefore, it would cost more than the previously mentioned component. The same applies to the other accessories in a commercial receiver; they have, in the majority of cases, been stripped down to the bare minimum and consequently a considerable amount of money has been saved.

A Safety Factor

It does not need much imagination to see that in the event of an overload—no matter how such overload may be caused—there is every risk of a complete breakdown in more than one part. This factor is of vital importance to the user of the apparatus, not from the point of view of personal safety, but also from the point of view of economy. Should the maker's guarantee have expired a considerable amount of money may have to be expended to put the receiver into working condition again, and, furthermore, in the majority of commercial receivers, it will be necessary to send the apparatus to a service station to be attended to owing to the inaccessibility of the parts. Contrast this with the

home-built receiver described in a wireless journal. The designer, in choosing the circuit and components, will have before him not simply one list, but the lists of all the manufacturers of component parts. Thus, should he need a smoothing choke for a mains receiver, he will work out the current which is passed, and then will examine all the lists and select those which will handle that current with safety, narrowing down his choice by picking those having the highest inductance, and finally selecting that which has physical dimensions most suitable for the design which he is working upon.

Admittedly, until recently the constructor had to pay an uneconomical figure for his components owing to the method in which these components were built up, but we have taken up this point with the majority of manufacturers, and as a result of the policy which we have adopted and which resulted in the introduction of the "Leader" series of receivers, a number of components may now be obtained in a similar condition to that in which they are supplied to the receiver manufacturers, a condition known as "stripped." That is to say, instead of terminals, long leads are fitted; no elaborate case surrounds thy component, and yet the original safete factor is still there.

Experimental Scope

There is, however, another more important point which must not be overlooked. Radio at the moment is by no means perfect, and it is quite possible for drastic modifications to be made in a very short space of time. For instance, during the past twelve months the valve alone has moved along most unthought-of lines. Listeners with a commercial receiver will find that it is almost impossible to modify the lay-out in order to take advantage of a new idea, or even to try out a new arrangement in order to satisfy themselves regarding some astounding claim. The home-made receiver, on the other hand, is readily accessible, and furthermore, when a new idea is introduced, the technical Press generally shows how the scheme may be fitted to an existing receiver which they have already described, or gives some data regarding it which will enable the listener to apply it to his receiver. It is thus conceivable that for the expenditure of a few shillings and perhaps an hour or so on a wet evening, the constructor may bring a receiver completely up to date, whilst the user of a commercial receiver will have to continue to use an out-of-date receiver or scrap it (owing to its low market value), and spend a large amount on a new receiver. It might be argued that drastic changes do not come about so suddenly, but one has only to remember the recent wavelength shuffle, and remember how many receivers were unable to separate stations, to realize that there is every possibility of similar changes occurring at any moment. And with the advent of television, this is a most vital point.

RADIO CLUBS AND SOCIETIES

Club Reports should not exceed 200 words in length and should be received First Post each Monday morning for publication in the following week's issue.

ANGLO-AMERICAN RADIO AND TELEVISION SOCIETY

New Zealand readers of PRACTICAL WIRELESS will be interested to know that the Southland Branch of the Anglo-American Radio and Television Society has been formed by Mr. James Searle, ZL4CE. The branch rooms are at Invercargill. This branch is in regular touch with the New Zealand Headquarters by radio, the N.Z. H.Q. stations being ZL-3HD and ZL-3JQ, both in Christchurch. Mr. Searle's address is 193, Ettrick Street, Invercargill, New Zealand.

The West Middlesex and East Bucks Branch has discontinued meetings over the summer months, but an attractive programme is being drawn up for the resumed meetings. Full particulars may be obtained from Mr. Leslie W. Orton, "Kingshorpe," Willowbank, Uxbridge, England.

SLADE RADIO

The programme of lectures, etc., for next month is as follows:—

- Sept. 6th.—Lecture by Dr. Harvey Marston. Short-wave working. R.N.W.R. Commercial and Naval, with special cine films of Rugby S.W. station.
 - Sept. 13th.—Recording and reproduction. Marcond-phone Co., Ltd.
 - Sept. 20th.—Lecture and special demonstration by Mr. L. G. Coade, "H.F. Currents in connection with electro-medical apparatus."
 - Sept. 22nd.—Visit to the S.W.S. Power Station at Stourport.
 - Sept. 27th.—Ladies' Night. Illustrated lecture, "Gallipoli," by Lieut.-Commander Brewster.
 - Sept. 29th.—Midnight D.F. test.
- Hon. Sec., 110, Hillaries Road, Gravelly Hill, Birmingham.

CATALOGUES RECEIVED

To save readers trouble, we undertake to send on catalogues of any of our advertisers. Merely state, on a postcard, the names of the firms from whom you require catalogues, and address it to "Catalogues," PRACTICAL WIRELESS, Geo. Neuen, Ltd., 5/11, Southampton St., Strand, London, W.C.2. Where advertisers make a charge, or require postage, this should be enclosed with applications for catalogues. No other correspondence whatsoever should be enclosed.

THE NEW AVODAPTER

It often happens when wishing to check up one's own or somebody else's set that there is a doubt as to the best way to set about the job. Of course, an ordinary meter can be used, but this may necessitate the disconnection of wires for inserting a meter, with subsequent re-soldering. This sort of thing, however, is superseded by the new AvoAdapter, which consists of a plug (instantly convertible for 4- or 5-pin valves) without loose parts, connected to a testing holder or base, which provides for the taking of voltages and currents in all the valve circuits, with comfort on the bench. The AvoCoupler is a 5- to 7-pin conversion adapter, which enables the operator to deal with multi-electrode valves also with ease and efficiency. It is used in conjunction with either plug or base depending on the type of valve to be tested. The plug is inserted in the valve-holder of the valve under suspicion, and the valve plugged into the AvoAdapter. A switch and link are provided to enable anodes, grids, screens, filament or heater currents and voltages to be measured. The currents and voltages of any circuit can be taken simultaneously or separately.

For those who already have, or wish to make up their own testing equipment, the AvoAdapter Convertible Plug can be supplied separately, complete with 6-way lead. Full particulars and prices are given in a folder just issued by the Automatic Coil Winder and Electrical Equipment Co., Ltd.

OLON ELECTRIC SOLDERING IRON

FOR making neat soldered connections quickly an electric soldering iron is a necessity, and the lightweight Solon electric iron, made by W. T. Henley's Telegraph Works Company, is specially suited for the purpose. The weight of this iron is 9½ozs.; it consumes 65 watts and is obtainable for various voltages from 100 to 250. A heavily tinned straight copper bit of oval section is provided, and the heating element is so arranged that the maximum amount of heat is at the working end of the iron. The flexible lead consists of 8ft. of Henley's tough rubber-sheathed three-core flex, which will withstand the roughest usage in service. The ends are trimmed ready for connecting to a 3-pin plug. The price of this handy iron is 9s. 6d., and an attractive folder giving further particulars of this and heavier irons can be obtained from the above-mentioned firm.

A MASSIVE FOUNDATION

HIVAC

THE SCIENTIFIC VALVE

BRITISH MADE

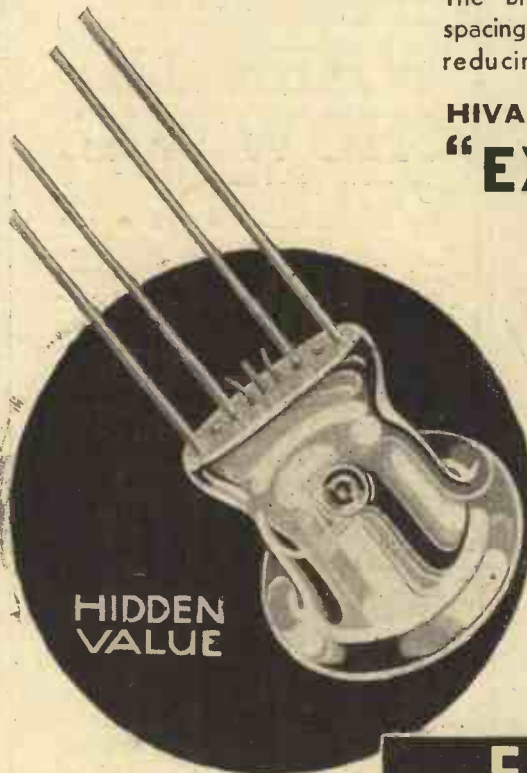

HIDDEN VALUE

Hivac use only the highest quality glass obtainable because "soft" glass will not stand up to and retain the "hard" vacuum essential to high efficiency and consistent characteristics.

The Broad "pinch" allows greater spacing of lead out wires thereby reducing inter-electrode effects.

HIVAC SPECIFIED FOR THE "EXHIBITION 3"

SG 220	= = =	10/6
H 210	= = =	3/9
P 220	= = =	5/6

Obtainable from all Curry's branches and high class dealers

BATTERY TYPES FROM **3/9**

MAINS TYPES FROM **9/6**

HIVAC 1935 VALVE GUIDE AND COMPARATIVE TABLE "N" FREE ON REQUEST.

STAND 27 OLYMPIA

ESSENTIAL TO STRENGTH

BRITISH MADE by

High Vacuum Valve Co., Ltd., 113-117 Farringdon Road, London, E.C.1

BEST for YOUR TESTS!



USE METERS

There are degrees of accuracy. Specify SIFAM Meters and be certain of complete accuracy in your radio tests.

MOVING COIL METERS. New dials make readings simple. Knife-edge pointers give greater accuracy. Mechanism perfectly balanced and tested. From 27/6.

MAGNETIC CONTROLLED METERS. Recommended by leading technicians for general radio and charging purposes. Guaranteed accuracy. In moulded cases 2½in. overall, 2in. hole in panel. From 7/6.



SIFAM ELECTRICAL INSTRUMENT CO., LTD.

York Works, Browning St., S.E.17. Tel. Rodney 3573

PATENTS AND TRADE MARKS. KING'S PATENT AGENCY, LTD., 146b, Qn. Victoria Street, E.C.4, offer "Advice Handbook" and Consultations free. 49 years' references. Write, call, or phone. Phone: City 6161. Director, B. T. King, C.I.M.E., Reg. Patent Agent, G.B., U.S.A., and Canada.

EASY PAYMENTS

"There's no place like HOLMES." The first firm to supply Wireless parts on easy payments. Nine years advertiser in Wireless Press. Thousands of satisfied customers.

			Monthly
		Deposit.	Payments.
TELSEN Latest 323 Kit	29/8	4/-	7 of 4/1
Lissen Skyscraper 4	112/6	10/-	11 of 10/3
EXIDE H.T. Accum.	120v.	60/-	6/- 9 of 6/8
BLUE SPOT 29PM.	...	32/6	4/5 7 of 4/5
ATLAS ELIMINATOR.			
No. OA25	...	59/8	5/- 11 of 5/6
B.T.H. Pick-up	...	21/-	3/10 5 of 3/10
EPOCH 20th G. P.M.	...	35/-	4/10 7 of 4/10

Parts for any Kit Set. Any make of Speaker. New Goods Obtained for Every Order.

Send us a list of the parts you require and the payments that will suit your convenience, and we will send you a definite quotation. Anything Wireless.

H. W. HOLMES, 29, FOLEY STREET, Great Portland Street, London, W.1.

Phone: Museum 1414.

Impressions on the Wax

By "TONEARM"

IF we were to look up our dictionary for a definition of the word "practical," we should probably find, in common idiom: "putting knowledge to real use." Now knowledge, or science, or art belong to an abstract world, and whilst there seems to be no objection to putting the first two to very practical ends, there exists the fervent conviction that art should survive for its own sake—subjectively, as it were, in deference to the cliché, "Art for Art's sake."

There is no reason why the aesthetic should not contribute something of itself to the practical. This is not to say that every expression of art should be turned into money; this would be, firstly, impossible for many, and secondly, unhealthy for everybody. But there is no valid or proper reason why art should not be viewed in terms of practical values, *practical* in the sense that one may look for some new experience or sensation apart from the purely academic viewpoint which many would have us adopt. Cannot we get at the message behind the mere expression?

Let us make an attempt to do so—here, of course, we are dealing with musical art as we hear it on gramophone records. We begin to listen to, say, the Beethoven *Fifth Symphony* (I know of no better illustration), detached from any other purpose than that of listening to some "good music." Almost at once, from behind the art which inspires it, leaps out the practical. There is a message there, insistent, vital, urgent. What that message is belongs only to Beethoven and the hearer, but in it is a very real structure on which may be built many foundations, all acutely real and translatable into action or conduct. Surely this exemplifies the practical side of music.

There are two ways, and two only, of *hearing* music. There are only two ways of *talking* of music. One—the frigid analytical method, where the poor corpse is laid on the slab of polemical dissection and cold-blooded evidence delivered as to the physical structure and condition of the deceased (thus the usual form of criticism); and, two, the intimate, honest effort to describe the attributes of a *living* entity always with us and its message and influence on our lives. Art for Art's sake—heaven forbid!

We shall go much farther than that in our efforts to draw our pictures! Everybody must take something away—something which will guide towards richer practical rewards. And this end can only be achieved by a portrayal (in the practical sense) of the piece before us. Does it really mean anything to us? Will it be of any value to us this time next year? Are ordinary, intelligent folk able to sense its merits, able to understand it? These are the questions we shall ask and endeavour to answer. The composer, the poet, and the artist either worked for *you*, or they did not; we shall try to show how far their efforts have succeeded.

From time to time we must examine an opera, and at the moment *Madame Butterfly* is presented to us. Listening to opera presents a double difficulty where its language is other than our own (as in this case). And yet there is no reason to run away from it. The emotional content of the music of the best operas is, with

(Continued on page 705)



and WHEN THE SHOW WAS OPENED

The fare at Olympia offers many surprises . . . new circuits, new tuning devices, new cabinets. But had you the time to investigate you would be more than surprised how you would find T.C.C. condensers "all over the show." Look inside the leading commercial receivers, call at the various press stands, see how often you meet the "condensers in the green case." Then go over to Stand 37 and see the range of T.C.C. condensers, the comprehensive selection of NON-INDUCTIVE paper types, the electrolytics, and the big transmitting condensers. Spare a second more, realise how their dependability has made T.C.C. the premier amongst condenser makers—realise too, you can have that dependability—for no extra cost.

T.C.C.

ALL-BRITISH
CONDENSERS

The Telegraph Condenser Co., Ltd.,
Wales Farm Road, N. Acton, W.3.

SEE THE
COMPLETE
RANGE ON
STAND 37

CA 5434





Random Gottings

By Jace

Conducting in a Sound-proof Box

BY means of a new invention which was tried out recently at the H.M.V. Recording Studios in London, one of the greatest difficulties in obtaining satisfactory performances of orchestras when performing in front of a microphone for the purpose of broadcasting, or making records and films, will be solved. In the past the conductor has not been able to obtain an accurate impression of how the performance is sounding to the listeners in the case of broadcasting, or how it will sound ultimately in the case of records or films. For example, a visitor to the recording studio during a dance band session recently found himself unable to hear the vocalist who was standing only a few inches from the microphone, whilst the recorders in their room adjacent to the studios heard

through a loud-speaker the performance as it will be on the finished record. The amplifying powers of the delicate microphone and apparatus made the vocalist's voice stand out above the orchestral accompaniment when the performance was heard through the recording engineers' loudspeaker.

This new invention, which has been developed under conditions of the greatest secrecy in the "His Master's Voice" studios, enables the conductors to hear the performances of the orchestras under their direction in the same way as the recording engineers, and also as they will sound on the finished records. The conductor stands in a specially made sound-proof cabinet with glass windows about double the size of a telephone booth. It is situated in the studio, and he directs his orchestra whilst inside the cabinet. He does not hear the performance direct, but listens to it through a loudspeaker which is at his side.

Ray Noble, the well-known light music conductor-composer, was the first to use this new invention whilst making some records in the H.M.V. studios of a number of the latest fox-trots.

It is believed that the idea may be extended to broadcasting and film studios,

where conductors of orchestras will find it extremely helpful, especially when conducting operatic works when vocalists have to sing with an orchestra. The H.M.V. recording official also stated that this invention would be used in future when making re-created records of Caruso and other celebrities of the past. "Conductors of symphony orchestras will," he said, "be able to hear the dead singers' voices through the loudspeaker in the cabinet whilst directing the orchestras through the window."

Droitwich—and After

THE new B.B.C. giant station at Droitwich will not officially begin broadcasting until early in September, but unofficial testing is now taking place every night after the other stations have closed down. Every possible precaution is being taken to ensure that there will be no last-minute hitches. But there is another reason for these early tests. The Radio Exhibition opened on August 15th, nearly a month before Droitwich starts transmitting in earnest. The new station will have a power of 150 kilowatts, as against Daventry's 30 kilowatts, and it is possible that this tremendous increase will vastly alter reception conditions.

CONDUCTING IN A SOUND-PROOF BOX.



Ray Noble, the dance music composer-conductor, used for the first time recently a new invention when making records in the "His Master's Voice" studios. He conducted his orchestra from a sound-proof box, and heard their playing through a loudspeaker at his side. Thus he was able to ensure that all the instruments were perfectly balanced and managed to obtain effects that have not been possible hitherto.

Up-to-Date Tuning Scales

BY not waiting for the official opening of Droitwich, the B.B.C. are providing radio manufacturers with an opportunity to check the performance of their new sets against actual transmissions. An example of the thoroughness with which manufacturers are making their preparations is provided by E. K. Cole, Ltd. The new EKCO models are being issued with Droitwich already marked on the tuning scales, so that the sets will be completely up-to-date immediately transmission begins. These dials are also easily replaceable in the event of a change-round.

Easy Terms

Why wait weeks for that new Radio accessory? You'll get it quicker from N.T.S. Any items advertised in this journal on Easy Terms. Strict Privacy Guaranteed. Cash or C.O.D. if preferred. Orders over 10s. Carriage and C.O.D. Charges Paid. SEND FOR QUOTATION FOR ANYTHING YOU ARE NEEDING.

W.B. STENTORIAN STANDARD P.M. MOVING-COIL SPEAKER

SENT ON 7 DAYS' TRIAL

For Power, Pentode and Class "B."

Send only 2/6 for 7 days' trial. If approved, balance in 7 monthly payments of 4/6. Cash or C.O.D. Carriage Paid, £1/12/6



BLUE SPOT "STAR" JUNIOR P.M. MOVING-COIL SPEAKER

SENT ON 7 DAYS' TRIAL

With 12-point matching transformer suitable for all outputs. Send only

2/6 for 7 days' trial. If approved, balance in 7 monthly payments of 5/-. Cash or C.O.D. Carriage Paid, £1/15/0



TELSEN "323" KIT

Complete Kit of Parts for new Telsen Straight 3. Send only 2/6; balance in 6 monthly payments of 5/-. Cash or C.O.D. Carriage Paid, £1/9/6.

If valves required, add 15/- to cash price or 6 deposit and 9 monthly payments of 5/-.



N.T.S. CLASS B SPEAKER

SENT ON 7 DAYS' TRIAL.

With full-size Cone and tapped Input Transformer. Send only 2/6 for 7 days' trial. If approved, balance in 5 monthly payments of 4/6. Cash or C.O.D. Carriage Paid, £1/3/6.

Power or Pentode Model, same price and terms. When ordering, state which type required. De Luxe Model for power or pentode 30/- (Cash in 7 days) or 2/6 deposit and 6 monthly payments of 5/-.

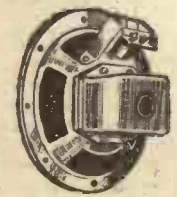

ATLAS ELIMINATOR

SEND FOR IT ON 7 DAYS' FREE TRIAL

Model C.A.12. For A.C. Mains, 100/250 v. 3 tappings; 60/80 v. 90/100 v.; 120/150 v.; 12 m/a at 120 v. Send only 5/- for 7 days' trial. If approved, balance in 11 monthly payments of 5/-. Cash or C.O.D. Carriage Paid, £2/12/6.

Model C.A.25. Send only 3/6. Balance in 11 monthly payments of 5/6 (or cash in 7 days £2/19/6). Carriage Paid.

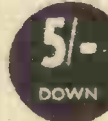

SEND FOR LATEST LISTS.

New Times Sales Co.

56, LUDGATE HILL, LONDON, E.C.4.
 Dear Sirs:
 (a) Please send me.....
 (b) I enclose Cash/Deposit.....
 NAME.....
 ADDRESS.....
 Pr. W. 25/8/34
 FIRST WITH EASY TERMS IN 1924

HOME CONSTRUCTION IN 1935

Radiolympia has Much of Interest for the Home Constructor,
for Many New Components are to be Seen

NINETEEN-THIRTY-FIVE will certainly be a constructors' year. Some months ago it appeared that interest in home construction was flagging, but the introduction by PRACTICAL WIRELESS of the "Leader" series of receivers marked a change, and that change is continuing to become more pronounced. As we show on another page the prices of components for set building are certainly lower than they have ever been before, whilst the standard of home-made receiver performance is particularly high.

It might so happen that some readers of this special "Olympia" Number forsook home construction a few months ago while prices were rather high, and it is chiefly for the benefit of such people that this article is being written. Those who have not been actively engaged in home construction during the past year or so might be in some

provide the best form of volume control—either automatic or manual. When the output circuit is being considered users of mains apparatus will almost invariably desire to use an output valve giving an undistorted output of two or more watts, and such valves are readily obtainable. The battery-set user will wonder whether to employ Class B or pentode L.F. amplification; where a particularly large volume is desired the former will be preferred, but it should not be overlooked that most of the latest types of moving-coil speaker are considerably more sensitive than their predecessors, so that a really ample output for most purposes can be secured by the use of one of the many high-efficiency pentodes. In this connection it might be mentioned that the new W/B "Stentorian" speakers, for example, will give nearly twice the volume of sound for any given signal input than would last year's models.

Tuning Components

When it comes to the choice of a tuning circuit the constructor can choose between iron-core and air-core coils. In the case of a very simple local-station receiver, or when selectivity is not of prime importance, the air-core inductance can still be used with every success. But when sharpness of tuning is a deciding factor, iron-core coils have it every time. There are tuning condensers in plenty, and we do not know of an unsatisfactory one made by any of the better-known manufacturers. Where compactness is desired recourse can be had to one of the many midget tuning condensers which are every bit as effective as their larger brethren. Such components are made by Wingrove and Rogers ("Polar"), British Radiophone, Wilkins and Wright ("Utility"), and others, whilst very attractive full-vision tuning scales of various types can be obtained for any of these.

Those who favour the superheterodyne on account of its selectivity, but who desire better quality of reproduction than this type of circuit is normally capable of providing, will be pleased to learn that it is possible to obtain oscillator coils and intermediate-frequency transformers of the adjustable type. These can be set to provide any band-width acceptance from about 6 to 12 kilocycles, so that the best possible quality can be secured from the nearby stations, at the same time as maximum selectivity is available when distant stations are wanted.

Multiple Switches

Many constructors prefer to cut down the control knobs to the lowest convenient number, and these will find the multiple anti-capacity switches made by such firms as Bulgin and Burne-Jones ("Magnum") extremely valuable as a means of combining the functions of a number of separate units. Other combination controls are to be found on most of the complete tuning units which are to be had for any and every circuit arrangement—the Colvern-matched tuners are a case in point.



A useful volume control for the home constructor.

There are still many houses which are supplied with D.C. mains, and as these will eventually be replaced by A.C. the occupiers are often in doubt as to the most suitable type of receiver to build. This question now lends itself to a ready answer, because almost every type of valve can to-day be bought in a form which can be operated equally well from A.C. or D.C. mains. These universal valves are by no means "experimental," but are just as satisfactory in every way as their A.C. counterparts.

All-Wave Tuning

Until this year there has been a dearth of tuners which would cover not only the

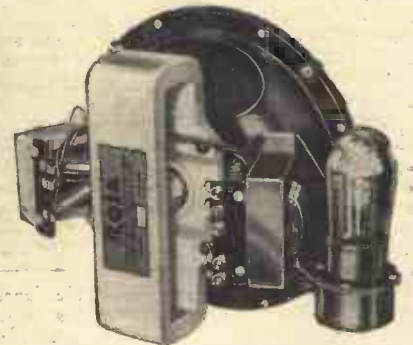

To enable a battery receiver to be converted this Rola Class B Speaker will prove invaluable.

long- and medium-wave bands, but also the principle short-wave ranges. There are now, however, two or three entirely satisfactory all-wave tuners; one of these employs interchangeable coils so that not only can short waves be received in addition to the broadcast bands, but any particular short-wave ranges can be accommodated. This tuner will go down to 10 metres and up to 2,000 metres merely by operating a switch.

Most readers are well aware that the ultra-short-waves are coming into greater prominence in connection with television, so it is not surprising to find that special coils for ultra-short wavelengths are obtainable.



A new type of fixed condenser from the Formo factory.

doubt regarding the latest components which are now available, and perhaps in rather a quandary to know what type of set they should make for the coming "season" (if there is any "season" in wireless to-day, which we very much doubt), and a few notes concerning the available parts will prove useful.

H.F. Pentodes

Whether it is proposed to make a superhet. or a "straight" receiver, variable- μ or plain H.F. pentode valves will be required, for these have almost entirely

A Formo double-gang tuning condenser fitted with a new and unusual form of tuning dial.

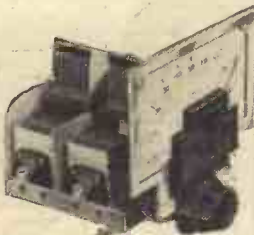

supplanted the ordinary S.G., which was previously a popular favourite. The latest valves are much more stable than their prototypes, and are capable of producing a far greater degree of sensitivity. In addition, valves of the variable- μ type

THE NEW COMMERCIAL RECEIVERS

A Résumé of the Salient Features of the 1934-35 Ready-made Sets.

THE variety of new receivers for the 1934-35 "season" will be as great as, if not greater than, for any previous year. Prices will be lower than ever before in the history of broadcasting, whilst the sets themselves will be much smaller in regard to their physical dimensions. The new models will not be so distinctive in the matter of new and unusual circuit arrangements as in respect of the many practical improvements which will be incorporated. As was the case last year, superheterodynes will predominate, and there will, in fact, probably be a far greater number of superhets at Olympia than at any previous Exhibition. "Straight" sets will not be entirely absent, but these will be featured in the lower-price range as a general rule. A rather important proof of the extra popularity of the superhet is afforded by Messrs. Philips Lamps, who last year employed their well-known "superinductance" principle in all their larger and more powerful receivers; they have not forsaken this efficient circuit, but they are producing two superhets—one for A.C. operation, and one of the universal type.

A.C.—D.C. Operation

Incidentally, it is worthy of mention that most of the better-known receiver manufacturers are including one or more universal (A.C. or D.C. operation) receivers in their range. This is in response to an ever-increasing demand, and has been made possible by the comparatively recent introduction, by British manufacturers, of extraordinarily effective universal valves. Among those who are producing universal receivers mention might be made of such well-known firms as Messrs. Ekco, Messrs. Telsen, Messrs. Aerodyne, Messrs. Ultra, Messrs. Pye, and Messrs. McMichael. There are, of course, many other firms producing such sets, but it is obviously impossible to mention every one by name.

One important change which has taken place with regard to commercial super-heterodynes concerns the reduction in the number of valves. This change commenced more than a year ago, but it has now advanced to the stage at which a total of four valves is the rule rather than the exception. The reason is not far to seek, and it is that the pentagrid, octode, and other special frequency-changing valves of extremely efficient types are now available. Additionally, the double-diode-triode and double-diode-pentode have now been

practically standardized for use in the second-detector position, where they also perform the functions of first L.F. amplifier and automatic volume control.

A.V.C. is to be found in nearly every one of the new season's sets of the more pretentious type, and it is probably the popularity of A.V.C. that has still further increased the number of superhets. This statement calls for an explanation, since it might not appear at first sight that there is any close relationship between A.V.C. and the superhet. The fact is that nearly all of the automatic volume control devices function more efficiently on the higher wavelengths (lower frequencies) at which the intermediate-frequency amplifier is designed to operate. Additionally, these devices vary slightly in efficiency at various frequencies, and can therefore only produce uniformity of result when they function continuously at the same frequency.

Whilst on the subject of intermediate frequency it might be mentioned that a number of the latest superhets have I.F. amplifiers which operate at a higher frequency than heretofore. The chief advantage of this is that a wider wave-

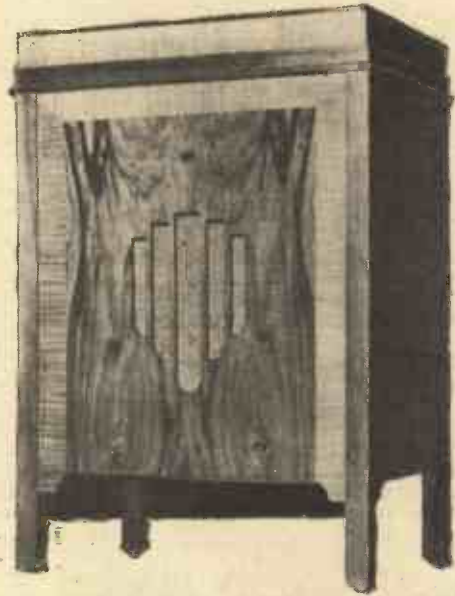

No unsightly controls and a neat and plain cabinet front form a novel departure from usual practice.

This is because the signals from any particular station remain at constant intensity over a fair number of degrees on the tuning dial, due to the "levelling" effect of the automatic control. This does not mean that selectivity is in any way impaired, but that a peculiar form of distortion is obtained if the dial is not set to the true tuning point; this is because half of the sidebands is "cut." The only real solution to this difficulty rests with the use of visual tuning, and this is a feature of most of the latest models. There are a number of methods of providing visual tuning, but one of the most popular is due to the recent development by Messrs. Cossor of a special form of neon indicator.

The device consists of a relatively long neon tube in which the two electrodes are placed at the top and bottom respectively. When the set is not tuned to a station the characteristic neon glow is very short, but as resonance is reached the glow extends towards the upper electrode. Thus, exact tuning is indicated when the glow reaches its maximum length. The neon indicator is employed in the Cossor model 535 A.C. superhet, as well as in several of the Ultra receivers, and others. There are several other types of visual tuning indicator, one of which takes the form of a milliammeter connected in the anode circuit of one of the controlled valves; the needle shows a maximum deflection when the set is exactly in tune. Other visual indicators indicate resonance by the width of a band of shadow, or of light, on a scale, whilst a particularly novel system is used on the Alba superhet. This receiver employs what the makers have called "searchlight" tuning, and a triangle of light is thrown on to the scale as the set is switched on, this rotating as the tuning knob is rotated. As the set is brought into tune with a station the width of the "searchlight" becomes less.

(Continued overleaf)

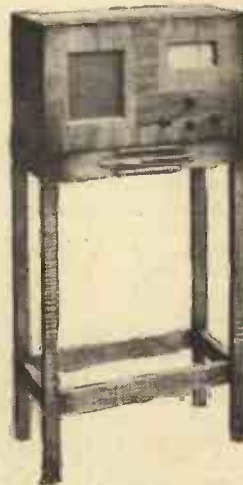

Two styles of receivers seen at Olympia. On the left a decorative cabinet, and on the right a pedestal receiver with stool.

length range can be covered by a set of this kind, and this is exactly what is wanted to cope with the conditions imposed by the Lucerne Plan.

Visual Tuning and Noise Suppression

It has been pointed out in these pages before that the normal use of A.V.C. brings one or two difficulties in its train, not the least of which is that it is more difficult to tune the set to the exact resonance point.

(Continued from previous page)

Visual tuning at once overcomes what was at first a serious drawback of A.V.C.—the large amount of inter-station noise. This has, of course, been prevented in many cases by the provision of some type of noise suppressor, quiet A.V.C. or "squelch" device, but it can be obviated more simply and cheaply simply by turning the (L.F.) volume control to its minimum position, tuning entirely "by eye," and advancing the volume control after the desired station has been selected.

The new receivers make it more than ever evident that the old idea of describing a receiver by the number of valves it contains is quite futile. For example, a four-valve superhet fitted with one of the many types of frequency-changers and a diode-pentode second detector acts in every way as seven-valver of previous type. Thus, the idea of naming a set by the number of stages, rather than valves, which

it contains is gaining ground. We believe that Messrs. Ekco were the first to standardize this method of nomenclature last year, but it is now being used fairly generally by most manufacturers.

New Tuning Devices

Much thought has been expended on the matter of tuning dials since last year, and it is gratifying to find that there has been a general improvement. Mention has already been made of the "searchlight" dial, and it is only fair that we should also mention "clock-face" tuning which was introduced by Messrs. Ultra. In this system the "clock face" is divided into two halves, for medium and long waves; the small hand covers the wavelengths from 200 to 550 metres, and the minutes hand from 950 to 2,000 metres. Messrs. Telsen have also introduced a new and ingenious form of tuning scale, which consists of a large replaceable station-calibrated scale over

which moves a celluloid cursor on which is engraved a sloping line. At the foot of the cursor there is also a short line that registers with a metre-calibrated scale running along the bottom of that on which are marked the station names. Against each name there is a square, and exact tuning is indicated when the sloping line passes through the middle of this. Most other manufacturers have increased the size of the tuning scale, and that on the Ekco sets, for example, is as large (in some cases, larger) as the diameter of the loud-speaker. The Atlas receivers are fitted with what the makers call a spectrum-tuning scale; when the switch is turned to the long-wave position only the long-wave stations are shown, these being in red, whilst when the switch is set for medium waves, the corresponding stations are shown in green. A further advantage of this tuning system is that the scale may be tilted to any angle so that the operator can see it without straining.

CHECKING FREQUENCY RESPONSE

Simple Methods of Testing the Response Curve of Any Receiver.

By H. BEAT HEAVYCHURCH.

AM I certain that my reproduction is a faithful interpretation of the programme performed in the studio? That is a question which every listener should ask himself as soon as his receiver is built and in working order. However pure the output, quality will not be perfect unless the speaker can translate that output into sound without introducing serious distortion, and the faults most likely to occur in this particular product are poor reproduction of very low notes and of very high notes, together with undue prominence of certain notes at various parts of the scale, due to unwanted mechanical resonances which are difficult to eradicate.

An Accommodating Ear

The human ear, however, is not equally responsive to all frequencies. As a matter of fact, it is most sensitive to frequencies of the order of 1,000 cycles per second, which corresponds to notes about two octaves above middle C of the piano. For the lower frequencies below 100 cycles, and for the extreme upper register (above 8,000 cycles), the response of the ear is much more feeble. Now, unfortunately, it is just those frequencies to which the ear is the least sensitive that some loud-speakers reproduce the worst, so the natural deficiency of the ear is aggravated by what may be termed the artificial deficiency of the speaker. On the other hand, the human ear is notoriously accommodating and is more easily deceived than any other human organ. It therefore recognises and accepts for reasonably life-like reproduction sounds which vary considerably from the original produced in the studio, and it is a fact that listeners may become so used to what is really very poor reproduction that they do not realize the extent to which the sounds produced by their loud-speaker fall short of perfection.

It is, however, not a difficult matter to carry out at home one or two practical tests which will indicate roughly what kind of response curve a speaker has. To carry out really accurate tests, expensive and very accurately designed apparatus is required, and this is generally outside the means of the average listener.

The Equipment

To commence with the simplest and cheapest test, it can be ascertained easily whether a speaker has a reasonable bass response by applying a 50-cycle note obtained from the A.C. electric light mains. Connect a fairly long length of flex, say five or six yards, to the grid and cathode terminals of one of the low frequency valves, and run this flex as close as possible to some wires carrying the alternating current house supply, such as the mains lead to your receiver, or the flex connecting a standard lamp. No connection, of course, should be made to the light supply itself. The result will be that an appreciable alternating voltage at a frequency of 50 cycles will be picked up by the trailing flex and will be amplified by the valves and applied as a strong 50-cycle signal to the speaker. If this component has a reasonable bass response, a good volume of deep hum should be heard. Unfortunately, this test only gives an indication for one particular frequency, but if a good performance is obtained at 50 cycles it is fairly safe to say that there is nothing wrong with its bass response.

Using Records

A far more accurate series of tests can be carried out with the aid of special gramophone records giving constant frequency notes. These constant frequency records are

not usually stocked by gramophone dealers, but they can be obtained, or it may be possible to borrow them from a progressive and up-to-date radio dealer. Each record produces a practically constant volume at given frequencies, about four different frequencies being recorded on each side. These frequencies are 25, 50, 100, 200, 500, 1,000, etc., going up in stages to 4,000.

A Simpler Method

There are other less accurate devices which anyone can try at home if he possesses a fairly sensitive microphone. The microphone should be installed in a room away from the speaker and sounds as near as can be judged at equal intensity should be produced, running right up and down the scale. This can be done by means of a piano or by stringed instruments. If you possess a violin this will be excellent for the upper frequencies, but a cello will be required to give a good test in the deeper notes. With such a test, of course, it is difficult to judge when the sounds performed at the microphone are of equal intensity, but they do give a fair indication of performance.

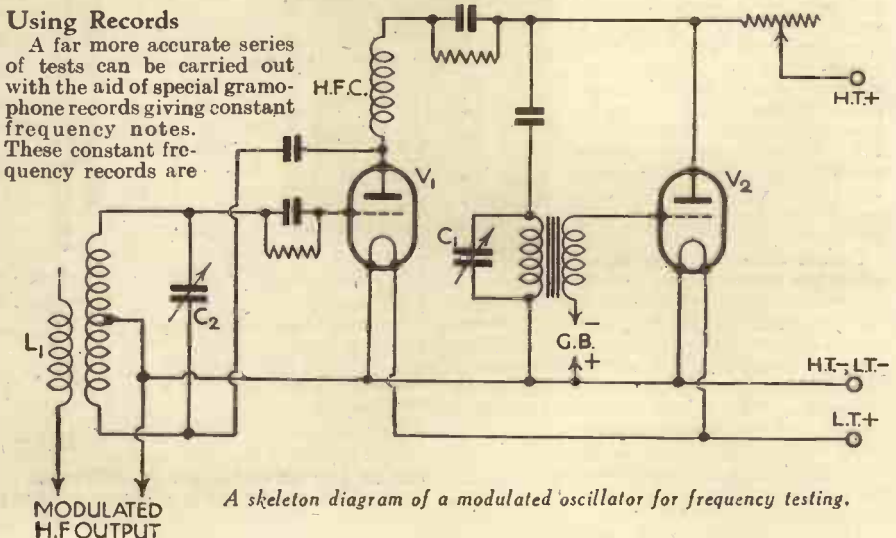

A skeleton diagram of a modulated oscillator for frequency testing.

Impressions on the Wax

(Continued from page 700)

the dramatic poetry of the story, often so ennobling as to make it of intrinsic worth to us. It is therefore comforting to know that very good translations, side by side with the original, are easily obtainable. So before we begin it is possible to absorb the whole story, and thus listen intelligently. To "Butterfly," then, in abridged form on six Columbia records at 4s. each (Nos. DX500-505). The set is comprised of all the "high-lights" of the opera. The company and orchestra are of the Scala, Milan, and the Milan Symphony respectively. (You get a free portfolio and leaflet if you buy the six at once.)

Still Beethoven

There are no apologies due for remaining in such good company, for it may be some time before we are again so privileged. The *Third Piano Concerto* must be noticed; first, because of its almost commonplace charm, secondly, because it has no bewildering thunder-and-lightning displays, and lastly, because of the oneness of the soloist (Artur Schnabel) and the London Philharmonic Orchestra.

The theme seems almost pastoral—nature *en fête*. One can visualize woodland scenes with the intrusion here and there of humans. In the middle comes the Largo—the third movement. This is a sublime thing, almost a proud, stately lament, able to stand alone as a great work, and yet it is in essence simplicity itself. Back to our rusticity to close, through music as clear and understandable as the day. Here is a great masterpiece for lesser folk, performed with unusual harmony between soloist and orchestra. This concerto is one to treasure for years to come, and you will hear it on five H.M.V. records—DB 1940-1944.

Two Vocalists to Enjoy

We must now turn our attention to two singers who have given of their very best. The first is Josef Schmidt, tenor. He has recorded a really notable performance of *O Paradiso* from Meyerbeer's *L'Africaine*. This is the leading tenor solo of the opera and was immortalized by Caruso (on a record) and by Jean de Reszke, who played the part of Vasco de Gama nearly forty years ago. It is a lovely thing, sung in a most romantic scene in the opera, and I cordially commend it (and Schmidt's rendering of it) as a record to earn many times over its cost in pleasure. It is on Parlophone R1593. Also from the same company comes another treat of great appeal—a vocal setting to the *Flower Waltz* from Tchaikowsky's *Casse Noisette Suite*. I am aware that more than one criticism has been levelled at the profanity of translating a ballet into words, but when it is done as well as Emmy Bettendorf, Orchestra, and Chorus do it, we need not fear. There is one word only to describe record R1605—it is utterly pleasant. I think you will endorse my opinion.

Lighter Moments

We must all of us be frivolous now and again if we are to retain our balance, and here is an exceedingly jolly record, which carries its artistry to a very high degree. Sketches on records are few, but *The Invalid*, on Columbia DB 1179, is a good one—well done, funny, and as it happens founded on fact.

These **13** facts spell
DUBILIER
dependability

- DESIGNED TO GIVE LONG LIFE AND STERLING SERVICE
- EXPERTS CONTINUALLY SPECIFY THEM
- PRACTICALLY ELIMINATE SERVICE TROUBLES
- ENTHUSIASTICALLY PRAISED BY ALL CONSTRUCTORS
- NO DEARER THAN INFERIOR MAKES
- DEFINITELY CONSTANT IN CHARACTERISTICS
- ASSURE TROUBLE-FREE RECEPTION
- BRITISH MADE
- INDEPENDENTLY THREE TIMES TRIPLE-TESTED
- LEADING SET-MANUFACTURERS USE THEM EXCLUSIVELY
- INDIVIDUALLY PACKED
- THROUGHOUT THE WORLD FAMOUS FOR RELIABILITY
- YET THE GREATEST REASON OF ALL IS—THEY BEAR THE NAME DUBILIER



Write for
New 1934 Illustrated Catalogue

DUBILIER
PAPER CONDENSERS

DUBILIER CONDENSER CO. (1925) LTD., DUCON WORKS, VICTORIA RD., N. ACTON, W.3.

ENGINEERS—IMPORTANT OFFER

As the leading Institute of its kind in the World, we offer to prepare you at home for the A.M.I.Mech.E., A.M.I.E.E., A.M.I.A.E., or similar qualification, on the distinct understanding that if you fail your Examination your tuition fee will be returned to you in full. Realise what a difference a few letters after your name will mean to you, and you will realise the value of our extraordinary offer to prepare you on "NO PASS—NO FEE" terms.

Our record in the above Examinations is over 95% successes.

Whatever your age or experience you should apply immediately for a copy of our hand-book "ENGINEERING OPPORTUNITIES," giving details of all leading Engineering Examinations, and over 100 Courses in all branches of Civil, Mech., Elec., Motor, Radio and Aero. Engineering. This book is sent free and without obligation.

BRITISH INSTITUTE OF ENGINEERING TECHNOLOGY, 390, SHAKESPEARE HOUSE, 29/31, OXFORD STREET, LONDON.

OSBORN CABINETS

5/- to £10.

Catalogue containing

37

DESIGNS

with amazing Osborn Box Baffle post free.

CHAS. A. OSBORN, Regent Works, Arlington Street, New North Road, Islington, London, N.1.



See Stand No. 109
Radiolympia.

ELECTRICALLY SOLDER YOUR RADIO CONTACTS

Electric Soldering is
**SPEEDY, CLEAN,
EFFICIENT, RELIABLE
AND ECONOMICAL**

Every Handyman
should use a



7/6

65 watts 7/6
125 " 22/6
(1lb. 1oz.)

240 " 37/6
(2lbs.)

SOLO
TRADE MARK
**ELECTRIC
SOLDERING
IRON**

If unable to obtain, send us the name
of your nearest dealer.

W. J. MENLEY'S TELEGRAPH WORKS COMPANY LTD.
7, 9, 19 Dept.—HOLBORN VIADUCT—LONDON—E.C.1

MADE IN ENGLAND



150 VOLTS AT 15-50 MA.

After considerable research work, Heyberd introduce a NEW Mains Unit—Model 15/50. The voltage regulation of this Unit remains practically constant at 150v. throughout the range of 15-50 ma. Westinghouse Metal Rectification employed. Absolutely free from all hum and background. The 15/50 can be used with extremely satisfactory results for Class "B" operation. Housed in neat metal case with controls mounted on bakelite panel.
MODEL 15/50—Output 150v. at 15/50 ma. H.T.1 variable 40-110v. H.T.2, variable 60-130v. H.T.3 fixed 150v. PRICE 88/6.

VISIT STAND 24 AT OLYMPIA AND INSPECT THE WIDE RANGE OF RADIO MAINS APPARATUS. If you cannot come, send your name and address, attaching this advt. and 3d. in stamps, for copy of NEW 1935 RADIO HANDBOOK

**F. C. HEYBERD
& CO.,
10, FINSBURY ST.,
LONDON, E.C.2.**

HEYBERD
MONARCH OF THE MAINS.

PRACTICAL LETTERS FROM READERS

The Editor does not necessarily agree with opinions expressed by his correspondents. All letters must be accompanied by the name and address of the sender (not necessarily for publication).

"A Wonderful Gift"

SIR,—Many thanks for the camera received safely. It is certainly a wonderful gift and will always be with me on future holidays and pleasure trips. The free service is also greatly appreciated, and I think it is typical of PRACTICAL WIRELESS in being so generous as to enable its readers to benefit in this way.—F. N. BEDWELL (Stratford-on-Avon).

Another Reader's Thanks

SIR,—Thank you for the excellent camera which came, appropriately enough, on August Bank Holiday morning. It was a great surprise, seeing that my application was posted only on the Thursday previous. Your gift service is indeed splendid, and when considered with the weekly entertainment regularly derived from PRACTICAL WIRELESS, it makes one glad to be privileged to share all these good things.—FRANK SUTTON (Cumbran, Mon.).

"Local Experts"

SIR,—I quite agree with our friend a "Service Man" from North Shields. I do not think these so-called local experts realize the enormous amount of damage they do by carrying out these something-for-nothing jobs. I could quote a good many cases where very expensive receivers have been messed up completely by men who, not knowing the technical and real theory, venture to test out and reconstruct sets which call for more knowledge than is anticipated. A person knowing a little about radio is a dangerous person, and some people with the knowledge of fixing batteries think they understand all about radio, and venture to gain knowledge at someone else's expense. The only alternative is send the set back to the makers if it happens to be a commercial set.

Now this is dangerous to us service men with the knowledge of the fundamental and wide principles of radio, gramos, and similar apparatus, and also dangerous to the manufacturer, because if a receiver and circuit is understood, as it would be by every good service man, reconstructing becomes child's play. I have overhauled sets which have been ruined in appearance as well as performance by these so-called local experts. I have noticed more lately that these experts very seldom have much to do with all-mains sets, as a shock now and again with 2 or 3 amperes passing is not encouraging. I cannot do better than say that unfortunately design changes so rapidly that people become disappointed after hearing an up-to-date receiver, say, two months after buying what they thought was the best obtainable. I also venture to say that really good service men are few, but so-called local experts are plentiful. I hope that by the time television is commercialized some protection will be available for the really genuine service man.—W. PARSONS (Margate).

Our Practical Journals

SIR,—Congratulations on publishing a new journal at the popular price of 6d. a month devoted solely to Television. I

wish you success with it. As an interested reader of the Television section of PRACTICAL WIRELESS I have long felt that much of the information you gave had necessarily to be considerably curtailed in order to get it into the available space. With *The Practical Motorist*, PRACTICAL WIRELESS, *Practical Television* and *Practical Mechanics*, you have four sound journals which are much appreciated in my district.—S. J. (Birmingham).

The Price Question: "Practical Television"

SIR,—I read with extreme interest your leading article on the Price Question in PRACTICAL WIRELESS dated August 11th. I am sure that your policy has had a great deal to do with the favourable terms on which it is now possible to make an excellent wireless receiver. It has always been my contention that a home-constructed wireless set is immeasurably better than a commercial receiver at a popular price, and I am glad to think that my favourite weekly radio journal has ensured that it is now possible to make a set at a price which takes away the appeal of the cheap commercial sets. I am pleased also to note that you have entered the field with *Practical Television*, and am sure you will take the lead in this young industry as you have done in the wireless field. I subscribe to all of your Practical journals and wish you continued success.—E. G. (Llandudno).

CUT THIS OUT EACH WEEK.

Do you know

—THAT the choice of the intermediate frequency in a super-heterodyne receiver will affect the occurrence of whistles throughout the tuning range.

—THAT artificial resonances may be introduced in a circuit to give emphasis to certain frequencies so as to make up for defects in a reproducing unit.

—THAT electrolytic condensers must not be used on a raw A.C. supply.

—THAT mica dielectric condensers are preferable, and almost essential, in high-powered R.C. amplifiers.

—THAT the reason for the above rule is to be found in the fact that a positive voltage must not be impressed on the grid of the amplifying valve.

—THAT to obtain maximum performance from a dual speaker system, a filter circuit should be fitted to limit the frequencies handled by each unit.

—THAT a plate of metal fixed high up on the side of a house will furnish a good aerial system for a flat-dweller who cannot erect the orthodox type of aerial.

The Editor will be pleased to consider articles of a practical nature suitable for publication in PRACTICAL WIRELESS. Such articles should be written on one side of the paper only, and should contain the name and address of the sender. Whilst the Editor does not hold himself responsible for manuscripts, every effort will be made to return them if a stamped and addressed envelope is enclosed. All correspondence intended for the Editor should be addressed: The Editor, PRACTICAL WIRELESS, Geo. Newnes, Ltd., 8-11, Southampton Street, Strand, W.C.2.

Owing to the rapid progress in the design of wireless apparatus and to our efforts to keep our readers in touch with the latest developments, we give no warranty that apparatus described in our columns is not the subject of letters patent.

LET OUR TECHNICAL STAFF SOLVE YOUR PROBLEMS

REPLIES TO



QUERIES and ENQUIRIES by Our Technical Staff

The coupon on Page iii of cover must be attached to every query

If a postal reply is desired, a stamped addressed envelope must be enclosed. Every query and drawing which is sent must bear the name and address of the sender. Send your queries to the Editor, PRACTICAL WIRELESS, Geo. Newnes, Ltd., 8-11, Southampton St., Strand, London, W.C.2.

SPECIAL NOTE

We wish to draw the reader's attention to the fact that the Queries Service is intended only for the solution of problems or difficulties arising from the construction of receivers described in our pages, from articles appearing in our pages, or on general wireless matters. We regret that we cannot, for obvious reasons—

- (1) Supply circuit diagrams of complete multi-valve receivers.
- (2) Suggest alterations or modifications of receivers described in our contemporaries.
- (3) Suggest alterations or modifications to commercial receivers.
- (4) Answer queries over the telephone.

Please note also that all sketches and drawings which are sent to us should bear the name and address of the sender.

Aerial Impedance Transformer

"I have purchased a special interference eliminator which has no name, but which is embossed with some figures and what appears to be the letters U.S. These are stamped on a tin plate at the bottom of the unit, and this has been bent and straightened, thus blotting out the maker's name. I have connected this to my aerial, using a screened down lead joined to the terminals ANT and GD, and have followed the recent articles by you on the subject of these impedance matching transformers. On the medium waves the device seems to work quite well, reducing interference and giving practically no loss in signal strength. On the long waves, however, it completely cuts out all signals, and I cannot even hear Daventry. I cannot account for this, as there is no switch or anything which could be faulty on the unit. Can you help?"—T. G. (Barnet).

The device is undoubtedly of American origin, and in that country they do not utilize the long waves. Consequently the transformer has been designed to function on the medium waves only and it upsets the remainder of your tuning circuit on the long waves. Although similar units are

on sale in England, these are of either English manufacture, or have been designed for our market and they therefore function more or less satisfactorily on both wavebands.

Coil Data Required

"I have recently obtained a pair of screened coils, but no circuit diagrams or explanations of connections were given. The only means of identification upon them is the Patent Nos. and the following is transferred on the base: DSG/2. Each coil has six terminals and wave-change is effected by means of a worm-drive. I wonder if you could supply any information concerning them?"—W. C. (Tankerton).

We regret that we have no details concerning these particular coils. They were made by the London Electric Wire Company, and if you write to them they may be able to assist you. Their address is:—Church Road, Leyton, E.10.

Telsen Coil Connections

"I have a Telsen screened coil No. W.216. Unfortunately I have lost the connecting instructions and should be glad if you could tell me the numbers for the various leads."—R. S. D. (Portsmouth).

Terminal 1 is for Aerial or Anode; Terminals 7 and 6 are to be joined to earth. Terminal 8 is the grid connection; Terminal 5 is the anode side of the reaction winding, and terminal 2 is the earth side of this winding. A three-point wave-change switch is required, one pole of which is joined to earth, and the other two poles to terminals 3 and 4.

Coil Winding Particulars

"I have an old ebonite former for 6-pin base, 1 1/2 in. diameter, 3 in. long. It has 8 slots 1/2 in. apart and about 1/4 in. deep. I wish to rewind it for medium and long waves. Will you kindly let me have number of turns per slot? I will fill up

any slots if necessary with Chatterton's Compound. What is the best capacity for a short-wave coil for reaction and tuning?"—E. F. P. (Liverpool).

Fill in all but 6 of the slots on your coil (on each rib), and for the medium waves wind on 65 turns of 26 gauge D.C.C. wire. For the long-wave section wind 60 turns of 34-gauge enamelled wire in each of 5 slots, and join this winding in series with the first winding. For reaction purposes wind 45 turns of 34 enamelled in the first slot next to the medium-wave winding. All turns must be wound in the same direction. For tuning on short waves you will find a .00015 mfd. condenser most suitable, with a .0002 or .0003 mfd. reaction condenser.

Ventilating a D.C. Set

"I am going to construct a D.C. set, but must use a 100-watt lamp for voltage dropping purposes. What is the best way of arranging ventilation for this set so that the heat will not damage the cabinet or other wireless parts?"—R. Y. (Bristol).

It will be very difficult to arrange a lamp to avoid damage to the wireless components. A small metal box without a back could be constructed and lined with asbestos sheeting if desired, but it would have to be arranged that the lamp was well clear of the cabinet side and speaker. A better arrangement is to purchase a special D.C. resistance or resistance mat of the correct type and fit this in the receiver, when the question of heat dissipation will not be found so serious. Suitable resistances may be obtained from advertisers in this journal.

Complete Diagrams

J. S. (Worthing), R. A. W. (Hull), and others.

As explained many times on this page, we regret that we cannot supply complete circuit diagrams to individual requirements.

The Queries Coupon appears on Page iii of cover.

OSTAR-GANZ

UNIVERSAL HIGH VOLTAGE MAINS VALVES (MADE IN VIENNA) are the only Universal Valves that can be wired in Parallel. There's no wider, finer or more up-to-date range available. They work equally as well on either D.C. or A.C. supply without alteration, off the full Mains Voltage and they do not require Transformers, Barretters or Breakdown Resistances. Because of their remarkable efficiency they have been specified and are fully recommended by "Wireless Press."

KITS SUPPLIED FOR ALL TYPES OF RECEIVERS—RADIOGRAMS—AMPLIFIERS.

It is simple to CONVERT Battery or any mains set to Universal AC/DC with Ostar-Ganz valves. Full details and circuits free.

Technical assistance free. EUGEN J. FORBAT, 28-29, Southampton St., Strand, London, W.C.2. Tel.: Temple Bar 8608.

MISSING AT OLYMPIA!

The Finest range of "Universal" All-Wave Receivers

They operate on either AC or DC Mains from 100 to 250 volts.

ALL models except the "Miniature" cover Ultra Short Bands as well as medium and long wavebands!

ALL models are available as "Universal" Radiograms in modern table or console cabinets!

ALL models are extremely economical in operation as no barretters or dropping resistances are employed and the filaments are connected directly across the mains!

ALL models owing to the use of Ostar-Ganz Super Power output valves give a greater undistorted output than corresponding sets on the market!

ALL models are completely hum-free on A.C. or D.C. mains!

UNIVERSAL HIGH VOLTAGE RADIO, LTD., 28-29, SOUTHAMPTON ST., LONDON, W.C.2.



Write at once for full details and prices. Telephone: Temple Bar 4985.

Miscellaneous Advertisements

Advertisements are accepted for these columns at the rate of 3d. per word. Words in black face type and/or capitals are charged double this rate (minimum charge 3/- per paragraph). Display lines are charged at 6/- per line. All advertisements must be prepaid. Radio components advertised at below list price do not carry manufacturers' guarantee. All communications should be addressed to the Advertisement Manager, "Practical Wireless," 8, Southampton Street, Strand, London.

PREMIER SUPPLY STORES

Offer the Following Manufacturers' Surplus New Goods at a Fraction of the Original Cost; all goods guaranteed perfect, carriage paid over 5/-, under 5/- postage 6d. extra, I.F.S. and abroad, carriage extra. Orders under 5/- cannot be sent C.O.D. PLEASE SEND FOR ILLUSTRATED CATALOGUE POST FREE.

STUPENDOUS Purchase of Set Manufacturers' Stock. All electric 3 Valve (S.G. Def. Pen.) Set-in Walnut Cabinet with moving-coil speaker 200-250 volt 40-60 cycles. Chassis built. 200-2,000 metres with 4 valves, £4/19/6.

ALL Electric 3-stage Amplifiers. 200-250v., 40-60 cycles, 10 watts, undistorted output, complete with 5 valves, £7/7-. Suitable speakers, pick-ups and microphones can be supplied.

SPECIAL Offer of P.M. and Energised M.C. Speakers. Purchased from well-known gramophone company. **TYPE 10071C.** 9in. diameter, 2000 ohm field, 40/70 m.a.; Pentode transformer. Handles 4 watts, 17/3.

TYPE 10055F. 9in. diameter, 11,650 ohm field, 20/30 m.a. auditorium type power transformer. Handles 10 watts, 30/-.

TYPE 10055H. 9in. diameter, 115 ohm field, 350/400 m.a. auditorium type Pentode transformer. Handles 10 watts, 30/-; A.C. Kit, 20/-.

TYPE 4480. 9in. diameter, permanent magnet. Handles 4 watts, 7 ohms speech coil, 13/6. Multi-ratio transformer, 4/6 extra.

PREMIER SUPPLY STORES announce the Purchase of the Complete Stock of a World Famous Continental Valve Manufacturer; all the following standard mains types, fully guaranteed, 4/6 each, H.L. power, High, Medium, Low magnification, Screen Grid. Directly heated Pentodes, 1 watt, 3 watt and 4 watt A.C. outputs.

THE following Type, 5/6 each; 350 v. and 500 v., 120 millamp full wave rectifiers, 23 watt indirectly heated pentode.

THE following American Types at 4/6: 230, 227, 112, 171, 210, 245, 26, 47, 24, 35, 51, 58, 53, 37, 80 and the following types, 6/6 each; 42, 77, 78, 2575 36, 38, 83, 39, 44, 53, 6A7, 6B7, 2A5, 2A6, 2A7, 2B7, 5Z3, 6C6, 6A4, 6D6, 6F7.

866 Valve, Filament 2.5 v., Filament Current 5 amp. Plate volts, Inverse peak 7,500, Plate Current Peak 0.6 amps. Price 25/-.

ELIMINATOR Kits, including transformer, choke, Westinghouse metal rectifier, T.C.C. condensers, resistances and diagram, 120v., 20 m.a., 20/-; trickle charger 8/- extra; 150v., 30 milliamperes, with 4v., 2-4 amps. C.T., L.T., 25/-; trickle charger, 6/6 extra; 250v., 60 milliamperes with 4v., 3-5 amps, C.T., L.T., 30/-; 300v. 60 m.a. with 4 volts, 3-5 amps., 37/6; 200v. 100 milliamperes, 39/6.

PREMIER chokes, 40 milliamperes, 25 hys., 4/-; 65 milliamperes, 30 hys., 5/6; 150 milliamperes, 30 hys., 10/6; 60 milliamperes, 80 hys., 2,500 ohms, 5/6; 25 milliamperes, 20 hys., 2/9.

ALL Premier Guaranteed Mains Transformers have Engraved Terminal Strips, with terminal connections, input 200-250v., 40-100 cycles, all windings paper interleaved.

PREMIER H.T. Transformer, output 135v. 80 m.a. for voltage doubling, 8/6; 4v. 3-4a., C.T. L.T. 2/- extra; with Westinghouse rectifier giving 200v. 30 m.a., 17/6.

PREMIER H.T.S. and 9 Transformers, 250v., 60 m.a., and 300v. 60 m.a. rectified, with 4v. 3-5a. and 4v. 1-2a. C.T. L.T. and screened primary, 10/-; with Westinghouse rectifier, 18/6.

PREMIER H.T. 10 Transformer, 200v. 100 m.a. rectified with 4v. 3-5a., and 4v. 1-2a. C.T. L.T. and screened primary, 10/-; with Westinghouse rectifier, 19/6.

PREMIER Mains Transformer, output 250-0-250v. 60 m.a., 4v. 3-5a., 4v. 2-3a., 4v. 1-2a. (all C.T.) with screened primary, 10/-.

PREMIER Mains Transformers, output 350-0-350v. 90 m.a., 4v. 3-5a., 4v. 2-3a., 4v. 1-2a. (all C.T.) with screened primary, 10/-.

PREMIER Auto Transformers, 100-110/200-250v. or vice versa, 100-watt, 10/-.

WESTERN ELECTRIC Mains Transformers, 300-0-300v. 65 m.a., 4v. 1-2a., 4v. 2-3a., 6/6; 500-0-500v. 150 m.a., 4v. 3-5a., 4v. 2-3a., 4v. 2-3a., 4v. 1a. C.T., 4v. 1a. C.T., 19/6; 1,000-0-1,000v. 250 m.a. 4v. 3a. C.T., 4v. 3a. C.T., 49/6; 2,000-0-2,000v. 150 milliamperes, 49/6.

SPECIAL Offer of Mains Transformers, manufactured by Phillips, input 100-200v. or 200-250v., output 180-0-180 volts 40 m.a., 4v. 3 amp., 4v. 3 amps., 4/6; 200-0-200v., 4v. 1a., 4v. 3a. 4/6.

PREMIER L.T. Charger Kits, consisting of Premier transformer and Westinghouse rectifier, input 200-250v., A.C., output 8v. 1 amp., 14/6; 8v. 1 amp., 17/6; 6v. 2 amp., 27/6; 30v. 1 amp., 37/6; 2v. 1/2 amp., 11/-.

B.T.H. Trussed Induction Type (A.C. only) Electric Gramophone Motors, 100-250v.; 30/- complete.

COLLARO Gramo. Unit consisting of A.C. motor, 200-250v. high quality pick-up and volume control, 49/-; without volume control, 46/-.

SPECIAL Offer B.T.H. Gramophone Motors, A.C. and D.C., 100/250v., 30/-. Listed £33/3-.

DISON Bell Double Spring Gramophone Motors, complete with turn-table and all fittings, a really sound job, 15/-.

SPECIAL Offer of Wire Wound Resistances, 4 watts, any value up to 50,000 ohms, 1/-; 8-watts, any value up to 15,000 ohms, 1/6; 15 watts, any value up to 50,000 ohms, 2/-; 25 watts, any value up to 50,000 ohms, 2/6.

WIRE Wound Potentiometers, 15,000 ohms, 1/6; 50,000 ohms 2/-; 500,000 ohms, 3/-; 1,000 ohms wire-wound semi-variable resistances, carry 150 m.a., 2/-.

CENTRALAB Potentiometers, 400 ohms 1/-, 50,000, 100,000, 1 meg. any value, 2/-; 200 ohms, wire wound, 1/-.

POLAR Star, manufacturers' model, 3-gang condensers, fully screened, 7/6; with trimmers.

AMERICAN Triple Gang 0.0005 Condensers, with trimmers, 4/11; Utility Bakelite 2-gang 0.0005 screened with uninkob trimmer, 3/6; Polar Bakelite condensers, complete with knob, 0.00015, 0.00035, 0.0003, 0.0005, 1/-.

ORMOND Condensers, 0.0005 2-gang semi-shielded, 2/6; brass vanes, with trimmers, 3/6. British Radiophone 110 kcs. Intermediate, 3/-.

MAGNAVox D.C. 152, 2,500 ohms, 17/6; D.C. 154, 2,500 ohms, 12/6; D.C.152 magna, 2,500 ohms, 37/6, all complete with humbucking coils; please state whether power or Pentode required; A.C. conversion kit for above types, 10/-; Magnavox P.M. 7in. cone, 18/6.

RELIABLE Canned Coils with Circuit, accurately matched, dual range, 3/- per coil; ditto, iron-cored, 3/6.

RELIABLE Interval Transformers, 2/-; multi-ratio output transformers, 4/6.

HELLESEN 8 mf. Electrolytic Condensers, 435 volts working, 2/3; Mershon ditto, 1/9.

POLAR 2-gang Uninkob Condenser with Trimmers and complete slow-motion Dial, 0/-.

WESTERN ELECTRIC Condensers, 250v. working, 2 mf., 1/-.

T.C.C. Electrolytic Condensers, 550v. working, 650v. peak, 8 mf., 4/-; 4 mf. or 8 mf. 440v. working, 3/-; 15 mf. 50 v. working, 1/-; 25v. working, 25 mf., 1/3; 6 mf. 50v. working and 2 mf. 100v. working, 6d.

T.C.C. Condensers, 250v. working, 2 mf., 1/9; 2 mf. 1,500v. working, 6/-.

H.M.V. Condensers, 400 v. working, 4+4+1+1+1+1+1+0+1+0.1+0.1+0.1, 4/9; 4+2+1+1+1+1+1+0.5, 3/9.

DUBILIER Condensers, 8 or 4 mfd. dry electrolytic 450v. working, 3/-.

VARLEY Constant Square Peak Coils, band-pass type BP7, brand new in maker's cartons with instructions and diagrams, 2/4.

VARLEY H.F. Interval Coils, BPS, hand-pass complete with instructions in original cartons, 2/6.

SCREENED H.F. Chokes by One of the Largest Manufacturers in the Country, 1/6.

PREMIER British-made Meters, moving irons, flush mounting, accurate, 0-10, 0-15, 0-100, 0-250 m.a., 0-1, 0-5 amps, all at 6/-.

LARGE Selection of Pedestal, table and radio-gram. cabinets, by best manufacturers, at a fraction of original cost, for callers.

THE Following Lines 6d. Each, or 5/- per dozen.—Chassis valve holders, 5-, 6-, or 7-pin, screened screengrid leads, any valve 1-watt wire end resistances, wire end condensers, 0.0001 to 0.1 Bulgis 3-amp. main switches, Cydon capacitors double trimmers.

PREMIER SUPPLY STORES

20-22, High St., Clapham, S.W.4. Telephone: Macaulay 2188. Nearest Station, Clapham North Underground.

MANUFACTURERS' CLEARANCE.

ULTRA "Panther," a modern cabinet, with contrasting figured walnut veneer panels, 20x17x11, 13/6; pedestal type, 33x22x12, 30/-, undrilled; photo sent on request.

SET and Speaker Cabinets; 5/- upwards.

RADIOGRAM Cabinets; 37/6 upwards.

SPEAKER Cabinets; 4/6 upwards.

SEND Particulars of Your Requirements (giving size of set, etc.), or call and make your choice from our stocks of over 100 different types; from 3/6 to £4/10.

H. SMITH and Co., Ltd., 287-9, Edgware Rd., London, W.2. Tel.: Padd. 5891.

H. A. WIRELESS for everything radio. Special Exhibition Offer. Visit the Exhibition and select the set you will require, then write to us. We can supply for cash or by very easy payments. Your old set taken in part exchange. Free demonstration at your own home (London and suburbs only). H. A. Wireless (Shoreditch), 9 and 13, Hackney Road, Shoreditch, E.2. B/Shopsgate 8169.

SOUTHERN RADIO'S Bargains.—Manufacturer's guaranteed surplus.

VARIABLE Condensers.—Lotus. All 0.0005. Complete with dials, escutcheons, knobs. Fully screened with trimmers. 3-gang, 12/6; 2-gang, 8/6; single, 4/9. (List 9/6). Hydra block condenser, 16 mfd. (2x2x8x2x1x1), 1,000v. D.C., 7/-; Dubilier 4 mfd. (2x1x1), 1,000v. D.C., 2/9; Utility Midget 2-gang variable condensers, 0.0005, with concentric trimmers, 3/5.

SPEAKERS.—Blue Spot permanent magnet, universal transformer for power, super power, pentode and Class B, 23/- (list 39/6); Coleston Soundex permanent magnet, 15/- (list 27/6).

BLUE Spot, genuine 100U, inductor speaker on chassis, 13/6 (list 39/6).

IGRANIC Coils, set of four (1 osc., 2 I.F. with pig-tails, 1 I.F. plain), 12/6 (list 50/-).

IGRANIC Band Pass, 3 Coils Unit iron-cored, screened on base, with switch; 14/- (list 33/-).

LISSEN Super-het, 3 Coils Unit, screened, ganged on base with wave-change and filament switches; type LN5181 for battery or mains, 12/6 (list 30/-).

VARLEY Constant Square Peak Coils, with all accessories, new, boxed; BP5; 2/4 each (list 15/-).

VARLEY H.F. Inter-valve Coils, BP6, 2/3 (list, 8/6).

5-VALVE Class B Super-het, Chassis by Plessey, wired ready for use, with 5 Mullard valves, new, in sealed cartons, £3/17/6; (list £12/12); valves alone are priced £3.

EKCO A.C. Eliminators, each new and boxed in original sealed cartons, type K25, with trickle charger, 25 milliamperes, 30/6 (list £5/7/6); type A.C.25, 33/6 (list £3/17/6); type K12 with trickle charger, 37/- (list £3/17/6); Ekco trickle chargers, type T.C.1, for 2-4 and 6-volt accumulators, 20/- (list 42/-).

LISSEN Base Revolving Turntables, 1/6 (list 5/-).

SPECIAL Offer of Lewcos Spaghetti Resistances, all sizes, in original sealed boxes, 4/- per dozen, assorted.

MAINS Transformers.—Full list of mains transformers and chokes sent free; specials can be supplied in 3 days; transformers and chokes guaranteed 12 months.

MORSE Tappers, complete with Buzzér, Flash Built and Battery, 2/-.

MISCELLANEOUS.—Rotorohm and Radiophone volume controls, all values, 3/- switch, 3/3 (list 10/6); Westinghouse metal rectifiers, H.T. 6, 7, 8, 9/3 each; Ferranti chokes, 20 henry 60 m.a., 6/9 each.

ALL Goods Guaranteed and sent Carriage Paid.

BRANCHES at 271-275, High Rd., Willesden Green, N.W.10, and at 46, Lisle St., W.C.2. Please send all post orders to 323, Euston Rd., N.W.1.

SOUTHERN RADIO, 323, Euston Rd., London, S.W.1. (near Warren St. Tube). Phone: Museum 6324.

THE following unused Set Manufacturers' Surplus; all goods guaranteed perfect; immediate delivery

COLVERDYNE (Ferrocot) 7/6; Dubilier or Erie resistors, 1 watt type, 7d., 2 watt type, 1/2, Marconi K19 pick-ups, 2/6. Radiophone IF transformers, 110K or 117.5K C. 6/6.

WESTINGHOUSE rectifiers, HTS, 9/6, HTP, HT10, LT4, LT5, 11/-; Regentone transformers for HTS or HTP with 4v-4a LT winding, 7/6.

MAINS transformers, 350-0-350v., 60 ma., 4-4a, 4v-2a, 12/6. Eliminators, outputs, 150v. 25ma, S.C. and detector. A.C. type with Westinghouse rectifier, 25/-; D.C. type, 12/6. Collaro gramophone motors, 100-250v. A.C., 34/-.

DUBILIER dry electrolytic condensers, 8mf. or 4mf. 500v. working, 50v. 50 mf. 3/6.

ROTOROHM volume controls, with switch, 2/6. BTH pick-up tone arms, 3/-.

ALL types of brand new American valves in stock, A first-class makes, guaranteed. 247, 235, 551, 89, 18, 19, 46, 50, 6A7, 15, 42, 41, 38, 39, 78, 75, 57, 58, 24, 44, 36, 43, 12/-; UX171A, UX190, UX280, UX245, UX226, UX227, 8/-; UX250, UX281, UX210, 18/-.

BTH-RK speakers, 6v field, suitable for P.A. work, 27/6. A.C. type with field rectifier, £2/7/6.

MAGNAVox speakers, complete with hum-bucking coils, output transformers, etc., 152 (9in. cone), 22/6. 154 (7in. cone), 15/9. Rola F6 (7in. cone), 17/6, with all 2,500 or 6,500 ohm fields. Magnavox PM254, 18/-; Magnavox, PM252 (9in. cone) 22/6. Carriage paid, cash with order or C.O.D.

WARD, 2nd floor, 45, Farringdon Street, London, E.C.4. Telephone, Holborn, 9703.

1934-35 SENSATION! Everybody can keep their 2-volt Accumulators in perfect condition and fully charged for 8/3 per annum. Ideal for remote districts, where there are no mains. Chargers from 7/-.

Full particulars, stamp—"Tonic" Chargers, Stourbridge Road, Halesowen, Birmingham.

REPAIRS-OVERHAULS, Quotations free. Bargains in receivers, components, etc. Lists 1d. post free.—E. F. Archbold, Radio Engineer, Lonsdale Terrace, Jesmond, Newcastle-upon-Tyne.

MAINS Transformers, Eliminators, Loudspeakers, Headphones, Transformers, etc., rewound and overhauled. Year's guarantee, 48-hours' service.—Breeze, Clapper House, Marlen, Kent.

1,000 RADIO BARGAINS!

COMPLETE AUGUST LISTS NOW AVAILABLE. ENCLOSE 3d. STAMPS FOR "THE RADIO GOLD-MINE" TO-DAY.

- 27/6 CLASS B A.C. ELIMINATOR KITS with full assembly instructions.
22/6 CL. B. III SEALED KITS. An unprecedented bargain.
18/6 S.G. III KITS. Complete in sealed cartons. Full diagrams.
17/6 A.C. ELIMINATOR KITS. 25 ma. State mains voltage.
14/6 ORMOND PERMANENT MAGNET. P.M. SPEAKERS (list 27/6).
12/6 SHORT-WAVE III VALVE KITS. Will tune in the world.
10/6 CLASS B CONVERSION KITS. Complete in sealed cartons.
10/6 STRAIGHT III KITS. In sealed cartons, with full instructions.
10/- SAMPLE BARGAIN COMPONENTS Parcel. Guaranteed value, 30/-—40/-.

THE 'GOLD-MINE' CHAIN STORES BRANCH No. 1 NOW OPEN For the use of all personal callers. Open Mondays - Fridays 8.0 a.m. - 6.0 p.m. Saturdays - 1 p.m. - 2.0 p.m. (2 minutes from London G.P.O.)

- 2/11 BRITISH RADIOPHONE VOLUME CONTROLS, 10, 20, 50, 100,000 ohms. 1 1/2 meg.
2/11 BRITISH RADIOPHONE FULL vision straight line, dial and knob.
2/11 COLUMBIA L.F. TRANSFORMER, 3 : 1, 5 : 1 (list 10/6).
2/6 IRON CORED DUAL RANGE COILS, with diagrams.
2/3 VARLEY SQUARE PEAK DUAL RANGE COILS (list 15/-), boxed with full diagrams.
1/11 L.F. CHOKES, 20 hen., 30 hen. Worth 5/6.
1/11 SCREENED DUAL RANGE COILS with 6-terminal base.
1/11 MICROPHONE TRANSFORMERS. 100 : 1. Worth treble.
1/2 READY RADIO SHORT-WAVE COILS, 6-terminal base (list 6/6).
1/2 ASTRA DIFFERENTIALS, .0001, .00015, .0003, 20 hen. Chokes (list 8/6), 1/11d.
1/- POLAR MICA DIELECTRIC Variable Condensers, .0003, .0005.
11d. BROWNIE DUAL-RANGE COILS, with reaction. Helby 2-mfd. condensers, 11d.
9d. S-WAVE H.F. CHOKES. Med. and long wave, 10d. Glazite, 3d. 10ft. roll.
7d. MICROPHONE BUTTONS, very sensitive, worth 3/-. V. holders, 4, 5 pin, 3d.; 7 pin, 6d.
6d. ERIE 1 WATT RESISTANCES, all sizes, 100 ohms - 500,000 ohms, 5/- doz.
4d. 1 WATT RESISTANCES, all sizes, 250-100,000 ohms, 1-5 meg. 2 watt. 9d.
4d. SPECIAL OFFER SPAGHETTI RESISTANCES. All sizes 1000-70,000 ohms. Or 3/- doz. each. FIXED CONDENSERS : .0005, .005, .001, .0004, .001 - .006; 1, 2 Gd.
3d. ONLY POST FREE. - Enclose 3d. stamps to-day, for your August number of the "RADIO GOLD-MINE." By far the most comprehensive lists of up-to-date surplus goods (Kits, components and accessories) yet produced, with a general price level lower than ever before. Avoid delay. Send (enclosing 3d. stamps) to-day.

LONDON EAST CENTRAL TRADING COMPANY (Dept. M.123), 23, Bartholomew Close, London, E.C.1. (Telephone: NATIONAL 7473). Immediate delivery. 24 hour service. Cash or C.O.D. "The Radio Gold-Mine" 3d. post free to-day

THE 'GOLD-MINE' STORES

VARLEY Constant Square Peak Band-Pass Coils. type B.P. 5. Complete, all accessories and instructions. New, boxed, 2/4. (List, 15/-)

POLAR 3-gang Star Minor Condenser, full screened, trimmers, new, 7/- (List, 18/9)
RICSSON 3-1 L.F. Transformers, new and guaranteed, 2/3. (List, 17/6)
COLLARO Electric Gramo Motor A.C. 100-250v. with pick-up and volume control. Auto Start and Stop. Brand new. List price, £4. Our price, 47/6 carr. paid. Bankrupt set maker's stock.
VOLUME Controls, 50,000 ohms, New, 1/3.

CELESTION Energised M.C. Speaker, 2,500 ohms. Model D.C. 2054, with universal transformer. List price, £2/5/0. Our price, 12/6.
PIONEER RADIO CO., LTD., Coptic Street, London. W.C.1. Museum 9607.

REPAIRS—REWINDING—OVERHAULS. English and American receivers, Conversions D.C. to A.C. New Cones and coils fitted to moving coil speakers. Chokes, L.F. and mains transformers and eliminators. All repairs guaranteed laboratory tested with quick service. Trade discount. Write REPAIR DEPT. A.
WEDON POWER LINK RADIO CO., 80, Lonsdale Avenue, London, E.6. (Grange Wood, 1837.)

ELIMINATORS, 25 ma., D.C. 10/-, A.C. 21/-; Transformers 3-1, 5-1, 1/9. British-made valves, H.F., L.F., and Dec., 1/9. Power 2/-, S.G. 5/- Carriage Paid Cash with Order.—Radio Electrical Supplies, 237, Cambervell Road, London, S.E.5.

OUR new lists, which are packed with useful information, are ready. Constructors of chokes, Transformers, and Coils should apply immediately.—Lumen Electric Coy, 9, Scarsbrick Ave., Litherland, Liverpool 21.

ACCORDIONS, Saxophones, Guitars. Send for Free Catalogues. Easy Terms. HESSY'S, 18-20, Manchester Street, Liverpool.

WOBURN RADIO'S New purchase of Resistances, etc.

RESISTANCES: Bargain parcels of resistances: Parcel "A," containing 13 resistors, all 1 1/2 watt, wire wound accurate to 1%, comprising one of each: 100, 400, 500, 1,000, 2,500, 5,000, 10,000, 15,000, 20,000, 25,000, 40,000, 50,000, 100,000, every one guaranteed perfect. 3/9 lot, post 3d. Parcel B, containing 26 resistors, including all the above and thirteen additional useful values, including several 2 watt, 7/6 post free.

WESTERN ELECTRIC MICROPHONES, boxed, very sensitive at 2/6 each, also transformers for use with above (ratio 85/1), 2/6.

WESTINGHOUSE rectifiers: Special offer 6v. 1 amp, 5/6. 6 v. 1/2 amp, 4/6. H.T. 8 and 9, 9/6. Dubilier Condensers, 2 mfd, 1,000 v. test, 1/4. Dubilier dry electrolytics, 4 mfd., 500 v. and 8 mfd. 450 v., 3/-. Wego Condensers, 750 v. test, 1 mfd., 1/- 2 mfd., 1/2. 4 mfd., 2/3. Tubulars : .02, .01 and 1 Gd. S.W. H.F. Chokes, 10d. Radiophone Straight Line Dials, with escutcheon (list, 8/6), 3/9. Toggles, 6d.

W.R.C. Eliminators, all guaranteed 12 months. 150 v. 30 m.a. D.C. Model, 9/6. A.C. Model, 21/-. Universal AC/DC model, 21/-. A.C. Model with trickle charger (2 v., 4 v., 6 v., 1/2 amp.), 32/6. Carr. 1/- extra.

VALVES.—Let us quote for your valve and component requirements.

WOBURN RADIO CO., 9, Sandland Street, W.C.1. Holborn 7289.

SCHOOL CINEMA EQUIPMENT AND RADIO CO., 7, Woburn Buildings, London, W.C.1. offer 4-pin chassis mounting valve-holders, 2/10 doz.; 5-pin chassis mounting valve-holders, 3/3 doz.; 7-pin chassis mounting valve-holders, 4/6 doz.; Columbia 3-1 and 5-1 Transformers, 1/9 each; Radiophone Dials, curved and straight; 3/- each; Western Electric Microphones, complete with Transformers, listed 21/-, postage ex., 4/6 each; Resistances, all values, 4/6 doz.; H.T. Metal Rectifiers, H.T.7, H.T.8, H.T.9, 9/- each; H.T.10, 10/6 each; L.T.2, 9/- each; Midget type permanent magnet M.C. speaker, by well-known manufacturers, new and guaranteed, 12/6 each.

"MELFO-RAD" for all Receivers, Kits, Components, etc.—Lowest prices—Cash/C.O.D. or H.P. Quotations and Lists Free.—Queen's Place, Hove. (Trade Supplied.)

YOUNG men trained for all branches of Wireless Profession. Britain's leading College, situated on sea-front. Boarders accepted. Training fee payable after appointment. Prospectus free. The WIRELESS COLLEGE, COLWYN BAY.

FREE ADVICE BUREAU COUPON This coupon is available until September 1, 1934, and must be attached to all letters containing queries. PRACTICAL WIRELESS, 25/8/34.

PERMANENT L.T.

Get permanent L.T. with WATES L.T. BATTERY. Supplies abundant current for average receiver for one year. No bother. Compact. Very low upkeep cost. A real investment. No troublesome accumulator recharging. £1. Carriage paid. Standard Wet H.T. Battery. 120 v. 12,500 m.a. Lasts years. Saves pounds. £2. carriage paid. Wet H.T. Battery Co., 26, Lisle Street, London, W.C.2.

PEARL & PEARL

190, Bishopsgate, London, E.C.2. All the following bargains guaranteed new goods. Cash or C.O.D. Carriage Paid. SOVEREIGN Iron Cored Coils, with circuits, 2/11 each. GRANIC Pentode tapped Choke, provides tapings from 1-1 to 6-1. List 7/6; our price 3/11. TRIOTRON 4-pole balanced armature speaker units, type "B"; sensitive, beautiful tone; list 22/6, our price 6/11. 2000 MARCONIPHONE 2-Valve Receivers with Speaker and Marconi valves, in handsome oak cabinet, 28/11 Carriage Forward. All Mail Orders Direct to PEARL & PEARL, 190, Bishopsgate, London, E.C.2. Tele: Bishopsgate 1212

VAUXHALL.—Magnavox Permanent Magnet Loudspeakers, universal, suitable for Class B power or pentode; 5 1/2 in. cone, 15/6; 7 in. cone, 17/6; 10 in. cone, 23/-. Energised 2,500 or 6,500, 10 in. cone, 22/6; 7 in. cone, 15/3. All new with humbucking coils.

VAUXHALL.—Radiophone Radiopaks, Band-pass or R.F. superhet., with Lucerne wavelength station-named scales, medium and long, complete, 32/6. VAUXHALL.—Radiophone I.F. transformers, with terminals, 6/-. Radiophone volume controls, with switch, 3/6.

VAUXHALL.—Coils, set of three on base with switch, 16/6. Three-gang condensers, with covers—superhet., 14/6; ordinary type, 12/6. Disc drives, complete, 4/9.

VAUXHALL.—Pick-ups, 8/-—£2. Write for quotation. State make. B.T.H. Collaro Motors, 32/6. Gramophone switches, 3/6.

VAUXHALL.—Westinghouse Rectifiers, H.T.8, 9/6; H.T.9, 10/-; Westectors, W4, WX6, 5/9. CASH with Order, post paid over 2/6, or c.o.d.; all goods unused manufacturers' surplus; guaranteed perfect. Lists free.

VAUXHALL UTILITIES, 163a, Strand, W.C.2. Phone: Temple Bar 9338. (Facing Bush House, over Denny's.)

ADVERTISEMENT INDEX

Table with 2 columns: Advertiser Name and Page Number. Includes entries like Amplion (1932), Ltd. (659), Automatic Coil Winder and Electrical Equipment Co., Ltd. (677), Belling and Lee (657), British Institute of Engineering Technology (705), Bulgin, A. F., and Co., Ltd. (696), Colvern, Ltd. (Inside Front Cover), Cossor, A. C., Ltd. (671), Dubilier Condenser Co. (1925), Ltd. (705), Eugen Forbat (707), General Electric Co., Ltd. (686; Back Cover), Graham-Farish, Ltd. (691), Hayberd, F. C., and Co. (706), High Vacuum Valve Co., Ltd. (699), Holmes, H. W. (699), International Correspondence Schools (Page ii Television Supplement), Jackson Bros. (London), Ltd. (657), King's Patent Agency, Ltd. (699), Lectro Linx, Ltd. (698), Lissen, Ltd. (692), London Radio Supply Co. (698), Lotus Radio (1933), Ltd. (677), New London Electron Works, Ltd. (695), Newnes' "Practical Television" (658), New Times Sales Co. (701), No-Mast Aerial and Central Equipment Co. (708), Osborn, Chas. A. (675), Parke-Davis (678), Peto-Scott, Ltd. (Front Cover Strip, 685), Pifco, Ltd. (672), Reproducers and Amplifiers, Ltd. (678), Sifam Electrical Instrument Co. (699), 362 Radio Valve Co., Ltd. (695), Telegraph Condenser Co., Ltd. (700), Telephone Mfg. Co., Ltd. (659), The Gramophone Co., Ltd. (660), Varley, Ltd. (695), W. T. Henley's Telegraph Works Co., Ltd. (706), Westinghouse Brake and Saxby Signal Co., Ltd. (696), Wet H.T. Battery Co. (Inside Back Cover), Whiteley Electrical Radio Co., Ltd. (681)

ON TOP AT OLYMPIA

SEE THE
RANGE
OF
OSRAM
VALVES
ON
STAND
NO.
34



Osram Valves

MADE IN ENGLAND

REDUCED PRICES

Sold By All
Wireless Dealers:

You can NOW buy OSRAM VALVES from 5'6

Advt. of The General Electric Co., Ltd., Magnet House, Kingsway, London, W.C.2.

C.7

Printed in Great Britain by NEWNES & PEARSON PRINTING CO., LTD., Exmoor Street, Ladbroke Grove, W.10, and published by GEORGE NEWNES, LTD., 8-11, Southampton Street, Strand, W.C.2. Sole Agents for Australia and New Zealand: GORDON & GOTCH, LTD. South Africa: CENTRAL NEWS AGENCY, LTD. *Practical Wireless* can be sent to any part of the world, post free, for 17/4 per annum: six months, 8/8. Registered at the General Post Office for Transmission by Canadian Magazine Post.