

RADIOLYMPIA SECRETS REVEALED!

Practical 3^D Wireless

Published every Wednesday by

**GEORGE
NEWNES
LTD.**

Vol. 2.—No. 46.
AUGUST 5th, 1933.

Registered at the G.P.O. as a Newspaper.



OTHER CONTENTS

THE MEANING OF
SQUELCH

CAUSES OF RATTLE

ALL ABOUT DECIBELS

SETS OF THE FUTURE

RECEPTRU
FOR TRUE RECEPTION

—the wonderful new low loss lead in cable definitely eliminates crackle, background noises, mush and all man-made static. It improves selectivity and increases sensitivity. Get one to-day. You can fix it in less than five minutes.

OF ALL DEALERS in lengths of 15 feet **10/-**

Longer sizes at proportionate prices.

BRITISH RAD:OPHONE LTD., ALDWYCH HOUSE, LONDON, W.C.2

Equip your Set with

CLASS "B" AMPLIFICATION

WE ARE EXHIBITING AT



COSSOR

CLASS "B" VALVES

—and get "Mains Volume"
without extravagant
H.T. Consumption.

By converting the output stage of your Set to Class "B" you can obtain volume equal to that of a powerful All-Electric Receiver. In spite of this huge output you will find the Cossor Class "B" valve extraordinarily economical. H.T. consumption will be no more than it is at present. Send the coupon for full particulars.

COSSOR 240 B.

Filament volts 2.0; Filament amps 0.4;
Anode volts 150 max.; Max. Anode
Current Swing 50 mA.; Max. Peak
Applied Signal (Grid to Grid) 40 volts;
Static Anode Current at $V_a=100$, $V_g=0$
(each half) 1.5 mA.

Price **14/-**

COSSOR 220 B.

Filament volts 2.0; Filament amps 0.2;
Normal Anode volts 120; Max. Anode
Current Swing 35 mA.; Max. Peak
Applied Signal (Grid to Grid) 40 volts;
Static Anode Current at $V_a=100$, $V_g=0$
(each half) 1.25 mA.

Price **14/-**

To A. C. COSSOR LTD., Melody Dept., Highbury Grove, London, N.5.
Please send me, free of charge, a copy of Folder No. L93,
which tells me how to use Class "B" Amplification.

Name.....

Address.....

Make a Note of it: **RADIOLYMPIA, AUG. 15th-24th**



Practical Wireless

EDITOR:
Vol. II. No. 46 || F. J. CANN || August 5th, 1933
Technical Staff:
H. J. Barton Chapple, Wh.Sch., B.Sc. (Hons.), A.M.I.E.E.
W. J. Delaney, Frank Preston, F.R.A., W. B. Richardson

ROUND *the* WORLD of WIRELESS

Better Signals from North Africa

AS the French Government is anxious to assist the development of broadcasting in Morocco, Algeria, and Tunisia, measures are shortly to be taken to increase the power of the stations in these protectorates and colonies. Plans have been drawn up for the construction of a 75 kilowatt transmitter at Algiers, one of roughly 50 kilowatts at Rabat, and an entirely new station (60 kW.) at Tunis. According to the new Lucerne Plan the wavelengths to be used are respectively 318.8 m. (941 k/cs), 499.2 m. (601 kc/s) and 514.6 m. (583 kc/s). The proposal to establish a smaller relay station at Marrakesh is still under consideration.

Radio Toulouse Again on the Air

THE French Posts and Telegraphs Administration has authorized the *Radiophonie du Midi*, proprietors of the new St. Agnan station, to resume broadcasts immediately but have stipulated that the power to be used is *not to exceed* that of the plant destroyed some three months ago by fire. As the energy then employed for the transmission of the programmes was only 8 kilowatts, it is hardly likely that it will satisfy local listeners who subscribed towards the cost of the super-power transmitter.

European Statistics

GERMANY appears to hold the record for the greatest number of broadcasts made by its stations during 1932, namely 110,000 transmissions representing a total of some 48,000 hours. Denmark secures second place with 4,557 hours for one station only, that of Copenhagen, or an average of twelve and one half hours per day, Austria coming third with eleven and three-quarter hours.

Sofia's New Transmitter

SO far Bulgaria has only possessed a small 500 watt station operated by a local wireless association (*Rodno Radio*), but it is to be replaced shortly by a 3 kilowatt broadcasting transmitter which was recently given to the Queen of Bulgaria by the city of Rome. Until January, 1934, there will be no alteration in wavelength.

Even with this power it is doubtful whether many listeners in Western Europe will hear the Sofia programmes; in the British Isles we may have to wait until the Bulgarian Government has launched the "super," the construction of which it has been considering for the last two years. The scheme includes also stations at Plovdiv (Philippopoli), Varna and Roustchouk, for all of which that country has secured wavelengths.

Yugoslavians for Yugoslavia

FOLLOWING a principle adopted in neighbouring countries the Minister of Education at Belgrade has decreed that no foreign artists are to be engaged to perform either at theatres, concert halls, or broadcasting studios. Exception, however, is to be made in the case of artists of world-wide fame for which special authority has been obtained.

Station RXKR Calling

THIS is the call-sign of a floating broadcaster installed on the s.s. *City of Panama* (formerly *La Playa*) and which, anchored outside United States territorial waters, off the Californian coast, daily transmits publicity programmes. The station has been registered with the Panama authorities in order to circumvent restrictions made by the Federal Radio Commission. The entertainments mainly consist of recitals of gramophone records or concerts by the ship's band. Revenue is entirely derived from advertisements by microphone. As the steamer is outside the jurisdiction of the Federal authorities it is not subject to any laws in respect to prohibition, and it is thus through visits to the studio, for which special trips are made from Los Angeles and neighbouring centres, that it anticipates a steady growth in popularity.

Hallo, Oslo!

UNDER the new *Plan de Lucerne* Norway has been granted an exclusive channel (1,186 metres-253 kc/s) for her high-power transmitter, but she will not be allowed to increase the energy radiated. This favourable position in the long-wave band was conceded in consideration of an undertaking to reduce radiation in a south-easterly direction in order to avoid any chance of interference with Denmark and other neighbouring countries.

Loud-speaker In the Pulpit

THE curé of a small parish church at Estivaux (France), finding that his sermons failed to attract a large congregation, hit upon the idea of relaying religious addresses broadcast by well-known preachers every Sunday through *Radio Paris*. At

OUR EXPERTS

Every member of the "Practical Wireless" Technical Staff possesses intensive and extensive experience of Drawing Office, Design, Manufacture, Theory, and Practice!

They are men specially selected because of their ability to combine sound, all-round experience, with an accomplished and easily-assimilated style of writing. Our Staff is easily the Finest Band of Radio Experts in the World.

OUR LABORATORIES

"Practical Wireless" has not one, but many laboratories, manned by highly-skilled technicians who are tireless in their efforts to make sure that every amateur may duplicate exactly the results we obtain!

That is the reason why "Practical Wireless," alone of all radio journals in the World, is able to Guarantee its Receivers. It is the reason, too, why our Free Advice Bureau has earned world-wide approbation from home-constructors.

OUR SYSTEM

The unique organization behind "Practical Wireless" ensures that every worth-while development is first brought to the notice of home constructors through the pages of this journal! Hence our slogan:

"REAL, RELIABLE AND UNRIVALLED READER SERVICE."

Changes in German System

WITH the advent of a new Director-General the German *Reichsfunk* intends to make drastic alterations in its organization during the next few months. The main aim is to bring all studios under one central control and to place the stations completely in the hands of the ruling political party. According to a Berlin report the first step to be taken is that of a thorough change of *personnel* in order to make room for over 1,000 active members of the National Socialist organization. In addition, great efforts are to be made to hurry on the construction of the new Hamburg and Berlin transmitters; the former is due to be opened officially in the autumn.

ROUND *the* WORLD of WIRELESS (Continued)

his own expense he installed a wireless receiver in the church with a loud-speaker in the pulpit. He has found that by this means the village of Estivaux has become a centre of attraction for many kilometres around.

The Next Wavelength Conference

ACCORDING to certain continental papers the next International European Conference is to be held at Cairo (Egypt) on May 15, 1936, but if some authorities are to be believed an earlier one may be convened in 1934.

Geneva Short-wave Broadcasts

IN order to effect relays of interesting transmissions from foreign countries, and to re-broadcast them through the Sottens station, the Swiss authorities propose to use a short-wave transmitter working on a wavelength between 40 and 80 metres; this method would obviate the hiring of special land-lines. The "pick-up" of the original broadcast may possibly be carried out by the Colovrex receiving station of the League of Nations system.

Madrid's Radio Flying Squad

SPAIN, after studying methods adopted in the United States, has equipped all motor-cycles of its flying squad with small radio receivers, thus enabling the members of the force to receive instructions direct from Central Police Headquarters.

B.B.C. Radio Theatre

AT the Radio Exhibition at Olympia this month, the B.B.C. will possess a specially built theatre capable of accommodating fifteen hundred spectators. An original revue to run throughout the week will be staged for one hour each day; admission will be by tickets obtainable from certain stall-holders. Another hour in the day's entertainments will feature a typical vaudeville show. It will be broadcast throughout Olympia and will also be relayed in the National and Regional programmes.

Europe's Biggest Transmitter

THE Moscow-Noghinsk 500 kilowatt transmitter now working on 1,481 metres, and which from January 15 next will operate on 1,714 m. (175 kc/s) is undoubtedly the largest station so far erected in the Old World. Its plant is ultra-modern, it has cost nearly four million roubles for machinery alone, and it only requires a staff of five engineers. The transmitter, situated at roughly forty miles from the Soviet capital, is connected to six separate studios pending the opening of Moscow's new Central Broadcasting House.

Listen for Kalundborg Tests

IF you "stand-by" on 1,153 metres towards 12.30 a.m. soon after the closing item of the Copenhagen programmes, you may hear experiments carried out by the new 60 kilowatt Kalundborg transmitter which is now being tested almost nightly. Whilst free of interference at

INTERESTING and TOPICAL PARAGRAPHS.

that hour, such may not be the case if *Radio Luxembourg* continues to broadcast on its unauthorized channel of 1,191 metres (252 kc/s) which only leaves a bare separation of 8 kilocycles between these two

THE COSSOR CATHODE RAY TUBE.



A modern type cathode ray tube made by Cossors, complete with base. Note the fluorescent screen. Will this tube provide the real solution to Television?

giants. The latter station, as you may perhaps have heard, by the *Lucerne Plan* is required at the beginning of 1934 to work on 240.2 m. and to limit its energy to 60 kilowatts. As the Luxembourg authorities have not signed the convention, it is not yet quite clear what may happen, but the presence of a 200 kilowatt transmitter in that section of the long-wave band, as it has been apportioned, would certainly cause confusion.

Portugal's Radio Plans

A COMPLETE scheme for the control of the future Portuguese broadcasting system has now been drawn up, and if all goes well should be carried out in the course of 1934-1935. Work on the 20

kilowatt station now in course of installation in the neighbourhood of the capital is progressing favourably and *Radio Lisboa* may open simultaneously with the coming into operation of the *Lucerne* plan. A smaller transmitter has been promised to the city of Oporto, and to assure the broadcast of radio programmes to their nationals overseas the authorities contemplate the construction of a 10 kilowatt short-wave station at Lisbon.

Japan Adopts Regional System

THE Japanese Broadcasting Corporation, in order to provide alternative entertainments to its listeners, has studied the B.B.C. Twin Regional plan. As a start a new 10 kilowatt station is to be erected at Osaka; it is to be followed by other transmitters in the most important centres.

Hitched Their (Radio) Wagon to a Star

FOR the opening ceremony of the Chicago World Fair, the Columbia Broadcasting System, through their New York station WABC, enabled their listeners to hear a star! Light impulses from *Arcturus*, computed to be 240 trillion miles distant from the earth, were picked up by the Harvard, Pittsburgh, and other observatories and utilized to switch on the lighting system of the Exhibition Grounds. The actual rays had been emanated by *Arcturus* forty years ago.

Manchester Airport Station

SIMILAR to Croydon and Heston, Manchester possesses its own airport, fully equipped with a wireless telephony transmitter, from which broadcasts can be made for the benefit of airplanes. The call-letters are GEM and the wavelength is 870 m. (345 kc/s.). Morse transmissions are carried out on the aviation channel of 900 m. (333 kc/s.).

The French Ferrié Plan

THE French Government has definitely adopted the Ferrié plan for the re-organization of the broadcasting system controlled by the State. By this scheme France will possess at least six high-power transmitters, namely, Paris (120 kW.), Toulouse PTT (120 kW.), Lyons (90 kW.), Nice, La Brague (60 kW.), Marseilles (60 kW.), Rennes-Thouries (120 kW.), and Lille (60 kW.). Nothing has been decided yet as regards the privately owned stations already in existence or under construction.

Radio versus Theatres

IN view of the present adverse economic conditions prevailing in the United States, the American theatre industry has put forward a suggestion to the authorities in which a request is made that radio receivers should be taxed to the same extent as the increased rate collected from houses of amusement for philanthropic purposes. Managers contend that it would be fair to enforce an amusement tax on broadcast entertainments in view of the present plight of stage and variety artists.

SOLVE THIS!

Problem No. 46.

Jackson fitted his receiver with an output filter circuit, but could get no signals. Whilst testing the leads for good connection he found that the output choke was quite warm. The loud-speaker was connected direct in the anode circuit in place of the choke and everything worked smoothly. What prevented signals in the former arrangement? Three books will be awarded for the first three correct solutions opened. Address your entries to The Editor, PRACTICAL WIRELESS, Geo. Newnes, Ltd., 8-11, Southampton Street, Strand, London, W.C.2. Mark your envelopes, Problem No. 46 and post to reach here not later than Aug. 7th.

SOLUTION TO PROBLEM No. 45.

The potentiometer for controlling the bias to the variable-mu valve in Swinburne's set was mounted on a metal bracket and had not been insulated. Consequently the grid bias battery was being short-circuited via the metal chassis.

No readers were successful in correctly solving Problem No. 44, and consequently no books have been awarded this week.

CAUSES OF

& SOME HINTS ON CURING IT.

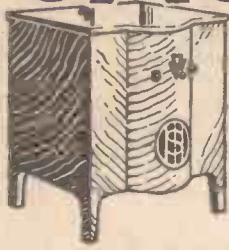

"RATTLE"

By G. W. DAVEY

THE term "rattling," as applied to loud-speaker reproduction, surely speaks for itself, and must have been experienced by nearly every amateur and experimenter. It is, of course, that metallic, vibrating noise which sometimes occurs, particularly during a sudden loud passage of music, and which sounds as though a nut in the loud-speaker is very loose, or the unit itself is badly out of adjustment. These two faults are, in fact, the conclusions almost immediately arrived at as soon as a rattle is heard. Often they are the cause of the trouble, but more often than not it is to be found elsewhere in the set itself. I propose, therefore, to enumerate a few of these causes which have been my experience, and to give a few hints on curing these mysterious rattles.

Loud-speaker Rattle

To take, then, firstly, the loud-speaker. As mentioned above, it may be out of adjustment, a nut or screw of the chassis may be loose, or the cone-fixing screws may have worked loose. Another source of loud-speaker rattle is the reed protruding several inches into the cone, after the latter has been fixed to it, and vibrating. Either break it off or wrap around it a piece of insulating tape, or stick a cork on to it. This will damp out the vibrations. The

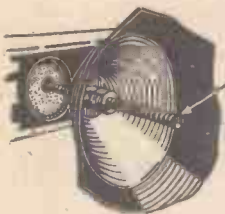

Fig. 2.—Another source of trouble is the reed protruding too far into the cone.

loud-speaker cabinet itself is a potential source of "rattle." Should it be of too thin wood it may resonate, causing a peculiar "buzz" occasionally. This may occur, too, if it is not standing evenly on the table or shelf.

Valve Overloading

Having exonerated the speaker from blame, let us turn to the set itself. We will continue to work backwards from the loud-speaker and look at the output valve. It can possibly safely be said that eighty per cent. of the cases of so-called "rattling" are due to overloading of this valve. Give it as much H.T. as possible, see that the grid-bias is right, and then use the volume-control well. If you have a milliammeter, just put it in the H.T. positive lead to your output valve, check up your G.B. voltage by seeing that, according to the valve-maker's curves, the current being taken by the valve is correct according to the H.T. voltage applied, and then just keep that needle steady *always*. You will be surprised how hard it is! The balanced armature unit tends to cover up deficiencies in quality due to overloading, etc., but the moving-

coil, which is becoming so popular now, does not, and the slightest overload, especially on a sudden loud *fortissimo*, will result in an unpleasant "tinny rattle." Don't think, either, that the output is the only valve that overloads; the first L.F. and the detector, too, do it almost as easily, so check them over just to make

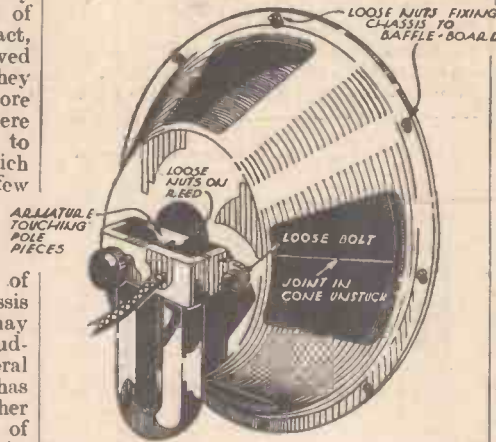

Fig. 1.—Where to look for possible causes of "rattling" in a loud-speaker.

sure. If you have an S.G. valve which is handing out quite a large output to the detector, especially on the locals, you may be sure it's detector-overloading that's causing that rattle. In this case, cut down the H.F. input by using a variable condenser in the aerial lead, or a variable-mu valve instead of your present S.G. one. Try also power-grid detection—grid con-

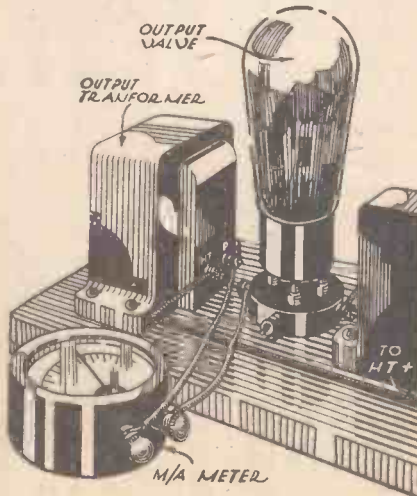

Fig. 3.—Checking for distortion in the output stage.

denser .0001 mfd., leak .25 megohm, and a high H.T. voltage on the plate, not merely on the detector H.T. terminal, where probably most of it is lost, trying to get through several thousands of ohms resistances.

Having had details of the most common causes of these mysterious "rattles" that are apt to arise, let us briefly run through the less common ones. Loose covers of chokes or transformers may vibrate and cause it (that is the reason why music can often be heard with no loud-speaker connected. In such cases, tighten them up or clamp them tightly together in some way. Broken grid-leaks, grid-leaks of incorrect value, run-down and high-resistance grid-bias batteries can all give rise to a distortion very much like a mechanical rattle. Run-down H.T. and L.T. batteries can, too, do the same, and so can worn out valves.

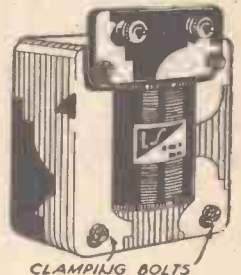

Fig. 4.—The covers and clamping bolts of transformers should be tightened up.

It will be understood from the foregoing that "rattling" is due to distortion as well as mechanical vibration, and to be free from distortion a wireless set must be kept in first-class condition. To do so may be a little more expensive, but that is amply repaid by increased quality, and hence additional enjoyment, of the broadcast programmes.

Olympia Radio Show

Tuesday, Aug. 15th to Thursday, Aug. 24th. 11 a.m. to 10 p.m.

Two Special Enlarged Numbers of

Practical Wireless

August 19th issue
COMPLETE GUIDE TO THE SHOW

A Forecast of the Exhibits, in At-a-Glance-form, with a guide to the Show alphabetically arranged.

August 26th issue
STAND-TO-STAND SHOW REPORT

A comprehensive report on each exhibit by our Technical Staff.

Order These Issues Now!



An Explanation of the New Term Applied to Quiet A.V.C.

OF all the technical terms coined, developed, and introduced to puzzle the wireless amateur, the latest and most popular is "squelch." Although its application to radio originated in America, the word itself is quite English, being defined in Nuttall's as "a flat heavy fall: to crush with a weight or blow." Obviously this definition has no use in radio work, and the word is used in place of the more explanatory phrases of "quiet automatic

By FRANK PRESTON, F.R.A.

Disadvantages of A.V.C.

These are the advantages of automatic volume control, but unfortunately they are accompanied by corresponding disadvantages which tend to neutralize them from the point of view of the listener. The chief disadvantage is that when the receiver is not tuned to a transmission the degree of

control comes into undue prominence. The net result of this is that the "between station" noises are often as loud as legitimate signals and this produces a most unpleasant and disconcerting effect. Besides, even when a station is tuned in, fading is still troublesome, due to the fact that the parasitic noises vary in strength, although the signal itself remains constant.

It is the disadvantages just referred to that give rise to the necessity for "squelch," the idea of which is to render the low-frequency amplifier inoperative on signals of less than "programme" strength. The "squelch" action functions in opposition, as it were, to the normal automatic volume control, so that when signal strength falls below some predetermined minimum the L.F. amplifier ceases to work, notwithstanding the fact that the high-frequency amplifier is operating at high efficiency. Generally, the "squelching" is carried out by a separate valve which is biased from the same source as are the variable-mu amplifiers. Thus, as the automatic biasing potential is reduced on a weak signal, the bias on the "squelch" valve is also reduced. This causes the valve to pass a greater amount of anode current. And as that current is drawn through a resistance connected in the grid-cathode circuit of the first L.F. valve the grid bias on the latter valve is increased. By so arranging the constants of the circuit (principally the value of the resistance) that the L.F. valve is biased to the point of zero anode current when the signal strength becomes less than the minimum decided upon, the low-frequency portion of the set is made "dead."

(Continued on page 642)

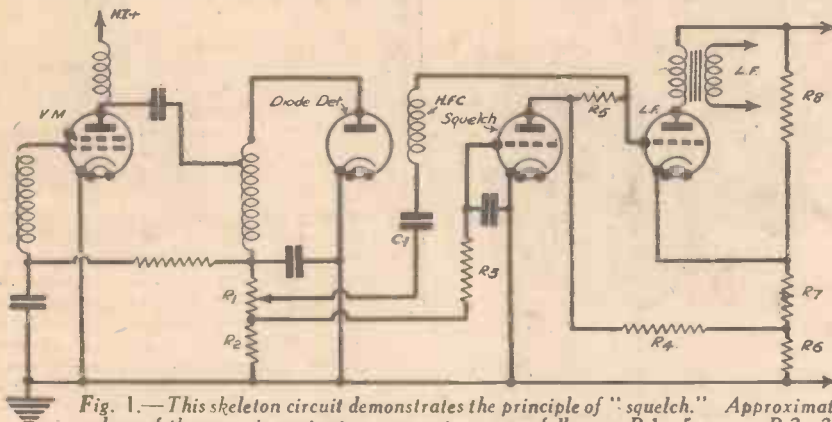

Fig. 1.—This skeleton circuit demonstrates the principle of "squelch." Approximate values of the more important components are as follows: R.1, .5 meg.; R.2, .25 meg.; R.3, 2 meg.; R.4, 50,000 ohms; R.5, 1 meg.; R.6, R.7 and R.8, depend upon the valves and available H.T. voltage; C.1, .1 mfd.

volume control" or "noise suppressor control." To understand the application of "squelch" one must therefore consider it in relation to the now-popular automatic volume control.

Those who have followed recent articles in PRACTICAL WIRELESS know that A.V.C. (to use the abbreviated term) is effected by so designing the receiver that the signal voltage applied to the detector stage is employed to supply a negative grid bias potential to the variable-mu high-frequency amplifier. Thus, as the detector signal voltage increases the V.-M. bias is raised and, in consequence, the degree of high-frequency amplification is proportionately reduced. The result of this is that a "balancing" effect is produced by which the output from the detector—and so the volume of sound from the loud-speaker—tends to remain constant irrespective of the intensity of the carrier wave picked up by the aerial. By this means the detector and low-frequency amplifier are prevented from being overloaded. Moreover, any fading of the signal has no effect on the output volume, since it is immediately compensated for by the increased amount of amplification given by the V.-M. amplifier.

high-frequency amplification is at a maximum, and so the various forms of "mush," constituting the "between station" noises are considerably magnified. In addition, the inevitable "hiss" produced by the valves working in their most sensitive

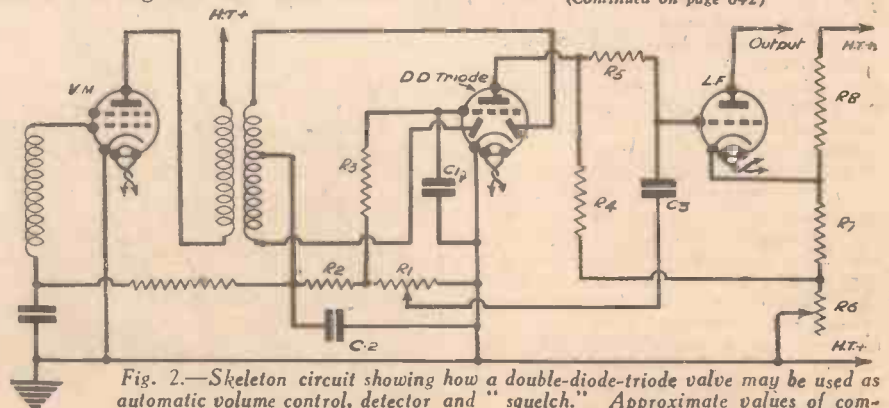

Fig. 2.—Skeleton circuit showing how a double-diode-triode valve may be used as automatic volume control, detector and "squelch." Approximate values of components are as follows: R.1, .5 meg.; R.2, .25 meg.; R.3, 2 meg.; R.4, 50,000 ohms; R.5, 1 meg.; R.6, to give a maximum voltage drop of about 60; R.7 and R.8, depending upon the valves and available H.T. voltage; C.1, .03 mfd.; C.2, .0001 mfd.; C.3, .1 mfd.

SETS OF THE FUTURE

WHAT WILL THEY BE LIKE?

A Prophetic Look at the Future
With a Lively Eye to the Past.

By H. J. BARTON CHAPPLE,
Wh. Sch., B.Sc. (Hons.), A.C.C.I., D.I.C., A.M.I.E.E.

A FEW days ago I paid a visit to the works of a large and well-known firm who undertake the overhauling and repair of radio sets on an extensive scale—what is known in the radio trade as “servicing.” I do not know how many receivers there were in “dock” at the time, but I must have seen at least five hundred in the portions of the works through which I was shown.

And what a collection they were—a veritable museum of radio progress during the past six or seven years! Of commercial sets there were types which stood out as landmarks on the road of wireless development, and very unsightly landmarks, too, some of them. There were flat-faced sets, of the first so-called “American” vertical panel type; sloping panel sets looking like old-fashioned writing-desks; sets in metal boxes varying in design from ornamental biscuit caskets to typewriter covers; “portable” receivers in every guise, from week-end cases to small packing-cases; and a fair sprinkling of ultra-modern cabinet sets with elaborate loud-speaker “frets,” and others of weird geometrical design, with queer angular excrescences by way of ornamentation.

Then there were the radio gramophones, ranging in size from small console instruments to huge affairs like sideboards, and others camouflaged to appear like bureaux or bookcases, or other pieces of furniture. Home constructed models were also well represented. These fell into three distinct classes—those housed in shop-made cabinets of various periods, or in carefully made copies of them; those fitted into crude home-made boxes, some of simply appalling design and worse workmanship, and ranging from huge, coffin-like affairs to poky little hutches made of three-ply wood, and third, those which were, and probably always had been and always would be, quite devoid of a cabinet. Of the internal wiring I prefer not to speak—principally because this article is chiefly about the external appearance of the set of the future, but also because—well, I suppose there *must* be good and bad in this world. Two examples of these sets of the past are shown in Figs. 1 and 2, the first being one of those ancient “R” valve types, with flashlamp batteries bundled together for H.T., while the second shows plug-in coils, a neutralizing condenser, and filament rheostats.

What are We to Do?

Now where does all this lead

to? At first glance it would seem that in the short history of British radio we have employed successively every possible form for our receivers, and that there was no new shape or treatment left for us to try. Yet it is hard to believe that the present fashion will be the final form of the radio set, and everyone with the slightest artistic sense will piously hope that we shall not revert to any of the monstrosities of the past.

disposed on the floor or on other shelves. A few more homes will have more or less neat, self-contained receivers, with built-in speakers of the cabinet type. A real enthusiast will have a fearsome-looking chassis standing in all its nakedness on some piece of furniture, and a moving-coil loud-speaker on a baffle as big as a barn-door, cluttering up one corner of the room, and there will be a radio-gram. or two. A few homes will have loft aerials, and as many more will content themselves with ugly picture-rail aerials and drapings of flex. But the majority will rely upon crazy masts in the back garden, making the view of a row of houses look like Lowestoft Harbour in the middle of the herring season.

Radio is a Service

Things obviously cannot go on like this indefinitely. At no time since the Adams period has the art of home decoration and home-making been at a higher level than to-day, yet it must be admitted that, with the exception of the most expensive models of receiver, wireless sets are the most difficult objects to fit into any well-conceived scheme of decoration. Simplicity and the elimination of both “fussy” pieces and massive objects are the keynotes of modern home design, and it will not be long before British housewives will demand, in no uncertain tones, radio equipments more in keeping with these ideas.

The two thoughts which I want to place before you, as those most likely to lead to somewhat revolutionary changes in the external form of radio sets, are these. First, radio is a service, as much so as the gas, electricity, and water supply, not to mention main drainage. Now we do not parade these services in the “best” rooms of our houses. It is true that we fit artistic apparatus to utilize these services—gas-fires, lighting pendants, and the like.

These devices are designed first and foremost on “functional” lines—that is to say, they are so made that they perform their jobs in the most efficient way, and then their external appearance is made to be either as inconspicuous as possible or to harmonize with the general decorative scheme. We do not, however, have gas meters and fuse-boxes, water-tanks and ball valves fitted in the living-rooms. These utilitarian, essential, but unsightly technical adjuncts are tucked away in the cupboard under the stairs, in the cellar,

or in the attic. No one has yet thought of disguising the shilling in the slot meter as a grandfather clock, or the hot-water

(Continued overleaf)

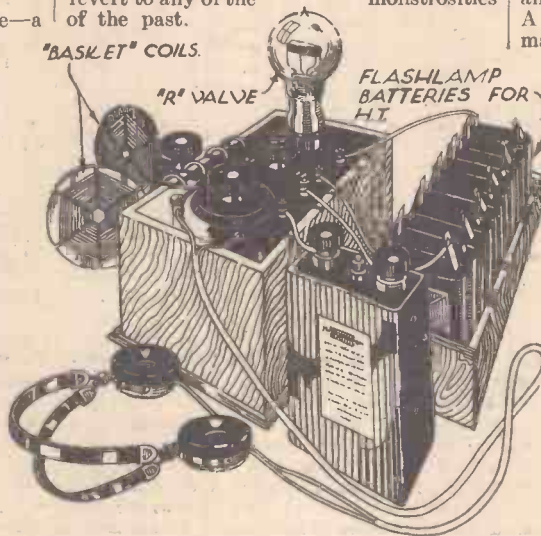

Fig. 1.—A receiver with an “R” valve, and flash lamp batteries for the high tension supply.

So what are we to do? I think the logical development of the set of the future can be deduced with very fair accuracy by the exercise of a little observation, coupled with imagination. Go and visit a dozen typical British homes and examine their radio installations. What will you find? In one or two cases there will be small, box-like sets with separate loud-speakers perched on side tables or bookshelves, and with batteries or eliminators

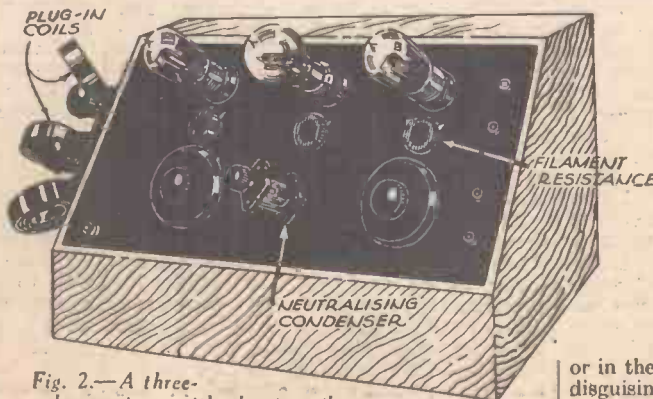

Fig. 2.—A three-valve receiver, with plug-in coils, neutralizing condenser and filament resistances.

cistern as a sideboard, and I do not suppose anyone ever will.

Decorative Blending

The logical conclusion is, therefore, if radio is a service, let us treat it as we treat all other household services—tuck the technical apparatus away out of sight, and retain in our living-rooms only the apparatus of utilization—namely the loud-speaker.

Next comes the question, what form shall the loud-speaker take, bearing in mind that the modern idea is to reduce to a minimum the number of separate articles in any room? Well, our electric light fittings must be visible and actually in the rooms, because unless they were, they could not do their jobs properly. But must a loud-speaker be a separate and visible unit in the room? I think not. If, as seems probable, the moving-coil loud-speaker becomes stabilized for a considerable period as the best reproducing instrument, why not build it into the walls of the various rooms? I can visualize the time when, in addition to the architect, the hot-water engineer, and the electrician, the builder of modern houses will employ the services of a skilled acoustic engineer to decide the most effective locations in each room for the loud-speaker, and suitable holes will be left in party walls for the accommodation of the loud-speakers, which will be covered either by a neat grille or treated in some other way so as to line up with the general architecture and decorations of the room.

Indeed, I know of several homes where something of the kind has already been done, at any rate so far as the loud-speaker is concerned. In some cases a disused service hatch has been pressed into use to house a moving-coil loud-speaker, while in others a hole has actually been cut in the wall. In nearly every case, however, the set itself is of more or less conventional form, and is installed in whichever of the living-rooms offers the best facilities for

aerial and earth connections, loud-speaker extension wires being run to the various rooms and some form of switching device, ranging from simple switches at each speaker point to automatic or semi-automatic switching. One ingenious friend has installed his receiver in his own den and has developed a system of relays operated from the principal living-room whereby

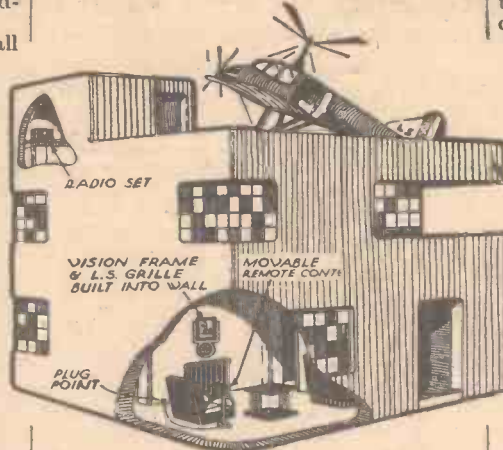

Fig. 3.—What the house of the future may look like.

any one of half a dozen stations can be selected at will. There are, of course, a number of "pre-selector" sets on the market, although in most of these the change from one station to another demands a personal visit to the set to switch over.

Remote Dialing

In all seriousness I suggest that developments on these lines are far from being out of the question. The automatic extension switches and switching systems already on the market show that equipment of this type can be reliable and efficient and not exorbitant in cost. It needs only a little ingenuity on the part of designers to produce

impulse switches and relays suitable for operating station selecting devices, and the technical difficulties in producing sets with a reasonable number of pre-tuned circuits are not insurmountable. Should the scheme be fully developed the only outward and visible signs of the radio installation will be an inconspicuous loud-speaker grille on the wall, and an impulse switch on which the listener can "dial" the station he desires to hear.

There is, however, another direction in which radio fashions may develop, namely the "transportable" all electric receiver. They are now being produced in America and that means that there will shortly be produced over here receivers of the super midget type—four valve all mains sets complete with built-in loud-speaker, the whole being little larger than a cigar box. A set of this description can be carried easily from room to room and plugged into the nearest wall socket. The output is ample for a small living-room and there is no doubt that, when built in Britain, quality will be reasonably good and will satisfy all but the most critical musical highbrow.

These sets are remarkably cheap in price—at any rate in the States—so there is no reason why several should not be available in any home. This would be a most flexible arrangement and would allow different members of a family to listen to the stations of their individual choice, whereas with the average set all must listen to whatever has been selected by the majority. But perhaps the experiments which have been going on with respect to police wireless receivers may result in a third solution. Shall we all wear individual radio sets about our person? If so, where shall we put them? Will they affect the shape and form of our clothes? Somehow or other I do not feel that this scheme will become popular, for a programme loses half of its enjoyment unless it is shared with others. No, I do not fear that we shall grow into a nation of solitary listeners.

Using "Squelch"

Rather than attempt to enlarge upon the brief explanation just given it will be better to take an actual example of a circuit employing A.V.C. and "squelch." Such a circuit is given in skeleton form in Figure 1, where an ordinary V.-M. valve, diode detector, first L.F. valve and "squelch" are shown, the circuit of the last-named valve being in heavy lines so that it can easily be recognised.

Two resistances, marked R.1 and R.2 are wired in series between the cathode and grid (through the tuning coil) of the diode detector, and the voltage drop across these is applied as grid bias to the V.-M. amplifier; the voltage is proportional to the intensity of the signal applied to the detector. That is the principle underlying ordinary A.V.C. The L.F. valve receives its signal input from the slider of R.1 in the usual way, through the small fixed condenser C.1 and the H.F. choke. That part of the circuit so far described is a normal and practicable automatic volume control arrangement, so we can now consider the part which is shown by heavy lines. The grid of the "squelch" valve is biased by the drop in voltage across the resistance marked R.2 and thus when the signal strength is greatest (producing the maximum voltage drop) it receives a substantial negative bias which limits its anode current to a negligible amount.

"SQUELCH"—WHAT DOES IT MEAN?

(Continued from page 640)

Under such conditions the "squelch" valve does absolutely nothing. When signal strength is low, however, the voltage drop across R.2 falls, so that the "squelch" valve has but a small negative bias. Due to this, its anode current increases in amount. Now the latter current is drawn through resistances R.4 and R.6, and as the current rises the voltage drop across these resistances becomes greater. But it can be seen that these resistances are in the grid circuit of the L.F. valve and the voltage drop produced by them is used to bias that valve. When the voltage drop is sufficiently high the valve is biased so heavily that its anode current is almost zero; the valve is then completely paralysed and fails to pass on any signals to the output stage and the loud-speaker.

The circuit of Figure 1 is useful for demonstrating the principle of the "squelch" action, but is not one which is likely to be used very extensively in practice, due to the fact that it necessitates the use of an additional valve to produce the noise suppression effect. An arrangement that is already in use in America, and will probably be adopted in this country in the event of automatic volume

control attaining a position of popularity, is exemplified by Figure 2. In this case a double-diode-triode valve serves the triple purpose of full-wave detector, automatic volume control, and "squelch." The latter valve has previously been described in PRACTICAL WIRELESS, so there is no need to repeat the details of it; it will suffice to say that it has two small anodes which, in conjunction with a portion of the cathode, serve the purpose of a full-wave rectifier, as well as a grid and main anode which also work along with the cathode as a three-electrode valve. Here, again the bias voltage for the V.-M. amplifier is obtained by the voltage drop across R.1 and R.2, whilst that for the grid of the double-diode-triode (acting as "squelch") is produced by the resistance marked R.1. By using a variable resistance in the position marked R.6, the point at which the "squelching" action takes place can be varied to suit any particular requirements.

The two circuits given are not by any means the only ones available, but serve as typical examples; modifications of them are numberless. Some readers might wish to try one of the arrangements described, and for their benefit very approximate values of components are given below the circuits themselves. It must be emphasized, however, that the figures are only approximate and will vary within fairly wide limits for various types of valves.

READERS' HALF-GUINEA WRINKLES

The Page

A Useful Tuning Dodge

HERE is an idea which may be of use to those amateurs who have a set with a small tuning dial. First of all a protractor (about 3 1/2 in. diameter) is procured. This protractor can be of either celluloid or metal. If a celluloid one is used the back surface must be roughened, and then a sheet of paper stuck on the back, and the whole glued on the panel so that it is concentric with the original dial. A hole must, of course, be cut at the centre of the protractor to allow for the condenser spindle. Then on the original dial, at the back, a pointer of black celluloid is fixed. In this way a

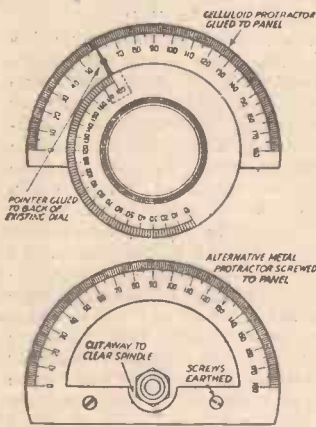

A useful tuning dodge whereby stations with similar wavelengths may be separated.

larger dial is obtained. If a metal protractor is used it must be screwed to the panel. To prevent distortion, however, this must be earthed, by connecting to the earthed vanes of the tuning condenser. Thus, if it is necessary to separate stations with similar wavelengths, this dodge is very useful, and stations can be logged with greater ease.—J. J. S. (Chesterfield).

A Radio-Gram. Fader

THE accompanying sketches show a combined radio-gram. fader for decreasing radio signals and switching in and

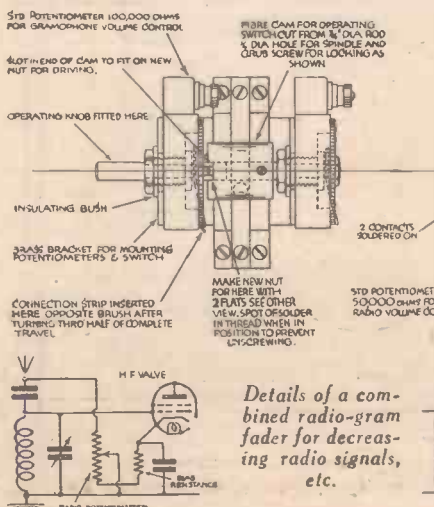

Details of a combined radio-gram fader for decreasing radio signals, etc.

THAT DODGE OF YOURS!

Every reader of "PRACTICAL WIRELESS" must have originated some little dodge which would interest other readers. Why not pass it on to us? We pay £1-10-0 for the best wrinkle submitted, and for every other item published on this page we will pay half-a-guinea. Turn that idea of yours to account by sending it in to us addressed to the Editor, "PRACTICAL WIRELESS," George Newnes, Ltd., 8-11, Southampton Street, Strand, W.C.2. Put your name and address on every item. Please note that every notion sent in must be original. Mark envelopes "Radio Wrinkles." Do NOT enclose Queries with your Wrinkle.

increasing gramophone signals, and vice versa, which I made up for my radio-gram. The drawings are self-explanatory, depicting two standard potentiometers ganged with an intermediate coupling cam for operating the switch. The first half a turn anti-clockwise decreases the radio signals when the gramophone switch is closed, and further turning increases gramophone signals. The connection on the gramophone potentiometer was made by releasing the resistance element and inserting copper ligament which clamped against the resistance on re-assembling.—O. C. LEADBITTER (Brondebury Park).

Making a Ribbed Former

REQUIRING a six-ribbed former on which to wind a long-wave coil, and being unable to obtain it immediately, the following dodge was successfully resorted to. A piece of paxlin or cardboard tube, about 1/4 in. smaller in diameter than the required former, was taken from the scrap-box, also a piece of 3/16 in. ebonite. Ribs were cut from the ebonite, and were stuck together with Chatterton's compound in order that the

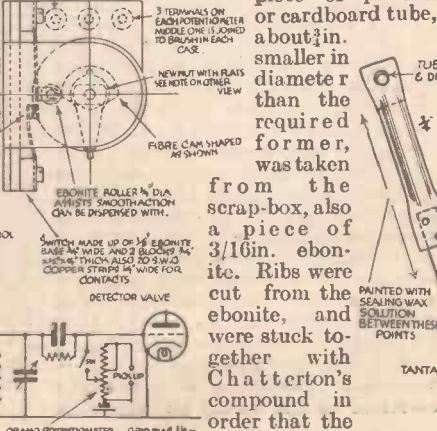

How to make a ribbed former.

slots for wire could be cut in all the ribs at one operation. They were then separated, the circumference of tube was divided into six equal parts, and the slotted ribs were stuck on with Chatterton's compound. The coil was then wound, and no trouble whatever was experienced.—L. W. BONES (Bexley Heath).

A Tantalum Charger

IN making a tantalum charger trouble is often experienced in making a good connection to the tantalum strip, as it cannot be soldered. Using the dodge shown in the accompanying sketch, I have had a charger in use for over two years without any trouble. The strips are 6 in. long by 1/4 in. wide and very thin. I obtained a 1/4 in. diameter lead pipe about 3 in. long, and flattened it out a little till I could push the tantalum strip in about 1/4 in. I then flattened the pipe again till it held the strip firm and drilled two small holes in both and riveted them together with two small lead rivets. After this a coating [of sealing-wax was put on, up to about 1/4 in. from the top of the lead tube; this can be put on with a brush, by dissolving some sealing-wax in methylated spirit. The accompanying sketches show the complete charger and circuit diagram of connections.—"ELECTRICUS" (Bradford).

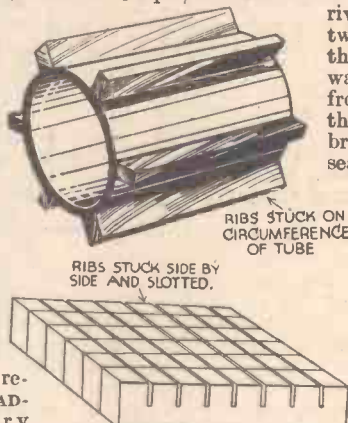

Converting a Short-Wave Coil

THE following notes explain how a commercial two-range short-wave coil was converted into a four-range coil having a considerably wider wavelength range. The coil was originally designed to cover from 19-50 m. when tuned by means of a .00013 mfd. condenser. The tuning condenser now used is a .00025 mfd, with a .0002 fixed condenser connected in series with it. By calculation it will be seen that the resultant capacity in the tuning circuit is about .00011 mfd.

(Continued overleaf)

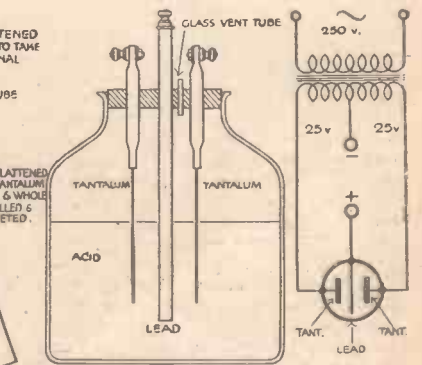

Making a tantalum charger.

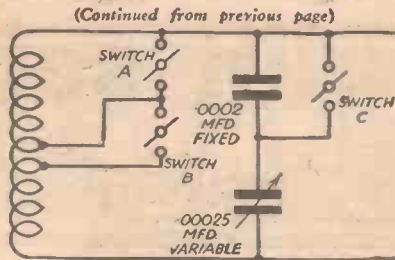

Converting a short-wave coil. Switches A—B closed, C open, range 14—24 m.; A closed, B and C open, range 19—30 m.; A, B and C open, range 28—50 m.; A and B open, C closed, range 50—100 m.

The grid coil had nine turns, five of which were shorted out to tune over the 19-30 m. band, thus leaving four turns in circuit. A tapping was taken one turn lower down the coil by seraping away the insulation for a length of about 1/4 in. and soldering the end of a piece of connecting wire along the bare portion. The other end of this connecting wire was taken to an additional push-pull switch, the effect of which is to short the extra turn, leaving three turns in circuit.

This was found sufficient to tune down to 14 m., and at the first attempt W2XAL was heard on the 16 m. band, and later LSL was well heard on the 14 m. band.

A third push-pull switch was then required to short-circuit the .0002 fixed condenser, and the coil could then be made to tune to approximately 100 m. It is thus possible to tune from 14-100 m. by the operation of three switches and without the inconvenience of coil changing. There must be a number of similar coils in use, the tuning ranges of which could be quite simply extended along these lines. The accompanying diagram should make the switching quite clear.

It should be noted that on the shorter ranges, i.e., up to 50 m. the tuning capacity used is .00011 mfd., which is sufficiently small to make tuning easy even on the lowest band, while above 50 m. tuning is quite easy with the .00025 mfd. capacity.

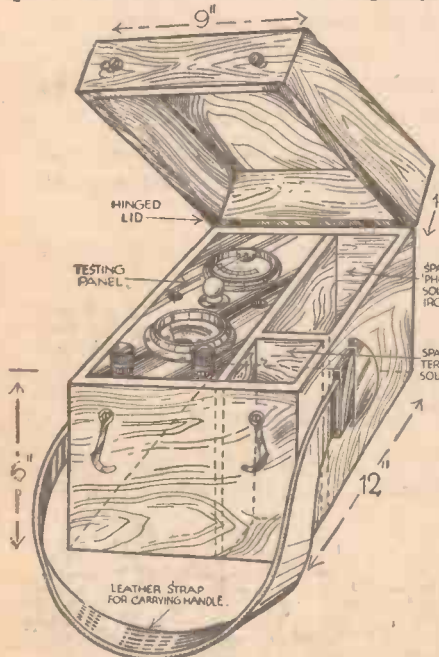

The finished testing set.

Inductive and capacitive couplings for the aerial may be experimented with to find which gives the best results over particular ranges, and it may be found that above about 50 m. an earth may be an advantage, whereas below that it can be dispensed with.

There may be some losses at the higher frequencies due to the additional switches and wiring, but this is compensated for by the convenience of the arrangement.—R. NYE (Southampton).

A Handy Testing Set

HAVING recently been called in to help my friends diagnose their wireless troubles it occurred to me that a testing set would be a very useful thing to possess. Not having the cash available to purchase any of the well-known testing outfits, I sorted out the "junk" box and discovered

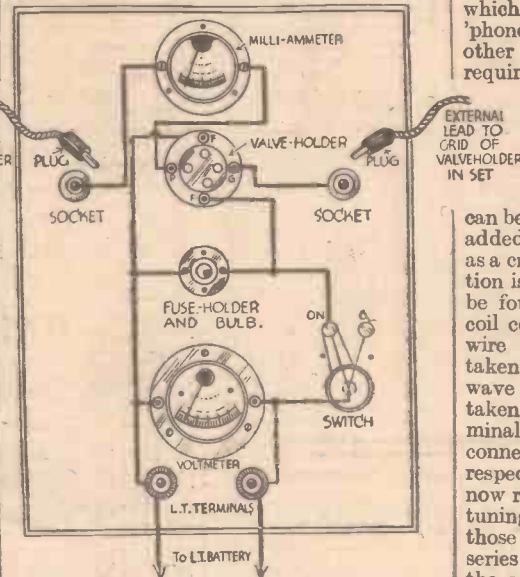

The wiring diagram of the testing set.

a panel-mounting 8-volt meter, valve-holder and switch arm with a few studs. I next obtained a second-hand 20 milliammeter and fuse-holder, together with a few terminals and plugs. Having an odd piece of ebonite I mounted the components on it and wired up as indicated above. The procedure for testing the set is to connect extra leads from the L.T. accumulators to terminals L.T.+ and -. Take out valve in set to be tested and plug in valve-holder on tester, plugging in grid and plate plugs in the set (allowing sufficient length of flex to reach inside set to existing valve-holder). By doing this you have simply transferred the valve to be tested to an external valve-holder. The reading of the voltmeter before the set is switched on can be taken, then by switching over the arm to the "on" position, the voltage drop of the accumulator can be noted; and this, in the absence of a hydrometer, serves as sufficient indication of the charge in the accumulator. The milliammeter gives an indication of the current consumption by the valve, whilst the fuse acts as a safeguard against any mistakes that may happen. Each valve in the set may be tested in turn by plugging-in the tester and replacing the grid and plate plugs in the correct positions. A variety of other uses can be found for the testing set, which has

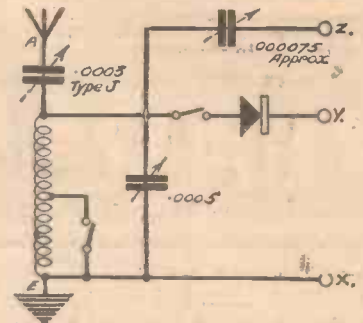

The circuit diagram of the stand-by unit.

certainly proved its worth as a fault-finder. The whole panel was mounted in a suitable box (as shown to the left) the box having a hinged top and two extra compartments, which are useful for carrying a set of 'phones, small soldering iron, terminals and other odds and ends which are so often required. A leather strap fixed to the sides serves as a carrying handle. —N. STRINGER (Wrenthorpe).

A Handy Stand-by Unit

THE accompanying diagrams give details of a handy unit which can be used either as a hand-pass tuner, to be added in front of existing tuning system, or as a crystal set in emergency. The construction is obvious, and most of the parts can be found in the average "junk box." The coil consists of 180 turns of No. 26 d.c.c. wire wound on a 3in. former. A tap is taken at fifty turns to cut off a medium-wave winding. The aerial and earth are taken off the set and attached to the terminals on the unit. Terminals X and Z are connected in the place of earth and aerial respectively. If the two tuning dials are now rotated and kept in step much sharper tuning is possible, giving results well above those obtained with wave-traps, simple series condensers, and so forth. Should the actual set fail, a pair of 'phones connected to X and Y give good stand-by reception and, finally, if one is experimenting with a particular tuning system, then on connecting X and Y to the input side of the L.F. transformer loud-speaker reception is possible.—J. F. EXCELL (Hampstead).

ORDER THEM NOW ! ! !
OUR SPECIAL SHOW ISSUES!
dated Aug. 19th and Aug. 26th.

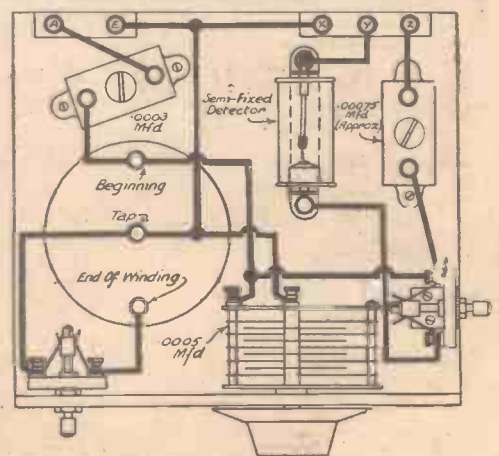

The wiring diagram of the stand-by unit.

"The finest speaker I ever heard" - - -

That's what everybody says about the

WHARFEDALE MOVING COIL SPEAKER

Even wireless dealers agree that the Wharfedale Speaker hasn't an equal at the price, and dealers are not given to throwing bouquets at manufacturers—they would sooner heave brickbats. The Wharfedale reproduces every note true to nature, from the highest treble to the deepest bass. The secret lies in the unusually massive magnet and generously-proportioned transformer. Dust protection of the vital air-gap is a refinement which guarantees consistent quality.

- BRONZE WHARFEDALE **39/6**
- POPULAR BLUE WHARFEDALE **32/6**
- DE LUXE GOLDEN WHARFEDALE **63/-**

The perfection of reproduction. All suitable for Class B and all usual output valves. (See what "Practical Wireless" says about the Wharfedale Speaker. Page 656)

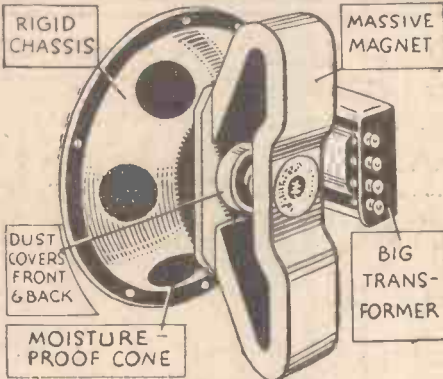

Send for Free Catalogue.

WHARFEDALE WIRELESS WORKS, 62, LEEDS RD., BRADFORD, YKS.

Please send Free Catalogue of Wharfedale Speakers. No obligation.

Name.....
Address.....
B.I.

GREAT UNKNOWNNS AT THE B.B.C.

by
Collie Knox

See

TIT-BITS

Now on Sale - - - 2d.

UNIVERSE



**1934
PICK-UP**

COMPLETE WITH
VOLUME CONTROL

11/6

RADIOLYMPIA
STAND No. 14
GRAND HALL

Ask your dealer for demonstration or write us direct for Catalogue.

The finest pick-up of its type yet produced. Fully guaranteed. Output is extraordinarily high. Special swivel head for easy needle changing. Impossible for pick-up head to get out of adjustment. Weight on record adjustable by compensator on end of arm. Smart brown bakelite.

COSMOCORD LTD. DEPT. P. CAMBRIDGE ARTERIAL RD., ENFIELD MIDDXX

for YOUR set



NEW IGRANIC CLASS-B DRIVER TRANSFORMER

Designed and produced after intensive technical research—so vital yet so frequently neglected—this new Igranitic class-B Driver Transformer is a masterpiece of scientific precision. Here are a few of its most notable advantages:

- High primary inductance, due to the use of a generous core, constructed on the well-known patented bi-metal principle.
- Low resistance windings prevent distortion of heavy peak currents.
- Fidelity of response obtained by accurate matching of windings.
- Maintenance of inductance on peak currents, ensuring accurate matching with the preceding valve.
- Two tappings are provided, giving two ratios (1 : 1 and 1.5 : 1), which permit many combinations of valves to be used. Price **11/6**

Write to-day for illustrated Catalogue No. J.1258 of Igranitic Quality Components.

IGRANIC ELECTRIC CO., LTD.,
149, Queen Victoria Street, E.C.4



Obtaining Filament Current from D.C. Mains

THE ultimate object of the national grid scheme is to supply the whole country with electric power in the form of alternating current. A supply has already been made available in many parts, and the change-over from existing direct current to alternating current supply is being carried out daily in other places. Probably at least thirty per cent. of the consumers of electricity in this country are still taking their supply from D.C. mains, and a considerable period must elapse before all existing D.C. supplies are replaced by A.C.

In the meantime, all mains sets and eliminators for A.C. working are naturally receiving most attention, while D.C. users are not so well catered for. High-tension battery eliminators for D.C. working are, of course, widely used, but complete D.C. units supplying H.T., L.T., and G.B. are decidedly in the minority. The reason for this is that there are certain obstacles to the use of D.C. mains for supplying low-tension current. The chief of these are the waste of current entailed in reducing the voltage of the mains to that required by the valves, the fact that each of the valves in the receiver must have the same current consumption, and the difficulty of producing standard D.C. units owing to the differing D.C. supply voltages in various parts of the country.

Reduction of Mains Voltage.

In the case of alternating current, a reduction of the mains voltage to that required for the L.T. supply to the valves is brought about by the simple and economical method of transferring to the lower voltage, but in dealing with direct current the mains voltage has to be reduced by absorbing or dissipating it by means of series resistance, during which process the current absorbed is lost, so far as serving any useful purpose is concerned.

This wastage of current is shown by considering, for instance, the case of a valve the filament of which is rated at 0.2 amp. at 4 volts. If the filament supply for this valve is drawn from an accumulator, it would consume 0.8 watt. If, instead, it

In this Article the Author Explains how Battery Sets can be Converted to Mains Operation

By G. H. WRAY, F.C.S.

is desired to heat this filament from 220 volt D.C. supply mains, 0.2 amp. at 220

The smoothing chokes should have a fairly high inductance and be capable of carrying the filament current (in this case 0.1 amp.) without overheating. The resistance should be of the heavy duty wire wound type, with the necessary current-carrying capacity. The mains plug should always be inserted in the same position in its socket, otherwise the polarity of the circuit will be reversed. The isolation of the mains from earth is an important point, and it is, therefore, essential that the 2 mfd. condenser shown connected between the negative side and earth should be incorporated.

Power Valve Requirements

Connected in the manner shown, the arrangement is only suitable for small sets, because the output valve being only of a small type will have a limited output. In order to overcome this, the circuit arrangement may be modified by connecting the filaments of the valves in series—parallel as shown in Fig. 2. The filaments of the first two valves are connected in parallel, and then carried in series with the output valve. For this arrangement, the filament current consumption of each of the first two valves must be exactly half that of the power valve, and suitable valves must be used accordingly. For instance, if the power valve takes 0.2 amp., then the other two valves should each take 0.1 amp. The power valve may be of either the 2, 4, or 6 volt type, but the two first valves must be of the same voltage rating. The current flowing in the circuit in Fig. 2 would be 0.2 amp., and the smoothing chokes and voltage resistance would require to be of twice the current-carrying capacity to those required for the circuit shown in Fig. 1.

Indirectly Heated Valves

Indirectly heated cathode valves, in various types, for D.C. mains operation, are now available, and if 220 V. MAINS it is proposed to purchase.

(Continued on page 658)

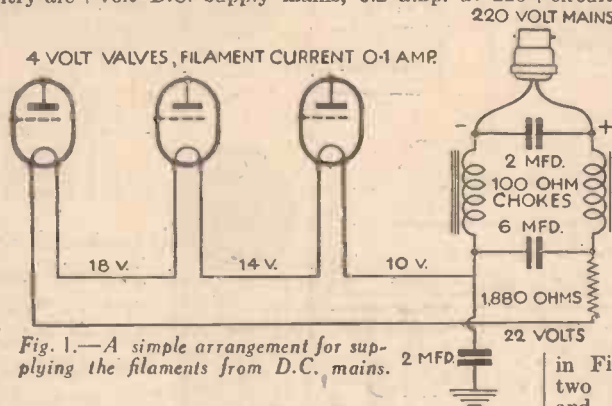

Fig. 1.—A simple arrangement for supplying the filaments from D.C. mains.

volts = 44 watts, must be taken from the mains for this purpose. Of this 44 watts 0.8 watt would be actually consumed by the filament, and the other 43.2 watts would be dissipated by the resistance.

In spite of the fact that obtaining a low-tension supply from D.C. mains is not in the best interests of economy, there are doubtless many readers on D.C. mains who may consider that the attendant disadvantages are easily outweighed by those associated with the charging and maintenance of L.T. accumulators. The conversion may be carried out with little difficulty, or expense, utilizing the existing valves in the set, provided that each of these have the same filament current consumption.

Fig. 1 shows the circuit arrangement for use with ordinary valves, the voltages at different points of the circuit being indicated on the diagram. When the circuit is connected up, volt-meter readings should be taken at these points to ensure that the voltage applied to the filaments is correct. It is important, of course, that the voltage rating of the valves should not be exceeded, and that the maker's instructions be adhered to.

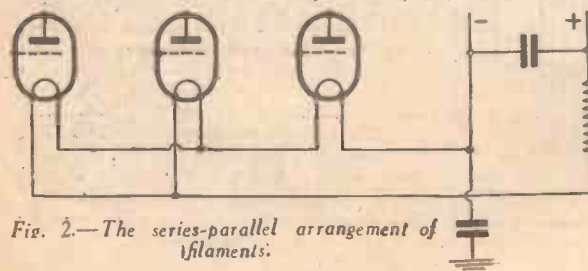

Fig. 2.—The series-parallel arrangement of filaments.

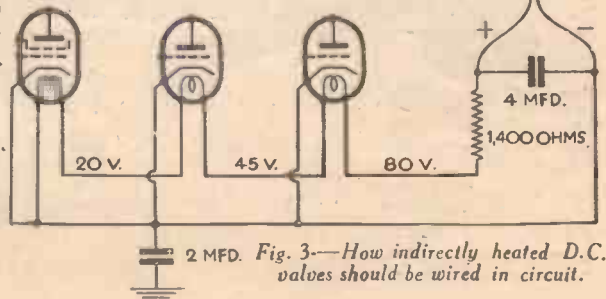

Fig. 3.—How indirectly heated D.C. valves should be wired in circuit.

These DECIBELS

WHAT DO THEY MEAN ?

Interesting Facts About the Measurement of Sound Intensity. The Decibel is not a Unit but a Logarithmic Ratio

By H. Beat Heavychurch

If you have been studying radio manufacturers' catalogues recently, or have read some of the more advanced articles in technical books and journals, you will certainly have come across the term "decibel" and have probably wondered exactly what a decibel is. As the term refers to a comparatively new system of measurement, which will undoubtedly be used more and more as time goes on, I propose to tell you as much as I can about decibels without involving you in abstruse mathematical explanations.

You know, of course, that there are two ways in which two things can be compared. You can say, for example, "This amplifier gives a greater output than that one." Or you can measure the outputs exactly and say "This amplifier gives an output of 2 watts, and the other an output of 1 watt. Therefore, the first amplifier gives twice the output of the second."

Comparisons

It is clear that the second, or "quantitative" method of comparison is the more accurate, and gives a better idea of the respective merits of the two amplifiers. In comparing most things in everyday life, such a method is perfectly satisfactory. Weights, distances, amounts of money, areas, in fact almost everything which is capable of measurement can be expressed in terms of suitable units—pounds, feet, shillings, acres and so forth, and two quantities of the same order, say two areas or two speeds, can be compared by saying the one is so many times greater than the other.

Unfortunately for us radio engineers and radio listeners, however, this simple method of comparison is not quite so satisfactory when we come to compare the performances of equipments which produce sounds. We can certainly say that the electrical power of one apparatus is, say, twice that of another, but that does not tell us very much about the amount of sound the two pieces of apparatus are capable of producing. The reason is that the amount of sound produced by a loud-speaker, although depending upon the amount of power put into it, is not strictly proportional to that power. By amount of sound, I mean, of course, the intensity of sound as heard by the ear.

For example, if you improved your wireless receiver so that it gave half as much output again as it does now, in the majority of cases you would not notice the difference in volume, and even doubling the power would have only just a noticeable effect upon the performance of your loud-speaker. Four times the output would approximately double the volume, and so on.

A Sensitive Ear ?

This apparently curious and irregular relationship between power and volume is explained by the fact that our ears are not equally sensitive to all intensities of sound. They are very sensitive to weak sounds, small changes in intensity being easily detected; but at strong sound intensities they are comparatively insensitive, quite big changes in stimulus being required to make any appreciable difference in apparent volume. This is really a very good thing for us, because the actual amount of energy corresponding to what we call loud noises is extremely large, and, if our ears were as sensitive to them as they are to small sounds, many modern noises would seriously harm the delicate mechanism of the ear, and would probably deafen us for life.

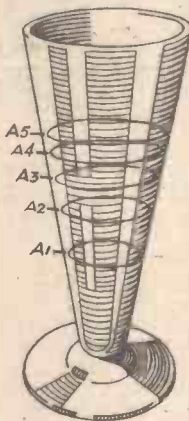

A conical jar illustrates the principle of the decibel.

Having read so far, you may be thinking that all this has little to do with decibels. But it has, and because it is so important that you should have a clear idea of this relationship between sound energy and sound volume, I am going to "infect" another analogy on you. In the diagram reproduced as Fig. 1 is depicted a vessel—a jar, or something of the sort, which is very slender at the bottom, and becomes much wider at the top. Suppose we pour a pint of water into this jar. It will reach a fair way up, because the jar is narrow—say to the point A1. Now pour a second pint in. The jar is getting wider above A1, and the second pint will not raise the level quite so much; perhaps only to point A2. Similarly, the third, fourth and successive pints will cause smaller and smaller gains in level, as at A3, A4, A5 and so on. Now try to think of the pints of water as being equivalent to quantities of electrical power delivered by an amplifier to a loud-speaker, and let the level of the water in the jar represent the volume of sound produced by the speaker, and you have a very good parallel. Small increases in power at low input give comparatively large gains in volume, but at greater power

a similar increase of input produces a much smaller gain in volume.

Power Ratio Expression

It is in order to express power ratios in a form which will represent fairly accurately their effect in terms of sound volume that the decibel system has been developed; and the decibel system works in this way: Although power and sound volume do not vary in simple proportion, they do bear a certain relationship, and experiment has proved that the gain in sound volume is proportional to what is known as the logarithm of the power ratio. I am not going to weary you with a long explanation of what a logarithm is, but I must tell you that the logarithm of a number is a second number which bears a special relationship with the first. There is more than one system of logarithms, but that usually employed, and used for the basis of the decibel system, is known as the "common" system. In this system, the logarithm of 10 is 1; of 100 is 2; of 1,000 is 3, and so on. In the decibel system, a tenfold increase of power is said to be a gain of 1 bel (named after Graham Bell, the inventor of the telephone).

But in radio engineering we seldom have to deal with increases in power amounting to 100 or 1,000 times, so the bel is a rather large unit to employ. It has therefore been subdivided into ten parts, called decibels, and gains or losses in radio and telephone practice are commonly expressed in decibels. The splitting up of the bel into decibels follows the same plan as the development of the bel scale. This means that increasing the power by a quarter corresponds to a gain of about 1 decibel; increasing it by one half means a gain of just under 2 decibels. Doubling the power gives a gain of 3 decibels; triple power means a gain of about 5 decibels; quadrupling the power is a gain of 6 decibels, and eight times the power gives a gain of 9 decibels. Ten times the power we have already seen means 10 decibels, or 1 bel.

Trained Ears

You will next want to know in what way decibels are related to the actual audible effects of power gain. Well, unless you are a specially trained listener—a post office telephone engineer or a very experienced musician, a gain of less than about 3 decibels will not be noticed by your ear. Experienced observers, of course, have so trained their hearing that they can distinguish between sounds which differ by much less than 3 decibels. As small a gain as $1\frac{1}{2}$ decibel, or even 1 decibel can be detected by a specially trained ear.

Another fact which may help you to

(Continued on page 660)

OLYMPIA SECRETS

WHAT WILL BE SEEN—

Components and

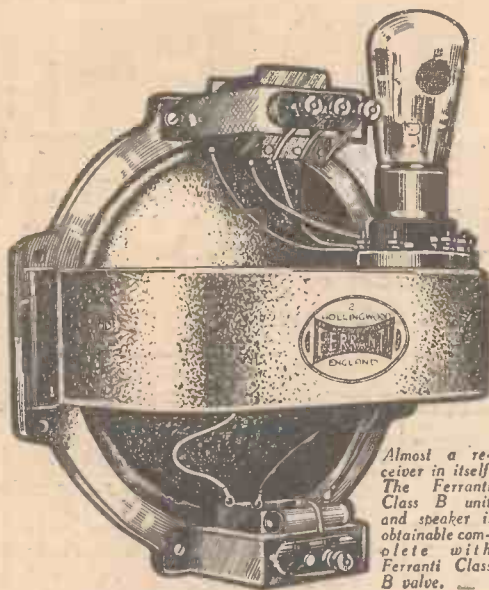

Almost a receiver in itself. The Ferranti Class B unit and speaker is obtainable complete with Ferranti Class B valve.

THERE are still several more days to go before the great Radio Exhibition opens at Olympia, and no doubt many are speculating regarding the form many exhibits will take. On the other hand, it is highly probable that many imagine that the Exhibition will be just a glorified shop window containing many goods which can already be seen in any good radio store. This is far from the truth, however, and we can reveal in this article some of the secrets which await you, and which will make this Exhibition even more interesting than those which have preceded it. The Exhibition naturally divides itself into two sections—complete receivers (either entirely radio, or combined radio gramophones), and component parts.

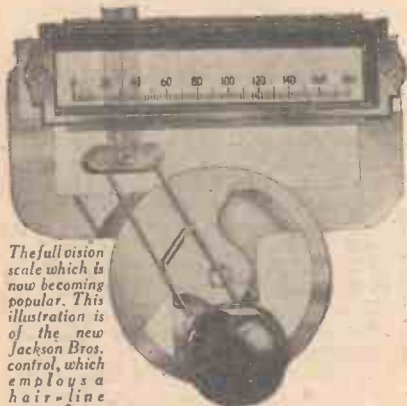

The full vision scale which is now becoming popular. This illustration is of the new Jackson Bros. control, which employs a hair-line cursor fitting close up to the scale and so avoids errors in fine readings.



A very efficient ganged condenser assembly with slow-motion dial. This is only one of the new Utility products.

New Receiver Design

Dealing first with the complete apparatus, undoubtedly the biggest feature which is entirely new this year, is the battery radio-gramophone. This is a complete radio and gramophone apparatus, with moving-coil loud-speaker, clockwork motor, pick-up, etc., capable of delivering sufficient volume for a small hall. Actually, the output reaches the order of 2 watts, and this is entirely due to the recently introduced Class B valve. Upkeep costs are very low, and from



A new Telsens receiver of interesting design.

- BREVET**
- Multitone complete Class B adaptor.
 - Igranic iron-core tuning coils.
 - Radio Instruments pre-set permeability tuning.
 - Ferranti Class B unit and speaker combination.
 - Jackson Bros. full-vision scale with travelling light.
 - Sonochorde Midget loud-speakers.
 - British Radiophone two-gang short-wave condenser.
 - G.E.C. Home-broadcaster.
 - Belling-Lee disturbance suppressor.
 - Lamplugh interference eliminator, and aerial unit.
 - W. B. Microlode, automatic matching loud-speaker.
 - Ferranti heptode valve.
 - Cossor double diode pentode.

the performance point of view it is practically impossible to distinguish whether the apparatus is of the mains type or not. Any fears which you may entertain regarding the cost must quickly be dispelled, for it is possible to purchase one of these radio-gramophones, absolutely complete, for round about £20. For the listener who must be absolutely up to date, and to whom television has as great an appeal as ordinary broadcasting, the Bush Radio Company's exhibit will come as a great surprise. Here will be seen a complete sound and vision receiver, somewhat similar in appearance to an ordinary grandfather clock. At the top, at a suitable level for comfortable viewing, is a large viewing screen, and below it the loud-speaker grille. The controls are comfortably situated near the centre. The television apparatus is of the mirror-drum type, enabling pictures to be seen with ease in an ordinary lighted room. And, finally, it is designed and finished in a style which may conveniently be matched to any furnishing scheme. It does not look like a piece of scientific, or laboratory apparatus.

Whilst on the subject of television we can reveal that an entirely new system of vision reception will be introduced, and unlike many new pieces

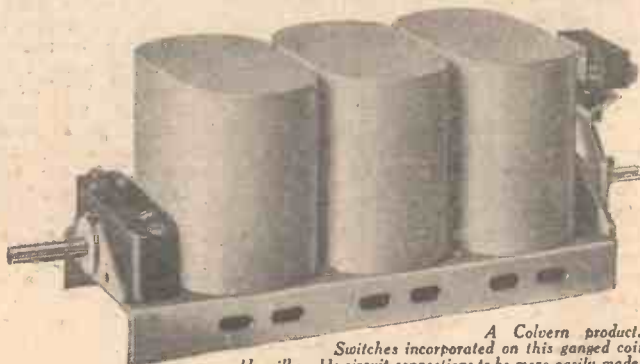

A Colvern product. Switches incorporated on this ganged coil assembly will enable circuit connections to be more easily made.



A new iron-core tuning coil by Telsens.

SETS REVEALED



Sets of Outstanding Interest

TIES

- Varley permeability tuning.
- Varley dust-core H.F. choke.
- Columbia battery-operated 2 watt radio-gramophone.
- Columbia new type pick-up with hum-bucking coil.
- British Radiophone new pattern ganged condensers.
- British Radiophone full-vision scales.
- British Rola Class B speaker unit.
- Bush Radio complete television and sound receiver.
- Colvern complete range of iron-core tuning coils.
- Lisaen iron-core tuning coils.
- Varley iron-core tuning coils.
- Wearite iron-core tuning coils.

of apparatus which appear from time to time, this receiver will be offered to the public in the form of a home-constructor's kit of parts. The system is based on an entirely new idea and the greatest claims have been made for it. When we tell you that the name of the firm who are introducing this kit is Messrs. Ferranti, you will appreciate that there must be some importance attached to the arrangement, and we must look forward to Olympia with interest, even if from this point of view alone.

Components

Almost naturally, the home constructor is concerned more with the new components which will be ob-

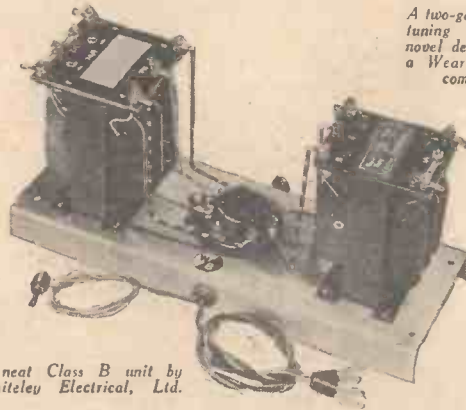

A neat Class B unit by Whiteley Electrical, Ltd.

tainable, than complete receivers, and therefore he wishes to know how his receiver may be modernized, or what new type of receiver he will be able to build next season. We can state now that the majority of the firms which manufacture variable condensers have redesigned their entire stocks, and the variable condenser will appear in some interesting new patterns. Messrs. British Radiophone, for instance, will be seen to have re-shaped their well-known ganged-condenser, and this is now obtainable with the trimming adjustments at the top—a much more convenient position. The well-known Polar condensers will also be seen to have undergone a change in shape. Practically every firm in this category—and that includes such names as Polar,

(Continued on page 655.)



The new W/B Micro-lode loud-speaker. The ingenious switching device—by which any valve may be matched—may be clearly seen.

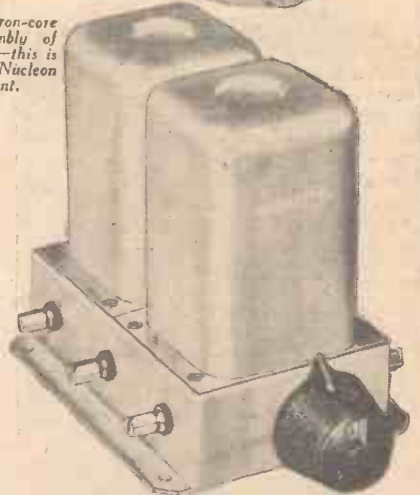

A two-gang iron-core tuning assembly of novel design—this is a Wearite Nucleon component.



The new Bush-Baird Television receiver, complete with sound apparatus.

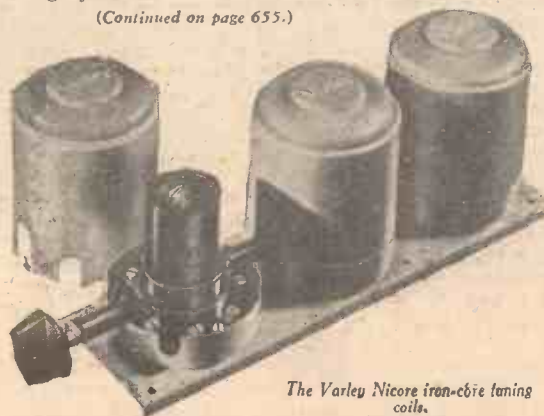

The Varley Nicore iron-core tuning coils.



A Battery Radiogram. This Columbia model incorporates a Q.P.P. output circuit, and a double-spring motor.

OUR VIEWS ON RECEIVERS

QUITE apart from the fact that the Cossor 3456 employs Class B Amplification, it is in many ways unique, as it has the volume of a mains set, the appearance of a small Superhet, and is priced at a low figure out of all proportion to its apparent worth. The outstanding merit of this little giant will be readily appreciated if its internal construction is brought into the limelight. The chassis is entirely made of heavy-gauge pressed iron finished with gun-metal, which gives it a remarkably imposing appearance.

Starting at the logical beginning it would be true to say that the aerial coil is entirely conventional, if it were not for the fact that it employs a Midget H.F. choke in the aerial to prevent the possibility of breakthrough on the long waves. The screened-grid valve is the new short-base Variable-mu valve, the Cossor 220 VS, which has a higher impedance than is customary, but the coil used and the high slope that the valve possesses results in a stage gain considerably in excess of that met with in the average receiver. Both the screen and anode of this valve are decoupled, like every other valve in the set other than the Class B valve itself. It is probably true to say that the outstanding feature of the theoretical circuit is the completeness of the decoupling used.

The H.F. coupling is an auto-transformer, a refinement being provided in the form of twin reaction coils for long and short waves. The detector is the Cossor 210 H.L., which, like the screened-grid valve, is not of the metallized type, which is perhaps rather surprising, although the stability of the set is all that could be desired. The detector valve is coupled to the driver valve, which is a Cossor 215 P, and this in turn is coupled to the output valve, which is the Cossor Class B valve, Type 220 B. The Class B anodes feed directly into the primary of the special output transformer, this being built on to the Permanent Magnet moving-coil speaker itself; following the customary practice a condenser is connected across each half of the primary. The controls consist of a ganged condenser driven by a single knob, but provided with trimmer, reaction control, and combined volume and on-off switch, in addition to which there is the wave-change switch, offering a choice of 900 to 2,000 metres and 200 to 530 metres. This switch is delightfully easy to operate, requiring only the slightest pressure.

The reaction control is too familiar to need further comment, while the volume control varies the bias on the variable-mu valve in the conventional manner. To turn off the receiver this latter control is rotated as far as it will go in a counter clockwise direction when a click announces beyond all doubt that the set is switched off.

The number of stations received was decidedly above the average, an advantage which might easily be accounted for by the great care bestowed on the design of the

THE COSSOR CLASS B BATTERY RECEIVER Type 3456

high frequency circuit. Selectivity was also well up to the standard of a straight battery set. Some idea may be gained from the following examples, on an aerial approximately 45 feet long including down-lead, situated at 22 miles from Brookmans Park on the outskirts of South London.



The new Cossor 3456 receiver, which is fitted with a Class B stage and M.C. speaker.

Starting with the long waves there was no difficulty in separating Radio Paris from 5XX, and were it not for a murmur in the loud-speaker it would be possible to find a quiet spot in between them. Eiffel Tower was also received without difficulty, a station that is usually much troubled by its neighbour. On the short waves Langenberg could be received clear of Northern Regional, London could be received clear of Barcelona, and Fécamp could be received quite clear of the short-wave Brookmans Park station.

It is interesting to note that this receiver goes well down to the bottom of the short-wave scale. An unidentified station came in at 7 degrees, which proved to have a wave-length of 209 metres when checked with a heterodyne wave-meter.

Interesting as the selectivity and sensi-

tivity of this set must prove to the reader specially concerned, there is no doubt that our comments on the quality of reproduction will be of more universal interest in view of the fact that this is the first commercial Class B receiver to be reviewed in PRACTICAL WIRELESS.

The volume and quality obtained on the local station made it impossible to believe that it was a battery receiver consuming less H.T. current than the ordinary standard 3-valve set. The actual output was considerably more than a watt, and the quality in every respect above reproach. In particular there was no sign of a jagged edge on piano notes, which is very noticeable when using Class B output that is working under incorrect conditions. There was plenty of bass and plenty of the higher treble, and the whole musical scale was balanced in a masterly fashion.

The H.T. consumption of the set will naturally vary on the station received, owing to the adjustment of the variable-mu bias. The quiescent current when the set was adjusted for the local station was 6.5 milliamps, and when adjusted for Radio Paris it was approximately 8.5. The average current is naturally the figure which will affect the listener's purse, and this was measured with a considerable degree of accuracy over an extended period on the London station with the receiver so adjusted that it would give the maximum output of well over a watt, and found to be under 10 milliamps, which is truly remarkable when it is remembered that without Class B the consumption for the same output could not be less than 29 milliamps.

The general appearance of the set may be seen from the accompanying illustration. The entire Console instrument stands 35 inches from the ground, is 14 inches wide and 11 inches deep.

The wood appears to be walnut, of pleasing selection, polished with a slightly dulled finish, which is distinctly refreshing after the tawdry appearance imparted to many receivers by spread-on varnish. The set is provided with such refinements as gramophone pick-up jack, fuse, multivay lead, etc., and is modestly priced at the remarkably low figure of £19 19s.

The Cossor New Season Programme

In addition to the Cossor Receiver reviewed on this page there are two other new sets which are to be supplied in "Kit" form for home assembly. Both are supplied complete with the new and popular type of cabinet in which the loud-speaker opening is beside, instead of above, the control panel. The cheaper model is to sell at the attractive price of £6 7s. 6d., and has a balanced armature speaker movement; the slightly more expensive one costs £7 2s. 6d., and is provided with a speaker of the moving-coil type. In both kits the receiver itself is the same and comprises three valves arranged as variable-mu screened grid amplifier, detector and pentode output. Single dial tuning is employed and operation of the receiver is further simplified by combining the volume control and on-off switch. The whole receiver is assembled on a rigid gun-finished all-metal chassis, so giving a distinctly "professional" finish.

This latest kit set will be known as the "1934 Cossor Melody Maker," and there is no doubt that it will prove a worthy successor to the now long range of "Melody Makers," the first of which was produced in 1927.

The BEGINNER'S SUPPLEMENT

Conducted by F.J. CAMM

THE EASY ROAD TO RADIO



Resistance-capacity Coupling

A method of coupling two valves together by means of a resistance and a condenser. See *COUPLING*.

Resonance

Two pieces of apparatus are said to be in resonance when they vibrate in unison. The vibrations may be mechanical, electrical, etc.

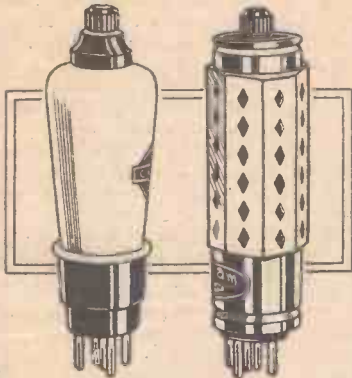

Fig. 1.—Two examples of screen-grid valves. One of the distinguishing features of this type of valve is the terminal connection at the top.

Rheostat

A variable resistance.

Screen-Grid Valve

A type of valve specially designed to secure low capacity between the grid and anode, and therefore particularly suited as a high-frequency amplifier. This low inter-electrode capacity is obtained by employing an extra grid known as the *screening grid*, which is placed between the ordinary grid, or *control grid* as it is called, and the anode. There are thus four electrodes in a screen-grid valve—filament, grid, screening grid, and anode. In the case of a mains S.G. valve there would, of course, be a fifth—the cathode.

The connection to the screening grid of an S.G. valve is taken to the pin in the base which corresponds to the anode pin in the ordinary type of valve, while the anode is connected to a special terminal on the top of the valve. See *VALVE* and *INTER-ELECTRODE CAPACITY*.

Screening

An arrangement for preventing one circuit in a wireless set from affecting another. To appreciate the need for screening one must understand how alternating electric currents set up electro-magnetic fields around the wire or piece of apparatus through which

THE BEGINNER'S A B C OF WIRELESS TERMS

(Continued from July 29th issue, page 628.)

they are flowing. This means that other apparatus nearby may be influenced by the current flowing in the first. In fact, electric currents may be induced in the latter, although it may have no material connection with the first circuit. Sometimes this *coupling*, as it is called, is purposely arranged (See *COUPLING*), but on the other hand, it is often not desired, and may have very deleterious effects, such as causing the receiver to howl. It is then that screening is resorted to. This often consists of enclosing the parts to be screened in a metal box, as in the case of screened tuning coils and condensers; or, again, in certain cases a simple metal sheet placed between the two components may suffice. Fig. 2. shows where a screen might be placed between two coils to reduce interaction between them. The lines of force shown in the diagram, due to a current through one of the coils, are depicted in the positions they would occupy if the screen were not in position. You will notice how they spread out and reach the other coil.

Secondary Winding

The winding or coil of wire in a transformer from which the transformed power is obtained. The input is fed to the primary winding and the output is taken from the secondary winding. See *TRANSFORMER*.

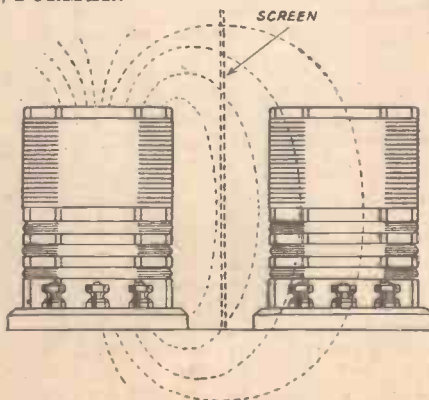

Fig. 2.—How a coil may set up currents in another by reason of the field surrounding it. A screen would help to prevent this.

Selectivity

The ability to receive or select certain frequencies to the exclusion of all others. A set which is selective is one which will only receive the station to which it is tuned. With a receiver lacking selectivity two or more stations may often be heard at the same time, although they are each transmitting on different wavelengths.

Self-Capacity

The capacity existing between various

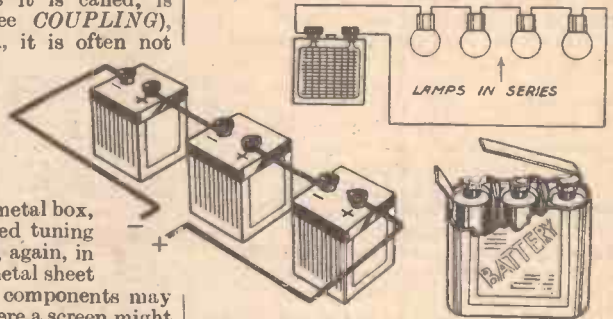

Fig. 3.—Diagram illustrating series connections of lamps and batteries.

parts of the same component or piece of apparatus. The self-capacity of a tuning coil is the total capacity existing between the various turns of wire. Each turn, separated as it is by insulation from the next turn, forms a small condenser. This effect is greatly increased if the turns are very close together and is most marked in pile-wound coils where the wire is jumbled one turn over the other. Large self-capacity in a coil or choke is not a desirable feature, as it decreases its efficiency. Self-capacity in a valve (known as inter-electrode capacity) is also deleterious to its performance if it is other than the very smallest figure.

Series Connections

When a number of lamps, cells, resistances, or other apparatus are joined together in the form of a chain so that the current flows through each in turn, they are said to be connected in series. Examples are given in Fig. 3. Another way of connecting them is so that the total current is divided between them. This is called *parallel connection*, while a combination of the two methods is called *series-parallel*. See also *PARALLEL CONNECTIONS*.

Short-Circuit

A circuit which has negligible resistance. As an example, a piece of thick copper

(Continued overleaf)

(Continued from previous page)

wire connected directly across the terminals of an H.T. battery or an accumulator would constitute a short-circuit. The wire would offer very little resistance so that a huge current would flow until the battery was discharged. In the case of the accumulator this would most likely cause buckling of the plates and ruin it.

Connecting a piece of wire across the terminals of any component in a wireless set would short-circuit that component, for instead of the current passing through the coil, transformer, resistance, or whatever it was that was "shorted," it would travel instead through the easier path offered by the piece of wire.

Short-circuiting a component may be carried out intentionally when testing a receiver. On the other hand, accidental short-circuits caused through careless wiring or rough handling of the set are often the cause of its failure to work. A careful look over the whole receiver will often disclose the fault right away. It may be such a small thing as a strand of frayed wire bridging the gap between two terminals.

Short Waves

Wireless waves between 10 and 50 metres.

Side-Bands

The wireless waves given out by a broadcasting station are not restricted to just one frequency or wavelength, but extend over several adjacent frequencies. To receive a faithful reproduction of the music or speech being sent out the receiving set must pick up the whole of this band of frequencies. This means that the receiver must not be too sharply tuned or the *side-bands* will not be received. This is called *side-band cut-off*, and is characterized chiefly by a loss of the higher notes of the speech or music being received.

Soft Valve

A valve from which not quite all the air or gas has been exhausted. Soft valves make excellent detectors, but are not manufactured now as they are unreliable in performance.

Spreader

The cross piece used to separate the wires of a multi-wire aerial.

Super-Heterodyne Receiver

One using a special circuit in which the high-frequency current of the received signal is converted into a lower frequency before being amplified and detected. It is remarkable for the high degree of selectivity obtainable.

Telephone

Primarily this is a device for talking over long distances, but the term is also used in a limited sense to mean the receiver or ear-piece only. A section of the earpiece of a wireless headphone is shown in Fig. 4. The current from the re-

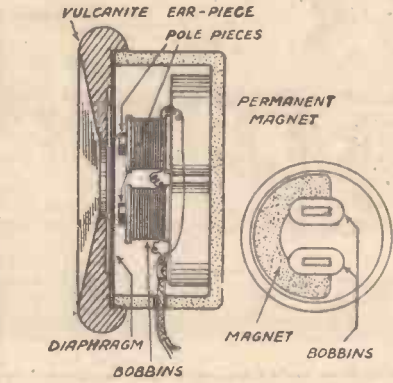

Fig. 4.—Section and plan of telephone ear-piece.

ceiving set passes through the two little bobbins of fine wire which are wound round the poles of a permanent magnet. Each fluctuation in the current strengthens or weakens the force of the magnet so that its attraction for the iron diaphragm varies accordingly. In this way the diaphragm vibrates backwards and forwards and creates sound waves.

Thermal Delay Switch

A double switch, the second switch in which does not come into operation until some seconds after the first one has been

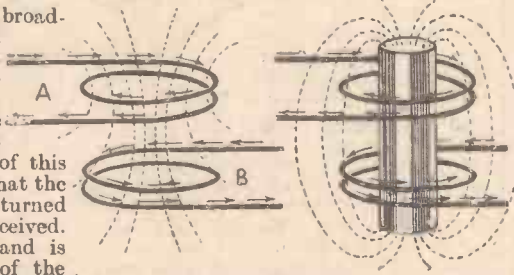

Fig. 5.—Diagram illustrating the principle of the transformer.

closed. It is used on mains sets. The second switch is closed by the heating action of the current passing through the first one. When the temperature reaches a certain figure the second switch is operated.

Three-Electrode Valve

The ordinary type of valve containing three electrodes, namely: filament, grid, and plate or anode.

Tone-Control

A device fitted to a receiver enabling the tone to be varied to suit the subject

being received, or to compensate for acoustical defects in the receiver itself or in the room in which it is situated. Tone controls usually consist of some arrangement of condensers and resistances connected in the set. By varying the resistance the response to the higher, medium, or lower notes of the scale may be controlled.

Transformer

A device for changing the voltage of an alternating current. It consists essentially of two coils of wire. A current of a certain voltage passed through one coil will cause a current to flow in the other coil if the ends of the latter are joined together. Fig. 5 shows how this happens. A current passing first one way and then the other through coil "A" causes magnetic lines of force to continually spread out and then collapse around the coil. These lines of force cutting coil "B" cause a current to flow in it also. The voltage of the current in "B" depends on the ratio of the turns in the two coils. If "A" has most turns, then the voltage of the current in "B" will be less than that at "A," but if "B" has more turns than "A" then the transformed voltage will be higher. It is said to be "stepped up." As an example, if "A" has 100 turns and "B" 200 turns, then the voltage produced by "B" will be twice that of "A."

For high-frequency currents this type of transformer is fairly efficient, but for low-frequency currents the transformer must have an iron or iron-alloy core. The diagram on the right in Fig. 5 shows a simple core. It will be noticed that it concentrates the lines of force. They prefer to travel through iron as it offers less resistance than air, and by placing it between the two coils all the lines of force cut the second coil instead of spreading out.

In practice an even more efficient arrangement is employed. The core is made to surround the coils. Fig 6 gives details of how a wireless low-frequency transformer is constructed. Here the two coils, which, incidentally, are known as the *primary winding* and the *secondary winding*, are wound one over the other. They are, of course, separated by a layer of insulation and insulated wire is used.

For certain types of circuit the primary and secondary are provided with a tapping at the electrical centre. In one or two cases the actual primary or secondary windings are divided into two sections so that the valves may be operated independently. The principal use of this type of transformer is, of course, for push-pull working, where a single primary winding is included in the anode circuit of an L.F. or detector valve, and the secondary feeds two separate valves. The ends of the secondary winding are in this case joined to the grids, whilst the centre is joined to grid bias or earth. For the supply of mains voltages, a special type of transformer is employed having one primary, but many secondaries.

See also **AUDIO-FREQUENCY TRANSFORMER**, and **PRIMARY WINDING**.

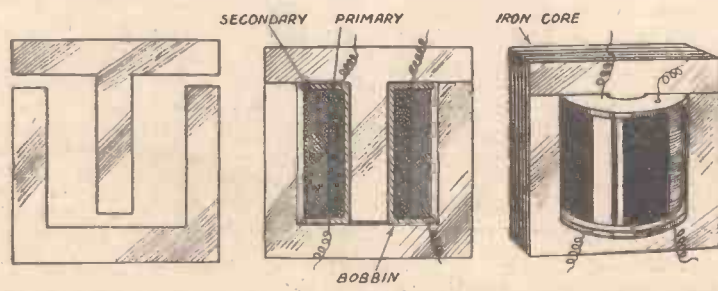

Fig. 6.—Details of an L.F. transformer. (Left) Stampings for the iron core. (Centre) Section through the windings. (Right) The instrument complete, except for the case and terminals.



A Review of the Many New Valves that have Recently Been Introduced

By FRANK PRESTON, F.R.A.

NEVER before have there been so many types of valve available to the set designer and home constructor. For every stage of a receiver there is a wide choice of types suitable for practically every conceivable circuit requirement. Peculiarly enough, the majority of the "special" valves have been introduced during the past few months, and in consequence many of them are still unknown to the amateur set builder.

Class B

It would be somewhat difficult to single out any one valve that has come into use during recent months and say that it was the most important, but I think there is very little doubt in regard to the valve which has become most popular. Since the Class B valve was first placed on the market a few months ago, thousands of amplifiers must have been made to incorporate it. This is not surprising in view of the fact that this valve, driven by a very modest supply of battery current, is easily capable of providing as much loud-speaker volume as a medium-sized A.C. mains valve consuming about six times as much electrical energy. Maximum output is not the only noteworthy feature of the Class B valve, however, and equal prominence should be accorded to the fact that it gives a practically undistorted output when used in very simple circuit arrangement. The Class B valve is, in effect, two valves in one, since it has two each of the usual three electrodes—filament, grid and anode. These are arranged in two pairs as has already been shown. The first Class B valves to be made were designed to give a signal output of 2 watts (compare this with the average figure of 200 milliwatts for the average battery-driven small-power valve) and had the rather high filament current consumption of .4 ampere at 2 volts. They also took an average anode current of some 11 milliamps. Later models have since become available, however, which have an output and a current consumption of about half the values just quoted and these will no doubt become even more popular than their "big brothers." Another type of Class B valve that is not so well known to the amateur constructor and yet is of great importance is one designed for operation from D.C. mains. Actually the valve is only one-half of a Class B valve, since two have to be used together in the usual push-pull arrangement. Two such valves will give the phenomenal output of 21 watts, and are thus perfectly ideal for public address and "talkie" apparatus.

Diode Combinations

The coming of automatic volume control has been responsible for the introduction of a number of new valves, some of which have quickly been superseded. Most of these valves have consisted essentially of a diode arrangement for rectification, since it was soon found that this type of detector was the only one which could handle a sufficiently large voltage input to provide an adequate biasing voltage for the preceding variable- μ stages. The diode is recognised as a perfect rectifier, but has the disadvantage that it cannot be made to amplify, as a three-electrode valve can, by the application of reaction. Consequently, when a diode detector is employed it is necessary to use at least one additional amplifying stage to obtain the same signal from the set as when a triode is used. This difficulty has been overcome by the introduction of so-called double-diode-triode or double-diode-pentode valves. Both of these latter consist of a cathode (indirectly heated, of course), two small (called "auxiliary") anodes, a grid, and a main anode; in the case of the pentode there is also a second or priming grid. The two small anodes function in conjunction with the cathode as a full-wave diode detector, whilst the other electrodes, along with the same cathode, form an L.F. amplifier. Thus, a single valve serves the combined purposes of detector and low frequency amplifier. The general form of construction used for the dual purpose is such that interaction between the two portions is prevented by the insertion of a small screen between the auxiliary anodes and the remainder of the electrode system. The double-diode-pentode is a particularly useful valve, because by connecting it in a certain way the A.V.C. bias voltage developed by the diode portion can be made to act upon the L.F. portion as well as upon the preceding variable- μ valves. By using these connections an almost perfect automatic volume control effect can be obtained.

The Short-Base Variable- μ

Another valve which has been developed for A.V.C. is the "short-base" variable- μ . As the name implies, this valve has a short grid voltage base. In other words, its amplifying properties can be varied from maximum to minimum by the application of a comparatively small variation in grid-bias voltage. The valve makes possible the use of A.V.C. in fairly simple sets which give only a small amount of high frequency amplification.

High-Frequency Pentodes

Ever since valve receivers were first used the designer has been confronted with the difficulty of obtaining stable high frequency amplification. The ordinary triode was very difficult to employ efficiently, and until the neutrodyne system was first evolved this type of valve gave very little amplification on wavelengths below 1,000 metres or so. The neutrodyne arrangement was effective up to a point, but suffered from the fact that it could not easily be used with sets which were required to cover more than a very limited wavelength range. The screened grid valve was better, but was liable to introduce distortion and other troubles. Next came the variable- μ valve, which at first appeared ideal. But it was soon found that the V.-M. was not so free from self-oscillation as was desired unless somewhat laborious precautions were taken to maintain its screening grid at a perfectly uniform potential. When the screening grid voltage was allowed to attain certain values it "robbed" the anode of its current and the valve fell into self-oscillation and was thus incapable of functioning correctly. The latest modification of the S.G. valve is the high-frequency pentode which, although identical with the S.G. or V.-M. valves in all other respects, has a third grid (which is connected internally to the cathode) inserted between the screening grid and the anode. This entirely prevents instability and at the same time improves the valve's amplifying properties. The H.F. pentode, which is made in both ordinary S.G. and variable- μ form, is undoubtedly the high-frequency amplifier of the future, and will probably be a feature of all the better-class sets during the coming year.

The Hexode and Pentagrid

The idea of making one valve do the work of two has always had a wide appeal, and for some time it has not been uncommon to use a screened grid or pentode valve as combined first detector and oscillator in superheterodynes. The system is fairly efficient once it has been put into operation, but it is not always easy to avoid different forms of interaction, cross modulation, and the like. A new single-valve "mixer" or frequency changer known as the hexode or pentagrid (the two names are not synonymous, but the valves are very similar in principle) has lately been developed on the Continent and in America. The valve has a cathode, four grids, and an anode arranged as on page 358, May 27th issue, and functions as an oscillator and also as a variable- μ screened-grid first detector.

(To be continued)

RADIO RAMBLINGS

By GRID LEAK

Gettings from my Notebook

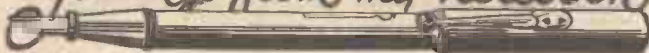

Tramway Interference

STILL the war goes on between listeners and the tramway authorities regarding the matter of interference. This is becoming a very serious problem, because while private users of dynamos and high-frequency electrical medical apparatus seem always ready to be corrected, the tramway people in far too many cases have adopted the attitude of "we-got-here first." They do not see why they should go to a lot of trouble and expense with their transport system to please a lot of radio fans, whose reception they are continually spoiling as each vehicle passes along. Of course, there is good and bad in every community, and some transport authorities have acted with courtesy and consideration, and have gone to no end of trouble to make their trams or trolley buses immune as sources of interference to listeners. To these I raise my hat, but not to the people responsible for the trolley buses running at Nottingham. In this town the noise has to be heard to be believed, and reception in any locality within fifty yards of the route is terrible. Anyway, it is so bad as to cause the Nottingham branch of the Wireless Retailers' Association to protest against the refusal of the transport department to take action of any sort in the matter, and it has been suggested that the Minister of Transport be approached. This is serious and short-sighted, because the march of progress cannot be stayed, and a large chunk of goodwill will be lost, to say nothing of the more tangible effect of loss of traffic receipts that must result by tramway owners offending a section of the public that is growing in numbers every day. Radio fans would be well advised not to ride on trams and vehicles not fitted with some sort of filter device as a measure of protest, although of course real radio fans are so glued to their dials and current issue of PRACTICAL WIRELESS as to make their excursions abroad very rare after the day's work is ended.

A Question of Valves

WHEN is a valve not a valve? That is a poser that has arisen out of the controversy as to whether a rectifier valve can be considered to be a valve in the specification of a commercially-built set. It is time the whole system of nomenclature was revised in radio, for while we can have a four- or three-wheel motor-car, I suppose the actual number of wheels of one sort

and another in a car would run nearly into a score or more. I notice, however, that no set intended for home construction and for use on the mains ever includes the rectifier valve as being one of the valves of the set. This is the better way, I think, and so long as we must rate our sets by the valve let us only count the valves that are actually engaged in handling the signals in some way or other. Myself, I have a strong liking for the metal rectifier as opposed to the valve rectifier, but whichever you prefer yourself you will be interested to learn that life tests made by the Westinghouse people on sample metal rectifiers of their manufacture have been taken on full load up to the present time of 45,600 hours, and a loss of efficiency of only 3.8 per cent. has been recorded. The tests are still going on and there is no reason to suppose that the life limit has been reached even though the duration of the test up to now is equivalent to twenty-one years of life when used for six hours per day!

Thermo-electric Sextant

IN a broadcast talk from an American station a demonstration was given of the Macneil thermo-electric sextant, which is able to detect the presence of the infra-red rays. The sextant employed a delicate thermo-couple, which, as readers are perhaps aware, changes the infra-red rays into electrical impulses which can be measured for intensity. The sextant detected the heat of a chimney-stack six miles away and it is hoped to be able to detect the presence of aircraft by the heat of their exhausts. The instrument will register the heat of a man's face at one mile distance and a horse at two miles. Warship funnels can be felt through the thickest fog or smoke screen, and there is practically nothing that emits heat in some degree or other that does not affect the thermo-electric sextant. It was an interesting talk, and it left me wondering how far away the filaments of our dull emitters could be detected from, and also how it discriminated between the various hot bodies, electric lamps and the like that are part of our scheme of things.

A Combined Driver and Diode Valve!

ONE of the disadvantages of Class B amplification is that an extra valve is required in the form of a driver, to maintain sensitivity. Now that three, four, and even five electrode valves, with a detector diode in the same bulb, is an accomplished fact,

why not a driver valve and a little diode detector in the same bulb?

Canned Coils

THERE is a tendency for single-coil sets to use canned coils, and when working at some distance from a broadcasting station the set often works better with the can removed: the reason being that the coil efficiency increases when a damping caused by the metal is removed. The inductance of the coil also increases, so the maximum or minimum tuning range will be somewhat higher.

A Peculiar Condenser Effect

WE have examined an authentic case of a receiver that gave a loud click in the speaker when the actual polished woodwork was touched with the finger, the astonishing point being that the phenomenon did not recur unless several minutes elapsed. French polish contains a large quantity of shellac varnish, which, being an excellent insulating material, becomes charged up by the proximity of two metal surfaces at different potential.

Unwanted Coupling Between Condensers

SOME screened-grid sets behave in a very peculiar manner at the bottom of the dial. The two dials may keep closely in step from, say, 180 to 20, and then one of them has to be increased to reduce the wavelength of the circuit; and, correspondingly, its fellow has to be decreased out of all proportion. This extraordinary happening is due to coupling existing between the condensers, the effect of which increases rapidly as wavelength is decreased, until the inaction is enough to bring about this state of affairs. If it causes annoyance it can be prevented by a screen between the two condensers, and duly earthed; silver paper or wire mesh being quite adequate.

Leakage Due to Moisture

THERE is always a great hue and cry about poor reception conditions in summer weather, but most people are far too ready to blame it on the elements instead of trying to do something about it. H.T. batteries pay for a little care in the direction of keeping them cool. Alternatively, another source of trouble is leakage in the set due to moisture. It is not usually convenient to have the set anywhere where temperature remains constant, but a small quantity of calcium chloride, in a suitable receptacle placed in the set, will absorb all the moisture.

The Screen-grid Condenser

NOBODY would dream of building a screen-grid set without connecting a comparatively large condenser between the screening-grid and L.T.—or cathode. but, apparently, most constructors think that any old condenser will do. As a matter of fact, it is essential that a non-inductive one should be chosen, as some of the old type of condensers have an impedance as high as 25 ohms at, say, 300 metres, which is quite enough to throw a properly-designed set off its balance.

SEE THE NEW

MICROLODE

AT STAND N°128



RADIOLYMPIA SECRETS REVEALED
(Continued from page 649)

Jackson Bros., Utility, British Radiophone, etc.—will offer you a slow-motion drive of the new full-vision scale. Some of these are wonderful pieces of work, and will certainly revolutionize your present set. In place of the small window, with a few degrees of the scale showing through, the entire scale will now be visible through a neat metal window. The most interesting feature about these dials is that the actual space occupied by the engraving does not occupy half a circle, as you might at first imagine. The dial is compressed into quite a small area, and the moving pointer is operated in such a way that although the condenser spindle turns through 180 degrees, the pointer travels only over a very small arc. If your present receiver is fitted with one of the older dials, you must try one of these new ones and you will be surprised how it simplifies tuning. Unlike many components, this is one which you can change in almost any receiver, without upsetting the circuit in any way. Messrs. Jackson Bros. have spent a great deal of time on their particular dial, and you will find that they have dispensed with the ordinary type of metal pointer. Instead, a thin piece of transparent material is used, and across this is cut a very fine hair-line. This is fitted right close up against the back of the transparent scale, and mounted immediately behind the hair-line cursor is a lamp bracket. A small dial lamp is fitted in this bracket, and wired to the filament or heater terminals. Thus, when the set is switched on, the light illuminates the scale, and, what is more important, as you turn the control, the hair-line moves, *together with the light.* There is thus no

you have to buy a valveholder, transformers, valve and speaker and then wire them up. Messrs. Ferranti, Bakers Selhurst, Rola, Grampian, Whiteley Electrical, and many other high-class speaker manufacturers will all be showing a unit which consists of a moving coil loud-speaker upon which is mounted the complete



Varley Nicore L.F. model B.P.42.

Class B stage. In most cases a simple plug completes the unit, and this is inserted in the last socket of your present set, or one or two simple connections have to be made, and away you go with a complete 2-watt high-quality output.

Automatic Gramophones

Although not exactly radio apparatus, the gramophone is now associated with it, and you will see some novel types of record changer. The H.M.V. and Columbia stands will both show an automatic radio-gramophone at a really low figure, upon which the automatic changer is fitted as part of the standard equipment. With this particular device eight records are supported above the turntable, and the pick-up moves into position, is lowered to the record already on the turntable, plays to the end of the record, and is then raised and removed to a position clear of the edge of the turntable. This is all done automatically by the mechanism enclosed in the cabinet. As soon as the pick-up is clear, the mechanism permits the next record to drop to the turntable, and this is then played, and so on. A most interesting adjunct is known as a reject button, and if a record commences to play, and for some reason or other you do not wish to hear it, you simply push the button which is situated on the outside of the cabinet, and the music instantly ceases, the pick-up is moved away and the next record is brought into position. This is a most uncanny piece of mechanism and will undoubtedly prove very popular. Another ingenious automatic gramophone which is hinted at does not necessitate the raising of the lid in order to put the record on. You simply push the record in at one side of the cabinet, it is automatically placed into position, played, and returned to you through another slot. The above notes cover only a few of the marvels which will be revealed at this great Exhibition, and many manufacturers are closely guarding secrets which will not be known to any but themselves until the opening day.



The MULE brays loudly

Many a wireless set is like that—more Braydio than Radio. Build your set with Graham Farish Components. They ensure perfect tone because they are real instruments, definite in their electrical values, and they are reliable because they are accurately gauged and tested.

LIT-LOS Condensers



Compact and efficient. Accurately gauged bakelite dielectrics and solid brass pigtail connection to moving vanes. All capacities up to .0005 mfd. in tuning straight line capacity and differential types.

2/- EACH

OHMITE Resistances

The most popular and efficient type of fixed resistance for all general purposes. "Better than wire-wound." All values 50 ohms to 5 megohms

1/6 EACH



100° F. Temperature rise.			
Ohms	Millamps	Ohms	Millamps
1,000	40	20,000	8
2,000	35	30,000	6.75
3,000	29	40,000	6
Other values pro rata.		100,000	3.5
Heavy Duty type, approximately double the above ratings, price 2/3.			

Graham Farish Components

Graham Farish Ltd., Masons Hill, Bromley, Kent.
Export Office: 11/12, Fenchurch St., E.C.3.



The new Ferranti speaker with matching transformer for Class B or power output valve.

Loud-speakers

One of the most interesting loud-speaker developments which you will see will be the complete Class B unit and loud-speaker combined. You have already become familiar with the great possibilities of the Class B valve, and in many cases you have a simple receiver with an ordinary type of speaker. The output from the Class B valve is so great and pure in tone that a good loud-speaker is warranted, and in the ordinary way this means that if you wish to convert to Class B working

Facts and Figures

Components Tested in our Laboratory

BY THE PRACTICAL WIRELESS TECHNICAL STAFF

R.I. AUTO-PARAFEED TRANSFORMER

A PART from its original shape, the little component illustrated below is coloured in a bright red. It is thus distinctive in more than one sense. It is an auto-transformer of the nickel iron type with high permeability and is internally shielded. The primary resistance is of the order of 1,100 ohms, and the D.C. resistance of



The R.I. Auto-Parafeed Transformer.

the secondary is 3,900 ohms. The inductance of the primary is 85 henries. The response curve is very interesting indeed, showing a difference of only just over one decibel at the lowest and highest frequencies. These are rated at 25 cycles and 8,000 cycles, and the curve is taken with normal valves of the battery-operated type. The component on test has proved in every way satisfactory, and goes one step further to simplifying and adding to the usefulness of L.F. amplification with high-quality receivers. The price of the Auto-parafeed, which is, of course a Radio Instruments production, is only 6s. 9d.

COSMOCHORD POTENTIOMETER AND SWITCH
A NEAT component has been submitted for test by Messrs. Cosmochord Ltd. This consists of a potentiometer with switch incorporated, and is mounted in a neat brown bakelite case. The value of the particular model submitted was 15,000 ohms, and this was very clearly marked on the case, on a white label stuck in a recessed position. This is only a small

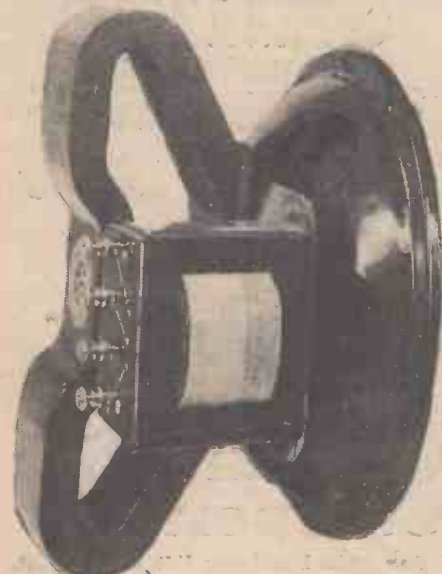

The Wharfedale Bronze loud-speaker reported on in this section last week.

point, but is important, as many of the potentiometers which are available to-day are not marked at all, or have the marking in some inaccessible position where it is very difficult to find. The switch is of the Q.M.B. type, rated at 3 amps. The action is particularly smooth, and on the particular model which we have it is as smooth as any which we have yet handled. We have no hesitation in recommending this handy little component, the price of which is 5s. 6d.

NEW FERROCART COIL

MESSRS. COLVERN announce the addition of a further coil to the Ferrocart range, and this now completes the entire range, enabling practically any type of receiver to be built up with these particular iron-core coils. The new coil is the F.5, intended for a simple aerial (detector) circuit, and it is wound on rather novel lines. The reaction winding serves also as an aerial coupling coil, whilst the grid coil itself is tapped so that the damping on the circuit due to the grid leak may be relieved.

GOODMANS AUTOMOBILE SPEAKER

WITH the increasing popularity of car radio, there arises the problem of the loud-speaker: What form shall it take? Where shall it be housed, etc.? Messrs. Goodmans have anticipated events by producing the speaker illustrated below, which is of unusual design. The actual chassis and the magnet system is all cast in one piece, thus reducing a certain amount of weight whilst adding to the strength of the magnet system. The depth from the front of the chassis to the

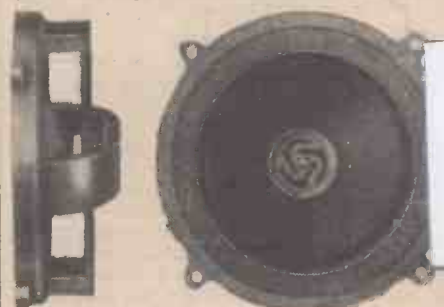

A neat automobile loud-speaker by Goodmans.

rear of the magnet is only 2 1/2 ins., whilst the overall diameter of the front is 6 1/2 ins. It will be seen that the speaker is thus of very small dimensions, but it performs in a very efficient manner. It will handle quite a large volume of sound, and will prove very useful for purposes other than those for which it was originally designed. For instance, a portable receiver could be made up quite nicely, using this speaker. The price of 27s. 6d. includes a matching transformer, and this latter accessory is not fitted to the speaker in any way, but is provided separately so that it may be fitted into the most convenient position, bearing in mind that leads must be correctly accommodated. The transformer may be obtained for Power, Super-Power, Pentode or Class B valves. It is a very useful component, and can be recommended.

NEW OSTAR-GANZ VALVES

TWO new valves are announced from the Ostar-Ganz factory, namely, the D.130 and the K.3560, selling at 17s. 6d. and 25s. 6d. respectively. D.130 is a detector or first L.F. valve, having an impedance of 40,000 ohms and the abnormally high amplification factor of 100. K.3560 is a power valve of unusually large output, having an impedance of 500 ohms and an amplification factor of 3. The normal anode current of this valve is of the order of 70 mA, with a plate voltage of 200 to 220. Mr. Eugen Forbat also announces that, owing to the big demand for the Ostar-Ganz valves, the rectifying types are reduced in price. Type EG.50

(half-wave rectifier) now costs 12s., and NG.40 (voltage doubler) costs 22s. 9d. The other rectifiers are proportionately reduced.

DISTURBANCE SUPPRESSOR

MESSRS. BELLING & LEE have gone into the question of interference which is caused via the supply mains, and the result of their inquiries and investigations is shown by the introduction of a device known as the Disturbance Suppressor. This reduces the interference to a very low level in most cases, and in others it entirely



Belling-Lee Disturbance Suppressor.

removes it. The suppressor is joined between the receiver and the electric supply point provided you are certain that the interference is coming via the mains. If, however, the aerial is responsible for picking up the disturbance, then the suppressor is joined across the mains, between the main switch and the distribution fuse-box. The device consists of two heavy duty 2 mfd. fixed condensers with a centre earthed point, in addition to a pair of safety fuses. This latter precaution ensures that the fuses will not be blown in the event of the suppressor breaking down. The suppressor is suitable for A.C. or D.C. supplies and the interference shadow, and the mains supply.

ECLIPSE HACK-SAW

THE illustration shows two of the range of Eclipse Hack-saw frames manufactured by Messrs. James Neil & Co., Sheffield. These are very robust and examples of really high-class workmanship. The pistol-grip model is No. 40 P.G. and costs 5s. The frame has great strength and rigidity, being made from bright drawn .45 per cent. carbon steel, whilst the handle gives a most comfortable grip. One small but important item is that the back of the frame is engraved with the figures 8, 9, 10, 11 and 12, so that the actual setting for various lengths of hack-saw blade may be speedily made. The other model is the 90.B., and this costs only 2s. 6d. With a frame manufactured from the same material as the other model, the strength of the instrument is practically as great, but the ordinary type of handle is fitted. Again, the frame is graduated for rapid and accurate setting. To the handyman or the radio engineer, these instruments will be found very useful indeed, and we give them our fullest recommendation.

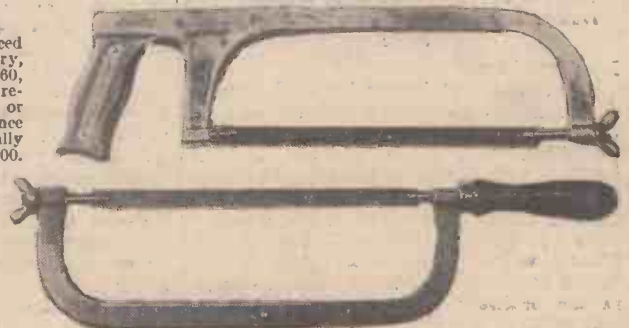

Two very useful Eclipse hack-saws.



Practical Letters

from

Readers.

The Editor does not necessarily agree with opinions expressed by his correspondents.

"Pigtail Connections"

SIR,—I should like to thank Mr. Johnson for his reply to my letter re pigtail connections and, at the same time, draw his attention to the fact that he has missed the main point of my remarks.

In my letter, I did not refer to the inductance variation due to the expansion and contraction of the pigtail spiral, but the fact that inductance was present, whatever its value may be. In his diagram, the

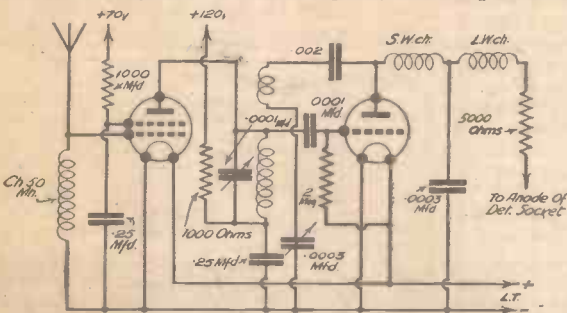

Fig. 1.—The circuit referred to in Mr. Faulkner's letter.

inductance "L.1." should be considered as fixed and the capacity "C.1." (?) as a varying mixture of capacity and resistance, thereby, to repeat the words used in my first letter, causing the inductance of the circuit as a whole to vary. Another way of looking at the problem is to consider "L.1." as having a varying or intermittent "P.D." across it.

The detector valve I have in use is perfectly normal and any other valve of similar characteristics can be used with equal success. I have tried several and the results justify this statement.

Fig. 1 shows a circuit diagram of my S.W. adaptor, but I would like to point out that the layout of the components is of far greater importance than the theoretical circuit.

This circuit is, I know, open to criticism, one of its disadvantages being that it is unselective. Some stations, such as O.K.N., H.A.S.2, 2R.O. and D.J.C., spread very badly over a large portion of the dial, but it is very easy to handle and certainly "delivers the goods."—W. FAULKNER (Manchester).

South African Readers, Please Note

I wish to correspond with some radio enthusiasts in South Africa, so if you could give me a few names or insert a few lines to the above effect, I would be much obliged. At the same time, I would mention that I would prefer you to forward letters from interested readers should you consider it necessary to advertise to the above effect.—M. J. GLOVER (Calcutta).

Our Reputation of Being Practical

SIR,—I received my copy of your Wireless Constructor's Encyclopædia some little while ago. I have had time to study the

contents and I must congratulate you on such a wonderful book, also its handsome appearance. As I am a wireless enthusiast from 1927, I have found the Encyclopædia a great help in the many snags which crop up in the construction of wireless apparatus. Also congratulations to PRACTICAL WIRELESS which is keeping up to its splendid reputation of being practical, and is easily understood by the expert and novice alike. I shall always be an ardent reader of your paper and wish it every success.—WM. MARSLAND, Jr. (Stockport).

Wireless Constructor's Encyclopædia

SIR,—I have now received my copy of Wireless Constructor's Encyclopædia, and hasten to inform you of the very great pleasure its receipt gave me. It is the most comprehensive, modern, and informative work that has been placed before constructors, and I assure you, sir, it will

prove a real boon.

Mr. Camm is to be heartily congratulated.
—C. LANCASHIRE (South Africa).

(Continued on page 658)

CUT THIS OUT EACH WEEK

DO YOU KNOW?

- THAT a three-gang permeability tuned circuit is now being experimented with. The overall size is no larger than a matchbox.
- THAT a constructor's kit for a television receiver may shortly make its appearance.
- THAT the full-vision tuning scale will be in almost universal use next season.
- THAT more new valves will soon be introduced to the English market.
- THAT care should be taken in choosing the ratings of resistances used for voltage dropping purposes.
- THAT a hum-bucking coil may be fitted to an existing loud-speaker which is not so equipped.
- THAT a similar coil is now obtainable on a well-known make of pick-up.
- THAT interference from synchronous gramophone motors is avoided by using the hum-bucking coil.

NOTICE

The Editor will be pleased to consider articles of a practical nature suitable for publication in PRACTICAL WIRELESS. Such articles should be written on one side of the paper only, and should contain the name and address of the sender. Whilst the Editor does not hold himself responsible for manuscripts, every effort will be made to return them if a stamped addressed envelope is enclosed. All correspondence intended for the Editor should be addressed: The Editor, PRACTICAL WIRELESS, Geo. Neuenes, Ltd., 8-11, Southampton Street, Strand, W.C.2.

Owing to the rapid progress in the design of wireless apparatus and to our efforts to keep our readers in touch with the latest developments, we give no warranty that apparatus described in our columns is not the subject of letters patent.



"We're Fluxite and Solder—the reliable pair; Famous for Soldering—known everywhere!"

At fixing WIRELESS we're expert—nothing more—nothing less; THAT is the reason— for this S...O...S!"

See that Fluxite and Solder are always by you—in the house—garage—workshop—anywhere where simple, speedy soldering is needed.

ALL MECHANICS WILL HAVE FLUXITE

IT SIMPLIFIES ALL SOLDERING

All Ironmongers sell Fluxite in tins: 4d., 8d., 1s. 4d., and 2s. 8d. Ask to see the FLUXITE POCKET SOLDERING SET—complete with full instructions—7s. 6d. Ask also for our leaflet on HARDENING STEEL with Fluxite.

FLUXITE LTD.
(Dept. W.P.), ROTHERHITHE, S.E.16.

FOR ALL REPAIRS!



Write for Illustrated Catalogue of Radio-Gramophone Cabinets of exclusive modern design, made by craftsmen in highly figured Oak, Walnut or Mahogany, post free. Cabinets made to order a speciality. Maker under licence of the

HOWE BOX BAFFLE. Recommended by the B.B.C. Full details on request.

GILBERT

Cabinet Maker SWINDON. Estimates free. Est. 1866.

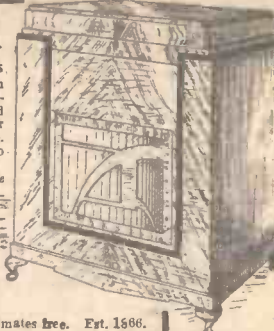

FAMOS 2 Magnet bal. arm. speaker units, large 4 pole type. List price, 21/-. to clear 6/-.

AMPLION cone speaker unit in Walnut domed-top cabinet, 7/6 complete.

ERICSSON 2-1 (suit 3-1) L.F. Transformers. Listed 17/6; each, 3/3.

AMPLION speaker units. Over 75 per cent. reduced. Each 2/3.

All new and guaranteed and sent carriage free U.K.

PIONEER RADIO MFG. CO., LTD., COPTIC STREET, W.C.1. Museum 9607.

PATENTS & TRADE MARKS

KING'S PATENT AGENCY, LTD., 146b, Qn. Victoria Street, E.C.4, offer "Advice Handbook" and Consultations free 47 years' references. Write, call, or 'phone (Central 0682). Director, B. T. KING, O.I.M.E., Reg. Patent Agent, G.B., U.S.A., and Canada.

The Plays That Have Thrilled Millions

MILLIONS of wireless listeners who have been thrilled by such plays as "The Path of Glory" and "The Mary Celeste" can now read them in book form for the first time. Five radio thrillers. 356 pages.

RADIO PLAYS

By L. DU GARDE PEACH

Obtainable at all Newsagents and Bookstalls, or by post, 2/9, from George Neuenes, Ltd., 8-11, Southampton Street, Strand, London, W.C.2.

2/6

PRACTICAL LETTERS

(Continued from previous page)

Vol I Index

SIR,—I have been a regular reader of PRACTICAL WIRELESS since its early numbers, and hope to continue as long as it remains practical.

There is one suggestion I should like to make; why not give your readers an opportunity to obtain the index which you have prepared in connection with your binding offer? I think a large number of readers would like the index, even if they do not want their copies bound.—
W. WOODWARD (Cirencester).

[The index to Vol. I can be obtained for 6d., post free, from our publishing dept.—ED.]

The "Beta" Four

SIR,—Being greatly interested in the "Beta" Four some time ago, I built the set. My trouble was having a super power valve, consuming about 17 milliamperes, which with the S.G. and Det. was consuming 20 milliamperes or so, supplied from an eliminator. Not wishing to have to purchase a power valve, I decided to run the three valves mentioned from the same H.T. source, and the Class B valve from the standard 120 H.T. dry battery. This arrangement works well, but an extra H.T. negative must be fitted (with fuse) for the battery. If you connect to existing negative lead, the fuse lights up on loud passages, and it tends to some L.F. instability. During preliminary tests (while awaiting delivery of Cossor 240B valve), I found that the Benjamin driver transformer made an efficient output transformer, connected direct to the input terminals of the speaker transformers. It seemed to make little difference whether the centre tap terminal of the Benjamin component was earthed or not. Perhaps this may be of interest to other readers. It should be stated that only one lead is employed from the dry battery, and that goes to the centre tap of output choke or output transformer on the speaker. I should also mention that the 10,000 ohm and 1 mfd. decoupling condenser were removed after experiment, as the driver valve used (Marconi P2) requires the full H.T. voltage, this causing no instability. I have lately tried a small power valve in the stage, but find the P2 is the best.
—A. H. SELWOOD (Bournemouth).

OBTAINING FILAMENT CURRENT FROM D.C. MAINS

(Continued from page 646)

new valves for the conversion, it is recommended, because of their greater efficiency, that these valves, which have been specially designed for that purpose, should be employed. The heaters of the valves are connected in series from the mains through a suitable voltage dropping resistance, which may conveniently take the form of a gas-filled lamp of the requisite voltage. The filament voltage rating of these special D.C. mains valves varies according to the type and make of the valve, from 5 to approximately 35 volts. Valves capable of working directly from D.C. mains at 220 volts are also obtainable, but up to the present these have not found much favour in this country.

Fig. 3 shows the circuit diagram for use with indirectly heated cathode valves. The heaters are fed with unsmoothed D.C., and smoothing chokes are therefore not required. The voltage ratings of the valves are: screened grid valve 20 v. detector 25 v. and output 35 v. The filament current

consumption of each of the valves is 0.1 amp. A fuse blowing at $\frac{1}{2}$ ampere should in all cases be inserted in each of the mains leads, the small enclosed type, such as the "Bulgin," being most suitable for this purpose.

The fitting of a double pole switch obviates the necessity of removing the mains plug from its socket, and should be included in the circuit. The resistance should always be placed in the positive lead of the mains, otherwise low frequency instability may be introduced. For mains voltages other than 220 volts, the value of the resistance must be calculated accordingly. A tapped resistance or potentiometer in series with the usual resistance, to provide finer adjustment, in conjunction with meter readings, is a desirable addition to the circuit.

PRACTICAL WIRELESS
BLUEPRINT SERVICE

In order to meet the requirements of readers who prefer to work from a full-size blueprint when building up any of the "Practical Wireless" Receivers, we can now supply full-size Blueprint Wiring Diagrams of all the "Practical Wireless" receivers for 1s. each, post free. When ordering, quote the number. Copies of the paper containing descriptions of the particular receiver cost 4d. each. Address orders to: The Publisher, George Newnes, Ltd., 8-11, Southampton Street, Strand, W.C.2.

Blueprint No.	Receiver.	Described in Issues dated
1.	Dolphin Straight Three	Sept. 24th Oct. 1st
2.	Long Range Express Three	Sept. 24th Oct. 1st
3.	Mains Express Three	Oct. 8th
4.	Sonotone Four	Oct. 8th
5.	Bijou Three	Oct. 15th
6.	Argus Three	Oct. 29th
7.	Empire Short-Wave Three	Nov. 5th Nov. 12th
8.	Solo Knob Three	Nov. 26th Dec. 3rd
9.	Midget Two (6d. only)	Dec. 10th Dec. 17th
10.	Selectone Battery Three	Dec. 17th 1933.
11.	Fury Four	Jan. 7th Jan. 14th Jan. 21st Jan. 28th
12.	Featherweight Class B Four-valver..	Jan. 21st Jan. 28th Feb. 4th Feb. 11th Feb. 18th Feb. 25th
13.	Q.P.-P. Three-Four	Apr. 29th May 6th May 25th
14.	Alpha Q.P.-P. Three	Mar. 4th Mar. 11th Mar. 18th
15.	Ferrocarril Q.P.-P. Hi-Mag Three	Mar. 25th Apr. 1st
16.	Supersonic Six	Apr. 1st Apr. 8th Apr. 15th
17.	Beta Universal Four	Apr. 8th Apr. 15th Apr. 22nd
18.	A.C. Twin	Apr. 15th Apr. 22nd Apr. 29th
19.	Selectone A.C. Radio-Gram Two	Apr. 22nd Apr. 29th
20.	A.C. Fury Four	Mar. 4th Mar. 11th
21.	Radiopax Class B Four	May 20th May 27th June 3rd
22.	Three-Valve Push-Pull Detector (6d. only)	Mar. 4th June 3rd
23.	Double Diode Triode Three	June 10th June 17th
24.	Three-Star Nicote	June 17th June 24th July 1st

RADIO CLUBS & SOCIETIES

Club Reports should not exceed 200 words in length and should be received First Post each Monday morning for publication in the following week's issue.

SLADE RADIO

There was a lantern lecture entitled "Water Power," by Mr. W. Wilson, M.Sc., B.E., M.I.E.E., M.A.I.E.E., at the meeting held last week. The lecture was mainly based upon his own experiences in New Zealand and the series of slides were from actual photographs which he had taken.

The lecture proved of great interest, and although a complete diversion from wireless, was thoroughly enjoyed by the members. Hon. Sec., 110, Hillaries Road, Gravelly Hill, Birmingham.

UXBRIDGE RADIO CLUB

The first meeting of the Uxbridge and District Branch of the Anglo-American Radio and Television Society will be held during September. Exact date and particulars may be obtained from Mr. Leslie W. Orton, "Kingshorpe," Willowbank, Uxbridge.

AMATEUR RADIO SOCIETY

The above Society held its annual Junk sale on July 18th, the role of auctioneer was very ably filled by Mr. B. Cooper, who was assisted by Mr. A. Brittan, the proceeds of the sale are to go towards the expenses of an exhibition of members apparatus which is to be held in December. From the Chair Mr. J. Ballinger, announced that the Mayor of Burton, Councillor W. Hutson, J.P., had accepted the Presidency of the Society, and Major W. S. Power, D.S.O., had consented to be a Vice-President.

The Society has room for new members and anyone interested is asked to write to the Hon. Secretary, 189, Burton Road, Burton-on-Trent, who will be pleased to forward full particulars together with a prospectus of lectures for next season.

The next meeting, the first of the winter season, will be held on September 5th, when a lecture entitled "The Output Stage" will be given. If any would-be members care to come along, the address is The Wheatsheaf Hotel, Station Street, and the meeting starts at 7.45 p.m.

NEW ZEALAND DX CLUB

Mr. Stephen Cullen, of 33, Dilston Grove, London, S.E.16, has been appointed London representative of the New Zealand DX Club.

This organization aims to aid DX enthusiasts through supplying them with station lists, etc.

Membership (including membership card and badge) is 2s. 6d. There is no other fee.

Those interested should write to Mr. Cullen or Mr. Leslie W. Orton, British Representative and International Secretary, 11, Hawthorn Drive, Willowbank, Uxbridge, England.

A London branch will be shortly formed, and the more members the merrier it will be. All correspondence will be answered.

EELEX EARTH BOWL WINNERS

On page 610 of our issue dated July 22nd 1933, we offered six Eelex earth bowls to the first six applicants. We have been inundated with applications for these efficient earth devices which are, of course, marketed by J. J. Eastick & Sons, Eelex House, 118, Bunhill Row, E.C.1. The first six applicants have already received a bowl each, and their names and addresses appear below:—

Mr. Leonard L. Viney, 48, Murray Road, South Ealing, W.5.

Mr. A. Rogers, 181, Desborough Road, High Wycombe, Bucks.

Mr. F. E. Gearing, 26, Terront Street, West Green, South Tottenham, N.15.

The Occupier, 40, Wilson Road, Camberwell, S.E.5.

Mr. A. Killingback, 91, Church Elm Lane, Dagenham, Essex.

Mr. G. G. Russell, South Farnboro', Hants.

PAGE MISSING

PAGE MISSING

'LISTENERS IN'!

LOOK NOW AT YOUR
WIRELESS LICENCE

IT MAY BE WORTH £50 TO YOU

 Compare your number
and claim your reward

£50 will be paid to holder of Licence
No. AP 843720

£25 will be paid to holders of Licences:
Nos. AO 488576 AP 425397

£10 will be paid to holders of Licences:
Nos. AN 434682 AO 802581

£5 will be paid to holders of Licences:
AJ 594816 AP 125757 AN 383600 AQ 366953 AK 809657

£2 will be paid to holders of Licences:

AH 648574	AK 217943	AM 12970	AN 555633	AO 261797	AO 511745	AP 002349
AI 214368	AK 766543	AM 168727	AN 649882	AO 181040	AO 284909	AP 383809
AI 22369	AM 793625	AM 232245	AN 171902	AO 415333	AO 460948	AP 32994
AJ 886549	AM 576664	AM 867414	AN 858665	AO 353262	AP 655808	AP 682408
AJ 577775	AM 031212	AN 061535	AN 923443	AO 796312	AP 943212	AP 767731
AJ 67987	AM 827005	AN 770714	AN 404800	AO 711117	AP 140613	AQ 520031

£1 will be paid to holders of Licences:

AH 992365	AI 052166	AL 216943	AN 264402	AN 238626	AO 417118	AP 054139
AH 654021	AJ 212649	AL 369864	AN 527887	AO 832119	AO 387355	AP 519098
AH 449362	AJ 989970	AL 888676	AN 495077	AO 056932	AO 946462	AP 638017
AH 506377	AL 319723	AL 089330	AN 108356	AO 280793	AO 533334	AP 425880
AI 767201	AL 146930	AM 502165	AN 821111	AO 914651	AP 467764	AP 330475
AI 505006	AL 002767	AM 004672	AN 613448	AO 371005	AP 500326	AP 148220
AI 314523	AL 709368	AN 712868	AN 060034	AO 063281	AP 245887	AP 591026
AI 44770	AL 952200	AN 002126	AN 588707	AO 192363	AP 367428	AP 822752

This offer applies to licences which are actually in force on Saturday, August 5, 1933.

Before the awards are paid, claimants will be asked to undertake a simple publicity service in distributing leaflets to encourage the sale of licences amongst those who at present do not fulfil their obligations by taking out a Post Office Wireless licence before receiving broadcast programmes. Claims cannot be considered in connection with any Licence the date of issue of which is after August 3, 1933.

For full particulars for
claiming awards and a long
list of other numbers see

TIT-BITS

ON SALE EVERYWHERE SATURDAY AUG. 5.

PRACTICAL HANDBOOKS

Clearly written and fully illustrated.

This series covers a wide field and will prove of the greatest value to everyone interested in models and how to make them; woodwork and other crafts.

Accumulators

An up-to-date handbook dealing with every type of accumulator, methods of charging them at home, care and maintenance, also explains how to erect a charging station.

Motor Car Upkeep and Overhaul

Information covering the engine, decarbonising, valve grinding, the lighting system, the carburetter, cooling system, lubrication, springs and shock absorbers, steering gear, brakes, wheels, axles, tracing noises, etc. etc.

Toy Making for Amateurs

How to make clockwork toys, model aeroplanes, model locomotives, model boats, ingenious toys operated by sand, wooden models and toys, electrical toys, steam toys, guns, kaleidoscopes, acrobats, etc.

Twenty-Five Tested Wireless

Circuits

All the sets described have been designed to meet modern needs. They range from simple crystal receivers to a seven-valve super-heterodyne, and all have been made and tested before inclusion.

Simple Electrical Apparatus

An excellent little book for those who wish to make simple and useful electrical appliances, such as galvanometers, electric motors, dynamos and Leyden jars.

Model Boat Building

Contains designs for battleship, speed boat, paddle steamer and yachts. Excellent models can be built with the simple directions and diagrams given.

The Home Woodworker

Clear instructions on how to make a large variety of articles in wood, together with many useful hints on wood-working.

Model Aeroplanes and Airships

Contains full descriptions of easy-to-make models of every description that will fly.

The Handyman's Enquire Within

Hundreds of practical ideas and hints of value to the man who is clever with his hands

25 Simple Working Models

Ingenious and practical designs for electric, steam and clock-work models.

NEWNES' HOME MECHANIC BOOKS

Obtainable at all Newsagents and Bookstalls, or by post 1/2 each from George Newnes, Ltd., 8-II, Southampton St., Strand, W.C.2

1/-
each

**FUN
FOR ALL THE FAMILY**



THERE are hours and hours of sheer enjoyment for old and young in Newnes' New "Princess Elizabeth" Jigsaw Puzzle—the Puzzle of which you will never tire. You simply must get one!

1/-

The
**PRINCESS ELIZABETH
JIG-SAW
PUZZLE**

On sale at all Newsagents, Stationers and Bookstalls 1/-, or 1/4 (including postage) from George Newnes, Ltd., 8-11, Southampton Street, Strand, London, W.C.2.

George Newnes, Ltd.

3 IMPORTANT REASONS



WHY YOU SHOULD BUY THE AUGUST HOLIDAY NUMBER



A DAY WITH A BOX CAMERA.—In this article the writer describes his first attempt to use a Box Camera, and illustrates it with the pictures he took. His experiences and pictures will interest every photographer, but especially the man or woman who has never yet taken a photograph, and who is thinking of making a start with a low-priced camera.



HOLIDAY EXPOSURES.—Simply written and easily understood hints—fully illustrated—on how to obtain the best possible pictures during your holiday. The advice given is based on practical photographic experience. This article will explain to many readers points that have puzzled them in the past, and smooth away a host of real (and imaginary) difficulties.



CRUISING WITH A CAMERA.—Anyone who goes on a cruising holiday without a camera is deliberately throwing away a thousand golden opportunities; so, too, is the man or woman who does not know what to look for. This article, by a widely travelled amateur photographer, will help you to come home with a set of pictures that will always be a joy to yourself and a source of pleasure to your friends.

The **HOME** **6D**
PHOTOGRAPHER
and **SNAPSHOTS**

Obtainable at all Newsagents, Bookstalls and Dealers, or post free 7½d. (Subscription rates: Inland and Abroad, 7/6 per annum; Canada, 7/- per annum) from Geo. Newnes, Ltd., 8-11, Southampton Street, Strand, London, W.C.2.

Geo. Newnes, Ltd.

P. W. Gift Stamp No. 45

Printed by NEWNES & PEARSON PRINTING CO., LTD., Exmoor Street, Tadbroke Grove, W.10, and published by GEORGE NEWNES, LTD., 8-11, Southampton Street, Strand, W.C.2. Sole Agents for Australia and New Zealand: GORDON & GOUGH, LTD. South Africa: CENTRAL NEWS AGENCY, LTD. *Practical Wireless* can be sent to any part of the world, post free, for 17/4 per annum; six months, 8/8. Registered at the General Post Office for Transmission by Canadian Magazine Post.

ORDER NEXT WEEK'S ENLARGED SHOW ISSUE NOW!

Practical Wireless

3^d

Published every Wednesday by

**GEORGE
NEWNES
LTD.**

Vol. 2.—No. 47.

AUGUST 12th, 1933.

Registered at the G.P.O. as a Newspaper.

THE LATEST SPEAKERS REVIEWED



RECEPTRU

FOR TRUE RECEPTION

—the wonderful new low loss lead in cable definitely eliminates crackle, background noises, mush and all man-made static. It improves selectivity and increases sensitivity. Get one to-day. You can fix it in less than five minutes.

OF ALL DEALERS in lengths of 15 feet **10/-**

Longer sizes at proportionate prices.

BRITISH RADIOPHONE LTD., ALDWYCH HOUSE, LONDON, W.C.2

NEW!

The COSSOR Melody Maker

MODELS 341 & 342

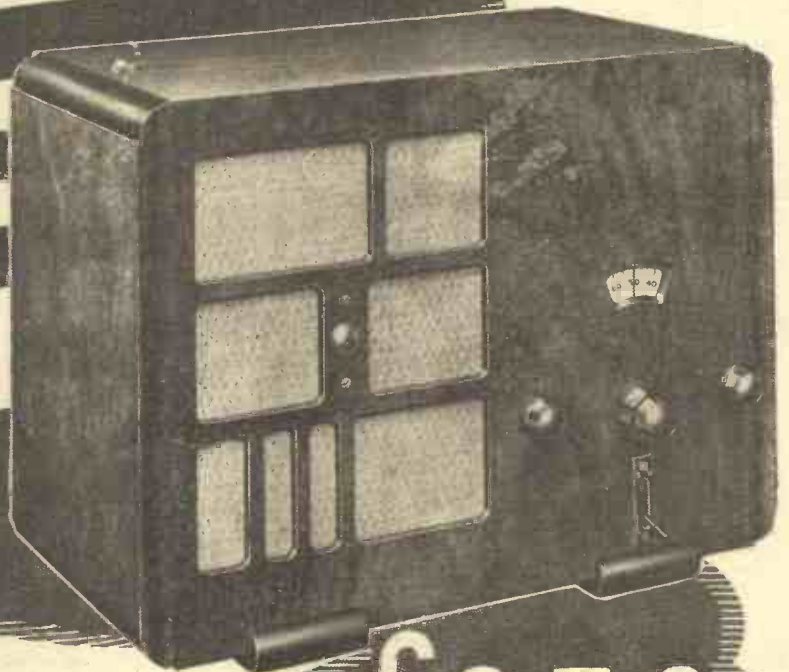
3-VALVES — PENTODE OUTPUT**VARIABLE-MU S.G. STAGE****ONE-KNOB TUNING****SELF-CONTAINED LOUD SPEAKER****£6=7=6**

You can now have all the advantages of a highly-priced Receiver for only £6. 7. 6.—the price of the Cossor Melody Maker (Model 341). This remarkable Set has Variable-Mu S.G. Stage giving "all-Europe" range and amazing selectivity—Pentode output for big, undistorted volume—all-metal chassis—combined volume control and "on-off" switch, etc.—every up-to-date feature of design. In spite of its many advantages the Cossor Melody Maker is so simple that you can assemble it yourself even if you know nothing about wireless. Send the coupon for a full-size Constructional Chart.

MODEL 341

Complete Kit of Parts for assembling Receiver as illustrated, including Cossor Variable-Mu Screened Grid, Cossor Detector, and Cossor economy Pentode Valves. Fully screened coils, Cossor Double-Gang Condenser, Blued, gun-finished all-metal chassis, and all the parts for simple home assembly. Handsomely finished cabinet 18½" x 13½" x 10" of modern design with space for batteries and accumulator. Balanced Armature Loud Speaker of the latest type: provision for gramophone Pick-Up Plug and Jack it required. Wave-length range 200/530 and 900/2,000 metres.

£6.7.6

Hire Purchase Terms 16/- deposit and 10 monthly payments of 12/6 or, alternatively, 20/- deposit and 6 monthly payments of 20/-

MODEL 342

Identical with Model 341 described above except that Permanent Magnet Moving Coil Loud Speaker is supplied.

£7.2.6

Hire Purchase Terms 17/6 deposit and 9 monthly payments of 15/6

COSSOR MELODY MAKER

BATTERY MODELS 341 & 342

Prices do not apply in I.F.S.

To A. C. COSSOR LTD., Melody Dept., Highbury Grove, London, N.5.
Please send me free of charge a full size Constructional Chart C. 16, which tells me how to build the Cossor Melody Maker (Models 341 & 342).

Name.....

Address.....

A. C. Cossor Ltd., Highbury Grove, London, N.5. Depots at Birmingham, Bristol, Glasgow, Leeds, Liverpool, Manchester, Newcastle, Sheffield, Belfast, Cardiff and Dublin.

♥ 3239

OUR STAND AT RADIOLYMPIA IS NO. 8 GROUND FLOOR!

ROUND *the* WORLD of WIRELESS

New Station for Czechoslovakia

AS according to the Lucerne Plan the Czech State was allotted a further channel—namely, 765 metres (393 kc/s)—the Government has decided to erect a high-power station on some site close to the Hungarian border mainly with a view to combat anti-Czech broadcasts.

Lugano via Sottens

RECEPTION of broadcasts from the Tessin transmitter on 1,143 metres is not always an easy matter for distant listeners in view of its close proximity in wavelength to Kalundborg (Denmark). From time to time we may be given an opportunity of hearing the Lugano programmes through an easier channel as now and again they will be re-broadcast through the Sottens stations.

Sofia's New Transmitter

THE 3 kilowatt station presented to the Queen of Bulgaria by the city of Rome is now being erected in the immediate neighbourhood of Sofia. It will work on 214 metres (1,402 kilocycles). The Bulgarian Government is seriously contemplating the erection of a 50 kilowatt transmitter on some favourable site in the country, in which case, when it is completed, the Sofia 3 kilowatt will only be used as a relay.

Yugoslavia Forges Ahead

IT is reported that the Belgrade Government has now definitely passed an order to the Marconi Company for a 40 kilowatt station to be built as early as possible. The entire broadcasting system is to be reorganized to bring it on a level with neighbouring States.

An Ultra-Modern Sanatorium

MUSSOLINI, who is an ardent radio fan, is anxious that broadcasting in Italy should be available to the entire population. In a recently opened sanatorium personal suggestions made by *Il Duce* for the benefit of patients have been carefully carried out by the authorities. A central receiving station installed in the building feeds headphones and loud-speakers throughout the establishment,

and even the terraces and gardens have been equipped with plugs in order to allow patients to hear radio and gramophone broadcasts. It is said to be the most up-to-date sanatorium in Europe.

What the Germans Think

GERMAN wireless papers do not publish the programmes of either Radio Luxembourg or of any of the Russian stations; almost unanimously they state as their

bulletins in German which do not always coincide with the official versions given out by Berlin!

Broadcast of Tidworth Tattoo

SPECIAL arrangements for the transmission of this show in the National programme last week had to be made by the B.B.C. engineers. In this instance, owing to the configuration of the ground, it was not advisable to place microphones in fixed positions as, the field being comparatively small, the grandstand tends to echo back the sound of the drums. A "mike" was therefore carried behind the Massed Bands and both it and its bearer were camouflaged in green, so as to make them inconspicuous against the wooded background. It is most probable that the spectators who were unaware of this hardly noticed the hooded object as it followed the musicians.

B.B.C. and Radiolympia

SOME alterations have been made in regard to the planning of the radio theatre on which the B.B.C. will stage an original revue and also variety hours during the course of the Exhibition at Olympia. As now designed the theatre will hold not 1,500 but 2,000 spectators at each performance. Moreover, admission tickets to these shows will be sold at the box-office (and will not be supplied by some stallholders) as was originally proposed.

German Interval Signals

THE Hamburg group of studios, following instructions issued by headquarters, has adopted new musical interval signals for its stations. Hamburg, in future, will broadcast between items a few notes from the Boatswain's song in Wagner's opera *The Flying Dutchman*; Hanover has adopted an old folk-song: *We Jolly Hanoverians*; Bremen, in its turn, reverts to a Frisian traditional: *When the North Sea waves are breaking on the strand*, and, finally, Kiel and Flensburg, when working from their own studios, will use an old German hymn which seeks to prove that Schleswig and Holstein are intimately related.

WE ARE EXHIBITING AT

STAND NO. 8.
We shall be At Home to Every Reader on Stand No. 8 (Ground Floor). A Qualified Technical Staff will be in attendance to answer readers' questions FREE OF CHARGE.

For Most Complete Show Guide order NOW next week's Greatly Enlarged Issue of PRACTICAL WIRELESS, dated August 19th, on sale August 16th.

A Complete Stand-to-Stand Report will be given in our Second Greatly Enlarged Show Issue dated August 26th, and on sale August 23rd.

opinion that, "as the former is mainly used for the advertising of foreign products, broadcasts on an arbitrarily chosen wavelength, and does not supply full details of its radio entertainments, they cannot be of interest to German listeners." As regards Russia, so long as their transmissions consist of Red propaganda the German Press does not consider that its subscribers can derive from such broadcasts either pleasure or benefit (*sic*).

Curiously enough, the local police authorities recently discovered a plot to blow up Radio Strasbourg, and a report states that a similar attempt was to be made on the Radio Strasbourg station. It should be explained that the latter broadcasts news

ROUND *the* WORLD of WIRELESS (Continued)

Testing Out Common Waves

THE Basle and Bern transmitters are now working on a common wavelength, the Basle channel (244.1 m., or 1,229 kilocycles); the experiment is being carried out in order to ascertain the practicability of using such common waves, as prescribed by the Lucerne Plan. So far as can be judged, unless both transmitters are crystal-controlled except within the actual "city range" of the stations, mutual interference has occurred.

Modernizing Sing Sing

EXPERIMENTS are to be made at Sing Sing prison (New York) with a low-power 5 metre transmitter and receivers for the use of the warders on their rounds. The apparatus is of a portable nature, weighing only six pounds, and can be carried as a military pack, the high-tension dry batteries contributing to the greater part of the weight. By this method it is hoped to enable the warders to keep in touch with the Chief Warden's office on their patrols through the penitentiary.

Moscow's Open-Air Radio Theatre

IN the central park of the capital, the Soviet authorities have installed a gigantic stage capable of providing space for two thousand artistes for the performance of open-air plays. Seats around this vast arena will accommodate an audience of twenty thousand spectators. It is proposed to relay these displays to the main broadcasting transmitters for the benefit of listeners throughout Russia.

Russia's New Radio Plan

THE Soviet is now considering the construction of a 1,000 kilowatt transmitter, having regard to the success achieved by the 500 kW. station recently built at Moscow-Noghinsk. In addition to this *super*, Russia already possesses five others rated at 100 kilowatts, and fifty-six of power ranging from 2 to 25 kilowatts. In that country the State is the sole supplier of wireless receivers of which, according to the latest statistics, there are already three million in use. They are turned out at the rate of 600,000 sets per annum. The policy to be adopted in future will be that of erecting more powerful transmitters with a view to the making of simpler and less expensive receivers. By doing so the State hopes to increase the production to some one and a half million yearly.

Listen While You Drive

AUTOMOBILE radio has definitely caught on in the United States, where, during 1932, 143,000 receivers were specially built for motor-car owners. At the factories it is estimated that 86 per cent. of the cars constructed this year will be supplied complete with special roof aerials. All sets are provided with remote control affixed to the steering wheel, and are designed for sharp tuning, the majority embodying a super-heterodyne circuit. As there are at present 20,000,000 car-owners in the United States, American manufacturers consider the 1933-1934 prospects very favourable to the radio trade.

INTERESTING and TOPICAL PARAGRAPHS.

Piccard's Next Attempt

PROFESSOR JEAN PICCARD, in the United States, hopes to break his twin brother's altitude record in the

THE NEW B.B.C. WOMAN ANNOUNCER.



FIRST WOMAN B.B.C. ANNOUNCER. Mrs. Giles Borrett, who has been appointed B.B.C. announcer at Broadcasting House, London. This is the first time in the history of British radio that a woman announcer has been employed. Mrs. Borrett is the wife of a naval officer and has acted in various radio plays under an assumed name.

stratosphere this summer. On this occasion the balloon will be equipped with both transmitting and receiving radio apparatus to enable him to broadcast a running commentary during the ascent. The weight of the complete radio equipment will not exceed 100 lbs. Transmission with a power of three watts will be carried out on 15,760 kilocycles, the receiving set being tuned to 6,100 kc/s. As the flight, which is to be made from Chicago, may last twenty-four hours, all stations of the National Broadcasting Company's network will stand-by for the reception of signals and Piccard's description of the experiment. Every effort is to be made to secure two-way communication with the aviator when he reaches his highest altitude. The broadcast will probably be taken by all American and Canadian medium and short-wave stations and will be relayed to Europe through the usual Rocky Point channels.

Have You Logged La Paz?

REPORTS on reception of the new Bolivian short-wave broadcasting station at La Paz have already been made by listeners in the British Isles. The transmissions—a relay of the main station working on 500 metres—are effected during the day on 19.61 metres, and at night on 49.3 metres. Announcements of items as well as the call will be heard in the Spanish language only. All reports for confirmation should be sent to *El Comité Ejecutivo pro Radio, La Paz, Bolivia, South America.*

On Top of the Himalayas

POSSIBLY within the next year a monastery similar to that established in Switzerland by the monks of St. Bernard may be opened on the Si-La territory between India, China, and Tibet on one of the highest points of the Himalayas dominating the junction of important native trade routes. Owing to fog and heavy snow-falls, many lives are annually lost in this mountainous district, and the monks hope to offer assistance to travellers. A fully equipped transmitting and receiving radio station will be installed in the monastery to permit two-way communication with the outside world.

Stringent Laws in Czechoslovakia

TO resist propaganda broadcast by the neighbouring German stations, the Czech authorities have decreed that political speeches if heard by their nationals may not be transmitted to the outside public by means of loud-speakers. The breaking of this rule not only results in a heavy fine, but also entails the confiscation of the transmitter's wireless apparatus.

British Wireless for Norway

IN connection with the re-organisation of the Norwegian broadcasting system, a second Marconi broadcasting transmitter has been ordered by the Norwegian Government for erection at Bergen.

The new station will have a power of 20 kilowatts in the aerial, similar to that ordered last month for installation at Trondhjem.

SOLVE THIS!

PROBLEM No. 47.

Bradley bought a set of commercial ganged coils and a ganged condenser, and built up a receiver strictly in accordance with the instructions supplied with the coil. The range of the coils was such that he should have heard Fécamp, but when the set was put into use he found that the lowest setting of the condenser was just above Fécamp, and he could not, therefore, hear this station loud enough. Why was this? Three books will be awarded for the first three correct solutions opened. Address your envelopes to The Editor, PRACTICAL WIRELESS, Geo. Newnes Ltd., 8-11, Southampton Street, Strand, W.C.2, and post to reach us not later than August 15th, 1933. All envelopes should be marked Problem No. 47.

SOLUTION TO PROBLEM No. 46.

The fixed condenser used in Jackson's output filter circuit was defective and was short-circuited inside the casing. This resulted in the H.T. supply being short-circuited through the circuit made up from the output choke and loud-speaker windings in series.

The following two readers received books in connection with Problem No. 45:—

E. G. Jackson, 64, Clapham Road, S.W.9.
B. L. Stuart, Brinnington Hall Lodge, Brinnington, Stockport.

THE LATEST LOUD-SPEAKERS REVIEWED

By W. J.
DELANEY

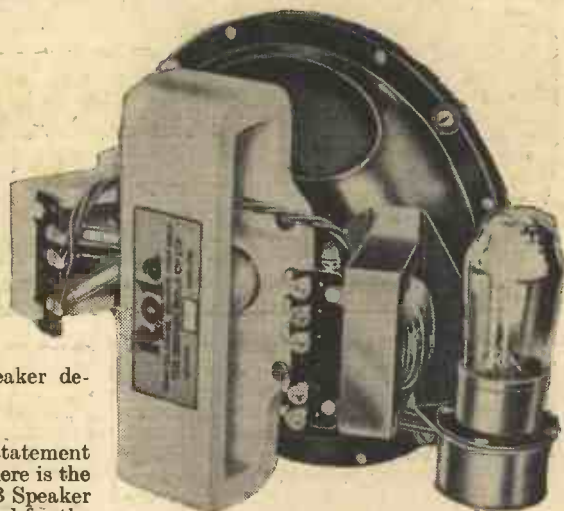

A Description of Some of the Changes Which Have Taken Place in Design and Construction During the Past Year.

NO fundamental change in design has taken place during the past year so far as the domestic loud-speaker is concerned. That is to say, the principles which are adopted to enable music and speech to be reproduced in the home from the broadcast receiver are exactly the same as they were a year ago. In every case a conical diaphragm is caused to vibrate, either by means of a magnetic armature attached to the apex of the cone, or by means of a coil of wire attached to a short cylinder which takes the place of a "point" on the cone. In the latter case the speech currents which come from the output valve are passed through the small coil, and this is suspended in a magnetic field, and the interaction of the magnetic lines of force and the varying speech currents causes the cone to be moved backwards and forwards, and so give rise to a reproduction of the sounds which are received by the broadcast apparatus. This is, of course, all old news to the majority of our readers, but they will wish to know what changes have taken place during a year which probably has seen more changes in wireless technique than any year which has yet passed. We have had, for instance, radical changes in practice and design in valves, coils, and transformers, but the speaker is, in principle, exactly the same as it was last year. Obviously, small changes have been introduced into manufacturing processes, and into the "mechanism," if it can be so called, but the fundamental principles are exactly the same, and there has been no

new type of speaker, or speaker development, introduced.

Midgets

Perhaps to some my last statement would appear to be wrong. There is the Midget speaker and the Class B Speaker Unit which are being introduced for the Exhibition this year. Surely, these are developments? Well, they are in one direction, but they are only the same types of speaker which we have had during the past twelve months, and except for being smaller in the one case, and built complete with an amplifying stage in the other, they are still the same in principle. However, let us examine these in turn. Taking first of all the Midget, what is this for? The introduction of car radio, and the probable introduction of the Midget receivers (which are already popular in America), has led to the necessity for a very small loud-speaker which is capable of giving fairly good reproduction. Obviously, it should be quite a simple operation to take a standard loud-speaker, and, by making every part half its size, produce a speaker which is a replica of the original standard loud-speaker. Would it work, however? I am afraid not. It is true it would make a noise, but so far as reproducing music is concerned we would get a poor travesty of the original. There are several important features which have to be borne in mind when designing a speaker with a total overall diameter of only 6ins. or so. You no doubt all know that the size of the diaphragm governs the kind of reproduction which is given by the speaker. To enable a really low organ note to be reproduced a very large and slow movement of the air is necessary, and for this reason best reproduction of a note of this sort is given by a large cone which is very freely suspended. The tiny cone will be too stiff to give a slow, easy movement such as is required by the very low musical notes, and accordingly it will fail to give them their full strength. On the other hand, the high notes, which demand only a short, quick movement, will be most readily dealt with by the small cone, and, therefore, it is safe to assume that a small cone will, normally, tend to give a high-pitched, unbalanced reproduction. This is where design comes in, and you can see now why the real midget loud-speaker has been so long in arriving. The Midgets which are obtainable now, and these include the Amplion "Sonette," the Rola Midgets, the Gramplan Midgets, and others, have been carefully designed, and the weight of the diaphragm, the size of the speech coil, and all the other parts which lead to the determination of the overall response, have been so chosen that the reproduction is really of a high standard. We naturally cannot expect such a speaker to handle 5 watts, but the Midgets which have so

far been brought to my attention will definitely handle the output from a Class B valve or a similar rated mains valve, delivering approximately 2 watts, and the results are really good. If you are thinking of building a small portable, either for general use, or for the car, one of these speakers will prove ideal, as it will enable a high standard of reproduction to be obtained and permit of really good volume for open-air dancing, etc. The Gramplan Company have produced some special balanced pairs of Midgets. As I pointed out above, the large cone deals easily with bass notes, whilst the small cone will fail to handle such notes as easily as the top notes. Accordingly, it is fair to assume that by using two speakers, one designed to cover the lower half of the musical scale, and the other to deal with the upper half, we should get a fairly straight-line curve, and in practice this has already been done by Celestion, Rola, Magnavox, and one or two other firms who specialize in loud-speakers. The new Gramplan Midget pairs measure only just over a foot in length, and are approximately 3ins. deep. The characteristics of the two speakers are well chosen, and give a really remarkable output.

Class B Speaker Units

The remaining development in new speakers is the combination of a complete Class B amplifying stage with a good moving-coil loud-speaker. In previous articles dealing with Class B amplification it has been pointed out that, in addition to giving an output of approximately 2 watts, this type of valve delivers really high quality, and owing to the absence of any grid-biasing adjustments, etc., it is possible to get the best from the L.F. stages with very little effort. The standard is so high, in fact, that one is justified in using a really high-class moving-coil loud-speaker.

It is now possible to obtain the new speaker in such a form that the existing receiver may be used, and by the simple addition of the speaker unit, the present apparatus is converted to a powerful receiver of the type you have always admired. The Class B stage looks after the quality of the output, and the moving-coil speaker handles the signal and does full justice to the volume and quality which is delivered to it. Whatever type of Unit is purchased, you may be sure of getting really fine results, and the Ferranti, the Rola, the Gramplan, and others are available for your choice.

Olympia Radio Show

Tuesday, Aug. 15th to Thursday,
Aug. 24th. 11 a.m. to 10 p.m.

Two Special Enlarged Numbers

of

Practical Wireless

August 19th issue

COMPLETE GUIDE TO THE SHOW

A Forecast of the Exhibits, in
At-a-Glance-form, with a guide to
the Show alphabetically arranged.

August 26th issue

STAND-TO-STAND SHOW REPORT

A comprehensive report on each
exhibit by our Technical Staff.

Order These Issues Now!

Measuring Radio and Audio Frequency Voltages

It is quite an easy matter to make voltage measurements in a circuit where only direct current is present, but to determine the A.C. voltage between two points is quite a different matter, especially when, as is the case with radio measurements, the frequency may be anything from ten to ten million cycles per second. Whilst the moving-coil meter finds extensive use in direct current measurements, it is quite useless where A.C. is concerned; most of the types of the popular moving iron instrument are equally valueless, though some of these are designed for low-frequency A.C.

There are three instruments of the type mentioned above, that is, instruments where the quantity to be

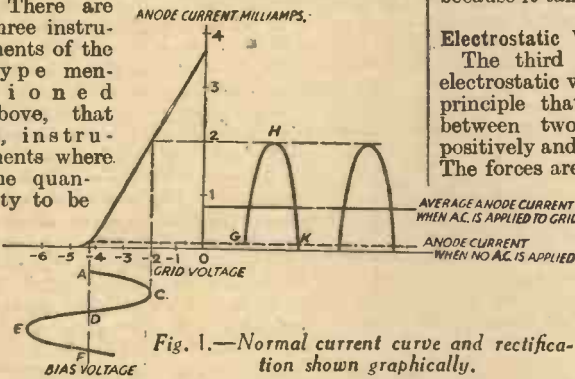

Fig. 1.—Normal current curve and rectification shown graphically.

measured is read off from a pointer and scale, which can be used with A.C., but they are, unfortunately, not suitable for both radio and audio frequency measurements.

The first of these is the rectifier instrument, in which the current is rectified by a metal oxide rectifier and is then passed through a D.C. instrument. This is probably the most useful and accurate type of A.C. meter, as it has many of the good

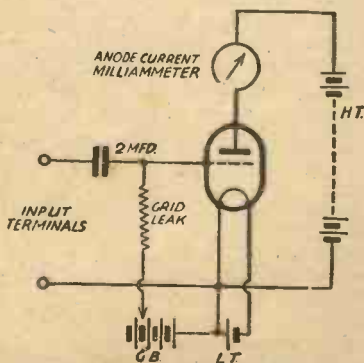

Fig. 2.—A simple valve voltmeter.

properties of the moving-coil instrument; it is, however, only of use up to frequencies of about 5,000 cycles, since the metal rectifier does not rectify to the same extent for frequencies above this and the readings of the scale become inaccurate.

An Article Dealing with the Different Types of Instrument Used. By G. L. GRIDALE

Thermo electric meters may be used on any frequency, since they merely measure the heat produced in a wire when a current to be measured is passed through it. The heating effect is the same for a given current at any frequency, but the meter cannot be used for voltage measurements, because it takes so much current.

Electrostatic Voltmeter

The third type of A.C. meter is the electrostatic voltmeter, which works on the principle that an attractive force exists between two conductors when one is positively and the other negatively charged. The forces are always very small and large voltages must be used to produce a deflection of the needle. The electrostatic meter can only be used accurately with potentials of some hundreds of volts, and for high voltage measurements it is ideal, as it takes no current.

All these instruments have one or more properties which make them unsuitable for our purpose. Fortunately, however, there is quite a simple device available, and that is the valve voltmeter. This will quite accurately measure A.C. of practically any frequency, the precision being governed by the precision of the D.C. measuring instruments involved and by the constancy of working conditions. The great quality of the valve voltmeter is that it takes very little power from the circuit to which it is connected, that is, it has a high impedance. It is well known that makers of voltmeters state the number of ohms per volt of their instruments, and that the better the instrument, in general, the greater the resistance per volt. The statement is equivalent to stating how many amperes are taken by the instrument on full-scale deflection. For 100 ohms per volt we know that a full scale deflection will take one-hundredth of an ampere or 10 milliamperes. So the resistance of a voltmeter for D.C. must be high and in the same way the impedance of an A.C. instrument should be as large as possible.

The general principle of all valve voltmeters is the same, though there are numerous variations to the circuit. The A.C. voltage to be measured is applied to the grid circuit of the valve and this is arranged like an anode bend detector and

the change in plate current is either observed or compensated by a grid-bias change.

In the simplest type of voltmeter the grid-bias is kept at a constant value. Fig. 1 shows a curve of anode current

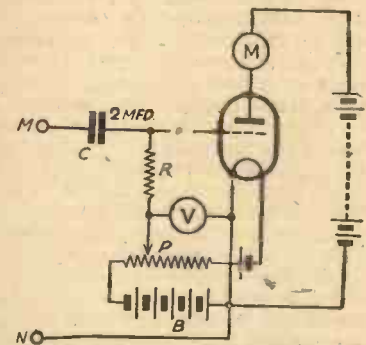

Fig. 3.—The Moulin valve voltmeter.

variation with grid bias, the common characteristic curve of a valve. The valve is biased to the point marked A, nearly to the current cut-off point, just as Q.P.P. valves are biased. Now the A.C. voltage is applied to the grid. If we follow this through the cycle starting at A and increasing to C, we find that the anode current also increases from G to H; continuing through the cycle the grid voltage decreases again to the old value and the anode current also returns nearly to zero, to the point K. This completes half of the cycle, and so far the anode current has increased with the grid voltage. But now

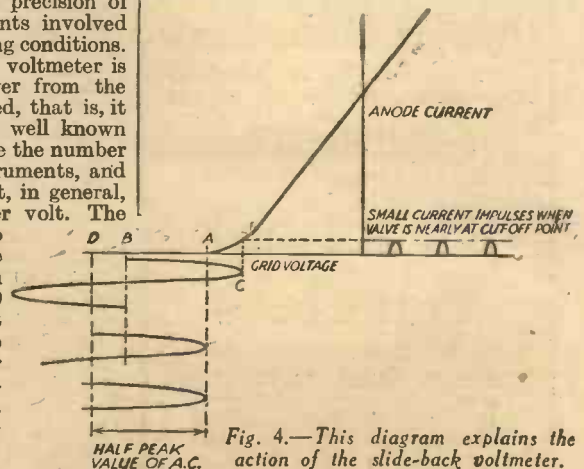
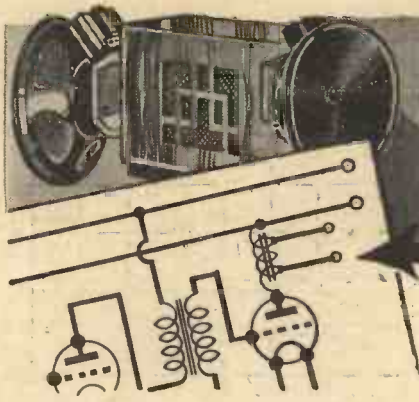

Fig. 4.—This diagram explains the action of the slide-back voltmeter.

we have to consider what happens when the grid swings still more negative. The voltage is carried right back past the value for zero anode current and the anode current cannot become negative so that it just stays at zero whilst the grid completes

(Continued on page 666)



Speaker Matching Pointers

By H. J. BARTON CHAPPLE, Wh.Sch., B.Sc., A.M.I.E.E.

TWO phrases which are cropping up constantly in radio journals are "the optimum load of an output valve" and "speaker matching." These have a very special significance and readers cannot have their attention drawn too frequently to them if "quality" is to be the real aim of the set user. The first phrase means that in order to obtain the maximum output from your set the impedance of the apparatus (loud-speaker and so forth) connected in the anode circuit of the output valve must at any rate be approximately equal to an "optimum" or ideal value, which depends upon the type and characteristics of the valve used.

The implication of the phrase "speaker matching" is that if the impedance of your speaker differs greatly from the optimum load for your output valve, matters must be adjusted by the use of a suitable output transformer or tapped choke, or distortion will arise. It is in this connection that the amateur frequently encounters difficulty, for in order to determine accurately the correct ratio for the output transformer, it is necessary to know the optimum load for the valve and the impedance of the loud-speaker, and then to perform a mathematical calculation which, although fairly simple in itself, is apt to puzzle those whose maths have become a bit rusty.

Optimum Load

In order to assist readers over this problem I propose to discuss briefly why each valve has its "optimum" load value, how a transformer can "match up" a speaker to a valve, how the essential calculation should be made, and, finally, to submit various methods whereby this calculation may be simplified to a considerable degree.

To begin with, then, why is there an "optimum" or best value for the load in the anode circuit of an output valve? You will, of course, agree that the power output of a valve is represented by multiplying together the effective variations in the anode current of the power valve and the value of the effective A.C. voltage drop across the load. In the case of a simple set the load is the speech winding of the speaker. It should also be clear to you that if the impedance of the speaker (that is, the opposition it offers to varying currents) is very small compared with the impedance of the valve itself, the voltage drop across

the speaker will also be small, and naturally the power expended in the speaker will be small.

The relation between the output and the load impedance for a given valve can be calculated, and can also be determined experimentally. If corresponding values of load and output be plotted on squared paper, the resultant curve will be of the form shown in Fig. 1. Here, you will observe, at low load values the output is small, as we would expect, but the output increases fairly rapidly as the load is increased. Beyond a certain load value, however (A in Fig. 1), the increase of

percentage distortion of output for different outputs. For a definite set of conditions, that is, grid bias, anode voltage and load, the output of a valve depends upon the strength of the signal voltage applied to its grid. As the characteristic curve of the valve is not quite straight, there will be a certain amount of distortion, and the distortion will be greatest at full output, because in order to get this full output the grid swing will cover more of the curved portion of the characteristic. Thus you will see that the distortion curve indicates greater distortion at big output than at low output.

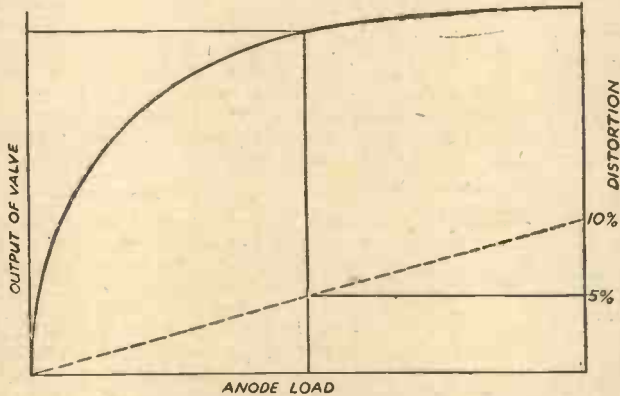

Fig. 2.—The relation between output and load with the addition of distortion curves.

It has been found by experience that as much as 5 per cent. distortion can be permitted without seriously impairing the quality of reproduction, so the published "optimum" load is selected as that value of load impedance which gives the biggest output consistent with reasonably small percentage distortion. In the curve reproduced in Fig. 2 the optimum load would probably be taken as A, for with this value practically the maximum possible output is obtained, and the distortion is within the limit of 5 per cent.

It may here be remarked that the distortion curve plotted in Fig. 2 is the second harmonic distortion curve. In the case of a pentode output valve the third harmonic distortion is likely to be

more serious than the second harmonic, and must be taken into consideration when deciding upon the optimum load.

Adjusting Matters

We must now consider why an output transformer can adjust matters if the impedance of the loud-speaker does not happen to be more or less equal to the optimum load. First of all, what is the impedance of the speaker? It is not necessarily the resistance of the speech winding. The opposition the winding offers to alternating current is different from that which it offers to direct current, and, moreover, is different for every frequency. It is usual to use, for the purposes of calculation, the impedance at a definite frequency—usually at 1,000 cycles. This figure is quoted by most speaker makers in their catalogues and leaflets. In some cases, however, the resistance only is quoted. In that case you will not be far wrong if you consider the impedance of a moving iron speaker to be the same as its resistance, and of a moving-coil speaker to be about one and a quarter times its resistance.

If the speaker impedance is (Continued overleaf)

output with increasing load is not so great, while after reaching the point B, further increase in load impedance makes little or no appreciable improvement in the power output.

Distortion

It would appear, therefore, as if any value of load impedance between, say,

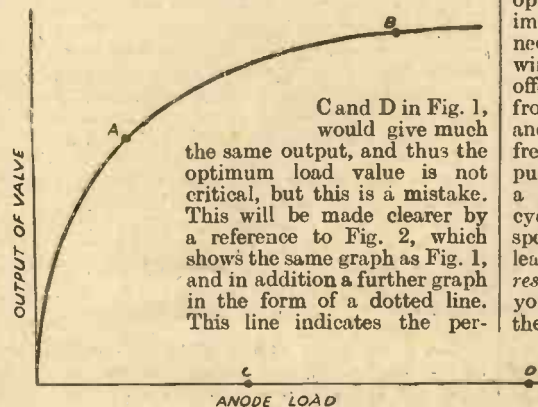

Fig. 1.—A curve showing the relation between output and load.

C and D in Fig. 1, would give much the same output, and thus the optimum load value is not critical, but this is a mistake. This will be made clearer by a reference to Fig. 2, which shows the same graph as Fig. 1, and in addition a further graph in the form of a dotted line. This line indicates the per-

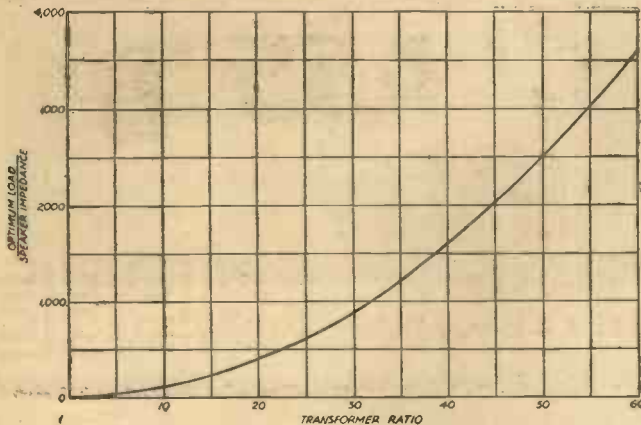

Fig. 3.—A matching chart for low-resistance speakers.

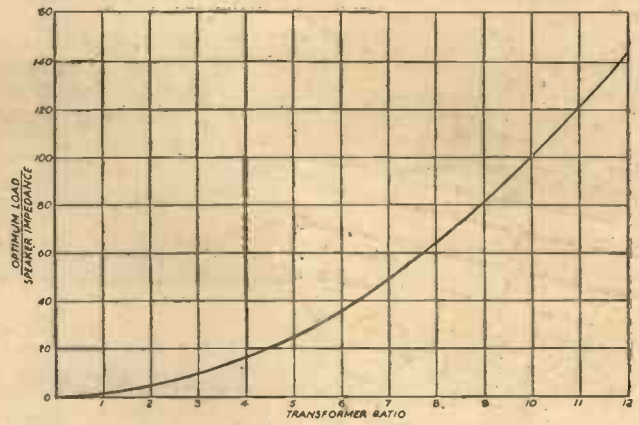

Fig. 4.—A similar chart to Fig. 3, but for high-resistance speakers.

SPEAKER MATCHING POINTERS

(Continued from previous page)

greatly different from the optimum load for the valve with which it has to work, a transformer of suitable ratio must be used to balance matters. The primary winding of the transformer is connected in the anode circuit of the valve, and the speaker is connected in the secondary circuit of the transformer. If the turns ratio of the transformer is correctly chosen, the primary winding will form a suitable load for the valve, while the speaker winding will form a suitable load for the transformer. The correct value of the ratio of the output transformer is calculated from a formula. I will not worry you with a long explanation of how the formula is deduced, but will give it to you right away:—

Transformer ratio=

$\sqrt{\frac{\text{Optimum load of valve in ohms.}}{\text{Impedance of speaker in ohms.}}}$

For those who are not mathematicians, I must explain that this means that to ascertain the correct ratio you divide the optimum load of the valve by the speaker impedance, and find the square root of the result. The answer to this little sum is the accurate value of the transformer ratio.

Of course, in many instances the result will be an awkward number like 1.82, or something similar. There is no need to try and purchase a transformer with an odd sort of ratio like that, for the actual value is not quite so critical, and the nearest standard ratio to the figure you obtain from your calculation will in many cases be found satisfactory.

Helpful Data

For the convenience of non-mathematical readers, the graphs reproduced in Fig. 3 and Fig. 4 have been prepared. To use these graphs, all you have to do is to divide the optimum load by the speaker impedance. Then find a point on the upright scale of Fig. 3 or Fig. 4 corresponding to the result of your division. Follow this point horizontally across the paper until you meet the curve, and then follow the point downward until you meet the horizontal scale at the bottom, on which you can read off the correct transformer ratio. Two curves are provided, one for use when the result of the division is comparatively small, say under 150, and the other for higher values up to 4,000.

MEASURING RADIO AND AUDIO FREQUENCY VOLTAGES

(Continued from page 664)

the second part of the cycle. The anode current thus follows out the positive half of the cycle, but remains at zero for the negative half. If we were to place a meter in the anode circuit and put very low-frequency A.C. on the grid, we should see the anode current first rise and then fall back to zero, where it would remain for half a period. The cycle would then be repeated. In practice the meter does not fluctuate up and down, but shows a steady average reading. When the A.C. is applied the current rises to some value and this value is determined by the voltage of the A.C. and it depends in no way upon the frequency. The voltmeter must be calibrated from known A.C. voltages, and this is one of its great disadvantages, for the battery voltages must be kept absolutely constant or the calibration will change.

Slide-back Valve Voltmeter

In order to overcome these difficulties, a second type of valve voltmeter is used, which is called the slide-back valve voltmeter by virtue of the fact that the grid bias is not kept constant but is slid back in order to compensate the increase in anode current when the A.C. is applied to the grid. The circuit of the instrument is shown in Fig. 3; the grid bias is applied through the grid-leak R from the potentiometer P and battery B. The grid bias is read off on the voltmeter V. Switches have been omitted from the diagram for the sake of simplicity.

The mode of action is as follows. The valve is biased till it just takes zero current and the A.C. is applied in the same way as before, but instead of noting the increase in the anode current we alter the setting of the potentiometer until there is once again just no current. The difference between this bias and the previous no-current bias is half the peak value of the A.C. voltage. An examination of Fig. 4 will show why this is so. When there is no A.C. the valve must be biased to A for cut-off of anode current. The A.C. is then applied and the current rises as before. Then the bias is increased. With the bias at B there will still be slight humps or impulses of anode current when the A.C. swings the grid voltage past the cut-off value at A; though these humps are quite small, they result in a small average anode current and this will remain until the bias is increased so much that the A.C. does not swing the grid voltage past A. When this is true the peak will reach just to A, which was the previous cut-off value. The increase in bias necessary thus gives the semi-peak value of the A.C. If the RMS value is required this must be multiplied by 1.41. It should be noted that in the above explanation the grid bias means the bias from the battery, as indicated by the voltmeter, and the grid voltage is the actual voltage of the grid at any time. Though the grid bias is constant for any one setting, the grid voltage is constantly changing, due to the superimposed A.C.

The advantages of the slide-back voltmeter are that it gives the voltages directly from the readings of a voltmeter without the use of any calibration curve, the valve and batteries and the anode meter being

mere indicators. The chief disadvantage is the matter of initial expense, since two meters are necessary, and one of these must be very sensitive for use in the anode circuit. The range should be as low as possible. The meter V should be of such a size that it will cover the A.C. range required. A two-range meter is better here. The valve should be chosen to have as great a slope as possible near the cut-off point.

High and Low-frequency Oscillator

To find the A.C. voltage between two points the terminals of the meter are joined to the points by two pieces of wire, which should be as short as possible. A high and low-frequency oscillator is a useful accessory to the voltmeter. With these two pieces of apparatus the amplification of a valve or a complete amplifier can be obtained simply by measuring the voltage going into the grid and that coming out of the plate. A D.C. voltage does not affect the working of the voltmeter, since there is a large blocking condenser in the grid lead. The output voltage of a valve can be found by connecting the voltmeter directly between plate and filament. A constant input such as that from a valve oscillator must be used, but the B.B.C. tuning note might be used if the oscillator is not available. The tuning note is often on for five minutes or more, and this is enough time to get a quick set of readings on a receiver if done with care. A valve oscillator is much better, though.

It should be noted that the valve voltmeter can also be used as a valve tester if the meter M can be used with a shunt to read up to 20 milliamperes or so.

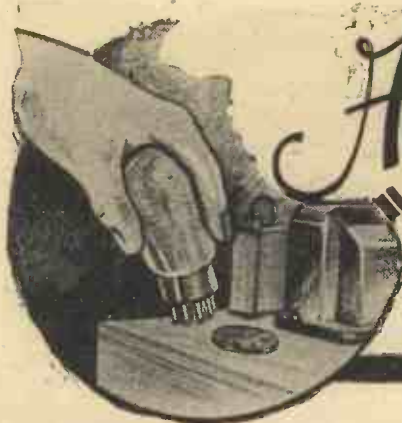

Adding CLASS "B" to the "SELECTONE" THREE

IN designing the "Selectone" 3-valve receiver some months ago I had in mind the production of a first-class up-to-date battery set which could be built for a modest sum. My expectations were more than justified by the results obtained and many readers have testified to the excellence of the instrument. I, personally, was so pleased with the "Selectone" that I have used it in my own home as a standard broadcast receiver ever since it passed through its final tests. The receiver has proved more than satisfactory in every way, but with the introduction of Class "B" it was decided to keep the set up-to-date by modifying it to include the latest system of amplification.

Having two low-frequency stages, the "Selectone" is particularly well suited to Class "B" and the change-over is both simple and inexpensive. Briefly, all that is required is to replace the third (power) valve-holder by a 7-pin component, exchange a special "driver" transformer for that used to couple the second and third valves, and fit a suitable output choke. The total cost of the modification, exclusive of the Class "B" valve, may be as low as 28/-, but for another 1/6 (the price of a fixed condenser) the refinement of tone control can be included.

Advantages of Class "B."

The set in its new form, that is with the inclusion of Class "B," is even better than before, and the volume of really pure reproduction of which it is now capable is tremendous. As you know, the Class "B" valve gives an undistorted output of about 2 watts which, compared with the original output of about 120 milliwatts, is really enormous. In point of fact, the actual signal output from the loud-speaker is equal to that to be obtained from a powerful mains receiver using an A.C. pentode in the final stage. It might be argued that so great a volume is never required in the house, but it is often a distinct advantage, particularly when it is combined with purity of an order that has probably never before been experienced by the user of a battery set. Quite apart from the maximum volume to be obtained,

This Article Explains How Any 2-L.F. Receiver may be Modified to Include the Latest Development in Low-frequency Amplification, and Takes the "Selectone" as a Typical Example. By FRANK PRESTON, F.R.A.

however, it must be remembered that Class "B" does actually provide a greater degree of amplification than do other systems, so that weaker and more distant stations which were previously quite weak are brought up to enjoyable programme strength.

More Power Without Extra Cost.

At first sight it would appear that the extra volume must be paid for in the way of high tension current, but this is not necessarily true, because the new valve is

Reducing H.T. Consumption.

By cutting down the H.T. to 100 volts the current consumption is reduced to less than 8 milliamps, although the undistorted signal output is still more than 1 watt, or equal to that of a mains receiver of the smaller type. These figures speak for themselves and there is no reason why I should comment on them! It should be pointed out that the one slight disadvantage of Class "B," is that the consumption of low tension current is increased from .4 to .7 of an ampere, but so long as the accumulator is of reasonable capacity this is of very little consequence.

If great economy of current is particularly required it can be obtained by using the 210 H.L. valve instead of the P. 220 as "driver." This will cut down the maximum speaker volume to a certain extent, but even so an output of very nearly 1 watt is still within reach when using 90 volts high tension. The average H.T. current under the latter circumstances is not much more than 6 milliamps, and can therefore be derived from the smallest type of battery.

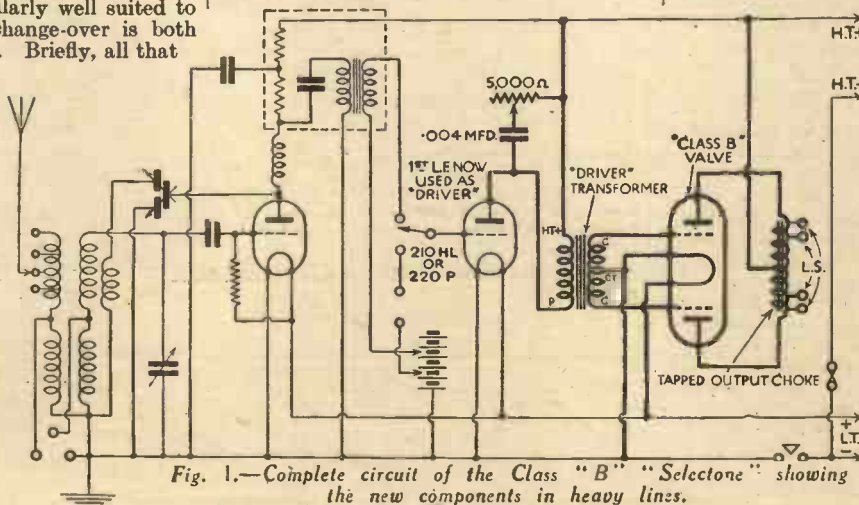

Fig. 1.—Complete circuit of the Class "B" "Selectone" showing the new components in heavy lines.

distinctly more efficient than other types. In other words, it will give a greater output for any given input. By way of being more precise I will state the actual measured anode current of the modified "Selectone." When using the P 220 power valve in the "driver" stage and with a total high tension voltage of 120 (a combination which gives nearly 2 watts output on stations up to ten miles or so) the total current taken from the high tension battery when the set is not tuned to a signal is just about 8 milliamperes, or rather less than that required by the valves previously employed. After tuning in a strong signal the current rises to an average value of approximately 11 milliamperes. This is just 1 milliamp more than the current taken originally, despite the fact that the signal output is increased fourteen-fold.

The Necessary Alterations.

And now we can turn our attention to the question of carrying out the necessary modifications. It should first be explained, however, that although these remarks will be directed principally towards one particular receiver the actual method of procedure will apply just the same to the conversion of any set having two low-frequency stages.

In Figure 1 you can see the complete circuit of the modified "Selectone," but in order to make the alterations quite clear the new components and wiring are drawn in heavy lines, whilst the part of the circuit which remains unchanged is shown faintly. Even at a first glance it is obvious that the changes are few in number and involve less than a dozen connections.

(Continued overleaf.)

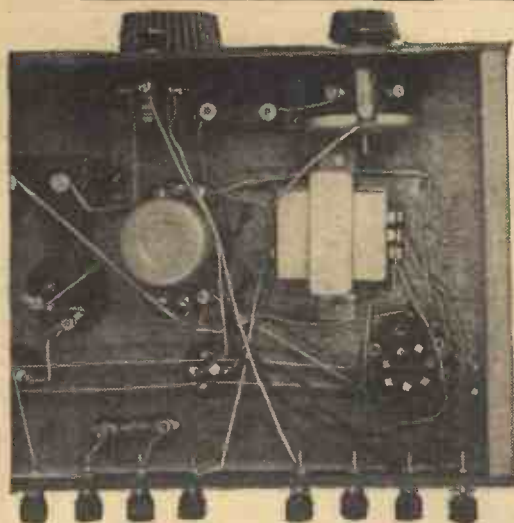

Fig. 3.—This photograph shows the "driver" transformer and new wiring.

(Continued from previous page.)

If you compare this diagram with the original one reproduced on page 768 of "Practical Wireless" No. 16 you will see that the "Rectatone" transformer has been substituted by a special "driver" transformer. A 5,000 ohm variable resistance was previously connected across the "Rectatone" to provide tone control, and the same resistance is now used in conjunction with a .004 mfd. fixed condenser for a similar purpose. The secondary winding of the "driver" feeds the grids of the Class "B" valve and its centre-tapping is taken to H.T.—. So that the original speaker—or any other standard type for that matter—can be employed, a tapped choke is used in the output circuit. The choke is one specially designed for Class "B" and has the necessary total impedance of 8—10,000 ohms under working conditions. It provides three output ratios of 1.5 : 1, 2 : 1 and 2.5 : 1; the Class "B" valve can thus be matched to any type of speaker, preferably a moving-coil or inductor dynamic. When the speaker is designed for use with an ordinary power valve it should be connected to the terminals which give a ratio of 2 : 1, or if it is of the "pentode" type it will be joined to the terminals which provide a 1.5 : 1 ratio. The Celestion "Soundex" loud-speaker specified for the original receiver has a tapped transformer which can be matched to either power or pentode valves, but slightly better results seem to be obtained by using the "pentode" tapplings. You can, however, try it both ways and make your own comparisons.

New Components Required

- The few extra parts required are :—
- One Benjamin Class "B" transformer.
- One Benjamin 7-pin valve-holder (for chassis mounting).
- One Varley Class "B" output choke.
- One Cossor "240B" valve.
- One .004 mfd. T.C.C. fixed condenser (if tone control is required).
- Short length "Glazite" and flex.

Practical Details

In commencing to modify the set the first thing is to disconnect all wires from the third valve-holder, "Rectatone" transformer and tone-control resistance; also remove the wire joining terminals "L.S.+" and "H.T.+" The former two components can then be removed entirely. Next, the hole in the baseboard from which the valve-holder has been taken must be enlarged from 1 1/4 in. to 1 1/2 in. diameter to receive the

Fig. 2. (below)—This wiring plan shows all the new connections required when adding Class "B" to the "Selectone." Compare it with the full plan given on page 808 of "Practical Wireless" No. 17.

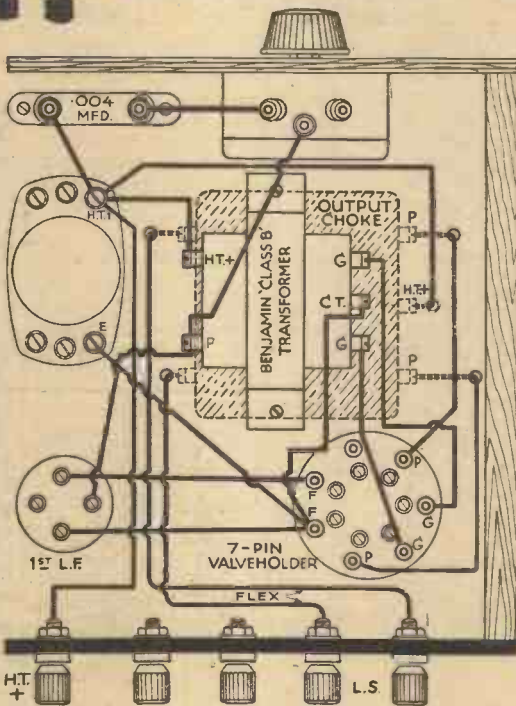

Type of "Driver" Valve	High-Tension Voltage					
	90		108		120	
	G.B.—	G.B.—1	G.B.—	G.B.—1	G.B.—	G.B.—1
210 H.L. ...	3v.	1 1/4 v.	3v.	1 1/4 v.	4 1/2 v.	3v.
220 P. ...	7 1/2 v.	0v.	0v.	7 1/2 v.	9v.	7 1/2 v.



Fig. 5.—A general view of the Class "B" "Selectone."



Fig. 4.—Here we see the output choke and the enlarged hole for the 7-pin valve-holder.

larger 7-pin holder. This little job can be done most easily by means of a half-round file. The valve-holder can then be mounted in position by screwing it to the underside of baseboard with the terminals arranged as shown in Fig. 2; it will be noticed that the filament terminals (the two which are closest together) are toward the second valve-holder. The Class "B" transformer is now attached to the underside of the baseboard, in the position indicated in the wiring plan, and photograph, and, if tone control is to be included, the .004 mfd. condenser may also be screwed in place.

Now turn the chassis over and attach the output choke on top of the baseboard. Its position is clearly shown in Fig. 4, and it will be found that this component fits nicely between the grid-bias battery, tuning condenser and valve-holder. Before wiring can be proceeded with, five 1/4 in. holes must be made through the baseboard near the terminals of the output choke; these are clearly shown in Fig. 2.

Simple Wiring

The wiring is straightforward enough, as you can see from the plan of Fig. 2; this drawing shows only the new wires, and all others will remain exactly as before. All connections except two are made in Glazite, but those from the speaker terminals to the output choke are in flex so that they may easily be transferred to alternative terminals when different output ratios are required. In Fig. 2 the 7-pin valve-holder is shown as having terminals, whilst that illustrated in the photographs is fitted with soldering tags only. This difference is explained by the fact that when I first modified my own set the new type of valve-holder was not actually on sale, but the makers kindly supplied me with a rough hand-made one for experimental purposes. The proper commercial components will be available by the time this is in print and will have terminal connections. Although the valve and holder have seven

(Continued on page 677)

COLVERN FERROCART COILS

There is now a Ferrocart Coil for practically every modern radio receiver.... We have written a booklet explaining the advantages of Ferrocart Coils and containing suitable circuit diagrams....

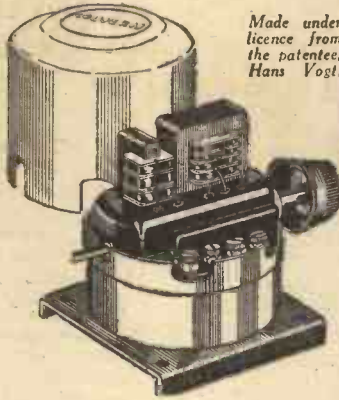

Made under licence from the patentee, Hans Vogt.

May we send you a copy? It's free!
Radio Olympia — August 15th — 24th.
See Our Stand No. 56.

COLVERN LIMITED,
ROMFORD, ESSEX

London Wholesale Depot, 150, King's Cross Rd., W.C.1.

"AIRSPRUNG"

An Outstanding Development
in Valveholder Design

CLIX introduces the first
Anti-Microphonic, Non-metal Chassis Mounting
VALVEHOLDER

POWERFUL LOUDSPEAKERS working close to valves throw off sound waves which create distortion. This NEW CLIX Chassis Mounting Valveholder is designed to absorb all such vibrations, thus preventing distortion and prolonging the effective life of the valve. It is also ideal for SHORT WAVE work, with the minimum amount of material used in the construction, the sockets are practically air-insulated.

4-Pin - - 1/2
5-Pin - - 1/3

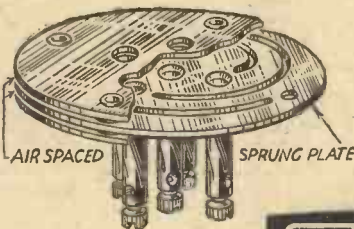

SEE THE FULL RANGE OF CLIX PERFECT CONTACT COMPONENTS ON STAND 37. OLYMPIA. Folder 'N' on request.



LECTRO-LINX LTD., 79a, Rochester Row, London, S.W.1.



EDISWAN

The name that means 'EXCELLENCE'

BALANCED CAPACITY
COSTS NO MORE
and gives you longer life
with less charging

E.L.M.2.	20 a/h capacity	- 4/3
E.L.M.4.	45 a/h capacity	- 8/-
E.L.S.5.	40 a/h capacity	- 11/-
E.L.S.7.	60 a/h capacity	- 12/6
E.L.S.9.	80 a/h capacity	- 15/6
E.L.7.	60 a/h capacity	- 10/3
E.L.9.	80 a/h capacity	- 12/3



Balanced Capacity is the newest development in accumulator manufacture. It means that the positive and negative elements are designed to function in exact electrical balance, making it possible to charge more quickly and discharge more slowly without damaging the cell. The Ediswan "Extra-life" accumulator will thus last longer and give you much better service than an ordinary unbalanced type—yet it costs no more. A definite economy.

FROM ALL GOOD RADIO DEALERS

EDISWAN

EXTRA-LIFE

ACCUMULATORS



THE EDISON SWAN ELECTRIC CO. LTD.
PONDERS END, MIDDLESEX

EDISWAN - the Better Service Batteries

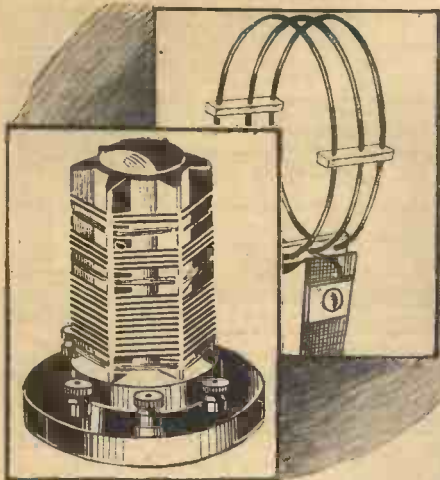

Coils For SHORT WAVE RECEIVERS

By K. E. BRIAN JAY

THE most important part of a simple short-wave receiver is undoubtedly the grid circuit of the detector-valve. This is the circuit that handles the incoming signal, and upon it depends the voltage available for operating the detector (and hence the signal strength) and the number of stations that can be heard at once (i.e., the selectivity). I have dealt in a previous article with the condensers to be used in this part of the circuit and now I will discuss the coil to be associated with the condenser, for these two components are the vital ones in the grid-circuit.

Fig. 1 shows a typical circuit, using band-spread tuning, and in what follows, the two variable condensers C_1 and C_2 will be regarded as a single condenser C . First of all, I want to talk about the tuned circuit as a whole, that is, the coil L^1 and the parallel tuning condenser C , so that we may see what is to be asked of the coil. The primary purpose of the tuned circuit is to discriminate between incoming oscillations, that is, to provide selectivity, by making the receiver sensitive to only one wavelength at a time. It does this by virtue of the fact that its resistance to an alternating current, called its reactance, for any particular condenser setting and size of coil, is very great indeed for one certain frequency called the resonant frequency. The voltage set up across the ends of the coil by a current of this frequency is much greater than the voltages set up by currents of other neighbouring frequencies. This can be seen at once from Ohm's law:

$$E = I.X$$

where E is the voltage, I the current, and X the reactance. Clearly, E will be greatest for the largest value of X , and consequently a wireless station transmitting on the resonant frequency will be heard to the exclusion (more or less) of all other stations, because X is greatest at the resonant frequency and decreases rapidly with increase or decrease of frequency.

The second property of the tuned circuit is that it magnifies the applied voltage at the resonant frequency, and this magnification depends on the inductance and resistance of the coil, which we see is now beginning to assume a special importance. Actually, this magnification is expressed in mathematical shorthand as:

$$2.\pi.f.L$$

R

where π is our old friend 3.1416, f the resonant frequency, L the inductance of

the coil, and R its resistance. Two things at once leap to the eye, namely, that if the magnification is to be big, the inductance must be as large and the resistance as small as possible.

Thick Wire for S.W. Coils

So far, everything I have said applies to coils for any wavelength whatever, but now I will show the bearing of these things on short-wave coils in particular. One of the first things you notice about most short-wave coils is the very thick wire used. The reason for this is pretty obvious, for the thicker the wire the lower the resistance. Actually, the resistance concerned is not the ordinary D.C. resistance, but the resistance to high-frequency currents, a much more complex quantity. Now D.C. currents travel through every part of the cross-section of the wire, but high-frequency currents travel only through a thin skin a molecule or two thick, on the surface of the conductor, so that apart from any other considerations the high-frequency resistance will always be much greater than the D.C. resistance and will increase with frequency, because the higher the frequency the thinner the skin through which the currents travel. This skin effect makes it possible, and desirable, to use copper tube instead of wire for transmitting inductances, and there is no reason why, from the point of view of resistance only, such coils should not be used for reception. From other points of view, especially expense and compactness, they would not be so attractive! The reason for reducing resistance as much as possible is, as we see from the formula above, that the higher the resistance the smaller the magnification, and since the actual number of turns required on a short-wave coil is not great, it is quite possible to use very thick wire and still have a coil that is not too unwieldy. However, when thick wire is used, a coil diameter of the order of two and a half to three inches is necessary to preserve reasonable coil proportions, and this immediately introduces fresh complications, because the larger the coil diameter the bigger the area covered by the magnetic field associated with it and consequently the greater the interaction of coil with other components in the receiver. Ultimately, interaction of this kind will give rise to instability, but long before such conditions arise it will have set up relatively large coil losses in the form of an actual loss of energy in eddy currents and an apparent increase in resistance, because the high-frequency resistance of a coil is far from being decided by the wire gauge only; if

the coil diameter is large, a metal condenser end-plate three inches away may introduce more losses than would result from halving the wire size. The necessity for a large coil diameter, therefore, is the first reason for doubting the value of thick wire in short-wave coils.

Resistance Losses

A second point arises in connection with resistance losses, however, that is of even more importance. Every simple short-wave receiver makes use of reaction, the application of which increases the sensitivity of the receiver up to a maximum, at which point it starts to oscillate. How does it do this? Simply by reducing the effective resistance of the coil. That is to say, the use of reaction amounts to making R as small as we wish until when the valve begins oscillating R becomes effectively zero. Why, then, worry about resistance at all when we can make it as small as we like by adjustment of the reaction control? Well, of course, it's not quite as simple as that; things never are in this life. In the first place, the higher the resistance of the coil the more reaction we have to apply to induce the set to oscillate, and this means increased losses and often an unmanageable receiver; in an extreme case we may not be able to get the receiver to oscillate at all. Second, and rather more important, is that only with a perfect reaction control will the resistance decrease continuously right up to zero; in practice it will reach a very small value and then suddenly become zero, so that the set spills over, as it were, into oscillation. In bad cases of this kind you can hear the effect in the sudden thud as the receiver begins to oscillate. Now, for listening to telephony we want the receiver in that condition of just not oscillating when the effective resistance has become very small indeed, and in order to obtain this state of affairs the coil should be made of reasonably low resistance. I think, however, that I have said enough to show that, owing to the reaction effect and the losses of large diameter coils, the use of very thick wire such as 16 or 18 S.W.G., is undesirable.

(To be continued).

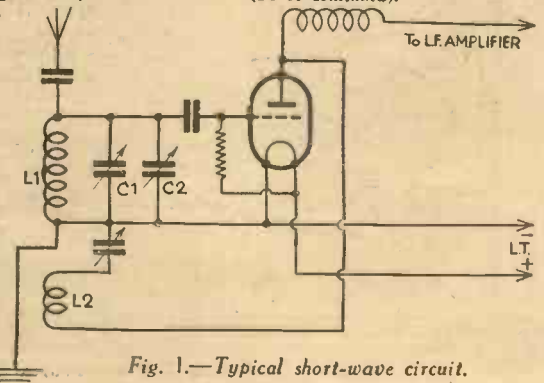
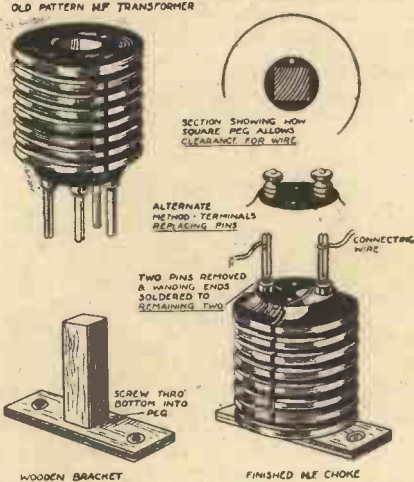

Fig. 1.—Typical short-wave circuit.

READERS' HALF-GUINEA WRINKLES Page

A Neat H.F. Choke

THE old type of four-pin H.F. transformers, as shown in the accompanying sketch, make ideal formers for H.F. chokes. The following is the procedure: Remove the old windings and also unscrew two of the pins, preferably the closest or "filament" ones, leaving the remaining two as soldering tags. Next wind on the required number of turns, soldering the ends to the most convenient pin. From a piece of square wood moulding and three-ply make up a bracket, as in sketch, to fit



Making an H.F. choke from an old H.F. transformer.

fairly tightly into the centre hole of the former. The finished choke can then be pushed on, and the whole screwed to the baseboard, or bolted to the panel as desired. The square peg will leave ample clearance for the wire leads inside, as shown, but if preferred these can, of course, be taken to the pins on the outside. I have used a choke made in the above manner quite successfully in a portable set.—R. GRAPER (St. Albans).

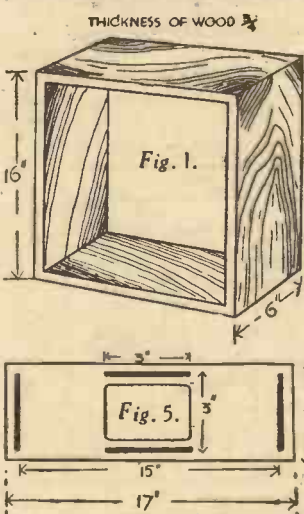

THAT DODGE OF YOURS!

Every reader of "PRACTICAL WIRELESS" must have originated some little dodge which would interest other readers. Why not pass it on to us? We pay £1-10-0 for the best wrinkle submitted, and for every other item published on this page we will pay half-a-guinea. Turn that idea of yours to account by sending it in to us addressed to the Editor, "PRACTICAL WIRELESS," George Newnes, Ltd., 8-11, Southampton Street, Strand, W.C.2. Put your name and address on every item. Please note that every notion sent in must be original. Mark envelopes "Radio Wrinkles." Do NOT enclose Queries with your Wrinkle.

Building a Cone and Chassis

HERE is a simple method of building a cone and chassis, which may prove useful to some readers. First of all, take four pieces of wood, and nail them together to make a box without either lid or bottom, as in Fig. 1. Then, across one end, stretch a piece of strong brown paper, soaked in water. To do this, brush the edge of the box with glue, then with the paper overlapping a little, stretch and just tack over the sides with drawing pins. When quite dry, it will be taut like a drum skin, and the surplus at the edges can easily be cut away with an old razor blade.

Making the Cone

Now comes the making of the cone itself, and from many trials I find this method a great advantage over any single thickness cone. A sheet of ordinary cartridge paper is cut into three cones, as in Fig. 2. First, the medium-sized cone is gummed on to the large one, then the small one on the medium one, making the centre three thicknesses of paper. When thoroughly dry, draw together and gum the flap. After this, cut the edge, as in Fig. 3, and gum in the centre of the stretched paper. When dry again, cut out the centre of stretched paper, up to inside edge of cone, leaving the cone on the stretched paper baffle (see Fig. 4), which is all vibrating area.

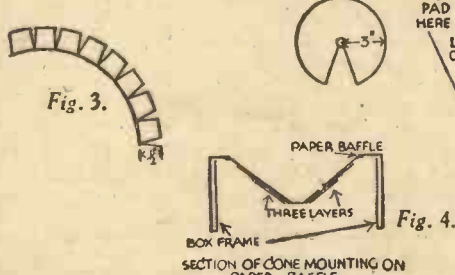
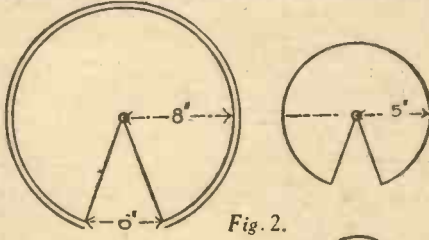

Chassis Construction

The next stage is the remainder of the chassis, which simply consists of a piece of three-ply, cut as in Fig. 5. As will be readily seen, with a screw each side to fit in slots, it is easy to centralize the unit to fit the cone. After adjustment the screws are tightened. To eliminate rattle, a piece of flannel or rubber must be used as a pad between the unit and three ply; also, a spot of melted wax in the reed end of chuck, cuts out reed dither.

Finally, four pieces of L-shaped tin are quite sufficient to fasten the completed job (Fig. 6) on to a baffle board. The reinforced cone gives a tone and volume in excess of a single one, and with the exception of the unit, a couple of shillings covers the cost.—H. CHADWICK (Rochdale).

A Novel Concealed Speaker

A NOVEL and efficient concealed speaker can be made from an old card table or from new wood, as shown in the accompanying sketch. The top is made from a piece of seven-ply wood perforated with round or square holes, or cut as an ornamental fret under which is fixed the baffle, leaving a 4-in. space as shown. The whole may be covered with a thin cloth, adding to the general appearance, and a vase or ornament can be stood in the middle to take off the plain effect.—

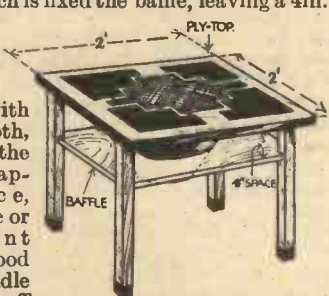

A concealed loud-speaker made from an old card table.

D. H. ROGERS. (Colchester).

Wire Bobbins as Coil Formers

ORDINARY wooden 8oz. and 1lb. wire bobbins can easily be converted into coil or choke formers. One end of the bobbin is divided into six parts, as shown, the bobbin placed on a table, and the lines carried down by means of a square. Radial saw-cuts are then made in the flanges of the bobbin sufficiently wide to take strips of 1/4-in. ebonite or old gramophone record.

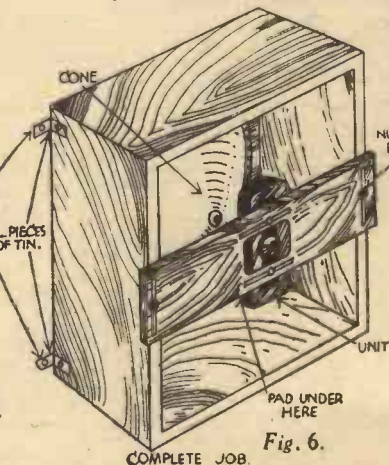

Fig. 6.

Showing how a loud-speaker cone and chassis can easily be made.

(Continued overleaf)

RADIO WRINKLES

(Continued from previous page)

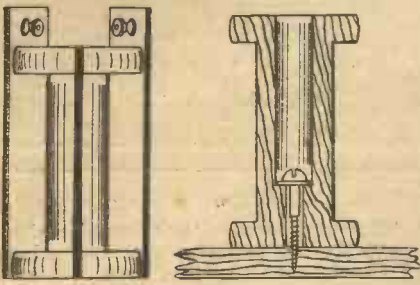

Wide saw-cuts can be made by using two or three coarse blades together in a hack-saw frame, the cuts being trimmed with a smooth file. The grooves need to be such that the strips hold securely when they are pressed in by hand. Some of the strips may be made



A simple coil-former made from a wire reel.

about 1/4 in. longer than the others, so as to carry the terminals, or the terminals can be fixed to an ebonite base. The former may be fastened to a baseboard by counter-boring it with a 1/8 in. twist drill and using a round-headed wood-screw and washer, as shown in the sectional view. Alternatively, it could be held to a plain ebonite base or one of the plug-in type by means of a threaded rod tapped into the base and carrying a nut and ebonite washer at the top.—B. PUGH (Barry).

A Simple General Purpose Tester

THE simply-constructed galvanometer herein described was made by the writer as an instrument which could be used to locate faults in many types of circuits, and it has proved itself of extreme utility in this respect. The galvanometer consists essentially of two parts only, one being a freely suspended magnetic needle of the pocket compass type, and the other a coil of insulated wire which can be connected in the circuit to be tested. These two components are mounted on any convenient baseboard, as shown in the sketch, in such a manner that the magnetic needle swings freely in a horizontal plane and the axis of the coil is horizontal and passes through the centre of the needle. The coil former can be of any suitable non-magnetic material, such as stiff cardboard, wood, ebonite, aluminium, or brass. Any number of turns of insulated wire can be used on the coil, but the larger the number of turns the more sensitive the instrument becomes to small currents. Generally, it will be found that about one or two thousand turns of wire of about 40 gauge will give ample sensitivity for all ordinary purposes.

Using the Instrument

THE method of using the instrument is as follows. The galvanometer is placed on a horizontal surface and arranged so that the needle comes to rest pointing at right angles to the axis of the coil (the position shown in the sketch).

Let us assume, for example, that it is required to test a transformer secondary winding for continuity. A battery is connected in series with the galvanometer and with the transformer winding to be tested. If the winding is complete, then current will flow through the galvanometer

coil and cause the needle to deflect, but if there is a break in the winding the needle will remain stationary—unless, of course, the insulation of the transformer is very poor and allows sufficient leakage current to pass to cause deflection of the needle.

The foregoing will suffice to show how this instrument can be used for testing either H.T. or L.T. circuits for continuity or for insulation. By suitable arrangement of resistances in conjunction with this galvanometer it can be used for measuring resistances by the wheatstone bridge method, and also as a rough form of ammeter or voltmeter.—A. H. TOMS (Hove).

Cleaning Accumulators

HERE is a simple method of quickly and efficiently cleaning the sediment out of a glass accumulator. Take a sharp-pointed knife (preferably an old one). Heat it in the fire until it is red hot, and then pierce the moulded composition on the top of the accumulator about 1/4 in. from the inside edge of the glass. Now work the knife round, following the shape of the container. As soon as the knife gets to a dull colour reheat in the fire and start again. About half an inch at a time will be sufficient to cut before the knife needs re-heating. When all the four sides have been cut the

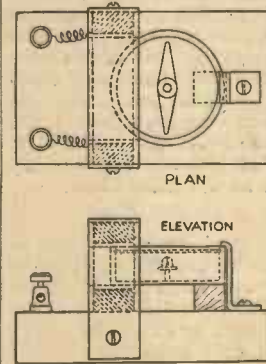

Wiring details of the simple tester.

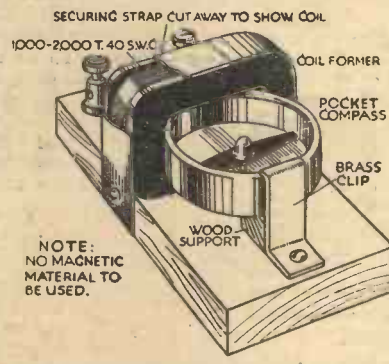

An idea of the complete instrument may be gained from this illustration.

inside of the accumulator can then be lifted out by getting hold of the two terminals. The plates and the glass container can then be thoroughly cleaned out in cold water.

After this is done, replace the plates, re-heat the knife, and, using the flat portion of the blade this time, run it round the cut portion of

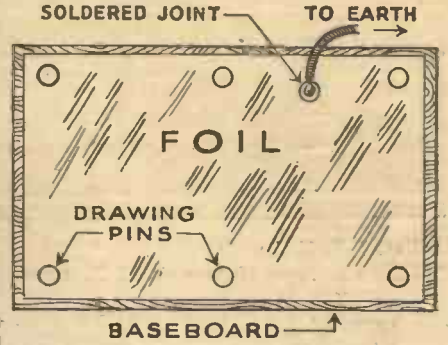

Attaching foil to the under surface of a baseboard

the moulded composition, when it will knit together. This will make the top leak proof, and as good as new. This method makes a far more efficient job than giving the accumulator several changes of water, as this does not ensure getting rid of the sediment owing to the closeness of the plates to the side of the container.—A. E. WRIGHT (Sheffield).

Simple Screening

IN simple sets of the detector L.F. type I have often found that instability and direct pick-up may be avoided by fitting a screening

plate beneath the baseboard. This can, of course, only be carried out where there is no sub-baseboard wiring. The illustration shows how I carried out the simple alteration. A sheet of foil is cut slightly smaller than the baseboard, and this is simply attached by means of ordinary drawing pins. To complete the arrangement a short wire is soldered to the foil and this is then joined to the earth terminal. On some sets I have found that this clears up the tone of reproduction.—A. MARSH (Wolverhampton).

(Continued on page 680)

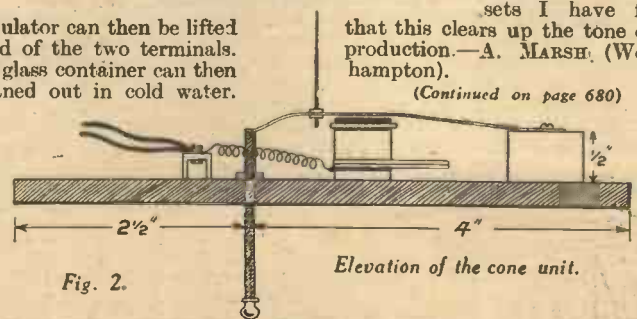

Fig. 2.

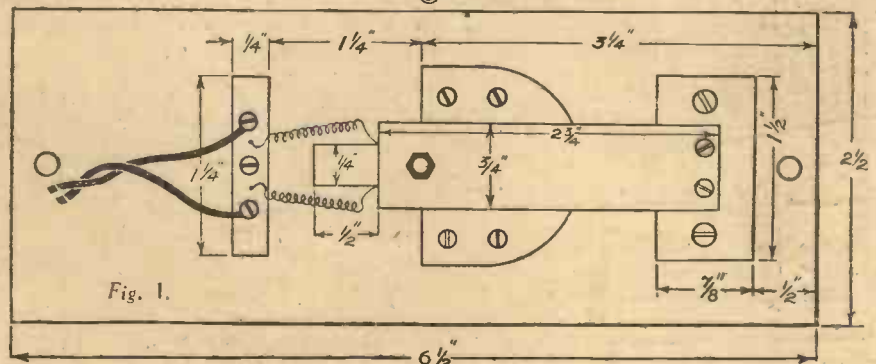

Fig. 1.

Plan and measurements of the cone unit. (For text see page 680.)

The NEW VALVES

A Review of the Many New Valves that have Recently Been Introduced

By FRANK PRESTON, F.R.A.

Concluded from page 653, Aug. 5th issue.

THE variable-mu feature is useful from the volume-control point of view, and makes the valve ideal for use in superheterodynes in which A.V.C. is provided. Screening between the two electrode systems is so complete that there is no interaction between the tuned circuits of the oscillator and detector, and no radiation when an outside aerial is employed.

the lesser-known firms of valve manufacturers are now turning their attention to this subject. One firm has recently introduced a range of universal valves fitted

to the further development of special valves for automatic volume control and "car-radio." The Class B double-diode-pentode, short-base variable-mu, and high-frequency pentode are, I consider, destined to be widely used during the next twelve months.

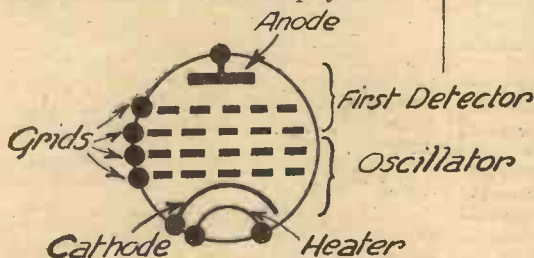

Theoretical diagram of the Hexode electrodes.

All-Metal Valves

Although their characteristics are the same as those of previous valves, the latest "Catkins" are worthy of special reference. These are made in all A.C. types, and instead of the electrodes being enclosed in the conventional glass envelope the copper anode forms the outer shell. In some models a perforated metal cylinder surrounds the anode, but this merely serves the purpose of a screen. Catkin valves are small in size, unbreakable, and have particularly rigid electrode supports. As a result they are ideal for sets that must be compact and which are subject to vibration or hard use. They are thus particularly well suited to the "car-radio" sets which are now being produced and which seem more than likely to become extremely popular during the coming year.

Valves for A.C.-D.C. Use

It seems inevitable that sets of a "universal" character that can be used equally well on either A.C. or D.C. mains must eventually be placed on the market. Such sets depend entirely upon the valves they employ, and it is interesting to observe that two or three of



The Cossor 240B 7-pin base valve.

with 20-volt, .18-amp. heaters which can be operated from any kind of mains supply. The usual mains transformer is not required, and the heater of the half-wave rectifier is simply wired in series with those of the receiving valves. On A.C. mains the rectifier changes the high-tension supply to direct current, but on D.C. it merely acts as a limiting resistance.

What of the Future?

To attempt to prophesy what other new valves will come into being during the next year or so would be a very difficult matter, but it seems fairly obvious that there cannot be nearly so many changes as there have been in the immediate past. What changes there are will probably be of a minor nature and will be in regard

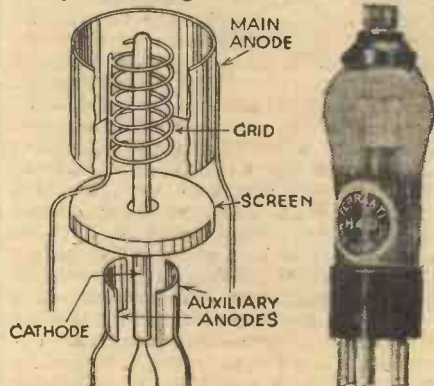

Showing the form of construction of a double-diode-triode valve.

The Ferranti double-diode-triode.

This review of new valves would scarcely be complete without a reference to what has, perhaps wrongly, been termed the "cold valve." Actually this is not a valve in the usually accepted sense of the word, but is rather a metal rectifier. It is similar in principle to the rectifiers used in eliminators for changing A.C. into D.C., but it is intended for use with H.F. current.



The new Cossor double-diode-pentode valve.

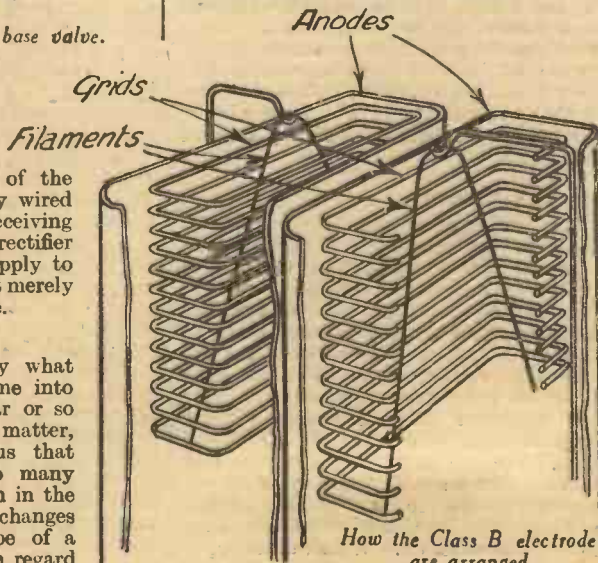

How the Class B electrodes are arranged.

The First Article on this Subject appeared on page 475 of our issue dated June 24th, 1933.

**FURTHER
NOTES
ON**

PERMEABILITY TUNING

By LAMBDA

IN the previous article on this subject the writer reviewed the existing tuning systems, showing their disadvantages, explained permeability, the way the new system operated, and its advantages. It is now proposed to deal with further aspects of this new system emphasizing some of the points dealt with and giving further details of the system itself. We know that circuits can be tuned to any desired frequency by varying either the capacity or inductance or both, but up to the present, owing to mechanical considerations, tuning by varying the capacity has been by far the most popular method. As resistance increases with frequency the electrical properties of a tuned circuit do not remain constant over the whole of the tuning scale. We therefore come to the conclusion that if constant selectivity is required when tuning over the waveband the ratio of inductance to resistance must be kept constant. With valve receiving circuits an important phenomenon known as parallel resonance is employed to obtain selective voltage amplification. When this type of circuit is tuned to resonance it is represented by a non-inductive load—the dynamic resistance—as previously explained. This is connected to the plate of a valve which possesses internal resistance. If the inductance of such a circuit could be varied for tuning and at the same time keeping the dynamic resistance constant, then the amplification of the valve would be constant throughout the tuning range. In permeability tuning the coil itself is designed to have the desired performance at the higher frequency band to be covered, that is, at the lowest wavelength. The apparent inductance is increased to tune to the lower frequency by introducing the magnetic core into the field of the coil, with the result that as it is gradually inserted more lines of the magnetic field are intercepted by the core and the average apparent permeability of the medium surrounding the coil increasing from 1 (which is taken as the permeability of air) to a certain maximum when the coil is totally inserted in the core.

Iron Core Material

Like many other scientific inventions, the subject of tuning by magnetic iron cores has been the object of research for many years and many attempts have been made to solve this problem. As far back as forty years ago attempts were made to produce compressed cores of iron dust. Since then continuous research has been conducted and ferro-magnetic cores have been produced made of finely divided particles using various highly permeable alloys. These alloys were experimented with, allowance having to be made for the tremendous loss in permeability which resulted from the numerous air gaps between the particles. Whilst some types

of iron have a permeability of about 400, many of the alloys used in these experiments had a permeability very considerably in excess of this figure. Unfortunately, however, when made into dust their permeability was very low indeed, hardly reaching 20 or 30.

It was at first thought impossible to use iron-core coils for the high frequencies employed in radio circuits, but such is not actually the case, although the gain in using iron is not so great for radio frequencies as it is for ordinary low frequencies. Because of the relatively small permeability required for tuning through the range of radio frequencies the permeability obtainable in finely divided pure iron is found to be adequate. We must consider, however, what losses, if any, are permissible in such a system in order that the desired degree of selectivity may be maintained.

At radio frequencies hysteresis losses are very small, so that we need not consider that matter any further. The other chief source of loss is due to eddy currents. The direction of the eddy currents is opposite to that of the current in the winding, hence at any point in the centre the magnetomotive force acting is really that produced by the winding diminished by a certain amount due to these eddy currents. Further, the strength of these eddy currents decreases with the thickness of the laminations or particles. In other words the eddy current losses expressed in terms of resistance introduced are roughly proportional to the square of the frequency and to the length of the circular path around each minute particle. Therefore the smaller the particle the less the eddy current loss.

Another consideration in the choice of powdered material is its uniform purity, which materially affects permeability. In order to obtain powder in sufficiently small grain size it is reduced by hydrogen or obtained from carbonyl of iron. Both methods will produce a powder of reasonable uniformity, purity, and size. The size of the grain being employed in these coils is of the order of one five-thousandth of an inch and they will float in air.

For the broadcast waveband a variable inductance of about seven times is required and by compression permeability of this order can be obtained. One of the problems to be overcome, however, was the insulation of each of these individual minute particles. The solution was found in the development of an entirely new insulating varnish capable of very fine filming and able to withstand extremely high pressures up to 25 tons per square inch. All the particles of the iron are insulated with this varnish in loosely powdered form and then mixed with a small amount of phenol resin powder for binding purposes. This mixture is then pressed into heated moulds of the required shape. The hardened material thus formed is fairly strong and has the appearance of solid iron. It contains about 95 per cent. of iron and about 5 per cent. of bakelite

and insulating varnish. The permeability of this material remains constant throughout a range of frequencies from 50 to 2 million cycles.

Application in Radio Receivers

For practical purposes the coil is slightly tapered, wound with Litz and the outer shell also being tapered to correspond. By tapering the coil the necessary variable magnetic density can be more easily obtained. The inductance of the coil is 65 microhenrys and is tuned to 1,500 kc/s. (200 metres) by a fixed capacity, with an adjustable leaf, of .00016 mfd.

When employing several circuits tuned together it is not essential to have exactly the same value of inductance in each circuit. Providing the coils have the same physical dimensions, if we insert two identical cores the same permeability change is produced in each circuit and they will, therefore, track perfectly and will always tune to the same wavelength if mechanically adjusted correctly.

Aerial Tuning

An important feature with permeability tuning is that we now have a method of tuning the aerial circuit and keeping it in exact alignment with the other coils. This will enable us to secure considerable gain in the aerial circuit due to being able to tune exactly to resonance, consequently a decrease in the amount of subsequent amplification can be achieved. An improvement in the "signal to noise" ratio can also be effected.

Superheterodyne Receivers

In superhet receivers the oscillator coil can be ganged quite satisfactorily and ganging will hold over the tuning scale to within about 0.1 per cent. The advantages of permeability tuning in ordinary tuned radio frequency receivers, however, are so great that it is possible that with the greatly increased selectivity obtainable it will be more generally used in this type of receiver, particularly as better quality will be obtained without the complication of an oscillator circuit and the need for two detectors. Adequate screening will be necessary which, although reducing the inductance of the coil, will increase the working frequency range of the receiver.

As no tuning condensers are necessary the number of leads emerging from the screens are reduced to a minimum, considerably simplifying receivers for the constructor. The frequency to which this system is tuned at any moment is almost proportional to the distance to which the core has been removed from the coil. By slight correction in the shape of the core the relation may be made exact, thus giving a uniform or straight line frequency distribution of the channels on the dial. To design a receiver covering several wavebands it is only necessary to use tapings

(Continued on page 684)

Bring your set up-to-date

NO MORE UNSIGHTLY AERIALS

An astonishing improvement in performance



Now dispense entirely with your old-fashioned aerial and get vastly improved reception. Just connect up the aerial and earth terminals of your set to the AIRCLIPSE Auto-Inductive Aerial. You will be astonished at the instant improvement in the performance of your set. Sensitivity and selectivity will be increased. The AIRCLIPSE, with its principle of auto-induction, filters incoming signals. It brings everything through crystal-clear—stops overlapping, gets distant stations with amazing clarity.

Tests prove it equal to the best outdoor aerial, and far superior to any indoor aerial. Only 3½ x 1½ inches. It is absolutely non-directional and can be placed inside or outside the set. Equally effective on both long and short waves. It enables any set to be moved from room to room. You need it for convenience—for safety—to cope with crowded broadcast conditions.

AIRCLIPSE

For Battery and A.C. Mains Sets PROV. PAT 9377/33
AUTO-INDUCTIVE AERIAL

5/-

Obtainable of all radio dealers, or in case of difficulty order direct from:

Airclipse Lfd., 182 Vauxhall Bridge Road, London, S.W.1
Telephone: Victoria 5022

the **R & A**
“CHALLENGER”

is now available in Five Models—

Whatever your Output—whether Super Power, Pentode, Class B or Q.P.-P. there is a Challenger Reproducer with correctly designed transformer. The “Challenger” series is unique; each model of equal eminence as a perfect reproducer of speech and music.

- ‘STANDARD’ model, for use with Super Power and Pentode Valves.
- ‘TYPE B8’ for use with Cossor Class B Valves.
- ‘TYPE B15’ for use with Mullard and Mazda Class B Valves.
- ‘TYPE P.’ An Extension Reproducer for use with Commercial Receivers.
- ‘TYPE Q’ for Quiescent Push-Pull (15,000 ohms. Plate-to-Plate Load).

Each model is complete with Transformer.

The complete range of R. & A. Reproducers, including the new ‘Alpha’ and Type 60 models, will be displayed at **Olympia, Stand 44**. Your dealer will gladly demonstrate, and new list will be sent free on request.

Take no risks—choose the **CHALLENGER** model designed for your set.

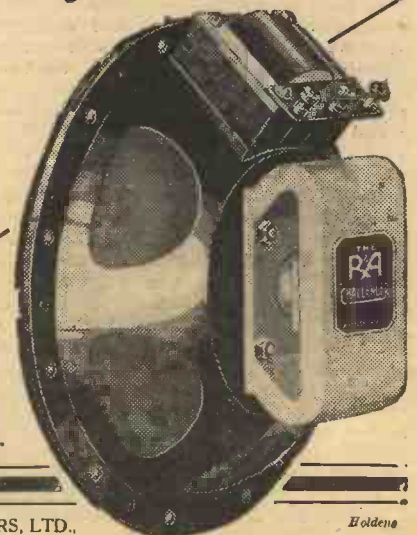

35/-

EACH MODEL COMPLETE.

REPRODUCERS & AMPLIFIERS, LTD., WOLVERHAMPTON.

Boldens

RADIO RAMBLINGS

By GRID LEAK

Gottings from my Notebook



The H.F. Pentode

THE pentode valve seemed in danger of dying at one time, but the new H.F. pentodes have given it a new lease of life. These are all the rage just now, and their sudden rise in popularity is even more surprising when it is remembered that the Cossor Company have had an H.F. pentode on the market since May, 1930. However, it seems quite possible that the H.F. pentode will wipe the screen-grid valve out of existence long before anybody expects it.

World's Greatest Radio-using Countries

CANADA is running Britain very closely for the honour of having the greatest number of wireless sets in proportion to the population, and they have now in use 770,436 receiving sets. This puts them fifth on the list of which Britain is fourth of world radio users, the first five of which are as follows:

Denmark, one set for every 8.12 people
U.S.A. " " 10 "
Sweden " " 12.12 "
Britain " " 13 "
Canada " " 13.12 "

This list I do not, however, believe to be quite true, for most of the radio amateurs I know seem to have more than one set, and I don't possibly see how these could appear in the statistics. In fact, I know one man who has no less than eight sets, all of them in working order and not less than two years old. Can any of you break this record? If so, I should like to hear of it.

New High Power B.B.C. Transmitter

I SEE that a further move has been made with regard to the new station to replace the long-wave one at Daventry. The B.B.C. has placed the order for the transmitter with the Marconi Company, and the whole job is being designed in co-operation with the B.B.C. engineers. A new system of modulation is to be used, known as "series modulation," of which I hope to tell you more later, and the output of the transmitter will be 100 kilowatts on the unmodulated carrier wave. Up to 90 per cent. modulation will be possible, so that quite hefty signals may be expected from this station soon. A section of the transmitter of special interest is the frequency controller, which will be used to keep the station rigidly on its wavelength in accordance with the very stringent international regulations. Not that the B.B.C. are offenders in this respect, as followers of the Brussels curves will appreciate, but only by constant check is the transmission held at a constant frequency, and it is a pity more Continental stations do not keep their wavelength "curves" as straight as those of the British stations. Each of the valves used in the new transmitter will be heated by a separate lighting dynamo. This is to some extent an innovation, and possesses many advantages over

the method hitherto employed of heating the filaments in parallel. This independent generation of filament voltage allows of a more critical voltage being applied to the filaments, and if one or more of the filaments go out of action there is no corresponding rise in the filament voltage on the other valves, as is often the case where all the filaments derive their current from one generator. The consumption of each valve filament is about 460 ampères at 32 volts. Imagine carrying home accumulators to run a set like this for an evening's entertainment!

Unique Telephone Installation

AT the World Power Conference held at Stockholm a unique Wireless Telephone installation was installed by the L. M. Ericsson Co., which is an important advance on methods previously used for reception of lectures and speeches.

The transmitter antenna was mounted around the walls of the conference chamber and each member carried a receiver outfit on his person. This receiver outfit, of very small dimensions, consisted of a coil antenna, a detector and a headphone. The receiver coil was put around the shoulder, and the receiver box fixed in a buttonhole, or a pocket. If the member's seat was below one of the antenna wires the plane of the loop had to be vertical and parallel to this wire. On the other hand, if the member's seat was anywhere else the loop had to be more or less horizontal. The best position was easily found after a short trial. Two similar installations were made, one for each of the halls reserved for the Conference, operating on different wavelengths in order not to disturb each other.

Standardized Positions for Control Knobs

I SHOULD like to see the position of the knobs on radio sets more or less standardized in the same way as the controls of motor-cars have been done. If you can drive one car you can drive practically any make, but rarely can you approach a strange wireless set and immediately proceed to bring 'em in right away. Commercial sets are no doubt the worst offenders in this respect, as in most home-built sets the reaction knob, for instance, is usually in the bottom right-hand corner with the tone control or volume control knob somewhere handy. This is not always the case with a commercial receiver, however, for I was recently handling one in which the reaction and tone control were as far left as it was possible to put them. This is decidedly unorthodox to a set-builder's eyes, as we generally like our signals to come in at the left-hand side of the set, and leave by the back door on the right. I think this is the best plan, and I believe it would be an improvement if a generally accepted position of the different knobs were agreed upon by set manufacturers. Another complaint I have to make against commercial set

knobs is that they are much too small. Some of them are but very little larger than kettle-lid knobs, and are very difficult to handle to say the least of it. A fault that is directly due to small knobs is the unsightly scratches that appear on the panel of the set behind the knobs where your finger nails rub in your endeavours to grasp the tiny controls. On a highly-polished panel this looks bad, and I know it is not beyond our manufacturers to pay attention to little details like this.

British versus American design

IN talking of knobs it strikes me that our sets are rapidly becoming more symmetrical, both on the panel and behind. This is in no small way due to the increased use of ganging which allows of the bank of variable condensers being placed in the centre of the set, with the H.F. on the left side, and the L.F. on the right. The pentode valve also by cutting out a L.F. stage helps to centralize the "works" as does the modern practice of making sets nearly as deep as they are wide. I was discussing these points of modern set design with a radio friend the other day, and to illustrate his remarks he showed me a magnificent American receiver he had just acquired. According to American practice the back was left open, even though it was a huge radio-gram, and all the works could be plainly seen. I must say, however, that in comparison with a British receiver, costing just half as much as the American, the workmanship of the latter was very much inferior. The arrangement of the valves, however, was good, the detector being placed quite near to the panel while the screened-grid and pentode valves were placed in a row behind. I noticed, however, that the ganging was not very consistent over the whole range of the tuning scale as the tuning was much sharper in the middle, and there was a definite falling off in volume and clarity on either side.

A Useful Plug Connection for A.C. Mains

MANY of you will have seen the advertisement clock erected in London, and which is stated to be the largest clock in the country, if not in the world. About 600ft. of neon tubing has been used in its construction, and it is interesting to note that the clock movement has been supplied by Smith's English Clock Co., Ltd. This movement is synchronous with the alternating current mains in the same way as the smaller clocks sold for domestic use, and is, of course, as reliable as the frequency of your A.C. mains. Those of you who use a synchronous clock may know of the little device that can be obtained for them, and also for use on a mains wireless set, by means of which a permanent connection may be made to the mains without the need for monopolizing an electric plug connection. Modern builders are not over generous with lighting or heating plugs, and the Wylex fused connector manufactured by the Smith Clock people allows of a radio or a clock being connected to an electric plug without disturbing its ordinary utility in the domestic supply. It often happens that a wireless set has to be put temporarily out of commission while a heater or even the household flat-iron is put in use through shortage of plug connections, and if this is the case with an electric clock it at once loses its accurate time-keeping propensities. The "Wylex" connector is retailed at 2s. from any dealer.

ADDING CLASS "B" TO THE "SELECTONE" THREE!

(Continued from page 668)

pins, only six are actually used, the seventh being a "dummy," That is why one terminal does not require any connection.

G.B. Voltages

When all wiring has been completed, the "new" receiver will be ready for test. Replace the "210 Det." valve in the detector holder, with either the "210 H.L." or "220 P." in the first L.F. holder and insert the "240 B." There are now only two grid-bias negative tappings, "G.B.—1," coming from the pick-up terminal, and "G.B.—" from the "Transfeeda." The correct positions for these will depend entirely upon the H.T. voltage available, and the type of valve used as "driver"; the table on page 668 will, therefore, be of assistance.

It will be seen that in every case the bias voltage is somewhat higher than that recommended when the valves are used for normal L.F. amplification, but this is found to produce equally good results with an appreciable saving in H.T. current consumption. Incidentally, it might be explained that it is permissible, and indeed wise, slightly to over-bias any valve which is being used as a "driver."

Tone Control Adjustment

Operation of the receiver will be almost the same as before. The only difference is in respect to the tone control resistance; as the knob is rotated *anti-clockwise*, the .004 mfd. condenser will be brought to bear more upon the circuit and will thus reduce high note response. You will remember that "top cut-off" was previously obtained by turning the potentiometer in a *clockwise* direction.

Results

Little need be said in regard to the results obtained with the "Class 'B' Selectone." I can only say that the volume and quality of reproduction are as good as can be obtained from any receiver regardless of its type. The local stations are naturally heard to best advantage, but a number of others can be very well received under normal conditions. Even when using the "210 H.L." as driver, and with 108 volts high-tension, the signal output is ample for all normal requirements, including outdoor listening. When extra "punch" is called for, however, it is a simple matter to change over to the 220 P. valve, and you will then have enough to fill a hall or to enable you to dance on the lawn, as you prefer. Reproduction of gramophone records is just as good as that to be obtained on "radio" and compares very favourably with the results given by the most expensive radio-gramophone.

Please Note

It is mentioned above that the modifications described can be applied to any set having two low-frequency valves. There is just one alteration which might be suggested in the latter case, however. That is, that instead of using a 5,000 ohms variable resistance and .004 mfd. fixed condenser for tone-control, these components might be replaced by others having values of 50,000 ohms and .01 mfd. respectively. The first-mentioned values are quite suitable for the "Selectone," which uses a very selective tuning circuit, but they might not give quite sufficient correction in every other receiver.

GET YOUR COPY FROM STAND 98 RADIOLYMPIA PRICE - 6d.

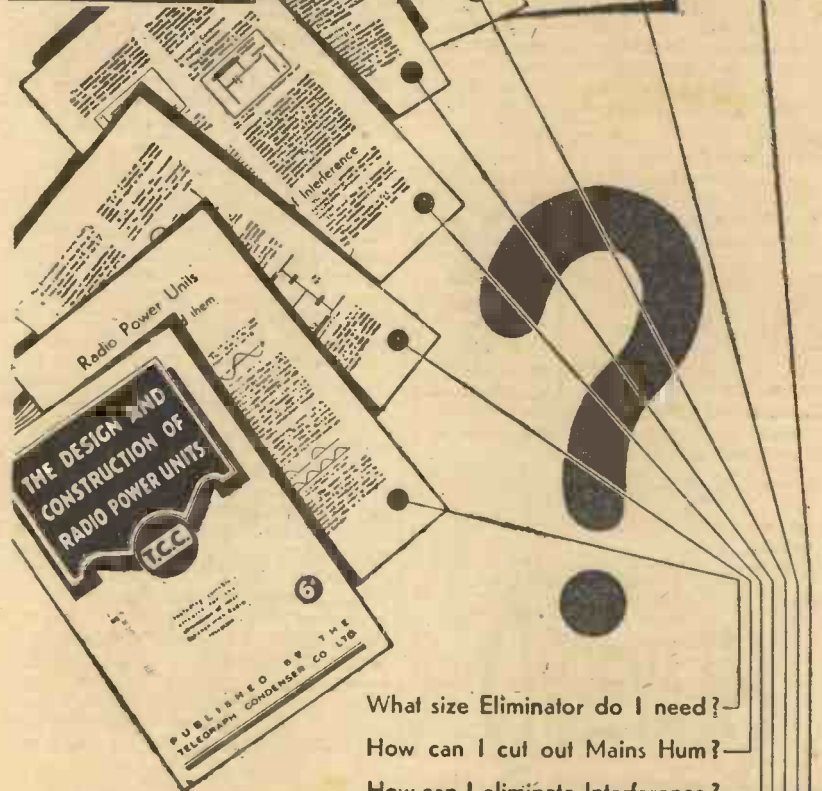

- What size Eliminator do I need?
- How can I cut out Mains Hum?
- How can I eliminate Interference?
- When should I use an Electrolytic?
- How do I build an A.C. Power Pack?
- What special precautions for D.C.?
- What resistance do I need?

YOUR MAINS PROBLEMS! — this Book answers them all

T.C.C. ALL-BRITISH CONDENSERS

GET YOUR COPY

COUPON To The Publicity Dept., The Telegraph Condenser Co. Ltd., Walks Farm Rd., N. Acton, London, W.3.

Please send me a copy of your book "The Design and Construction of Radio Power Units," for which I enclose six penny stamps to cover cost and postage.

NAME.....

ADDRESS.....

FRAC. 12/9/33. Please write in block letters



Mains Units by Specialists!

When choosing Mains Apparatus it is advisable to buy from Specialists. Only thus can you be sure that your purchase is safe, sound and reliable. Heyberd Mains Units and Components are not skimmed or "cut down" to a price. Skilled technicians, using the finest British materials, produce Heyberd Mains Apparatus. A searching test is carried out at each stage of manufacture—that is why all Heyberd Units and components carry the well-known Guarantee. For nearly eleven years Heyberd have specialised in Mains apparatus, and the result of their research and experience is at your service. A complete display of the latest Mains Units, Kits, Transformers, Home Chargers and Amplifiers will be shown at Radiolympia. You will be welcomed at the Heyberd Stand.

STAND
16
OLYMPIA

POST COUPON NOW

I enclose 3d. stamps for NEW revised Handbook, "Mains Power for your Radio."

Mr.

Address

Prac.

10, FINSBURY STREET, LONDON, E.C.2



MONARCH OF THE MAINS.

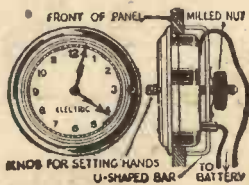

FIT THIS ELECTRIC CLOCK

TO YOUR SET!
NO MAINS NEEDED!
KEEPS CORRECT TIME!
NO WINDING!

Works off small battery lasting 12 months, or can be plugged into G.B. battery without affecting reception. Uses practically no current. Fits into hole 3 1/2 in. dia. in any panel up to 1/2 in. thick. Easy to fit—no screws required. Only 1/2 in. from front of panel to back of case. Swiss movement. Hands set from front. Nickel-plated bezel. Useful addition to any set.

RIVERSIDE MFG. Co., Ltd.,
Dept. 21, Crisp Road,
Hammersmith, W.6.
Telephone: Riverside 6392.

12/6
COMPLETE WITH BATTERY
POSTAGE 6D



Famous Maker's Offer!
£5 Radio-Gram 65/-
SEVEN DAYS' FREE TRIAL
(OR 10/- MONTHLY)
Polished Oak! and Piano built!
The acoustic Tone brings a fine thrill. Makers to Radio-Press, B.B.C., 3,000 clientele.
MODELS FROM 35/- to £15.
Photographs and List FREE.
PICKETTS' Gramophones,
(R.F.), Albion Road, Bezzieheath

IMPRESSIONS ON THE WAX

A REVIEW OF THE LATEST DISCS

THE programmes of the past month or so have yielded their usual crop of pieces to collect. Here are a few of which outstanding recordings exist, and which can safely be bought to increase the number of records for entertainment now, and for many years to come.

By E. REID-WARR

Mozart's Most Popular Piece

Without doubt, *Eine Kleine Nachtmusik* answers this description in every way. Originally its appeal was intimate—chamber music, in fact. Now it has become a fully-fledged orchestral show piece, but it is so delightfully tuneful throughout as to retain all of its charm. There are four movements—*Allegro*, *Romanze*, *Minuetto*, and *Rondo*, each of which goes on to one side of two records I recommend unreservedly—*Columbia LX144-5*. There is everything which makes music endearing somewhere in this composition—gladness, beauty, sentiment, grace. And it is all so very understandable, too. Hear this recording by the British Symphony Orchestra under Bruno Walter and be captivated by it.

A Spanish Dance to Keep

Moskowski's *Malaguena* is quite often heard in wireless programmes, and can safely be included in those pieces which always come up fresh. There is a tendency to worship at the more modern shrines of De Falla and Albeniz, but their music has not the appeal of the type of dance of which this record is so good a representative. You will find a first-rate performance on *H.M.V. C2235* by the New Light Symphony Orchestra. There is an enchanting waltz, *Abandonado*, by Posadas, on the other side, which makes it as good value as any record I know.

A Charming Old Song of 1619

It was probably a very unorthodox thing to put bird calls into a song in the early Stuart days, but *Sweet Suffolk Owl* is an example. This song is one of the madrigal group, and was written by Thomas Vautour. Those who want something unusually attractive three centuries old will find it on *Columbia 5549*, where it is sung by the St. George's Singers unaccompanied. It is quite a revelation to hear the very clever composing which comes from those days. There is a twin number, *Upon a Bank with Roses set about* (Ward), on the other side.

The "New World"

Most of us know Dvorák by his Humoresque, but this trifle will be forgotten forever after hearing the No. 5 Symphony in G Minor, one of the biggest symphonies ever written—big in every sense of the word. There is something in it for every mood. The opening movement seems essentially modern, alternating from grave to gay. Then the Largo. One of the loveliest

things imaginable, a plaintive air, almost hymnal, closing in a sublime passage with the organ. The following third movement, modern again, with enough thematic material to supply the song writers of a nation for years. In this section almost every instrument is heard by itself. The last (fourth) movement swings pleasantly along to an impressive climax of sublime power. To hear the *New World* is more than a treat—it is an experience. It has been superbly recorded by the Philadelphia Symphony Orchestra on five *H.M.V.* records, *D1893-7*, and everybody should become acquainted with this superb symphony, every bar of which can be understood and appreciated by the ordinary listener.

A Waltz of Great Merit

This is *Die Schoenbrunner*, by Lanner. It is one quite in the Viennese tradition—a mixture of Strauss and Waldteufel, perhaps. I want especially to commend a magnificent performance by the Vienna Symphony Orchestra on *Columbia DB1064*. Here it is played with an opulence which is quite remarkable and by what seems a full-strength "turn." And on the other side is that old favourite *The Skaters*, by Waldteufel.

Ideal Light Music

Linke wrote much in this category, but *Amina* is a piece which is always liked, however much it is heard. It has a peculiar quality which makes one "feel good," rather as if it were played as the opening piece to a very jolly show. If you hear it played by the London Palladium Orchestra on *H.M.V. B3756* you'll understand perfectly what an effective aperitif *Amina* is.

The Ballad de Luxe

Airlie Dix's *Trumpeter* is probably the most-sung ballad in existence, and only a really good singer can save it from being painful. And yet it is the subject of one of the most impressive records I know. It would probably be described in a programme as a song scena, since effects and acting of parts are included. On *Columbia 9776*, Raymond Newell, Ion Swinley, a military band and chorus, really bring the *Trumpeter* to life. It is, perhaps, a trifle harrowing, but only because the whole thing is so very well done. There is nothing like it, and anyone who wants a stirring dramatic story should hear this record.

TWO FINE NEW RECORD ISSUES

Haydn's "Military" Symphony

A new recording of this has just been issued, and it is so very good as to earn extended mention. First of all, it is shockingly misnamed, and so do not expect to hear martial strains. This, really the 100th in G Symphony, has a strong English

(Continued on page 684)

Facts and Figures

Components Tested in our Laboratory

BY THE PRACTICAL WIRELESS TECHNICAL STAFF

MAGNUM DUAL CONDENSER

THE illustration below shows the newly-introduced Burne Jones dual ganged condenser of the bakelite type. This is a most interesting component, consisting of two bakelite-dielectric condensers ganged on a single central spindle. Separating them may be seen a brass plate which is in contact with the driving spindle, and therefore, when connected in the normal manner in a standard circuit, this screen is earthed. The slow motion drive which is supplied is of the standard Mag-

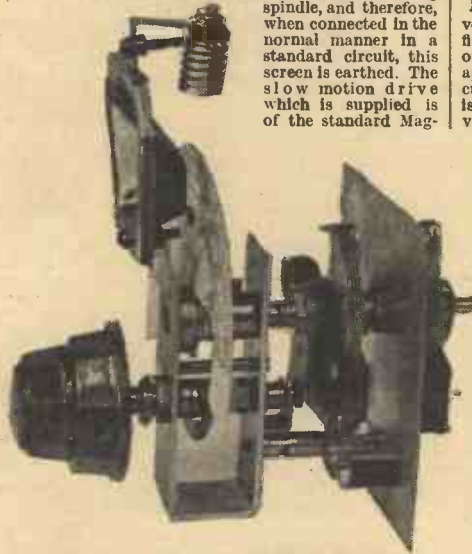

The Magnum dual-gang bakelite-dielectric variable condenser.

num type, and in addition the small concentric control knob rocks the fixed vanes of the first condenser through several degrees. This device is necessary, of course, for trimming purposes. In addition to the neat bronze escutcheon, a bracket and panel light socket are fitted so that the complete component may form the tuning unit of a really good broadcast receiver. The action is quite smooth, and the component was tested in one or two simple receivers with admirable results. The price of the complete unit is only 10s. 6d.

NEW POLAR CONDENSERS

IT will be seen from the illustration on this page that the well-known Polar condensers manufactured by Messrs. Wingrove and Rogers have been re-designed. The first point of interest is that the condenser is now mounted on its side which results in a rather larger dimension from the baseboard, although on the other hand, the actual baseboard space which is taken up is slightly smaller. The actual constructional details are very similar to the original pattern, robustness being the chief feature. The vanes are locked at the ends, so preventing possible short-circuits, and the spacing is perfectly uniform. With the end method of mounting the trimming condensers are brought to the top, and the dust cover which is now fitted is provided with holes on the upper surface so that a screwdriver

or similar instrument may be inserted and the trimmers easily adjusted. The popular battleship-grey cellulose finish is adopted, and the condensers represent very good value. They are highly recommended.

TELSEN COMPONENTS

THE new range of Telsen components, samples of which have been received by us, represents some very good improvements in existing designs. Dealing first with the electrolytic condensers, the illustration on the next page will give some idea of the neat appearance of these condensers. In place of the customary aluminium canister, the Telsen condenser is finished in a neat black surface, upon which the various details such as rating, name, etc., are engraved in gold. They are of the dry pattern and, consequently, may be mounted in any position, although the vertical position is generally found most convenient. For the latter purpose, Messrs. Telsen supply a neat mounting platform (shown in the illustration), although they may, of course, be mounted on a wooden chassis, provided a wire or other method of connection is made between the case and the negative source of supply. When a metal chassis is employed, the case is automatically connected to the negative pole via the metal chassis. These are very sound condensers, and may be recommended.

The reaction condenser has also been re-designed, and is now totally enclosed. It is of the same shape as the old type, but the condenser is enclosed in a moulded case, and when fitted into position the condenser becomes quite airtight and therefore dustproof. As in the previous condenser under review, the component is finished in black with gold lettering. This lends it a most distinguished appearance. The price remains unaltered.

The iron-core tuning coils have already been mentioned, and these are the smallest tuning coils we have yet examined. The total height of the coil, on its bakelite base and with the screening can in position is only two and a half inches. The diameter of the screening can is less than one and a half inches, and—the coil former is only five-eighths of an inch in diameter. Six terminals are provided on the base for connection, and these are clearly embossed with the figures from 1 to 6.

AIRCLIPSE AUTO-INDUCTIVE AERIAL

A VERY novel device for use as an aerial has been submitted for test by Messrs. Airclipse, Ltd.. It is a very neat device in a moulded bakelite case just over an inch in diameter and about three inches long. One end is fitted with two terminals, and at the other end a long flexible lead projects. One terminal is marked for attachment to the aerial terminals of the receiver, whilst the other terminals is joined to the earth terminal on the receiver, the flexible lead being then connected to a convenient earth point, or if there is no such point available, it is simply left loose. Upon examination the device is found to consist of three separate windings on a cylindrical former, a short winding being provided from the E terminal, and two separate windings from the remaining points. These are wound in such a manner that inductive and capacitive couplings exist, and the makers claim that the design is such that the results are equivalent to a good outside aerial, with the additional feature that a filtering effect is provided and tends to remove fading, etc. On test the device certainly proved very

(Continued overleaf)

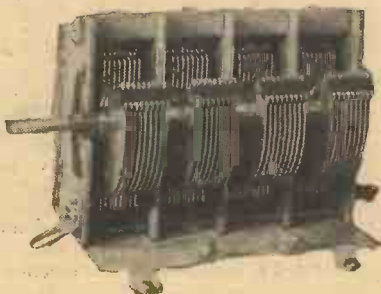

A four-gang Polar condenser of new design.



L.D

Stop that cackle!

Some sets are like the Hen—all cackle and scratch. Hens are made that way, but Radio Sets shouldn't be.

Cut the cackle and get pure resonant reception—quality and volume—by using Graham Farish Components. These instruments are scientifically designed, meticulously tested, and guaranteed to give you better radio.

OHMITE Resistances

The most popular and efficient type of fixed resistance for all general purposes. "Better than wire wound." All values 50 ohms to 5 megohms.



1'6 EACH

100° F. Temperature risc.

Ohms	Milliamps	Ohms	Milliamp
1,000	40	20,000	8
2,000	35	30,000	6.75
3,000	20	40,000	6
Other values pro rata.		100,000	3.5
Heavy Duty type, approximately double the above ratings, price 2/3.			

GRAHAM FARISH PRODUCT

Graham Farish Ltd., Masons Hill, Bromley, Kent. Export Office: 11/12, Fenchurch Street, E.C.3.

ANNOUNCEMENT

★ to men who want careers in **RADIO**



The I.C.S. Radio Courses cover every phase of radio work, from the requirements of the youth who wishes to make wireless engineering his career to the man who wants to construct and maintain a broadcasting set for his home.

The Radio industry is progressing with amazing rapidity. Only by knowing thoroughly the basic principles can pace be kept with it. Our instruction includes American broadcasting as well as British wireless practice. It is a modern education, covering every department of the industry.

OUR COURSES

Included in the I.C.S. range are Courses dealing with the Installing of radio sets and, in particular, with their Servicing, which to-day intimately concerns every wireless dealer and his employees. The Operating Course is vital to mastery of operating and transmitting.

There is also a Course for the Wireless Salesman. This, in addition to inculcating the art of salesmanship, provides that knowledge which enables the salesman to hold his own with the most technical of his customers.

We will be pleased to send you details of any or all of these subjects. Just fill in, and post the coupon, or write in any other way, stating which branch of Wireless interests you—the information you require will be forwarded at once.

International Correspondence Schools, Ltd.,
Dept. 94, International Buildings,
Kingsway, London, W.C.2.

Without cost, or obligation, please send me full information about the Courses I have marked X

- COMPLETE RADIO
- RADIO SERVICING
- RADIO EQUIPMENT
- RADIO SERVICING AND SALESMANSHIP
- WIRELESS ENGINEERING
- WIRELESS OPERATORS

Name..... Age.....

Address

FACTS AND FIGURES

(Continued from previous page)

efficient, the results obtained being very similar to those which we normally get on a very good indoor aerial. In our particular case we could not get such good results as with a good outdoor aerial, but as the apparatus had to be dismantled for examination before test, it had probably been slightly damaged, and this would account for the lack of optimum results. There is no doubt, however, that the device is very efficient and will be found most useful where a good outside aerial cannot be erected, or severe interference is experienced. The price is 5s.

COSMOCHORD PICK-UP.

An interesting new Pick-up is announced by the Cosmochord Company, and is known as the "Universe" Super Pick-up. It is claimed that the output rises as high as 4 volts, and that the characteristic has been designed to give the maximum response on the bass, thus compensating for recording deficiencies. The cut-off is at approximately 4,000 cycles, and this,

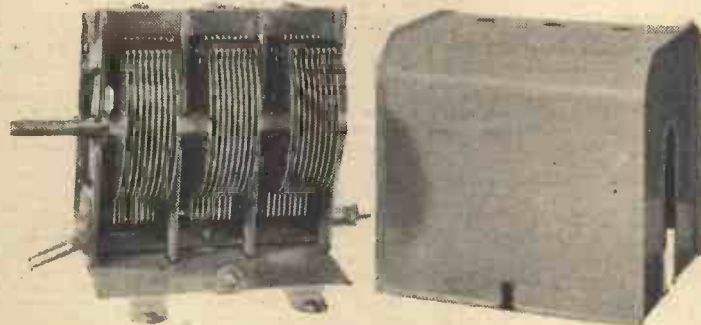

The new Polar three-gang condenser from which the vertical method of mounting may be seen.

combined with a shunt type resistance, reduces needle scratch to a minimum. A special weight compensator is fitted at the end of the arm so that the actual weight on the record may be adjusted to a minimum. The price, complete with volume control (5,000 ohms.) is 22s. 6d., and we shall give a more detailed report of this Pick-up when we have had an opportunity of testing it.

EPOCH MOVING-COIL MICROPHONE

A NEW type of microphone is announced by the Epoch Radio Manufacturing Company, and should prove a most interesting development. The manufacturers claim that this type of microphone forms as great an advance over all other types of microphone as does the moving-coil loudspeaker over all other types of speaker. The sensitivity is of a very high order, and no pre-stage amplification or batteries are necessary. Internal noises are absent, and the instrument should prove of great value for public address work and similar work where speech has to be relayed. The price is £4 4s., and a special built-in transformer is obtainable at an extra charge of 12s. 6d.



The new Telsen electrolytic condenser, and special mounting bracket.

WILBURN (PEAK) CONDENSERS

THE latest list from Messrs. Wilburn and Company shows some interesting types of fixed condensers, both paper and electrolytic. The latter are available in 4 mfd. and 8 mfd. types at 4s. 3d. and 4s. 9d. respectively. These are of the type designed for 450 volts D.C. peak working, and will withstand overloads of the order of 150 volts. The leakage is remarkably low for this type of condenser. A special neat bracket is obtainable in order that these condensers may be conveniently mounted on a wooden baseboard, and these brackets are fitted with a terminal. The price is 6d. The range of paper condensers (non-inductive) includes those designed for 250 volt D.C. working up to 1,500 volt D.C. working, the latter types being tested at 4,500 volts D.C. Small tubular condensers with wire ends may be ob-

tained in capacities from .005 to .1 mfd. at a cost of 1s. These are of the 750-volt D.C. test type, designed for 250 volts D.C. working. A similar condenser, but with terminals at the ends in place of the wire connections, may be obtained for 1s. 6d. Buffer condensers (centre-tapped type) are obtainable with values of .001, .1, 1 or 2 mfd., at prices from 2s. 6d. to 6s. 3d., whilst the complete range of Peak condensers is completed by the blocks of various capacities up to 4+4+2+2, costing 10s. 6d.

BULGIN PUSH-PULL Q.M.B. SWITCH

A NEAT little push-pull switch of the quick-make-and-break type is obtainable from Messrs. Bulgin at 1s. 9d. This has the normal appearance of a simple push-pull switch such as is used for switching on or off the battery circuit of a receiver, but the plunger is adapted in this particular case to cause a small "U"-shaped piece of metal to be thrown one way or the other by means of a small spring. It passes between two spring contacts in the "On" position, and these are left about 1/16 in. apart in the "Off" position, so that there is very little chance of leakage.

The component will be found most efficient for many purposes where a simple make-and-break is required.

RADIOPHONE VALVEHOLDERS

SOME neat chassis-type valveholders have been received from Messrs. British Radiophone. These are of the thin paxolin type, with patented sockets made to provide a really good grip on the solid pin type of valve. The sockets are bent up from strip copper, and an extended lug in the centre is taken

round to provide an additional thickness in the centre of the socket. As this naturally is of smaller diameter than the remainder of the socket, the valve leg must be gripped quite tightly at this point and rigidity is thus ensured. The holders are obtainable for 4, 5, and 7 pin valves, and cost 4d., 5d., and 6d. respectively.

RADIO WRINKLES

(Continued from page 672)

A Simple Cone Unit

TO make this simple cone unit, the following materials will be required: Metal 2 1/2 in. by 7/10 in., baseboard 2 1/2 in. by 6 1/2 in., 1 telephone (2,000 ohms), wood 6 1/2 in. by 2 1/2 in. by 1/2 in., 6 BA rod 3 in. long, two 6 BA nuts, 4 BA rod 3 in. long, two 4BA nuts, 1 4 BA terminal top, screws, and a piece of clockspring. Most constructors probably will have some of these materials in their junk box. Although simple to construct, most satisfactory results have been obtained using a free edged cone of 8 in. diameter. As will be seen from the diagrams, construction is simplicity itself, and will not require much explanation. The only tools required are a screwdriver, drill, and tinsnips. A hole to take the 4 BA rod is first drilled in the baseboard and the telephone magnet screwed into position. The wood block carrying the metal diaphragm is then placed in position and the diaphragm firmly fixed to it by means of two wood screws, as shown in Fig. 1. The shape of the diaphragm is important, as best results will only be obtained if the portion of the diaphragm over the magnets is parallel with them. A small piece of clockspring, shaped as indicated in Fig. 2, is fixed to the diaphragm by means of the stylus bar. The stylus is made from 6 BA studding filed down to a convenient size where the stylus enters the chuck used in the cone. The terminal block, carrying the connecting wires is the one used in the original telephone, and will be found quite satisfactory for its new purpose.



Practical Letters

from
Readers.

The Editor does not necessarily agree with opinions expressed by his correspondents.

Short-Wave Reports Wanted

SIR,—Our client, Mr. J. F. W. de Kort, of Bragaweg 34, Bandoeng, Java, Dutch East Indies, would be glad to receive reports on the reception, in this country, of his short-wave transmissions. His station works every working day from 23.45 till 00.15 G.M.T. on a wavelength 49.02 metres. Call PK1WK Bandoeng, Java, D.E.I. Announcements are in Dutch and English.—W. R. EVERETT (London, E.C.).

Television

SIR,—I must commend you on your articles concerning television, a subject to which a large number of our earlier wireless pioneers are turning their activities. I am only sorry that so little publicity is given to it at Radiolympia in late years.

I am sure that your readers appreciate the very practical articles which are the mainstay of your journal. As a reader from No. 1, who failed through foolish doubt, to qualify for your Wireless Encyclopædia, I am wondering if you have any volumes of the work left over from the last edition. If so, perhaps I and several other disappointed readers might qualify for a copy.

Thanking you for your magnificent weekly journal.—E. S. WEEKS (Hants).

A Treat a Week

SIR,—Although having taken various wireless weeklies for many years and PRACTICAL WIRELESS for only the last sixteen weeks, I must express my appreciation of the very fine practical matter which it contains.

Other readers' thanks and praise for the Encyclopædia has made me extremely desirous of obtaining this book myself, but I have seen no reference since I became a regular reader, as to how they became the proud possessors of same. Can you help me?

Thanking you for giving me a treat a week.—W. E. BOWKETT (South Wales).

Radio Luxembourg

SIR,—I am very much surprised to read in this week's PRACTICAL WIRELESS that you advocate the suppression of Radio Luxembourg owing to his power and difficulty of cutting him out.

It is a wonderful station, clear tone, no fading, with really enjoyable mixed programmes.

My set is a plain straightforward Det. and two transformer coupled amp. (not S.G.), and I have no difficulty in cutting him clean out in three degrees on either side of his best tuning point. Please do not agitate for his destruction. A friend of mine who lives about half a mile from here has a S.G. three all mains and he can cut Luxembourg dead out two degrees either side of his best tuning point.—R. W. STEPHENSON (Hounslow).

An Enthusiastic Reader

SIR,—I have to thank you for the "Eelex Earth Bowl," awarded to me as a prize, which arrived safely.

Like most of PRACTICAL WIRELESS articles, circuits and hints, the prize distribution was "Up to the minute." I have been a reader since No. 1 was published and before that time my knowledge of wireless was limited to the words "Aerial and Earth." I knew absolutely nothing. I am glad to pay tribute to PRACTICAL WIRELESS for the knowledge I have obtained.

I built up the "Dolphin 3" from No. 1. I must admit I felt frightened when my parts arrived, but through your instructions and wiring diagram being so clear and instructive, I found it quite an easy task.

I have also learnt a great deal from the pages of the Encyclopædia which, of course, I wouldn't or couldn't do without. Please carry on with the good work. There must be hundreds of novices who blessed the day PRACTICAL WIRELESS was published. Again, many thanks and best wishes for the success of "our paper."—A. KILLINGBACK (Essex).

What Readers Think

SIR,—May I take this opportunity to express my opinion of your paper? Here it is (a mere novice's). (Continued overleaf)

CUT THIS OUT EACH WEEK

DO YOU KNOW?

- THAT an improvement may often be effected in long-distance reception by interchanging aerial and earth connections to the receiver.
- THAT adequate ventilation should be provided in a powerful mains receiver.
- THAT fixed condensers should not be fitted too close to a mains valve owing to the heat which is given off by this type of valve.
- THAT hum may be caused in a cabinet by acoustic means, as well as through electric sources.
- THAT if two resistances of equal value are joined in parallel the current carried by each is half of the total flowing through the circuit.
- THAT the response curve of a loud-speaker is altered if the diaphragm is exchanged.
- THAT for the above reason a new cone should not be fitted to a speaker without the makers' approval.
- THAT a special type of electrolytic condenser is now obtainable for use in the biasing circuit of powerful receivers.

NOTICE.

The Editor will be pleased to consider articles of a practical nature suitable for publication in PRACTICAL WIRELESS. Such articles should be written on one side of the paper only, and should contain the name and address of the sender. Whilst the Editor does not hold himself responsible for manuscripts, every effort will be made to return them if a stamped addressed envelope is enclosed. All correspondence intended for the Editor should be addressed: The Editor, PRACTICAL WIRELESS, Geo. Newnes, Ltd., 8-11, Southampton Street, Strand, W.C.2.

Owing to the rapid progress in the design of wireless apparatus and to our efforts to keep our readers in touch with the latest developments, we give no warranty that apparatus described in our columns is not the subject of letters patent.

EASY TERMS

Everything Wireless supplied on lowest terms.

THE NEW BLUE SPOT LOUD-SPEAKER UNITS. The new Blue Spot range represents, in our opinion, the finest value in loud-speaker units available. With the new cones the quality and sensitivity is still further improved. New Season's models now in stock.

NEW BLUE SPOT 99 PM MOVING-COIL UNIT, with transformer. Cash Price, £2.19.6, or 5/- with order and 11 monthly payments of 5/6.

NEW BLUE SPOT 45 PM MOVING-COIL UNIT, with transformer. Cash Price, £2.5.0, or 5/- with order and 9 monthly payments of 5/-.

BLUE SPOT 6GR UNIT, with large cone and chassis. (The most sensitive balanced armature unit made.) Cash Price now £1.18.0, or 5/3 with order and 7 monthly payments of 5/3.

NEW BLUE SPOT PICK-UP, including built-in volume control. Cash price, £1.15.0, or 5/- with order and 6 monthly payments of 5/8.

NEW BLUE SPOT 62 PM MOVING-COIL UNIT, including transformer, built into high-grade cabinet. Cash Price, £3.7.6, or 6/3 with order and 11 monthly payments of 6/3.

MULTITONE CLASS "B" UNIT, including Cosor valve. This unit, plugged into your set will give you all-mains volume and quality of reproduction. Ready for immediate use. Cash Price, £2.11.6, or 7/- with order and 10 monthly payments of 5/.

Descriptive leaflet of all the above on request. All prices carriage paid.

To avoid delay will customers kindly send first payment with order.

Estd. 1925 THE Phone: NATIONAL 1977

LONDON RADIO SUPPLY COMPANY
11, OAT LANE NOBLE STREET LONDON, E.C.2

IF YOUR RECEPTION IS ONLY "LOCAL"

SUPERIAL
THE AERIAL WHICH MADE BROADCASTING POPULAR
ELECTRON'S SUPER-AERIAL

WILL MAKE IT CONTINENTAL



because it is the most selective aerial. The extra heavy rubber insulation not only cuts out interference, but abolishes masts, insulators and separate leads-in. Don't buy inferior imitations, but insist on SUPERIAL the only efficient invisible or indoor aerial. Get your £100 Free Lightning Insurance today from your wireless shop.

100 ft 3/6: 75 ft 2/6: 50 ft 1/9: 25 ft 1/4
THE NEW LONDON ELECTRON WORKS LTD 26 EAST HAM LONDON E.6

FREE BARGAIN BULLETIN

Thousands of end-of-season lines to be cleared at Gift Prices. A FREE GIFT of useful Drilling Template sent Post Free with lists to all applicants. J. H. Taylor & Company, 28, Radio House, Macaulay Street, Huddersfield.

FAMOS 2 Magnet bal. arm. speaker units, large 4 pole type. List price, 21/-, to clear 6/-.
AMPLION cone speaker unit in Walnut domed-top cabinet, 7/6 complete.
ERICSSON 2-1 (suit 3-1) L.F. Transformers. Listed 17/6; each, 3/3.
AMPLION speaker units. Over 75 per cent. reduced. Each 2/3.
All new and guaranteed and sent carriage free U.K.
PIONEER RADIO MFG. CO., LTD., OPTIC STREET, W.C.1. Museum 9607.

PRACTICAL LETTERS

(Continued from previous page)

PRACTICAL WIRELESS is absolutely O.K. and the best radio paper going, from the tuppennies to the bobs. I have taken it from No. 1 and intend to go on taking it. I remember when **PRACTICAL WIRELESS** was first announced excitement reigned supreme here, in Newport—all the news-agents had sold out in about an hour, and I, with others, didn't receive No. 1 until the following week.—**E. V. SPARKE** (Newport).

A Satisfied Reader

SIR,—I received your letter and have altered my wiring as per your instructions; I have also added the components you suggested, and I wish to thank you for your very kind assistance, the set is working wonderfully well considering the components it consists of.

I am using three old G.P. valves and a home-made coil; I tested it out yesterday and received many foreign stations at good loud-speaker strength, included among them being Fécamp, Trieste, Poste Parisien, Toulouse, Vienna.

I am going to call my set, for obvious reasons, "The Mongrel Three," for no two parts match.

I have been taking **PRACTICAL WIRELESS** since No. 1 was issued, so am endeavouring to learn a little about the mystery of wireless.—**W. MACDONALD** (Croydon).

A Suggestion

SIR,—I have been a regular reader of **PRACTICAL WIRELESS** since No. 1 was published, and I hope to continue to be the same. Yet I have a bone to pick with you.

I should like to see you designing one or more sets incorporating some of the latest

developments and at the same time keeping the cost in mind.

I suggest the following Straight Three's: Det. P125 as driver and new Cossor Class B valve B220, with band-pass tuning without ganged condensers; or other selective Straight Three's with the new Class B valve, and so one can use, if desired, some of their old components.

I should think this arrangement with the new Cossor Class B valve, L.T. and H.T.

consumption would not be much more than the old Straight Three. If you design a set of this kind, I am sure lots of readers and non-readers, who still stick to the old sets, would re-build, knowing what is in store for them next year. Wishing you continued success, greater amplification, and a bigger output.—**J. BUNTING** (Sheffield).

[I note your remarks and am giving them careful consideration.—Ed.]

RADIO CLUBS & SOCIETIES

Club Reports should not exceed 200 words in length and should be received First Post each Monday morning for publication in the following week's issue.

SLADE RADIO

A lecture on "H.F. measurements" was given by Mr. R. G. D. Holmes A.Inst. W.T., A.I.Rad.E., at the meeting held last week. A coil voltmeter was described and also how to use it, after which inductance, self capacity, H.F. resistance, dynamic resistance and how to measure them was described and the formulas given. A few words on permeability tuning brought a most interesting lecture to a close, and a number of questions were raised. Full details of the society and advance programme may be had on application to the Hon. Sec., 110, Hillaries Road, Gravelly Hill, Birmingham.

MIDLAND AMATEUR RADIO SOCIETY

This society is probably one of the strongest purely local societies in the world. Of its one hundred and fifty members, no less than forty-six hold full

transmitting licences, and the following are some of the successful achievements by some of its members, during 1932-33: The winning of the B.E.R.U. Trophy, given for the best performance of any station in the British Empire, during the B.E.R.U. Test. Our member scored almost twice as many points as those obtained by our nearest competitors, and so brought the Trophy back from Australia. Receiving Test Challenge Trophy—First in the whole of the Empire. Senior Transmitting Test—First in Great Britain and Second in the Empire. Junior Transmitting Test—First in Great Britain and seventh in the Empire. The R.S.G.B. Test—First.

The society's activities are extremely varied. At a "Junk Sale" held on behalf of the Birmingham Mail Christmas Tree Fund, for the provision of food and clothing for poorer people, the sum of £21 2s. was raised by the members. We give a number of trophies for experimental and research work, in all departments of radio. Last year a complete transmitter was built by the society, and operated under portable licence with a large measure of success. Lectures are given, not only on short-wave work but on everything appertaining to radio and television. The society is proud to number amongst its members many well known legal, medical, and theological notabilities. Meetings are held in the Oak Room of the Hope and Anchor Hotel, the use of the room being given free by Councillor Eli Fletcher, who is also an enthusiastic member. There is no entrance fee to the society, the annual subscription being 5s. only, and the Hon. Secretary, W. H. D. Nightingale, G5NI, will be pleased to welcome all interested in radio on application to either his private address, "Winswood," Beaks Hill Road, Kings Norton, Birmingham, or his business address, Radio Mart, 19, John Bright Street, Birmingham, 'Phone No. Mid. 3254.



Mr. L. S. Hargreaves, Managing Director of Aerialite Ltd.

.....I have produced **THE FINEST AERIAL**



The success of Aerialite Aerial Wire last season so convinced me that wireless enthusiasts definitely appreciate every step made in the progress of radio reproduction, that I have now produced a super aerial, **LEVENSTRAND**, which **BETTERS THE BEST**. This super aerial has a larger copper surface than any other on the market, which ensures better results than have ever been possible before. Double thickness of the now famous Aerialite covering ensures perfect insulation, and our stupendous offer of £200 **FREE LIGHTNING INSURANCE** with every coil is your guarantee and safeguard from lightning. **LEVENSTRAND** is absolutely guaranteed to give better results, more stations and greater volume.

THERE IS NO STEEL WIRE IN **LEVENSTRAND**.

50 ft. 1/9, 75 ft. 2/6, 100 ft. 3/6.

PERCOLITE ALL-COPPER EARTH TUBE

PERCOLITE proves how all important is a good earth. This improved chemical earth gives remarkable results compared with any other. Percolite will definitely improve reception and is the world's best earth by test. Simple to fix, Percolite is the earth that gets right **2/6** down to it. **PRICE** **AERIALITE 7-STRAND PURE COPPER AERIAL**. You can still obtain **AERIALITE 7-strand Pure Copper Aerial Wire** in boxes. Prices: 50 ft. 1/3, 75 ft. 1/10, 100 ft. 2/5. From your dealer or direct from:

AERIALITE LTD. AERIALITE HOUSE
AMBER ST., MANCHESTER

THE HEART OF THE SET

362 VALVES

DIRECT BY POST FROM THE MAKERS AT 50% SAVING.

362 Valves are British throughout. Non-Microhomic and Fully Guaranteed. Equal to any—better than most! See them at:

Post Free from **3/6**

OLYMPIA, STAND No. 226.

R.C., H.F., L.F., or Det., 3/6. Power, 4/- Super-Power, 4/6. 5.G. or Var-Mu, 7/6. Pentode type, 10/- All in 2v., 4v., or 6v. Metallised 3d. extra.

"CLASS B" 2-v. filament, 9/- 7-pin base, A.C. MAINS VALVES, 4-volt, 1 amp. (Indirectly Heated). Prices 7/6 to 12/6. Full List post free.

Cash with order. Cheques and P.O.'s must be crossed and made payable to: **THE 362 RADIO VALVE Co., Ltd. (Dept. W.12), 415, Mare Street, Hackney, London, E.8**

MODERN WIRELESS SETS AND HOW TO MAKE THEM
 By F. J. CAMM

This handbook explains the construction of a number of highly-efficient receivers, designed around the latest and most up-to-date components, such as band-pass and screen coils, variable-mu valves, etc. They have been designed to eliminate most of the drawbacks to efficient wireless reception. Most of the sets have compartments for the batteries and accumulators, and make use of built-in speakers. They are all extremely selective, cheap to make, and simple to construct.

EIGHTY PAGES FULLY ILLUSTRATED
6d.

On sale at all Newsagents and Bookstalls, or post free 7d. from George Newnes, Ltd. 8-11, Southampton Street, Strand, London, W.C.2.

PAGE MISSING

PAGE MISSING

'LISTENERS IN'!

LOOK TO-DAY AT YOUR WIRELESS LICENCE

IT MAY BE WORTH £50

Compare your number and claim your reward

£50 will be paid to holder of Licence No. AM 606314

£25 will be paid to holders of Licences: Nos. AM 629719 AN 248950

£10 will be paid to holders of Licences: Nos. AQ 014176 AO 964205

£5 will be paid to holders of Licences: AM 168697 AM 947333 AO 181418 AN 636825 AL 192700

£2 will be paid to holders of Licences:

AH 983625	AK 008754	AM 029340	AN 588728	AO 532208	AP 374996	AP 14520
AI 744709	AK 436690	AM 544734	AN 476092	AO 920000	AP 218426	AP 367520
AJ 620000	AM 287631	AM 660871	AN 108342	AO 232545	AP 440009	AP 996318
AJ 549672	AM 699947	AM 887609	AN 022451	AO 639572	AP 638194	AP 219453
AJ 353861	AM 50012	AN 383613	AN 700024	AO 063292	AP 002528	AP 837627
AK 152558	AM 973456	AN 239945	AN 695237	AO 887128	AP 425327	AQ 243609

£1 will be paid to holders of Licences:

AH 700965	AJ 225133	AL 210010	AN 188749	AN 770628	AO 327948	AP 82000
AH 346268	AJ 45789	AM 296380	AN 40281	AO 795919	AO 374216	AP 330712
AH 277424	AJ 727041	AM 867332	AN 952930	AO 350225	AO 461000	AP 375600
AL 738166	AL 740963	AM 640777	AN 366891	AO 058437	AO 715828	AP 052026
AI 284963	AL 368234	AM 75213	AN 859738	AO 192318	AP 467720	AP 798261
AI 009410	AL 457118	AM 374968	AN 434695	AO 884246	AP 043419	AP 296047
AI 426212	AL 892995	AN 692870	AN 238544	AO 417230	AP 655208	AP 928076
AJ 593600	AL 075243	AN 061221	AN 927610	AO 753605	AP 864821	AP 981003

This offer applies to licences which are actually in force on Saturday, August 12, 1933.

Before the awards are paid, claimants will be asked to undertake a simple publicity service in distributing leaflets to encourage the sale of licences amongst those who at present do not fulfil their obligations by taking out a Post Office Wireless Licence before receiving broadcast programmes. Claims cannot be considered in connection with any Licence the date of issue of which is after August 10, 1933.

For full particulars for claiming awards and a long list of other numbers see

TIT-BITS

ON SALE EVERYWHERE SATURDAY AUG. 12.

PRACTICAL HANDBOOKS

Clearly written and fully illustrated.

This series covers a wide field and will prove of the greatest value to everyone interested in models and how to make them; woodwork and other crafts.

Accumulators

An up-to-date handbook dealing with every type of accumulator, methods of charging them at home, care and maintenance, also explains how to erect a charging station.

Motor Car Upkeep and Overhaul

Information covering the engine, decarbonising, valve grinding, the lighting system, the carburetter, cooling system, lubrication, springs and shock absorbers, steering gear, brakes, wheels, axles, tracing noises, etc. etc.

Toy Making for Amateurs

How to make clockwork toys, model aeroplanes, model locomotives, model boats, ingenious toys operated by sand, wooden models and toys, electrical toys, steam toys, guns, kaleidoscopes, acrobats, etc.

Twenty-Five Tested Wireless

Circuits

All the sets described have been designed to meet modern needs. They range from simple crystal receivers to a seven-valve super-heterodyne, and all have been made and tested before inclusion.

Simple Electrical Apparatus

An excellent little book for those who wish to make simple and useful electrical appliances, such as galvanometers, electric motors, dynamos and Leyden jars.

Model Boat Building

Contains designs for battleship, speed boat, paddle steamer and yachts. Excellent models can be built with the simple directions and diagrams given.

The Home Woodworker

Clear instructions on how to make a large variety of articles in wood, together with many useful hints on wood-working.

Model Aeroplanes and Airships

Contains full descriptions of easy-to-make models of every description that will fly.

The Handyman's Enquire Within

Hundreds of practical ideas and hints of value to the man who is clever with his hands.

25 Simple Working Models

Ingenious and practical designs for electric, steam and clock-work models.

NEWNES' HOME MECHANIC BOOKS

Obtainable at all Newsagents and Bookstalls, or by post 1/2 each from George Newnes, Ltd., 8-11, Southampton St., Strand, W.C.2

1/-

WITHOUT FEE YOU CAN CONSULT

The "Tit-Bits" Barrister or Solicitor

Advice on all legal questions—Rent Acts, Workmen's Compensation, Marriage Laws, House Purchase, Adoption, Insurance, etc.

Our Doctors

All matters relating to health.

Our Dentist

Advice regarding all dental troubles.

The Careers Expert

How to train for trades, professions, business.

The Pensions Expert

On Old-Age, Widows', Orphans', Army and Navy Pensions, etc.

Our Domestic Science Authority

The home; cookery; how and what to buy; labour-saving devices; dyeing and cleaning; etiquette; furnishing and decorating.

Our Child-Welfare Expert

Diet, sleep, clothing, play, etc.

A Beauty Expert

Care of complexion, hair, eyes, hands, etc.

Our Holiday Bureau

Where to go; how to travel; cruises, etc.

Our Film Expert

Facts about the "stars" and films. Amateur cinematography.

The Sports Expert

Football, Tennis, Cricket, Racing, Athletics, Billiards, Greyhound and Speedway Racing, etc.

A Veterinary Surgeon

Dog ailments, diet, care and attention, etc.

Our Cycling and Motor-Cycling Experts

Touring advice. Tyre and engine troubles, maintenance and repair, etc.

Address all letters to
THE EDITOR OF

TIT-BITS

who will be happy to give you, by post, advice and assistance upon any matter that is worrying you. All letters must contain the Free Advice Coupon to be found at the top of the Editor's Page.

George Newnes, Ltd.

FOR EVERYONE • FOR EVERY OCCASION

The MOVIE CAMERA

WHY "spend" your holiday? Why not keep it and enjoy it all over again? You will be able to do this if you take a movie camera with you. Movie cameras are even easier to use than ordinary "still" cameras. Let "Home Movies" tell you how to make pictures that will be a lasting pleasure to you and yours.



"HOME MOVIES" caters for every home movie interest. Even if you have not yet started the hobby you will like this delightful magazine



YOU WILL FIND EVERYTHING YOU WANT TO KNOW ABOUT THIS POPULAR HOBBY

in
HOME MOVIES
AND HOME TALKIES
NOW ON SALE **6d** EVERYWHERE

Obtainable at all Newsagents, Bookstalls and Dealers, or post free 7½d. (Subscription rates: Inland and Abroad 7/6 per annum. Canada, 7/- per annum) from Geo. Newnes, Ltd., 8-11, Southampton Street, Strand, London, W.C.2.

George Newnes, Ltd.

P. W. Gift Stamp No. 46

Printed by NEWNES & PEARSON PRINTING CO., LTD., Exmoor Street, Ladbroke Grove, W.10, and published by GEORGE NEWNES, LTD., 8-11, Southampton Street, Strand, W.C.2. Sole Agents for Australia and New Zealand: GORDON & GOTCH, LTD. South Africa: CENTRAL NEWS AGENCY, LTD. Practical Wireless can be sent to any part of the world, post free, for 17/4 per annum; six months, 8/8. Registered at the General Post Office for Transmission by Canadian Magazine Post.

PAGE MISSING

PAGE MISSING

INSIDE and OUT!

A Ferranti AF Transformer will stand the closest inspection. From core to case it is literally packed with the results of more than fifty years' experience of transformer design and manufacture.

Even when made as only Ferranti can make it, you cannot buy a Ferranti AF transformer until it has been eleven times tested—apart from previous separate coil tests—to ensure that its performance shall come within 5% of the amplification indicated by the published curve, and within 5% of every other transformer of the same type.

A Ferranti transformer cannot be cheap. It can be, and IS, a real engineering production of highest efficiency, and value for money. There are cheaper transformers, but then, as Ruskin wrote:—

"There is hardly anything in the world that some man cannot make a little worse and sell a little cheaper, and the people who consider price only are this man's lawful prey."

Type AF 3	Ratio 1/3.5	Price 25/-
" " 5	" 1/3.5	" 30/-
" " 6	" 1/7	" 30/-
" " 8	" 1/3.5	" 11/6
" " 10	" 1/3	" 8/6

See the full range of Ferranti Radio Components on STAND No. 74 at Olympia (also Stand No. 38 at the Scottish National Radio Exhibition, Glasgow).

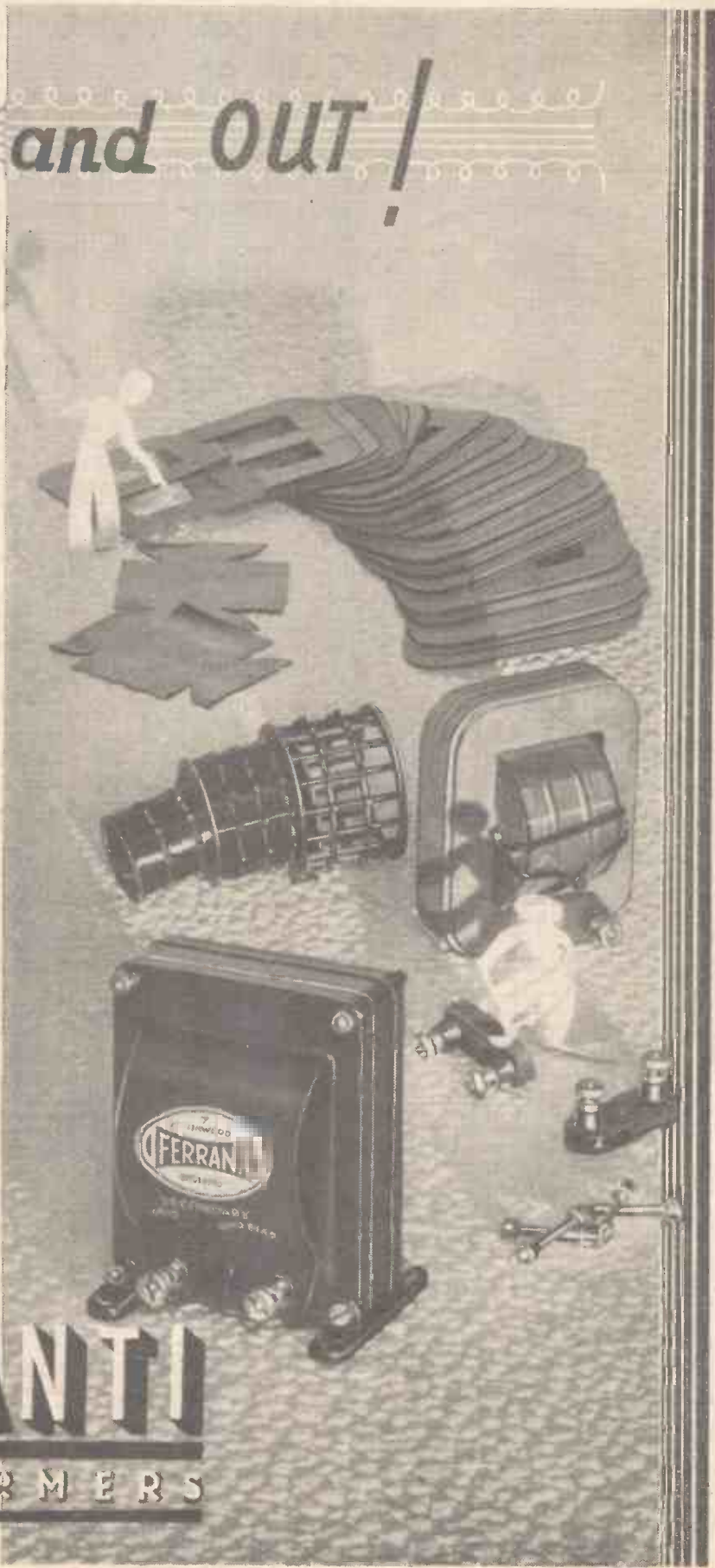

FERRANTI

TRANSFORMERS

FERRANTI Ltd., HOLLINWOOD, LANCASHIRE.
London: Bush House, Aldwych, W.C.2.

OLYMPIA
STAND No.

47

For YOU to put YOUR finger
UNFAILINGLY on every fault

**TWO INSTRUMENTS FORMING A
COMPLETE EXPERT'S TESTING EQUIPMENT**

THE
AVOMETER



D.C.
AVOMETER AMPS.
0-12 amperes
0-1.2 "
0-.12 "
0-.012 "

VOLTS.
0-1200 volts
0-120 "
0-12 "
0-1.2 "
0-.12 "

OHMS.
0-1,000,000 ohms.
0-100,000 "
0-10,000 "
0-1,000 "

8 GNS.

UNIVERSAL
AVOMETER.

Gives the thirteen
ranges of the D.C. Avometer
and also the following A.C.
readings (50 cycles)
0-12 amps.
0-1.2 "
0-0.12 "
0-1,200 volts
0-120 "
0-12 "
0-1.2 "
0-.12 "
12
GNS.
Deferred Terms if Desired

EVERY D.C. or A.C.
READING
AMPS-VOLTS & OHMS

BRITISH
MADE

REGD.
DIRECT READINGS without Calculations
or External Shunts, Multipliers or Transformers

This one precision instrument
enables you to make every
D.C. or A.C. test. The
Avometer is the only combina-
tion measuring instrument
that gives direct and accurate
readings in current, voltage
and resistance without the
necessity for mathematical
calculations.

Service engineers of the
leading radio firms have found
it to be the one instrument
that adequately meets their
needs. There are two models:
The D.C. Avometer and the
Universal (D.C. and A.C.)
Model.

If you do not visit Olympia write
for fully descriptive folders post free.

THE AUTOMATIC COIL WINDER & ELECTRICAL EQUIPMENT CO., LTD.,
WINDER HOUSE, DOUGLAS STREET, LONDON, S.W.1. Telephone: Victoria 3405/7

EVERY
VALVE TEST
Easily
made
Externally



THE
AVODAPTER

Improved for 1934—this invaluable instrument
enables all valves and valve circuits
to be tested externally with precision and
ease. Simply plug the valve into the
AvoDapter base and insert the AvoDapter
Plug (convertible to 4 and 5-pin valves) in
the valve holder. Heater or filament,
anode, screen and grid currents are measured
without change of connections; and fila-
ment or heater, screen and anode voltages
can be taken simultaneously or separately.

For those wishing to make their own
testing equipment, the patent AvoDapter
Convertible 4 and 5 pin plug, with a
12-wire lead is supplied separately
at 7s. 6d.

COMPLETE
25/-

GEORGE NEWNES, LTD.

HELPFUL WIRELESS PUBLICATIONS

Just Published

**THE WIRELESS
CONSTRUCTOR'S
ENCYCLOPÆDIA**

By F. J. CAMM (Editor of "Practical Wireless")

This invaluable encyclopædia is written in plain language
by one of the most accomplished designers and writers on
the practical side of wireless construction. The whole
subject is fully covered, and the volume is remarkable for
the number of practical illustrations used to illustrate the
text, there are hundreds of circuits, wiring diagrams and
layouts.

5/-; By Post 5/3

THE ELEMENTS OF WIRELESS.

By RALPH STRANGER. 3/6
By post, 3/9
Indispensable to everybody who wants to understand the working of wireless
receivers. The Author starts with elementary principles, covers the whole
field of wireless reception, both from the theoretical and practical points of
view, and finishes with a complete survey of a four-valve wireless receiver
explaining its working from the aerial terminal to the loud-speaker.

FIFTY TESTED WIRELESS CIRCUITS.

By F. J. CAMM (Editor of "Practical Wireless") 2/6
By post, 2/9
This book contains every modern circuit, complete with instructions for
assembling, component values, and notes on operation.

DICTIONARY OF WIRELESS TERMS.

By RALPH STRANGER. 2/6
By post, 2/9
Mr. Ralph Stranger, who is a master of lucidity, has produced in his "WIRE-
LESS DICTIONARY" a valuable and fully-explained synopsis of technical
terms that everybody can understand. A boon to every wireless enthusiast
who reads technical books and journals.

NOW ON SALE

THE OUTLINE OF WIRELESS.

The Wireless "Omnibus Book." 8/6
By RALPH STRANGER. By post, 9/-
Fourth Edition. 816 pages. Especially written for the "man in the street," it covers the whole subject of wireless
reception from A to Z.

THE MATHEMATICS OF WIRELESS.

By RALPH STRANGER. 5/-
193 pages. Fully Illustrated. By post, 5/3
Essential for the wireless amateur who desires to gain a fuller knowledge
of his subject. Written by one who has the gift of explaining abstruse
subjects in a simple fashion.

FINDING FOREIGN STATIONS.

By R. W. HALLOWS. 3/6
By post, 3/9
A book which will be eagerly welcomed by all wireless enthusiasts. It
will solve their difficulties and enable them to obtain the best possible
results of which their sets are capable.

WIRELESS, THE MODERN MAGIC CARPET.

By RALPH STRANGER. 3/6
Fifth Edition. By post, 3/9
Wireless simply explained at the beginning and seriously treated at the
end.

WIRELESS, STEP BY STEP.

By "DICTRON." 2/6
Tenth Edition. By post, 2/9
A book which shows the wireless enthusiast how to obtain the maximum
enjoyment from his wireless set.

Obtainable at all Booksellers, or by post from George Newnes, Ltd., 8-11, Southampton St., Strand, London, W.C.2.

... from the **NEW POLAR** range of **CONDENSERS and DRIVES**



POLAR STAR MINOR TWO-GANG CONDENSER

Cadmium plated steel frame. Trimmers operated from top. Matched within 1% or 1 mfd. (whichever is the greater).

2 x '0005 **12/6**
With full-vision "Horizontal" (as shown) "Arcuate" or "Semi-circular" drive 18/3.



POLAR "ARCUATE" DRIVE

Slow-motion drive. Bevelled scale in wavelengths and 0-100 degrees. Moulded escutcheon. Lampholder. **5/9**

Fitted with air-dielectric trimmer as "Uniknob" design, 7/9.



POLAR "SEMI-CIRCULAR" DRIVE

Slow-motion drive. Bevelled scale in wavelengths and 0-180 degrees. Moulded escutcheon. Lampholder. **5/9**

Fitted with air-dielectric trimmer as "Uniknob" design, 7/9.

POLAR "MOVING SCALE" DISC DRIVE

Slow-motion drive. Bevelled scale in wavelengths, and degrees 0-180. Moulded escutcheon. Lampholder. **4/6**

Fitted with air-dielectric trimmer as "Uniknob" design, 6/6

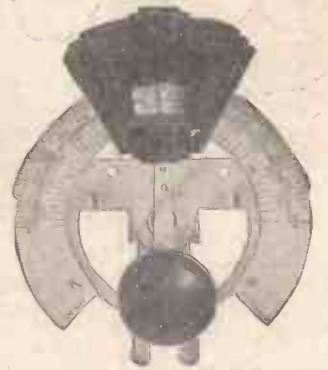

SEE THE COMPLETE RANGE AT RADIOLYMPIA

STAND 93

WINGROVE & ROGERS LTD., 188/9, STRAND, LONDON, W.C.2.
Polar Works: Old Swan, Liverpool. Phone: Temple Bar 2244/5/6

3330



Read this **QUALITY** Produces **EFFICIENCY**

TESTED BEFORE DESPATCH
The original BECOL ebonite low loss formers are thoroughly reliable. They are used in all parts of the world. Look for the BECOL trade mark. Ask your dealer. If unable to supply, write direct. SEND NOW, enclosing 6d. (post free) for up-to-date handbook of tuning coils for DUAL RANGE, BAND-PASS, and SUPER-HET. circuits. Fully illustrated with data. A very interesting handbook.

RODS, SHEET, TUBES, PANELS
The BRITISH EBONITE Co., Ltd.,
Hanwell, London, W.7.



SEE this **CAMCO** CABINET at **OLYMPIA**

The "Argyll" is another addition to the extensive range of Camco cabinets and has been specially designed for housing mains or Battery receivers with speaker.

It is supplied complete with baffleboard and baseboard and costs only 38/-. In Walnut Veneer.

See this handsome cabinet when you visit Olympia and send coupon for your copy of FREE Camco Cabinet Catalogue.

CARRINGTON MFG., CO., LTD.,
Showrooms: 23, Hatton Garden, London, E.C.1.

Phone: Holborn 8202.
Works: S. Croydon.



All Wireless Enthusiasts Must Read

THE FUTURE OF THE B.B.C.

The Inside Secrets of British Broadcasting—as Vital as Wireless Itself

By **SIR JOHN REITH** in

PEARSON'S WEEKLY
NOW ON SALE - - - TWOPENCE

● **OLYMPIA**
STAND 83

Post in 1d. envelope.
NAME.....
ADDRESS.....
12 PR.W.

COMPONENTS

RADIOLYMPIA
AUG-15-24 1/6 DAILY
STAND No. 45

BELLING-LEE DISTURBANCE SUPPRESSOR

Mains leads or aerial carry high frequency interference which often ruins radio reception.

The Belling-Lee Disturbance Suppressor reduces this trouble to a minimum and usually eliminates it entirely.

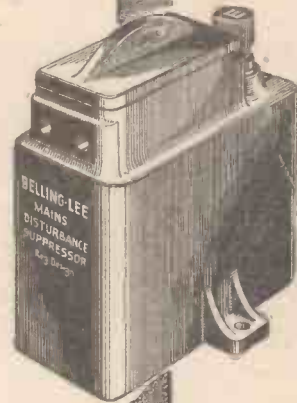

9/6
L1118. With Complete instructions.

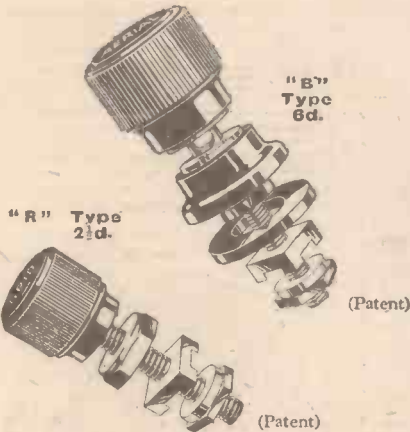

(Patent) Fuses in both mains leads for A.C. or D.C. supplies up to 250 v.

BELLING-LEE TWIN-TERMINAL

The most practical and ingenious terminal yet offered. Even for chassis mounting no terminal mount is required. Will take wire, flex, spade terminal or wanderplug. 8 assorted letterings. In pairs (no mount required).
No. 1102;

1/6



BELLING-LEE TWIN SOCKET STRIP

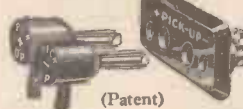

(Patent) No. 1047. 9d.
(Each with necessary plugs).

BELLING-LEE 3 PIN PLUG

Designed for connections between receiver chassis and loudspeaker. Centre tap speaker transformers; field coils with connection for earthing speaker chassis, or 3 wire arrangements to carry speech and energising currents to speaker.



3 Pin Plug in Walnut Bakelite complete with socket panel.
List No. 1119. 1/3

BELLING-LEE MAINS INPUT CONNECTOR

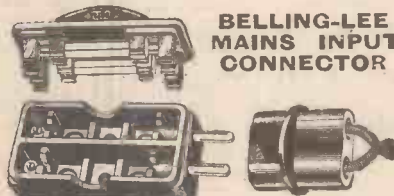

(Regd. Design)

Modification of Safety Twin Fuseholder. On removing cover the fuses are instantly accessible and circuit is dead. Impossible to touch live parts of fuseholder. Flex part carrying mains entirely shrouded. Complete with 1 amp. fuses.

No. 1098. Each 3/3

BELLING-LEE PICK-UP

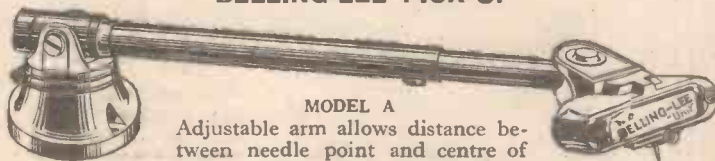

MODEL A

Adjustable arm allows distance between needle point and centre of base to be varied from 7 1/2" to 9 1/2". The arm should be as long as cabinet space permits. Head angle is also adjustable to obtain minimum tracking error for different arm lengths.

LET YOUR EAR BE THE JUDGE! List No. 1090 27/6

Special Features. — Perfectly natural frequency response
... minimises needle scratch while retaining high notes and brilliancy of reproduction
... Minimum record wear
... Copper screened flex.

BELLING-LEE
FOR EVERY RADIO CONNECTION

Advert. of Belling & Lee, Ltd., Cambridge Arterial Road, Enfield, Middlesex.

Write for Booklet "Radio Connections" giving particulars of Pick-ups, Disturbance Suppressor, Terminals, Wander-plugs, Plugs and Sockets, Mains Input Connectors, Fuses, Fuseholders, Battery-cords, etc.

EPOCH WONDERFUL NEW MODELS AND PRICE REDUCTIONS

Epoch Radio Manufacturing Co. have pleasure in announcing (1) several new models that will again be unequalled in their price classes, and (2) great reductions in most of the Epoch super-quality models. Particular attention is drawn to the price reduction of the world-famous "Domino" models by £1 to £2, according to type, bringing the finest domestic Speaker the world has ever heard within the reach of many more thousands of Real Quality Lovers.

Unrivalled manufacturing experience and research work of moving-coil speakers, which have been carried out by Epoch for years before many of the present manufacturers, and which resulted in inventions—some of which have been adopted by other manufacturers—are behind these products, assuring results and value far ahead of all other makes.

SEND FOR FULL PARTICULARS OF THE FOLLOWING NEW SEASON'S MODELS or call for a comparative demonstration.



"SUPER DWARF." A sensitive and relatively powerful P.M. moving-coil speaker suitable for portable sets, motor cars, etc., 5-in. Diaphragm. Capacity, $\frac{1}{2}$ to 2 watts.



TYPE B.5 P.M. This famous hand-made and balanced "quality" model is continued without increase in price until further notice. The model is one of the sturdiest built P.M. speakers and will stand heavy abuse. The magnet has been improved, giving greater sensitivity without loss of quality. 9% cobalt magnet weighing 10lbs. Interchangeable diaphragms. Capacity $\frac{1}{2}$ to 5 watts undistorted.

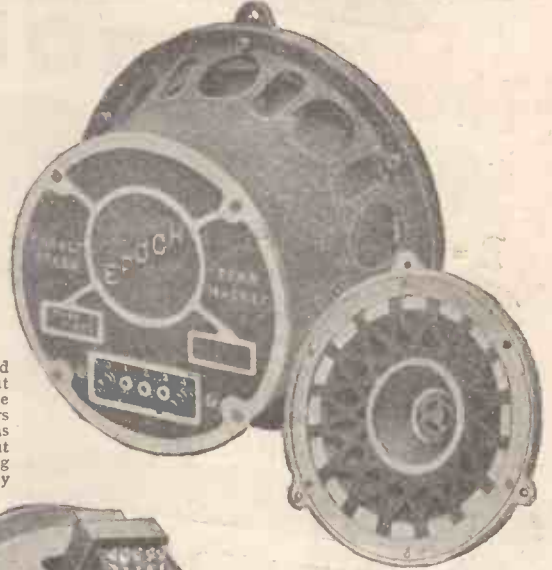

"TYPE A21." A new hand-made quality model of outstanding appeal for those who want something approaching perfection in a loud-speaker at a reasonable price. The unit is a very beautifully-designed and engineered job. With 10-ratio transformer. Sells at 63s.



"ELEVEN INCH SUPER." A new P.M. of outstanding quality, sensitivity and power, at an extremely low price. Suitable for domestic requirements or Public Address. Handling capacity, one-tenth to 8 watts undistorted. 9% cobalt magnet. 11-in. moulded diaphragm. With 10-ratio transformer. Price only 45/-

EPOCH CLASS B COMBINATION SPEAKER. This Unit combines a Class B adaptor and high-class cobalt P.M. unit, carefully balanced to give superb quality with colossal volume. Ready for immediate connection to the output of most battery sets. Lists at 49s. 6d. complete except for valve.

STAND No. 2 AT OLYMPIA

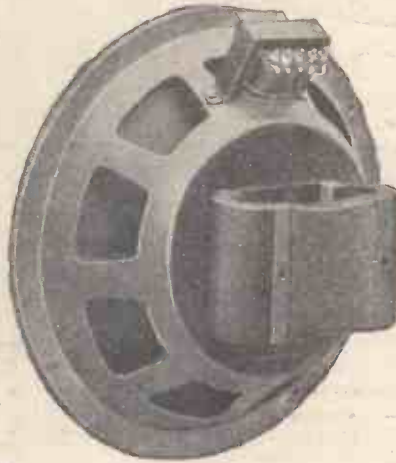

"TWENTIETH CENTURY." This "best seller" of last season is continued for a limited period in 9% cobalt steel, despite the heavy increase in the cost of cobalt magnets, making the intrinsic value of the unit 10s. higher than the price. 8 $\frac{1}{2}$ -in. Diaphragm. Capacity one-tenth to 4 watts. Extremely sensitive.



EPOCH "DOMINO" MODEL — ENERGISED. The finest and most sensitive domestic speaker the world has ever heard. At its greatly reduced price it will come within the reach of new thousands of users. 13in. (O.D.) interchangeable diaphragm.

EPOCH MOVING COIL MICROPHONE This invention will be regarded as important as that of the Moving-Coil Speaker, and as great an advance over the Carbon, Condenser, and all other types of microphones, as the Moving-Coil Speaker is over all other types of speakers. Perfect quality at all frequencies. Sensitivity much greater than the best carbon, and many times as great as condenser microphones, therefore in many cases not requiring pre-stage amplification. No batteries required. There are no internal or external noises. No hum. No "blasting." No springing or other suspension is used. A high-class engineering job at a comparatively very low price, to make it popular.



Ask your dealer for them but do not be put off with other makes. If unable to obtain them from your local dealer consult the manufacturers:— **EPOCH RADIO MANUFACTURING CO., LTD., Exmouth House, Exmouth Street, London, E.C.1. Clerkenwell 6666 (4 lines).**

NEW!

The COSSOR Melody Maker

MODELS 341 & 342

3-VALVES — PENTODE OUTPUT

VARIABLE-MU S.G. STAGE

ONE-KNOB TUNING

SELF-CONTAINED LOUD SPEAKER



£6=7=6

You can now have all the advantages of a highly-priced Receiver for only £6. 7. 6.—the price of the Cossor Melody Maker (Model 341). This remarkable Set has Variable-Mu S.G. Stage giving "all-Europe" range and amazing selectivity—Pentode output for big, undistorted volume—all-metal chassis—combined volume control and "on-off" switch, etc.—every up-to-date feature of design. In spite of its many advantages the Cossor Melody Maker is so simple that you can assemble it yourself even if you know nothing about wireless. Send the coupon for a full-size Constructional Chart,

MODEL 341

Complete Kit of Parts for assembling Receiver as illustrated, including Cossor Variable-Mu Screened Grid, Cossor Detector, and Cossor economy Pentode Valves. Fully screened coils, Cossor Double-Gang Condenser, Blued, gun-finished all-metal chassis, and all the parts for simple home assembly. Handsomely finished cabinet 18½" x 13½" x 10" of modern design with space for batteries and accumulator. Balanced Armature Loud Speaker of the latest type: provision for gramophone Pick-Up Plug and Jack if required. Wave-length range 200/530 and 900/2,000 metres. Price **£6.7.6**

Hire Purchase Terms 16/- deposit and 10 monthly payments of 12/6 or, alternatively, 20/- deposit and 6 monthly payments of 20/-.

MODEL 342

Identical with Model 341 described above except that Permanent Magnet Moving Coil Loud Speaker is supplied. Price **£7.2.6**

Hire Purchase Terms 17/6 deposit and 9 monthly payments of 15/6.

COSSOR MELODY MAKER

BATTERY MODELS 341 & 342

Prices do not apply in I.F.S.

To A. C. COSSOR LTD., Melody Dept., Highbury Grove, London, N.5.
Please send me free of charge a full size Constructional Chart C. 16, which tells me how to build the Cossor Melody Maker (Models 341 & 342).
Name _____
Address _____

PAAG, 19/33

A. C. Cossor Ltd., Highbury Grove, London, N.5. Depots at Birmingham, Bristol, Glasgow, Leeds, Liverpool, Manchester, Newcastle, Sheffield, Belfast, Cardiff and Dublin.

♥ 3269

FREE! 50 W.B. LOUD-SPEAKERS AS PRIZES! SEE PAGE 705



EDITOR:
 Vol. II. No. 48 || F. J. CAMM || August 19th, 1933
 Technical Staff:
 H. J. Barton Chapple, Wh.Sch., B.Sc. (Hons.), A.M.I.E.E.
 W. J. Delaney, Frank Proston, F.R.A., W. B. Richardson

ROUND *the* WORLD of WIRELESS

Our Début

THE past year has seen the most phenomenal progress in wireless since wireless became one of our national hobbies. Undoubtedly the most important introduction to the market of home construction during the past twelve months was the publication of PRACTICAL WIRELESS, and its appearance was greeted alike by amateur and manufacturer with acclamation. It revived the lagging interest which was being shown in the home construction of wireless receivers and apparatus, and introduced to many the principles of the science which brings to the home the events which are taking place perhaps thousands of miles away. As a direct result of this re-awakened interest in home construction many ideas—such, for instance, as the Class B method of amplification—which would normally perhaps have been reserved for the manufacturer, have been passed on to the home constructor. We have, therefore, been directly responsible, in no small measure, for the strides which have been made during 1933. Our far-flung circulation should convince the most sceptical that this is no idle boast. We have filled a long-felt want, and we pride ourselves that we have filled it adequately. We trust that the forthcoming year will see a still greater increase in the numbers of home constructors and therefore a corresponding increase in the development of the technique of Wireless Broadcasting.

German Dance Music Only

LAST April the German authorities banned all jazz melodies in their dance hours; saxophones and other kindred instruments were also vetoed. To-day they have decreed that the fox-trot, tango, and one-step must also be deleted from the broadcast programmes. In their place the old German waltz, the *Tanz-marsch* (march dance) and *Rheinländer* are to be revived as well as some of the earlier square dances.

Another Ascent to the Stratosphere

THE Belgian engineer, Max Cosyns, who took part in Professor Piccard's experiment last year, proposes to carry out a similar ascent on his own in a specially constructed balloon within the next few weeks. It is probable that he may start in the early hours of the morning, but if arrangements can be made, a running

To New Readers OF Practical Wireless By the Editor

With this special enlarged issue many home constructors will make their acquaintance with PRACTICAL WIRELESS for the first time. It is, therefore, appropriate that we re-affirm our objects and our policy with which regular readers will already be well acquainted.

OUR PRACTICAL POLICY

This is not a normal issue; for the importance of the Wireless Exhibition has, quite justifiably, claimed a large proportion of our pages.

Normal issues of "Practical Wireless" contain a fair blending of every wireless home-constructor interest—practical articles on set-building, television, mains receivers, reader's ideas, coil-making, fault-tracking, reliable test reports on the latest components, expert replies to readers' questions—everything, in fact, which is of practical interest to the home-constructor written in everyday language and attractively illustrated.

SPECIAL SECTIONS

A Special BEGINNER'S SUPPLEMENT regularly appears for the benefit of those who have just taken up the hobby, and those interested in short-wave work will find our SHORT-WAVE SECTION provides them with up-to-date information on the latest practice in this branch of radio.

READERS' IDEAS

Readers' Ideas of a practical nature are invited, and half-guinea is paid for every one published—£1 11s. 6d. for the best each week.

REAL, RELIABLE AND UNRIVALLED READER SERVICE!

Our FREE ADVICE BUREAU answers readers' questions promptly and accurately FREE OF CHARGE. Only those parts used by our designers are specified for PRACTICAL WIRELESS receivers—no alternatives. Every receiver built according to our instructions must do all we claim for it. Hence our FREE ADVICE GUARANTEE.

OUR LABORATORIES

Our well-equipped Laboratories, staffed by a band of enthusiastic experts, is always tirelessly at work designing the very best receivers for home constructors.

PRACTICAL WIRELESS provides an excellent instructional course for the beginner and a refresher course for the expert. It is

THE LEADING HOME-CONSTRUCTORS' WEEKLY.

If you wish to inspect back issues, our fine series of Wireless Handbooks, require a blueprint for a particular Receiver, or require free technical advice, call at our

STAND No. 8, ON THE GROUND FLOOR.

commentary will be broadcast by one of the Brussels stations. The date of the start has not yet been fixed, as it will depend on weather conditions, but it will take place towards the middle of August or beginning of September. In order to keep in touch with the land stations, the aerial explorer will take with him a short-wave transmitter working on 21.4 and 41.1 metres.

Norway's New Stations

THE first steps taken in the re-organization of Norway's broadcasting system will be the installation of 20 kilowatt transmitters to replace those now working at Trondheim and Bergen. Both plants are being built at the Marconi works (Chelmsford), and will prove to be of the most up-to-date type.

To Eliminate Distortion

THE MARCHESE MARCONI is now planning a series of experiments on his yacht, *Elettra*, in the Mediterranean, with a view to the elimination of distortion in wireless broadcasts. The yacht will operate in conjunction with the Marconi works at Genoa and with the Roca di Papa radio station near Rome.

Berlin's Canned Commentaries

AS the Nazi authorities are anxious that the wireless programmes should contain *verbatim* reports of all their speeches as well as official running commentaries on patriotic and other national demonstrations, in every instance records of these events are made on special discs through portable transmitters installed in mobile outside broadcast motor vans. The records are then dispatched to the different studios for re-transmission. Many of the Berlin entertainment programmes are also dealt with in this manner and thus less use is made of the land-lines for the relays. Contrary to the method adopted by the B.B.C., the German studios do not appear to use the Stille process for "canning" these broadcasts.

Some Consumption

ACCORDING to statistics published as a result of the Electrical Conference at Paris, it is computed that there now exists roughly thirty-five million wireless receivers in the world. Their total consumption of electricity would approximate three hundred thousand kilowatts.

ROUND the WORLD of WIRELESS (Continued)

Arab Station For Morocco

AS Morocco has been granted two wavelengths, namely 499 metres (destined to Rabat) and 345.6 metres, the latter channel will be used for broadcasts in the Arabic language for the native population. At present, Oriental concerts are given by Radio Maroc four times weekly between B.S.T. 19.00—20.00, but to satisfy listeners it will be necessary to build a new station for these transmissions alone. Although the site has not been definitely selected, it is expected that it will be found in the neighbourhood of Meknes or Marrakesh. For part of its programmes the new station would relay entertainments from Rabat, but much of the material would be of local native origin.

A Funereal Carillon

IN Czechoslovakia it is customary to toll bells at all graveyards on the occasion of a burial. As the main cemetery at Debrccen, although possessing a small chapel for services possesses no belfry, the authorities have solved the problem on such occasions by relaying a carillon from one of the principal churches in the city and re-broadcast the peal of bells through a number of loud-speakers.

Alternate Programmes for Milan

TO provide two different programmes to listeners in Northern Italy the E.I.A.R. have brought into operation the older Milan (Vigentino) transmitter on 453.2 metres, which now nightly relays the Rome broadcast entertainments. The local transmissions from Milan, Trieste, Genoa or other cities forming part of the same group are given through the more modern and higher powered Siziano station. A similar policy of "double programmes" is also to be adopted in the Italian capital, where a new 1 kilowatt relay station will be built with a view to giving listeners in that area an opportunity of hearing operatic and other performances from the Northern studios.

Germany's 1934 Plan

IN connection with the re-allocation of wavelengths according to the Lucerne Plan, the Reichsfunk intend to avail themselves of the maximum limit of power allowed to broadcasting stations in each band. Work is to be started without delay on the building of new transmitters, and on the reconstruction of the older plants. Mühllacker, Langenberg, Munich, Berlin, and Hamburg next year will be rated as *one hundred kilowatts*, and to secure better radiation, will be provided with the latest aerial systems. In the meantime, however, Mühllacker, Berlin, and Munich will exchange wavelengths in December; Mühllacker will operate on 532.9 metres, Munich will take over the present Berlin wavelength, and Berlin, in its turn will use the channel now occupied by Mühllacker. As the plant of the latter must undergo considerable alteration, it will suspend its broadcasts for a period

INTERESTING and TOPICAL PARAGRAPHS

during the autumn, the transmissions being taken over by the old 1½ kilowatt Stuttgart station. For technical reasons, although the Hamburg super-station is almost ready, it will not be brought into action

before January 15th, 1934, except for testing purposes. The new Bremen and Hanover relays as well as Magdeburg (now attached to the Berlin group) will pass into the Hamburg network in the course of the next few weeks. In the same way Freiburg, which has been rebuilt, in October next will work on a common wavelength with Cassel and Frankfurt-am-Main. It is also proposed to feed from this latter station a smaller relay at Coblenz. Not content with this considerable development of her broadcasting system, Germany has decided to raise the power of the Königs Wusterhausen and Leipzig stations to 150 kilowatts.

NAVAL TIME-BALL SIGNALS AT DEVONPORT DISMANTLED.



The Naval Time-Ball Signals, which have been in constant use since 1888 at Mount Wise, Devonport, Devon, giving the official time to the naval ships and mariners, have, by Admiralty orders, to be dismantled, the more up-to-date method of time signalling by wireless now being in use.

Photo shows:—The final scene—the time-ball signal reaches the ground, thus ending a practice which has been in use at Mount Wise, Devonport, since 1888, when the Duke of Edinburgh was Commander-in-Chief.

Loud-speakers in the Sky
EXPERIMENTS are being carried out in Holland with a new type of aeroplane fully equipped with microphone amplifiers and loud-speakers. Tests recently made satisfactorily demonstrated that at heights varying between 2,000 and 2,500 feet broadcasts made from the aircraft whilst in flight were perfectly well heard by listeners on the ground. A company has been formed for utilising this system of aeroplane broadcasts for the transmission of advertising matter over towns.

Another Conference

NOT in Europe this time, but in South America, where, at Mexico City, delegates are endeavouring to adjust the channels used by transmitters located in Mexico, United States, Cuba, and Canada. The need for discussions on the matter is due to the fact that during the past year some Mexican broadcasting stations have "jumped" the wavelengths already allocated to North American transmitters and in many instances have thus caused considerable interference. In addition, the United States have been anxious for some time to secure a reduction in power of stations installed just outside their territories and of which the publicity broadcasts are mainly destined to American listeners.

Austria's 485,000 Licences

IN Austria this year the figures have shown a decided increase. It is alleged that this is due to the considerable interest taken by the nation in the present Austro-German political conflict. The Government is anxious that the Munich propaganda broadcasts should not be available to the general public and has decreed that where listeners tune in to this station they are forbidden to broadcast the transmission through loud-speakers placed at windows or on balconies for the benefit of passers-by. Apparently this stringent order, which carries with it heavy fines and even imprisonment, is only a provisional one, as according to a report from Vienna in view of the failure of diplomatic protests lodged by the Austrian authorities, they may be compelled to jam certain programme features emanating from Munich, Heilsberg and other German studios.

SOLVE THIS!

PROBLEM No. 48.

Ratcliffe built a simple three valve A.C. mains receiver which worked quite satisfactorily for about a week. When switched on one evening, however, signals were very weak indeed, and after examining all connections, Ratcliffe inserted a meter in that anode lead and found that the total anode current was much below that which he normally expected. On testing the total consumption (at the negative H.T. lead) he found that there was only half the current which the three valves should normally consume. He naturally suspected the rectifying valve, but when this was replaced by a new one there was no alteration in the meter reading, and results were exactly the same. All connections were tested and found in order. What was wrong? Three books will be awarded for the first three correct solutions opened. Mark your envelopes Problem No. 48, and address them to The Editor, PRACTICAL WIRELESS, Geo. Newnes, Ltd., 8-11, Southampton Street, Strand, London, W.C.2. No entries will be accepted after August 21st.

SOLUTION TO PROBLEM No. 47.

When adjusting the trimmers on the ganged condensers, Bradley had them all screwed up too tightly, thus raising the minimum setting. By slackening the trimmers slightly he could have tuned down low enough to receive Fecamp.
The following three readers received books in connection with Problem No. 46:—
Mr. Charles McKenna, City Hospital, Fazakerley, Liverpool; Mr. M. A. Tucker, 10, Castle Close, Southsea; Mr. L. J. Davies, 3, Freshford Road, S.W.18.

NOVEL LOUD-SPEAKER IDEAS

In this Article the Author Describes Four Unconventional Methods of Fitting Speakers.

By CONSTRUCTOR.

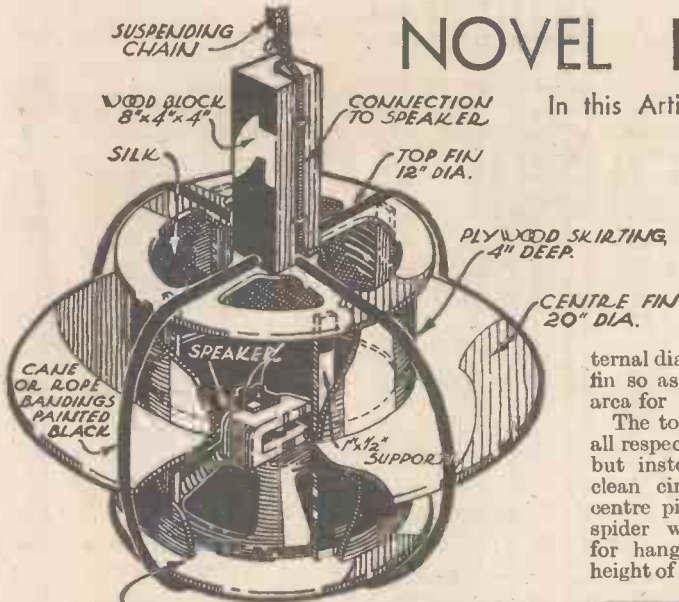

Fig. 1.—Showing the construction of the pendant loud-speaker.

THESE ideas concerning loud-speakers may not be suitable to every reader's radio quarters or aesthetic taste, yet to many, one of them may prove useful as an alternative to an existing baffle-board or cabinet which, owing to various causes, is other than a serviceable, eye-appealing affair.

Fig. 1 shows the general assembly of a speaker which to all outward appearances is an electric light pendant.

The exact diameters of the three discs, which may be cut from opal glass or three-ply, are best left to the discretion of the constructor, who will to some extent be guided by the size of his loud-speaker cone; but for the sake of clarity the dimensions of the writer's final model are given.

The difference between the inside and outside edges of the bottom fin is 4in.; the external diameter being 12in., leaving, therefore, an 8in. cut out to match the diameter of the cone of the speaker used.

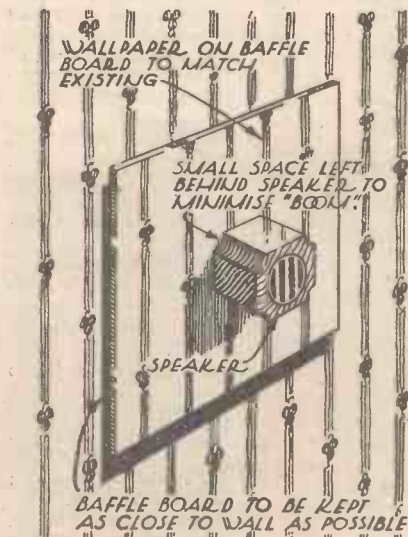

Fig. 2.—A method of camouflaging the loud-speaker.

The middle fin overhangs the bottom one 4in. at every point, and its cut out is 10in. or 2in. less than the external diameter of the bottom fin so as to form a receiving area for the skirting.

The top fin was cut equal in all respects to the bottom one, but instead of cutting out a clean circle in its middle, a centre piece formed within a spider was left as depicted for hanging purposes. The height of both pieces of skirting

Fig. 2 shows a novel way of using a large baffle-board in conjunction with a small cabinet without the result standing out at the expense of space in a room or recess. The feature of this arrangement is the idea of camouflaging the baffle-board so that to appearances it is not there. This is done by pasting over it wallpaper of the same design as that already on the wall.

This unwanted effect, however, if it is apparent, may be counteracted to some extent by leaving a small gap between the back edge of the cabinet and the board (a). If thin ply-wood is used for the board, and this is above 20in. square, it is advisable to screw a number of cleats on its back to prevent excessive vibration. These cleats will also prevent the board from twisting.

Fitting a Speaker in a Cabinet

The third idea may prove useful to those who wish to fix their loud-speakers (armature unit type) in a two-doored cabinet similar to the one shown in Fig. 3. Obviously, if one of the door panels is cut and overlaid with a fancy fret the balance of the cabinet will be spoiled; and with certain types of cabinet work a fancy fret on both doors would look ridiculous. A good way of overcoming these drawbacks is to replace one of the door panels with a panel of thin veneer, and to fix the driving rod to this as though being fixed to an ordinary cone without large cone washers.

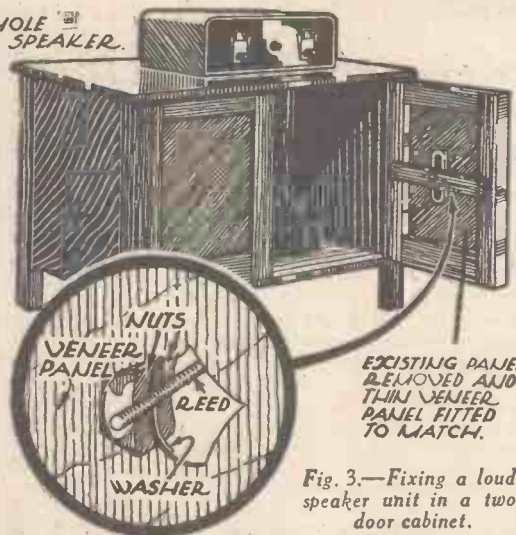

Fig. 3.—Fixing a loud-speaker unit in a two-door cabinet.

is 4in., and these two pieces were not cut to any length in the beginning, but for easy working were cut to requirements from a strip of ply-wood as they were moulded round the fins' stanchions (Fig. 1).

Using as a test a hefty M.C. speaker in this thin frame there was noticed a queer kind of bumping, which was found to be due to the bottom fin acting as a sounding board, and this was remedied by fitting inside a 1in. thick circle of wood. Moreover, at first trial the assembly was hung only 9in. from the ceiling, with the idea of better sound distribution—an idea which proved as false as the false bass notes experienced. The top fin was finally hung 18in. from the ceiling.

In trying to overcome a tendency for loud passages of deep music to transmit themselves in an amusing manner through the ceiling into the bedroom above, the chain suspension was interlaced with an elastic link, and this idea was successful.

Pendants of this kind made from ply-wood may be painted white or tinted to match a coloured ceiling with distemper—if the wood is first glue-sized. A piece of muslin or silk should be glued over or under the top fin's spider to prevent dust getting into the speaker unit. The assembly should be hung from a ceiling joist and not be haphazardly plugged into the plaster.

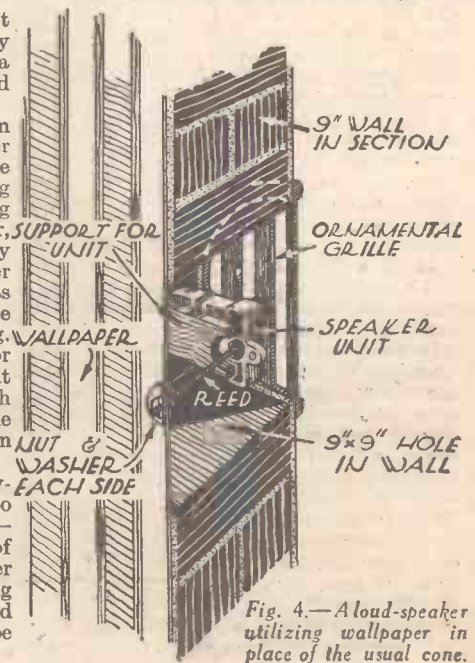

Fig. 4.—A loud-speaker utilizing wallpaper in place of the usual cone.

ANOTHER OUTSTANDING
"PRACTICAL
WIRELESS"
RECEIVER!



The Superset

The Set that Supersedes

Every Worth-while Improvement Incorporated in This
New-season's Five-valve Battery Receiver for Home
Constructors. Iron-core Coils—Class B Output—
Metallized Wooden Chassis—Two Variable- μ Stages
—Simple and Few Controls—Special Tone Control—
New Cabinet Design. **By F. J. GAMM.**

EVERY reader of PRACTICAL WIRELESS is aware of the extreme painstaking care expended in our laboratories in producing really satisfactory receivers for our readers. We satisfy ourselves that every component is satisfactory before we specify it; we do not specify components which the public cannot buy, preferring to wait until supplies are on the dealers' shelves; we do not specify alternative components; we guarantee PRACTICAL WIRELESS receivers to perform in the manner claimed, *but only when the components we specify are used.* And it must be obvious that, if the reader uses those parts and follows our instructions, he *must* duplicate our results. The FREE ADVICE BUREAU gives prompt and reliable advice in case of difficulty, which in most cases are peculiar to a locality and not due to faulty construction or design.

The 1934 Superset is designed around the very latest components; and an examination of the circuit diagram reveals that the very best principles are incorporated according to the known state of the science at the moment of going to press. It can, hence, really claim to be an up-to-the-minute receiver.

It is a Superset—not a superhet; I am convinced that, in a correctly-designed receiver such as this unquestionably is, all of the advantages of the superhet (which usually is merely super-sonic without being really super), can be obtained without going to the expense entailed by adopting that queer and fluky Yankee circuit system. The superhet usually lacks that elusive thing we call *quality*; it has

been sacrificed at the altar of selectivity and sensitivity.

But the introduction of iron-core coils has almost entirely solved the problem of selectivity, and at the same time almost entirely eliminated the possibility of breakthrough on the long-waves. Hence the great advantage of the superhet is gained without expensive components and complicated circuit arrangement. The superhet is popular, but it seldom provides that which, for want of a better term, we call quality.

In a superhet the frequency of the received signal is converted into a lower frequency, then amplified by two or more H.F. stages, again detected and then passed via the L.F. stages to the speaker. No wonder quality is usually absent!

So in the Superset it was desired to

produce superhet selectivity *plus* the quality of a normal well-designed receiver; to employ an economical Class B output stage; to provide unusual sensitivity, extreme simplicity of control (which means a minimum number of them); tone control, provision for gramophone pick-up, and finally to house the receiver in a cabinet of modern design. Every one of those requirements is in the Superset, which covers the medium and long wave-bands. The most exacting listener could not cavil at the performance of this receiver, which I determined should not only be worthy of PRACTICAL WIRELESS, but should be a worthy souvenir of the first Radio Exhibition since the publication of Number 1.

It is a receiver with which you can easily tour round the British, European, and American stations; it has 1½ watts output—sufficiently robust for all ordinary needs.

The earliest part of the receiver to undergo consideration was the chassis. Should it be of metal, foil-covered wood, or just plain wood? The great advantages of the metal chassis are that it provides adequate screening, quickly-made and short earth-return leads, and a professional finish to the receiver. And then Messrs. Peto-Scott came to the rescue; for at that time they sent me round a sample of their new metallized wooden chassis; they have invented an ingenious process of spraying metal *into* the wood, so that the advantages of the metal

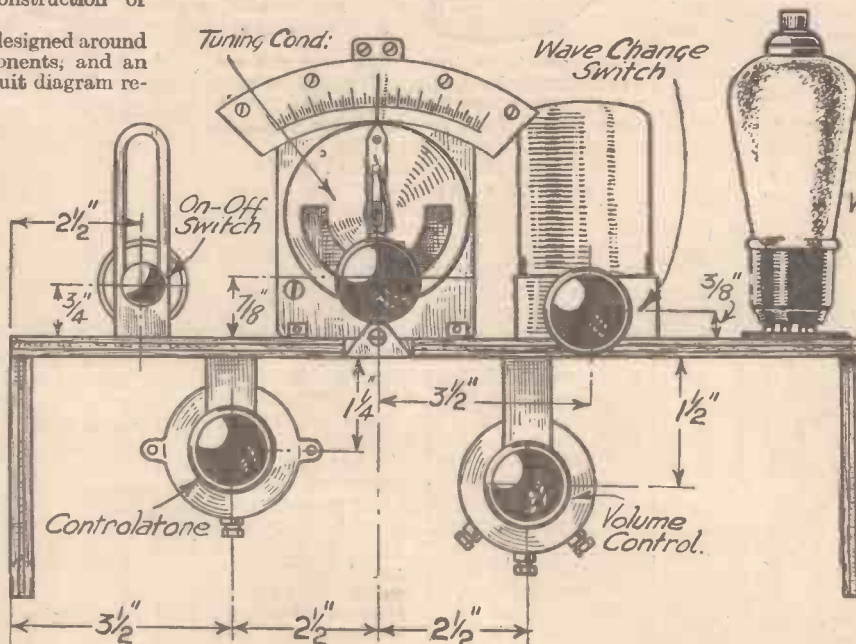

Dimensioned front view of the Superset. Use this Diagram for marking off the positions of the control spindles on the front of the cabinet

chassis are combined with the ease of construction provided by the wooden chassis. It really is a most efficient process, and I want to accord Messrs. Peto-Scott a special word of praise. They have always had the needs of the home constructor at heart, and this new metal-sprayed chassis, which you may order from them in any size, shape or form, is every bit as good as metal itself. It may freely be used (as I have done in the Superset) for earth return leads, and it certainly gives a professional finish to a part of the receiver which usually is left in the bare wood stage—soon to get finger-marked! And while I am dealing with the baseboard, I can also discuss the cabinet. You will note from the heading that this is of special design, with the speaker neatly and snugly disposed to the left of the receiver. This results in a low-built cabinet, and provides logical and instinctive positions for the controls—except in the unlikely event of your being left-handed. An additional advantage is that all batteries are also housed in the cabinet.

This cabinet is reasonably priced, and is dovetailed together, quarter veneered, with the speaker-grille bars picked out in black. Every constructional detail is given in his article, including the wiring diagrams. A feature the reader will appreciate is that every component is mounted on the chassis. It may thus be completely wired up outside the cabinet. The front of the cabinet should be drilled, in accordance with the drilling diagram given here; the complete chassis is then slid into place and the knobs locked on to the spindles.

Some Circuit Details

I wanted the Superset to be economical in L.T. current; I therefore decided to use the .2 amp. type instead of the usual .4 amp. This also effects an economy in H.T. current, yet yields an output of 1½ watts—adequate for normal home use.

A further feature introduced in the interests of economy concerns the H.F. stages. Short-base variable-mu valves are used, so enabling a small 9-volt grid bias battery to be used. The Class B valve does not, of course, require bias; the driver needs approximately 4.5 volts, and it would therefore be sheer waste to use an 18-volt grid-bias battery merely for biasing the H.F. valves.

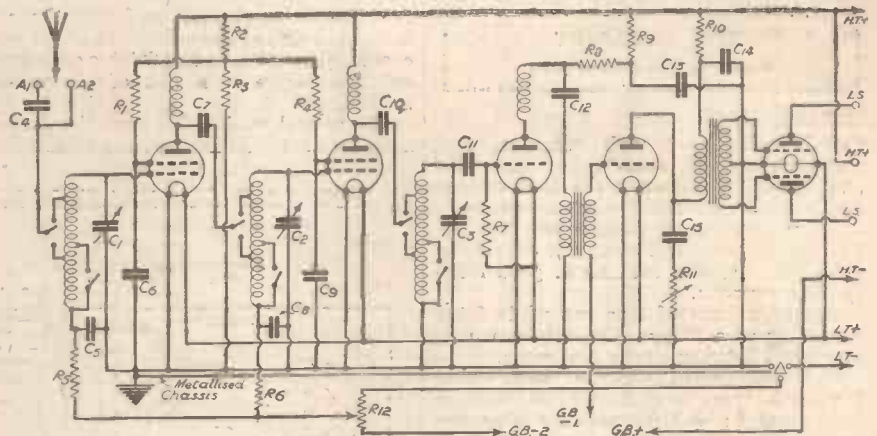

Theoretical Diagram of the Superset.

The new Cossor short-base variable-mu enable the same degree of volume control to be obtained with a G.B. battery only half the size normally required.

I have introduced no complications in the form of an excessive number of controls. I wanted the Superset to be simple. I (Continued on page 696)



Rear view of the Superset.

LIST OF COMPONENTS FOR THE 1934 SUPERSET

- One Three-gang Condenser with full-vision scale (Type 604) (British Radiophone).
- Three Iron Core Coils—one Aerial and two H.F. (Lissen).
- One Class B. Driver Transformer (Wearite).
- Two Superhet H.F. Chokes (Bulgin).
- One Midget H.F. Choke (Bulgin).
- One Type 34 .0001 mfd. Fixed Condenser (T.C.C.).
- One Type 34 .002 mfd. Fixed Condenser (T.C.C.).
- Two Type 50 2 mfd. Fixed Condensers (T.C.C.).
- Five Type 50 1 mfd. Fixed Condensers (T.C.C.).
- Two Type 34 .0002 mfd. Fixed Condensers (T.C.C.).
- One Type 23 Component Bracket (British Radiogram).
- Two Type 21 Component Brackets (British Radiogram).
- One "Nictet" L.F. Transformer (Varley).
- One 25,000 ohm Potentiometer (Wearite).
- One Type B "Controlatone" (Bulgin).
- Four 4-pin Chassis type Valve-holders (Clix).
- One 7-pin Chassis type Valve-holder (Clix).
- Ten "Ohmites"—500, 500, 500, 500, 8,000, 40,000, 35,000, 60,000, 80,000 ohms and 2 megohms (Graham Farish).
- Eight Junior Type terminals, A1, A2, E, P.U., L.S.—, H.T.—, and L.S.— (Belling-Lee).
- One Type 50 S.P.D.T. Switch (British Radiogram).
- One Type 3-point Switch (British Radiogram).
- One eight-way Battery Cord (Belling-Lee).
- One "Metaplex" Chassis (Peto-Scott).
- Two Type 220 V.S. Valves (Cossor).
- One Type 210 H.F. Valve (Cossor).
- One Type 215 P. Valve (Cossor).
- One Type 220 B. Valve (Cossor).
- One 120-volt H.T. Battery (Ediswan).
- One 9-volt G.B. Battery (Ediswan).
- One 2-volt 40-ampere L.T. Accumulator (Ediswan).
- One "Superset" Cabinet (Osborn).
- One Length Receptu Screened Down Lead (British Radiophone).
- One Filtr Earthing device (Graham Farish).



THE SUPERSET

(Continued from previous page)

therefore dispensed with reaction, and really obtain the same effect from the H.F. stages by adjusting the H.T. voltage applied to the screening grids and anodes.

These two stages provide ample selectivity for the normal reception of all the principal European stations at good loud-speaker strength.

A special form of tone control is fitted consisting of a Bulgin Controlatone unit connected between anode and earth.

One advantage of this arrangement is that it reduces connections, as only two terminals are provided; at the same time it enables a very smooth control of volume (from boomy bass to high-pitched tenor) to be obtained.

Notice that the tone control precedes the Class B stage, and therefore the control acts by reducing the tone to that which is desired before amplification is effected. Quite obviously this is a better arrangement than carrying out complete amplification of the signal and effecting tone control at the output end.

Another economy which the reader will appreciate is that the loud-speaker is fitted with the output transformer, so saving the expense of a separate component.

A radio gramophone switch is provided for record reproduction; more will be said about its use in a later article.

The Wiring Diagram

An inspection of the wiring diagram given to the right reveals the extreme simplicity of the layout. The chassis will come to you with the holes for the chassis mounting valve-holders already built. Additionally it will have the ebonite terminal strip fixed in place. By purchasing this special metalized chassis from Messrs. Peto-Scott Ltd. you will be saved the trouble of making up the wooden chassis. This special metalized chassis, by the way, is sold under the trade name of "Metalex." Alternative aerial terminals are provided to eliminate damping where a long aerial is used. The radio-gramophone switch, it will be seen, is incorporated between the two pick-up terminals.

Earthing Points

Earthing points should be made by means of an ordinary wood screw with a washer plate under the head to provide adequate clamping area, except in one instance, the earthing point immediately behind the three-gang variable condenser, where a bolt is used to ensure good metallic connection between the top and under surfaces. A pictorial view of the complete receiver is given on page 700, together with photographic illustrations of the top and under views of the chassis, from which the disposition of the various components, wiring, etc., should easily be followed.

Marking Out the Cabinet

There are two methods of marking out the cabinet to receive the set. The first, and probably the most satisfactory, is to remove the knobs from the spindle and to slide the set into the cabinet, when a firm pressure on the terminal strip will cause the spindle extensions to form indentations on the inside of the cabinet front. A carpenter's twist bit should be used to

drill the holes, drilling half way through from each side of the cabinet front. Great care must be taken in this drilling operation, otherwise there is a risk of the veneer splitting off.

The second method is to use the dimensioned view of the front of the chassis and

carefully mark the position of the holes. It will be necessary, of course, to drill clearing holes so that the spindles turn without binding on the wood. If you desire to ask any questions regarding either the Superset, the Auto B Three, the All-Wave

(Continued on page 700)

TOP AND SUB-BASEBOARD WIRING OF THE SUPERSET

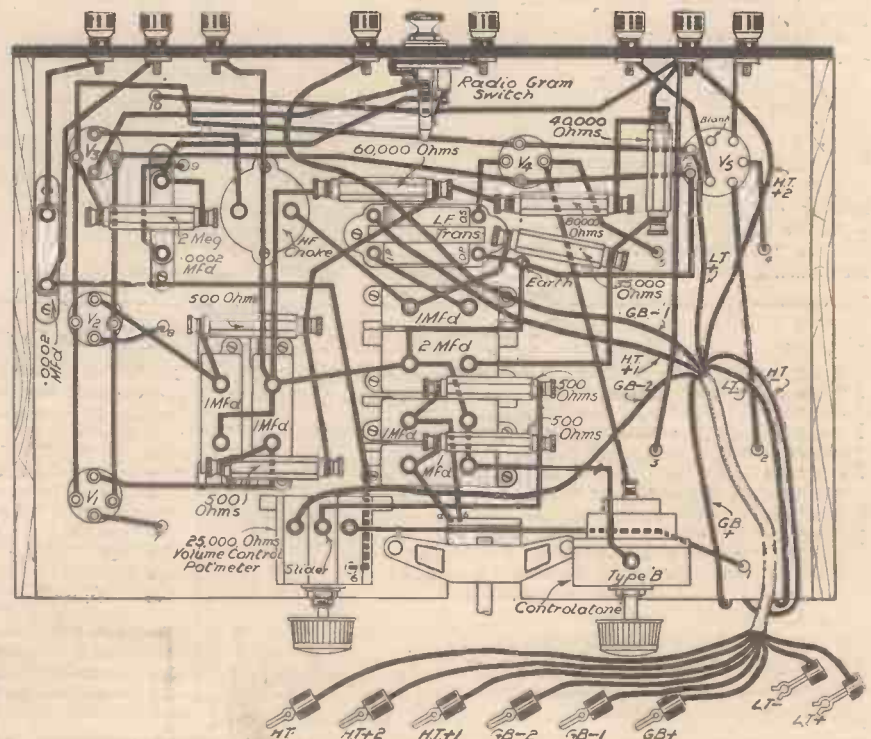
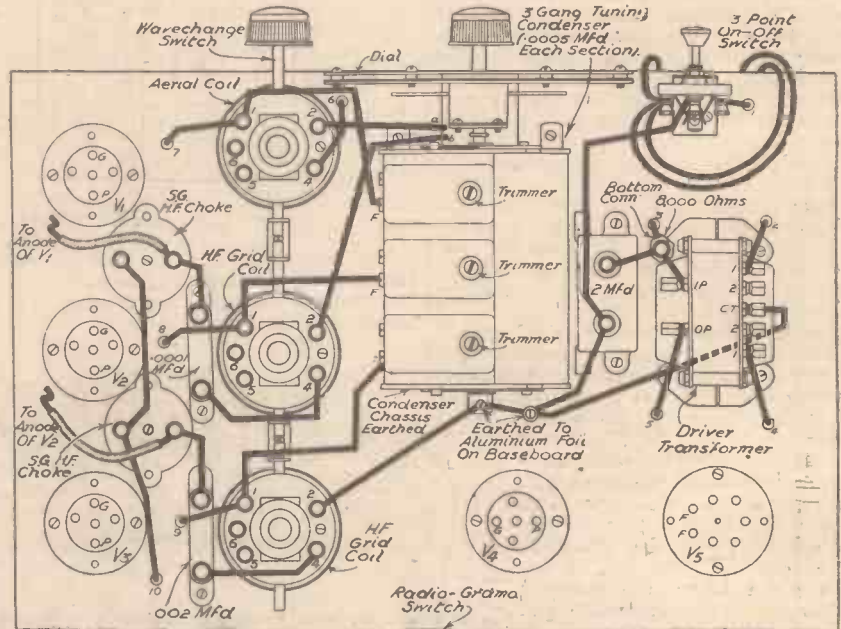



The Centre of Interest at the Radio Exhibition

On "His Master's Voice" Stand there is an exhibition in itself—the complete range of the "His Master's Voice" radio receivers and radio-gramophones to meet 1934 broadcasting conditions.

THE RANGE OF "HIS MASTER'S VOICE" 1934 RADIO AND RADIOGRAMS TO BE SEEN AT OLYMPIA

Model 532 Superhet Ten Autoradiogram De Luxe	95 guineas
Model 532 (standard) Superhet Ten Autoradiogram	80 guineas
Model 524 Superhet Autoradiogram Seven	48 guineas
Model 523 Superhet Radiogram Seven	39 guineas
Model 512 Superhet Radiogram Five	29 guineas
Model 470 Superhet Lowboy Seven	25 guineas
Model 467 Superhet Concert Seven (Table)	22 guineas
Model 501 Transportable Radiogram	19 guineas
Model 438 Superhet Selective Five	15 guineas
Model 459 Superhet Portable Six M.C.	14 guineas
Model 436 De Luxe Radio Four	12 guineas
Model 116 Record Player	7 guineas

"HIS MASTER'S VOICE"

The Gramophone Co., Ltd., 98-108 Clerkenwell Road, London, E.C. 1

The MOST LUXURIOUS RECEIVER EVER



**COMPLETE
WITH SEVEN
VALVES**

£8-17-6

CHART IN FULL COLOUR
AND LAVISHLY
ILLUSTRATED

POST COUPON AND **FREE**
GET YOUR COPY

To LISSEN, LTD.,
Publicity Dept., Isleworth.

Please send me FREE CHART of the "Skyscraper" Seven Valve Superhet.

Name

Address

P.T. 134

Lissen have published for this great new "Skyscraper" Seven Valve Superhet a most luxurious Chart which gives more detailed instructions and more lavish illustrations than have ever before been put into a constructional chart. It makes success certain for everybody who decides to build this set; it shows everybody, even without previous constructional experience, how they can have a luxury receiver and save pounds by building it themselves. A copy of this Chart will be sent FREE in return for coupon on the left or your radio dealer can supply you. Get your FREE CHART now!

OFFERED TO HOME CONSTRUCTORS

7 VALVES
IN A
SIX STAGE
BAND PASS
FILTER
EXACT 9 K/C
CHANNELS -
AMPLIFIED
AUTOMATIC
VOLUME
CONTROL
CLASS "B"
OUTPUT
MOVING-COIL
SPEAKER

Never before has there been any receiver for Home Constructors on such an ambitious scale as this new Lissen "Skyscraper" Seven Valve Superhet. It embodies every up-to-the-minute advance and refinement of the most luxurious factory-built superhets—it gives the constructor the opportunity to build a £20 receiver for less than half that price.

The circuit of the Lissen "Skyscraper" Seven Valve Superhet incorporates a 6-stage bandpass filter giving exact 9-kilocycle channels and therefore providing a standard of selectivity never before achieved by a home constructor's kit set and very rarely found except in laboratory apparatus. Amplified Automatic Volume Control is provided, a special valve for this purpose having been produced by Lissen for use in this receiver. The use of this Amplified Automatic Volume Control constitutes an entirely new experience in listening; no "fading," no "blasting"—you will find yourself enjoying every word of every programme, however near or however distant, without the slightest temptation to interfere with the receiver once you have tuned it. This is radio listening as it should be enjoyed.

a new full-power Lissen Moving-coil loudspeaker—glorious rich tone and majestic volume, actually more faultless in its reproduction than anything you ever heard from even the most powerful mains receiver, yet working economically in this Lissen "Skyscraper" from H.T. batteries.

Tuning is something new in single-knob control—in fact, not only single-knob control but *single station tuning*. You never hear two stations together, you never need to think about separation. The 9-kilocycle tuning peak of the circuit ensures "one station at a time" all round the dial, and the Amplified Automatic Volume Control adjusts the receiver automatically to provide the same volume from each transmission. This simplicity is the true luxury of listening—and this is the Luxury Receiver for Home Constructors.

Lissen Class "B" Output through



Price complete with
 Inlaid Walnut Cabinet
 and Moving Coil Speaker

£11-10^s.

LISSEN

"SKYSCRAPER" 7
SEVEN VALVE SUPERHET

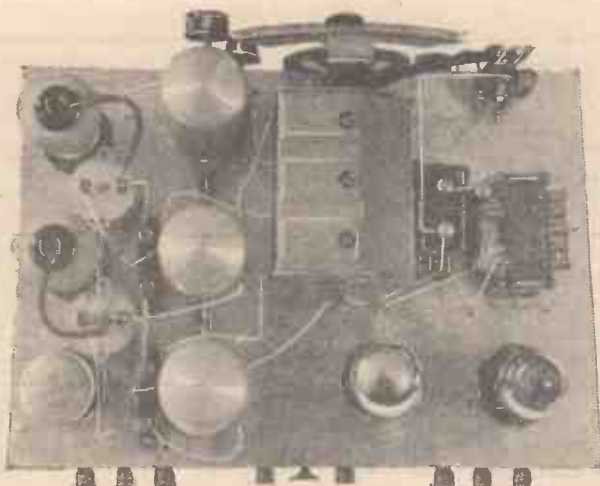

Top view of the Superset.

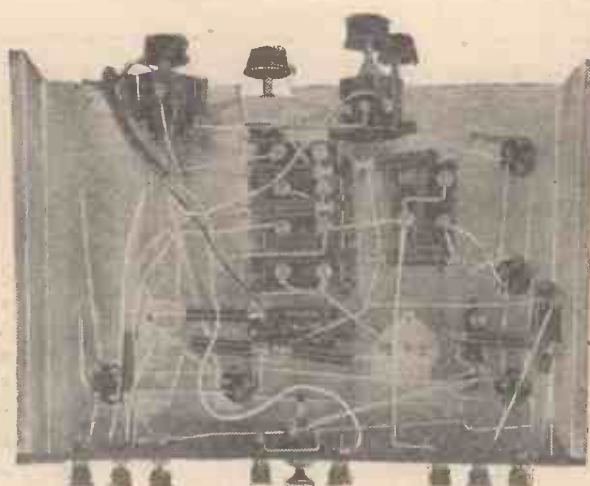

Sub-baseboard view of the Superset.

THE SUPERSSET

(Continued from page 696)

Two (all of which are described in this issue), or about any other PRACTICAL WIRELESS receiver, a full list of which appears on page 761, you should call at our

stand, No. 8, on the Ground Floor of Olympia.

I would conclude this article with the advice that only those components actually specified should be used ; I cannot guarantee results when parts are used which I have

not actually tried in the Superset. The substitution of a seemingly trivial part may upset the balance of the whole circuit.

I have gone to a great amount of trouble to make the Superset right. Don't choose wrong components and get it wrong !

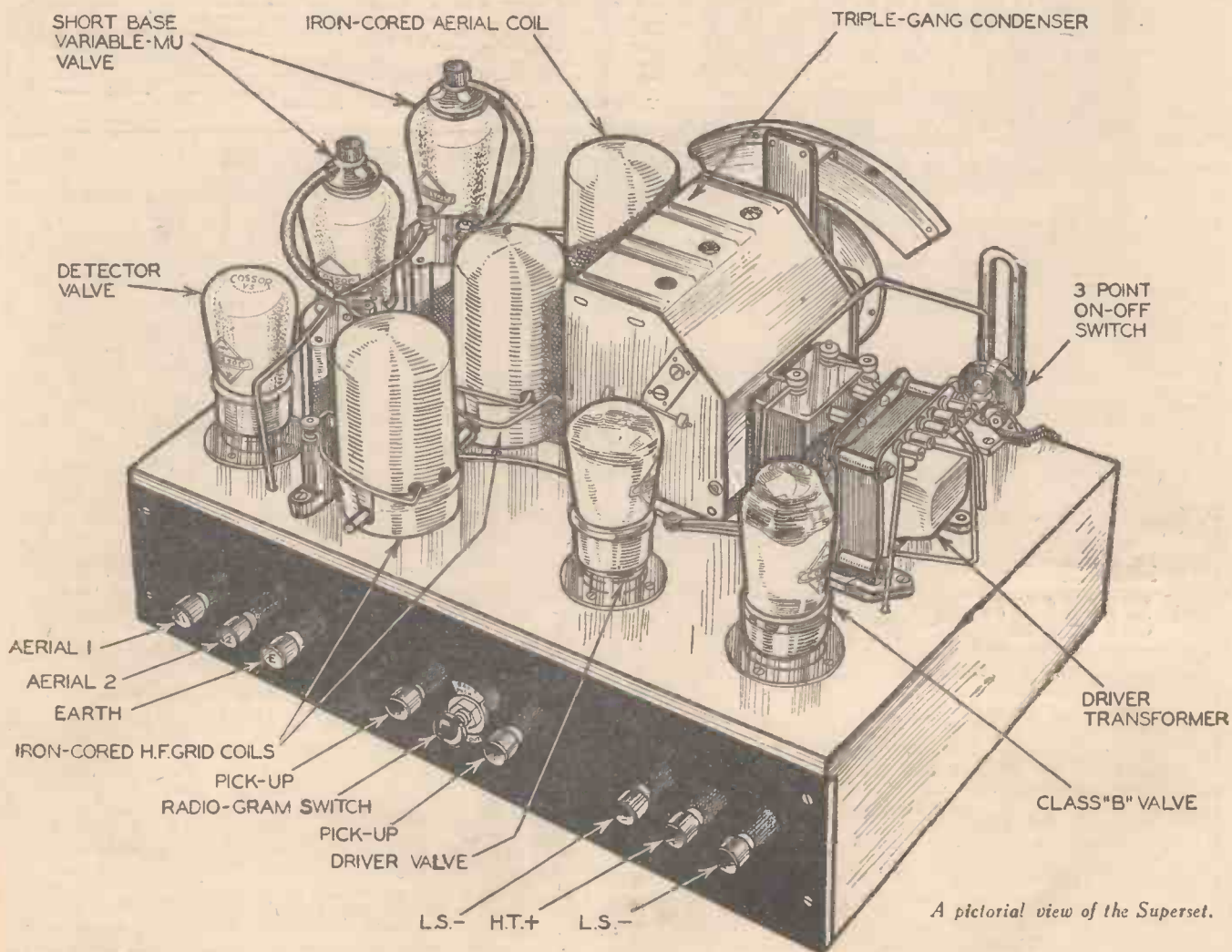

A pictorial view of the Superset.

PAGE MISSING

PAGE MISSING

PAGE MISSING

PAGE MISSING

A simple, Easy-for-all Competition which YOU may enter! No entrance fee!

FIFTY



MICROLODE SPEAKERS

FREE to Readers of "PRACTICAL WIRELESS"

Fifty of these splendid new W/B speakers, which incorporate an entirely new principle in speaker construction, providing instant matching of the speaker with the output valve, are offered in a simple competition in accordance with the Rules and Conditions given below. These speakers cost 42/- each, and are renowned for the brilliance of their reproduction and extreme sensitivity. A switch-arm is incorporated at the back which enables matching to be carried out without having to disconnect the speaker—in fact whilst the speaker is in operation.

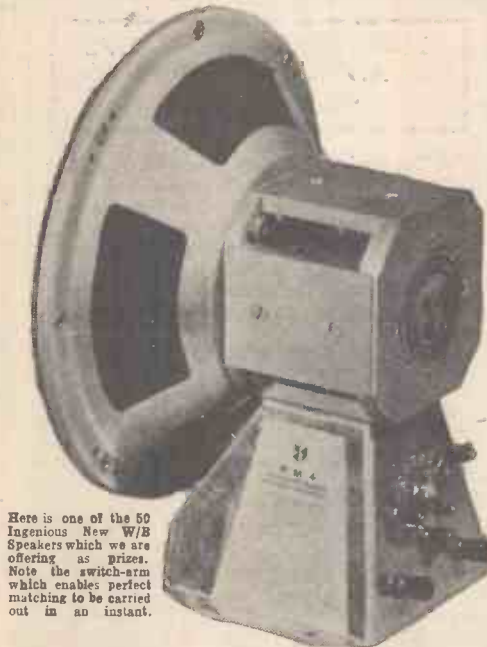

Here is one of the 50 Ingenious New W/B Speakers which we are offering as prizes. Note the switch-arm which enables perfect matching to be carried out in an instant.

ENTER NOW for this simple competition in which every reader—expert and amateur alike—has an equal chance! Here is a golden opportunity to win the very latest in loud-speakers, and an excellent chance of obtaining an important part of your new season's equipment. There is no entrance fee, and you may send in as many attempts as you like. The competition will be judged quickly so that you will not be kept waiting for the result.

Place the following twelve regular features in what you consider to be their order of merit.

STUDY THESE RULES CAREFULLY!

RADIO WRINKLES	
ROUND THE WORLD OF WIRELESS ...	
SET CONSTRUCTION	
FACTS AND FIGURES	
QUERIES AND ENQUIRIES	
SHORT-WAVE SECTION	
COMPONENT CONSTRUCTION	
OUR VIEWS ON RECEIVERS	
PRACTICAL LETTERS	
BEGINNER'S SUPPLEMENT	
GENERAL CONSTRUCTIONAL ARTICLES	
RADIO RAMBLINGS	
NAME.....	
ADDRESS.....	

- To the left appears a list of twelve regular "Practical Wireless" features. What you have to do is to place these in what you consider to be their order of merit. For example, if you think that "Radio Ramblings" is the best feature, place a figure 1 in the space provided. Then carefully consider the remaining eleven, and if you think that "Radio Wrinkles" comes next, place the figure 2 in the space provided. Continue in this manner with the twelve items.
- After filling in the coupon in this way, fill in your name and address in block letters at the foot of the coupon and post, in a sealed envelope, addressed to The Editor, "Practical Wireless," Geo. Newnes, Ltd., 8-11, Southampton St., Strand, London, W.C.2.
- Mark the word **COMPETITION** in the top left-hand corner of the envelope.
- Post to reach us not later than August 31st.
- Readers may send in as many attempts as they like in one envelope, provided that each attempt is written on a separate coupon, each of which must bear the full name and address of the sender.
- Only one speaker can be awarded to each reader.
- The result will be published in our issue dated September 16th.
- The Editor's decision is final and legally binding, and this is an express condition of entry. No correspondence whatever can be entered into regarding this competition.

OUR VIEWS ON RECEIVERS

THE news that Messrs. Ferranti have lately introduced an entirely new seven-valve A.C. superheterodyne will be warmly welcomed by those who require "something better" in the way of a modern receiver at a reasonable price. This receiver, the "Gloria" model, is a particularly interesting and excellent receiver from every point of view. Fitted with all the latest devices, it has an immediate appeal to the technically-minded amateur, whilst its perfect simplicity of control and good appearance make it the ideal set for home use.

The receiver is built in console form and is self-contained with loud-speaker in a beautiful cabinet measuring approximately 17in. wide, 17in. high, by 10½in. deep. The cabinet is of walnut and has an inlaid panel which greatly adds to the appearance. So as to prevent the possibility of any "boxy" resonances, the back is left open; this also serves to allow a greater freedom of air circulation, which is useful in dissipating the heat generated by the valves and energized moving-coil loud-speaker. Inside the cabinet is a soundly constructed metal chassis which encloses everything except the valves and ganged tuning condenser. Additionally, however, three of the valves and the condenser are themselves enclosed in screening compartments, and so the ingress of a certain amount of dust cannot possibly have any bad effect.

"Safety First" Precautions

All "live" mains connections are well out of harm's way, and even the meddler would be quite safe from electric shock. A small panel at the rear of the chassis is provided with three sockets so that the receiver can be adapted for any A.C. voltage from 200 to 250, but even this is covered by a metal plate which can only be removed by withdrawing a screw.

The controls on the front of the cabinet are few in number and symmetrically placed, giving a very neat arrangement. Four knobs are provided in all, of which one (the lowest) is a switch acting as on-off, medium and long-wave control; the knob on the right is for tuning, and operates two illuminated tuning scales of which one reads in wavelengths, whilst the other is "station" calibrated; the left-hand knob is a really useful volume control, and the small knob just below the speaker fret is used to effect tone control. An illuminated opening to the left of the station dial reveals a scale which is divided into ten divisions, and over which a pointer moves when the set is in operation. This is a "visual" tuning device, actually consisting of a milliammeter connected in the anode circuit of the first (variable-mu H.F.) valve. Due to the use of automatic volume control, stations are heard at uniform strength over the whole of their

THE FERRANTI 7-VALVE A.V.C. SUPERHET "Gloria" Model

dial "spread," and thus it would be rather difficult to locate the exact resonance point by ear. And if this were not done, a certain amount of "sideband cutting" would be inevitable. But the needle of the milliammeter shows a maximum dip at resonance, and therefore perfect tuning is child's play to the most uninitiated by



The Ferranti "Gloria" superheterodyne.

simply rotating the tuning knob slowly until the lowest reading is obtained. Whilst mentioning the method of tuning it should be pointed out that the process of going from one station to another is simplicity itself, and anyone who had never previously handled a wireless set could not fail to bring in upwards of twenty-five stations in just about as many seconds.

An Interesting Circuit

The circuit arrangement is distinctly modern and has obviously been worked out with much more than usual care—its designer is to be congratulated upon a very fine piece of work. Six Ferranti receiving valves are used in all, and these comprise three type V.P.T.4 variable-mu acting as preliminary H.F., first detector, and I.F.; a type D.4 oscillator; a type H.4D. (a new double-diode-triode) second detector-A.V.C.-L.F., and a type L.P.4 super-power output. The seventh valve is a Ferranti R.4 full-wave rectifier. An

unusual and extremely effective aerial filter circuit is used, and this is normally connected through a fixed condenser to one of the mains leads, thus obtaining a "mains" aerial. When it is desired to use an external aerial, however, it is only necessary to connect the latter to a plug which is supplied and push this into a socket at the rear of the chassis. The first valve, as was mentioned before, acts as a preliminary high-frequency amplifier, and it is to this that the A.V.C. grid-bias voltage is applied from the double-diode-triode. A separate oscillator feeds into the grid circuit of the first detector, and is, of course, tuned by one section of the gang condenser. Only a single intermediate-frequency valve is employed, and there is no doubt that this is easily capable of giving all the amplification that is required. The double-diode-triode second detector is connected in a more or less conventional manner, and its L.F. portion can be used along with the output valve as a gramophone amplifier. A 1-megohm potentiometer wired in the grid circuit acts as a particularly effective volume control on both radio and gramophone. The double-diode-triode is coupled to the output valve by means of a resistance-capacity combination, and has a tone control connected in its anode circuit. This control takes the form of a .01 mfd. fixed condenser and .5 megohm variable resistance joined in series between the low-potential end of the high-frequency choke and earth. The control is more than usually effective and really does permit of a perfect variation of tone to suit all requirements. The output valve is of the super-power type and is a directly-heated triode having a maximum undistorted output of about 2,500 milliwatts. Its filament is fed from a separate winding on the mains transformer, and grid bias is obtained through a fixed potentiometer connected across the speaker field winding which is used as a smoothing choke. Actually, this is the only choke used in the whole receiver, and the fact that it produces what might be termed perfect smoothing is wonderful testimony to the design of the power supply system. The loud-speaker is of the low resistance type and is fitted with a hum-bucking coil. Provision is also made for connecting an external low-resistance speaker, however, and the self-contained one can then be put out of action by rotating a small switch knob protruding from the back of the speaker frame.

The "Gloria" on Test—Real A.V.C.

We have put the "Gloria" superheterodyne through a series of "aerial" tests, and have nothing but praise for it. The set was first tried without either an earth lead or an external aerial, the only connection being that to the mains, and no less than twenty stations were tuned in within a few minutes. All of them were amply loud to afford comfortable listening and the volume control had to be used on more than half of them, despite the fact that the set was being used in a large room. The very first test was conclusive proof of the value of automatic volume control in a powerful receiver such as this. Practically every station received was at the same strength, and one could only differentiate between the locals and, say, Rome, Barcelona, or Brno by the small amount of "mush" which could be

(Continued on page 743)

7,000,000 people waited for it!
CQA made it possible!

The **BATTERY Radiogram** with the same
superb performance
as an all-electric
instrument



Model 1003

The CQA BATTERY RADIO-GRAPH

- Three-stage band-pass receiver.
- Quiescent push-pull pentode amplification.
- Automatic lighting of appropriate scale from switch M.W.-L.W. (and Gram.).
- Permanent magnet moving coil speaker.
- Marconi Valves.

20
GNS.

Radio only: CQA BATTERY FOUR Model 1001, 11 gns.

Everybody covets a radio-gramophone — most of all, perhaps, the 7,000,000 without electric supply. A Columbia instrument is within their reach at last — an instrument with the power, tonal purity and economy of its all-mains equivalent. Constant Quality Amplification means purity at all volume. Self-regulated Battery Life means H.T. Consumption in proportion to the strength required for each note and no more!

Send the coupon below for full details of this new discovery and learn how easily you can own a CQA Battery Radio-graph.

See these CQA models, and the full Columbia range of Radio and Radio-graphophones
 on
STAND 66
 at
RADIOLYMPIA

the
Columbia
 RADIO & RADIO-GRAPHOPHONES

Please send me fullest particulars of the new
 ★ CQA Battery Radiogram or
 ★ CQA Battery Four. ★ Cross out if not required.

Name

Address

Prac. W. 19/8/33.



Cut this out and post in an unsealed envelope bearing 1d. stamp to Columbia, 98/108 Clerkenwell Road, London, E.C.1.

*More than anything,
you've wanted this!*

AN EXPERT'S Testing INSTRUMENT
for EVERYONE

THE AVOMINOR

TRADE MARK



MILLIAMPS
0-6 millamps
0-30 ..
0-120 ..

VOLTS
0-6 volts
0-120 ..
0-300 ..

MILLIAMPS
VOLTS
OHMS
tested with
Ease,
Rapidity and
ACCURACY

OHMS
10-10,000 ohms
0-60,000 ..
0-1,200,000 ..

40% COMPLETE

ACCURATE TESTING! That has been practically impossible hitherto, except with high-priced instruments. But now the AVOMINOR provides an expert's instrument for everyone. It is an entirely new departure; a small self-contained moving-coil combination testing instrument giving accurate readings. The Avomator is a smaller counterpart of the world-famous Avometer. It has a similar degree of accuracy and provides similar testing facilities.

It measures nine different ranges of D.C. milliamps, volts and ohms—with the use of only one pair of leads. It tests all types of receiving valves—all pair of resistance measurements, your H.T., L.T., Grid Bias and Mains or Eliminator voltages. With the Avomator you can make any and every test with rapidity, ease and a degree of precision unobtainable before.

The Avomator is light and compact, being 4" x 3" x 1 1/2". Each instrument is complete in a handsome case, together with pair of leads, interchangeable crocodile clips and testing prods.

BRITISH MADE

OLYMPIA
STAND No.
47

A Younger Brother to the Famous Avometer

Obtainable from all radio dealers, Made by the makers of the famous Avometer.

If you do not visit Olympia, write for fully descriptive Pamphlet.

THE AUTOMATIC COIL WINDER & ELECTRICAL EQUIPMENT CO., LTD., Winder House, Douglas St., London, S.W.1.
Telephone: Victoria 3405-6-7.

CLIX

The consistent specification of Clix Components in the technical press is eloquent testimony to the fact that Clix can be confidently relied upon to provide Perfect and Reliable Contact. Use Clix always and ensure highest efficiency.

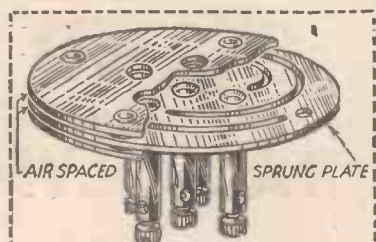

CLIX "AIRSPRUNG" ANTI-MICROPHONIC, NON-METAL VALVEHOLDER

An outstanding development in Valveholder design.

POWERFUL LOUDSPEAKERS working close to valves throw off sound waves which create distortion. This NEW CLIX Valveholder is designed to absorb all such vibrations, thus preventing distortion and prolonging the effective life of the valve.

It is ideal for **SHORT WAVE** work. With the minimum amount of material used in the construction the sockets are practically air-insulated.

Specified for the

1934 SUPERSET

Clix Chassis Mounting VALVEHOLDERS

STANDARD TYPE

4-Pin - - - - 8d.
5-Pin - - - - 9d.

FLOATING TYPE

7-Pin - - - - 1'

ANTI-MICROPHONIC

4-Pin - - - - 1'2
5-Pin - - - - 1'3

● You can examine over 30 Clix Perfect Contact components on

STAND 37 OLYMPIA

Write for New Folder

"A Matter of Connection"

LECTRO LINX LTD., 79a, ROCHESTER ROW, S.W.1.

Combine HIGH QUALITY



with LOW PRICES

IMPORTANT—Hivac Valves are British Made in our own Factory.

HIGHLY RECOMMENDED

The Editor of "Practical Wireless" said—

"In actual use in standard receivers, the valves were all very good and noticeably free from microphony. Although these valves are cheap they may be highly recommended."

WRITE NOW FOR THE HIVAC VALVE GUIDE (C)

It gives a comparative table of equivalent high efficiency valves at low cost. Here are some of the Hivac 2-volt Valves for battery sets:—

H210—Grid Det. or Oscillator in Superhets.	} 4/6
L210—1st L.F. Amplifier or Anode Bend Det.	
D210—Special Det. with electrode internally shielded.	} 5/6
P220—Semi-Super Power	
PP220—Super Power valve	} 6/6
SG210—H.F. Amplifier, Low current consumption.	
VS210—Vari-mu H.F. Amplifier	} 10/6
Recommended for the 1934 SUPERHET: Hivac Types VS210 (10/6), H210 (4/6), P220 (5/6), B220 (10/6).	

Recommended for the ALL WAVE TWO: Hivac Types H210 (4/6), Z220 (12/6).

From all Dealers; if any difficulty send P.O. direct to us with name and address of a local dealer.

HIVAC STAND 108 OLYMPIA
THE SCIENTIFIC VALVE

HIGH VACUUM 113-117 Farringdon

VALVE Co. Ltd., Road, E.C.1.

READERS' HALF-GUINEA WRINKLES

The
HALF-GUINEA
Page

A Handy Tester.

FOR finding breaks or shorts in low resistance circuits or components (excluding valves and fuses) the simple tester shown in the accompanying sketch, will be found useful. It consists of a 4.5 volt battery to which is fitted, by means of a tin strap and two screws, a wood panel (about 2ins. square). Upon this are mounted two terminals and a bulb holder,

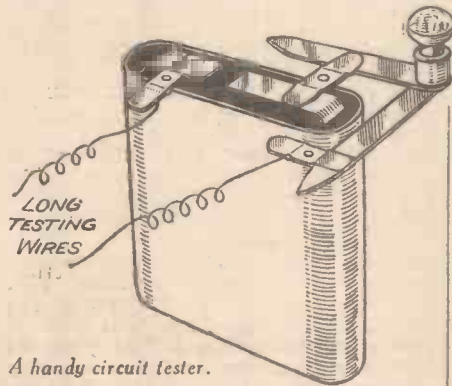

A handy circuit tester.

with a 3.5 volt bulb connected as follows: one terminal to holder; holder to battery; and battery to remaining terminal. Flex leads with wander plugs as prods connected to the terminals complete the instrument. The lamp, by glowing or not lighting, indicates a short, or break, etc., as the case may be when prods are suitably placed in circuit or upon the terminals of the component.—J. G. SIMPSON (Durham).

A Home-made Gas Soldering Iron

THE sketch shows a home-made gas-soldering iron which will prove useful for soldering wires in wireless set construction, as the bit keeps tinned for quite a long period. It is quite simple to make if anyone has an old or spare gas-burner and piece of copper for a bit. I utilized a spare soldering-iron bit, the bracket for holding the bit was made of sheet iron, 5/16 in. by 1 1/2 in. by 1-16 in. thick. The bit is made to swivel so that it may be used in most awkward places.—E. L. CLARKE (Somerset).

A Simple Cone Cutter

ALL that is required is a piece of hardwood about 1ft. in length and at one end screw (at an angle) an old (Gillette type) safety razor blade.

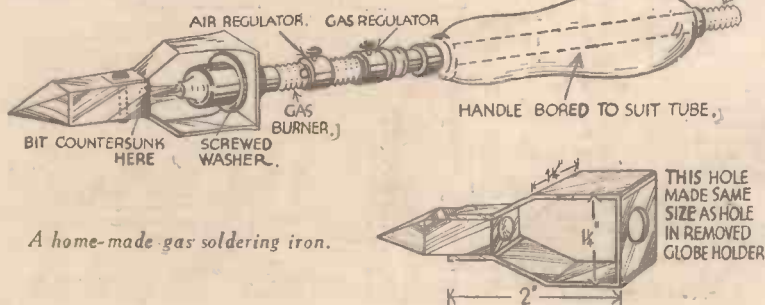

A home-made gas soldering iron.

THAT DODGE OF YOURS!

Every reader of "PRACTICAL WIRELESS" must have originated some little dodge which would interest other readers. Why not pass it on to us? We pay £1-10-0 for the best wrinkle submitted, and for every other item published on this page we will pay half-a-guinea. Turn that idea of yours to account by sending it in to us addressed to the Editor, "PRACTICAL WIRELESS," George Newnes, Ltd., 8-11, Southampton Street, Strand, W.C.2. Put your name and address on every item. Please note that every notion sent in must be original. Mark envelopes "Radio Wrinkles." Do NOT enclose Queries with your Wrinkle.

Then about 6in. from the end nearest the cutter make a series of holes 1-16in. in diameter, and about 1/4 in. apart. To operate this gadget, secure the cone parchment on the drawing board, or table top. Get a small hatpin and place it through the hole in the rod, parchment and drawing board. Place the right-hand on the centre pin to hold the device steady, and with the left hand describe a circle, applying a little pressure on the latter.

I have cut quite a number of cones in this way and I find that with one turn the centre comes out quite clean, without any steps

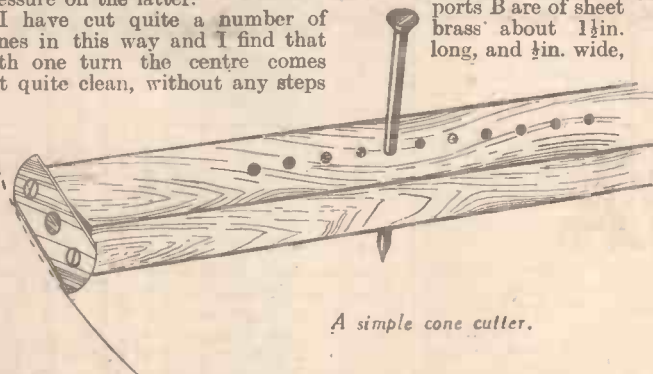

A simple cone cutter.

and jumps one gets by using the scissors.—J. ATHERTON (Wales).

Two Simple Switches

ALTHOUGH efficient switches are at present rather cheap, the following will be found very useful, and quite a number may be made on a strip of ebonite taking up little space.

All that is required for each switch is three cheese-headed bolts and four nuts to fit same, a piece of scrap brass, and the ebonite mounting.

Clean the ebonite and drill three holes in line so that when the two outer screws are fixed there is enough space between them to clear the

middle screw, the hole for the latter should be tapped, and in the slot of this screw should be soldered a piece of brass to form a handle. Connections are easily understood from the drawing. The connection is completed by screwing down the middle bolt until its head makes tight contact with the other screws. The second can be used as a wave-change switch or change-over switch when testing transformers, etc.

The sketch show all the necessary details. The supports B are of sheet brass about 1 1/2 in. long, and 1/4 in. wide,

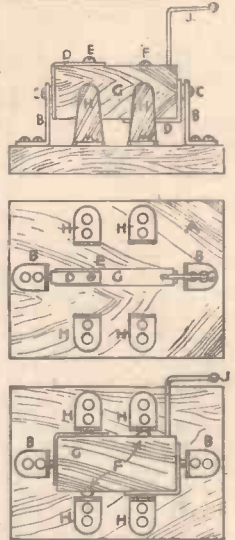

Details of the wave-change switch.

the two contacts H and I are of "springy" brass of similar dimensions, in all cases the outside screws are used to clamp the connecting wire. The parts A and G are of wood, the latter measuring 1 1/2 in. long, 1/2 in. wide, and 1/4 in. thick, these should be soaked in melted

wax. Two pieces of sheet brass 1/4 in. thick are bent at right angles to form the parts D, these are fastened to the wood G by the screws E which make contact on H when the switch is turned; the screws C also fasten the brass and also form an axis on which the wood G rotates.

The two screws marked F are to prevent the contacts from the waxed wood, while

(Continued overleaf)

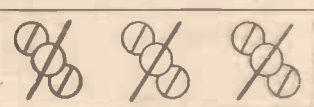
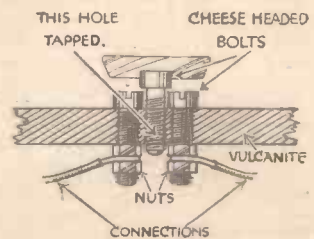

An ingenious On-Off Switch.

RADIO WRINKLES—

(Continued from previous page)

the scraping action keeps the contacts clean. Any arrangement can be adopted for a turning handle as J.—J. G. BRACK (Sunderland).

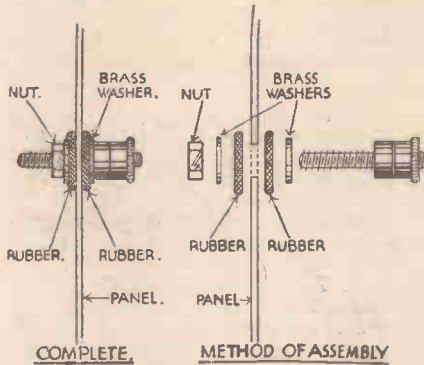

An insulating dodge.

An Insulating Dodge

A GOOD dodge for insulating terminals on metal or wood panels is shown in the sketch on this page. Take a piece of fairly thick rubber tubing which will slip easily over the terminal thread, and cut it so as to leave about 1/4 in. on each side of the panel, push terminal through, and slip on a brass washer and nut. As the nut is tightened up the rubber on each side of panel will bulge out, forming an insulating washer.—FRANK OGDEN (Stockport).

Preventing Frothing in Old Accumulators

FROTHING in old celluloid accumulators, which is frequently a very great source of annoyance, may be cured quite easily and simply by the following method. There are certain organic chemicals which are used by chemists to prevent frothing in certain chemical processes, these act by virtue of their property of lowering surface tension. I have recently carried out some experiments to ascertain the action of Caprylic alcohol (one of the higher alcohols, relatively non-volatile) to ascertain whether it has any action on celluloid, and find that it is inert to this substance. Finding that there was no solvent action, I therefore added a small quantity to each cell of a six-volt accumulator in which frothing had become so bad that the acid used to froth over and form considerable pools long before the battery was fully charged. The result was a complete success, the existing froth visibly breaking up. Since then I have had no further trouble whatsoever, and can very strongly recommend the method to any other reader who has a frothing accumulator. The quantity of Caprylic alcohol required is very small, sufficient only being required to form a thin layer over the

surface of the acid in the cells, and only amounts to three or four drops per cell according to the size of the battery. Caprylic alcohol may be obtained from laboratory supply agents, or from any chemist by ordering. I would recommend that only a small quantity be purchased, say about 1/2 to 1oz., as at most it will only be necessary to add the appropriate quantity once every two or three months.—K. P. GILES (Manchester).

A Novel Pocket Wireless Tester

I HAVE found this simple tester very convenient, owing to its size, for continuity tests, where resistance is not high, and for detecting short circuits, etc. It is housed in a matchbox and consists of one penlight dry cell, 1 1/2 volts, and a 1.5 fuse bulb, these are soldered in series by



A useful pocket wireless tester.

a short length of flex; two flexible leads about 6in. in length fitted with wander plugs emerge from one end of the box, no holes are required, neither does it prevent the box from being closed; for when the circuit is made by contact of the plugs to the part requiring testing, the light from the bulb can be inspected by looking through cover of box.

When not in use leads can be wound around box so that plugs do not come in contact with one another, and held together by a small band of elastic.—R. GILL (Guernsey).

£1 11s. 6d. paid for the best, and 10s. 6d. for every other reader's notion published.

Sketches illustrating H.T. from "Ford" spark coil (old type).

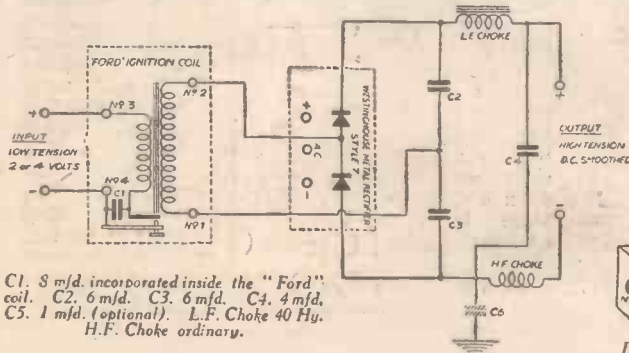

C1. 8 mfd. incorporated inside the "Ford" coil. C2. 6 mfd. C3. 6 mfd. C4. 4 mfd. C5. 1 mfd. (optional). L.F. Choke 40 Hy. H.F. Choke ordinary.

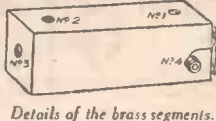

Details of the brass segments.

A Useful Adaptor

AS will be seen this device is a glorified version of the split anode adaptor, but has the advantage of being able to be used with any type of set, A.C. or battery, and no matter how much room there is to spare inside the cabinet (the snag generally experienced with the usual type).—GEORGE A. LEY (North Shields).

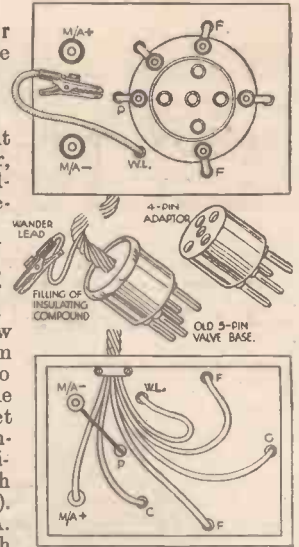

A universal adaptor.

High Tension from "Ford" Ignition Coil (Old Type)

OBTAIN an old "Ford" spark coil at any Ford garage, and on it will be found three brass segments, as sketch. Segments Nos. 1 and 2 are output—A.C. Segments Nos. 1 and 3 are input—L.T. The side of wooden case must be opened to disconnect the wire that joins contact-breaker to segment No. 1 (taking care to leave the other wire from the secondary winding connected to No. 1). Bring out the wire from the contact breaker, calling it No. 4, leaving segments Nos. 1 and 2 for secondary only. Connect up to "Westinghouse" metal rectifier, as shown in the circuit diagram.

Smoothing may be carried out with the secondary windings of an old L.F. transformer, if on hand, instead of a L.F. choke.

The hum on the speaker when worked off this unit is less than the average A.C. mains set. The consumption of the spark coil from a 2-volt accumulator is approx. .4 amps. Output in high tension D.C. is about 60 to 80 volts, 10 milliamps on 2-volt low tension input. The voltage can be regulated by tightening the nut on the contact breaker, causing the trembler to vibrate faster.

A larger voltage and current can be gained by using a 4-volt input. As this unit makes a buzzing noise when working,

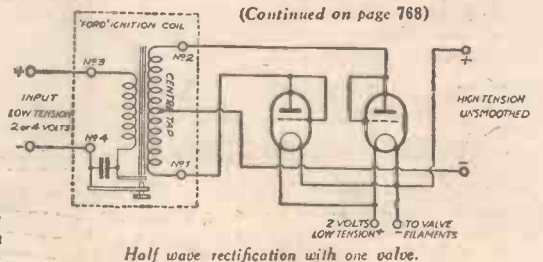

Half wave rectification with one valve.

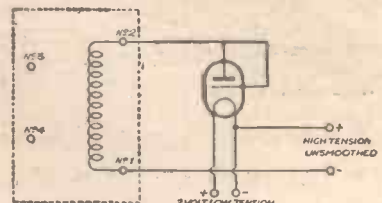

Smoothing can be carried out as the output of the metal rectifier diagram.

**ON TOP AT
OLYMPIA**



**Osram
Valves**
MADE IN ENGLAND

NATIONAL RADIO EXHIBITION, STAND No. 92

Advt. of The General Electric Co., Ltd., Magnet House, Kingsway, London, W.C.2.



The "Auto-B Three"

Every Home Constructor Should Build This Class B Receiver, which is the First Class B Set to Use Automatic Grid Bias. By W. J. DELANEY

THE advantages of Class B working are by now well known, and in addition to the immense amplification which is afforded, not the least important detail is the fact that no grid bias is required for the Class B valve.

which enables this battery to be finally discarded, and which also ensures that the driver is correctly biased, no matter how run-down the H.T. battery has become. Not only this, but I have incorporated the very latest in tuning arrangements, namely an iron-core tuning coil. Still further to assist in developing a receiver which may be built by the home-constructor, and which may compare both in appearance and performance with the factory-built set, I

structural notes, I must ask you to examine the theoretical circuit, although if you are one of those keen amateurs who,



Mr. W. J. Delaney, the well-known Radio Authority and a member of the Technical Staff of "Practical Wireless."

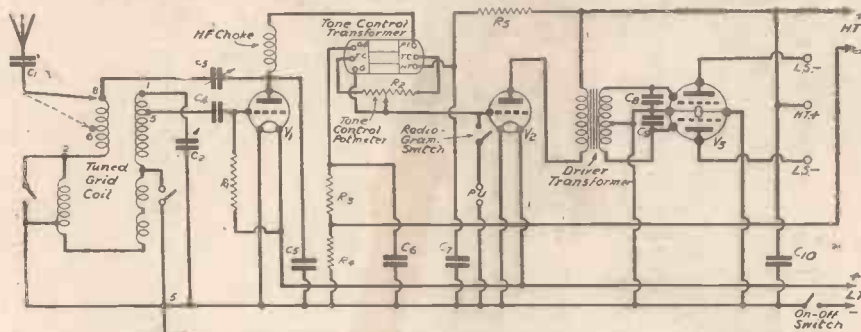

CIRCUIT DIAGRAM OF THE AUTO-"B" THREE.

Values of components are:—C1, C4 and C5, .0001 mfd.; C2, .0005 mfd.; C3, .0003 mfd.; C6 and C7, 1 mfd.; C8 and C9, .01 mfd.; C10, 8 mfd.; electrolytic; R1, 2 meg.; R2, 4 megohms; R3, 250,000 ohms; R4, 500 ohms; R5, 25,000 ohms.

Not only does this avoid the constant attention which is required to maintain an output valve at its correct working point, and so avoid distortion due to overloading, etc., but it ensures that the valve will work at its best without any aid from the listener. Thus, this valve delivers the very best so far as quality is concerned. Unfortunately, however, it has to be "driven," or, in other words, used in conjunction with a valve which will supply a certain voltage to the special coupling transformer which has to be used, and this valve—known as the "driver"—is of the ordinary small-power type. It does not, therefore, possess the advantage of requiring no biasing potential, and in all previous Class B receivers this important but troublesome grid bias battery has had to be retained—simply to ensure that the Class B valve was fed with an undistorted signal by the driver valve. In the Auto-"B" Three I have been successful in incorporating a principle

have utilized a pressed steel chassis. The result may be seen from the illustrations. It is the last word in home-constructed sets. Range, selectivity, power, and purity are the four principal features, and when you add to these ease of construction, you have some idea of what the Auto-"B" means. Before commencing the con-

Unfortunately, cannot yet fully understand this type of circuit I must ask you to skip this section and pass on to the actual constructional details.

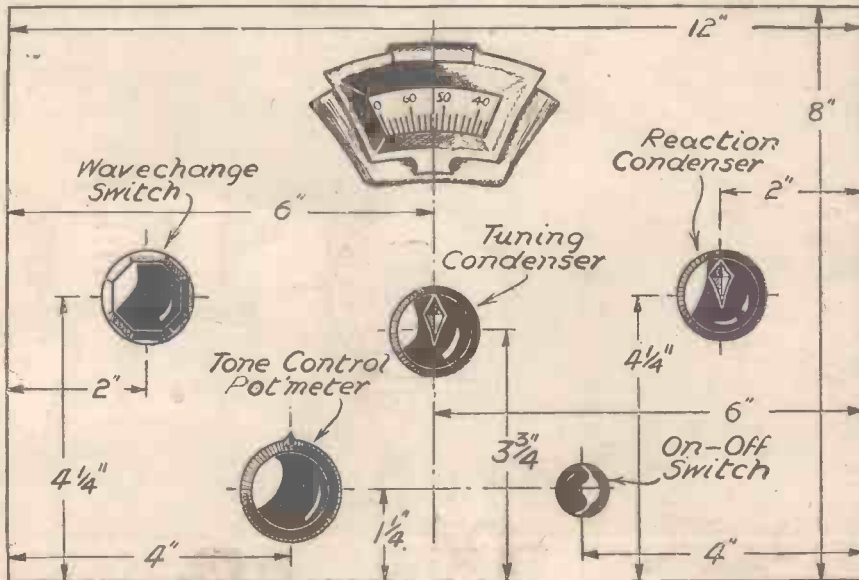

Panel Lay-out for the Auto-"B" Three.

The Circuit Details
The arrangement of the tuning coil will, no doubt, attract attention, but this has been designed by Messrs. Colvern and gives in a single coil a degree of selectivity which hitherto has only been obtainable with two tuned circuits. The special iron-core which is used enables the coil to be built on most compact lines, and at the same time permits of the rather unusual circuit arrangement. Within a few miles of the Brookmans Park transmitters these stations are confined to only two or three degrees, and when the local station is situated more than six or seven

miles away you will find that one degree will eliminate it. An ordinary grid leak detector circuit is employed for the first stage, and this is coupled to the first L.F. (or driver) stage by means of one of the latest tone-control transformers. This gives a high degree of amplification, but also enables the tone of the reproduction to be varied from maximum high note to maximum low note. This control is exceedingly smooth in its action, and it enables the organ to be reproduced with all its richness, or the spoken word to be delivered with a crispness which is not usually obtainable from a receiver not adapted for tone control. The usual driver transformer is used for the Class B stage, and the actual output reaches the order of 2 watts. The automatic biasing is carried out by the usual method of fitting a special resistance in the high-tension negative lead, but as the current from the Class B valve varies according to the volume or type of music received, it might be thought that the grid bias voltage obtained through the resistance would also vary. This, in fact, does occur unless certain precautions are taken. In this receiver I have included a large-capacity electrolytic condenser (actual value, 8 mfd.) across the high-tension battery, and whilst this acts as a perfect reservoir and so ensures that a steady current is delivered to the biasing resistance, the association of a decoupling circuit with the biasing resistance maintains a constant voltage for the driver valve. It might at first be a little obscure how such a device can function satisfactorily, but I can readily dispel any fears you may have, and can assure you that it does work. If it did not it would not have been incorporated in one of the famous PRACTICAL WIRELESS Guaranteed Receivers. So much, then, for the circuit details.

The Construction

It will be seen from the list of components that a special chassis is employed upon which to build up this receiver, and this chassis is made from pressed steel—not aluminium. It is thus perfectly rigid and substantial, but rather difficult to work. Accordingly, Messrs. Burne Jones supply it ready drilled for this receiver, and you must make quite certain that you order it correctly and thus avoid any disappointment due to difficulty in mounting the components. For the same reason it is essential to purchase the actual parts which I specify. When you do this you will be enabled to build a receiver which is an



Three-quarter rear view.

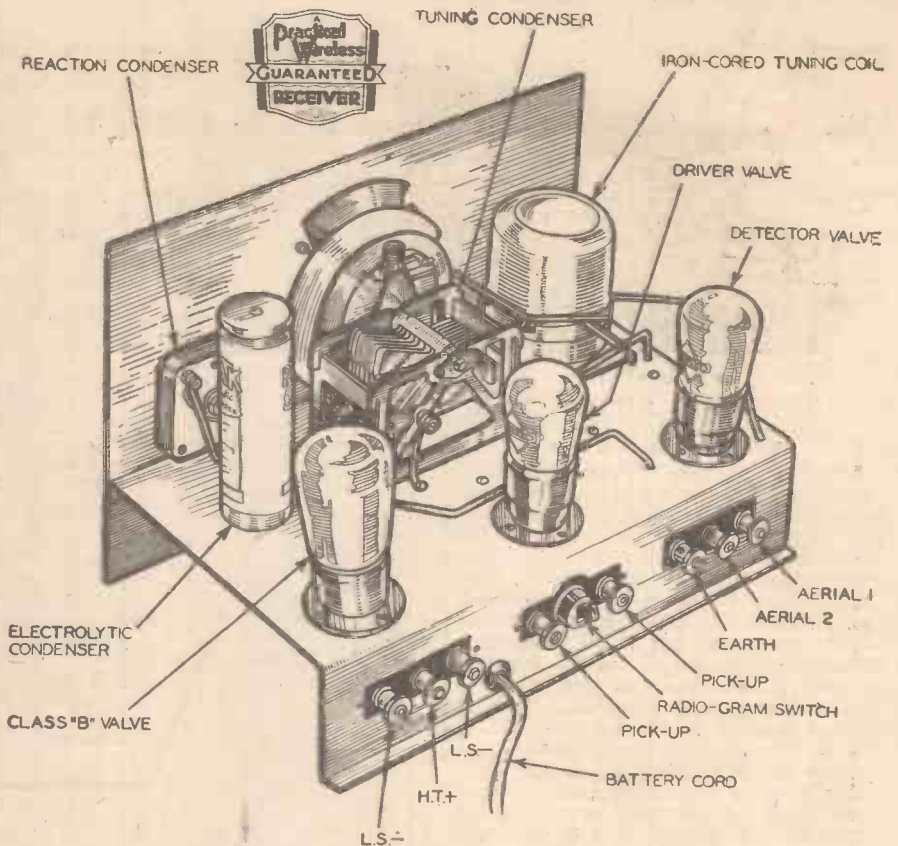

Our artist's impression of the Auto-"B" Three.

exact replica of the original, and therefore it is certain that you can duplicate the results which I obtained. It is quite possible that the receiver would work with components having similar characteristics, but of different make. As, however, the receiver illustrated has been tested and found to give certain results, we are able to guarantee it, and this is your safeguard. You must remember, however, that if for any reason you use some part which I do not specify, the receiver cannot come within the conditions of the PRACTICAL WIRELESS Guarantee. Your actual constructional work is also simplified by using the specified parts, as it will be found only necessary to pass bolts through the holes in the component and chassis, and tighten up a nut on the end of the bolt. There are no holes to be drilled and no time to be wasted in making certain that each part is in its correct position and will not foul some other part.

The two transformers appear very similar on this drawing, but you should notice that the driver is the red one: do not get these interchanged or the receiver will not work. Bolt these two parts down first and then proceed to fit the H.F. choke, fixed condensers, and terminals. Now attach the coil, after removing the knob from the spindle and fitting the small thick portion of the spindle on the rear of the panel. You will note that this enables the knob to be attached and then prevents the switching rod from being withdrawn. Bolt up the variable condensers, fix the reaction condenser to the panel, and finally fit the large electrolytic condenser,

This will hold quite firmly in the large hole provided, and the spring washer should be placed between the locking nut and the under surface of the chassis. This part of the constructional work should not take more than half an hour to complete, and you are then ready for wiring-up.

(Continued overleaf)

LIST OF COMPONENTS FOR THE AUTO-"B" THREE

- One "Magnum" Auto-"B" Metal Chassis (Burne Jones).
- One .0005 mfd. Variable Condenser with Vernier Dial (Telsen).
- One .0003 mfd. Reaction Condenser (Telsen).
- One Type "F.5" "Ferrocort" Coil (Colvern).
- Two 4-pin sub-baseboard Valve-holders (Clix).
- One 7-pin sub-baseboard Valve-holder (Clix).
- One On-Off Switch (Busby).
- One "Toco" 4-1 L.F. Transformer (Multitone).
- One Graded Potentiometer (Multitone).
- One Class B 1-1.5 ratio Driver Transformer (Multitone).
- One 8 mfd. Electrolytic Condenser (Peak).
- Two 1 mfd. Condensers (Peak).
- Three .0001 mfd. Type "M" Condensers (T.C.C.).
- Two .01 mfd. Condensers (Peak).
- One Type "L.M.S." H.F. Choke (Graham Farish).
- One 2 megohm Grid Leak (Dubilier).
- One 250,000 ohm Resistance (Erie).
- One 25,000 ohm Resistance (Erie).
- One 500 ohm Resistance (Erie).
- Eight Treble Duty Terminals Marked "Aerial," "Aerial 2," "Earth," "Loud-speaker+," "Loud-speaker-," "H.T.+", "Two "Pick-up" (Ealex).
- One Four-Way Battery Cord (Belling Lee).
- One 210 det. Valve (Cossor).
- One 215 P. Valve (Cossor).
- One 240 B. Valve (Cossor).
- One Auto-B, Cabinet (Camco).
- One "Sonette" Loud-speaker (Amplion).
- One 120-volt Annodex Class "B" H.T. Battery (Smiths).
- One 2-volt 40-Ampere Hour L.T. Accumulator (Smiths).
- One Coil Glazite.
- One Length Rectru Screened Down Lead (British Radiophone).
- One Filtr Earthing Device (Graham Farish).
- One Toggle Switch (Type 460) (Becker)

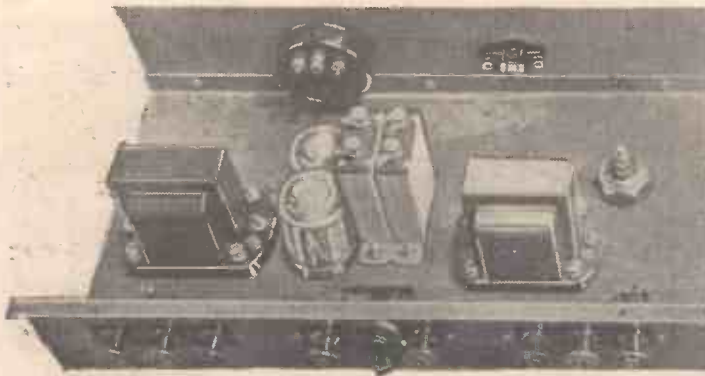

A view of the under-side of the chassis showing the few components which have to be attached.

and the component attached to a terminal, for instance, quicker than bending a loop in a piece of wire, removing a nut, placing the loop over the terminal, and then replacing and tightening the nut. As, however, there are only one or two points where soldering is necessary it should not be shirked. It won't take a minute and it is, unfortunately, necessary. When all the wiring has been completed, using the wiring diagram or theoretical circuit as a guide, the receiver is ready for testing, but I shall defer these instructions until next week. In the meantime, carefully check over all connections; tighten up all nuts as tight as possible with the fingers (do not use pliers or you may strip the threads); and wipe away all traces of flux which may remain upon the soldered joints. Next week I will give you operating instructions and a test report of this interesting receiver.

(Continued from previous page)

In order to save disappointment or aggravating difficulties at a later stage it is as well to carefully check the receiver at this stage. Above all, make certain that the transformer which in the wiring diagram on this page is marked "Tone Control L.F. Transformer" is the black one. Also make quite sure that the locking nut on the rear of the terminals is sufficiently tight to prevent the terminal working loose when attaching the nut which holds the wires in position. A small spanner is ideal for this purpose, but do not overdo the tightening process and fracture the paxolin strip. It may seem rather a waste of time to mention these small points, but when you are constructing a receiver you do not want to have the trying experience of having to remove some wires or components because a nut has come loose. The construction of a receiver should afford pleasure, and therefore a little time should be spent in ensuring that the pleasure will not be marred by trivialities such as I have just mentioned. The wiring may now be commenced.

Wiring

If you examine the wiring diagram on this page you will notice that there are a number of components which are not fixed to the chassis or any of the other components by screws or bolts. The two .01 condensers, for instance, are of the tubular type with wire ends, and these wires are used for connecting purposes. The resistances, too, are attached in their correct positions by a similar device. Carry out the wiring in a systematic manner, that is, wire the filament leads first of all. Take a length of the Glazite and cut it to the exact length, afterwards baring the ends and the small portion in the centre where contact is made with the valve-holder for V2. Next wire the leads from the transformers, then attach the fixed condensers and resistances, and so on, crossing each wire through on the wiring diagram with a blue pencil, or otherwise making some indication to avoid the omission of a wire or a wrong connection.

It will be noticed that in one or two places soldering has to be resorted to, but this should not deter you. Soldering is not difficult if you remember to keep the iron really hot (not red-hot) and make certain that it is clean by rubbing it quickly over a piece of emery-cloth before applying it to the work. The slightest trace of flux and cleanliness will ensure that the solder runs in a neat blob very quickly, and you will find that the wires may be soldered

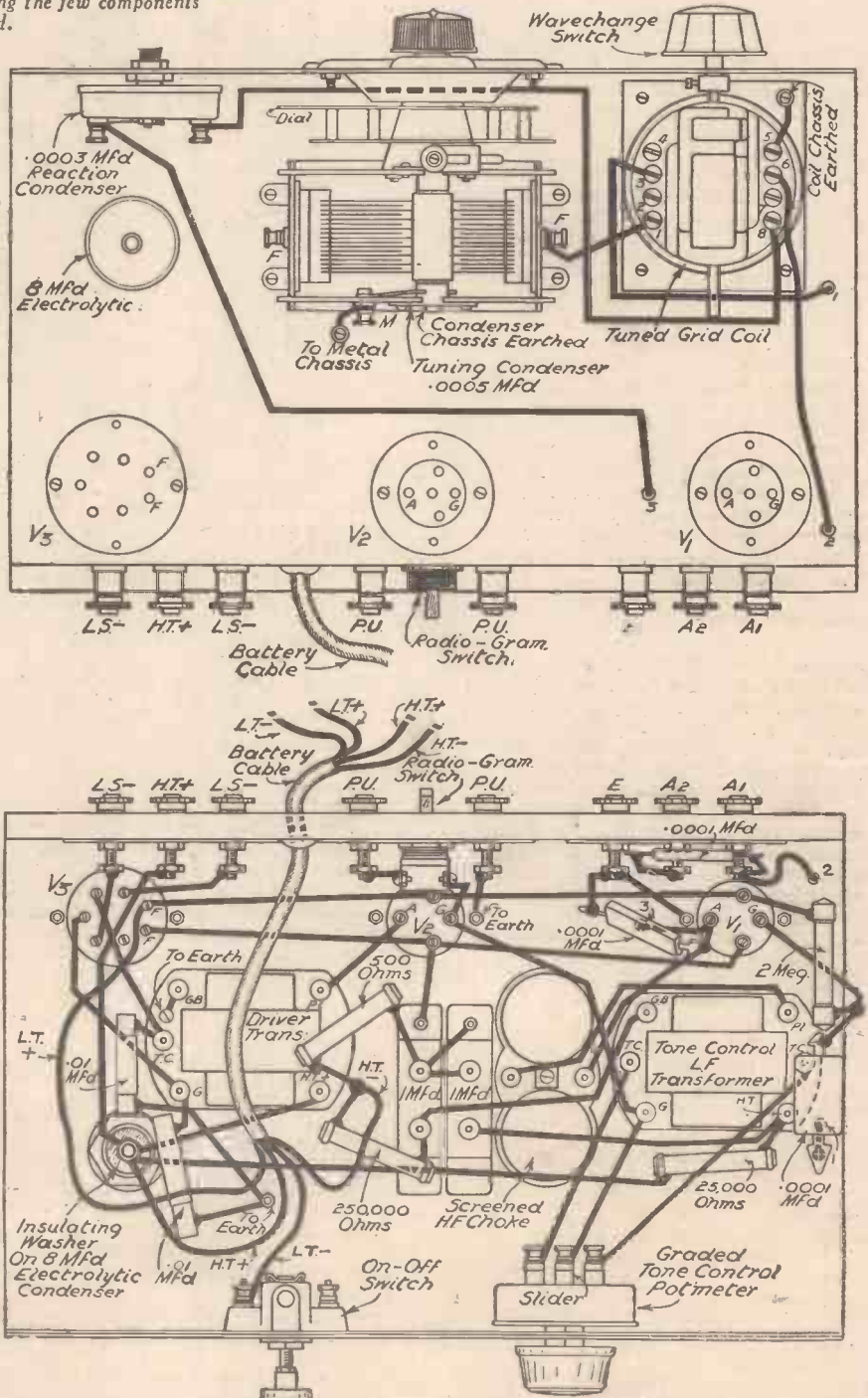

Top and sub-chassis wiring diagram of the Auto-"B" Three.

PAGE MISSING

PAGE MISSING

PAGE MISSING

PAGE MISSING

PAGE MISSING

PAGE MISSING

PAGE MISSING

PAGE MISSING

PAGE MISSING

PAGE MISSING

PAGE MISSING

PAGE MISSING

PAGE MISSING

PAGE MISSING

PAGE MISSING

PAGE MISSING

PAGE MISSING

PAGE MISSING

PAGE MISSING

PAGE MISSING

PAGE MISSING

PAGE MISSING

PAGE MISSING

PAGE MISSING

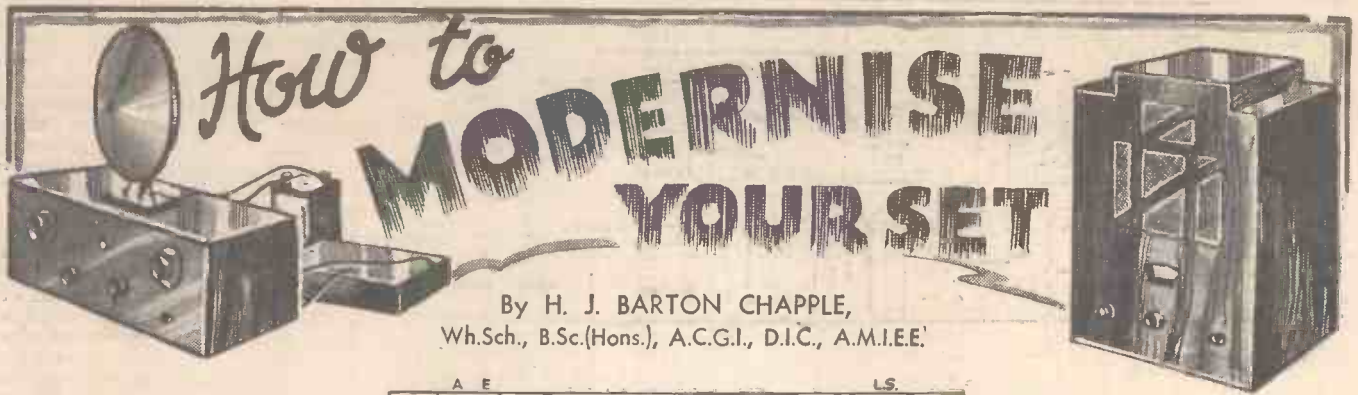

ONE of the joys of constructional radio is that, providing the original design of your receiver is reasonably good and that high-class "key" components are incorporated, it is usually possible to make additions or alterations from time to time in order to take advantage of the improvements and new devices which radio manufacturers bring forth with such regularity every season. In fact, a home constructed radio set need never be considered as absolutely completed—parts may have to be removed or renewed, and others added, and even, eventually, little or nothing of the original instrument may remain—but it can always be up to date.

Surely no better opportunity has occurred in any other radio season for improving the performance of an old receiver than today, for the developments produced this year are of outstanding technical interest, and, when properly applied, result in really substantial improvements in actual performance.

Originally Ideal, Now Obsolete

It would be impossible to do more than make the barest suggestions for improvements if any attempt was made to deal with every type of radio receiver. I propose, therefore, to confine myself to a few of the more typical sets, and those, moreover, which, on account of antiquated design, stand more particularly in need of modernization to enable them to cope with 1933 broadcasting conditions.

Probably the type of receiver which, even to-day, is most commonly found, is the battery-operated three-valver, comprising a detector and two low frequency stages, the last being a super-power valve. In its day, this form of receiver was the ideal set for home construction—simple to build, giving adequate volume on the local stations, and capable, under average conditions, of bringing a good number of foreigners. Under present-day conditions, however, it falls far short of perfection in many directions.

There are two alternatives for

By H. J. BARTON CHAPPLE,
Wh.Sch., B.Sc.(Hons.), A.C.G.I., D.I.C., A.M.I.E.E.

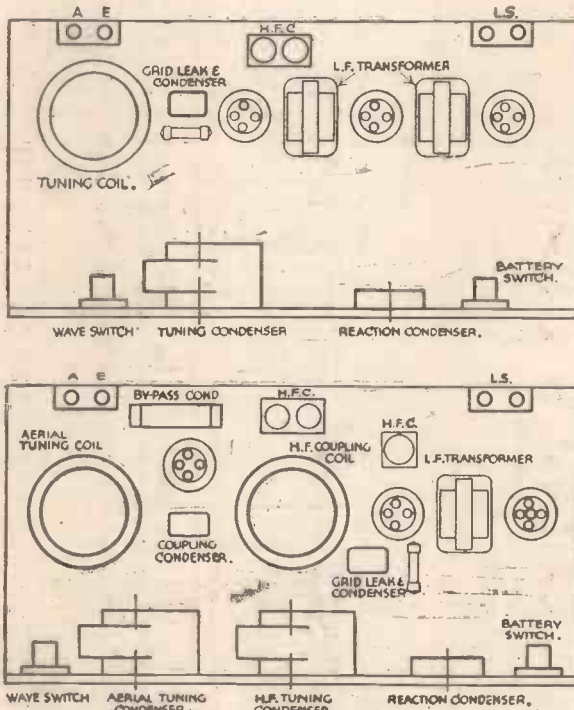

Fig. 1. (Above)—The usual layout of a detector and two L.F.; and (below) a suggested conversion.

modernizing a set of this sort. If you are living more or less in the shadow of one of the main B.B.C. transmitters, your trouble will be that the set is not sufficiently selective to permit the local programme to be cut out when you wish to receive distant stations—and you may even find some difficulty in separating the National and Regional programmes.

First Plan

Your best plan in these circumstances is to convert the set into a screened grid, detector and pentode combination. The screened grid high frequency valve will give added range and improved selectivity, and the use of a pentode output valve will not in any way reduce the volume of sound. The exact way in which to tackle this problem depends upon the original design of the set. Usually, however, it means the purchase of an additional coil similar to the original tuning coil, a variable condenser of .0005 mfd. capacity and a few minor components to be noted later. Space must be found on the left hand side of the panel for the new tuning condenser, and on the left of the base-board for the new coil. This may mean the re-arrangement of most of the components, as adequate screening of the H.F. circuits must be provided. Fig. 1 shows the usual layout of a detector and two L.F. set and a suggested layout for the converted receiver, while Fig. 2 shows the theoretical circuit of the set as modernized. The use of "canned" coils and a metallized screened grid valve will overcome the screening difficulty, especially if a tuning condenser be employed

for the H.F. stage. This conversion does not envisage ganged tuning which would be impractical if, for reasons of economy, only the essential additional components are to be used. A more ambitious conversion, of course, would mean the scrapping of the original coil and condenser, and putting in matched coils and a ganged condenser—in which case the only original components to be retained would be the

detector valve and one of the original low frequency intervalve couplings!

Second Plan

It may be, however, that you are situated at some considerable distance from your local station, and that you do not feel the need, of a high frequency stage—either because, owing to your favourable situation, you can receive a few foreigners free from interference, or

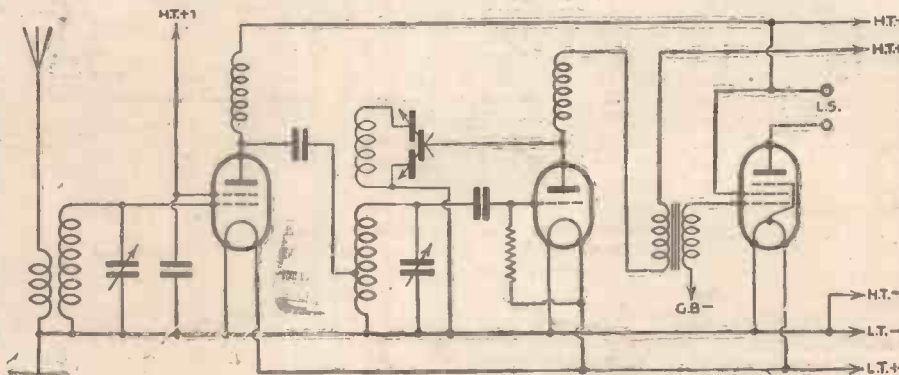

Fig. 2.—The theoretical circuit of the set shown in Fig. 1 modernized.

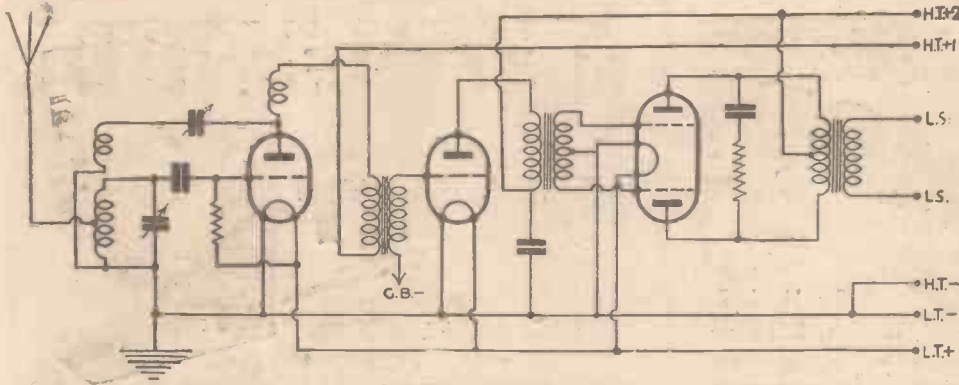

Fig. 3.—A typical Class B set, although there are many variations.

because you are mainly interested in your local programmes. In that case, you might consider converting your old three-valve to Class B output. The effect would be that you would be able to obtain greater volume than ever when required, or alternatively you could obtain the same or greater volume with less risk of distortion on loud passages of music, while at the same time, your high tension consumption would be restricted to the economic discharge rate of a small high tension battery—a great economy.

Such a conversion is much simpler, though no cheaper than the conversion to high frequency amplification. To begin with, the detector and first L.F. stage need no alteration, except that the first L.F. valve will have to be changed to the type recommended as the "driver" valve for the particular make of Class B valve you intend to employ.

The second low frequency transformer, however, will have to be replaced by a special Class B input transformer with a centre tapped secondary. The output valve-holder must be changed to one of the seven pin type, and, of course, a Class B valve will be wanted for this stage. Then you will require a special Class B output transformer or choke, and one or two smaller components such as grid stopper resistances and a small fixed condenser and resistance to shunt across the output transformer primary.

Fig. 3 shows a typical diagram for a Class B set, but there are several variants, and you will be well advised to employ the particular circuit recommended by the maker of your Class B valve. Usually there is sufficient room in the average detector (and two L.F. receiver cabinet to accommodate the additional output transformer so that little if any alteration to the original layout will be needed.

Of course Class B can be added to any type of battery set—say to a H.F., detector and L.F. set, but in receivers of this type, especially if of fairly recent design, there may not be room for the additional components. It will then be best to use the existing output valve-holder for the driver valve, and to accommodate the Class B valve with its input and output transformers in a separate unit.

Another Suggestion

Another type of battery operated set which could do with a little modernizing to-day is the simple two valver comprising detector and output pentode. If the set is built into a small and compact cabinet, there is little which can be added to it,

but it might be considered worth while to dismantle the whole of the tuning system, and to turn the set into a two-valve low-

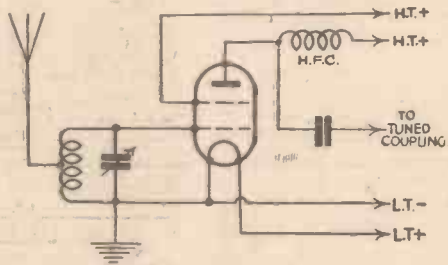

Fig. 4.—An ordinary S.G., H.F. stage.

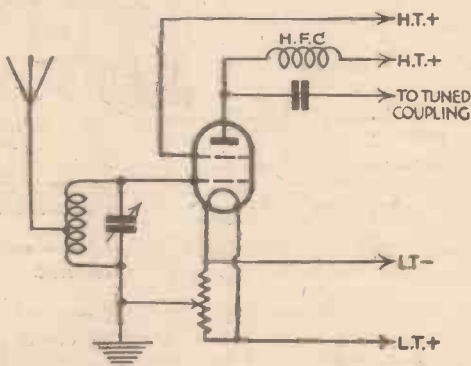

Fig. 5.—Converting Fig. 4 to variable-mu working.

frequency amplifier using the original detector as L.F. stage, and fitting the output stage with a larger valve of the super-power or even Class B type. Then a separate detector unit, comprising screened grid valve and detector could be built and the two coupled together with, of course, a changeover switch to permit of gramophone reproduction with a pick-up. There is a good deal to be said for this two unit plan of construction. In the first place, it is seldom that both the high frequency and the low frequency sides of your set require rebuilding at the same time, so if you wish to modernize or alter your H.F. side, it is a simple matter to uncouple that unit and substitute a temporary detector—a single valver or even a crystal set will do at a pinch, while the alteration is being made.

Less Drastic

Now for some drastic schemes of modernizing. Is your present high frequency valve of the "straight" screened grid type? If so, and you want to be right up to date, why not change over to a variable-mu valve. By doing so, you will provide your set with a very handy method of volume control, and at the same time means will be available to avoid overloading the H.F. stage when listening to powerful local transmissions. You will, of course, have to purchase the variable-mu valve—remember the prices of these valves have recently been substantially reduced—and a 20,000 ohms potentiometer for applying variable grid bias to this stage. That is all the expense, and the two diagrams reproduced in Figs. 4 and 5 show the very slight circuit alterations which are necessary.

So far I have said nothing about the modernization of A.C. mains sets, principally because the average mains set is more up to date than the average battery set. But there are one or two directions in which improvements can be made without very great cost. For instance, a variable-mu H.F. valve can be substituted for a straight screened grid valve with advantage. This necessitates an alteration to the arrangements for obtaining the screen voltage and the provision of variable automatic bias. Most valve makers have their own pet scheme for this, but the fundamental circuit is given in Fig. 6. The actual values of the resistances vary for different makes of valve, but the figures given in the diagram are the usual values.

As an alternative, you could replace your screened grid valves by high frequency pentodes. Probably you will have to make no other change than the valve substitution, although for optimum results the values of the screen and biasing resistances may have to be altered; but here again, you must be guided by the recommendations given on the instruction leaflet enclosed with your new valve.

The notes given in this article do not pretend to be comprehensive, but cover the more urgent needs of some of the oldest yet commonly used types of set.

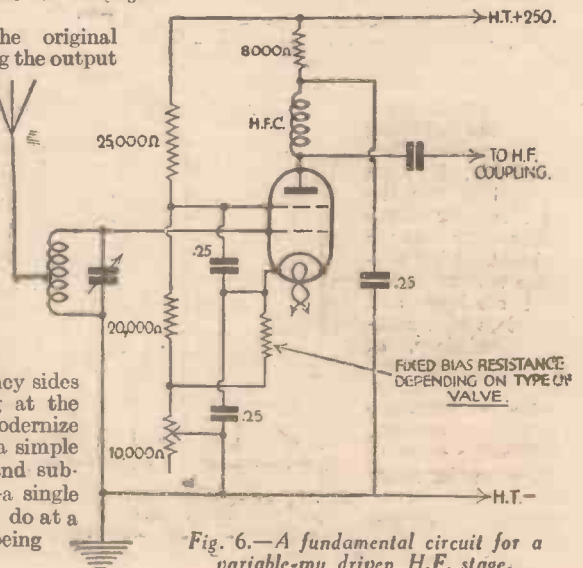

Fig. 6.—A fundamental circuit for a variable-mu driven H.F. stage.



SUPERCHARGED WITH POWER!

MORE and more power: that is the demand of the modern radio set. And no battery is so densely packed with power as the Grosvenor.

For, by the Grosvenor process, MERCURY protects the all-important zinc cells against corrosion. So long do the cells last that, to use them up, they are crammed with extra chemicals by hydraulic pressure.

That is why Grosvenor batteries give such astonishingly long life. For sheer value-for-money, try Grosvenor next time, and see for yourself!

MERCURY
means ENORMOUSLY INCREASED LIFE

Also long-lasting Grosvenor Mercury Batteries for Torches, Pocket and Cycle Lamps.

Grosvenor Mercury Batteries are made in three grades for every Radio need.

Grosvenor Red Line 5/6 to 11/-

Grosvenor Brown Line 6/- to 15/6

Grosvenor Blue Line 7/- to 20/-



GROSVENOR ELECTRIC BATTERIES LTD.
2-3 WHITE STREET, LONDON, E.C.2

Works: WATFORD, HERTS.
Telephone: METROPOLITAN 6866 (3 lines).
Grams: GROBATCOY, AVE, LONDON.

A WONDERFUL RECEPTION



the NEW AMPLION SONETTE

Only just left the Factory, but here it is, used and specified in the PRACTICAL WIRELESS "AUTO B THREE." The name Amplion was a sufficient guarantee.

The Sonette is the junior of the Amplion range, its performance will amaze you, the price you will hardly credit. Perfect in every detail, and fitted with a universal transformer for use with Class "B" and all other modern output valves.

Make sure you get the right one—the Amplion Sonette, price 27/6.

OTHER AMPLION COMPONENTS SUITABLE FOR THIS RECEIVER INCLUDE "B" Driver Transformer, 9/6d. Binocular H.F. Choke, 4/6d. "Plastape" aerials, earths and extension wires. Send for illustrated leaflets.

AMPLION

AMPLION (1932) LTD., 82/84 ROSOMAN STREET, LONDON, E.C.1. CLERKENWELL 5440-1

RADIO RAMBLINGS

By JACE

Gettings from my Notebook

Lifts for Radio Sets will Reduce Fatigue

ONE of the greatest labour problems in the construction of modern radio receivers is the fact that the operatives have to bend their backs whilst assembling many of the components of the chassis. It is hoped that an invention of one of the operatives in the works will result in much saving of fatigue for the staff, especially in the hot weather. The operatives will now be able to work without bending by the use of many hundreds of lifts, which are believed to be the first of their kind. They have been made in the H.M.V. cabinet factory and comprise small platforms which may be raised or lowered through shafting and gears by wheels similar in appearance to the steering wheels of cars. In future, when the operatives are making adjustments to the lower parts of the receivers, the lifts will be left at their maximum height, and as the girls gradually work upwards, so the lifts will be lowered, and thus the work will always be at their eye levels. There have just been 1,100 additional operatives taken on in the "His Master's Voice" factories at Hayes, where over 8,000 men and girls (excluding the administrative staff) are now working at top speed on the manufacture of radio receivers, radio gramophones and records.

New 10 kW. Transmitter for Japan

THE Japanese have been studying our system of Regional Broadcasting for some time, and have become great admirers of the idea. In fact, they have become so intrigued that they are going to copy the system and have arranged with the Marconi Company that their station at Osaka be fitted with an additional transmitter, to work simultaneously with the present transmitter, also a Marconi instrument. The new station will consist of a Marconi P.A. transmitter of 10 kW. output, incorporating a low power modulation system. With such a low power it is doubtful if either of these stations will ordinarily be heard in this country, so accustomed have we become to listening to giants sending out 75 and 100 kilowatts,

but who knows, some painstaking amateur may log the signal on a quiet evening. Whether he will understand the signal when he gets it will be quite another matter!

Radio Beacons in U.S.A.

AMERICAN pilots who fly the regular passenger and mail aeroplanes by day and night are making use of a new aid to safety now being employed by the series of radio beacons on the 19,000 miles of air routes. Sixty of these beacons have been erected, each of them sending out in the four points of the compass a different letter of the alphabet in Morse code. The pilot flying by night or in fog listens to the letter in his headphones and knows by



The H.M.V. factories are working overtime to produce new sets in time for the exhibition. Here a girl can be seen assembling a new H.M.V. superhet on a new form of lift which enables the girls to reach all parts of the sets easily without undue fatigue. The lift is raised or lowered by the girl holding the steering wheel.

his chart which beacon he is approaching and from which direction. If he finds he is out of his course he swings over to the right or left as the case might be until he hears one of the other three letters the beacon is sending out. If he wishes to land at the flying ground attached to the beacon he keeps in the beam of the signals in such a way that they gradually get louder, and as the beam gets narrower as it approaches the beacon he is thus directed right to the aerodrome. When the signal approaches maximum loudness it suddenly

breaks off, and the pilot knows that he is in the cone of silence directly over the station.

Sideband "Splash"

I HAVE been very pleased to find out late that the heterodyne nuisance on the medium waveband is not nearly so bad as it was a few weeks ago. Only last night I ran round the dial with the "Selectone" and of some seventy-six stations tuned in only two were so badly heterodyned that they could not be received at reasonably good quality by making full use of the tone control. But the difficulty of sideband "splash" seems to be worse than ever. I refer to that peculiar "twiz-siz-siz" sound which is heard when a station of near wavelength to that being received is transmitting speech. This kind of interference is particularly objectionable, and although its severity varies on different types of receiver, there seems to be no means of eliminating it at the listening "end." The "splash" is caused by the use of very deep modulation for speech transmission by the broadcasting stations, and it appears that the only satisfactory way of preventing it would be to limit the permissible depth of modulation of the carrier wave. This would entail the formulation of an entirely new regulation which is, to my mind, already overdue. Perhaps the question will be dealt with at the broadcasting conference to be held at Prague in the coming spring. Let us hope so.

Fading

WHILST going round the dial I was glad to find a noticeable absence of fading on a few of the stations which have previously been very troublesome in this respect, such as Fécamp, Hilversum, and Florence, but Huizen, Trieste, and Toulouse seemed to be acting most queerly. The three latter stations were found to vary in strength enormously from minute to minute, and at times were practically inaudible. The periodic variations in strength were so great that even a set using automatic volume control would have been insufficient to cope with them.

On Short Waves

THIS reminds me of a question I am often asked by some of the older listeners who have not spent very much time with their hobby for the last few years. They ask where are the amateur transmitters we used to hear so much of on Sunday mornings. The fact is that the amateurs are still as busy as ever, but whereas they previously used the 300-440 metre waveband they are now compelled by regulations to use one of the shorter wavebands and in consequence they cannot be heard on the ordinary broadcast receiver. Quite a number of them can be tuned in with a S.W. receiver during any Sunday morning or after about 10 o'clock on most evenings.

CHOOSE AT OLYMPIA—THEN COME TO PARTEX

LET us take your old Set or components in PART EXCHANGE for New Season's Radio—NEW KITS, NEW ACCESSORIES, or PART KITS—in fact, any RADIO APPARATUS you choose from OLYMPIA. Best quotations and fullest allowances given. Balance payable by Cash or H.P. Send us your enquiry for quotation by return. Fill in the coupon—no obligation. WE GIVE YOU MORE.

PARTEX RADIO, VULCAN HOUSE, 56, Ludgate Hill, LONDON, E.C.4.

Dear Sirs, Please give me your best PART EXCHANGE value for the Radio Apparatus detailed in my letter attached.

Name.....

Address.....

Prw. 19/8/33

OUR VIEWS ON RECEIVERS

(Continued from page 706)

heard as a background on the more distant stations. In testing the set in this way it was interesting to compare the field strengths of various transmissions by noting the amount of dip on the needle of the visual tuning scale. Actually, the latter varied from a full nine degrees for London Regional to zero for many of the less powerful transmitters. In view of this one can do no more than describe the perfect automatic volume control action as revolutionary and we would invite all those sceptics who declare that A.V.C. is of no real value to make a point of hearing this receiver—their ideas are sure to be modified. It was decided to see what A.V.C. would do on signals that are subject to bad fading, and Fécamp, Milan, Bucharest, and others which were known to fade badly in the district where the set was being tested were tuned in. Although the tests were continued for at least an hour on two or three evenings, only once could any sign of fading be detected. This was on Fécamp and even then the fading lasted only for a few seconds and was not sufficient to cause any difficulty in following the announcements being made. To make sure that conditions were not abnormal, the same stations were tuned in on another receiver and were found to fade just as badly as ever. There was really no need for this comparison, since fading could easily be detected by watching the movements of the needle of the milliammeter, and this often moved over two or three degrees within a period of ten minutes or so.

Innumerable Stations

The receiver was later tried out on an outside aerial of average efficiency and with a proper earth lead. Results were truly astonishing; there are fifty-eight medium-wave and sixteen long-wave stations marked on the tuning dial and every one of these, plus two newcomers which were not identified, were brought in at ample programme strength. In some cases atmospheric and other interferences were too severe to permit of uninterrupted reception, but otherwise every station was at good programme strength and entirely free from interruption by stations working on adjacent wavelengths. Selectivity was all that could be desired and a very distinct cut-off was noticeable between different transmissions.

The receiver was next tried as a gramophone amplifier by connecting the pick-up to two plugs which are supplied with the set and inserting these into corresponding sockets conveniently placed at the rear of the chassis. Absolutely no fault could be found with the quality of reproduction, which was just as good as on radio, and the smooth progressive actions of the volume and tone control knobs were noteworthy. By rotating the latter through a complete revolution the tone could be varied from quite "thumpy" bass to a rather screechy treble; between the extremes plenty of latitude was obtainable to suit all tastes.

Priced at £25 4s., and consuming less current than an ordinary 60-watt electric lamp, the Ferranti "Gloria" model super-het is easily the best set of its type which we have ever had the pleasure of testing, and backed by such a well-known firm of manufacturers it is sure to appeal to the discriminating purchaser.

CHARTS

by **FERRANTI**, for Home Constructors, embodying **RADIO'S VERY LATEST AT ITS VERY BEST**

The FERRANTI "SUPERMIN." A screened Grid Three of simple construction and modest cost, with good performance, both as to quality of Reproduction, Selectivity, and Range.

The FERRANTI BATTERY BAND PASS THREE. A new and revised edition, incorporating a Variable Mu Screened grid Valve. A set with high selectivity, simple and inexpensive.

The FERRANTI BATTERY CLASS "B" FOUR. Also now including a Variable Mu Screened grid valve. A highly efficient receiver, capable of giving considerable volume with low H.T. consumption. The best class "B" set available.

The FERRANTI A.C. MAINS BAND PASS THREE. Completely revised to include a Ferranti H4D Double Diode Triode Detector Valve, a Ferranti Variable Mu H.F. Pentode, Type VPT4 and partial Automatic volume control.

The FERRANTI SHORT-WAVE CLASS "B" FOUR. The latest and best in short-wave circuits. A battery operated 4 valve screened grid receiver, including a high grade Class "B" output stage. Range 15-100 metres, with plug-in Coils to give medium wave reception up to 600 metres if required.

Complete dimensioned diagrams and comprehensive instructions are given so that those of little experience will have no difficulties.



Send 1½d. for a copy of the chart which best suits your requirements to:

FERRANTI LTD., Dept. "P.W.", HOLLINWOOD, LANCASHIRE.



"ENGINEERING OPPORTUNITIES" is a 250-page Handbook that has been prepared after years of patient search into the possibilities of various Engineering Careers. It shows clearly and definitely the way in which you may carve out a successful career in your chosen branch of Engineering, irrespective of your age, education or experience. Among a host of other things, it outlines Home-Study Courses in all branches of Civil, Mech., Elec., Motor, Aero., Wireless and "Talkie" Engineering, and shows the way to pass A.M.I.C.E., A.M.I.Mech.E., I.E.E., A.M.I.A.E., M.I.M.T.G.P.O., Matriculation, Civil Service and other Examinations. "ENGINEERING OPPORTUNITIES" is a unique Handbook that you should most certainly read. Send for your copy to-day—FREE of any cost. **British Institute of Engineering Technology, 390, Shakespeare House, 29/31, Oxford Street, London, W1.**

SET CRACKLING IS ANNOYING!

IF IT'S YOUR SWITCH

FIT THE "BUSCO" SWITCH

each 1/0
1/3 Post Free.

and ensure perfect switch contact! There is no contact point to turn round, and when you "switch on" you have contact like a power switch. They are as cheap as the inferior type, but far superior in operation.

Patented. From your local dealer or

BUSBY & CO., LTD. (Patentees)
Dept. P.W., PRICE ST., BIRMINGHAM

THE FIRST AGAIN!

ALL-WAVE TWO

The First Two-valve Receiver covering Short, Medium, and Long Waves, and Employing the New Iron-core Tuning Coils.

By FRANK PRESTON, F.R.A.



It has never before been possible for the home constructor to embody all the features of simplicity, cheapness, all-wave tuning, long range, selectivity, and ease of control in a single receiver. The "All-Wave Two" has been designed expressly to provide the amateur and experimenter with something quite new in simple broadcast receivers. It is not merely a collection of unusual parts assembled in a "stunt" circuit, but is a genuine design which has been carefully worked out and experimented with, bearing in mind the

object of producing what might well be called the ideal simple set for either ordinary broadcast or D.X. reception. At the present time one is apt to look upon the non-S.G. set as obsolete and useful only for local station listening, but any such idea will quickly be forgotten by the builder of the "All-Wave Two," which employs the well-known detector-pentode circuit. As a matter of fact, this circuit is the only one that is really suitable for use in a combined long-short wave instrument of the simpler type, and, provided that it is properly employed, it is undoubtedly capable of astonishing results. As justification for this statement it might be pointed out that the little set to be fully described has been found to give excellent

loud-speaker reception from at least five medium and long-wave stations, and from the same number of short-wave stations when used on an indoor aerial consisting of thirty feet of wire taken round the picture moulding of a ground floor room. Under the same conditions a large number of short-wave signals from all parts of the world could be brought in at good 'phone strength. Such results, although they may not sound very startling, are decidedly good when compared with those to be obtained from far more expensive receivers of normal type, and serve as a guide as to what the constructor might expect to obtain. Naturally, a far greater number of stations could be received on a good outside aerial, but it is considered better to make a

LIST OF COMPONENTS FOR THE "ALL-WAVE TWO":

One Peto-Scott "Metaplex" Chassis, 12in. by 7 $\frac{1}{2}$ in. by 2 $\frac{1}{2}$ in.
 One "Becol" Ebonite Panel, 12in. by 8in.
 One Igranic "Igranitor" Coil, Type "A."
 One Igranic "Igranitor" Coil Type "S.W."
 One Igranic Insulated Switch Rod Coupler.
 One Graham Farish .0005 mfd. "Zelos" Condenser.
 One Igranic "Indigraph" Vernier Knob and Dial.
 One British Radiogram .0002 mfd. Reaction Condenser.
 One British Radiogram 2-point Switch.
 One British Radiogram 3-point Switch.
 One British Radiogram Short-Wave H.F. Choke.
 One "Goltone" .0001 mfd. Pre-set Condenser.
 One "Goltone" Super H.F. Choke.

One W.B. Chassis Mounting 4-pin Valve-holder.
 One W.B. Chassis Mounting 5-pin Valve-holder.
 One Bulgin "Senator" L.F. Transformer.
 One Bulgin Crocodile Clip.
 One Dubilier .0001 mfd. Fixed Condenser, Type 670.
 One Dubilier 1 mfd. Condenser, Type BB.
 One Dubilier 2 mfd. Condenser, Type BB.
 One Graham Farish "Ohmite" 1 megohm Resistance.
 One Graham Farish "Ohmite" 20,000 ohm Resistance.
 One Graham Farish "Ohmite" 30,000 ohm Resistance.
 One Graham Farish "Ohmite" 100,000 ohm Resistance.
 Two Belling Lee Terminal Mounts.

Four Belling Lee Terminals, Type "B", marked "A," "E," "L.S.+", "L.S.-"
 One Belling Lee 6-way Battery Cord with Terminals marked "H.T.+", "H.T.-", "L.T.+", "L.T.-"
 One "Microfu" Type 100 mA.
 One Mazda Type L.2 Valve (Metallised).
 One Mazda Type Pen. 220 Valve.
 One Peto-Scott "All-Wave Two" Cabinet.
 One R. & A. "Bantam" Loud-speaker Unit.
 One Graham Farish "Filt" Earthing Device.
 One length British Radiophone "Receptru" Down Lead.
 One "Drydex" 120-volt High Tension Battery, Type H 1006.
 One "Drydex" 9-volt Grid Bias Battery Type H 1001.
 One Exide 2-volt 20 a.h. Accumulator Type B.T.G.

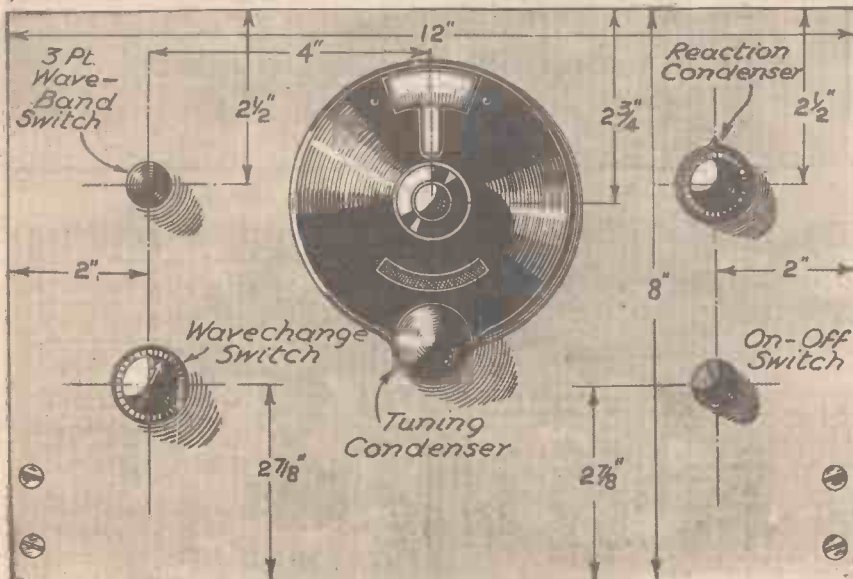

Panel-drilling diagram.

modest claim so that those constructors who are unfortunately situated from the point of view of good reception conditions will have no difficulty whatever in substantiating it.

Highly Selective

Another point of particular moment concerns the set's selective properties. When tested at seven miles from the Brookmans Park transmitters no difficulty was experienced in eliminating either programme; in fact, the tuning "spread" in neither case exceeded five degrees on the condenser dial. No break-through was experienced on the long-wave band, and Daventry, Radio-Paris and Luxembourg could all be received quite clear of each other at excellent strength. These results are due in no small measure to the new iron-core coils used, which have proved to be far more selective than any single circuit aerial tuners hitherto tested.

Quality Reproduction

With a small set the quality of reproduction often leaves much to be desired, but the "All-Wave Two" gives a fullness and roundness of tone not only equal to, but a

good deal better than, that to be obtained from the average three or four valve set. It has not been found necessary to resort to the use of any complicated tone-corrector systems to achieve this result, although great care was expended in properly choosing and matching the various components and valve in the low frequency circuit.

Four Tuning Ranges

The set is extremely easy to operate, and tuning on the medium and long waves is simplicity itself. Even on the short waves it is delightfully simple, due to the entire absence of hand-capacity effects (which are prevented by the use of adequate screening), and to the use of a slow-motion tuning knob with which the dial can be moved through a fraction of a degree with the utmost ease. The change-over from one waveband to another is accomplished by the use of only two switches; one of these is of the three-point type and is used to short circuit the windings of the broadcast coil when short-wave reception is required. In addition to this there is a second switch knob which operates a pair of ganged switches situated one in each of the coils. Depending upon the position of the three-point switch, this gives the tuning ranges of 15 to 30 metres and 28 to 80 metres, or 210 to 510 metres and 950 to 2,200 metres. Since the set does not cover the full wavelength range right from 15 to 2,000

metres, it might be argued that the name is a misnomer, but it need only be pointed out that the four ranges which are covered embrace every powerful broadcasting station in the world, as well as all the amateur transmissions.

When housed in its attractive modern cabinet, the "All-Wave Two" costs approximately £8 10s. complete with every accessory, or about £4 for the set alone. These figures tell their own story, and show that for a really up-to-date set of universal application the price is distinctly reasonable. The illustrations on this page show clearly the simple lay-out and straightforward design of the set so it would be almost superfluous to mention that it can successfully be made by the veriest novice. It is hoped that many of our new readers who have perhaps had no previous experience of constructional work will make this their first set. For the benefit of such readers it might be added that the "All-Wave Two," like all other PRACTICAL

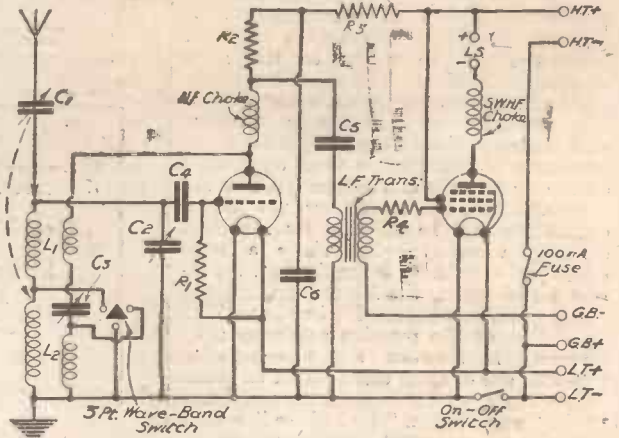

The theoretical circuit.

The components are:—L.1, Short-Wave coil; L.2, Broadcast Coil; C.1, .0001 mfd. Pre-Set; C.2, .0005 mfd.; C.3, .0002 mfd.; C.4, .0001 mfd.; C.5, 1 mfd.; C.6, 2 mfd.; R.1, 1 megohm; R.2, 30,000 ohms; R.3, 20,000 ohms; R.4, 100,000 ohms.

WIRELESS receivers, is covered by our guarantee. Consequently, should any slight (or even great) difficulty present itself to the constructor he is entitled to our advice entirely free of charge. The only provision is that the specified parts be employed

The Circuit Explained

It can be seen from Fig. 1 that the circuit

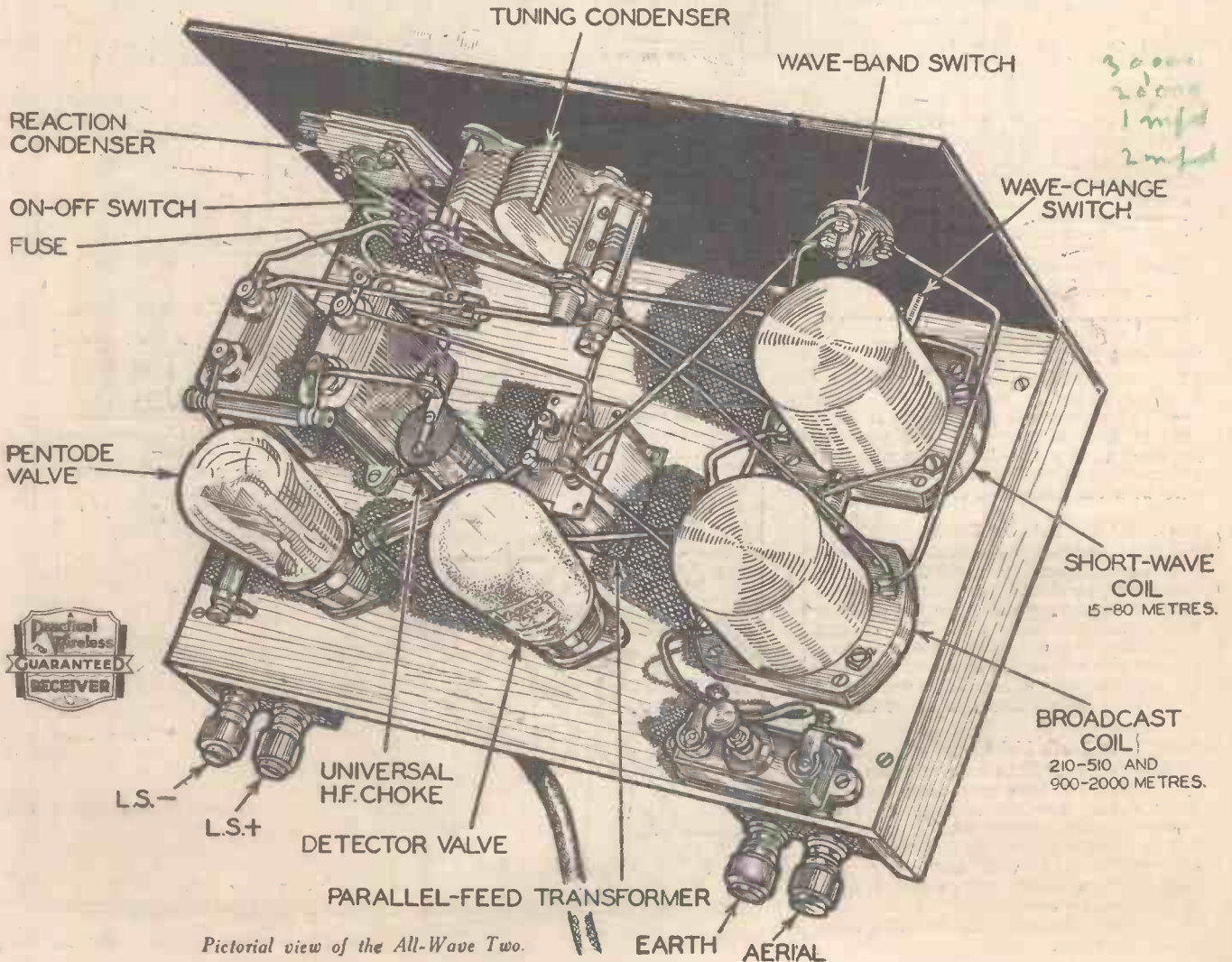

Pictorial view of the All-Wave Two.

is of a straightforward nature, but one or two comments on the points of chief interest might be useful to the more experienced reader. The special arrangement of the two tuning coils has already been mentioned so it need only be added that the connection from the pre-set aerial condenser is transferable from terminal 3 on the short-wave coil to terminal 2 on the broadcast one. In most cases, the former connection will be suitable for reception on every waveband, but where a little additional selectivity is required on broadcast wavelengths, the latter tapping point will be somewhat better. Notice the position in circuit of the reaction condenser; by inserting it between the two reaction windings one of them can be short circuited very simply, whilst leaving the condenser in the "earth return" lead where it cannot give rise to unwanted hand-capacities.

Grid leak rectification is used, and the detector valve is coupled to the pentode by means of a parallel-fed L.F. transformer. By using this system extra step-up is obtained and the detector anode circuit impedance is accurately matched by a 30,000 ohm coupling resistance. The H.F. choke connected in the anode lead of the detector is of the all-wave type, and is suitable for use on all wavelengths down to 10 metres. Ample decoupling is provided and high frequency currents are prevented from passing into the pentode by the insertion of a 100,000 ohm "stopper" resistance in the grid lead. The priming grid of the pentode receives its H.T. voltage from the same source as the anode; decoupling of this circuit was tried in the first experimental receiver but proved to be quite unnecessary. To prevent the possibility of instability on the shorter wavelengths a special short-wave choke is included between the anode of the output valve and the loud-speaker.

TOP AND SUB-BASEBOARD WIRING DIAGRAM OF THE "ALL-WAVE TWO"

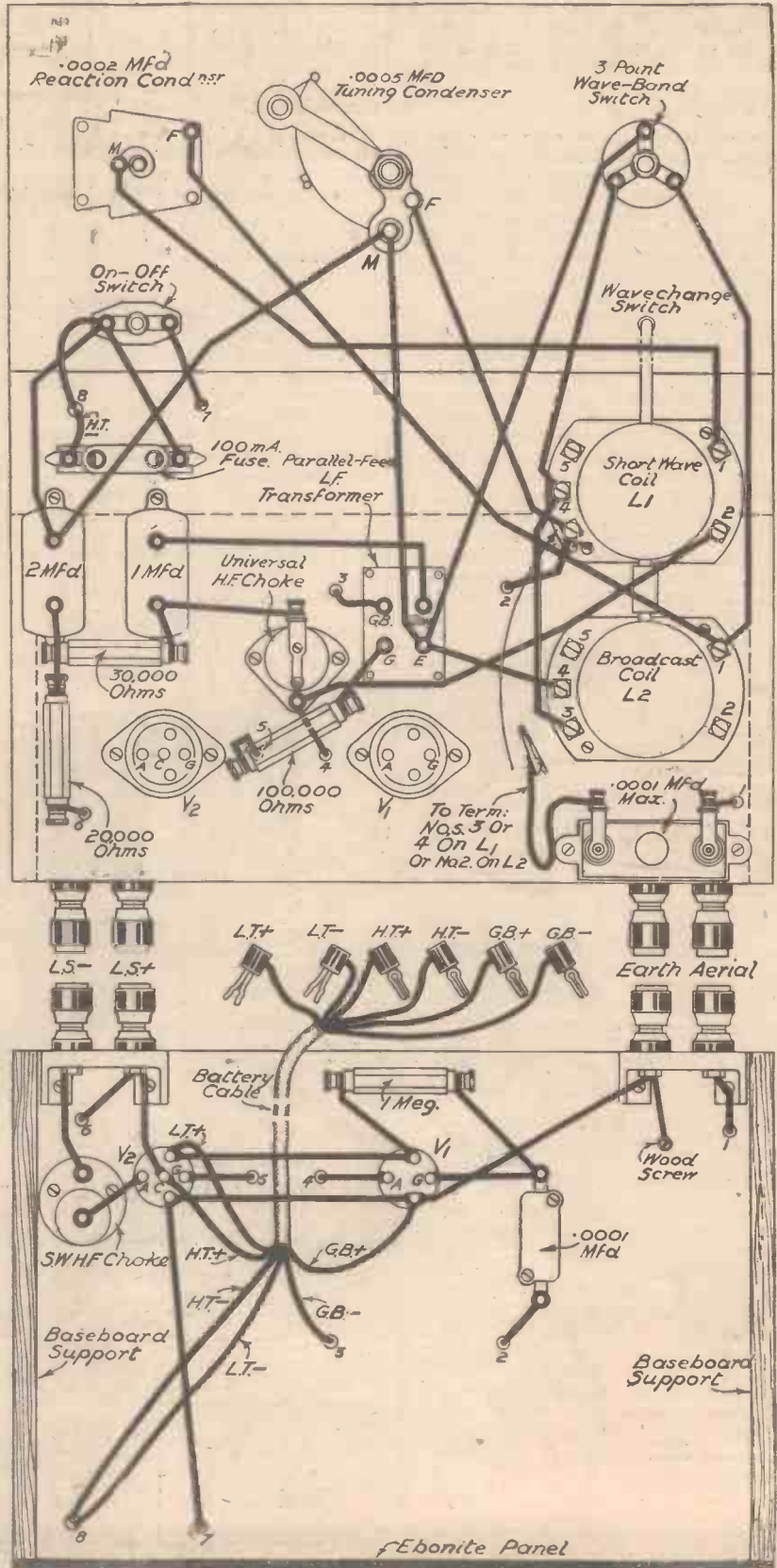

NEXT WEEK:

Further Constructional and Adjusting Notes on the "All-Wave Two."

Iron-cored H.F. Coils

IT seems that iron-cored H.F. coils have come to stay. Bearing in mind that a coil of very small proportions is more efficient than a very large coil with an air core, what possibilities lie in a coil of reasonable proportions wound with Litz wire with the same iron core.

Improving the Detector Stage

NOW that Class B has made really good outputs possible for the battery user, many will, no doubt, turn their attention towards improving quality in the detector stage, and, providing that H.T. current is not of supreme importance, the small steep slope power valves will be found very sensitive and capable of handling a really good input with the minimum of distortion.

Keep Your Earth Moist

THE following lines were recently published in some gardening notes:—"During the hot summer days the earth gets incredibly dry." This is, no doubt, quite true from a gardening point of view, but it is equally true of the wireless earth, which is quite useless when surrounded by dry soil, and it should be well saturated with water when necessary.

FIRST IN 1919—FOREMOST ALWAYS

NEW SEASON'S RADIO CASH—C.O.D.—H.P.

● **Originators of Kits of Parts in 1919**
we supply all your Radio Needs Cash,
C.O.D. or Easiway. Our customers are invited
to take advantage of our FREE Technical Service
or call for Demonstrations at 77, City Road,
London, E.C.1, or 62, High Holborn, London, W.C.2.

NEW LISSEN SKYSCRAPER FOUR ALL-WAVE CHASSIS MODEL, complete kit comprising all components, including set of Lissen Valves. Cash or C.O.D., Carriage Paid, £5/12/6. Balance in 11 monthly payments of 10/3 only. **Send 10/3**

NEW LISSEN ALL-ELECTRIC SKYSCRAPER THREE, complete with four valves and constructional Chart in Sealed Carton. Cash or C.O.D., Carriage Paid, £7/19/6. Balance in 11 monthly payments of 14/6. **Send 14/6**

NEW LISSEN SKYSCRAPER THREE (Battery Model), complete with three valves and constructional chart in sealed carton. Cash or C.O.D., Carriage Paid, £4/9/6. Balance in 11 monthly payments of 8/3. **Send 8/3**

NEW COSSOR MODEL 341. S.G., Detector and Pentode, and balanced armature Speaker, complete with Cabinet. Cash or C.O.D., Carriage Paid, £6/7/6. Balance in 11 monthly payments of 11/9. **Send 11/9**

NEW FERRANTI "CLASS B" SUPER POWER CONVERTOR. Instantly converts your present set to "Class B." Complete with valve. Ready assembled. Cash or C.O.D., Carriage Paid, 6/3/-. Balance in 11 monthly payments of 5/9. **Send 5/9**

AMAZING OFFER



PETO-SCOTT
P.M. MOVING-COIL SPEAKER

15/-

Exquisite tone; sensitive to every sound inflection. Moulded diaphragm. Tapped input transformer for Power or Pentode. Mains Energised Model for A.C. (2,500 ohms) or D.C. Mains (5,000 ohms) .. 15/-

In beautiful Walnut polished Cabinet, Cash or C.O.D., 25/-

NEW ATLAS C.A.25 for A.C. Mains, Class "B" and Q.P.P. Four Tappings, 60/80, 50/90, 120, 150, 25 m.a. Cash or C.O.D., Carriage Paid, £2/19/6. Balance in 11 monthly payments of 5/6. **Send 5/6**

NEW W.B. Type P.M.4.A. MICROLODE, complete with input transformer. Cash or C.O.D., Carriage Paid, £2/2/0. Balance in 7 monthly payments of 5/9. **Send 5/9**

NEW BLUE SPOT 29P.M. Complete with tapped input transformer. Cash or C.O.D., Carriage Paid, £1/12/6. Balance in 8 monthly payments of 5/-. **Send 5/-**

NEW BLUE SPOT 99P.M. PERMANENT MAGNET MOVING-COIL SPEAKER, complete with tapped input transformer. Cash or C.O.D., Carriage Paid, £2/19/6. Balance in 11 monthly payments of 5/6. **Send 5/6**

NEW CELESTION P.M.19 PERMANENT MAGNET MOVING-COIL SPEAKER, complete with tapped input transformer. Cash or C.O.D., Carriage Paid, £2/7/6. Balance in 8 monthly payments of 6/3. **Send 6/3**

NEW ROLA F.6 P.M. PERMANENT MAGNET MOVING-COIL SPEAKER. Complete with input transformer. Cash or C.O.D., £2/9/6. Balance in 8 monthly payments of 6/-. **Send 6/-**

NEW GARRARD MODEL A.C.4. 12m. Electric Motor. A.C. Mains. Cash or C.O.D., Carriage Paid, £2/2/6. Balance in 7 monthly payments of 5/9. **Send 5/9**

PILOT AUTHOR KITS

F. J. GAMM'S 1934 SUPER-SET

KIT "A" Author's Kit of Finest Specified parts, including Peto-Scott "Metaplex" chassis (less valves and cabinet). **YOURS FOR 14/9**
CASH or C.O.D. Carriage paid, Balance in 11 payments of 14/9
£8 : 2 : 0

KIT "B"
As Kit "A," including valves but less cabinet. CASH or C.O.D. Carriage Paid. **£11 : 2 : 9**
or 12 monthly payments of 20/6.

KIT "C"
As Kit "A," including valves and cabinet. CASH or C.O.D. Carriage Paid. **£12 : 7 : 9**
or 12 monthly payments of 22/8.

KIT BITS You pay the postman. We pay post charges on all orders over 10/-.

1 Set of Valves	£3 0 9
1 British Radiophone 3-gang Cond., with full vision scale, Type 604	£1 8 6
1 (Lissen) Set of 3 Iron Core Coils	£1 17 6
1 Varley "Nictel" L.F. Transformer	7 6
1 Bulgin Type "B" "Controltone"	5 0
1 Peto-Scott "Metaplex" Chassis	3 6
1 Peto-Scott "Luxor" Cab.	£1 5 0

ALL-WAVE TWO

KIT "A" Author's first specified parts, including Peto-Scott "Metaplex" Chassis, Ready-Drilled Panel, but less Valves, Cabinet and Speaker. **YOURS FOR 7/6**
CASH or C.O.D. Carriage Paid, Balance in 11 payments of 7/6.
£4 2 0.

KIT "B"
As for Kit "A," but including valves, but less Cabinet and Speaker. CASH or C.O.D. Carr. Paid. **£5 : 5 : 6**
or 12 monthly payments of 9/7.

KIT "C"
As for Kit "A," but with valves, Cabinet, but less Speaker. CASH or C.O.D. Carr. Paid. **£6 : 10 : 6**
or 12 monthly payments of 12/-.

KIT BITS You pay the postman. We pay post charges on all orders over 10/-.

1 Set of Specified Valves	£1 3 6
1 Pair of Igranico Coils, type A, and S.W. with Coupler	£1 5 0
1 Bulgin "Senator" L.F. Transformer	6 0
1 Loudspeaker, R. & A. Bantam	£1 7 6
1 Peto-Scott "Metaplex" Chassis (12x7 1/2x2 1/2)	3 6

NEW W.B. Type P.M.4.A. MICROLODE, complete with input transformer. Cash or C.O.D., Carriage Paid, £2/2/0. Balance in 7 monthly payments of 5/9. **Send 5/9**

Exact to Specification

PILOT "CLASS B" CONVERSION KIT
Converts your present Battery Set to "Class B" Amplification. Complete with all necessary components, including Peto-Scott driver transformer, Peto-Scott "Class B" output choke, W.B. 7-pin valve holder, B.V.A. "Class B" valve, wire and screws, etc. Full-size Blueprint, assembly instructions and diagrams. Cash or C.O.D., 37/6. Balance in 7 monthly payments of 5/6. **Send 5/-**
All "Class B" Components and other Parts obtainable from your local dealer **SENT C.O.D. Easy Terms Available orders value over 35/-.** We have the largest stocks in the country. Orders over 10/- Sent Post Paid.

BUILD YOUR NEW SET into the INLAID WALNUT ADAPTAGRAM



In Oak or Mahogany, no extra.

DIRECT FROM FACTORY. No MIDDLEMAN'S PROFITS. Built by master craftsmen of the piano trade. Real inlaid walnut, mortised, tenoned, french-polished. With screened motor-board by the new METAPLEX PROCESS. Front ready drilled to take your set. Ample room for Speaker and batteries. Size 38" high, 22" wide, 15 1/2" deep. Baseboard depth, 14". Speaker compartment, 17" x 19" x 14". Plain front or vignette for panels up to 18" x 8". Baffleboard 3/6 extra. **YOURS FOR 8/3**
Balance in 11 monthly payments of 5/9, Carriage Paid. CASH or C.O.D. 63/- CARRIAGE 2/6 EXTRA.

See **METAPLEX** Baseboards and **PETO-SCOTT RADIO CABINETS** used in the "Practical Wireless" Exhibition Sets, **OLYMPIA—STAND 8**

IMPORTANT Miscellaneous Components, Parts, Kits, Finished Receivers or Accessories for Cash, C.O.D., or H.P. on our own system of Easy Payments. Send us a list of your wants. We will quote you by return. C.O.D. orders value over 10/- sent carriage and post charges paid.

PETO-SCOTT CO. LTD.
77, CITY ROAD, LONDON, E.C.1.
Telephone: Clerkenwell 9406-7.
West End Showrooms: 62, High Holborn, London, W.C.1. Telephone: Holborn 3248.

Dear Sirs,
Please send me CASH/C.O.D./H.P. _____
for which I enclose £.....
CASH/H.P./DEPOSIT.

NAME _____
ADDRESS _____
P.W. 14-2-33.

SEND DIRECT to AVOID DELAY — CASH, C.O.D. or EASIWAY

Why a High-Resistance Voltmeter Should Be Used

With the Aid of Ohm's Law the Writer Explains the Reason

By J. EVANS

THERE are numerous amateur set constructors who do not seem to clearly understand why they are being continually advised to use a high-resistance voltmeter for eliminator-voltage measurements.

Meter Resistance

It should be clearly understood that a voltmeter is a milliammeter having a resistance in series with one of its leads, this resistance being usually enclosed in the meter casing. The function of the resistance is to cut down the current to the value permissible through the ammeter. When a voltage is applied across the output terminals of the ammeter-resistance combination (i.e. the voltmeter terminals), a current will flow through the meter, causing a deflection of the needle. To avoid loss of time in calculation, the ammeter scale is marked in volts, so that while the current is still the actuating force in the meter, the deflection is now registered in volts.

The value of the series resistance is governed by the current range of the meter, and the maximum voltage it is desired to measure. For reasons that will be explained later, this resistance must have a high value if accurate voltage measurements are to be obtained.

A milliammeter having a full-scale deflection of 5 mA., or less, may be converted into a reliable voltmeter: or in other words, a voltmeter having a resistance of 200 ohms per volt, or more, will give sufficiently accurate voltage measurements for all ordinary wireless purposes.

Reason for Inaccuracy

A low-resistance meter is unsuitable for measuring eliminator voltages, because eliminators have a high internal resistance, due to the incorporation of smoothing chokes and dropping resistances. A low-resistance meter will naturally drain more current than a high-resistance instrument—Ohm's Law states that current is equal to voltage divided by resistance. This high current drain reacts on the source of voltage to be measured, thus causing an inaccurate indication on the meter.

Effect on D.C. Mains Unit

Let us take, for example, a simple 250-volts D.C. mains unit as shown in Fig. 1, having an output of 125 volts at 25 mA.,

or, in other words, having a voltage of 125 across points A and B when the current registered on milliammeter C is 25 mA.

As will be seen from the sketch, the total internal resistance of the eliminator is

connected across A and B, the actual voltage across these points will only be $83\frac{1}{3}$ volts (250 minus $166\frac{2}{3}$), but as soon as the meter is removed the voltage will rise to 125 volts.

If, however, the meter resistance were 100,000 ohms instead of 5,000 ohms, it will be evident from the above calculation that its effect on the voltage output would be negligible, and therefore the reading obtained would be sufficiently accurate.

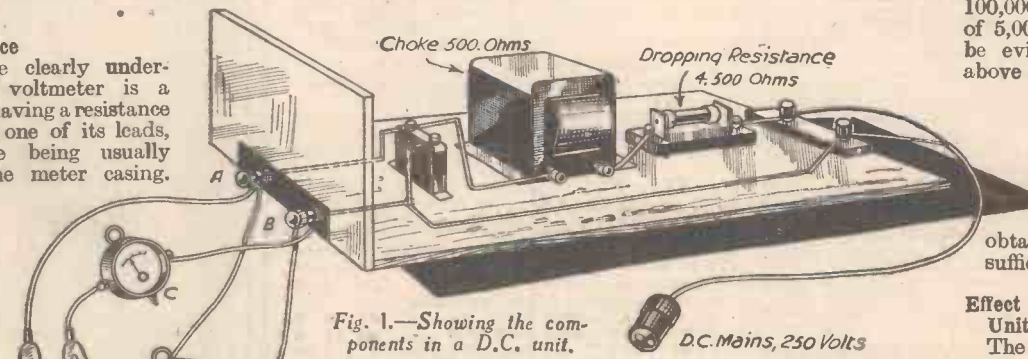

Fig. 1.—Showing the components in a D.C. unit.

5,000 ohms (500 ohms choke plus 4,500 ohms dropping resistance). In order to obtain the specified output of 125 volts, the current consumption must be 1/40 amp. (25 mA.), and therefore the total circuit resistance must be 250 volts divided by 1/40 amp., which amounts to 10,000 ohms. We already have 5,000 ohms in the eliminator, therefore the external load (receiver to which eliminator is connected) must be 5,000 ohms. If a voltmeter having a resistance of 5,000 ohms is now connected across A and B, with the receiver switched on, the total load will be reduced to 2,500 ohms, because the meter resistance of 5,000 ohms will be in parallel with receiver resistance of 5,000 ohms. Therefore the total resistance across the 250-volt mains will be 4,500 ohms (dropping resistance) plus 500 ohms (choke) plus 2,500 ohms (meter and receiver). This amounts to 7,500 ohms, and consequently the total current consumption will be increased to 1/30 amp. (250 volts divided by 7,500 ohms). The voltage drop inside the eliminator will then be its internal resistance of 5,000 ohms multiplied by 1/30 amp., which amounts to $166\frac{2}{3}$ volts. Therefore when the meter is con-

Effect on A.C. Mains Unit

The foregoing limitation applies when dealing with A.C. units also, but we have a further limiting factor to contend with—namely, the effect of the reservoir condenser. This condenser is connected across the rectifier output circuit, and the voltage across its terminals varies with the output-circuit current drain. Fig. 2 shows the drop in D.C. voltage across the reservoir condenser as the current drain imposed by the receiver is increased. It is therefore obvious that if a low-resistance meter were connected across the output terminals, the current drain would be greatly increased, and consequently the voltage across the reservoir condenser terminals would be reduced, and the reading registered on the meter would not be the true output voltage.

The foregoing calculations should also make it quite clear that the specified output voltages of an eliminator are only obtained when the eliminator is on load—that is, when the receiver is switched on.

Battery Receivers

In the case of the battery-operated receiver, a low-resistance meter will give sufficiently accurate measurement of the voltage of the H.T., L.T., and G.B. batteries, because the internal resistance of these is very low. If, however, it is desired to measure the H.T. voltage applied to the plate of a valve having a resistance in its anode circuit, for example, a detector valve preceding a parallel-fed transformer or R.C.C. unit, the low-resistance instrument again becomes unsuitable for the same reason as that given above in the case of the D.C. mains unit.

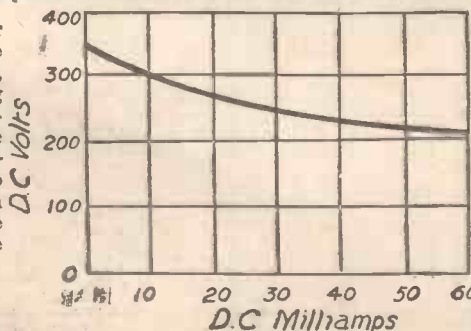

Fig. 2.—Voltage across reservoir condenser of typical full-wave rectifier.

ORDER IT NOW!

Next Week's 2nd Enlarged Show Issue of Practical Wireless.

Same Price - - - 3d.

PAGE MISSING

PAGE MISSING

PAGE MISSING

PAGE MISSING



EVE-OF-SHOW PROGRAMME RELEASES REVIEWED

A Resumé of Manufacturers' Programmes Released After the Special Show Guide (Included in this Issue) had Gone to Press.

BELLING & LEE, LTD., Cambridge Arterial Road, Enfield, Middx. Stand No. 45.

AN additional new release from the Belling factory consists of a special high-frequency disturbance suppressor. This consists of a neat bakelite case containing two heavy-duty 2 mfd. fixed condensers with a centre point connected to a shrouded earth terminal, and the other connections via a pair of safety fuses to terminals for connection to the mains. It is claimed that the device, which bears the name Disturbance Suppressor, will completely remove interference arising either from the aerial direct, or through the mains. It is supplied in two models for A.C. or D.C. and costs 9s. 6d.

R. O. BRIDGER & CO., Sheldoff Place, Church Street, Stoke Newington, N.16. Stand No. 221.

AS manufacturers exclusively of cones for loud-speakers, there will be many different types of material and conical diaphragms exhibited on this stand. From a simple paper cone of the seamed type, suitable for a simple moving iron speaker, to a special rot-proof, vermin-proof, cellulose non-hygroscopic material, moulded to any size, the exhibits should give the ordinary listener some idea of the large amount of experimental work which is undertaken in the design of cones for loud-speakers. Each individual speaker requires a definite size and weight of diaphragm, in addition to which "colouration" may be obtained by choosing a material of the right kind. Messrs. Bridger have specialized in this kind of work for a long time now, and have, in fact, vacated their original premises and have taken over a new factory at the above address where even more efficient machinery is being installed to enable them to carry on the work they have so ably undertaken in the past. They claim to have a virtual monopoly in this special line of business.

BRITISH ROLA CO. LTD., Minerva Road, Park Royal, N.W.10. Stand No. 52.

AMONGST the latest announcements from the Rola company is one regarding the Dual Balanced Pairs. These are so designed that the overall frequency response is greatly increased over that obtainable from one single speaker, and the high notes and the lowest of bass notes is reproduced with full volume. The cheapest pair from the Rola range costs £2 12 6d., and consists of two 6in. diameter speakers with

energized fields. The same two speakers with permanent magnet fields cost £2 17s. 6d. The range comprises seven different types, and the most expensive is made up from one permanent magnet type with a cone of 7 1/2ins. diameter and one with a diameter of 9ins., and a transformer is fitted for triode, pentode or push-pull valves. The cost is £4 17s. 6d.

THE CITY ACCUMULATOR CO., LTD., 13-20, Norman's Buildings, E.C.1. Stand No. 94.

IN addition to a comprehensive range of cabinets the following receivers are being shown by the C.A. Company.

The "Norman" Class B Three is a three-valve

The "Oxford" is a four-valve battery receiver with triple-ganged iron-cored tuning. One H.F. stage is employed, a triode detector, a driver valve and Class B output. A permanent magnet moving-coil speaker is built into the set and a continually variable pre-driver tone control is used. The power output is two watts.

The "Cambridge" A.C. Two is a two-valve A.C. set with an output of about 2 1/2 watts, and the quality of reproduction from the energizing moving-coil speaker fed from a Catkin pentode is of a high order. A special single Ferrocart coil is used, which gives a high degree of selectivity, especially as an H.F. pentode is employed as a power grid detector.

The "C.A.C." Pentagrid Superhet. A four-valve superheterodyne of the most modern technique. A Pentagrid converter is used as a single valve frequency changer and a variable-mu pentode is to be found in the I.F. stage, after which follows a double diode pentode second detector, giving straight line automatic volume control. The output stage is a Catkin pentode.

A gramophone amplifier, giving six watts undistorted output. There is provision for the use of two energized matched speakers, the fields of which act as smoothing chokes.

EASTICK & SONS, 118, Bunhill Row, E.C.1. Stand No. T.12.

IN addition to other lines already mentioned, Messrs. Eastick will be showing the special short-wave converters and modulated oscillator. The converters are available for mains receivers or battery receivers, and in addition may be obtained with cabinet complete or as a chassis for addition to an existing equipment. The modulated oscillator is of special interest, although it has a specialized application. It generates oscillations which may be tuned to any frequency, and in addition permits of the superimposition upon the oscillations of music or speech. The coils supplied with the oscillator cover the 200-600 and 1,000 to 2,000 metre wave-bands. A very ingenious use of the device is for the purpose of reproducing gramophone records. For this purpose the records are played and the output from the pick-up fed to the modulating circuit of the oscillator, after which the broadcast receiver is used to pick up the signals and reproduce them in exactly the same manner as the broadcast programmes are received. The use of this device enables scratch to be eliminated to all intents and purposes.



The new small model of the Avometer known as the Avominor. This gives many different readings with great accuracy and is a most satisfactory instrument.

battery receiver incorporating a single Ferrocart coil. The absence of a ganged condenser and ganged coils ensures an inexpensive equipment, although the performance meets the demand of listeners in nearly every locality. There is a continuously variable tone control. The circuit comprises a triode detector with reaction, a driver valve, Class B output valve matched to a permanent magnet moving-coil speaker. Price, £6 17s. 6d. complete.



A very useful public address apparatus. The microphone may be switched in to take the place of the pick-up shown on the gramophone amplifier unit. The makers are Birmingham Sound Reproducers Ltd.



The Avodaptor which enables readings to be taken whilst the valve is working in a set. The plug on the left is inserted in a valveholder in the set in place of the valve and the valve plugged into the adaptor. It is used in conjunction with the Avominor above.

INSURE YOUR VALVES

against 'blow-outs' with a

MILLGATE

Safety-fuse

BATTERY

Millgate batteries, manufactured by expert British labour from the finest of raw materials and fully guaranteed, now incorporate a novel Safety Fuse which not only protects the set, but also prevents short circuit to the battery itself, which cannot be accomplished by a fuse in the set.



Ask your dealer for the "Millgate SAFETY FUSE Battery."

CHORLMET RADIO ELECTRIC LTD.
Stal House, Judd Street, King's Cross, London, W.C.1

60 VOLT
5'6
120 VOLT
11'-

See the Millgate Safety Fuse Battery at Radiolympia Stand No. 215

Use **GLAZITE** Connecting Wire For Perfect Circuit Wiring

The popularity of Glazite Connecting Wire is attributable to the superior craftsmanship and superb raw materials used in its manufacture.

Glazite Connecting Wire is damp proof and is made in six colours at sixpence per ten foot coil by a firm with over 50 years' manufacturing experience.

BEWARE OF IMITATIONS!

THE LONDON ELECTRIC WIRE COMPANY AND SMITHS, LIMITED
CHURCH ROAD LEYTON LONDON E.10

PEAK BRITISH MADE CONDENSERS

Because of their sterling service under the most exacting conditions, **PEAK** Condensers are regularly specified by the designers of sets described in the leading journals. Their performance and appearance justify the confidence shown in their selection for use in "THE AUTO-B THREE"

These are the chosen condensers —

- One 8 mfd. Electrolytic, Type "W" 4/9
- Two 1 mfd. Condensers, Type "A.4" 2/2 each
- Two .01 mfd. Condensers, Type "M." 1/- each

WILBURN & CO.,
Wheatshale House, Carmelite Street, London, E.C.4.
Tele: Central 6810.

Northern Agents:
W. Andrew Bryce & Co., Tile St., Bury.

Write for New Complete illustrated Price List "B."

this OSBORN CABINET

SPECIFIED FOR
F. J. CAMM'S 1934 SUPER-SET

Another proof of the popularity of Osborn Cabinets—this new Ultra-Modern radio cabinet has been specified for F. J. Camm's 1934 Super-Set. Size 25ins. wide, 11ins. deep, 11ins. high. Obtainable in Oak, Mahogany or Walnut.

WRITE FOR CATALOGUE.

CHAS. A. OSBORN, Dept. P. Regent Works, Arlington St., New North Rd., London, N.1. 'Phone: Clerkenwell 5095. Showrooms: 21, Essex Rd., Islington, N.1. 'Phone: Clerkenwell 5634.

PRICES:
Machined Ready to Assemble, Kit of Parts, Oak 12/6, Mahogany 15/-. Walnut 15/-. Assembled Ready to Polish, Oak 17/-. Mahogany 21/0, Walnut 21/0, Assembled and Polished, Oak 21/2, Mahogany 21/5, Walnut 21/5.0
ALL MODELS CARRIAGE PAID.

BATTERY CHARGERS

For A.C. Mains
THE SENIOR TWO TYPE N.P. (illustrated) will charge one to thirty batteries at once. 15-20 volts at 3 amps. Sliding Variable Resistance from small amperage—Westinghouse Metal Rectifiers. For H.T. and L.T. Cells.

Trade Price 105/-
Complete delivered.

Other models up to £40
Eliminators from 57/6
Send for 1933 trade list.

NASH PRODUCTS LTD.
STEEHFORD, BIRMINGHAM (9)

THE HEART OF THE SET—362 VALVES

DIRECT BY POST FROM THE MAKERS AT 50% SAVING.

362 Valves are British throughout. Non-Microphonic and Fully Guaranteed. Equal to any—better than most! See them at

OLYMPIA, STAND No. 226

3/6

R.C., H.F., L.F., or Det., 3/6. Power, 4/- Super-Power, 4/6. S.G. or Var-Mu., 7/6. Pentode type, 10/-. All in 2v., 4v., or 6v. Metallised 3d. extra.

"CLASS B" 2-v. filament, 9/- 7-pin. base,
A.C. MAINS VALVES, 4-volt, 1 amp. (Indirectly Heated). Prices 7/6 to 12/6. Full List post free.

Send with order. Cheques and P.O.'s must be crossed and made payable to—
THE 362 RADIO VALVE Co., Ltd. (Dept. W. 14), Stoneham Road, London, E.5.

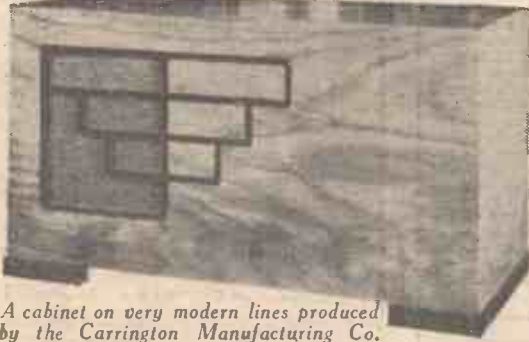

A cabinet on very modern lines produced by the Carrington Manufacturing Co. This model is the "Daventry," and is in walnut veneer throughout. It costs 36s.

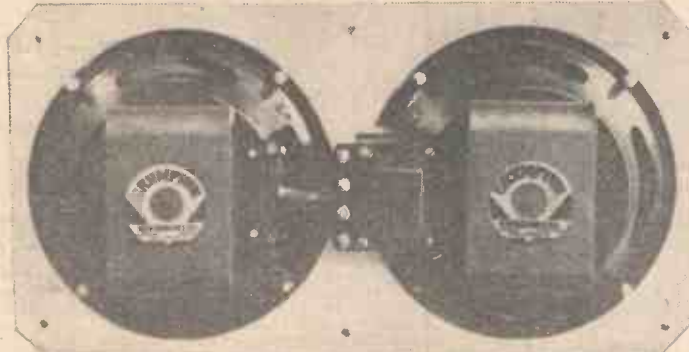

A balanced pair of Grampian speakers. These are the new Midgets which we have already mentioned and they have an overall depth of only approximately 3ins.

GENERAL ELECTRIC COMPANY, LTD., Magnet House, Kingsway, W.C.2. Stand No. 90.

SOME interesting new receivers will be seen on the G.E.C.

stand and these are as follows:—An inexpensive 3-valve battery receiver, fitted with a moving-coil loud-speaker. Self-contained batteries. Walnut finish cabinet. A popular priced table model 5-valve superhet, incorporating up-to-date principles for A.C. mains. Tone control—speaker switching—stations by name. Handsome grained walnut cabinet. Similar to No. 2 for D.C. mains. A console 5-valve superhet for A.C. mains, fitted with large moving-coil speaker. A 6-valve superhet battery model, with "Class B" output. An 8-valve superhet for A.C. mains—a deluxe table model, incorporating A.V.C., muting, and an attractive station index. A console 8-valve superhet for A.C. mains, on lines similar to No. 6. A radiogram 5-valve

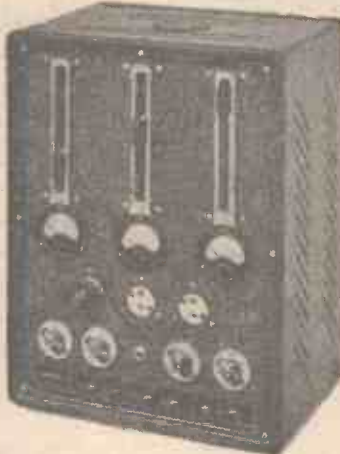
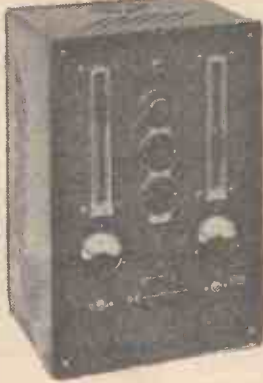

Manufactured by the Lancashire Dynamo and Crypto Ltd., the apparatus on the left is Karadio and on the right a Crypto Charger. The neat finish of these instruments may be seen from the illustrations.

balanced response curves, so that the overall frequency response which is obtainable is remarkably uniform over a very large range. The depth of these small units is 3ins., and the overall size is only 13½ins. by 7½ins. Several further new models will also be seen on this stand.

HALFORD RADIO, LTD., 39, Sackville St., W.1. Stand No. 49.

ALL the firm's standard models continue to be listed, but at considerably reduced prices. Their 7-8 valve superhet chassis, hitherto sold at 28 guineas, is now 25 guineas and will embody A.V.C. and other new features. Receivers and radiograms are correspondingly reduced. Their new model is a 5-valve superhet. The chassis price of this is 17 guineas and it is being embodied in a series of receivers and radiograms ranging in price from 18 guineas (a table model receiver) to 40 guineas for the Autoradiogram. The firm are introducing a series of 7 and 10-valve all-wave receivers and radiograms costing between 30 guineas for a 7-valve long, medium and short-wave receiver to 85 guineas for a 10-valve Autoradiogram. Halford Radio are specializing in short-wave receivers and will be showing five models especially designed for the overseas market.



One of the new Osborn Radio-gramophone cabinets. For the benefit of those who prefer it, Osborn cabinets may be obtained in an unassembled but completely machined condition ready for home assembly.

superhet (floor model) for A.C. mains. The Osram Thirty-Three Kit Constructor's battery-operated set.

Among the loud-speakers to be shown are a magnetic loud-speaker in bakelite cabinet, and in chassis form only; a "Junior" permanent magnet loud-speaker, in both cabinet and chassis form; and a "Senior," permanent magnet moving-coil loud-speaker in both cabinet and chassis form.

An array of equipment suitable for public address, broadcast call systems, dance halls, hotels, sports meetings, hospital installations, and the like, will also be staged, while a selection from a wide range of components and accessories will also be on view.

Three new battery valves are also promised in time for the Exhibition. These include a straight screen grid with a non-microphonic construction; a variable-mu screen grid of the short grid base type; a driver and a Class B valve.

GRAMPIAN REPRODUCERS, LTD., Station Avenue, Kew Gardens, Surrey. Stand No. 23.

THE two most recent items of importance emanating from Grampian Reproducers are the Midget speakers and the Midget dual units. The former is obtainable in permanent magnet or energized types and has a depth of only 3½in. The overall unit size is 6½ins. and the handling capacity is 2.5 watts. The price is 25s. for the energized type and 32s. 6d. for the P.M. type. The dual units consist of two of these Midgets, with carefully

EASY TERMS WITH PROMPT SERVICE

WE ARE "BLUE SPOT" SPECIALISTS.



THE NEW BLUE SPOT LOUD-SPEAKER UNITS AND PICK-UP

The new Blue Spot range represents in our opinion, the finest value in loudspeaker units available. The Pick-up has been further improved and the price reduced. New Season's Models delivered from stock.

NEW BLUE SPOT 99 PM MOVING-COIL UNIT, with transformer. Cash price £2/19/8, or 5/- with order and 11 monthly payments of 5/6.

NEW BLUE SPOT 45 PM MOVING-COIL UNIT, with transformer. Cash price £2/5/-, or 5/- with order and 9 monthly payments of 5/-.

BLUE SPOT 66R UNIT, with large cone and chassis. (The most sensitive balanced armature unit made.) Cash price now £1/18/-, or 5/3 with order and 7 monthly payments of 5/3.

NEW BLUE SPOT 62 PM MOVING-COIL UNIT, including transformer, built into high-grade cabinet. Cash price £3/7/6, or 6/3 with order and 11 monthly payments of 6/3.

NEW BLUE SPOT PICK-UP, including built-in volume control. Cash price £1/15/-, or 5/- with order and 6 monthly payments of 5/8.

ALL OTHER BLUE SPOT MODELS SUPPLIED ON SIMILAR TERMS.

ELIMINATORS

These M.P.R. Eliminators are of sound design and construction and are fully guaranteed. Please note the prices.

M.P.R. ELIMINATOR, Model A.C.3. Output 28 milliamps, 3 H.T. tappings. Cash price £3/1/-, or 6/- with order and 10 monthly payments of 6/-.

M.P.R. ELIMINATOR, Model A.C.2. Output 22 milliamps, 3 H.T. tappings. Cash price £2/10/-, or 5/- with order and 10 monthly payments of 5/-.

M.P.R. D.C. ELIMINATOR, Model D.C.2. Output 25 milliamps, 3 H.T. tappings. Cash price £1/10/-, or 5/- with order and 5 monthly payments of 5/7.

"CLASS B" UNITS

FERRANTI "CLASS B" SPEAKER AMPLIFIER, consisting of moving-coil unit, "Class B" amplifier and valve. Beautifully made. Cash price £4/4/-, or 10/- with order and 11 monthly payments of 7/6.

MULTITONE "CLASS B" CONVERTER, including Osborn valve. This unit, plugged into your set, will give you all-mains volume and quality of reproduction. Ready for immediate use. Cash price £2/11/8, or 7/- with order and 12 monthly payments of 5/-.

Interesting descriptive leaflets of all the above will be sent on request.

All goods carriage paid to your door. To avoid delay, will customers kindly send first payment with order?

We can supply practically all radio goods shown at Olympia on easy payment terms. Quotation will be sent on request.

Estd. 1925 THE **LONDON RADIO SUPPLY COMPANY** Phone: NATIONAL 1977
11, OAT LANE, NOBLE STREET, LONDON, E.C.2



A very complete and useful valve and set tester. The service man or the keen experimenter will find this the most useful piece of apparatus. It is made by the Radiolab Co.

HEYBERD & CO., F. C., 10, Finsbury Street, E.C.2. Stand No 16.

AN additional mains transformer will be included in the exhibits on this stand, and will take the form of a substantial model especially designed for use in conjunction with the Westinghouse H.T. 12 rectifier. The output from the transformer consists of two windings, one of 110 and 140 volts for the rectifier, and one 4 volt 4 amp L.T. supply. The price is 22s. 6d. A similar model will probably be introduced without the L.T. winding. The price will be 14s.

LANCASHIRE DYNAMO AND CRYPTO, LTD., 94, Petty France, S.W.1. Stand No. 50.

A MOST interesting programme is promised by this firm, and undoubtedly "Karadio" will prove the greatest attraction.

This is an entirely new type of charger and is, we believe, the only one of its kind at present on the market. It has been specially designed to enable motor car starter batteries and also radio batteries to be charged from the same unit. It will charge 2, 4, 6 or 12 volt accumulators irrespective of size. It adjusts itself automatically to the voltage of the battery charged and needs no attention whatsoever. It operates on A.C. mains and uses



The neat and efficient Di-feed transformer manufactured by Radio Instruments Ltd.

very little current. It is small, strongly made and compact and can easily be fixed to the wall of a garage or other suitable position. It is particularly useful for all motor users, particularly those who, like doctors, travellers and business men, make very heavy demands on their starter batteries. By means of the special attachment supplied for fixing to the steering column, it is an extremely simple matter to put the starter battery on charge. "Karadio" can then be safely left to charge the battery overnight and thus ensure an easy start in the morning.

"Karadio" will be shown for the first time on the L. D. C. stand and will be on sale, price £4, including all necessary cable and steering column attachment, etc., and complete with adaptor ready for plugging into the nearest electric point.

In addition on this stand will be seen valve rectifier battery chargers and the "Crypto" constant potential battery chargers.



Smiths have incorporated a novel feature on this accumulator. The side is finished with a matt surface on which charging dates and other details may readily be entered in pencil.

PAGE CAR RADIO, 55, Windsor House, Victoria Street, S.W.1. Stand No. 52a.

IN addition to Special Plug Suppressors and other apparatus which has been found necessary in connection with car radio, some interesting car receivers will be seen on this stand. They include:—

Type "A" Car Radio Set. An ambitious 5-valve superhet, housed in a steel case for sinking into the floorboards. There is a highly efficient H.F. stage and the overall sensitivity reaches the remarkable figure of 3 microvolts. Automatic volume control is included and unbreakable valves are used throughout (Catkins). Steering column remote control of tuning, volume, waveband changing and on-off (master switch and key) is arranged. A separate generator is required.

Type "B" Car Radio Set. A straight 3-valve circuit, giving a highly satisfactory all-round performance.

Type "C" Car Radio Set. A "Baby" 2-valve set using bi-grid valves in an inverted circuit. The car accumulator (12-volts) provides H.T., L.T. and bias. Phone reception.

PORTADYNE RADIO, Portadyne Works, Gorst Road, North Acton, N.W.10. Stand No. 75.

SOME interesting receivers will be seen on this Stand and they include the P.B.5—a portable receiver employing S.G. power grid detector and L.F. stage, coupled to a Class B output stage. A moving-coil permanent magnet speaker is fitted, and the complete receiver costs £13 13s. inclusive of valves, batteries, etc. The Portadyne S/A.C. receiver is a superhet fitted with automatic volume control and energized moving-coil loud speaker. The price is £15 15s. Other interesting receivers will also attract attention.

RADIOLAB MANUFACTURING COMPANY, Sandridge, St. Albans. Stand No. 206.

FULL details are now available regarding the exhibits of the Radiolab Company, and these comprise a most interesting range of Set Testers. At £12 12s. you can purchase a complete Valve and Set Tester which measures the A.C. and D.C. voltages in a set without the necessity of disconnecting a single wire, and with no possibility of overloading the meter. The latter is of the 1,000 ohms per volt type, guaranteed to British engineering standards first grade accuracy. Buttons and terminals are so arranged that any desired reading may speedily be obtained. In addition, a space is



One of the Silver Ghost range of loud speakers made by Lamplugh Radio.

provided in the carrying case for tools, spare valves, etc. A valveholder on the panel is provided with connections, so that external batteries may be connected up to give a complete check of all the valve characteristics. It is a most useful instrument for the service engineer or keen experimenter.

RONNIE ENGINEERING, Crowdon Road, S.W.9. Stand No. 27.

SOME very interesting novelties will be seen on this Stand, including the new Ronnie Mineral Compound, a new Earth Tube and sundry small, interesting components for the home constructor.

Ronnie Mineral Compound represents the discovery of a combination of four minerals which, when blended together by a special process produce a hygroscopic action in all soils. When the compound attains a hydrous condition a deliquescent substance of exceptionally high conductivity is produced which always retains the hygroscopic action of the original crystals. This liquid can only be dried under intense artificial heat, it percolates the immediate area surrounding any present earth plate or tube so creating a permanent, ever damp, low-resistance earthing system in contact with the existing metal. It is packed in special airtight, waterproof containers, and costs 1s. 3d.

The Earth Tube consists of a heavy gauge copper tube, perforated; a solid gunmetal ferrule at one



In addition to the smaller home constructor's mains apparatus, Messrs. Heyberd can supply charging apparatus of which the above is a specimen.



Among the new receivers introduced this year by Slekton Products Ltd., is the above all-electric Twin for A.C. mains.



The new type of reaction condenser manufactured by Messrs. Telsen excludes dust and dirt from the vanes. As may be seen, the sides are now moulded and the component now presents a very neat and workmanlike appearance.

end and a heavy gunmetal casting shaped like a funnel at the other; this, the "Condensing Vent," is left above ground. All joints are strongly metalled. Its scientific construction ensures that the tube itself offers those currents the "waste products" of radio, an exceptionally easy path to earth, which is vitally important for good reception. The tube is filled with Ronnic new invention Mineral Compound, which creates a perfect low resistance connection between the metal and the soil. Two models are available: No. 1, standard finish, 5s.; No. 2, plated cadmium and nickel, 6s.

SIX-SIXTY RADIO

CO., LTD., 17, Rathbone Place, W.1. Stand No. 95.

The new valves which will be introduced in time for the Exhibition include the 220B, the H.P.1.A.C. and the I.H.60/250. The 220B is a low consumption high efficiency valve of the Class B type, delivering an output of approximately 1.25 watts. It costs 14s. The



One of the new Utility dials which possesses many new features.

H.P.1 A.C. is an indirectly heated H.F. pentode. Where the receiver design permits, this type of valve should replace ordinary 8.G. stages,

when greatly improved results will result. The cost is 17s. 6d. The I.H.60/250 is an indirectly heated receiver delivering an output of 60 milliamperes with an applied voltage of 250 volts r.m.s. It will cost 12s. 6d.

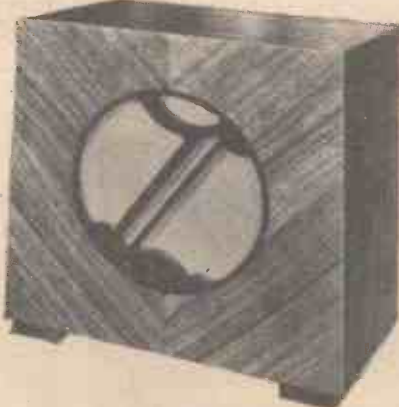

The P.M.4.—A loud-speaker manufactured by W.B. may be obtained in the attractive walnut cabinet shown above. The combination of a sensitive loud-speaker with a modern cabinet of this type results in a very useful piece of apparatus.



**ENTHUSIASTS!
-TEST THEM FOR
YOURSELVES at**

**STAND
42**

Listening in to Magnavox Speakers on Stand 42.



(Shown above) Magnavox Standard Permanent Magnet Model Type 254 supplied in sealed dust-proof bag and fitted complete with universal transformer.

Price £1 17s. 6d.

If you don't already own a Magnavox speaker or one of the many kinds of sets in which they are standard equipment now's your chance to hear loud-speaker reproduction at its best by Magnavox. You will at once understand why manufacturers fit them, why Radio Journals recommend them and why enthusiastic constructors buy them.

A complete range of mains energised models, Dual-compensated pairs, and Permanent Magnet models can be seen and heard at Stand 42.

AND AMONGST OTHER THINGS

See the new Benjamin range of valve-holders, switches and transformers and the many, many famous circuits in which they have been specified and successfully used.



(Illustrated) the Benjamin Driver Transformer for use with all types of circuits and valves. Price 10s. 6d.

All the above speakers and components are British made throughout by

THE BENJAMIN ELECTRIC LTD., TARIFF ROAD, TOTTENHAM, N.17.



Mains SPECIALISTS invite your inspection

We shall be happy to meet you on the Heyberd Stand—Number 16. We want to show you the result of eleven years' specialising in the production of first-class mains apparatus. You will appreciate the sound design and attention to detail which characterises the whole range of Mains Units and Components. Come and examine for yourself the interior of a standard Heyberd Mains Unit—when you perceive the sturdy components and the wonderful smoothing circuits you will understand the confidence that prompts us to give a Three Years Guarantee!

Heyberd are always first in designing New Transformers for use with New Rectifiers. The following models have been designed for use with the latest Westinghouse Metal Rectifiers:—

NEW HEYBERD TRANSFORMERS

MODEL W.40 (HT.12 Rectifier)—Rectified Outputs: 175v. 25 ma. or 200v. 30 ma. Price **14/-**
 MODEL W.41 (HT.12 Rectifier). Similar H.T. Outputs to the W.40, but with a L.T. A.C. Supply of 2+2v. 4 amps. Price **22/6**
 MODEL W.42 (HT.13 Rectifier) Half-wave for Class "B." Secondary Tappings: 150v. 40 ma. Price **17/6**

There are many new transformers in addition to the above. Other products to be exhibited at the Heyberd Stand include: Portable Amplifiers, Battery Chargers, Mains Unit Kits and a varied selection of Chokes, Condensers, Resistances, etc. Let us show you the new features!

OLYMPIA — STAND 16



POST COUPON TODAY

Please send me your 1934 Handbook—entirely revised and packed with new information and circuit diagrams. I enclose 3d. stamps.

Mr.

Address

..... Prac.

To F. C. HEYBERD & CO.,
 10, FINSBURY STREET, LONDON, E.C.2
 (One minute from Moorgate Und. Station)



Telsen have also introduced some new receivers this season and the above model is the Air Marshall. This is a three-valve supplied complete with valves, batteries, and speaker (moving iron or moving coil). With moving iron speaker it costs £4 17s. 6d. and with moving coil £5 5s. 0d.

TANNOY PRODUCTS, Dalton Street, W. Norwood, S.E.27. Stand No. 103.

THIS firm's exhibits will include the following amplifiers:—

Type G.A.60, which is particularly suitable for transportable purposes; available for A.C. or D.C. The output consists of a 60 Watt D.A.60 valve, providing an undistorted output of 15/16 Watts A.C.

Type G.A.120 has twin turntables and pickups, fader controls and switching and can also be provided with radio. Two D.A.60 valves in the output give an anode dissipation of 120 watts and an undistorted output of 30/35 watts A.C.

Type R.G.25 is a radio-gramophone suitable for restaurants, small dance halls, etc. An efficient S.G. variable-mu H.F. am-

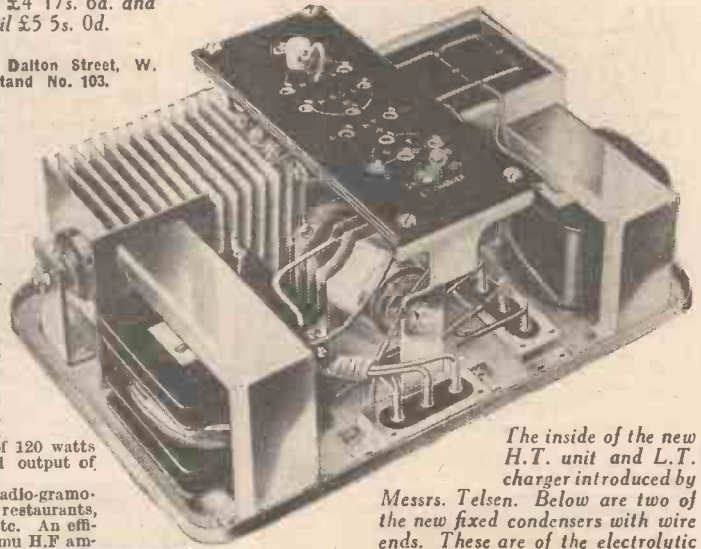

The inside of the new H.T. unit and L.T. charger introduced by Messrs. Telsen. Below are two of the new fixed condensers with wire ends. These are of the electrolytic type, and are easily suspended in the wiring of the receiver.

plifier, the L.F. comprising 25 watt push-pull output. The popular traders' equipment, the G.A.25, will also be shown.

As usual, Tannoy has produced a super Radiogramophone for the Exhibition. The cabinet is in figured oak, beautifully finished and well worthy of the superlative set it contains. This is made in two parts, each a complete chassis, with its own H.T. supply. The first chassis consists of a 7-valve Super-heterodyne with Westinghouse rectifier. The latest type pentode valves are used in the signal, H.F. and intermediate frequency stages and also as first detector and special stable oscillator. A really effective and perfectly silent automatic volume control

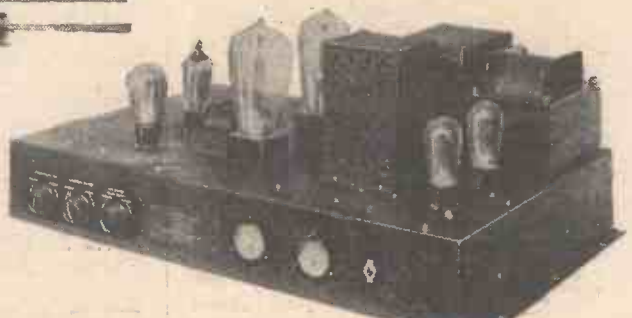

For Public Address work or for similar high-power relay of music, the above 120 watt amplifier, manufactured by Birmingham Sound Reproducers Ltd., will be found a most efficient piece of apparatus.

ensures a complete absence of background and atmospheric noises between stations. The output from the L.F. stage, which is matched to a standard output of 600 ohms is coupled to a second chassis consisting of an L.F. amplifier, which in the two standard models has an output stage with an anode dissipation of 25 watts and 60 watts respectively. By fixing these output and input impedances it is possible to couple the receivers to any standard amplifier chassis providing an output of 25 watts to 1,000 watts without alteration to meet special requirements.

To ensure silent switching the switch is made to break the output circuit, and a perfect adjustment of volume is effected by means of a specially graduated volume control. Automatic tone correction for high and low signal levels is incorporated and a carefully matched energised moving coil speaker, in an anti-resonant chamber completes a really de luxe set in which no effort has been spared to provide a receiver built to an ideal, and not to a price.

A comprehensive range of Tannoy light and heavy duty loud-speakers and micro-phones will also be on show.

THE 362 RADIO VALVE CO., LTD., Stoneham Works, Stoneham Road, E.8. Stand No. 214.

A FULL range of battery valves will be seen on this stand, as well as a special exhibition of valves and components for Class B. A range of valves for A.C. mains will also be released and these are of new and interesting design. A double cathode is employed resulting in longer life. The "Toledo" metal battery valves will also be exhibited for the first time. These valves are practically unbreakable and have many other advantages over the older type.

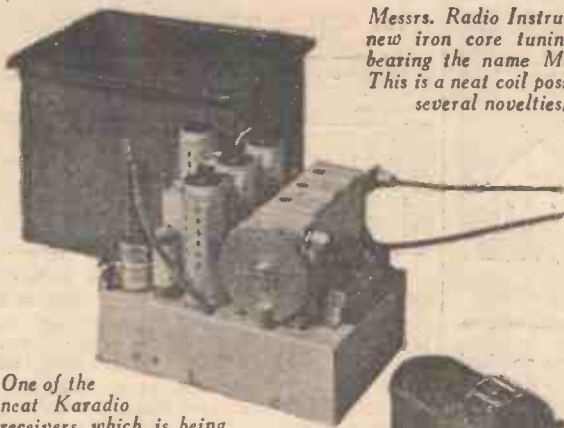

Messrs. Radio Instruments' new iron core tuning coil bearing the name Micron. This is a neat coil possessing several novelties.

One of the neat Karadio receivers which is being introduced by Mr. Page. It will be noted how compact the receiver has been made and it should also be noted that metallized valves are fitted.

TELSEN ELECTRIC CO., LTD., Thomas Street, Aston, Birmingham. Stand No. 88

AMONG the many new items on this stand will be the Class B Output Transformer giving ratios of 35:1, 50:1 and 65:1. This enables correct matching to be carried out, and the transformer costs 8s. 6d. An output Choke is also available for those



The Lampex Radio Company's super battery set. This employs a Class B output stage and a highly efficient loud-speaker, and represents very good value.

who prefer this method of coupling the loud-speaker, and this provides ratios of 1:1, 1.3:1, 2:1 and 2.6:1. This also costs 8s. 6d. Two Driver Transformers will be seen; one provides a ratio of 1:1 and the other 1.5:1 and the price is the same as for the previous Class B components. An interesting H.T. Unit and L.T. Charger for A.C. Mains will attract much attention,



One of Messrs. H. M. Clarke & Co.'s new mains units.



as it provides an output of 28 millamps at 150 volts, with separate maximum, detector and S.G.appings. Very generous smoothing ensures the absence of hum, and the charger delivers 5 amps at 2, 4 or 6 volts. The price is £4 17s. 6d. Other new components include an All-wave Screened Binocular H.F. Choke at 4s. 6d.; Differential Condensers at 2s.; Short-Wave screened choke at 3s.; Resistors with wire ends at 1s. per watt, and a 7-pin solid type valveholder at 1s. 6d.

VARLEY (OLIVER PELL CONTROL), LTD., 103, Kingsway, W.G.2. Stand No. 85

THE additions to the range of Varley products include a special automatic volume control unit at



This is the new Radio Instruments' Class B four-valve Madrigal receiver, which costs £15 15s. including royalties. The tuning scale is calibrated in wavelengths.

15s. 6d.; a special compensating R.C.C. unit at 11s. 6d. and three new items for mains apparatus. The new power choke is of the 30 henry type, carrying up to 150 mA., and having a D.C. resistance of 150 ohms. A special multi-volt transformer for Westinghouse metal rectification delivers an output of 150 volts 300 mA.; 4 volts 2 amps C.T. and 4 volts 6 amps O.T. The remaining model is also a transformer for the metal rectifier and delivers an output of 250 to 300 volts at 550 mA., and has two 4 volt 5 amp. windings provided with centre taps. This model costs 55s.

WHITELEY ELECTRICAL RADIO CO., LTD., Radio Works, Victoria Street, Mansfield, Notts. Stands 128 and 129.

FULL details are now available regarding the Microlode, the new W.B. loud-speaker. The base of the speaker (which resembles the well-known P.M.4) is provided with a special tapped transformer. The tapping points are taken to a special semi-circular selector switch, and on the rear of the chassis are two arms and three terminals. The two outer terminals are intended for connection to the loud-speaker terminals on the receiver, and then the two switch arms may be rotated to provide seventeen different ratios. In addition, when the centre terminal is connected in circuit four alternative ratios suitable for Class B, Q.P.-P. or Push-pull working are obtainable.

NEW RADIO on the easiest of

Easy Terms

Choose your NEW RADIO at OLYMPIA, or from any advertisement in "Practical Wireless." Send us your requirements and we will quote you the Easiest of

Terms per return. WE DEAL WITH YOU DIRECT. No Third Party Finance Company, thereby ensuring strictest privacy. Immediate delivery from Stock.

JUST RELEASED

LISSEN ALL-WAVE SKYSCRAPER FOUR CHASSIS MODEL. Complete kit comprising all components, including set of Lissen valves. Cash or C.O.D. Carriage Paid. £5/12/6. Balance in 11 monthly payments of 10/3. With 10/3 order

LISSEN ALL-ELECTRIC SKYSCRAPER THREE, complete with 4 valves and constructional chart in sealed Lissen carton. Cash or C.O.D. Carriage Paid. £7/19/6. Balance in 11 monthly payments of 14/6. With 14/6 order

LISSEN SKYSCRAPER THREE (Battery Model), complete with 3 valves and constructional chart in sealed Lissen carton. Cash or C.O.D. Carriage Paid. £4/9/6. Balance in 11 monthly payments of 8/3. With 8/3 order

NEW FERRANTI "CLASS B" SUPER POWER CONVERTOR. Instantly converts your present set to Class "B." Complete with valve. Ready assembled. Cash or C.O.D. Carriage Paid. 63/-. Balance in 11 monthly payments of 5/9. With 5/9 order

COSSOR MODEL 341. S.G., Detector and Pentode. Complete with cabinet and balanced armature speaker. Cash or C.O.D. Carriage Paid. £6/7/6. Balance in 11 monthly payments of 11/9. With 11/9 order

ATLAS C.A.25 for Mains, Class "B" and Q.P.P., fourappings. 60/80, 50/90, 120, 150, 25 m.a. Cash or C.O.D. Carriage Paid. £2/19/6. Balance in 11 monthly payments of 5/6. With 5/6 order

W.B. TYPE P.M.4A MICROLODE PERMANENT MAGNET MOVING-COIL SPEAKER with input transformer. Cash or C.O.D. Carriage Paid. £2/2/0. Balance in 7 monthly payments of 5/9. With 5/9 order

PETO-SCOTT MOVING-COIL P.M. SPEAKER with multi-ratio input transformer for power or pentode. Cash or C.O.D. Carriage Paid. 15/-. Balance in 2 monthly payments of 5/6. With 5/6 order

BLUE SPOT 99 P.M. PERMANENT MAGNET MOVING-COIL SPEAKER, complete with tapped input transformer. Cash or C.O.D. Carriage Paid. £2/19/6. Balance in 11 monthly payments of 5/6. With 5/6 order

CELESTION P.P.M.19 PERMANENT MAGNET MOVING-COIL SPEAKER, complete with tapped input transformer. Cash or C.O.D. Carriage Paid. £2/7/6. Balance in 8 monthly payments of 6/3. With 6/3 order

ROLA F6 P.M. PERMANENT MAGNET MOVING-COIL SPEAKER, with input transformer. Cash or C.O.D. Carriage Paid. £2/9/6. Balance in 8 monthly payments of 6/-. With 6/- order

GARRARD MODEL 202A. 12in. Turntable, A.C. Mains. Cash or C.O.D. Carriage Paid. £2/10/0. Balance in 8 monthly payments of 6/-. With 6/- order

To EST. 1924 NEW TIMES SALES CO. 56, Ludgate Hill, London, E.C.4.

Please send me..... for which I enclose £ : s. d. Cash Deposit

Name.....

Address.....

.....Pr. W. 10/8/33.

THE first things we must specify, when setting about the design of an electrically excited field magnet for an M.-C. speaker, are the width (i.e., radial dimension) of the gap, and the field density B. So far as B is concerned, unless it is desired to produce something exceptional in performance and sensitivity, B may be taken as 7,000 lines per cm.². For a very high-class job the value may be taken as high as 10,000; beyond this it is very extravagant to go; a speaker designed in the Bell Laboratory is reported to have had a value of B=20,000, but this may be regarded as a *tour de force*. The gap width in a speaker for the ordinary user is commonly in the region of 1 mm.; a good rule is to make the gap 1 mm. per inch pole diameter—0.25 mm. This gives:—

Pole diameter.	Gap width.
3/4 in.=19 mm.	1 mm.=0.1 cm.
1 in.=25.4 mm.	1.25 mm.=0.125 cm.
1 1/4 in.=32 mm.	1.50 mm.=0.150 cm.
1 1/2 in.=38 mm.	1.75 mm.=0.175 cm.

These figures may be varied to suit the winding, but it is not a bad plan to adopt the appropriate gap width as tabulated, and select the gauge of wire and number of turns to suit, a final adjustment of the gap dimension may then be made to give the necessary clearances internal and external. (The internal clearance should be about .005 in. and the external clearance (over the winding), about .008 in. (Diametrical allowances, .01 and .016 respectively.)

The value of H in the gap (in air) is the same numerically as B, which we take as 7,000; therefore the gilberts required for the gap will be, gap width x 7,000. It being easier to follow a numerical example than symbolic expression, we shall take the gap to have a value 0.15 cm. (appropriate to a pole diameter 1 1/4 in. as in table). Therefore gilberts=7,000 x .15=1,050, and we know that ampere turns=.08 x gilberts=840 in the present example. This is the value of ampere turns required for the maintenance of the field in the gap. We must now add the value necessary to carry the field flux through the iron circuit. The simplest way of dealing with this is to postulate some definite value of H in the iron, or ampere



turns per inch (two ampere turns per inch of length is equal to one (H) gauss in strength), and then to design the iron circuit accordingly from the magnetization curve proper to the grade of iron used. Here are a few figures:—In cast iron, 100 ampere turns to the inch will carry B=6,600 lines per cm. In wrought iron or special magnet mild steel casting:—40 ampere turns per inch will carry 14,000 lines per cm.², or, 30 ampere turns per inch will carry 13,000 lines per cm.².

On these figures we may reject cast iron as an unsuitable material, and take the lower figure, namely 30 amp. turns per inch as having to be provided by the winding. In order to apply this with exactitude we should need to design the magnet core before we could calculate the amp. turns. To avoid this we shall assume that the length of the core circuit is 10 in. and allow 30 x 10 = 300 amp. turns as required. Thus the total amp. turns to be provided will be:—

For the air gap	.. 840 amp. turns.
For the iron circuit	. 300 amp. turns.
Total	.. 1,140 amp. turns.

In order to calculate the watts all we need do is to specify the *belt of copper*; given the area of copper provided to carry the 1,140 ampere turns it matters not the least whether it be one turn carrying 1,140 amps or 1,140 turns carrying one amp., the value for the purpose of field excitation will be the same, and the dissipation in watts will be the same.

The following table is useful:—

Density of current. Amps. per sq. in.	Watts dissipated per unit Vol. Amps. per cm. ² .	Per cu. in.	per c.c.
600	.93	.245	.0150
700	1.09	.335	.0205
800	1.25	.442	.0270
900	1.40	.620	.0380
1,000	1.55	.880	.0415
1,100	1.70	.820	.0500
1,200	1.86	.980	.0600

Thus if we prescribe a copper belt of sectional area=1 square inch and call the current density 1,200 amps. per square inch which from the above table gives .98 watts per cubic inch. If we take the accompanying illustration as a rough layout, the mean circumference is 7.5 in. and the power required 7.5 x .98=7.35 watts. The sectional area provided for the winding needs to be at least 50 per cent. greater than that to be allowed for copper.

We may consider this excessive; if so, we may prescribe a belt of copper of 2 square inch section, then we may take the current density=600 and, from the above table, watts dissipated per cubic inch=.245 and the power required is:—

$$7.5 \times .245 = 1.84 \text{ watts.}$$

This is unnecessarily low so that one of the intermediate current densities may be chosen. 1,000 amps. per square inch copper is a good average figure, giving a dissipation of copper loss=5 watts.

The correct gauge of copper to be employed is most simply calculated on the basis of *one turn only carrying the whole current*. Thus, if it be intended to work from a 12-volt battery, we will take the current in round numbers as 1,200 amps. then the resistance of the one turn will be .01 ohm, and since the length is 7.5 in.=19 cm. we have 1,900 cm. per ohm; from the tables we find this to correspond to 22 1/2 s.w.g. To avoid ordering a split gauge we take the nearest, namely 23 s.w.g. At 1,000 amp. turns per inch the belt has an area=1.2 square inches, which corresponds to 2,650 turns requiring 50,000 cm. length of wire having a resistance of 29 ohms. At 12 volts the current will be

(Continued on page 761)

THE WHOLE WORLD OVER!

(Continued from page 760)

PEARL & PEARL RADIO BARGAINS

Special H.P. Offer

1933 Lamplugh Silver Ghost Senior P.M. moving coil loudspeaker includes 3-ratio transformer to match any output valve. Hire-purchase terms for "Practical Wireless" readers—15/- down and 6 monthly payments of 2/9. Speaker 29/6 sent immediately on receipt of first payment of 15/-. No references. **Cash**

NEW AMPLION "SONNETTE"

The latest Amplion moving-coil speaker on view at the Show and specified for the "Practical Wireless" Auto-B Three described in this issue. .. 27/6

OLYMPIA 1933 SET BARGAIN 2 ONLY!

The famous Climax 1933 Table Radiogram, beautiful instrument, 3-valve single dial tuning, calibrated in wavelengths, moving-coil speaker suitable for A.C. mains. Special price to clear—9 Gns. two remaining in stock.

SEND YOUR ORDER NOW

K.B. A.C. "KOBRA"

Well-known "Kobra" 3-valve A.C. Receiver, moving-coil speaker, provision for mains aerial and pick-up. List price £11.18.6. .. **£5.15.0**

K.B. A.C. or D.C. "PUP"

Self-contained, simple, safe, trouble-free, the K.B. all-electric "Pup" is excellent and reliable. Mains-operated receiver for A.C. or D.C. mains. List price £7.10.0. **£3.12.6**

K.B. BATTERY "PUP"

includes speaker, valves, and batteries. Attractive cabinet, automatic grid bias and sockets for extra speaker. List price £4.10.0... .. **£2.3.6**

FAMOUS "SOVEREIGN JUPITER"

complete with Exide accumulator and Tungram valves. Self-contained speaker, chassis built Walnut cabinet. Usually £7.7.0. **£2.19.6** Marvellous bargain.

LISSEN PENTODE TRANS- PORTABLE

This famous Lissen portable is complete with 120-volt Battery, 9-volt G.B. Battery, 2-volt Accumulator and Lissen valves. Balanced armature speaker. Special bargain price **£2.19.6**

B.T.H. SYNCHRO BLUE MOTOR

The famous Synchro Blue Electric Gramo. Motor suitable for all A.C. 50 cycle mains, low current consumption, no interference with radio sets. Special purchase. List price 39/6. Hire-purchase terms for "Practical Wireless" readers 12/- down, 6 monthly payments of 2/6. No references required. **Cash 25/-**

The well-known Lincoln Stewart dual range shielded coils, 200-550 metres, 800-2,100 metres. **3/9** List price 6/6.

Limited number of Telsen Major Speaker chassis. This is a super bargain and is available while stock lasts. Usually 10/6... .. **3/3**

All Goods sent Carriage Paid.

PEARL & PEARL,
190, Bishopsgate, E.C.2.

0.41 amp. and the amp. turns = $2,650 \times .41 = 1,100$ and the watts dissipated (C^2R loss) = $.41 \times 12 = 4.9$ which shows that the use of 23 s.w.g. (.024 in. dia.) in place of the half-gauge size, may be justified.

A few words must be said as to the design of the iron circuit in the matter of sectional area. We have assumed that either wrought iron or a steel, such as Edgar Allen's special field magnet steel (which is nearly pure iron), is employed, and that the flux density B is approximately 13,000 lines per cm.², the question is what is the flux? The flux in the gap is the flux density in the gap multiplied by the gap area, which may be taken for the example under consideration = $8 \text{ cm.}^2 \times 7,000 = 56,000$. But there is also the leakage flux, and this we only know from experience: the total flux is about two and a half times the actual gap flux. The total flux is therefore taken as 140,000 lines and the iron area required is $140,000 = 10.8 \text{ cm.}^2$ or 1.7

13

square inches. The core components should be calculated with an area (section) at no point in the path of the circuit less than this. This cannot be done in the actual neck of the centre pole but that point does not need to carry the whole leakage field, part of the field has already leaked away; the neck should be kept up to as near the full pole diameter as possible; that is all that can be done beyond adding extra ampere turns in computing the total required. Allow for, say, 1 cm. length at a higher flux density. An addition of 50 to 100 amp. turns is usually an ample allowance.

PRACTICAL WIRELESS BLUEPRINT SERVICE

In order to meet the requirements of readers who prefer to work from a full-size blueprint when building up any of the "Practical Wireless" Receivers, we can now supply full-size Blueprint Wiring Diagrams of all the "Practical Wireless" receivers for 1s. each, post free. When ordering, quote the number. Copies of the paper containing descriptions of the particular receiver cost 4d. each. Address orders to: The Publisher, George Newnes, Ltd., 8-11, Southampton Street, Strand, W.C.2.

Blueprint. Receiver.
No.

1. Dolphin Straight Three.
2. Long Range Express Three.
3. Mains Express Three
4. Sonotone Four.
5. Bijou Three.
6. Argus Three.
7. Empire Short-Wave Three.
8. Solo Knob Three.
9. Midget Two (6d. only).
10. Selectone Battery Three.
11. Fury Four.
12. Featherweight Class B Four-valver.
13. Q.P.-P. Three-Four.
14. Alpha Q.P.-P. Three.
15. Ferrocact Q.P.-P. Hi-Mag Three.
16. Supersonic Six
17. Beta Universal Four.
18. A.C. Twin.
19. Selectone A.C. Radio-Gram Two.
20. A.C. Fury Four.
21. Radiopax Class B Four.
22. Three-Valve Push-Pull Detector. (6d. only).
23. Double Diode Triode Three.
24. Three-Star Nicore.
25. The D.C. Acc.
26. The Superset.
27. The Auto-B Three.
28. The All-Wave Two.

All these Blueprints are on sale at our Stand No. 8, ground floor, together with a full range of Wireless Handbooks.

LISTEN TO
AUSTRALIA
TO-NIGHT!



Short-wave reception now possible with most receivers!

Short-wave stations can be tuned in with practically every receiver when fitted with an Eelex Short-wave Converter. Programmes from Australia, America, and other distant countries are brought in without trouble even by those with little or no experience of Short-wave reception.

You can spend many thrilling hours tuning in distant countries, and your friends will be amazed at the remarkable increase in the range of your set.

with an EELEX Short-wave Convertor

Supplied for mains or battery receivers. Eelex Short-wave Convertors have a range between 15 and 60 metres and will receive, among others, the new B.B.C. Empire Short-wave Station.

Duplex Type for mains or battery sets £2 12s. 6d., valve extra.

Why not ask your dealer to demonstrate? Or send now for the Eelex Short-wave booklet number EE5 free.

J. J. EASTICK & SONS
EELEX HOUSE, 118 Bunhill Row
LONDON - - - - - E.C.1
Phone: Metropolitan 0314 (6 lines)

Is It Television's Aladdin's Lamp?

The

CATHODE RAY TUBE

By H. J. BARTON CHAPPLE, Wh.Sch., B.Sc. (Hons.), A.C.G.I., D.I.C., A.M.I.E.E.



FROM the earliest beginnings of the art, television has, for some unaccountable reason, been the victim of scares, and much harm has been done, some almost irreparable, by the flamboyant claims of irresponsible people. Some of these deal with so called new developments, while others are just as adamant in their statements that it is physically and practically impossible to perform certain television experiments or transmissions, while all the time the work is being undertaken and progress made.

While it is an admittedly difficult proposition to sift the wheat from the chaff, it really is incumbent upon those who put pen to paper for others to read, to be at least a little more careful in their superficial investigations and give the facts their true significance. One of the chief television devices which has formed the basis for fresh comments has been the cathode ray tube. The use of this tube for television purposes was first described in England in a patent taken out by Boris Rosing as far back as 1907. Subsequent to that date repeated efforts have been made to use it for television reception and transmission, especially by the anti-mechanical section of workers, with varying success.

Brief Working Details

In the space at my disposal I want to try and examine the position fairly and dispassionately, at least as far as present practice is concerned. My first acquaintance and use of a cathode ray tube of any sort for scientific work was in 1921, and I was quick to realize that here was an instrument which, for visual interpretation of certain phenomena, was second to none. I had to wait a period of ten years, however, before I was privileged to witness cathode ray television images of a quality comparable in any way to those portrayed by simple disc apparatus. This was by the Ardenne system, and it is common knowledge that Ardenne himself has devoted much of his time to the perfection of cathode ray tubes for scientific purposes.

Before referring to this system, however, let me deal briefly with the normal functioning of a cathode ray tube. In Fig. 1 will be seen a typical cathode ray tube similar to that used for television. First of all it must be understood that a "Cathode Ray" is really a form of electrical discharge which occurs when electricity at a very high potential is forced through a high degree of vacuum. It is quite

a simple matter to produce the rays through the medium of the filament emission of electrons, somewhat as in the case of an ordinary valve, and this ray or stream of electrons can be directed on to a special form of fluorescent screen, where their high impact velocity renders them visible.

Now, since this cathode ray

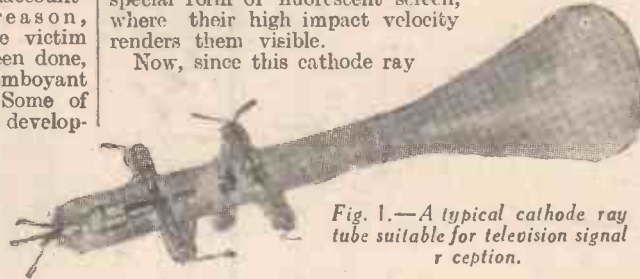

Fig. 1.—A typical cathode ray tube suitable for television signal reception.

beam is, as I have just mentioned, a stream of electrons, it has no weight and hence no inertia, and in consequence there is, in theory, no limit to the speed at which it can be caused to



Fig. 2.—An actual photograph of a television image using Ardenne's original cathode ray apparatus.

move about. Added to this we have the characteristic, common once more to valve working, that the ray stream may be moved or diverted from its path by either magnetic or electric means.

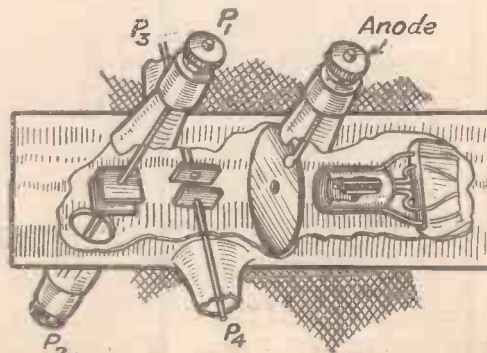

Fig. 3.—A cut-away showing the electrode system of an original Ardenne tube.

Problems Involved

The two prime problems, therefore, are to make the ray scan the fluorescent screen in a manner exactly similar to that of the exploring spot undergoing its pre-determined path at the transmitting end. Secondly, the intensity of the fluorescence seen on the screen must vary according to the degrees of light and shade of the resultant image.

Here then we have presented the pure essentials of an embryo cathode ray television receiver. The bulk of those workers who have and still are experimenting with cathode ray tubes, obtain the light and shade in their received image by keeping the scanning velocity constant while varying the number of electrons per unit area reaching the screen. In the scheme demonstrated some time ago by von Ardenne, he obtained his light and shade, not by a variation of the number of electrons passing through the unit cross-section of the electron beam, but by a method suggested by Rosing, namely a variation of the transverse velocities of the beam. In this way a slow transverse velocity brings about relatively intense fluorescence and accordingly gives a relatively brilliant element in the picture, while on the other hand a high velocity of scanning gives less response and consequently a dark element in the received picture.

The images produced in this way were extremely good, although the only item demonstrated at the time was a still from a film showing the heads and shoulders of two girls, and the illustration, Fig. 2, is an actual photograph of the image. Photographs of television images, however, never look nearly as good as the actual image, but it will enable readers to judge the nature of the subject, while in Fig. 3 is seen a "cut away" of the electrode system of the original von Ardenne cathode ray tube. The cathode or filament is seen surrounded by the Wehnelt cylinder—together with the anode and deflecting plates for controlling the electron stream.

Unfortunately this scheme had the disadvantage that only films could be transmitted and not living or inanimate objects, and furthermore the receiving apparatus could not be employed to receive any system of television transmitted by [mechanical] methods. This was a most serious drawback quite apart from any difficulties associated with the apparatus itself, but no doubt further developments will be made and we are sure to hear more of cathode rays.

Coming a little nearer home, what do we find? One or two manufacturers have been specializing in the production of

cathode ray tubes, notably Cossor's and Ediswan's, and in an admirable publication, just issued by H.M. Stationery Office and written by Watson Watt, Herd and Bainbridge-Bell, tribute is paid to the products of the first-named firm.

Three Methods

Examining the three methods of showing a television image, namely disc, mirror drum, and cathode ray, so far as they have been demonstrated under various conditions recently, one can draw the following conclusions.

First of all with the disc type of machine working in conjunction with a flat plate neon lamp (or alternatively the beehive or letter pattern), we have a very simple and relatively cheap form of apparatus capable of giving excellent definition when the disc itself is mechanically correct. Against this we have the limitation that the image is fairly small and can be seen by only three or four persons simultaneously. On the other hand, with the improvements which have been promised in connection with the light source, an image of greater brilliancy should be possible, and this will very materially overcome one of the prime objections to disc working.

Secondly we have the development of the mirror drum apparatus. This type of apparatus, when working in conjunction with the new type hermetically sealed Baird Grid Cell as the modulating medium of a beam of light from a projection lamp, produces a large and very bright image which can be seen by a room full of people simultaneously. For example, the machine now in use in one of the B.B.C. listening rooms gives an image 14 inches high by 6 inches wide, and this is seen in Fig. 4, but in order to obtain these added advantages we have the fact that the apparatus is considerably more expensive than the disc type.

Coming now to cathode ray tube working we find that it offers the advantage of having no moving parts, and is in consequence silent in operation, while the image can be seen by a large number of people at the same time. Except in the hands of experts, however, with a sound knowledge of television technique the results are open to grievous disappointment. First of all, with the methods which have so far been demonstrated publicly, the size of the image is limited to the area at the end of the cathode ray tube, say, about 4ins. by 2ins. with the present ratio of B.B.C. transmissions.

In order to obtain a constant cathode ray spot diameter over the range of Wehnelt cylinder voltage required to give good depth of modulation, the tubes have to be specially chosen. Unless this is done it is the easiest of matters to be rewarded with images (a) lacking in detail due to a "fluffy" and misfocused spot, and (b) lacking in contrast owing to the spot expanding instead of darkening with decrease of signal.

Conclusions

Dealing with the methods of scanning, whereby the spot movement is made to conform to the exploration made at the transmitting end, namely, bottom to top spot movement and right to left strip movement, particular attention must be paid to the electrical circuits used to produce the time bases, to avoid any inductive effects which might give rise to delays in the "return" stroke of the thyatron valve used for this purpose. The charging action is linear by virtue

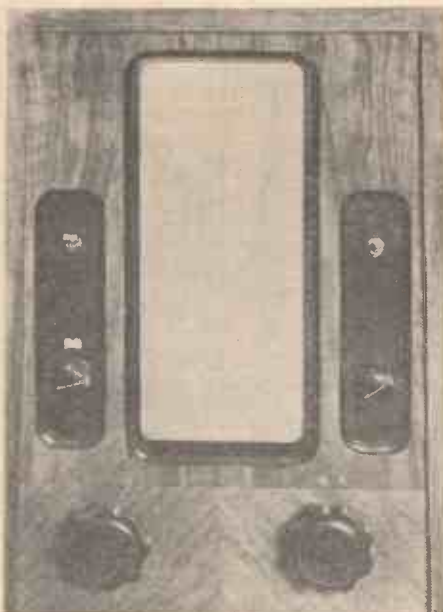

Fig. 4.—A close-up of the television screen used by the B.B.C. for showing images, together with the controls.

of the action of a saturated diode or its equivalent, but the return action due to discharge through the thyatron must be as rapid as possible. (This is known as the "saw tooth" effect.)

When we come to synchronizing, if it were possible to use linked A.C. mains the problem would be very easy by making the mains trigger a thyatron in a circuit arranged to respond to the picture frequency, so that the low frequency time base is automatically held in place.

The high frequency or "strips per picture" time base is synchronized from the signal by the well-known Baird principle, using the strip frequency intercalated signal, which is always extant in the B.B.C. transmissions.

On top of this we are faced with the fact that the auxiliary apparatus (apart from the somewhat expensive tube) is quite costly and fairly complicated, so summing up the whole situation it would appear that in the present state of the art the mirror drum machine is capable of producing the largest pictures with the best pictorial effect. The disc with the neon lamp offers a very simple and cheap receiver, but has the disadvantage that only three or four people can view the image at the same time.

The cathode ray is midway between the two, and it is quite possible that ultimately there will be a market for all three devices.

Bearing this in mind, it is hoped shortly to furnish readers with practical details of mirror drum working, and they will then be in a position to judge for themselves.

Blue Prints for all "Practical Wireless" Receivers are on Sale at our

STAND No. 8,
GROUND FLOOR, OLYMPIA.

POLICE NOTICE

(and everybody else as well!)
that **LYONS "B.A.T."**
COMPONENTS are the best obtainable irrespective of price.

"Q.M.B." RADIO SWITCHES, from 1/6d. to 7/6d. Single-Pole, Double-Pole, 2-Way, 3-Point, 4-Way Rotary, D.P.D.T., T.P.D.T., Etc., Etc.

"B.A.T." PRECISION RESISTORS, from 10½d. (1-watt) to 4/- (5-watts); also 10, 20, 30, 60 and 120-watt wire-wound vitreous-enamelled resistors to order (3-4 Days).

"B.A.T." MICROPHONES, all patterns.

CLAROSTAT POTENTIOMETERS, 50 ohms to 50,000 ohms in wire-wound, and up to 1 megohm with special element.

"B.A.T." MAINS TRANSFORMERS & POWER CHOKES, all patterns, low prices. Etc., Etc.

CATALOGUES. Really useful, informational Art Catalogues free and post free on request, if you mention "P.W."

CLAUDE LYONS, LTD.,
76, OLDHALL ST., LIVERPOOL.
40, BUCKINGHAM GATE,
WESTMINSTER, S.W.1.



FIT THIS ELECTRIC CLOCK TO YOUR SET!

NO MAINS NEEDED!
KEEPS CORRECT TIME!
NO WINDING!

Works off small battery lasting 12 months, or can be plugged into G.B. battery without affecting reception. Uses practically no current. Fits into hole 3½ in. dia. in any panel up to ½ in. thick. Easy to fix—no screws required. Only ½ in. from front of panel to back of case. Swiss movement. Hands set from front. Nickel-plated bezel. Useful addition to any set.

RIVERSIDE MFG. Co., Ltd.,
Dept. 21, Crisp Road,
Hammersmith, W.6.
Telephone: Riverside 6392

MAKE A RADIOGRAM OR GRAMOPHONE

Our 64-page Illustrated List for 8d. will tell you how, and show you a great variety of Spring and Electric Motors, Turntables, Tone Arms, Soundboxes, Horns, Loudspeakers, Pickups, Cabinets, hinges, Hilstays, door-locks, knobs, handles, and catches. Also Receivers, Kits, complete Gramophones, accessories, Springs, needles, and repair parts at lowest prices, wholesale or retail.

The Regent Fittings Co., D 285
(Est. 30 years), 120, Old Street, London, E.C.1.



PATENTS & TRADE MARKS
KING'S PATENT / GENOY, LTD., 146b, Qn. Victoria Street, E.C.4, offer "Advice Handbook" and Consultations free. 47 years' references. Write, call, or 'phone (Central 0682). Director, B. T. King, O.I.M.E., Reg. Patent Agent, G.B., U.S.A., and Canada.

UNIVERSE

1934 PICK-UP

COMPLETE WITH VOLUME CONTROL
22'6

RADIOLYMPIA STAND No. 14 GRAND HALL

Ask your dealer for demonstration or write us direct for Catalogue.
*Phone: Enfield 2646.

COSMOCORD LTD. DEPT. P. CAMBRIDGE ARTERIAL RD. ENFIELD MIDDXX

The finest pick-up of its type yet produced. Fully guaranteed. Output is extraordinarily high. Special swivel head for easy needling, changing. Impossible for pick-up head to get out of adjustment. Weight on record adjustable by compensator on end of arm. Smart brown bakelite.

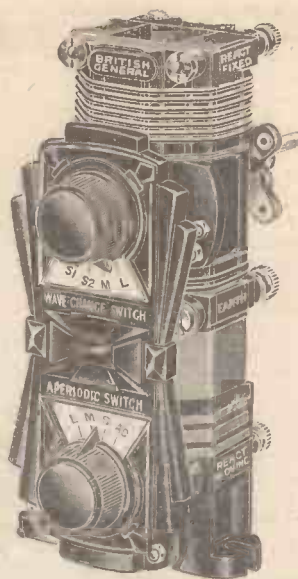

See the **ONLY Successful All-Wave Tuner**—operating from 14.5 to 2,000 metres

BRITISH GENERAL

STAND

PRICE ONLY 9/6

38

RADIOLYMPIA

From all dealers or direct from:
BRITISH GENERAL MANUFACTURING CO., LTD.,
Brockley Works, London, S.E.4.
*Phone: Lee Green 5055.

DIRECT FROM THE MAKERS
RADIOGRAM CABINETS FOR **1/6** WEEKLY

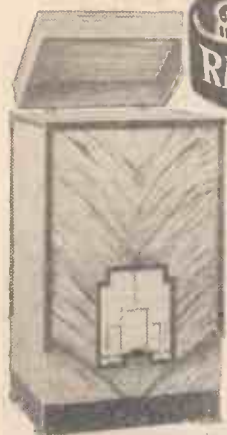

10/- DEPOSIT and 6 monthly payments of 6/-.
Cash Price 42/-.
CARRIAGE AND PACKING FREE.
Specification: Soundly constructed of well-seasoned timber and beautifully polished rich walnut shade with ebonised mouldings.
SIZES OVERALL.
Height, 3ft. 3ins. Width, 1ft. 8ins. Depth, 1ft. 4ins.
Allowing ample room for pick-up turntable and set with panel 18 x 7, baseboard 14ins. Also speaker and all accessories. Fitted with hinged motor board for easy access to set.
SEND FOR ILLUSTRATED LEAFLET.

Sent to you all ready to take your set.
From Sole Manufacturer:
W. S. WILKIN,
Nelson Mews, Southend, Essex.
Phone: Southend 4330.

SPECIFIED IN THE AUTO BIAS 3

Ask for a demonstration of Multitone components at any Multitone dealers. Then you will realise why the leading designers in *Practical Wireless* specify Multitone Transformers in preference to all others.

This Guide (H), which is the most complete practical manual on Class B and Q.P.-P., can be obtained free from your dealer or direct from us.

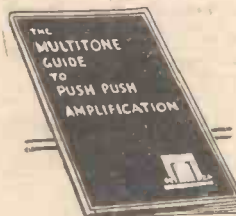

- * Driver Transformer BEPU (Ratios available: 1-1, 1.5-1, and 2-1.) **9/6**
(The highest grade transformers on sale, yet lowest in price.)
- * Tone-control Transformer, TOCO, 1-4. **17/6**
In the 1st L.F. stage gives 30 per cent. extra H.T. saving and ensures good quality.
- Graded potentiometer. **3/6**
- PUCHOKE, for matching your existing speaker to the Class B output. **9/6**

MULTITONE
ELECTRIC COMPANY LIMITED
95-98, White Lion Street, London, N.1. Terminus 5063

Set building made easy

Those usually tricky soldering jobs can be cleanly, easily and surely done by electric soldering. Simply plug into a lamp socket, switch on and in four minutes the SOLON is ready for use.



SOLON
ELECTRIC
SOLDERING
IRON

If your local dealer does not stock SOLON, please send us his name and address!

76

W.T. HENLEY'S TELEGRAPH WORKS CO., LTD.
DEPT. Y.O.7. HOLBORN VIADUCT, LONDON, E.C.1



Practical Letters from Readers.

The Editor does not necessarily agree with opinions expressed by his correspondents.

Using a Gramophone Pick-up with a Radio Receiver

SIR,—The present low price of valves has given the amateur much more scope in prosecuting experiments towards achieving first class results. It is common experience that, where the use of the gramophone pick-up has been made with the use of the "radio-receiver," results have been disappointing. Usually the detector valve is made very unstable, resulting in the scrapping of the pick-up for the sake of radio quality.

A simple circuit, as shown below whereby another valve is used, will do most, if not all, to obviate the unstable detector in an amateur radiogram.

The components required are few, *i.e.*, (1) Valve-holder, (2) Suitable valve, (3) D.P.D.T. Switch. The amplifying stages are connected to one side of the switch and L.T.+ from the same unit to the other pole; when in use, this switch brings the amplifier into either the anode circuit of the detector valve, or into that of what may be

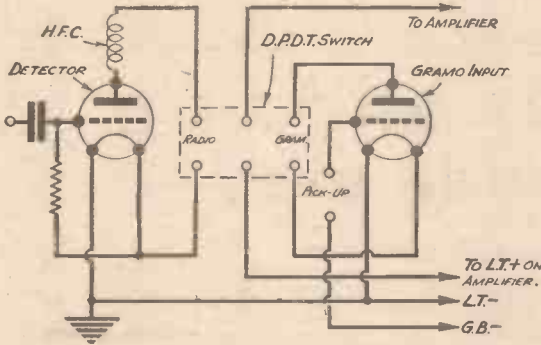

Using a gramophone pick-up with a radio receiver.

called the "gramo-input" valve; and also conveys the positive low tension to these units as required. The grid circuit of the detector is left untouched, whilst the pick-up is connected in the usual way, to the grid of the extra valve.—J. FIELDER (Portsmouth).

Exponential Horn Speakers

SIR,—The article on page 517 of PRACTICAL WIRELESS, July 1st issue, by Photon, gives no measurements for the horns. The following is a transfer of one side and four such as this, made to the measurements given, makes a perfect horn which gives both low and high note reproduction, if used with a Baldwin unit or such.—C. CRIPPS (Oxen).

A Satisfied Reader

SIR,—Please accept my sincere thanks for the splendid "Constructor's Encyclopædia," which I received by last mail.

It is truly a most excellent work of reference and has in the first few pages cleared up quite a number of vague points which had been bothering me up till now, and although I have not yet gone through it thoroughly I hope to have more subjects explained in the clear and concise manner so typical of PRACTICAL WIRELESS.—B. BENEKE (South Africa).

Praise from Overseas

SIR,—I am very pleased indeed with the Encyclopædia, which is the first English publication of its kind I have seen. The Data Sheets and their Binder are a very useful idea, in fact I have been making use of them already.

The PRACTICAL WIRELESS is just the paper we in Australia require, as we have no one to advise us. It is all very well being told to do this or alter that, but your publication tells how to do it, and also illustrates the way. Every Saturday I walk into the township and back six miles for a copy of PRACTICAL WIRELESS.

The Federal Postal Department charged nothing for the books entering the Commonwealth. I expected to have something to pay. I thank you again for the very useful presents I received.—J. C. PEARSON (West Australia).

On the Short Waves

SIR,—Allow me to congratulate you upon the publication, in current issue, of Old Circuits Revived. When one remembers the apparatus at hand years ago it makes one a little surprised that in the old days they worked at all. To those who wish to experiment I recommend this article. The finest article of its type I have ever read is "On the Short Waves." I hope to see similar articles of this nature at different times of the year as reception conditions change, and a different set of

conditions prevail. With reference to the Encyclopædia, I have not overrated the usefulness of this volume and constantly refer to it for certain matter which one does not require a great deal. Needless to say such information is always there. I will conclude with a number of suggestions. Short-wave reception is increasing in popularity and deservedly so. I always read readers' letters and hope readers will continue to write you. It is interesting to know what others think, like, or do. My first suggestion is prompted by a number of interesting letters from overseas readers who are short-wave enthusiasts. Why not invite those who desire to correspond with other enthusiasts to write their names, addresses, and type or types of receivers used by them, and publish, say, four per week in a small space. Fresh corres-

(Continued overleaf)

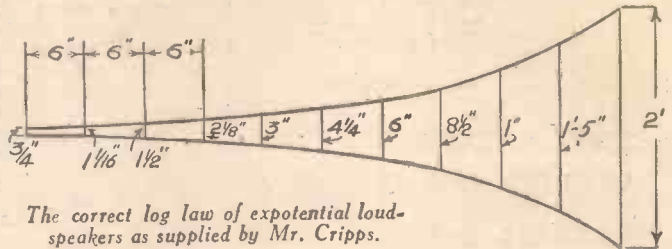

The correct log law of exponential loud-speakers as supplied by Mr. Cripps.

CUT THIS OUT EACH WEEK

DO YOU KNOW?

- THAT sal-ammoniac may be used as a make-shift for a chemical earth. It is not, of course so efficient as the various proprietary brands of chemical earth which are obtainable from our advertisers.
- THAT aluminium paint is useless as a substitute for metallizing valves, chassis, etc.
- THAT a meter and a battery will convince you of the above if you connect them in series and try and obtain a reading across a surface which has been so coated.
- THAT it is possible to receive two separate programmes on one aerial and reproduce them through two separate receivers, without interaction.
- THAT the response of a loud-speaker may often be brightened up by removing the cone an inch or so from the rear edge of the baffle.
- THAT loud-speaker leads should not be permitted to come near the aerial or earth leads.
- THAT when designing a circuit care should be taken that the "input" and "output" ends of the circuit are well separated.
- THAT a screened aerial lead will reduce interference from electric signs, etc.

NOTICE.

The Editor will be pleased to consider articles of a practical nature suitable for publication in PRACTICAL WIRELESS. Such articles should be written on one side of the paper only, and should contain the name and address of the sender. Whilst the Editor does not hold himself responsible for manuscripts, every effort will be made to return them if a stamped addressed envelope is enclosed. All correspondence intended for the Editor should be addressed: The Editor, PRACTICAL WIRELESS, Geo. Neumes, Ltd., 8-11, Southampton Street, Strand, W.C.2.

Owing to the rapid progress in the design of wireless apparatus and to our efforts to keep our readers in touch with the latest developments, we give no warranty that apparatus described in our columns is not the subject of letters patent.

WHAT IS MISSING AT OLYMPIA ?

"UNIVERSAL KITS."

Work from either A.C. or D.C. supply without alteration, Ev. Set: £5 15s., 3v. £3 15s.; 2v. Amplifier £3 5s.; 3v. £5 5s. All-electric Radiogram Kit, complete £12 15s. All prices include Valves, Rectifier and full size Blueprints.

The only really UNIVERSAL high voltage mains valves. Work direct off either A.C. or D.C. supply. No transformers or resistances required. Remarkably free from mains hum. ALL TYPES as previously advertised, and a range of NEW ones, including the K 8560, a valve with maximum dissipation of 15 watts. D.130. A high-mu valve of outstanding characteristics. For Detector-1st L.F. stage or as H.F. Ask for particulars and circuits. It's cheaper and easier to build a new mains set or convert an old one if you use only OSTAR-GANZ valves.

The OSTAR-GANZ High Voltage Mains Valves Obtainable through dealers or from Sole Agent for Great Britain:

EUGEN FORBAT

28/9 Southampton St. Strand, London, W.C.2
Telephone: Temple Bar 8608

You want
**SHARP, CLEAR,
BETTER RECEPTION?**

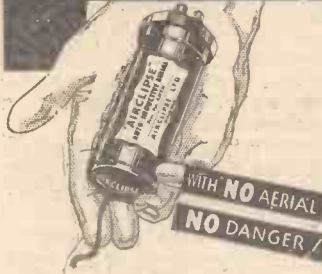

Discard your present aerial and connect up to the AIRCLIPSE Auto-Inductive Aerial. At once there will be an astonishing improvement in the performance of your set. The wonderfully convenient AIRCLIPSE, with its principle of auto-induction, filters incoming signals. It increases sensitivity and selectivity; gets distant stations with amazing clarity. Equals the best outdoor aerial and infinitely surpasses any indoor aerial. Only 3 1/2 x 1 1/2 inches. Can be placed inside or outside the set, and enables any set to be moved from room to room.

AIRCLIPSE

Auto-Inductive AERIAL

For A.C. Mains and Battery Sets.
Of all dealers, or in case of difficulty,
order from:—
AIRCLIPSE Ltd., 182, VAUXHALL BRIDGE RD., LONDON, S.W.3
Telephone: Victoria 5022.



"We're Fluxite and Solder — the reliable pair; famous for Soldering—known everywhere!"

See that Fluxite and Solder are always by you—in the house—garage—workshop—anywhere where simple, speedy soldering is needed.

ALL MECHANICS WILL HAVE FLUXITE

IT SIMPLIFIES ALL SOLDERING
All Ironmongers sell Fluxite in tins: 4d., 8d., 1s. 4d., and 2s. 8d. Ask to see the FLUXITE POCKET SOLDERING SET—complete with full instructions—7s. 6d. Ask also for our leaflet on HARDENING STEEL with Fluxite.

FLUXITE LTD.
(Dept. W.P.), ROTHERHITHE, S.E.16.

FOR ALL REPAIRS!



PRACTICAL LETTERS

(Continued from previous page)

pondence keeps one up to date and keen. For a number of years I have corresponded with fellow enthusiasts in America, Australia, Ceylon, and New Zealand, enlarged magazines of radio interest, photographs of receivers, transmitters, local views, etc. Another suggestion is that readers let us know what they hear on short waves and, more important still, what they try for and never hear. I have been searching for little N.R.H. of Costa Rica for years and never hear him on my o-v-2 or a de luxe all mains six valve short waver. Onc-valve enthusiasts don't despair. You have no high background. My final suggestion is that your column, My Opinion, appears frequently in the future. As to technical suggestions, I have none to offer at the moment. I am, however, busy experimenting in various directions and trying out a new o-v-2 of my own design. I am pleased to note that constructional articles are receiving the attention they deserve. Amateurs are interested in making their own coils and other apparatus, and PRACTICAL WIRELESS wherever possible avoids starting off a list of components with one XYZ coil 25s. 6d., which in the past has made many an enthusiast turn over the page and cross his ideal receiver off the list.—ALF. W. MANN (Middlesbrough).

Spares for Wates Wet H.T. Batteries

SIR,—As a matter of interest to your readers we should be pleased if you will have information published in your journal that spares for Wet H.T. Batteries, which can no longer be obtained from the original manufacturers are now being manufactured by The Wet H.T. Battery Co. of 26, Lisle Street, London, W.C.2.

A considerable number of your readers are users of these batteries and no doubt they will be pleased to have the information given above.—The Wet H.T. Battery Co., F. H. WATES.

RADIO CLUBS & SOCIETIES

Club Reports should not exceed 200 words in length and should be received First Post each Monday morning for publication in the following week's issue.

ANGLO-AMERICAN RADIO AND TELEVISION SOCIETY

In order to aid DX enthusiasts the Anglo-American Radio and Television Society is now issuing lists of DX stations which are audible in this country at the time the list is issued.

During the last week or so American reception has been quite good, the following stations having been received at various strengths ("M" on list—moderate, "G"—good) with three valves (v.v.1.).

VAS, Glace Bay, 434.5 m., M.; WBZ, Boston, 302.8 m., G.; LR9, Buenos Ayres, 291.1 m., M.; WTAM, Cleveland, 280.2 m., M.; LS2, Buenos Ayres, 252 m., M.; LS6, Buenos Ayres, 222.5 m., M.; WJSV, Washington, 295.4 m., M.; LR3, Buenos Ayres, 315.6 m., M.; LR4, Buenos Ayres, 302.8 m., M.; WTIC, Hartford, 282.8 m., G.; WPG, Atlantic City, 272.6m., G.; WIOD, Miami, 230.6 m., G.; WAAB, Boston, 212.6 m., M.

Short-wave stations, W-3XAU, 3XAL, 8XK, 8XAL, 9XF, 2XAD, 2XAF, VE-0GW, XEW, HKC, 1BC, have provided good results in all parts of the country.

DX listeners are advised to try out their receivers upon the medium wave-band between 2 and 4 a.m., when they are almost sure to receive one of the above American stations.

GOLDERS GREEN AND HENDON RADIO SCIENTIFIC SOCIETY

The Golders Green and Hendon Radio Scientific Society held the seventh annual Direction Finding Competition which was organised by Lieut-Col. H. Ashley-Scarlett, D.S.O. It was held in the neighbourhood of Berkhamstead, St. Albans, Watford, Amersham. The topography of the country made a most searching test for the competitors. The transmitting station was under the control of Mr. D. N. Corfield (G5CD). The wave length used was 164 metres, and was crystal controlled. The transmitter was mounted in a van, the chassis of which provided a most suitable earth.

The high tension was supplied by an M.L. rotary converter. The power in the aerial was between .5



Members of the Golders Green and Hendon Radio Society on the occasion of their recent field day.

and .7 amp, the length of which was about 12ft. Signal strength and quality were reported to be excellent.

The receiver was installed in another car under the direction of Col. H. Ashley-Scarlett.

The check transmitting station was controlled by Mr. A. R. Gardiner (G5RD), near King's Langley. This station was of very great assistance, as it enabled competitors to check and adjust their apparatus on the field and make any necessary correction for local errors.

The judges were Mr. W. A. Hudson, M.P.S., Mr. Humphrey Andrews, B.Sc., A.C.G.I., M.I.E.E., Wing-Commander G. Struan Marshall, R.A.F. The results showed a great improvement on previous years, over 80 per cent. found the hidden station, and the average error of the first two groups was only 0.8 per cent.

ELECTRADIX MICROPHONES

1/- Unit as illus.
Complete Button Unit, usually sold at 3/6, but our price has always been 1/-, or 1/6 post free with 2in. mica diaphragm 1-500m. thick. Volume controls. Panel or base 6d. Home Radio No. 11 Mike, 2in. brass case pendant, 6/6. Ring pedestal desk Mike 18/6. Marconi Hand Mikes, 15/-; Lecture Desk Mike, 65/-; Pub. Address Amplion, 25. Browns, £20 model, £12. West. Elect., £14. Microphone Carbon Grammes. In glass capsule, enough for four buttons. Grade No. 1, 8d.; No. 2, Medium, 1/-; No. 3, Fine, 1/6; Carbon, solid back, blocks, 3d. Mouthpieces, curved or straight, 10d. Carbon diaphragm, 55m/m., 4d. Panel brackets, pivoted, 5/-. Reed Receiver Unit (or Amplifier making, 3/-; High-ratio 100-1 Amplifying Transformers for all makes, 3/6, 5/6, and 7/6.

TRU-VIEW GAMERASCOPES, BROWNS, double lens, folding, 2/-; Telescopes, Cooke monocular prism RF, with 3-mile distance scale 7in. long, weight 31lbs. 17/6. Naval Gun-Sighting Telescopes, Internal focusing, 24in. long, 2in. dia., weight 6lbs., magnification 6, for short and long range. Cost £25.

Sale, 17/6. Navy Spotting Telescopes, 17in. x 1 1/2in., 25/- Pressure Gauges, 150lb., 2/6. Micter movements, 5/-; R.A.F. Watch Movements, 1/6;

RESISTANCES. 140 Varley Wire-wound 500,000 ohms, 1/3. 72 Tubular 400 ohms, 6d. 5,000 Vacuum Resistors, and Grid Leaks, Fig. 8, "Sutra," .01, .025, .05, .5, 1 meg., all new goods, 1/- line, for sale 3d. each. Tapped Wire-wound Eliminator Resistances, 2/6. Edibell wire-wound Resistance Coils, 6,000 ohms, 16,000 ohms and 38,000 ohms. 1/8. Reg. Volume Controls, as illus, for Gramos, or Mikes, 300,000 ohms, rocker-ring type, 3/-; line for 1/7. 48,000 ohm Western Electric wire-wound, 1/6.

LAMP CHARGING RES. 100 v. 60 watt, 6d., 100 v. 400 watt 8d., 2 in series on 200/250 v.

The BATTERY SUPERSEDER makes H.T. from your L.T. 2-volt battery, rectified and smoothed. Gives 3 tappings and lasts indefinitely. A boon to those who are not on the mains. Reduced from 43 15/-. New and improved. Guaranteed ... 37/6 LT.

CHASSIS for Set Builders. All-Metal Base Chassis, fitted 2 valve holders, all drilled for Brownie components, 3/6. FRETS for speaker panel (fronts or baffles. Fine 8in. octagon, in hanged, black moulded bakelite, as on Brownie's 30-pintina sets, 1/- only. Post free, 1/3. COILS. Cossor 3-pin short-wave, 1/- each. Aerial Reaction, Long, Short, and Multiple-tuning Coils, 24in. by 3in., 1/6. Ribbed Former, only 9d. H.M.V. Tuning Long and Short-wave Aerial Band-pass 8in. Coils (as illustrated), need repair, 8d., post 3d. Tapped Inductances, 11in. by 4 1/2in., 4 taps, 3/6. Tapped Inductances, 9 1/2in. by 7 1/2in., with 7-stud rotary switch, 5/-. 1,000 Ebonite 6-ribbed small 1 1/2in. diameter, 1in. long, 2d. Star Reaction Tuners, broadcast band, new, 9d. each. Igranite Untone Couplers, usually 2/6, Major and Minor, 9d. each.

Write for Sale List "N"
ELECTRADIX RADIOS,
218, UPPER THAMES ST., LONDON, E.C.4.

LET OUR TECHNICAL STAFF SOLVE
YOUR PROBLEMS

REPLIES TO



If a postal reply is desired, a stamped addressed envelope must be enclosed. Every query and drawing which is sent must bear the name and address of the sender. Send your queries to the Editor, PRACTICAL WIRELESS, Geo. Newnes, Ltd., 8-11, Southampton St., Strand, London, W.C.2.

QUERIES and ENQUIRIES
by Our Technical Staff

The coupon on this page must be attached to every query

SHORT WAVE CONVERTER FOR SUPERHET

"I have a 7-valve American Superheterodyne Radio-gram and wish to obtain a one-valve short wave converter for use with the set. I have already been in touch with one of your advertisers, who states that their converters are not suitable for American sets. Can you tell me where I can get one, or, failing that, could you advise me of a suitable circuit?"—E. J. Slater.

If E. J. Slater will send us his correct address we shall be pleased to assist him. The address given on the notepaper was false, and our reply has been returned by the Postal Authorities.

H.F. OSCILLATION

"I have just built a gramophone amplifier for addition to my radio set, and this makes a four-valve set with a push-pull output. Something appears to have gone wrong, as directly I switch on (the apparatus is mains driven) there is a very high-pitched whistle and the volume is not at all what it ought to be. If I touch one of the grid terminals of the two output valves, the whistle stops and signals roar through. I believe this signifies oscillations, and I should like to stop it. What is the correct method for dealing with such a case, please?"—(F. B. M., Margate.)

The reason you give for your trouble is quite correct; the output valves are oscillating at high frequency. There are two or three ideas which might remove the trouble, and these depend upon the manner in which the stage is arranged. If you are using automatic grid-bias, you may find that a resistance with a value between 30,000 and 100,000 ohms, between the centre-tap of the input transformer and the biasing resistance, will cure the trouble. A further scheme is to fit a similar resistance in series with each grid lead. A low-value resistance—not more than 200 ohms—in each anode lead is also useful in removing the oscillation. One of the above schemes will be found to meet your case, and the first-mentioned is the best.

TONE CONTROL

"I have a rather antique four-valve set, employing two L.F. stages. The results are truly amazing, and I must say that although it employs a neutralized H.F. stage it gives me more stations than many of my friends' modern S.G. sets. The only point which I can criticize is the quality of the reproduction, and although I have tried modern L.F. transformers, I cannot always get the type of reproduction which I like. I want, therefore, to fit a tone adjuster of some kind, so that I can vary the reproduction of different instruments. Can I fit something to my present transformers instead of buying a new one, or do you not recommend this course?"—(A. W. M., Surbiton.)

You may vary the reproduction from your present transformer by connecting a tone-control circuit, but as the component is not an up-to-date one you may find that it will not be easy to decide upon the correct values. You may introduce troubles from various resonant points, etc., and we would therefore only advise you to buy a modern tone-control transformer. This can be substituted for your present component, and will enable you to carry out the adjustments which interest you without affecting the remainder of the circuit.

RESISTANCE RATINGS

"I notice that a good many of the solid type of resistances which are now on the market are called '1 watt type.' How does one ascertain what wattage is required of a resistance? And how is the wattage of the resistance obtained?"—(S. F., Peterborough.)

As has been explained many times in our pages, the passage of a current through a resistance results in a voltage drop. The value of this voltage is obtained by multiplying the resistance (in ohms) by the current (expressed as a decimal

part of an amp.). Or, put in another way, the resistance in ohms is multiplied by the current in milliamps, and the answer divided by 1,000. This will give the volts dropped through the resistance. If now this voltage is multiplied by the current in milliamps, and the answer divided by 1,000 the result will give you the watts dissipated by the resistance.

S.G. ANODE COMPONENT

"I am making up a small receiver in which I wish to use a screened-grid valve as a detector. Is it advisable to use an ordinary L.F. transformer direct coupled with this valve? What I mean is, may I include the primary of the transformer in the anode circuit direct? I appreciate that the S.G. type of valve has a rather high impedance, but I do not know whether this precludes the use of a transformer in the manner I suggest. Your advice would be esteemed."—(R. X. S., Hanwell, W.)

The high impedance of the S.G. valve demands that the anode impedance shall also be high if

DATA SHEET No. 48

Cut this out each week and paste it in a notebook

MAINS TRANSFORMER DETAILS

(2) Turns per square inch—assuming that the wires have been wound more or less evenly, but without endeavouring to make each layer perfectly even.

S.W.G.	Turns per square inch.			
	Enamel	D.S.C.	S.S.C.	D.C.C.
10	56	57	58	49
12	85	85	87	72
14	143	140	145	113
16	226	213	223	173
18	392	377	400	297
20	685	641	692	472
22	1,110	1,010	1,110	692
		1,770		1,280
24	1,770	1,600	1,770	977
26	2,560	2,270	2,560	1,280
28	3,760	3,160	3,650	1,680
30	5,370	4,500	5,180	2,950
32	6,890	5,650	6,610	2,550
34	9,610	7,310	8,730	3,020
36	13,500	10,300	12,100	4,110
38	20,400	14,700	17,800	5,100
40	32,500	20,100	25,200	6,100

full advantage is to be taken of the principal features of this type of valve. Therefore it is always preferable to use a resistance having a high value in the anode circuit, and so parallel feed the L.F. transformer. You will find that by this means you will obtain the maximum amplification, as well as a more even response over the entire musical scale.

TELEVISION LAMP

"I am constructing a Television receiver after reading the articles in your journal, but I find from reading a catalogue that the lamp for the picture will cost too much for my pocket. As I have spent a long time making the other parts of the set, and these have cost me only a few shillings, I should be glad if you could assist me by informing me how to make up a lamp instead of buying one. Can Neon gas be obtained separately and is it possible to get it into a lamp at home? I am handy with tools and would like to try and make the lamp so that I can say I have made all of the receiver."—(H. T., Croydon.)

Even if you could purchase the Neon gas, you would find it beyond your powers at home to make the Neon lamp. However, you need not

be deterred in your experiments, as there is a very simple solution. It is the use of an ordinary sign lamp, or night-light, which employs Neon. You may have seen the illuminated advertisements in shop-windows, where bulbs only as large as the ordinary electric lamp are caused to glow with the characteristic Neon orange colour, and a letter of the alphabet is fitted inside the bulb. These lamps are obtainable at a good electrician's and cost only 3s. 8d. The letters "H" and "M" are most satisfactory for your purpose. The beehive pattern night-light is also suitable, if mounted so that the end of the lamp is behind the receiving disc. The resistance which is included in the base must be removed by soaking the base in methylated spirit for a night, and then unsoldering the two leads. After removing the resistance, which is wound on a small fibre former, connect a short length of wire and remake connection to the base of the lamp. It must not be connected to the mains after removing the resistance.

FREE ADVICE BUREAU
COUPON

This coupon is available until Aug. 26th, 1933, and must be attached to all letters containing queries.
PRACTICAL WIRELESS 19/8/33.

PETO-SCOTT
FIRST WITH
EASY TERMS FOR
LISSEN SKYSCRAPER
7 VALVE
SUPER-HET KIT

FREE CONSTRUCTIONAL
CHART WITH EVERY KIT

CHASSIS MODEL
WITH VALVES

Cash or C.O.D.
Carriage Paid
£8-17-6

Balance in 11 monthly
payments of 16/6

YOURS FOR
15/-

TABLE CABINET MODEL complete
with valves. Cash or C.O.D. Carriage
Paid £9-15-0.

(or 12 monthly payments of 17/6)

CONSOLETTIE CABINET MODEL
complete with Valves and Permanent
Magnet Moving Coil Speaker. Cash
or C.O.D. Carriage Paid £11-10-0.

(or 12 monthly payments of 21/-)

PETO-SCOTT Co. Ltd.

77, CITY ROAD, LONDON, E.C.1

Telephone 1 Clerkenwell 9406/7 EST. 1919

West End Showrooms: 62 High Holborn, London, W.C.1

CATALOGUES RECEIVED

To save readers trouble, we undertake to send on catalogues of any of our advertisers. Merely state, on a postcard, the names of the firms from whom you require catalogues, and address it to "Catalogue," PRACTICAL WIRELESS, Geo. Neuenes, Ltd., 8/11, Southampton St., Strand, London, W.C.2. Where advertisers make a charge, or require postage, this should be enclosed with applications for catalogues. No other correspondence whatsoever should be enclosed.

CHLORIDE ELECTRICAL STORAGE CO.
The new catalogue of the above well-known firm of wireless battery manufacturers has just come to hand wherein they present a range of Exide and Drydex batteries designed specially for all wireless, public address and sound projector systems, gramophone, medical, X-ray and laboratory equipment; relay, signalling, alarm and similar circuits; for all electric models and portable lamps of all types. They welcome enquiries either for their special catalogues, obtainable from 205-231, Shaftesbury Avenue, W.C.2., post free, or for further information on any point of individual need.

VARLEY RECEIVERS AND COMPONENTS FOR 1933-4

THE above well-known firm have just issued their new 28-page components catalogue, covering all their new ranges of coils, chokes, transformers, etc., for the coming year. Of special interest is their "Nicoire" tuning coils, the design and winding of which is a totally different matter from that of air core coils; owing to the high permeability of the core, the coils are very small indeed and the winding becomes an extremely skillful job.

Varley, however, have specialised in winding for many years, and they have now produced the Nicoire Coils.

In producing these coils the most important factor has been consistency, but the additional research necessitated revealed an even greater efficiency than was thought possible. Selectivity, that important essential to good radio reception, is a maximum with these coils and has to be experienced to be appreciated. Both medium and long wave bands are accommodated in a very small and compact assembly completely screened against the remote possibility of interaction.

A complete range of resistances is also given in this interesting booklet, which can be obtained post free from Messrs. Varley, Kingsway House, Kingsway, W.C.2, upon application.

Of particular interest with regard to their receivers are the Varley 3-valve Receiver Model AP34 at 12 guineas, and the 4-valve Superhet at 15 guineas. We would also draw your attention to the fact that all the new Varley 5-valve Superhets are fitted with automatic volume control.

A pamphlet on their new receivers can also be obtained post free from the above address.

RADIO WRINKLES

(Continued from page 710)

it should be situated distant from the set. My own is on a shelf in an out-house, connected to the set by two lead-covered leads, one as input from the accumulator in the set, and the other as the high tension, feeding the set from the unit. The Ford coil can be used in conjunction with valve

rectification, half and full wave, using old radio valves, with plate and grid legs shorted. On full wave rectification the Ford coil needs centre tapping on the secondary windings. The wooden case is broken open and the pitch removed, the secondary windings will be seen as two separate bobbins joined together in the centre with fine wire; on this must be soldered the centre tap, a delicate job, as the wire is about No. 40's. Connect up as shown in the circuit diagram.—H. ALEXANDER (Tyldesley).

Replies to Broadcast Queries

B.R.S. 1038 (Eddington): WEF, Rocky Point (N.Y.) on 31.61 m. (9,490 kc/s) relaying programme from U.S.A. to Rio de Janeiro (Brazil). SEARCHER (Glasgow): (1) WIY, Rocky Point (N.Y.) on 21.02 m. (13,860 kc/s) relaying Berlin to U.S.A. Dr. Schacht (on Monetary Conference); (2) Rabat (C.N.R.) on 37.33 m. (8,036 kc/s) relaying Radio Maroc; (3) Too vague, regret, cannot trace; (4) OXY, Skamlebaek relaying Copenhagen on 40.4m. (6,075 kc/s); (5) possibly YV11BMO, Maracay (Venezuela) on 48.95 m. (6,127 kc/s); (6) vague; no time stated. If on Sunday, possibly 8KR, Constantine (Algeria) on 45 m. (6,667 kc/s); G68W, T. Bull, Cambridge House, Mill St., Cannock (Staffs.); G28A, H. A. Savage, 53, Station Rd., Burnham-on-Crouch (Essex); G58K, W. H. Maycock, 33, Camden St., Stoke, Coventry (Warwickshire). APPLETON (Sunderland): OH2CA, probably OH2NA, Kakkosten Kerho (The Club of 2's), Helsinki, Finland; PAOKT, F. Kerkhof, Albertina van Nassastraat, 21, Eindhoven (Holland); F8DY, Renc Desbordes, 160 bis, Rue des Landes, Chatou, France (S. & O.); OZ7FK, K.F. Christiansen, Ø Fjordvej, Nyborg, (Denmark).

MODERN WIRELESS SETS AND HOW TO MAKE THEM

By F. J. CANN

This handbook explains the construction of a number of highly-efficient receivers, designed around the latest and most up-to-date components, such as band-pass and screen coils, variable-mu valves, etc. They have been designed to eliminate most of the drawbacks to efficient wireless reception. Most of the sets have compartments for the batteries and accumulators, and make use of built-in speakers. They are all extremely selective, cheap to make, and simple to construct.

Eighty Pages Fully Illustrated

6d.

On sale at all Newspapers and Bookstalls, or post free 7d. from George Neuenes, Ltd., 8-11, Southampton Street, Strand, London, W.C.2.

EARL VOLUME CONTROL

THE Earl Manufacturing Co. have now fitted a special bracket to their loud-speaker unit which houses the transformer and a volume control. The outstanding feature is that the volume control is acting as a low impedance potentiometer across the secondary of the speech transformer, this being arranged in such a manner that there is no effect whatsoever upon the audio frequency response. The control is graded in such a way that it gives a pleasing gradation of volume from minimum to maximum. A further feature of this volume control is that maximum sensitivity of this speaker is in no way impaired at the full volume position. When the volume control is placed at minimum position the input to the loud-speaker is automatically cut out, this being a great asset in the event of it being used as, or in conjunction with, an extension speaker.

NEW MARCONI VALVES

FOUR new Marconi valves will be released in time for the Exhibition. They are S.24—a high-efficiency 2-volt screen grid non-microphonic valve with a slope of 1.4 mA/V. The price is 15s. 6d. The VS.24 is a 2-volt short grid-base variable-mu valve with a similar slope. It also costs 15s. 6d. The L.21 is a new 2-volt Class B driver valve with an impedance of 8,900 ohms and an amplification factor of 16. It costs 7s. The B.21 is a Class B valve which, unlike the majority of valves of this class, requires an initial application of grid bias. It costs 14s. Some new valves will also be announced shortly after the Exhibition.

EASY PAYMENTS—

"There's no place like HOLMES."

The first firm to supply Wireless parts on easy payments. Nine years advertiser in Wireless Press. Thousands of satisfied customers.

After visiting the show you will certainly choose the finest speaker

EPOOH 11in. SUPER

45/- cash
4/11 Deposit. 9 payments of 4/11.

	De.	Monthly	posit	Paym'ts
LISSEN SKYSCRAPER Kit	89/6	8/3	11	of 8/3
TELESEN 325 Star Kit	39/6	5/5	7	of 5/5
EXIDE H.T. Accum. 120v.	£3	6/-	9	of 6/8
EKCO Eliminator A.C.18	67/6	7/5	9	of 7/5
CELESTION M.C. P.-M.	35/-	4/10	7	of 4/10
B.T.H. Pick-up	25/-	4/8	5	of 4/8

Parts for any Kit Set. Any make of Speaker.
New Goods Obtained for Every Order.

Send us a list of the parts you require and the payments that will suit your convenience, and we will send you a definite quotation. Anything Wireless.

H. W. HOLMES, 29, FOLEY STREET, Great Portland Street, London, W.1.

Phone: Museum 1414.

CHARGING WITHOUT MAINS

Thousands are charging their own accumulators, why don't you? "TONIO" trickle-charger Kits keep two-volt accumulators fully charged. Ideal for remote districts. From 7/-, postage 6d. Full particulars, stamp.

WILLIAMS, Netherend, Cradley, Nr. Birmingham.

ADVERTISEMENT INDEX

	Page
Aircelpe, Ltd.	766
Amplion (1932) Ltd.	741
Automatic Coil Winder & Electrical Equipment Co., Ltd.	686 and 708
Belling & Lee, Ltd.	688
Benjamin Electric, Ltd.	757
Block Batteries, Ltd.	Adot. Supp. VIII
British Ebonite Co., Ltd.	687
British Institute of Engineering Technology	743
British Radiophone, Ltd.	Adot. Supp. XIII
British Radio-Gramophone Co., Ltd.	Adot. Supp. XV
British Blue Spot Co.	Inside Back Cover
British General Mfg. Co., Ltd.	764
Bulgin, A. F. & Co., Ltd.	Adot. Supp. I
Busby & Co., Ltd.	743
Carrington Mfg. Co., Ltd.	687
Chorimet Radio Electric Ltd.	754
Colvern, Ltd.	Adot. Supp. VI
Columbia Graphophone Co., Ltd.	707
Cossor, A. C., Ltd.	690
Cosmochord, Ltd.	764
Dubilier Condenser Co. (1925), Ltd.	Adot. Supp. XIV
Easticks, Ltd.	761
Edison Swan Electric Co., Ltd.	Adot. Supp. X and XI
Electradix Radios	766
Epoch Radio Mfg. Co., Ltd.	689
Eugen Forbat (Ostar-Ganz)	765
Ferranti, Ltd.	685 and 743
Fluxite, Ltd.	766
General Electric Co., Ltd.	711
Gilbert, J. C.	768
Graham Farish, Ltd.	Back Cover and Adot. Supp. V
Grosvenor Electric Batteries, Ltd.	741
Heyberd, F. C. & Co.	758

	Page
Henley's Telegraph Works, Co., Ltd.	764
High Vacuum Valve Co., Ltd.	708
Holmes, H. W.	768
Igranic Electric Co., Ltd.	Adot. Supp. IX
King's Patent Agency, Ltd.	763
Lectro Linx, Ltd.	708
Lissen, Ltd.	698, 699 and Adot. Supp. II, III
London Electric Wire Co. and Smiths, Ltd.	754
London Radio Supply Co.	755
Lyons Claude, Ltd.	763
Multitone Electric Co., Ltd.	764
Nash Products, Ltd.	754
New Times Sales Co.	759
Newnes' Wireless Publications	686
Osborn, C. A.	754
Partex Radio	742
Pearl & Pearl, Ltd.	761
Peto-Scott, Ltd.	747 and 767
Regent Fittings Co.	763
Reproducers & Amplifiers, Ltd.	Adot. Supp. XII
Riverside Mfg. Co., Ltd.	763
Telegraph Condenser Co.	Adot. Supp. VII
The Gramophone Co.	697
The 362 Radio Valve Co., Ltd.	754
Varley, Ltd.	Inside Front Cover
Vinces Dry Batteries, Ltd.	Adot. Supp. XVI
Westinghouse Brake and Saxby Signal Co., Ltd.	Inside Back Cover
Whiteley Electrical Radio Co.	Front Cover Strip and Adot. Supp. IV
Wingrove & Rogers	687
Wilburn & Co.	754
Wilkin, W.S.	764
Williams	768

PAGE MISSING

PAGE MISSING

Practical Wireless

3^d P

Published every Wednesday by
GEORGE NEWNES LTD.
Vol. 2, AUGUST 26th, 1932, No. 43.
Approved by the G.P.O. as a Newspaper

2nd Enlarged Show Number

Home Constructor
Sets for
Every need &
Every Pocket

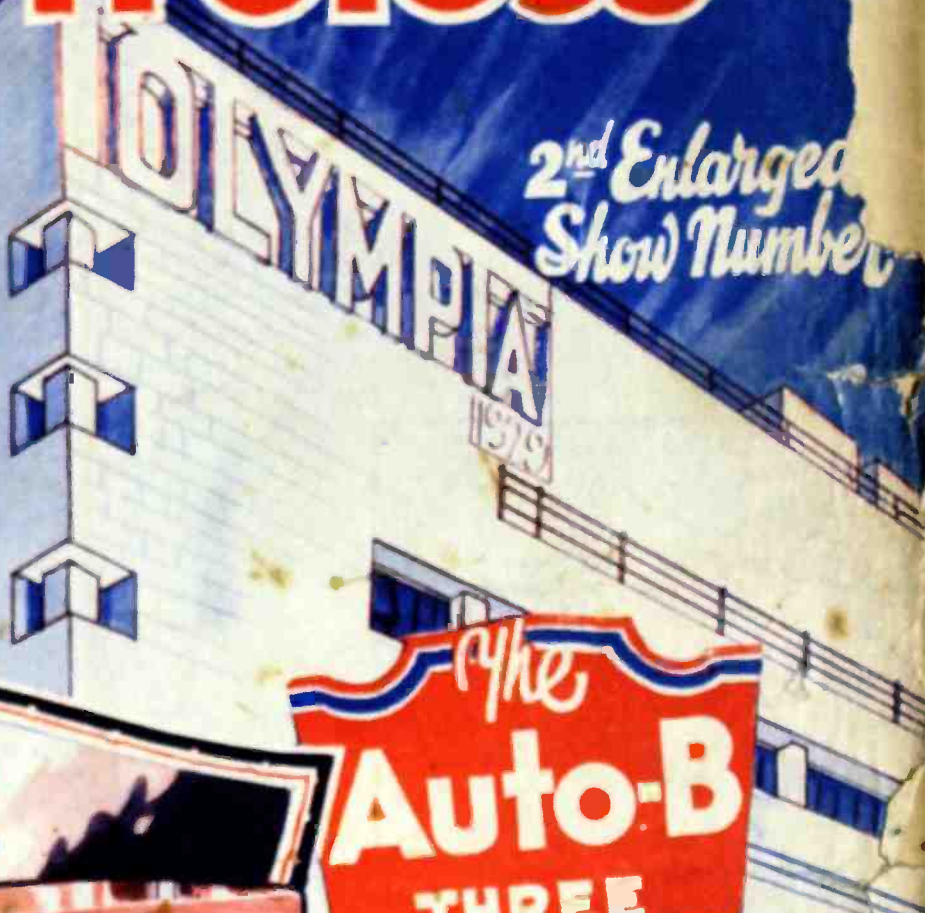

The 1934

Superset.



The
**Auto-B
THREE**

The
**ALL-WAVE
TWO**

GARD AGAINST LIGHTNING

Lightning strikes through Wireless Aerials. Make your home safe. Fix a Graham Farish "Gard" between Aerial and Earth Lead-in. From all Radio Dealers, or post free from—

1/6

GRAHAM FARISH LTD. MASON'S HILL, BROMLEY, KENT



**£100
GUARANTEE**
Every Graham Farish
Gard Lightning Arrestor
Carries £100 Guarantee

ADVT

N I C O R E

T U N I N G C O I L S

Varley again! Leaders in the new tuning technique as in the old . . . Varley NICORE Coils mark the biggest advance in radio tuning since the introduction of "Square Peak."

Consistency has been the great aim, and the characteristics of NICORE Coils will not alter in use. These New Coils combine maximum efficiency with maximum selectivity and are suitable for all circuits.

The use of powdered metal cores is not new to Varley. As far back as 1926 Varley produced some Constant Inductance Chokes with powdered iron cores. Varley NICORE Coils are an outstanding result of years of research. Write to-day for FREE illustrated literature. B.P.30—Aerial or Tuned Grid with Reaction **10'6** B.P.31—H.F. Intervalve Transformer with Reaction **10'6** Set of 3 coils ganged on base **33'6**

STAND



No. 85
Main Hall

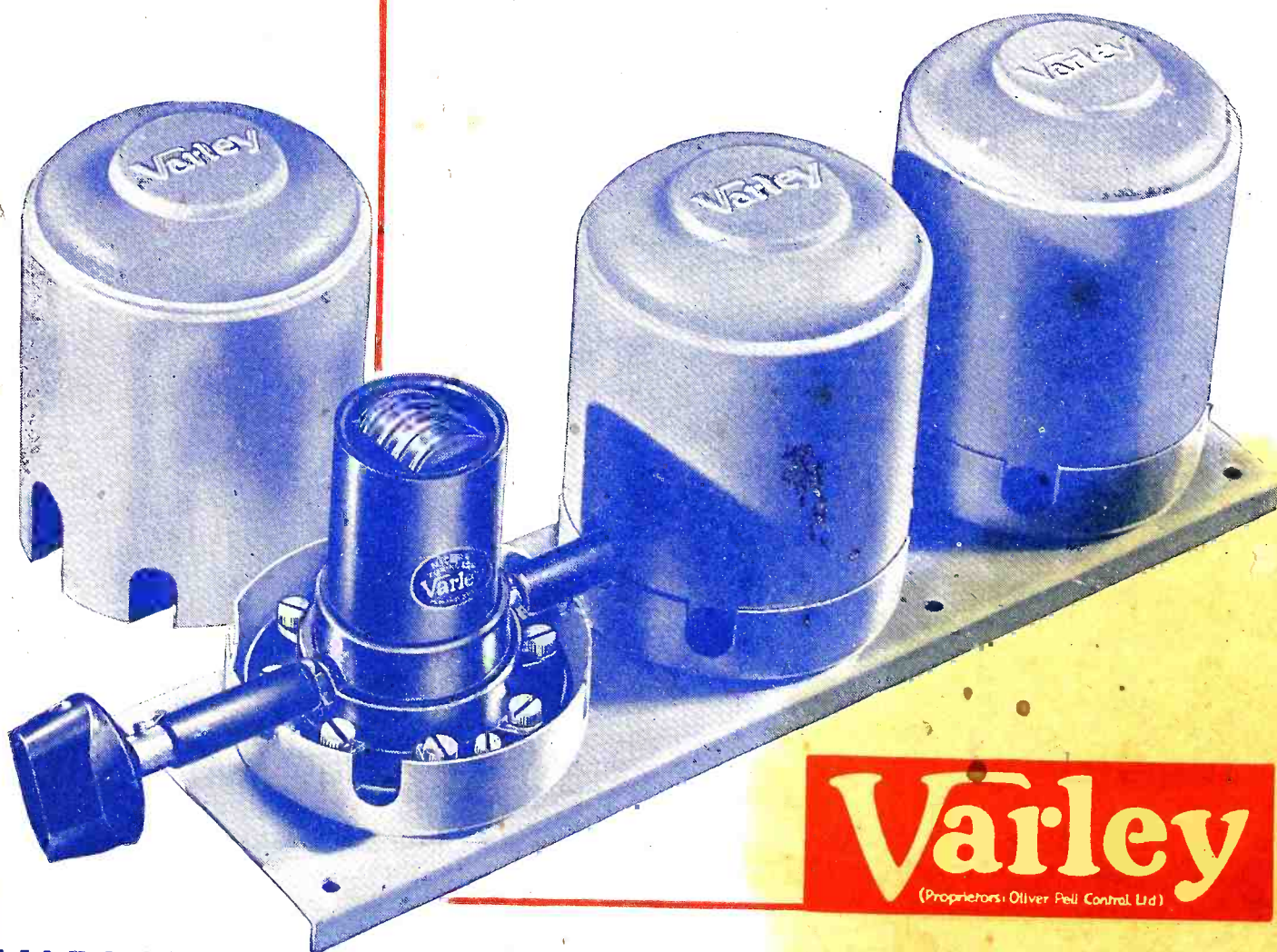

VARLEY— FOREMOST AS PIONEERS

Advertisement of Oliver Pell Control Ltd., Kingsway House, 103, Kingsway, London, W.C.2. Telephone: Holborn 5303

COLVERN FERROCART COILS

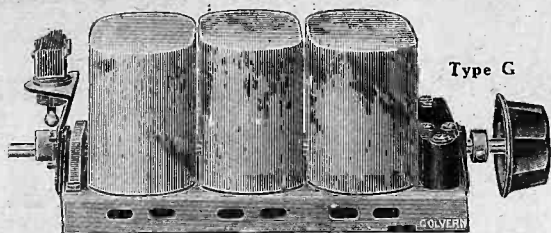

Type G

SPECIAL G Type GANGED COILS

Complete with gramophone and wave change switch

Two Gang ..	25/-
Three Gang ..	37/6
Four Gang ..	50/-

On and off Switch if required 1/6 extra. State if required for battery or mains receivers.

COLPAK Type H

Comprising Ferrocart G type Coils, Tuning Condenser, Gramophone and on and off Switch (state if required for battery or mains receivers).

Coils can be supplied for 1 SGHF stage receivers with Band Pass filter or Band Pass filter and Oscillator Coil for Superheterodyne receivers.

Price 57/6

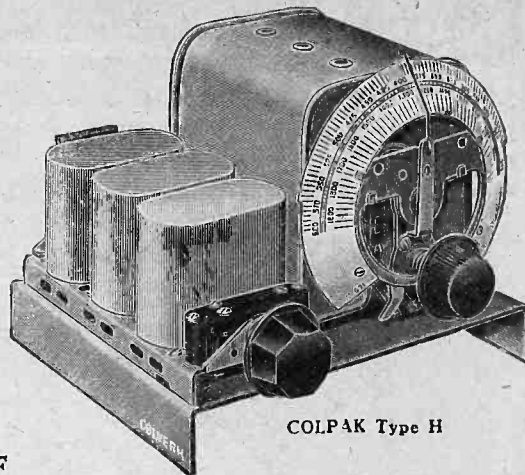

COLPAK Type H

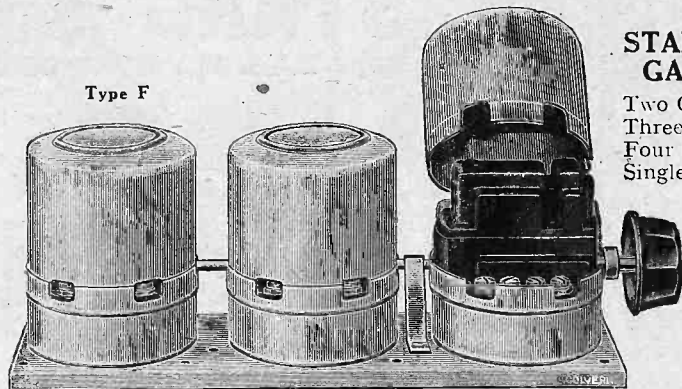

Type F

STANDARD Type F GANGED COILS

Two Gang ..	25/-
Three Gang ..	37/6
Four Gang ..	50/-
Single Coils ..	12/6

COLVERDYNE FERROCART INTERMEDIATES

Type FC 110 } 12/6 each
 Type FC 150 }
 With universal mounting bracket, limited capacity adjustment and band pass coupling controlled externally.

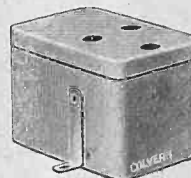

RADIOLYMPIA.
 August 15th—24th.
SEE OUR STAND No. 56

Send for the Colvern Ferrocart Booklet.

COLVERN LIMITED, MAWNEYS ROAD, ROMFORD, ESSEX
 London Wholesale Depot: 150, King's Cross Road, London, W.C.1

"My dear Watson...!"

... IT IS OBVIOUS THE VALVE HAS GONE .."

"It took me only a very short time to discover that—thanks to the 'All-in-One' Radiometer. With this invaluable instrument to help me I'll guarantee to track down any trouble in a few minutes."

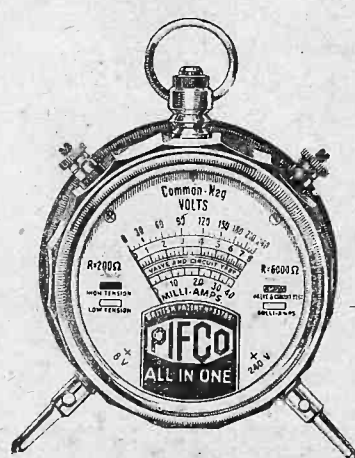

The "All-in-One" Radiometer is essential to every radio user. It tests everything, locates faults instantly and helps to keep any set in 100% condition. Ask your radio dealer about it, or write direct to:

PIFCO, LTD.,
 High Street, MANCHESTER, or 150, Charing Cross Road, London, W.C.2.

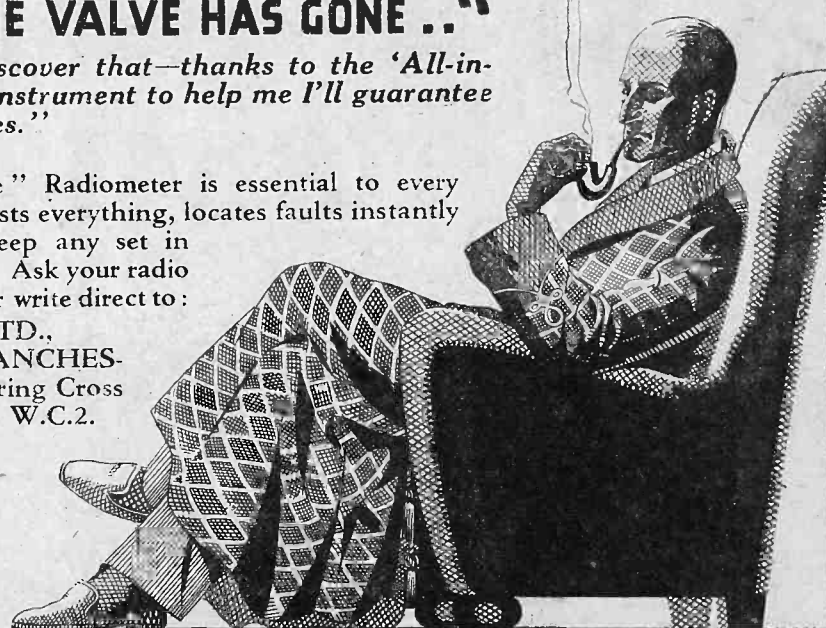

PIFCO ALL IN ONE RADIOMETER

Standard Model "All-in-One" Radiometer, for Battery Sets only, as shown here. Price **12'6**

De Luxe Model, for Battery Sets, Electric Receivers and Mains Units. Price - - - **£2:2**



POLAR CONDENSERS

SEND FOR
NEW POLAR
CATALOGUE

in ANY CIRCUIT mean
EFFICIENCY

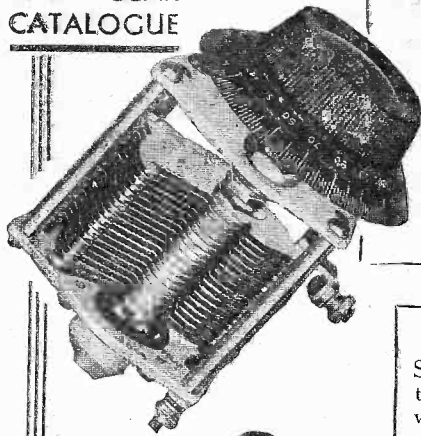

POLAR
No. 2.S.M.

The Polar fast- and slow-motion condenser. Made in aluminium. Ball bearings. Robust construction and rigid framework as illustration.

.0005 } 6/6
.0003 }

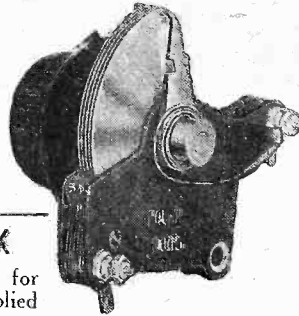

POLAR COMPAX

Solid dielectric. Suitable for tuning or reaction. Supplied with knob.

.0005, .0003, .00015, } 2/6
.0001, .00005 }

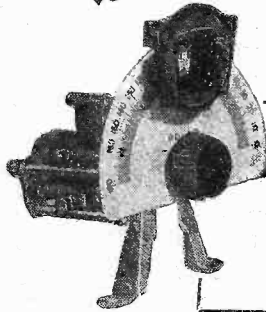

POLAR APERTURE

Latest design. Slow motion control. Baseboard mounting. Pleasing appearance. Fitted lampholder.

.0005, .0003 7/6

POLAR DIFFERENTIAL

Insulated spindle. Improved design. Supplied with knob.

.0001, .00015, .0003 3/-

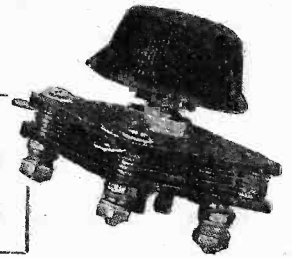

THE COMPLETE
POLAR RANGE AWAITS
YOUR INSPECTION ON

STAND 93
RADIOLYMPIA

WINGROVE & ROGERS, LTD.
188-189, STRAND, LONDON, W.C.2.

POLAR WORKS, OLD SWAN, LIVERPOOL. Grams: Compounded, Estrand. 8351

Once again...
chosen by "Practical Wireless"



**SMITH'S
ACCUMULATOR
2 volt 40 amp.
'ANODEX'**

120 volt 'class B'
H.T. BATTERY



Exclusively Specified for the
"AUTO B3"

S. SMITH & SONS (Motor

Accessories) LTD., CRICKLEWOOD, LONDON, N.W.2

REVOLUTIONARY
Dispenses with UNSIGHTLY AERIALS
GIVES BETTER, CLEARER RADIO IN ANY ROOM

No longer be bothered with an ugly aerial or with overlapping programmes. Make a vast improvement in the performance of your set by discarding your present aerial altogether and connecting up to the AIRCLIPSE Auto-Inductive Aerial. You will be astonished at the immediate difference, at sharper tuning, and clearer reception. The AIRCLIPSE, with its principle of auto-induction, filters incoming signals. It increases selectivity and sensitivity—gets distant stations with amazing clarity. Tests prove that it equals the best outdoor aerial and far surpasses any indoor aerial. Placed inside or outside the set. Enables any set to be moved from room to room. Eliminates all danger from lightning. For A.C. and Battery Sets.

AIRCLIPSE PROV. PAT. 9377/33
AUTO-INDUCTIVE AERIAL

Of all dealers or in case of difficulty order direct from:
 AIRCLIPSE LTD., 182, VAUXHALL BRIDGE ROAD, LONDON, S.W.1
 Telephone: Victoria 5022.

Combine HIGH QUALITY

with LOW PRICES

THE BEST BETWEEN AERIAL AND EARTH

The HIVAC range comprises a series of first quality, inexpensive 2-volt valves that are second to none for efficiency. Whatever the circuit, there's a HIVAC to suit. For efficiency with economy, fit HIVAC in all stages.

THE HIVAC VALVE GUIDE "N" gives our complete range and a comparative table of equivalent high efficiency valves at low cost.

WRITE NOW FOR A FREE COPY Here are 5 types for modern circuits :

- H.210: Grid Det. or Oscillator in Superhets **4/6**
- L.210: 1st stage L.F. Amplifier or Anode Bend Det. and Driver.
- B.220: Class-B. Anode-anode load 14,500. A.C. output in milliwatts, 1,250 **10/6**
- VS.210: Vari-mu H.F. Amplifier
- Y.220: Multi-Grid, low consumption **12/6**

IMPORTANT—Hivac Valves are British Made in our own Factory. From all dealers. If any difficulty, send us P/O and address of nearest dealer.

STAND 108 RADIOLYMPIA
HIVAC
 THE SCIENTIFIC VALVE
 HIGH VACUUM 113-117, Farringdon VALVE Co., Ltd. Road, E.C.1.

CHARACTERISTICS

- Primary resistance 400 ohms
- Half of Secondary (full) 150 ohms
- Half of Secondary (tapped) 100 ohms
- Inductance, using average 2 m.a. driver valve on average signals, 35 henries.
- Ratios: Outer terminals, 1 to 1; half, 2 to 1; Tap, 1.5 to 1; Half Tap, 3 to 1.

TYPE B.J. PRICE **8/6**

The NEW WEARITE B-MAG TRANSFORMER

Selected for F. J. CAMM'S "1934 SUPER-HET"

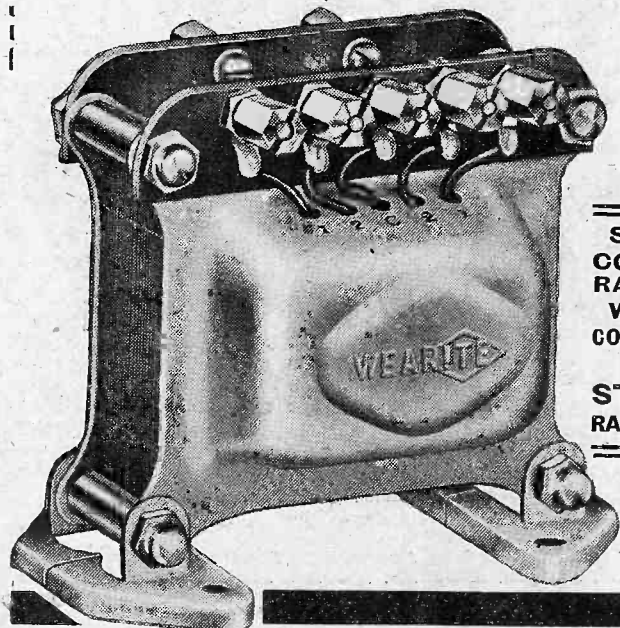

SEE THE COMPLETE RANGE OF WEARITE COMPONENTS on **STAND 1 RADIOLYMPIA**

Excellent characteristics and a workman-like looking job are what the designer considered when selecting this Transformer for his "1934 Super."

For the same reasons he insists that you use the WEARITE 25,000 OHM POTENTIOMETER (PRICE, 4s. 6d.). Wearite is a by-word for reliability. Send for your copy of the Wearite Book before you start any Set.

Get your copy of the NEW WEARITE BOOK NOW—Send Coupon



COUPON To Messrs. WRIGHT & WEAIRE, Ltd., 740, High Road, Tottenham, London, N.17.

Please send me a copy of your new booklet, No. G.N.2, giving full details of your components and how to use them, together with technical data. I enclose 3d. in stamps to cover cost and postage.

NAME

ADDRESS

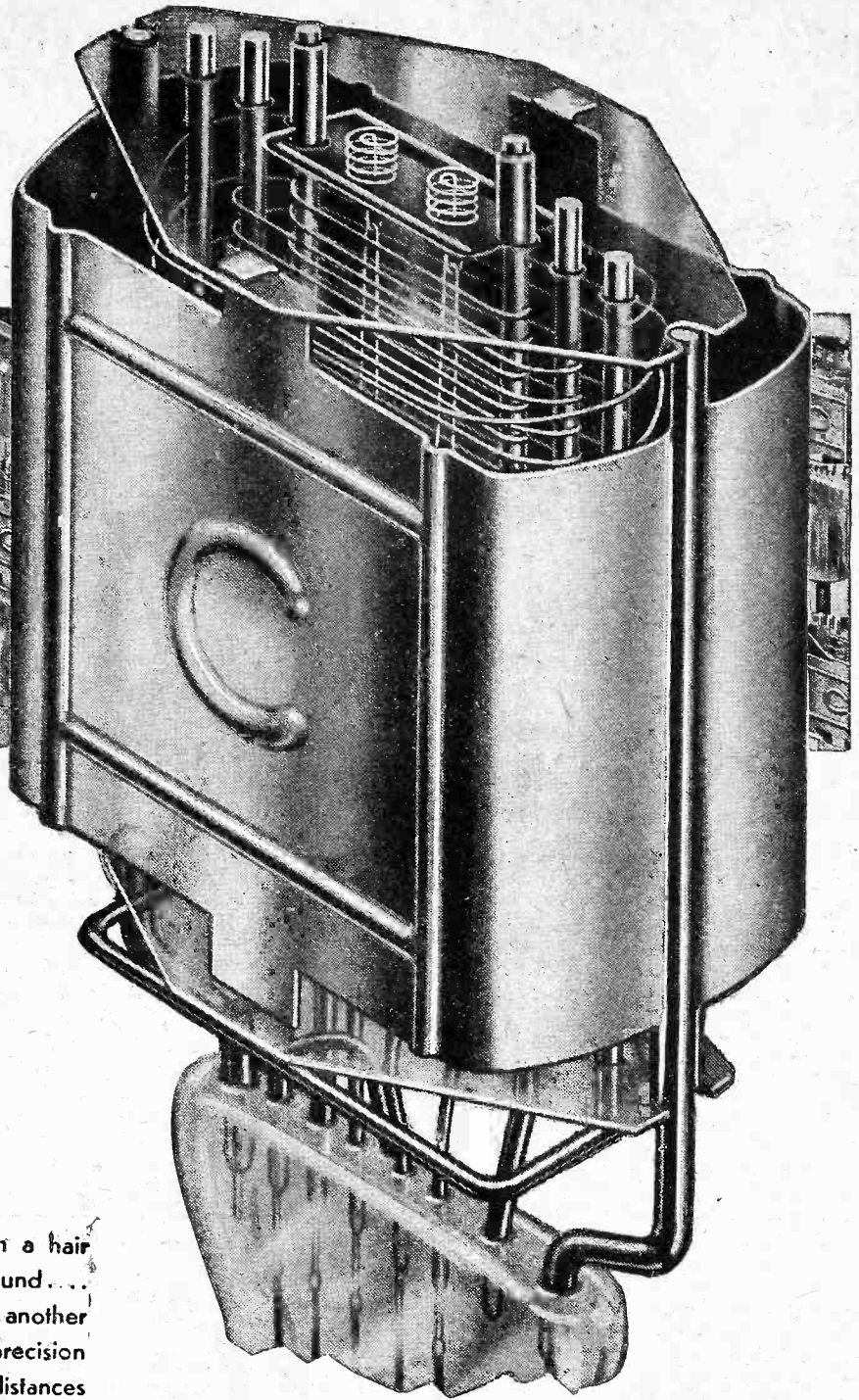
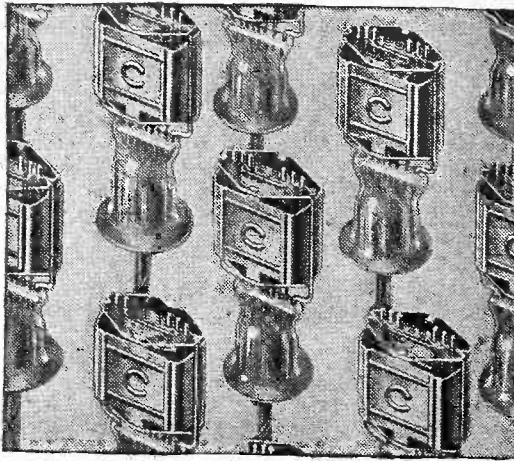

ACCURACY

... meticulous ...
microscopic

MACHINES whirr . . . filaments finer than a hair . . . nimble fingers work . . . grids are wound . . . anodes pressed . . . a hundred operations . . . another Cossor Valve is made . . . made with the precision of a watch . . . accurate . . . microscopic distances exactly spaced . . . meticulous accuracy . . . accuracy that ensures that your Cossor Valve . . . wherever you buy it . . . whatever its type . . . is the exact counterpart of the original laboratory-developed design.

COSSOR VALVES

To A. C. COSSOR LTD., Melody Dept., Highbury Grove, London, N.5.

Please send me, free of charge, a copy of the 40-page Cossor Valve and Wireless Book B.17.

Name

Address

PRAC. 26/8/33.

Send for a free copy of the 40-page Cossor Valve and Wireless Book which contains a wealth of interesting and useful information including Radio Definitions—Useful Circuits—List of Stations, etc., etc. Please use the Coupon.

A. C. Cossor Ltd., Highbury Grove, London, N.5. Depots at Birmingham, Bristol, Glasgow, Leeds, Liverpool, Manchester, Newcastle, Sheffield, Belfast and Dublin.

3313

THE LEADING HOME CONSTRUCTORS' WEEKLY!



EDITOR :
 Vol. II. No. 49 || **F. J. GAMM** || August 26th, 1933
Technical Staff :
 H. J. Barton Chapple, Wh.Sch., B.Sc. (Hons.), A.M.I.E.E.
 W. J. Delaney, Frank Preston, F.R.A., W. B. Richardson

ROUND *the* WORLD of WIRELESS

Our First Show Issue

MANY thanks to the hundreds of readers who have taken the trouble to write to us congratulatory letters on our last week's first enlarged Show Issue. That issue, together with this week's issue, should be carefully preserved as a complete guide to current programmes, prices, and tendencies. As readers can easily imagine, the editorial offices have been for many weeks past the scene of strenuous activities and long hours of work in preparing (Real Reader Service again!) the special Printer's Pies necessitated by Radiolympia. Our thanks also to those many readers who called at our Stand on the opening day of the Exhibition to express their appreciation of the paper itself, its policy, its outlook, and its real, reliable, and unrivalled reader service—a service which is without parallel in radio journalism.

Radio and the Norwegian Fishermen

THE nationalization of the Norwegian broadcasting network is to be followed by Government assistance to the fishing industry. In future all trawlers, smacks and other coastal and seagoing craft will be equipped with wireless receivers. Special broadcasts destined in particular to these ships are to be made by a number of stations, such as Stavanger, Bergen, etc., and at fixed hours during the day information collected by Government seaplanes will be given in respect of the best fishing grounds, state of weather and other items of interest to the industry. News bulletins, market quotations in Norway and other countries and especially gale warnings will be transmitted at more frequent intervals than has hitherto been the case.

Allo ! Ici Tunis Kasbah

THE French military station at La Kasbah (Tunisia) which for some time had suspended its broadcasts, with the assistance of local wireless associations has now resumed its daily transmissions. The wavelength used is slightly higher than the channel previously adopted, namely 1,275 metres; the power of the transmitter has

been increased to roughly 1½ kilowatt. The main evening transmission, starting at B.S.T. 20.30, opens with the announcer counting numbers in a similar way to the principal adopted by other French stations. There are no broadcasts on Sundays. The programmes consist of news bulletins, weather forecasts, time signals and musical items contributed by local talent. An effort is to be made to relay broadcasts from Paris studios. All announcements are made in the French language and the station

Radio and the Chilean Army

WITH a view to popularizing "listening" as a pastime throughout all classes of the community and also, incidentally, to curtail imports of foreign wireless apparatus, the Chilean War Ministry has made arrangements to open special technical classes for members of its army. Tuition in all radio matters and especially in the construction of wireless sets is to be given by qualified engineers. The Government has in view the establishment of military works for the manufacture of both receivers and transmitters. By this means it is hoped to supply apparatus at a low cost to the general public and thus encourage in Chile the development of the industry.

Proposed Zionist Broadcasting Station

IF a report from Prague is to be credited, at the Zionist congress to be held in that city in August, a proposal is to be put forward to install an all-Jewish broadcasting station somewhere in central Europe. Although no mention has been made of any particular country it has been suggested that a suitable site could be found in either Czechoslovakia or Romania. The report states that sufficient capital for the installation of a high-power transmitter would be promptly subscribed providing the need for such a station is satisfactorily demonstrated.

SATISFACTORY SERVICE

PRACTICAL WIRELESS answers every reader's question Free of Charge.

PRACTICAL WIRELESS guarantees its receivers (when built from our recommended components) to perform in the manner claimed, under a Free Advice Guarantee.

Every worth-while development is first brought to the notice of the home constructor through the columns of **PRACTICAL WIRELESS**. Only components which readers can purchase are dealt with.

PRACTICAL WIRELESS could not do justice to the vast number of "firsts" to its credit in the small space here available. Several columns would be required. There is hence complete justification for our slogan: "Real, Reliable, and Unrivalled Reader Service."

PRACTICAL WIRELESS is the **LEADING HOME CONSTRUCTORS' WEEKLY.**

closes down with the conventional "Bon Soir," followed by the playing of "La Marseillaise."

Kalundborg on the Air

THE new 75 kilowatt Kalundborg (Denmark) transmitter relaying the Copenhagen programmes has now been heard nightly since July 18th and it is expected that the station will be officially opened at an early date. The main reason for the erection of this heftier plant was the desire of the Danish Government to enable broadcasts to be well heard in Iceland and Greenland. In future all announcements in the programmes will be given out in German and English as well as in the Danish language.

Novelties and Composer-Conductors

SEVERAL first performances are to be heard at Queen's Hall during the forthcoming season of Promenade Concerts, though perhaps on the whole the year has not proved very fruitful in new orchestral music of outstanding interest. The most eagerly expected novelty in the programmes is unquestionably Frederick Delius's new "Idyll" for soprano, baritone and orchestra, which is to be given on October 3, with Miss Olga Haley and Mr. Roy Henderson, two well-known Delius specialists, in the solo parts. The invalid composer is, unhappily, no longer able to write, but the musical world has much cause to be thankful that he remains in full possession of his faculties.

ROUND *the* WORLD of WIRELESS (Continued)

Swiss Common Wave

THE Berne station has reverted to its original wavelength of 245.9 m. as the experiments tried in transmitting these programmes on a channel common to Basle proved unsuccessful.

Radio Toulouse Concerts

AN early-morning transmission may now be heard from Radio Toulouse as the station is already on the air at 8 a.m. B.S.T. Moreover, the midday broadcast has also been extended until 2 p.m. In regard to programmes apart from these minor alterations, the schedule remains the same as for the old transmitter, and concerts are broadcast throughout the day until past midnight.

Hier Hilversum de A.V.R.O.

THE A.V.R.O., undoubtedly the largest association of radio listeners, recently celebrated its tenth anniversary. By the end of the year it is anticipated that its membership will reach the 200,000 mark. Although a private organization, which receives no subsidy from the Dutch Government, it gives work to a staff numbering over two hundred persons, possesses large headquarters at Amsterdam, and has built several modern studios at Hilversum. At present the broadcasts are carried out through the Kootwijk (PTT) transmitter on 1,875 metres.

Hear the Vienna Programmes

THE new Vienna - Bisamberg station now broadcasts from 11.30 a.m. B.S.T. daily, and will continue to carry out these duties until the new reflector aerial tower is ready to be erected. During its installation the programmes will be transmitted by the old Rosenhügel station until 5 p.m. daily. UOR 2, the short-wave transmitter, has been closed down for a complete overhaul; its power is to be increased.

Vienna's New Call

WITH the opening of the Bisamberg high-power station, which, with its greater range, covers considerably more than the Austrian capital, the call from Vienna is likely to be altered. Viennese listeners suggest that the announcer should not introduce the station to the unseen audience abroad as *Radio Wien*, but that as the voice of the Republic it should be known as *Radio Oesterreich* (Austria). However, if you do not recognise the transmitter under that name, listen for the metronome interval signal of which the rapid "tick-tock" is so familiar to us.

U.S.S.R. and German Broadcasts

MOST of us are familiar with the international broadcasts in various languages put out almost nightly by the Moscow and Leningrad transmitters, but programmes in German from Kiev on 1,034.5 metres will come as a surprise to some listeners. These are given on Sundays Thursdays and Saturdays between B.S.T. 22.00 and 23.00, and are usually accom-

INTERESTING and TOPICAL PARAGRAPHS.



PUZZLE, FIND THE B.B.C. CIRCUITS!

Among this mass of cables, 100 in all, containing 70,000 circuits, are the important B.B.C. circuits. They have all to be removed to a different position in Holborn to make room for Tube station improvements. No circuit has to be interfered with. Among this nightmare of wiring are to be found wires along which some of your favourite broadcasts have been carried.

SOLVE THIS!

Problem No. 49.

Lawrence built a two-valve short-wave receiver and connected it to his aerial ready for a preliminary test. Adjusting the 'phones, he rotated the tuning dial through a complete revolution, but heard no signals. The reaction control seemed to have no effect, and he was just going to remove the 'phones to test the circuit wiring, when he was surprised to hear his neighbour giving a 'phone number. He listened for a moment, and was startled to hear quite clearly the whole of the 'phone conversation, during which he found that the tuning condenser in his receiver made no difference to the strength of this signal. What was wrong with his set? Three books will be awarded for the first three correct solutions opened. Address your envelopes to The Editor, PRACTICAL WIRELESS, Geo. Newnes Ltd., 8-11, Southampton Street, Strand, London, W.C.2. All entries must be received not later than August 25th, and envelopes should be marked Problem No. 49.

SOLUTION TO PROBLEM, No. 48.

The mains transformer had broken down and several turns of the secondary were short-circuited. If Ratcliffe had felt the transformer he would have known of the trouble due to the heat which would have been generated.

The following three readers received books in connection with Problem No. 47:—
Mr. A. Labund, 59, Belgrave Avenue, Watford.
Mr. J. M. Gambles, 14, St. Matthias Terrace, Torquay.
Mr. W. P. Howard, 43, White Horse Street, Stepney, E.1.

panied by an orchestral and vocal concert. As is customary at most Russian studios the announcer is a woman.

Some Spark!

TWO well-known French physicists, d'Arsonval and Georges Claude, recently risked their lives in a laboratory experiment involving an electrical discharge at a pressure of some three millions of volts. The test was made during the night, and as the discharge was accompanied by a hefty thunder-clap, the immediate neighbourhood was rudely awakened. The local authorities have since requested the experimenters to give due warning of any other similar electrical "stunts" they may wish to indulge in at a future date!

German Station for Czechoslovakia

IN view of the large German-speaking population in certain parts of the country—formerly the Austrian province of Bohemia—it is proposed to erect a special transmitter from which an all-German programme could be broadcast daily. The plan is receiving favourable consideration from the authorities inasmuch as it is thought preferable to the alternative of listening to transmissions from Germany direct.

French Census of Listeners

WITH the bringing into operation of the new licensing tax some idea may now be obtained of the number of wireless sets owned by listeners in France. Up to the present in the Paris region only roughly six hundred thousand have been registered, yet the capital possesses seven broadcasting stations. It is estimated that the total number of listeners in France will not exceed two million.

Going South

UNDER this title Derek McCulloch has strung together a series of local cameos depicting life in the Southern States as seen through the eyes of a Negro Pullman car attendant on a train travelling from New York to New Orleans. You will hear these tone pictures in the National programme on August 30. *Going South* includes a number of plantation songs and Negro spirituals presented in their true atmosphere.

Is Radio a Luxury?

IN Kosice (Czechoslovakia), when this question was brought up in a case of bankruptcy, the judge decided that a wireless receiver was not a luxury article, but a necessity, inasmuch as through this medium people were enabled to complete their education. It was just as much a necessary article of the household as an ordinary sewing-machine.

Radio Paris P.T.T.

ACCORDING to a French journal, Radio Paris will be nationalized and included in the French State radio network on January 1st, 1934. From that date it is possible that sponsored programmes and microphone publicity may be discontinued.

ANOTHER OUTSTANDING
"PRACTICAL
WIRELESS"
RECEIVER!



The Set that Supersedes

Every Worth-while Improvement Incorporated in This New-season's Five-valve Battery Receiver for Home Constructors. Iron-core Coils—Class B Output—Metallized Wooden Chassis—Two Variable- μ Stages—Simple and Few Controls—Special Tone Control—New Cabinet Design.

By F. J. GAMM.

OWING to the tremendous pressure on our space this week I am not able in these notes to give complete details for the setting up and operation of this new and efficient receiver. I must, therefore, restrict this week's notes to a brief discussion of the more salient points, in order that those who have already finished the receiver may obtain some results whilst waiting for complete and detailed instructions. Obviously, the first point of importance is the installation of the receiver, and although not difficult, if once correctly carried out this part of the work may be ignored and full attention paid to the tuning adjustments, etc. At the rear of the receiver are three terminals for aerial and earth connections, and three for the loud-speaker connections. On the special Microlode speaker which I recommend will also be found three terminals. These must be joined to the three terminals marked L.S. and H.T., with the latter terminal joined to the centre one of the three on the loudspeaker. Do not make any mistake with this lead. The aerial, for a start, should be joined to terminal

A2, and the earth lead then connected to terminal E. Push the radiogram switch in, and ignore, for the time being, the pick-up terminals.

Battery Voltages

The insertion of the battery lead plugs in the correct positions is essential, and must be carried out as follows. The two leads marked L.T.— and L.T.+ are connected to the accumulator, the positive tag being joined to the red terminal. H.T.— and G.B.+ are each inserted in the respective battery sockets bearing similar marks. The remaining plugs require more careful positioning, and the following sockets should be used temporarily. H.T. 1 should be inserted in a socket on the H.T. battery round about 80 volts,

and H.T. 2 into the 120-volt socket. G.B.1 should be inserted into the 1.5 volt tapping on the grid bias battery, whilst G.B.2 should be inserted in the 4.5 volt tapping. The receiver is now ready for a preliminary test. Turn the wave-change switch control to the right (clockwise), and set the lower right-hand control (marked Volume Control on the sketch on page 694 of last week's issue) to a position approximately half-way round. The Controlatone control should also be turned to a position midway between its two end positions. Pull out the On-Off switch, and you should hear a faint rushing sound from the loud-speaker. If, however, a loud whistle greets you, switch off at once, and adjust the position of the plug marked H.T.1. This should be inserted in such a position that the volume control knob

(Continued on page 836.)

LIST OF COMPONENTS FOR THE 1934 SUPERSET.

One Three-gang Condenser with full-vision scale (Type 604) (British Radiophone).
Three Iron Core Coils—one Aerial and two H.F. (Lissen).
One Class B. Driver Transformer (Wearite).
Two Superhet H.F. Chokes (Bulgin).
One Midget H.F. Choke (Bulgin).
One Type 34 .0001 mfd. Fixed Condenser (T.C.C.).
One Type 34 .002 mfd. Fixed Condenser (T.C.C.).
Two Type 50 2 mfd. Fixed Condensers (T.C.C.).
Five Type 50 1 mfd. Fixed Condensers (T.C.C.).
Two Type 34 .0002 mfd. Fixed Condensers (T.C.C.).
One Type 23 Component Bracket (British Radiogram).
Two Type 21 Component Brackets (British Radiogram).
One "Nictet" L.F. Transformer (Varley).
One 25,000 ohm Potentiometer (Wearite).
One Type B "Controlatone" (Bulgin).
Four 4-pin Chassis type Valve-holders (Clix).
One 7-pin Chassis type Valve-holder (Clix).
Ten "Ohmites"—500, 500, 500, 500, 8,000, 40,000, 35,000, 60,000, 80,000 ohms and 2 megohms (Graham Farish).
Eight Junior Type Terminals, A1, A2, E, P.U., P.U., L.S.—, H.T., and L.S.— (Belling-Lee).
One Type 50 S.P.D.T. Switch (British Radiogram).
One Type 50 3-point Switch (British Radiogram).
One eight-way Battery Cord (Belling-Lee).
One "Metaplex" Chassis (Peto-Scott).
One W.B. Microlode Loud-speaker (Type P.M. 4A).
Two Type 220 V.S. Valves (Cossor).
One Type 210 H.F. Valve (Cossor).
One Type 215 P. Valve (Cossor).
One Type 220 B. Valve (Cossor).
One 120-volt H.T. Battery (Ediswan).
One 9-volt G.B. Battery (Ediswan).
One 2-volt 40-ampere L.T. Accumulator (Ediswan).
One "Superset" Cabinet (Osborn).
One Length Recepter Screened Down Lead (British Radiophone).
One Filtr Earthing Device (Graham Farish).

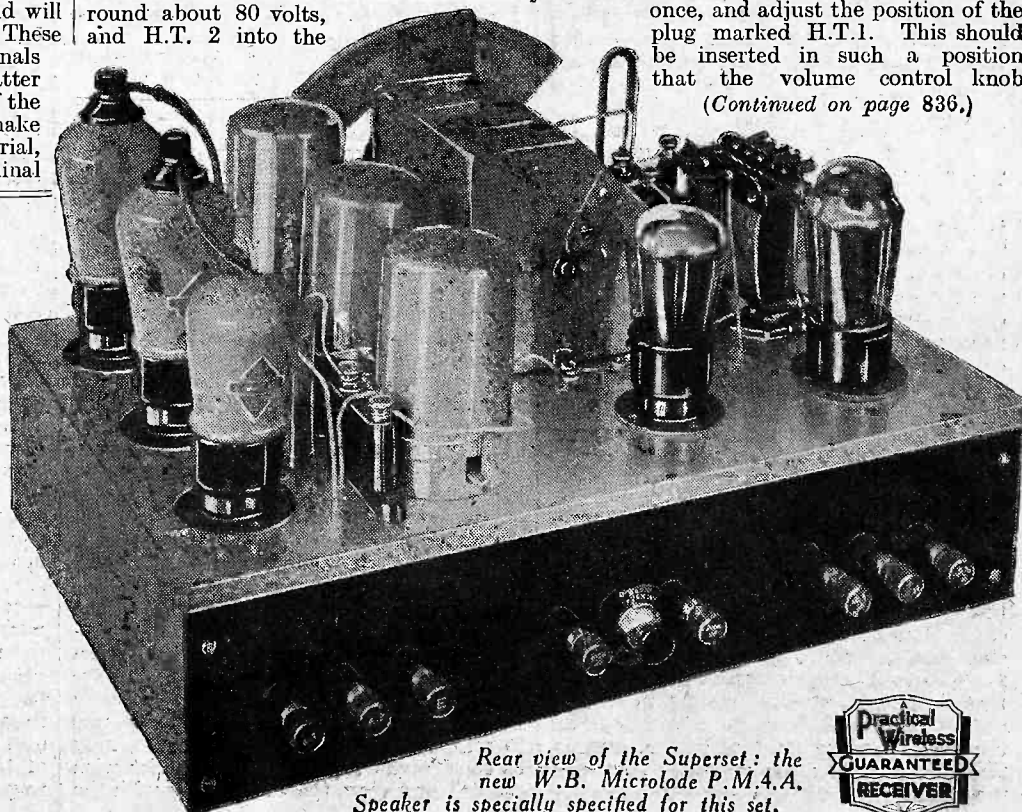

Rear view of the Superset: the new W.B. Microlode P.M.4.A. Speaker is specially specified for this set.



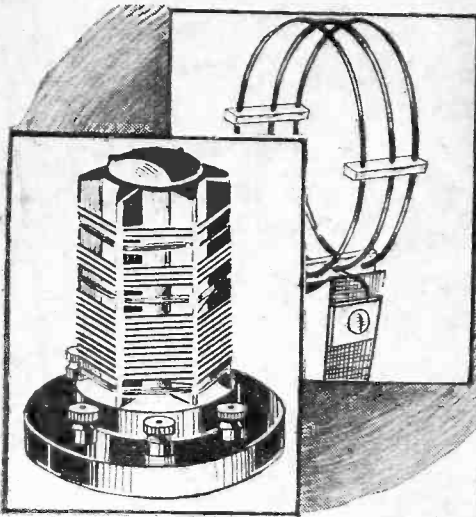

Coils for SHORT WAVE RECEIVERS

By K. E. BRIAN JAY

(Concluded from page 670, August 12th issue.)

THE second thing we notice about a short-wave coil is the use of a skeleton former, or sometimes no former at all, the coils being of thick wire held rigid by threading three or four ebonite spacing strips on to it. The reason for this type of construction is this: the adjacent turns of a coil form in effect a small fixed condenser, because each pair of turns can be regarded as two annular metal plates separated by an insulator, which in the case of close-wound coils of covered wire consists of the covering and the material of which the former is made. Now, as is well known, the capacity of a condenser is always increased when anything but air is used for the dielectric and also when the distance between the plates is decreased; consequently the use of covered wires wound close together on an insulating former will make the little condensers, formed by the turns of wire, of higher capacity than would be the case when a bare wire, self-supporting winding is adopted. The net result is that the skeleton type of winding has a lower "self-capacity" than any other type. Furthermore the effect of the former is not confined to increasing the capacity, because dielectrics vary in their efficiency, since they actually absorb a little power in doing their work and some absorb more than others.

The Number of Turns

The third thing about a short-wave coil is that the number of turns is very small. This, of course, cannot be helped; if your circuit is to be used at short wavelengths the inductance must be small, and so the coil can only have a few turns. The necessity for so few turns gives rise to complications, however, that may be more important than the obvious sources of loss, such as the resistance and self-capacity we have discussed above. We have already seen, from the formula $2\pi fL$, that the

R

magnification of the coil is directly proportional to the inductance, that is to say, that the bigger the coil the louder the signals. The importance of this has been brought out very clearly by an American experimenter, who showed that whereas changing the gauge of the wire of a coil from 30 to 20 only increased the efficiency by 9.8 per cent. at 41.67 metres, increasing the inductance of the coil to about $2\frac{1}{2}$ times the original value (and, of course, proportionately reducing the capacity) increased the efficiency by 61 per cent. This clearly demonstrates the desirability of using as

much coil and as little condenser as possible, but here we are up against another difficulty. In order to obtain this desirable gain in efficiency we must use a variable condenser having a small maximum capacity, but, unless we are prepared to use several plug-in coils the lower limit of permissible maximum capacity is restricted by the necessity of covering a reasonably wide band of wavelengths. If we could make a receiver with negligible stray capacities and a coil with negligible self-capacity then, provided our variable condenser had a very small minimum capacity, we should be able to get adequate wavelength coverage with

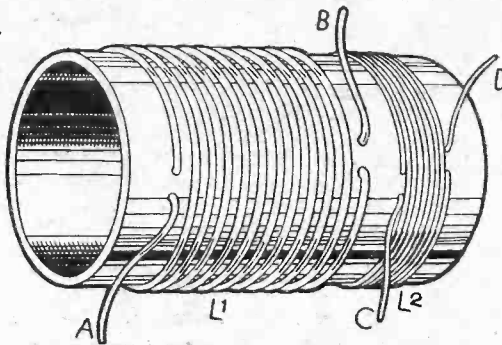

Fig. 2.—How the coil should be wound to ensure that smooth reaction is obtained.

TABLE 1

No. of turns	Wavelength range in metres obtained with condensers of		
	.0001 mfd.	.00015 mfd.	.0002 mfd.
13	31.38 to 71.40	31.38 to 79.40	32.30 to 91.00
11	27.30 to 58.80	27.30 to 85.20	31.25 to 71.40
7	22.90 to 47.60	22.90 to 52.70	23.40 to 58.80
4	16.80 to 34.20	16.80 to 37.50	17.80 to 40.30

quite a small condenser. Since none of these things can be realised in practice, however, we have to compromise.

The type of coil which I have taken as an example of current practice is one that is inevitably associated with the idea of short-wave reception, and because it gives an impression of complication it is one of the things that tends to frighten people off short-wave work. If you have contemplated one of these impressive structures and come to the conclusion that it's all too difficult, do try again; wind a few turns of any covered wire you happen to have between say 22 and 28 S.W.G. on a two-inch cardboard tube and find out for yourself that it is really quite easy. I have shown that the skeleton type of winding has been adopted to combat the losses due to self-capacity, which, within limits, may be considered as a resistance in series with the coil and may, therefore, along with the actual resistance of the winding, be very

largely nullified by a proper use of reaction. Add to this the fact that the large field of skeleton type coils is bound to give rise to eddy current losses, instability and hand capacity effects and we have made out quite a good case for using small diameter, thin wire coils. That these will work is borne out by my own experience, for the coils I use on all waves from 60 to 14 metres are wound with 26 D.C.C., or D.S.C. wire on the bakelite bases of burnt-out valves. This type of construction was adopted in order to provide a simple and standard plug-in coil, the need for the plug-in arrangement arising from the very considerable degree of band-spreading required for listening to amateur transmissions and the preference for using a big coil and small condenser. I should, however, hesitate to recommend this particular construction for everyone because one cannot be too sure of the efficiency as a high frequency dielectric of the material of the valve bases.

Sources of Inefficiency

As a basis for design I suggest something like this: that the coil be wound of D.C.C. wire between 22 and 26 S.W.G. on ribbed ebonite or bakelite formers not more than $1\frac{1}{2}$ in. in diameter, the turns being spaced a distance equal to the wire diameter. It is difficult to say how many turns will be needed because of the very wide variations that are certain to occur between individual circuit and valve capacities; in order to provide some data on which to work, the approximate wave ranges of a series of coils were measured and are tabulated in Table 1. The windings were of 22 S.W.G. wire spaced by approximately the wire diameter. Reaction windings should be of thin wire (I used 36 D.S.C.) wound near the earthed end of the grid coils, the turns being close together. The number of turns needed will usually be two or three less than the number in the grid coil, but this is a matter for experiment. Considerable divergences from the figures for minimum wavelengths may be expected and generally they should be rather smaller than those given, because the stray capacities were rather high in the receiver used to make the measurements. In computing the maximum capacity of the condenser across the coil do not forget that, if a band spread arrangement is used the total capacity is equal to the sum of the maximum capacities of C_1 and C_2 , the two variable condensers. A dual range coil to cover the most useful part of the short-wave band was made by winding on 11 turns and tapping at 4 turns from the grid end, shorting the 7 turns between this tap and the earthed end of the coil when the shorter waveband was required. The reaction winding consisted of 4 turns wound between the two sections of the grid winding and another 5 turns wound at the end of the larger (7 turn) section.

STILL LEADING AND SHOWING THE WAY!



The Auto-B Three

Every Home Constructor Should Build This Class B Receiver, which is the First Class B Set to Use Automatic Grid Bias. By W. J. DELANEY

If you carefully carried out the constructional details which were given last week you should have experienced no difficulties of any kind and the receiver should be in a condition ready for the first test. Of course, you may have finished the receiver within a few hours of obtaining all the parts and already have found out its capabilities. However, it will not require a great deal of space to instruct you in the use of this ingenious little receiver, as it is of the very simplest design so far as operating is concerned. As there is only one tuning condenser you have no worries regarding circuit ganging, and although there may appear at first sight to be rather a large array of controls on the panel these are actually very few. For instance, the central knob immediately below the escutcheon is the main tuning control and this is simply rotated in order to select the station to which you wish to listen. The knob immediately to the left of this changes the range over which you can tune, from the medium-wave band to the long-wave band. In the majority of cases, therefore, all that will be necessary will be to turn the wave-change switch to the required band and tune in the station on the central knob. However, this is rather anticipating matters so far as the

Adjusting and Operating Notes for this Ingenious Receiver which Dispenses Entirely with the Grid-bias Battery

beginner is concerned, so perhaps I had better go through the operating instructions rather more explicitly on the assumption that you are a complete newcomer to radio and have chosen this admirable receiver as your first constructional venture.

Connecting Up

The battery cords each carry at the end a clearly marked plug, and if you wired up the receiver correctly these plugs—as shown on the blueprint or wiring diagram—must be inserted into the correct battery positions. For instance, two of the cords carry a form of spade-end lettered L.T.— and L.T.+. These must be attached to the terminals of the 2-volt accumulator, the black spade (L.T.—) being attached to the black terminal on the accumulator and the red spade fitted to the remaining accumulator terminal. There are only two leads

left and these carry a wander plug marked H.T.— and H.T.+. The former is inserted into the end socket of the H.T. battery marked with a similar negative sign, whilst the positive plug is inserted into the socket marked 120 volts. As was mentioned in the previous article no grid-bias battery is required with this receiver and therefore the battery connections are reduced to the very minimum and should occasion no trouble to even the youngest listener. Now at the rear of the receiver chassis there are three terminals at either end, and two in the centre. In between these latter terminals is the radiogram switch and this must be set to enable the radio to be heard for the preliminary test. If you fitted it exactly as shown in the wiring diagram, the small toggle of the switch should be pushed to the top right for this purpose. Now on the speaker will be seen three terminals, and these have to be joined to the three terminals on the receiver marked L.S., H.T. and L.S. Join the centre terminal of these three to the centre terminal on the speaker and then connect up the remaining two terminals. It will

(Continued overleaf)

LIST OF COMPONENTS FOR THE AUTO-"B" THREE

- One "Magnum" Auto-"B" Metal Chassis (Burne Jones).
- One .0005 mfd. Variable Condenser with Vernier Dial (Telsen).
- One .0003 mfd. Reaction Condenser (Telsen).
- One Type "F.5" "Ferrocart" Coil (Colvern).
- Two 4-pin sub-baseboard Valve-holders (Clix).
- One 7-pin sub-baseboard Valve-holder (Clix).
- One On-Off Switch (Busby).
- One "Toco" 4-1 L.F. Transformer (Multitone).
- One Graded Potentiometer (Multitone).
- One Class B 1-1.5_ratio Driver Transformer (Multitone).
- One 8 mfd. Electrolytic Condenser (Peak).
- Two 1 mfd. Condensers (Peak).
- Three .0001 mfd. Type "M" Condensers (T.C.C.).
- Two .01 mfd. Condensers (Peak).
- One Type "L.M.S." H.F. Choke (Graham Farish).
- One 2 megohm Grid Leak (Dubilier).
- One 250,000 ohm Resistance (Erie). 1
- One 25,000 ohm Resistance (Erie).
- One 500 ohm Resistance (Erie).
- Eight Treble Duty Terminals, Marked "Aerial," "Aerial 2," "Earth," "Loud-speaker—" "Loud-speaker—" "H.T.+", Two "Pick-up" (Ecelex).
- One Four-Way Battery Cord (Belling Lee).
- One 210 Det. Valve (Cossor).
- One 215 P. Valve (Cossor).
- One 240 B. Valve (Cossor).
- One Auto-B. Cabinet (Camco).
- One "Sonette" Loud-speaker (Amplion).
- One 120-volt Annodex Class "B" H.T. Battery (Smiths).
- One 2-volt 40-Ampere Hour L.T. Accumulator (Smiths).
- One Coil Glazite.
- One Length Receptu Screened Down Lead (British Radiophone).
- One Filt Earthing Device (Graham Farish).
- One Toggle Switch (Type 460) (Becker).

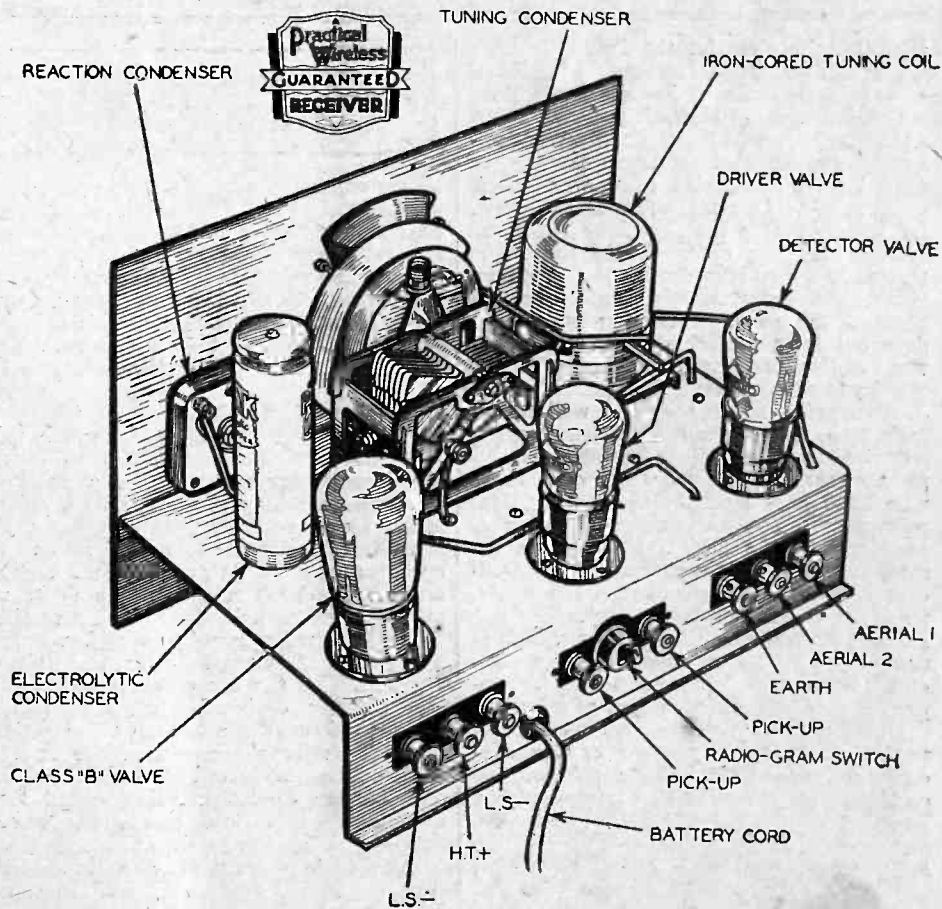

Our artist's impression of the Auto-"B" Three.

THE AUTO-"B" THREE

(Continued from previous page)

not matter which L.S. terminal is joined to the respective receiver terminal so long as the two sets of three terminals are joined together, with the two centre terminals connected. This is most important as the loud-speaker carries the coupling transformer for the two halves of the Class B valve, and the centre tap must be joined to H.T. positive. This positive return is made in the receiver and must be correctly maintained.

Aerial and Earth

The question of the aerial/earth system is vital, and it is hopeless to build up a good receiver and connect it to an inefficient aerial or earth and then blame the receiver for producing inferior results. It should, of course, be obvious that the wireless signals are conveyed to the receiver through the medium of the aerial and lead-in, and if this is of very small dimensions, or slung up in between some high trees it will obviously be heavily screened and will not pick up sufficient energy to enable the detector valve in the Auto-B to pass on a strong enough signal to derive the utmost from the Class B stage. Remember that this will deliver 2 watts when fully loaded. It will not give you two watts if you try to receive a station 200 miles away on a few feet of wire hung up in a cellar. Therefore give the valves a chance and spend a little time in erecting a really good aerial/earth system. The principal points to aim at are:—

1. Height.
2. Insulation.
3. Efficiency.

The height may be obtained either by fitting a good pole, or by using a tree or

similar support. Fit a good chain of insulators (not less than 3) at the end and use the well-known aerial wire consisting of seven strands of 22-gauge wire (known as 7/22's). At the house end fit a length of strong rope or wire to a chimney stack or in a staple and take the aerial wire to another chain of insulators attached to this. Now attach a length of Receptru to this junction. This material will ensure that any local electrical interference is reduced to minimum. Carry out the makers' instructions regarding the earthing of the screen, etc., and carry the lead-in carefully to the receiver. Do not run the lead-in across a room. Place the receiver on a table or similar stand close to the window where the lead-in enters the room. The earth is obtained by connecting the lead to the terminal on the small copper canister in the Filt carton, and filling the vessel with the chemical in the glass phial. Again, read the maker's instructions carefully and make sure that you get a really high-efficiency earth system. When you have had the receiver working for a time, you can rig up a poor earth and see for yourself what a difference it does make.

You are now ready to try out the receiver, and you must use the small push-pull switch on the panel in order to bring the valves into action. Pull out the switch and slowly rotate the main tuning knob (making certain first of all that the knob to the right of this is turned as far as it will go to the left). It should not take long to hear the local station, and if this is situated not too far away it will come in at really surprising strength. If, however, you run right through the scale and do not hear the station, rotate the wave-change control knob to the correct range, as you may have it set for long waves. When the local is correctly tuned in you will find that

it may be heard over only a degree or so, and to obtain the best quality it must be tuned exactly to the correct spot. Now to vary the tone the lower left-hand knob should be turned, when it will be found that with the knob turned fully round to the right the high notes predominate, whilst when turned to the left the lower notes are strongest. You must therefore adjust this to give you the balance which best suits your ear or the room in which the receiver is used. You will find, for instance, that a large, barely furnished room will require the control set towards the "bass" end, whilst a heavily draped, or crowded room will make the same item of music sound better with the control turned to give a better high note response.

The Reaction Control

The right-hand knob will only require adjusting when a very distant station is required, and it should be used most sparingly, as it introduces distortion, although it may be of only a slight nature. Generally speaking, distant stations do not produce the best so far as quality is concerned, and therefore there is no need to worry about quality, but remember that this control is a servant—to be called upon only when circumstances demand—and do not let it become your master. I think you will find, after a very short time, that this receiver will give you music at sufficient volume to satisfy the most critical, and with a quality which has hitherto been associated only with the high-class mains receiver. If, however, you do come across any difficulty, either in construction or operation, remember that our Query Service is entirely free, and we reply to all queries by return of post under the conditions of our Guaranteed Receiver Service.

Multitone Receiver for the Deaf

A PART from the many thousands of components and receivers which one could see whilst walking through the Exhibition at Olympia, certain items stood out prominently due to their extreme novelty or appeal from the point of view of their great utility. One of the foremost of these, for instance, was the ingenious Multitone receiver for the deaf. Radio has made tremendous progress during the past few years, but unfortunately those who are without the sense of hearing have been debarred from participating in the enjoyment of the broadcast programmes. Now, thanks to the painstaking research of Mr. J. Poliakoff, inventor of the well-known Multitone tone-control L.F. transformer, a device has been perfected, and is included in this new receiver, by which even those who have been deaf mutes all their lives may now enjoy the material which is broadcast by the B.B.C. In addition, the receiver may be used as a means of communication between other members of the family, for instance, and the deaf person. For this latter purpose, the loudspeaker which is normally used for reproducing the broadcast programmes is turned into a microphone by the simple operation of a switch.

In outward appearance, this would seem to be an ordinary receiver of the self-contained type, with the usual controls and loudspeaker fret. The volume controls, however, are divided to fulfil two purposes, one controlling the normal output from the loudspeaker, and the other modifying the volume reproduced by the deaf-aid. The set is battery-operated, and utilizes a Class B output stage. Five valves in

SHOW SURPRISES SUMMARIZED

all are employed, and the speaker is of the moving-coil type. The well-known Multitone tone-control is fitted and the complete apparatus costs twenty guineas. It would, perhaps, be worth while to point out that the Editor, Mr. F. J. Camm, was present at a recent demonstration of this receiver and can fully substantiate the claims which are made for it by the makers.

A Receiver of the Future

ALTHOUGH it cannot be purchased, at least for some time to come, the Marconiphone exhibit of a receiver of the future may prove to be only a vision, and may never emerge from the experimental or scientific novelty stage. It operates entirely without control knobs, and is, in effect, a robot. In order to select any desired transmitting station it was necessary merely to call, vocally, the name of the particular transmitter required. By the use of a most intricate and cleverly designed system of relays the vibrations of the human voice acting upon the microphone caused the instrument automatically to be tuned-in without any further operation being called for. Combined with the wonderful voice-controlled telephony receiver, this apparatus is designed to produce, at one and the same time, a pictorial reproduction of the scene or artist being broadcast. In other words, it is a combined television receiver de luxe.

Televisors

THE complete television and sound receivers, capable of receiving the present transmissions, were very neatly combined. The Grafton receiver on Stand No. 111, for instance, although only a little larger than an ordinary Console Radio receiver, gives a picture just over 9in. by 4in., and provides two separate controls for vision and sound. The Bush receiver, although of somewhat larger dimensions, had the additional feature of a focusing device for the television screen. Both of the above receivers utilized the mirror-drum apparatus which enables the picture to be seen in an ordinary lighted room.

Supersets

THERE were several receivers which might be termed "Supersets" or Receivers de Luxe. Amongst these was the 12-valve radio-gramophone, manufactured by the Radio Gramophone Development Company, Ltd. Practically every modern refinement was incorporated in this receiver. Such features as Automatic Volume Control; Silent Tuning; Visual Tuning; Twin Matched Loudspeakers; Automatic Record Changing, were fitted, and in spite of such refinements the cost was only ninety-five guineas. An instrument on similar lines was also shown by the Gramophone Company, and in this particular case novelty was introduced by the method of mounting the loudspeakers. Instead of these being fitted flat up against the back of the cabinet baffle, they were mounted at an angle, and it is claimed that this results in added brilliancy and better reproduction.

CLIX

SIX MILLION

Every owner of a Post Office Licence for Receiving or Transmitting should not fail to inspect or write for details of the full range of

CLIX COMPONENTS FOR PERFECT CONTACT

The advent of Class "B," and the need for anti-microphonic chassis mounting valveholders to counteract the distortion created by powerful loudspeakers working close to valves, are successfully met with.

CLIX 7-PIN VALVEHOLDER (FLOATING TYPE)
CLIX "AIRSPRUNG," NON-METAL VALVEHOLDER (ANTI-MICROPHONIC)

Regular readers of Radio publications will have noticed how consistently our products are used and specified by the designers of sets for home construction. This in itself is an assurance that in the important question of contact, you are faithfully served by Clix.

STAND 37

YOU CANNOT ALL COME TO OLYMPIA

Do the next best—write at once for our New Folder "A Matter of Connection." It gives full details and clear illustrations of every component we produce to give you

Cheapest - Perfect - Contact.

LECTRO LYNX LTD.
79a, ROCHESTER ROW,
LONDON, S.W.1

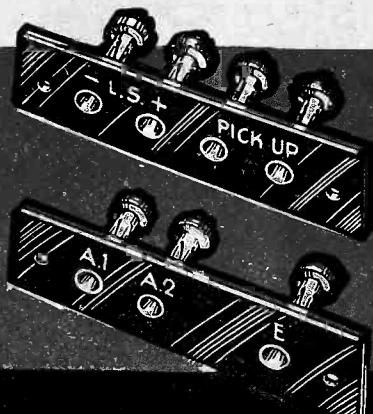
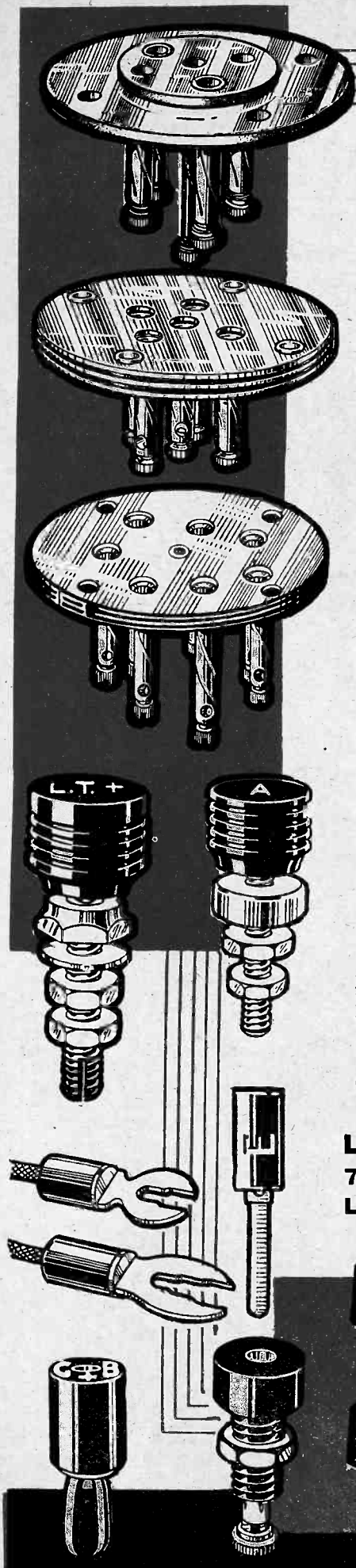
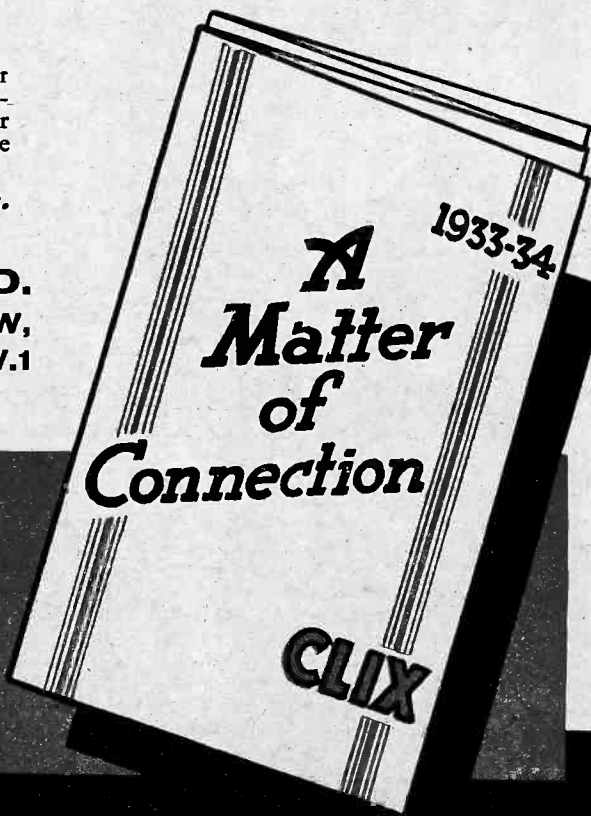

ALL-WAVE

at last!

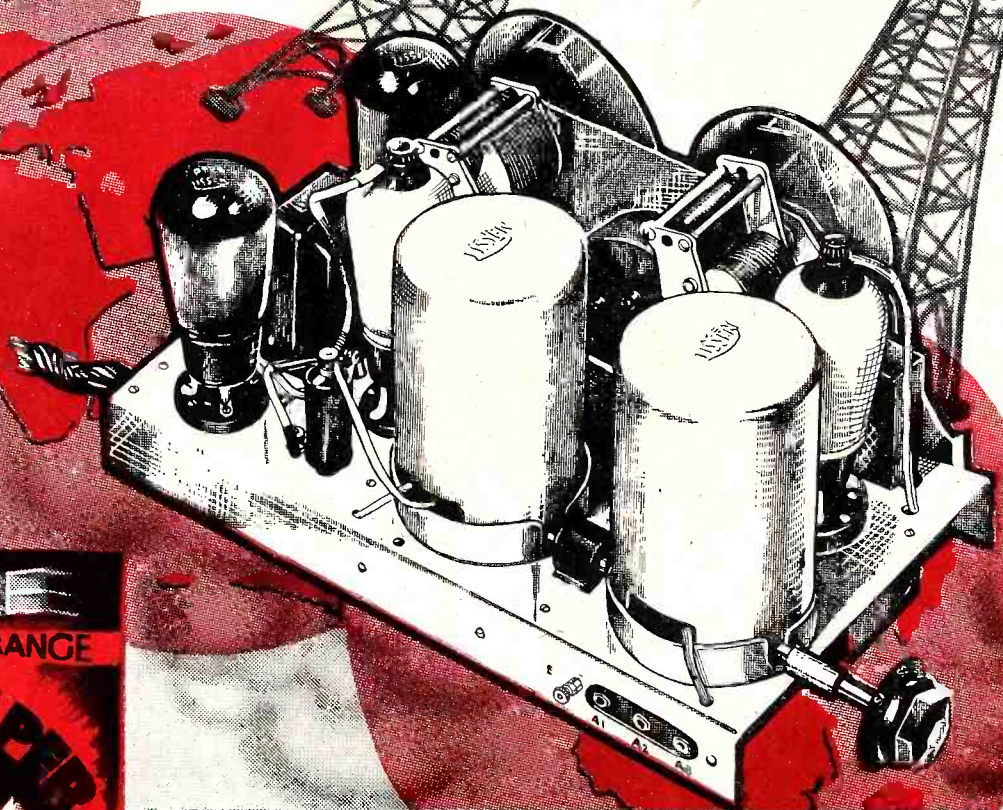

AMERICA & AUSTRALIA ON MOVING COIL LOUDSPEAKER FOR THE FIRST TIME..

The Lissen All-Wave All-World "Skyscraper" 4 marks a milestone in radio progress—a milestone so important that it can only be compared to the change from crystal sets to valves. As the first valve sets made practical a range of hundreds of miles, so the new principles involved in this Lissen All-Wave All-World "Skyscraper" make practical the thousands-of-miles ranges of Australia and America. But more than this, it brings two whole new wave-length bands within reach of the ordinary listener—stations and programmes which it was before a scientific impossibility for him to receive—and leaves open for future development a field which may well be used to solve all the problems of ether-congestion at present perplexing the authorities.

POST COUPON

Lissen have published a splendid Chart of the All-Wave All-World "Skyscraper." It tells you exactly what to do with every single nut and screw, so that success is certain. Post coupon on left for your FREE copy.

LISSEN
ALL-WAVE
 ALL WORLD RANGE
SKYSCRAPER

ILLUSTRATIONS
 PHOTOGRAPHS
 DIAGRAMS
CHART FREE

ULTRA-SHORT - SHORT - MEDIUM - LONG WAVE
 IN A KIT SET FOR THE FIRST TIME

TO LISSEN LTD.
 PUBLICITY DEPT.,
 ISLEWORTH, MIDDLESEX.

Please send me FREE CHART of the All-Wave All World "Skyscraper."

NAME

ADDRESS

ALL-WORLD RADIO

STUPENDOUS
ADVANCE
IN RADIO
RECEPTION

LISSEN GIVE
FIRST BENEFITS
TO HOME
CONSTRUCTORS

ULTRA-SHORT • SHORT MEDIUM & LONG WAVES for the first time on a Constructor's Set

At last the day of All-World Radio has arrived and all the thrill of conquest has returned to radio reception with the introduction of a new Home Constructor's Kit Set by Lissen, which incorporates for the first time four wavelength ranges instead of two—which tunes from 12 to 2,100 metres—which brings America and Australia within range of British listeners who hitherto have only known the home stations and the chief Continental programmes.

And you can build the Lissen All-Wave All-World "Skyscraper" for yourself. Lissen have made it a Home Constructor's Kit Set because it adds to your enjoyment to use your own hands, it saves you pounds in first cost, it makes you an enthusiast to feel and to hear what a wonderful thing you have created! And when you see the Great Free Chart of the All-Wave All-World "Skyscraper," which tells you how to build it and how to work it and why it gives such marvellous results, you will agree at once that it would be wise of you to build for yourself rather than buy a factory assembled receiver when Lissen have so simplified home construction. **YOU CAN'T GO WRONG!** There are pictures of every part, with every wire numbered, every hole lettered, every terminal identified. Even the exact length of every connection is given to you! But get the Chart and see for yourself—then build the Lissen All-Wave All-World "Skyscraper" 4 and become a pioneer of the World Range Radio of 1934.

High Frequency Amplification for the first time on all wavelengths.

12 to 2,100 metres tuning at the turn of a switch.

Double balanced-Pentode Quiescent Output Stage.

Moving Coil Loudspeaker

Battery operated—and a real battery—economiser!
Less than 10 m/a H.T. consumption!

Now receive stations the World Over!

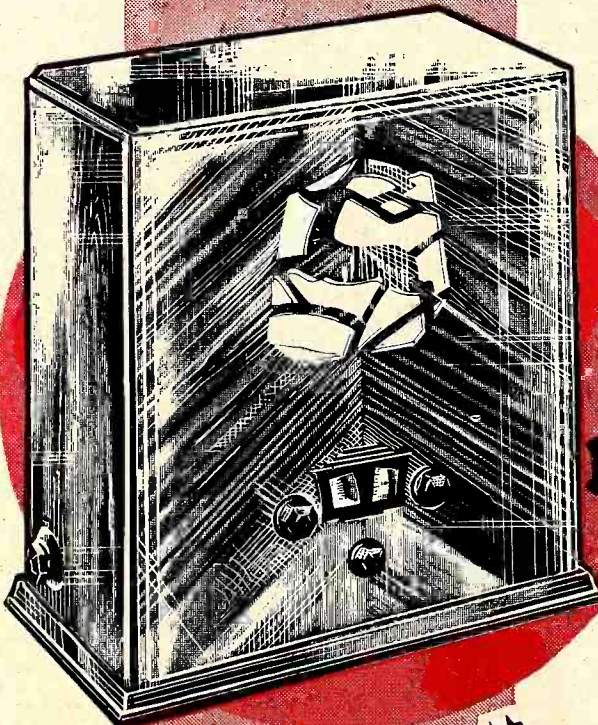

"SKYSCRAPER" 4

PERFECT MATCHING

for ANY receiver



PM4A 42/- Complete

- Seventeen ratios for power and pentode
- Four ratios each for Class B or Q P P without alteration
- Accurate adjustment instantly to the correct optimum load for any output under any working conditions.

for F. J. CAMM'S 1933 SUPERSET this W.B. speaker is solely specified—incorporating the new and sensational

"MICROLODE" feature

Whiteley Electrical Radio Co. Ltd., Mansfield, Notts.

E.W.G

Still Leading and Showing the Way!

The ALL-WAVE TWO

Here You Are Given Full Constructional Details of the Most Fascinating Two-Valve Set That Has Ever Been Offered to the Home Constructor.

By FRANK PRESTON, F.R.A.



THE "All-Wave Two" will be welcomed by all those who require a really efficient, modern and simple receiver. In particular, the set will appeal strongly to readers who have not previously experienced the enjoyment to be gained by making their own set, since the design lends itself to extreme simplicity of construction.

All the parts required are listed elsewhere, and most of them are of perfectly standard type which may be obtained from any good local dealer. The only exception is the special metallized chassis, which is supplied ready cut and drilled, exactly in accordance with that used in the original receiver illustrated. The chassis can be ordered direct from the makers, whose address will be found on the advertisement pages, or through the usual retailer. Ample stocks are available, so there is no reason why any inferior substitute should be resorted to. It might be mentioned in passing that the special chassis specified is actually made of 5-ply wood, and is sprayed with metal by a new and patented process. As a result it has all the combined advantages of wood and metal; components can be attached to it without drilling, and it forms a perfect screen which greatly improves the stability of the receiver. Nothing need be said of the remaining components, since they are all of well-known patterns. Just one word of warning, though—please

do not attempt to use alternatives, because if you do, trouble is almost sure to be experienced sooner or later.

Drilling the Panel

Having obtained all the necessities, then, a start can be made on the constructional work by drilling the ebonite panel

bush is 7-16in. in diameter; the four for the switches and reaction condenser are all 5-16in. and the four for the wood screws (for attaching the panel to the chassis) are $\frac{1}{4}$ in. The tenth hole is not shown on the drawing, and is to take a small stop which is supplied with the "Indigraph" slow-motion dial. The hole is only 3-32in. diameter, and its position can easily be found after mounting the

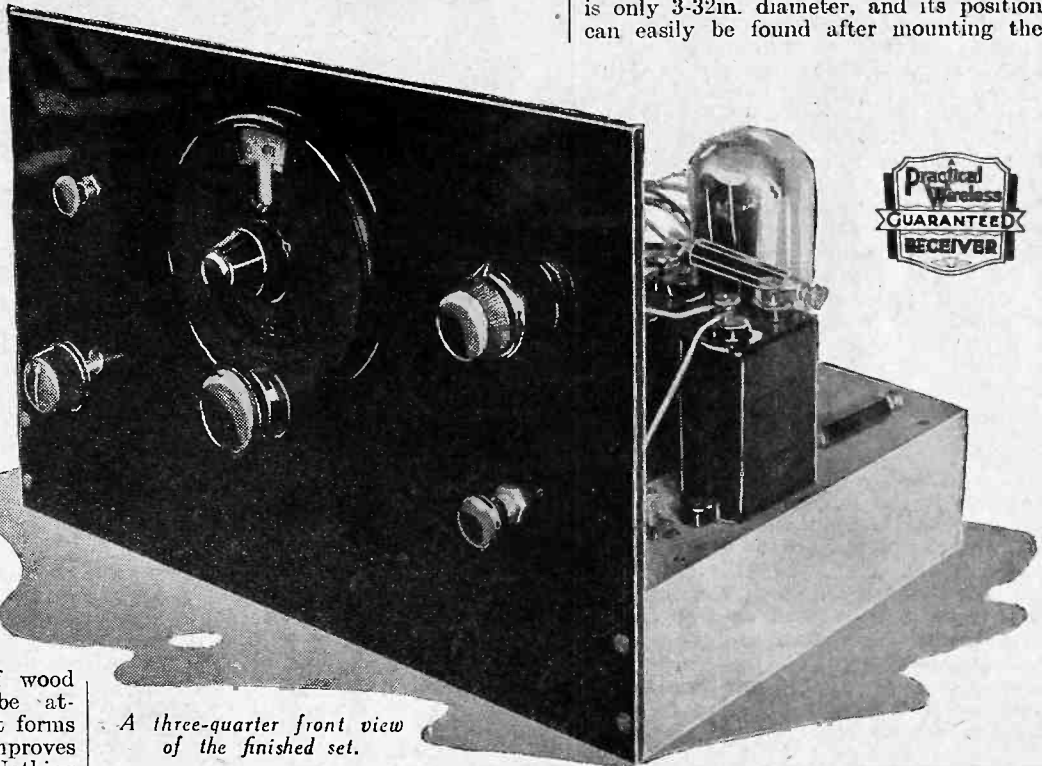

A three-quarter front view of the finished set.

in accordance with the lay-out shown last week. Ten holes are required altogether, and of these, that for the tuning condenser

panel components Z, by following the directions supplied with the dial.

(Continued overleaf)

LIST OF COMPONENTS FOR THE "ALL-WAVE TWO":

- | | | |
|--|--|---|
| One Peto-Scott "Metaplex" Chassis, 12in. by 7 $\frac{1}{2}$ in. by 2 $\frac{1}{2}$ in. | One W.B. Chassis Mounting 4-pin Valve-holder. | Four Belling Lee Terminals, Type "B"; marked "AZ," "E," "L.S.+", "L.S.-" |
| One "Becol" Ebonite Panel, 12in. by 8in. | One W.B. Chassis Mounting 5-pin Valve-holder. | One Belling Lee 6-way Battery Cord with Terminals marked "H.T.+", "H.T.-", "L.T.+", "L.T.-" |
| One Igranic "Igranitor" Coil, Type "A." | One Bulgin "Senator" L.F. Transformer. | One "Microfu" Type 100 mA. |
| One Igranic "Igranitor" Coil, Type "S.W." | One Bulgin Crocodile Clip. | One Mazda Type L2 Valve (Metallized). |
| One Igranic Insulated Switch Rod Coupler. | One Dubilier .0001 mfd. Fixed Condenser, Type 670. | One Mazda Type Pen. 220 Valve. |
| One Graham Farish .0005 mfd. "Zelos" Condenser. | One Dubilier 1 mfd. Condenser, Type BB. | One Peto-Scott "All-Wave Two" Cabinet. |
| One Igranic "Indigraph" Vernier Knob and Dial. | One Dubilier 2 mfd. Condenser, Type BB. | One R. & A. "Bantam" Loud-speaker Unit. |
| One British Radiogram .0002 mfd. Reaction Condenser. | One Graham Farish "Ohmite" 1 megohm Resistance. | One Graham Farish "Fit" Earthing Device. |
| One British Radiogram 2-point Switch. | One Graham Farish "Ohmite" 20,000 ohm Resistance. | One length British Radiophone "Receptru" Down Lead. |
| One British Radiogram 3-point Switch. | One Graham Farish "Ohmite" 30,000 ohm Resistance. | One "Drydex" 120-volt High Tension Battery, Type H 1006. |
| One British Radiogram Short-Wave H.F. Choke. | One Graham Farish "Ohmite" 100,000 ohm Resistance. | One "Drydex" 9-volt Grid Bias Battery, Type H 1001. |
| One "Goltone" .0001 mfd. Pre-set Condenser. | Two Belling Lee Terminal Mounts. | One Exide 2-volt 20 a.h. Accumulator, Type B.T.G. |
| One "Goltone" Super H.F. Choke. | | |

(Continued from previous page)

When the panel has been drilled it can be fastened to the side members of the chassis by means of four $\frac{1}{2}$ in. by 5's screws, and the components can next be assembled. Start by mounting the condensers and switches on the panel, and then fasten the two tuning-coil spindles together by means of the small ebonite coupling link supplied with them. In doing this take care that the two spindles do not touch each other inside the coupling link, or else the broadcast coil (type "A") will be short circuited. Now lay the two coils down on the baseboard in the position indicated in the wiring plan, taking care that the switch spindle is exactly in line with the hole made for it in the panel. Fasten down the coils with $\frac{1}{2}$ in. by 5's screws, and then mount all the other components in the positions shown on the diagrams published last week. It will be clear, of course, that the resistances and grid leak are not attached directly to the chassis, but are held in place by the wiring; they can, therefore, be ignored until a later stage is reached. Once the components have been properly fixed down the wiring can be proceeded with. So as to obviate the possibility of mistakes it is best to carry out the wiring in some simple sequence. Start by putting in the filament circuits on the underside of the chassis and then work from left to right on the top. All the wiring is done in "Glazite" with the exception of a single lead from the pre-set aerial condenser and the battery cords. The former wire consists of a 6 in. length of flex with a crocodile clip attached to one end. Most of the connections are made by looping the end of the wire and securing this under the heads of terminals, but this system is modified in respect to leads going to the valve-holders. The holders are not provided with terminals, so the wires must be soldered to the tags which are fitted. Actually, this method is somewhat better, especially for a set which is to be used on short waves, and no reader need have any fear of difficulty in making the soldered contacts if the following simple method of procedure is adopted. First cut off the wire to length, bare the end for a distance of $\frac{1}{2}$ in. or so, place the bared end through the small hole in the soldering tag, smear a very small amount of flux over the wire and tag, and then apply the hot soldering iron which has previously been tinned. If you have no experience whatever of soldering it might be advisable to call in the assistance of a

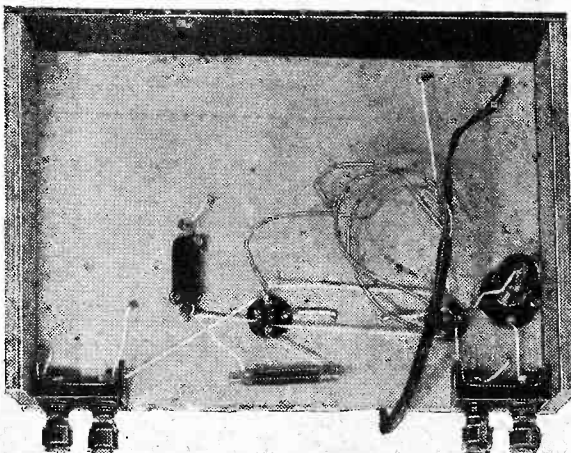

Showing the sub-baseboard wiring and layout of components.

friend, but the whole job should take no more than a few minutes.

Notice especially that a wire is taken from the earth terminal to a small wood screw fastened to the under-side of the baseboard. This connection serves to earth the chassis, so that it may function as an efficient screen. The chassis might have been used for all "earth return" leads, but it was not considered wise to do this in view of the absolutely perfect electrical contact which is essential in a short-wave receiver.

Connecting the Batteries and Testing

After all the constructional work has been finished you can try out the set by

with care there will be no need ever to make the set oscillate and so to cause annoyance to neighbouring listeners, but if by mistake it is allowed to oscillate, the reaction control should at once be slacked off. A very little practice will soon enable the merest novice to feel absolutely at home with this simple set, whilst anyone who has previously handled a set of any type should experience no difficulty at all.

Short-Wave Tuning

Tuning on the short-wave band is naturally rather more delicate than on the higher wavelengths, but even so it is not by any means difficult if the operator will only remember the simple rule that the tuning

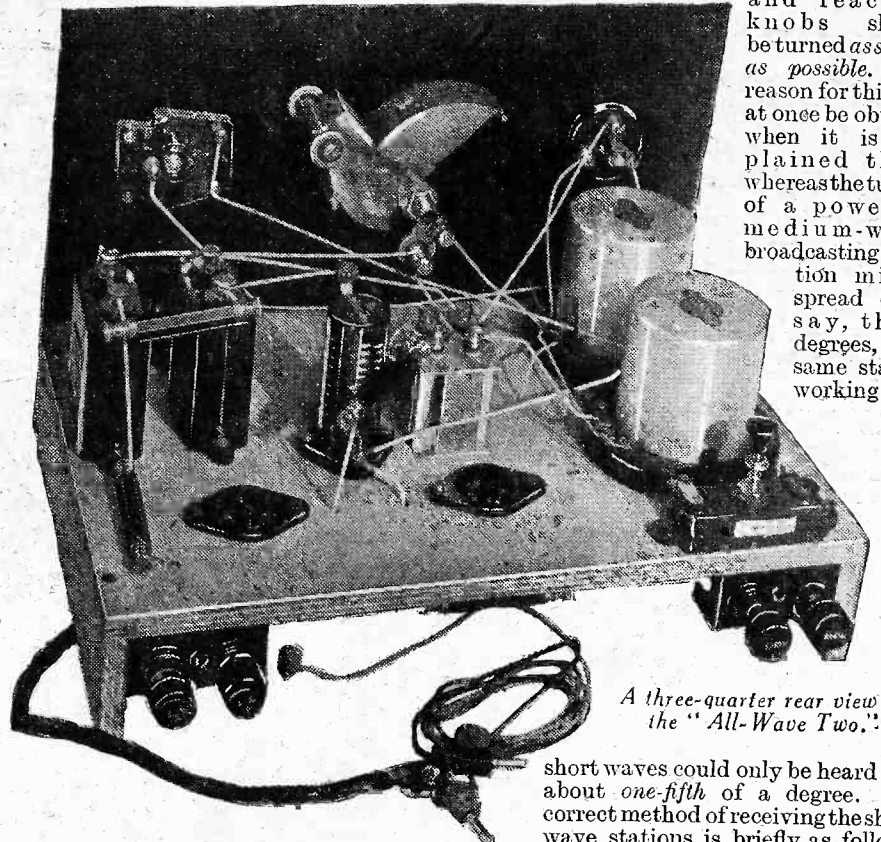

A three-quarter rear view of the "All-Wave Two."

and reaction knobs should be turned *as slowly as possible*. The reason for this will at once be obvious when it is explained that, whereas the tuning of a powerful medium-wave broadcasting station might spread over, say, three degrees, the same station working on short waves could only be heard over about *one-fifth* of a degree. The correct method of receiving the short-wave stations is briefly as follows: First pull out the knob of the three-point switch, transfer the crocodile clip to terminal number "3" on the short-wave coil, and turn the coil switch to the left or right according to whether the 15 to 30 or 28 to 80 metre waveband is required. Set the dial of the tuning condenser to zero, and adjust the reaction condenser until a faint hiss indicates that the set is just on the point of oscillation. Rotate the tuning dial *slowly*, and if necessary slightly alter the reaction setting at the same time, so as to keep the set on the edge of oscillation. When a signal is tuned in a whistle will, of course, be heard, indicating the presence of the carrier wave. This can be "resolved" by *slowly* slacking off reaction and making a slight readjustment of the tuning dial. Incidentally it should be explained that when working on short waves only the first half of the tuning condenser (up to 50 degrees) should be used, as efficiency will fall off rapidly at higher settings. This is not a disadvantage, because at 50 degrees the lower wavelength range goes up to 30 metres, which is higher than the lowest wavelength to be obtained on the second short-wave range. It should be possible to hear the more powerful S.W. Stations on the self-contained loud-speaker.

putting wander plug "H.T.—" into the negative socket of the H.T. battery, taking plug "H.T.+" to the 120-volt socket, putting plug "G.B.+" into the positive grid-bias battery socket, placing plug "G.B.—" into the 4½-volt socket and connecting the two low-tension spade terminals to the appropriate terminals on the accumulator. Connect up aerial, earth, and loud-speaker leads, and then attach the crocodile clip to terminal "2" on the broadcast coil (L2). Push in the knob of the three-point wave-change switch, and then turn the lower switch knob (working on the coils) to the left or right for medium or long waves respectively. Set the reaction condenser to its minimum (anti-clockwise) position and rotate the tuning knob until the local station is heard. Next increase the reaction setting to a point where the set is just short of oscillation; this will be recognised by the fact that reproduction will show signs of becoming slightly distorted. Now, carefully re-tune and make a final reaction adjustment. If the method just outlined is followed

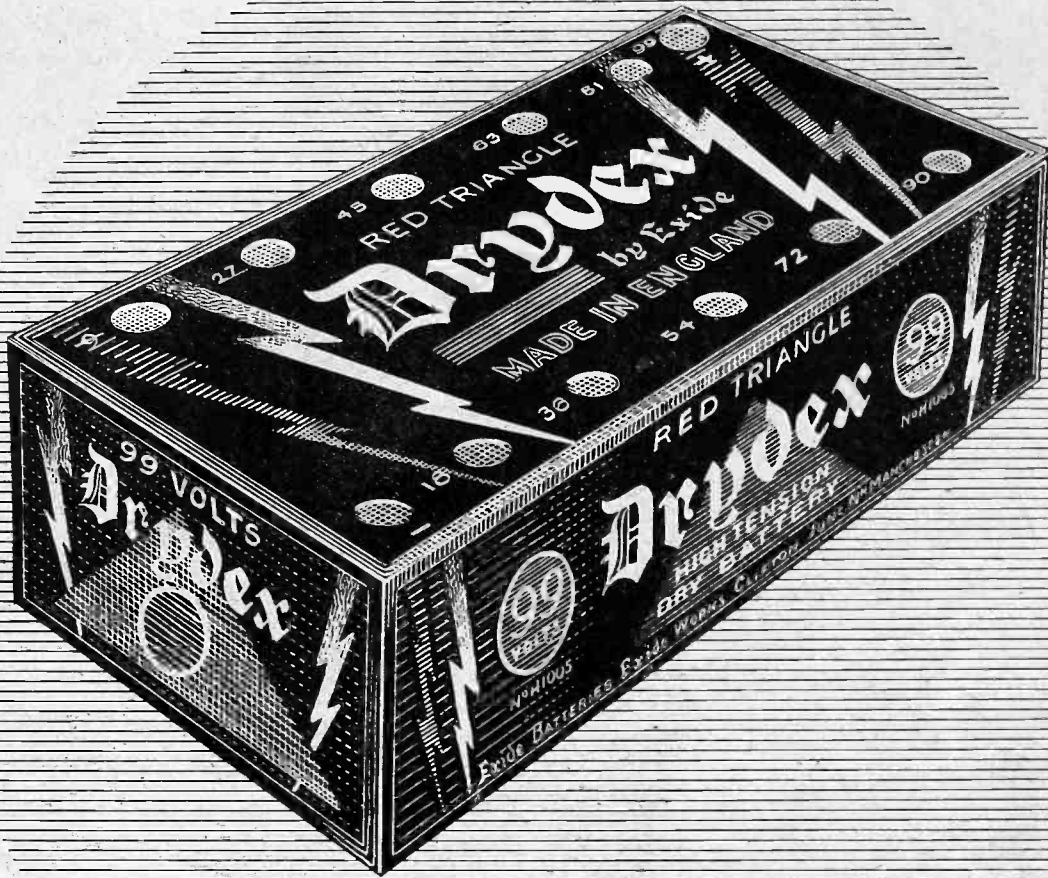

“My friends are simply amazed at the performance”

(Sgd.) C.J.D., Weaste

Most of the leading set-makers fit Exide Batteries for L.T. or Drydex Batteries for H.T.
Stand 241, Radiolympia

Drydex

by Exide

**DRY BATTERIES
 FOR WIRELESS**

Obtainable from Exide Service Stations and all reputable dealers. Exide Service Stations give service on every make of battery
 Exide Batteries, Exide Works, Clifton Junction, nr. Manchester. Branches: London, Manchester, Birmingham, Bristol, Glasgow, Dublin and Belfast.
 Dx 101

The MOST LUXURIOUS RECEIVER EVER



COMPLETE WITH SEVEN VALVES
£8-17-6

CHART IN FULL COLOUR AND LAVISHLY ILLUSTRATED
 POST COUPON AND **FREE**
 GET YOUR COPY

To LISSEN, LTD.,
 Publicity Dept., Isleworth.

Please send me FREE CHART of the "Skyscraper" Seven Valve Superhet.

Name

Address

.....

P.R. 334

Lissen have published for this great new "Skyscraper" Seven Valve Superhet a most luxurious Chart which gives more detailed instructions and more lavish illustrations than have ever before been put into a constructional chart. It makes success certain for everybody who decides to build this set; it shows everybody, even without previous constructional experience, how they can have a luxury receiver and save pounds by building it themselves. A copy of this Chart will be sent FREE in return for coupon on the left or your radio dealer can supply you. Get your FREE CHART now!

OFFERED TO HOME CONSTRUCTORS

7 VALVES
IN A
SIX STAGE
BAND PASS
FILTER
EXACT 9 K/C
CHANNELS -
AMPLIFIED
AUTOMATIC
VOLUME
CONTROL
CLASS "B"
OUTPUT
MOVING-COIL
SPEAKER

Never before has there been any receiver for Home Constructors on such an ambitious scale as this new Lissen "Skyscraper" Seven Valve Superhet. It embodies every up-to-the-minute advance and refinement of the most luxurious factory-built superhets—it gives the constructor the opportunity to build a £20 receiver for less than half that price.

The circuit of the Lissen "Skyscraper" Seven Valve Superhet incorporates a 6-stage bandpass filter giving exact 9-kilocycle channels and therefore providing a standard of selectivity never before achieved by a home constructor's kit set and very rarely found except in laboratory apparatus. Amplified Automatic Volume Control is provided, a special valve for this purpose having been produced by Lissen for use in this receiver. The use of this Amplified Automatic Volume Control constitutes an entirely new experience in listening; no "fading," no "blasting"—you will find yourself enjoying every word of every programme, however near or however distant, without the slightest temptation to interfere with the receiver once you have tuned it. This is radio listening as it should be enjoyed.

a new full-power Lissen Moving-coil loudspeaker—glorious rich tone and majestic volume, actually more faultless in its reproduction than anything you ever heard from even the most powerful mains receiver, yet working economically in this Lissen "Skyscraper" from H.T. batteries.

Tuning is something new in single-knob control—in fact, not only single-knob control but *single station tuning*. You never hear two stations together, you never need to *think* about separation. The 9-kilocycle tuning peak of the circuit ensures "one station at a time" all round the dial, and the Amplified Automatic Volume Control adjusts the receiver automatically to provide the same volume from each transmission. This simplicity is the true luxury of listening—and this is the Luxury Receiver for Home Constructors.

Lissen Class "B" Output through

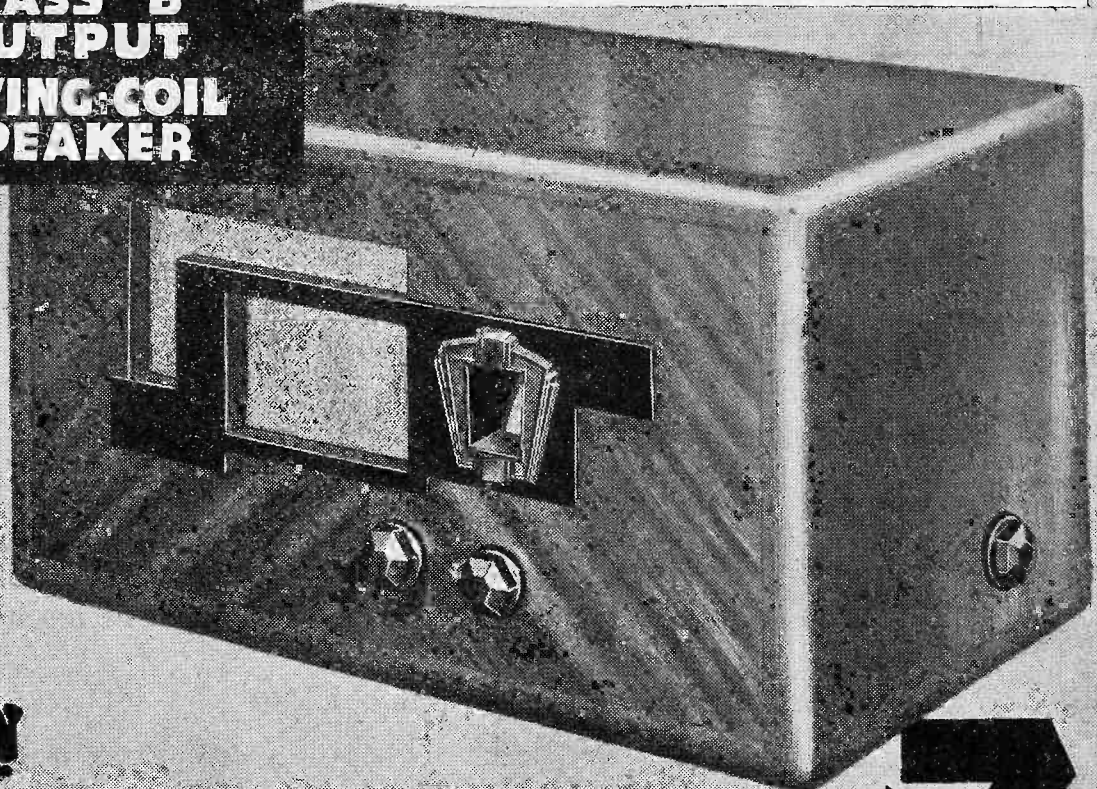

Price complete with
 Inlaid Walnut Cabinet
 and Moving Coil Speaker
£11-10^s.

LISSEN

"SKYSCRAPER" 7
SEVEN VALVE SUPERHET

"GOLTONE" COMPONENTS
for the
ALL-WAVE TWO
Described in this
issue



"GOLTONE" COMPRESSION TYPE CONDENSER

Panel or Baseboard Mounting. As recommended for the "ALL-WAVE TWO." A unique feature is that this Condenser can be mounted on the panel and adjusted from outside the set as with the ordinary controls.

Type "F" R15/87 9d. each

"GOLTONE" Components are obtainable from all First-Class Radio Stores. Refuse substitutes—if any difficulty, write direct.

"GOLTONE" SUPER H.F. CHOKE
AS USED IN THE "W.C." ALL-WAVE TWO.
For S.G. and Super Het. Circuits.

Covering wave-lengths from 10 to 2,750 metres.

Inductance 350,000 mics. D.C. Resistance 225 ohms. Maximum amplification from "Variable-Mu" Valve.

Price 4/6

FREE
"GOLTONE" 1933/34 RADIO CATALOGUE. Just Released. Send for this 56-page profusely illustrated list. FREE on request.



CONVERT YOUR SET INTO AN ALL WAVE SET

for **9/6**

only **9/6**

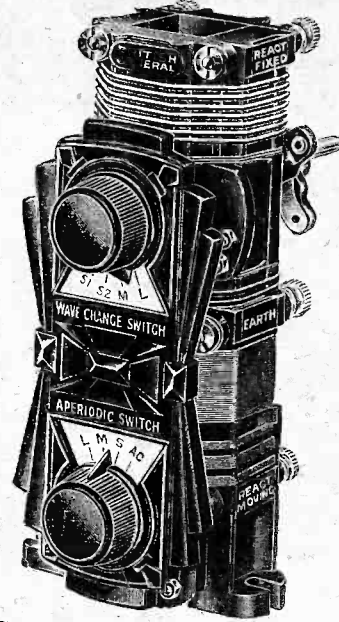

All wave lengths from 14.5 to 2,000 metres covered by this British General All-Wave Tuner.

Free wiring diagrams showing how you can build or convert your set supplied Free. State circuit when ordering.

From all dealers or direct from the manufacturers:

BRITISH GENERAL
BRITISH GENERAL MANUFACTURING CO., LTD.,
Brockley Works London, S.E.4

A few of Belling-Lee's latest developments

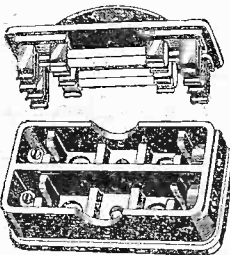

MAINS INPUT CONNECTOR

Patent

Modification of Safety Twin Fuseholder. On removing cover the fuses are instantly accessible and circuit is dead. Impossible to touch live parts of fuseholder. Flex part carrying mains entirely shrouded. Complete with 1 amp. fuses. Each **3/3**

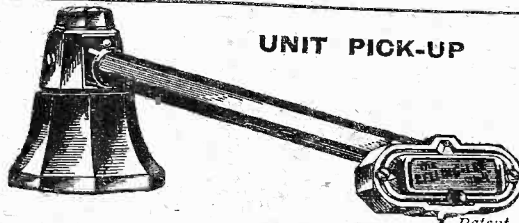

UNIT PICK-UP

Patent

Constructed of metal, this new pick-up follows modern design in appearance and technique. Octagon in form, self-contained Volume Control, Ball Bearing Swivel. The whole arm rotates 180 degrees to facilitate needle changing and simultaneously lifts to swing clear over the record. Complete with template. List No. 1117. **35/-**

TWIN TERMINAL

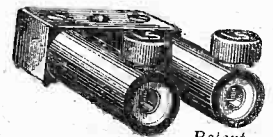

Patent

The most practical and ingenious terminal yet offered. Even for chassis mounting no terminal mount is required. Will take wire, flex, spade terminal or wanderplug. 8 assorted letterings. In pairs (no mount required). No. 1102. **1/6**



BELLING-LEE PICK-UP

Patent

MODEL A. Adjustable arm allows distance between needle point and centre of base to be varied from 7 1/2 inches to 9 1/2 inches. The arm should be as long as cabinet space permits. Head angle is also adjustable to obtain minimum tracking error for different arm lengths. **27/6**

Special Features—Perfectly natural frequency response . . . minimises needle scratch while retaining high notes and brilliancy of reproduction . . . Minimum record wear . . . Copper screened flex.

3-PIN PLUG

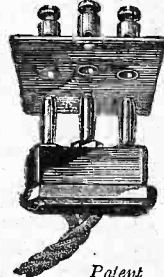

Patent

For connections between receiver chassis and loudspeaker. Centre tap speaker transformers; field coils with connection for earthing speaker chassis, or 3 wire arrangements to carry speech and energising currents to speaker. List No. 1119. **1/3**

DISTURBANCE SUPPRESSOR

Mains leads or aerial carry high-frequency interference which often ruins radio reception. The Belling-Lee Disturbance Suppressor reduces this trouble to a minimum and usually eliminates it entirely. Fuses in both mains leads for A.C. or D.C. supplies up to 250 v. LH18. With complete instructions **9/6**

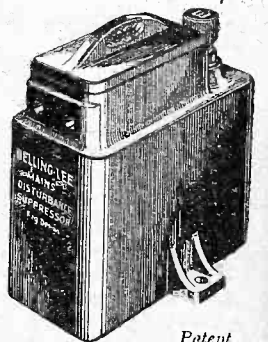

Patent

WRITE FOR BOOKLET "RADIO CONNECTIONS"

BELLING-LEE FOR EVERY RADIO CONNECTION

Advt. of Belling & Lee, Ltd., Cambridge Arterial Road, Enfield, Middlesex

READERS' HALF-GUINEA WRINKLES

The Page

A Handy Tester

THIS useful tester is made from two pieces of 4 BA threaded rod, about a foot of motor-car windscreen wiper tube, a bulb holder and two wander-plugs. The accompanying sketch shows how the parts are connected, the finished device

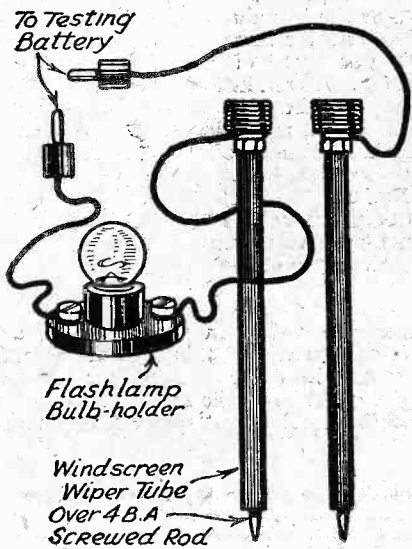

Details of the tester.

being useful for testing circuit wiring. By using the bulb lead only, it may be used for testing filament circuit or any battery circuit wiring.—A. W. LANGE (Herne Hill).

A "Through the Glass" Lead-in

MANY wireless set owners must be seriously handicapped by the modern type of narrow iron-framed window, which does not allow of a lead-in tube being placed through the frame. The writer has solved the difficulty in his own case by bringing the lead through the window-pane itself. The job is carried out as follows:—Obtain a small sewing-cotton reel and cut it into two pieces, as indicated in Fig. 1. The two halves are given a coat of paint, or varnish, to improve their appearance, and clamped together, through a hole in the window-pane, by a nut and washer on each end of a piece of 2 BA screwed brass rod. The end of the aerial is secured to the outer end of the brass rod by another nut (the connection may be made more secure by soldering), and the lead to the set is attached in similar manner to the interior end of the rod. The complete arrangement is shown in Fig. 2.

To bore the hole through the window, a piece of brass or copper tube about 4in. long, of the same outside diameter as the brass rod, or a trifle larger, is taken, and one end filed with a number of serrations, as shown in Fig. 3. It is held in a hand-drill in the usual manner.

In order to locate and guide the drill at the commencement of drilling the

THAT DODGE OF YOURS!

Every reader of "PRACTICAL WIRELESS" must have originated some little dodge which would interest other readers. Why not pass it on to us? We pay £1-10-0 for the best wrinkle submitted, and for every other item published on this page we will pay half-a-guinea. Turn that idea of yours to account by sending it in to us addressed to the Editor, "PRACTICAL WIRELESS," George Newnes, Ltd., 8-11, Southampton Street, Strand, W.C.2. Put your name and address on every item. Please note that every notion sent in must be original. Mark envelopes "Radio Wrinkles." Do NOT enclose queries with your Wrinkle.

smooth surface of the glass, a cork bung or a piece of wood 1/4-in. to 1/2-in. thick, is bored through with a hole the size of the drill (the drill itself may be used for this), and stuck on to the window pane with seccotine so that the hole corresponds with the required position of the hole in the glass.

A cutting composition is now made by mixing a little coarse carborundum powder (obtainable from a garage or

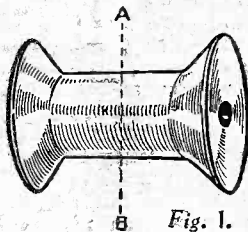

Fig. 1.

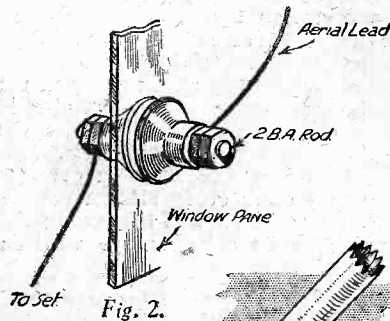

Fig. 2.

Various constructional details of the "through-the-glass" lead-in.

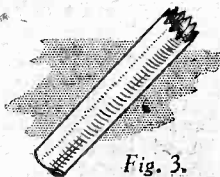

Fig. 3.

tool dealer) into a thin paste with turpentine. This is smeared in the cutting end of the drill and the latter inserted into the hole in the guide piece. Drilling is then started with a fairly light pressure. The drill should be partly withdrawn from time to time, to feed up fresh carborundum, and, if it ceases to cut with a gritty feel, withdrawn and smeared afresh with the carborundum turpentine mixture. A few minutes only are required as a rule to pierce the glass, and good control should be kept of the pressure on the hand-drill, otherwise the operator may push it

through the window-pane when the bit penetrates.

When the hole is bored, the guide is removed after soaking with warm water, and the pane is ready for mounting. The assembly, when finished, has a very neat appearance, especially when the smallest size of reel is used, and the insulation provided by the glass pane is excellent. Capacity effects are also much reduced.—J. W. CRAWFORD (Ardrossan).

Eliminating Howl

MANY constructors are troubled with L.F. howl, in sets containing two L.F. transformers. The accompanying

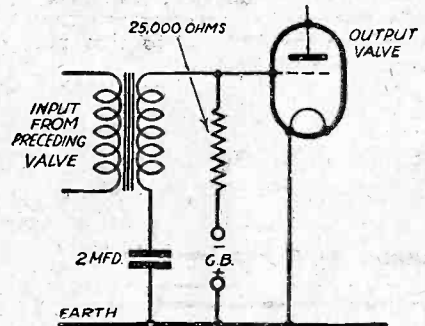

How the grid circuit of the output valve is decoupled.

sketch shows how I cured a troublesome case after all the usual methods had failed. The grid circuit of the output valve was simply decoupled by the addition of a 2 mfd. condenser and 25,000 ohm resistance in the circuit, as shown. This had no detrimental effect on the quality, but effectively eliminated the howl.—H. J. PLUMMER (Islington).

A Loop Forming Gadget

A USEFUL gadget for bending wires on the end of connecting wires can be very easily constructed, as shown in the accompanying diagram. Two 3in. round nails are obtained and the top parts cut off. The nails are then driven into a stout piece of wood, leaving space for the thickness of a wire between them. Nails of varying sizes can be mounted for different sized loops.—A. H. BARKER (West Ham).

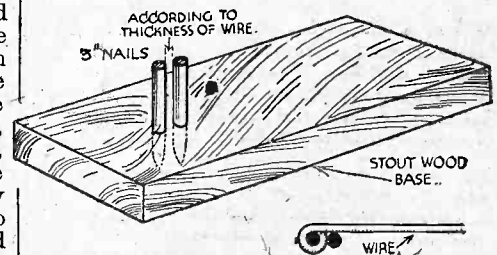

A device for forming loops in wire.

The Superhet

Its Evolution & Possibilities

A Practical Article Dealing With Its Development and Modern Improvements.
By H. J. BARTON CHAPPLE, Wh.Sch., B.Sc., A.M.I.E.E.

SUCH a lot has been said lately of the superhet (supersonic-heterodyne receiver) that it will not be out of place here to record how this special form of set was developed. The principle upon which the superhet operates is more or less familiar, even to those listeners who have not operated apparatus of this type. Briefly, it consists in producing, within the receiver itself, an oscillating current of a frequency considerably lower than that of the original signal, yet higher than audio frequency, and of transferring the programme modulation to this new or intermediate frequency.

Amplification takes place at the intermediate frequency, after which the signal is rectified in the ordinary manner, amplified at audio frequency, and finally passed to the loud-speaker.

The superhet set owed its first entry into broadcast receiving practice because of the extreme inefficiency of early forms of high-frequency amplifier. In those days, the early 'twenties, the only type of valve available was the triode; and as has already been explained in some recent articles of mine, the triode, due to its high inter-electrode capacity, permitted a large amount of unwanted reaction, so that in order to ensure reasonably stable operation as a high-frequency amplifier the efficiency of the valve, never very high under the most favourable circumstances, had to be further cut down by various devices.

Frequency Changing

The superhet principle provided a ready means of avoiding this difficulty by changing the frequency of the original signal to a lower value at which amplification could take place more efficiently. The principle was already well-known to radio engineers, for it had been used for a considerable period as a means of rectifying radiotelegraphic transmissions. As first applied to broadcast reception it operated in the following manner. Within the receiver was a valve known as the local oscillator—a triode in which the coils in the anode and grid circuits were closely coupled inductively. Readers will recognize this as a valve operating under conditions of excessive reaction, causing free oscillations to be generated. One of the oscillator coils, or both, were tuned by a variable condenser, and by this means the frequency of the local oscillations was adjusted until it differed from the frequency of the incoming radio signal by a definite amount—usually 100,000 cycles.

By coupling the local oscillating circuit to that of the incoming signal, and passing both to the grid of another valve—the so-called "first detector," the two frequencies were combined to give a new frequency,

equal to the difference of their individual frequencies, namely, 100,000 cycles. What is more, the new frequency was modulated in the same way as the original signal frequency.

Thus the new, or intermediate, frequency appeared in the anode circuit of the first detector valve and acted as carrier frequency to the programme modulation. Next followed two or even three stages of intermediate frequency amplification—ordinary triode valve, the inter-valve couplings being more or less carefully matched, and self-tuned transformers. After the intermediate frequency amplifiers came the second detector, which rectified the signal in the ordinary way, and was followed by the usual low-frequency amplifying stages, terminating with the output valve.

Disadvantages

There is no doubt that these early superhets did provide a very large degree of signal amplification—in other words, they were extremely sensitive and had wonderful range; and for that reason they had a very considerable vogue among those who could afford this rather expensive type of receiver. They had many disadvantages, however. In the first place they were costly to build and to maintain. Seven, eight, or even nine valves were required—and valves then cost something like a sovereign apiece, and took nearly three-quarters of an ampere for low tension.

They were bulky, tricky to construct and to adjust for optimum efficiency—remember that the frequency of the oscillator had to be readjusted for each station, and no ganged condensers were available. Also, one had to face difficulties in operation, for in most cases every station could be tuned in at two settings of the tuning dial.

Another grave disadvantage was that, with the circuit as then used, the superhet was very prone to re-radiation, although this was to some extent mitigated by the use of a frame aerial. But most important of all the disadvantage was the very poor quality of reproduction.

It was no wonder, therefore, that when the neutralized triode method of high-frequency amplification was developed, the superhet's popularity began to wane, and declined almost to zero as soon as the screen-grid valve brought "straight" high-

frequency amplification to a high pitch of efficiency.

After the introduction of the screen-grid valve, and for some years following, very little was heard of the superhet in this country. A certain number were made, of course, and there were still enthusiasts, both amateur and professional, who maintained their interest in this ingenious circuit.

A Revival

Oddly enough, although it was the screen-grid valve which caused the first disappearance of the superhet, it was also the screen-grid valve which permitted its revival. People had played about with screen-grid valves in superhet sets, and had discovered that this type of valve, in common with other types of four electrode valve, could be applied with great success as first detector or "mixer" valve, and also as combined first detector and local oscillator.

More recently, screen-grid valves have come to be used also as intermediate frequency amplifiers as well. A great many different arrangements are possible whereby the screen-grid valve can be employed in superhets and some have been described in recent issues of this journal, and it must suffice to indicate briefly just one or two methods. For example, energy can be taken from the anode circuit of the first screen-grid valve to a tuned oscillator circuit coupled to another coil in the screen circuit, thus "injecting" the local oscillating frequency into the valve circuit where the "mixing" and production of the intermediate frequency takes place. In another arrangement, the oscillating circuit is coupled to the cathode circuit of the screen-grid valve and the heterodyne voltage is introduced at the cathode of the valve.

(To be continued.)

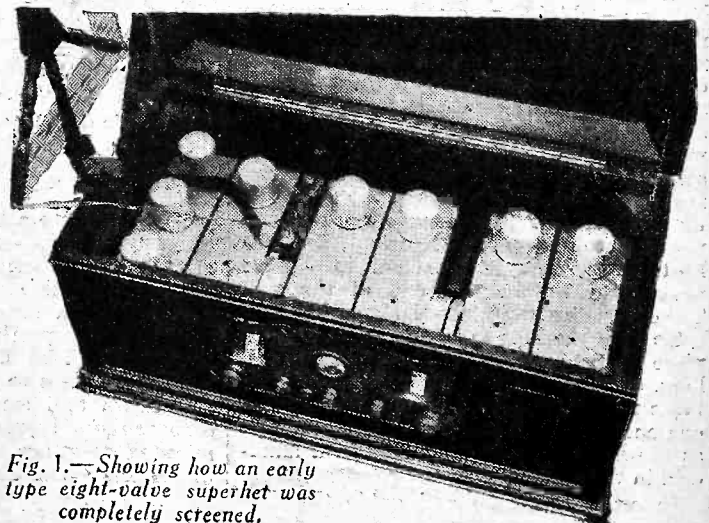
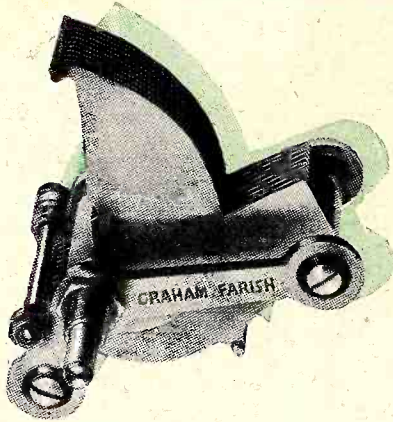

Fig. 1.—Showing how an early type eight-valve superhet was completely screened.

GRAHAM FARISH

COMPONENTS



NILOS

VARIABLE CONDENSER

A superb component, possessing extreme rigidity of construction, mechanical perfection of moving parts and high electrical efficiency. Two point fixing of centre spindle, and no spacing washers ensures precision and reliability. Negligible H.F. loss, large accessible terminals, shaft provides easy ganging.

5'-

EACH
Capacity .0005

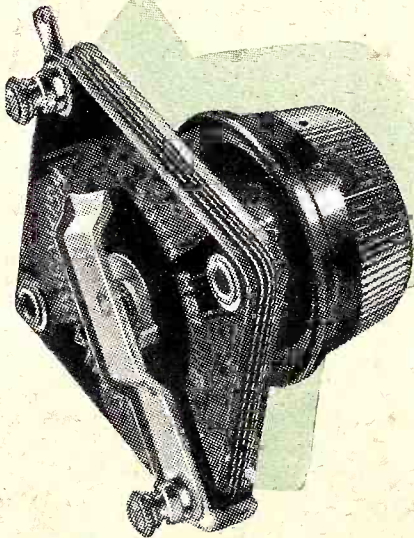

LITLOS

VARIABLE CONDENSER

The LITLOS condenser is a fitting example of high-grade workmanship. It is a very carefully constructed instrument, compact in size and efficient in design, with accurately gauged bakelite dielectrics and solid brass pigtail connection to moving vanes. Made in all capacities up to .0005 mfd. in tuning straight-line capacity and differential types. One hole fixing; supplied complete with terminals.

2'-

EACH
Differential tuning or
reaction types

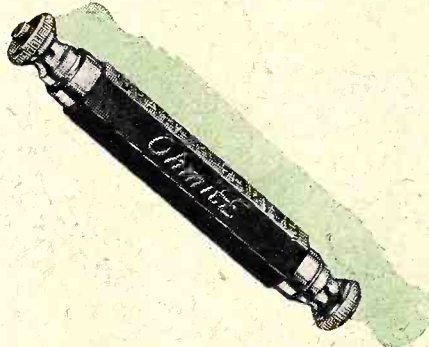

OHMITE

RESISTANCES

The most popular and efficient type of fixed resistance for all general purposes. Better than wire wound, non-corrosive and non-inductive, they cannot create hum, and do not readily overheat. All values 50 ohms to 5 megohms. 100° F. Temperature rise. Heavy Duty type approximately double the above ratings. Price 2/3.

For those who prefer interchangeability and convenience in mounting, holders are available, vertical and horizontal, 6d. each.

1'6

EACH

Write for the new 1933/4 Catalogue to be published in September.

GRAHAM FARISH LTD., MASONS HILL, BROMLEY, KENT

Export Office: 11/12, FENCHURCH STREET, LONDON, E.C.3.

THE GENIE OF ALADDIN'S LAMP COULD DO NO MORE FOR YOU.

A superb range of speakers of beautiful tonal quality. All fitted with Universal Transformers for use with any set. HEAR and SEE them at our **STAND NO. 104.**



39'6

THE M.C.22.—Embodying all the latest Amplion improvements but selling at the same price as last year's model. WITH UNIVERSAL TRANSFORMER. Price **39'6**



27'6

THE SONETTE.—The baby speaker with the big voice. Weight 2½ lbs. exactly. Price **27'6** Only Amplion could have done it.

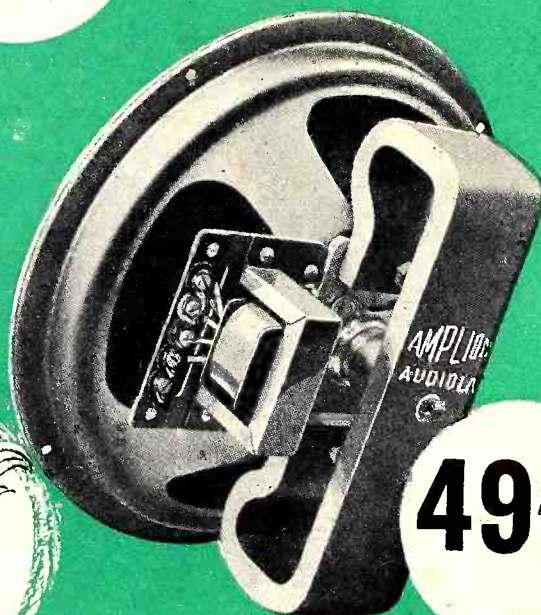

49'6

THE AUDIOLA.—A luxury speaker at a price within the reach of all. 7in. cone and universal transformer. Price **49'6**



AMPLION (1932) LTD.,
82/84, ROSOMAN STREET, LONDON, E.C.1.

SEE THE
COMPLETE
RANGE ON
**STAND
No. 98**
RADIOLYMPIA

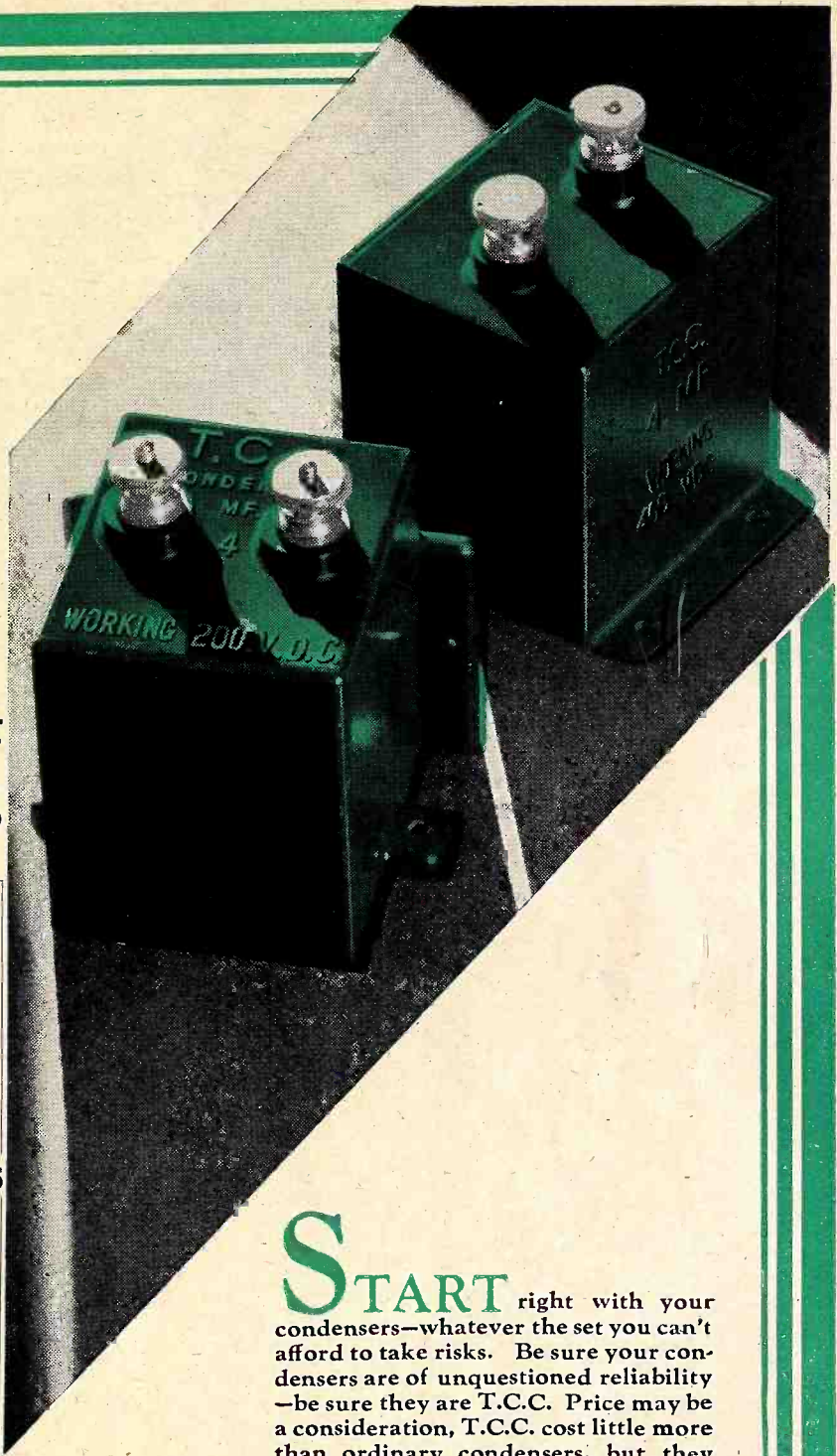

CURRENT PRICES OF T.C.C. CONDENSERS

PAPER CONDENSERS. TERMINAL TYPES

Mfd.	Type 50/61	Type 80/81	Type 101	Type 121
	s. d.	s. d.	s. d.	s. d.
0.1	—	2 0	—	—
0.25	—	2 4	—	—
0.5	2 4	2 6	5 0	7 0
1	2 6	3 0	6 0	8 6
2	3 6	4 0	9 0	13 0
3	5 0	6 0	—	—
4	5 6	7 0	17 6	25 0
5	7 3	9 0	22 0	31 0
6	8 6	10 6	25 0	37 6
8	11 0	14 0	—	—
10	14 0	17 6	—	—

PAPER CONDENSERS. SOLDERING TAG TYPES

Mfd.	Type 65	Type 84	Type 87
	s. d.	s. d.	s. d.
0.1	1 8	2 0	2 2
0.25	1 10	2 2	2 4
0.5	1 11	2 4	2 6
1	2 0	2 9	3 0
2	2 8	3 9	4 0
3	—	—	—
4	5 0	6 9	7 3
5	—	—	—
6	7 0	10 0	—
8	9 0	13 0	—
10	11 6	16 0	—

MICA CONDENSERS

Mfd.	Type M	S.P. Type	Type 34
	s. d.	s. d.	s. d.
.00005	0 8	—	1 3
.0001/3	0 8	2 0	1 3
.0004/5	0 9	2 0	1 3
.001/4	1 0	2 6	1 8
.005/6	1 6	3 0	2 0
.01	2 0	—	3 0

ELECTROLYTIC CONDENSERS

Mfd.	Type 802 Aqueous	Type 801 Aqueous	Type 902 Dry
	s. d.	s. d.	s. d.
8	8 0	—	6 6
4	5 0	—	—
7	—	6 0	—

START right with your condensers—whatever the set you can't afford to take risks. Be sure your condensers are of unquestioned reliability—be sure they are T.C.C. Price may be a consideration, T.C.C. cost little more than ordinary condensers, but they are pedigree condensers backed by the oldest firm in the country whose activities are solely condenser making!

The Telegraph Condenser Co., Ltd.,
Wales Farm Rd.,
N. Acton, W.3.

T.C.C.

ALL-BRITISH
CONDENSERS



Now H.T.

Imagine it!
 60 v 5000 ma.h. H.T. 14 $\frac{3}{4}$ " x 4 $\frac{1}{2}$ " 37/6
 30 v " " " 8 $\frac{3}{16}$ " x 4 $\frac{5}{8}$ " 21/-

*accumulators
 half the size!*

NO NEED NOW FOR DRY BATTERY EXPENSE

●A new era opens. Gone are the costly dry batteries. Gone are the bulky H.T. accumulators. To-day comes a new kind of H.T. source—a plate-less accumulator hardly bigger than the old dry battery itself. ●Startlingly low in first cost, it costs you nothing after except for occasional re-charging. The secret is the Block plate-less cell, that does away with the old weight, space and weakness of accumulator plates. ●Non-fragile. Elegant (the case is coloured bakelite). More durable than the plate type; inexpensive. Demand is overwhelming—order at once for early delivery.

**DOUBLE CAPACITY
 L.T.**

What a boon!

Cut away view of Block cell.— First the coloured bakelite that covers the L.T. type; next a lead cylinder (both the 'negative' and the cell's container.) Inside it, active paste. Last is the central 'positive' column and separator.



Price of 80^{a.h.}
 L.T. 2.v. 11/6

**STAND
 22
 MAIN HALL
 OLYMPIA**

BLOCK

PLATE-LESS ACCUMULATORS

Block Batteries Ltd, Abbey Road, Barking, Essex. Tel: Grangewood 3346/7

TAS/BC.43

Radio has Moved with the Times

Retrospections and Reflections on the Development of the Radio Industry, as Exemplified by its Exhibitions.

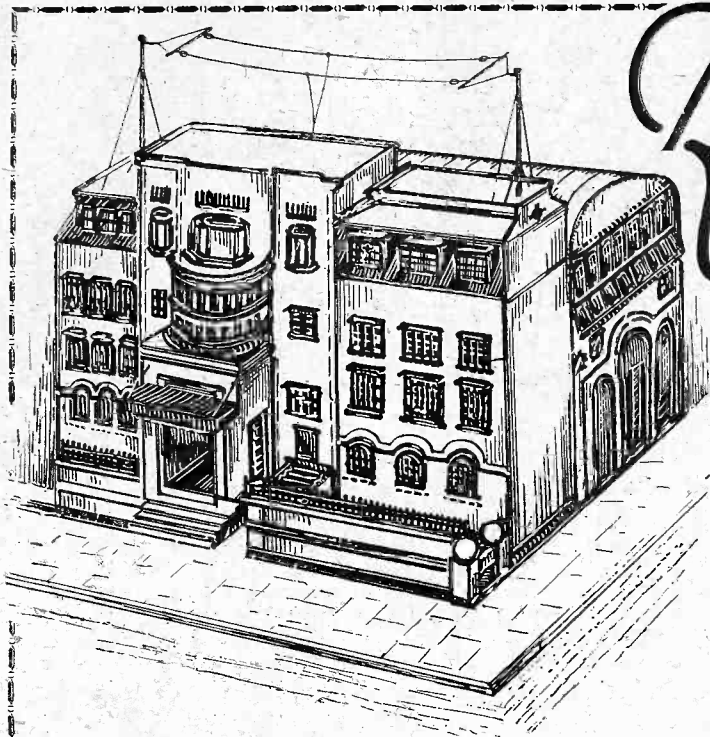

The first All-British Radio Exhibition and Convention was held at the Horticultural Hall. Note the twin aerial.

THE greatest exhibition of wireless products in the whole world will be thrown open to the public at 11 a.m. on Tuesday, August 15th, in the Grand Hall at Olympia. This National Radio Exhibition, to give its full name, is being organized by the Radio Manufacturers' Association, and there will be exhibitors of British made receivers, components, and accessories of every conceivable type. The 1933 Show will be the twelfth and greatest of a series which was commenced in 1922. In the latter year the "First All-British Wireless Exhibition and Convention" was organized by Messrs. Bertram Day and Co., Ltd., for the benefit of the wireless manufacturers and traders in this country. It was held in the comparatively incommensurate premises of the Horticultural Hall, and despite the fact that there were only about fifty stands it proved

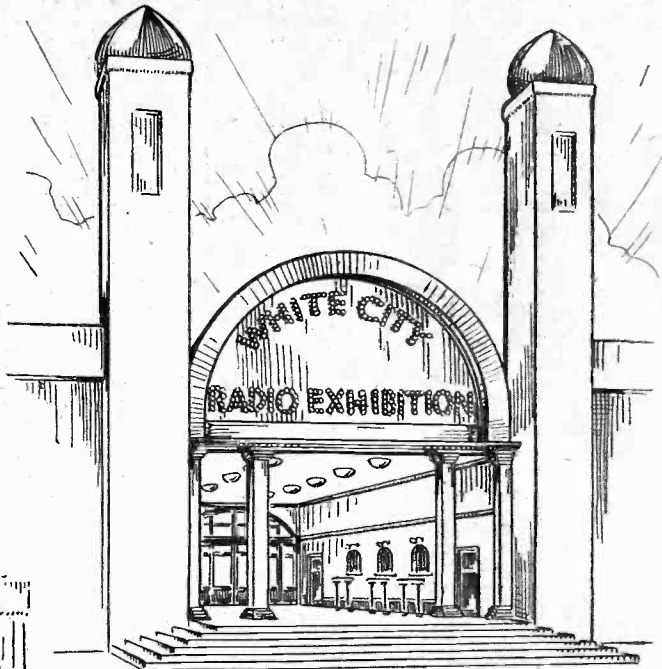

The White City, where the second Exhibition was held.

so successful that plans were immediately put in hand to run a second exhibition the following year.

In passing it will be of interest to quote a few sentences from the catalogue issued in connection with the 1922 Exhibition, viz., "This All-British Wireless Exhibition and Convention is the first of its kind ever held in this Country, and, apart from other (Continued on page XIV)

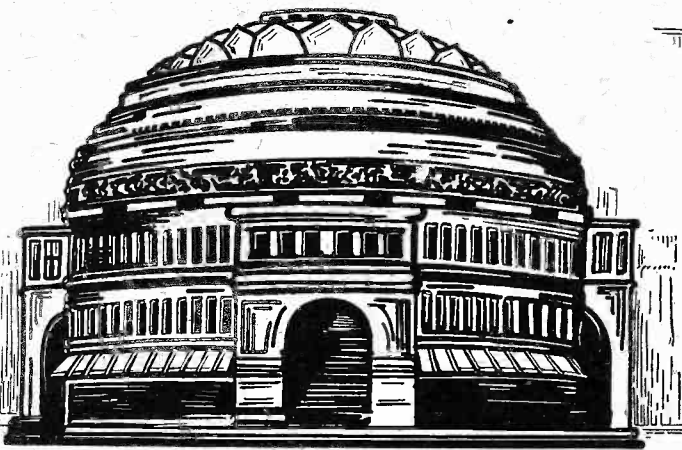

The Albert Hall—the third link in the chain of progress.

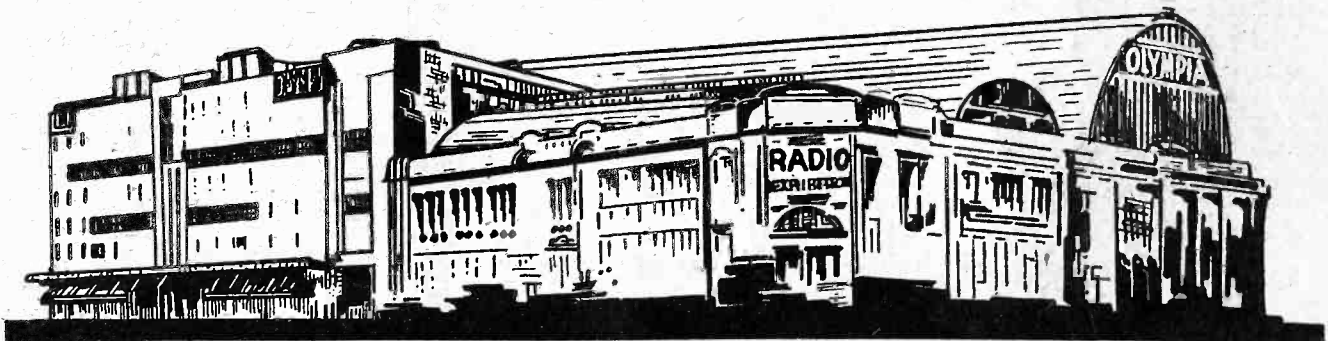

An artist's impression of the present vast building—Olympia—necessitated by the enormous size of the wireless industry.

AN ALPHABETICAL



NAME	ADDRESS	STAND No.	NAME	ADDRESS	STAND No.	NAME	ADDRESS	STAND No.
Apollo Gramophone Co., 4, Bunhill Row, E.C.1.		T23	Dyson & Co., Ltd., Works, J., 5, Godwin St., Bradford		T17	Loewe Radio Co. Ltd., 4, Fountayne Rd., Tottenham, N.		245
Aerialite Ltd., 10, Amber St., Manchester		220	Earl Engineering and Electrical Co., 132A, Much Park St., Coventry		249	London and Provincial Factors Ltd., 140, Theobalds Rd., W.C.1.		T4
Amalgamated Press, Fleetway House, Farringdon Street, E.C.4		11	Eastick & Sons, J. J., 118, Bunhill Row, E.C.1.		T12	Lugton & Co. Ltd., 203, Old St., E.C.1.		T26
Amplion (1932) Ltd., 82-84, Rosoman St., E.C.1.		104	East London Rubber Co., 29-33, Great Eastern St., E.C.2.		T19	Levick & Sons, Ltd., Clarence Steel Works, Sheffield		36
Automatic Coil Winder and Electrical Equipment Ltd., Winder House, Douglas St., S.W.1		46	Econasign Co., Ltd., 137, Victoria St., S.W.1		231	Magnacore Ltd., 85, Alsen Rd., Holloway, N.7.		223
Baird Television Ltd., 133, Long Acre, W.C.2.		117	Edge & Sons, Ltd., Wm., Bolton, Lancs.		121	Manufacturers Accessories Co. (1928) Ltd., 85, Gt. Eastern St., E.C.2.		T10
Bakers Selhurst Radio, 75-77, Sussex Rd., Croydon, Surrey		35	Edison Swan Electric Co., Ltd., 155, Charing Cross Rd., W.C.2.		82	Mains Power Radio Ltd., Broadway Works, Eastern Rd., Romford, Essex		211
Balcombe Ltd., A. J., 52, Tabernacle St., E.C.2.		61	Eldeco Radio, Ltd., 62, Conduit St., W.1.		100	Marconiphone Co. Ltd., 210, Tottenham Court Rd., W.1.		77
Belling & Lee, Ltd., Cambridge Arterial Rd., Enfield, Middx.		45	Electrical Measuring Co., Ltd., 55, Cardington St., Hampstead Rd., N.W.1		222	McMichael Radio, Ltd., Wexham Rd., Slough, Bucks		69
Benjamin Electric Ltd., Brantwood Works, Tariff Rd., N.17		42	Electro Dynamic Construction Co., Ltd., Devonshire Grove, S.E.15		240	Metal Agencies Co. Ltd., Queen Sq., Bristol		T30
Benn Bros., Ltd., Bouverie House, Fleet Street, E.C.4		212	Ensign Ltd., 88, High Holborn, W.C.		T24	Milnes Radio Co. Ltd., Victoria Works, Church St., Bingley, Yorks		242
Bernard Jones Publications, 58, Fetter Lane, E.C.4		10	Epoch Radio Mfg. Co., Ltd., Exmouth House, Exmouth St., E.C.1		2	Montague Radio Inventions and Development Co. Ltd., Beethoven Works, Gt. College St., Camden Town, N.W.1		87
Birmingham Sound Reproducers Ltd., Claremont St., Old Hill, Staffs.		218	Ever Ready Co. (G.B.) Ltd., Hercules Place, Holloway, N.7		57	Mullard Radio Valve Co. Ltd., Mullard House, Charing Cross Rd., W.C.2		71
Block Batteries, Ltd., Abbey Road, Barking, Essex		22	Faudels Ltd., 36-40, Newgate St., E.C.1.		T3	Multitone Electric Co. Ltd., 95, White Lion St., Islington, N.		55
Botolph Radio Ltd., 119, Bishopsgate, E.C.2		244	Ferranti Ltd., Hollinwood, Lancs.		74	National Accumulator Co. Ltd., 50, Grosvenor Gardens, S.W.1		216
Bowyer-Lowe & A. E. D., Ltd., Diamond Works, Coombe Road, Brighton		102	Film Industries Ltd., 60, Paddington St., W.1		246	New London Electron Works Ltd., East Ham, E.6		107
Bridger & Co., R. O., 334, Shaftesbury Avenue, W.C.2		221	Flinders Ltd., East Stockwell St., Colchester		T7	Newnes Ltd., George, 8-11, Southampton St., Strand, W.C.2		8
Britannia Batteries Ltd., 233, Shaftesbury Avenue, W.C.2		124	Fox Publications Ltd., 14, Britannia St., W.C.1		111	N.R.S. Ltd., 15-16, Alfred Place, W.C.1		T22a
British Blue Spot Co., Ltd., 94-96, Rosoman St., E.C.1		97	Fuller Accumulator Co. (1926), Woodland Works, Chadwell Heath, Essex		34	Nuvolon Electrics Ltd., Meredith Yard, Park Crescent, Clapham Park Rd., S.W.4		238
British Broadcasting Corp., Broadcasting House, W.1		—	Garrard Engineering & Mfg. Co., Ltd., 17, Grafton St., W.1		119	Odham Press Ltd., Long Acre, W.C.2		T18
British Ebonite Co., Ltd., Nightingale Rd., Hanwell, W.7		207	G.E.C. (Batteries), Magnet House, Kingsway, W.C.2		112	Oldham & Son Ltd., Denton, Manchester		123
British General Mfg. Co., Ltd., Brockley Works, Brockley, S.E.4		33	General Electric Co., Ltd., Magnet House, Kingsway, W.C.2		90	Ormond Engineering Co., Ltd., Ormond House, Rosebery Av., E.C.1		99
British Fix Co., Ltd., 118, Southwark St., S.E.1		204	General Mouldings		59	Orr Radio (Inc. United Radio Manufacturers), 63, Lincoln's Inn Fields, W.C.2		40
British Radiophone Ltd., Aldwych House, Aldwych, W.C.2		118	Gilbert & Co., Ltd., C., Arundle St., Sheffield		T20	Osborn, Charles A., Regent Works, Arlington St., N.1		202
British Rola Co., Ltd., Minerva Rd., Park Royal, N.W.10		52	Grafton Radio Co., 79, Lots Rd., Chelsea, S.W.		111	Osram Valves, Magnet House, Kingsway, W.C.2		92
British Thomson Houston Co., Crown House, Aldwych, W.C.2		209	Graham Parish Ltd., 153, Masons Hill, Bromley, Kent		205	Partridge Wilson & Co., Devenset Works, Evington Valley Rd., Leicester		127
Brown Bros. Ltd., Great Eastern St., E.C.2		T15	Gramophone Co. Ltd., 363, Oxford St., W.1		80	Phillips Lamps Ltd., 145, Charing Cross Rd., W.C.2		81
Bulgin & Co., Ltd., Abbey Rd., Barking, Essex		122	Gramplan Reproducers Ltd., Station Avenue, Kew Gardens, Surrey		23	Portadyne Radio, Portadyne Works, Gorst Rd., N.W.10		75
Burgoyne Wireless (1930), Ltd., 34A, York Rd., King's Cross, N.1		3	Gripsco, 28, Victoria St., S.W.1		251	Powertone Products, 88a, Cromer St., W.C.1		253
Burton, C. F. & H., Progress Works, Bernard St., Walsall		4	Grosvenor Electric Batteries Ltd., 2-3, White St., Moorgate, E.C.2		126	Pye Radio Ltd., Africa House, Kingsway, W.C.2		73
Bush Radio Ltd., Woodger Rd., Shepherd's Bush, W.12		64	Goodmans, 69, St. John Street, Clerkenwell, E.C.1		109	"Radio for the Million," 63, Lincoln's Inn Fields, W.C.2		39
Cadisch & Sons, R., 5-6, Red Lion Sq., W.C.1		T5	Hacker & Sons, H., Perfecta Works, Ray Lea Road, Maidenhead		120	Radio Gramophone Development Co. Ltd., 18-20, Frederick St., Birmingham		79
Carrington Mfg. Co., Ltd., 24, Hatton Gdns., E.C.		83	Halford Radio Ltd., 39, Sackville Street, W.1		49	Radio Instruments Ltd., Purley Way, Croydon, Surrey		41
Celestion Ltd., London Rd., Kingston-on-Thames		125	Harlie Ltd., Balham Road, Lower Edmonton, N.9		54	Radio Society of Gt. Britain, 53, Victoria St., S.W.1		201
Chloride Electrical Storage Co., Ltd., Clifton Junction, nr. Manchester		241	Haynes Radio, 57, Hatton Garden, E.C.1		9	Rawplug Co. Ltd., Rawplug House, Cromwell Rd., S.W.7		262
Churchmans Ltd., Colchester		T1	Heayberd & Co., E. C., 10, Finsbury St., E.C.2		16	R.C. Radio Electric Ltd., 51, Whitcombe Street, W.C.2		243
Cifel Products, Ltd., 134, Pentonville Rd., N.1		239	Hellesens Ltd., Morden Rd., S. Wimbledon, S.W.19		160	Radiolab Mfg. Co., Sendridge Works, St. Albans		206
City Accumulator Co., 7, Angel Court, Strand, W.C.2		94	Henderson Wireless & Electrical Service, 54, Queen's Rd., Brighton		T16	Redfern's Rubber Works Ltd., Hyde, Cheshire.		26
Clarke & Co. (M/c) Ltd., H., George St., Patricroft St., Manchester		91	Henley's Telegraph Works Co., Ltd., W. T., 11, Holborn Viaduct, E.C.1		53	Regent Supply Co., 21, Bartlett's Buildings, E.C.4		58 and 60
Climax Radio Electric Ltd., Haverstock Works, Parkhill Road, N.W.3		84	Higgs (Gt. Britain), Ltd., Westbourne Place, Hove, Sussex		12	Reproducers & Amplifiers Ltd., Frederick St., Wolverhampton		44
Cole, Ltd., E. K., Ekco Works, Southend-on-Sea, Essex		70	High Vacuum Valve Co., Ltd., 113, Farringdon Road, E.C.1		108	Rist (1927) Ltd., A., Waveney Works, Freemantle Rd., Lowestoft		208
Columbia Graphophone Co. Ltd., 98, Clerkenwell Rd., E.C.		66	Hillman Bros., 123, Albion St., Leeds		T28	Ronnie Engineering Co., Gewdson Road, S.W.9		27
Colvern Ltd., Mawneys Rd., Romford, Essex		56	Hobday Bros., Ltd., 21-27, Great Eastern St., E.C.2		T11	Seabrook Batteries, 205, Bedford Av., Trading Estate, Slough, Bucks		210
Consolidated Radio Ltd., 75, Kilburn Lane, W.10		115	Hustler Simpson & Webb, Ltd., 317, Hoe St., Walthamstow, E.17		62	Selecta Gramophones Ltd., 81, Southwark St., S.E.1		T2
Cosmocer Ltd., Cambridge Arterial Rd., Enfield, Middlesex		14	Igranic Electric Co., Ltd., 147, Queen Victoria St., E.C.4		86	Shalless & Evans, Tranquil House, Tranquil Vale, Blackheath, S.E.3		254
Cossor Ltd., A. C., Cossor House, Highbury Grove, N.5		89	Iliffe & Sons, Ltd., Dorset House, Stamford St., S.E.1		7	Shawndel Tool Co., 99, Regent St., W.1		203
Cromwell (Southampton), Ltd., 32-33, Brintons Terrace, Southampton		76	Itonia Ltd., 58, City Rd., E.C.1		T27	Siemens Electric Lamps & Supplies Ltd., 39, Upper Thames St., E.C.4		31
Chorimet Radio Elec. Ltd.		215	Jackson Bros. (London) Ltd., 72, St. Thomas St., S.E.1		116	Six-Sixty Radio Co., 17-18, Rathbone Pl., W.1.		95
Dallas & Co. Ltd., John E., 6-10, Batterton St., W.C.2		T22	Johnson Talking Machine Co., 96, Clerkenwell Rd., E.C.1		T9	Simpsons Electric Co., Grange Works, Leyton, E.10		17
Darwins Ltd., Fitzwilliam Works, Sheffield		43	Kolster Brandes Ltd., Cray Works, Sidecup, Kent		63	Sinclair, Stafford, 49-50, Twyford St., N.1.		252
De La Rue & Co., Ltd., Thos., 90, Shernhall St., Walthamstow, E.17		6	Lampareux Electrical Supply Co. Ltd., 3, Dyers Buildings, E.C.1		18			
Dew & Co. Ltd., A. J., 33, Rathbone Place, W.1		T13	Lamplugh Radio Ltd., 177, Foleshill Rd., Coventry		219			
Diggle & Co., Alfred, Jane St., Rochdale, Lancs.		13	Lancashire Dynamo and Crypto Ltd., 94, Petty France, S.W.1		50			
Dubilier Condenser Co. (1925) Ltd., Ducon Works, Victoria Rd., North Acton, W.3		68	Lectro Linx Ltd., 79a, Rochester Row, S.W.1		87			
Duflecto-Polyphon Ltd., 2-3, Newman St., W.1.		T25	L.E.S. Distributors Ltd., 15-16, Alfred Place, W.C.1.		T14			
			Lissen Ltd., Worples Rd., Isleworth, Middx.		72			

(Continued on page XIV)

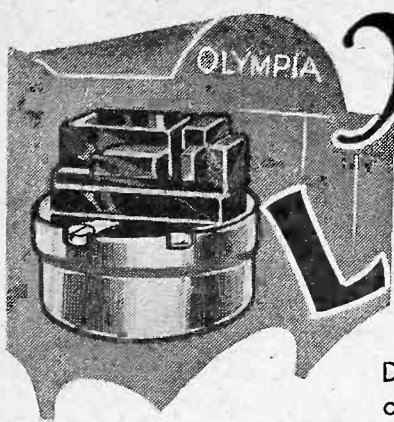

The LATEST in COILS

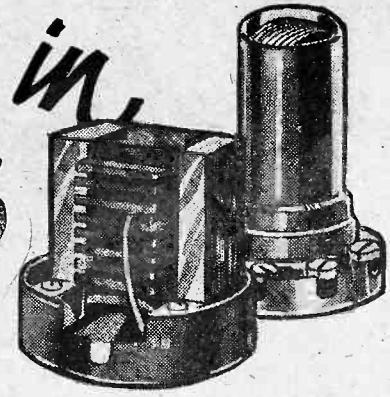

A Short Review of the Development of the Tuning Coil with a Forecast of the Coil of the Future. By W. J. DELANEY

A GLANCE at some photographs of old wireless apparatus will no doubt cause surprise to the amateur who is only just old enough to make his first acquaintance with a wireless receiver. The actual coil which I used on my first receiver in pre-war days took three days to make from sheets of brown paper. It took seven full-size sheets each carefully brushed over with shellac and wrapped round a large earthenware ink bottle. When each sheet had dried another was wrapped over it, and so on until finally I had a cylinder just over six inches in diameter and eighteen inches long. Thirty gauge enamel wire was wound round this, each turn touching until the cylinder was full, and this was a tuning coil! To select the amount of wire required to tune to a station a brass rod was attached to wooden end pieces and a brass slider was run along the wire with a bared portion to make contact (Fig. 1). It certainly worked, but what a contrast to the coil of to-day! Suppose we review the design which has been employed in tuning coils—what do we find? Quite a mixture of ideas, some of which have been introduced and hailed as ideal, only to be dropped and brought up again at a later date. Take, for instance, the actual former, or tube, upon which the coils were once wound.

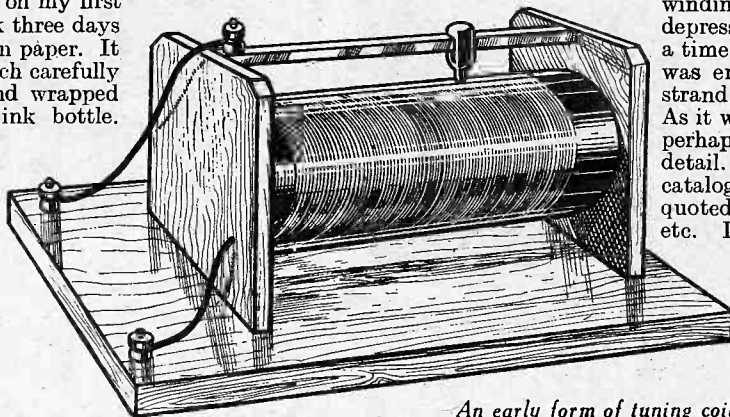

An early form of tuning coil, which, compared with a modern coil, illustrates the progress made in ten years.

The Former.

As I stated above, the first tuning coils, or inductances, were wound on large diameter cylinders. The size of these was

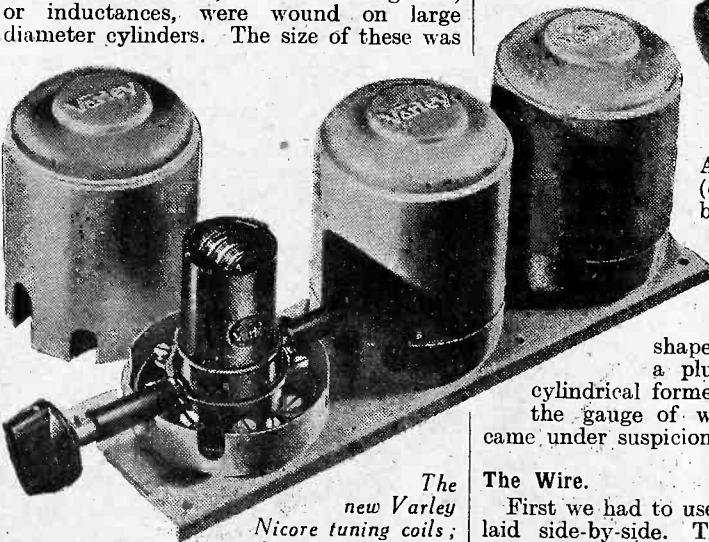

The new Varley Nicore tuning coils; they are available as single, double, and triple-gang units.

gradually reduced as the art "progressed," and there came a time when an "expert" (or it may have been a manufacturer!) stated that there were losses in the coil former, and the wire should be self-support-

ing. Consequently from that time numerous ideas were developed to do away with the coil former. We are no doubt all familiar with the plug-in coil, and this was really the outcome of the attempt to avoid losses in a coil former. But what happened?

The Wire.

First we had to use thin wire, each turn laid side-by-side. Then thick wire was used. After a time it was found that better results were obtained when the wire was

"pile wound." Many interesting forms of coil winding were developed, and at least one coil which I made up was wound on a round wooden former, heavily coated with shellac, and when this was tacky the entire winding was transferred into a concave depression in another piece of wood. After a time a special type of wire known as Litz was employed. This consists of a multi-strand cable wound in a particular manner. As it will be referred to again later it would perhaps be as well to describe this wire in detail. If you glance at a wire-maker's catalogue you will see that Litz wire is quoted as being 9/27's; 18/36's; or 9/40's, etc. It will be noticed from these figures that the first part of the number is a multiple of three. This is the most important feature of the Litz wire, and this is how it is made up. We will take 9/27's. A strand of gauge 27 wire covered with a single covering of silk is taken and plaited with two other similar strands. This gives a

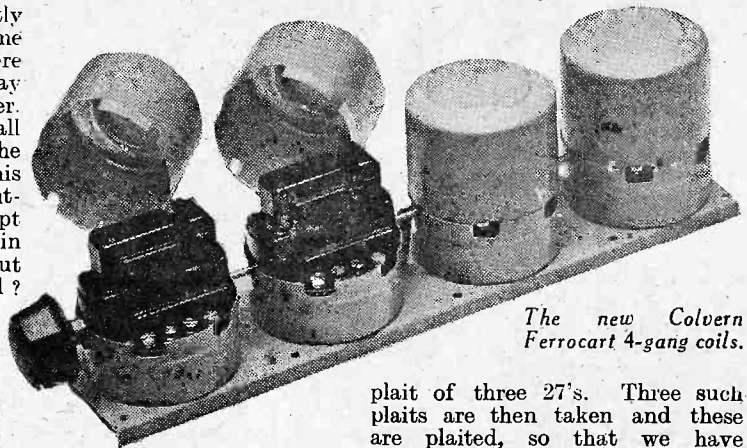

The new Colvern Ferrocart 4-gang coils.

plait of three 27's. Three such plaits are then taken and these are plaited, so that we have actually nine separate insulated pieces of 27 gauge wire plaited in sets of three. The whole is then finally wound with silk so that it resembles a single wire except that the slight irregularities due to the plaited cord may just be discerned through the silk. This wire possesses a very low H.F. resistance, and there was a time when a coil of it was used for tuning purposes and the efficiency was certainly of a very high order. So high, in fact, that only one such coil could be used without very complete screening. Screening in this case does not mean the placing of a small can round the coil, but the erection of a large metal box at least four inches away from the coil in all directions. Such boxes were obtainable from some manufacturers at a cost of about 3/-!

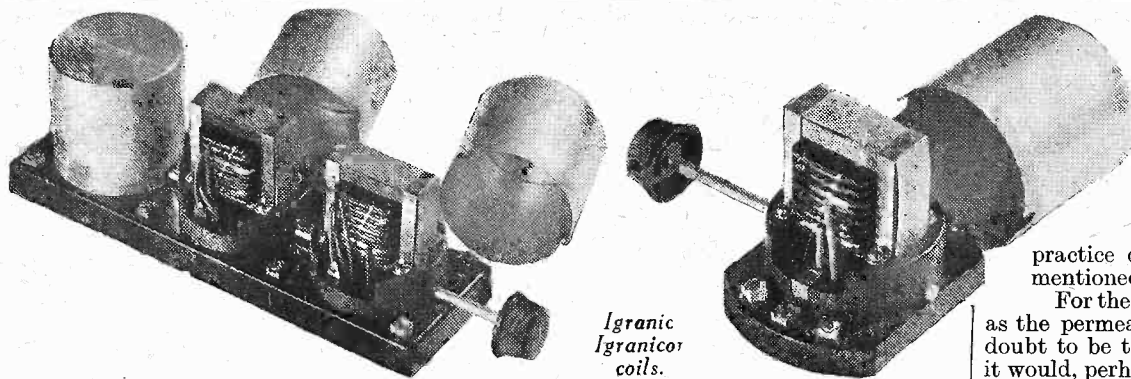

Igranite coils.

Back to the Former

What happened next? The former was still being used, but an "authority" ruled that ebonite was subject to losses and was not suitable for supporting an inductance coil for tuning purposes. Poor amateur! What was to be done now? A material was

soon produced—known variously, as Paxolin, Ivorlin, etc. This was better, and we began to settle-down. Suddenly, however, manufacturers of coils began to find that customers were returning coils because of crackling and similar noises, and it was found that the fine wire which was being

wound on these coils was being eaten away by some chemical in the former. We are now about the year 1932 and from what has been said the newcomer to wireless will gather that we were in a mess. That is, if we were doing everything we were being told. However, valves, transformers, and other parts of a receiver were also being subjected to alteration and improvement, and the coil became of less importance as it was possible to use an inefficient coil and make up for losses by employing a number of valves which by now were obtainable for 10s. instead of 30s. Thus, a return was made to the ebonite former, but now, owing to the fact that valves were easier to obtain, the coil was made of very small dimensions, put in a can to still further reduce its efficiency, and you had to buy two or three valves, and you got the results previously obtained with one large coil and one valve. Thus we "progress." However, perhaps I am painting a rather black picture. Actually, of course, other conditions were gradually getting worse, and it was essential to employ a number of tuned circuits or you were tuning-in several stations at once, and this could not be permitted. The large Litz-wound coil was not, by itself, selective, and tapping it to provide selectivity naturally reduces its efficiency. We are thus driven to employ two or more tuned circuits and consequently, if the valve is sufficiently efficient, there is no necessity to go all out for coil efficiency, so long as we get a reasonable pick-up. We were thus, at the end of 1932, in the position of using coils wound on a former of about 1in. in diameter, enclosed in a screening can, and which give an efficiency factor probably equal to an ordinary plug-in coil of the old days. Not so good as the Litz coil on a large diameter low-loss former, but better than a thin-

wire, badly wound coil on a cardboard tube. And, of course, we must remember that where two or more coils are being used they must be inductively separated, and this is easily carried out when they are in the cans, but difficult to carry out when not screened.

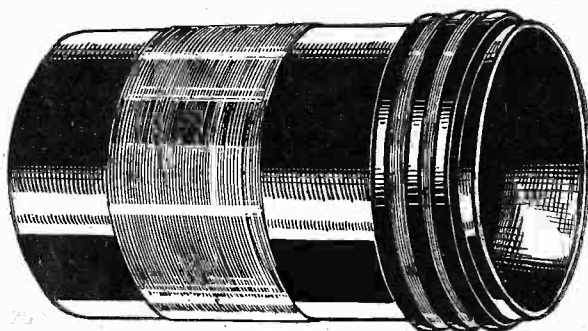

An early commercial cylindrical coil.

The Iron-core Coil

By the end of 1932 experiments had proved that a coil with an iron core was a pronounced possibility, and accordingly in the early months of this year we had the iron-core coil thrust upon us. The formers upon which these coils are wound is under an inch in diameter in most cases, and the wire is of the Litz type. The efficiency of these is undoubtedly of a high order, and many things are now possible. I have already dealt in these pages with this type of coil, and it now remains to try and visualise the further developments which the coils can make. Cannot the wire be removed altogether? This may seem absurd, but a careful study of the developments which have been made show that it certainly is possible. What of the tuning condensers? So far this has been a necessity, but with the advent of the iron-core this will be dispensed with next year. This is not a prophecy, but a definite fact, and the coil itself will be tuned by varying the position of the iron core. This has already been touched upon in these pages, and the system is known as permeability tuning. At the moment, however, the device is rather on the large side, but there is, no doubt, a method of making a smaller, and thus the receiving set will also be able to be reduced in size. But is there not another method of tuning whereby both the coil and the condenser

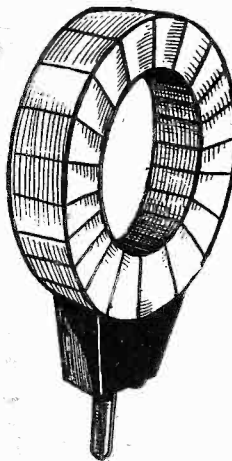

An efficient, but early type of plug-in coil.

may be dispensed with? As we are only half-way through 1933, it is useless to attempt to suggest that there is no other method, and it is just as likely that the tuning methods of 1934 may differ from those of this year by as wide a margin as does this year's practice differ from the methods first mentioned in this article.

For the benefit of the new reader, and as the permeability method of tuning is no doubt to be the next development in radio, it would, perhaps, be as well to give a rough indication of the arrangement as it is at present being developed in the majority of the manufacturers' laboratories. First of all, from what has already been said, it is obvious that the inductance of the coil is increased when it is wound round a powdered-iron core. Obviously, therefore, the withdrawal of the core will decrease the inductance. This naturally leads us to assume that it should be possible to tune

from say 200 to 600 metres by varying the position of the core in relation to the coil. Unfortunately, however, there are one or two difficulties which occur, and it is not simply

a question of taking a small core and a small coil and simply pushing the core into the coil. In order to obtain a straight line variation it is probably necessary to make the coil (or the core) of a certain definite shape and the mechanical side of the operation may then be simplified. Furthermore, once this particular shape has been decided upon it will be obvious to all that every coil will possess absolutely the same "law," and that such variations as now exist between, say, an aerial coil and a tuned-grid coil will no longer exist. This leads us further to the assumption that the ganging of three or more circuits will become absolutely simple and accurate, which will in turn lead to greater overall efficiency.

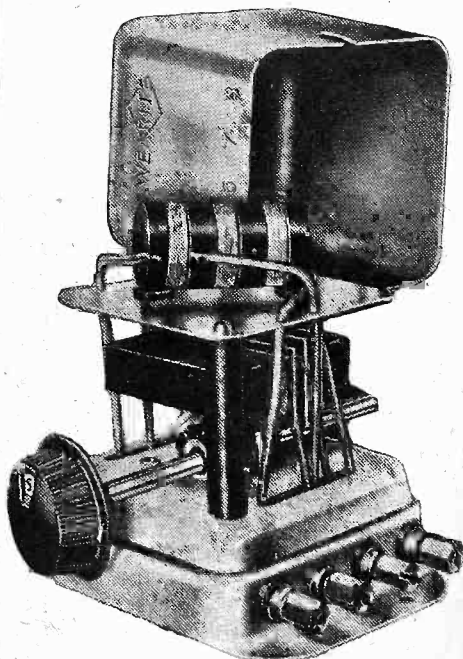

The new Wearite Nucleon iron-core tuning coil.

Where is DESIGN

A Critical Review of Some of the Improvements Which Have Been Introduced During the Past Year.

Leading?

THE present, on the eve of the Radio Exhibition, is to the wireless amateur rather like the end of March to the business man. The Show marks the beginning of a new radio year, and at the end of the old one we may find it interesting to review the events of the past twelve months, noting, among the numerous developments, those which have proved an immediate success, those which have quickly been superseded, and those which have opened out new fields for future exploration.

There is no doubt whatever that the radio year which is nearing its end has been a most remarkable one in every way and one that will stand out in wireless history as the most important in several respects. A greater number of really important inventions have been made than ever before in the same space of time. More difficulties have been successfully overcome and we are a good deal nearer to perfection. Despite this, our achievements have shown us that there is much more to be learnt and many new paths still to be pioneered. They indicate in which direction those paths lie, but only by further endeavours can we trace them and mark them out on the radio map.

"Straight" or Superhet?

But enough of similes; let us see just what our new knowledge means to us and how we can apply it to future progress. Dealing first with the types of receivers which have been most popular during the last year one cannot help noticing the growth in numbers of superheterodynes. Of all the various types of sets the superheterodyne has increased in numbers by the greatest proportion. Why? Chiefly, I think, because the question of selectivity has gradually become so much more acute. Simple sets with band-pass tuners, although perfectly good in their way, have been found far too unselective to cope with the more congested ether conditions, and the superhet is at the moment the only kind of set that can be said to tune sufficiently sharply to separate stations working on frequencies less than 9 kilocycles apart. During the past year it has often been said that the superhet is the only kind of receiver for the future. I am tempted to ask

"Is it?" And I also venture to reply "I doubt it." As reason for this reply I would say that the new systems of tuning which are just coming into prominence will probably give us—for the next year at any rate—a sufficient degree of selectivity for our needs when used in "straight" sets. The latest iron core coils give amazingly sharp tuning, and with the perfection of permeability tuning (in which the variable condenser is dispensed with, and tuning accomplished by varying the position of the iron core), it is very probable that the ordinary "straight" three or four valver will be given a new lease of life.

To Buy or to Make

A question that has arisen very frequently during the past year is: "Is it worth while to build one's own set when a really good ready-made one can be bought so cheaply." Most readers of PRACTICAL WIRELESS will have no hesitation in replying in the affirmative, but there might be some who have their doubts. The person who builds his own set (assuming that it costs as much as the ready-made article) is much better off, though, because as the many novelties and improvements become known he can add them to his set at very little cost, whilst the owner of a commercial receiver is obliged to wait until the new season's sets are available before he can enjoy the latest features. And features that are new

when the set is first bought may be rendered obsolete in a few weeks, or even in a matter of days. My meaning will be made more clear if I mention that thousands of home-constructors have already tried and adopted such things as Class B amplification, automatic volume control, iron-core tuning coils, high frequency pentode valves and numerous other innovations that have come into being during recent months. The user of a commercial set must wait until after the Show, however, before he can take advantage of them.

Class B and Q.P.-P.

And now let us analyse the more important of the year's developments and consider how they are likely to contribute to the future of radio. I do not know what you would consider the most important recent contribution to radio, but I should be inclined to vote for Class B amplification, which has brought the so-called humble battery receiver on to the same plane as the more luxurious mains set from the point of view of undistorted loud-speaker output. The average Class B valve when suitably operated will give an output of two watts, or twice as much as the smaller mains driven set can deliver. Class B has been in use for only a very short time, but has proved itself to be all that was expected of it, and entirely free from "snags" such as one often finds with new inventions. Perhaps the only objection that could be levelled against the first types of Class B valves was that they required a filament current of 4 ampere, or twice as much as the usual type of small power valve. This difficulty no longer exists, however, since a number of smaller Class B valves, taking a filament current of only .2 ampere, are now available. These smaller valves give a maximum signal output of

about 1 watt, and although this may seem rather low, it is quite as much as the average listener ever requires and is enormous when compared with the previously considered ample output of a few hundred milli-watts.

Whilst on the subject of Class B one might make reference to quiescent push-pull, the system of amplification which was introduced immediately prior to Class B. Q.P.-P.

(Continued overleaf)

THE DOUBLE-DIODE-TRIODE THREE

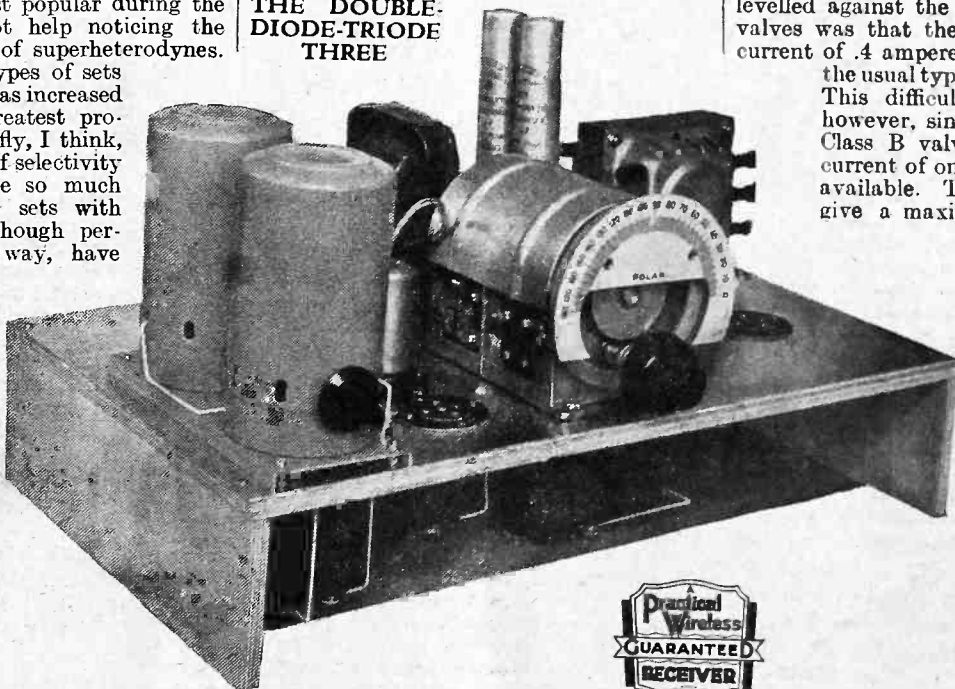

(Continued from previous page)

has, of course, the same primary objects as the system which followed it and might have become extremely popular had it not been found that Class B gave even better results in a simpler and less expensive manner. Although it marked a great forward step, Q.P.-P. had the shortest life of any radio development I can recall—not because it suffered from any serious fault but merely because contemporary progress was too rapid for it.

Automatic Volume Control

Automatic volume control has come very much into the limelight during the last year and has, in my opinion, though some may doubt it, a brilliant future. By maintaining the volume of sound reproduced by the loudspeaker at a constant level despite the fluctuating signal voltages picked up by the aerial system, it minimizes the greatest objection to long distance reception—fading, and prevents distortion caused by valves being overloaded by a nearby or powerful station. A.V.C. is particularly useful and important in a receiver designed for use in a moving motor-car; in fact, "car radio," as it is being called, is almost impossible without it, due to the fact that the signal strength picked up by the aerial varies enormously as the car passes under bridges, near to metal structures, through streets or over the open country. It is because of the increasing use of automatic volume control that several new valves have been designed during the past year. Double-diodes, double-diode-triodes, double-diode-pentodes and short-base variable- μ valves all owe their introduction to the development of A.V.C. and will no doubt be widely used in the future. The first three named serve the dual purposes of detector and automatic volume control, whilst the second and third do still more by functioning also as low frequency amplifiers. The fourth valve is useful in so far as its degree of amplification can be varied from zero to maximum by the application of a grid bias voltage of only slight variation. Because of this, the automatic volume control action is much more complete than when ordinary V.-M. valves are employed.

The "Cold Valve"

Another new device which at one time was considered to have a future is the "cold valve," or more correctly, the dry high-frequency rectifier. This is similar in construction to the well-known metal rectifiers used in A.C. eliminators, but is, of course, much smaller, and is intended for use with high or radio frequency currents. Having no filament to heat, and taking no high-tension current, the new H.F. rectifier is certainly economical, but for some reason or other has not become popular. The "cold valve" can be used very successfully in

THE FERROCART Q.P.-P. THREE

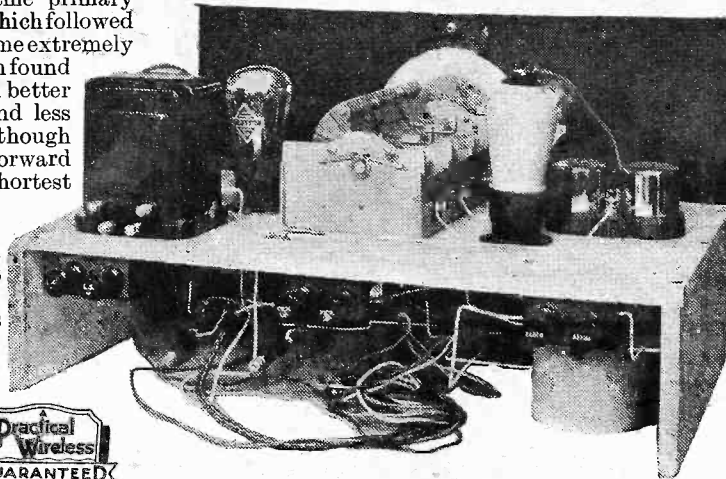

Rear view of a guaranteed "Practical Wireless" receiver, employing Ferrocart coils.

THE FEATHERWEIGHT PORTABLE FOUR

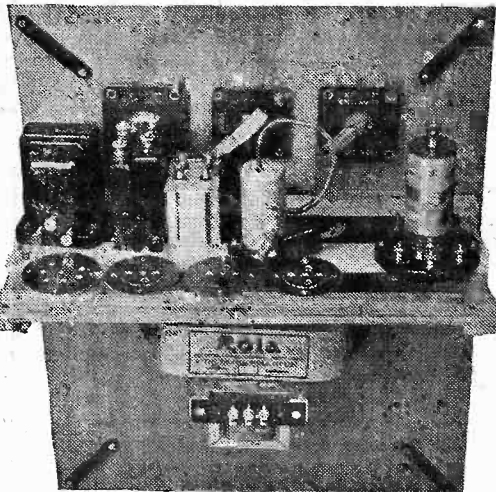

A.V.C. circuits, and one might think that this fact alone would be sufficient to ensure popularity. But it can only be used as a detector—it has no amplifying properties—and thus does not in reality effect any saving because valves are available which

THE BETA UNIVERSAL FOUR

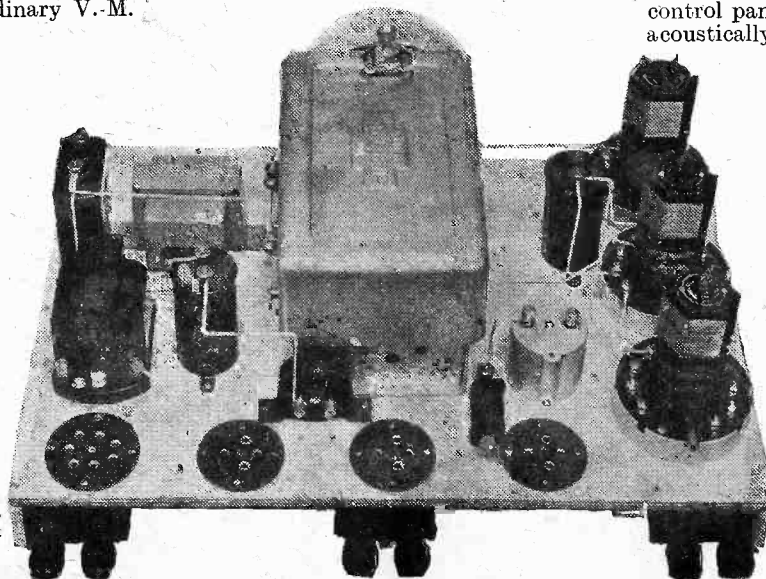

will rectify and at the same time give a very large amount of amplification. Another defect of the dry high-frequency rectifier is that it has a comparatively low resistance and thus exerts considerable "damping" on any tuned circuit in which it is included. This can only satisfactorily be overcome by feeding the component through a specially designed step-down transformer or by connecting it to a "low" tapping on the preceding tuning coil. The dry H.F. rectifier is most efficient at the lower radio frequencies (longer wavelengths) and may thus be used most successfully as the second detector of a superheterodyne. At the present stage of developments, however, it is very doubtful if the "cold valve" will ever be used extensively; had it been possible to introduce it at an earlier stage it would undoubtedly have become a standard fitting.

All-Wave Receivers

Short-wave reception has become increasingly popular during the last year, chiefly due to the opening of the Empire Transmitters at Daventry, but also because of the extended use of short waves by stations in every part of the world. I think it is quite safe to predict that in future practically all broadcasting which is intended to be picked up over great distances will be carried out on short waves. This must inevitably lead to the perfection of receivers so designed that they will receive on all wavelengths from about 10 metres up to 2,000 metres. A few sets of this kind have already made their appearance and some of them have proved to be extremely efficient, but there is still room for considerable advancement in this direction.

Structural Alterations

Dealing with the general external design and appearance of receivers, only few changes seem to have been made during recent months, and sets of 1933 are not vastly different to those of 1932. The reason might be that designers have been too busy dealing with the "internals" to consider the less important aesthetic details, or that the appearance of present day sets meets with general approval. One change that has been made by a few firms, and which is likely to prove a popular one, concerns the position of the loud speaker in console type receivers. For some reason it became standard practice to have the speaker fret directly above the control panel, and though the system was acoustically satisfactory it had the disadvantage—in battery sets at any rate—of wasting a good deal of useful space. Some manufacturers are now using a cabinet which is long rather than high, so that the speaker can be arranged beside the set instead of above it. It is probable that this style will eventually be used by practically all makers of battery receivers, if not also by manufacturers of mains sets. Many improvements have been made to tuning condenser drives with the object of making them easier to read, and most of the 1934 sets will be fitted with "full vision" tuning scales. With these the whole scale is visible whilst a pointer moves

(Continued on page xii)



Items of Special Interest

IN order to assist those who wish to investigate developments in special directions, the following notes are classified under various headings, and it should be possible to read here brief details of certain developments or new components, and then proceed to the appropriate stand in order to examine the actual component.

LOUD-SPEAKERS

THE principal link in the chain of wireless reproduction is undoubtedly the loud-speaker, and in many receivers it is possible to fit a new loud-speaker without in any way altering the receiver circuit. A new speaker will, in quite a number of cases, give an old receiver a new lease of life, although it must be remembered that a good loud-speaker will show up faults in a receiver which are now not audible owing to the failure of the speaker to give a sufficiently straight-line response. For the smaller type of receiver—or for receivers intended for use in cars—the new Midgets will undoubtedly prove of great utility. The Grampian speakers in this class, for instance, have an overall size of 6½ in., with a depth of only 2½ in. They will handle 2.5 watts. In addition to this model there is the Sonochorde, the Amplion "Sonette," and several others. In all of these the quality of reproduction has definitely not been sacrificed in order to get a small type of speaker. Careful choice of the cone material, the centralizing device and the transformer ensure that the response curve is sensibly level over the normal range and there is nothing "squeaky" about them. However, a visit to the respective stands should soon convince you regarding the response and the volume which is obtainable.

The other type of speaker which will attract equal attention is the combined Class B Unit and Speaker mounted on the same chassis. The Ferranti is a very good example of this, being almost a complete receiver. The Rola is built up on similar lines, and other firms which are introducing this type of speaker include Epoch, Bakers Selhurst, Amplion, and Sonochorde. In most cases all that is necessary is to connect the present output terminals to the two input terminals on the speaker unit, and in this way your present set receives the addition of a Class B stage and a really good moving-coil loud-speaker. When it is remembered that the output of this combination is of the order of 2 watts, the improvement which is effected to an existing simple receiver is astounding.

Before finishing this section mention must be made of the new Grampian Dual Midget speakers. The Dual speakers are already well known and may be seen on the Celstion, Rola, Magnavox, and other stands, and they consist of two speakers mounted on one chassis, but they have different response curves. Thus it is possible to obtain a much greater musical range than is normally obtainable from one single speaker. For the convenience of the listener with limited accommodation, and for special cases, the Grampian Midget Dual has been introduced, and this measures only 13½ ins. long by 3 in. deep. It handles 5 watts and costs only 55s.

CONDENSERS

THE new types of variable condenser will appeal to many, and the principal developments in this direction may be seen on the stands of British Radiophone, Polar and Jackson Bros. The Radiophone condensers are very much smaller than have hitherto been obtainable, and represent a great improvement in condenser design. In the ganged type the trimmers are now situated on the top, and they are totally enclosed, making them thoroughly dust-proof with no dust-cover to get mislaid or lost. For short-wave work a special type of condenser is obtainable from this firm in either a single or a two-gang type. These are substantial components mounted on a thick steatite base. The new Polar condensers are more substantial than former models, and will also be found full of good points. A glance round the stands will reveal several other firms who have introduced or improved condensers of both the fixed and variable types, and the Peak fixed condensers on the Wilburn stand are worth close attention. These are made in several types, and will be found very cheap, especially in the tubular type. The Peak range of electrolytic condensers will also attract attention.

L.F. TRANSFORMERS

NATURALLY all the manufacturers of transformers will be found to have introduced special components for the recently introduced Class B method of working. In this connection we must draw particular attention to the Benjamin, Sound Sales, Multitone, Wearite, R.I., and Varley stands. On all of these will be found various types of input and output transformer. In some different types of Driver transformer are manufactured for use with the different types of valve, whilst in others the transformer is provided with tapings so that it may be used with any type of Class B valve. The prices vary according to the types. The Multitone components are, of course, especially designed for tone control, and this firm supplies a special potentiometer for connection to appropriately marked terminals on the transformer. When connected in circuit, this potentiometer gives a perfect gradation of tone from "all bass" to "all top," or, in other words, it is possible to accentuate just what part of the musical scale you wish. It is a most interesting device. A number of very small transformers may be seen, in which the core is of special material. The Igranico Parvo will probably be the smallest L.F. transformer on view, although the Bulgian Senator runs it very close. The R.I. new component, consisting of an auto-transformer and bearing the name Auto-parafede Transformer is also of the midget type and is also unconventional in design. In most of this year's transformers the quality will be found to have advanced over those of last year.

1933 MILESTONES!

- Quiescent push-pull amplification introduced to this country.
- Class B amplification introduced.
- Iron-core coils for tuning, and complete sets of ganged coils employing such cores, made available to the home constructor.
- Full-vision tuning scales.
- Shadow-tuning scales.
- Silent tuning.
- Automatic volume-control made possible by the introduction of new types of valves.
- Delayed automatic volume-control introduced.
- Quiet automatic volume-control introduced.
- Midget loud-speakers available for the home constructor.
- Permeability tuning reaching a practical stage, but not, at the time of going to press, in a state suitable for release to the public.
- All-metal receiving valves introduced.

COILS

THERE should be no need to remind the keen amateur that coils have undergone the most drastic changes during the past season. Now the majority of coils will be of the iron-core type, in which the iron core is made up from powdered iron held in suspension in some manner or other, according to the particular patented method adopted by the individual manufacturer. The Ferrocart coil was the original wireless coil to employ this system and will be seen on the Colvern stand in practically every type necessary in modern wireless practice. On the Varley stand may be seen some similar coils, but built up in a different manner. The Lissen coils, together with those manufactured by Messrs. Telsen, are probably the smallest yet seen for broadcast purposes. In the latter case especially the complete coil with screen is only 2 in. high. The former upon which the Lissen coil is wound is about half an inch in diameter. Messrs. Wearite and Igranico will also be showing this special type of coil, and literature obtainable on the stands will enable you to appreciate the improvements which may be effected in a receiver when these coils are employed.

In addition to the simpler types of iron-core coil there will no doubt appear at least one ready-made commercial type of permeability tuning circuit. This is a development of the iron-core coil above-mentioned, with the addition that the iron core itself is removable. The coil is wound to a certain value, and the core is arranged on some form of control so that the adjustment for wavelength is carried out by withdrawing the core, or inserting it into the coil. Thus the variable condenser is dispensed with; tuning may be made much sharper; circuits may be more accurately matched; the amplification of the circuit can be much higher, and, in fact, there are many great advantages for this form of tuning. Several attempts have already been made to design an efficient permeability tuner, but various little difficulties have crept in, and at the moment, at least, there is no efficient device of this nature available. By the time the Exhibition is upon us, however, progress will no doubt have been made and we shall see some form of permeability tuning on one of the stands. Whether or not this form of tuning will become so popular as to render the variable condenser obsolete, we do not know, neither do we attempt to prophesy.

VALVES

IF you have been following the progress of wireless during the past few months you will have seen that many new types of valve have been introduced. Undoubtedly to the majority the most interesting is the Class B valve. This, for the benefit of newcomers, is a double valve in which the well-known push-pull arrangement is employed in a novel way. As a result, no grid bias is required, and the single battery valve, for an average anode current of only 6 to 7 milliamps, delivers an output of approximately 2 watts. This is, of course, equivalent to the output of many mains pentodes taking 200 volts H.T. and consuming 30 milliamps or more. The other principal valve development is the Catkin valve, produced by the Marconi and Osram people. This is an all-metal valve absolutely unbreakable, and is obtainable in all the principal mains types. Another interesting new valve is the variable- μ H.F. pentode, and specimens of this may be seen on the Mullard, the Ferranti and other stands. On the Cossor stand may be seen a new valve bearing the name Double Diode Pentode. This is a special valve which performs the combined functions of diode detector, automatic volume control, and is itself a controlled L.F. pentode. A most marvellous piece of work. On the Ferranti stand may be seen a special type of valve known as the Heptode, which is a seven electrode valve performing the combined functions of H.F. valve, detector, oscillator, etc. It works wonders in a superheterodyne circuit.

TELEVISION

There is certainly a great interest in the subject of Television at the moment, and unfortunately we have not yet received any details concerning the Baird Company's exhibits. There will, however, be a most interesting exhibit by the Bush Company (Stand No. 64) consisting of a combined sound and vision receiver built on novel lines. Utilizing the mirror-drum apparatus, this receiver has the appearance of a grandfather clock, a method of construction which lends itself admirably to the fitting of a viewing screen at a suitable level for comfortable use. The loudspeaker is situated immediately below the viewing screen, and so lends the final touch to the illusion of reality. There will also be on view a constructor's kit by Messrs. Ferranti, for a receiver on totally new lines. Hitherto the scanning disc or the mirror-drum has been the most efficient method of receiving the television transmission, and in fact of transmitting it also. The cathode-ray tube has also been adapted for use in the reception of television, although it has not been greatly successful. The new system is at present rather obscure, but from what we have heard it introduces a completely new method and is anticipated to give results greatly superior to any method which has yet been employed. The fact that Messrs. Ferranti are marketing the receiver tends to show that there is likely to be some novelty and good promise in the receiver, but as at the moment no full details are available, we must wait until the Show.

SUNDRIES

THERE are numerous other small items which will well repay inspection, and although it is not possible to deal with every one, it should not be difficult to find any item you particularly require from the Guide to the Show which was published in last week's issue. If, however, you are in any doubt whatsoever, ask one of the staff in attendance on our stand. Remember the number—8.

"LITTLE and good" is an expression which has special significance for the radio listener, and particularly for the listener who has but a modest amount of money to spend upon his equipment. In such circumstances, limits must be set somewhere to the capabilities of the receiver; and it is something of a problem to know just where those limits should be applied.

Ultimately, of course, the decision must rest with the individual listener, but it is only fair that a clear statement of the various alternatives should be placed before him. Briefly stated, the subject for discussion is: Inexpensive radio, its possibilities, and what to choose.

By the term "inexpensive" may be understood inexpensive in the first cost of the equipment, or inexpensive to run, or a combination of both, the last mentioned being, possibly, the ideal. It is possible to purchase or to make a very inexpensive outfit which, however, may be much more costly in operating charges, battery consumption, renewals and repairs, than another, apparently similar set, costing a few shillings or pounds more. Thus, the saving in initial cost may be lost over and over again in the first year or so of use—a very unwise and expensive "economy."

A Guiding Rule

The first guiding rule, therefore, in inexpensive radio, is to use the best possible materials—whether ebonite, or wood, or wire, or components such as transformers, condensers, valves or batteries. Even if this means that you must content yourself with a simpler or less powerful equipment, the sacrifice in this direction is well worth while—let "little and good" be your motto from the start.

This brings us, however, to the crux of the whole question. Low first cost, coupled with due economy in running expenses, provided these can be allied to trouble-free service, are very obvious advantages; but the ultimate test of any radio outfit must be the performance it gives by way of programme reproduction. Now programme reproduction can be gauged in terms of three factors: first, the number of

stations which the set can pick up at reasonable volume; second, the quality of the musical reproduction; and third, the average volume of sound.

It may be taken at once that in an inexpensive set—and in this connection is meant not necessarily a very cheap set, but a set of moderate first cost and reasonably economical to operate, it is not possible to obtain world-wide reception, *plus* perfect quality of reproduction, *plus* "public address" volume.

At least one of these features (generally two) must be sacrificed if the interests of economy are to be served. This statement must not be taken to mean that it is utterly impossible to combine range, quality, and volume in one receiver—it can be done, but at a cost which the average listener cannot afford.

Alternatives?

What, then, are the alternatives? Let me state them in what mathematicians would call "descending order of range." For a reasonably low cost you could provide yourself with either: (1) a long-range receiver capable, in favourable circumstances, of receiving anything up to a hundred stations, but giving reproduction which not even the most optimistic could pronounce even fair; (2) a receiver, which, under good conditions, will give you a dozen or more stations at tolerable quality and useful volume; (3) a set primarily designed to receive the local or alternative stations and to give reproduction which leaves little to be desired on the score of either quality or volume.

The above, of course, is only a rough classification, for types of apparatus are innumerable, and the different classes merge imperceptibly into each other. For example, a modification in the output stage of one set, or the substitution of a better type of speaker, may result in that outfit meriting promotion to a higher class. Or, by spending just a little more money, the range quoted



By H. J. BARTON CHA

in the second class just mentioned may be associated with the high-quality characterising the third class.

The suggestion I wish to make, however, is that every listener who has to study economy—and who has not?—should apply the axe to range rather than to quality. Good reproduction at any price, but distant reception as a very secondary consideration, is my sincere advice. The reason? Well, in the first place we must not forget that the broadcast service has been designed for the enjoyment of programmes first and foremost, and not as a medium for showing the paces of scientific apparatus which, if not perfect, are highly ingenious. So that if we accept broadcasting for what it sets out to be, and what it is—the finest and cheapest form of entertainment—we might as well enjoy it to the full, and this can only be done by the use of apparatus which reproduces the programmes with the minimum of distortion.

Your Achievement

In this connection, the technically-minded listener is often apt to forget that he is probably the only member of the family who is at all interested in the experimental side of radio, or in long-distance reception. The majority of the family, and certainly all the ladies, want radio for listening to the local programmes. They seldom thank you for installing a complicated set upon which you can bring in programmes from foreign countries, and they do not enjoy the foreign programmes when they hear them. But they will be full of gratitude if your new season's set will always give them the alternative local programmes, and, perhaps, one or two of the best foreigners, with quality better than they have ever heard before.

Again, I fully believe that the thrill experienced by many at a goodly bag of foreign stations is the thrill caused by the achievement. It is not the foreigners, but it is having brought in the foreigners, which counts. Well, then, let your thrill be that of having achieved better reproduction. I judge that, to be able to boast that your reproduction is as near perfect as can be achieved, should give you quite as much satis-

An Early Home-Built Receiver, which gave Quantity—But Not Quality.

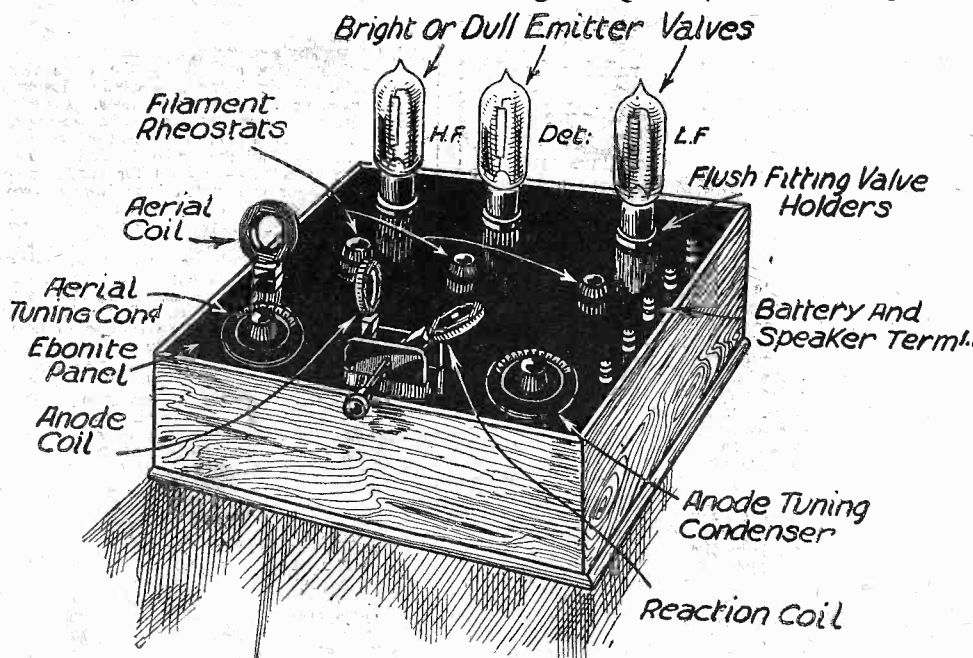

FOR Q
YOU
USE A
SPE
AND
VA

QUALITY for QUANTITY

Wh.Sch., B.Sc. A.M.I.E.E.

faction as to be able to boast that you have logged more stations than anyone else in the road.

Finally, if further argument is wanted, let me point out that if you now sacrifice quantity for quality and put in a set which will do ample justice to the excellent fare provided by the local station, you have the nucleus of an equipment which can be extended for long range work at any time, whereas if you expend your limited funds on a cheap set which will bring in half the world and appal your ears at the same time, nothing on earth short of rebuilding entirely will give you really enjoyable quality.

Quality Features

If, after having read so far, you are convinced that the thing to do is to go in for high quality reproduction, you will now be wanting some practical recommendations. What, you may ask, are the features of a "quality" set? The following suggestions cannot pretend to cover the ground more than superficially, and fuller investigation must be left to some future occasion, when it may be possible to show how quality is affected by each component and stage. Also, I am engaged in designing a PRACTICAL WIRELESS quality receiver which will appear in a forthcoming issue.

First of all, let us consider the valve arrangement. While adequate volume can be obtained from the local station, even if situated some fifty miles away, by a set having no high-frequency stage, I very much favour the use of one high-frequency screened-grid valve in the first stage. The reason is that with the greatly increased number and power of broadcasting stations, a very considerable degree of selectivity is required in order to free even the relatively powerful local transmission from interference. The use of a high-frequency stage before the detector introduces at least one extra tuned circuit, thus greatly increasing selectivity. Moreover, such a device as a series aerial condenser is a useful aid to selectivity, but imposes some loss of signal strength which can be made up in the high-frequency stage.

I would strongly advise that the high-frequency valve be of the

variable-mu type, so that, when listening to the local stations, the acceptance of the valve can be increased by increasing the grid bias. This will avoid any risk of distortion in the high-frequency stage, the point at which quite as much distortion is introduced—so far as my own observation is concerned—as in any other two stages put together.

Obviously, the next valve will be the detector, and here good signal handling capacity is of vital necessity if quality

reproduction is the main aim. My personal opinion is that a power grid detector, a diode or a dry rectifier is extremely good. Any reliable make of valve of the H.L. or detector class, carefully operated according to the makers' recommendations for power grid detection, should be free from suspicion. In this connection, the correct values of grid leak and grid condenser are important, and plenty of H.T. volts.

A set having one high-frequency stage and used for the reception of the local station should not require any reaction. If I were building such a set I would not fit any arrangements for boosting the signal in this manner. As, however, most commercial coils incorporate a reaction winding, you may feel inclined to put in the necessary differential reaction condenser. Keep it "all out" however, when listening to the local station, reserving the use of reaction for those occasions when you cannot resist the temptation to search around for a few foreigners.

On the L.F. Side

Now for the low-frequency side. If high-tension supply is plentiful, that is to say, if your set is mains-driven or you are using a battery eliminator with a normal battery set, I would advise a good big super-power triode for the output stage. In all probability your high-frequency and detector combination will give you ample signal voltage to operate such a valve with a good aerial, but if you are doubtful you can interpose a further low-frequency stage.

My reason for this choice is that such a valve has a very large maximum undistorted output. Note, please, that this does not necessarily mean big volume, but you must remember that the signal voltage at the low-frequency grid corresponding to a really loud passage in a normal programme is from three to five times as great as that corresponding to an average passage

of music. Your output valve, therefore, must be capable of handling without distortion, these sudden and infrequent bursts of strong signal—and only a valve having "super power" characteristics can do that. So let it be a super-power triode for preference. Failing this, a large pentode will handle quite a respectable signal, but to be on the safe side, a volume control of the potentiometer type following the detector is advisable, to prevent over-loading.

Should high-tension economy be a very important point—if, that is to say, you must depend upon dry batteries, use Class "B" for your output stage. You will thus obtain all the benefits of signal handling capability possessed by a super-power valve, but at far smaller cost for high-tension.

Tone Control

With Class "B," however, as also with a pentode output valve, the distinctive quality of the output is different from that of a triode. This is because both these classes of valve have a greater response to the high notes than a triode, and in comparison the reproduction seems a trifle shrill and high pitched. The question of tone control must be left to your own individual judgment. In this connection much depends upon your loud-speaker, in fact, the output stage, from the quality point of view, must be considered as a combination of output valve and speaker. Possibly your particular moving-coil loud-speaker, in conjunction with a pentode valve, gives a quality which appeals to you. If not, a tone control in the form of a condenser and resistance in series connected across the output terminals can be used and adjusted until you obtain the quality you desire.

If you are seriously out after good quality, do purchase a high-grade moving-coil loud-speaker. Really excellent permanent magnet instruments, which leave little to be desired, can be bought at a reasonably low price. Give it a fair chance by providing a large and thick baffle, and spend a little time experimenting to find the most satisfactory position in your room for it, if it is not incorporated in the set itself.

The Famous "Fury Four"—Quantity and Quality Combined.

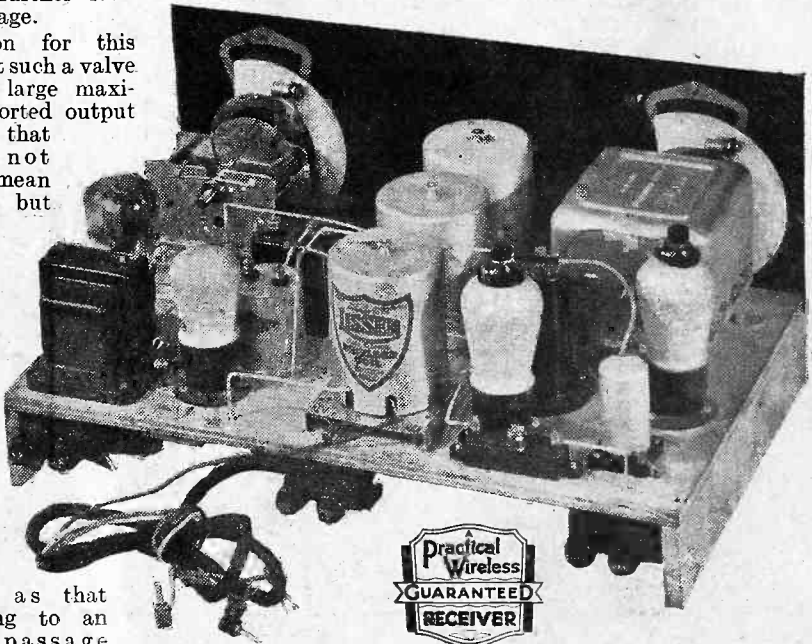

A FEW HINTS— WHICH MAY— (OR MAY NOT)— BE HELPFUL TO THOSE VISITING THE EXHIBITION!

WHAT TO WEAR.



OLD SCHOOL COLOURS

VERY SUITABLE ATTIRE. (N.B. SPATS ARE NOT GOOD FORM!)



NEAT AND SERVICEABLE.



HORN RIMS WITH OR WITHOUT GLASS— GIVE ONE THAT TECHNICAL AIR.



FOR THE FAIR SEX! A CHIC ENSEMBLE WITH DINKY POCKETS FOR PAMPHLETS AND CATALOGUES.

GETTING INTO THE SHOW.

EITHER PAY 1/6

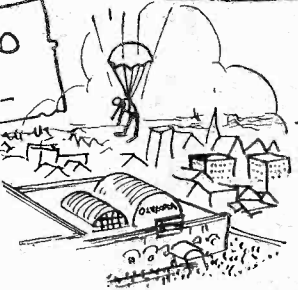

JUMP THROUGH THE ROOF



WALK IN BACKWARDS— (THEY'LL THINK THAT YOU'RE COMING OUT)

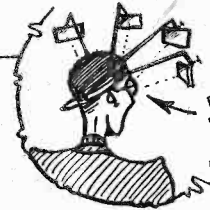

FOR AMERICANS— & THOSE IN A HURRY! A NEAT DEVICE WHICH ENABLES ONE TO INSPECT FOUR STANDS AT ONCE.

IT'S DANGEROUS TO WAKE HIM



OR PRETEND THAT YOU'RE SLEEP-WALKING!

AIN'TS ON DEPARTMENT.



* THE BASS RESPONSE IS PUTRID!

TALK TECHNICALLY * THIS REMARK IS ALWAYS PRETTY SAFE!

AN UNCONTROLLED VOLUME OF LIQUID TRANSMISSION AT GREAT FREQUENCY, MISS!



WHEREVER YOU ARE!



DON'T STRIKE MATCHES ON THE STAND ATTENDANTS



THEY MAY OBJECT!

INSPECTING THE EXHIBITS.



I TOLD YOU THERE WERE SEVEN VALVES, SIR!

I THOUGHT THAT THERE WAS ONLY ROOM FOR SIX!

HAVE A LITTLE FAITH!

COLLECTING PAMPHLETS.



PROCURE A TROOP OF SCOUTS

BE PREPARED!

GO!



& LEAVE IT TO THEM!

OR ELSE USE A VACUUM CLEANER!



A FINAL WORD!



WHAT DO YOU THINK OF THE CHASSIS CONSTRUCTION SIR?

MARVELLOUS!

KEEP YOUR MIND ON WIRELESS!

Arthur Ashdeley '33

What Set Shall I Build?

An Article Intended Primarily for the Newcomer to the Ranks of Home Constructors.

By W. B. RICHARDSON.

WITH the extraordinary number of new ideas and inventions which have been introduced into the radio world during the past year or so it is small wonder that those who are contemplating building new sets should have some difficulty in selecting the right type, especially as some radio journals seem to delight in bringing out a new set for each new gadget which is invented.

To the keen amateur the rapid appearance of Q.P.-P., Class B, iron-core tuning coils, Catkin valves, double-diode-triodes, D.D. pentodes and so forth must, to say the least, appear somewhat bewildering. It is only natural that he should ask: "When is it going to stop? When will there be a lull in order that I can look around and decide just what type of set I shall build for the coming season?"

Well, the answer is that the stream of progress will certainly not stop. No doubt it will slow down somewhat after its recent hectic flow, but it is no use waiting with the idea that things will settle down to a condition of little change. They will not. On the other hand it is just as foolish to endeavour frenziedly to keep abreast of the tide by building the very latest receiver as it comes out. *There is no sense in building up the latest set if it is of a type that does not meet your requirements!*

Deciding Your Requirements

The choice of the kind of set will depend on the following considerations. Firstly, what you expect from it, secondly local conditions, and thirdly the price you are prepared to pay. These three factors are, of course, largely interdependent so that each must be considered in relation to the other two. However, let us take the first. By what you expect from your set I mean not only what programmes you will want to receive but at what volume; whether you will want to move the set from room to room or take it away from home; whether you will want to combine a gramophone with it and so on.

Many people make the mistake of over-estimating their requirements. Like the motorist who says he wants a fast sports car and then potters along at 30 m.p.h., so they demand a long-range receiver and then keep it tuned to the local station, or else they ask for volume when all they want is purity of tone. If you are content with, say, a dozen alternative programmes,

and you will probably know from past experience just how much the foreign stations interest you, it is only a waste of money to build a seven-valve superhet. A three-valver would probably be quite adequate. Of course, if you happen to be situated so near the local station that nothing but the most selective receiver is

Q.P.-P. or Class B output if you do not want large volume. If, for instance, the set is going to be installed in a small room where an ordinary pentode or small-power valve would give a sufficient body of sound, then Class B would be quite unnecessary. Many people apparently do not realize that Q.P.-P. or Class B is essentially a system for obtaining comparatively large volume for a modest H.T. consumption. When delivering only a small volume it is no more economical than a single high efficiency pentode, and of course there is the extra initial cost.

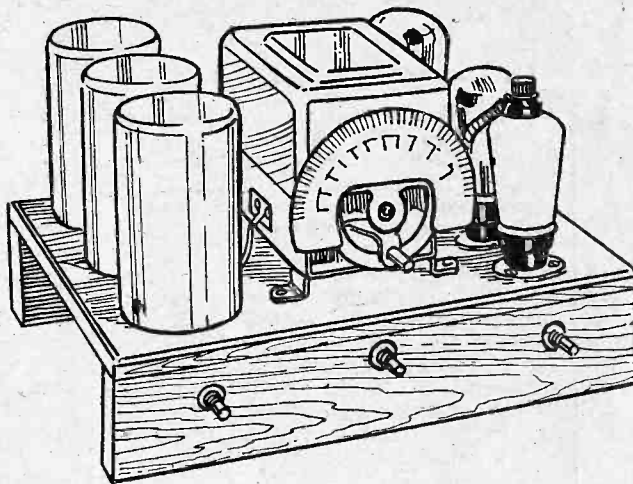

The wooden chassis style of home-built receiver, which makes use of the cabinet front as a substitute for the panel.

of any use, then a superhet will not be an extravagance but a necessity. However, under average conditions a three-valve set (S.G., det., pen.) will be well capable of giving you your dozen stations at moderate loud-speaker strength. Under favourable conditions it will give you many more.

Many people are satisfied with the two alternative programmes provided under the regional scheme. In their case, a good two-valver will meet their needs, providing they are prepared to erect a small aerial (preferably out of doors).

Q.P.-P. and Class B

Over-estimating one's needs regarding range is perhaps more common than over-estimating the volume required. However, it may be just as well to remind you that in the case of a battery set there is nothing to be gained by using

Do You Want Quality Reproduction?

Range and volume are not the only matters to decide in determining what you expect of your set. There is the question of quality of tone, portability, ease of control, etc. Unfortunately these things are not always compatible with one another. For instance, the demands of portability are such as to limit the choice of components to the lightest and smallest, and in the case of the speaker and batteries particularly, this is not inductive to the finest reproduction, nor is the fact that the speaker cone is usually placed in close proximity to the valves and other components. If, therefore, you demand portability you must not expect too much in the matter of tone.

If good quality reproduction is the chief qualification of a radio set in your opinion, and personally I think it should be, then the following points will be a guide to the

(Continued overleaf)

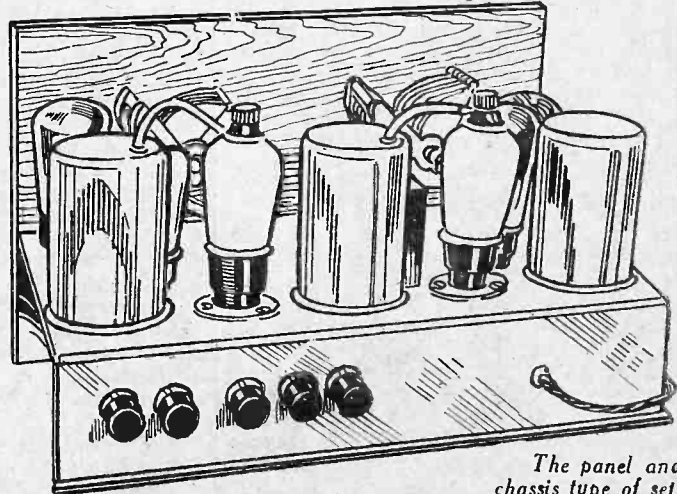

The panel and chassis type of set.

(Continued from previous page)

kind of specification to aim at. (1) Mains operation (or super-size batteries where mains are not available). (2) Band-pass tuning, or some form of tone-compensation where knife-edge tuning is employed. (3) Limited reaction. (4) Volume control, if employed, to be of the variable-mu type. (5) A tone control. (6) A good moving-coil speaker.

Let us see the reasons. (1) With mains operation there is no risk of the operating voltages dropping below the optimum values and so causing distortion as often happens with overtaxed or rundown batteries. (2) Band-pass tuning will avoid attenuation of the high notes due to side-band cutting, although at the same time a set employing ordinary loose-coupled, sharply-tuned circuits is quite suitable providing some form of tone compensation, such as a transformer with a rising characteristic, is employed. (3) By "limited reaction" I mean that the reaction control must not be capable of bringing the circuit anything like near oscillation point, or alternatively that it should be used with discretion because the full use of reaction always tends to sharpen the tuning and so cut off the high notes. Of course the variable tone control could be adjusted according to the degree of reaction employed but many would consider this an unnecessary addition to the task of tuning-in. (4) For the average three- or four-valver where a volume control is necessary, variable-mu is the best, as it does not introduce distortion. (5) The provision of a tone control may appear somewhat of a luxury, but here again if you are all-out for quality it is really worth while, quite apart from its use in compensating for high-note loss when reaction is used. (6) I suggest a moving-coil speaker because a good one will give you the best reproduction possible. Incidentally, if it is a question of cost I have usually found that it is better to buy a first-class moving-iron speaker of the inductor or balanced-armature type than a very cheap moving-coil instrument.

Local Conditions

Having decided on what you expect from your new receiver, you will have to consider your local conditions, for on these will depend the type of set which will be needed to carry out your requirements. The third factor, namely, cost, will, of course, enter into the question, but as this will hardly be overlooked I will not dwell on that point. Obviously, if your ambition is a seven-valve super and your pocket says a two-valver, then you will have to modify your ideas accordingly. Now, about these local conditions. Under this heading I would include the following:—

- (1) Proximity to the local broadcasting station.
- (2) Facilities for an aerial.
- (3) Power facilities.

Let us consider these in order. On the distance you are from the local station depends largely the question of selectivity. Generally speaking, if you are five to fifteen miles from the "local" and you want to get "plenty of foreigners" then you will need a set with a minimum of three tuned circuits. There may be one H.F. stage with band-pass input and a single tuned intervalve coupling, or there may be two H.F. stages with three single tuned circuits. There is not much to choose

between the two arrangements as regards selectivity, although the latter usually gives greater range. The first method can be employed in a three-valver (one H.F. stage, detector, and one L.F. stage),

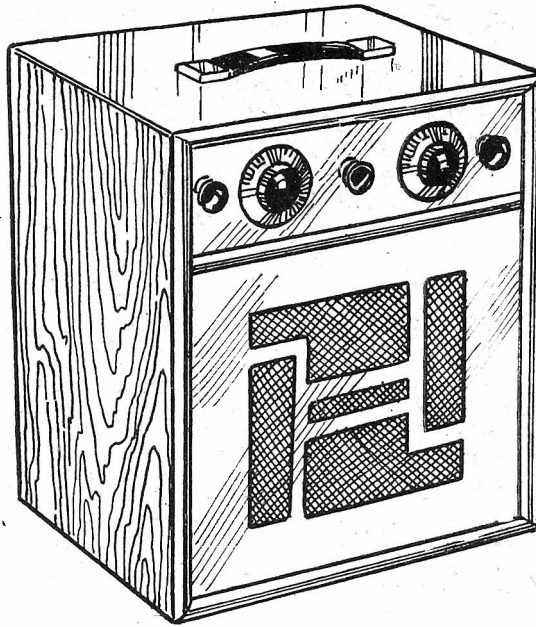

The all-in transportable style of cabinet.

but the second is usually to be found in a "four" (two H.F., detector, and one L.F. stage). The three circuits will have to be ganged. The decision as to whether to use a three-gang condenser or a two-gang and a single condenser rests with you. The three-gang allows of one-knob tuning, but the other allows of slightly finer adjustment. Examples of recent designs employing the two different methods are to be found in the Radiopax Four and the Fury Four. The former utilized a 3-gang instrument while the latter proved a remarkable station-getter using a 2-gang condenser for the aerial and first intervalve circuit with a separate condenser for the detector grid circuit.

Iron Core Coils ?

If iron core coils are used, the selectivity and range should be of a very high order, but the very fact of the coils being so selective necessitates perfect ganging so that care must be taken to see that the ganged condenser is a first class instrument and that the wiring is properly balanced. Of course, if you follow any of the designs published in these pages you may rest assured these points have been carefully studied. The danger lies rather in deviating from the specification. For instance, it may appear to be economical to use up an old condenser of out-of-date design which you may have by you instead of buying a new one, but it is more than likely to be quite unsuitable since the ganging of some of the earlier models was not carried out with the degree of accuracy demanded by these new type coils.

If you are situated very close to the local broadcasting station or some other form of interference such as a commercial station, then a straight set employing as many as four tuned circuits may be necessary, or alternatively a superhet.

Now let us consider the aerial question. At one time it used to be said that to raise the aerial ten feet was as good as adding another valve to the set. There was certainly some truth in it, but the point is

that the performance of a set is very considerably affected by the type of aerial system used and, therefore, in deciding on the type of set to build due consideration must be given to this point. If you object to an aerial you must allow for the reduced pick up provided by a frame contained in the cabinet. This will mean that to get the equivalent range of, say, a three-valver with outside aerial you will need a "four" or even a "five" with a frame aerial.

Battery or Mains ?

The question "Shall I build a battery or mains set?" is almost synonymous with "Have I electric power available or not?" for nowadays mains equipment is so perfected that there is no more reason why a battery set should be employed in an electrically equipped house than that oil lamps should be used for lighting. Therefore, by all means go ahead and construct an all-mains receiver if you have electric light in the house. The extra initial cost of the set itself will be counter-balanced by the saving in running costs, to say nothing of the convenience and the certainty that there are no batteries to run out at just the wrong moment.

To conclude these remarks on "what type of set to build," let me summarize with the following suggestions. To the man of modest means: Build a straight

two-valver, either battery or mains operated. To those desiring a dozen or so alternative programmes at moderate volume—a straight three (S.G., det., pentode), with the usual two tuned circuits. For greater selectivity a similar set with three tuned circuits, while those desiring a little more "punch" should build up a four-valve set. This in the case of a battery set should have Class B output, which will assure "mains volume" for a reasonable current consumption. The five-valve straight set with, say, four tuned circuits will be reserved for the DX enthusiast or for use where a less powerful set is inadequate owing to unfavourable local conditions. For consistent reception of distant stations a superhet with automatic volume control would be ideal.

If you want a set which will provide music for dancing then considerably greater volume than is normally required will be necessary. This means that for a large room a set with an output of several watts will be needed, or alternatively you could construct a separate amplifier to plug in to your set when required.

WHERE IS DESIGN LEADING ?

(Continued from page VI)

across it; this is just the reverse of the previous arrangement where the scale moved over a pointer and only a few degrees could be seen at the same time. Another important feature will be the marking off of the tuning scale not only in meaningless degrees but also in wavelengths or frequencies.

By way of summing up one might say that 1934 receivers will be very greatly in advance of their immediate predecessors, and will probably set a standard that can be maintained for a few years to come. Further developments are inevitable, but it is most unlikely that 1934 will see so many drastic and important changes as 1933 has done. Whatever happens, the readers of PRACTICAL WIRELESS will be kept well informed, as they have been in the past.

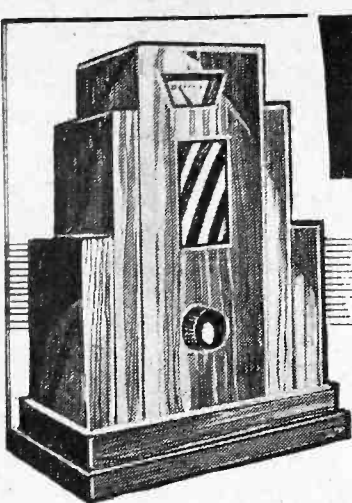

1934 RECEIVERS

An Attempt to Visualize the Type of Receiver which will be Developed During the Forthcoming Year. A Rapid Review by the Technical Editor

It is always rather foolish to attempt to forecast events, and the wireless art is in such a condition that one does not really know to-day just what to-morrow may bring forth. Who, for instance, could have foreseen the developments of the present year? In attempting, therefore, to describe the receivers of 1934 it is quite possible to hazard guesses at some of the things which might appear and yet which may, although unknown to the majority, already be well past the experimental stage in some laboratory. On the other hand, there may be inventions as yet unthought of which will cause as great a change in 1934 receivers as had been caused in the 1933 receivers by the arrival of Class B and iron-core coils.

The Superhet

It is almost certain, and I do not think I shall make a mistake here, that the superheterodyne circuit will be the most used in next year's receivers. The principal reason for this is, of course, the congested state of the ether. With the rumours that certain countries will not follow the advice of the controlling body, and will use just what wavelength and power they please, an even worse state of affairs may come to pass. Even at the present time, with allocated wavelengths and power, there are several points on the medium waveband where two or even three stations may be heard at once, on even the most selective receiver. The superheterodyne circuit is—at present at least—the only arrangement which can be adjusted so that stations working on even an abnormal separation may be separated.

The quality of reproduction suffers, of course, but it is fairly simple to fit tone correctors to make up for this loss. There are already four valve types available which render the construction of a circuit of this nature possible with a maximum of five valves—the complete circuit being then equivalent to a 10 valve super of three years ago. Such valves as the pentagrid, the double-diode pentode and the variable-mu H.F. pentode will need no introduction to our readers, as they have

rectification is provided. The heaters of the special valve used are rated to provide an adequate load with either method of supply. Unfortunately these valves are not available in this country yet, but next season may see their production. In America, the great utility of this type of circuit has led to the development of very small receivers, officially styled "Midgets," but which have received from the American public the nickname of "squeak-boxes." Measuring only about 10 by 8in., with a

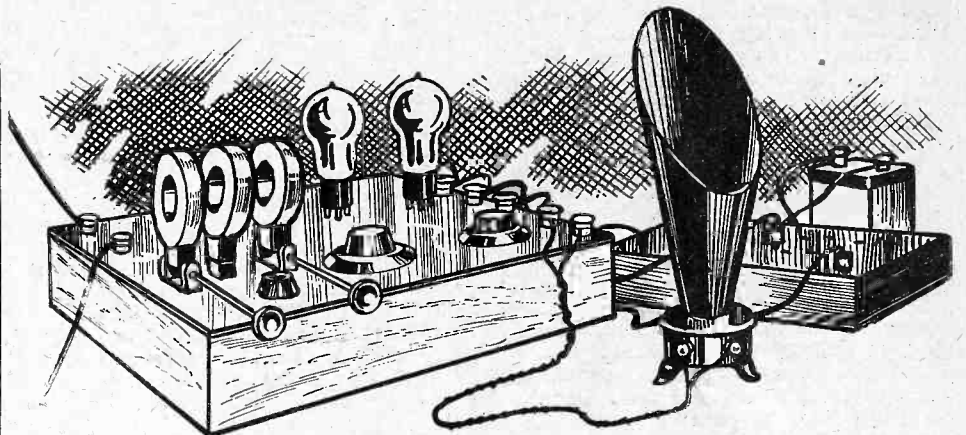

Fig. 1.—One of the earliest complete broadcast receivers.

already been described in these pages. Of course, at the moment such a receiver would be only mains driven. The battery receiver has not yet approached this standard. Before dealing with battery-operated receivers there is one other type of mains receiver which must be anticipated.

Universal Receivers

This type of receiver originated in America, but would be of great use in England. It is so designed that it may be used on D.C. or A.C. mains without any circuit alterations. A special valve, or a metal rectifier, is included in the mains input, and on D.C. this acts simply as a resistance, whilst on A.C. half-wave

depth of about 6in., these contain four and five valve circuits as well as a moving-coil loud-speaker. Naturally, the diameter of the diaphragm is only 3in. or so and the reproduction which this type of speaker gives has led to its nickname. Special midget components may be produced in this country shortly, and if so, we may see this type of receiver. I think, however, that it will be very short-lived, as the British public prefers good quality reproduction to "stunts." However, as I mentioned in the opening paragraph, it is unwise to prophesy.

Battery Receivers

The battery receiver with a simple triode output valve will almost certainly die this season. I cannot imagine a manufacturer producing a 1934 receiver without either a pentode for the cheaper class of receiver or a Class B stage for the better receiver. The output given by either of these arrangements is sufficiently good to warrant a moving-coil loud-speaker, and therefore I should imagine all self-contained receivers will have this type of speaker as standard equipment. The improved use of this speaker will lead to the gradual abolition of the moving-iron type and

(Continued overleaf)

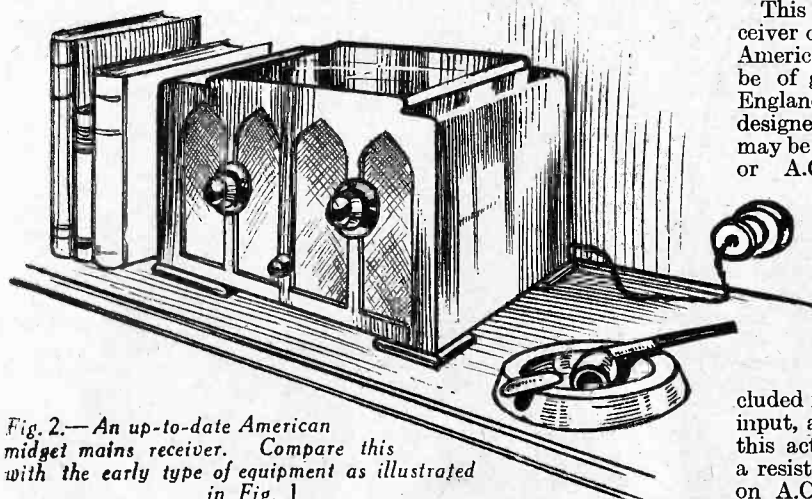
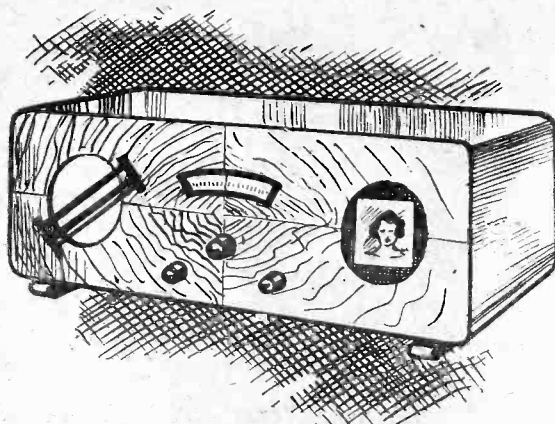

Fig. 2.—An up-to-date American midget mains receiver. Compare this with the early type of equipment as illustrated in Fig. 1

1934 RECEIVERS

(Continued from page XIII.)

consequently the reproduction which will be demanded by the public will gradually reach a very high standard, which will, in turn, lead to the development of "quality" circuits and components. This will inevitably lead to the use of multi-valve sets, and it is quite probable that the simple two and three valve sets will fade out. If, of course, special valves of the mains types are developed for battery users, then only two or three valves will be required to give vast range and volume. The battery radiogram will certainly appear, and in fact advance announcements have already been made by one or two firms concerning such a receiver. The Class B stage enables volume to be obtained which is much better than many small gramophones and the current consumption is not so high that a battery radiogram can be called expensive to run. Fifteen guineas should purchase a really good four-valve radiogram, complete with pick-up, clockwork motor, etc. This is, of course, another step towards the "quality" line.



Will a combined receiver and television be the set of the future?

Television

Will television forge ahead? This problem is a vexed one, and whilst so many alternatives are being tried it is not possible to visualize a complete television (sound and vision) receiver next year. As two separate

and complete receivers are necessary for the complete reception of vision and sound, the dimensions of the receiver become rather large. Added to this is the fact that interaction must be avoided, separate mains equipment may be required, the loud-speaker has to be housed, and the television equipment, either mirror-drum or disc, must also be packed into the same cabinet. This results in a cabinet being required which is at least as large as a good radiogram, and in order to see the picture properly it is necessary for the screen to be sufficiently high. As this means a tall cabinet, and as the modern furnishing tendency is to reduce everything to suit modern houses and flats, I cannot see at the moment just what is going to happen here. I think it is safest to leave this part of the subject alone.

Sufficient has been said to give some indication of what we might expect next year, but who knows, the valve itself may be obsolete by this time next year.

ALTHOUGH it was confidently expected that by the time the 1933 Radio Exhibition opened its doors to the public, permeability tuning would be available to every home constructor, no manufacturer has yet demonstrated to the Technical Staff of PRACTICAL WIRELESS that this hope has been realized. Nevertheless, readers of this paper will be very gratified to learn that the Editor of "Practical Wireless" has for some time past devoted a considerable amount of attention to this absorbing subject and has almost perfected a workable and efficient scheme, of which it is hoped to give full details to our readers at an early date. He has tackled the problem from a somewhat unusual angle and has succeeded in combining a practical mechanical form of construction with very high electrical efficiency. But of that—more later. The whole problem of permeability tuning is far more complicated than the

PERMEABILITY TUNING

An Important Announcement

average wireless amateur realizes, and although there is no difficulty whatever in designing a single tuning circuit which can be made to function by varying the position of the dust-iron core in relation to the tuning coil, the question is vastly different where two or more circuits are involved. It is a particularly difficult—many would even say "impossible"—task to design a set of ganged permeability coils which can be operated by a single control. The primary trouble is to find a core material which is perfectly homogeneous and of which any number of identical samples can be produced. With most of the materials at present available the change in inductance of a coil for any given movement of

the core is an unknown quantity, whilst a particular amount of movement cannot be made to produce the same effect at different parts of the tuning scale. There is little doubt that the difficulties referred to will eventually be removed as the methods of production are perfected, but for the time being it appears that no scheme has been evolved whereby really satisfactory and fool-proof permeability tuning can be offered to the home constructor as a commercial article. Permeability tuning will come, but we think that we shall have to wait a little longer before it proves so successful that we shall all feel justified in scrapping our present tuners and variable condensers. Rumours of permeability tuners to be available at the Exhibition have reached us for months past, but it is significant that none has yet been submitted to us for the exhaustive tests to which we subject all apparatus before recommending such to our readers!

Sektun Products, Winder House, Douglas St., S.W.1	47
Smith & Sons (Motor Accessories) Ltd., Cricklewood Works, N.W.2	51
Sonochorde Reproducers Ltd., 1, Willesden Lane, N.W.6	113
Sound Sales Ltd., Tremlett Grove, Junction Rd., N.19	213
Sovereign Products Ltd., 52, Rosebery Av., E.C.1	101
Standard Telephones & Cables Ltd., Connaught House, Aldwych, W.C.2	96
Stratton & Co. Ltd., Balmoral Works, Bromsgrove St., B'ham	21
Sun Electrical Co. Ltd., 118-120, Charing Cross Rd., W.C.2	T8
Sunbeam Electric Ltd., Sunbeam Rd., N. Acton, N.W.10	65
Tannoy Products, 1-7, Dafton St., W. Norwood, S.E.27	103
Telegraph Condenser Co., Ltd., Wales Farm Rd., N. Acton, W.3	98
Telephone Mfg. Co. Ltd., Hollingsworth Works, W. Dulwich, S.E.21	217

AN ALPHABETICAL GUIDE TO THE EXHIBITS

(Continued from page II.)

Telsen Electric Co. Ltd., Thomas St., Aston, Birmingham	88
The 362 Radio Valve Co., 415, Mare St., Hackney, E.8	214
Thompsons, Diamond & Butcher, 34, Farringdon Rd., E.C.1	T21
Trade Chronicles Ltd., 6, Carmelite St., E.C.4	T6
Telegraph Construction & Maintenance Ltd., East Greenwich, S.E.10	248
Ultra Electric Ltd., Erskine Rd., N.W.3	78
Univolt Electric Ltd., 119, Finsbury Pavement, E.C.2	5
Vandervell Ltd., C. A., 319, Regent St., W.	228

Varley (Oliver Pell Controls Ltd.), 103, Kingsway, W.C.2	85
Vince's Dry Batteries Ltd., Lion Works, Garford St., E.14	105
Vulco Dry Battery Co. Ltd., Vulco Works, N.19	110
Warner Brunswick Ltd., 1-3, Brixton Rd., S.W.9	67
Wates Radio Ltd., 184, Shaftesbury Av., W.C.2	19
Westinghouse Brake & Saxby Signal Co., Ltd., 82, York Rd., Kings Cross, N.1	32
Whiteley Electrical Radio Co., Ltd., Victoria St., Mansfield, Notts	123, 129
Wilkins & Wright Ltd., Holyhead Rd., Birmingham	20
Wingrove & Rogers Ltd., Mill Lane, Old Swan, Liverpool	93
Wireless League, 12, Grosvenor Crescent, S.W.	233
Wireless Retailers Association of Gt. Britain, 1, Mitre Court, Fleet St., E.C.4	250
"Wireless Trader," Dorset House, Stamford St., S.E.1	T31
Wright & Weaire Ltd., 740, High Rd., N.17	1
Zeitlin & Sons, Ltd., 54, Lambs Conduit St., W.C.1	T29

RADIO HAS MOVED WITH THE TIMES

(Continued from page I.)

considerations, marks a very definite step forward in the progress and diffusion of 'Wireless.' For the first time in the annals of its rapid development the wonderful achievements and possibilities of wireless telephony as a means of instruction, recreation and amusement are displayed before the public in the form of an exhibition devoted exclusively to 'Wireless.' The fifty odd Exhibitors include the most prominent British Manufacturers and Suppliers of Wireless Apparatus, comprising altogether the most representative gathering of Wireless trade interests ever held." Those remarks read somewhat strangely to-day, but they give us an insight into the founding of one of the most important trade demonstrations of modern times.

Glancing through the pages of the first Wireless Exhibition catalogue one finds the names of several firms which are still actively

THE WIRELESS CONSTRUCTOR'S ENCYCLOPAEDIA

should be on every Reader's Bookshelf.

Purchase a copy from STAND No. 8, GROUND FLOOR.

servicing the radio public. Among these mention might be made of Messrs. Cossor, Dubilier, Igranic, Peto-Scott, and Radio Instruments. One also finds the names of others who were at the time well known, but who have since "fallen by the wayside" or transferred their activities from wireless to other branches of trade. Messrs. S. G. Brown, Burndopt, Elwell and Fellows are among those firms who will well be remembered by readers whose interest in wireless goes back over the past decade.

Since 1922 the Exhibition has changed its name to the "N.A.R.M.A.T. Wireless Exhibition," "National Radio Exhibition," and "Radiolympia" and has been held at Royal Albert Hall, the New Hall, Olympia, and in the Grand Hall, Olympia. It has rapidly increased in size and prestige with the passage of time, so that this year there is very little space to spare in either the ground floor or gallery of the Grand Hall at Olympia. We have no hesitation in saying that the 1933 National Wireless Exhibition will be the "best ever," and every reader who can possibly do so should make an effort to attend.

NEW SEASON STYLES IN CABINETS

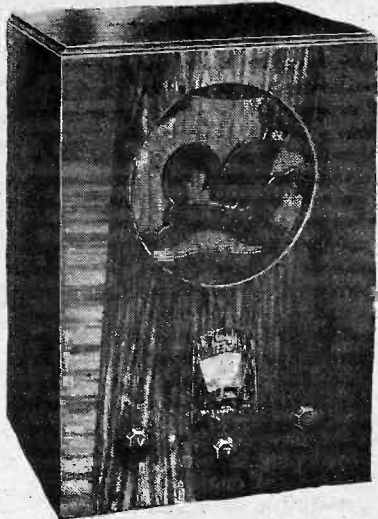

A 5-valve superhet, A.P. 46, made by the world-renowned firm of Messrs. Varley Ltd.

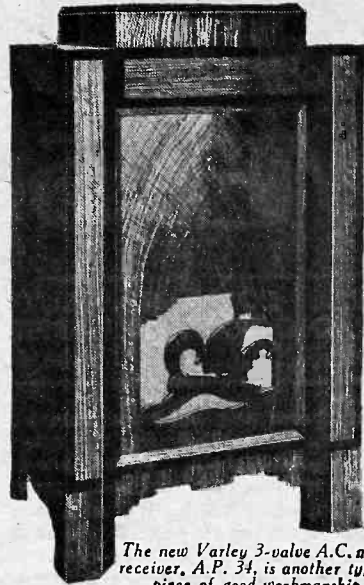

The new Varley 3-valve A.C. mains receiver, A.P. 34, is another typical piece of good workmanship.



A Ferranti all mains superhet of pleasing design and efficient workmanship.

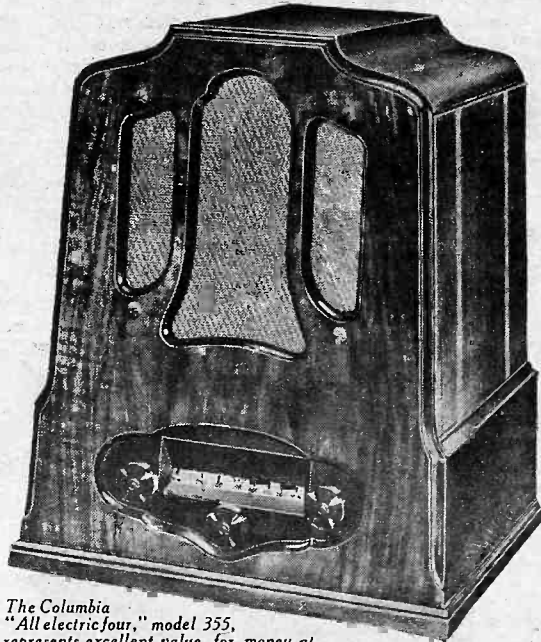

The Columbia "All electric four," model 355, represents excellent value for money at 12 guineas. It incorporates a highly efficient band-pass receiver. Models are available for A.C. or D.C.

The problem of the type which should be adopted for the wireless cabinet is well illustrated on this page, where several leading manufacturers' designs are shown. It will be seen that in some cases the design favoured is extremely simple and plain, whilst in others an elaborate and embellished pattern is utilized. No doubt our readers have their own ideas regarding the lines which should be taken, and these illustrations will give some idea of the extremes which are obtainable when choosing a receiver to harmonize with the furnishings of the home.

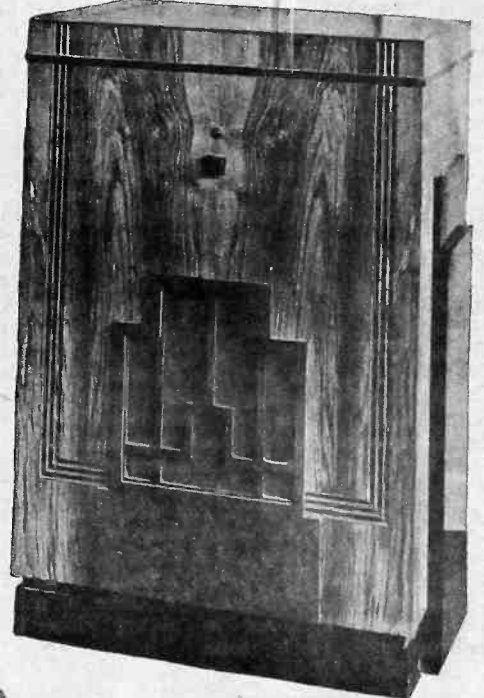

One of the most expensive instruments made by the famous firm of H.M.V. is their "Superhet Autoradiogram Ten de Luxe," which costs 95 guineas. It also incorporates delayed A.V.C.

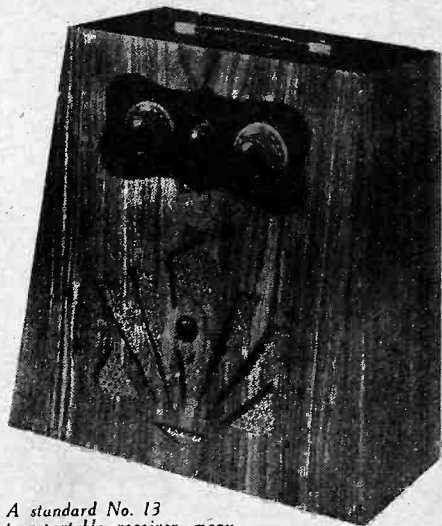

A standard No. 13 transportable receiver, manufactured by Shalless and Evans, has a neat and compact appearance.



A fine piece of workmanship is the Bush A.C.3 Receiver, which is shown in a standard cabinet.

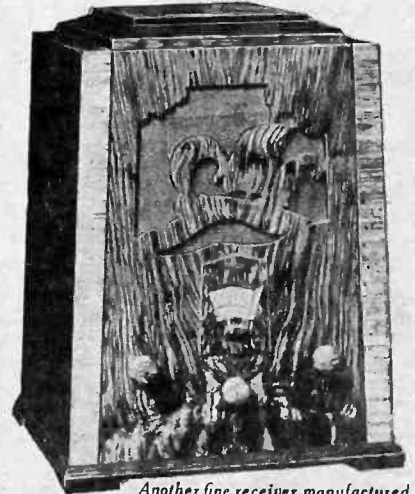

Another fine receiver manufactured by Messrs. Varley Ltd.

OUR VIEWS ON RECEIVERS

IN this piece of apparatus we have almost the last word in combined radio - gramophones. From the cabinet to the pick-up, every part is the result of long experiment and experience in the radio and gramophone sphere. It is almost impossible to find fault with the cabinet, which is finished in a very simple design which can be housed in practically any room without appearing out of place. The loud-speaker grille is not of the over-worked type, nor does it resemble the front of a Victorian pianoforte. The external controls (volume control and reject button) have been designed in keeping with the general appearance and do not resemble laboratory or workshop controls. The back of the cabinet is enclosed by a framework across which is stretched a piece of fine gauze, thus excluding dust without introducing echoes or box resonance. Thus we pass to the interior of this receiver.

The Circuit

The circuit consists of a seven-valve superheterodyne of the very latest type, the output stage being equipped with an Osram PX.4 valve. This delivers just over 2 watts, and handles a really good signal, so avoiding difficulties in overloading and similar forms of distortion. The arrangement of the oscillator, first detector, etc., is such that second channel whistles are avoided, cross modulation is absent, and the selectivity is of the real square-peak type with sufficient selectivity to permit of the reception of stations working on the allotted *minimum* separation. Tone correction is afforded and functions in a very efficient manner in giving either brilliant or "mellow" tone. The arrangement of the controls is very ingenious and worthy of mention. They are situated on the side of the motor-board, so that it is necessary to raise the lid in order to tune to a station. The scale is calibrated in kilocycles and stations, and a large control knob is provided for wave-range adjustment. A flat-sided roller is fitted to the switching mechanism and as the main control knob is adjusted this roller is rotated so that the actual setting of the instrument is very clearly indicated. Immediately to the left of this "Radio Panel," is the gramophone turntable and the automatic record changing equipment. In addition there is a control which enables the automatic mechanism to be brought into action. In view of the novelty of this mechanism I propose to describe it rather fully.

The Automatic Changing Mechanism

A long spindle is provided and is attached to the normal spindle in the centre of the turntable. This then projects sufficiently high to permit of eight records being rested on two arms arranged at opposite sides of the turntable. When the switch is turned to the position marked "Auto" and the

THE COLUMBIA AUTO-RADIOGRAPH SUPERHET SEVEN Model 631

motor started, two small projections on the side arms are withdrawn and the lower record drops slightly. After a few revolutions of the turntable a further movement of the arms takes place and this allows the lower record to drop to the turntable (a distance of only a few inches), and the next record is put into position ready to be dropped when its turn arrives. The pick-up now rises from its position of rest and slowly moves across to the first groove on the record which is now turning round on the turntable. It is lowered slowly to the groove, and reproduction forthwith takes place. When the record is played right through the arm rises, travels back to a position clear of the record and the next record drops down. The same procedure is then gone through until the eighth record has been played. At the end of this record, the arm travels out to its furthest position, drops on to the rest provided, and the motor is automatically switched off. An additional novel feature is the reject button fitted to the front of the cabinet. If for any reason you do not wish to hear a record after it has commenced to play, you press this button and the pick-up immediately rises from the record, travels to the outside and the next record comes into action. This apparatus works very smoothly indeed, and we were very impressed with it, although we appreciate the maker's instructions on the fly-leaf of the instructional book which states: "Despite the almost human performance of this instrument, remember that it is a machine and must be handled with thought." It would, of course, be quite easy to damage intricate mechanism of this nature if it were treated without due care.

Radio Results

On the radio side the results are very satisfying indeed. When the volume control is set to a suitable position, it is possible to rotate the main tuning control right through the scale and station after station comes in at very good volume. There are no tricky adjustments to be made, and no careful adjustment of reaction and volume control, but simply the one knob to turn from one end of the scale to the other. Naturally the volume control must not be set to its maximum position except when trying to receive a most distant station, as the amplification afforded by the receiver is so great that background

noises, atmospherics, and similar noises are much too loud for enjoyment. We found, with the particular aerial which was used, that the control required adjusting to a position about half-way on, and then upwards of forty stations were tuned in one after the other with ease, and all of sufficient volume to provide real entertainment. The local stations, of course, only necessitated the control just on; and when set so that the maximum volume on these stations was obtained without distortion, the volume was sufficient for the largest room, and no doubt would provide sufficient signal strength for a small hall. When a station is received accompanied by a heterodyne whistle, the tone control on the radio panel may be adjusted to completely remove it, and this was found a valuable feature on the particular evening when the receiver was tested, as heterodyne whistles seemed to be worse on this particular night than we have heard them for some time. A special plug is fitted to the rear of the instrument and engraved MAE. When this is inserted into the aerial socket in place of the normal aerial, the mains wiring is employed for that purpose, and it was found that there were still many stations receivable without any adjustment of the volume control setting. In this connection it should be noted that if hum is experienced when using this device, it is sometimes advisable to reverse the plug in the mains socket.

Hum Control

A special hum control device is fitted to the mains equipment of this receiver so that in the event of hum being troublesome this control may be adjusted to give a minimum position for the hum.



COLUMBIA RADIO-GRAMOPHONE WITH AUTOMATIC CHANGER

The Columbia "Autoradiograph Superhet Seven," Model 631, now costs 43 guineas. This handsome instrument in a walnut cabinet has an automatic record-changer and highly efficient seven-valve (including rectifier) radio receiver. Brilliance control, felt-lined lid, illuminated station indicator and electro-magnetic moving coil speaker, are other features of this popular priced radio-gramophone.

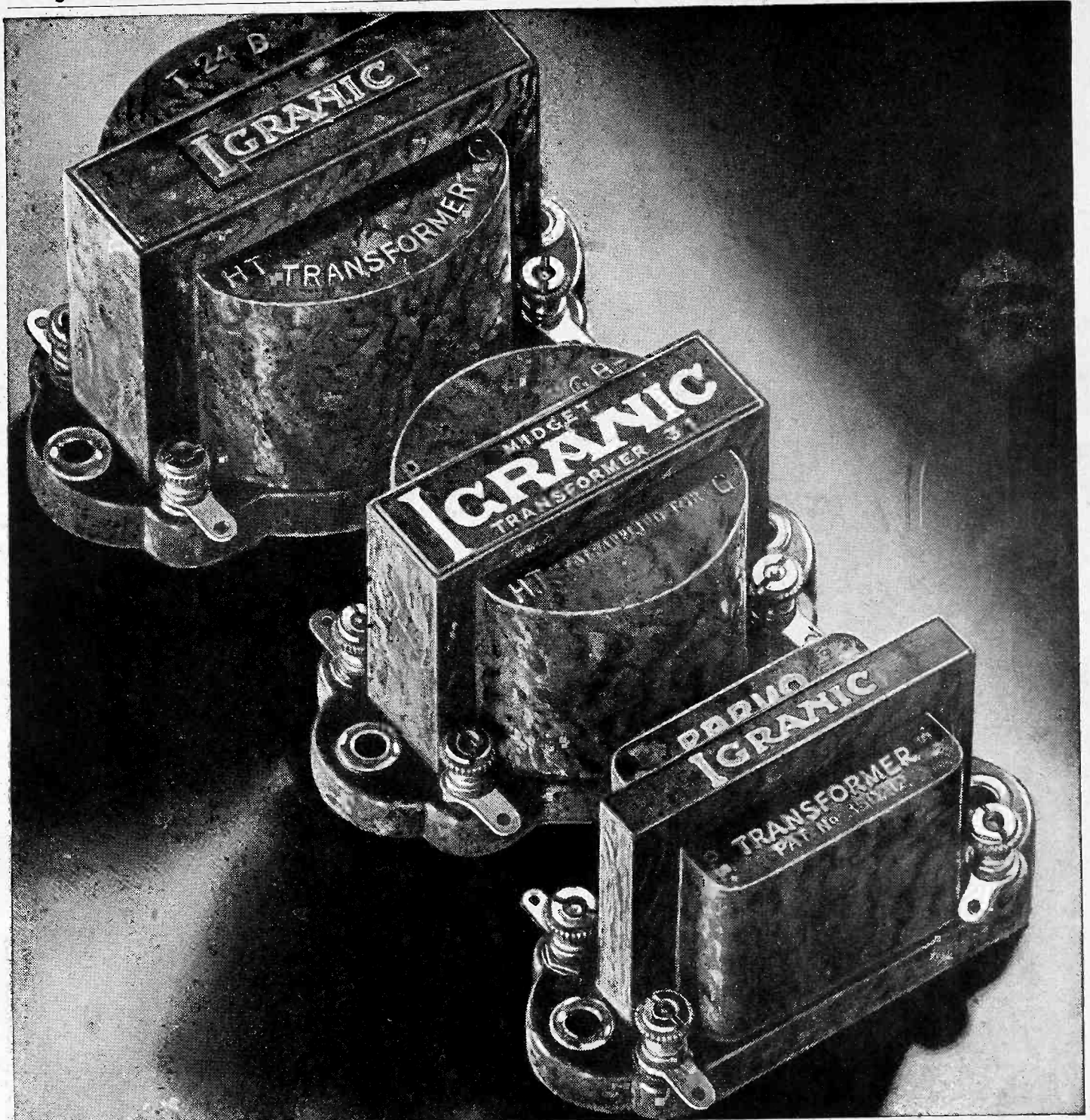

There is a complete range of Igranitic Transformers to suit every requirement of the up-to-date constructor. The special feature of all Igranitic Transformers is a patented core of high permeability and small polarization which permits a reasonably high current-carrying capacity in the primary. A high amplification of all bass notes and faithful reproduction of all notes over the whole scale of musical frequencies are the results of experienced design and meticulous care in construction; the finest bakelite finish is in keeping with the reputation of all Igranitic radio components. The prices of Igranitic Transformers are:

T.24B.....	5/6	Parvo.....	6/9	Midget.....	8/6
------------	-----	------------	-----	-------------	-----

MEET US AT
STAND 86
 RADIOLYMPIA



Write for fully illustrated Catalogue No. J.1259 of Igranitic Quality Components.

IGRANIC ELECTRIC CO., LTD., 149, Queen Victoria Street, E.C.4.

If you cannot obtain Igranitic Components, write to us direct and include the name of your local dealer.



Purveyors of Electric Lamps By Appointment



Manufacturers and Purveyors of Electric Lamps By Appointment

EDISWAN

The name that means 'EXCELLENCE'



"Yes, we'll specify Mazda again this year"

*Resistances
Chokes
Condensers
Mazda -
AC/SG
AC/HL
AC/PEN
UU60/250.*

Specified by the leading designers

MAZDA



The FOREMOST BRITISH VALVES

The Edison Swan Electric Co. Ltd.  155 Charing Cross Rd., London, W.C.2

Mazda Radio Valves are manufactured in Great Britain for The British Thomson-Houston Co. Ltd., London and Rugby.

RECOMMENDED BY ALL GOOD RADIO DEALERS



EDISWAN

The name that means 'EXCELLENCE'

FACTS

for those about to

buy H.T. Batteries

and Accumulators

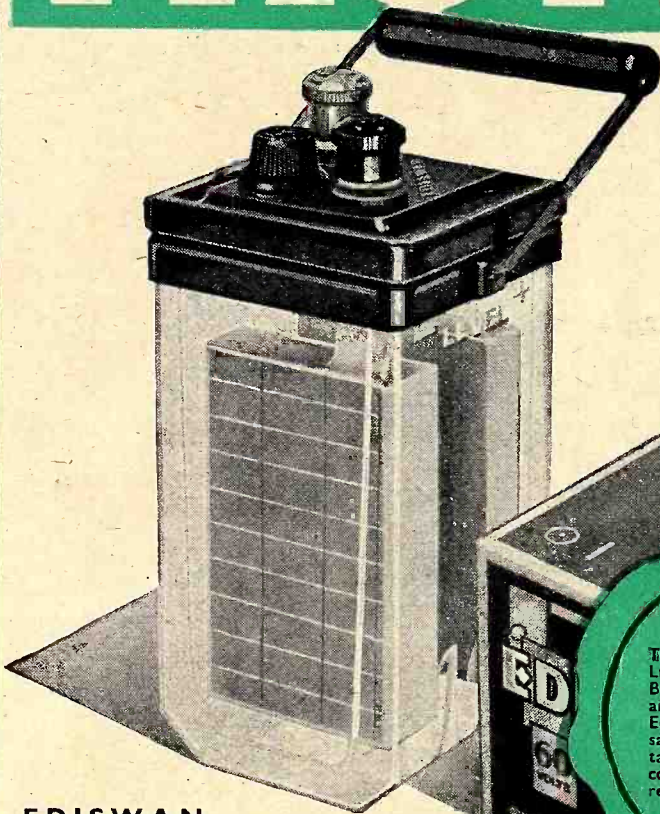

EDISWAN 'EXTRA-LIFE' ACCUMULATORS

Balanced capacity—that is the secret of the extra and better service which these accumulators give you. It means that the positive and negative plates are designed to function in exact electrical balance. This makes quicker charging and slower discharging possible without damaging the plates. Certainly an economy. There is a wide range of types at prices from 4/3.

EDISWAN H.T. BATTERIES

When you buy an Edison battery you don't have to take it on trust. It has run the gauntlet of the most exacting tests. It has been passed as fit to bear the Edison Guarantee. It is ready for a long life of good service. Think what this means to you. A saving of money, a saving of trouble—your full money's worth out of every battery. Five and sixpence for 60 volts.

EDISWAN

GUARANTEED H.T. BATTERIES AND **EXTRA-LIFE** ACCUMULATORS

The Edison Swan Electric Co. Ltd.



155 Charing Cross Rd., London, W.C.2

RECOMMENDED BY ALL GOOD RADIO DEALERS

Take no risks—get an R&A Reproducer

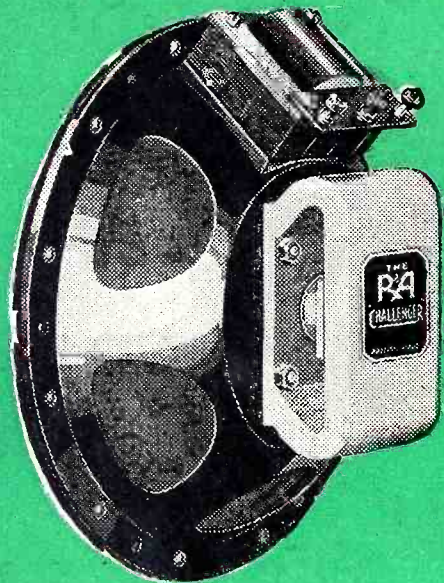

The Challenger

A model for every output 35/-

There are four definite reasons why you should purchase an R. & A. Reproducer :

Firstly—They are designed and produced by specialists, whose sole business is to manufacture reproducers of the highest degree of excellence, regardless of price.

Secondly—Performance, which is of paramount importance from your point of view, is not equalled by any other loud-speakers at similar prices.

Thirdly—R. & A. Reproducers are sold under guarantee, at the lowest possible prices, thus enabling you to save money on this most important component.

Fourthly—The R. & A. range comprises Differential Armature and Moving-Coil Reproducers for every type of output, be it small power valve, Q.P.P., Class B, or power amplifiers.

In short, there is an R. & A. Reproducer exactly suited to your receiver.

Your dealer will gladly demonstrate. Write us for details of the complete range.

A new era in trouble-free reproduction —

"ALPHA"

A triumph of design and construction . . . a revelation in true reproduction.

Write for particulars.

R&A REPRODUCERS

COMPLETE RANGE
OF REPRODUCERS
FROM 21/- TO 70/-

Send postcard for full details.

STAND TO STAND SHOW REPORT

DETAILS OF EXHIBITS OF OUTSTANDING INTEREST ON EACH STAND, BY THE TECHNICAL STAFF

STAND No. 1
WRIGHT & WEAIRE, LTD., 740, High Road, Tottenham, N.17.
UNDOUBTEDLY the principal point of interest on this stand was the new Nucleon coil. This was shown in its many types, and the home-constructor gained some idea of the extent to which this coil has been developed. In addition, the number of smaller components for the home-constructor called for close attention and surprise at the high quality which was shown. The neat battleship grey cellulose finish on some of the transformers attracted many to the details of a component which might otherwise have escaped attention. Messrs. Wright and Weaire are to be congratulated on the arrangement of their stand.

STAND No. 2
EPOCH RADIO MFG. CO. LTD., Exmouth St., E.C.2.
THE "Super-Dwarf" midget loud-speaker was one of the most interesting exhibits on the Epoch stand, and its extremely small dimensions were the subject of appreciative comment. A new large permanent magnet moving-coil speaker at a very low price was also examined with great interest. All the older speakers were shown, and it was interesting to notice that most of them had not only been reduced in price but had been much improved.

STAND No. 3
BURGOYNE WIRELESS (1930), LTD., 34a, York Road, N.1.
AN excellent range of no less than eight different receivers was shown. A self-contained Class B battery set was perhaps the most notable exhibit, and priced at £6 10s., it was a popular attraction. Among the other receivers were the "Popular Three" and the "Olympic Three De Luxe," both of which represent excellent value for money. Altogether

there was a really good display of receivers for all requirements and at diverse prices.

STAND No. 4
BURTON, C. F. & H., Progress Works, Bernard St., Walsall.
THE exhibits on this stand consisted very largely of small components and these were closely examined by many wireless constructors. They consisted of H.F. chokes, tuning coils, variable condensers, etc., of various types, all of which are sold at attractive prices. Additionally, there were some interesting mains units for both A.C. and D.C. use. Most of the A.C. ones were shown both with and without a trickle charger which could automatically be brought into use by switching off the set.

STAND No. 5
UNIVOLT ELECTRIC LTD., 11, Finsbury Pavement, E.C.2.
PRACTICALLY all of the apparatus required for the reproduction of gramophone records could be seen here, and from the small pick-up to the complete electric radiogram unit, the record fan was able to make a good selection for his needs. The reduction in prices should no doubt lead to an increased demand, and the pick-up, which now costs 25s. (as against 32s. 6d. last year), is a splendid proposition. The Het aerial was well demonstrated, and many will undoubtedly prefer this type of aerial to the usual odd piece of wire strung across a living-room. It is certainly less obtrusive, and much more efficient.

STAND No. 8
GEO. NEWNES, LTD., 8-11, Southampton St., Strand, W.C.2.

IN addition to the extensive range of books published by Messrs. Newnes, and noteworthy among which are "Practical Wireless," "The Radio Times," "The Listener," "World-Radio," and the many wireless handbooks, the specimen receivers which were exhibited proved probably the biggest attraction in the whole exhibition. Here were seen most of the receivers which have been popularized by PRACTICAL WIRELESS during the past season, and with the attractive display which was arranged in conjunction with the new PRACTICAL WIRELESS receivers introduced for the exhibition, home constructors were intensely interested in the ingenuity displayed in the various designs. The Technical Staff are being kept busy answering queries for readers and assisted in solving some tricky problems which had caused some amateurs many sleepless nights.

(Continued overleaf)

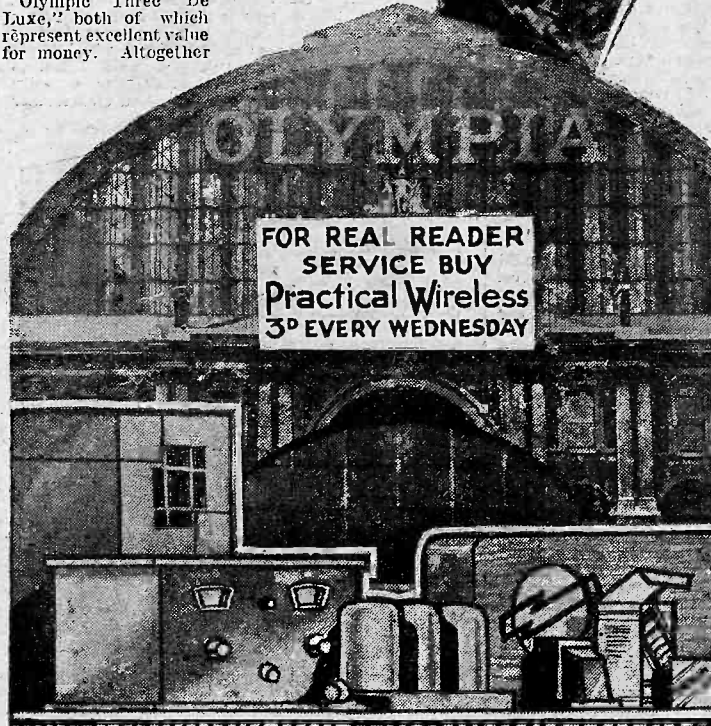
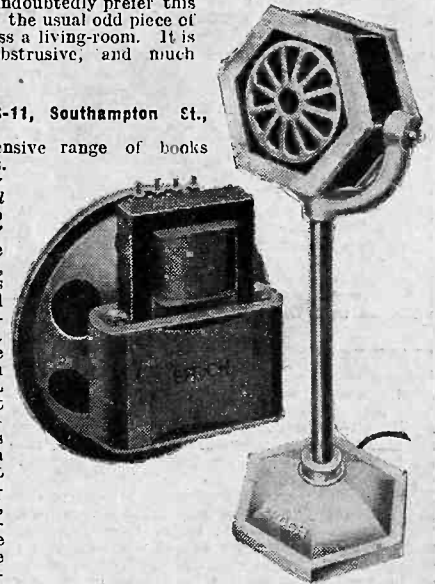

**FOR REAL READER SERVICE BUY
Practical Wireless
3^d EVERY WEDNESDAY**

STAND TO STAND SHOW REPORT

(Continued from previous page)

STAND No. 9
HAYNES RADIO, 57, Hatton Garden, E.C.1.

THIS stand proved to be a very popular one to the more advanced constructors and experimenters, due to the fact that a very wide range of specially designed and guaranteed kit sets were on view. The sets included the "Haynes Class B Four," the "Haynes Quality Receiver," superheterodynes for both A.C. and D.C. operation, as well as a special short-wave superhet and a short-wave converter.

A new component in the form of a noise-free volume control also attracted a good deal of attention because of its unusual features. It has a very narrow edge contact, an insulated spindle, adjustable stops to limit the amount of rotation of the arm and a simple system of ganging so that two or more components can be operated by the same knob.

STAND No. 12
HIGGS MOTORS, Witton, Birmingham.

SOME interesting types of converter were seen on this stand, together with other types of electric motors and similar apparatus. The new converter delivers a heavy output suitable for the largest radio-gram, and is intended for use on the standard D.C. house supply. It will no doubt prove valuable to many who are at the moment restricted to the use of D.C. mains and who wish to use one of the splendid A.C. receivers which may now be obtained.



One of the neat signal devices which were a great feature of the *Bulgin Stand*. Several different models are obtainable and the one illustrated is called "Meditation."

STAND No. 14
COSMOCORD, LTD., Cambridge Arterial Road, Enfield, Middlesex.

A NEW pick-up, known as the "Universe," was given the most prominent position on this stand. This is an interesting component, having an audio output of some 4 volts. It has been designed to give maximum response to the bass in order to compensate for record deficiencies, and it has a "top cut-off" at about 4,000 cycles so that needle scratch is reduced to a minimum. The track arm is provided with an adjustable balance weight whereby the needle pressure may be varied to suit different records.

An interesting component also shown was a combined potentiometer and Q.M.B. switch. This is a very neat little article built in a bakelite case and fitted with accessible soldering tags. It is remarkable for its very smooth action and steady resistance variation over the full range of movement.

STAND No. 16
HEAYBERD, F. C., & CO., 10, Finsbury Street, E.C.2.

ON this stand was seen practically every component for the construction of mains apparatus, in addition to chargers for home use or for the service station. Small transformers delivering L.T. supplies at 4 volts 4 amps, to multi-wound transformers delivering H.T. of the order of 500 volts with several L.T. windings; smoothing chokes; fixed condensers in single units or blocks containing several different values; metal rectifiers; metal cases for complete mains units; connecting cable; the complete range seemed to embrace every item which could be thought of in connection with a complete mains-operated receiver. In addition, complete units were displayed, and the various types of trickle charger enabled a very accurate selection to be made to suit any individual need.

STAND No. 17
SIMPSONS' ELECTRICALS, LTD., Grange Road, Leyton, E.10.

THE synchronous turntable manufactured by this firm has already proved extremely popular in the past, and should be even more popular in the future. The simple one-hole fixing which is adopted enables the motor to be speedily fitted to an existing cabinet after the old clock-work motor has been removed, or in the case of a new radio-gram. It necessitates only the drilling of an inch hole. It works, of course, from A.C. mains of 50 cycles only, but is of extremely simple construction, having no governors or other complicated mechanism. It rotates at the correct speed all the time. The new Straight Track Pick-up is a splendid partner for this turntable, and is a most efficient and robust piece of apparatus.

STAND No. 20
WILKINS & WRIGHT, LTD., Holyhead Road, Birmingham.

ON this stand the new version of the "Utility" straight-line dial was the point of interest, and it was ably backed by the combination reaction condenser and potentiometer. The new switch, bakelite knobs, and other accessories gave a good idea of the vast field covered by Utility products and called for comment regarding the high standard which was set.

STAND No. 21
STRATTON & CO., LTD., Balmoral Works, Broomsgrove Street, Birmingham.

THE short-wave enthusiasts spent a good deal of time round this stand, and, undoubtedly the Eddystone short-wave apparatus merited attention. Apart from the smaller components, the complete receivers also showed what could be done with short-wave reception, and, no doubt, many who have not previously shown any interest in this sphere of wireless will have decided to carry out some short-wave experiments in one direction or another as a direct result of the exhibits on this stand.

STAND No. 22
BLOCK BATTERIES, LTD., Abbey Road, Barking.

THE most interesting exhibit here was the entirely new plateless high-tension accumulator which was shown in various patterns. Having a capacity of 5,000 milliampere-hours, these accumulators are only half the size of corresponding ones of normal construction. Moreover, due to the shape of the electrodes, they are particularly robust, and should have a long trouble-free life.

The "Block" L.T. accumulator, which has proved so popular since its fairly recent introduction, was also shown and attracted a considerable amount of interest from users of battery sets.

STAND No. 23
GRAMPIAN REPRODUCERS, LTD., Station Avenue, Kew Gardens, Surrey.

MESSRS. GRAMPIAN were, we believe, the first to introduce dual balanced midgeet loud-speakers, so it was only natural to find that these were accorded a prominent position on the stand. The overall sizes of the pairs of balanced midgeets is only 13 $\frac{1}{2}$ in. by 7 $\frac{1}{2}$ in. by 3in. deep, yet they are capable of handling the enormous output of 5 watts.

A large number of other types of Gramplan speakers were also shown, and it was interesting to observe that most complete and useful technical information was available in regard to each one. In every case there was a pattern specially intended for Class B use. Messrs. Gramplan's slogan, "A Year Ahead," seemed to be fully justified.

STAND No. 26
REDFERN'S RUBBER WORKS, LTD., Hyde, Cheshire.

SOME very interesting ebonite panels were seen on this stand, and the combination of two different finishes on one panel (mahogany on one side and black on the other) will enable the listener to purchase a panel and use the side which appeals to him at the time of construction.

STAND No. 27
RONNIE ENGINEERING, Crewsdon Road, S.W.9.

THE new Mineral Compound for ensuring a good earth connection, and the new types of earth tube proved one of the high lights of the show. Many visitors seemed to find it an important point to improve their existing earth connections, and this new Mineral, obtainable in cartons at 1s. 3d., enables the present earth connection to be kept continually damp owing to the action of the chemical of which it is composed. The earth tubes, in copper and chromium plate, are filled with the mineral and this is a splendid idea and is simple to fit. Some other radio novelties were also seen.

STAND No. 31
SIEMENS ELECTRIC LAMPS & SUPPLIES, LTD., 38-39, Upper Thames Street, E.C.4.

THE "Full o' Power" batteries made a splendid exhibit here, and the range was most extensive. The new types of Class B battery will do much to popularize this method of amplification during the coming season, and the prices are most competitive. These batteries are all made at Woolwich by special machinery, and this is, of course, only a part of the extensive Siemens business.

STAND No. 32
WESTINGHOUSE BRAKE & SAXBY SIGNAL CO., LTD., 82, York Road, King's Cross, N.1.

A MOST comprehensive range of mains apparatus was seen here and probably the main portion of the exhibits consisted of the famous metal rectifiers. In all types, these were set out to show the extensive range which may be covered by means of a mains unit utilizing this form of rectifier. In addition, the new receivers, in which the rectifier was fitted as part of the mains equipment, also called for inspection, and the smaller rectifiers and photo-cells, etc., attracted the more technically-minded visitors.

STAND No. 34
FULLER ACCUMULATOR CO. (1926), LTD., Woodland Works, Chadwell Heath, Essex.

A NEW accumulator, styled the MDG, was the most notable exhibit on this stand. Made in the 2-volt 45-ampere size, and selling at 8s. in a dry-charged

state, this latest accumulator represents unusual value for money.

The well-known "Sparta" high-tension batteries were also shown in all varieties, and with discharge rates varying from 10 m.a. for small sets to 20 m.a. for those using large power or Class B valves. A comprehensive range of other batteries and accumulators attracted well-merited attention.

STAND No. 35
BAKER'S "SELHURST" RADIO, Sussex Road, Croydon, Surrey.

A N entirely new and very convenient Class B unit, which can almost instantly be attached to any kind of battery-operated receiver, was one of the most interesting exhibits. Another which attracted a considerable amount of attention was the combined moving-coil loud-speaker and complete Class B Unit mounted together on a single metal chassis of rigid construction. A wide range of speakers of all patterns was also on view.

STAND No. 37
LECTROLINX, LTD., 79a, Rochester Row, S.W.1.

THE well-known Clix components formed the centre of this stand, and in addition to the chassis-type valve-holders, the terminal strips, plugs, sockets, and similar items were worthy of close inspection. Non-corrosive spade ends for accumulator connections are quite cheap and will save time in hunting for bad connections which may be due to the effects of acid on the ordinary flex used by many listeners for battery connections. Similarly, the plugs and sockets form a ready means of ensuring that connections between various parts are firmly made and noises due to poor connections are completely avoided.

STAND No. 38
BRITISH GENERAL MANUFACTURING CO., LTD., Brockley Works, Tyrwhitt Road, Lewisham, S.E.4.

THIS firm is well known as manufacturers of dual-range tuners and the latest model was well in evidence. A parallel feed inter-valve coupler and a new screened H.F. choke were also displayed and attracted interest. Another very small but interesting component was the flexible coupling which has been specially designed to enable the constructor easily to gang together any number of ordinary variable condensers.

STAND No. 40
ORR RADIO (INC. UNITED RADIO MANUFACTURERS), 63, Lincoln's Inn Fields, W.C.2.

A N interesting feature on this stand was the A.C. mains receiver employing the new H.F. screened pentode. Although only a three-valver, this gives admirable results and is a splendid receiver. The battery receivers which were shown were also of really up-to-date design, and the tuning dials were of the plain, easily read type.

STAND No. 41
RADIO INSTRUMENTS, LTD., Purley Way, Croydon.

IT was really difficult to say which exhibit here offered the greatest attraction. The receivers, the components, the new iron-core tuning coils all seemed to claim attention. The six-valve superhet will doubtless prove an important receiver next season, and this employs automatic volume control and full vision tuning. The four-valve Class B battery receiver with iron-core tuning coils is a really up-to-date receiver which will appeal to the listener who has not the advantage of the mains supply. In addition to being economical to maintain, it delivers a really powerful output. The new auto-parafeed transformer

(Continued on page 819)

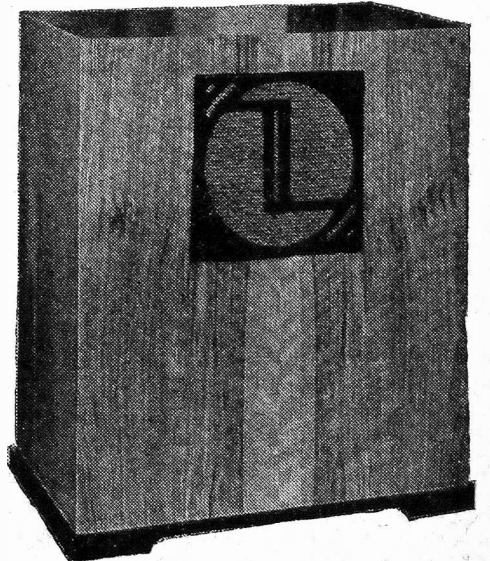

The new Camco "Argyll" Cabinet. This is recommended for the Auto-B Three.

PETO-SCOTT RADIO BY MAIL

NEW COSSOR MODEL 341. S.G., Detector and Pentode, and balanced armature Speaker, complete with Cabinet. Cash or C.O.D., Carriage Paid, £6/7/6. Balance in 11 monthly payments of 11/9. **Send 11/9 only**

NEW R. & A. "ALPHA" P.M. MOVING-COIL SPEAKER DE-LUXE, with tapped input transformer. Cash or C.O.D., Carriage Paid, £2/12/6. Balance in 8 monthly payments of 6/6. **Send 6/6 only**

NEW W.B. Type P.M.4.A. MICROLODE, complete with input transformer. Cash or C.O.D., Carriage Paid, £2/2/0. Balance in 7 monthly payments of 5/9. **Send 5/9 only**

NEW ROLA CLASS-B PERMANENT MAGNET MOVING-COIL SPEAKER AND AMPLIFIER with Valve and Input Transformer. Two models: A for PM2B, PD220, and 220B; B for 240B and HP2 (state which when ordering). Cash or C.O.D., Carriage Paid, £3/11/0. Balance in 11 monthly payments of 6/6. **Send 6/6 only**

FIRST AGAIN
LISSEN SKYSCRAPER
7 VALVE SUPER-HET

FREE CONSTRUCTIONAL CHART WITH EVERY KIT CHASSIS MODEL YOURS FOR
Complete Kit with Lissen Valves in Sealed Carton
CASH OR C.O.D. CARRIAGE PAID
£8 : 17 : 6



Balance in 11 monthly payments of 16/6. **Send 16/6 only**
TABLE CABINET MODEL, complete with valves. Cash or C.O.D., Carriage Paid, £9/15/0. Balance in 11 monthly payments of 17/6.

CONSOLETTA CABINET MODEL, complete with Valves and Permanent Magnet Moving-coil Speaker. Cash or C.O.D., Carriage Paid, £11/10/0. Balance in 11 monthly payments of 21/-. **Send 21/- only**

NEW LISSEN SKYSCRAPER FOUR ALL-WAVE CHASSIS MODEL, complete kit comprising all components, including set of Lissen Valves. Cash or C.O.D., Carriage Paid, £5/12/6. Balance in 11 monthly payments of 10/3. **Send 10/3 only**

NEW LISSEN SKYSCRAPER FOUR ALL-WAVE CONSOLETTA CABINET MODEL, complete kit comprising all components, including set of Lissen Valves, Cabinet and Moving-Coil Speaker. Cash or C.O.D., Carriage Paid, £8/2/6. Balance in 11 monthly payments of 15/-. **Send 15/- only**

NEW EPOCH MODEL 200, 200B, or 200C PERMANENT MAGNET MOVING-COIL SPEAKER for ordinary power. Class-B or Q.P.P. respectively, complete with input Transformers. Cash or C.O.D., Carriage Paid, £1/15/0. Balance in 6 monthly payments of 5/6. **Send 5/6 only**

NEW AMPLION SONETTE P.M. MOVING-COIL SPEAKER, with Class "B" Input Transformer. Cash or C.O.D., Carriage Paid, £1/7/6. Balance in 5 monthly payments of 5/-. **Send 5/- only**

NEW BLUE SPOT 99P.M. PERMANENT MAGNET MOVING-COIL SPEAKER, complete with tapped input Transformer. Cash or C.O.D., Carriage Paid, £2/19/6. Balance in 11 monthly payments of 5/6. **Send 5/6 only**

NEW ATLAS ELIMINATOR C.A.25 for A.C. Mains, Class "B" and Q.P.P. Four Tappings, 60/80; 50/90, 120; 150, 25 m.a. Cash or C.O.D., Carriage Paid, £2/19/6. Balance in 11 monthly payments of 5/6. **Send 5/6 only**

NEW HEAYBERD ELIMINATOR, MODEL D.120 for A.C. Mains. 120v., 18 m.a., and 2 v., 0.25 amp. Trickle Charger. Tappings 40/110 var. S.G., 100v., and 120v. fixed. Cash or C.O.D. Carriage Paid, £4/5/0. Balance in 11 monthly payments of 7/9. **Send 7/9 only**

NEW EXIDE H.T. ACCUMULATOR, 120 VOLTS, W.H., in crates, 5,000 m.a. Cash or C.O.D., Carriage Paid, £4/13/0. Balance in 11 monthly payments of 8/6. **Send 8/6 only**

NEW FERRANTI "CLASS B" SUPER POWER CONVERTOR. Instantly converts your present set to "Class B." Complete with valve. Ready assembled. Cash or C.O.D., Carriage Paid, £3/3/0. Balance in 11 monthly payments of 5/9. **Send 5/9 only**

F. J. CAMM'S 1934 SUPER-SET

KIT "A" Author's Kit of First Specified parts, including Peto-Scott "Metaplex" chassis (less valves and cabinet). **YOURS FOR 14/9**
CASH or C.O.D. Carriage paid, Balance in 11 payments of 14/9
£8 : 2 : 0

KIT "B" As Kit "A," including valves but less cabinet. CASH or C.O.D. Carriage Paid, **£11 : 2 : 9** or 12 monthly payments of 20/6.

KIT "C" As Kit "A," including valves and cabinet. CASH or C.O.D. Carriage Paid, **£12 : 7 : 9** or 12 monthly payments of 22/6.

KIT BITS You pay the postman. We pay post charges on all orders over 10/-
1 Set of Valves - £3 0 9
1 British Radiophone 3-gang Cond., with full vision scale, Type 604 - £1 8 6
1 (Lissen) Set of 3 Iron Cored Coils - £1 17 6

ALL-WAVE TWO KIT "A" Specified Values £1 - 3 - 6 Peto-Scott Metaplex Chassis 12in. x 7 1/2in. x 2 1/2in. **YOURS FOR 7/6** Balance in 11 Monthly Payments of 7/6

AUTO-"B" 3 YOURS FOR **8/6**
KIT "A" Author's Kit of First Specified Parts, including metal chassis, but less Valves, Cabinet, Speaker. **YOURS FOR 8/6**
CASH or C.O.D. Carriage Paid, Balance in 11 monthly payments of 8/6
£4 : 12 : 0

KIT "B" As Kit "A," but with Valves only. CASH or C.O.D. Carriage Paid, **£6 : 1 : 9** or 12 monthly payments of 11/3.

KIT "C" As Kit "A," but complete with Valves and Cabinet less Speaker. CASH or C.O.D. Carriage Paid, **£7 : 19 : 9** or 12 monthly payments of 14/6.

Set of Specified Valves - £1 : 9 : 9
Camco "Argyll" Cabinet - £1 : 18 : 0
Amplion Sonnette Class "B" Speaker £1 : 7 : 6

1 Varley "Nictet" L.F. Transformer - 7 6
1 Bulgin Type "B" "Controlatone" - 5 0
1 Peto-Scott "Metaplex" Chassis - 3 6
1 Peto-Scott Classic Cabinet, as illustrated - £1 5 0

PILOT AUTHOR KITS - Exact to Specification

PETO-SCOTT CLASSIC WALNUT CABINET

With standard fret as illustrated, an ultra-modern design with graceful lines combining beauty of appearance with utility and efficiency. The ideal cabinet for the Home Constructor, in keeping with present-day set design. In chosen, veneered walnut with contrasting silk covered fret. Front drilled to your specification. Size inside: 20in. long, 10in. high, 12in. deep. Takes panel 12in. by 10in.; baseboard 12in. by 12in. **Cash or C.O.D. Carriage Paid (less stool). 25/-**



STOOL IN VENEERED WALNUT TO-MATCH (28in. high) Cash or C.O.D. 25/- Carriage 2/6 extra.
CLASSIC CABINET AND STOOL. Cash or C.O.D. Carriage Paid £2 12 6 or 7/6 Deposit and 10 monthly payments of 5/-.

PILOT "CLASS B" CONVERSION KIT—Converts your present Battery Set to "Class B" Amplification Complete with all necessary components, including driver transformer, "Class B" output choke, W.B. 7-pin valve holder, B.V.A. Class "B" valve, wire and screws, etc. Full-size Blueprint, assembly instructions and diagrams. Cash or C.O.D., 37/6. Balance in 7 monthly payments of 5/6. **Send 5/- only**

All "Class B" Components and other Parts unobtainable from your local dealer SENT C.O.D. Easy Terms Available orders value over 33/-. We have the largest stocks in the country. Orders over 10/- Sent Post Paid.

CASH, C.O.D. or EASIWAY

IMPORTANT MISCELLANEOUS COMPONENTS, Paris, Kits, Finished Receivers or Accessories for Cash, C.O.D., or H.P. on our own system of Easy payments. Send us a list of your wants. We will quote you by return. C.O.D. orders value over 10/- sent carriage and post charges paid.

NEW GARRARD RADIOGRAM UNIT, Send COMPRISING 202A MOTOR, Pick-up tone-arm with speed regulator and needle cup. Cash or C.O.D., Carriage Paid, £4/1/9. Balance only in 11 monthly payments of 7/6. **Send 7/6 only**

PETO-SCOTT CO. LTD., 77, City Rd., London, E.C.1.
West End Showrooms: 62, High Holborn, London, W.C.1.
Dear Sirs,
Please send me CASH/C.O.D./H.P.
for which I enclose £.....
CASH/H.P./DEPOSIT
NAME
ADDRESS
Pr. W. 26/8/33.



SUPERCHARGED WITH POWER!

MORE and more power: that is the demand of the modern radio set. And no battery is so densely packed with power as the Grosvenor.

For, by the Grosvenor process, MERCURY protects the all-important zinc cells against corrosion. So long do the cells last that, to use them up, they are crammed with extra chemicals by hydraulic pressure.

That is why Grosvenor batteries give such astonishingly long life. For sheer value-for-money, try Grosvenor next time, and see for yourself!

MERCURY

means **ENORMOUSLY INCREASED LIFE**

GROSVENOR
MISCANLITE
ELECTRIC
TORCHES

Beautifully made from the new material MISCANLITE. Very strong, will last for ever, and finished in artistic assorted colours. Buy one now, for autumn and winter use. All sizes and types, priced from

1/6 to 12/6

Grosvenor Mercury Batteries are made in three grades for every Radio need.

- Grosvenor Red Line 5/6 to 11/-
- Grosvenor Brown Line 6/- to 15/6
- Grosvenor Blue Line 7/- to 20/-

Also long-lasting Grosvenor Mercury Batteries for Torches, Pocket and Cycle Lamps.

GROSVENOR ELECTRIC BATTERIES LTD.
2-3 WHITE STREET, LONDON, E.C.2
Works: WATFORD, HERTS.
Telephone: METROPOLITAN 6866 (3 lines).
Grams: GROBATCOY, AVE, LONDON.

CLASS B SIMPLIFIED!

THE NEW ROLA P.M. MC. UNIT SPEAKER & IN ONE

MAINS VOLUME FROM ANY BATTERY SET AT VERY LOW USE OF H.T. — JUST CONNECT TO YOUR SET WITHOUT ANY ALTERATION!

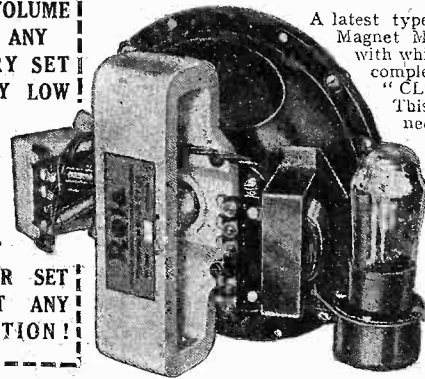

A latest type ROLA Permanent Magnet Moving Coil Speaker with which is incorporated a complete, properly matched "CLASS B" amplifier. This assembly when connected with any Battery Set converts it to "Class B" output, increasing the overall sensitivity of the set several times, and increasing the Power Output or Volume up to 5 Times!



SEND FOR IT ON 7 DAYS' TRIAL

Send only 5s. for 7 days' trial, if satisfied, pay balance in 10 monthly payments of 7s. 6d. (Cash, in 7 days, £3 11s.).

SEND ONLY 1/6

for the Famous "PIFCO" Radiometer



If satisfied, complete purchase by 5 monthly payments of 2/6 (Cash, 12/6.) Tests everything — valves, components, circuit, etc.

This Rola "CLASS B" SPEAKER AMPLIFIER UNIT can quickly and simply be connected to any battery set, and is complete with Cossor, Mullard, or B.T.H. "Class B" valve, with full instructions.

The result of adding this unit to your battery set will be equivalent in performance, as regards richness of tone and volume, to a high grade all mains set, whilst at the same time retaining economy in battery consumption. Send deposit to-day!

E. J. HERAUD, Ltd., Dept. P.21, Number One, EDMONTON, LONDON, N.18
Branches: 78/82, Fore St., Edmonton; 77, West Green Rd., Tottenham; 34, St. James St., Walthamstow; and 130, Hertford Road, Enfield Wash.

SERADEX RESISTORS

as specified for the "Wireless World Monodial Superhet," and "Modern Battery Four"



- M-75 3/4-1 Watt rating, most values 6d. each
- M-150 1 1/2-2 Watts rating 8d. each
- M-300 3.0 Watts rating 1s. 3d. each
- SERADEX GRID LEAKS. .1, .25, 5, 1 and 2 Megs. 5d. each.

Illustrated lists of above and other types free on mentioning "Practical Wireless."

TREVOR PEPPER, WAKE GREEN RD., BIRMINGHAM

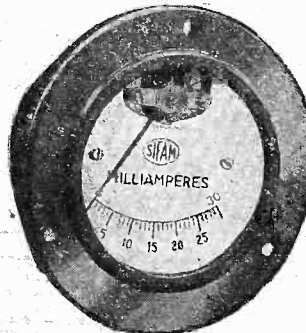

SIFAM ALL BRITISH METERS

Sifam moving-coil meters fitted in the new black bakelite flush type case are now available in a complete range of volts, amperes and milliamps. Sifam meters have been extensively used for the last nine years for checking voltages of batteries or eliminators and measuring filament currents, also for indicating poor quality due to distortion. Sifam moving coil meters are accurate, reliable and inexpensive.

Volts 3-500. Amps. 1-10. Milliamps 1-500.
Prices from 25/- to 42/6.
1,000 ohms per volt and A.C. Rectifier type 50/- to 72/6.

SIFAM ELECTRICAL INSTRUMENT Co., Ltd., York Works, Browning Street, S.E.17.

STAND TO STAND SHOW REPORT

(Continued from page 816)

is a neat component which will receive close attention during the forthcoming season and the remaining L.F. components are already well known.

STAND No. 42
BENJAMIN ELECTRIC, LTD., Brantwood Works, Tariff Road, N.17.

A FULL range of excellent Class B components was perhaps the most interesting feature of the Benjamin stand. Various types of transformers were shown, of which two were of the universal type, being tapped so that a number of alternative ratios can easily be obtained.

The well-known "Transceda," as well as various types of valve-holders and switches were also to be seen, and proved to be of more than passing interest to the many home constructors who looked over this stand.

STAND No. 43
DARWINS LTD., Fitzwilliam Works, Sheffield.

A WIDE and comprehensive range of magnets for all wireless purposes was shown on this stand. Various types included those for moving-coil and balanced armature speakers, gramophone pick-ups, telephones, galvanometers, etc.

STAND No. 44
REPRODUCERS AND AMPLIFIERS, LTD., Frederick Street, Wolverhampton.

THE well-known speakers bearing the name "R. and A." made a delightful setting on this stand, and comprised the small Bantam, the Challenger, the Victor, and the new 12-inch moving-iron model. The new Class B unit and speaker assembly will, no doubt, encourage many listeners to scrap their existing speaker and purchase one of these in order to obtain the benefits of Class B amplification plus a good moving-coil speaker, and this will, of course, lead to an increased demand for quality apparatus.

STAND No. 45
BELLING AND LEE, LTD., Cambridge Arterial Road, Enfield, Middlesex.

BESIDES the extremely wide variety of connecting and safety devices shown by this firm, considerable interest was centred round the ingenious "Clip-on" pick-up fitted with track arm and volume control, and which can easily be fitted on to any kind of gramophone when electrical reproduction is wanted.

Another item of general interest was the Disturbance Suppressor. The object of this is to obviate interference with radio reception often caused by the electric lighting mains. The unit actually consists of a pair of large-capacity fixed condensers connected in series. Three terminals are provided and these should be connected to the two mains leads and to earth respectively.

STAND No. 46
AUTOMATIC COIL WINDER AND ELECTRICAL EQUIPMENT CO., LTD., Winder House, Douglas Street, S.W.1.

A WORTHY successor to, and smaller brother of the well-known "Avometer" and known as the "Avomitor," was perhaps the outstanding item of interest on this stand. This instrument is not intended to supplement the larger instrument, but is a cheaper version which is sure to find favour with those who require a reliable multiple instrument at a distinctly reasonable price. The "Avodaptor" and "Avometer" were also well in evidence and attracted not a little attention.

STAND No. 47
SLEKTUN PRODUCTS, LTD., Winder House, Douglas Street, S.W.1.

THE new Slektun receivers proved very interesting amongst the smaller Slektun products which have proved so popular during the past season. The two-valve receiver for A.C. mains operation is an ideal receiver for the listener who desires a choice of only one or two stations at really good quality and with the minimum of trouble from the point of view of handling and risk of replacements. The new band-pass coils should also be used a great deal during the coming season.

STAND No. 49
HALFORD RADIO, LTD., 39, Sackville Street, W.1.

UNDOUBTEDLY the most intriguing exhibit here was the recently introduced "Tele-control." This is, in effect, a complete remote control by means of which the receiver can be operated entirely from any point in the house. The device consists of a cleverly arranged system of relays which are actuated automatically by the simple process of selecting the required station on the scale and depressing a small knob. Although somewhat expensive at the moment, due to the complicated nature of its construction, the unit is extremely interesting and strikes one as being almost uncanny. Nevertheless, it is free from all "snags" and can be considered as almost completely foolproof.

A number of high-class receivers were also exhibited and of these special mention should be made of five short-wave models which have been especially designed for the overseas market.

STAND No. 50
LANGASHIRE DYNAMO AND CRYPTO LTD., 94, Petty France, S.W.1.

A NEW and unusual type of battery charger was the feature of chief interest. Known as the "Karadio" it is probably the only unit of its kind on the market, and has been specially designed to enable motor car and wireless batteries of all sizes to be charged without any adjustment being required. It automatically regulates itself to the correct voltage and requires no attention whatever.

The well-known "Crypto" battery chargers were also shown, and were of chief interest to the service engineer and electrician.

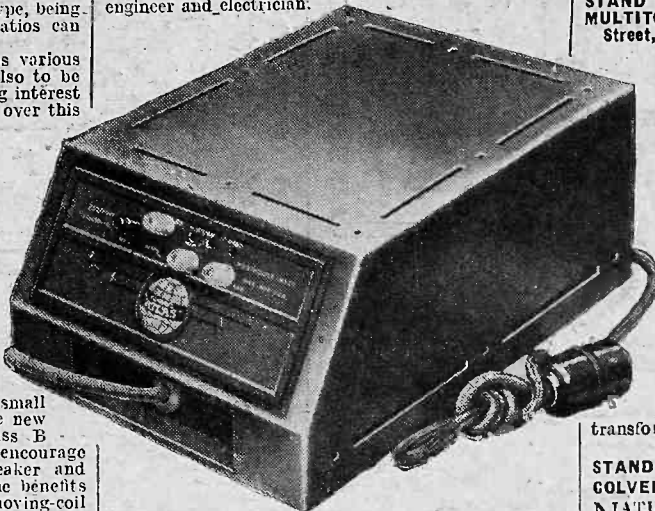

The well-known Atlas Mains Unit. Several different types of this Unit are available for A.C. or D.C. mains.

STAND No. 51
S. SMITH AND SONS (MOTOR ACCESSORIES) LTD., Cricklewood Works, N.W.2

ACCUMULATORS and H.T. batteries made a wonderful show on this stand, and the attractive Anodex labels gave a very good indication of the various ratings which were obtainable, from the small 60-volt battery to the largest Class B type. The accumulators, both of the small 2-volt type and the large H.T. blocks, were worthy of attention and represent very good value.

STAND No. 52
BRITISH ROLA CO. LTD., Minerva Road, Park Royal, N.W.10

IT is rather difficult to label any one exhibit as the most popular on this stand, but it was noticed that great interest was shown in the miniature speaker units and in the complete speaker with Class B amplifier. But loudspeakers of every conceivable pattern, from the midget to the large auditorium model, were on view and no matter what the visitor's speaker requirements happened to be he could certainly satisfy them.

STAND No. 53
HENLEY'S TELEGRAPH WORKS CO. LTD., Holborn Viaduct, E.C.1

THE new "Empire Solon" soldering iron was the item of outstanding interest here, and one which appealed particularly to set repairers and constructors. Straight or angle bits can be interchanged so that the tool is applicable to every type of soldering job. It has a consumption of only 70 watts, and can be obtained for any kind or voltage of mains supply. The older "Solon" iron which has proved so popular in the past was also shown, and its use was demonstrated in an interesting manner.

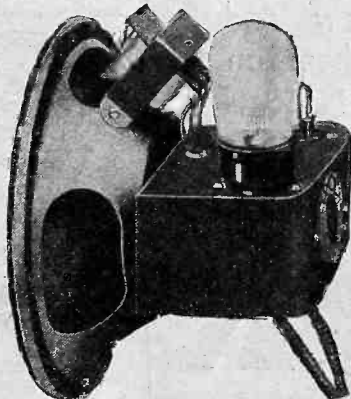

Manufactured by Epoch, this complete loud-speaker and Class B amplifying stage forms a valuable unit for adding to an existing low-powered receiver.

STAND No. 54
HARLIE LTD., Balham Road, Lower Edmonton, N.9.

A POPULAR exhibit on this stand was the "Fix-a-gram," a cleverly designed unit consisting of a motor, turntable, and pick-up, which can be used with any type of receiver. It was shown with both clock-work and electric motors and was seen to be a very attractive piece of furniture, in addition to its being a most useful and efficient accessory.

Other items shown were the Harlie pick-up, various types of switches, microphones, automatic gramophone motor stops, and tone selectors.

STAND No. 55
MULTITONE ELECTRIC CO. LTD., 95-98, White Lion Street, Islington, N.1.

SOMETHING entirely new to wireless was shown on this stand in the form of a five-valve Class B receiver, having two S.G. stages by which it is claimed that the deaf can hear wireless programmes with perfect ease. This claim does not only apply to those who are more or less temporarily deaf, but even to deaf mutes who have never heard before in their lives. In addition to its use as a normal broadcast receiver, the instrument can also be employed as an amplifier in conjunction with a microphone to enable the deaf to hear normal conversation. This set is undoubtedly revolutionary and should prove of extreme value to those who have been deprived the privilege of hearing.

Other interesting exhibits were the new Class B unit which can instantly be connected to any battery receiver, the popular Multitone tone control transformer and a wide variety of Class B transformers and output chokes.

STAND No. 56
GOLVERN LTD., Mawney's Road, Romford, Essex.

NATURALLY, the principal exhibits on this stand were a complete range of Ferrocart coils. These were shown in every type and in numerous ganged combinations, suitable for use in almost every type of multi-valve receiver. An interesting example of complete tuning unit is one comprising a set of band pass and tuned-grid coils for two-S.G. sets, and fitted with an interesting 4-point switch which gives "long waves," "medium waves," "gramophone," and "off" when set to the alternative positions. A number of special coil assemblies for modern superheterodynes were also shown, and these attracted considerable attention.

For the constructor who is more interested in the making of simple Det.-L.F. receivers the new Ferrocart aerial coil, which is specially designed to give high selectivity and freedom from break-through, proved a most interesting new line.

STAND No. 57
EVER READY CO. (G.B.), LTD., Hercules Place, Hol-loway, N.7.

BATTERIES for every requirement were to be seen on this stand. It was noticeable that most types of high-tension batteries were shown in both low capacity and Class B patterns. The latter probably proved to be of greatest interest, due to the popularity which Class B amplification has lately achieved.

STAND No. 58 and 60
REGENT RADIO SUPPLY CO., 21, Bartlett's Buildings, E.C.4.

MESSRS. REGENT RADIO SUPPLY CO. were one of the first firms to produce high tension eliminators, and their "Regentone" units have attained a position of great popularity with listeners in every part of the country. It was not, therefore, surprising to find an excellent series of mains units of every conceivable type displayed on this stand. Units for A.C. and for D.C., with and without trickle chargers, were very much in evidence, whilst a staff of engineers was in attendance to give free advice in regard to the suitability of the various units for different kinds of receivers.

STAND No. 61
A. J. BALCOMBE, LTD., 52-58, Tabernacle St., E.C.2.

THE good range of superheterodyne receivers in both mains and battery forms attracted most attention on this stand. The novel tuning control, consisting of two scales for medium and long waves, disposed one on each side of the tuning knob, came in for much favourable comment, whilst the distinctive cabinet work was warmly appreciated. Battery users found the self-contained four-valve Class B set of particular interest, and it was shown in both console and radiogram form.

STAND No. 63
KOLSTER-BRANDES, LTD., Cray Works, Sidcup, Kent.

THREE interesting superheterodynes were very noticeable on this stand, and they were in four, six and eight-valve models. The six-valver is fitted with A.V.C. and automatic tone correction, whilst the eight-valve set has quiet automatic volume control, operated through a double-diode

(Continued on page 821)

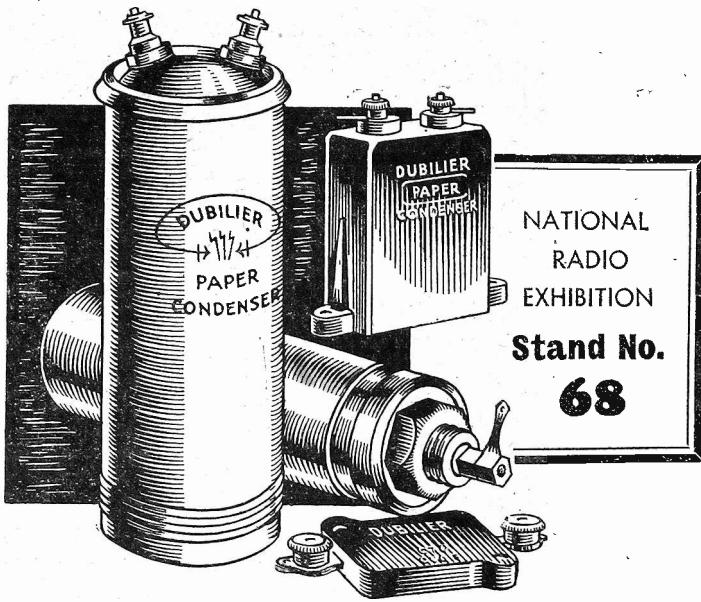

NEW and IMPROVED CONDENSERS AND RESISTANCES FOR 1933-4

THE new Dubilier products mark a great advance in Condenser and Resistance design and will maintain Dubilier's established position as the foremost manufacturers of the highest quality products, at the lowest price levels. Write for new illustrated booklet fully describing the new and unique designs, or inspect them on the Dubilier Stand, No. 68, National Radio Exhibition, Olympia.

DUBILIER CONDENSERS AND RESISTANCES

Dubilier Condenser Co. (1925) Ltd., Ducon Works, Victoria Road, North Acton, W.3

this OSBORN CABINET

SPECIFIED FOR F. J. CAMM'S 1934 SUPER-SET

Another proof of the popularity of Osborn Cabinets—this new Ultra-Modern radio cabinet has been specified for F. J. Camm's 1934 Super-Set. Size 25ins. wide, 11ins. deep, 11ins. high. Obtainable in Oak, Mahogany or Walnut.

All Models Carriage Paid. WRITE FOR CATALOGUE. CHAS. A. OSBORN, Dept. P., Regent Works, Arlington St., New North Rd., London, N.1. Tel.: Clerkenwell 5093. Showrooms: 21, Essex Rd., Islington, N.M. Tel.: Clerkenwell 5634.

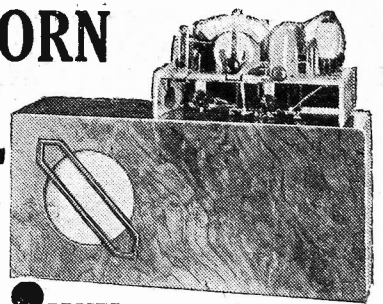

PRICES:
Machined Ready to Assemble, Kit of Parts, Oak 12/6, Mahogany 15/-, Walnut 15/-. Assembled Ready to Polish, Oak, 17/-, Mahogany £1.0.0, Walnut £1.0.0. Assembled and Polished, Oak £1.2.6, Mahogany £1.5.0, Walnut £1.5.0.

OSBORN SUPER ACOUSTIC BAFFLE BOARD.
Prevents 90 per cent. speakerworry. Any size hole cut FREE. 18ins. by 18ins., 3/-; 24ins. by 24ins., 5/-; 30ins. by 30ins., 8/-; 36ins. by 36ins., 11/3. Carr. paid U.K. Send For Free Sample.

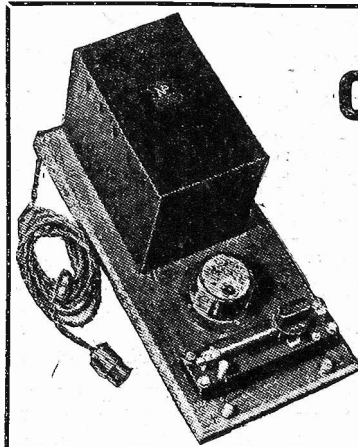

BATTERY CHARGERS

For A.C. Mains
THE SENIOR TWO TYPE N.P.
(Illustrated) will charge one to thirty batteries at once. 15-20 volts at 3 amps. Sliding Variable Resistance from small amperage—Westinghouse Metal Rectifiers. For H.T. and L.T. Cells.

Trade Price 105/-
Complete delivered.
Other models up to £40
Eliminators from 57/6

Send for 1933 trade list.
NASH PRODUCTS LTD.
STECHFORD, BIRMINGHAM (9)

PEAK BRITISH MADE CONDENSERS



Write for New Complete Illustrated Price List "B."

Compared with other leading makes, PEAK Condensers are low in price, but they are of the very highest quality. Made by the most up-to-date machinery from the finest materials obtainable, they are representative of the very latest developments and can be relied upon for unflinching service.

"PEAK" ARE SPECIFIED FOR "THE AUTO-B THREE"

These are the ones you need:—
One 8 mfd. Electrolytic, Type "W," 4/9
Two 1 mfd., Type "A4," @ 2/2 each
Two .01 mfd., Type "M," @ 1/- each

WILBURN & CO.,
Wheatsheaf House, Carmelite St., London, E.C.4.
Tele.: Central 6810.
Northern Agents: W. Andrew Bryce & Co., Tile St., Bury.

SAVE 50% ON VALVES

Buy British 362 by post direct from the makers. There is a FULLY GUARANTEED type for every purpose.



The 362 "Class B"—the first and most successful of all "Class B" valves.

362 are Non-Microphonic and are definitely as good as any and better than most. They bring you better radio at lower prices. BRITISH ALL THROUGH.

Post-Free from **3/6**

R.C., H.F., L.F., or Det., 3/6. Power, 4/-. Super-Power, 4/6. S.G. or Var-Mu., 7/6. Pentode type, 10/-. All in 2v., 4v., or 6v. Metallised 3d. extra.
"CLASS B" 2v. filament, 7-pin base, 9/-.
A.C. MAINS VALVES, 4-volt, 1 amp. (Indirectly Heated). Prices 7/6 to 12/6. Full List post free.
362 UNBREAKABLE METAL VALVES (BATTERY type) will shortly be released.

Cash with order. Cheques and P.O.'s must be crossed and made payable to:—
THE 362 RADIO VALVE Co., Ltd. (Dept. W. 15), Stoneham Road, London, E.5.

STAND TO STAND SHOW REPORT

(Continued from page 819)

triode second detector. Two pentodes form a push-pull output stage and give over 5 watts signal output. All K.-B. receivers are designed for use with a screened aerial down-lead for the suppression of electrical interference, and the necessary equipment for this purpose was exhibited.

**STAND No. 64
BUS-RADIO, LTD., Woodger Rd., Shepherd's Bush, W.12.**

ALTHOUGH a range of excellent and interesting receivers was shown on this stand, one cannot deny the fact that the *pièce de résistance* was the complete television receiver. This latter was examined by every keen "fan," and proved of extreme interest. Those who found time to examine the receivers were pleased to observe their many up-to-date and novel features.

**STAND No. 65
SUNBEAM ELECTRIC, LTD., Sunbeam Rd., N.W.10.**

THE Universal receiver was first introduced to this country by the Sunbeam Electric, and now the Midget has been introduced by the same firm. Many visitors expressed surprise at the neat and compact receiver which has been developed, and the standard of reproduction — as well as could be judged by the method of re-broadcasting which was adopted — reflects quite a high standard. The Class B battery receiver at £10 10s. also proved extremely popular.

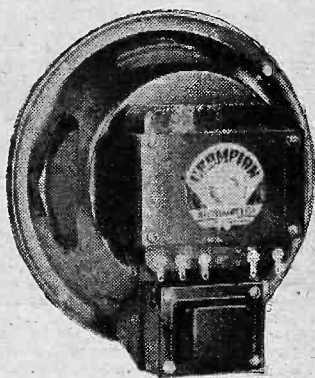

A Gramian Midget Loud-speaker. The cone is only 6ins. or so in diameter, but it can handle well over 2 watts.

**STAND No. 66
COLUMBIA GRAPHOPHONE, LTD., 98-108, Clerkenwell Rd., E.C.1.**

HERE there was a most extensive range of high-grade receivers and radiograms of all types, and at prices to suit any pocket. The new "Autoradigram" with automatic record changing device, and using a five-valve superheterodyne receiver, quite naturally proved to be the centre of attraction, and many onlookers were fascinated by the working of the ingenious record-changing mechanism.

There were plenty of smaller sets, which obviously had a wide appeal to every class of buyer, whether he was a mains or battery user.

**STAND No. 68
DUBILIER CONDENSER CO. (1925), LTD., Ducon Works, Victoria Rd., North Acton, W.3.**

IT would be almost superfluous to point out that I condensers of every conceivable type were displayed on this stand, but it might be mentioned that really useful booklets giving complete details of them were available. These latter were in great demand in view of the useful information which they contained. Many of the older and popular condensers were shown in new and improved form, and it was interesting to find that in most cases the ranges had been extended. Something quite new in the way of non-inductive paper dielectric condensers was shown. This was of tubular form and accommodated in a metal container fitted with a screw-on base; once the base has been attached to the receiver any number of alternative condensers can be screwed into it without the use of any tools whatever. This is a very ingenious feature and one which will have a strong appeal to the experimenter. Another notable point about the new condenser is that the terminals are mounted on a domed bakelite top in such positions that they cannot accidentally be short-circuited in wiring up.

The well-known metallised resistances were shown in an improved form, and they should now prove even more attractive than before.

**STAND No. 69
MCMICHAEL RADIO, LTD., Wexham Road, Slough, Bucks.**

TWO receivers of outstanding interest were shown on this stand, in addition to several existing models which are being continued. The first was the "Lodex 5," a five-valve Class B battery set fitted in the now-popular horizontal cabinet and having moving coil speaker, full vision scale and other McMichael features. The "Twin Supervox" is the second new set and is a 4-valve A.C. model with twin balanced moving coil speakers, one of which is mounted on each side of the central tuning panel. A horizontal cabinet is again used and the set has two S.G. stages and pentode output.

**STAND No. 70
COLE, LTD., E. K., Ekco Works, Southend-on-Sea, Essex.**

"EKCO" mains units in types suitable for every type of receiver were shown on this stand. As the first firm in this country to manufacture eliminators on a large scale, Messrs. Ekco undoubtedly know the requirements of their customers, and their latest models are clear proof that these have been amply fulfilled.

A large portion of the stand was devoted to a new range of "Ekco" superheterodyne receivers, which attracted a considerable amount of favourable comment. There is little doubt that these latest receivers will become even more popular than the previous models that have sold during the past few years.

**STAND No. 71
MULLARD WIRELESS SERVICE CO. LTD., Charing Cross Rd., W.C.**

UNDOUBTEDLY the most attractive feature here — apart from the stand and its exhibits — was the free gift which was obtained by probably every visitor to the Show. Who was there who did not find the attractive little fan of the greatest assistance in keeping cool? And who was there who did not avail themselves of the chance of obtaining one of the neat little carriers in order to carry away the various pamphlets and catalogues which were obtainable throughout the exhibition? However, the arrangement of this stand — in the form of a fortress, attracted many, and one could see well arranged displays of the very latest valves such as the variable-mu pentodes for H.F. work; Class B valves for power output in battery receivers; screen-grid valves, and so on. Altogether this was a stand where any type of valve could be seen, and undoubtedly many will make certain that their next valve replacement will be obtained by a Mullard product.

**STAND No. 72
LISSEN LTD., Worpole Road, Isleworth, Middlesex.**

IT is really difficult to pick out on this stand the item which proved most attractive. The kits sets, the complete receivers, the sundry components, all seemed to hold the attention. The new superheterodyne will undoubtedly prove one of the big lines of the coming season, and the new iron-core coils will also prove an important accessory in many receivers. The new Skyscraper kit for an All-Wave receiver, covering short, medium and long waves will also introduce many to the short waves for the first time. The 6-stage Band Pass super-het. with automatic volume control and Class B output at a cost of £11 10s. is a remarkable bargain and, in our opinion, this represented one of the best offers in the Show.

**STAND No. 73
PYE RADIO LTD., Africa House, Kingsway, W.C.2.**

SOME novel types of receiver were tastefully displayed on this stand, and the new Class B receiver was probably the most interesting, incorporating as it does the latest method of L.F. coupling. Many old receivers were still to be seen, and these have made a name for themselves in the past and are still in great demand.

**STAND No. 74
FERRANTI LTD., Hollinwood, Lancashire.**

AMONGST all the various types of receivers and loud-speakers, the various smaller components and meters seemed to form an exhibit of such a comprehensive nature that one could only stop and marvel. The Gloria was probably the high-light of the complete receivers, and this as well as some of the other models was also seen to be obtainable with a small electric clock forming part of the cabinet. Splendid representative types of loud-speaker were also seen, and the new Ferranti Valves, with the new carton, will no doubt be seen in many shop windows in the future.

**STAND No. 75
PORTADYNE RADIO, Portadyne Works, Gorst Road, N.W.10.**

THE portable receivers manufactured by this company were well set out, and some of the novelties were extremely interesting. The novel tuning dials, in which a red line has to be matched up to ensure that the station is accurately tuned will no doubt prove a great attraction to the listener with no wireless knowledge, and it is fool-proof. The new Class B receiver was also a great attraction.

**STAND No. 76
CROMWELL (Southampton) LTD., 32-33, Brinton's Terrace, Southampton.**

FIVE new receivers were seen here, and these embraced a Universal (A.C. or D.C.) receiver, as well as a battery Class B receiver. The 8-valve super-heterodyne, with automatic volume control and Class B output, complete with moving coil loud-speaker, will give many battery users the chance to obtain a really powerful receiver. The cost is 18 guineas, and for the same figure one can obtain a powerful A.C. mains receiver fitted with a 3.5 watts pentode.

**STAND No. 77
MARCONIPHONE COMPANY LTD., 210, Tottenham Court Road, W.1.**

NO fewer than a dozen different types of receiver could be counted on this stand, and they ranged from a small battery receiver using only 2 valves, to a multi-valve superheterodyne radio-gram complete with automatic record changer. Obviously here was a set for anyone, and they represented the last word in design and workmanship. In addition, there were several different types of loud-speaker, from the simple cone to the large energized field moving coil. All types of valves were seen, including the new Double-Diode Triodes, and the new Class B. The new Pick-up is also a most interesting model, showing a great improvement on last year's design.

**STAND No. 78
ULTRA ELECTRIC LTD., Erskine Road, N.W.3.**

THE receivers here displayed were of the very latest type, and in addition to the superheterodyne principle, automatic volume control and other modern developments were incorporated. The cabinets were certainly modern so far as design is concerned, and the names applied to the receivers are certainly well remembered.

**STAND No. 79
RADIO GRAMOPHONE DEVELOPMENT CO. LTD., 18-20, Frederick Street, Birmingham.**

THE 12-valve superheterodyne radio-gram was undoubtedly the *pièce de résistance* on this stand. Although so many valves are employed many of them are, in effect, "passengers." These include, for instance, an automatic volume control valve, a "squelch" valve, a rectifier, etc. The output utilizes a push-pull circuit on the resistance-capacity principle, and it is altogether a de luxe receiver, delivering an undistorted output of 6 watts. Other splendid receivers on this stand also showed considerable ingenuity and concentration on detail.

**STAND No. 80
GRAMOPHONE CO., LTD., 98-108, Clerkenwell Road, E.C.1.**

AN item of outstanding interest on this stand was the new "Superhet Selective Five," which is an all-mains five-valve superheterodyne receiver selling at the attractive price of 15 guineas. A larger instrument, which proved extremely popular, was the "Superhet Ten Autoradiogram." This is really a super de-luxe ten-valve radiogramophone fitted with delayed automatic volume control, tone control, automatic record changer and mains aerial device. The cabinet work is most elaborate and of particularly pleasing appearance, and the instrument is one which will harmonise with practically any furnishing scheme. The "Superhet Portable Six" was another receiver that received close attention by visitors. This is a battery set of an advanced type and has a wavelength calibrated tuning dial and self-contained M.C. speaker.

**STAND No. 81
PHILIPS LAMPS, LTD., 145, Charing Cross Road, W.C.2.**

THE Superinductance receivers formed the greater part of this exhibit, although the various types of rectifying valves, etc., also had an important position on the stand. The Superinductance Five is probably the most popular of the complete range and this gives results almost equal to those obtained with a superhet. type of receiver. The various Philips accessories also attracted attention.

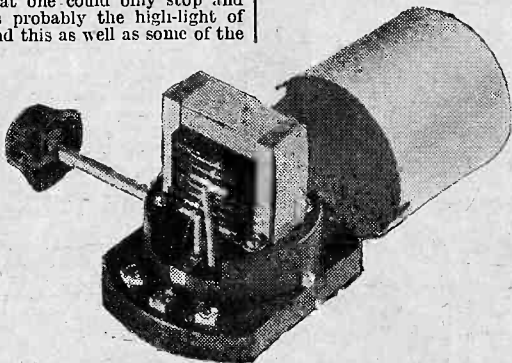

Already familiar to our readers, this is one of the new Igranicores dust-iron core tuning coils.

**STAND No. 82
EDISON-SWAN ELECTRIC CO., LTD., 155, Charing Cross Road, W.C.2.**

THE cathode ray oscillograph was the centre of attraction on this stand and was carefully inspected by the many visitors who are now taking an interest in television. Many were fascinated by the wave forms reproduced by the oscillograph of the music being reproduced by the loud-speakers.

There were also on exhibition a wide range of R.K. moving-coil loud-speakers and the well-known range of B.T.H. pick-ups. The former were shown both as "baro" units and also as complete cabinet models of attractive design.

**STAND No. 83
CARRINGTON MFG. CO., LTD., 24, Hatton Garden, E.C.**

AMONG the particularly extensive range of cabinets shown on this stand one was at once attracted by several of the very latest designs. These included both consolelets and complete radiogram cabinets in patterns to suit every taste. One could not fail to recognise the high-class workmanship which was

(Continued overleaf)

STAND TO STAND SHOW REPORT

(Continued from previous page)

undoubtedly put into their construction and the fact that they were obviously of both sound construction and good appearance was responsible for a number of visitors deciding to use one for his new set.

STAND No. 84.
CLIMAX RADIO ELECTRIC, LTD., Haverstock Works, Parkhill Road, Hampstead, N.W.3

UNDOUBTEDLY the most interesting receiver on this stand was the entirely new Model S.4 superheterodyne. This is a four-valve (plus rectifier) A.C. mains receiver and includes several novel features. Amongst these one might mention the balanced band-pass input circuit fitted with a special second channel interference suppressor; illuminated tuning scale with station names and wavelengths clearly marked; straight line volume control; mains aerial; provision for connecting an external aerial; adaptability for either 100/120 or 200/250 volts A.C. mains, and an attractive walnut cabinet with silver speaker grill. Numerous other very up-to-date receivers of diverse types were also shown and these deserved the praise which they received.

STAND No. 85
VARLEY (OLIVER PELL CONTROL), LTD., 103, Kingsway, W.C.2

RECEIVERS, as well as small components, were tastefully displayed here, and it was really difficult to find the principal item of interest. The receivers certainly were worth a thorough inspection, but the mains transformers, chokes, etc., as well as the new iron-core tuning coils also held a prominent position. The new superhet, undoubtedly held a premier position in the complete receiver class, but the complete stand served to show how thorough is the range of Varley products for the home constructor. The permeability tuner is undoubtedly a forerunner of the tuner of the future and no doubt interested every visitor. The high-class finish on all the Varley products was most conspicuous.

STAND No. 86
IGRANIC ELECTRIC CO., LTD., 149, Queen Victoria Street, E.C.4

THIS was a very tastefully arranged stand, showing many various types of the new iron-core coil. In addition, new types of tubular condenser were displayed and two short-wave adaptors. Amongst the many other exhibits were Class B transformers; standard L.P. transformers; a neat loud-speaker; chokes; microphones, etc. The complete range is very vast indeed, and there was an atmosphere of refinement about all of the samples shown, and this, together with the well-known name, served to convince many that here were components which could be relied upon.

STAND No. 87.
MONTAGUE RADIO INVENTIONS & DEVELOPMENT CO., LTD., Beethoven Works, Great College Street, Camden Town, N.W.1.

THE new S.G. 4 receiver is the principal model which this firm has developed for this exhibition, and it is a very good little receiver. Iron-core coils are employed and with the Pentode output valve and moving coil loud-speaker it represents splendid value at 11 guineas. Several other models were also to be seen.

STAND No. 88.
TELSEN ELECTRIC CO., LTD., Thomas Street, Aston, Birmingham.

RECEIVERS and components. This sums up the total exhibit but gives no idea of the vast range which was exhibited in both classes. Switches, coils, condensers, resistances — practically every component required for the construction of a receiver was shown, and the very latest in design was included. For instance, the new iron-core tuning coil was shown, as well as the very small electrolytic condensers for biasing purposes. The receivers also were of modern design, incorporating all those features which have been developed during the past season. The workmanship was worthy of comment, and judging by the crowds which always surrounded the stand it was a most popular show.

STAND No. 89.
COSSOR, A. C. LTD., Cossor Works, Highbury Grove, London, N.5.

SOME interesting features were seen on the Cossor stand, and many were attracted to the large scale model of the electrode assembly of the Cossor Pentode. This gave the visitor an admirable idea of the work which is put into a valve, and many were surprised to think that so much could be



The new Six Sixty H.F. valve.

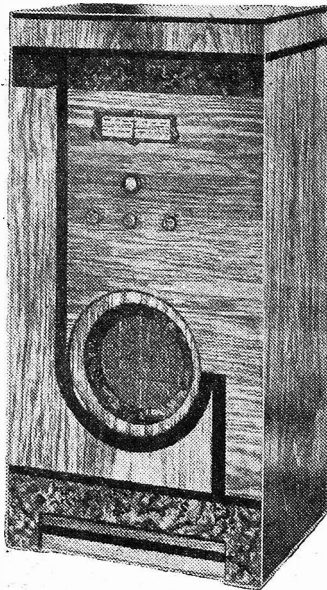

A fine super-heterodyne radio-gramophone manufactured by Radio Instruments. This instrument costs £35.

was first impressed by the new 5-valve mains superheterodyne. Fitted with tone control, station calibrated tuning dial and other up-to-date features the set is contained in a very handsome grained walnut cabinet. An 8-valve de-luxe A.C. superhet was also an interesting exhibit. It was shown in both table and console types, both of which were very attractive. The "Thirty Three" kit set for home construction proved to be an interesting exhibit and one which will prove a worthy successor to the well-known range of "Music Magnet" receivers that have been produced during the last few years.

Three new "Osram" battery valves were also the centre of considerable interest: these include a special screened grid one with non-microphonic construction, a short base variable-mu and a Class B.

STAND No. 91.
CLARKE & CO. (M/c), LTD., George Street, Patricroft Street, Manchester.

BESIDES the wide variety of well-known "Atlas" mains units (including special types for Class B and Q.P.P.) there were some particularly interesting receivers shown on Messrs. Clarke's stand. The most popular of these were the mains one, type A.4, having an undistorted output of 3 watts, and a four-valve Class B battery set fitted with an excellent moving coil loud-speaker.

STAND No. 92.
OSRAM VALVE, Magnet House, Kingsway, W.C.2.

THE Catkin valve was undoubtedly the main attraction on this stand, and the method of assembly was clearly seen in the larger models which were displayed. In addition, the ordinary types of valve which were seen included some of the newer types such as the Class B. This latter differs from the majority of the Class B valves which are obtainable in that an initial application of grid bias is required. It is claimed that this results in improved results and greater output.

STAND No. 93.
WINGROVE & ROGERS, LTD., Arundel Chambers, 188-189, Strand, London, W.C.2.

THE new types of condenser and slow-motion dials attracted considerable interest. The new types of dial, although shown on many stands at this particular exhibition, call for close attention, and from the remarks of many of the people round this stand it is certain that this type of tuning dial will find great popularity during the coming season. The novel addition of the air-dielectric trimmer to these dials was, in our opinion, the most important feature of the stand.

STAND No. 94.
CITY ACCUMULATOR CO., LTD., 18-20, Norman's Buildings, E.C.1.

A WIDE range of excellent cabinets was a strong feature of this exhibit, but a considerable amount of attention was directed towards various types of new receivers which were on view. These varied from a simple three-valve battery model, known as the "Norman Class B Three" and incorporating a Ferrocoat coil, to an ultra-modern superhet. The latter is a four-valve mains instrument, including the recently-introduced pentagrid converter, variable-mu pentode and double-diode pentode second detector. A gramophone amplifier giving an output of six watts also merited

crowded into the small glass bulb with which we are all familiar. The new Cossor receivers on the rotating shaft in a glass case also enabled one to see every part of the receiver and assisted in holding the attention. In addition to the many new valves, sundry components were also to be seen.

STAND No. 90.
GENERAL ELECTRIC CO., LTD., Magnet House, Kingsway, W.C.2.

ON examining the exhibits on this stand one

the keen interest which was shown in it by those requiring a large output of undistorted record reproduction.

STAND No. 95.
SIX SIXTY RADIO CO., LTD., 17, Rathbone Place, W.1.

IN addition to the many different types of valves shown here the receivers also attracted considerable attention. The new types of mains valve will no doubt prove extremely popular in the receivers of the coming season, and the Super Five receiver will find many purchasers. This is a really high-class receiver giving a choice of many stations at really good quality.

STAND No. 96.
STANDARD TELEPHONES & CABLES, LTD., 364, Gray's Inn Road, W.C.1.

THE broadcast receivers shown on this stand were of high quality, and no doubt the A.C. superheterodynes claimed first place. The two-valve A.C. mains receiver with moving coil loud-speaker will no doubt prove a good seller during this season and is capable of a really fine performance, despite the small number of valves.

STAND No. 97.
THE BRITISH BLUE SPOT CO., LTD., 94-96, Rosebery Avenue, E.C.1.

ONE need hardly remark upon the fact that an extremely wide range of loud-speakers of both balanced armature and moving coil types was exhibited by this firm. New lines which attracted a good deal of well-earned attention consisted of a range of mains energised M.C. units in a variety of types to suit all kinds of supply mains. In addition to the "bare" speaker units a number of others in attractive and modern cabinets were examined with keen interest by the non-constructional amateurs.

STAND No. 98.
TELEGRAPH CONDENSER CO., LTD., Wales Farm Road, North Acton, W.3.

THE familiar green cases for condensers identified this stand. In addition to the larger metal-cased Mansbridge type of condenser, the nudget (or Type "M") condensers were also shown, together with other types of small mica condenser. The total range—both for reception and transmission—covered a most comprehensive number of types and values and in most it was found possible to obtain models with terminals for connections, or soldering lugs for those who prefer that method of wiring. Some of the special manufacturer's models were also shown.

STAND No. 99.
ORMOND ENGINEERING CO., LTD., Ormond House, Rosebery Avenue, E.C.1.

SPEAKERS, ranging in price from 12s. 6d. to nearly £3, formed one of the principal features here, and in addition to the models which have been so popular during the past year some new types were to be seen. In addition the range of variable condensers was well set out, and some of the vast range of products of the Ormond Company were seen.

STAND No. 100.
ELDECO RADIO, LTD., 62, Conduit Street, London, W.1.

THE Stenode all-mains six-valve superheterodyne with automatic volume control and electric tuning was the principal attraction on Stand No. 100, and in addition there were several other interesting types of receiver. The ingenious Log Box well repaid examination and no doubt many listeners will make certain that this forms part of their equipment during the coming winter months.

STAND No. 101.
SOVEREIGN PRODUCTS, LTD., "Sovereign House," 52-54, Rosebery Avenue, E.C.1

A MOST extensive range of the smaller components was shown here, and they included many which were already familiar to the home-constructor. Such

(Continued on page 827)

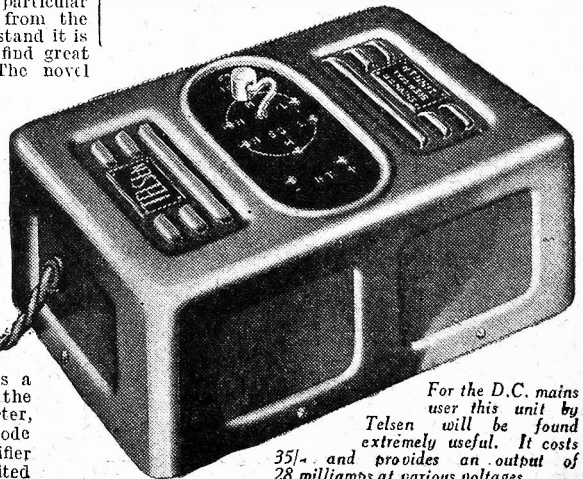

For the D.C. mains user this unit by Telsen will be found extremely useful. It costs 35/- and provides an output of 28 milliamps at various voltages.

NOW!



**THE BRITISH
RADIOPHONE
RANGE OF
PRODUCTS**

RADIOPAKS

Band Pass
Super Het. R.F.
Super Het. B.P.
2 R.F.

COILPAKS

BAND PASS
SUPER HET.
2 R.F.

I.F. COILS

ALLWARE COILS
GANGED CONDENSERS
SHORT-WAVE CONDENSERS

SINGLE TUNING CONDENSERS

SLOW MOTION DISC DRIVES (5 types)

FIXED CONDENSERS
CLASS "B" TRANSFORMERS

PICK-UPS

POTENTIOMETERS
THE DUOVOL

RECEPTRU

Q.M.B. SWITCHES
VALVE HOLDERS

"PUSH-BACK" CON-

NECTING WIRE

ETC., ETC.



VISIT US AT
OLYMPIA
STAND . . 118

**you can
be SURE
of Better Radio**

BRITISH RADIOPHONE have earned a high reputation for quality and accuracy. "Matched perfection" is their slogan, and they live up to it.

The proof of this is to be found in the fact that few sets of any importance are designed without the inclusion of one or another of Radiophone "matched perfection" components.

Where experienced professional designers evince so much confidence the private

constructor can have no doubt. Follow the golden rule for success. Use British Radiophone components and be sure of better radio. The British Radiophone range for 1933-34 is complete in every way. And every item from the latest ganged condenser down to the smallest switch is guaranteed to be accurate in the highest degree and of superlative quality.

Ask your dealer or write for catalogue to British Radiophone, Ltd., Aldwych House, London, W.C. 2.

**BRITISH RADIOPHONE
"MATCHED PERFECTION"**

THE NEW J.B.

LINACORE

BAND-PASS TUNER

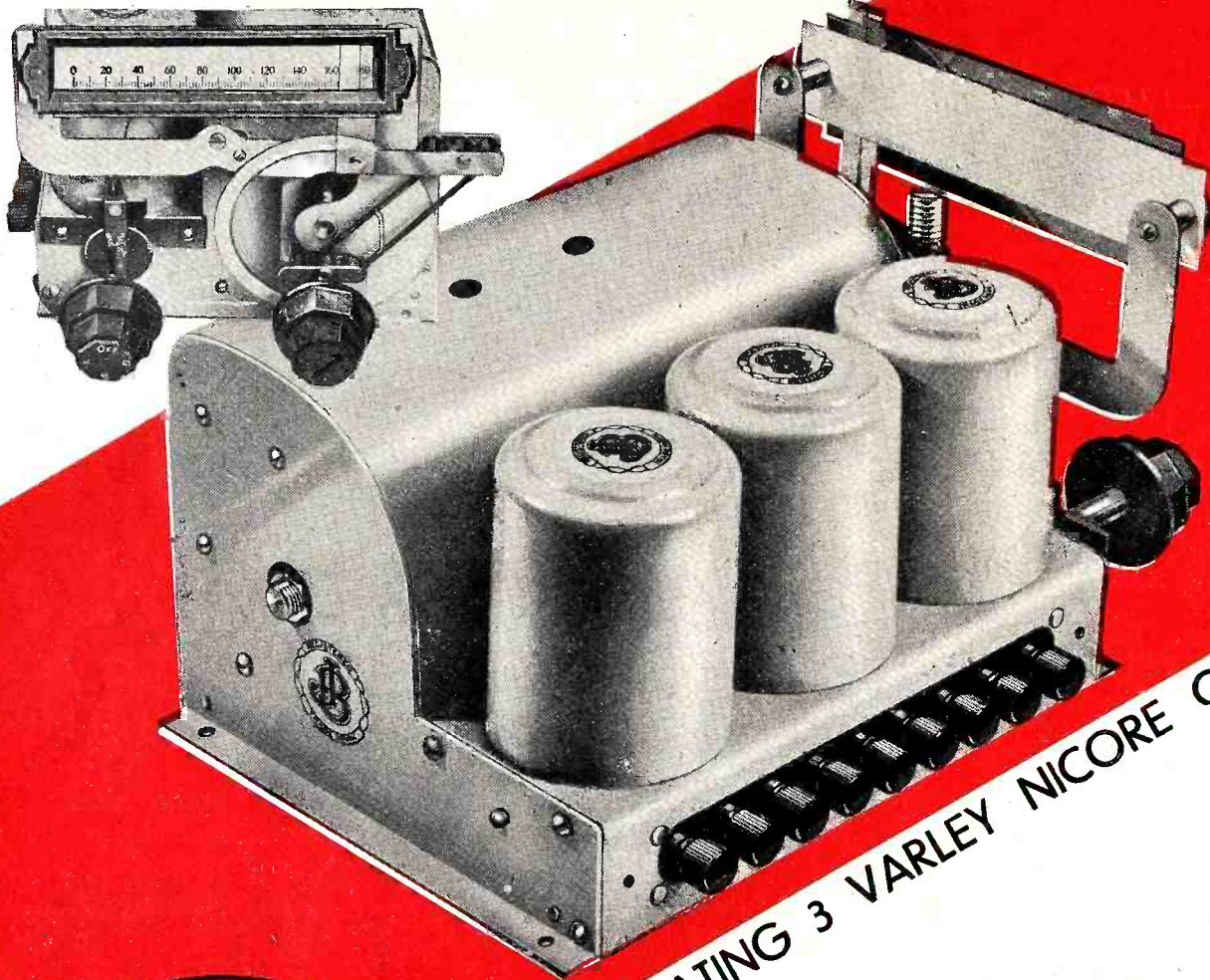

INCORPORATING 3 VARLEY NICORE COILS



The J.B. LINACORE... an exceptionally selective band-pass tuning unit employing the latest type of iron-cored coils. LINACORE takes all the worry out of set-building. Far more efficient than if home-assembled and far more compact. Obviates all ganging difficulties. Makes the most of its super-selective coils by very accurate matching of the condenser sections. Tunes from 200-550 and 800-2000 metres. LINACORE gives a 3-valve set a performance comparable to a superhet. Complete with volume and reaction controls and all switching. Fitted with the latest pattern J.B. Straight Line Dial. See it at STAND 116, NATIONAL RADIO EXHIBITION, OLYMPIA.

B.R.G. SPECIFIED AGAIN

**ACCEPT NO SUBSTITUTE
INSIST UPON  COMPONENTS**

As Used by Mr. F. J. CAMM
in The

F. J. CAMM 1934 SUPER-SET AND ALL-WAVE TWO

B.R.G. COMPONENT MOUNTING BRACKETS

Solely specified for
F. J. CAMM 1934 SUPER-SET

Set of 3, Drilled and Plate-finished.

1/6

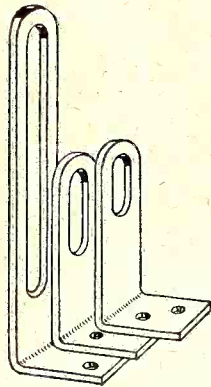
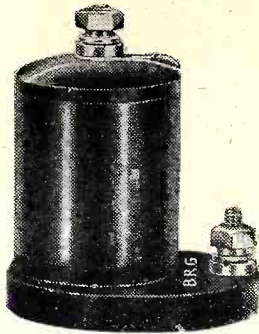

B.R.G. SHORT-WAVE H.F. CHOKE

Solely specified for
ALL-WAVE TWO
Single layer wound for lowest possible loss. Terminal Connections.

1/9

B.R.G. REACTION CONDENSER

Solely specified for
ALL-WAVE TWO
with solid di-electric. Positive contacts. .0002 mfd

2/6

B.R.G. 3 POINT SWITCH No. 48

Push-pull type. Solely specified for
F. J. CAMM SUPER-SET and ALL-WAVE TWO

Specially strong phosphor-bronze self-cleaning contacts

1/3

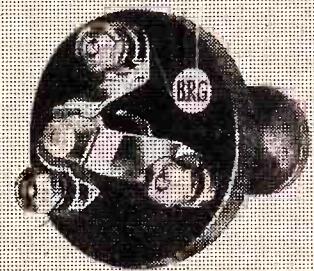

B.R.G. 2 POINT SWITCH No. 49

Push-pull type as Solely specified for
ALL-WAVE TWO

Self-cleaning contacts and specially strong phosphor-bronze

1/0

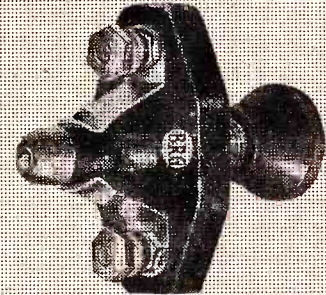

B.R.G. 3 POINT SWITCH No. 50

Solely specified for
F. J. CAMM 1934 SUPER-SET

Push-Pull Type with special contacts.

2/0

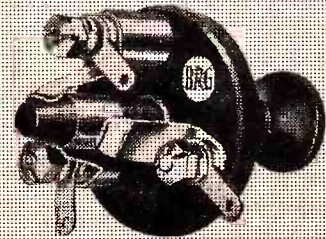

SOLE DISTRIBUTORS OF METAPLEX BASEBOARDS

Specified in the F. J. CAMM 1934 Super-Set and the All-Wave Two.

Dealers are invited to send for latest list of B.R.G. Components and Metaplex Baseboards

BRITISH RADIO-GRAMOPHONE CO. LTD. PILOT HOUSE, CHURCH STREET, STOKE NEWINGTON, LONDON, N.16

Telephone: Clissold 6287-6288

B.R.G. COMPONENTS ARE OBTAINABLE FROM ALL DEALERS

In cases of difficulty send for name and address of nearest Stockist.



CONSTRUCT THE WESTINGHOUSE A.C. MAINS SUPERHET

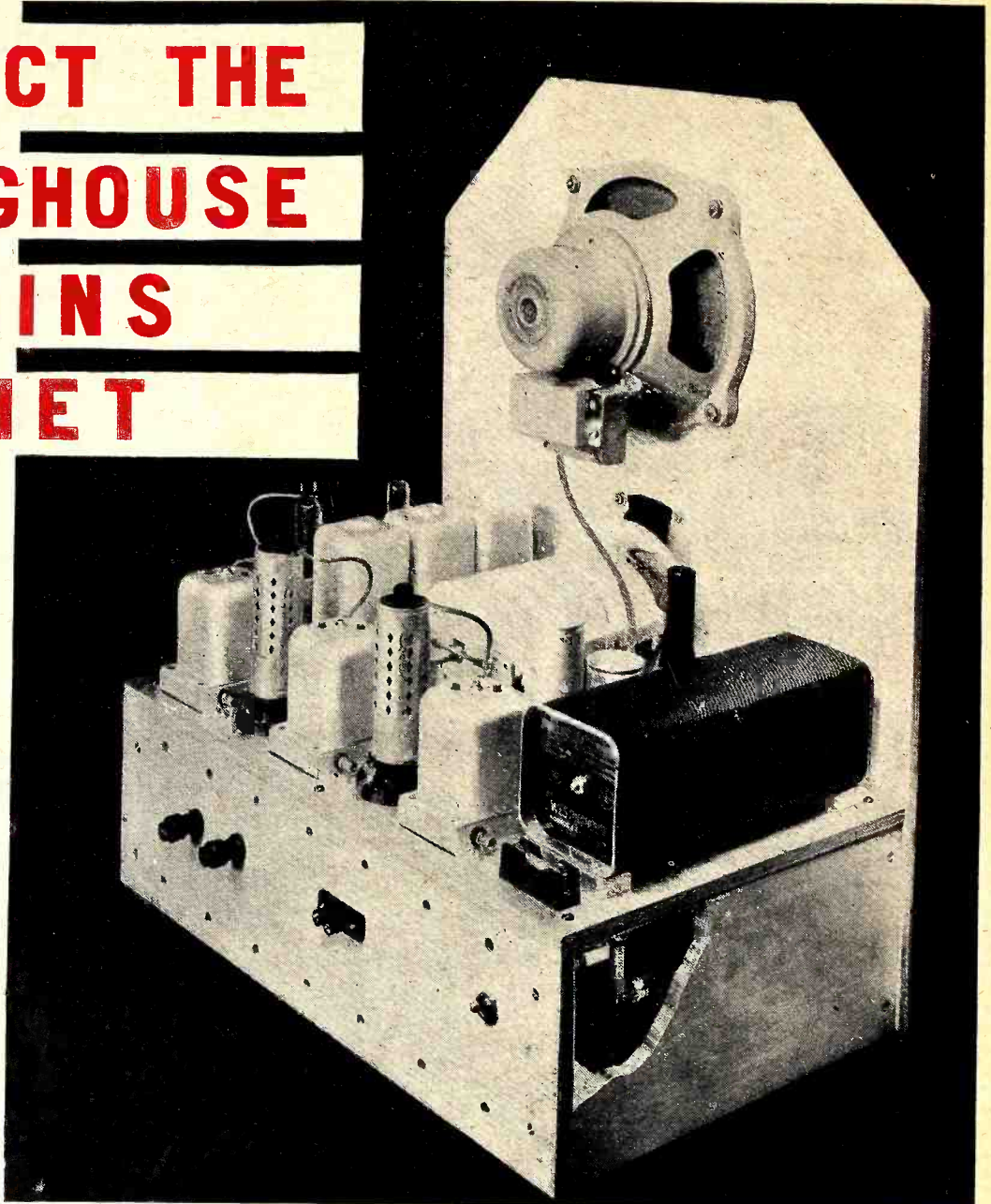

The first ALL METAL
A.C. Mains Superheterodyne
Receiver designed for
the Home Constructor.

Some of the special features are

- ★ WESTECTOR linear second detector
- ★ WESTINGHOUSE METAL RECTIFIER
for high tension supply
- ★ CATKIN VALVES 3 watts output
- ★ Automatic Volume Control
- ★ SINGLE DIAL TUNING
- ★ BAND PASS PRESELECTION
- ★ NOVEL RADIOGRAM ARRANGEMENT—
last I.F. valve used as L.F. amplifier on Gramophone

SEE IT ON STAND 32

Full size diagrams and complete constructional details will be on sale on the Stand, or post free 1/-.

THE WESTINGHOUSE BRAKE & SAXBY SIGNAL CO., LTD.,
82, York Road, King's Cross, London, N.1.

COUPON

Please send me diagrams and complete details of the new Superhet for which I enclose 1/-.

Name

Address

.....

.....

.....

PRA. 26/8/33

STAND TO STAND SHOW REPORT
(Continued from page 822)

items as the pre-set condenser, fixed condensers chokes, etc., were extremely popular during the past season, but several new ones have now appeared. These included a new toggle switch and iron-cored tuning coils. Complete mains apparatus, and an electric soldering iron, selling at a really competitive price, also gave an idea of the extent to which Sovereign Products have now developed their manufacturing processes. The latest product was, of course, the permeability tuner, which removes completely the necessity for a variable tuning condenser. It is a forecast of the future.

STAND No. 102
BOWYER LOWE CO. & A. E. D., LTD., Diamond Works, Coombe Road, Brighton.

The principal feature on this stand was the revised edition of the well-known pick-up, and this was ably backed up by the volume controls and other types

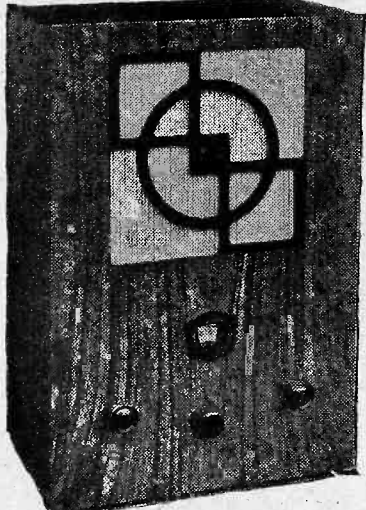

A neat and moderately-priced receiver by Slektun.

of wire-wound resistances. The Mark IV pick-up is a magnificent de-luxe affair costing 42s., and it gives a remarkable output.

STAND No. 103
TANNOY PRODUCTS, 1-7, Dalton Street, W. Norwood, S.E.27.

NOT every visitor to the Exhibition wants a 100-watt amplifier in the home, but some of the amplifiers shown on this stand have been developed for public address work and social functions such as sports meetings, dances, etc. This firm does a most extensive business in this type of catering and at many open-air functions the familiar van and loudspeakers may be seen around the field. Smaller amplifiers were also seen and these will enable really ideal gramophone reproducers to be built up suitable for high quality domestic purposes.

STAND No. 104
AMPLION (1932), LTD., 82-84, Rosoman Street, London, E.C.1.

A NEW permanent magnet moving-coil speaker unit of the midget type attracted a considerable amount of interest. Known as the "Sonette" it sells at a low figure and due to its small dimensions it is very suitable for use in the now-popular ultra-small sets. Besides this item a number of new Class B components were to be seen as well as a binocular H.F. choke having extraordinarily good characteristics.

STAND No. 105
VINCE'S DRY BATTERIES, LTD., Lion Works, Garford Street, E.14.

PRACTICALLY every type of dry battery was represented on this stand, and the trade mark "Lion" served to focus the attention. The exhibit was very well staged and proved attractive in showing how many different types of H.T. battery can be required and are marketed by a firm who concentrates on this type of manufacture. The special Class B batteries will no doubt find a ready market during this season.

STAND No. 106
HELLESENS, LTD., Morden Road, S. Wimbledon, S.W.19.

THE well-known batteries have now been improved and they appeared with the new name "Hi-Life." Practically every type of battery was seen here, and the super types, especially designed for Class B receivers, etc., were one of the main attractions.



A public-address system by Tannoy Products. The neat microphone and stand may clearly be seen.

STAND No. 107
NEW LONDON ELECTRIC WORKS, LTD., East Ham, E.6.

AS was to be expected, aerial equipment formed the main portion of this exhibit, and a new production, known as Varial, formed the principal feature. This is a new type of variable aerial. In addition, different types of wire for indoor or outdoor use, and special ingenious indoor aerial were also featured.

STAND No. 108
THE HIGH VACUUM VALVE CO., LTD., 113-117, Farringdon Road, E.C.1.

SOME interesting valves were seen on this stand, and they included a new Class B valve, as well as various different types of battery valve. The PX 230 is a super-power output valve, delivering a very large output. These valves are all very reasonable in price, the Class B valve, for instance, costing only 10s. 6d., and the above-mentioned super-power valve costing 7s. 6d.

STAND No. 109
GOODMANS, 69, St. John Street, Clerkenwell, E.C.1.

WHILST loudspeakers formed the subject of this firm's exhibits, the special shallow car-type loudspeaker was probably the principal item. This has the chassis formed as part of the entire magnet system and results in great electrical strength as well as compactness. Several other interesting types were also seen.

STAND No. 110
VULCO DRY BATTERY CO., LTD., Vulco Works, London, N.19.

THE large range of batteries shown on this Stand attracted great attention. Some of the methods which were incorporated in the manufacturing processes proved of interest, and the new Stag batteries will, no doubt, be purchased during the forthcoming season by many battery users.

STAND No. 111
GRAFTON RADIO CO., 79, Lots Road, Chelsea, S.W.

THE Television receiver on this stand was one of the neatest combined sound and vision receivers which we have yet seen. Although so small it provides a really large television image, and the combined receivers are very well accommodated in the cabinet. The mirror-drum is utilised as the television system. Several other interesting receivers were seen.

STAND No. 113
SONOCHORDE REPRODUCERS, LTD., 1, Willesden Lane, N.W.6.

THE first Midget speakers were seen on this stand, and they were certainly most interesting items. To those who had previously never seen a midget speaker, they appeared more like scale models, but they are capable of a really hefty output, and the association of a field winding on such a speaker is certainly a clever piece of design work. All the speakers in the comprehensive Sonochorde range were well set out, and the centralizing device proved very interesting.

STAND No. 115
BULLPHONE RADIO, New North Road, Barking-side.

A.C. Mains Units, D.C. Mains Units and Loudspeakers formed a major portion of the Bullphone exhibit, and the new double cone speaker was one of the principal novelties. Among the many smaller components were the R.C. coupling Unit and the L.F. transformers. A dual-range coil was also shown, and this sells at the low figure of 4s.

STAND No. 116
JACKSON BROS. (LONDON), LTD., 72, St. Thomas Street, S.E.1.

IN addition to the well-known types of variable condenser, some interesting new dials were featured by Messrs. Jackson. These are of the new full-vision type, and provide very accurate readings. The most novel dial is that which incorporates a travelling pilot-light and so prevents any mis-reading due to shadows, etc. A special short-wave dial with two separate ratios was also seen, and this costs 6s. 6d., and provides the ratios of 8 to 1 or 150 to 1.

STAND No. 117
BAIRD TELEVISION, LTD., 133, Long Acre, W.C.

THE large number of wireless enthusiasts who now take an active interest in television found enormous pleasure in examining the very latest kit of parts for the home-constructed television display here. The kit was of the mirror drum type from which

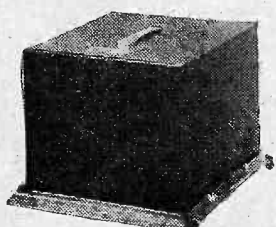

a fair-sized picture can be obtained even in a normally-lighted room. An interesting variety of older types of television apparatus could also be examined.

STAND No. 118
BRITISH RADIOPHONE, LTD., Aldwych House, W.C.2.

A FEATURE of unusual interest on this stand was the model of the PRACTICAL WIRELESS "1934 Superset," which aroused widespread interest at Olympia and which will, no doubt, be extensively built during the coming season by thousands of home constructors. This set employs the latest model British Radiophone three-gang condenser which, although extremely compact, is guaranteed accurate to within quite negligible limits. Other types of variable condensers and a range of the latest "full-vision" tuning scales were also features of more than passing interest.

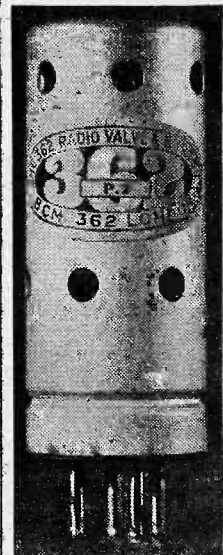

The first all-metal battery valve. This is a product of the 362 Valve Company, and is made under a patented process.

A new and excellent gramophone pick-up was also on view and this attracted much attention in view of its many up-to-date features and almost "straightline" response. Other interesting components, included fixed condensers, Class B components, and a range of complete "Radiopak" tuning units. Incidentally, it might be mentioned that Messrs. British Radiophone were first to introduce the latter kind of unit to the market, so there is no wonder that it received a considerable amount of attention by home constructors visiting the Show.

STAND No. 119
GARRARD ENGINEERING & MANUFACTURING CO., LTD., 17, Grafton Street, W.1.

AS manufacturers of the well-known gramophone motors, the stand was arranged to display to the best advantage the latest type of automatic gramophone unit. This incorporates not only a neat electric motor, but also an ingenious record changer. It is built as a complete unit, and may instantly be fitted to an existing gramophone. In addition, the pick-up, with or without volume control was also shown.

STAND No. 120
HACKER, H., & SONS., Perfecta Works, Ray Lea Road, Maidenhead.

A RADIO-GRAM employing twelve valves was the centre of this stand, and the manufacturers hold out great hopes from this circuit. It should certainly attract attention for some time to come, and it was ably backed up by the several other ingenious Hacker receivers.

STAND No. 121
EDGE RADIO, LTD., Bolton, Lancs.

ALTHOUGH newcomers to the radio industry, the products of this firm did not by any means betray the fact. The four-valve Class B receiver was a very high-class set, and the radio-gramophone version, costing 21 gns., was certainly a de-luxe instrument. Matched speakers were incorporated in the A.C. mains super-heterodyne, and this instrument is of such a design that it is not intended to make it on mass production lines for general stock. It will only be made to order.

STAND No. 122
BULGIN & CO., LTD., Abbey Road, Barking.

ONE could have spent a whole day on this stand, had time permitted, for there were components of nearly every conceivable pattern well displayed. Some of the newer lines probably proved most attractive, and in this respect special mention should be made of a really beautiful novelty known as the "Decorative Signal Lamp." This is an illuminated statuette, which can be stood on top of the wireless set and wired up to indicate whether the set is switched on or off. It is made in four different patterns, all of which were much admired.

The new "Mechanical Colour-Change Wavelength Unit" also came in for a good deal of well-earned praise. Of the smaller components, the "Controlatone" proved to be a popular exhibit; this unit consists, of course, of a fixed condenser and variable resistance mounted together in a bakelite shell. It serves as an excellent tone control when connected across the speaker terminals. It may also be joined in parallel with the primary winding of an L.F. transformer.

(Continued overleaf)

STAND TO STAND SHOW REPORT

(Continued from previous page)

STAND No. 123

OLDHAM & SON, LTD., Denton, Manchester.

THE Lively-O was the keynote of this stand, and the vast range of accumulators for all purposes was a most impressive show. The patented indicator, showing when the cell requires recharging, is a great feature of these batteries, and will save much trouble due to the over-running which many inexperienced listeners give to their L.T. battery.

STAND No. 124

BRITANNIA BATTERIES, LTD., 233, Shaftesbury Avenue, W.C.2.

AN extensive range of the well-known "Peritrix" batteries was shown on this stand, and particular attention was focused on the new large-capacity types specially introduced for Class B receivers. Special attention was drawn to the unique feature of "Peritrix" dry batteries, namely, that they do not contain sal-ammoniac, and have thus a longer shelf life than batteries of the more usual type.

STAND No. 125

CELESTION, LTD., London Road, Kingston-on-Thames.

THE different types of matched dual speakers attracted considerable attention on this stand, whilst the latest cabinet designs were appreciatively examined. Additionally, however, the latest pick-up was a feature of interest and was prominently displayed.

STAND No. 126

GROSVENOR ELECTRIC BATTERIES, LTD., 2-3, White Street, Moorgate, E.C.2.

A SPLENDID range of batteries was shown on this stand, and the patented method employed by the firm tends to prolong the life of the battery to quite an appreciable extent. The new types of heavy-discharge battery, produced especially for Class B types of receiver formed one of the additions to the existing range.

STAND No. 127

PARTIDGE, WILSON & CO., Davenset Works, Evington Valley Road, Leicester.

THE numerous items for mains requirements were a great feature on this stand. The name Davenset is, of course, very well-known in this connection, and from the smallest mains transformer, to the largest charging equipment, the apparatus exhibited was of high quality.

STAND No. 128 and 129

WHITELEY ELECTRICAL RADIO CO., LTD., Radio Works, Victoria Street, Mansfield, Notts.

THE Microlode was probably the high-spot of the exhibition. Although so reasonable in price, a speaker incorporating the features which form the basis of the Microlode was bound to attract attention, and we venture to suggest that this will be a really star seller during the coming season. In addition to this model, however, the other W/B speakers created intense enthusiasm, especially in respect of the cabinet models.

STAND No. 202

OSBORN, C. A., Regent Works, Arlington Street, N.1

A REALLY splendid range of cabinets was seen here, and the new radio-gram. cabinet represents really splendid value. The great point is, of course, that these cabinets are obtainable in an unassembled form for those who would like to assemble the cabinet at home and carry out the finishing process of polishing. In addition, the cabinets are obtainable in an unassembled form, but unpolished, or absolutely complete and polished.

STAND No. 203

SHAWNDEL TOOL CO., 99, Regent Street, W.1

INGENIOUS coil-winding machines formed the main portion of this firm's exhibit, and although they interested the manufacturer primarily, they gave the lay visitor some idea of the ingenuity displayed in the machinery which is used for winding the various types of coil which are used in wireless receivers.

STAND No. 204

BRITISH PIX CO., LTD., Pix House, 118, Southwark Street, S.E.1.

A SPECIAL feature on this stand was the display of the famous "Pix" invisible aerial, which consists of an adhesive insulated strip that can be secured round the wall of a room to provide an excellent indoor aerial. Being made in a variety of colours, it can be made so to harmonise with the surroundings that it becomes almost invisible. Additionally, there was the well-known "Pix" selectivity device which is connected in series with the aerial lead-in. A full range of valves fairly recently introduced by this firm was also to be seen, and was examined with interest.

STAND No. 205

GRAHAM FARISH, LTD., Mason's Hill, Bromley, Kent.

IT was interesting to find that this well-known firm of wireless manufacturers have now turned their attention to tuning coils, and these were shown in types suitable for every kind of receiver. Another entirely new and extremely good component was the "Zelos" condenser. This is an air dielectric one built in a particularly rigid steel frame and having a readily adjustable spindle which can be made to project any distance to suit alternative operating dials; it also

enables any number of condensers to be ganged together with the greatest of ease.

Readers of PRACTICAL WIRELESS will be interested to note that this condenser was used in one of our "Show" sets, the "All-Wave Two."

Yet another new Graham Farish line is a complete kit of parts for an efficient aerial-earth system. Known as the "Aeroficient" aerial outfit, this comprises a length of aerial wire, lead-in tube, "Gard" lightning arrestor, a "Fit" earthing device, and the necessary insulators. Selling at 6s. 6d., this outfit was a very popular line at the Show.



The Camco Oxford Pedestal Cabinet.

STAND No. 206

RADIOLAB MANUFACTURING CO., Sandridge Works, St. Albans.

THE ingenious testing set manufactured by this company was certainly worthy of a few minutes' careful examination. It is built into a neat case and, in addition to the panel which contains meters, sockets, terminals, etc., a space is left at one end for the accommodation of soldering iron, pliers and other tools, which might be necessary to the service man or the keen experimenter.

STAND No. 207

BRITISH EBONITE CO., LTD., Nightingale Road, Hanwell, W.7.

AN extremely wide range of coil formers and small ebonite parts were shown on this stand, and these were favourably criticised by thousands of amateurs and experimenters who are interested in the constructional side of wireless. There were, of course, a large number of panels in various finishes.

STAND No. 208

RIST (1927) LTD., A., Wavney Works, Lowestoft.

THIS stand was principally of interest to the manufacturer, since the exhibits consisted chiefly of wires of all kinds, battery cords for commercial receivers, and small bakelite parts.

STAND No. 209

BRITISH THOMSON-HOUSTON CO., LTD., Crown House, Aldwych, W.C.2

ELECTRIC gramophone motors were the items of interest here. All the last year's models (which are to be continued during the new season) were shown.



Another neat Bulgin signal device

These included the "Truspeed" with synchronous mechanism, the "Golden Disc" induction type, and the very popular "Universal." An entirely new model, the "Truspeed D.C.," was also shown. This is suitable for use on 100 or 200-volt D.C. mains, and sells at 67s 6d.

STAND No. 210

SEABROOK BATTERIES, LTD., 205-207, Bedford Avenue, Trading Estate, Slough, Bucks

SEABROOK wireless batteries in all types for both H.T. and G.B. were the main exhibits on this stand. A new pocket-lamp battery, fitted with wireless terminals, was also shown.

STAND No. 211

MAINS POWER RADIO, LTD., Broadway Works, Eastern Road, Rbmford, Essex.

A WIDE variety of mains units and battery chargers formed the exhibit here. The units were of attractive design and appearance, being enclosed in pressed steel containers which were bronze finished. The full range of eliminators shown covered all A.C. and D.C. requirements and many of the A.C. models were also fitted with trickle chargers.

STAND No. 213

SOUND SALES, LTD., Tremlett Grove Works, Junction Road, N.19.

THE most noticeable exhibit on this stand was a new M.C. speaker incorporating an entirely new system of cone suspension. This was in two forms, one of which was for use as a speaker purely and simply, whilst the other was intended for converting an ordinary battery receiver to a class B instrument.

Cathode ray television apparatus and a wide range of mains transformers were additional exhibits of interest.

STAND No. 214

THE 362 RADIO VALVE CO., 415, Mare Street, Hackney, E.8.

THE first all-metal battery valve formed the centre of attraction on this stand, and some of the examples of valve construction served to show how the wireless valve is made up. Although at the moment only the more popular two-volters are being produced by this company, we understand that in the forthcoming season several mains valves will be put on the market.

STAND No. 215

CHORLMEY RADIO ELECTRIC, LTD., Arras Mills, Rochdale Road, Manchester.

A NUMBER of "Triotron" Class B components were in evidence on this stand. One of the most interesting was a speaker complete with a neat Class B unit. A separate Class B unit assembled in a bakelite case also attracted attention.

STAND No. 216

PETO AND RADFORD, 50, Grosvenor Gardens, S.W.1.

A COMPLETE range of "Dagenite" accumulators in both H.T. and L.T. types figured most prominently on this stand. The rest of the exhibits consisted of special accumulators of various patterns for use by service engineers and charging stations.

STAND No. 217

TELEPHONE MANUFACTURING CO., LTD., Hollingsworth Works, West Dulwich, S.E.21.

THE new "Hydra" condensers were one of the principal attractions on this stand, and although these have in the past been well-known they have been of foreign origin. The new arrangements entered into with the German company will now enable these condensers to be manufactured in this country by the Telephone Manufacturing Company, and in addition to the types which were exhibited it is proposed to manufacture the complete range required for modern wireless practice.

STAND No. 218

BIRMINGHAM SOUND REPRODUCERS, LTD., Claremont Road, Old Hill, Staffs.

HIGH-POWER amplifiers for halls and public address work were the chief feature and the "Dual Path Console" delivering an output of either 30 or 60 watts attracted considerable interest. Other exhibits included an eight-valve superhet receiver, and interesting band-pass wireless chassis and a full range of mains transformers and chokes.

STAND No. 219

LAMPLUGH RADIO, LTD., 177, Foleshill Road, Coventry.

THE "Timpani-Tone" speaker baffle was the centre of this exhibit. This is an unusual type of baffle, incorporating several new features, the cone being of metal instead of the more usual paper. A very full range of "Silver Ghost" speakers and "Farrand" inductor speakers were also shown in conjunction with a new "Antistat" aerial interference eliminator unit.

STAND No. 220

AERIALITE LTD., 10, Amber Street, and 17, Manover Street, Manchester.

THE outstanding exhibit on this stand was a new aerial wire, known as the "Levenstrand" which consists of eleven strands of copper wire insulated with a double covering of the special "Aerialite" material. Undoubtedly the most interesting point in connection with this aerial wire is that every sample is supplied with a £200 insurance against lightning.

(Continued on page 830)

**THE W.B. TYPE P.M. 4A.
"MICROLODE" LOUD-
SPEAKERS**

An Entirely New and Clever Departure
in Loud-speaker Design.

THIS speaker has been carefully designed to eliminate one of the greatest bugbears to the amateur and home constructor—that of accurately matching the output stage of the receiver to the speaker. This latter difficulty has recently become most acute, because of the extended use of Class B and Q.P.P. amplification, with the result that with the ordinary types of speaker several different output transformers would be required to enable one to match up the speaker to more than a single receiver.

OUR COMPETITION!

Closing Date Aug-31st. There is still time to enter for our competition. See page 705 of last week's issue.

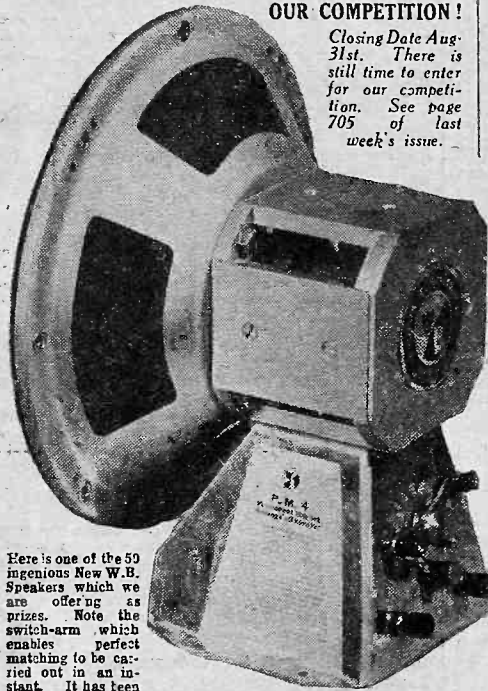

Here is one of the 50 ingenious New W.B. Speakers which we are offering as prizes. Note the switch-arm which enables perfect matching to be carried out in an instant. It has been specially selected for F. J. Camm's 1934 Superst.

Messrs. Whitley Electrical Co. have removed this difficulty entirely by introducing the "Microlode." This is actually a new and excellent speaker with the addition of a universal output transformer with which almost any ratio can be obtained in an instant, and any output stage (whether it should consist of an ordinary power valve, a pentode, a Class B or two triodes or pentodes in Q.P.P.) can quickly and accurately be matched to the speaker. Three connecting terminals are provided and there are two brass arms which can be moved over nine tapping studs connected internally to the transformer windings. When the speaker is to be used with a power or pentode valve the outside terminals only are used and by suitably adjusting the tapping arms the necessary output ratio can be obtained. All three terminals are used with a Class B or Q.P.P. set, in which case the centre one is joined to H.T. positive in the usual way. Again, by moving the arms, any required ratio can be chosen in a second. A small chart is attached to every speaker to indicate the correct tapping points for various ratios and the proper one can easily be calculated when the impedance of the output valve is known, since the speech coil impedance is given as 3 ohms.

BULGIN

BRITISH MADE



RADIO PRODUCTS

PROOF OF LEADERSHIP

Evident in every page of the wonderful New Catalogue No. 153 (N) now ready for distribution. Bulgin have spared no effort this year to present to wireless constructors the largest and most up-to-date range of quality products ever offered by any component manufacturer. Contains full details of

Sixty-Four Price Reductions

and a new

28-p. **TEXT BOOK & MANUAL**, giving valuable technical information and diagrams.

Also full information on

Numerous Brand-New Lines

including New Switches, Remote Controls, H.F. and L.F. Chokes, Class B Components, Decorative Signal Lamps, Bakelite Knobs, Anti-interference Units, Colour Change Units, Valve Holders, etc., etc.

ASK FOR CATALOGUE No. 153 (N).

Enclose 2d. Postage.

A. F. BULGIN & CO., LTD., ABBEY RD., BARKING.

London Showrooms: 9-10-11 Cursitor St., Chancery Lane, E.C.4

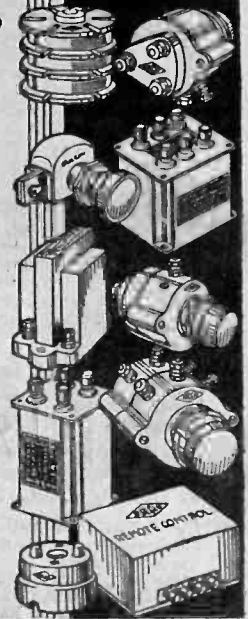
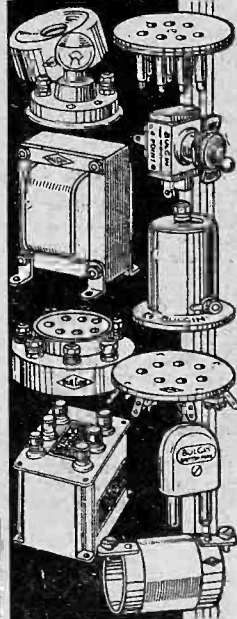

Send for **NEW 80 page Catalogue & Manual**
269 Illustrations 50 Diagrams Enclose 2^d Postage

What is ENGINEERING OPPORTUNITIES
250 pages

"ENGINEERING OPPORTUNITIES" is a 250-page Handbook that has been prepared after years of patient search into the possibilities of various Engineering Careers. It shows clearly and definitely the way in which you may carve out a successful career in your chosen branch of Engineering, irrespective of your age, education or experience. Among a host of other things, it outlines Home-Study Courses in all branches of Civil, Mech., Elec., Motor, Aero., Wireless and "Talkie" Engineering, and shows the way to pass A.M.I.C.E., A.M.I.Mech.E., I.E.E., A.M.I.A.E., M.I.M.T., G.P.O., Matriculation, Civil Service and other Examinations. "ENGINEERING OPPORTUNITIES" is a unique Handbook that you should most certainly read. And for your copy to-day.—FREE of any cost.

British Institute of Engineering Technology,
320, Shakespeare House, 29/31, Oxford Street, London, W1.

MAKE A RADIOGRAM OR GRAMOPHONE

Our 64-page Illustrated List for 3d. will tell you how, and show you a great variety of Spring and Electric Motors, Turntables, Tone Arms, Soundboxes, Horns, Loudspeakers, Pickups, Cabinet hinges, lidstays, door-locks, knobs, handles, and catches. Also Receivers, Kits, complete Gramophones, accessories, Springs, needles, and repair parts at lowest prices, wholesale or retail.



The Regent Fittings Co., D 235
(Est. 30 years), 120, Old Street, London, E.C.1.

MICROFU
Specified For The ALL-WAVE TWO

FUSE 6d. HOLDER 6d. Complete 1/-
The Pure Gold Film of the Microfu "blows" under overload before the wire has even time to get warm, and guarantees full protection. Absolutely reliable. 100% British.

Folder "N" gives full technical details

MICROFUSES, Ltd., 26, Clerkenwell Road, E.C.1.
Telephone: Clerkenwell 4049.

CHARGING WITHOUT MAINS

Thousands are charging their own accumulators, why don't you? "TONIC" trickle-charger Kits keep two-volt accumulators fully charged. Ideal for remote districts. From 7/-, postage 3d. Full particulars, stamp.

WILLIAMS, Netherend, Cradley, Nr. Birmingham.

EASY TERMS

- Everything Wireless supplied on lowest terms. Prompt delivery guaranteed. Price list free on request.
- NEW COSSOR, MODEL 341, MELODY MAKER Cash Price £8/7/6. With Order And 11 monthly payments of 11/4. → **15/-**
- NEW BLUE SPOT 99 PERMANENT MAGNET MOVING-COIL UNIT. With Order "The most popular Moving-Coil Unit at the Radio Exhibition." Cash Price £2/19/6. And 11 monthly payments of 5/6. → **5/-**
- "CLASS B" KIT, consisting of Multitone driver trans. and output matching choke, Cossor 240 B valve and special valve holder. Free instruction book with every order. Cash Price £1/13/3 or 6/- with order and 6 monthly payments of 5/6.
- 12 EXIDE W.H. HIGH-TENSION ACCUMULATORS (120 volts, 5,000 M.A.). The cheapest and best High-Tension Supply where Mains are not available. Cash Price £8/15/- And 11 monthly payments of 7/- → **7/-**
- ALL CARRIAGE PAID. QUOTATIONS BY RETURN.
- To avoid delay will customers kindly send first payment with order!

THE LONDON RADIO SUPPLY COMPANY
11, OAT LANE · NOBLE STREET · LONDON, E.C.2

MAGNUM AUTO-"B" METAL CHASSIS
FITTED WITH 3 TERMINAL STRIPS, GREY CELLULOSED FINISH AS SPECIFIED BY THE DESIGNER

Have you had particulars of PRICE Magnum Short-wave Adaptors, and list of latest short-wave stations? Free on request. **5/6**

BURNE JONES & CO., Ltd., "Magnum" House, 298, Borough High St., London, S.E.1. Tel.: Hop 6257 & 6258

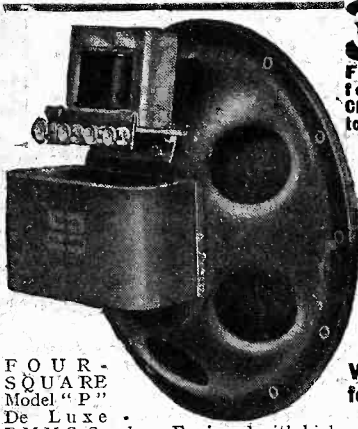

35/-
Fitted Trans-
former for
Class B, Pen-
tode, Power or
Super Power.

FOUR-
SQUARE
Model "P"
De Luxe

P.M.M.C. Speaker. Equipped with high cobalt content Magnet. Employs entirely new system of Cone mounting, eliminating all undesirable resonances. Extreme sensitivity with full Bass response gives performance in the highest class.

Write NOW
for New List.

**STAND NO.
109**

OLYMPIA, AUG. 15 to 24

FOUR-SQUARE Auto P.M.M.C. Speaker for portable receivers. Unique design embodies entire chassis in magnetic system. Diam., 6 1/2". Depth, ONLY 2 1/2". Price, including Universal Ratio Transformer, 27/6.

GOODMANS

69, ST. JOHN ST., E.C.1.
Telephone: Clerkenwell 3838 & 3839

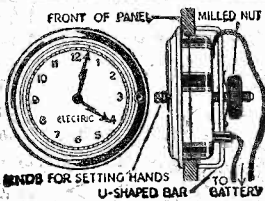

**FIT THIS
ELECTRIC
CLOCK
TO YOUR SET!**
NO MAINS NEEDED!
KEEPS CORRECT TIME!
NO WINDING!

Works off small battery lasting 12 months, or can be plugged into G.B. battery without affecting reception. Uses practically no current. Fits into hole 3 1/2 in. dia. in any panel up to 3 in. thick. Easy to fit—no screws required. Only 1/2 in. from front of panel to back of case. Swiss movement. Hands set from front. Nickel-plated bezel. Useful addition to any set.

12/6
COMPLETE WITH BATTERY
POSTAGE 6D

**THE ELEMENTS
OF WIRELESS**

By RALPH STRANGER

This book is indispensable to everybody who wants to understand the working of wireless receivers. The author, who has the remarkable gift of explaining highly technical matters in perfectly simple language, starts with elementary principles and covers the whole field of wireless reception, both from the theoretical and practical points of view.

Obtainable at all Booksellers, or by post 3/9 from George Newnes Ltd., 8-11, Southampton Street, Strand, London, W.C.2.

3/6

STAND TO STAND SHOW REPORT

(Continued from page 828)

STAND No. 221
BRIDGER & CO. (R. O.), No. 4, Factory, Shelford Place, Stoke Newington, N.16.

A SERIES of "Grantona" speaker cones occupied the whole of this stand and it was amazing to observe, how many different cones were available. The "Grantona" cones are of special seamless construction and are being produced in tremendous quantities to meet the requirements of the trade.

STAND No. 222
ELECTRICAL MEASURING INSTRUMENT CO., LTD., 55, Carrington Street, N.W.1.

A COMBINED testing instrument, known as the "Set Analyser," was the most prominent exhibit on the "Emco" stand, but numerous other measuring instruments and meters, made under the trade names of "Emicol" and "Wates," were also to be seen.

STAND No. 223
MAGNACORE, LTD., Magnacore Works, 85, Alsen Road, Holloway, N.7.

AN extensive range of transformers of both mains and L.F. types, including some newly-introduced Class B components, were displayed. A number of neon signs, intended for use by dealers, were also being demonstrated.

STAND No. 225
THE 362 RADIO VALVE CO., LTD., 415, Mare Street, Hackney, E.8.

THE most interesting exhibit here was an entirely new battery valve, known as the "Toledo," made in a tubular metal sheath. The valve is said to be practically unbreakable and is of small dimensions.

A full range of glass bulb valves, including S.G. power, Class B and rectifiers were also shown.

STAND No. 228
VANDERVELL, C. A., LTD., Well Street, Birmingham.

A VERY complete range of batteries was shown here, although there was little to see in the way of new designs. The NGM5 was a new season's production and represented splendid value at 9s. 6d.

STAND No. 229
ADEY PORTABLE RADIO, 99, Mortimer Street, Regent Street, W.1.

PORTABLE sets at all prices from £3 17s. 6d. to £15 15s. were shown here, and there was obviously a type for every need. A so-called "Self-coupling" valve was also on view which the makers claim has considerably improved the effectiveness of the "Radio-Hat" used by the police in many parts of the country.

STAND No. 230
ACTON BATTERY CO., LTD., Dorland House, Regent Street, S.W.1.

HIGH tension batteries in three different capacity ratings and sold under the respective names of "Cynthex," "Eltax" and "Gold-Seal," occupied a considerable amount of space on this stand. A range of special "Power-plus" batteries, giving an output of 35 m.a., was also shown and is made for those who require to operate a powerful receiver and who have no mains supply.

STAND No. 231
EGONASIGN CO., LTD., 137, Victoria Street, S.W.1.

THIS stand was of principal interest to traders who require stencil sets for the making of showcards and small advertisements.

STAND No. 232
SINCLAIR SPEAKERS, 49-50, Twyford Street, N.1.

AN extensive range of moving coil speakers at very reasonable prices was on view. Pairs of dual-matched speakers at the attractive price of 56s. were also shown, as well as a chrome steel magnet speaker at 25s.

STAND No. 238
NUVOLION ELECTRICS, LTD., Park Crescent, Clapham Park Road, S.W.4.

MOVING coil loud-speakers comprised the complete exhibit on the Nuvolion stand. The last year's models are being continued and were all on view, whilst two new P.M. models were also shown. The special one-piece seamless cone and speech coil feature was well demonstrated.

STAND No. 240
ELECTRO DYNAMIC CONSTRUCTION CO., LTD., 733b, Old Kent Road, S.E.15.

THE recently introduced high tension converter for use with motor car batteries, and which is specially designed for recessing into the floorboards, was the item of main interest here. It was shown in four alternative types for 6 or 12 volt batteries and with different output ratings.

STAND No. 241
CHLORIDE ELECTRICAL STORAGE CO., LTD., Exide Works, Manchester.

THERE was to be seen a most extensive range of dry batteries of types suitable for every purpose. The high tension batteries are made in various types, known by different coloured triangles, and are suitable for discharge rates from 6 to 20 milliamps. Accumulators of all kinds for fixed and portable sets were also to be seen.

STAND No. 242
MILNES RADIO CO., Victoria Works, Church Street, Bingley, Yorks.

THERE were no new models shown here, but the existing types of H.T. units were well demonstrated. As most readers are aware, the Milnes

units consist of a number of alkaline accumulator cells which are mounted in cases fitted with series-parallel switches which enable them to be charged from the L.T. accumulator.

STAND No. 243
R. C. & WILSON ELECTRIC, LTD., 51, Whitcomb Street, Leicester Square, W.C.2.

ALTHOUGH the collection of exhibits on this stand covered so many different items, the self-feeding soldering iron was probably the most noticeable to the home-constructor. The method of

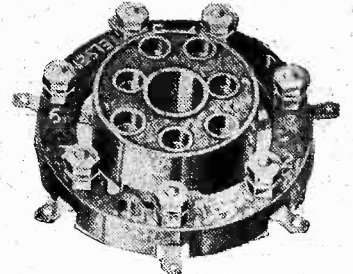

The new Telsen 7-pin valveholder

holding a stick of solder and so leaving one hand free to hold a wire or other item which is being soldered is most ingenious and does not cost a lot of money. At 10s. 6d. for a 60 watt iron, with an additional 3s. for the self-feeding apparatus, this represents a really splendid accessory for domestic use.

STAND No. 244
BOTOLPH RADIO, LTD., 2, Ravenscourt Square, W.5.

A MOST comprehensive range of sets at all prices were arrayed on this stand. They ranged from a simple "Chummy-de-Luxe" 3-valver at 4 guineas to a luxury "Social" model superbet at 40 guineas. The latter is an elaborate piece of furniture embracing not only an efficient receiver, but also a cocktail cabinet and an electric clock.

STAND No. 245
KENSINGTON, LTD., 196, Upton Lane, E.7.

A WONDERFUL variety of wireless cabinets formed the Kensington exhibit, and special prominence was given to a number of floor stands suitable for accommodating table receivers of all the better known makes. Another innovation was a walnut electric playing cabinet for converting any ordinary table receiver into a complete radiogram.

STAND No. 246
FILM INDUSTRIES, LTD., 60, Paddington Street, W.1.

A NEW "Baby" public address equipment took pride of place on this stand. This consists of a moving coil microphone, self-contained battery-driven Class B amplifier and a permanent magnet horn-type loud-speaker. It is claimed that this apparatus is capable of giving clear reproduction of speech over a range of 500 yards.

STAND No. 247
RADIALADDIN, 46, Brewer Street, W.1.

STAND No. 248
TELEGRAPH CONSTRUCTION AND MAINTENANCE, LTD., E. Greenwich.

SPECIAL types of alloy used in the construction of modern transformers formed the principal feature on this stand, and the remainder of the exhibit was principally of interest to the manufacturer.

STAND No. 249
EARL ENGINEERING & ELECTRICAL CO., 132a, Much Park Street, Coventry.

SOME interesting loud-speakers were seen on this stand, and in addition to the more orthodox types of chassis, the newly-patented Earl chassis bracket, upon which is mounted a volume control, formed the main feature.

STAND No. 251
GRIPSO CO., 32, Victoria Street, S.W.1.

VALVEHOLDERS, self-locking tags, connectors and sundry other small items formed the subject of this firm's exhibit and some interesting features were noticed.

STAND No. 252
RAWPLUG CO., LTD., Rawplug House, Cromwell Rd., S.W.7.

STAND No. 253
POWERTONE PRODUCTS, 88a, Cromer Street, W.C.7.

THE interesting portable receivers seen on this stand possessed several novelties, and attracted great attention. The prices were certainly moderate.

STAND No. 254
SHALLESS & EVANS, Tranquil Works, Tranquil Vale, Blackheath, S.E.

A FINE range of mains receivers was seen on this stand, and the method of mounting the parts on the metal chassis left no room for complaint. The all mains 2-valver will no doubt prove one of the leading designs next season, and the Class B battery receiver will enable many listeners to obtain good quality, combined with large power.

TWO NEW MULLARD VALVES

Some Interesting Details Concerning the New High Efficiency Screened Pentode for H.F. Work, and the Class B Valve Produced by the Mullard Factory.—By W. J. DELANEY.

THE screen-grid pentode differs from the ordinary screen-grid valve only by the addition of a third grid, situated between the anode and the screening grid. It is not provided with a terminal, but is internally connected to the cathode. (The valve is, of course, at the moment only obtainable for mains use.) This extra grid acts in a very similar manner to the extra grid in the ordinary L.F. pentode, and, generally speaking, the H.F. pentode may be used in any set at present employing an S.G. valve.

How it Works

In the ordinary S.G. valve the screening grid limits feed back between anode and grid which is due to the inter-electrode capacity. Unfortunately, the valve does not act as it should, and it has been found that in addition to the anode receiving the electron stream from the cathode it emits certain electrons (due, no doubt, to the heat which is generated) and this emission—known as secondary emission—passes back to the screen. The extra grid in the pentode acts as a barrier or trap, and conveys this secondary stream of electrons to earth. Therefore it is apparent that much greater amplification is possible, although it is important to remember that the impedance of the valve is greater than that of an ordinary S.G. valve, and therefore the maximum amplification will not be experienced unless the coupling is of suitable high impedance. It is interesting to note that the amplification factor of the new V.P.4 (which is one of the new Mullard H.F. Pentodes) is 5,000, a figure which has never before been achieved in any type of receiving valve. This valve is of the 4 volt 1 amp type, rated at 200 volts for the anode and 100 volts for the screening grid. The grid bias voltage may be varied between 1.5 and 22 volts in exactly the same manner as a variable-mu S.G. valve to provide perfect volume control. The S.P.4 is a similar valve, but without the variable-mu characteristic and is intended primarily for use as a first detector or frequency changer in a superheterodyne receiver.

The Class B Valve

The Mullard Class B valve is of the one and a quarter watt type, and is fitted with a .2 amp filament. It is therefore justly described as an economy valve and has the additional advantage that the driver valve may be of the ordinary general purpose type requiring an anode current of only 1 milliamp or so. The standing anode current of this Class B valve, when operated at the correct working point, is only 3 milliamps, and on the average signal which is heard from the B.B.C. stations working on maximum volume, the average current of this valve will only approximate 4 milliamps or so. It will be seen, therefore, that the standard H.T. battery may be employed with a receiver using this type of Class B valve, and the drain will be no greater than with a standard power valve.

You know FERRANTI QUALITY



now compare for
PRICE!

Ferranti recently introduced the Class "B" Speaker Amplifier—a complete stage of Class "B" amplification combined with special NEW P.M. MOVING COIL Speaker.*

Its instant and phenomenal success was due in no small measure to the speaker, which affords reproduction of exceptional brilliance and faithfulness over a wide range of frequencies.

This speaker is now available separately in two forms; Model M5, without transformer, and M5T with multi-range transformer to meet all normal needs.

For the thousands of critical listeners who have believed that, hitherto, a low price involved too great a sacrifice in quality of performance, this new Ferranti speaker will prove of exceptional interest.

MODEL M5 without Output Transformer.	MODEL M5T with Transformer suitable for Ordinary Power Valve, Super Power Valve, Pentode, or Class "B."
Price 30/-	Price 37/6

*CLASS "B" SPEAKER AMPLIFIER.
Complete with Valve, 84/-
Without Valve, 70/-

Attractive Modern Cabinet for above **35/-**

It will take its place at STAND No. 74 at Olympia (also Stand No. 38 at the Scottish National Radio Exhibition, Glasgow), along with the full range of the world-famous Ferranti Speakers.

FERRANTI
MOVING COIL SPEAKER

FERRANTI Ltd., HOLLINWOOD, LANCASHIRE
London: Bush House, Aldwych, W.C.2.

SET CRACKLING IS ANNOYING!

IF IT'S YOUR SWITCH



FIT THE "BUSCO" SWITCH

1/0 each
1/3 Post Free.
Patented.

and ensure perfect switch contact! There is no contact point to turn round, and when you "switch on" you have contact like a power switch. They are as cheap as the inferior type, but far superior in operation.

From your local dealer or

BUSBY & CO., LTD. (Patentees)
Dept. P.W., PRICE ST., BIRMINGHAM

Regd.
"EWEBEC"
Trade Mark



The Wonderful New Universal COIL FORMER

Ideal for home constructors. Suitable for all wave lengths. No slotting or drilling required. Make your own coils for the published circuits at half the cost and double the efficiency. Numerous unsolicited testimonials. Complete with instructions and wiring diagrams.

Pat. No. 369735
TRADE ENQUIRIES SOLICITED

Price **1/3 ea.**

Terminals 1d. each. Fixing brackets with screw 1d. 28 D.S.C. wire 2 oz. 1/-.

Full particulars 11d. stamp. Of all good wireless dealers or direct from the Patentees & Manufacturers:

THE EVINGTON ELECTRICAL MANUFACTURING CO., BECKINGHAM ROAD, LEICESTER.



MANY INTERESTING NEW SHORT WAVE COMPONENTS —By EDDYSTONE

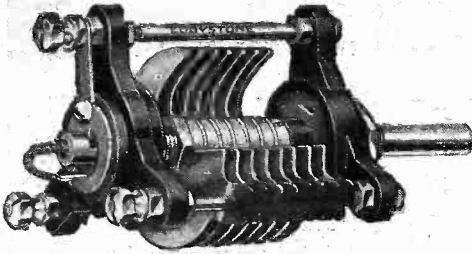

SCIENTIFIC S.W. CONDENSER

A new "EDDYSTONE" production with special Isorex endplates, soldered brass vanes, a screened and insulated non-inductive pigtail and ideal for all short-wave use.

35 m.mfd. ... 6/- 100 m.mfd. ... 7/-
60 m.mfd. ... 6/8 150 m.mfd. ... 7/6



FREQUENTITE SHORT WAVE H.F. CHOKES

This choke is wound on a special Frequentite hollow former and consists of four small honeycomb coils spaced apart so that the self-capacity is exceedingly low.

PRICE 2/9

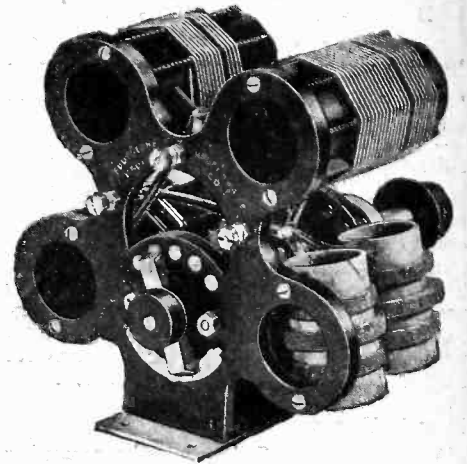

MULTI-WAVE SWITCHED COIL UNIT

This unit gives five wave-ranges, covering from 12/85, 220/540 and 1,100/1,900 metres. It carries three separate windings and forms the perfect tuning inductance for an all-wave set.

PRICE 35/-

NEW COMPONENT LIST NOW READY

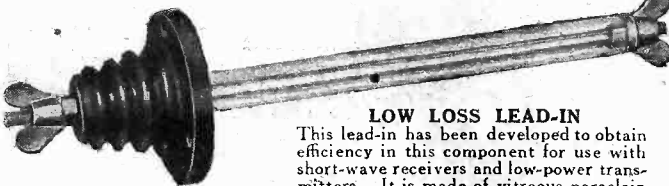

LOW LOSS LEAD-IN

This lead-in has been developed to obtain efficiency in this component for use with short-wave receivers and low-power transmitters. It is made of vitreous porcelain and special glass insulating tube. Overall length 9 in.

PRICE 2/6

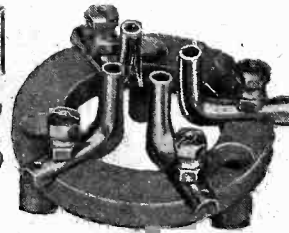

FREQUENTITE LOW LOSS SHORT-WAVE VALVEHOLDER

Frequentite is a new material introduced by "EDDYSTONE" which is far superior to all present insulators for high-frequency work, its characteristics only being excelled by fused Quartz.

4-pin ... PRICE 1/5
5-pin ... PRICE 1/8

EDDYSTONE SHORT WAVE COMPONENTS

Sole Manufacturers—
STRATTON & CO. LTD., BALMORAL WORKS, BIRMINGHAM.
LONDON SERVICE DEPOT—
WEBB'S RADIO STORES, 164 Charing Cross Rd., W.C.2



HOME BATTERY CHARGING

You can charge your accumulators in your own kitchen—quickly, efficiently and cheaply. Simply instal a Heayberd Home Charger,

connect it to the mains and to the accumulator which, in a short time, is fully recharged. Moreover, besides the saving in cost and trouble, your accumulator is always kept at the peak of efficiency—never over or under-charged. Two models are available for A.C. mains. Both are enclosed in handsome metal cases with safety plugs and sockets and are ready for immediate use.

MODEL AO.2 Charges 2, 4 or 6 volt Accumulators at 1/2 amp. **35/-**
MODEL AO.3 Charges 2, 6 or 12 volt Accumulators at 1 amp. **42/6**

Should you prefer to build your own Charger, send for a copy of the Heayberd Handbook which gives details and circuits.

—SEND COUPON TO-DAY— **STAND 16—RADIOLYMPIA**

I enclose 3d. stamps for latest Handbook "Mains Power for your Radio"—packed with new hints and blueprints, etc.

Mr.

Address

Prac.
10, FINSBURY STREET, LONDON,
E.C.2.
One minute from Moorgate Underground Station.



AN INTERESTING GIFT



RESISTORS

To prove the superiority of our "B.A.T." (Best—After—Test) **BRITISH-MADE FIXED RESISTANCES** (1/2, 1, 2, 3, and 5-WATTS) we will send Free and Post-Free to applicants mentioning this Journal, our **2-Colour Art Booklet, 2nd ENLARGED EDITION, 16pp., entitled:**

"OHMS LAW WITHOUT TEARS"

A Complete Treatise, with Circuits, Simple Formulae, Voltage-Dropping and Current-Carrying Charts, "ABAC," worked examples, etc. It tells you all you ought to know about the "mysteries" of Volts, Amps, Resistance Values and Watts-Dissipation as applied to the use of Resistors for Radio purposes. The edition is limited.

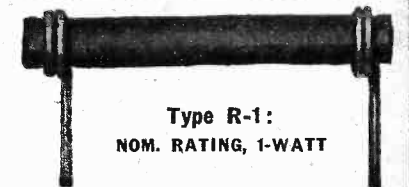

Type R-1:
NOM. RATING, 1-WATT

DOES YOUR SET SUFFER FROM "HUM-M-M"



Do not let your reception be spoiled by objectionable Mains HUM-M-M-M. This can be either reduced to an extremely low level or entirely eliminated, by the use of our Type HD-30 "HUMDINGER" (Regd. No. 503,368). The cost is insignificant—only Half-a-crown. Full instructions, with circuits, with each. Obtainable from all good dealers, or direct in case of difficulty. Explanatory leaflet free on request.

CLAUDE LYONS, LIMITED,
76, OLDHALL STREET, LIVERPOOL.
40, BUCKINGHAM GATE, LONDON, S.W.1.

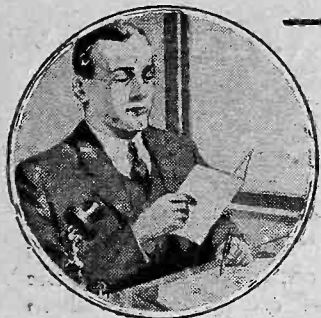

Practical Letters from Readers.

The Editor does not necessarily agree with opinions expressed by his correspondents.

A Reply to "Grid Leak"

SIR,—With regard to the trolley-bus interference in Nottingham, I think it is only fair you should publish the other side of the matter. The reason is not far to seek. No way of suppressing the interference has yet been found which is effective on the long wavelength of our local National Transmitter 5XX. The cost of equipping 106 buses is very high, and as only a partial cure would be effected by the coils at present on the market, it is only natural that the Corporation are waiting for the report of the Government Commission on the subject, and the introduction of a satisfactory stopper coil. When the latter are available steps will be taken.—W. HICKS (Nottingham).

Short-Wave Reports Wanted

SIR,—Our client, Mr. J. F. W. de Kort, of Bragaweg 34, Bandoeng, Java, Dutch East Indies, would be glad to receive reports on the reception, in this country, of his short-wave transmissions. His station works every working day from 23.45 till 00.15 G.M.T. on a wavelength 49.02 metres. Call PK1WK Bandoeng, Java, D.E.I. Announcements are in Dutch and English.—W. R. EVERETT (London, E.C.).

Ferranti Ropes Them In

SIR,—I read in the daily newspapers that millions of listeners were disappointed when an attempt was made to relay a broadcast interview with Amy and Jim Mollison from New York on Friday evening, July 28th.

It may interest you to know that I heard every word of the five minutes' broadcast with perfect clarity, and was astounded and greatly disappointed when the announcer apologized for the distorted conversation and complete fiasco.

My set is a Ferranti 3-Valve Console, 1931 model.

Yours faithfully,
(Mrs.)

[The above is a copy of a letter recently received by Messrs. Ferranti, Ltd. It will probably interest some of our readers.—ED.]

The "Featherweight Four"

SIR,—I wish to thank you very much for the co-operation and interest you have shown in advising and helping me to construct my portable. The Featherweight Four is the best portable I have constructed for good volume and tone, and I can recommend it to anyone desiring first-class results for little cost.—W. GREEN (London, W.C.).

From an Overseas Reader

SIR,—Thanks for your letter, and very many thanks for my copy of Encyclopædia. I must say it is quite beyond my expectations. I was in Perth yesterday and brought my copies of PRACTICAL WIRELESS up to date. It is certainly a practical paper

and worth its weight in gold. I am sending you under separate cover a copy of a wireless paper published in Sydney, as it features a new superhet circuit which I thought would be of interest. I much appreciate the constructional articles in PRACTICAL WIRELESS.—A. H. WILSON (Bassendean, W. Australia).

Neon Lamp Circuits

SIR,—I wonder at some future date if you will kindly let us have some theoretical diagrams of output circuits with a neon lamp arranged for television.—L. J. D. (Earlsfield). (Yes.—ED.)

Double-Diode-Triode Three

SIR,—I am writing to ask if you could publish a version of the double-diode-triode three, and include reaction and a mains energized speaker, and to specify a metal chassis that could be supplied ready drilled. I have never built a set before, but I have been reading PRACTICAL WIRELESS for the past nine months and I think I could construct such a set. It is cheaper to build from components here as the duty on them is only 20 per cent., while it is 70 per cent. on completed receivers. Wishing your paper every success.—PATRICK SHERIDAN (Arva, Ireland).

CUT THIS OUT EACH WEEK.

DO YOU KNOW?

- THAT mica has a dielectric constant of 6 as compared with a value of 1 for air.
- THAT one horse-power is equivalent to 746 watts.
- THAT 300,000 divided by metres will give you the frequency of a station in kilocycles.
- THAT 300,000 divided by the number of kilocycles will give you the wavelength of a station in metres.
- THAT the new short grid-base variable-mu H.F. valves enable a small grid-bias battery to be employed.
- THAT some interesting experiments may be carried out by burying various lengths of wire and employing them as an aerial.
- THAT a meter may be employed to enable you to watch a receiver working on the automatic volume control principle.
- THAT serious results may arise if you overload a fixed condenser.
- THAT overloading a condenser often results in an effect similar to a short-circuit, hence the above remark.

NOTICE.

The Editor will be pleased to consider articles of a practical nature suitable for publication in PRACTICAL WIRELESS. Such articles should be written on one side of the paper only, and should contain the name and address of the sender. Whilst the Editor does not hold himself responsible for manuscripts, every effort will be made to return them if a stamped addressed envelope is enclosed. All correspondence intended for the Editor should be addressed: The Editor, PRACTICAL WIRELESS, Geo. Neaves, Ltd., 8-11, Southampton Street, Strand, W.C.2.

Owing to the rapid progress in the design of wireless apparatus and to our efforts to keep our readers in touch with the latest developments, we give no warranty that apparatus described in our columns is not the subject of letters patent.

BUILD AN EELEX SHORT-WAVE CONVERTOR CHASSIS INTO YOUR NEW SET

—Make it an
All-Wave Receiver

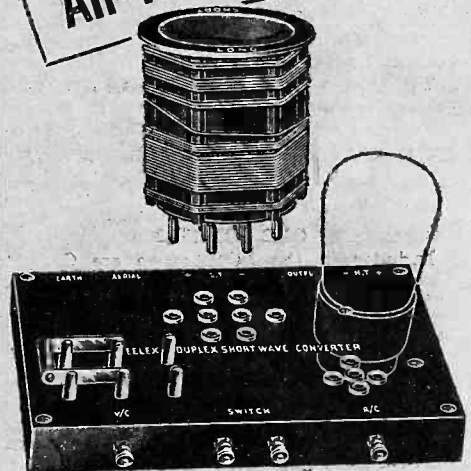

When you build your new receiver, make it an all-wave set by incorporating an Eelex Short-Wave Chassis in the circuit. You will then be able to receive short-wave stations from America, Australia, and other distant countries. There are various types obtainable for Mains or Battery receivers.

DUPLEX CHASSIS

Single valve chassis supplied with Duplex coil. Price £1.15.0. Other components extra.

For further particulars send for free leaflet No. EE6.

J.J. EASTICK & SONS

Eelex House, 118, Bunhill Row, London, E.C.1

'Phone: Metropolitan 0314 (6 lines)

ANNOUNCEMENT

★ to men who want careers in **RADIO**



In the sign language of the Broadcasting Room this symbol means "Announcement."

The I.C.S. Radio Courses cover every phase of radio work, from the requirements of the youth who wishes to make wireless engineering his career to the man who wants to construct and maintain a broadcasting set for his home.

The Radio industry is progressing with amazing rapidity. Only by knowing thoroughly the basic principles can pace be kept with it. Our instruction includes American broadcasting as well as British wireless practice. It is a modern education, covering every department of the industry.

OUR COURSES

Included in the I.C.S. range are Courses dealing with the Installing of radio sets and, in particular, with their Servicing, which to-day intimately concerns every wireless dealer and his employees. The Operating Course is vital to mastery of operating and transmitting.

There is also a Course for the Wireless Salesman. This, in addition to inculcating the art of salesmanship, provides that knowledge which enables the salesman to hold his own with the most technical of his customers.

We will be pleased to send you details of any or all of these subjects. Just fill in, and post the coupon, or write in any other way, stating which branch of Wireless interests you—the information you require will be forwarded at once.

International Correspondence Schools, Ltd.,
Dept. 94, International Buildings,
Kingsway, London, W.C.2.

Without cost, or obligation, please send me full information about the Courses I have marked X

- COMPLETE RADIO
- RADIO SERVICING
- RADIO EQUIPMENT
- RADIO SERVICING AND SALESMANSHIP
- WIRELESS ENGINEERING
- WIRELESS OPERATORS

Name..... Age.....

Address

THE "EELEX" SHORT-WAVE CONVERTER.

An Efficient and Inexpensive Unit with which any S.G. Receiver can Easily and Quickly be Converted into a Short-wave Superheterodyne.

SO far as we are aware, the "Ealex" short-wave superheterodyne converter, made by the old-established wireless firm of Messrs. J. J. Eastick & Sons, was the first instrument of its type to be put on the market. Since its introduction some few years ago it has earned a truly enviable reputation for its sound design and high efficiency. It has been referred to in these pages before, but in view of the wide interest now being shown in short-wave reception by our readers we are taking this opportunity of again recommending it to those who wish to participate in world-wide short-wave reception without going to the expense of a new receiver specially made for the purpose. The unit is particularly compact and is supplied in a neat cabinet of attractive appearance. With the single highly efficient coil supplied, it will cover the two wavelength ranges of from 15 to 30 and from 28 to 60 metres. Actually these two bands include practically every powerful S.W. broadcasting station and every amateur transmitter in the world, but where other ranges are required they can be obtained by the simple process of changing the eight-pin plug-in coil for one of another size which is supplied by the makers at slightly extra cost. Tuning is remarkably easy and even the beginner will find no difficulty in bringing in innumerable short-wave stations.

At the price of 52s. 6d. (less valve) this converter represents a sound investment for anyone wishing to participate in real short-wave reception.

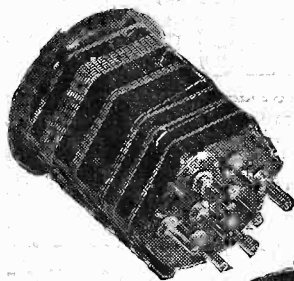

The Ealex short-wave 8-pin reversible coil and base.

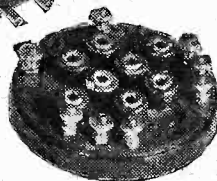

The Ealex short-wave converter chassis.

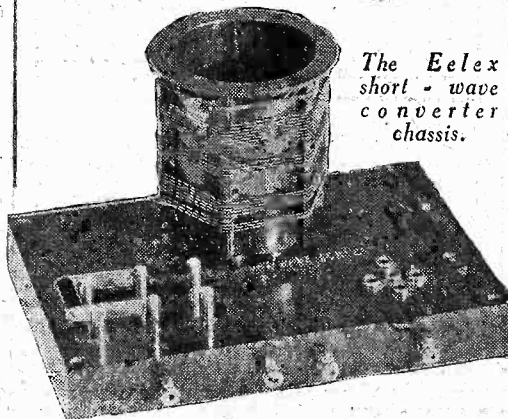

BENJAMIN RADIO PRODUCTS

Constructors realise that the ultimate success of their circuits depends almost entirely on the quality of component used in assembly. Good components made by skilled craftsmen are necessary; components made by engineers who have a thorough grasp of modern Radio requirements.

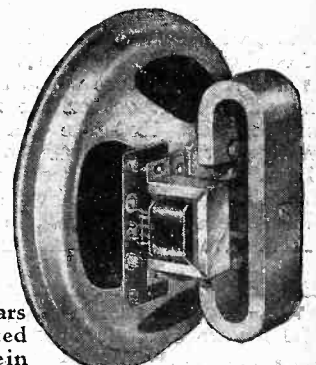

Twenty years accumulated experience in designing Moving-Coil Speakers has gone into the production of Magnavox Speakers, and we believe them to be the best that money can buy. Illustrated is the "Senior" Permanent Magnet Model, Type 252.

Price £3 3. 0.
Standard Model
Type 254.
Price £1 17. 6.

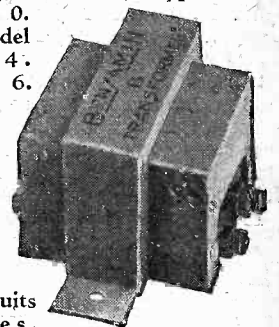

"B" Input Driver Transformer—For use with all types of circuits and valves.

Tapped to give choice of overall ratios 1½ to 1 and 1 to 1. Price 10/6.

The 7-pin Valve holder—Made of highest quality black bakelite with special self-cleaning contacts. Fitted with soldering tags and easy wiring terminals, which are reversible for under-chassis wiring. For Class "B" and other 7-pin valves. Price 2/.

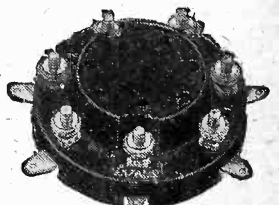

Data Sheets are available giving full particulars of the complete Benjamin range of valveholders, transformers, chokes and Magnavox Mains-energised Speakers.

BENJAMIN ELECTRIC LTD.,
Tariff Road, Tottenham, London, N.17.

Benjamin and Magnavox
Patents and Registered Designs

LET OUR TECHNICAL STAFF SOLVE YOUR PROBLEMS

REPLIES TO



QUERIES and ENQUIRIES
by Our Technical Staff

If a postal reply is desired, a stamped addressed envelope must be enclosed. Every query and drawing which is sent must bear the name and address of the sender. Send your queries to the Editor, PRACTICAL WIRELESS, Geo. Newnes, Ltd., 8-11, Southampton St., Strand, London, W.C.2.

The coupon on this page must be attached to every query.

SPECIAL NOTE

We wish to draw the reader's attention to the fact that the Queries Service is intended only for the solution of problems or difficulties arising from the construction of receivers described in our pages, from articles appearing in our pages, or on general wireless matters. We regret that we cannot, for obvious reasons—

- (1) Supply circuit diagrams of complete multi-valve receivers.
- (2) Suggest alterations or modifications of receivers described in our contemporaries.
- (3) Suggest alterations or modifications to commercial receivers.
- (4) Answer queries over the telephone.

Please note also, that all sketches and drawings which are sent to us, should bear the name and address of the sender.

AMERICAN NOMENCLATURE

"I have had an American Radio set and it puzzles me very much just how to set it up. There are six valves and the wiring reads in this fashion: (Red) A—, (White) 90—, (Black) A—C—, (Brown) 135 B—, (Yellow) 45—, (Green) C—. The reading here is different and I have asked a few who are, like myself, at a loss, hoping someone of your staff can solve the problem for me. Also what kind of accumulator would be best, as I think myself that a 2-volt would be of no use."—(G. D. Catrine, Scotland.)

In America the following letters indicate the type of battery:—

- A—L.T. accumulator.
- B—H.T. Battery.
- C—Grid-bias battery.

You must find out the voltage of your valves to know the type of accumulator to use. As you do not give us the type numbers we cannot help you here. We feel sure you will find it quite easy to connect this set up now you know to which batteries the leads should be taken.

TUNABLE HUM

"I have recently built a mains three-valve, S.G., Det. and L.F. stages. All parts are of good make, and the mains side is well smoothed. In addition, each stage is efficiently decoupled. In spite of this, however, when I tune in the London station I get a terrible loud hum. This only occurs on the London station, and the set is quite silent all over the dial. Can you explain this, and perhaps indicate a cure?"—(R. B., Edmon-ton.)

The fault is known as a modulated hum, and is caused by the strong signal from your local station modulating the hum from the mains side of the set. The cure is quite simple and cheap. You require what is known as a Buffer condenser. This consists of two condensers of, say, 1 μfd., joined in series. The junction of the two condensers is joined to earth, and the other terminals are joined to the two anodes of the rectifying valve. Special condensers are obtainable for the purpose.

TESTING CONDENSERS

"I have some large fixed condensers in my set, and I wish to test them for leakage (if any), especially the two condensers in the R.C. transformer-coupled stages. I understand that any slight leakage in these condensers may result in bad distortion through placing positive bias on the L.F. valves, thereby cancelling any negative bias from grid-bias battery, resulting in incorrect milliammeter reading. Both Det. and L.F. stages are decoupled, also, I have a filter output, the choke being of first-class make, its specification being D.C.C. resistance, 260 ohms, inductance, 14/28 henries."—(R. W. F. O., Northumberland.)

The simplest test is to connect the condenser across a fairly high value voltage supply, and leave it joined there for some time. Then disconnect it and avoid touching the terminals. At the end of an hour, short the terminals with a metal object, and if you can obtain a fairly good spark, the leakage

from the condenser is negligible. The size of the spark will depend, of course, on the value of the condenser. In a dry atmosphere, the condenser will hold its more charge for a longer period. To carry out a more efficient test, connect a high voltage, say, 200, to a voltmeter through a .25 megohm grid-leak, and note the reading, if any. Then connect the condenser to be tested in place of the leak. If the reading is less, then its resistance is proportionately more than the leak.

L.F. INSTABILITY

"My receiver, which is of conventional design although built more or less from my own knowledge, suffers from the following peculiar fault. When I listen to the local stations the results are quite satisfactory and might even be called ideal. When, however, I turn up the reaction slightly to reach out, the set howls. I have definitely traced this to L.F. howling, although I am unable to see why it should do so. Can you offer any suggestion?"—(F. J. S., Barnet.)

The most probable cause of the trouble is the value of the grid leak and condenser. Try the effect of

DATA SHEET No. 49.

Cut this out each week and paste it in a notebook.

OPTIMUM LOAD VALUE FOR VARIOUS TYPES OF PENTODE.

Manufacturer	Type	Optimum Load (Ohms)
COSSOR	220 HPT	17,000
	220 PT	7,500
	410 PT	7,500
	PT 41	8,000
	PT 41 B	8,000
MARCONI OSRAM	MP/Pen.	10,000
	PT 2	17,000
	PT 425	9,000
	PT 4	7,500
	MPT 4	8,000
MAZDA	DPT	8,000
	Pen. 220	17,000
	Pen. 220 A	7,500
	AC/Pen.	8,500
	DC/Pen	10,000
MULLARD	DC2/Pen.	10,000
	PM 22 A	15,000
	PM 22	8,000
	PM 24 A	10,000
	PM 24 M	8,000
SIX-SIXTY	Pen. 4 V 1	8,000
	SS 220 Pen.	12,000

using a leak with a lower value, or change about both leak and condenser. Various values should be experimented with until you find a combination which suits the particular valve which you are using as a detector. The leak may actually be faulty, although in this case there would probably be some distortion when tuned to the local.

TUNING CONDENSER USELESS

"The tuning condenser in my set does not make the slightest difference to the tuning. I can turn it from 0 to 100 and the signals are exactly the same. What is wrong?"—(Y. S., Chepstow.)

You do not give any information which would enable us to definitely locate your trouble, Y. S. There are various faults which could arise and cause the trouble, but if the receiver has only just been constructed and the tuning condenser has never functioned, obviously the earth connection, or the lead to the coil has been omitted. If, however, the receiver has functioned for a time and has now ceased to work, the actual connection to the moving vanes may be broken. If this is a "pig-tail," you should carefully examine it, and in any case all connections to coil and condenser should be carefully traced and checked. If you have built the receiver from a

design in a book, you may have used a wooden chassis instead of a metal one and so omitted the earth return lead.

GRID-BIAS BATTERY

"I should like you to clear up a small point which has been worrying me for some little time. In the course of studying how the valve works, I have seen that the grid-bias battery is used to apply a negative potential to an L.F. valve, but that the circuit for this battery is incomplete and consequently no current flows. I can follow this more or less, but it seems to me that the battery should never need replacing if this is the case. In my own set I have found that the battery does not last three months. Can you associate these two facts?"—(A. L. K., Hornsey, N.)

The facts are not difficult to reconcile, A. L. K. Firstly, it is true that no current is taken from the grid battery, and therefore it does not "wear out." Secondly, your battery needs replacing every three months or so because it has "dried up." The active elements in the battery consist of zinc and a semi-liquid material. As has already been explained in these pages the latter part of the cell evaporates—slowly, it is true. Therefore, although the battery does not become used up it ceases to become active. It should, however, last longer than three months, and therefore we can only assume that you have placed your battery rather close to a valve, or the receiver is in a warm, dry position. All dry batteries should be kept, as far as possible, in a cool place.

INDOOR AERIAL INEFFICIENCY

"I have erected an indoor aerial but can only get very poor results. I used a good thick wire, I think about 22 D.C.C., and it runs round the picture rail for a total length of about 25 feet. Can you suggest how I might improve the results. I can hear the local faintly, but no other stations."—(S. M. N., Cardiff.)

The aerial is no doubt badly screened by water pipes, electric light conduit or similar earthed metal in the walls. In addition, a wire of this nature should not be sunk into the picture rail. Much better results are obtained when the wire is held at least one foot away from the walls, and, furthermore, it should not be turned to form various angles. A straight short wire will often prove more efficacious than a long wire which winds round three sides of a room. Try a shorter wire running direct from the set to the further point of the room (disregarding appearances for the time being). If you find this works efficiently you must contrive to utilise a similar arrangement unless you are content to have the wire showing. A further scheme is to run the wire vertically to a floor above.

BIASING A MAINS VALVE

"I am building up a mains set but I have come to rather a difficulty. The valves are all of the indirectly-heated type except the output which is a directly heated pentode. I appreciate that biasing resistances may be inserted in the cathode lead of indirectly-heated valves or in the centre-tapped heater winding of the directly heated valves. As, however, I wish to run all my four valves from a single 4 amp. winding I am at a loss where to put the biasing resistances for the two L.F. stages. Can you assist me, please?"—(T. Z. S., Shoeburyness.)

It is not difficult to carry out the biasing scheme. The resistance for the first L.F. valve should be inserted in the cathode lead in the ordinary way. We presume you know how to work out the required value. The resistance for the output valve should be joined between the centre tap of the heater winding and the earth line. The loudspeaker should then be fed by the usual output filter, and instead of connecting the loud-speaker to the earth line it should be taken direct to the centre-tap.

FREE ADVICE BUREAU COUPON

This coupon is available until Sept. 2nd, 1933, and must be attached to all letters containing queries.

PRACTICAL WIRELESS, 26/8/33.

CATALOGUES RECEIVED

To save readers trouble, we undertake to send on catalogues of any of our advertisers. Merely state, on a postcard, the names of the firms from whom you require catalogues, and address it to "Catalogue," PRACTICAL WIRELESS, Geo. Neveles, Ltd., 811, Southampton St., Strand, London, W.C.2. Where advertisers make a charge, or require postage, this should be enclosed with applications for catalogues. No other correspondence whatsoever should be enclosed.

REDFERN'S EBONITE PANELS
MESSRS. REDFERN'S RUBBER WORKS LTD.
 Messrs. Redfern have sent to us a copy of a new price list for ebonite panels, low-loss formers, lead-in tubes, and a variety of moulded goods in rubber and ebonite for the wireless and electrical trades. Readers interested should write for a copy of the list to the address given above.

MULLARD PAMPHLET ON CLASS "B" AMPLIFICATION
 WE have received a copy of a new pamphlet which has just been issued by The Mullard Wireless Service Co. Ltd. It describes in simple terms what Class "B" amplification is, the characteristics of the Mullard P.M.2B, Class "B" valve, how to use Class "B" amplification with existing sets, and how to design a Class "B" unit. A copy of this useful instruction sheet can be obtained from Mullard House, Charing Cross Road, London, W.C.2.

TANNOY EQUIPMENT
TANNOY PRODUCTS are well known for their power amplifiers and other radio apparatus, particulars of which are given in a loose-leaf folder issued by this firm. Amongst the apparatus dealt with in the leaflets are various types of power amplifiers, heavy duty speakers, radio-gramophone equipment, microphones and receivers. The address is Dalton Street, West Norwood, London, S.E.27.

THE SUPERSET

(Continued from page 775)

may be turned to its maximum position (clockwise) without instability taking place. Having found this position you should be able to rotate the tuning control and hear a number of stations at full volume at various settings of the dial. Naturally, the volume control will have to be brought into use on many of them in order to prevent overloading.

Adjusting the Tone

The Controlatone knob will give a pleasing modification of the high-note response and remove any shrillness that may be apparent on certain musical items. Certain broadcasting stations are always received with a nasty high-pitched whistle in the background, and this control will be found invaluable in reducing or even completely eliminating this whistle. Although the above notes are, unfortunately, rather brief, I am sure they will enable you to put the set into operation and obtain some idea of its

station-getting properties and the high quality of reproduction which is obtainable on this receiver. The small switches on the rear of the loudspeaker must, of course, be adjusted to correctly match the Class B valve, and for this purpose they should be turned to cover the letters D and F, although your particular requirements may be better satisfied with the connections adjusted to provide a higher ratio, namely letters C and G. However, that is one of the great features of this particular speaker and you may quickly find the best ratio to give the particular results which your room's acoustics demand.

Replies to Broadcast Queries

STEVENSTON (Dringhouses): GMBJ, R.M.S. *Empress of Britain*. We cannot identify the other transmitter as you do not give the call-sign. SPARKS (R.A.F., Winchester): GNI, Niton (I.O.W.); FFB, Boulogne-sur-Mer (France); G.L.D., Land's End; cannot trace GJT, as you appear to have misread call; GQYJ, S.S. *Ile of Guernsey*; UNCC, Belgian S.S. *Carica Milica*; OYIC, Danish S.S. *Jane Maersk*; GSM, Fog Beacon, Start Point Lighthouse; GCM, Fog Beacon, Casquets Lighthouse (C.I.) both on 1,010 m. (297 kc/s). MEACHEM (Bletchley): Dutch experimental amateur transmitter; K. J. Asselberg, 8, Burgmeester Kerstenlaan, Breda (Holland).

SOUTHERN RADIO'S Wireless Bargains.—Set manufacturer's guaranteed surplus—

VARIABLE Condensers.—British Radiophone 4-gang superhet type, fully screened and trimmers, 6,0003, 8.9 (list 45/-). Same type, complete with dial knob and escutcheon, 12.9 (list 50/-). Hydra block condensers, brand new, 16 mfd., 2+2+6+2+1+1, 1,000 volt test (made for Canadian Marconiophone Co.), 8/9; 4 mfd., 2/6; 2 mfd., 1/9; 1 mfd., 1/-; all 750 volt.

SPEAKERS.—Celestion Soundex permanent magnet, 10" (list 27/6); Rola F6 permanent magnet, 28" (list 49/6); D.E. mains energised, 2,500 to 6,500 ohms, complete with humbucking coils and transformers 16/6 (list 39/6); Peter Grassman dynamic speakers and chassis, 10.6 each (list 35/-); G.E.C. Stork speakers, complete in magnificent cabinet, 19/9 (list 43/10); Ormond speakers, complete in cabinets, 10" (list 25/-).

CONSTRUCTORS' Kits.—Ready Radio "303" battery 3-valve kits, less valves, 18/- each; complete with 3 Mullard valves (P.M.I.L.F., P.M.2, 2D.X.), 33/- each (list 70/-); Ready Radio Meteor screen grid 3-valve kit, less valves, 26/-; with 3 Mullard valves (P.M.12a, P.M.2D.X., P.M.2a), 49/- (list 43/7/6); Universa Radio 3-valve kits, ready assembled on chassis, 12/6 (list 46/-).

READY RADIO S.T.400 Kits, as specified by Scott Taggart, £2 10/6 each (list 44/17/6).

READY RADIO Meteor Screen Grid 3-valve "A" Kit, complete with cabinet, permanent magnet speaker (less valves), £3 7/6, with 3 Mullard valves, £4 10 (list 48/17/6); Mullard Radio for Million 3-valve A.C. kit, complete with 3 Mullard A.C. valves (Pen. 4V, 354 V, 84V), £3 10 (list 40/10); Mullard Radio for Million 3-valve battery kits, complete with 3 Mullard valves £3 9/0 (list 40/2/6); all kit brand new, in original sealed cartons.

WE have purchased a small liquidated stock of brand new components and offer a limited quantity of Pifco Radiometers All-in-One latest type bakelite case, 8/9 (list 12/6), 6 only; B.T.H. Junior Pick-ups, 17/6 (list 25/-); British General Band Pass tuning units, 10-K.C. aerial or anode, 5/- each (list 14/6).

ALL Goods Guaranteed Brand New and Perfect and Sent Carriage Paid.

PLEASE Note.—We have opened Branches at 271-275, High Rd., Willesden Green, N.W.10, and at 46, Lisle Street, W.C.2, where callers are cordially invited to inspect our large stocks of wireless bargains. Please send all post orders to 323, Euston Rd., N.W.1.

SOUTHERN RADIO, 323, Euston Rd., London, N.W.1 (near Warren St. Tube). Phone: Museum 6324.

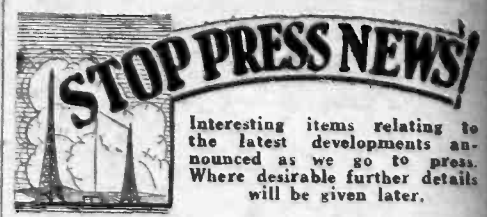

Interesting items relating to the latest developments announced as we go to press. Where desirable further details will be given later.

NEW AMPLION SPEAKERS
 AMONGST the new Amplion speakers to be introduced this season are the Sonette and the M.C.22. The Sonette has already been mentioned, and is of the midget type, having a cone of only 6 1/2 in. diameter. The magnet is of a new type and provides a greater field strength than is usually obtained, resulting in additional sensitivity. In addition, the magnet-centring device is of unique design, enabling the frequency response to reach a really high standard. The M.C.22 is a very robust speaker, costing 85s. 6d. The over-all size of the cone is just over 5 in., and it will handle a really large output. The cone is weather-proofed, and certain improvements have been introduced into the moving-coil suspension. These facts, together with the addition of a universal input transformer result in a really high-class but moderately-priced loudspeaker.

VULCO STAG BATTERIES
 THE Vulco Company have incorporated in their new Vulco Stag Batteries the results of what they say is undoubtedly the most important discovery in the science of battery-making in the twenty years of the company's existence. Scientific research in battery making has been directed especially since the advent of wireless, towards the solution of three problems: (1) How to increase electrical conductivity in the cell or, in other words, how to lower the internal resistance; (2) how to increase the proportion of the active material—namely, the manganese—in the depolariser, at the expense of the merely conducting elements; (3) how to get rid of the gases which are formed while the battery is working, and which interfere with depolarisation and shorten the life of the battery. After considerable research, the solution to these three problems was found in the product of combustion, under pressure, of hydrocarbon bases. This material has now been incorporated in the new Vulco Stag batteries, and every cell in every stag battery is guaranteed to contain its due proportion and is also guaranteed to contain the increased proportion of active manganese which its presence makes possible. Owing to economies in production, this revolution and expensive alteration has been effected without exceeding normal prices.

Famous Maker's Offer! **£5 Radio-Gram 65/- CABINET for SEVEN DAYS' FREE TRIAL (OR 10/- MONTHLY)**

Polished Oak 1 and Piano built! The acoustic Tone brings a fine thrill. Makers to Radio-Press. B.B.O., 3,000 clientele. MODELS FROM 35/- to £15. Photographs and List FREE. **PICKETTS** Piano-Tone Cabinets, (R.F.), Albion Road, Bezzley Heath



"D" £6-15-0

ADVERTISEMENT INDEX

Airclipse Ltd.	Page 771	Jackson Bros.	Page Supp. XIV
Amplion (1932) Ltd.	Supp. VI	Lectro Lynx, Ltd.	Supp. I
Belling & Lee, Ltd.	788	Lissen, Ltd.	Supp. II and III, 786 and 787
Benjamin Electric, Ltd.	834	London Radio Supply Co.	829
Block Batteries, Ltd.	Supp. VIII	Lyons Claude, Ltd.	832
British Blue Spot Co., Ltd.	Inside Back Cover	Microfuses, Ltd.	829
British General	788	Nash Products, Ltd.	820
British Institute of Eng. Technology	829	New London Electron Works	833
British Radio-Gramophone Co., Ltd.	Supp. XV	Osborn, Chas. A.	820
British Radiophone, Ltd.	Supp. XIII	Peto-Scott, Ltd.	817
Bulgin, A. F., & Co., Ltd.	829	Picketts	836
Burne-Jones, Ltd.	829	Pifco, Ltd.	769
Busby & Co., Ltd.	831	Regent Fittings Co.	829
Colvern, Ltd.	769	Reproducers & Amplifiers, Ltd.	Supp. XII
Cossor, A. C., Ltd.	772	Riverside Mfg. Co. Ltd.	830
Dublier Condenser Co., Ltd.	820	Sifam Electrical Instrument Co., Ltd.	818
Eastick, J. J., & Sons	833	Southern Radio	816
Edison Swan Electric Co., Ltd.	Supp. X and XI	S. Smith & Sons (M.A.), Ltd.	770
Evington Electrical Mfg. Co.	831	Stratton & Co., Ltd.	832
Exide Batteries	785	Telegraph Condenser Co., Ltd.	Supp. VII
Ferranti, Ltd.	831	The 362 Radio Valve Co., Ltd.	820
Goodmans	830	Trevor Pepper	818
Graham Farish, Ltd.	Front Cover Strip and Back Cover and Supp. V	Varley, Ltd.	Inside Front Cover
Grosvenor Electric Batteries, Ltd.	818	Ward & Goldstone, Ltd.	788
Heayberd, F. C., & Co.	832	Westinghouse Brake and Saxby Signal Co., Ltd.	Supp. XVI
Heraud, E. J., Ltd.	818	Whiteley Electrical Radio, Ltd.	Supp. IV
High Vacuum Valve Co.	771	Wilburn & Co.	820
Igranic Electric Co., Ltd.	Supp. IX	Williams	829
International Correspondence Schools	834	Wingrove & Rogers, Ltd.	710
		Wright & Weaire	771

IF YOUR RECEPTION IS INDIFFERENT

SUPERIAL
 THE AERIAL WHICH MADE BROADCASTING POPULAR
 ELECTRON'S SUPER-AERIAL

WILL MAKE IT BETTER



because it definitely increases signal strength, and cuts out interference. The most selective aerial, protected by the heavy rubber insulation, which abolishes masts, gulators and separate wires in. The first and only efficient invisible or indoor aerial. Lightning proof—you can get your £100 Free Insurance to-day from any dealer.

100 ft 3/6: 75 ft 2/6: 50 ft 1/9: 25 ft 1/4
 THE NEW LONDON ELECTRON WORKS LTD 8 EAST HAM LONDON E.6