

JANUARY 1994

£2.20

# TELEVISION

SERVICING·VIDEO·SATELLITE·DEVELOPMENT

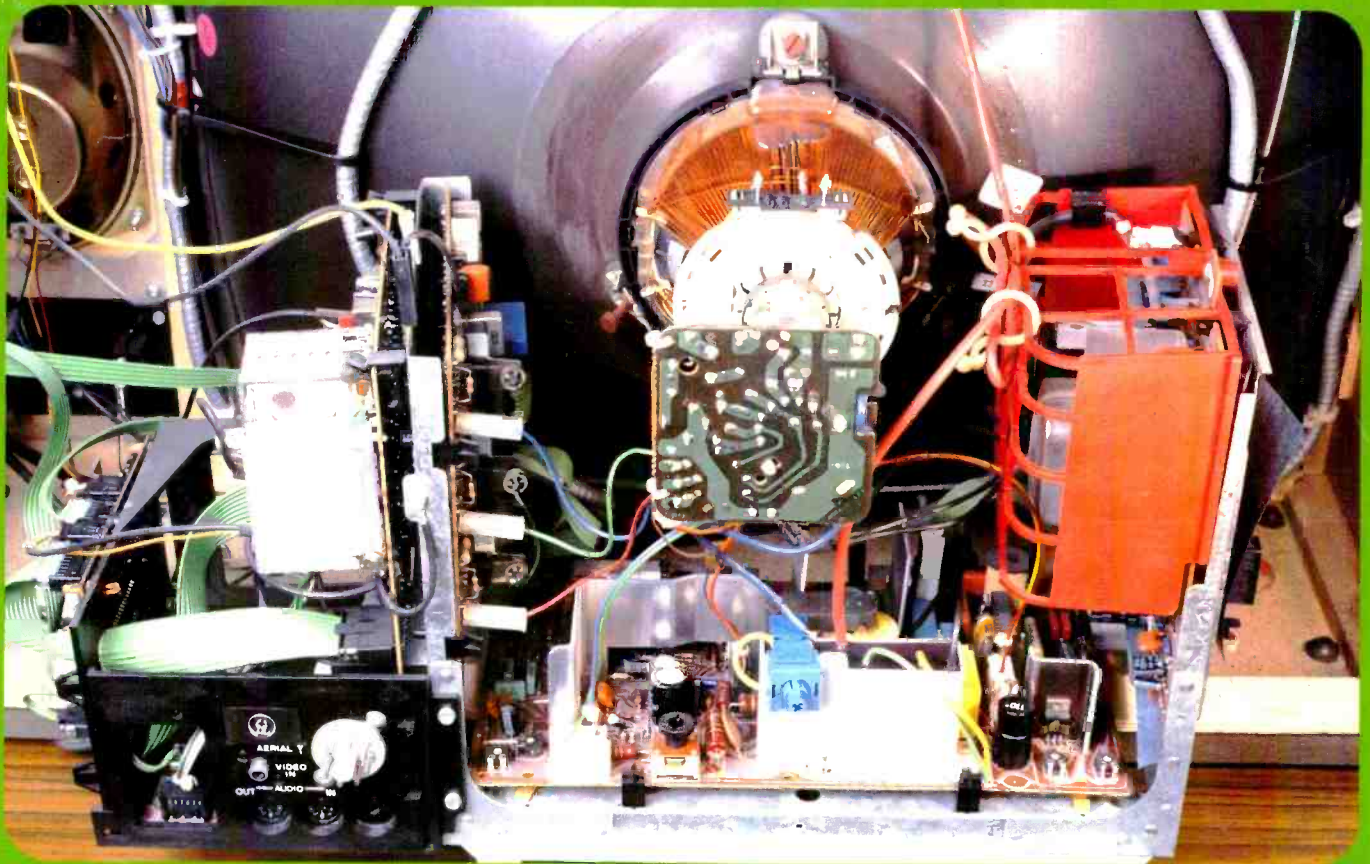

**The Rediffusion Mk 4 Chassis**  
**Power Supplies for TV Receivers**  
**All about Fuses · UPS Review**  
**Panasonic's Cardiff TV Chassis**  
**Symptoms without Faults · DX-TV**  
**VCR Clinic · TV Fault Finding**

A REED BUSINESS PUBLICATION



**WILLOW VALE ELECTRONICS LIMITED**

**WVE**

**WVE**

**the answer to the  
spares puzzle**

Akai Kamasa  
Altai Konig  
Amstrad Labgear  
Antex Leader  
Antiference Ledu  
A.D.S. Link Hamson  
Aiphone Microtec  
Ambersil Mitsubishi  
Aiwa Nikkai  
Alba Oryx  
AWI Pye  
Baldwin Boxall Philips  
Bose Portasol  
BK Precision Ross  
Blackstar Saisho  
Celtel Samsung  
Celtex Sansui  
DNH Satfinder  
Electrolube Seaward  
ERL Servisol  
Ferguson Sharp  
Fidelity Shure  
G.E.C. Sony  
Goldstar Thander  
Grundig Thompson  
Hameg Toshiba  
Inkel Trantec  
J.V.C. Weller

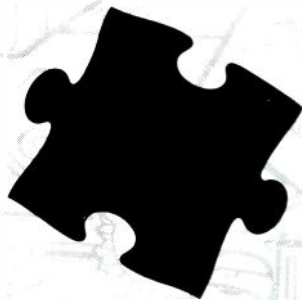

**WILLOW VALE**  
**ELECTRONICS LIMITED**

**'The Better Choice'**

**MANCHESTER BRANCH:**

Unit 4 Enterprise Park, Reliance Street  
Manchester, M10 0AL.

Tel: 061-682 1415 Fax: 061-682 9031

**HEAD OFFICE:**

11 Arkwright Road, Reading, RG2 0LU.  
Tel: 0734 876444 Fax: 0734 867188

**ACCOUNTS DEPARTMENT:**

Tel: 0734 860158

**NOTTINGHAM BRANCH:**

11 Marhill Road, Carlton,  
Nottingham, NG4 3AJ.

Tel: 0602 870789 Fax: 0602 878772



THE EDITOR AND STAFF OF TELEVISION WOULD LIKE TO THANK OUR READERS AND ADVERTISERS FOR THEIR CONTINUED SUPPORT AND WISH THEM ALL THE VERY BEST FOR THE NEW YEAR.

# TELEVISION

January 1994 Vol. 44, No. 3 Issue 519

On sale December 15th

## COPYRIGHT

© Reed Business Publishing Ltd., 1994  
Copyright in all drawings, photographs and articles published in *Television* is fully protected and reproduction or imitation in whole or in part is expressly forbidden. All reasonable precautions are taken by *Television* to ensure that the advice and data given to readers are reliable. We cannot however guarantee it and we cannot accept legal responsibility for it.

## CORRESPONDENCE

All correspondence regarding advertisements should be addressed to the Advertisement Manager, "Television", Quadrant House, The Quadrant, Sutton, Surrey SM2 5AS. Editorial correspondence should be addressed to "Television" Editorial Department, Reed Business Publishing, Quadrant House, The Quadrant, Sutton, Surrey SM2 5AS.

## INDEXES AND BINDERS

Indexes for Vols. 38 to 42 are available at £3.50 each from Video Interface Products Ltd., who can also supply a five-year consolidated index on computer disk. For further details see page 186.

Binders that hold twelve issues of *Television* are available for £5 each from Television Binders, 78 Whalley Road, Wilpshire, Blackburn BB1 9LF. Make cheques payable to "Television Binders".

## SUBSCRIPTIONS

An annual subscription costs £26 in the UK, £37 for Eire/Europe airmail (postage included for all rates) Rest of the world airmail available upon request). Send orders with payment to Quadrant Subscription Services Ltd., Oakfield House, Perrymount Road, Haywards Heath, Sussex, RH16 3DH.

Subscription hotline for 24-hour ordering with Credit Card telephone 0622 721666 quoting INJ.

## BACK NUMBERS

Some back issues are available at £2.75 each from Television Back Issues, Room L323, Quadrant House, The Quadrant, Sutton, Surrey SM2 5AS. Make cheques/postal orders payable to Reed Business Publishing Ltd. See box on page 203.

ISSN 0032-647X

- |     |  |  |
|-----|--|--|
| 165 | <b>Leader</b>  |  |
| 166 | <b>Modern TV Receiver Techniques, Part 13</b>  | <b>Eugene Trundle</b>                  |
|     | A look at the operation of the various types of power supply circuitry used in modern TV receivers.  |  |
| 173 | <b>Teletopics</b>  |  |
| 174 | <b>VCR Clinic</b>  |  |
|     | Reports from Philip Blundell, AMIEE, Eugene Trundle, Richard J. Avis, Adrian Farnborough, John Edwards, Alfred Damp, Mike Leach, John Coombes, Chris Avis, Steve Cannon, Chris Watton and Simon Bodgett. |  |
| 177 | <b>Faults that Aren't There</b>  | <b>D.A. Chaplin</b>                    |
|     | Many symptoms are present because of equipment misuse rather than a fault. This can lead to wasted time. Some examples as a warning to others and a call for more information on this subject.           |  |
| 178 | <b>Letters</b>   |  |
| 180 | <b>Servicing the Rediffusion Mk 4 Chassis</b>  | <b>Chris Watton</b>                    |
|     | A guide to common problems with this generally reliable and well-built chassis.  |  |
| 183 | <b>Next Month in Television</b>  |  |
| 184 | <b>Long-distance Television</b>  | <b>Roger Bunney</b>                    |
| 186 | <b>Test Case 373</b>   |  |
| 187 | <b>Camcorner</b>   |  |
|     | Reports from Simon Bodgett and David C. Woodnott.  |  |
| 188 | <b>Panasonic's Cardiff Chassis</b>   | <b>Ray Meadows</b>                     |
|     | A look at the various TV chassis produced since Panasonic set up production lines in South Wales.  |  |
| 191 | <b>Help Wanted</b>   |  |
| 194 | <b>Ottawa HDTV '93</b>   | <b>Geoff Lewis, B.A., M.Sc.</b>        |
|     | Latest HDTV and other developments in N. America.  |  |
| 195 | <b>Help Wanted</b>   |  |
| 196 | <b>TV Fault Finding</b>  |  |
|     | Reports from Philip Blundell, AMIEE, Nick Beer, Eugene Trundle, Richard Newman, Steve Cannon, Mike Leach and Edward Joyce.   |  |
| 199 | <b>Test Report: Emerson Model 20 UPS</b>   | <b>Donald Bullock</b>                  |
|     | An uninterruptible power supply can be essential to prevent loss of data. This one is well suited to the needs of individuals and small businesses.  |  |
| 202 | <b>All About Fuses</b>   | <b>Ray Porter, M.Sc., C.Eng., MIEE</b> |
|     | Characteristics and use of the various types of fuse available.  |  |
| 204 | <b>Adding a Bubblejet Printer to the Amstrad PCW</b>   | <b>Keith Wevill, B.Sc.</b>             |
| 207 | <b>What a Life!</b>  | <b>Donald Bullock</b>                  |

OUR NEXT ISSUE DATED FEBRUARY  
WILL BE PUBLISHED ON JANUARY 19

BC107	8p	B0D28	50p	R2008B	100p	ZN6355	120p	EY85	70p	AN7145	195p	LA2000	150p	NE555	20p	STK41821	800p	STR41090	500p	TD62308AP	200p	TD43592A	350p
BC108	8p	B0D89	50p	R2010B	100p	ZN6403	160p	EY87	70p	AN7146	210p	LA2101	270p	NE565	40p	STK4192	850p	STR4411	650p	TD62382	200p	TD43640	350p
BC109	8p	B0D99	50p	R2015B	100p	ZN6403	160p	EY88	70p	AN7147	210p	LA2200	270p	NE565	40p	STK4211	990p	STR44115	650p	TD62506	200p	TD43651	200p
BC110	10p	B0D90	50p	S2800M	72p			PC97	100p	AN7156	240p	LA3160	120p	NE566	120p	STK42311	990p	STR4511	700p	TD62705	250p	TD43652	200p
BC111	20p	B0D91	50p	S2800M	72p	DIODES		PCF80	100p	AN7157	240p	LA3210	120p	NE567	150p	STK42312	990p	STR45115	700p	TD62706	250p	TD43653	200p
BC142	20p	B0D32	100p	T2800M	72p			PCF80	100p	AN7158	240p	LA2210	120p	NE571	200p	STK42313	990p	STR45115	700p	TD62707	250p	TD43654	200p
BC143	20p	B0D33	100p	T2800M	72p			PCF80	100p	AN7159	240p	LA2220	120p	NE572	200p	STK42314	990p	STR45115	700p	TD62708	250p	TD43655	200p
BC144	20p	B0D34	100p	T2800M	72p			PCF80	100p	AN7160	240p	LA2230	120p	NE573	200p	STK42315	990p	STR45115	700p	TD62709	250p	TD43656	200p
BC145	20p	B0D35	100p	T2800M	72p			PCF80	100p	AN7161	240p	LA2240	120p	NE574	200p	STK42316	990p	STR45115	700p	TD62710	250p	TD43657	200p
BC146	20p	B0D36	100p	T2800M	72p			PCF80	100p	AN7162	240p	LA2250	120p	NE575	200p	STK42317	990p	STR45115	700p	TD62711	250p	TD43658	200p
BC147	20p	B0D37	100p	T2800M	72p			PCF80	100p	AN7163	240p	LA2260	120p	NE576	200p	STK42318	990p	STR45115	700p	TD62712	250p	TD43659	200p
BC148	20p	B0D38	100p	T2800M	72p			PCF80	100p	AN7164	240p	LA2270	120p	NE577	200p	STK42319	990p	STR45115	700p	TD62713	250p	TD43660	200p
BC149	8p	B0D93	50p	TIP30C	30p			PC181	80p	AN7310	100p	LA3360	150p	SAA1008	450p	STK4362	600p	STR51011	650p	TD62714	250p	TD43661	200p
BC150	8p	B0D94	50p	TIP31A	30p			PC182	80p	AN7311	100p	LA3370	150p	SAA1010	450p	STK4372	600p	STR52041	650p	TD62715	250p	TD43662	200p
BC151	8p	B0D95	50p	TIP31C	30p			PC184	80p	AN7312	100p	LA3380	150p	SAA1020	450p	STK4382	600p	STR52043	650p	TD62716	250p	TD43663	200p
BC160	20p	B1127	35p	BY196	20p			PC185	80p	AN7313	100p	LA3390	150p	SAA1030	450p	STK4392	600p	STR52045	650p	TD62717	250p	TD43664	200p
BC171	10p	B1127	35p	BY196	20p			PC185	80p	AN7314	100p	LA3400	150p	SAA1040	450p	STK4402	600p	STR52047	650p	TD62718	250p	TD43665	200p
BC172	10p	B1127	35p	BY196	20p			PC185	80p	AN7315	100p	LA3410	150p	SAA1050	450p	STK4412	600p	STR52049	650p	TD62719	250p	TD43666	200p
BC173	10p	B1127	35p	BY196	20p			PC185	80p	AN7316	100p	LA3420	150p	SAA1060	450p	STK4422	600p	STR52051	650p	TD62720	250p	TD43667	200p
BC174	10p	B1127	35p	BY196	20p			PC185	80p	AN7317	100p	LA3430	150p	SAA1070	450p	STK4432	600p	STR52053	650p	TD62721	250p	TD43668	200p
BC175	10p	B1127	35p	BY196	20p			PC185	80p	AN7318	100p	LA3440	150p	SAA1080	450p	STK4442	600p	STR52055	650p	TD62722	250p	TD43669	200p
BC176	10p	B1127	35p	BY196	20p			PC185	80p	AN7319	100p	LA3450	150p	SAA1090	450p	STK4452	600p	STR52057	650p	TD62723	250p	TD43670	200p
BC177	10p	B1127	35p	BY196	20p			PC185	80p	AN7320	100p	LA3460	150p	SAA1100	450p	STK4462	600p	STR52059	650p	TD62724	250p	TD43671	200p
BC178	10p	B1127	35p	BY196	20p			PC185	80p	AN7321	100p	LA3470	150p	SAA1110	450p	STK4472	600p	STR52061	650p	TD62725	250p	TD43672	200p
BC179	14p	B1195	7p	TIP34	50p			PL84	80p	BA311	80p	LA4100	85p	SAA1250	280p	STK4833	720p	STR59041	600p	TD62726	250p	TD43673	200p
BC180	7p	B1195	7p	TIP34	50p			PL85	80p	BA313	60p	LA4110	120p	SAA1251	280p	STK4843	720p	STR6001	650p	TD62727	250p	TD43674	200p
BC181	7p	B1195	7p	TIP34	50p			PL85	80p	BA313	60p	LA4120	120p	SAA1252	280p	STK4853	720p	STR6001	650p	TD62728	250p	TD43675	200p
BC182	7p	B1195	7p	TIP34	50p			PL85	80p	BA313	60p	LA4130	120p	SAA1253	280p	STK4863	720p	STR6001	650p	TD62729	250p	TD43676	200p
BC183	7p	B1195	7p	TIP34	50p			PL85	80p	BA313	60p	LA4140	120p	SAA1254	280p	STK4873	720p	STR6001	650p	TD62730	250p	TD43677	200p
BC184	7p	B1195	7p	TIP34	50p			PL85	80p	BA313	60p	LA4150	120p	SAA1255	280p	STK4883	720p	STR6001	650p	TD62731	250p	TD43678	200p
BC185	7p	B1195	7p	TIP34	50p			PL85	80p	BA313	60p	LA4160	120p	SAA1256	280p	STK4893	720p	STR6001	650p	TD62732	250p	TD43679	200p
BC186	7p	B1195	7p	TIP34	50p			PL85	80p	BA313	60p	LA4170	120p	SAA1257	280p	STK4903	720p	STR6001	650p	TD62733	250p	TD43680	200p
BC187	7p	B1195	7p	TIP34	50p			PL85	80p	BA313	60p	LA4180	120p	SAA1258	280p	STK4913	720p	STR6001	650p	TD62734	250p	TD43681	200p
BC188	7p	B1195	7p	TIP34	50p			PL85	80p	BA313	60p	LA4190	120p	SAA1259	280p	STK4923	720p	STR6001	650p	TD62735	250p	TD43682	200p
BC189	7p	B1195	7p	TIP34	50p			PL85	80p	BA313	60p	LA4200	120p	SAA1260	280p	STK4933	720p	STR6001	650p	TD62736	250p	TD43683	200p
BC190	7p	B1195	7p	TIP34	50p			PL85	80p	BA313	60p	LA4210	120p	SAA1261	280p	STK4943	720p	STR6001	650p	TD62737	250p	TD43684	200p
BC191	7p	B1195	7p	TIP34	50p			PL85	80p	BA313	60p	LA4220	120p	SAA1262	280p	STK4953	720p	STR6001	650p	TD62738	250p	TD43685	200p
BC192	7p	B1195	7p	TIP34	50p			PL85	80p	BA313	60p	LA4230	120p	SAA1263	280p	STK4963	720p	STR6001	650p	TD62739	250p	TD43686	200p
BC193	7p	B1195	7p	TIP34	50p			PL85	80p	BA313	60p	LA4240	120p	SAA1264	280p	STK4973	720p	STR6001	650p	TD62740	250p	TD43687	200p
BC194	7p	B1195	7p	TIP34	50p			PL85	80p	BA313	60p	LA4250	120p	SAA1265	280p	STK4983	720p	STR6001	650p	TD62741	250p	TD43688	200p
BC195	7p	B1195	7p	TIP34	50p			PL85	80p	BA313	60p	LA4260	120p	SAA1266	280p	STK4993	720p	STR6001	650p	TD62742	250p	TD43689	200p
BC196	7p	B1195	7p	TIP34	50p			PL85	80p	BA313	60p	LA4270	120p	SAA1267	280p	STK5003	720p	STR6001	650p	TD62743	250p	TD43690	200p
BC197	7p	B1195	7p	TIP34	50p			PL85	80p	BA313	60p	LA4280	120p	SAA1268	280p	STK5013	720p	STR6001	650p	TD62744	250p	TD43691	200p
BC198	7p	B1195	7p	TIP34	50p			PL85	80p	BA313	60p	LA4290	120p	SAA1269	280p	STK5023	720p	STR6001	650p	TD62745	250p	TD43692	200p
BC199	7p	B1195	7p	TIP34	50p			PL85	80p	BA313	60p	LA4300	120p	SAA1270	280p	STK5033	720p	STR6001	650p	TD62746	250p	TD43693	200p
BC200	7p	B1195	7p	TIP34	50p			PL85	80p	BA313	60p	LA4310	120p	SAA1271	280p	STK5043	720p	STR6001	650p	TD62747	250p	TD43694	200p
BC201	7p	B1195	7p	TIP34	50p			PL85	80p	BA313	60p	LA4320	120p	SAA1272	280p	STK5053	720p	STR6001	650p	TD62748	250p	TD43695	200p
BC202	7p	B1195	7p	TIP34	50p			PL85	80p	BA313	60p	LA4330	120p	SAA1273	280p	STK5063	720p	STR6001	650p	TD62749	250p	TD43696	200p
BC203	7p	B1195	7p	TIP34	50p			PL85	80p	BA313	60p	LA4340	120p	SAA1274	280p	STK5073	720p	STR6001	650p	TD62750	250p	TD43697	200p
BC204	7p	B1195	7p	TIP34	50p			PL85	80p	BA313	60p	LA4350	120p	SAA1275	280p	STK5083	720p	STR6001	650p	TD62751	250p	TD43698	200p
BC205	7p	B1195	7p	TIP34	50p			PL85	80p	BA313	60p	LA4360	120p	SAA1276	280p	STK5093	720p	STR6001	650p	TD62752	250p	TD43699	200p
BC206	7p	B1195	7p	TIP34	50p			PL85	80p	BA313	60p	LA4370	120p	SAA1277	280p	STK5103	720p	STR6001	650p	TD62753	250p	TD43700	200p
BC207	7p	B1195	7p	TIP34	50p			PL85	80p	BA313	60p	LA4380	120p	SAA1278	280p	STK5113	720p	STR6001	650p	TD62754	250p	TD43701	200p
BC208	7p	B1195	7p	TIP34	50p			PL85	80p	BA313	60p	LA4390	120p	SAA1279	280p	STK5123	720p	STR6001	650p	TD62755	250p	TD43702	200p
BC209	7p	B1195	7p	TIP34	50p			PL85	80p	BA313	60p	LA4400	120p	SAA1280	280p	STK5133	720p	STR6001	650p	TD62756	250p	TD43703	200p
BC210	7p	B1195	7p	TIP34	50p			PL85	80p	BA313	60p	LA4410	120p	SAA1281	280p	STK5143	720p	STR6001	650p	TD62757	250p	TD43704	200p
BC211	7p	B1195	7p	TIP34	50p			PL85	80p	BA313	60p	LA4420	120p	SAA1282	280p	STK5153	720p	STR6001	650p	TD62758	250p	TD43705	200p
BC212	7p	B1195	7p	TIP34	50p			PL85	80p	BA313	60p	LA443											

LINEAR ICs - Cont.	2SA1162 20p	2SC536 20p	2SC2414 140p	2SC2320 40p	2SC2342 75p	2SC3531 225p	2SD-186 100p	2SD-1400 280p	2SK 214 170p	COMPUTER ICs	8748 700p
UIC1363 190p	2SA1169 500p	2SC558 275p	2SC2425 140p	2SC2324 120p	2SC2337 250p	2SC3547 100p	2SD-187 80p	2SD-1402 280p	2SK 216 150p	2114 150p	8755 800p
UIC1363C 300p	2SA1170 500p	2SC583 40p	2SC2426 75p	2SC2329 480p	2SC2338 480p	2SC3549 200p	2SD-188 100p	2SD-1404 125p	2SK 217 35p	2532 200p	280ACPU 150p
UIC1364C 350p	2SA1175 40p	2SC605 100p	2SC2428 75p	2SC2333 200p	2SC2344 620p	2SC3568 200p	2SD-189 100p	2SD-1406 150p	2SK 218 400p	2716 150p	280ACPU 150p
UIC1365 250p	2SA1186 500p	2SC619 100p	2SC2434 240p	2SC2334 240p	2SC2368 75p	2SC3583 170p	2SD-190 100p	2SD-1408 125p	2SK 220 50p	2732 220p	280ADMA 200p
UIC1367 500p	2SA1188 70p	2SC641 80p	2SC2435 120p	2SC2335 120p	2SC2369 60p	2SC3584 200p	2SD-191 140p	2SD-1409 170p	2SK 222 770p	2764 150p	280BPU 150p
UIC1370C 300p	2SA1190 500p	2SC642 50p	2SC2436 150p	2SC2336 150p	2SC2370 150p	2SC3585 20p	2SD-192 100p	2SD-1410 175p	2SK 224 750p	2768 200p	280BPU 150p
UIC1373 85p	2SA1208 70p	2SC644 25p	2SC2437 50p	2SC2337 60p	2SC2371 45p	2SC3586 200p	2SD-193 100p	2SD-1411 175p	2SK 226 750p	2772 200p	280BPU 150p
UIC1377C 200p	2SA1209 100p	2SC647 300p	2SC2438 120p	2SC2338 120p	2SC2372 325p	2SC3604 650p	2SD-194 100p	2SD-1412 175p	2SK 228 750p	2776 150p	280BPU 150p
UIC1378 180p	2SA1210 120p	2SC681 340p	2SC2439 120p	2SC2339 120p	2SC2388 250p	2SC3605 60p	2SD-195 100p	2SD-1413 175p	2SK 230 120p	2782 300p	280BPU 150p
UIC1382 110p	2SA1215 120p	2SC683 120p	2SC2440 120p	2SC2340 120p	2SC2395 60p	2SC3606 100p	2SD-196 100p	2SD-1414 175p	2SK 232 140p	2786 150p	280BPU 150p
UIC1384 120p	2SA1216 550p	2SC685 100p	2SC2441 120p	2SC2341 120p	2SC2399 45p	2SC3607 100p	2SD-197 100p	2SD-1415 175p	2SK 234 140p	2790 150p	280BPU 150p
UIC1387 250p	2SA1217 100p	2SC710 20p	2SC2442 120p	2SC2342 120p	2SC2400 140p	2SC3608 100p	2SD-198 100p	2SD-1416 175p	2SK 236 100p	2794 150p	280BPU 150p
UIC1394 120p	2SA1220 120p	2SC711 20p	2SC2443 120p	2SC2343 120p	2SC2401 120p	2SC3609 100p	2SD-199 100p	2SD-1417 175p	2SK 238 100p	2798 150p	280BPU 150p
UIC1397 350p	2SA1227A 100p	2SC717 50p	2SC2444 120p	2SC2344 120p	2SC2402 120p	2SC3610 100p	2SD-200 100p	2SD-1418 175p	2SK 240 100p	2802 150p	280BPU 150p
UIC 400p	2SA1232 250p	2SC730 450p	2SC2445 120p	2SC2345 120p	2SC2403 120p	2SC3611 100p	2SD-201 100p	2SD-1419 175p	2SK 242 100p	2806 150p	280BPU 150p
1403CA 650p	2SA1242 40p	2SC732 40p	2SC2446 120p	2SC2346 120p	2SC2404 120p	2SC3612 100p	2SD-202 100p	2SD-1420 175p	2SK 244 100p	2810 150p	280BPU 150p
UIC 450p	2SA1244 120p	2SC733 25p	2SC2447 120p	2SC2347 120p	2SC2405 120p	2SC3613 100p	2SD-203 100p	2SD-1421 175p	2SK 246 100p	2814 150p	280BPU 150p
1420CA 450p	2SA1246 80p	2SC735 40p	2SC2448 120p	2SC2348 120p	2SC2406 120p	2SC3614 100p	2SD-204 100p	2SD-1422 175p	2SK 248 100p	2818 150p	280BPU 150p
1421CA 650p	2SA1261 150p	2SC739 150p	2SC2449 120p	2SC2349 120p	2SC2407 120p	2SC3615 100p	2SD-205 100p	2SD-1423 175p	2SK 250 100p	2822 150p	280BPU 150p
UIC 550p	2SA1262 160p	2SC761 150p	2SC2450 120p	2SC2350 120p	2SC2408 120p	2SC3616 100p	2SD-206 100p	2SD-1424 175p	2SK 252 100p	2826 150p	280BPU 150p
UIC 200p	2SA1263 280p	2SC762 150p	2SC2451 120p	2SC2351 120p	2SC2409 120p	2SC3617 100p	2SD-207 100p	2SD-1425 175p	2SK 254 100p	2830 150p	280BPU 150p
UIC1504C 400p	2SA1264 280p	2SC783 100p	2SC2452 120p	2SC2352 120p	2SC2410 120p	2SC3618 100p	2SD-208 100p	2SD-1426 175p	2SK 256 100p	2834 150p	280BPU 150p
UIC1505C 400p	2SA1265 280p	2SC790 80p	2SC2453 120p	2SC2353 120p	2SC2411 120p	2SC3619 100p	2SD-209 100p	2SD-1427 175p	2SK 258 100p	2838 150p	280BPU 150p
UIC1506C 400p	2SA1283 60p	2SC792 380p	2SC2454 120p	2SC2354 120p	2SC2412 120p	2SC3620 100p	2SD-210 100p	2SD-1428 175p	2SK 260 100p	2842 150p	280BPU 150p
UIC1507C 200p	2SA1284 60p	2SC805 225p	2SC2455 120p	2SC2355 120p	2SC2413 120p	2SC3621 100p	2SD-211 100p	2SD-1429 175p	2SK 262 100p	2846 150p	280BPU 150p
UIC 200p	2SA1285 60p	2SC806 225p	2SC2456 120p	2SC2356 120p	2SC2414 120p	2SC3622 100p	2SD-212 100p	2SD-1430 280p	2SK 264 100p	2850 150p	280BPU 150p
UIC 250p	2SA1286 60p	2SC828 280p	2SC2457 120p	2SC2357 120p	2SC2415 120p	2SC3623 100p	2SD-213 100p	2SD-1431 280p	2SK 266 100p	2854 150p	280BPU 150p
UIC 250p	2SA1290 150p	2SC829 20p	2SC2458 120p	2SC2358 120p	2SC2416 120p	2SC3624 100p	2SD-214 100p	2SD-1432 280p	2SK 268 100p	2858 150p	280BPU 150p
UIC1520CA 250p	2SA1294 450p	2SC839 25p	2SC2459 120p	2SC2359 120p	2SC2417 120p	2SC3625 100p	2SD-215 100p	2SD-1433 280p	2SK 270 100p	2862 150p	280BPU 150p
UIC1536C 550p	2SA1301 350p	2SC870 100p	2SC2460 120p	2SC2360 120p	2SC2418 120p	2SC3626 100p	2SD-216 100p	2SD-1434 280p	2SK 272 100p	2866 150p	280BPU 150p
UIC 100p	2SA1302 300p	2SC898 275p	2SC2461 120p	2SC2361 120p	2SC2419 120p	2SC3627 100p	2SD-217 100p	2SD-1435 280p	2SK 274 100p	2870 150p	280BPU 150p
UIC 100p	2SA1303 300p	2SC908 275p	2SC2462 120p	2SC2362 120p	2SC2420 120p	2SC3628 100p	2SD-218 100p	2SD-1436 280p	2SK 276 100p	2874 150p	280BPU 150p
UIC 100p	2SA1304 300p	2SC908 275p	2SC2463 120p	2SC2363 120p	2SC2421 120p	2SC3629 100p	2SD-219 100p	2SD-1437 280p	2SK 278 100p	2878 150p	280BPU 150p
UIC 100p	2SA1305 300p	2SC908 275p	2SC2464 120p	2SC2364 120p	2SC2422 120p	2SC3630 100p	2SD-220 100p	2SD-1438 280p	2SK 280 100p	2882 150p	280BPU 150p
UIC 100p	2SA1306 300p	2SC908 275p	2SC2465 120p	2SC2365 120p	2SC2423 120p	2SC3631 100p	2SD-221 100p	2SD-1439 280p	2SK 282 100p	2886 150p	280BPU 150p
UIC 100p	2SA1307 300p	2SC908 275p	2SC2466 120p	2SC2366 120p	2SC2424 120p	2SC3632 100p	2SD-222 100p	2SD-1440 280p	2SK 284 100p	2890 150p	280BPU 150p
UIC 100p	2SA1308 300p	2SC908 275p	2SC2467 120p	2SC2367 120p	2SC2425 120p	2SC3633 100p	2SD-223 100p	2SD-1441 280p	2SK 286 100p	2894 150p	280BPU 150p
UIC 100p	2SA1309 300p	2SC908 275p	2SC2468 120p	2SC2368 120p	2SC2426 120p	2SC3634 100p	2SD-224 100p	2SD-1442 280p	2SK 288 100p	2898 150p	280BPU 150p
UIC 100p	2SA1310 300p	2SC908 275p	2SC2469 120p	2SC2369 120p	2SC2427 120p	2SC3635 100p	2SD-225 100p	2SD-1443 280p	2SK 290 100p	2902 150p	280BPU 150p
UIC 100p	2SA1311 300p	2SC908 275p	2SC2470 120p	2SC2370 120p	2SC2428 120p	2SC3636 100p	2SD-226 100p	2SD-1444 280p	2SK 292 100p	2906 150p	280BPU 150p
UIC 100p	2SA1312 300p	2SC908 275p	2SC2471 120p	2SC2371 120p	2SC2429 120p	2SC3637 100p	2SD-227 100p	2SD-1445 280p	2SK 294 100p	2910 150p	280BPU 150p
UIC 100p	2SA1313 300p	2SC908 275p	2SC2472 120p	2SC2372 120p	2SC2430 120p	2SC3638 100p	2SD-228 100p	2SD-1446 280p	2SK 296 100p	2914 150p	280BPU 150p
UIC 100p	2SA1314 300p	2SC908 275p	2SC2473 120p	2SC2373 120p	2SC2431 120p	2SC3639 100p	2SD-229 100p	2SD-1447 280p	2SK 298 100p	2918 150p	280BPU 150p
UIC 100p	2SA1315 300p	2SC908 275p	2SC2474 120p	2SC2374 120p	2SC2432 120p	2SC3640 100p	2SD-230 100p	2SD-1448 280p	2SK 300 100p	2922 150p	280BPU 150p
UIC 100p	2SA1316 300p	2SC908 275p	2SC2475 120p	2SC2375 120p	2SC2433 120p	2SC3641 100p	2SD-231 100p	2SD-1449 280p	2SK 302 100p	2926 150p	280BPU 150p
UIC 100p	2SA1317 300p	2SC908 275p	2SC2476 120p	2SC2376 120p	2SC2434 120p	2SC3642 100p	2SD-232 100p	2SD-1450 280p	2SK 304 100p	2930 150p	280BPU 150p
UIC 100p	2SA1318 300p	2SC908 275p	2SC2477 120p	2SC2377 120p	2SC2435 120p	2SC3643 100p	2SD-233 100p	2SD-1451 280p	2SK 306 100p	2934 150p	280BPU 150p
UIC 100p	2SA1319 300p	2SC908 275p	2SC2478 120p	2SC2378 120p	2SC2436 120p	2SC3644 100p	2SD-234 100p	2SD-1452 280p	2SK 308 100p	2938 150p	280BPU 150p
UIC 100p	2SA1320 300p	2SC908 275p	2SC2479 120p	2SC2379 120p	2SC2437 120p	2SC3645 100p	2SD-235 100p	2SD-1453 280p	2SK 310 100p	2942 150p	280BPU 150p
UIC 100p	2SA1321 300p	2SC908 275p	2SC2480 120p	2SC2380 120p	2SC2438 120p	2SC3646 100p	2SD-236 100p	2SD-1454 280p	2SK 312 100p	2946 150p	280BPU 150p
UIC 100p	2SA1322 300p	2SC908 275p	2SC2481 120p	2SC2381 120p	2SC2439 120p	2SC3647 100p	2SD-237 100p	2SD-1455 280p	2SK 314 100p	2950 150p	280BPU 150p
UIC 100p	2SA1323 300p	2SC908 275p	2SC2482 120p	2SC2382 120p	2SC2440 120p	2SC3648 100p	2SD-238 100p	2SD-1456 280p	2SK 316 100p	2954 150p	280BPU 150p
UIC 100p	2SA1324 300p	2SC908 275p	2SC2483 120p	2SC2383 120p	2SC2441 120p	2SC3649 100p	2SD-239 100p	2SD-1457 280p	2SK 318 100p	2958 150p	280BPU 150p
UIC 100p	2SA1325 300p	2SC908 275p	2SC2484 120p	2SC2384 120p	2SC2442 120p	2SC3650 100p	2SD-240 100p	2SD-1458 280p	2SK 320 100p	2962 150p	280BPU 150p
UIC 100p	2SA1326 300p	2SC908 275p	2SC2485 120p	2SC2385 120p	2SC2443 120p	2SC3651 100p	2SD-241 100p	2SD-1459 280p	2SK 322 100p	2966 150p	280BPU 150p
UIC 100p	2SA1327 300p	2SC908 275p	2SC2486 120p	2SC2386 120p	2SC2444 120p	2SC3652 100p	2SD-242 100p	2SD-1460 280p	2SK 324 100p	2970 150p	280BPU 150p
UIC 100p	2SA1328 300p	2SC908 275p	2SC2487 120p	2SC2387 120p	2SC2445 120p	2SC3653 100p	2SD-243 100p	2SD-1461 280p	2SK 326 100p	2974 150p	280BPU 150p
UIC 100p	2SA1329 300p	2SC908 275p	2SC2488 120p	2SC2388 120p	2SC2446 120p	2SC3654 100p	2SD-244 100p	2SD-1462 280p	2SK 328 100p	2978 150p	280BPU 150p
UIC 100p	2SA1330 300p	2SC908 275p	2SC2489 120p	2SC2389 120p	2SC2447 120p	2SC3655 100p	2SD-245 100p	2SD-1463 280p	2SK 330 100p	2982 150p	280BPU 150p
UIC 100p	2SA1331 300p	2SC908 275p	2SC24								





<b>VCR PINCHROLLERS Cont.</b> <b>Sharp Cont.</b> VC481, VC483, VC486, VC496, VC581, VC582, VC583, VC585, VC402, VC471, VC473, VC477, VC500, VC571, VC573, VC584, VC5920C, VCA1031 VC561, VC681, VC685, VC750, VC780, VC781, VC785, VC787, VC790, VC792, VC600, VC622, VC684, VC693, VC699, VC700, VC772, VC7810, VC782, VC782Z, VC7282MK2, VC783, VC783, VC786, VC800, VC73, VCA100, VC102, VCA104, VCA202, VCA303, VCA211, VCA234, VCA501, VCA602, VCC801, VCC802, VCH852, VCH881 VC820 <b>SAISHO</b> VR2000, VC3800 <b>SOLARA</b> SV6500, SC6600, SV7300, SV8200, SC8300, SV8200, SC8300, SV7400, SV8400, SV8420, SV8500, SV8520, SC8550, SV8600, SV8620, SV8700, SV8710, SV8720, SV8800, SV8830, SV8900, SV9600, SV9810, SV8000, SV5100 <b>SAMSUNG</b> SV716, SV717, VB510, VB520, VB610, VB616, VB617, VB619, VB620, VB626, VB627, VB629, VB630, VB631, VB632, VB633, VB634, VB635, VB636, VB637, VB638, VB639, VB640, VB641, VB642, VB643, VB644, VB645, VB646, VB647, VB648, VB649, VB650, VB651, VB652, VB653, VB654, VB655, VB656, VB657, VB658, VB659, VB660, VB661, VB662, VB663, VB664, VB665, VB666, VB667, VB668, VB669, VB670, VB671, VB672, VB673, VB674, VB675, VB676, VB677, VB678, VB679, VB680, VB681, VB682, VB683, VB684, VB685, VB686, VB687, VB688, VB689, VB690, VB691, VB692, VB693, VB694, VB695, VB696, VB697, VB698, VB699, VB700, VB701, VB702, VB703, VB704, VB705, VB706, VB707, VB708, VB709, VB710, VB711, VB712, VB713, VB714, VB715, VB716, VB717, VB718, VB719, VB720, VB721, VB722, VB723, VB724, VB725, VB726, VB727, VB728, VB729, VB730, VB731, VB732, VB733, VB734, VB735, VB736, VB737, VB738, VB739, VB740, VB741, VB742, VB743, VB744, VB745, VB746, VB747, VB748, VB749, VB750, VB751, VB752, VB753, VB754, VB755, VB756, VB757, VB758, VB759, VB760, VB761, VB762, VB763, VB764, VB765, VB766, VB767, VB768, VB769, VB770, VB771, VB772, VB773, VB774, VB775, VB776, VB777, VB778, VB779, VB780, VB781, VB782, VB783, VB784, VB785, VB786, VB787, VB788, VB789, VB790, VB791, VB792, VB793, VB794, VB795, VB796, VB797, VB798, VB799, VB800, VB801, VB802, VB803, VB804, VB805, VB806, VB807, VB808, VB809, VB810, VB811, VB812, VB813, VB814, VB815, VB816, VB817, VB818, VB819, VB820, VB821, VB822, VB823, VB824, VB825, VB826, VB827, VB828, VB829, VB830, VB831, VB832, VB833, VB834, VB835, VB836, VB837, VB838, VB839, VB840, VB841, VB842, VB843, VB844, VB845, VB846, VB847, VB848, VB849, VB850, VB851, VB852, VB853, VB854, VB855, VB856, VB857, VB858, VB859, VB860, VB861, VB862, VB863, VB864, VB865, VB866, VB867, VB868, VB869, VB870, VB871, VB872, VB873, VB874, VB875, VB876, VB877, VB878, VB879, VB880, VB881, VB882, VB883, VB884, VB885, VB886, VB887, VB888, VB889, VB890, VB891, VB892, VB893, VB894, VB895, VB896, VB897, VB898, VB899, VB900, VB901, VB902, VB903, VB904, VB905, VB906, VB907, VB908, VB909, VB910, VB911, VB912, VB913, VB914, VB915, VB916, VB917, VB918, VB919, VB920, VB921, VB922, VB923, VB924, VB925, VB926, VB927, VB928, VB929, VB930, VB931, VB932, VB933, VB934, VB935, VB936, VB937, VB938, VB939, VB940, VB941, VB942, VB943, VB944, VB945, VB946, VB947, VB948, VB949, VB950, VB951, VB952, VB953, VB954, VB955, VB956, VB957, VB958, VB959, VB960, VB961, VB962, VB963, VB964, VB965, VB966, VB967, VB968, VB969, VB970, VB971, VB972, VB973, VB974, VB975, VB976, VB977, VB978, VB979, VB980, VB981, VB982, VB983, VB984, VB985, VB986, VB987, VB988, VB989, VB990, VB991, VB992, VB993, VB994, VB995, VB996, VB997, VB998, VB999, V1000 <b>SIEMEN</b> FM350, FM352, FM355, FM361, FM362, FM363, FM364, FM381, FM382, FM383, FM451, FM462, FM464, FM466, FM461 <b>SONY</b> SL5, SL6, SL7, SL3000, SL8000, SL8080, SL8200, SL8600, SL73, SL74, SL75, SL76, SL77, SL78, SL79, SL80, SL81, SL82, SL83, SL84, SL85, SL86, SL87, SL88, SL89, SL90, SL91, SL92, SL93, SL94, SL95, SL96, SL97, SL98, SL99, SL100, SL101, SL102, SL103, SL104, SL105, SL106, SL107, SL108, SL109, SL110, SL111, SL112, SL113, SL114, SL115, SL116, SL117, SL118, SL119, SL120, SL121, SL122, SL123, SL124, SL125, SL126, SL127, SL128, SL129, SL130, SL131, SL132, SL133, SL134, SL135, SL136, SL137, SL138, SL139, SL140, SL141, SL142, SL143, SL144, SL145, SL146, SL147, SL148, SL149, SL150, SL151, SL152, SL153, SL154, SL155, SL156, SL157, SL158, SL159, SL160, SL161, SL162, SL163, SL164, SL165, SL166, SL167, SL168, SL169, SL170, SL171, SL172, SL173, SL174, SL175, SL176, SL177, SL178, SL179, SL180, SL181, SL182, SL183, SL184, SL185, SL186, SL187, SL188, SL189, SL190, SL191, SL192, SL193, SL194, SL195, SL196, SL197, SL198, SL199, SL200, SL201, SL202, SL203, SL204, SL205, SL206, SL207, SL208, SL209, SL210, SL211, SL212, SL213, SL214, SL215, SL216, SL217, SL218, SL219, SL220, SL221, SL222, SL223, SL224, SL225, SL226, SL227, SL228, SL229, SL230, SL231, SL232, SL233, SL234, SL235, SL236, SL237, SL238, SL239, SL240, SL241, SL242, SL243, SL244, SL245, SL246, SL247, SL248, SL249, SL250, SL251, SL252, SL253, SL254, SL255, SL256, SL257, SL258, SL259, SL260, SL261, SL262, SL263, SL264, SL265, SL266, SL267, SL268, SL269, SL270, SL271, SL272, SL273, SL274, SL275, SL276, SL277, SL278, SL279, SL280, SL281, SL282, SL283, SL284, SL285, SL286, SL287, SL288, SL289, SL290, SL291, SL292, SL293, SL294, SL295, SL296, SL297, SL298, SL299, SL300, SL301, SL302, SL303, SL304, SL305, SL306, SL307, SL308, SL309, SL310, SL311, SL312, SL313, SL314, SL315, SL316, SL317, SL318, SL319, SL320, SL321, SL322, SL323, SL324, SL325, SL326, SL327, SL328, SL329, SL330, SL331, SL332, SL333, SL334, SL335, SL336, SL337, SL338, SL339, SL340, SL341, SL342, SL343, SL344, SL345, SL346, SL347, SL348, SL349, SL350, SL351, SL352, SL353, SL354, SL355, SL356, SL357, SL358, SL359, SL360, SL361, SL362, SL363, SL364, SL365, SL366, SL367, SL368, SL369, SL370, SL371, SL372, SL373, SL374, SL375, SL376, SL377, SL378, SL379, SL380, SL381, SL382, SL383, SL384, SL385, SL386, SL387, SL388, SL389, SL390, SL391, SL392, SL393, SL394, SL395, SL396, SL397, SL398, SL399, SL400, SL401, SL402, SL403, SL404, SL405, SL406, SL407, SL408, SL409, SL410, SL411, SL412, SL413, SL414, SL415, SL416, SL417, SL418, SL419, SL420, SL421, SL422, SL423, SL424, SL425, SL426, SL427, SL428, SL429, SL430, SL431, SL432, SL433, SL434, SL435, SL436, SL437, SL438, SL439, SL440, SL441, SL442, SL443, SL444, SL445, SL446, SL447, SL448, SL449, SL450, SL451, SL452, SL453, SL454, SL455, SL456, SL457, SL458, SL459, SL460, SL461, SL462, SL463, SL464, SL465, SL466, SL467, SL468, SL469, SL470, SL471, SL472, SL473, SL474, SL475, SL476, SL477, SL478, SL479, SL480, SL481, SL482, SL483, SL484, SL485, SL486, SL487, SL488, SL489, SL490, SL491, SL492, SL493, SL494, SL495, SL496, SL497, SL498, SL499, SL500 <b>TOSHIBA</b> DV80, DV90, DV96, SC97, V200, V201, V202, V203, V207, V300, V309, V500, V508, V55, V57, V61, V63, V65, V66, V67, V70, V71, V72, V74, V75, V77, V81, V83, V85, V86, V93, V94 V5470, V5485 V91, V961 (Pressure Roller Assembly) <b>AKAI</b> VP7100, VS9300, VS9500, V9700, VS9800 V51, V52, V54, V55, V52, V515, V53, V58, V59, V62, V65, V69, V510, V511, V512, V513, V514, V515, V516, V517, V518, V519, V520, V521, V522, V523, V524, V525, V526, V527, V528, V529, V530, V531, V532, V533, V534, V535, V536, V537, V538, V539, V540, V541, V542, V543, V544, V545, V546, V547, V548, V549, V550, V551, V552, V553, V554, V555, V556, V557, V558, V559, V560, V561, V562, V563, V564, V565, V566, V567, V568, V569, V570, V571, V572, V573, V574, V575, V576, V577, V578, V579, V580, V581, V582, V583, V584, V585, V586, V587, V588, V589, V590, V591, V592, V593, V594, V595, V596, V597, V598, V599, V600, V601, V602, V603, V604, V605, V606, V607, V608, V609, V610, V611, V612, V613, V614, V615, V616, V617, V618, V619, V620, V621, V622, V623, V624, V625, V626, V627, V628, V629, V630, V631, V632, V633, V634, V635, V636, V637, V638, V639, V640, V641, V642, V643, V644, V645, V646, V647, V648, V649, V650, V651, V652, V653, V654, V655, V656, V657, V658, V659, V660, V661, V662, V663, V664, V665, V666, V667, V668, V669, V670, V671, V672, V673, V674, V675, V676, V677, V678, V679, V680, V681, V682, V683, V684, V685, V686, V687, V688, V689, V690, V691, V692, V693, V694, V695, V696, V697, V698, V699, V700, V701, V702, V703, V704, V705, V706, V707, V708, V709, V710, V711, V712, V713, V714, V715, V716, V717, V718, V719, V720, V721, V722, V723, V724, V725, V726, V727, V728, V729, V730, V731, V732, V733, V734, V735, V736, V737, V738, V739, V740, V741, V742, V743, V744, V745, V746, V747, V748, V749, V750, V751, V752, V753, V754, V755, V756, V757, V758, V759, V760, V761, V762, V763, V764, V765, V766, V767, V768, V769, V770, V771, V772, V773, V774, V775, V776, V777, V778, V779, V780, V781, V782, V783, V784, V785, V786, V787, V788, V789, V790, V791, V792, V793, V794, V795, V796, V797, V798, V799, V800, V801, V802, V803, V804, V805, V806, V807, V808, V809, V810, V811, V812, V813, V814, V815, V816, V817, V818, V819, V820, V821, V822, V823, V824, V825, V826, V827, V828, V829, V830, V831, V832, V833, V834, V835, V836, V837, V838, V839, V840, V841, V842, V843, V844, V845, V846, V847, V848, V849, V850, V851, V852, V853, V854, V855, V856, V857, V858, V859, V860, V861, V862, V863, V864, V865, V866, V867, V868, V869, V870, V871, V872, V873, V874, V875, V876, V877, V878, V879, V880, V881, V882, V883, V884, V885, V886, V887, V888, V889, V890, V891, V892, V893, V894, V895, V896, V897, V898, V899, V900, V901, V902, V903, V904, V905, V906, V907, V908, V909, V910, V911, V912, V913, V914, V915, V916, V917, V918, V919, V920, V921, V922, V923, V924, V925, V926, V927, V928, V929, V930, V931, V932, V933, V934, V935, V936, V937, V938, V939, V940, V941, V942, V943, V944, V945, V946, V947, V948, V949, V950, V951, V952, V953, V954, V955, V956, V957, V958, V959, V960, V961, V962, V963, V964, V965, V966, V967, V968, V969, V970, V971, V972, V973, V974, V975, V976, V977, V978, V979, V980, V981, V982, V983, V984, V985, V986, V987, V988, V989, V990, V991, V992, V993, V994, V995, V996, V997, V998, V999, V1000 <b>ALBA</b> VCR3000X, VCR4000 <b>AMSTRAD</b> TVR123, VCR4600, VCR4700, VCR5200, VCR7000 VCR6000, VCR6100 <b>AUTHENTIC</b> N850 <b>DECCA</b> VR8300 VR4842, VR6945, VR6946 <b>FERGUSON</b> 3292, 3V00, 3V01, 3V16, 3V22, 8900, 8901, 8902, 8903, 8904, 8906, 8909, 8912, 8922, 8923, 8924, 8925, 8926, 8927, 8928, 8929, 8930, 8931, 8932, 8933, 8934, 8935, 8936, 8937, 8938, 8939, 8940, 8941, 8942, 8943, 8944, 8945, 8946, 8947, 8948, 8949, 8950, 8951, 8952, 8953, 8954, 8955, 8956, 8957, 8958, 8959, 8960, 8961, 8962, 8963, 8964, 8965, 8966, 8967, 8968, 8969, 8970, 8971, 8972, 8973, 8974, 8975, 8976, 8977, 8978, 8979, 8980, 8981, 8982, 8983, 8984, 8985, 8986, 8987, 8988, 8989, 8990, 8991, 8992, 8993, 8994, 8995, 8996, 8997, 8998, 8999, 9000, 9001, 9002, 9003, 9004, 9005, 9006, 9007, 9008, 9009, 9010, 9011, 9012, 9013, 9014, 9015, 9016, 9017, 9018, 9019, 9020, 9021, 9022, 9023, 9024, 9025, 9026, 9027, 9028, 9029, 9030, 9031, 9032, 9033, 9034, 9035, 9036, 9037, 9038, 9039, 9040, 9041, 9042, 9043, 9044, 9045, 9046, 9047, 9048, 9049, 9050, 9051, 9052, 9053, 9054, 9055, 9056, 9057, 9058, 9059, 9060, 9061, 9062, 9063, 9064, 9065, 9066, 9067, 9068, 9069, 9070, 9071, 9072, 9073, 9074, 9075, 9076, 9077, 9078, 9079, 9080, 9081, 9082, 9083, 9084, 9085, 9086, 9087, 9088, 9089, 9090, 9091, 9092, 9093, 9094, 9095, 9096, 9097, 9098, 9099, 9100, 9101, 9102, 9103, 9104, 9105, 9106, 9107, 9108, 9109, 9110, 9111, 9112, 9113, 9114, 9115, 9116, 9117, 9118, 9119, 9120, 9121, 9122, 9123, 9124, 9125, 9126, 9127, 9128, 9129, 9130, 9131, 9132, 9133, 9134, 9135, 9136, 9137, 9138, 9139, 9140, 9141, 9142, 9143, 9144, 9145, 9146, 9147, 9148, 9149, 9150, 9151, 9152, 9153, 9154, 9155, 9156, 9157, 9158, 9159, 9160, 9161, 9162, 9163, 9164, 9165, 9166, 9167, 9168, 9169, 9170, 9171, 9172, 9173, 9174, 9175, 9176, 9177, 9178, 9179, 9180, 9181, 9182, 9183, 9184, 9185, 9186, 9187, 9188, 9189, 9190, 9191, 9192, 9193, 9194, 9195, 9196, 9197, 9198, 9199, 9200, 9201, 9202, 9203, 9204, 9205, 9206, 9207, 9208, 9209, 9210, 9211, 9212, 9213, 9214, 9215, 9216, 9217, 9218, 9219, 9220, 9221, 9222, 9223, 9224, 9225, 9226, 9227, 9228, 9229, 9230, 9231, 9232, 9233, 9234, 9235, 9236, 9237, 9238, 9239, 9240, 9241, 9242, 9243, 9244, 9245, 9246, 9247, 9248, 9249, 9250, 9251, 9252, 9253, 9254, 9255, 9256, 9257, 9258, 9259, 9260, 9261, 9262, 9263, 9264, 9265, 9266, 9267, 9268, 9269, 9270, 9271, 9272, 9273, 9274, 9275, 9276, 9277, 9278, 9279, 9280, 9281, 9282, 9283, 9284, 9285, 9286, 9287, 9288, 9289, 9290, 9291, 9292, 9293, 9294, 9295, 9296, 9297, 9298, 9299, 9300, 9301, 9302, 9303, 9304, 9305, 9306, 9307, 9308, 9309, 9310, 9311, 9312, 9313, 9314, 9315, 9316, 9317, 9318, 9319, 9320, 9321, 9322, 9323, 9324, 9325, 9326, 9327, 9328, 9329, 9330, 9331, 9332, 9333, 9334, 9335, 9336, 9337, 9338, 9339, 9340, 9341, 9342, 9343, 9344, 9345, 9346, 9347, 9348, 9349, 9350, 9351, 9352, 9353, 9354, 9355, 9356, 9357, 9358, 9359, 9360, 9361, 9362, 9363, 9364, 9365, 9366, 9367, 9368, 9369, 9370, 9371, 9372, 9373, 9374, 9375, 9376, 9377, 9378, 9379, 9380, 9381, 9382, 9383, 9384, 9385, 9386, 9387, 9388, 9389, 9390, 9391, 9392, 9393, 9394, 9395, 9396, 9397, 9398, 9399, 9400, 9401, 9402, 9403, 9404, 9405, 9406, 9407, 9408, 9409, 9410, 9411, 9412, 9413, 9414, 9415, 9416, 9417, 9418, 9419, 9420, 9421, 9422, 9423, 9424, 9425, 9426, 9427, 9428, 9429, 9430, 9431, 9432, 9433, 9434, 9435, 9436, 9437, 9438, 9439, 9440, 9441, 9442, 9443, 9444, 9445, 9446, 9447, 9448, 9449, 9450, 9451, 9452, 9453, 9454, 9455, 9456, 9457, 9458, 9459, 9460, 9461, 9462, 9463, 9464, 9465, 9466, 9467, 9468, 9469, 9470, 9471, 9472, 9473, 9474, 9475, 9476, 9477, 9478, 9479, 9480, 9481, 9482, 9483, 9484, 9485, 9486, 9487, 9488, 9489, 9490, 9491, 9492, 9493, 9494, 9495, 9496, 9497, 9498, 9499, 9500, 9501, 9502, 9503, 9504, 9505, 9506, 9507, 9508, 9509, 9510, 9511, 9512, 9513, 9514, 9515, 9516, 9517, 9518, 9519, 9520, 9521, 9522, 9523, 9524, 9525, 9526, 9527, 9528, 9529, 9530, 9531, 9532, 9533, 9534, 9535, 9536, 9537, 9538, 9539, 9540, 9541, 9542, 9543, 9544, 9545, 9546, 9547, 9548, 9549, 9550, 9551, 9552, 9553, 9554, 9555, 9556, 9557, 9558, 9559, 9560, 9561, 9562, 9563, 9564, 9565, 9566, 9567, 9568, 9569, 9570, 9571, 9572, 9573, 9574, 9575, 9576, 9577, 9578, 9579, 9580, 9581, 9582, 9583, 9584, 9585, 9586, 9587, 9588, 9589, 9590, 9591, 9592, 9593, 9594, 9595, 9596, 9597, 9598, 9599, 9600, 9601, 9602, 9603, 9604, 9605, 9606, 9607, 9608, 9609, 9610, 9611, 9612, 9613, 9614, 9615, 9616, 9617, 9618, 9619, 9620, 9621, 9622, 9623, 9624, 9625, 9626, 9627, 9628, 9629, 9630, 9631, 9632, 9633, 9634, 9635, 9636, 9637, 9638, 9639, 9640, 9641, 9642, 9643, 9644, 9645, 9646, 9647, 9648, 9649, 9650, 9651, 9652, 9653, 9654, 9655, 9656, 9657, 9658, 9659, 9660, 9661, 9662, 9663, 9664, 9665, 9666, 9667, 9668, 9669, 9670, 9671, 9672, 9673, 9674, 9675, 9676, 9677, 9678, 9679, 9680, 9681, 9682, 9683, 9684, 9685, 9686, 9687, 9688, 9689, 9690, 9691, 9692, 9693, 9694, 9695, 9696,	
---	--





## VIDEO SERVICE KITS

<b>AMSTRAD</b>	
VCR700	
<b>Contents</b>	
BELT SET PINCH ROLLER REEL IDLER VIDEO LAMP	£5.50
Order Code: SK41	
<b>FERGUSON &amp; JVC</b>	
3V4243	
HRD455 HRD725	
<b>Contents</b>	<b>Economy Kit Contents</b>
BELT SET PINCH ROLLER CLUTCH MECHANISM TENSION BAND	BELT SET PINCH ROLLER SUPPLY CLUTCH TAKE UP CLUTCH
Order Code: SK37	Order Code: SK38
£17.50	£9.50
3V58/59/64/65	
HRD170/180/210/233/300/320/370/400/430/530/700/750	
HRS5000	
<b>Contents</b>	
BELT SET PINCH ROLLER IDLER ARM TENSION BAND	
Order Code: SK44	£8.50
3V29/3V30	
HR7200/7300/7350	
<b>Contents</b>	
BELT SET PINCH ROLLER TENSION BAND IDLER TYRES	£6.00
Order Code: SK05	
3V35/36/38/39/49	
HRD110/111/120/225	
<b>Contents</b>	
BELT SET PINCH ROLLER TENSION BAND IDLER TYRES	£5.50
Order Code: SK04	
3V31/3V42	
HR7600/7610/7650/7655	
<b>Contents</b>	<b>Economy Kit Contents</b>
BELT SET T.U. REEL TABLE TYRE PINCH ROLLER REEL IDLER T.U. CLUTCH T.U. IDLER TENSION BAND VIDEO LAMP	BELT SET T.U. REEL TABLE TYRE PINCH ROLLER REEL IDLER TYRE T.U. IDLER TYRE T.U. CLUTCH
Order Code: SK33	Order Code: SK34
£12.00	£5.50
3V35/36/38/39/49	
HRD110/111/120/121/225	
<b>Contents</b>	<b>Economy Kit Contents</b>
BELT SET T.U. REEL TABLE TYRE SUPPLY REEL TABLE TYRE PINCH ROLLER T.U. CLUTCH T.U. IDLER REEL IDLER TENSION BAND	BELT SET T.U. REEL TABLE TYRE SUPPLY REEL TABLE TYRE PINCH ROLLER T.U. CLUTCH T.U. IDLER TYRE REEL IDLER TYRE
Order Code: SK35	Order Code: SK36
£10.50	£6.50
3V29/3V30	
HR7200/7300/7350	
<b>Contents</b>	<b>Economy Kit Contents</b>
BELT SET T.U. REEL TABLE TYRE SUPPLY REEL TABLE TYRE PINCH ROLLER REEL IDLER T.U. CLUTCH T.U. IDLER TENSION BAND VIDEO LAMP	BELT SET T.U. REEL IDLER TYRE SUPPLY REEL TABLE TYRE PINCH ROLLER REEL IDLER TYRE T.U. IDLER TYRE T.U. CLUTCH
Order Code: SK31	Order Code: SK32
£11.50	£5.60
3V44/45/48/53/54/55/57	
HRP50/HRD140/150/158/160	
HRD250/257/565/566/755	
<b>Contents</b>	<b>Economy Kit Contents</b>
BELT SET PINCH ROLLER CLUTCH MECHANISM TENSION BAND	BELT SET PINCH ROLLER
Order Code: SK39	Order Code: SK40
£15.00	£9.50
<b>FISHER</b>	
FVHP905/906/907/908/910/911/916/918	
<b>Contents</b>	<b>Economy Kit Contents</b>
BELT SET PINCH ROLLER IDLER GEAR IDLER UNIT TENSION BAND	BELT SET PINCH ROLLER IDLER TYRE
Order Code: SK57	Order Code: SK58
£13.00	£5.00
FVHP615/618/620/622/710/711/715/716/720/721/722/725	
730/830/840	
<b>Contents</b>	<b>Economy Kit Contents</b>
BELT SET PINCH ROLLER IDLER GEAR IDLER UNIT TENSION BAND	BELT SET PINCH ROLLER IDLER TYRE
Order Code: SK68	Order Code: SK69
£12.50	£3.60
<b>HITACHI</b>	
VT11/VT33	
<b>Contents</b>	
BELT SET PINCH ROLLER TENSION BAND IDLER TYRES	£6.00
Order Code: SK08	
VT11/VT33	
<b>Contents</b>	<b>Economy Kit Contents</b>
BELT SET T.U. REEL TABLE TYRE SUPPLY REEL TABLE TYRE PINCH ROLLER FF-REW IDLER CLUTCH PLATE TENSION BAND	BELT SET PINCH ROLLER FF-REW IDLER TYRE T.U. REEL TABLE TYRE SUPPLY REEL TABLE TYRE
Order Code: SK45	Order Code: SK46
£15.00	£4.50

## VIDEO SERVICE KITS (Cont.)

<b>HITACHI</b>	
VT52/61/62/63/64/65/85/86/640	
<b>Contents</b>	<b>Economy Kit Contents</b>
BELT SET PINCH ROLLER FF-REW ARM CLUTCH PLATE TENSION BAND	BELT SET PINCH ROLLER FF-REW IDLER
Order Code: SK49	Order Code: SK50
£14.00	£3.25
VT400/405/410/113/14/15/18/420/25/26/28/430/31/35/48/450/498	
510/520/25/26/530/35/36/540/545/46/48/570/75/576/580/85/88	
<b>Contents</b>	
TIMING BELT PINCH ROLLER FF-REW ARM CLUTCH BASE TENSION BAND	£11.50
Order Code: SK52	
VT100/110/111/113/115/118/120/125/128/130/135/138/145/150/	
175/220/225/250/255/258/260/MTL30	
<b>Contents</b>	
BELT SET PINCH ROLLER FF-REW ARM CLUTCH PLATE TENSION BAND	£15.00
Order Code: SK51	
<b>PANASONIC</b>	
NV2000/NV2010	
<b>Contents</b>	<b>Economy Kit Contents</b>
BELT SET PINCH ROLLER TENSION BAND IDLER TYRES	BELT SET PINCH ROLLER TENSION BAND IDLER TYRES
Order Code: SK03	Order Code: SK02
£6.25	£5.50
NV300/NV330/NV333/NV340/NV366	
<b>Contents</b>	
BELT SET PINCH ROLLER TENSION BAND IDLER TYRE	£5.50
Order Code: SK01	
NV2000/NV2010	
<b>Contents</b>	<b>Economy Kit Contents</b>
BELT SET PINCH ROLLER FF IDLER PLAY IDLER TENSION BAND VIDEO LAMP	BELT SET PINCH ROLLER IDLER TYRE PULLEY TYRE
Order Code: SK13	Order Code: SK14
£9.50	£4.50
NV7000/NV7200/NV7800	
<b>Contents</b>	<b>Economy Kit Contents</b>
BELT SET PINCH ROLLER IDLER UNIT PLAY IDLER TENSION BAND	BELT SET PINCH ROLLER IDLER TYRE CLUTCH TYRE
Order Code: SK11	Order Code: SK12
£10.00	£4.20
NV300/NV330/NV333/NV340/NV366	
<b>Contents</b>	<b>Economy Kit Contents</b>
BELT SET PINCH ROLLER IDLER UNIT PLAY IDLER TENSION BAND	BELT SET PINCH ROLLER IDLER TYRE PLAY IDLER TYRE
Order Code: SK15	Order Code: SK16
£8.00	£4.00
NVG7/NVG9/VNG10/NVG11/NVG12/NVG14/NVG15/NVG16/	
NVG18/NVG30/NVG120/NVG130/NVG400/NVH65(PX/AC)/	
AG18/10(P/K)	
<b>Contents</b>	<b>Economy Kit Contents</b>
LOADING BELT CAPSTAN BELT PINCH ROLLER IDLER TENSION BAND	LOADING BELT CAPSTAN BELT PINCH ROLLER IDLER TYRE
Order Code: SK27	Order Code: SK28
£9.50	£4.50
NV332	
<b>Contents</b>	<b>Economy Kit Contents</b>
BELT SET PINCH ROLLER PLAY IDLER FF-REW IDLER TENSION BAND FF-REW TYRE	BELT SET PINCH ROLLER PLAY IDLER TYRE FF-REW IDLER TYRE
Order Code: SK29	Order Code: SK30
£13.00	£5.10
NV230/250/260/280/430/450/460/470/650/810/890/	
AG120/PK/AG1500PK	
<b>Contents</b>	<b>Economy Kit Contents</b>
BELT SET PINCH ROLLER IDLER TENSION BAND	BELT SET PINCH ROLLER IDLER TYRE
Order Code: SK23	Order Code: SK24
£7.00	£3.50
NV600/NV688	
<b>Contents</b>	<b>Economy Kit Contents</b>
BELT SET PINCH ROLLER PLAY IDLER FF-REW IDLER TENSION BAND	BELT SET PINCH ROLLER PLAY IDLER TYRE FF-REW IDLER TYRE
Order Code: SK25	Order Code: SK26
£13.00	£6.50
NV730/NV770	
<b>Contents</b>	<b>Economy Kit Contents</b>
SLOT IN BELT LOADING BELT PINCH ROLLER IDLER UNIT TENSION BAND	SLOT IN BELT LOADING BELT PINCH ROLLER IDLER TYRE
Order Code: SK19	Order Code: SK20
£7.00	£4.30
NV370/NV380/480/630/780/830/850/AG2100PK/AG2200PK	
<b>Contents</b>	<b>Economy Kit Contents</b>
BELT SET PINCH ROLLER IDLER TENSION BAND	BELT SET PINCH ROLLER IDLER TYRE
Order Code: SK21	Order Code: SK22
£7.00	£3.50
NV777/NV788	
<b>Contents</b>	<b>Economy Kit Contents</b>
BELT SET PINCH ROLLER IDLER UNIT TENSION BAND	BELT SET PINCH ROLLER IDLER TYRE
Order Code: SK17	Order Code: SK18
£7.50	£4.00

## VIDEO SERVICE KITS (Cont.)

<b>SHARP</b>	
VC37	
<b>Contents</b>	<b>Economy Kit Contents</b>
BELT SET PINCH ROLLER REEL IDLER TENSION BAND VIDEO LAMP	BELT SET PINCH ROLLER REEL IDLER TYRE
Order Code: SK47	Order Code: SK48
£9.00	£5.00
VC500/VC571/VC581/VC582/VC583/VC584/VC5F3	
<b>Contents</b>	<b>Economy Kit Contents</b>
BELT SET PINCH ROLLER REEL IDLER TENSION BAND	BELT SET PINCH ROLLER REEL IDLER
Order Code: SK60	Order Code: SK61
£9.50	£6.50
VC781/VC781A/VC782/VC785/VC786/VC793/VC800	
VCA100/VCA102/VCA104/VCA202	
<b>Contents</b>	<b>Economy Kit Contents</b>
BELT SET PINCH ROLLER REEL DRIVE UNIT TENSION BAND	BELT SET PINCH ROLLER REEL DRIVE UNIT TYRE
Order Code: SK64	Order Code: SK65
£13.50	£6.25
VC681/VC682/VC684/VC685/VC693/VC699/VC6F3/VC700	
<b>Contents</b>	<b>Economy Kit Contents</b>
BELT SET PINCH ROLLER REEL DRIVE UNIT TENSION BAND	BELT SET PINCH ROLLER REEL DRIVE UNIT TYRE
Order Code: SK62	Order Code: SK63
£13.50	£6.25

## THIS MONTHS SPECIAL OFFERS

STK461	£6.00	STK7563F	£8.00
STK5332	£1.80	STK73410	£3.50
STK5333	£5.50	TA8205AH	£2.50
STK5422	£3.75	TA8210AH	£3.00
STK5476	£3.50	TA8215H	£3.00
STK7308	£3.50	TA8216H	£3.75
STK7348	£2.80	TIPL791A	£0.80
STK7358	£4.40		

## SONY FUNCTION SWITCH (2 LEG) SPECIAL PRICE £0.50

VIDEO REEL MOTOR PU51381V	£15.00
3V29, 3V30, 3V31, 3V32, 3V39,	
8830, 8931, 8941, 8942, HR7200	
HR7300, HR7600, HR7610,	
HR7650, HR7655	
HITACHI VIDEO HEAD	£11.00
VT11, VT14, 16, 30, 33, 34, 330,	
340, 503, 640, 5030	
MITSUBISHI VIDEO HEAD	£16.00
HS303, 304, 320, 700	
HS306, 318, 710	£18.00
HS300, 301, 302, 310	£17.00
HS337, 347	£17.00
HITACHI TRANSFORMER 2434274	£14.00
OJTPUT TV MODULE HM6251	£5.50

## PHILIPS

CASSETTE LEFT ASSEMBLY 69120366	£11.00
DV183, 19C, 285, 471, 562, 761, VR6180, 6182, 6185,	
VR6285, 6299, 6291, 6293, 6362, 6367, 6393, VR6467, 6468,	
6470, 6567, 6570, 6760, 67E1, 6870, 6970	
PRESSURE ROLLER ASSEMBLY	£5.00
DV183, DV180, DV286, DV486, DV471, DV582, DV571,	
DV761, VR6180, VR6182, VR6185, VR6285, VR6290,	
VR6291, VR6293, VR6362, VR6367, VR6380, VR6391,	
VR6312, VR6467, VR6468, VR6470, VR6561, VR6570,	
VR6581, VR6670, VR6676, VR6760, VR6761, VR6762,	
VR681C, VR6870, VR6975, VR6861, 635B7, 685B4,	
715B4, 725B3, 925B31	

## I.C. PROTECTOR

ICPF10	ICPN5
ICPF15	ICPN10
ICPF20	ICPN15
ICPF25	ICPN20
ICPF38	ICPN25
ICPF50	ICPN38
ICPF75	ICPN50
	ICPN75

## IMPORTANT NOTICE

Attention all customers who purchased the WOODEN HANDLE SOLDERING IRONS (BRAND MITSUKO - MODEL MX-34 (30/40 AND 60 WATTS) from us. Please DO NOT USE this tool. We would like you to return this item to us immediately and we will refund your money together with the postage. We apologise for any inconvenience caused.

PRICE: ONLY 30p EACH

# GRANDATA LTD

K.P. HOUSE, UNIT 15

POP IN COMMERCIAL CENTRE, SOUTHWAY  
WEMBLEY, MIDDLESEX, ENGLAND HA9 0HB  
Telephone: 081-900 2329 Fax: 081-903 6126

Access & Visa Card accepted.

Open Monday to Saturday.

# JUST ARRIVED

## VIDEO HEADS

<b>AKAI</b>	
VSF600, VSF650	3800P
VP7100, VP7200, VP77	1500P
VS155, VS165	2600P
VS20, VS22, VS24, VS25, VS26, VS27, VS422, VS425, VS426, VS427, VSF10, VSP8, VSP9	1700P
VS240, VSP82, VS202	1500P
VS33	2600P
VSR9	1700P
<b>AMSTRAD</b>	
VCR8800, VCR8804, VCR9340	2400P
DD8900, DD8904, TVR4, VCR6200, VCR8600, VCR8602, VR8700	1300P
VCR8603, VCR8604, VCR8704, VCR8714	1350P
<b>BAIRD</b>	
VC14L	3000P
VHS82	7000P
<b>BLAUPUNKT</b>	
CR1000, CR1200, CR1500	4650P
CR1800	4100P
RTV321, RTV322	1700P
RTV330	2300P
RTV333	1000P
RTV33B	2800P
RTV348	2700P
RTV404, RTV414	3000P
RTV635	3000P
RTV640	3000P
RTV750, RTV800, RTV900	3500P
RTV810	4400P
RTV910	4500P
<b>JVC</b>	
HRD330, HRD337, HRD440, HRD637, HRD641, HRD660, HRFC100	2200P
<b>JVC AND FERGUSON</b>	
8902/8903/8909/8912/8922	1000P
8923/8925/8929/8935	650P
8931/8933	750P
FV43H, HRD860	3800P
VC141L, HRD190, HRD610	3050P
FV44L	2200P
BR1600, HRD142, HRD156, HRD152	1550P
BR6200	720P
HRD154, HRD217, HRD321, HRD350, HRD521, HRD522, HRD525, HRD527, HRD550	1700P
HRD580, HRD620, HRD650	2900P
<b>FIDELITY</b>	
VR900, VR910	1600P
<b>FISHER</b>	
FVHD140, FVHD40, FVHP1, FVHP10, FVHP20	
FVHP40, FVHS10	1600P
FVHP200, FVHP210, FVHP300, FVHP310	2100P
FVHP500, FVHP5100, FVHP730, FVHP830	1200P
FVHP980	2500P
<b>FUNAI</b>	
E1100, VIP5000	1200P
VCR5840, VCR8007, VIP2500A, VIP3000A, VIP6000, VIP150	2200P
VCR4530, VCR6000, VCR6100	1600P
VCR8103, VCR600, VCR6100	1600P
VCR8103, VCR8107	2200P
VIP300A MKII	1900P
<b>GEC</b>	
V4005H	2000P
<b>GOLDSTAR</b>	
GHV1232, 1233, 1241, 1242, 1243, 1244, 1290, 1291, 1295, 1296, 1891, VCP4130, 4300, 4301, 4305, 4306, 4310, 4311, 4315, 4316, 4320, 4321, 4326	1650P
<b>GRUNDIG</b>	
VS456	1700P
SE6110, SE9100, TVR4510, TVR5510, VS500, VS510, VS5180, VS6190, VS700, VS900	1800P
VS790, VS930, VS940	3800P
MVS660, SE6160, VERONA, VS660, VS6690	3500P
MVS710, MVS720, MVS910, SE9120, VS800, VS810, VS910, VS920, SE7120, VS710, VS720	1800P
VS160, VS740	4400P
VS170	4600P
VS680	4600P
<b>HINARI</b>	
VCR34H, VTV200, VXL90	1850P
<b>HITACHI</b>	
VT15, VTP10, VTP30	1100P
VT16B, VT260, VT498	2700P
VT570, VT575, VT576, VT580, VT585, VT588	3400P
VT5600	1200P
VT60	1500P
VT660E	2600P
VT6700, VT6800	1200P
VTL30	2100P

VT522, VTM620, VTM622, VTM720, VTM722, VTM822	2000P
VTM725, VTM726, VTM72B	1600P
<b>ITT</b>	
VR3520, VR3701, VR3719, VR3720, VR3721, VR3759, VR9720	2000P
VR3730, VR3731, VR3749, VR3907, VR3908	2700P
VR3918, VR3919, VR3938	1800P
VR396B	7000P
VR3984	2300P
VR3958, VR4993	650P
VR4913, VRP3833	650P
<b>LUXOR</b>	
9245, 9251, 9254	1225P
9255, 9256	2150P
9270, 9271, 9273	1800P
9272, 928217	2700P
9252	2500P
928017, 928077, 928097, 929107, 929117	1700P
9253	2500P
9281	2700P
9284, 9295, VR3701, VR3721, VR3731, VR3761	2100P
<b>MATSUI</b>	
VX600	1100P
VX750	1500P
VX990	1600P
<b>MITSUBISHI</b>	
HSE12, HSE22, MX1	2400P
HS411EZ, HS411GZ	2900P
HS273	1700P
HSB10, HSB20, HSE10, HSE20, HSE21, HSE41	2200P
HSB11, HSB21	2200P
HSB30	2400P
HSE31, HSB31, HSE32	2800P
HSE50	3300P
<b>NATIONAL</b>	
NV8050, NV8051	2800P
AG1000, AG1050, NV260	1650P
AG6010, AG6015	2500P
AG6840	2400P
NV200	850P
NVD80	5000P
NVF65, NVH75	3400P
NVF51	4200P
NVG19	2300P
NVJ33, NVL21, NVJ30	1800P
NVJ35	3000P
NVM1, NVM3, NVM5	4200P
AG2100, AG2200	700P
NVF65	3200P
<b>N.E.C.</b>	
DX2000	3400P
DS6000	3500P
DX1000, DX1600, N9040, N9053, N9055	2000P
DX4000, N9610, DX3000	3200P
N9052, N9530	3400P
N9110, N9120, N914C	2700P
VCP1	1700P
PVC2300, PVC240, PVC740, PVC744, PVC760, PVC764	1600P
<b>SAMSUNG</b>	
VM1560, VN1561	2200P
<b>SANYO</b>	
VHR7900	3600P
<b>SHARP</b>	
VC585, VC685	2300P
VC90ET	3900P
VFH815	2800P
<b>SONY</b>	
SLV373UB	3000P
<b>TOSHIBA</b>	
V660	2350P
V880MS	2600P
V700G	3700P
V500G, V509G	2500P
V9680	2900P
V300G, V301, V305, V309G	2550P
V61, V63	1700P
V110, V120, V130, V140, V210, V220	1800P

## TELEVISION ON/OFF MAINS SWITCHES

Baur, Normende, Nova, Pioneer, Quelle, Saba, Salora, TEC, Thomson & Vega 375P

## VIDEO MOTORS

<b>HITACHI</b>	
VT11, VT14, VT15, VT16, VT17, VT19, VT35, VT39, VT57, VT88 (capstan motor)	3100P
<b>BANG &amp; OLUFSEN</b>	
VHS65, VHS90 (capstan motor)	3100P

## LOADING MOTOR UNITS

<b>ITT</b>	
VR3605, VR3905, VR3955, VR3985	1100P
VP2826, VR3906, V43926, VR3976	1250P
VP3946, VR3906, VR3948, VR3986, VR3995, VR6948	1500P
<b>JVC</b>	
HRD110, HRD111, HRD120, HRD121, HRD225	1100P
HRD140, HRD150, HRD157M, HRD158MS, HRD160, HRD250, HRD257MS, HRD566, HRP50	1250P
HRD455, HRD725, N895	1500P
<b>SABA</b>	
VR6005, VR6014, VR7004, VR7011, VR8011, VR8014	1100P
VR6006, VR6007, VR608, VR6009, VR6018, VR7007, VR7018, VR9006	1250P
VR6016, VR6038, VR7016	1500P
<b>TELEFUNKEN</b>	
VR1925, VR1930, VR1940, VR1950, VR925, VR930, VR940, VR950	1100P
A920, VR2920, VR12970, VR7921, VR7926, VR7931, VR7971, VR975	1250P
VR1970, VR1980, VR7970, VR7980, VR970, VR980	1500P
<b>THOMSON</b>	
V320, V321, V323, V326, V4200, V4300	1100P
V342, V343, V352, V353, V360, V4210, V4230, V4260	1250P
V364, V368, V4400, V6000	1500P
<b>THORN-FERGUSON</b>	
3V35, 3V36, 3V38, 3V39, 3V49, 8943, 8944, 8947B, 8948	1100P
3V44, 3V45, 3V48, 3V54, 3V55, 3V57, 8947, 3V43, 9845	1250P
3V43, 9845	1500P
<b>TOSHIBA</b>	
V55, V57	1100P
V65, V66, V67	1250P
V61, V63	1500P

## CASSETTE HOUSING

<b>AKAI</b>	
VS35, VS53, VS55, VS66, VS75	2600P
<b>FERGUSON</b>	
FV31R	4300P
<b>JVC &amp; FERGUSON</b>	
HRD515, HRD520, HRD527, HRD540, HRD550, HRD580, HRD600, HRD610, HRD620, HRD660, HRD670, HRD830, HRD840, HRD850, HRD860, HRD4050, HRD6600 & FV37H	2400P

## IC TRANSISTORS

M491BB1	500P
SAA5243PE	800P
TIP112H	50P
UPC1488H	150P
STR4090A	650P

## IC AND TRANSISTORS

BU506DF	120P
BUZ11	200P
BUZ80	200P
M494B1	700P
SAA5231	300P
SAA1293	550P
S2000A3	175P
S2000AF	175P
S2055A	200P
S2000AF	175P
S2530A	100P
TEA201BA	200P
UC3844	100P
UPC1185H2	400P

## REMOTE CONTROLS

<b>AKAI</b>	
RC-V10A	1000P
RCV37B	1000P
V25A	1000P
<b>BUSH</b>	
2020T, 2114T, 2321T, 2514T	1000P
2020, 2114, 2321, 2514	1000P
<b>DECCA</b>	
RC70	850P
<b>FISHER</b>	
RC905B	1000P
<b>GRANADA/REDIFFUSION</b>	
UNIVERSAL, 79500C, 986700	850P
<b>SATELLITE</b>	
MK4 TEXT, 70115G, 70133G, 70357E	850P
MK4A TEXT, 70375C	850P
95288E	1000P
94490D	1000P

## REMOTE CONTROLS

### GRUNDIG

TP160E 1050P  
 TP200, TP300 1000P  
 TP400 850P  
 TP590-600 1050P  
 TP390, TP610 1050P  
 TP621 1050P  
 TP630, TP650 1000P  
 TP660 1050P  
 TP661 1050P

### HITACHI

CLE800-CLE830 900P  
 A617402/655602 1000P  
 A512120/230 1000P  
 A514790 1000P  
 A5088470 1000P  
 A518612 1000P  
 SCL002 1000P  
 C2096 1000P  
 A511940 1000P  
 655602H 1000P

### ITT

IFB13, 14, 15 900P  
 FS4 850P  
 RG305 900P  
 RG306 900P  
 FS9/1-10/1 900P  
 VS5 RUK 900P  
 VS4-1 900P  
 MULTICONTROL (17C20) 1000P

### KORTING

18279, 18396, 18460, 18521 SE 1000P  
 40540 VTS 1000P

### LOEWE

DC11 1000P

### MATSUI

010270601 1000P  
 VX770 1000P

### METZ

JAVA COLOR (6890) 1000P  
 COLOR (7156) 1000P  
 JAVA (7180) 1000P

### MITSUBISHI

939P/03607, 939P/03609 900P

### NOKIA

SATELLITE 1000P

### NORMENDE

TC2336 1050P  
 CMC1, TC3519 1050P

### OCEANIC

390C9500 1000P

### ORION

RC53 1000P

### PANASONIC

EUR51200 900P  
 TC2200 900P  
 VSQ0357/NV730 1050P  
 TNQ1621 1000P

### PHILCO

CARVEL, CONCORDE, MERCURY 1000P  
 TELESTAR 1000P  
 TC10 1000P

### PHILIPS

RC5002, 5154 900P  
 KT3 NON TEXT 900P  
 69117032 1050P  
 69117194 1050P  
 RC5991 UNIV 850P  
 RC3B 900P  
 KT3 TEXT 900P  
 RC5352 900P  
 RC5375 900P  
 RC5 STANDARD 900P  
 RC5901 900P  
 RC5903 900P

### SABA

T6772 1000P  
 TC319-320 1050P  
 TC356 1050P  
 TC358 1050P  
 TC360 1000P  
 TC365 1000P

### SALORA

SERIES L 1000P  
 86173 1000P

### SANYO

RC218, RC222, RC228, RC238 900P  
 JXGE 1000P  
 JXDE 1000P  
 VHR2300 1000P  
 RC628 1000P

### SHARP

G0121CESA, 123CESA, 204, 251 900P

### SIEMENS

FC616 1000P  
 FC631 1000P  
 FC742 1000P

### SONY

RM604, RM605, RM606 900P  
 32 CHANNEL 900P  
 RM613 900P  
 RM632, RM636 900P

### TATUNG

FXA 1000P  
 RC70 900P  
 FX70 FASTTEXT 850P

### TELEFUNKEN

FB632 1000P  
 FB639 1000P

### THORN/FERGUSON

3V35-42 900P  
 3V31-32 900P  
 3V57-58 1050P  
 TX10 TEXT 850P  
 TX10 STEREO TEXT 850P  
 TX9-90-100 850P  
 3V55, FV11 1050P  
 TX100 FASTTEXT 900P  
 TX100 STEREO FASTTEXT 900P  
 PROFESSIONAL 850P

### TOSHIBA

CT937 1000P  
 CT9117 1000P  
 201R4B 1000P

### UNIVERSAL PROGRAMMABLE REMOTE CONTROL

Controls up to 4 different devices which use infra red remote controls including TV, audio, VCR and satellite. (Need original remote control to program)

Order code: IR100R Price: 1950P

We stock Remote Controls for over 5000 different models. Ring for further details on 081-900-2329.

## BACKUP BATTERIES

### REPLACEMENT PHILIPS NI-CAD BACKUP BATTERIES

Replaces Philips Part No's: 138-10138, 138-10313. 1.2V - 90mAh 160P  
 Replaces Philips Part No's: 138-10229. 2.4V - 90mAh 260P

### REPLACEMENT FERGUSON NI-CAD BACKUP BATTERIES

Replaces Ferguson Part No: 00E6-067-001. 1.2V  
 Used on: TX10 150P  
 Replaces Ferguson Part No's: 00E6-066-001. 2.4V  
 Used on: 3V35, 3V56, 3V58, 3V65 280P

## LINE OUTPUT TRANSFORMERS

Description	Price	Order Code
HITACHI 2433752	1500P	LOT01
ORION 3714002	1500P	LOT02
FIDELITY ZX300	1500P	LOT03
FE TX100 90 DEG	1500P	LOT04
SABA 490007182	1500P	LOT05
FE TX90 WHITE	1650P	LOT06
ITT D307/37 EQ	1600P	LOT07
BLAUPUNKT 210	1600P	LOT08
GRUNDIG 2922010	1600P	LOT09
ITT CVC800/1/3	1500P	LOT10
ITTD218/37 EQ	1600P	LOT11
NORMENDE 5255	1600P	LOT12
SABA 81000 200	1600P	LOT13
SALORA T236 EQ	1650P	LOT14
SABA 811-50-24	1600P	LOT15
SABA 770223500	1600P	LOT16
TELEFUNKEN AT1	1450P	LOT17
TELEFUNKEN EQ	1400P	LOT18
SALORA FM0218B	1600P	LOT19
NORMENDE 5255	1600P	LOT20
ITT CVC 1150/1	1500P	LOT21
ITT COMPACT 80	1500P	LOT22
FE TX100 GREEN	1450P	LOT23
HINARI CT4/5 5113	1500P	LOT24
SELECO 6320410	1600P	LOT25
BLAUPUNKT 8667	1600P	LOT26
ITT COMPACT B1	1450P	LOT27
ITT CT3326 MUL	1500P	LOT28
ITT D066/37 EQ	1600P	LOT29
ITT 3546 EQ	1500P	LOT30
LUXOR 5810110	1600P	LOT31
SABA 849380920	1600P	LOT32
HITACHI 2434141 CP	1450P	LOT33
FE TX100 110 D	1700P	LOT34
HANTAREX 28021	1600P	LOT35
SHARP C3700 EQ	1600P	LOT36
HITACHI 2432981 CP	1500P	LOT37

We stock line output transformers for over 100 different models. Please ring 081-900 2329 for more information.

## FAULT FINDING GUIDE BOOK

Video Recorders Edition 2

Lists more than 2200 faults for 43 different brands

Price: £9 45p Only. No VAT  
 Order Code: BOOK01

Television Edition 3

Lists more than 3500 faults for 50 different brands

Price: £9 45p Only. No VAT  
 Order Code: BOOK02

## VIDEO HEAD CLEANING STICKS



Order Code: SP14

Price: 17p Each  
 15p Each Pack of 10pcs  
 13p Each Pack of 25 pcs

## FUSES

Value	TIME LAG (20mm)		QUICK BLOW (20mm)	
	Order Code	Price	Order Code	Price
160mA	FUSE01	75P	FUSE17	60P
250mA	FUSE02	75P	FUSE18	60P
315mA	FUSE03	75P	FUSE19	60P
400mA	FUSE04	75P	FUSE20	60P
500mA	FUSE05	75P	FUSE21	60P
630mA	FUSE06	75P	FUSE22	60P
800mA	FUSE07	60P	FUSE23	60P
1A	FUSE08	60P	FUSE24	60P
1.25A	FUSE09	60P	FUSE25	60P
1.6A	FUSE10	60P	FUSE26	60P
2A	FUSE11	50P	FUSE27	60P
2.5A	FUSE12	50P	FUSE28	60P
3.15A	FUSE13	55P	FUSE29	50P
4A	FUSE14	55P	FUSE30	50P
5A	FUSE15	60P	FUSE31	50P
6.3A	FUSE16	60P	FUSE32	50P

## CERAMIC PLUG TOP

3A	FUSE33	100P
5A	FUSE34	100P
13A	FUSE35	100P

ALL THE ABOVE PRICES ARE FOR PACKS OF 10 FUSES

Solder Mop 1.2mm x 10 metres	300P
Tubed Silicon Grease 50 gram	200P
Tubed Heat Sink Compound 25 gram	150P

## UNIVERSAL HEAD EXTRACTOR TOOL

Hand tool designed for extracting hard to remove heads without damage to either the head or the mounting assembly. Adjustable so as to suit various brand heads.

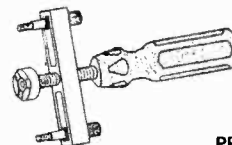

PRICE - £7

## GRANDATA LTD

K. P. HOUSE, UNIT 15,  
 POP IN COMMERCIAL CENTRE,  
 SOUTHWAY, WEMBLEY,  
 MIDDLESEX, ENGLAND HA9 0HB  
 Tel: 081-900 2329 Fax: 081-903 6126



ELC EAST LONDON COMPONENTS			AUDIO TELEVISION VIDEO COMPONENTS AT VERY KEEN PRICES		
TEL: 081-472 4871 FAX: 081-503 5926			REMOTE CONTROLS FROM £9.99		
<b>VIDEO BELT KITS</b>			<b>VIDEO SPARES</b>		
AKAI	VS1/25	1.75	3V29 TAKE UP IDLER	£1.00p	
AKAI	VS2/25	2.00	3V29 FF-REW IDLER	£2.00p	
AKAI	VS105/250	1.50	VS59/65 FV1014 IDLER	£1.50p	
ALBA	VC4R000	1.50	3V23 LOADING ROLLER BAR	£3.99p	
ALBA	AMSTRAD	1.50	SHARP 0005 & 0006	£1.95p	
ALBA	VC4R600	1.80	SHARP V0651 ASSEMBLY	£6.99p	
ALBA	VC6R000	1.30	VT11/14/17 IDLER	£1.95p	
ALBA	VC7R000	1.00	VT11 CLUTCH ASSEMBLY	£6.99p	
ALBA	FERGUSON	1.00	VT100/225/260 IDLER	£2.75p	
ALBA	3V22	1.80	NEC 9013 IDLER	£4.99p	
ALBA	3V29/30/33	1.00	SANYO VHR3300 IDLER	£3.99p	
ALBA	3V42/65	0.85	AKAI VS105/250 CLUTCH ASSEMBLY	£11.99p	
ALBA	4T5	1.25	SAISHO VR380 CLUTCH	£4.99p	
ALBA	CT45	1.50	MITSUBISHI H5337 F/F IDLER	£2.70p	
ALBA	HITACHI	1.30	ALBA SENTRA PULLEY	£1.35p	
ALBA	CPT1444	21.99	MATSUJIM LUMITER POST	£1.25p	
ALBA	CPT1453	19.99	PAISONIC NV370 IDLER	£1.95p	
ALBA	CPT1456	19.99	FISHER 015 IDLER	£3.50p	
ALBA	CPT1471	29.99	FISHER GEAR ASSEMBLY	£5.99p	
ALBA	CPT1473	29.99	AMSTRAD PINCH WHEEL MOD KIT	£4.99p	
ALBA	CPT1474	29.99	UNIVERSAL TRIPLER	£7.99p	
ALBA	CPT1476	19.99	UNIVERSAL TRIPLER WITH FOCUS	£7.99p	
ALBA	CPT1482	19.99	HITACHI MODULE HM6251	£6.99p	
ALBA	CPT1493	19.99	CUC210 TRIPLER	£16.99p	
ALBA	CPT2028	21.99	TENSION BAND FOR MOST MOD FROM	£1.99p	
ALBA	CPT2078	19.99	CIRCUIT PROTECTOR ICP	£5.99p	
ALBA	CPT2174	19.99	TX10 FOCUS UNIT	£7.99p	
ALBA	CPT2176	19.99	PHILIPS BACK-UP BATTERY	£1.50p	
ALBA	CPT2178	19.99	ALBA BATTERY 1F5 5V	£2.00p	
ALBA	CPT2234	19.99	TV SWITCHES FOR MOST MOD. FROM	£1.00p	
ALBA	CPT2248	19.99	SONY FUNCTION SWITCH	£1.00p	
ALBA	CPT2274	19.99			
ALBA	CPT2278	19.99			
ALBA	CPT2508	39.99			
ALBA	CPT2808	39.99			
ALBA	CPT2748	25.00			
ALBA	CVC20	13.99			
ALBA	CVC28/32	9.99			
ALBA	COMPACT	12.99			
ALBA	BOR	19.99			
ALBA	FST	19.99			
ALBA	CVC1215	19.99			
ALBA	DIG13 110	19.99			
ALBA	DIG13 90	19.99			
ALBA	CT3315	19.99			
ALBA	CT3835	19.99			
ALBA	FX3448	19.99			
ALBA	3V65/VR32 CASSETTE HOUSING	25.00			
ALBA	3V38/45 CASSETTE HOUSING	24.99			
ALBA	VT33/65 CASSETTE HOUSING	24.99			
ALBA	OSAKI VCR33 HOUSING	24.99			
ALBA	VT408/800 HOLDER CASSETTE	7.00			
ALBA	VT400/800 SIDE BRACKET	11.99			
ALBA	VR6462 CASSETTE HOUSING	19.99			
ALBA	VR6467 CASSETTE HOUSING	14.99			
ALBA	3V35 CAPSTON MOTOR	19.99			
ALBA	3V65 CAPSTON MOTOR	24.99			
ALBA	VT110/150 CAPSTON MOTOR	24.99			
ALBA	VT500 CAPSTON MOTOR	29.99			
ALBA	VT600/700 CAPSTON MOTOR	29.99			
ALBA	MVG SERIES PINCH ASSEMBLY	8.50			
ALBA	MITSUBISHI ASSEMBLY	19.99			
ALBA	VR6367 PINCHWHEEL RACK	19.99			
ALBA	VR6367 MODIFICATION KIT	8.99			
ALBA	VIDEO HEAD PULLER	6.90			
ALBA	VR6367 CHARLIE LOADING KIT	9.99			
ALBA	VCR CILIPS & SPRING KIT	5.50			
ALBA	AN3822K	7.99			
ALBA	AN5151	6.99			
ALBA	AN5435	2.50			
ALBA	AN5452	2.99			
ALBA	AN5521	2.99			
ALBA	AN5900	1.50			
ALBA	AN7161	3.40			
ALBA	AN7171	4.25			
ALBA	AN7178	2.60			
ALBA	BA718	1.99			
ALBA	BA3402	3.99			
ALBA	BA6268	2.99			
ALBA	BA6109	1.80			
ALBA	BA6211	2.99			
ALBA	BA6222	1.99			
ALBA	BA6229	2.80			
ALBA	BA6238	1.99			
ALBA	BA6239	2.50			
ALBA	BA6304	1.90			
ALBA	BA6305	1.90			
ALBA	BA6259	2.99			
ALBA	BA10324	1.99			
ALBA	BA10358	1.80			
ALBA	BA15218	2.20			
ALBA	CN765	4.99			
ALBA	CN766	4.99			
ALBA	CN767	4.99			
ALBA	CN768	4.99			
ALBA	CN769	4.99			
ALBA	CN770	4.99			
ALBA	CN771	4.99			
ALBA	CN772	4.99			
ALBA	CN773	4.99			
ALBA	CN774	4.99			
ALBA	CN775	4.99			
ALBA	CN776	4.99			
ALBA	CN777	4.99			
ALBA	CN778	4.99			
ALBA	CN779	4.99			
ALBA	CN780	4.99			
ALBA	CN781	4.99			
ALBA	CN782	4.99			
ALBA	CN783	4.99			
ALBA	CN784	4.99			
ALBA	CN785	4.99			
ALBA	CN786	4.99			
ALBA	CN787	4.99			
ALBA	CN788	4.99			
ALBA	CN789	4.99			
ALBA	CN790	4.99			
ALBA	CN791	4.99			
ALBA	CN792	4.99			
ALBA	CN793	4.99			
ALBA	CN794	4.99			
ALBA	CN795	4.99			
ALBA	CN796	4.99			
ALBA	CN797	4.99			
ALBA	CN798	4.99			
ALBA	CN799	4.99			
ALBA	CN800	4.99			
ALBA	CN801	4.99			
ALBA	CN802	4.99			
ALBA	CN803	4.99			
ALBA	CN804	4.99			
ALBA	CN805	4.99			
ALBA	CN806	4.99			
ALBA	CN807	4.99			
ALBA	CN808	4.99			
ALBA	CN809	4.99			
ALBA	CN810	4.99			
ALBA	CN811	4.99			
ALBA	CN812	4.99			
ALBA	CN813	4.99			
ALBA	CN814	4.99			
ALBA	CN815	4.99			
ALBA	CN816	4.99			
ALBA	CN817	4.99			
ALBA	CN818	4.99			
ALBA	CN819	4.99			
ALBA	CN820	4.99			
ALBA	CN821	4.99			
ALBA	CN822	4.99			
ALBA	CN823	4.99			
ALBA	CN824	4.99			
ALBA	CN825	4.99			
ALBA	CN826	4.99			
ALBA	CN827	4.99			
ALBA	CN828	4.99			
ALBA	CN829	4.99			
ALBA	CN830	4.99			
ALBA	CN831	4.99			
ALBA	CN832	4.99			
ALBA	CN833	4.99			
ALBA	CN834	4.99			
ALBA	CN835	4.99			
ALBA	CN836	4.99			
ALBA	CN837	4.99			
ALBA	CN838	4.99			
ALBA	CN839	4.99			
ALBA	CN840	4.99			
ALBA	CN841	4.99			
ALBA	CN842	4.99			
ALBA	CN843	4.99			
ALBA	CN844	4.99			
ALBA	CN845	4.99			
ALBA	CN846	4.99			
ALBA	CN847	4.99			
ALBA	CN848	4.99			
ALBA	CN849	4.99			
ALBA	CN850	4.99			
ALBA	CN851	4.99			
ALBA	CN852	4.99			
ALBA	CN853	4.99			
ALBA	CN854	4.99			
ALBA	CN855	4.99			
ALBA	CN856	4.99			
ALBA	CN857	4.99			
ALBA	CN858	4.99			
ALBA	CN859	4.99			
ALBA	CN860	4.99			
ALBA	CN861	4.99			
ALBA	CN862	4.99			
ALBA	CN863	4.99			
ALBA	CN864	4.99			
ALBA	CN865	4.99			
ALBA	CN866	4.99			
ALBA	CN867	4.99			
ALBA	CN868	4.99			
ALBA	CN869	4.99			
ALBA	CN870	4.99			
ALBA	CN871	4.99			
ALBA	CN872	4.99			
ALBA	CN873	4.99			
ALBA	CN874	4.99			
ALBA	CN875	4.99			
ALBA	CN876	4.99			
ALBA	CN877	4.99			
ALBA	CN878	4.99			
ALBA	CN879	4.99			
ALBA	CN880	4.99			
ALBA	CN881	4.99			
ALBA	CN882	4.99			
ALBA	CN883	4.99			
ALBA	CN884	4.99			
ALBA	CN885	4.99			
ALBA	CN886	4.99			
ALBA	CN887	4.99			
ALBA	CN888	4.99			
ALBA	CN889	4.99			
ALBA	CN890	4.99			
ALBA	CN891	4.99			
ALBA	CN892	4.99			
ALBA	CN893	4.99			
ALBA	CN894	4.99			
ALBA	CN895	4.99			
ALBA	CN896	4.99			
ALBA	CN897	4.99			
ALBA	CN898	4.99			
ALBA	CN899	4.99			
ALBA	CN900	4.99			
ALBA	CN901	4.99			
ALBA	CN902	4.99			
ALBA	CN903	4.99			
ALBA	CN904	4.99			
ALBA	CN905	4.99			
ALBA	CN906	4.99			
ALBA	CN907	4.99			
ALBA	CN908	4.99			
ALBA	CN909	4.99			
ALBA	CN910	4.99			
ALBA	CN911	4.99			
ALBA	CN912	4.99			
ALBA	CN913	4.99			
ALBA	CN914	4.99			
ALBA	CN915	4.99			
ALBA	CN916	4.99			
ALBA	CN917	4.99			
ALBA	CN918	4.99			
ALBA	CN919	4.99			
ALBA	CN920	4.99			
ALBA	CN921	4.99			
ALBA	CN922	4.99			
ALBA	CN923	4.99			
ALBA	CN				

**WE WILL ONLY SUPPLY TOP QUALITY,  
BRANDED COMPONENTS.  
REPUTATION COUNTS WITH US**

# G.G.L. COMPONENTS

PO BOX 72, UNIT 7, SOUTH JOHN STREET, CARLISLE, CUMBRIA CA2 5AL.  
TEL: (0228) 39693/20358 Fax: (0228) 515127.

**BUY WITH**



## AERIAL ACCESSORIES

COAX PLUG.....18
F CONNECTOR.....20
FLY LEAD 2M.....75
VIDEO LEAD 2M.....75
4 WAY DISTRIBUTION
AMPLIFIER MAINS.....19.95
8 WAY DISTRIBUTION
AMPLIFIER MAINS.....21.75

## BATTERIES

AA (pkt of 4).....1.20
AA (pkt of 4).....1.20
FERGUSON 3V55.....4.95
PHILIPS MEMORY 1V2.....1.90
PHILIPS MEMORY 2V4.....2.75

## CAPACITORS

0.1f 5v (back-up).....2.50
63v.....18
100uf at 63v.....22
220uf at 63v.....35
250v
1uf at 250v.....20
4.7uf at 250v.....25
10uf at 250v.....30
22uf at 250v.....40
47uf at 250v.....65
100uf at 250v.....1.25
400v
1uf at 400v.....23
4.7uf at 400v.....35
10uf at 400v.....70
22uf at 400v.....85
(ALL PCB MOUNTING).....85

## DIODES

R2M.....95
BY133.....15
BY227.....20
BY299/800.....35
IN4007.....10
IN5408.....20
BZX61C (pkt of 5) 6v8 7v5 12v
15v 24v 33v 68v 120v 130v
1.00

## EHT TRAYS

CONTINENTAL 30AX FOCUS 8.95
DECCA 120/130.....7.95
GRUNDIG CUC2410 14".....16.95
GRUNDIG CUC2410 22".....16.95
PHILIPS KT3.....7.95
UNIVERSAL.....5.95

## FUSES

20mm A/S (PKTS OF 10)
250MA, 315MA, 500MA, 630MA ..1.20
800MA, 1A, 1.6A, 2A, 2.5A, 3.15A
20mm Q/B (PKTS OF 10)
500MA, 630MA, 800MA, 1A,
1.6A, 2A, 2.5A, 3.15A.....80

## I.C.'s

CNX62A.....4.75
SA11293-02.....5.95
SA11293-03.....6.95
SA11293A-03.....8.35
SL1432.....1.95
STK5331.....4.95
STK5332.....4.95
STK5333.....5.75
STK5421.....4.95
STK5422.....6.95
STK5482.....4.95
STK5490.....7.95
STK7308.....5.50
STK7348.....5.50
STR4211.....4.50
STR5412.....4.95
STR50020.....7.35
STR50103A.....5.95
STR54041.....6.95
STR58041.....5.95
TDA1170S.....1.95
TDA11770A.....3.95
TDA2030.....1.95
TDA2170.....2.95
TDA2270.....2.75
TDA2576A.....3.50
TDA2577A.....3.50
TDA2578A.....2.95
TDA2579.....3.95
TDA2581.....4.50
TDA2582.....2.50
TDA2600.....5.50
TDA2653AQ.....2.95
TDA3330.....8.50
TDA3560.....4.95
TDA3561A.....4.95
TDA3562A (TFK).....4.95
TDA3565.....3.95
TDA3571BQ.....8.95
TDA3576B.....12.95
TDA3650.....8.95
TDA3651/3.....2.95
TDA3651AQ.....4.75
TDA3653A.....3.50
TDA3654A.....2.95
TDA4500.....4.50
TDA4501.....5.25

TDA4503.....4.95
TDA4505E.....5.45
TDA4600/3.....2.95
TDA4600/2D.....3.95
TDA4601.....2.95
TDA4601 DIL.....3.75
TEA1039.....1.95
TEA2018A.....2.50
TMP47C434N-3414.....14.95
TMP47C434N-3415.....14.95
TMP47C434N-3537.....14.95
TMP47C434N-3555.....15.55
TMP47C434N-3558.....15.55
TMP47C434N-3559.....14.95
CIRCUIT PROTECTORS
N10,N20,N25 (each).....50

## LINE O/P TRANSFORMERS

FERGUSON TX90 20".....15.95
FERGUSON TX99 51P7.....23.50
FERGUSON TX100 90C.....18.25
FERGUSON TX100 110D.....14.50
FERGUSON TX100 FST.....17.75
FIDELITY ZX2000 + MOD.....13.95
FIDELITY ZX3000.....12.95
HINARI CT45.....16.95
HITACHI CPT1474/1476.....18.95
HITACHI CPT2174/76/78.....17.95
HITACHI CPT2276/2278.....17.50
HITACHI CPT2476/2478.....18.95
ITT COMPACK 80.....18.50
ITT CVC12001.....19.95
ITT MONOPRINT BMM.....18.85
MATSU1410/20/40.....18.95
PHILIPS CF90.....23.50
PHILIPS CP91.....17.95
PHILIPS CTX14120".....18.50
PHILIPS 2A.....18.50

## SERVICE MANUALS

AMSTRAD 4600.....9.95
AMSTRAD 6000.....9.95
FERGUSON TX85.....9.95
FERGUSON 3V55.....13.95
FERGUSON 3V65.....13.95
FERGUSON FV11.....13.95

## SWITCHES

FIDELITY CTV145.....1.50
GRUNDIG CUC731.....3.50
ITT TX SERIES.....4.95
KT4/CTX REMOTE.....1.75
TX9/10 STANDARD.....1.00
TX9/10 REMOTE.....1.75
TX90/10 STANDARD.....1.50
TX90/10 REMOTE.....1.75

## TRANSISTORS

BC639.....20
BC640.....20
BF460.....95
BU208A(H/D).....1.45
BU208D.....1.95
BU426A.....1.45
BU500.....2.00
BU508A.....1.50
BU508AF.....1.95
BU508D.....1.95
BU508DF.....2.50
BU508V.....2.25
BU807.....1.75
BUT11AF.....2.35
BUT56A.....2.25
BU164.....80
R4050.....2.95
T9053V/T9054V.....3.50
T9064V.....1.95
TIP29E (TO18BV).....75
TIP41C.....50
TIP42C.....50
TIP112H (TO167V).....75
TIP1791A.....1.95
2SD1497.....3.95
2SD1497/02.....4.25
TRANSISTOR EQUIVALENT BOOKS
TVT A-Z & 2N-2SD.....28.45

HITACHI CPT2174.....17.95
HITACHI CPT2188.....9.75
HITACHI CPT2246.....14.50
ITT FS9/10 DIGIVISION.....13.25
ITT RG305.....13.25
ITT RG306.....13.95
ITT V4.....13.25
ITT V5S TEXT.....13.25
MATSU11440.....12.75
PACE 6000.....13.95
PANASONIC TNQ1411/2.....14.95
PANASONIC TNQ1419.....13.95
PHILIPS G11 I/R TEXT.....13.95
PHILIPS KT3/30 NON TEXT.....12.95
PHILIPS KT3/30 TEXT.....12.50
PHILIPS RC5991.....12.95
PHILIPS RC5903 GENUINE.....12.95
PHILIPS MINIATURE.....9.95
PHILIPS VR6462.....12.25
PHILIPS VR6467.....12.95
PROGRAMMABLE.....22.50
REDIFFUSION MKIV.....10.95
REDIFFUSION MKIVA.....12.45
SAISHO CT142R.....11.50
SAISHO CT1497X.....12.95
SANYO VHR 1100/1200.....14.25
SONY RM615/632/636.....10.75
SONY RM670/672/676.....10.75
TATUNG RC40/45.....10.25
TATUNG RC70.....10.25
TATUNG RC90.....11.95
TOP TEL.....24.95

## NEW RANGE OF PANASONIC LOPTS ASKING FOR DETAILS

### REMOTE CONTROLS

FERGUSON T725.....9.75
FERGUSON T734.....9.75
FERGUSON T742.....9.75
FERGUSON T785 FAST TEXT 11.95
FERGUSON T786 FAST TEXT 11.95
FERGUSON TX16 NON TEXT 11.50
FERGUSON TX100 TEXT.....9.75
FERGUSON TX100 STEREO 11.95
FERGUSON TX100 TEXT.....10.95
FERGUSON ICA5.....17.95
FERGUSON SRA1.....13.50
FIDELITY CTV145.....12.95
FIDELITY CTV227.....12.75
FINLUX 1101 TO 2386.....11.50
GOODMANS TX1100/1200.....18.95
GRANADA UNIVERSAL.....12.95
GRUNDIG TP400 TEXT.....12.90
GRUNDIG TP650 TEXT.....14.25
GRUNDIG TP650.....11.45
HITACHI CPT1445.....13.95

### VIDEO HEADS

AKAI VS15.....8.50
ALBA 4000X.....16.95
AMSTRAD 4500/9000.....14.70
AMSTRAD 4600/4700.....14.50
AMSTRAD 6000.....17.50
AMSTRAD 7000/39.....14.95
FERGUSON 3V00/39.....8.50
FERGUSON 3V42/55.....17.25
FERGUSON 3V59/FV12.....27.95
FERGUSON 3V65/FV11.....17.95
FERGUSON FV12L/32L.....27.95
FERGUSON FV31.....27.95
FISHER FVH615/910.....16.50
FISHER FVH725.....28.95
FISHER FVH966/916.....18.50
GOLDSTAR V1211/1290.....16.25
HITACHI 8000/9700.....15.00
HITACHI VT11/33.....15.70
HITACHI VT17/19.....24.50
HITACHI VT63/64.....19.25
HITACHI VT65.....28.50
HITACHI VT120E/220E.....21.25
HITACHI VT130E.....27.50

VIDEO HEADS ARE OF THE BEST QUALITY AND ARE BRANDED OR MANUFACTURERS OWN

### SERVICE AIDS

ANTEX 17W IRON.....8.50
ANTEX 25W IRON.....8.75
CLEAR TEST TAPE.....7.95
FIBRE CLEANING PEN.....3.50
HEATSIK COMPOUND.....1.55
ONYX SOLDER PUM.....9.95
ONYX TIPS.....1.50
SILICON GREASE.....1.85
SOLDA MOP.....1.80
SOLDER 0.5KG 18SWG.....8.50
SOLDER 0.5KG 22SWG.....8.75
WELLER GUN TIPS (2).....1.25

## NEW LISTS NOW AVAILABLE PLEASE REQUEST

### ALBA VIDEO SPARES

VCRA4000
BELT KIT.....1.95
CAPACITOR BACK-UP.....1.85
PINCH ROLLER.....3.95
REEL IDLER.....3.95
REEL PULLY.....1.95

### AMSTRAD VIDEO SPARES

VCRA4500
BELT KIT.....1.95
GEAR ASSEMBLY.....3.95
MODIFICATION KIT.....5.50
PINCH ROLLER.....3.50
VCRA6000
BELT KIT.....1.95
GEAR ASSEMBLY.....3.95
MODIFICATION KIT.....5.50
PINCH ROLLER.....3.50
VCRA6000
BELT KIT.....1.95
PINCH ROLLER.....3.95
CLUTCH.....3.95

### FERGUSON VIDEO SPARES

3V29/30
BELT KIT.....1.95
CAPSTAN MOTOR.....32.50
CASSETTE LAMP.....70
LOADING BELTS (5).....1.95
PINCH ROLLER.....3.95
REEL IDLER.....3.95
TAKE UP CLUTCH.....2.95
TAKE UP IDLER.....1.95
3V35/39
BELT KIT.....1.95
CAPSTAN MOTOR.....21.50
CASSETTE HOUSING.....25.95
LOADING BELTS (5).....1.95
MAINS TRANSFORMER.....23.95
PINCH ROLLER.....3.95
REEL IDLER.....2.95
TAKE UP IDLER.....1.95
TAKE UP CLUTCH.....2.95
3V44/45
BELT KIT.....1.50
CASSETTE HOUSING.....25.95
PINCH ROLLER.....3.95
3V65/FV11
BELT KIT.....1.75
CAPSTAN MOTOR.....27.50
CASSETTE HOUSING.....27.50
PINCH ROLLER.....3.95
REEL IDLER.....2.75

### FISHER VIDEO SPARES

FVH5000
BELT KIT.....2.20
REEL IDLER.....5.50
PINCH ROLLER.....3.50
TENSION BAND.....2.60
FVH615/720
BELT KIT.....1.95
CLUTCH ASSEMBLY.....5.95
PINCH ROLLER.....4.50
REEL IDLER.....5.95
FVH905/910
BELT KIT.....1.95
CLUTCH ASSEMBLY.....5.95
REEL IDLER.....5.95

### HITACHI VIDEO SPARES

VT8000/8700E
BELT KIT.....1.95
FF/REW IDLER.....2.95
FF/REW PULLY.....95
PINCH ROLLER.....3.95
PLAY IDLER.....3.95
REEL TABLE.....3.95
TENSION BAND.....2.95
VT9300/9700E
BELT KIT.....1.95
FF/REW IDLER.....2.75
FF/REW PULLY.....95
PINCH ROLLER.....3.95
PLAY IDLER.....3.95

### PHILIPS VIDEO SPARES

VR6460/6520
BELT KIT.....1.95
PINCH ROLLER.....3.95
REEL IDLER.....3.30
REPAIR KIT.....12.95
VR6462/6560
REPAIR KIT.....12.95
CASSETTE HOUSING.....16.95
PINCH ROLLER.....3.95
REEL IDLER GENUINE.....4.95
VR6467/6760
REPAIR KIT GENUINE.....21.50
BELT KIT.....2.95
CASSETTE HOUSING.....17.95
PINCH ROLLER ARM ASSY.....7.50

### SANYO VIDEO SPARES

VTC5000
BELT KIT.....1.00
REEL MOTOR GENUINE.....7.95
REEL PULLY GENUINE.....5.95
VHR1100/1300
BELT KIT.....2.25
PINCH ROLLER.....3.50
REEL DRIVE ROLLER.....5.95
VHR3100/3700
BELT KIT.....1.95
PINCH ROLLER.....3.50
REEL DRIVE ROLLER.....5.95

### PANASONIC VIDEO SPARES

NV230/430
BELT KIT.....1.95
PINCH ROLLER.....3.95
REEL IDLER GENUINE.....3.30
NV333/366
BELT KIT.....1.95
PINCH ROLLER.....3.95
PLAY IDLER GENUINE.....5.50
REEL IDLER GENUINE.....1.35

### SHARP VIDEO SPARES

VC9300/381
BELT KIT.....2.50
PINCH ROLLER.....3.95
REEL IDLER GENUINE.....3.95
REEL MOTOR GENUINE.....16.95
TENSION BAND.....2.95

### VC481/482

BELT KIT.....2.50
PINCH ROLLER.....3.95
REEL IDLER GENUINE.....3.95
REEL MOTOR GENUINE.....17.95
VC581/582
BELT KIT.....2.50
REEL IDLER GENUINE.....3.95
PINCH ROLLER.....3.95
REEL PULLY GENUINE.....7.95

### SONY VIDEO SPARES

C5/6/7
BELT KIT C5/7.....2.50
BELT KIT C6.....1.95
PINCH ROLLER.....4.50
REWIND KIT C5/7.....4.95
REWIND KIT C6.....3.95

### VIDEO LAMPS

FERGUSON 3V00/22.....50
FERGUSON 3V29.....80
PANASONIC NV2000.....95
SHARP 9300.....1.50
UNIVERSAL.....50

### VIDEO LEADS

SCART LEAD FULLY WIRED.....4.95
SCART LEAD TO 6 PHONO.....4.95
SCART COPYING SKT.....5.95
SCART TO 2 SCART SKT.....5.95
SCART TO 5 SCART SKT.....6.95
VIDEO COPYING KIT.....5.95

### VIDEO REPAIR KIT

ALBA 4000.....11.50
FERGUSON 3V23.....15.95
FERGUSON 3V29/30.....12.95
FERGUSON 3V35/39.....12.95
FERGUSON 3V44/45.....14.95
FERGUSON 3V64/65.....11.95
FISHER FVH615/715.....12.75
FISHER FVH905.....12.95
HITACHI VT8000.....12.95
HITACHI VT9300.....12.95
HITACHI VT11/33E.....16.95
HITACHI VT120/130E.....16.95

## Cellular dealers wanted

### BATTERY CHARGERS DESK TOP TRICKLE

MOTOROLA T/PORTABLE.....38.95
MOTOROLA 8000/8800X.....23.95
MOTOROLA MICROTAC.....24.50
NEC P3.....24.95
NOKIA 101.....24.95
PANASONIC E/H SERIES.....39.95

**HOW TO INCREASE YOUR PROFITS, IMPROVE YOUR SERVICE, WITH COST EFFECTIVE TEST EQUIPMENT.**

**HAMEG OSCILLOSCOPES**

HAMEG are Europe's top selling DUAL TRACE OSCILLOSCOPES. Select from four superb models. All, with the exception of the HM 1005, incorporate a useful COMPONENT TESTER. Size - all models - 285mm x 145mm x 380mm. Clear display 8cm x 10cm. Mains supply: 110/220.240V AC 50/60Hz. All supplied with 2 PROBES, a COMPREHENSIVE MANUAL and a 2 YEAR WARRANTY.

**HM203-7 20MHz STANDARD**

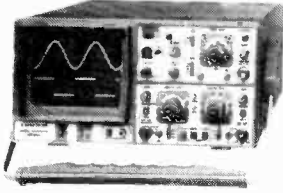

- SPECIFICATION**
- \* 2 Channels
  - \* Bandwidth: DC - 20MHz
  - \* Sens: Ch.1, Ch.2, 1mV/cm
  - \* Timebase: 0.1s - 20ns/cm
  - \* Triggering: DC - 40MHz
  - \* Active TV - Sync - Separator
  - \* Variable hold-off
  - \* Trigger LED Indicator
  - \* Calibrator: 1KHz Square wave
  - \* Component tester
  - \* Plus many features

Price £362.00 + £63.35 V.A.T. FREE Specialist Carrier Delivery

**SPECIFICATIONS**

- \* 2 Channels
- \* Bandwidth: DC - 60 MHz
- \* Sens: Ch.1, Ch.2, 1mV/cm
- \* Timebase: 2.5s - 5ns/cm
- \* Triggering: DC - 80MHz
- \* Active TV - Sync - Separator
- \* After delay trigger
- \* Sweep delay
- \* Delay line
- \* Trigger LED indicator
- \* Calibrator: 1KHz & 1MHz Sq. Wave
- \* Component tester

**HM604 60MHz UNIVERSAL**

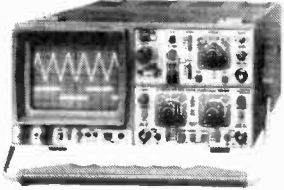

Price £653.00 + £114.28 V.A.T. FREE Specialist Carrier Delivery

**HM1005 100MHz UNIVERSAL 3 CHANNELS - UP TO 6 TRACES**

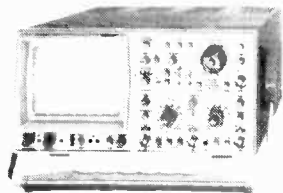

- SPECIFICATION**
- \* 3 Channels
  - \* Bandwidth: DC - 100MHz
  - \* Sens: Ch.1, Ch.2, Ch.3, 1mV/cm
  - \* Timebase A: 2.5s - 5ns/cm
  - \* Timebase B: 0.2s - 5ns/cm
  - \* Triggering DC - 130MHz
  - \* After delay trigger
  - \* Delay line
  - \* Trigger LED indicator
  - \* Overscan LED indicator
  - \* Active TV - Sync - Separator
  - \* Calibrator: 1KHz & 1MHz Sq. Wave

Price £847.00 + £148.23 V.A.T. FREE Specialist Carrier Delivery

**HM205-3 20MHz DIGITAL STORAGE**

**SPECIFICATION**

- \* Digital Storage
- \* Analogue real time (Same as 203-7)
- \* Bandwidth: DC - 20MHz
- \* Sens: Ch.1, Ch.2, 1mV/cm
- \* Timebase Digital: 5s-1µs/cm
- \* Triggering DC - 40MHz
- \* Active TV - Sync - Sampling
- \* Max sampling rate: 2 x 20MHz
- \* Memory: 2 x 2048 x 8 Bit
- \* Dot joiner
- \* Printer/plotter output

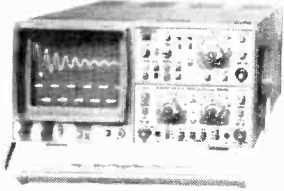

Price £653.00 + £114.28 V.A.T. FREE Specialist Carrier Delivery

**BLACK STAR COLOUR PATTERN GENERATOR**

**THE 'ORION' THREE-IN-ONE PAL VHF/UHF - PAL VIDEO COMPOSITE - R.G.B.**

The Orion is a compact, bench instrument offering a wide range of patterns and facilities at a truly low cost.

In addition to a switchable sound carrier facility which allows use with the majority of PAL TV systems, the Orion provides highly flexible TGB outputs, ensuring compatibility with most video monitors.

More than 50 pattern combinations can be selected, including those for testing static and dynamic divergence, video amplifier linearity, colour purity, general colour performance, focus etc.

A separate video input to modulate camera signals; fully variable RF and video output levels facilitating AGC testing; trigger output allowing easy triggering of difficult oscilloscope waveforms; external sound modulation input via DIN connector for frequency response testing of TV sound systems; adjustable wide frequency coverage of VHF and UHF TV bands.

Indispensable in the manufacture, test, and servicing of televisions, and computer and video monitors.

**FEATURES**

- \* Colour bars, purity, greyscale, crosshatch, dots, focus, etc.
- \* VHF/UHF Channels.
- \* 5.5MHz, 6.0MHz, 6.5MHz Sound Carriers.
- \* Internal/External Sound.
- \* External Video Output.
- \* Trigger Output.
- \* PAL B,D,G,H,I,K.
- \* Separate R, G, B and sync. O/P's.
- \* RGB @ TTL & 1V.
- \* Green - 0.3V Syncs.
- \* Composite Video Output.
- \* Variable RF/Video Output.
- \* Switchable Video Polarity.
- \* Mains powered 220/240V AC 50/60Hz.
- \* Size: 98 x 219 x 240mm.

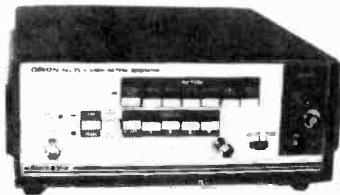

Price £229.00 + £40.08V.A.T.

**NEW! DEGAUSSING COIL**



A very effective degaussing coil, ideal for degaussing TV tubes, computer monitors, oscilloscopes etc. Mains Power: 220/240 50/60Hz. Size: 355 x 355 x 24mm.

Price £46.00 + £8.05V.A.T.

**B & K PRECISION CRT ANALYSER-RESTORER**

The number one CRT Test Instrument. Over 5000 U.K. Television engineers wouldn't be without it.

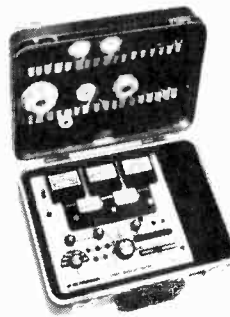

- \* All CRT's checked identically, including all in-line and one gun types
- \* Tests all three guns of colour CRT's simultaneously under actual operating conditions (model 490)
- \* Exclusive multiplex technique (model 490)
- \* Measure true dynamic beam current that actually passes through G1 aperture to screen
- \* Measures all shorts and leaks - preserving more CRT's
- \* Tests focus electrodes lead continuity finding faults that other testers miss
- \* Uses most powerful restoration method known with minimum danger to CRT
- \* Rejuvenates CRT's guaranteed as new for two years
- \* Obsolescence proof - perpetual set up chart updated and new adaptors developed
- \* Tests and rejuvenates VDU's and oscilloscope tubes
- \* A range of over 40 CRT base adaptors available
- \* Increase profit
- \* Pays for itself in months.

**Prices**

Model 490 Tri-dynamic three meter instrument inc. 6 common adaptors..... £559.00 - £97.83V.A.T.  
Without adaptors..... £496.00 - £86.80V.A.T.  
Model 480 Single meter instrument inc. 6 common adaptors..... £425.00 - £74.38V.A.T.  
Without adaptors..... £360.00 + £63.00V.A.T.

**SADELTA SIGNAL STRENGTH METERS**

The Sadelta Field Strength Meters have been designed to facilitate the dish alignment of satellite TV systems and aerial alignment of VHF/UHF television and radio systems. Signal levels can be accurately measured on the TC402-D, TC90 AND TC80, allowing the evaluation of signal conditions for satisfactory operation. All models have a clear LCD direct frequency readout, coupled to a multiturn tuning control enabling precise channel identification.

**TC402-D VHF & UHF**

**FEATURES**

- \* Three bands:
  - Low VHF: 45-170MHz
  - High VHF: 170-450MHz
  - UHF: 450-862MHz.
- \* Digital display for direct frequency readout.
- \* Built-in monitor loudspeaker AM/FM.
- \* Signal measurement from 20µV to 3V.
- \* Powered by eight 1.5V AA batteries.
- \* Fully portable with sturdy carrying case.



Price £289.00 + £50.57 V.A.T.

**TC90 VHF-UHF- SAT.**

**FEATURES**

- \* Five bands:
  - Low VHF: 45-110MHz
  - High VHF: 110-300MHz
  - Hyper VHF: 300-470MHz
  - VHF: 470-862MHz
  - Satellite: 950-1750MHz.
- \* Digital display for direct frequency readout.
- \* Signal measurement VHF/UHF 20µV to 3V.
- \* Signal measurement satellite -70dBm to -10dBm.
- \* Audible indication of satellite signal level.
- \* Built-in monitor loudspeaker AM/FM (not satellite).
- \* Powered by rechargeable battery (complete with charger 220/240V AC).
- \* Fully portable with sturdy carry case.



Price £499.80 + £87.47 V.A.T.

**NEW! TC80 SATELLITE**

The TC80 incorporates three unique features: video composite output; audio output with built in loudspeaker; ramp and RF signal outputs, which enable an oscilloscope to be used as a spectrum analyzer.

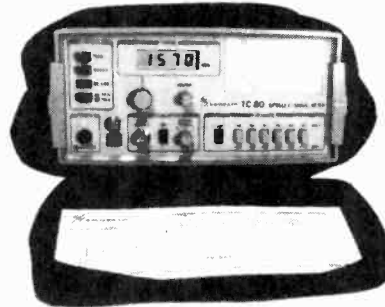

**TC-80 IN ITS STURDY CARRY CASE**

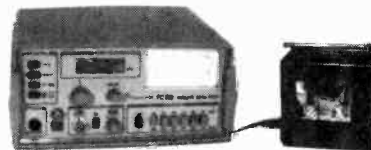

**TC-80, USING A LCD TV AS A MONITOR**

- \* 4 digit LCD freq. display
- \* Freq. range 950 to 1750MHz
- \* Sweep mode sweeps entire freq. band for rapid satellite location
- \* Tone select switch for audible tone proportional to signal strength
- \* Measurement from 40 to 100dBµV
- \* Audio demodulation with internal loudspeaker
- \* Video demodulation
- \* Rear SCART connector for A/V connection
- \* Oscilloscope/spectrum analyzer output
- \* Sound tuning 5 to 8MHz
- \* LNC PSU 14V or 18V
- \* LNC current measurement
- \* Internal rechargeable battery with charger

Price £490.00 + £85.75V.A.T.



U.K. POST PAID, export enquiries welcome. Visa/Access or cheque with order, payable B. K. Electronics. Official Orders welcome from Govt. Depts., colleges, P.L.C.s etc. Large (A5) S.A.E. for technical leaflets of complete range. Credit card orders are accepted by 'phone, fax or post. Delivery normally within seven days.



**B. K. ELECTRONICS**  
UNITS 1 & 5 COMET WAY, SOUTHEND-ON-SEA  
ESSEX S92 6TR  
Tel.: 0702 - 527572 Fax.: 0702 - 420243



PROPERTY OF:  
DEPT APPLIED ELECTRONICS  
SCHOOL OF TECHNOLOGY  
NORTHERN TERRITORY UNIVERSITY

# TELEVISION

## *Broadcasting's Future*

The government doesn't seem to be at all sure what to do about commercial TV. It has been under considerable pressure from major independent television companies to change the ownership rules, enabling them to merge or take each other over. The arguments for this have a certain plausibility. By international standards, even the largest of the UK companies are comparatively small. So they need to be larger if they are to become international concerns. If they don't, they may be taken over by larger companies with international broadcasting interests – the advent of the European Union brings with it the right of companies elsewhere in Europe to make hostile, cross-border bids. Conversely, some of the smaller companies have argued that things should be left as they are: that they are efficient and fulfil their franchise requirements. In the event, what the government is proposing is a sort of half-way house: ITV companies will be allowed to own two regional licences, though the London weekday and weekend licences must continue to be held by separate companies – and newspaper publishers will for the foreseeable future continue to be restricted to ownership of not more than twenty per cent of an ITV company. These proposals could result in a fall in the total number of ITV companies from fourteen to eight.

One gets the impression that the government feels it has to make some concession to the major franchise holders that are pressing for relaxation of the rules but is uncertain how much to concede. The government is right to be cautious. The question that it doesn't seem to have addressed is "what is broadcasting all about?" Till now it has been regarded, in the UK at any rate, as primarily a cultural – in the widest sense – phenomenon rather than a simple commercial business with the aim of generating a maximum return on the money invested. It can be argued that the current restrictions are becoming irrelevant as technical progress brings much greater possibilities: the regional ITV set-up was devised in the days when channels were few and needed to be allocated with care – the days before satellite broadcasting, wideband cable networks and digital transmission. But the fact remains that the existing franchises are valuable public assets whose use deserves careful consideration. Also that broadcasting is an aspect of our popular culture, and that this carries with it responsibilities. Are those who are pressing for complete deregulation suggesting that broadcasting companies should be there for buying and selling by anyone, with little regard for the purposes and possibilities of broadcasting? More sinisterly, that it no longer matters much who owns broadcasting companies and what they might choose to do with them? The recent antics of Silvio Berlusconi, owner of the major Italian networks, in using his channels to broadcast ninety-minute programmes propounding his own political views – at a politically sensitive time – serve as a warning to what can all too easily happen.

The unfortunate thing is that the European Union threatens to impose a purely commercial view of what broadcasting is all about. It needs to be emphasised that television broadcasting plays a major role in providing information and entertainment, and in so doing moulds people's view of the world. All right, you may say, but anyone can start or buy a newspaper, which is a similarly influential medium, so why not TV? The answer really is that the present set-up was originally devised with great care as a framework which would encourage free, independent, creative broadcasting that provides a variety of programming to cater for the diverse needs of different viewer groups. It is vital that this tradition is preserved. A choice of a hundred or a thousand channels will not of itself guarantee the continuation of quality broadcasting. These are the considerations that the government should weigh against the clamour for short-term advantages in the creation of media monsters.

### **EDITOR**

John A. Reddihough

### **PRODUCTION EDITOR**

Tessa Winford

### **EDITORIAL OFFICE**

081 652 8120

Fax 081 652 8956

Note that we are unable to answer technical queries over the telephone and cannot provide information on spares other than that given in our Spares Guide.

### **ADVERTISEMENT MANAGER**

Carol Nobbs

081 652 8327

### **SALES EXECUTIVE**

Pat Bunce

081 652 8339

Fax 081 652 8931

### **ADVERTISING PRODUCTION**

Brian Chapman

081 652 8681

Fax 081 652 8917

### **PUBLISHING DIRECTOR**

Susan Downey

### **SUBSCRIPTION ENQUIRIES**

0444 445 566

### **SUBSCRIPTION HOTLINE**

24-hour subscription ordering with credit card number phone 0622 721 666 and quote reference INJ.

### **COVER PHOTO**

This month's cover photograph shows the Rediffusion Mk. 4 chassis. See servicing article on pages 180–183.



REED  
BUSINESS  
PUBLISHING

### **Thanks**

Our thanks to Terry Mahmood of Colourtrade who donated a TV receiver and a VCR as prizes for a Christmas charity raffle organised by Reed Business Publishing.

# Modern TV Receiver Techniques

## Part 13: Power Supply Circuits

Eugene Trundle

The various different sections of a TV receiver we've looked at in previous instalments all require operating power. This month we'll examine the power supply section of a TV set: basically it's used to convert the mains (or other) energy input to one or more closely stabilised and regulated d.c. supply lines.

### Power Supply Requirements

Because of load and distribution factors the domestic mains supply, which is nominally 240V a.c., can vary by  $\pm 6$  per cent. So an important function of the power supply is stabilisation, i.e. providing a constant output voltage despite mains voltage variations. Regulation is also required: this means holding the output voltage steady regardless of the load imposed on it by the various other sections of the set – within the normal operating limits. Variable loads are presented in particular by the beam current consumption, which can vary from zero to 25W over the possible picture content range in a large screen set, and the audio output stage whose current demand varies with sound volume, again from virtually zero to around 25W in a set with a high-power stereo sound system.

If the voltages supplied to the timebases are not stabilised and regulated there will be changes in picture size and proportion with image brightness and mains supply variations. Sound distortion will be the result if the voltage supply to the audio amplifier isn't held stable. To avoid tuning drift the varicap tuning voltage supply must be constant. And microcontroller and logic circuits can make wrong decisions and corrupt the data passing through them unless their operating voltages are held within a few per cent of the nominal figure. Hence the need for close stabilisation of virtually every supply line in a TV set.

Most TV receiver power supplies must also be able to adjust the stabilised output so that, for example, a chassis can be used to drive different types of tube. Another requirement is protection circuitry to ensure safe operation. The protection circuits incorporated must be able to cut off the power if a short-circuit or overload raises the set's consumption to a dangerous level or the voltages in the set rise by more than a few per cent above their nominal levels. Higher than normal

anything of the same sort present in the mains a.c. supply. It must not generate radiation in the form of strong magnetic or r.f. fields as these could be picked elsewhere in the set, causing sound interference and patterning on the picture. This is particularly important with non-synchronous power supply circuits and, in view of its wide dynamic range and high signal-to-noise ratio, where Nicam sound is incorporated in the set. The more efficient the power supply's conversion process the better, since this will conserve energy and contribute to good reliability through cool running.

We haven't completed the list of requirements yet! In most modern sets there's electrical isolation between the live mains input to the receiver and the outputs from the receiver's power supply. This makes it easier to link the set to other equipment. Finally the outputs from the set's power supply must be free from ripple, hum and hash, and have a low source impedance (or the effect of this) to ensure good decoupling between different sections of the receiver that use the same supply line.

From the practical design viewpoint many of these characteristics and features are interdependent: the same circuitry provides regulation and stabilisation; mains isolation, voltage conversion and energy storage use a single transformer; and so on. But unlike other circuit sections of a TV set, where the operating principles mean that the circuitry used is to some extent standardised, there is tremendous variation in the power supply designs used in different makes and models. We'll look at the principles and consider the most common types of power supply circuit in current use in TV sets. First however we must briefly examine the basic regulators and stabilisers on which more sophisticated designs are based.

### The Zener Diode

The simplest form of voltage stabiliser is shown in Fig. 1(a). It consists of a series resistor R1 and a zener diode D1. The important feature of a zener diode is the sharp knee in its voltage/current characteristic when the device is operated with reverse bias, see Fig. 1(b). This means that the voltage across the diode remains constant over a wide range of current flow through it. The most common application for this simple arrangement in a TV set is in the provision of a stable tuning voltage for a varicap tuner. In this case the zener diode is usually in practice a two-terminal i.c. with built-in thermal compensation: unlike the simple zener diode, the two-terminal voltage regulator chip has virtually zero temperature coefficient.

All power supplies that provide regulation must have an internal voltage reference source of some form with which the output or a proportion of the output can be compared. It generally takes the form of a zener or similar diode, though it may be hidden away within a regulator/stabiliser chip of one sort or another.

### Series and Shunt Regulators

An absorption circuit that compensates fully for supply and demand variations is easy to arrange. Fig. 2(a) shows the basic shunt regulator principle, with regulator transistor Tr1 connected across the load and both fed from an unstabilised

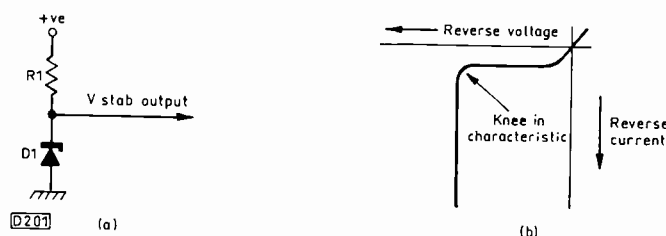

Fig. 1: Use of a zener diode as a shunt stabiliser (a), zener diode reverse voltage/current characteristic (b).

working voltages could lead to excessive dissipation and the emission from the tube of X-ray radiation in excess of the normal minimal level.

Ideally the power supply should draw current from the mains throughout both half cycles (positive- and negative-going). It should not pollute the mains supply by adding spikes and interference, while at the same time being immune to



# TECHNICAL BOOKS



A selection from our range of books for the repair trade



## TELEVISION

### CHASSIS GUIDE.

Full cross reference for all models  
Order MP-18. £5.95.

### TELEVISION EQUIVALENTS

Lists models which are the same  
Order MP-150. £5.95.

### FAULT LISTS FOR TELEVISIONS.

Hundreds of specific faults for dozens of different makes and models.

Order MP-205. £6.95.

### TELETEXT REPAIR MANUAL.

Covers SAA range of boards.

Order MP-38. £6.95.

### TELEVISION REMOTE CONTROL CIRCUITS.

Dozens of Diagrams on many remotes.

Order MP-167. £10.00.

### TV POWER SUPPLY CIRCUITS.

Dozens of P.S. circuit stages.

Order MP-219. £10.00.

### SCART EUROCONNECTOR SYSTEM.

Comprehensive details of the system.

Order MP-21. £3.00.

### P.C. HARD DISC DRIVE REFERENCE MANUAL.

Comprehensive Drive Details.

Order MP-84. £5.00.

### P.C. DIAGNOSTICS SOFTWARE.

Dozens of programs to aid you in diagnostics of PC's and Drives etc.

2 sets of 7 x 3.5" Discs per set.

Set 1. Order MP-250. £12.50.

Set 2. Order MP-251. £12.50.

## VIDEO RECORDER AND CAMCORDER EQUIVALENTS.

Full Cross-reference guides.  
Makes A-J. Order MP-217 £5.95.  
Makes K-Z. Order MP-218 £5.95.

## FAULT LISTINGS FOR VIDEO.

Lists Hundreds of Faults for dozens of makes and models.

Volume 1. MP-206. £6.95.

Volume 2. MP-228. £6.95.

## VHS VIDEO RECORDER PRINCIPLES.

Detailed guide on how it works.

Order MP-58. £3.95.

## VIDEO TEST JIG.

Special cassette lets you operate the machine in test mode.

Order VTJ. £15.00.

## VIDEO HEAD CLEANING KIT.

Special kit with comprehensive instructions on how to service heads.

Order VHCK. £4.00.

## VIDEO RECORDER FAULTS.

Unique repair guide for beginners.

Order MP-5. £3.95.

## WIRE ANTENNAS FOR H.F. OPERATORS.

THE aerial book for Amateurs.

Order MP-243. £5.95.

## REEL TO REEL TAPE RECORDER SERVICING.

Theory and circuits for repairs.

Order MP-201. £5.00.

## TRANSISTOR RADIO REPAIR GUIDE.

Comprehensive servicing charts.

Order MP-7. £2.50.

**RECORD PLAYER SPEED DISC.**  
Get your phonograph up to speed.  
Order MP-8. £1.00.

**SWITCH MODE POWER SUPPLY I.C. TYPE TDA-4600.**  
Circuitry and operation explained.  
Order MP-37. £6.00.

**VOLTAGE REGULATORS, STABILISERS & POWER SUPPLIES.**  
Identification and specifications.  
Order MP-9. £3.00.

**CMOS DATABOOK.**  
Pinouts and circuits for 4000 series.  
Order MP-10. £5.00.

**TTL DATABOOK.**  
Pinouts and circuits for 7400 series.  
Order MP-34. £5.00.

**TRANSISTOR EQUIVALENTS.**  
Includes details on testing them.  
Order MP-24. £3.00.

**OFFICE EQUIPMENT EQUIVALENTS.**  
Photocopiers & Fax machines covered.  
Order MP-200. £6.00.

**TELEPHONE CODE LOCATION GUIDE.**  
Find the Town from the Phone Code.  
Order MP-19. £4.00.

**MANUFACTURERS EQUIVALENTS.**  
What makes are the same.  
Order MP-220. £3.00.

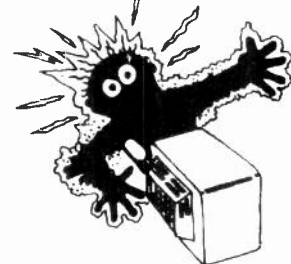

SHOCKINGLY GOOD BOOKS

**SERVICE MANUALS**  
available for most equipment.

Order TODAY using Access/Visa for immediate despatch.

All orders plus £2.35 Post and Packing. (Overseas £5.00)

The above selection are just a few of the Hundreds of Unique Repair and Data Guides shown in our FREE catalogue - Yours for the asking.  
Sent FREE with all orders or send 2 x 1st class stamps for your copy TODAY!

## MAURITRON TECHNICAL SERVICES (TV)

47A High Street, Chinnor, Oxfordshire, OX9 4DJ.

Tel:- 0844-351694. Fax:- 0844-352554.





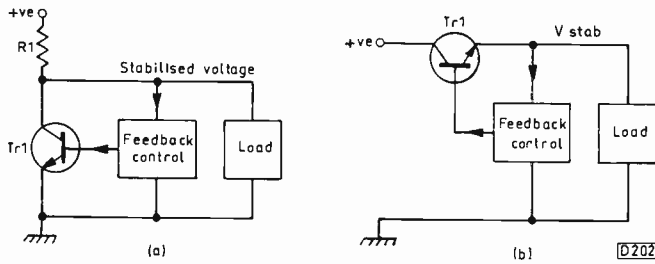

Fig. 2: Basic absorption regulator arrangements, (a) shunt type (compare with Fig. 1) and (b) series type. Both are closed-loop systems.

source via the ballast resistor R1. Feedback to the base of Tr1 varies its conduction to compensate for load variations, maintaining a constant voltage across its collector-emitter terminals. With this arrangement zero load corresponds with maximum dissipation in Tr1.

The series regulator idea, shown in Fig. 2(b), is less wasteful of energy. Here the regulating transistor is in series with the load. Feedback is used to alter its resistance as the current demand by the load varies, once again maintaining a constant output voltage. Series regulators are no longer used as the main stabiliser in large-screen TV receiver power supplies though many VCR power supplies, where the loading is lighter and more even than that of a TV receiver, continue to use them, often in heatsinked i.c. form. Series regulators are commonly used in both TV and video equipment for the auxiliary supplies, e.g. the provision of a 5V supply for logic circuitry. They are often packaged in the

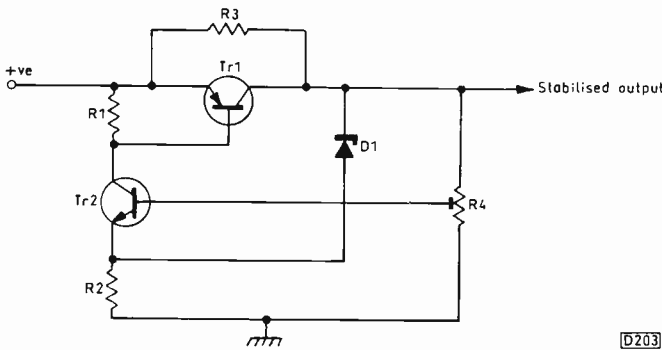

Fig. 3: A practical series voltage regulator circuit.

form of a three-legged i.c., for example the well-known 78 series.

The principle of a series regulator, using two transistors and a zener diode, is shown in Fig. 3. Tr1 is the series element, whose conduction/resistance is governed by comparator transistor Tr2's collector current. The emitter of Tr2 is held at exactly 7.5V below the regulator's output voltage by zener diode D1, which provides the voltage reference. A proportion of the output, set by R4, is applied to Tr2's base. If, because of increased current demand by the load, Tr1's collector voltage starts to fall, this voltage reduction appears across R2 in Tr2's emitter circuit and, in attenuated form, at its base. The effects of these voltage changes on Tr2's collector current are opposite but the change at Tr2's emitter, being larger, predominates. Thus in this example Tr2's emitter voltage falls and, being an npn device, its collector current increases, with a corresponding decrease in its collector voltage. Tr1's base-emitter current increases, in turn increasing its emitter-collector current. Thus Tr1's resistance is decreased, it supplies a greater current to the load and

the output voltage is stabilised. R4 enables the output voltage to be set up. R3 serves two purposes. It provides a start-up feed for the output side of the circuit and shares the dissipation with Tr1.

This type of circuit provides a very low effective output impedance and, because of the very low dynamic resistance of the zener diode, excellent ripple suppression. The regulating action works up to quite high frequencies. Thus the circuit can be looked at as an active ripple filter, whether the ripple consists of mains-rate hum on the unstabilised supply at Tr1's emitter or is the result of short-term changes in current demand by the load.

## The Switch-mode Concept

The regulator arrangements described so far have the advantage of simplicity but are wasteful of energy, which is dissipated as heat by the regulating device itself and any ballast resistor present, for example R1 in Fig. 1(a) and Fig. 2(a) and R3 in Fig. 3. Heat is not conducive to the reliability of either the device that generates it or the components that share its environment. Other disadvantages of the absorption type of regulator are that it cannot provide a voltage step-up while isolation between the input and output cannot be provided. A more efficient approach uses a control element that absorbs virtually no power itself as it acts as a switch. There is obviously no power dissipation when the switch is open-circuit: when the switch is closed it presents a very low impedance so that the dissipation is minimal.

In a switch-mode power supply (SMPS) the ratio of the on time to the off time of a driven switch (usually an npn transistor) that's used to chop the input is varied to suit the load demand. When little energy is required the switch remains in the on position for only a short time during each cycle of operation, briefly topping up an inductive or capacitive reservoir that supplies the load during the chopper's off period. When the load's energy demand is large a monitoring circuit automatically reduces the mark-space ratio of the chopper device so that it remains on for a longer period during each cycle, thus increasing the energy supplied to the reservoir. In this way the energy drawn from the primary power source almost exactly matches the energy required by the load with minimal wastage. The energy reservoir, whether in inductive or capacitive form, need not be large or bulky: if the chopping switch is operated at 20kHz or more small, light inductors and capacitors can be used.

Fig. 4 shows the principle of the switch-mode ('chopper') power supply. The incoming mains voltage is full-wave rectified by the bridge rectifier D1-4 to produce an unregulated supply of around 320V across its reservoir capacitor C1. This supply feeds the primary winding of transformer T1, the electronic switch S1 being in series with this winding. Each time

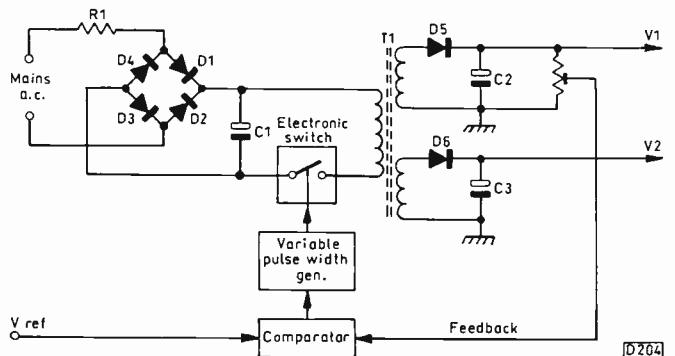

Fig. 4: Essentials of a switch-mode (chopper) power supply.

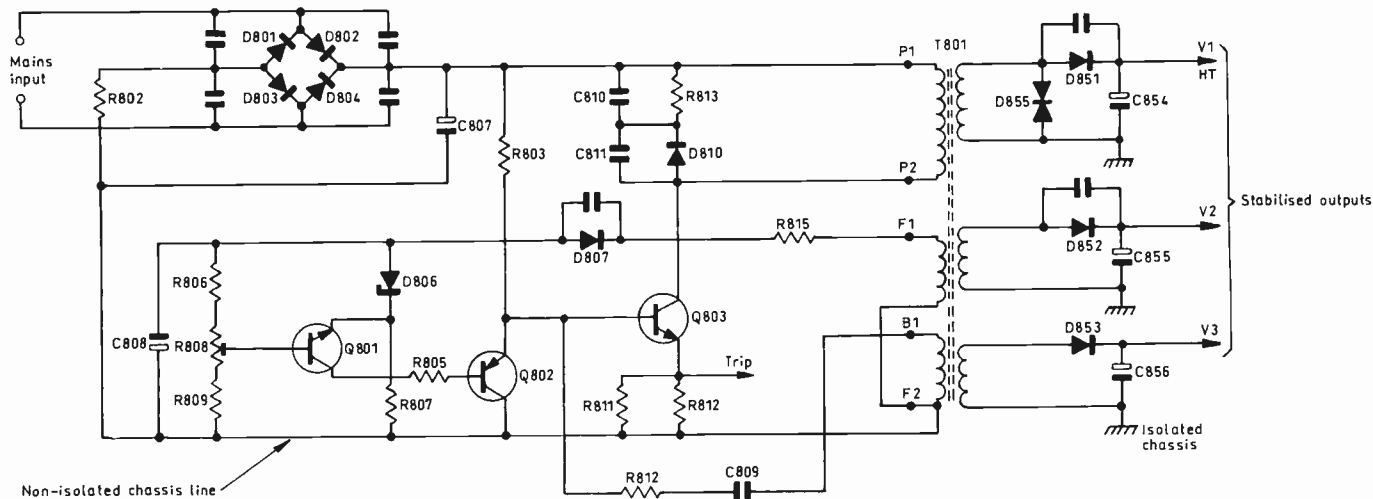

Fig. 5: Typical self-oscillating switch-mode power supply, often known as a ringing-choke converter. Note that T801 provides mains isolation, there being no electrical connection between the circuitry on its primary and secondary sides.

the switch is closed, a current ramp builds up in T1's primary winding and magnetic energy is stored in its core. When the switch is opened, say 50µsec later, the magnetic field collapses, transferring energy to the secondary side of the circuit – rectifier diodes D5 and D6 conduct, current flowing in the transformer's secondary windings to charge C2 and C3. The phasing of the windings is arranged so that there is no conduction on the secondary side of the circuit when S1 is closed. The loads are continuously supplied by the reservoir capacitors C2 and C3.

Since the total loading affects all the secondary-side supplies, because they are all activated when the transformer's magnetic field collapses, only one output need be monitored for control purposes – this is normally the one that supplies the major proportion of the total load. The output voltage here is monitored to provide feedback to the chopper control circuit. A comparator compares the feedback voltage with a reference voltage, producing an error voltage that's proportional to the load. This error voltage in turn controls a pulse-width modulator whose output pulses, of width proportional to the load, determine the on/off timing of the switch. Thus the switch's duty cycle is varied to suit the current demand.

In most modern circuits the frequency as well as the duty-cycle is varied to suit different load conditions. Many circuits are self-oscillating, with feedback from the transformer to the transistor to produce oscillation. Others use a purpose-designed i.c. as the control element to provide current drive to the base of a bipolar transistor, or voltage drive to the gate of a power field-effect transistor (FET), that contributes the switching action. The power transistor may be incorporated in the i.c., the result being a simple circuit with few peripheral components.

R1 is an important item in all rectifier circuits: it's included to limit the current surge when C1 charges at switch on, protecting the rectifier diodes.

### Self-oscillating SMPSs

Discrete component SMPS circuits with the chopper transistor and transformer acting as an oscillator have been in and out of favour over the years and are still used in modern TV sets. Fig. 5 is representative of a large number of such designs – the same operating principle is used in most of the large, heatsinked i.c. packages that incorporate the power switch in the chip.

When power is first applied, the chopper transistor Q803 begins to conduct because of the forward base bias applied

via R803. As a result, current flows in the primary winding of the chopper transformer T801. This induces a current flow in the feedback winding F2-B1. The signal generated here is coupled back to the base of Q803 via C809 and R812, and as a result Q803 is driven rapidly to saturation. In this condition the current in the primary winding of T801 soon stabilises and the positive feedback ceases (this is the classic blocking oscillator configuration). During this process C809 acquires a negative charge so that Q803 is cut off and held off – until the capacitor has discharged via R812 and R803. At this point Q803 begins to conduct again and the process repeats itself. Continuous oscillation occurs, and energy is fed to the loads across the secondary supplies produced by the transformer and the associated rectifier circuits.

In this arrangement regulation is achieved by monitoring the voltage developed by feedback winding F1-F2 and the associated rectifier circuit D807/C808. This voltage is proportional to those produced across the secondary supply lines. It's applied to the emitter of the comparator transistor Q801 and to the base of this transistor via the potential divider R806/8/9. Q801 acts in exactly the same way as Tr2 in Fig. 3 therefore, its conduction being governed by the negative voltage developed across C808. This transistor's operating point, and thus the circuit's output voltages, is set by R808 which forms the 'set h.t.' control.

Q801 in turn controls the conduction of Q802, which sets the d.c. level at the base of Q803 and thus the discharge time for C809: the effect is to control Q803's turn-on timing and hence the duty cycle of the oscillator. We thus have a complete control loop which regulates and stabilises the three output lines.

The voltage developed across resistors R811 and R812 is proportional to the current that flows in Q803 and T801. In the full design this voltage is fed to an overload trip circuit (not shown here) that shorts out the feedback drive to the base of Q803 in the event of an excess current overload. Over-voltage protection is provided by diac D855 whose breakover voltage is reached when the h.t. output rises to about 110 per cent of the normal figure. It then conducts and latches on, shorting out the windings on the secondary side of T801. This brings the excess-current trip into operation. The power supply then shuts down until the mains power is switched off and on again to reset the trip.

T801 also provides mains isolation, there being no electrical connection between the windings and circuitry on its primary and secondary sides. In this particular circuit the surge limiter resistor R802 is included at the chassis return

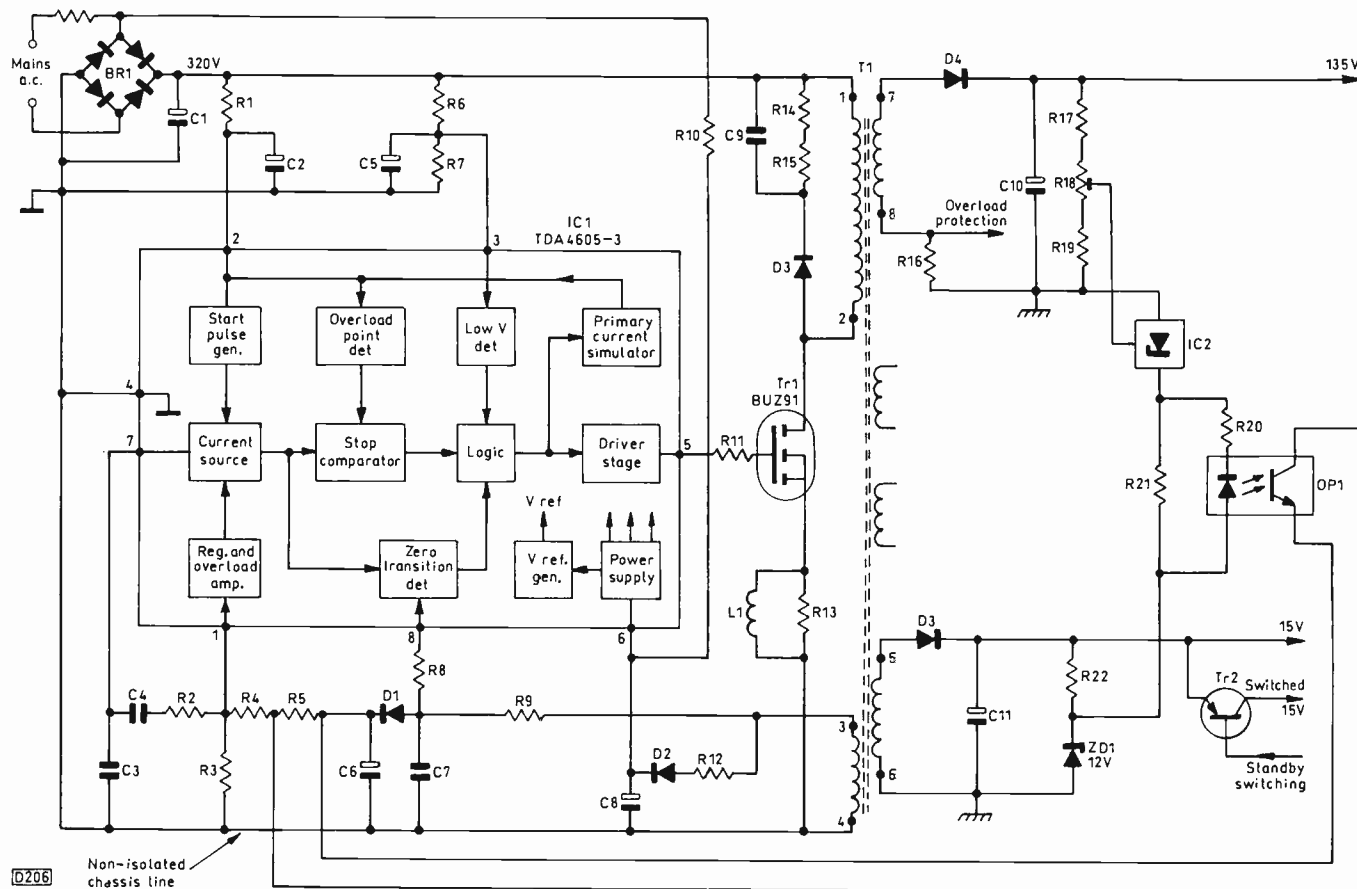

Fig. 6: A high-frequency, i.c.-controlled chopper power supply, using a MOSFET transistor and a dual-loop feedback system. Mains isolation is provided by T1 and the optocoupler OP1.

side of the mains bridge rectifier instead of the live feed side.

### IC-controlled SMPSs

Many different types of switch-mode power supply chips have been used in TV sets over the last decade. The early ones operated line synchronously, that is they were locked to the 15.625kHz line scan rate. There were two reasons for this: the avoidance of beat-pattern interference on the picture, and the supply of power when it's most needed – when the line output transistor switches on and current is drawn through the transformer. Later and current SMPS control chips run at a frequency that depends on the load. In the design shown in Fig. 6 the operation of the circuit varies between 32kHz at maximum load and 150kHz at minimum load, i.e. with the set in the standby condition.

The switching is done by the power FET Tr1, which earths and isolates pin 2 of the chopper transformer T1 alternately as it switches on and off. Circuit operation is basically as described above, though unlike the previous design (Fig. 5) the circuit doesn't oscillate. When Tr1 switches on, the 320V supply developed across C1 by the mains bridge rectifier BR1 is applied to T1's primary winding (pins 1-2). As a result there's a ramp current build up in the winding, and energy is stored in the transformer's ferrite core in the form of a magnetic field. The phasing of the secondary windings is such that rectifiers D3 and D4 don't conduct at this stage. After a few microseconds IC1 switches Tr1 off at its gate. The magnetic flux in T1 then reverses, producing current flows in the transformer's secondary windings via the now conductive rectifiers D3, D4 etc. (there are others, but these have been omitted in the interests of providing a simple circuit description). When T1's magnetic energy has been dissipated, Tr1 is switched on again and the cycle is repeated.

Thus T1 is being continuously charged and discharged with magnetic energy. When T1 is being charged, the reservoir capacitors on the secondary side of the circuit, C10, C11 etc., are being discharged by their loads. When T1 discharges, the charge stored by C10 etc. is replenished. It's important to appreciate that with this particular circuit the time scale is very short: there are typically six or seven 'pump' actions by the power supply during the period of a single line scan. This storage period of a few microseconds means that not much capacitance is required, so T1, C10 and C11 do not have to be large or heavy. But the circuit, especially T1, has to be well screened and decoupled to prevent radiation to other sections of the receiver.

The snubber network D3, C9, R14 and R15 across the primary winding of the transformer prevents excessive reverse voltage rise at the moment when Tr1 switches off, so that the dissipation in Tr1 during the brief transition from its on to its off state is reduced to a safe level. D810, R813, C810 and C811 serve the same purpose in Fig. 5.

### The Control Chip

The heart of the circuit is the TDA4605-3 control chip IC1. At switch on it's powered from the mains supply via R10 and C8, which form an integrating network. Once the circuit is up and running its operating voltage is provided by winding 3-4 on the transformer in conjunction with rectifier diode D2 and the reservoir capacitor C8. The pulses generated at pin 3 of the transformer serve two other purposes: they are fed via R9 and R8 to pin 8 of the chip to indicate that the transformer's magnetic energy has been expended, so that a new switch cycle should be started, while rectifier circuit D1 and C6 generates a voltage that's proportional to the output voltages. This is applied via R5 and R4 to pin 1 for regulation



# MANOR SUPPLIES

MKV PAL COLOUR TEST GENERATOR  
FOR DOMESTIC TV & VCR.

TEST  
DEMONSTRATIONS  
AT 172  
WEST END LANE



- ★ 40 different patterns and variations.
- ★ Fully interlaced sync pulses with correct picture blanking
- ★ EBU colour bars, BBC colour bars, whole rasters & split bars (specially useful for VCR service), white, yellow, cyan, green, magenta, red, blue and black
- ★ Chequerboard
- ★ Mono outputs with border castellations, cross hatch, grey scale, vertical lines, horizontal lines and dots. UHF modulator output plugs straight into receiver aerial socket.
- ★ Additional video output for CCTV & VCR.
- ★ Facilities for sound output.
- ★ Easy to build kit, standard parts. Only 2 adjustments. No special test equipment required.
- ★ Mains operated with stabilised power supply.
- ★ All kits fully guaranteed with back-up service.
- ★ Also available with VHF Modulator.

Price of Kit **£79.00**  
Case (10" x 6" x 2 1/4") app **£19.00**  
Optional Sound Module (6MHz or 5.5MHz) **£5.90**  
Built & Tested in Case including Sound Module Post/Packing **£129.00**  
Add VAT 17.5% TO ALL PRICES

## PAL COLOUR BAR GENERATOR (Mk4)

- ★ Output at UHF, applied to receiver aerial socket.
- ★ In addition to colour bars R-Y, B-Y etc.
- ★ Cross-hatch, grey scale, peak white and black level.
- ★ Push button controls, battery or mains operated.
- ★ Simple design, only five i.c.s on colour bar P.C.B.
- ★ Backup service available.

PRICE OF MK4 COLOUR BAR GENERATOR KIT **£39.00. CASE £5.80. BATT HOLDERS £4.20**  
MAINS SUPPLY KIT **£5.80**  
(Combined P&P £4.50)

VHF MODULATOR (CH 1 to 4) FOR OVERSEAS **£6.80.**  
EASILY ADAPTED FOR VIDEO OUTPUT & C.C.T.V.

ADD  
VAT  
17.5%

## LINE OUTPUT TRANSFORMER TESTER

- ★ Service Aid.
- ★ Saves time and money.
- ★ Checks short turns.
- ★ Simple to use.
- ★ Reliable.
- ★ Battery operated.
- ★ Pocket size.

PRICE **£24.00**  
POST/PACKING **£2.50**

ADD  
VAT  
17.5%

## INFRA RED REMOTE CONTROL TESTER

- ★ Pocket size.
- ★ LED + audible indication.
- ★ Simple to use.

PRICE **£20.00**  
POST/PACKING **£2.50**

## KITS AND PROJECTS

SAW IF AND TUNER UNIT complete and tested for video & audio outputs **£28.50** p.p. **£1.80.**  
PAL DECODER KIT (Video to RGB) for Monitors **£27.00** p.p. **£1.80.**  
PAL ENCODER KIT (RGB to Video) **£20.00** p.p. **£1.80.**  
CRT TESTER & REACTIVATOR KIT For Colour & Mono complete with Case. Panel Meter Indicator - can be adapted for latest CRTs **£45.00** p.p. **£4.50.**

# TV & VIDEO SPARES

## REMOTE CONTROLS

Replacement for: Ferguson, Hitachi, Philips, Panasonic, Grundig, ITT, Sony, Saito, Granada, Saito + many others.  
Phone for make and model no.

## PHILIPS SPARES

MANUALS (CF), CTX-E, CTX-S, CP90, CP110, GRIAX, G90AE, 2B, 3A, NC3-CR.  
GH10 £7.50 p.p. £1.80, 2A £10.50 p.p. £1.80,  
BACUP BATT. 2.4V £3.80 1.2V £2.00 p.p. 90p  
K30, KT4, CTX-EHT Lead £4.90 p.p. £1.00

## THORN/FERGUSON SPARES

TX10 Focus control **£8.50** p.p. **£1.80**  
TX9/10 Remote & tuning 1515N **£5.00** p.p. **£1.80**  
TX10 Stereo Audio Board **£3.50** p.p. **£2.50**  
TX100 Chopper TX **£15.80** p.p. **£2.50**

## IC SELECTION

AN5521	£3.80	SAAS243	£23.50	TA7680AP	£5.80	TDA2600	£6.80	TDA4610	£6.80
AN5900	£2.20	SAB3037	£9.80	TA7680B	£9.80	TDA2611A	£1.90	TDA4950	£1.60
BA6209	£3.80	SAB3037	£8.80	TA7698P	£6.80	TDA2640	£3.20	TDA5510	£12.50
BA6219	£3.80	SAF1032	£4.50	TA8739P	£4.50	TDA2653A	£5.80	TDA5850	£2.80
BA6229	£3.80	SAF1039	£2.20	TBA1205	£1.20	TDA2694	£5.70	TDA7052	£2.50
BA6238A	£2.80	SL470471	£2.40	TBA1205	£2.20	TDA2655B	£16.60	TDAS153	£7.80
BA6239	£3.80	SL486	£3.20	1BA920	£2.80	TDA2670	£3.20	TDAS170	£3.00
CCUR6G07	£1.40	SL490	£3.80	1BA950	£2.20	TDA2680	£3.80	TDAS180 KT	£7.50
CNX62	£4.80	SL1430	£2.40	1CA270	£1.80	TDA2690	£3.80	TDAS190	£3.80
HAI1211	£2.80	SL1432	£2.40	TDA190Z	£2.20	TDA2780	£6.80	TDAS305	£9.80
HAI1423	£3.80	SN76226DN	£1.80	FLA1035T	£1.40	TDA3190	£4.20	TDAS341	£4.20
HA513385P	£21.50	SN76705	£9.80	TLA1037	£1.90	TDA3301	£6.80	TDAS341	£4.20
LA4445	£3.80	STK5325	£6.80	TLA1044	£2.90	TDA3303	£19.80	TDAS503	£3.80
LA4520	£3.80	STK5326	£6.80	TLA1060	£6.80	TDA3330	£12.50	TDAS513	£4.80
LA7800	£1.80	STK5332	£6.80	TLA1082	£4.80	TDA3500	£6.80	TLA1009	£2.80
LA7520	£3.80	STK5333	£8.80	TLA11705	£1.80	TDA3505	£4.50	TLA1014	£3.50
LA7801	£3.50	STK5338	£6.80	TLA1180	£2.20	TDA3510	£9.80	TLA1039	£2.80
LA7820	£3.80	STK5337	£7.00	TLA1524	£6.80	TDA3540	£5.20	TLA2102A	£2.50
LA7830	£2.80	STK5339	£6.80	TLA1432P	£5.70	TDA3541	£3.50	TLA2102A	£2.50
M104B1	£6.80	STK5342	£4.80	TLA1512	£3.20	TDA3561A	£5.80	TDA2029	£5.80
M293B1	£15.80	STK5392	£6.80	TLA1515	£4.50	TDA3562A	£5.80	TLA2104	£3.95
M490BB1	£14.80	STK5421	£6.80	TLA1524	£6.80	TDA3565	£3.80	TLA2165A	£6.80
M491BB1	£14.80	STK5422	£8.50	TLA1670A	£3.20	TDA3566	£5.80	TLA3175	£6.80
M494	£9.80	STK5471	£6.50	TLA1701	£3.80	TDA3571	£4.20	1MS1008N21	£13.80
MC13002P	£5.80	STK5481	£5.80	TLA1770A	£3.20	TDA3576H	£9.80	1MP47C-432AP	£18.50
MDA2062	£3.80	STK5482	£5.80	TLA1870	£6.80	TDA3640	£9.80	S185	£21.95
ML237	£2.80	STK5490	£7.80	TLA1872	£9.80	TDA3650	£9.80	TMP47C-432AP	£15.50
ML926	£4.80	STK6962	£3.80	TDA1908	£2.80	TDA3651	£4.20	TMP47C-434N	£16.80
MN15425	£15.80	STK7308	£6.80	TDA1940	£3.20	TDA3653A	£3.80	1MP47C-434N	£16.80
SAA1024	£5.80	STK7348	£10.80	TDA1950	£3.50	TDA3653B	£3.20	3555	£16.80
SAA1025	£5.80	STR04420	£4.80	TDA2004	£2.80	TDA3654	£3.20	3555	£16.80
SAA1124	£3.50	STR3125	£4.80	TDA2040	£4.80	TDA3810	£5.50	TMP47C-434N	£16.80
SAA1250	£3.80	STR441	£15.80	TDA2150	£3.20	TDA4420	£2.20	3559	£15.80
SAA1251	£8.40	STR450	£11.40	TDA2270	£3.80	TDA4426	£3.20	TJA2000	£8.50
SAA1293 (2)	£3.80	STR458	£14.80	TDA2572	£2.20	TDA4427	£2.20	U4006	£14.80
SAA1293 (3)	£1.80	STR454	£14.80	TDA2548	£5.80	TDA4442	£2.80	UC3844	£2.50
SAA1293 (4)	£1.80	STR4211	£6.80	TDA2576A	£7.80	TDA4443	£7.80	UC1363C	£5.80
SAA5000	£6.80	STR5412	£9.00	TDA2577A	£4.80	TDA4500	£5.80	UC1363CA	£5.80
SAA5010	£5.80	STR6091	£6.80	TDA2578	£3.80	TDA4501	£7.80	UC1378	£1.90
SAA5012	£5.80	STR6020	£6.80	TDA2579	£3.80	TDA4502A	£13.50	UC1394	£3.80
SAA5020	£5.80	STR50103	£5.80	TDA2581	£6.80	TDA4503	£5.80	UC1394	£3.80
SAA5030	£5.80	STR54041	£6.80	TDA2582	£2.80	TDA4505	£6.80	UC1428A	£2.20
SAA5040	£6.80	STR54041	£6.80	TDA2583	£1.80	TDA4555	£9.80	UC1488	£3.20
SAA5050	£1.80	STR59441	£6.80	TDA2594	£3.80	TDA4600	£3.85	UCD1397C	£4.80
SAA5231	£7.80	STR6020	£7.80	TDA2595	£4.80	TDA4601	£2.80	IC p.p. 90p	

## LINE OUTPUT TRANSFORMERS p.p. £1.80

AMSTRAD 2200	£28.80	PANASONIC TLF-1456F	£29.00
B&O LX250A, 2800 A T207781	£28.80	PHILIPS KT3	£13.80
BUSH A2279/10	£34.80	PHILIPS K30	£22.80
DECCA 109	£19.80	PHILIPS CTA L/S	£24.80
FIDELITY ZX2000	£15.80	PHILIPS KT4	£22.80
FIDELITY ZX3000	£14.50	PHILIPS 2A	£25.80
HINARI CT4, CT5	£24.80	PHILIPS K40	£27.50
HITACHI CPT1455, 1456, 1476, 1491	£19.50	PHILIPS K40	£23.80
HITACHI CPT1446/46 PNC242981	£18.90	PHILIPS CPT	£23.80
HITACHI CPT2174/76/78	£18.90	PHILIPS CPT	£23.80
HITACHI PNC243752	£21.80	PHILIPS CPT	£23.80
ITT Compact B 110	£19.80	PHILIPS GRIAX	£25.90
ITT Compact 80, 110	£22.80	PHILIPS NC3	£22.50
ITT Compact 80, 110 EST	£19.80	SAISHO MATSUBI 2714002	£21.80
ITT CVC 25, 30, 32	£9.80	SAISHO MATSUBI 3214009	£22.80
ITT CVC 801, 801, 803	£18.50	SANYO CPT144, 2145, CPT1644	£28.80
ITT CVC1100, 1206, Picos	£18.50	SANYO CPT17132 80P Chassis	£39.80
ITT CVC1100, 1175	£22.80	SONY KV1412	£21.80
ITT CVC1300, 1201, Min 2	£18.50	SONY KV1440, 1400/62	£21.80
ITT CVC1304	£17.80	SONY KV1882	£24.80
ITT CVC1310/12/15/17	£17.80	SONY KV2056, 2062, 66	£32.00
ITT Core 110 FST	£17.95	SONY KV21XRTU	£52.00
ITT TX33267	£22.80	SONY KV252/56, 2752/56, 2762/66 PL3	£29.00
ITT TX3440	£22.80	SONY KV27XRTU	£29.00
ITT Monopack 2	£1.80	THORN IC C5-2 TYPLS	£24.00
ITT Comp. 125T	£19.95	THORN TX9	£23.50
January 1993 - buy LOPTES kit & get 15% discount off marked prices		THORN TX10 (Chopper)	£19.80
LOLWE Profi, Basic, Contour, etc (Quote mod. No.)	£33.00	THORN TX85	£19.80
LUXOR P4580/10 01	£33.00	THORN TX89	£19.80
MATSUBI 1855	£32.50	THORN TX90 14"	£17.00
PANASONIC TLF-1453JUF, TLF-1456F	£29.00	THORN TX100, 110 Green Spot	£17.00
PANASONIC TLF-14521F, TLF-14567F	£29.00	THORN TX100/90 LST Yellow Spot	£21.80
PANASONIC TLF-14584F	£29.00	THORN TX101/111 1700451	£21.80
		THORN TX100 Blue Spot	£21.80
		THORN 51P7	£32.00

## TRIPLERS EHT MULTIPLIERS p.p. £1.80

CONTINENTAL UNIVERSAL TVK & BG RANGE (Quote exact no.) **£13.80**  
U.K. UNIVERSAL (best quality) **£7.80**  
DECCA/TATUNG BG 200/44 TYPE **£7.80**  
GRUNDIG BG 2077-642-1003/1004 **£16.80**  
GRUNDIG BG 2087-642-1001/1002/1006 **£16.80**  
THORN 9000 **£9.80**

## MISCELLANEOUS p.p. £1.80

MAINS TRANSFORMERS: 6.3 Volts CRT boost **£6.80** p.p. **£1.80**  
TV FAULT FINDING GUIDE **£14.80**  
VCR FAULT FINDING GUIDE **£14.80**  
455 CRYSTALS for handsets, 4 for **£2.00** p.p. 80p  
DEGAUSSING ROD **£33.75** p.p. **£3.50**  
TRANSPARENT VIDEO SERVICE CASSETTE  
HITACHI THERMISTOR TH902 **£2.40**

HOW TO ORDER: ADD p&p TO ORDER + VAT 17.5% TO THE TOTAL.

PRICES ARE SUBJECT TO CHANGE WITHOUT NOTICE

Telephone 071-794 8751/794 7346

Fax 071-431 5778



## MANOR SUPPLIES

172 WEST END LANE, LONDON NW6 1SD

CALLERS WELCOME AT SHOP

Mon-Fri 9.30-6pm - Thurs 9.30-1pm - Sat 9.30-5pm



purposes. Thus the basic feedback loop is formed, with a sample voltage applied to pin 1 and a reference voltage generated within the chip.

When mains power is first applied the secondary reservoir capacitors C10, C11 etc. are all discharged. To limit stress on the power supply during the initial charging surge a soft-start system is provided within IC1. It brings up the duty cycle of the drive pulse output at pin 5 at a slow rate, governed by the charging time of capacitor C3 at pin 7. The driver stage behind pin 5 takes the form of a push-pull amplifier which switches the output between chassis and the chip's supply potential. Although the power MOSFET Tr1 is a voltage-operated device a drive current capability of  $\pm 1A$  is required for rapid charge and discharge of its gate capacitance.

Most of the chip's other pins are concerned with circuit and component protection. Pin 3 samples the mains derived supply via potential divider R6/7: if the voltage developed across C1 becomes too low for normal operation of the circuit the power supply shuts down. Excessive mains voltage is sensed at pin 6, the circuit similarly shutting down.

The main overload protection centres on pin 2 however. When Tr1 is off, pin 2 is earthed (to pin 4) by a switch inside the chip – it's in the block labelled primary current simulator. During Tr1's on periods the switch is opened so that C2 can charge from the 320V line via R1. Thus C2 generates a sawtooth voltage whose peak amplitude is proportional to the chopper transistor's duty cycle. This waveform is monitored within the chip: if the peak voltage exceeds a certain threshold excessive energy demand is indicated and Tr1's duty cycle is limited to reduce the output from the power supply.

While this energy-limitation system provides good general protection, its position on the primary side of the power supply cannot guard against overloads in individual circuits supplied by the secondary side. For example a situation could arise where the line output stage draws excessive current without increasing the set's total power consumption beyond the preset limit. To guard against this the current in the 135V line is monitored by the low-value resistor R16 which is connected in series with winding 7-8 of the transformer. A negative voltage that's proportional to the current is developed at the junction of pin 8 and R16: if this voltage exceeds a certain level a switch is triggered, disabling the line oscillator so that the line output stage shuts down.

Apart from such extra arrangements the power supply is inherently short-circuit proof. If a secondary winding on the chopper transformer is shorted out for example the energy stored by the primary winding is very quickly transferred to the secondary side, leading to high-frequency operation with a minimal switching duty cycle and low energy dissipation.

We have already seen that feedback from the transformer via rectifier circuit D1/C6 and resistors R5 and R4 to pin 1 of the chip is used to provide stabilisation. There's an additional feedback loop that's also linked to pin 1 but monitors the 135V h.t. supply. A sample of the h.t. voltage is taken via the potential divider R17/18/19 to the input terminal of IC2, which acts as a variable zener diode. It's connected across the stabilised 12V supply produced by R22 and zener diode ZD1. Part of IC2's current flows through R20 and the optocoupler OP1: this current will vary with any increase or decrease in the h.t. voltage. The light produced by the LED section of the optocoupler shines on and varies the conduction/resistance of the phototransistor in the package. This phototransistor is connected across R5, thus varying the voltage applied to pin 1 of IC1 to improve the stabilisation characteristic.

Isolation between the primary and secondary sides of the circuit is provided by T1 and OP1.

Power supplies like this continue to run in the standby mode, operating at high frequency. This represents minimum

load, with a typical mains power consumption of about 6W. In the arrangement shown in Fig. 6 transistor Tr2 provides a switched 15V line. When the standby command is given the microcontroller chip in the set switches Tr2 off: removal of the switched 15V line shuts down the line output stage and other essential sections of the set while the control department remains operational to receive further commands.

## Bipolar Transistor Circuits

The circuit we've been looking at is properly known as a free-running flyback converter. It's a development of the well-known configuration using a TDA4600/4601 series control chip. The latter has been very widely used by setmakers in conjunction with a bipolar switching transistor. The main difference with the arrangement shown in Fig. 6 is the much higher operating frequency, which is made possible by the fast-switching power MOSFET and the transformer's specially-developed ferrite core.

## Degaussing

In dealing with picture tubes in Part 8 (August) we mentioned that the magnetic shield and shadowmask within the tube and the rimband are demagnetised by applying a decaying burst of mains a.c. to a coil that's wound round the bowl of the tube. The provision of this degaussing energy is another function of the receiver's power supply.

Fig. 7 shows the simple circuit generally used. At switch on mains current is passed through the two posistors (thermistors with a positive temperature coefficient) PTC1 and PTC2 and the degaussing coil/coils (depending on the tube type). The two posistors are mounted in intimate thermal contact in a small, three-legged package. Initially, when the dual posistor is cold, a relatively heavy current flows. PTC1 acts as a heating element while PTC2 contributes a switch-like

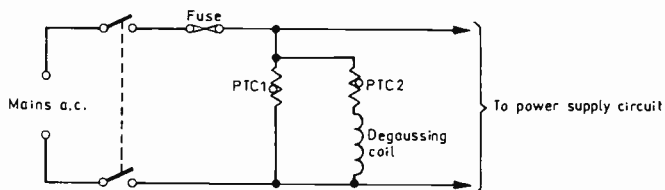

Fig. 7: Basic tube degaussing circuit. The current flowing through the degaussing coil falls from 400mA to less than 100 $\mu$ A within a few seconds of the application of the mains supply to the dual-posistor PTC1/2. In some designs the thermistor that acts as the heating element is connected in series with the supply to the rest of the receiver instead of being in parallel as shown here: it has to have a negative temperature coefficient therefore, and can contribute to switch-on surge limiting.

action. The device warms up rapidly, its resistance rising substantially: PTC2 goes very high, virtually cutting off the current flow through the coil(s), while PTC1's resistance rises to a stable point so that it runs warm enough to keep PTC2 in its high-resistance state.

The usual practice has been to connect the degaussing circuit after the mains on/off switch so that the tube is degaussed each time the set is switched on. Where the set alternates between on and standby modes, with all or part of the power supply running continuously, a triac or relay triggered by the power-up or /standby line may be used to switch power to the degaussing circuit.

**Next month: The digital bits**

# Teletopics

## US HDTV PROGRESS

The Grand Alliance of firms developing the US HDTV system has reached broad agreement on three of the four main technical specifications. The MPEG-2 video compression system, with B Frames, will be used. There will be two scanning formats, 1,080 sequential lines with 1,920 square pixels per line at 24, 30 and 60 frames/sec; and 787.5 sequential lines variable to 1,050 interlaced at similar pixel and frame rates. For sound, Dolby AC-3 has been adopted. The main area of contention lies in the transmission system: several different techniques are to be tested in early 1994. The FCC has given approval for a prototype system for evaluation to be built. It's expected that a complete prototype system with all the final technical specifications agreed should be ready by the third quarter of 1994.

## SERVICING NVQs

National Vocational Qualifications in consumer electrical/electronic product servicing should be available for award within a year. Standards of competence have been drawn up but not finalised: the Department of Employment is responsible for this and is to appoint a consultant to undertake the task. NVQs are intended as industry-led competence qualifications that are recognised as national standards. The City and Guilds of London Institute and the Electronics Examination Board will be the joint awarding bodies. Employers will be responsible for putting forward staff. There will be three levels.

## CABLE TV

Channel One, a new cable channel for the London area carrying light entertainment and features, sports programmes and news, is to be launched in April. The London Interconnect Group, a consortium of the capital's six largest cable TV operators, has awarded a ten-year licence to Channel One, which will be run by Associated Newspapers and SelecTV. Initially there will be about twelve hours a day of programmes. Associated Newspapers has an 80 per cent stake while SelecTV will be mainly responsible for the provision of entertainment programming. An investment of £30m is to be undertaken over the next few years and the group will be building a television studio.

The ITC has issued the first invitation for four years to apply for a new UK cable TV licence: the franchise will cover Sevenoaks, Tonbridge and Tunbridge Wells in west Kent and will be the first to be advertised under the 1990 Broadcasting Act.

The latest cable figures show that for the first time the number of UK subscribers to modern, broadband cable services has exceeded half a million.

## INTERACTIVE TV

Swedish public broadcaster Sveriges Television (SVT) is the first in Europe to plan an interactive TV system, with digital transmission capable of terrestrial, cable or satellite operation at standard or HDTV line rates. The system, being developed in conjunction with the Swedish Institute of Computer Science, is called Idun. It will provide teletext type displays though the quality will be much higher than

standard teletext, and output to a laser printer is envisaged: both still and moving pictures can be presented. Receivers will need to be able to store about 100Mbytes of information. The system works like a Windows program, controlled by the TV handset. A feedback channel is incorporated for viewer interactive use and/or pay TV operation. Philips' Postscript decoder development could be used.

## BUSINESS NEWS

Amstrad chairman Alan Sugar sees no evidence of a pre-Christmas spending boom. At the company's annual general meeting he commented that "trading conditions are not very good: people just aren't spending money". October produced worse results than anticipated, particularly in the UK where volumes and margins have been under pressure. The company expected November and December to reflect "relatively weak demand". Amstrad is losing money on its remaining high street personal computer sales, and has seen satellite television margins plunge.

Satellite TV equipment distributor Longreach Marketing Ltd. of Bath has agreed to buy Supervision from the administrative receivers. A new company, Longreach Supervision, has been set up.

Daewoo has set up the headquarters for its UK electronics sales company at Winnersh Triangle near Reading. Full address is Daewoo Electronic Sales UK Ltd., Daewoo Building, Wharfedale Road, Winnersh Triangle, Wokingham, Berks RG11 5TP, telephone 0734 272 272, fax 0734 699 922. An alteration to our spares guide entry is required - the spares/service fax no. is now 0734 699 900. The company is building a plant for the production of colour TV sets and tubes at Fameck, France.

Grundig has shut its TV receiver assembly plant at Creutzwald, France.

## PUBLICATIONS

U-View, 4 South Parade, Bawtry, Doncaster, Yorkshire DN10 6JH (0302 719 997, fax 0302 719 995) has now published *Video Servicing 1991-2* at £195. This massive three-volume set provides circuit diagrams and other essential servicing data for 322 models from 44 manufacturers.

GDN Publications, Longmeadow, Miles Lane, Cobham, Surrey KT11 2EA (0932 862 592) has published *Hacker Radio*. There is a special price to *Television* readers of £3.20 inclusive of post and packing from the above address. This well-illustrated, 28-page book by Geoffrey Dixon-Nutall and Gordon Bussey is a fascinating account of the Hacker brothers' involvement in the UK radio industry, first with the Dynatron company and later Hacker Radio.

## NEWS ROUND-UP

The colour television licence fee is to rise from £83 to £84.50 from April 1st 1994, an increase of 1.8 per cent.

Kodak is now offering higher-capacity, writable CDs that store up to 17 per cent more information in digital form. The new discs can hold up to 680Mbytes of data or 74 minutes of digital audio and cost £18.50 each (the original discs hold 580Mbytes/63 minutes of audio).

Dixons has issued a recall for the 20in. Matsui Models 209R and 209T for a safety modification because of possible overheating. About 50,000 sets have been sold. Owners can contact Mastercare's Customer Relations Department on freephone 0500 234 558.

Matsushita and Sony have both entered the video games market.



# VCR Clinic

**Reports from Philip Blundell, AMIEIE, Eugene Trundle, Richard J. Avis, Adrian Farnborough, John Edwards, Alfred Damp, Mike Leach, John Coombes, Chris Avis, Steve Cannon, Chris Watton and Simon Bodgett**

## Philips VR6761

In the E-E and playback modes there was sound but just a blank raster. Checks on the record/playback switching voltages showed that there was only 2V instead of 12V at D6403 on signals board P306 in the E-E and playback modes. This voltage comes from mother board P606, where the BC328/40 transistor Tr7607 was found to be open-circuit base-to-emitter. **P.B.**

## Ferguson 3V35/JVC HRD120

Check for h.f. ripple on the 12V supply, at pin 1 of connector CN4, if the playback picture suffers from herringbone patterning. A ripple voltage of 0.5V here should lead to a check on C16 (47 $\mu$ F) which you will probably find is open-circuit. **P.B.**

## Samsung SI/SX7220/Goodmans VCR2500

If one of these machines fails to eject the tape or dies as it completes the tape loading process it's likely that the loading motor is weak. On a couple of occasions recently however we've found that poor regulation by the STK5333 chip on the power regulator PCB was the cause. **E.T.**

## Tatung TVR6111/Amstrad VCR9410/etc

There are doubtless other Amstrad VCRs and more makes and models that use this mechanism. A very common fault with it now is intermittent failure to rewind or wind fast forwards. The motor whirrs but the reel-drive gears don't

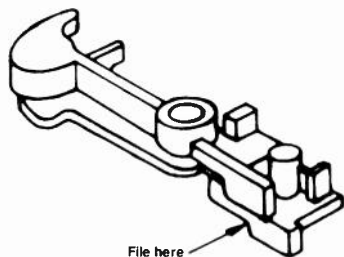

*Fig. 1: Where to file the trigger lever – see Tatung TVR6111/Amstrad VCR9410/etc.*

move into engagement. The cause of the problem is failure of the trigger lever (item 260 in the exploded view of the deck) to flip back into position in the stop mode. Cure it by filing a fraction of a millimetre off the end of its skirt, as shown in Fig. 1. **E.T.**

## JVC HRD520

This machine had been to several service departments, always with the complaint of intermittent tape looping. After a great deal of time we traced the cause of the fault to the mode switch, which is available from CPC under part no. TNPU60622-1-1. **R.J.A.**

## Ferguson 3V32/JVC HR7655

The 3V32 is not a common visitor to our workshop. In view of this and its complex circuitry we tend to be apprehensive when one comes along. The fault with this one was complete

absence of the fluorescent display. Not surprisingly we found that the filament supply voltage was missing. It comes from a 37kHz oscillator which is mounted on a small subpanel behind the main display, the main items here being T201 and Q205. There should be 3V p-p at the centre-tapped secondary winding but a scope check showed that the oscillator had stopped. It turned out that the oscillator transistor's 22k $\Omega$  base bias resistor R281 was open-circuit. **A.F.**

## Akai VS22

The tape loaded correctly but there was no drum or capstan rotation in either direction because the BU2735AS chip IC503 was faulty. We've had failure of this chip on a number of occasions. **J.E.**

## Ferguson 3V23/JVC HR7700

A tape was stuck in this machine: the eject button had no effect because there was no voltage across the carriage loading motor. We found that fuse F5 had blown because C36 was short-circuit. Replacing these items put matters right. **J.E.**

## Panasonic NV370/830/850

If you get one of these machines that's dead with no displays and no functions check the 0.39 $\Omega$  resistor R1001 in the small power area on the main board. It will probably be open-circuit with no contributory cause – it feeds the 5V regulator. A new resistor should provide a cure. **J.E.**

## Hitachi VT8000

All functions worked in this old machine, but only for about five seconds. It would then shut down. The cause was a stretched take-up spool carrier to counter belt – so the counter and the take-up spool rotation pulses stopped. A new belt solved the problem. **J.E.**

## Philips VR6362

In rewind or fast forward this machine would stop and eject the tape after a few seconds. In the play mode it would lace up then unlace and eject the tape. All this was because the drum didn't rotate as the 3.3 $\Omega$  resistor R3142, which is in the 13V feed to the drum drive circuit, had failed. **J.E.**

## Philips DMP2 Deck

Shortly after we'd fitted a service kit to one of these machines the customer returned it with the complaint that although it now worked it would occasionally refuse to load a tape. The machine worked all right for several days before the fault showed up. When we called up the fault status from the machine's software we got an indication that tape loading was too long, heavy loading, etc., in other words a service kit was required. In an attempt to see what was happening we examined the machine from all angles. Nothing was obvious until I peered into the loading motor and pulley housing:

while a tape was being loaded the pulley moved from side to side. When the top deck was dismantled we found that the shaft on which the differential gear sits was loose in its chassis mount. We got over the problem by fitting a chassis from a scrap machine – otherwise the machine would have been beyond economic repair. **A.D.**

### **NEC DX1000K**

This machine was brought in for a new idler and service. When we obtained and fitted the necessary parts we found that the E-E video was overloaded – there was a gradual improvement as the machine warmed up. This machine has a digital still TV picture mode. When this was selected we got a good still E-E picture. The cause of the fault was traced to pin 3 of IC207, where the voltage didn't go low enough for E-E video. There was leakage here, due to the glue that had been applied to the PCB to secure cables. **A.D.**

### **Panasonic NVG21**

There was no audio playback. We found that the audio mute line was high, the cause of this being absence of the CTL pulses. We checked back to the servo pack where C240 in the 'AGC CTL' circuit was defective. **A.D.**

### **Saisho VR1000/Matsui VX800**

The complaint was that the 2.5AT fuse F502 would blow intermittently. While the machine sat on the bench it behaved normally, but as soon as it was moved the fuse blew. We found that the bottom PCB had warped beneath the power supply. As a result the fuse blew every time the PCB came into contact with the metal bottom case. **A.D.**

### **Crown VRS200/Alba VCR7000/8000**

The capstan speed would slow and the machine would switch from the SP to the LP mode. Scope checks showed that the control pulses were curved and that there were 1V negative-going pulses on the 6V line. The bridge rectifier was the cause of the fault. **A.D.**

### **Samsung SI1260**

There was a blank raster and no playback. After removing the top cover we saw that there was neither drum nor capstan rotation: the blank raster gave the impression that the machine was stuck in the AV mode, though it wasn't. Voltage checks showed that the switched 5V supply was missing at D109 (1N4001) which had gone open-circuit. A replacement restored normal operation. **M.L.**

### **Ferguson 3V54**

The clock worked but there was no other operation. None of the front controls had any effect. As the circuit protectors in the main body of the power supply were all in order we turned our attention to the main PCB where we found that the switched 5V supply was missing. The cause of the fault was C605 on the top panel – it was leaky, a replacement restoring normal operation. **M.L.**

### **Akai VSC200**

If there's no playback check that the video lock is not in the on position. To unlock, press the remote control unit's play button and hold it down for ten seconds then do the same

with the stop button. If this fails to restore playback check that the cassette is accepted correctly. If not, check or replace the cassette loading block. **J.C.**

### **Mitsubishi HS337**

For no rewind or fast forward operation and failure to record check the record inhibit switch. It may be misaligned, broken or damaged as the result of use of a C format cassette. **J.C.**

### **JVC HRD540**

There was no E-E sound. The cause was failure of the 4.7Ω safety resistor R47 in the l.t. feed to the audio circuit. **J.C.**

### **JVC HRD520**

For muted sound with lines on the picture check the f.m. waveform. This will show that the guide poles are misaligned. Under these conditions the VCR may record and play back its own tapes all right but it won't play back prerecorded tapes. **J.C.**

### **Toshiba V110**

If the tuning is off, check the 2.7V zener diode DT53 in the video 5V supply regulator circuit. It tends to become leaky. Other possible symptoms when this diode is leaky are no playback colour or distorted playback and E-E pictures. **J.C.**

### **Amstrad TVR2**

It's difficult to decide whether to list this fault in the TV or VCR section. The symptom was severe 100Hz hum on the TV picture and sound, though tape playback was o.k. Its cause was in the video power supply however, where the 2,200μF, 25V capacitor C606 was almost open-circuit. It smooths the 20V supply to the 12V regulator chip IC601. **C.A.**

### **Hitachi VT410**

An obscure fault caused this machine to lace up, play briefly, then unlace. The counter was working, and the waveforms around the syscon chip IC901 were all o.k. except for the 25Hz signal at pin 23 which was found to be of low amplitude when a comparison check was carried out with a working machine. The signal comes from the servo chip IC601, where a comparative resistance reading to chassis revealed that the faulty machine had a 400Ω leak. The cause of this was C23, a surface-mounted capacitor on the video head preamplifier PCB! **C.A.**

### **JVC HRD540**

The problem was intermittent E-E and playback sound. Application of freezer anywhere around Q5 and Q6 on the tuner/i.f. PCB instigated the fault, as did any attempt to measure the voltages around Q6 (FMS2) which proved to be the culprit. This tiny, five-legged surface-mounted device is not listed by any of our usual suppliers, but a replacement was obtained from JVC without difficulty. **C.A.**

### **Philips VR422**

There was intermittent mistracking and generally very poor playback. As there were no obvious mechanical faults and

the deck had been realigned a few times we suspected an electronic fault. A scope check on the drum PG/FG pulses at the head amplifier showed, when a comparison was made with the oscillogram, that there was no synchronising pulse. The oscillogram shows this as a gap in the drum pulse waveform. After replacing the TDA5140 drum motor driver chip IC7301 and carrying out slight realignment of the deck we obtained an excellent picture. C.W.

### **Bush VCR185**

There were no E-E signals. Checks showed that the u.h.f. tuner received a 0-30V ramp voltage while search tuning but, as voltage UB was missing, no signals were selected. R132 (10k $\Omega$ ) in the band-switching system was open-circuit. C.W.

### **Logik VR950/Samsung VI611**

This machine wouldn't play. We found that the drum didn't rotate and the operate LED didn't light up. Although some of the power controlled circuits were working, the PC12 line was low. The cause of the trouble was D4 (1N4002) on the power supply PCB. C.W.

### **Akai VSF33**

When any operation was selected, via either the machine's own controls or the remote control unit, the power went off leaving just the clock. When the machine was switched on again it would stay on until a tape was inserted or the channel was changed. It would then power down again. The cause of the fault lay in the 23.5V regulator circuit, where R221 (120 $\Omega$ ) had gone high in value. C.W.

### **Hitachi VTM740**

The customer complained that there were lines on the picture and that the tracking light flashed, mostly at the start of a tape. When we ran a test tape the symptoms were as described: the tape speed varied, being mostly slow. Checks on the pinch roller, the back tension and the tape path led us to the capstan motor, whose upper bush was bone dry. Dismantling the motor, lubricating the bush then reassembling the unit provided a complete cure. C.W.

### **Pye 65VR20/Philips VR6520**

This machine sometimes stopped after only a few minutes, but only in the record mode. It turned out to be a nice easy job for a change: the recording tab switch was as black as your hat! A new switch restored normal operation. C.W.

### **Amstrad VCR8600**

There was no drum rotation. The cause was traced to tiny cracks on the signal panel, where the YC subpanel is joined. This is a very flimsy area, and the print is quite tricky to repair. I applied a few blobs of glue to help support the subpanel. C.W.

### **Panasonic NVG21**

The lift was jammed half way in and the machine was dead – no clock display or power-on LED indication. A check in the power supply showed that the 1 $\Omega$  safety resistor R15 was open-circuit. This was the cause of the dead machine, and I assume that the jammed lift was responsible for its

failure. Once the lift had been extracted I found that various plastic tabs had broken off, so a new side plate (part no. VXA2677) was obtained from SEME. If you have to fit one of these I recommend that you read Nick Beer's article (May 1991) on servicing this model: without his advice I'm sure that I would still be trying to align the gears. C.W.

### **Hitachi VT430**

This machine was stuck in pause. When a cassette was inserted the pause indicator lit up. Other functions could be selected, e.g. play, but this produced only a still picture. A check at pin 56 of IC901 produced a reading of 3.2V instead of 0V. This led us to I1581, a 100 $\mu$ H choke that's in series with the camera pause socket. C.W.

### **JVC HRD880**

A tape was stuck in the cassette housing and there were no functions. We found that a key scan port associated with IC1 was stuck high. Everything worked correctly when the chip had been replaced. S.B.

### **S-VHS Instability**

The complaint with a JVC HRD4700 was that it wouldn't record via the S-VHS sockets while the S-VHS output signals were inherently unstable. We found that it recorded and played back very well in the S-VHS mode. The playback instability occurred with titles that had been added by the amateur film maker who owned the VCR. We told him that the black-level clamping in his titling machine wasn't up to much – if indeed it had such a thing. S.B.

### **JVC HRD560**

One of these machines wouldn't tune. We replaced the tuner, the tuning memory chip, then the tuner/timer chip for key scan control. all to no avail. Finally we replaced the system control chip. That did it!

Another of these machines came in dead. We replaced circuit protector CP1 in the power supply then, on final test, noticed that the capstan motor was inclined to act erratically – in fact at one time it went into reverse. A new motor had to be fitted. S.B.

### **Panasonic WJMX12 Mixer**

This mixer caused us a lot of trouble. The alleged fault was loss of channel 2 colour after some time – a tape was supplied as proof. We were unable to confirm the fault and got a second opinion from Panasonic who ran the machine on test for a week then concluded that it wasn't faulty. The report said that the VXOs and VCOs were all set up correctly and that full genlock was consistently obtained. We eventually discovered that the fault did exist when the mixer got hot. The cause of the fault was a crystal in the channel 2 input colour decoder. It went off frequency when hot, i.e. very hot. S.B.

### **Grundig 2 x 4 Super**

I rarely see one of these machines. This one came in with a power supply fault. After removing the 25A car fuse and replacing the intermittent on/off switch I eventually found the real cause of the fault – the coupling capacitor between the TDA4600 chopper control chip and the chopper transistor. S.B.

# Faults that Aren't There

D.A. Chaplin

Because of the complexity of many modern consumer electronic products the service engineer must, when fault-finding, take great care to check on the basics before plunging in at the deep end. A careful check on control settings, both mechanical and electronic, can save a lot of time that might otherwise be spent on searching for the cause of a fault that isn't actually there. Here are some examples where a fault was initially thought to be present but it wasn't necessary to use any tools to put matters right. Most of them are based on my personal experience, and I admit that with hindsight some of them look like blunders. But it's easy to assume that a fault is present when some of these conditions are met for the first time, and I doubt whether I'm alone in this respect.

## A Handset Problem

There were two symptoms with an ITT Trimline receiver that came in. The main one was intermittent loss of the signals. This was quickly diagnosed as being caused by dry-joints in the tuner/i.f. module: a quick rework of all the connections here restored reliable operation. I was also told that the remote control system hadn't worked for months. As the batteries were flat I cleaned and retensioned the contacts and fitted new ones. But there was still no action when the unit was tried.

A couple of fruitless hours were then spent stripping the unit more than once, replacing the remote-control receiver assembly in the set and the associated i.c.s. Finally in desperation I pointed the handset at the receiver and pushed each button in turn. Suddenly everything began to work normally. The next few minutes were spent working out what had happened. Then the penny dropped. It was one of those TV sets that come with a teletext handset even though there's no text panel. Someone had pushed the text button, after which the normal functions weren't available until the picture button had been pressed. To make matters worse the markings on the buttons had worn off, so it was not obvious that the handset was a teletext one. I tried removing the batteries with the text mode selected; when they were replaced several minutes later the unit was still in the text mode.

## Standby Problems

My first brush with the Ferguson ICC5 chassis occurred when a friend gave me a set that bore the Model number 51L5BQ – incidentally in every list of ICC5 sets I've come across this model is omitted, does anyone know why? Anyway the set was in a really bad way, hence the gift.

After repairing much damage and many faults the set finally sprang to life. But the second time I switched it on the set went into the standby mode before a picture appeared. Several more attempts produced the same result. I eventually found, to my great relief, that the set could be brought back to life by holding in the channel-up button. I

subsequently learnt that when the set is switched off in the standby mode this fact is stored in the memory, the result being that it returns to the standby mode when next switched on. The set can of course also be brought out of standby by using the handset in the normal way.

I've heard that some sets behave in a similar fashion when switched off manually while programmed in the timer-off mode. The next time the set is used it switches off after the period for which the timer was set on the previous occasion. Those unaware of this could waste much time looking for a non-existent fault.

## Play Problem

An Amstrad TVR3 televideo unit I had in for repair had a badly cracked control PCB in the video section. When I tested the machine after carrying out the repair I found that it went into play as soon as a tape was inserted and the stop button was ineffective. I stripped the unit down twice more and rechecked the panel but no further faults were found. Luckily the last time I inserted the video section into the cabinet I noticed a switch, marked 'repeat play', at the rear of this section. Normal operation was obtained when this switch was flicked to 'off'.

## Store Lock/Hotel Mode

I carry out TV/VCR repairs for local hospitals. A recent addition to my list of customers is the private wing at the District General Hospital. Eighteen Philips GR1-AX portables had been installed here. The first one to cause problems produced only very limited volume. Fortunately I hadn't wasted much time on fault-finding before something began to stir at the back of my mind. I searched through my copies of Philips' *Service Link* and eventually found details of the store lock/hotel mode that's a feature of this chassis.

This facility is used to prevent alteration to stored TV and VCR programme tunings, to prevent alteration to sound and picture personal-preference values, and to limit the available volume range to a preset maximum. Store lock is made operative by selecting programme 38. Adjust the volume to the maximum desired level, then press the store and programme-up buttons simultaneously. To unlock, you select programme 38 then press the store and control-up buttons simultaneously. The set worked normally when this unlocking procedure had been followed.

The Philips GR2.1 chassis also has a hotel mode and channel 38 again has to be selected when locking and unlocking. But with this chassis you press programme '-' or volume '+' to lock or unlock respectively.

## Child Lock

A Toshiba V411B VCR wouldn't respond to any key commands. The cure was simple but not obvious. Someone had accidentally activated the child-lock function. When the machine is in this mode the only clue is the stop indication in the VCR display. Normal operation is restored by pressing the handset's tuner button until the stop indication goes out. To set the child-lock function, press the standby button for more than eight seconds – until the stop indicator lights up.

## In Conclusion

In conclusion I hope that these examples will be helpful in saving some of your time and would welcome information from other readers on similar potential time-wasters.



# Letters

## **COWBOYS ETC**

Much has been written in recent issues on the subject of what makes a cowboy. It's not the qualifications they do or don't have but their attitude and approach to the work they handle. My business deals with brown and white goods and in both these fields we have to compete with various self-employed engineers who have worked for national TV rental companies or domestic appliance manufacturers' service depots. You wouldn't expect men from such backgrounds to be cowboys, but in my experience they certainly are. Here are some examples.

One TV man is notorious for quoting around £90 to repair simple little faults. He was well known by his colleagues at his previous employer for being lazy. He probably quotes high because he doesn't want many of those who approach him to go ahead with a repair. If say three people a week accept a £90 quote he has £270 in his hand. Working from home, the only overhead he has is his ad. in the paper. Another TV man seems to be capable of repairing only Ferguson products. We've seen numerous items that he has botched up then told the customer that parts aren't available. He told the owner of a set fitted with the Philips KT3 chassis that it had a duff tube when the cause of the trouble was faulty RGB output stage operation because of a small print crack in the line output stage.

Two guys from the same previous employer compete with us in the domestic appliance field. They both appear to have gone into business to make the maximum amount of money for the least effort. They charge for parts they've not fitted at prices that would be too high if they had fitted them, and in some cases have invented names for things they claim to have fitted. They never turn up when they get a call-back, and both have been known to return items they either couldn't fix or for which they had an estimate refused with bits missing.

A man you would call a skip scavenger has brought me numerous items that had been dumped though they had only minor faults. I can't help wondering whether they were dumped because their owners had been misled by these real cowboys.

*Name and address supplied.*

I'm appalled by the increasing number of manufacturers that refuse to give advice to non-account holders. Often the only response I get is "buy a £30-£35 manual" to help with the repair. I always mention such lack of support to my customers and hope that the message gets through.

I've been in the business of servicing TV sets, VCRs etc. for over twenty five years and have worked for a manufacturer. I always gave advice, technical or not, as I felt that you should look after your products, not just sell them. We're not all cowboys.

*J.R. Luniss,*

*Swindon, Wilts.*

## **NICAM ON A SHOESTRING POSTSCRIPT**

I'd like to add the following postscript to Keith Wevill's article in the February 1993 issue. Like Mr. Wevill I bought a Nicam unit from Sendz Components, though there was no Nicam service in this area at the time. Once Nicam became available I got the article out and studied it. The suggested

interface was more complex than necessary for my purposes: all I required was for my set to switch to stereo automatically when this was present and back to mono otherwise. The following modifications – additional to the filter, crystal etc. modifications in the previous article – make this possible.

(1) Fit a link between pins 16 and 20 of input plug BS15. This makes IS12 (4053) switch between Nicam (pins 2 and 12) and second scart (pins 1 and 13) inputs in accordance with the status of the N line.

(2) Lift the IS04 side of R524 and connect the freed end to pins 1 and 3 of the second scart socket. This supplies the mono signal.

(3) Lift the IS04 side of J031 and J008. These provide the right- and left-channel outputs respectively. Because of the values of C557 and C556 a fairly high-impedance load is needed: I fitted emitter-followers here.

Not having any way of applying I2C control I decided to use IS06, IS16 and IS07 on their own. The modifications required to do this are as follows.

(1) Lift CW28 and CW25 on the IS05 side. These are the inputs to IS06 and IS16 respectively. Note the polarity of these capacitors to ensure that this is compatible with your interfacing arrangements.

(2) To use IS07, lift the IS05 sides of J033 (right) and J020 (left). These feeds require a bias of about 6V.

I won't provide details of the gain-controlled interface I use between IS12 and IS06/16 as it employs an obscure Japanese chip that happened to be in my junk box. The output from IS12 does need a small amount of amplification to drive IS06/16, but none is necessary for IS07.

*Philip Lane,*

*Aberaeron, Dyfed.*

## **CAR RADIO-CASSETTE PLAYERS**

As I spend my time repairing car radio-cassette players I found Alan Bouskill's article in the October issue and B.D. Andrews' letter in the November issue interesting.

My experience with the Philips P1 and P6 decks is that the belts do need to be replaced – I do it as a matter of course. In these mechanisms the belt provides drive during play and wind/rewind and also moves the head and pinch roller(s) into the cassette when one is inserted. If the belt is at all slack the head/pinch roller assembly will stall before this movement is complete and it will then be impossible to eject the cassette. Should this happen while the owner is using it and he employs strong-arm methods to force out the cassette a plastic lug will as often as not break off, rendering the deck fit only for the bin! In addition the corners of the square-section belt used in the P6 deck become rounded after a time: the result can be intermittent rotation of the belt along its length, which in turn causes unpleasant speed variations.

I agree that it's now uneconomic to replace the on/off switch in the Ford RST21P unit, which was made in Brazil by Blaupunkt. When it was a current model however I replaced over a hundred. The job takes about one and a half hours. Everything has to come out of the case, including the push-button/tuner unit! What finally finished this a.m. only model for me was the demise of Radio 2 on the medium wave (so customers lost interest) and the increasingly expensive deck spares (available from Motorola stockists).

It's possible to wire across the legs of the switch. Remove the left-hand spring clip (one of the pair that secures the unit in the car), the left-hand upper PCB (the one over the volume control) and the cassette deck. Getting a soldering iron in isn't easy – but is possible! Alternatively the switch can be bypassed by shorting out two points on the rear socket-panel PCB, or by connecting the 12V+ and electrical aerial terminals together and feeding power to their junction via a 3A fuse. Despite some loss of supply filtering, these bypass methods don't seem to create interference problems. But I don't personally wire across or bypass switches any more, because what happens when a unit develops a fault and starts to emit smoke while the owner is driving in the outside lane of a motorway and the only method of switching the unit off is to use the ignition key?!

*Geoff Davies,*

*Rugby, Warwickshire.*

### SCOPE REPAIRS

Roger Burchett's letter (November) on the high cost of scope repairs reminded me of a problem we had with the popular Philips PM3055. A few years ago the company I work for bought ten of these scopes. Earlier this year they all started to fail. The symptom was always the same: the scope would be running all right at the end of one day, but wouldn't start at the beginning of the next. The screen remained blank, the cursor illumination didn't work and the power supply made a singing noise.

The cause of the fault proved to be very elusive. We sent a scope to a local calibration and maintenance company, but they couldn't fix it. Meanwhile, other scopes were failing in the same way. Some could be persuaded to work after a few off-on switchings, and the situation became so acute that if a scope was working all right we left it on for 24 hours a day. We spoke to Philips, who told us that it was a power supply fault which they fixed by simply replacing the power supply. Their standard charge for doing this for us would be about £800 a time!

As this was more than the value of the ageing scopes I decided to have a go and, to cut a long story short, discovered that most of the electrolytic capacitors in the power supply had gone low in value. The main culprits were C6011, which caused the control loop to hunt, and C6103, which resulted in the -6.4V supply dropping to about -5.8V: this was sufficient for the protection circuit to become trigger happy and fire the crowbar thyristor. Also the ripple voltages were inconsistent. So we replaced all the reservoir capacitors, using high-frequency, high-ripple types. Ten scopes were fixed in this way. We didn't have to spend £8,000, just fit a hundred capacitors. Materials and labour came to about £400, a 95 per cent cost saving!

The capacitors required for this repair are listed below. Note that the high-frequency, high-ripple current types marked \* have radial, not axial, leads. They can be easily fitted however but the leads must be sleeved to prevent shorting to adjacent tracks.

C6011	22µF, 63V	RS107-094
C6103/6/8	470µF, 16V*	RS105-925
C6111	220µF, 25V*	RS105-975
C6113	100µF, 25V*	RS105-969
C6116	100µF, 63V*	RS106-114
C6119	22µF, 63V*	RS106-091
C6132	100µF, 25V	RS107-022

C6011 was 33µF originally. We also added an 0.1µF capacitor (RS124-178) across the emitter and base of V6137

in the protection circuit to prevent spurious transients triggering the crowbar thyristor. This capacitor is small enough to fit on the back of the PSU board.

*Keith Cummins,*

*Holbury, Hants.*

Because of a leak in the roof a drop of water had fallen into our Hameg HM203-6 scope. This caused a lot of grief, as the scope is an old friend and I'm lost without it. So I removed the top cover, inspected and dried the panel, replaced the 50mA fuse 701 and switched on. Almost instantly there was a spark between various components in the high-voltage circuit. I then cleaned the panel and made sure that no further tracking could occur. The unit then operated after a fashion, with only a single spot on the screen. The spot moved, the timebase started to run then stopped again. I switched off, started to check the silicon in this area and noticed that R525 was burnt. After fitting a new 1kΩ resistor I thought that the scope might work, but that would have been too easy.

On checking more components in this area I found that transistors T506/7/8 were all faulty. When these had been replaced I had a display, with two very bright dots on the left of the trace and a narrow X scan. I connected the probes (both channels) to the squarewave test pin at the front of the unit: though the display now worked it looked as though it was in a chopped mode. After more testing T504/5 were found to be faulty and were replaced. This removed the chopped effect but there was still lack of width. Closer inspection of the display showed that the Y and X amplitudes were both reduced. This led me to the conclusion that the e.h.t. was too high. Transistors T506/7/8 which had previously been replaced are part of an e.h.t. regulating system, along with the 741 operational amplifier chip IC502. Replacing this chip cured the last fault. The scope was now back to full health and after using some equipment that was close by to test it I put it back together, gave it a loving kiss and wrapped it in cotton wool!

*Chris Watton,*

*Boston, Lincs.*

### A PRINTER REPAIR

Here's another story about manufacturers' high repair charges. When I upgraded my old computer system to an IBM compatible for my wordprocessing I was given a Canon PW-1080A dot-matrix printer to go with it. Unfortunately the printer wouldn't print anything: it just fed out blank sheets until it was switched off. It would print out a test pattern in its test mode however. I decided to phone Canon and ask for advice. After chatting to the technical department for a few minutes about correct connections etc. I was told that repair would cost £120 labour plus parts. I told them I'd think about it and rang off.

I managed to get a service manual from a colleague, and after looking at the circuit and going through the circuit description narrowed the cause of the fault to four chips. One of these was a Canon special but the other three were standard items (and gates, nor gates and a RAM) that are available from RS Components for £5.50 the lot. I decided that this small sum was worth a gamble and replaced all three chips, leaving the Canon special alone. The printer has worked perfectly ever since. I thus saved £120: total time for the repair was a few hours one evening, not counting the one-day wait for the chips to arrive. So repairing your own equipment is well worth it if you possibly can. Maybe I should extend my business to the repair of printers!

*Richard Newman,*

*Croydon, Surrey.*

# *Servicing the Rediffusion Mk 4 Chassis*

*Chris Watton*

On a recent visit to an ex-rental TV receiver outlet I was amazed to see so many Doric/Rediffusion Mk 4 sets. As they were originally used mainly as rental models many engineers may be unfamiliar with them. So here's a short survey of some of the areas that cause problems and how to deal with them.

One thing that's unusual is the fact that many of these sets have a three-core mains lead. This earths the chassis instead of leaving it floating, as is usually the case. Any set with an isolated power supply could have its chassis earthed of course, but the fact that this one sometimes has a solid earth connection to the mains plug should be borne in mind when doing any servicing without a mains isolating transformer, the point being that live mains will be present along with an earthed metal frame.

The power supply is on the right-hand side of the chassis. It's a chopper circuit with a TDA1060 control chip, a two-transistor (4TR1/2) driver stage and a start-up circuit with a thyristor (4THY1) and a wirewound, spring-off resistor (4R2). The circuit is shown in Fig. 1. Chopper transformer 4T1 provides mains isolation. The timebase panel is mounted at the bottom. It provides field and line drive, e.h.t. from a tripler and scan correction. Note that there are two versions, one for use with 90° the other for 110° tubes. There are also two different types of field timebase (the chip type was changed in later production). Moving over to the left-hand side the next panel, which is hidden behind the aerial socket, is the audio/video interface board. The colour decoder/RGB output panel is mounted above this, facing a text interface board in sets that have teletext. To the left of this there's the tuner/i.f./audio output panel: there are several types, some with separate v.h.f. and u.h.f. tuners and some with a prescaler can for use with frequency-synthesis tuning, in which case a large panel at the extreme left-hand side of the chassis provides tuner control and remote control operation. The teletext decoder panel, where this is fitted, is fixed to the side of the cabinet.

## **Faults**

There are quite a few common faults, but fortunately they are in the main easy to remedy. Provided the tube is in good condition the set should display a good picture and provide reliable operation. The following notes provide guidelines on fault tracing: a fault summary with the usual cures is provided at the end of the article.

## **The Power Supply**

A dead set usually means that there's a power supply fault. You will probably find that either 4R2 is open-circuit or the fuse has blown because the BU326A chopper transistor 4TR3 is short-circuit. If the fuse is o.k. and 4R2 is intact but hot check 4C6 which may have dried up. If 4TR3 has failed check whether 4C16 in the snubber circuit is dry-jointed, the transformer for dry-joints and 4TR2 in the driver stage for leakage. If 4R2 is open-circuit check whether 4D6 is short-circuit then move over to the line output stage and check the BU208A output transistor.

It's quite common to find that 4R2 is open-circuit. As a result the set won't start up. The cause may be an overload in another circuit, usually the line output stage – more on this later. 4R2 fails when there's no l.t. supply from the chopper transformer. Any fault that reduces the voltage developed across winding G-A on the transformer will have this effect: the power supply then tries to run on the start-up voltage and after a short while 4R2's spring opens as the solder melts.

If the fuse is open-circuit, usually blackened, and the chopper transistor 4TR3 is short-circuit the cause is almost certainly on the power supply panel, dry-joints being the usual culprit. These may be obvious – disastrous-looking scorch marks, though these can usually be cleaned off and a successful repair carried out. If 4C16 in the snubber network is badly jointed a trail of destruction may be left behind – check 4TR1/2/3, 4IC1 and resistors 4R30, 4R23, 4R22 and 4R26. When these components have all been replaced the power supply should run. It's advisable to check the connections to 4C16 whenever one of these sets is serviced. Another common source of dry-joints is the transformer: it may look as though it's connected perfectly, but faults start to occur when the set has been on for a while. Also tiny cracks can appear close to the transformer, blowing 4TR3. A leaky BD433 transistor (4TR2) in the chopper driver stage can cause a trail of component failures.

If the set is dead, 4TR3 and 4R2 are o.k. but the fault is in the power supply, check that 4IC1 is receiving its 14V supply at pin 1. If this is o.k., check that the chip is producing output pulses at pin 15. On a few occasions I've found that the chopper transistor is open-circuit. All voltage checks on this side of the circuit should be made with respect to the power supply earth line (the negative side of 4C5/6/7 etc.), not the main chassis earth line (the negative side of 4C20/21 etc.). The rectifiers on the secondary side of the circuit (4D20/21 etc.) and their associated reservoir capacitors (4C20/21 etc.) can be responsible for the dead set symptom, but in this case 4R2 will normally be open-circuit.

Note that there are two power supply panels, one for 90° and the other for 110° sets. The former provides a 125V h.t. output while the latter provides 150V. Different transformers are used, and the connection plug is arranged so that a 110° panel can't be connected to a 90° set and vice versa.

In most sets the power supply unit can be removed from the chassis and disconnected from its load: provided there's no major fault and a suitable dummy load is provided (a 60W or 100W bulb connected between 4L5 and the chassis on the secondary side) the supply will run when connected to the mains. There's an earth connection point with a push-on plug which is normally connected to the chassis frame. This serves as an earth test point for checking the output voltages when the panel has been removed.

## **The Timebase Panel**

There are different timebase panels for 90° and 110° sets. In addition in later production a TDA1670 field timebase chip is used instead of a TDA1470. Earlier version panels can be interchanged with later ones and vice versa, but the

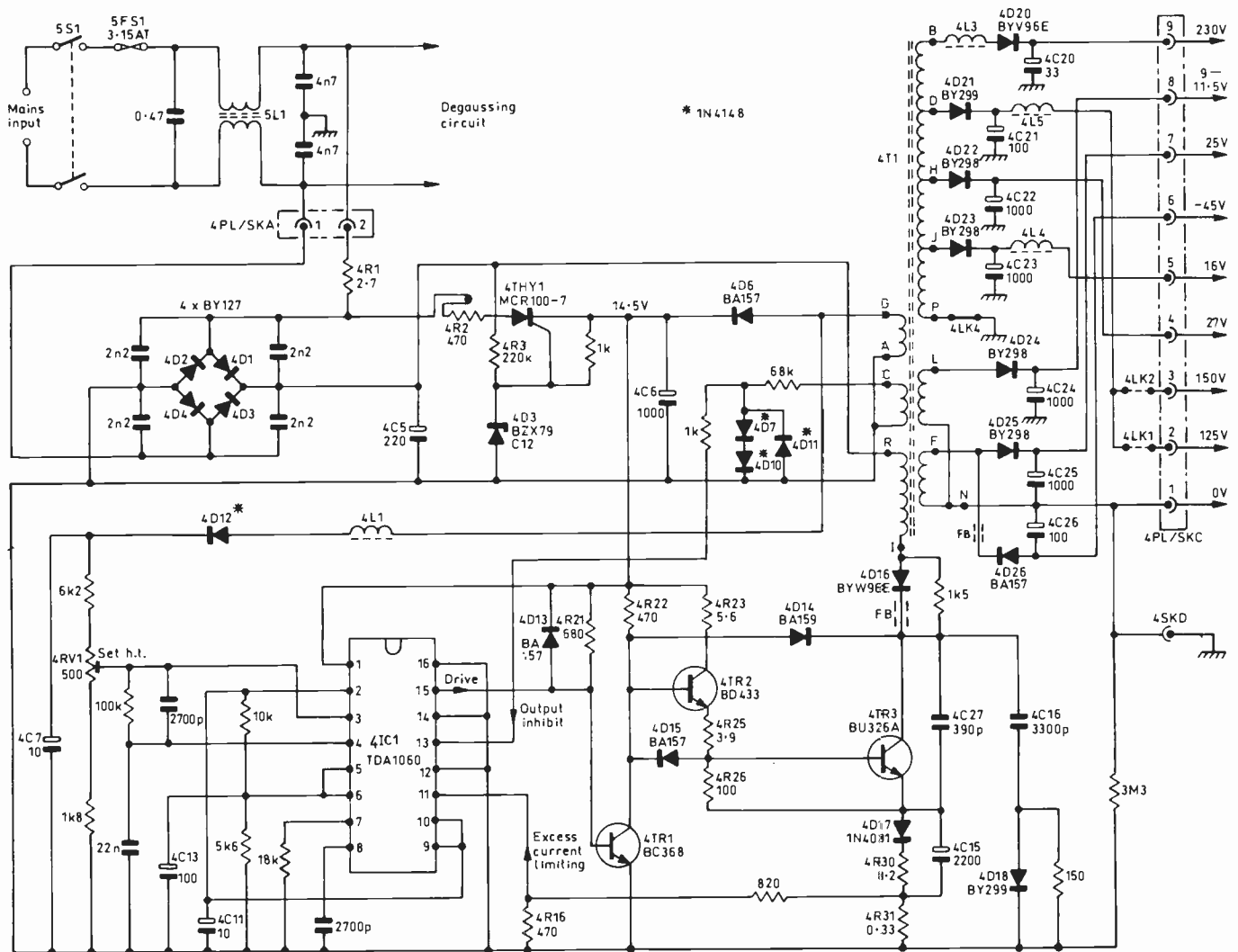

Fig. 1: The power supply circuitry.

correct type must be used to drive either 90° or 110° tubes. The 110° type can be recognised by the extra components fitted for EW correction. Fault finding in this part of the set can be tricky. The panel is difficult to work on when in the chassis, and the short leads mean that the set can't be operated with the panel removed. Only small areas of the print are accessible from the bottom.

The tripler, which has a built-in focus control, often fails. It either goes short-circuit internally or a crack or hole appears in the case. With the latter fault you get sparks and bangs as the e.h.t. jumps to the fixing screws. Care is required when removing the tripler as the solder tag on the transformer isn't the strongest thing in the world and the lead to the tripler is wrapped through the hole.

The BU208A line output transistor will fail in 110° sets if there are any dry-joints around the EW modulator transformer 3T3 or diodes 3D4 (BYW96D) and 3D3 (BY228). These components should be resoldered whenever a set is repaired. In all sets a dry-jointed chopper transformer can kill the line output transistor. The screws that hold this transistor can be extremely tight, a stout screwdriver being needed to remove them. Be sure to support the panel when doing this as it can crack.

EW faults are usually caused by failure of the BDW23C output transistor 3TR6. Failure of 3C24 (3.3nF, 2kV) can cause lack of width with overheating.

The beam current trip on this panel operates when the beam current exceeds about 3mA. It uses thyristor 3THY1 as a crowbar across the 12V supply. When it fires there's no supply to the line oscillator and the set shuts down. The trip

is reset by switching the mains supply off. False tripping can be caused by the tripler. The beam current limiter circuit is also connected to the colour decoder panel for normal limiting via the contrast control.

The line drive comes from pin 2 of the TDA1950 chip 3IC1. Between this point and the base of the line output transistor there's a conventional line driver stage with a BF819 transistor (3TR1) and transformer (3T1). 3IC1 contains the line and field sync circuits, the video input being at pin 11 and the field sync output at pin 9. There's also a sandcastle pulse output at pin 4. This goes to the decoder panel and, in sets with remote control, the frequency-synthesis tuning circuit. Pin 5 of the chip is used for VCR sync adjustment: it's linked to either the tuner pushbutton unit or the remote-control panel. The chip is quite reliable, but can be responsible for a ragged picture or no line sync. Before changing it check capacitors 3C4 (0.1µF) and 3C5 (0.01µF). The line hold control 3RV2 (10kΩ) can also be faulty. To set the line hold short together the two pins next to the i.c. and adjust 3RV2 for a stationary picture.

The most common fault in the field timebase is loss of scan because of a dry-jointed deflection coil plug. The fault may be intermittent of course. Poor joints can also be present around the chip itself, whichever type is used, though the TDA1670 version seems to be more prone to this. Field collapse can also be caused by failure of 4D22 (BY298) on the power supply panel, since this provides the field timebase chip's 27V supply. Failure of the safety resistor 3R53 (4.7Ω) is another cause of field collapse, though this usually goes open-circuit only when the chip is



faulty with an internal short. If you find that the field time-base chip has failed, check for dry-joints around the chopper transformer and the scan coil plug.

### The Colour Decoder Panel

The decoder panel is almost certainly the most reliable part of the set. The main items here are the TDA3300B chip, which provides auto grey-scale tracking as well as colour decoding, and the RGB output stages. Each of these has three transistors. You get occasional trouble here, such as one colour missing or a predominance of one colour. We've found it best to replace all three transistors and any burnt resistors in the faulty channel – changing single transistors usually leads to further breakdowns. No colour can be caused by the 4.43MHz crystal 2XL1, but the chip is more often responsible for this symptom. Another fault that can be blamed on the chip is when the colour level increases as the set warms up, until the colour is at maximum with the control at minimum.

### The Signal Panel

As previously mentioned there are various versions of this panel. The most common problem is drift and/or loss of signals caused by cracked earthing in the u.h.f. tuner, where its internal PCB meets the metal frame. Resoldering will often provide a cure but a new tuner is sometimes required. If you suspect a low-gain tuner, it's worth checking the TDA2540 i.f. chip 01C3 and the SL1430 SAWF driver chip 01C2 first: they can both be responsible for a snowy picture that gives the impression of a low-gain tuner.

Tuning drift can be caused by the ZTK33B 33V regulator 01C1, but in most cases the tuner or, in manual control models, the pushbutton unit is responsible.

The TDA1035T chip 01C4 and the 33 $\mu$ F, 16V capacitor 0C33 are the usual causes of no sound.

### Control Units

The basic set has an eight-button tuning selector that has given more than its fair share of trouble. It can be responsible for drifting or sudden loss of signals. In most cases a successful repair is possible as the cause of the problem is the spring contacts, which become tarnished. Clean them and the unit will be all right. It's a waste of time using miracle spray or even (joke) WD40 as the cause of the fault will still be there.

Care is required when separating the pushbutton unit as the plastic snap-fit parts can easily be broken. At first sight getting the unit apart may look difficult. Remove a couple of wires from the a.f.c. switch, gently ease the plastic catches outwards, then pull the potentiometer pack from the latch section. You will now have a piece with spring contacts that stick out: they must be as bright as new pins before reassembly. If you feel that the contact area is too worn it's possible to remove the springs and turn them over. I clean them with a soft fibre stick, but a cotton bud and meths will do. The latch assembly also has a contact plate in it. This can be removed but is difficult to replace. If a cotton bud is used the contact area can be cleaned without any

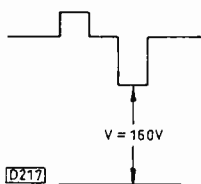

Fig. 2: Waveform at the collectors of the RGB output transistors when using a scope to set 6RV1. Check which transistor has the highest amplitude trace, then use this to set V to 160V.

need for removal. Reassemble the unit when every part is clean: take care to position the a.f.c. switch and its button (which is easily lost) correctly otherwise it will work the wrong way round, i.e. when the door is open.

### Remote Control Versions

The remote control and frequency-synthesis tuning circuitry is on a large panel at the left-hand side. The chips used are of the same type as in many ITT sets produced at that time. This panel also drives the release solenoid for the on-off switch.

Knowing the functions of the chips can be helpful when looking for the causes of faults in this area. 8IC1 (SAA1174) provides frequency-synthesis control, 8IC2 (SAA1075) is a non-volatile memory, 8IC3 (SAA1276) provides the on-screen display while 8IC4 (SAA1251) decodes the remote-control signals. There's also a TEA1009 chip in the remote-control receiver can – circuit reference 9IC1.

The supplies in this section are as follows: 18V, which is derived from the 25V rail via 8R81 (12 $\Omega$ ) and the three-pin 7818 regulator 8IC5, and 5V which is used by the prescaler module and comes via 8R1 (56 $\Omega$ ), with zener diode 8D1 (1N5338) providing regulation.

Remote control handsets are available quite cheaply from most major component suppliers. Many ITT remote control units will work with these sets as similar chips are used.

### Setting Up

**Power supply:** There's only one adjustment, for the h.t. voltage. Set 4RV1 for 125V (90° sets) or 150V (110° sets) at the top of coil 4L5 on the power supply panel.

**Tube drive:** 2RV3/4/5 on the colour decoder panel are the drive controls for the RGB output stages. They should be set for maximum drive then if necessary one or two of them can be adjusted to correct the picture highlights. The first anode preset 6RV1 is on the tube base panel. It's important that this is correctly adjusted, which is best done using a scope. Turn down the colour, brightness and contrast controls, then check the waveforms at the collectors of the RGB output transistors 2TR1/2/3 to find which one has the greatest amplitude. The traces will be as shown in Fig. 2. Set voltage V to 160V. The voltage can be set using a meter, but this is not as accurate. The method is as follows. Switch to the video mode, turn the brightness to minimum then check at the collectors of the three RGB output transistors 2TR1/2/3 to find out which one gives the highest reading. Adjust 6RV1 to bring this reading to 185V.

All other controls in the set are straightforward.

### Use with a VCR

On receivers with manual control the VCR line sync time-constant is set by a small switch at the back of the pushbutton unit (at position 8). With remote-control receivers four programmes can be used, 7, 8, 15 and 16. Alternatively direct audio and video can be fed in via sockets at the back, with selection by a switch at the front of the set – it's behind a small flap at the bottom of the speaker grill. A red LED comes on when this mode is selected.

### Fault Summary

**No signals:** The U341 tuner unit, the pushbutton unit, the TDA2540 chip or the SL1430 chip may be responsible. If

the pushbutton unit is replaced it may be necessary to fit link 2 (u.h.f.) on the signal panel. With remote-control sets the SAA1174 chip may be responsible for loss of the tuning voltage.

**Tuner drift:** The ZTK33B stabiliser 01C1, the U341 tuner unit or the pushbutton unit may be responsible

**AFC pulls off when the door is closed:** The switch on the tuner unit may be incorrectly fitted or 0L7 might need slight adjustment.

**No colour:** Check the TDA3300B chip and crystal 2XL1.

**Can't turn the colour down:** The colour control may be open-circuit or the TDA3300B chip faulty.

**No sound:** Check the TDA1035T chip and capacitor 0C33 (33µF).

**Distorted sound:** Check 0C33 (33µF).

**No picture, raster o.k.:** The TDA1950 chip may not be providing a sandcastle pulse output or the TDA3300B chip may be faulty.

**No raster:** Tripler faulty.

**No sync:** Replace the TDA1950 chip.

**Field collapse:** Check for dry-joints at the scan coil plug and around the field timebase chip 31C2. 4D22 or 3R53 could be open-circuit. If 3R53 is open-circuit 31C2 is probably shorted internally.

**Lack of width:** Check the 3.3nF, 2kV capacitor 3C24 (110° sets).

**Concave picture:** Check 3TR6 (BDW23C) and 3D4 (BYW96D). Cause could be dry-joints, which could also have been responsible for failure of the semiconductor devices (110° sets).

**Line shimmer:** Check 3C4 (0.1µF), 3C5 (0.01µF) and 31C1 (TDA1950).

**Dead set with 4R2 open-circuit:** Check the tripler, the BU208A line output transistor, 4D6, 4C6, 41C1 and the chopper transformer for dry-joints.

**Dead set with fuse open-circuit:** Check the bridge rectifier diodes 4D1-4 and the associated reservoir capacitor 4C5. Then check the BU326A chopper transistor. If it's short-circuit check for dry-joints or cracks around the chopper transformer, for dry-joints at the connections to 4C16, and 4TR2 for leakage. If 4C16 is dry-jointed or 4TR2 is leaky check 4TR1, 41C1, 4R22, 4R23 and 4R26.

**Dead set with fuse and 4R2 o.k.:** Check 4TR2 (BD433), 4THY1 (MCR100-7), 4C6 and for a cracked connection at the feed to the chopper transformer (pin R).

**Line output transistor keeps blowing:** Look for dry-joints on the EW modulator drive transformer 3T3: they may look o.k. but open when hot. Also check the EW modulator diodes 3D3/4. These items are in 110° sets only. Poor joints around the chopper transformer can also lead to the destruction of 3TR2. Again, they may look o.k.

# Next Month in TELEVISION

## THE PACE PRD800 SATELLITE RECEIVER

A detailed look at the circuitry used in this popular satellite TV receiver, which is also the basis of the Ferguson SRD5 and other well-known models.

## DOLBY SURROUND SOUND

Several TV receivers now incorporate Dolby Surround and Pro-Logic Surround Sound, so it's time to get acquainted with these systems and the way in which they are implemented in TV sets.

## INTRODUCTION TO TELETEXT

The next instalment in Eugene Trundle's series brings us to the digital circuitry used in modern TV receivers. We make a start with teletext.

## SCREEN ENTERTAINMENT 2000

George Cole reports on a technical conference that considered the video and TV prospects for the year 2000.

## SATELLITE SCENE

More modifications and fault reports.

## THE BUSH 2521T

Chris Watton on programming this model, which has been sold under a number of other guises, and some common faults.

## PLUS ALL THE REGULAR FEATURES

### ORDER FORM

To.....  
(Name of Newsagent)

**Please reserve/deliver the February issue of TELEVISION (£2.20), on sale January 19th, and continue every month until further notice.**

Name.....

Address.....

.....

# Long-distance Television

Roger Bunney

Pressure over the UK during much of October was high and stable, producing overcast skies here in the south. Fortunately tropospheric conditions improved during the final week of the month, particularly in the north. I spent a week's holiday at Croyde Bay near Barnstaple in late October: despite the sloping site to the west across the sea there was no sign of RTE (Ireland), which I suspect was screened by the rocky headland nearby. Apart from the local vertically-polarised relay signals the TV bands were largely empty – an ideal spot for Band I TV DXing! Given time and patience Sporadic E reception was possible on most days, as the following collated log testifies:

5/10/93	TVE (Spain) ch. E2.
6/10/93	TVE E2, 3.
9/10/93	TVE E2.
10/10/93	DR (Denmark) E3; TVE E3; ARD (Germany) E2, 4; RAI (Italy) IA.
12/10/93	TVE E2, 3, 4.
13/10/93	TVE E2, 3, 4.
14/10/93	NRK (Norway) E2, 3; RUV (Iceland) E4.
15/10/93	RTP (Portugal) E2, 3; TVE-1 E2, 3, 4; TVE-2 E2; RAI IA.
16/10/93	DR E3; TVE E2, 3, 4.
17/10/93	RAI IA, B; TVE E2, 3, 4.
18/10/93	TVE E2, 3, 4; DR E3; +PTT (Switzerland) E3.
19/10/93	TVP (Poland) R1, 2, 3; CST (Czech Republic) R1, 2; ARD E2, 3; TVE E2, 3, 4.
22/10/93	+PTT E3; TVE E2, 3.
24/10/93	+PTT E3; TVE E2, 3, 4.
25/10/93	TVE E2; TVP R1, 2.
30/10/93	DR E3; +PTT E2.

There was a good tropospheric opening on the 19th, with Band III/u.h.f. signals from Germany, Scandinavia and the Benelux countries – Simon Hamer sent in an impressive log of Swedish and Norwegian reception at his location in mid-Wales. From the 25th the prolonged high-pressure system

produced reception from the same countries/areas across much of England and into Scotland – David Glenday reported very strong signals, his highlight being an RTL (Luxembourg) test pattern with the identifications CH24 and RTL – TV1 on November 1st. Oddly, conditions in Scotland were much better than in the south.

My thanks to Peter Schubert (Rainham), David Glenday (Arbroath), Simon Hamer (Powys), Iain Menzies (Aberdeen), Roger Fussell (Torpoint) and Brian Williams (Penarth) for sending in logs and reports.

## News Items

**Portugal:** A new ch. E2 transmitter, location not known, is in operation. The first RTP service is now called Canal 1, a small 'C1' being inserted at the top left of the screen during programmes; the second service is called TV2, again with logo at top left. Our thanks to the Benelux DX Club for this information. Outside programme times RTP transmits either a FubK test pattern, with or without clock, or a black/white pattern. The third service, SIC, is a commercial one that comes on in the early afternoon. A fourth service is run by Catholic Radio Renascenaca, which also runs an f.m. radio service.

**Canal Plus:** The French broadcaster has applied to run a national service in Poland, also local services in ten major towns. It has also entered into a partnership with an organisation called EKO to provide services to the five largest cities in Turkey – the Syster scrambling system will be used.

**Sri Lanka:** The ETV-2 service is now transmitting 'Prime Sports' on ch. E35 while ETV-1 is transmitting BBC WSTV, both taking their feeds from Star TV Hong Kong via AsiaSat-1. ETV-2 is Colombo's sixth TV channel. For FM DXers, TNL-FM is at 90MHz and 101.7MHz stereo while the TNL-TV audio channel is transmitted in stereo at 89MHz. Our thanks to Bandula Gunasekera for this information.

**Israel:** Palestinian radio and TV broadcasting has started from Ramallah on the West Bank. The Israeli Broadcasting Authority proposes to start a third channel operating in Hebrew, Arabic and Russian; it would probably be distributed via satellite.

**Estonia:** There are now five terrestrial channels the most recent, a commercial one, being Kanal Kaks (Channel Two).

**The Netherlands:** Nozema plans to start scrambled Pay-TV services via NED1 and NED2 during the night (0200-0700). DX catch ZH-TV continues with test transmissions on ch. E49.

**Czech Republic:** The country's first commercial service,

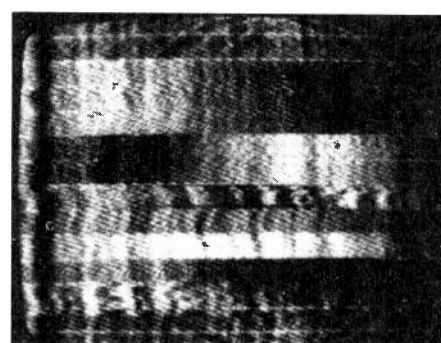
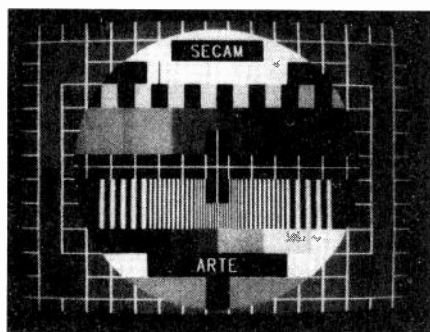

Left: The French ARTE test pattern, received by Tim Anderson (St. Leonards, East Sussex). Centre: An NTSC news feed received by D.J. Hunt (Brighton) from Eutelsat II F1 at 13°E, using a 60cm dish and a Pace 9210 IRD. Right: F2 layer reception of the IRIB (Iran) ch. E2 test pattern by Tim Anderson.

the Prague-based Nova, plans to open in February using the present F1 channels.

**Russia:** There's a new channel, NTV, in Moscow.

**China:** The commercial City Network Corporation is to provide an evening service to areas with a population of some 55m. These include Guangdong, Chengdu, Ningbo, Hangzhou, Nanjing and Harbin City. China hopes to start an HDTV service by 1999, with test transmissions from 1996 onwards.

### TV-DXing for Beginners – 2

This time we'll consider the equipment required for DX-TV reception. First the receiver itself. There are three options here: (1) a multistandard set, (2) a standard u.h.f.-only UK set with a v.h.f.-u.h.f. converter, (3) use of an outboard tuning system that provides a u.h.f. output for feeding to a standard UK set.

The first option is the simplest. Though more expensive it will cater for the different vision and sound standards and, if it includes system L, the unusual French standard (with positive-going vision modulation and a.m. sound). You should be able to get a small-screen monochrome system B/G/I/L receiver for under £100, though a colour set will cost around £250. Multistandard sets have v.h.f. and u.h.f. coverage and can handle several different sound carrier spacings. Such sets are available from specialist dealers. Asda often has v.h.f./u.h.f. sets on sale, while Nikkai markets a relatively inexpensive multistandard colour receiver. A set that also caters for the US NTSC standard is likely to be on the expensive side.

The second option is a much cheaper way of getting v.h.f./u.h.f. coverage. It works best with a u.h.f. receiver that has a single rotary tuning knob or one with lots of memory channels. The converter is a small box that converts 40-250MHz to a similar chunk of the u.h.f. spectrum. Connect a v.h.f. aerial to its input and feed its output to the main receiver's aerial socket. Then, by tuning the receiver between about chs 30-60, using either a rotary knob or memories, you have v.h.f. coverage. The converter changes only the frequency, not the standard, so a UK set will display foreign pictures, in colour if they are PAL ones, but will not provide sound reproduction (unless the signal is a system I one). You will not be able to resolve French transmissions. A new upconverter costs around £50. Labgear produces converters for use with cable systems: some have an r.f. amplifier, others may not – you want one with an r.f. amplifier.

The third option operates in a similar manner to the second but the separate v.h.f./u.h.f. tuner provides an output on a single u.h.f. channel. Thus all the tuning is done by the outboard unit. Several systems have been described in past

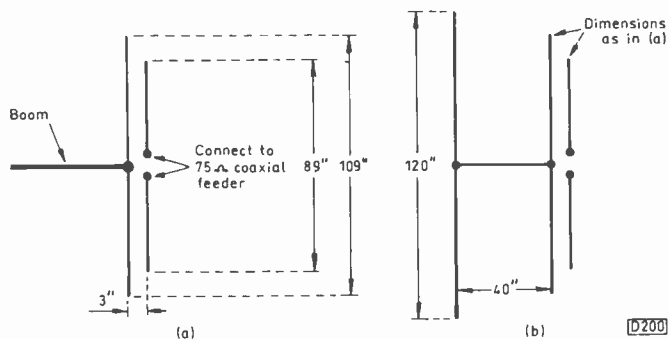

Fig. 1: DX aerial designs for Band I reception. (a) Wideband (48-68MHz) dipole. (b) Dipole plus reflector. Use 1in. outside diameter aluminium tubing for the boom, 0.5in. aluminium tubing for the aerial elements.

## NEW PRODUCTS



**Kansai TVR51K 21" Multi-system Colour TV**



**AKAI VS X475EGN Multi-system VCR (new model with Digital Tracking)**

Aerial Techniques brings you two new products to complement our already extensive range.

- "Personal Preference" memory function – (Volume, Colour Brightness, Contrast and Hue)
- 5-System PAL-B/G, PAL-D/K, PAL-L, SECAM B/G, SECAM D/K and NTSC 3.58/4 43
- Infrared Remote Control
- 90 Preset Channels
- Automatic Tuning
- On Screen Display – Volume, Colour, Brightness, Contrast, Hue and Channel
- EURO-AV (SCART) Socket
- Sound Muting Function
- Presettable Off Timer (15-120 Minutes)
- Automatic Power Off Function – when no broadcasting signal is received within 10 minutes
- Full VHF/UHF Coverage
- Cable Tuner
- Single or Dual Digital Control

- Multi-system 10 standard compatibility. Covers VHF (Bands 1, 2 and 3), UHF, plus in between cable channels. Records, plays back and receives: PAL System 1 (for UK), PAL System B/G (for Europe), PAL System D (for China), SECAM System L (for France), SECAM D/K (Eastern Bloc), SECAM B/G (Middle East etc), also NTSC 3.58 and 4.43MHz
- ▷ NTSC playback on PAL TV
- ▷ Quick start
- ▷ Quick index search
- ▷ Quick intro scan
- ▷ IMS
- ▷ DX 4 head
- ▷ Long play
- ▷ Remote handset
- ▷ On-screen programming
- ▷ Dual-mode digital tracking
- ▷ Multi-speed play
- ▷ 90 event – 1 year automatic timer
- ▷ Next function memory
- ▷ Auto voltage selector
- ▷ 45-channel synthesizer tuner
- ▷ Child-lock system
- ▷ Various auto functions
- ▷ Dimensions. 425Wx92Hx315D mm

**£269.00**

**£499.00**

(All prices are inclusive of Vat, Carriage & Insurance delivery £9.00 on large items).

Serving the TV and Satellite trade, the retail and enthusiast sector, we have been providing an expert and knowledgeable sales with a free consultancy service for over 14 years. We sell both the usual and often requested, together with the unusual and rarely asked for, if we've not got it then if it's made we WILL obtain it. Terrestrial or Satellite – we're there.

Our CATALOGUE at £1 samples some but not all that we can supply, send for your copy today. UK & overseas despatch normally ex stock within 24 hours, we'll accept the usual credit cards: cash, cheques, PCs – as convenient. Ring daytime with your query or late on our 24 hr phone or send in your fax and we'll get back to you shortly.



**11 Kent Road, Parkstone, Poole, Dorset BH12 2EH**  
**Tel: 0202 738232 Fax: 0202 716951**

Aerial Techniques

issues. One advantage is that the tuner unit can incorporate variable i.f. selectivity – much better results are obtained with weak signal reception when the i.f. bandwidth is reduced. Surplus tuners etc. are available from suppliers such as Sendz Components. A commercial tuning system, Model D100, is available from HS Publications, 7 Epping Close, Mackworth Estate, Derby DE3 4FR at around £100. For further details send an s.a.e. to HS Publications.

While multiband aerial arrays are available they are expensive. For Band I reception it's not difficult to make a suitable aerial. We need something that will pick up all the Band I channels. Fig. 1 shows two designs. The wideband dipole (a) works well but doesn't provide any gain. It should be mounted horizontally (though SpE signals have no respect for polarisation) and will need to be rotated by hand or motor. The addition of a reflector, see (b), adds gain and directivity. It will also need to be rotated. If you don't want to rotate the aerial, make or buy two wideband dipoles and mount them at right-angles to each other. Connect them either via separate feeders to an indoor selector switch or via similar lengths of coaxial feeder to a wideband combiner, e.g. a triax, Fringe or Antiference ferrite combiner, taking the output from this to the receiver. If you can weatherproof it, the cheap Taiwan-type Y splitter/combiner can be used. Make sure that the unit is ferrite cored, not the resistive version. The two female sockets are for the aerial inputs, the male plug providing the output.

### Satellite TV

Starting this summer the London-based Middle Eastern Broadcasting Centre (MBC) is to provide a five-channel



package for the Arabic states. Other services due to start this year include Orbit Satellite Television Network, a Pay-TV service for North Africa and the Middle East, and a German Channel devoted to travel, Reise-TV, which will use a Eutelsat transponder.

Intelsat has brought its first series 7 satellite into operation at 174°E to provide a trans-Pacific communications link for telephone and TV services.

Berry Habekotte (Holland) recently tried using a Triax offset feedhorn and magnetic polariser with a 65cm Maspro dish. Sadly the results were disappointing. When a Triax dish was used however the performance was impressive. He suggests that it's important to use a feed assembly recommended by the manufacturer of the dish being used. The Triax feedhorn is manufactured by Fuba.

## Test Case 373

Dylan wearily walked up the path of number 16, Rother View. It was getting near the end of the day, was dark and the call promised no joy at all – jumbled teletext it said on the card. Once in the living room he was confronted with a large TV set that produced a very corrupted text display. Some of the pages were half readable, and at each transmitted update the form of the corruption changed. It was the same on all channels. There was no way in which he was going to tackle this one on the spot! Into the van with it then, and away to the workshop.

As it happened there were few calls next day, so Dylan was given the set to repair himself. It had a CCT (computer-controlled teletext) decoder, using the well-known SAA5230/SAA5240-41 chip combination in conjunction with an MAB-series microcontroller. This arrangement was very common in sets produced a few years ago.

The fact that the fault was the same in the workshop eliminated Dylan's first suspect, the aerial system. Although reception and aerial faults can upset text reception, they seldom affect all four channels equally – and here the fault was present with the set run from the workshop distribution system, alongside others with clear text displays.

The symptom, randomly incorrect or missing characters that changed with each update, suggested to Dylan that the cause was data corruption. So he started by hooking an oscilloscope to the decoder's video input – pin 27 of the VIP chip – to check the waveform. It looked perfectly all right, but how could he be sure? He switched off the a.f.c. and adjusted the tuning so that it was spot-on. He then made slight experimental adjustments to the vision demodulator coil. This produced no improvement in either the waveform displayed

on the scope or the jumbled teletext display – indeed the clock readout at the top right of the page started to change from numbers to letters when the coil's core was moved more than a quarter of a turn. Dylan next had the bright idea of carrying out an eyeheight test on the video signal. But when he checked up on the procedure in a servicing book he hastily concluded that neither he nor his modestly-specified oscilloscope was up to it! He decided that the decoder's input signal was not the cause of the problem.

Into the decoder itself then. His first check here was on the supply lines. The needle of the AVO meter swung over to show that they were within ten per cent of the correct 5V and 12V for the logic and analogue sections respectively. Were the chips getting a reset, Dylan wondered? He couldn't find any reset pins around the SAA-series chips, but there was one at the MAB microcontroller chip: this was being reset all right. Maybe the frequency of the text clock was incorrect? A new 13.875MHz crystal was found and fitted at pin 11 of the VIP chip, but this made not the slightest improvement to the decoding process. Dylan didn't check the dot clock because he knew that this is concerned with synchronisation of the text display rather than the data-decoding process.

There seemed nothing for it but to replace the VIP chip, so in went another SAA5230. The results were little different from before, and while his soldering iron was still smoking Dylan had another CCT/decoder chip in there. The display was still garbled in exactly the same way as it had been on initial inspection at the house in Rother View. Enquiries around the workshop produced the suggestion that the decoder's chassis line was not properly earthed to the rest of the set, but it was.

Where had Dylan been too hasty with his checks? See page 208 for the answer.

### TELEVISION INDEX & DIRECTORY

#### and REPRINTS SERVICE

A computerised index to *TELEVISION* magazine covering volumes 38 to 42 (1988 – 1992) is now available. It contains over 3500 references to TV/VCR fault reports and articles, with synopses. It includes a TV/VCR spares guide, an advertisers list and a directory of trade & professional organisations. The software is easy to use and very quick. It runs on any IBM or compatible PC with 512K RAM and a hard disc.

**Price: £30 (specify 5.25" or 3.5" format)**

Reprints of articles from *TELEVISION* back to 1986 are also available: ordering information is provided with the index, or can be obtained from the address below. Hard copy indexes of *TELEVISION* are available for volumes 38 to 42 at £3.50 each.

All the above prices include UK postage and VAT where applicable. Cheques should be made payable to Video Interface Products.

**Video Interface Products Ltd., 1 Vineries Close, Cheltenham GL53 0NU, UK.**



## Ferguson FC31

The complaint with one of these camcorders was of intermittent no functions with a drip showing in the viewfinder: a dodgy dew sensor was the cause of the problem.

Another FC31 suffered from random operation, a permanent dew indication and a warped cassette housing, the latter probably because of forced cassette extraction. As first steps we fitted a new dew sensor and cassette housing. The cause of the random operation was a noisy record safety switch. **S.B.**

## Sony CCDF380

There was a cassette stuck in this camcorder. At least the customer hadn't used too much force in trying to get it out: the damage was restricted to a poor eject damper, while the cause of the trouble was failure of a circuit fuse buried deep inside, on the main deck PCB. **S.B.**

## Ferguson FC06

This machine had suffered at the hands of an incompetent. As a result of previous 'repairs' all the circuit protectors had blown and there was some print damage. After replacing the circuit protectors and tidying things up a bit we found that the loading motor drive chip was the cause of the original fault. **S.B.**

## JVC GRS70

The cause of very intermittent luminance was traced to R339 in the camera encoder section. A second machine came in with the complaint that the picture went green, red then black-and-white. This was not as serious as it sounds: all that was required was to set up the camera phase-locked loop. **S.B.**

## Panasonic NVMS2

We had two of these camcorders in recently from the same customer. Both had the same fault symptom: no functions. The cause was also the same – reversed battery supply connections. You know what happens: this one doesn't work so we'll try the other one! Naturally the cure was the same in both cases, replacement of the fusible link (VSF0059) and the M54543L loading motor control chip. This restored normal operation though further checks were carried out to ensure that no other damage had been sustained. **D.C.W.**

## Sanyo VMD6P

There was no viewfinder picture because the viewfinder focus control was open-circuit. Its lower end feeds the brightness circuits. **D.C.W.**

## Panasonic NVMC6

The complaint was of a loud 'shrieking' noise from the mechanism, with picture wobble and warbling sound. When we inspected the capstan motor's rotor we found that the plating material which covers the magnetic disc had almost completely lifted. The remaining material scraped against

the motor's windings, causing the noise and damage to the varnish. Motor drive signals in the windings were being conducted to chassis via the plating material. A new motor restored normal operation. **D.C.W.**

## Sanyo VMD3P

There were no viewfinder pictures. The cause was yet another electrolytic capacitor, this time C9911. Maybe it's best to replace all the electrolytics in these camcorders. Nearly every day seems to bring a 'new one'. **D.C.W.**

## Sharp VLC690

The cause of intermittent operation, cutting out and various other symptoms was traced to broken connections at the junction of the main PCB and the operation PCB. If there's a shock at the rear end because one of these cameras has been dropped, as this one had, the connectors at this point are easily detached from their respective print points. **D.C.W.**

## Panasonic NVM7

This camcorder would intermittently go into the pause mode, with 'tape' showing in the viewfinder, when recording. The cause was a corroded contact on the 'rec. prevent tab switch'. **D.C.W.**

## Sony CCDTR55

There was a cassette stuck in the mechanism and the 'caution' warning was being displayed. No functions were available. The cause of the trouble was a short-circuit loading motor (the short was to chassis). There was also an open-circuit circuit protector (type PS602-N25). **D.C.W.**

## Panasonic NVMS2

The customer's complaint was that batteries lasted for only a very short time. We checked the charger and batteries and found that they were o.k. On test a fully-charged battery gave a recording time of about two hours. Nothing wrong then – except that the viewfinder display said that the battery was low after only a very short period of operation! We checked and set up the supply rails and R6002 (battery low detect). This provided a complete cure. **D.C.W.**

## Sony CCDTR50

Playback was o.k. but there was no camera picture. We found that Q501 on the main camera PCB was open-circuit all ways. **D.C.W.**

## Panasonic NVMC6

The complaint was that this camcorder cut out after a few seconds in both the record and playback modes. Checks on the sensor inputs to the syscon microcontroller chip showed that the supply-reel pulses were intermittent. This was because R6075 had gone open-circuit. **D.C.W.**

# Panasonic's Cardiff Chassis

Ray Meadows

In recent issues we've taken a look at Panasonic's new Euro 1 digital TV chassis. Readers may find it helpful if we provide a short survey of its predecessors, particularly some of the older types that sometimes cause confusion. We'll go back in time to the first models produced by National Panasonic, as it was then known, at the Cardiff plant.

The very first sets were assembled from kits prepared in Japan, using almost all Japanese components. The first models to use the S1 chassis were the TC2201, a 22in. set fitted with the Philips A56-120X tube, and the TC262G which was fitted with a 20in. Japanese tube. Very shortly afterwards a new chassis specifically for the European market was introduced. This used a large proportion of locally-sourced parts and was known as the U1 chassis.

## The U1 Chassis

The U referred to the approximate shape of the chassis: it has a main base board with a vertical panel at the left-hand side for the signals, colour decoder and RGB output stages and a vertical right-hand frame that supports the line output transformer and power supply protection circuit panel, see Fig. 1. Introduced in 1979, it used mainly Philips chips for signal processing and a Philips line output transformer. Most models, for example the TC2203 and the remote

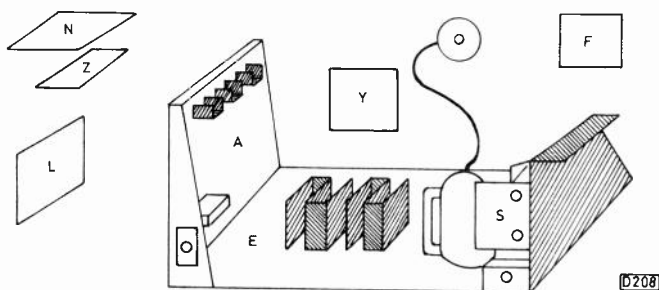

Fig. 1: The U1 chassis. Panels are as follows: E power supply, timebases, audio, EW correction and mains filter; A tuner, i.f., colour decoder and RGB output stages; F NS correction and line linearity; N local controls and the remote-control receiver; Y tube base; S protection; Z mains switch. Models include the TC9200, TC2203, TC2204 and TC2206.

control versions TC2206 and TC2002, were fitted with Philips 510X type tubes, but the TC2204 had a Matsushita tube. This was a Quinrix tube, an early black-matrix type. All models bore the Quinrix logo however, regardless of the tube type fitted. There were 20 and 22in. models. One popular low-cost model, the TC9200, had simple mechanical pushbuttons for channel selection, a throwback to the S1 chassis.

Memorable features include a mains lead that's soldered to two hollow pins at the rear of the chassis, just at the point where most people grab the metalwork to pull it out. The live chassis design has a discrete-component power supply with a 2SC1875 chopper transistor. Over-voltage protection of the 160V h.t. line is provided by two diodes (diacs actu-

ally) that tend to protect the set rather too often. As a result, service engineers sometimes simply removed them. Another thing to watch out for is the two large copper heatsinks near the centre of the main panel: they carry h.t.! All models have a 'magic-line' tuning system: the a.f.c. system drives a green, on-screen vertical bar that narrows as the optimum tuning point is reached.

A separate control block screwed to the inside of the front panel carries the mains switch, local controls and, where fitted, remote-control receiver. One model (TC2292UR) which was designed for the Italian market had two panels back-to-back, joined by not quite flexible wires that easily break when the panels are hinged apart. This set was the first and for quite some time only one to be equipped with search tuning, with two AA batteries for memory back-up. A problem could occur when a set was manually degaussed, as a strong magnetic field applied close to the side of the cabinet would stop the dynamic memory's oscillator circuit with loss of the tuning information. Nevertheless the performance of all these models was excellent.

## The U2 Chassis

The U2 chassis, see Fig. 2, was introduced around 1980-1. From the servicing point of view the most useful features were the adoption of an isolated chassis and the fact that the main cord is directly attached to the switch itself, on the control block. The base model, TC2205, has remote control but still used manual thumbwheel tuning, the controls being hidden in a long push-open drawer. Standby power is provided by a transformer that's screwed to the inside of the cabinet. As before, all models have the magic-line feature to assist with manual tuning. Model TC2207 is the non-remote control, touch-sensor version.

The design was again based largely on European compo-

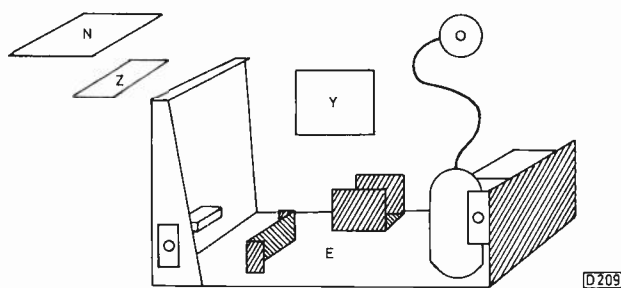

Fig. 2: The U2 chassis. Panels are as follows: E power supply, timebases, EW correction, audio; A tuner, i.f., colour decoder and RGB output stages; N user controls and remote-control receiver; Y tube base; Z mains switch and filter. Models include the TC2205 and TC2207.

nents, though a Japanese line output transformer is used. The discrete-component power supply has a BU326A chopper transistor and two crowbar thyristors to provide over-voltage and excess-current protection.

A weak point in this chassis is the Thomson TDA1104SP

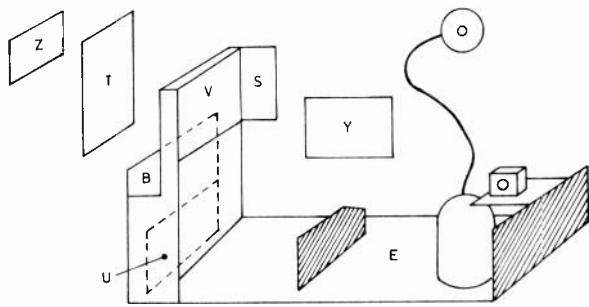

Fig. 3: The U3 chassis. Panels are as follows: E power supply, timebases, tuner and i.f.; B colour decoder; T remote-control receiver and tuning; Y tube base with RGB output stages; Z mains switch and filter. Text models incorporate the V text module, U buffers and S interface panel. Models include the TX2284.

field output chip. Failure of this device results in field collapse, with or sometimes without beam limiting. It was also quite easy to short the chip's output pins when connecting probes to them, thereby destroying the chip, so silicon bond was used on the foil side of the PCB to cover the chip's sensitive pins.

There were 20 and 22in. models, also some 26in. ones later mostly for export markets. As with the U1 chassis, Philips tubes (540X series) were used in most models.

### The U3 Chassis

Perhaps because of reliability problems with some of the European sourced components used in the U2 chassis the U3, see Fig. 3, uses Japanese semiconductor devices for almost every function. This isolated chassis has a complex power supply with an AN5900 control chip, a 2SD792 chopper transistor and five signal transistors. It was the first Panasonic chassis to use a SAW filter in the i.f. strip, eliminating the block filter with its many alignment cores. A discrete-component field output stage was used for improved reliability. There are two versions of the chassis, the U3 for models fitted with 90° tubes (20in. and Japanese 22in.) and the U3W for models with 110° tubes. The latter incorporate EW correction.

One model, the TX2284, was equipped with a teletext decoder. It was added to the basic U3W chassis by using a Philips VM6101 module and three small interfacing panels. By this time remote control and voltage-synthesis search tuning were standard on all models. So the magic line was dropped, as auto and manual search tuning were available. Auto was of little use in practice however, as it tuned and hence stored all the channels in frequency order: this is not how most people like them. Rather infuriatingly it immediately cleared all existing memory positions, so a moment of carelessness could wipe out all the stored channel settings.

On reflection this chassis was probably more reliable than its predecessors had been, though it didn't seem to offer quite the same picture quality.

### The U4 Chassis

The U4 chassis (Fig. 4), introduced in 1983, saw a move back to the use of European components, being designed around a mixture of Philips and Matsushita devices. At last the teletext decoder was fully integrated as a single panel which was mounted adjacent to the i.f. panel. There was a simpler, discrete-component isolated power supply with a 2SD1391 chopper transistor and three signal transistors.

Field output was provided by an AN5521 chip. This device has remained in use, being employed in some Alpha 2 chassis sets. All U4 sets have a Matsushita line output transformer with integral focus and first anode (screen) presets.

As the chassis is quite small the first model was a portable, the TC1631, which later became available with text as the TX1632. Prior to this all portables had been imported, being based on the Japanese M series chassis. One major addition appeared on the U4 chassis: AV inputs.

An early problem that was troublesome, particularly with small sets, was memory loss. This could usually be attributed to electrostatic damage to the CITAC tuning processor chip. As the control panel on which this item is mounted is very close to the tube an antistatic plastic barrier was fitted.

While most 22 and 26in. models continued to be fitted with Philips 540X series tubes a new low-cost model with a 90°, 22in. Japanese tube was introduced. This was the TX2200, which as the number indicates was text equipped: many of these sets are still in service.

The U4 sets were the first to drop the National badge from the model designation, the company at this time shortening its name to just Panasonic in Europe, though the National bit was retained for white goods. Shortly after this two Saisho

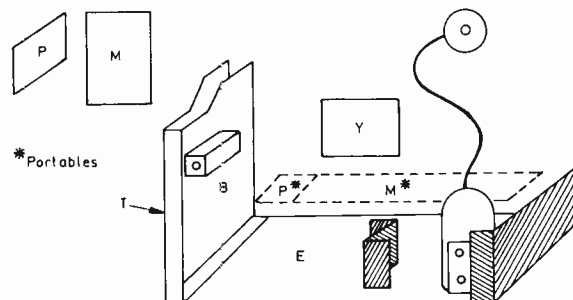

Fig. 4: The U4 chassis (the U5 is similar). Panels are as follows: E power supply, timebases and (U4W) EW correction; B tuner, i.f., audio and colour decoder; T text; M user controls and remote-control receiver; Y tube base and RGB output stages; P mains switch and filter. Models include the TX2200 and TX1632 (U4) and the TXC22 and TX5500 (U5).

(Japanese for first) models were produced exclusively for Dixons, using older cabinet designs and colours. These were the CT20S and CT22S. the former being fitted with the U4 chassis and the latter the U4W (with added EW circuit).

### The U5 Chassis

The next chassis in the series, the U5, again used a discrete-component, isolated power supply, of very similar design to that in the U4 chassis. There were no major changes apart from those required to drive the new FS type of tube. As a result of the new glass shape, cabinet design was changed from the older push-through tube presentation to the mask type with which we are familiar today. Some small-screen models began to be fitted into monitor-style cabinets, with a symmetrical layout and beneath the screen controls.

There were two main versions of the chassis, the U5 for use with 17in. 90° tubes and the U5N for 21, 24 and 28in. 110° tubes.

### The Alpha 1 Chassis

What was to have been called the U6 chassis was eventually produced as the Alpha 1 chassis (see Fig. 5). This



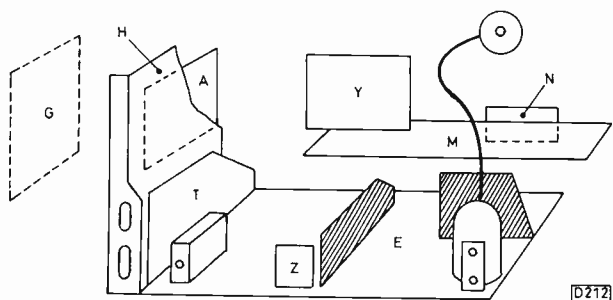

**Fig. 5: The Alpha 1 and Alpha 1W chassis.** Panels are as follows: E power supply, timebases/EW correction, audio, AV1, tuner, i.f., colour decoder; H AV2, sound i.f., Nicams; T text; M local controls, remote-control receiver, mains switch and filter; N LED display; Z int/ext speakers (stereo models); Y tube base with RGB output stages; A Nicam adaptor option; G graphic equaliser option. Models include the TXC78, TX2 and TX3.

change of name was probably a good idea as the Alpha 1 was quite different from its predecessors.

The power supply employs a Sanken STR54041 chopper chip with relatively few other components. Philips chips are used extensively for signal processing and CITAC tuner control. A Philips MAB84XX series microcomputer chip is used for remote and on-board control, a second one being used for text control. On-screen displays are generated by the text system, though a few models such as the 28in. TXC78 have an extra graphic equaliser panel with an OSD chip. There's extensive AV switching with provision for two external inputs and two outputs. The internal and external AV signals take a rather laborious route around the set: as a result there was an increase in the quantity of inter-connecting wires, something that Panasonic has been trying to reduce ever since.

Some models incorporate Nicam reception circuitry while an add-on kit was available for others. For Nicam reception a different H panel, with a new sound i.f. circuit and Nicam demodulator, is required. Also required are an X panel with a PCM decoder and DA converters, and an A panel to interface the lot. It was not an elegant solution, but worked fine. As Nicam was then in its infancy, it was often necessary to realign the H panel to cater for local conditions. This problem was not unique to Panasonic.

Black monitor styling was used for many models, some with stereo sound from front- and side-facing speakers. With these sets the model numbering scheme changed, though older-style sets such as the TX2488 continued to use the previous scheme. A low-cost, 21in. mono-sound monitor-style model, the TX2, proved popular, as did its successor the TX3. These used the basic Alpha 1 chassis while models with 110° tubes used the Alpha 1W variant.

### The Alpha 2 Chassis

The Alpha 2 chassis (Fig. 6) was introduced in about 1988. At the time of writing some of these models are still in production, this being the longest-lived chassis of them all. Internally the chassis is of similar design to the Alpha 1, but the Nicam arrangement is much simpler and next-generation colour decoder and video control chips (the TDA4510 and TDA3505 respectively) are used. There were originally two chassis variants, the Alpha 2 and Alpha 2N.

Monitor-style sets continued with models such as the 28in. TXC88 and 24in. TXC84, some with Nicam built in while others were adaptable. Two new mono-sound sets had all-plastic cabinets. These were the TX21T1 and TX24T1

and their non-text equivalents the TC21R1 and TC24R1. The most interesting models however were the W1 and A1 series. These stereo-sound sets have invar-shadowmask tubes, two or three AV inputs and high-quality sound. The TX24W1 and TX28W1 (W for wide) feature full-size, two-way speakers for each channel and a removable glass faceplate while the TX24A1 and TX28A1 have slimline coaxial speakers sealed in enclosures that are wrapped around the rear of the tube. Panasonic promoted the A1s under the name 'dome sound'. A 33in. model, the TX33A1G, which is made in Japan and has a Mitsubishi tube, completes this range. A locally-designed 21in., 90° stereo model, the TX21V1, with 'mini-dome' speakers and a Toshiba tube, was later introduced. It's the company's smallest stereo set to date.

Although the Alpha 3 was subsequently introduced as a replacement for the Alpha 2, some Alpha 2 variants continue to be produced as they offer excellent cost-performance ratios. One example is the TX24T1, which was fitted

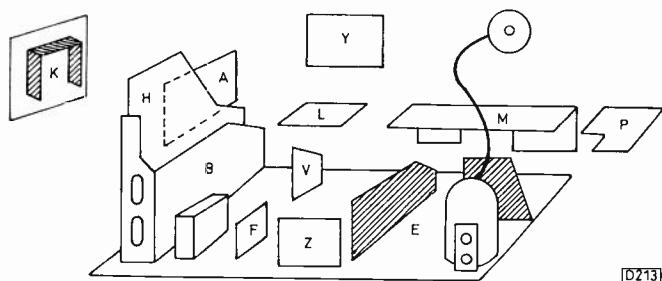

**Fig. 6: The Alpha 2/2M/2N chassis.** Panels are as follows: E power supply, timebases, tuner, audio, AV1, colour decoder; B vision and sound i.f./Nicam; H AV2, S-VHS, text; V video buffer; F beam limiter; Y tube base with RGB output stages; M user controls, remote-control receiver; Z int/ext speakers (stereo models); P mains switch; A Nicam option; L front AV (where fitted); K audio (prism model only). Models include the TX25T1, TX21V1, TX25A1 and TXC88.

with a Toshiba tube and later became the TX25T2. Later still the tube was changed to a Philips black-matrix type, the model number becoming TX25BM1.

In 1991 a modified A2N chassis called the A2M appeared. The main changes were the use of a Philips IVT text decoder and a Toshiba Nicam decoder. This chassis was used in two low-cost stereo models, the TX25G1 and TX28G1, and in some cost-reduced variants of A1 models (renamed J1) which are fitted with iron-mask tubes.

### The Alpha 3 Chassis

The Alpha 3 chassis (Fig. 7) represented another big design change, being significantly more complex than the Alpha 2. The first models appeared in early 1990. This time the main chassis was split in two, with separate signals and power/deflection base panels. The vision i.f./Nicam and text/AV panels plug into the left-hand signals panel. Improved mains filtering was achieved by splitting the line filters between the P and the Z panels. Scan velocity modulation was added, with the tube-neck hung S panel.

Models fitted with this chassis include the TX25W2, TX28W2, TX25A2, TX28A2 and TX33A2, the latter having a more powerful deflection circuit. Other variants appeared during the life of the chassis, to take advantage of changing tube technology and other advances. Because of the large physical size of this chassis and its cost, there were

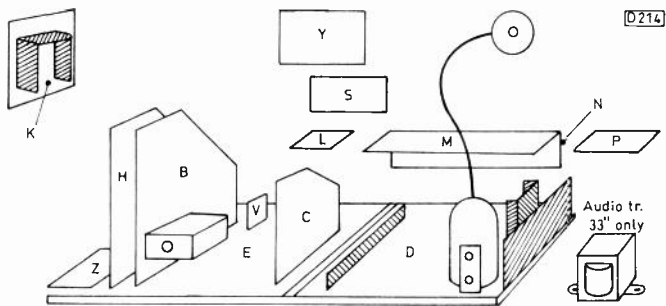

Fig. 7: The Alpha 3 chassis. Panels are as follows: D power supply, timebases, EW correction; E AV1, colour decoder and RGB switching, microcontroller chip; B tuner, i.f.s and Nicam; H AV2, text, S-VHS; K audio amplifiers; M user controls, remote-control receiver; P mains switch and filter; Z mains filter; C int/ext speakers, ambience; EV video buffer; L AV3, headphone; Y tube base with RGB output stages; S scan-velocity modulation. Models include the TX25A2, TX28A2 and TX33A2.

no small- or medium-screen models. An Astra tuner was included in the very first model, the TX25W2A, and is also a standard feature of the Japanese-made TX37A2G.

More information on the Alpha 3 chassis will follow in later articles.

### The Alpha 4 Chassis

The Alpha 4 chassis, see Fig. 8, is the current mid-/large-screen analogue chassis. There are two variants, the Alpha 4 for 90° tubes and Alpha 4H for 110° tubes. The base panel returns to being a single item, though the plug-in board system and the actual circuitry are similar to the Alpha 3. New developments such as a single Nicam chip and integration of the audio amplifiers back on to the main panel help to simplify things and reduce costs.

The current Model TX21V2 is fitted with the Alpha 4 chassis while the TX25X1 and TX28X1 have the Alpha 4H chassis.

### Euro 1

The Euro 1 digital chassis was introduced at the end of 1992, taking over from the Alpha 3 for top-of-the-range sets. Current models include the TX25W3, TX28W3, TX25A3 and TX28A3. The W3s are fitted with the Philips Black-Line Super tube and are 'conventional' in appearance, the A3s continuing the 'dome-sound' tradition with, in addition, the new Philips Superflat tubes.

### The Z3 Chassis

As mentioned above the first UK-produced portable set, Model TC1631, was fitted with the U4 chassis. This was an expensive solution, as a large-screen chassis was being used in a small cabinet. The Z3 single-panel chassis was developed as a better solution, being introduced with Model TC1480. Because it was a live chassis, a simple composite AV input could be added only by using opto-isolators. When the requirement for a small-screen model with teletext and RGB inputs arose, the Z3T chassis was introduced. This is similar to the Z3 but has an isolated power supply and a full-scart AV specification. Models include the TX1786 and TX2195.

There have been many 14, 17 and 21in. models, including some monitor-only versions, and as with the

Alpha 2 chassis the introduction of a new chassis failed to kill off the earlier one as it offered excellent cost-performance ratios. Thus models with the Z3 and Z4 chassis have been produced side by side.

### The Z4 Chassis

The Z4 is really a mini Alpha 3, being aimed at the high-quality, multi-feature portable TV market. Models include the TX15M1T and TX21M1T, which have 'top-dome' speakers and curious on-screen displays including calculator, calendar and 'mood-light' modes. The subsequent M2

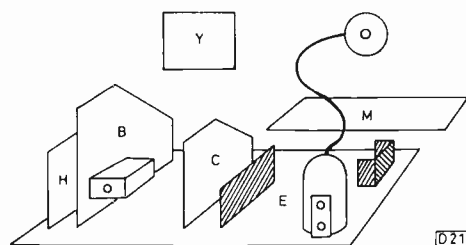

Fig. 8: The Alpha 4/4H chassis. Panels are as follows: E power supply, timebases, AV1, microcontroller chip, audio and EW correction (Alpha 4H); B tuner, i.f.s, Nicam; H text, AV2, S-VHS; C colour decoder, video switching; M user controls, remote-control receiver, AV3, mains switch and filter; Y tube base and RGB output stages. Models include the TX21V2 and TX25X1.

models are basically the same except that the 'soft' paint finish has been changed to a harder wearing and less costly one while the 15in. tube has been changed from an invar- to a cheaper iron-mask type.

### Current Line-up

The present Panasonic line-up includes Alpha 2N, 2M, Z3, Z4 and Euro 1 based models. Possibly the best performer however, and certainly the most complex, was the Alpha 3. We shall be returning to it in later articles.

### Chassis Identification

Figs. 1-8 will enable the various chassis to be identified. In all cases small subpanels that carry LEDs, a headphone socket etc. have been omitted in the interests of clarity. Shaded areas are heatsinks.

## HELP WANTED

**Wanted:** Help in enabling the stereo switching with a Loewe Model T26 (C9000 chassis), also a circuit to emulate the 54.7kHz pilot tone – the receiver is being converted to the *Television* Nicam stereo sound project. P. Hill, 3 Mayfair Avenue, Halifax HX4 9JH. 0422 370 338.

**Wanted:** Circuit diagram and any other information on ADE alarm panels Logic 4, Optima Mk. 2, Optima Plus, also any information on the chips used, and can anyone provide details of and suggest a supplier of the TDA1070P chip used in a Hoover washing machine motor PCB? D. Lee, 16 Devonshire Place, Claughton, Birkenhead, Merseyside L43 1TU16.

**Wanted:** Fidelity M20 ZX3000/M Mk. 2 chassis or chopper transformer, also a circuit. M.J. Levy, 19 Tottenham Close, Kenton, Harrow, Middx HA3 0HS. 081 907 3620.

# ECONOMIC DEVICES 32 TEMPLE STREET, WOLVERHAMPTON, WV2 4AN

15.80H	3.83	2SC1398	0.80	2SD468C	0.00	BB105B	0.24	BD190	0.31	BF959	0.18	BYW56	0.46	M192B1	1.86	SGG13	18.79	TA7176P	1.30	TDA1190Z	4.98	TEA1009	1.61
15.85R	3.84	2SC1413A	1.30	2SD476	0.97	BC107B	0.20	BD201	0.40	BF960	0.27	BYW5600	0.20	M21C	1.65	SGSF344	6.62	TA7193AP	3.06	TDA1200	0.91	TEA1014	1.87
17052	3.85	2SC1509	0.51	2SD525	1.27	BC108	0.15	BD203	0.46	BF966	0.61	CA1310E	0.78	M293	14.63	SKE4F104	0.97	TA7193P	7.98	TDA1270	1.79	TEA1035	2.15
17053	2.38	2SC1520	0.54	2SD551	5.81	BC109A	0.16	BD232	0.28	BF970	0.30	CA309A	3.06	M490	15.30	SKE5F210	1.68	TA7205AP	1.51	TDA1412	0.77	TEA2018A	1.49
17088	2.38	2SC1573	0.36	2SD613	0.63	BC109B	0.15	BD234	0.25	BF973	0.35	CD4001	1.14	M491	7.94	SKE5F310	1.68	TA7207P	1.68	TDA1506	4.59	TEA2164	2.68
17089	3.39	2SC1573Q	0.26	2SD636	0.14	BC117	0.14	BD237	0.30	BF981	0.44	CD4011	0.21	M50115AP	3.24	SL1430	1.41	TA7210P	1.50	TDA1510	2.54	TEA2165	6.26
17127	1.77	2SC1675	0.09	2SD637	0.12	BC139	0.33	BD238	0.11	BF980	0.61	CD4013	0.34	M51102L	1.77	SL1431	1.70	TA7217AP	1.27	TDA1515A	2.54	TIC106M	0.55
1N4001	0.04	2SC1685	0.17	2SD667	0.26	BC140	0.21	BD239	0.29	BF980A	0.77	CD4016	0.14	M51231P	2.03	SL1432	1.70	TA7222	1.27	TDA1516Q	3.56	TIC45	0.59
1N4002	0.07	2SC1740	0.12	2SD669	0.63	BC141	0.34	BD241	0.41	BF991	0.43	CD4021	0.43	M51393AP	4.64	SL490	2.31	TA7222AP	1.24	TDA1518Q	3.32	TIL100	0.52
1N4003	0.05	2SC1741	0.17	2SD669A	0.63	BC147A	0.06	BD243	0.39	BF996	0.53	CD4052	0.29	M51515L	2.01	SL490	2.31	TA7230P	2.29	TDA1670A	2.81	TIP110	0.36
1N4004	0.07	2SC1815	0.14	2SD716	1.46	BC148	0.12	BD243A	0.43	BF992A	0.48	CD4053	0.20	M51521L	0.54	SN76272N	1.48	TA7240P	1.95	TDA1905	0.94	TIP120	0.58
1N4005	0.06	2SC1826	0.72	2SD718	1.45	BC148A	0.06	BD243C	0.44	BF85	0.55	CD4066	0.30	M52181	0.48	SN76274AN	1.39	TA7233P	1.60	TDA1907	4.86	TIP112	0.30
1N4006	0.06	2SC1827	1.00	2SD734	0.24	BC148B	0.04	BD244A	0.34	BFY50	0.34	CD4069	0.17	M5231L	0.55	SN76013ND	7.97	TA7233P	1.60	TDA1701	2.81	TIP112	0.36
1N4007	0.06	2SC1845	0.20	2SD762	1.51	BC149	0.04	BD244C	0.42	BFY51	0.34	CD4070	0.21	M52316P	1.48	SN76272N	1.48	TA7240P	1.95	TDA1870	3.37	TIP112H	0.58
1N4148	0.04	2SC1846	0.51	2SD774	0.43	BC149C	0.04	BD245C	0.72	BR100	0.17	CNK62A	2.95	M54543L	1.61	SN76705AN	1.70	TA7240P	1.95	TDA1904	1.21	TIP120	0.57
1N4448	0.06	2SC1923	0.14	2SD787E	0.36	BC157	0.13	BD246C	0.71	BR101	0.98	CR30M	2.62	M54544L	3.29	SN76666N	1.26	TA7241	2.30	TDA1905	0.94	TIP121	0.42
1N5061	0.38	2SC1942	3.33	2SD837	0.90	BC159	0.06	BD278A	0.56	BR103	0.53	CR02AM	2.17	M54548L	1.87	SN76705AN	1.70	TA7250	4.02	TDA1908A	1.14	TIP126	0.48
1N5402	0.12	2SC1959	0.11	2SD841	1.34	BC161	0.27	BD317	0.87	BR303	1.22	CV12E	2.70	M54644BL	3.62	STK441C	2.88	TA7270P	1.73	TDA2002	0.85	TIP295	0.83
1N5404	0.13	2SC1969	2.46	2SD856	0.94	BC167	0.42	BD318	1.10	BR444	1.02	CI09	7.05	M54648P	5.95	STK0029	5.80	TA7271P	1.76	TDA2004	1.27	TIP29C	0.30
1N5406	0.12	2SC1983	1.78	2SD869	3.28	BC171B	0.14	BD430	0.34	BRV56	0.43	DTA124EF	0.13	M54898AP	0.17	STK0039	7.11	TA7273	3.21	TDA2005	1.36	TIP29E	0.46
1N5408	0.12	2SC2001	0.14	2SD870	3.81	BC177	0.14	BD433	0.29	BSS38	0.23	DTA142EF	0.13	M58485P	5.95	STK0039	7.11	TA7274P	2.72	TDA2006	1.06	TIP305	0.77
1N914	0.04	2SC2073	0.51	2SD871	5.08	BC178	0.11	BD434	0.34	BT120	1.28	ER1400	2.15	M63730	2.38	STK0059	9.57	TA7280	2.11	TDA2009	2.29	TIP30C	0.17
1S1555	0.22	2SC2078	0.77	2SD880	4.48	BC182L	0.06	BD436	0.32	BT129	3.26	HA11235	1.95	M63731	2.88	STK025	9.57	TA7299	2.34	TDA2020	3.72	TIP31A	0.32
1S2076	0.29	2SC2141	1.48	2SD882	0.43	BC182L	0.06	BD436	0.32	BT139500	1.14	HA11244	1.21	M63732	2.88	STK3042	6.80	TA7313AP	0.62	TDA2030H	0.61	TIP31B	0.40
2N2219A	0.27	2SC2166	1.27	2SD898B	4.23	BC184	0.09	BD437	0.32	BT151500R	1.10	HA1124A	1.21	M63733	2.88	STK3062	6.80	TA7317P	0.93	TDA2030V	1.05	TIP31C	0.34
2N2222	0.22	2SC2168	0.85	2SD904	5.95	BC184C	0.04	BD438	0.31	BT151800	1.15	HA11423	2.02	M63734	2.88	STK4131	7.97	TA7325P	0.45	TDA2170	2.55	TIP32A	0.39
2N2905	0.21	2SC2236	0.25	2SD973	0.93	BC184C	0.10	BD441	0.34	BZ025	1.07	HA11440	2.92	M63735	1.62	STK4141	9.31	TA7343AP	0.72	TDA2270	1.68	TIP32C	0.38
2N2926G	0.37	2SC2271	0.22	74L500	0.21	BC204	0.14	BD442	0.29	BZ028A	1.16	HA1166X	3.43	M63736	1.26	STK4142	9.31	TA7358P	0.72	TDA230	3.76	TIP33A	0.39
2N3053	0.36	2SC2272	0.22	7805	0.28	BC207B	0.23	BD510	1.34	BZ028D	1.53	HA11713	1.24	M63737	1.24	STK4162M	8.21	TA7358P	0.68	TDA2540	0.88	TIP33C	0.82
2N3054	0.98	2SC2274K	0.22	7808	0.30	BC212B	0.06	BD529	0.97	BZ326A	1.36	HA11741	1.36	M63738P	1.45	STK4162M	8.21	TA7358P	0.68	TDA2540	0.88	TIP33C	0.82
2N3055	0.77	2SC2314	0.33	7812	0.30	BC212L	0.06	BD530	1.10	BZ406	0.68	HA11745	1.50	M63739	1.59	STK4171	10.50	TA7670AP	2.62	TDA2541	0.72	TIP34	0.00
2N3442	1.00	2SC2335	1.43	7815	0.30	BC213	0.11	BD535	0.43	BZ407	0.43	HA13001	1.70	M63740	1.70	STK4181	12.85	TA7670AP	1.95	TDA2560	4.46	TIP34C	0.89
2N3702	0.11	2SC2458	0.12	7818	0.41	BC214F	0.09	BD536	0.48	BZ407	0.43	HA13108	3.56	M63741	1.70	STK4181A	12.85	TA7630P	0.97	TDA2576A	5.95	TIP41A	0.38
2N3704	0.14	2SC2482	0.34	7905	0.34	BC237	0.10	BD675	0.30	BZ407A	0.97	HA13118	1.87	MJ2955	0.97	STK4332	5.54	TA7640AP	1.86	TDA2577A	4.25	TIP41C	0.37
2N3773	1.27	2SC2547E	0.24	7912	0.43	BC237B	0.05	BD677	0.32	BZ426A	0.96	HA13119	2.03	MJ802	2.37	STK4352	1.70	TA7676P	4.25	TDA2578A	2.55	TIP42A	0.39
2N3819	0.34	2SC2565	0.46	AA119	0.36	BC238	0.11	BD707	0.51	BZ426E	2.13	HA13403	4.66	MJE13005	0.85	STK437	1.80	TA7680AP	3.81	TDA2581	5.75	TIP42C	0.37
2N3904	0.11	2SC2570A	0.29	AA143	0.49	BC238B	0.05	BD839	0.51	BUS00	1.32	HA1377	2.42	MJE2955	0.68	STK4392	5.92	TA7698AP	5.93	TDA2581Q	10.15	TIP47	1.51
2N4444	3.22	2SC2577	1.46	AC127	0.11	BC239	0.04	BD901	0.51	BUS00A	0.95	HA1388	2.63	MJE3055	0.51	STK441	11.81	TA7705P	1.68	TDA2591	1.15	TIP47A	0.24
2N6292	0.62	2SC2581	3.05	AC141K	0.46	BC252B	0.07	BD902	0.51	BUS00AF	1.27	HA1389	2.62	MJE340	0.50	STK459	11.17	TA7769P	1.43	TDA2591	1.15	TIS43	0.66
2SA1015	0.10	2SC2632	0.43	AC176K	0.30	BC300	0.48	BD911	0.65	BUS00D	1.27	HA1392	1.51	MJE340	0.50	STK459	11.17	TA7769P	1.43	TDA2591	1.15	TIS43	0.66
2SA1016	0.17	2SC2655	0.25	AC176L	0.18	BC301	0.28	BD912	0.65	BUS00E	1.87	HA1392	1.46	MJE340	0.50	STK459	11.17	TA7769P	1.43	TDA2591	1.15	TIS43	0.66
2SA1020	0.43	2SC2671	0.68	AC187K	0.33	BC302	0.36	BD955B	1.16	BUS00H	1.28	HA1398	2.33	MNI405WV	11.08	STK4843	11.10	TA8210H	4.74	TDA2594	2.21	TL091	1.31
2SA1020Y	0.43	2SC2688	0.30	AC188	0.36	BC303	0.22	BD984C	1.28	BUS26	1.41	HA1452	4.86	MNI435VXB	10.66	STK5322	6.35	TA8691N	6.67	TDA2600	3.08	TMP47C43ZAP	11.24
2SA1095	7.44	2SC2785	1.12	AC198K	0.82	BC307	0.06	BD993C	0.58	BUS36	1.60	HM6292	10.36	MNE50	2.50	STK5325	5.92	TA8626	1.05	TDA2611A	0.64	TMP47C43AN-3555	17.87
2SA1102	2.54	2SC2791	5.44	AD149	0.52	BC307A	0.06	BD994C	0.46	BUS68	1.44	HM6291	9.52	MPSA46	0.23	STK5326	6.20	TBA120	0.53	TDA2611AQ	2.03	UC3844	1.74
2SA1143	0.17	2SC3150	1.44	AD161	1.02	BC307B	0.06	BDX32	1.70	BU705	1.61	HM7103	14.07	MPSA56	0.12	STK5331	3.02	TBA120AS	0.90	TDA2640	4.13	UPA81C	0.98

## SPECIAL OFFERS - ENDS 31/01/94 OR WHILE STOCKS LAST

BU208A x 5	3.99	'F' CONNECTOR (SCREW TYPE) x 25	3.00
BU 426A x 5	3.50	TDA 2600 x 2	3.95
BU 508A x 5	3.60	TDA 2579A x 2	5.00
BU 508AF x 5	5.00	TDA 3562A x 2	3.99
BUT 11AF x 5	3.25	TDA 3654 x 2	2.20
TV FAULT FINDING GUIDE	9.99	TDA 4501H x 2	2.49
VIDEO FAULT FINDING GUIDE	9.99	TDA 4601 x 2	2.50
SATELLITE FAULT FINDING GUIDE	14.95	TDA 4612 x 2	2.95
CO AXIAL AERIAL PLUG x 25	3.75	STR 54041 x 2	7.50

2SA1175	0.25	2SC3153	2.37	AD162	0.96	BC308	0.06	BDY20	2.13	BU806	0.82	ICH281	0.26	MPSA93	0.09	STK5332	2.74	TBA120S	0.89	TDA2652	14.32	UPC1181H	6.80
2SA1186	3.73	2SC3156	4.22	AF124	0.77	BC308A	0.09	BF115	0.41	BU806A	0.80	KAZ101	0.83	MKR85A	0.14	STK5333	4.28	TBA120T	0.51	TDA2653A	3.26	UPC1182H	5.95
2SA1208	0.34	2SC3182	3.25	AF127	0.59	BC308C	0.06	BF179	0.31	BU807	0.51	KB108	0.47	MSM5840H	15.36	STK5372	3.40	TBA120U	0.39	TCA2680	5.10	UPC1185H	10.20





# Ottawa HDTV '93

*Geoff Lewis, B.A., M.Sc.*

The great advantage of this Canadian event lies in the compact venue. It's always easy to have individual discussions with the authors of the technical papers and the other delegates, making it much easier to gain a clear appreciation of the current situation. There have been many conflicting statements recently on the situation in North America, and I hoped that HDTV '93 would provide some definitive answers. After much discussion however it appears that there are still many problems to be resolved before a digital high-definition (HDTV) service can be brought into operation.

The three-day programme included sessions on both the broadcasting and the non-broadcasting applications of HDTV and the implications for satellite, terrestrial and multi-channel use. To further complicate the issue there were a significant number of papers on ultra-definition TV (UDTV), which is defined as systems with resolutions in excess of 2,000 lines, and three-dimensional TV (3DTV). These, together with papers on new bit-rate reduction and coding techniques for broadcast, cable and recording systems, confirm that a considerable amount of research is going on.

## **US HDTV System**

The Advisory Committee on Advanced Television Systems (ACATS) and the Federal Communications Commission (FCC) recently said that to enable a decision on the US HDTV system to be made before the end of 1994 they expected final hardware to be laboratory and field tested before next June. It was therefore expected that the Grand Alliance (GA) formed by those who have developed the various proposals would be able to present a definitive system for consideration by the assembled experts. This was not to be however.

A number of problems have arisen because of the sometimes conflicting interests of the broadcast, cable, satellite and computer industries involved. As a sop to the latter, square pixels have been included in the specification, even though the analogue nature of the display device will round the corners. Then there is the fear that each member of the GA will expect elements of their original proposals to be included in the final specification in order to safeguard their patent and intellectual property rights. Such in-fighting could lead to a less than best final choice.

The proposed US digital TV system has now been defined in terms of a four-layer model, with some layers more precisely defined than others.

Layer one, the picture or image, provides a future-proof, flexible strategy that includes 24, 30 and 60 frames per second (f/s) with progressive scanning. The original 1,050-line resolution has been updated to 1,080 lines, with 1,920 digital samples per line. Because 60f/s is not currently practicable, the initial specification is based on 24 and 30f/s progressive. To cater for live video feeds and provide backwards compatibility, the specification includes 787.5 lines progressive and 1,050 lines with interlaced scanning. With this degree of flexibility there's a need to define a common image format (CIF).

Layer two, the compression system, is based on the MPEG-2 standard, as far as the video signal is concerned at least. After testing the European Musicam system the ACATS decided that Dolby AC-3 running at 384kbits/sec,

as used by many current cinema feature films, suits North America better. Further tests are being carried out by the MPEG committee in Seoul, Korea however, so it's just possible that the final specification will include both as alternative sound systems.

Layer three, the transport layer of the MPEG-2 standard, specifies the arrangement of the data stream, the data packets, priorities and universal headers.

Layer four, which relates to transmission, specifies the use of either quadrature amplitude modulation (QAM) or vestigial sideband (VSB) after rejection of the European coded orthogonal frequency-division multiplex (COFDM) system. Further tests will lead to a decision on whether to adopt 32QAM, which provides five bits per transmitted symbol, or 4 or 6VSB. With the latter the carrier signal is amplitude modulated to one of four or six discrete levels, the carrier being positioned half way down the lower band edge of the 6MHz channel.

## **The Wider Scene**

A report that the MPEG-4 committee is close to producing a draft report dealing with the future needs of audio-visual processing suggests that ideas about compression and coding techniques are not yet ready to be cast in concrete. This body is considering the applications and operational conditions with bit rates as low as a few tens of kHz. With all the variations that have now been put forward, a future world digital HDTV standard will almost certainly have to be based on an open and smart receiver. Fortunately this problem can be easily resolved with digital systems: by including special code patterns in the transmitted bit stream the receiver can automatically switch to the correct system.

With a view to the possible introduction of wide-screen NTSC as an interim measure the Communications Research Centre (CRC) of Canada reported on the results of a survey it had carried out on the scan-and-pan and the letter-boxing techniques used in Europe. This involved a relatively small sample – a hundred professional and non-professional viewers. Whilst a majority of both groups preferred to view a full-screen image and disliked the black banding with letterbox displays, the latter were found to become more acceptable after a period of viewing. In all cases however pan-and-scan was preferred to letter-boxing. Although the report didn't mention the display screen size, one wonders whether the same results would hold for PAL-Plus in the UK and mainland Europe.

## **Miscellaneous Problems**

Several concerns became apparent during private discussions with authors and delegates.

Many of the 1,600 or so US TV transmitter stations operate in the v.h.f. band. With ageing masts, there were doubts as to whether many would meet current construction standards. The point about this is that because HDTV is to be introduced using simulcasting the extra v.h.f. aerials could overload the structures. As an alternative a new service using smaller, u.h.f. aerials could be introduced. But this would reduce service areas and the incomes of the broadcasters. However this is resolved, it amounts to more bucks per bit! Could a similar situation arise in those parts

of Europe that still use the v.h.f. bands for TV broadcasting?

Concern was also expressed about the multi-channel possibilities with digital TV: how could profitability be achieved with perhaps 150 or more channels of video-on-demand becoming available, and what effect would this have on the introduction of the new HDTV services?

The wide use of personal and home computers and video games has created serious r.f. interference problems for low-power mobile and amateur communications. Will this problem get out of hand when every TV receiver becomes a digital processor?

## HELP WANTED

**Wanted:** A line output transformer for the Sanyo CTP3131 and for the CTP5101. Keith Docwra, DTV Service, 38 Kent Road, Margate, Kent CT9 3SN. 0843 231 408/220 773.

**Wanted:** LOPT for the ITT CVC40 chassis and any information on converting a Sony SL-HF100 PAL/Secam (Beta) B/G machine to PAL I. Bill Harris, 13 Bridle Drive, Clapham, Beford MK41 6BB. 0234 363 813.

**Wanted:** Handbook/circuit for the Tektronix 561A scope and 3A1, 3B3 plug-in units. Phil Lacey, 12 Chaworth Road, Ottershaw, Surrey KT16 0PE. 0932 872 730.

**Wanted:** KEF 8in, B200 bass-mid driver (SP1039). P. Brown, 14 The Moat, Weston Coyney, Stoke-on-Trent ST3 6NB. 0782 32 234.

**Wanted:** Circuit diagram (or copy) for the Finlandia Model C22TZ5. A. Tomkinson, 10 Lodge Court, Station Grove, Wembley, Middx HA0 4AP. 081 903 5574.

**Wanted:** Handset for the B and O 30AX chassis (Beovision 5100 etc.). T. Jarman, Acme TV Repairs, 7 Cadet Way,

Pirates have demonstrated that it's possible to use a computer monitor's electromagnetic radiation to copy its display. If this could be done with an encrypted TV signal, it would be possible for pirates to bypass the need for an authorised decoder. This introduces a further problem that might need to be considered in the design of an HDTV receiver.

After three days of intensive discussions it was clear that even if a worldwide digital HDTV standard came to be adopted TV engineering would continue to be a field full of interest.

Church Crookham, Fleet, Hants GU13 0UG. 0252 616 938.

**Wanted:** LOPT for the Network Model 1410 and a chrominance panel for the Osaki Model P50G. B. Potter, 10 Holmbury Close, Southgate West, Crawley RH11 8TG. 0293 513 787 (evenings).

**Wanted:** Service manual for the Philips Model 3570. I have for disposal copies of *Television* for the years 1949 to 1990 except 1960. I.R. Holmes, 33 Avenue Road, Winslow, Buckingham MK18 3DH. 0296 722 462.

**Wanted:** Circuit diagram and layout or service manual (photocopy will do) for the Rollie P3800 dual-slide projector. Fred Hay, 27 Crayke Road, Stockton-on-Tees, Cleveland TS18 4EY. 0642 674 560.

**Wanted:** Data sheet or any information on the General Instrument 72522-1 on-screen display chip. S. Duddridge, 53 Burgoyne Road, Thornhill, Southampton, Hants SO2 6PA.

**Wanted:** Service manual/sheet for the Matsui VX800 (Currys). I have the VX850 sheet but this model differs. George Pond, 57 Summerwood Lane, Clifton, Nottingham NG11 9FU.

ICS	2SA748	0.85	2SD2340	0.45	STR461	6.00	
A155	0.20	2SA777	0.35	2SC325	STR1050	7.25	
AD161	0.50	2SA841	0.40	2SC355	STR2029	4.75	
AD162	0.50	2SA893	0.50	2SD400	STR3042	4.20	
BC108	0.07	2SA1011	1.35	2SD467	STR3042/2	4.75	
BC141	0.30	2SA1102	1.60	2SD525	STR4191/5	18.50	
BC142	0.20	2SA1123	0.49	2SD600	STR5325	4.45	
BC307	0.08	2SA1175	0.40	2SD612	STR5332	1.80	
BC337	0.07	2SA1287	0.80	2SD636	STR5333	2.40	
BC546	0.07	2SA1307	1.50	2SD716	STR5422	4.20	
BD131	0.30	2SB370	0.40	2SD725	STR5476	4.00	
BD132	0.30	2SB374	0.65	2SD836	STR7348	3.15	
BD243	0.38	2SB541	1.90	2SD856	STR73410	4.00	
BD246	0.65	2SB546	0.55	2SD1136	ST4401	3.50	
BDX33	0.50	2SB618	3.05	2SD1273	ST4411	3.80	
BDX54	0.50	2SB641	0.11	2SD1275	ST4441	2.50	
BF197	0.20	2SB649	0.38	2SD1278	ST4441	4.75	
BF259	0.70	2SB717	0.52	2SD1398	ST4451	13.95	
BF494	0.15	2SB961	1.50	2SD1426	STR5412	4.40	
BF681	0.30	2SB1015	0.60	2SD1441	STR1090	5.90	
BFY51	0.80	2SB1016	1.10	AN318	STR50103	2.65	
BFY90	2.00	2SC372	0.70	AN5011	STR59041	6.40	
BU124	1.35	2SC458	0.68	AN5512	TA7157	1.20	
BU180	1.90	2SC681	3.20	AN5521	TA7270	2.00	
BU205	0.85	2SC741	3.00	AN6367	TA7280	2.25	
BU208	0.68	2SC867	3.00	AN6673	TA7604	2.35	
BU208A	0.70	2SC941	0.12	AN7115	TAB205	2.90	
BU208A	0.90	2SC998	3.05	BA318	TAB207	1.65	
BU325A	1.10	2SC1008	0.20	BA658	TAB210	3.50	
BU407	0.65	2SC1103	0.50	BA1330	TAB214	3.40	
BU409	1.10	2SC1123	0.45	BA5466	2.50	TAB215	3.00
BU476	1.50	2SC1222	0.11	BA6219	1.20	UPC574	0.50
BU508A	0.85	2SC1327	0.78	HA1156	1.35	UPC1020	2.00
BU508Y	1.35	2SC1382	0.30	HA1377	1.40	UPC1032	0.60
BU5080	1.10	2SC1429	0.55	HA11227	1.50	UPC1185	4.00
BU536	1.05	2SC1447	0.80	KA2101	1.00	UPC1230	1.50
BU526	1.45	2SC1514	0.42	KA2263	1.00	UPC1363C	1.90
BU506AF	1.20	2SC1569	0.55	LA1352	1.45	UPC1378	1.80
BU5080F	1.35	2SC1674	0.15	LA1460	2.05	UPC1394	1.50
BU111A	0.70	2SC1767	0.36	LA4182	1.65	UPC4556	0.50
BU111AF	0.85	2SC1815	0.12	LA4200	1.30		
BU112A	0.85	2SC1852	0.49	JA4440	1.18		
BU112AF	1.10	2SC1914	0.15	LA4460	1.30		
BU156A	0.80	2SC1383	0.90	LA4700	4.40		
TIP30C	0.25	2SC2002	0.22	LA6324	1.90		
TIP31A	0.25	2SC2027	2.20	LM318	1.15		
TIP32B	0.30	2SC2076	1.10	LM723	0.45		
TIP41A	0.30	2SC2236	0.25	LM1818	2.25		
TIP47	0.45	2SC2278	1.00	LM6402	5.25		
TIP110	0.45	2SC2347	0.18	MS143P	1.40		
TIP112	0.85	2SC2500	0.25	MS220L	1.75		
TIP142	0.90	2SC2579	1.25	MS1172	2.60		
TIP191	1.30	2SC2763	0.12	MS8884	4.50		
TIP2955	0.50	2SC2668	0.10	MT151/800	0.85		
MIE340	0.25	2SC2688	0.30	MR3732	2.45		
MIE521	0.35	2SC2838	3.00	MR3756	2.20		
2N2222	0.20	2SC2979	2.00	MC1327	0.65		
2N3035	1.10	2SC3182	1.50	MC14426	2.50		
2N3773	1.50	2SC3262	3.60	MC14493	8.50		
2N6130	0.40	2SC3345	1.00	SA11293A	4.85		
2SA350	0.60	2SC3506	3.40	SA11293-2	5.15		
2SA606	0.75	2SC3883	2.80	SA1293-3	5.15		
2SA629	1.95	2SC4242	1.40	SA5010	4.95		
2SA722	0.62	2SD198	1.60	SA5243P/E	7.15		

**VIDEO HEADS AT A VERY COMPETITIVE PRICE WHILE STOCKS LASTS**

<b>AIWA</b>	
AV66/77F	10.95
<b>FERGUSON</b>	
3V 58/FV13H	18.95
FV14T	24.80
<b>FUNAI</b>	
VP 3000A	4.00
<b>GOLSTAR</b>	
GHV 1221/1241	11.99
<b>GRANADA</b>	
AH3	19.00
EH3	19.00
DH2/EH2	15.00
BH1/CH1	13.00
FJ2	24.00
FM2	23.00
VBX81	10.95
<b>GRUNDIG</b>	
VS160	45.00
MVS660/V5660	38.90
<b>HITACHI</b>	
VT16/35	19.00
VT65	24.50
VT136/435/535	19.00
VS20/100/400	15.00
VS2/64	13.00
VT38/39	21.00
<b>JVC</b>	
HRD 370/430/750	18.95
HRD 530/565	24.80
HRD 408/580	25.75
<b>LOGIK</b>	
VR955/960	12.45
<b>MATSUI</b>	
VX 730/750	12.45
<b>MITSUBISHI</b>	
HS 400	28.75
HS 338	25.50
HS 330	29.00
HSB 10/20	23.00
HSE 50	34.95
<b>NEC</b>	
DX1000/N901/7033	15.00
<b>PANASONIC</b>	
NV 788	25.50
NVM 1/3/5	45.00
NV480/630/PK/780	31.00
AT E100/E200	29.15
NVD80/NV65/NVH75	38.90

**NEW - NEW - NEW**

Hey look time is money, if your workshop is computerised then ask for FREE evaluation disc with your next order on:

**"WORKSHOP MANAGER PLUS"**

Only available from us.

*We wish all our customers a very Happy Christmas and a Prosperous New Year*

**NEW STOCK**

TUA 2000-4	4.25
TPU 2732	12.99
MDA 2062	3.00
TMP 47C434N-3555	20.50
TMP 47C434N-3537	17.20
TMP 47C 432AP-8189	24.15
TMP 47C 432 P-8188	24.15

**IDLER TIRES**

DON'T FORGET JJ'S TIRE. DUE TO RECESSION PRICE IS THE SAME. MIN 3PKTS PER ORDER

**SOLE DISTRIBUTORS**

**RA100 - DESOLDERING STATION**

RA100 DESOLDERING STATION  
£225 + £12 + VAT RA100 + DS 3102 IRON £225 + £65 + £12 + VAT. Overseas postage accordingly. 5% surcharge if paying by credit card.

**J.J. COMPONENTS**

63 THE CHASE, EDGWARE, MIDDX. HA8 5DN, ENGLAND

Tel Fax: 081-952 4641 Hotline No: 081-381 1700  
Free fax orderline 0800 318498  
24 hr answering machine Tel: 081-952 4641

TELEVISION JANUARY 1994

195

# TV Fault Finding

*Reports from Philip Blundell, AMIEE,  
Nick Beer, Eugene Trundle,  
Richard Newman, Steve Cannon,  
Mike Leach and Edward Joyce*

## Philips Anubis A AC Chassis

There was a blank raster and no sound with this new set, though the on-screen display worked. An external video signal fed in at the front sockets proved that the set was in the external mode with the u.h.f. program positions. A check on the status voltage at pin 18 of IC7015 produced a reading of 3V instead of 0V. This voltage comes from transistor 7877, where we found that the earth line was floating because the jumper by the scart socket had never been soldered. **P.B.**

## Panasonic Alpha 2W Chassis

This set was almost dead: there was no sound or vision, but the power supply was making a ticking noise. Checks showed that the 155V supply's protection diode D854 was short-circuit, indicating an over-voltage problem, while R567, the fusible resistor that's in series with the supply to the line output stage, was open-circuit. I replaced the protection diode, removed R567, connected a dummy load and powered the set via a variac. A check on the voltage at TPE1 as the input was increased showed that there was no regulation – the voltage would have passed 160V if I'd let it. A new STR54041 chip restored regulation, and the h.t. voltage could now be stabilised at 155V. So a replacement was fitted in the R567 position, the dummy load was removed and the set was tried with the full mains input. R567 went open-circuit and the line output transistor Q551 went short-circuit. A new line output transformer, transistor and R567 completed the repair. **P.B.**

## Philips 24CE7570/05S (3A Chassis)

For no sound when cold, or the picture and sound flashing on and off every second or so, check by substitution the electrolytic capacitors in the FE644 tuner/i.f. module. **P.B.**

## Toshiba 201T4B

If the set is slow to go into the standby mode, check whether R819 or R820 is open-circuit. These resistors both have a value of 110k $\Omega$ . **P.B.**

## Philips GR1-AX Chassis

If you get the dead set symptom because the line oscillator isn't working, check whether the 12V zener diode D6030 is open-circuit.

For no sound or vision, just a blank screen, check whether C2044 (4 $\mu$ F) is short-circuit. **P.B.**

## Grundig Cinema 9050

This projection set produced a washed out picture. We decided to carry out checks on the RGB board. The supplies and the beam-limiter signals were o.k. but the data switching signal at pin 7 was suspect, the voltage here being 0.6V. This point is connected to pin 31 of the abstimm (tuning) module. When this pin was disconnected the

picture was restored. The 0.6V was coming from the TMS3743 chip on the tuning board, a replacement solving the problem. **P.B.**

## Philips CP110 Chassis

This set had no sound or vision, with F1 showing in the channel display. We found that the line oscillator had stopped as there was no supply at pin 12 of the sync/i.f. module. The cause of the trouble was a crack in the print beside the line output transformer. **P.B.**

## Panasonic TX28W3 (Euro 1 Chassis)

This is the fearsome digital chassis that has been featured in recent issues of *Television*. This one intermittently lost signals, on any preset channel, as you watched it. It was not a memory problem – the data for each preset remained correct. Calling up the self-test display during the few seconds when the fault was present showed that there were no errors, so no help here. Despite the fact that the tuner address was o.k. the fault was in the tuner, though obviously nothing to do with the bus. A new tuner restored correct operation. **N.B.**

## Samsung CI5013T (P58 Chassis)

This set would drift off tune about five seconds after selecting a channel stored in the memory. If sweep tuning was tried the set wouldn't stop when a channel was found. There's precious little by way of voltages or waveforms in the manual, but I decided to check the voltage at pin 9, the a.f.c. input, of the microcontroller chip RIC01. There was nothing much by way of d.c. here. The input comes from pin 18 of IC101 via a potential divider that consists of two 120k $\Omega$  resistors, RR26 and R116. The latter was open-circuit. **N.B.**

## Ferguson 51J7 (TX99 Chassis)

The picture would intermittently go pink or bright green. The cause was dry-joints on the green output transistor. **N.B.**

## Salora 22K37 (K Chassis)

This set operated in standby but was otherwise dead. A check on the S2000A line output transistor showed that it was very leaky. The set worked when a replacement had been fitted but after soak testing for a few hours the fault returned. This time the line output transistor was o.k., but the tuning capacitor CB507 was low in value at only 55pF instead of 15.5nF (1.5kV). **N.B.**

## Philips GR90AE Chassis

This set is used as a computer monitor in a local school. The complaint was of no red in the display with an RGB input. I found that the cause was the BAS32 surface-mounted diode

D6854 which is connected between the R input and chassis – it was short-circuit. **N.B.**

### **Sony KV21XRTU**

When teletext was selected we obtained only TV chroma. When mix was selected there was TV vision but no text. When TV was selected all was well. The cause of the problem was a high-impedance connection at pin 5 of connector D3, the blanking output from the text decoder. Cleaning cured the fault. **N.B.**

### **Salora 24K7H (K Chassis)**

Every few hours this set would quietly revert to standby. There would be no clues – no effect on the picture or sound prior to the event. The usual dry-joints had been attended to and it wasn't the mains switch, as is often the case. I eventually traced the cause of the fault to a hairline crack around one leg of CB613. **N.B.**

### **Samsung CI5012Z (P58 Chassis)**

This set wouldn't produce any signals: the tuning voltage showed that it swept, but no station was ever found. A check at the tuner showed that the tuning voltage was missing. There was 33V at the cathode of DZ824 but nothing at the collector of the integrating transistor RQ04. Its tiny 0.25W feed resistor RR05 (10k $\Omega$ ) was open-circuit. **N.B.**

### **B and O 39XX Chassis**

Spitting from the left-hand speaker at switch on has twice been traced to a poor connection between the earthing braid, its spring, the c.r.t.'s Aquadag coating and the rimband. A rusty deposit forms under the spring on the right-hand side as viewed from the back of the set, i.e. behind the left-hand speaker as viewed from the front. Also clean dust from behind the speaker frets. **N.B.**

### **Fidelity C14M06/C14R06**

Intermittent field collapse was the problem with one of these sets. We found that D25 (1N4002) which is connected to pin 6 of the TDA3653 field output chip IC10 was going open-circuit. **N.B.**

### **Saisho CT142RX/Matsui 1440A**

This set suffered from very severe tuning drift. The cause of this was the the BT amplifier transistor Q501 which had a varying collector-emitter leak. **N.B.**

### **Panasonic TX21M1T (Z4 Chassis)**

There was a strange fault with this set: if you stored a channel in a tuning memory position that already stored information the same information would be stored in all other locations in use. The cause of the fault lay on the text PCB, which had been subjected to previous damage. Link J10 was broken. In other circumstances it would be worth looking for a dry-joint in this area. **N.B.**

### **Boots CTV1417**

This set wouldn't go into the standby mode properly: the light didn't come on and although there was no sound or

vision a raster was still present and the audio output stage continued to operate. Standby switching is applied to the base of transistor Q607 in the power supply. This transistor was switching correctly. When it switches on Q605 should turn on and Q606, which is in series with the 108V h.t. supply, should switch off. The cause of the trouble was that Q606 was short-circuit: a new 2SC2335 transistor put that right.

We ran the set on soak test and two days later the fault returned. The new transistor had bitten the dust and the h.t. was now very high and couldn't be set. In fact the h.t. was at over 200V in standby, which is why Q606 had again failed. When the set warmed up however the h.t. fell and could be set. A spot of freezer on C607 (47 $\mu$ F, 25V) which couples the drive to the base of the chopper transistor made the h.t. go high again, with loss of control. A new electrolytic finally put an end to these pranks.

What usually happens with capacitors in this position is that they dry up then reform at a higher capacitance value when warm. Often the chopper transistor will fail as a result, being left on for too long. Electrolytic capacitors in higher temperature and frequency circuits are prime suspects when a fault is present. If I find that a capacitance-coupled chopper transistor has gone short-circuit I always replace the capacitor as well, believing that this saves a lot of potential recalls. **N.B.**

### **NEI 2031TX**

This set wouldn't come on from standby via the remote control unit. It would start if precise action was applied to the mains switch, but this didn't seem to be quite right. The cause of the trouble was the start circuit in the SAA1293A remote control decoder chip, a replacement restoring normal operation. **N.B.**

### **Tatung 170/180 Series Chassis**

The symptom with one of these sets was described as "yellow faces – sometimes". We put it on soak test and after a few hours the colour bars looked strange indeed: the red bar turned to an orange hue and the blue bar was brighter than it should have been. The cause was traced to intermittent leakage in C531 (1 $\mu$ F, 50V), which is in the colour decoder's a.p.c. loop. **E.T.**

### **Philips G110 Chassis**

On test this set behaved exactly as the fault report said – "intermittent start and no standby". The on-off switch sometimes had to be operated half a dozen times before the set would come on. Everything then worked normally until the set was put into the standby mode, when it shut down without even the standby LED being alight.

In the fault condition the h.t. voltage fell to almost zero and a slight whistle came from the chopper transformer. This suggested that the power supply was in the protection state, which was confirmed by measuring the voltage at the base-collector connection between transistors T7656/7655. The voltage here should be zero or slightly negative but was 0.7V, enough to turn on the transistors and thus the optocoupler, shutting down the power supply. Disconnecting the line output stage made no difference to the fault condition, so I checked the 20V zener diode D6657 which monitors the 16V supply. It read perfectly when checked with the diode test facility of a digital meter but produced a 1M $\Omega$  reverse leakage reading when checked with the good old Avo. A new

diode cured both problems with the set.

I've had this diode fail before, but on previous occasions the set shut down completely. All this confirms my belief that digital meters are no substitute for a good analogue meter when it comes to testing diodes and transistors. **R.N.**

### **Akai CT2125/Samsung P58SC Chassis**

The complaint was of an intermittent blank raster with flyback lines. We found that the fault cleared when connector TD203 on the teletext board was removed. Scope checks then showed that the 27MHz crystal TZ01 wasn't oscillating properly. A replacement cured the problem. **R.N.**

### **JVC AV25F1EK**

The customer complained about various intermittent faults. He said that the remote control sometimes locked up and didn't appear to work, the signals would disappear briefly and then come back again, and other things. I removed the back cover and tapped around the tuner section. This instigated the fault condition, which was caused by dry-joints at the 7805 regulator chip IC522. A good solder-up here cured all the intermittencies, including the apparent remote-control problem. **M.L.**

### **Alba CTV743**

The channel numbers on the front control panel lit up but there was no h.t. supply. As we didn't have a circuit diagram we poked around a bit and stumbled across the cause of the fault: D806 in the power supply was short-circuit. We fitted a new BYD33M in place of the original 1N4936 and our problem was solved. **M.L.**

### **GEC C2201 (Tatung 146 Chassis)**

The initial problem was field collapse. We found that R434 was open-circuit, which seems to be a common fault these days. With the full field scan restored the set produced only a blank raster. The TDA3561 colour decoder chip was getting warm but a replacement made no difference. Checks around this chip showed that the voltage at pin 7 was very low. This brought us to the BZX79C5V6 zener diode D502 which was short-circuit. A replacement restored the picture. **M.L.**

### **Panasonic TX25W2A (Alpha 3 Chassis)**

This set was stuck in standby, a fault we've had on several occasions in sets fitted with this chassis. This time however the fault was related to the microcontroller chip. Transistor Q825, which drives the optocoupler in the power supply, was hard on. By removing R843, which links the base of this transistor to the microcontroller chip's power on/off pin, the set was able to start up. Full h.t., e.h.t. etc. were obtained but there was no sound, picture or on-screen display – total failure of the microcontroller section. We checked the supplies to the microcontroller chip and found that they were o.k. When we checked the reset line however we found that it was stuck at 2V instead of being at 5V. What notorious component is connected to this line? A 10nF capacitor, C1251. It read about 2kΩ in and out of circuit. A replacement cured the fault. **S.C.**

### **Philips FL1.1AA Chassis**

This fault took us a while to pin down. The set would go into the protection mode, i.e. with the standby, mute and

stereo LEDS flashing but the set otherwise dead. Unfortunately the fault was extremely intermittent – it might happen only once a week! We suspected a fault in the protection circuitry, but as the protection provided in this chassis is comprehensive it took us a while to find the culprit. This turned out to be the 18V zener diode D6376 that monitors the chopper transformer derived 17V supply (it feeds the 13V regulator). Sanity was restored when a new surface-mounted zener diode had been fitted. **S.C.**

### **Hitachi CPT2188 (Salora Ipsalo 3/K Chassis)**

There was line tearing and the screen would intermittently go bright blue. Was it a single fault or two separate ones? At first I suspected faulty decoupling. The 12V line goes to the sync/timebase generator and the colour decoder chips, but it was rock steady with an insignificant line-frequency content. What else could be common to the two symptoms? The sync/timebase generator's validate pin was the answer. It's pin 13 of the TDA2579 chip ICB500. With a 50Hz signal there should be 11V here, falling to 7.5V with a 60Hz signal and 0V with no signal at all. A check showed that the voltage was stuck at zero even though the set was tuned in, with sound and a picture present. This line also goes to the auto grey-scale correction circuit in the colour decoder chip ICB200, hence the video fault. A new TDA2579 chip cured the trouble. **S.C.**

### **Sony KVX2162U**

The problem with this almost new set was intermittent sound, which cut out when the volume control was turned up. Its cause was a dry-jointed crystal, X1101, on the Nicam sub-PCB. **E.J.**

### **Philips CP110 Chassis**

This set had a very misleading fault: there was no picture for a few minutes then when it did appear it looked as though the tube's emission was low. I had the feeling that the tube was probably o.k. however, and so it was. The cause of the fault turned out to be the 22μF, 250V h.t. reservoir capacitor C2670. For good measure we replaced the associated 22μF smoothing capacitor C2621 as well. **E.J.**

### **Osaki P10R**

The fault with this nice little set was field collapse. We found that C428 (0.022μF) was leaky. **E.J.**

### **Philips 2A Chassis**

There were black lines on the picture – it looked as though every other line of picture content was missing. After a long time had been spent carrying out scope checks etc. we finally found that C2050 (47μF, 50V) was open-circuit. It's off the 12V rail, in the i.f. can. **E.J.**

### **Panasonic TX24A1 (Alpha 2W Chassis)**

I was asked to look at this set as a colleague had run out of ideas with the fault he now had. The set had originally been dead. After replacing R815 (5.6Ω fusible), Q801, Q802 and the STR54041 chopper chip it would start up and then immediately turn off again. This was because the wire attached to plug V2 had been fitted to socket H16 (factory preset) instead of socket M2 on the front PCB – a case of more haste, less speed! **E.J.**



# Test Report: The Emerson Model 20 UPS

**Donald Bullock**

Almost every aspect of our lives nowadays depends on electronics. The importance of the reliability of electronic systems is thus evident. But this depends in turn on the reliability of the mains supply. A sudden power cut or even a voltage reduction can cause havoc with a mains-driven computer system. Since most of the power used in the UK is distributed via landlines, none of us is immune.

As a writer, the advent of the wordprocessor has been a great boon. But it wasn't long before I learnt, the hard way, that it has one major disadvantage compared with the typewriter. Anything you've typed is yours. Anything you've written into a wordprocessor is yours only once you've printed or saved it. A sudden power blip can rob you of at least some work that may be hard if not impossible to recreate.

Having one day lost half a chapter of carefully prepared prose because of a sudden, momentary power cut, I decided to equip myself with an uninterruptible power supply (UPS). The one I chose is made by Emerson, which produces an extremely wide range of UPS units to cater for almost every possible requirement. The AccuPower Model 20, rated at 300VA, should be suitable for most individual users and small offices.

I've used my Model 20 daily for well over a year, including trips to rural Spain where voltage fluctuations are common and it's not unusual to suffer at least one power cut a day. If it weren't for the musical warning chirps that the 20 emits when the mains power is interrupted or falls to an unacceptable level, I would not even notice these hiccups.

## **Description**

The 20 requires no installation. It operates with a 220V or 240V, 50Hz single-phase a.c. mains supply, its output being the same with a power rating of 300VA. Dimensions are 93 x 140 x 380mm (width, height and depth respectively), weight being 6.8kg. The finish is a pleasant fine matt light grey. At the back there's a pair of recessed sockets, that can't be confused, for the input and output. The unit comes with a heavy input lead that has a moulded 13A plug and an output lead that's terminated with a 13A, four-socket terminal strip.

The simple front panel has a recessed lift-for-on mains switch and an 'on' beacon that lights up green unless the mains input is reversed (easy on the Continent, where non-polarised two-pin mains plugs are used) when it lights up

amber. Emerson advise against using an incorrectly polarised mains input.

## **Use**

You simply plug the unit in series with the mains connection to, in my case, the wordprocessor. When settling down to use this I simply lift the UPS switch as well as switching on my machine. If a power cut occurs the unit beeps softly for as long as it lasts and my wordprocessor continues unabashed, giving me time to save everything I've written and in fact to work on. The specified time for operation without the mains supply being present is eight to ten minutes, with continuous use, but I've worked on through power cuts lasting well over twice as long. The unit has never failed me and since buying it I've not lost a word.

## **Electronics**

After rectification the input from the mains supply is filtered to reduce spikes, transients and general noise. It's then stabilised and processed for application to an electronic 'fast-transfer' switch. When the unit detects a significant fall in the input voltage it immediately switches on the inverter section of its a.c./d.c./a.c. converter system. This

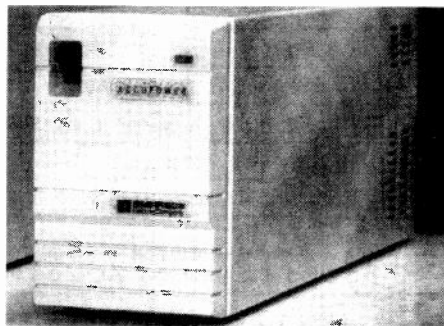

*The Emerson AccuPower Model 20 uninterruptible power supply.*

draws power from the built-in, maintenance-free battery, converting it to a.c. which is passed via the transfer switch to continue feeding the load. When the power cut ends, the UPS switches off the inverter. Under normal running conditions the internal battery is kept charged by a d.c. supply.

The Emerson Model 20 is the last word in careful design and manufacture. A glance at the circuit shows the lengths that have been taken to provide tight voltage stabilisation at every stage. I've never seen so many voltage stabilisers before in any piece of equipment!

## **In Conclusion**

I have complete confidence in the unit. Time and time again it has done its job, beeping away and giving me ample time to complete and save work in hand. I wouldn't, in fact couldn't, be without it.

Finally I am indebted to Darren Jell of Emerson Computer Power who supplied me with circuits and advice on my requirements, also to Javier Nogales Moran, commercial director of Emerson's Spanish distributors Itisa Investigacion Tecnica Industrial, S.A.

Enquiries in the UK should be sent to Emerson Computer Power, Elgin Drive, Swindon, Wilts SN2 6DX, telephone 0793 553 355, fax 0793 553 401. The current list price of the AccuPower Model 20 is £271.00 plus VAT.



# FUZZY PLAYBACK?

## EURAS SYSTEM WILL BRING IT INTO FOCUS

Video technology is changing fast. New models get introduced with alarming regularity, each with the latest enhancement. So it's not surprising to find models and faults you've not encountered before.

The problem is you can spend costly, unchargeable time searching for elusive faults, which is where Eurás System can help.

The Eurás System is Eurás's largest repair tips database for Video, Television and CD.

With over 120,000 repair tips for 14,000 models from 270 manufacturers you are sure to find the solution quickly. And because it is frequently updated, it always covers the latest models.

For a FREE demonstration diskette to run on your PC or details of Eurás System in manual form, clip the coupon or phone 0272 860900.

**EURAS INTERNATIONAL LTD**  
EURAS HOUSE, 51 BRISTOL ROAD,  
KEYNSHAM, BRISTOL, BS18 2BA



# EURAS

Solutions at your fingertips

PLEASE SEND ME A FREE DEMONSTRATION DISKETTE   
PLEASE SEND ME DETAILS OF EURAS SYSTEM IN MANUAL FORM

NAME \_\_\_\_\_

TITLE \_\_\_\_\_

COMPANY \_\_\_\_\_

ADDRESS \_\_\_\_\_

POSTCODE \_\_\_\_\_

# OUT NOW!!

## HENRY'S NEW 1994 COLOUR CATALOGUE

TRADE • EDUCATION  
RETAIL • MAIL ORDER  
EXPORT



Open 6 days a week - CALLERS WELCOME

**HENRY'S**  
404 Edgware Road,  
London W2 1ED

Components  
Telephone: 071-723 1008

Security - Communications  
Telephone: 071-724 0323

Audio and Test Instruments  
Telephone: 071-724 3564

Trade/Quantity  
Telephone: 071-258 1831

Fax: 071 724 0322

### RETAIL - MAIL ORDER VERSION

With price lists, special offers and purchase vouchers. Send PO/Cheque £4.00 (UK) £6.00 (EC) £10.00 (Non EC) Callers £2.00.

Education, trade, quantity purchasers  
Post or fax letterhead for **FREE** copy with trade/quantity price list (UK).  
Overseas prices as above.

### COMPONENTS For TV • Video Audio • Computer

IC SELECTION			
AN5753	£3.68	TA7280F	£4.99
BA5102	£1.95	TA7281F	£5.21
AY3912P	£7.74	TA7288F	£3.59
BA4236L	£3.92	TA7324P	£2.68
BA5406	£2.90	TA76988P	£1.89
BA5259N	£2.57	TA8402F	£4.95
CA741CE	£0.29	TA8410K	£4.97
CDP6818AE	£2.24	TBA530	£1.74
CXN62A	£3.55	TA73434P	£3.49
DS1482M	£0.43	TEA810F	£1.16
DS75150N	£1.85	TBA810S	£1.62
DS75154N	£1.85	TCA940	£3.33
H1113	£2.98	TD11001B	£2.86
HA1137W	£3.61	TD11022	£2.64
HA12006	£6.09	TD11035T	£2.59
HA12413	£4.75	TD11170D	£4.98
HA13007	£5.12	TD11180P	£3.49
HD58455P	£2.18	TD11516Q	£4.63
KIA7217AP	£2.47	TD11906A	£2.06
LA3160	£2.28	TD12003	£2.44
LA3361	£1.79	TD12541	£2.49
LA480	£2.46	TD12563	£3.45
LA7016	£2.99	TD13653	£3.93
LA7910	£2.62	TD14442	£2.71
LM1233N	£10.79	TD14451G	£3.75
LM7131V	£2.43	TD14500-2	£2.95
LM833	£1.79	TD14601	£2.49
M54544L	£3.38	TD1495C	£2.15
M54548L	£5.29		
MAB8461P	£5.17		
MAB8049H	£5.19		
MB81416-12	£4.59		
MP4564N	£2.45		
MP4504	£3.94	TD18140	£3.49
MSM6242B	£11.77	TD18170	£3.47
MC1377P	£7.32	TEA2000	£4.33
MC14522BCP	£0.78	TL431	£1.85
ME42501	£2.88	UM8522	£6.99
NE555GDP	£0.29	UM8272A	£14.09
PR255A	£2.95	UPC1277	£4.23
PC7131V	£2.39	UPC1378H	£2.45
SA11124	£3.88	UPC1397C	£3.94
SED9420CAC	£15.68	UPD9038LC	£12.38
STK4332	£5.71	ZXB400APS	£4.63
STK5451	£8.29	14D194782	£19.25
STK5482	£8.99	27C256-200	£2.98
TA7226P	£3.76	4116-2N	£1.89
IC PROTECTORS (1 for N Ranges)			each £0.79

### MANY MORE FROM STOCK

TMS4532N4L	DRAM (Spec)	(11+)	£0.99	£0.89
ZX8302	ULA (Spec)	(Q1)	£5.49	£4.39
ZX8401	ULA (Spec)		£5.44	£4.89
40054	ROM (+2)		£11.69	£9.99
74LS00	TTL (QL)		£0.15	£0.10
74LS157	TTL (Spec)		£0.30	£0.25
74LS245	TTL (QL)		£0.39	£0.35

### SPECTRUM & OL CHIPS \* SPECIAL OFFER \*

TMS4532N4L	DRAM (Spec)	(11+)	£0.99	£0.89
ZX8302	ULA (Spec)	(Q1)	£5.49	£4.39
ZX8401	ULA (Spec)		£5.44	£4.89
40054	ROM (+2)		£11.69	£9.99
74LS00	TTL (QL)		£0.15	£0.10
74LS157	TTL (Spec)		£0.30	£0.25
74LS245	TTL (QL)		£0.39	£0.35

All items subject to availability - Prices can change without notice.

### ORDER BY POST OR PHONE

We accept payment by VISA, Access, DELTA, SWITCH, Cheque or P.O.

### THIS IS JUST A SMALL SAMPLE OF STOCK

We can supply spares for many makes of equipment. WRITE FOR A 'PRICE & AVAILABILITY' on your requirements.

0452 526883

COMPUTER SPARES	
AMSTRAD Serv. Manual CM11342	£8.51
Power Switch CM9073	£8.63
Printer: Amstrad (PCW 9512)	£4.20
User Manual (PCW9512)	£10.95
Serv. Manual (PCW9512)	£14.99
Serv. Manual (PC1640)	£19.32
PHILIPS Serv. Manual BM7513	£3.49
Serv. Manual CM8833	£7.82
Serv. Suppl. CM8833	£3.00
Most Amstrad, CBM, Philips parts available - plus selected Acorn, Atari, Sinclair & others	
MONITOR LEAD - Amiga to Scart I/P	£8.29
TRANSISTORS	
2SA1706	£1.85
2SA231	£1.59
2SK301	£1.85
BUV48A	£4.99
TV/MONITOR LINE OUTPUT TRANSFORMERS	
AMSTRAD, IBM, DIGITAL, etc.	P.O.A
COMMODORE 1084-PI3P etc.	P.O.A
PHILIPS CM8533/CM8833 etc.	£24.94
PHILIPS CM11342/62 (CM8833 MK II)	£28.51
Ferguson TX90 14" 90"	£23.99
Ferguson TX100 20" 90"	£22.25
Ferguson TX100 22"/26" 110"	£20.91
Ferguson TX100 51cm FST	£23.95
GE C2089H/80H/C2280 to 2291H/C2294H	£23.99
Hitachi CPT11483/CPT1623/24/25/44/45	£22.99
Hitachi CPT2036/46/76/78/CPT2234/36/CPT2246/78	£23.99
Matsui 1480A/1481/1481B	£22.25
Saisho CT1141 etc. (Supply No on L.O.T.)	P.O.A
Many other Line Q/P Transformers available	
AUDIO SPARES	
AMSTRAD MX200/CDX400 (FUNAI) CASSETTE DOOR	£3.64
B.T. FREEWAY TELEPHONE - REPLACEMENT AERIAL	£3.65
PHILIPS CS1427 SERVICE MANUAL	£4.50
PHILIPS DB458 SERVICE MANUAL	£3.49
SHARP RGF278, 281, 284 MAIN BELT	£1.40
TOSHIBA STU2/L MAINS TRANSFORMER	£3.99
TV SPARES	
AMSTRAD TVR2 SERVICE MANUAL	£17.38
GECHITACHI FRAME MODULE HM6251	£3.29
PHILIPS 96009 Deg. POSISTOR (White)	£1.34
GOLDSTAR C154361/4441/CIT2162X/2172X 0/0 SWITCH	£6.49
SAMSUNG C1537V/CX558W On/Off SWITCH	£6.05
Many other Switches, Manuals, Posistors, etc. from stock.	
VIDEO SPARES	
SHARP VC381/385/C3300 CAPSTAN MOTOR	£34.99
Large range of Video Heads, Idlers, Bell Kites, Pinch Rollers from stock - plus much, much more. Please contact.	
We also stock REMOTE CONTROLS + Many General Components.	

We are pleased to serve both the Trade and End User.  
**DO NOT ADD VAT TO THE PRICES SHOWN - BUT PLEASE ADD £1.25 P&P**

MAIL ORDER ONLY to:  
MARAPET (TV)  
1 HORNBEAM MEWS  
GLOUCESTER GL2 0UE

ORDER BY POST OR PHONE

We accept payment by VISA, Access, DELTA, SWITCH, Cheque or P.O.



# All About Fuses

Ray Porter, M.Sc., C.Eng., M.I.E.E.

The first patent on fusing was filed by Edison in 1880. Ever since fuses have been used as current interrupters in electrical and electronic systems, being low-cost devices that always go open-circuit when subjected to the overload level at which they are designed to trip. It gives you a feeling of safety when a piece of equipment is fitted with a fuse, which is the first item an engineer checks when confronted with a completely dead circuit. There are several different types of fuse: this article explains the forms of protection they provide.

## Miniature Wire Fuses

The fuse most commonly seen by the electronics technician is the miniature wire type. They are made to meet the varying national standards that exist throughout the world. Should an excessive current flow the wire overheats, melts and finally evaporates. An arc occurs at the melting point:

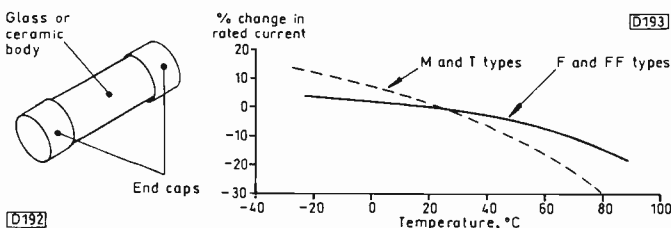

Fig. 1 (left): The conventional cartridge fuse.

Fig. 2 (right): How the current rating changes with change in the ambient temperature.

as a result the temperature rises to several thousand degrees and molten metal particles shoot away from the arc region. With a cartridge fuse, see Fig. 1, the pre-arcing heat and metal spray are contained by a glass or ceramic tube. PCB-mounted Wickman fuses are very similar to the tubular cartridge type in their ratings and characteristics.

## Current Rating

The current rating marked on a fuse is the current it will carry continuously, at an ambient temperature of 23°C or

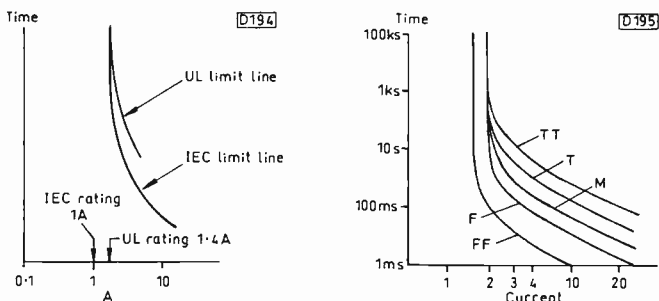

Fig. 3 (left): IEC and UL fuse ratings.

Fig. 4 (right): Time-current fuse characteristics.

whatever the relevant approval standard specifies, without blowing. As Fig. 2 shows, the rating changes when the fuse is operated at a different ambient temperature. It's important to note that the relationship between the current which will blow a fuse and the current which the fuse is rated to carry continuously differs with the standards organisation that gives it approval. European fuses are rated in accordance with IEC standards while American equipment uses UL (Underwriters' Laboratories) approved fuses. Fig. 3 shows that a 1A IEC fuse would be rated at 1.4A by UL.

## Time-current Characteristics

Fuses don't blow instantly: it takes time for the wire to heat to its melting point. Delayed-action fuses are made by adding more cooling to the wire. Fig. 4 shows curves for TT (very slow), T (slow), M (medium or normal), F (fast) and FF (very fast) fuses. T fuses are often used in domestic electronic equipment to avoid fuse blowing when there's a current surge at switch on – as the power supply capacitors charge initially and when degaussing pistors are cold.

The energy a fuse allows through into a circuit depends on its  $I^2t$  value.  $I^2Rt$  is the energy a fuse dissipates during a time period  $t$ , where  $R$  is the fuse's resistance. Thus a fuse with a small  $I^2t$  value imposes less stress on the circuit being protected. Circuit designers also take this into account.

## Voltage Drop

Voltage drop is the voltage developed across a fuse when it is carrying its rated current. The voltage drop across a 1A, 20mm fuse is a few hundred mV. Up to half a watt may be dissipated by a high-current 20mm fuse. In most electronic equipment this causes an insignificant local temperature rise.

## Current Breaking Capacity

When maximum fault current is present the wire heats so rapidly that there's a risk of fuse explosion and fire within the fuse holder. To ensure a safe shut-off, circuit designers specify a fuse that has a breaking capacity greater than the maximum prospective short-circuit fault current. To increase their breaking capacity fuses can be filled with heat-resistant material and enclosed in a ceramic tube. So that it doesn't flash over a fuse's voltage rating has to be taken into account – don't use a 125V fuse in a 240V circuit.

## Cut-off Characteristic

To minimise arcing a fuse must shut off the fault current rapidly, before the voltage maximum of the sinusoidal a.c. mains supply is reached. A poorly designed fuse could arc for a complete half cycle, i.e. 10msec with a 50Hz supply, allowing considerable energy to enter the faulty circuit. Fig. 5 shows how a poorly-designed fuse will fail to cut off the fault current. A similar situation arises when a fuse is used at a voltage above its rating.

## Deterioration with Age

The passage of current pulses through a time-delay fuse will wear it out. Thus the number of pulses such a fuse can survive is limited. The rate of deterioration depends on the  $I^2t$  value of the current pulses, see Fig. 6. Note that a fuse could fail after 3,000 pulses of ten times the normal overload surge. This explains why fuses can fail when there is

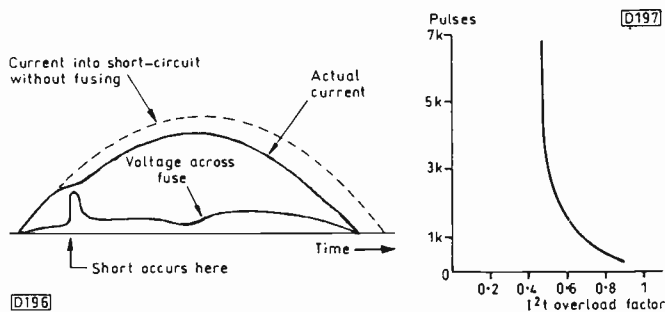

Fig. 5 (left): Fuse arcing to the end of an a.c. half cycle.

Fig. 6 (right): Ageing of time-delay fuses.

no overload fault. For example if a mains switch is operated 3,000 times in three years and the switch-on surges haven't been taken into account a fuse could fail, much to the user's annoyance.

### Colour Coding

International standard IEC 127A specifies fuse ratings and an optional colour code that's similar to the three-band resistor colour code. The first two bands are in mA, the third band being the multiplier. Thus a fuse marked like a 1k $\Omega$  resistor has a 1A rating. A fourth band, twice the width of the other three, signifies the speed of the fuse: brown is FF, red is F, yellow is M and blue is T.

### Integrated Circuit Protectors

ICPs are miniature fuses packaged for easy assembly on PCBs that carry low-voltage circuitry. The N type looks like a two-legged signal transistor while the F type looks like a two-legged single in-line chip. Their voltage rating is 50V, the voltage drop being less than 100mV at the rated current. To determine the current rating, multiply the last two digits of the type number by 40: for example, an ICP-F10 has a 400mA rating and blows in 100msec when a three-times overload occurs. Thus the characteristics are similar to those of an F type cartridge fuse. The N and F versions are similar electrically, the only difference being in the packaging. Never use an ICP where there's more than 50V.

### Thermal Fuses

The thermal fuse doesn't offer protection against an excess-current condition until the fault produces heat that warms the outside of the fuse's body. Construction and application are similar to those of a thermostat, an internal switch opening when a preset temperature is reached. A thermal pellet inside melts at a calibrated temperature, allowing a spring to open contacts that remain open when the temperature falls back. Typical current ratings are 1-15A, usually at 250V. Temperature settings can be in the range 60-240°C: 100°C to 150°C units are commonly used to provide insulation protection, in a transformer for example.

Don't try to substitute a conventional wire fuse for this type of component, as the protection the two types provide is different. And don't try to solder to them – the temperature of the iron can melt the pellet inside, catastrophically.

### Fusible Resistors

The fusible type of resistor is similar in appearance to a

conventional carbon resistor, but the construction is such that the device goes open-circuit readily when severely overloaded, with no fire hazard. Fusible resistors are used in power supplies as surge limiters, providing safe fusing when the associated reservoir/smoothing capacitor goes short-circuit. The fusible resistor fails open without a long high-temperature period. Philips' fusible resistors are the size of a conventional 0.33W resistor: they are coloured grey and go open-circuit in thirty seconds when 4W is applied or ten seconds when 6W is applied.

Fault-finding is simple: there's an open-circuit to trace, though there won't be any charred board to home in on.

### Polymer Fuses

The polymer fuse is a relatively new device. It consists of a mixture of carbon black and plastic and operates like a PTC thermistor, i.e. it heats up when excess current is present, its resistance increasing dramatically but slowly, then resets automatically when left to cool. Polymer fuses have more closely defined resistance characteristics than a normal thermistor, and a very low cold resistance, e.g. 10m $\Omega$  for an 8A device. The voltage rating is usually 60V or less, but some low-current 250V types are now available. The current rating is included in the marking on the body: an MF090 type for example is rated at 900mA continuous current.

### Safety

Fuses are included in circuits to protect the user and his equipment in the event of a malfunction. If you fit a device with different current cut-off features to the original one designed into the circuit there is an increased risk of injury, to yourself and others. So the correct type as specified by the equipment manufacturer must always be used. Remember that the manufacturer will have carried out extensive product testing, with faults intentionally introduced, and chosen fusing critically to ensure that the user is protected. If you alter a fusing system, will you have considered all the effects that an increased current flow could cause?

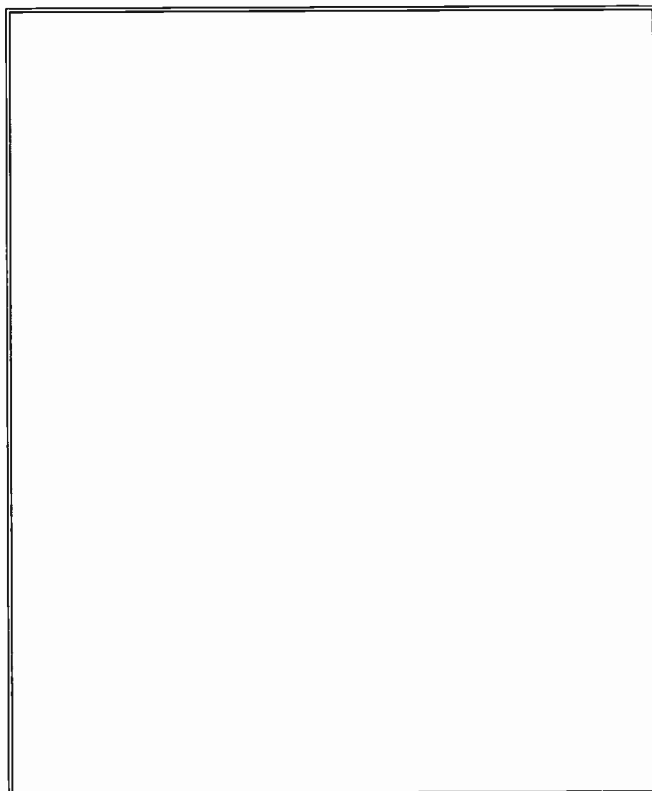



# Adding a Bubblejet Printer to the Amstrad PCW

Keith Wevill, B.Sc.

There are probably many *Television* readers who use one of the Amstrad PCW series of word processors. Originally introduced in 1985, they consist of a keyboard, monitor and printer, with Locoscript word-processing software. The original PCW8256 had a single 3in. 180Kbyte capacity disc drive, 256Kbytes of RAM and a dot-matrix printer. Later additions were the PCW8512 which had two 3in. disc drives with 180K and 720K capacity and 512K of RAM, and the PCW9512 with one 3in. 720K capacity disc drive, 512K of RAM and a daisy-wheel printer instead of a dot-matrix type. The original Locoscript 1 and later Locoscript 2 were described in the December 1986, March 1989 and May 1989 issues. The latest version of Locoscript 2 is v2.32.

The 3in. discs, with a capacity of 180K in the single-sided, single-density format or 720K in the double-sided, double-density format, never really caught on with the computer industry, which adopted the 3.5in. disc as its standard. It's possible to add a 3.5in. disc drive to a PCW8256 – many companies supply suitable drives. An article in the December 1992 issue dealt with this. 3.5in. discs are cheaper and more readily available than the 3in. type. The more recent Amstrad pcw series word processors have a 3.5in. disc drive as standard. The pcw9256 has 256K of RAM and a dot-matrix printer, the pcw9512 512K of RAM and either a daisy-wheel or a bubblejet printer.

## Types of Printer

The types of printer supplied with the various versions of the PCW differ in their print quality and versatility. This is because of the method used to produce the characters. With a dot-matrix printer the characters are formed, as the name suggests, from a series of dots. A daisy-wheel printer has solid characters on the 'petals' of the wheel. Bubblejet printers shoot small dots of ink on to the paper.

The PCW dot-matrix printer uses nine pins in one of two modes. In the draft mode the dots are visible and the printing speed is around 90 characters per second (c.p.s.). For the Near Letter Quality (NLQ) mode the paper is shifted up by half the vertical inter-dot gap after each line is printed and the characters are then reprinted. This fills in the gaps, improving the appearance of the text but slowing the print rate to about 20 c.p.s. Other dot-matrix printers that use 24 pins are available, giving finer text in a single printing.

The daisy-wheel printer produces solid characters on the paper like a typewriter, but the wheel has to be changed should a different font, e.g. italics, be required. It cannot handle graphics and tends to be noisy.

The bubblejet printer forms small ink droplets by heating the ink in a nozzle, ejecting the droplets on to the paper. Characters are formed in a similar manner to the dot-matrix printer, but there are many more nozzles than pins. The bubblejet printer supplied with the PCW9512 has 64 nozzles and is capable of very high-quality printing at high speed.

It's also much quieter than a dot-matrix or daisywheel printer.

There is another type of printer, the laser type, that's now the standard for many offices and businesses. It works in a similar way to a photocopier and is capable of extremely high-quality printing. But it is much more expensive. So for the time being the bubblejet is fast becoming the standard low-cost, high-quality printer.

## The Canon BJ10ex Printer

The bubblejet printer supplied with the PCW9512 is a Canon BJ10, which is available separately for under £200 plus VAT. It can, with the appropriate interface and software, be used with any PCW series word processor. Once installed it can print all the characters and fonts available with Locoscript 2.

In order to match many laptop type computers the BJ10ex is physically small (310 x 216.5 x 47.5mm), weighing 1.8kg. It's powered by an a.c. adaptor but has space for an optional NiCd battery pack for portable use. There is a parallel Centronics interface, and the print speed in either the high-quality or economy mode is 83 c.p.s. – the economy mode puts less ink on the paper, making the text lighter.

Front-panel controls select high quality/economy, pitch, line/form feed, forward and reverse paper feed adjustment. Other functions are available by using these controls – details are contained in the user's manual.

The BJ10ex can emulate several different types of printer in one of three modes that are set by eleven DIL switches and has various built-in fonts. By using a program such as Microdesign 2 or 3 in the PCW graphics and drawings can be printed. A slot at the back enables envelopes to be printed and an optional sheet feeder to be fitted.

The ink is supplied in a cartridge that also contains the print nozzles. So you get a new printhead whenever the cartridge is replaced. This makes the cartridges more expensive than the ribbons for a dot-matrix or daisywheel printer, but the print quality is consistent over the life of a cartridge – which is more than can be said of a ribbon. Cartridge life is quoted as approximately 700,000 characters, but it's possible to refill a cartridge and many firms can supply a refill kit at about half the price of a new cartridge.

Note that the BJ10e is similar but has only two modes and one less DIL switch. It is otherwise compatible with the following installation instructions.

## Installing the Printer

To use a BJ10ex with a PCW the software required to drive the printer has to be installed and the appropriate hardware interface connected. The PCW has neither a parallel Centronics nor a serial RS232 port but does have an expansion port, in the form of an edge connector, to enable different interfaces to be fitted. Many different interfaces

are available from various manufacturers. The most popular types are the RS232/Centronics and extra memory interfaces. Each just plugs into the exposed edge connector at the back of the PCW. Many have a through-port facility so that more than one interface can be added. The memory interfaces enable up to 1.5Mbytes of extra memory to be added, and some have a built-in Centronics port. The extra memory is useful when copying B-drive discs as the disc can be copied in one go instead of having to keep on changing over the source and destination discs. The graphics and desk-top publishing (DTP) programs also benefit from the extra memory. The PCW can use a maximum 2Mbytes of memory.

Those with a PCW8256 or PCW9256 can easily fit an extra 256K of memory internally by installing eight extra RAM chips in the eight empty sockets on the PCB and switching over two internal DIL switches. Many firms can supply a kit with full instructions for under £20.

Once a parallel Centronics port has been installed an external printer can be used by converting the document to a page-image ASCII file. Run CP/M, use the command `DEVICE LST = CEN` to set the list device (the printer) to the Centronics port, then transfer the ASCII file to the printer by using the command `PIP LST:= drive:filename` where *drive* is the disc drive, A or B, that the file is on and *filename* is the name of the ASCII file. This is a long-winded method and is not recommended to any but the most desperate or computer-literate CP/M enthusiast. It will print out the text but won't allow such things as underlining or italics. The font and pitch have to be set on the printer, and it may take more than one attempt to get it right.

To get the full character set, styles and layouts available with Locoscript 2 the Start Of Day disc must contain suitable printer drive files. This calls for the Locomotive Software Printer Support Pack, which contains all the files needed to drive a number of types of printer including the dot-matrix (both 9- and 24-pin), bubblejet and laser types. Full installation instructions are supplied with the support pack – it's advisable to read through the booklet before attempting to install the files.

The following procedure however is the one I used when installing a BJ10ex with my PCW. My first attempt took over two hours but, once the problems had been sorted out, subsequent installations took 10-15 minutes.

There are two possible modes of operation for the printer, download and built-in character set. The latter uses the printer's own character set when printing and cannot print all the characters available with Locoscript. In the download mode the computer sends details of the character set to the printer before printing starts, so it can print any of the available characters including the Greek and Cyrillic alphabets. This is the mode for which the following procedure is intended.

My PCW system consists of a PCW8256 expanded to 512K of memory, an external 3.5in. B drive, a Centronics and RS232 interface, a BJ10ex bubblejet printer, the standard dot-matrix printer and a Keymouse for use with MicroDesign 2 and 3.

### Installation Procedure

You will need your Locoscript 2 Master disc, the Printer Support Pack discs and at least one blank A drive disc that doesn't need to be formatted. If Locospell, Locomail or Locofile are to be installed, either the `MATRIX.#SS` or `MATRIX.#ST` file will have to be deleted to make room on the disc. These are font files for use with the internal dot-

matrix printer. There's an easy way of overcoming this if a B disc drive is available – more on this later. The procedure will have to be followed for each different Start Of Day disc made. The installation program is fairly easy to follow, and will prompt you to insert your master disc(s) and the blank disc(s) when required.

(1) Switch on the computer and insert the Installation Program for Locoscript 2 – at the time of writing the latest version for the PCW is v2.32. A message will appear on the screen, with the amount of memory found. If this is correct, press ENTER.

(2) Select OPTION 6 – Multiple Products. Insert your Locoscript 2 Master disc and press ENTER. The screen menu will then prompt you to select the additional programs required – Locospell, Locomail or Locofile. Select the required programs and press ENTER. When prompted, install these programs from the appropriate master discs.

(3) When the printer menu comes up select 'Built in matrix' and 'External printers using downloaded characters'. Press ENTER.

(4) Insert a blank disc in the A drive and press ENTER. Press ENTER again to format the disc and copy the files to it. This is now your Start Of Day disc.

(5) Once the files have been written on to the disc press ENTER to return to the initial options menu. Select OPTION 9 – Quit Installer. Then press any key to restart the computer, using the new disc just created? Check that the file `LQ24.DRV` (the 24-pin printer drive file) is in group 0 of drive A.

Now the printer files have to be installed.

(6) Insert the Printer Support Disc 1, Side 1, and copy file `24BJ10E1.PRI` to the M drive group 0. This is the BJ10 driver file.

(7) Insert the Printer Support Disc 2, Side 1, and copy one of the 24PIN fonts to the M drive group 0. There are four font files on the disc in group 7 (`24FONTS`) – `24PIN.#LS`, `24PIN.#LT`, `24PIN.#SS` and `24PIN.#ST`. `#LT` and `#ST` are the standard fonts, `#LS` and `#SS` the sans-serif ones (the type used, in italic form, for captions in *Television*). `#LS` and `#LT` are lighter versions. Select one of the fonts and copy it to the M drive group 0.

(8) Insert the new Start Of Day disc just created and copy file `24BJ10E1.PRI` to group 0 of drive A. Copy a font file `24PIN.#XX` to group 0 of drive A and rename it to `24BJ10E1.#XX` where `XX` is either `LS`, `LT`, `SS` or `ST`.

The font and `.PRI` files must have the same file name up to the dot. The instructions recommend renaming the `.PRI` file, but I chose to rename the font file as this enables me to see which printer I've chosen.

(9) Press `SHIFT + EXTRA + EXIT` simultaneously to restart the computer. Check that group 0 of the M drive now contains files `LQ24.DRV`, `24BJ10E1.PRI` and `24BJ10E1.#XX` where `XX` is the font selected in (7).

The settings now have to be updated. Note that to select or deselect most of the options in this section you use the + or – selection keys at either side of the space key followed by the ENTER key.

- (10) Select the 'settings' option by pressing f6.
  - (11) Select 'For printer' then option 24BJ10E1.
  - (12) Select 'Standard printer' then option 24BJ10E1.
  - (13) Select 'Printer defaults', then 'Printer options' then 'Sheet feeder'. This simplifies the printing procedure when changing paper, as the PCW cannot tell when a new sheet of paper has been inserted in the BJ10 and needs to be told by pressing the PTR key followed by the + selection key and the ONLINE button on the printer when the new sheet of paper has been loaded. By selecting the sheet feeder option all that's needed is to load a new sheet of paper then press the printer's ONLINE button.
  - (14) Select 'EXIT' then 'Write SETTINGS.STD'. Press ENTER to write the SETTINGS.STD file on the Start Of Day disc.
- Your Start Of Day disc is now set up with its standard printer as the BJ10ex with the selected font. Set the write protect hole on the disc to prevent accidental erasure. If you print any existing documents you'll get a warning message that the current and intended printers don't match and will have the option to use the current (BJ10ex) or the intended (matrix) printer. To avoid this, the document set-up for the document must be changed as follows:
- (15) Select the document and edit it with E.
  - (16) Select 'f1 Actions'.
  - (17) Select the 'Document set up' option.
  - (18) Select 'f6 Printing'.
  - (19) Select 'Printer' then 24BJ10E1.
  - (20) Check that the character set is the one chosen in step (7). If the character sets are different a warning message will be displayed when the document is to be printed. This is not serious, as the character sets available are compatible and either one can be used. Other character sets, available as a LocoFont disc, may not be compatible and could cause problems when printing. So it's advisable to ensure that the character set is the same as that chosen in step (7).
  - (21) Select 'Exit', then 'Exit' and return to the document.

The document and computer are now set up for the bubblejet printer with a single Start Of Day disc. All that remains is to set the DIL switches in the printer. These tell it, when it has been switched on, how to respond to the data sent to it. The factory settings are with all eleven switches at off. For use with the PCW and Locoscript, set switch 8 to on. This sets the download memory to 34K and the receive buffer to 3K, enabling the character set to be downloaded from the PCW. All the other switches should be off.

If you intend to use the printer with other programs it may be worth setting switch 4 to on. This sets the page length to 12 rather than 11in. For use with MicroDesign 2 the Alternate Graphics Switch 7 must be set to on. For MicroDesign 3 this switch must be off.

The user manual contains more information on the functions of all the switches.

## **Two Disc Drive Systems**

If you have two disc drives it's possible to use the printer in more than one mode and to have more than one font available. Follow the instructions given above but, instead of copying the .PRI and #XX files to the A drive, copy them to group 0 of the B drive. In this way you can load both the standard and sans-serif fonts and their lighter versions if necessary.

You can use the printer's own built-in character set as well by selecting the 'External printer using built in characters' option when initially setting up the Start Of Day disc. Then copy file BJ130E.PRI to group 0 of the B drive. When you examine the printer options you will find that there are now three printers available.

Using the B drive like this has advantages and disadvantages. One disadvantage is that you need the disc in the B drive when you start up the system, but this is no real problem if you put the files on all your B discs. Another disadvantage is that the files take up space on the discs, but this is typically less than ten per cent of the space available. I've yet to succeed in filling a B disc – yet! The advantage is that you can set up each B disc for a different printer and font that suits the documents on the disc.

## **Back-up Copies**

It's a good idea to make a note of the procedure you used, and which files you used, on each Start Of Day disc – in case the disc gets damaged and a new copy has to be made, or changes are made to the disc such as adding Locospell, Locofile, Locomail or a new printer. I've included a copy on one of my B drive discs, with a print out stored in a separate file, along with other useful notes on the computer. Keep your master discs in a safe place, and make back-up copies of the Start Of Day discs.

## **Installing Other Printers**

To install a printer other than the BJ10ex the procedure is the same except that the .PRI files appropriate to that printer have to be used. There is a list of printers and their .PRI files in the PCW External Printers Guide that's supplied with the Printer Support Pack.

## **Switching on/off Procedure**

There's a recommended procedure for applying the mains supply to the printer and the computer. Switch on the mains supply to the printer first, then switch it on using its own on/off switch. Finally switch on the computer. The switch off procedure is the reverse. If the printer is switched on when the computer has been powered the printer can affect it. At worst the result will be a complete lock-up, with possible loss of files being edited.

To allow it to clean the print head, switch the printer off with its own on/off switch before you switch off at the mains.

## **Postscript**

Since this article was written the BJ10sx printer has replaced the BJ10ex and Locoscript 2 has been superseded by Locoscript 3. The BJ10sx has a higher print speed than the BJ10ex: the same installation procedure can be used. Locoscript 2 and the Locoscript 2 Printer Support Pack are no longer generally available, but you may still be able to obtain a copy. Otherwise you could upgrade to Locoscript 3 with its own Printer Support Pack.

# What a Life!

**Donald Bullock**

A dead Hitachi colour portable came in the other day – it was fitted with the NP84CQ chassis. When I opened it up I found the most crowded little chassis I've seen for some while. As I didn't have a circuit diagram I started to make checks in the power supply and immediately found that Q902, a BU806 Darlington power transistor, was short-circuit. I replaced it then checked the 2SD1453 line output transistor Q703 which was also short-circuit. So I replaced this too then switched on. The set grunted, but that was all. At this point a circuit was really needed and an idea came to me. I took down Mike Lyon's ECS model-chassis guide and found that the chassis is also used in the GEC Model C1405H, for which we do have a manual.

The BU806 is part of a sort of pre-regulator, or initial regulator, circuit. It's followed by an LM317 variable voltage regulator chip, IC901, that lives at the other end of the giant heatsink. A check showed that it had also failed. I replaced it and switched on again. Once more the set grunted, and that was all.

Then I stopped and thought. I'd been silly, hadn't I? I hadn't checked the replacement BU806 after replacing the LM317. They'd both be useless now. I checked them and they were.

As I'd just one more BU806 and LM317 I carefully checked the resistance between the h.t. line and chassis. The reading was respectable, so the remaining BU806 and LM317 were fitted. Then I checked the line output transistor again. The new one was all right.

I took down my variac arrangement – I've added a voltmeter, an ammeter and a 2A mechanical cutout (from a Thorn 3500 chassis) to the variac itself – and used this to supply power to the Hitachi portable. All went well as I wound up the voltage. The ammeter's hand shuddered a bit at switch-on, then settled back happily against its stop. I wound on cautiously, darting my eyes about like a weights and measures pest. Then the hand suddenly flew over to the other stop as the set grunted again and died.

## **Mrs Tubby**

It was at this point that Mrs. Tubby rolled in from the Dean Forrest. She talks in riddles and a visit from her was the last thing I wanted.

"I've parked my car in the road. It's faulty" she said.

I looked up wearily. "I can't mend cars Mrs. Tubby" I said.

"The telly's faulty" she said, leaning towards me as though I was an idiot, "the one you mended the other day. It's never been right since you did it. But we thought we'd give it a chance. It didn't settle down though. You'll have to get it out of the car."

I followed her out from the drive, wishing I'd been an optician or a rich and aloof car mechanic. She walked on. Her car was a hundred yards away. I pulled out the weighty Sony KV2217UB and started the trek back to the workshop. When I got there I was tottering.

"I want you to do me a favour Mr. Bullock" she then said. "My son Walpole leaves school soon. He seems to have some electrical questions to answer. Perhaps I could pop him in tomorrow. This workshop could do with a clean

up. He'll do it while you answer his little questions." And off she went.

## **Back to the Hitachi**

I took another look at the Hitachi/GEC circuit and noticed that there's a bit of the power supply that's right over at the other side of the chassis, as far away from the rest as could be. It's an over-voltage trip that removes the 12V supply to the line driver transistor and various other parts of the set. Maybe something here was causing the grunting. There's a crowbar thyristor and a 36V zener diode (ZD903), which turned out to be short-circuit. I'd have to order one. So I phoned JJ Components and placed an order for this and various other items.

They arrived next morning. After fitting the zener diode in the Hitachi set I started it up again. This time it came on perfectly. The faulty line output transistor must have killed ZD903 as well as causing the damage in the power supply. Anyway the birds were now singing and the sun was shining. Then a cloud appeared. It was Mrs. Tubby and her son Walpole.

## **Walpole's Questions**

Sure enough Walpole had the workshop tidy in no time. He then made some tea and we sat down for his questions.

"What's electricity, voltage and current?" he asked, with his pencil poised.

"Steady" I said, "first things first. Electricity is the movement of electrons. Got that?" He looked blank.

"Everything – pear-drops, elephants, copper wires – consists of lots of atoms which in turn consist of a nucleus with some little electrons bumping around it. The atoms are each like a tiny solar system."

"Can't see it" Walpole said blankly.

"Look" I said, "imagine a long tunnel full of footballs. Each one has a dozen tennis balls jostling around it. You're at one end with an enormous basket of tennis balls and I'm at the other with an empty basket. And I just love tennis balls. You lob a tennis ball into your end of the tunnel. This attaches itself to the nearest football which now has say thirteen tennis balls surrounding it, an unlucky number. So it jettisons a tennis ball farther into the tunnel. This in turn enters the orbit of another football which in turn kicks one out. The chain reaction carries on all along the tunnel and I wind up with a tennis ball in my basket – though not the one you tossed in. Then you lob the rest of your tennis balls in, as fast as you can, and I get an equal number out at my end. Call the tennis balls electrons. You've created a flow of electricity."

"But what's current and voltage?"

"Current is the number of electrons – er, tennis balls – you're lobbing in" I said, "and voltage is the force with which you're lobbing them in."

He made some notes, then looked at me thoughtfully.

"Where do all these electrons come from?"

"There's an enormous reservoir of them" I replied, "and your standing on it – the earth. They are cruelly dragged out of it at the power station and can't wait to get back. We send them all over the place before they get there, to wherever we want work done, and make them flow through our gadgets as they fight their way back home."

Walpole looked even more thoughtful. "What's resistance, capacitance and inductance then?"

"Walpole" I said, "I've got sets to fix, and your ma's just entered the drive. Bring the rest of your questions along next time."

I humped the Sony set (YE2 chassis) on to the bench, hoping that I could mend it. I'd fitted a new mains switch six months earlier. When I switched it on the power supply sang like a kettle for a few seconds then fell silent. There were no voltages at its outputs.

I headed for the usual culprits, R607 and R618, but they were all right. C12 also proved to be o.k. when checked on my capacitance bridge. So I disconnected plug F6 and connected a 100W bulb across pins 1 and 2 – the 135V output and chassis – then switched on again. The bulb lit up. Checks showed that the other output voltages were also present and correct. So the cause of the fault had to be an overload on the 135V line, which supplies the line output stage.

I turned to the line output panel and checked the resistance between the h.t. input and chassis. It was down at 5Ω. So I rushed to the line output transistor which was all right. I traced the short to pin 1 of the line output transformer. The circuit shows that it's connected only to pins 10 and 11, so I isolated these by nicking the print. But the short remained. There was nothing for it. Out came the transformer, and I then found that pins 1, 10 and 11 read continuously with nearly every other winding. A new line output transformer restored normal operation.

### **Mr Flighty's Mitsubishi CT1447BM**

Just as Greeneyes brought in my tea Mr. Flighty danced in with a Mitsubishi CT1447BM TV set. He ignored me, put the set down with part of it on my hand, and grinned at Greeneyes, asking how she was and had she been on holiday yet. He went on and Greeneyes chortled. I waited. When he'd run down I pointed to my trapped hand with my good one and he moved the set off it.

"Sorry old chap" he said, "it's stuck in standby."

"I know the feeling" I replied.

He then danced out, waving at Greeneyes. Muttering something about ferrets I applied myself to the set. I checked the STR44115 chopper chip IC901 and found that its pins were all shorted together. So I fitted a replacement. The set again failed to start up and I noticed that the chip's

heatsink was getting hot. In this chassis (Euro 3) D906, a 132V zener diode, acts as a crowbar in the event of excessive h.t. voltage. It was short-circuit. I fitted a replacement and started the set up with the variac. It drew current but that was all: there was still an h.t. short-circuit. So I disconnected the 115V supply at pin 2 of the line output transformer. This cleared the short. I checked and cleared the 2SD1426 line output transistor Q551, then the two rectifier diodes D552 and D553 which were also o.k. I then took out the line output transformer to check its windings with the circuit. The primary winding (pins 1-2) was shorted to the two secondary windings. A replacement cured the trouble.

### **Another Visit from Mr Pearshape**

Mr. Pearshape's Jaguar sang into the drive. He tumbled out in a cloud of cigar smoke. A shy but well-built little lady hung in the background. She might have been his cleaner, but wasn't. . .

"Set in the boot. Bad back you know" he rasped. I carried it in and he propelled the young lady in with his finger.

"Blue picture wasn't it m'dear?" he croaked. She nodded at the ground. He handed me his card and added "mend it quick and ring me, right?" Then they departed.

The set was a 14in. Sony Model KVM14TU. Its picture had scarcely any blue content and the red was smeary. In addition the chroma seemed to be far too intense. When I changed channels the blue content improved. I decided that the actual fault was a dark picture with a varying chroma balance but I had no means of adjusting it – the remote control unit hadn't been brought along.

A check showed that the tube's first anode voltage was low at 150V. I traced its source back to the line output transformer where R852 was powdered and white while D852 was sooty. When these items had been replaced I had full brightness and correct colour balance. A relatively simple cause of symptoms that had threatened to baffle me.

A phone call to Pearshape brought a hoarse chuckle. "I like to keep her happy you know" he rasped.

---

## **Answer to Test Case 373**

– see page 186 –

Teletext problems are not usually too difficult to sort out: the circuitry runs at low energy levels, and apart from the control and RAM chips there are, in the type of decoder used in this example, only two processing chips to worry about. What do you do when you've replaced them both and the fault is still present? With

this particular fault you don't consider replacing either the control or the memory chip because they cannot really cause this type of random data corruption or decoding error. A sensible course of action would be to replace the entire decoder if it's separate from the rest of the set and a substitute is available. But this was not the case here! In fact the fault would have remained the same had the entire decoder been replaced.

Sage was called in. He examined the decoder's video input signal and agreed that it was free of defects. He next transferred the scope's probe to

the supply lines. The 12V supply was fine, but the 5V line carried a mass of hash and noise whose peak-to-peak amplitude, riding on a mean voltage level of about 4.8V, averaged about 1V! This supply comes from a 5V stabiliser that consists of a three-legged, heatsinked chip on the main panel. The 9V input to this chip was correct, and the fault was cured when a new regulator had been fitted. The previous one must have been grumbling mightily inside! Dylan would have found the culprit himself of course if he hadn't made such a cursory check on the 5V supply.

---

Published on the third Wednesday of each month by Reed Business Publishing Ltd, Quadrant House, The Quadrant, Sutton, Surrey SM2 5AS. Filmsetting by Marlin Graphics, 2-4 Powerscroft Road, Sidcup, Kent DA14 5DT. Printed in England by BPCC Magazines Division, Carlisle Web Offset, Cumbria. Distributed by IPC Marketforce, Kings Reach Tower, Stamford Street, London SE1 9LS (071 261 5000). Sole Agents for Australia and New Zealand, Gordon and Gotch (Asia) Ltd.; South Africa, Central News Agency Ltd. "Television" is sold subject to the following conditions, namely that it shall not, without the written consent of the Publishers first having been given, be lent, resold, hired out or otherwise disposed of by way of Trade at more than the recommended selling price shown on the cover, excluding Eire where the selling price is subject to currency exchange fluctuations and VAT, and that it shall not be lent, resold, hired or otherwise disposed of in a mutilated condition or in any unauthorised cover by way of Trade or affixed to or as part of any publication or advertising, literary or pictorial matter whatsoever.



## Design your own satellite system!

You can with the help of this brilliant new program by DJ Stephenson



### SATMASTER Version 4 Only £35 (plus post)

- Allows you to design a system and test its performance *before* you install it!
- Provides essential dish setup angles - polar and apex elevation for motorised systems, elevation, azimuth, polarisation offset, from *any* location in the World for *any* geo-satellite - now and in the future!
- Includes magnetic map and footprints for all popular satellites across Europe
- Easy-to-use pop-up menu interface makes tedious tasks simple for everyone!
- Complete with User Instruction Manual!
- Contains 20,000 word on-screen technical context-sensitive helpline, with fault-finding, cable specs and site survey guide.
- Calculates full link budget including dish size optimisation to ensure the best quality picture!

requires IBM PC compatible with MS DOS 3.0 or higher, and 1 MB hard disk.

- Plots beamwidths and lobe patterns so you can judge potential interference from neighbouring satellites!
- Results and graphs can be output to file, screen or printer!

### SATMASTER PRO Only £69 (plus post)

- Contains additional country/town files!
- Supports laser printers!
- Displays CCIR rain-climatic zone map!
- Takes account of circular or linear polarisation in link budget analysis!
- Lists polar and apex angles per town!
- Calculates rain fade margin automatically!

Avoid guesswork ... order **SATMASTER V4** or **SATMASTER PRO** today!

**Swift Television Publications**

17 Pittsfield, Cricklade, Swindon SN6 6AN Tel: 0793 750620 Fax: 0793 752399

Please send me program (3.5" disk)

SATMASTER V4 @ £35  tick choice (✓)

SATMASTER PRO @ £69

Postage £1 in UK, Europe add £2, Other add £4

I enclose cheque/PO for £ \_\_\_\_\_ made payable to Swift Television Publications, or please debit my Access/Visa credit card.

No. \_\_\_\_\_

Expires: \_\_\_\_\_

Name \_\_\_\_\_

Address \_\_\_\_\_

Postcode \_\_\_\_\_

# W.M.T.V.

THE LARGEST INDEPENDENT WHOLESALERS IN WALSALL - SUPPLIERS OF HIGH QUALITY EX-RENTAL TVs AND VIDEOS TO THE TRADE AT COMPETITIVE PRICES

ALSO AVAILABLE: NEW B-GRADE PRODUCTS - TVs, VIDEOS, AUDIO & MICROWAVES - ALL TESTED & BOXED

1/2 Mile of Junction 10 M6. Easy Parking Facilities

**UNIT 3, BENTLEY LANE BUSINESS PARK**

BENTLEY LANE, WALSALL WS2 8TL

Tel: 0922 724542. Fax: 0922 722208

Mobile: 0860 499495 (24 Hours)

OPEN:  
MON-FRI,  
9-6pm  
SAT 9-2pm  
SUNDAY BY  
APPOINTMENT  
DELIVERY  
SERVICE  
THROUGHOUT  
THE COUNTRY

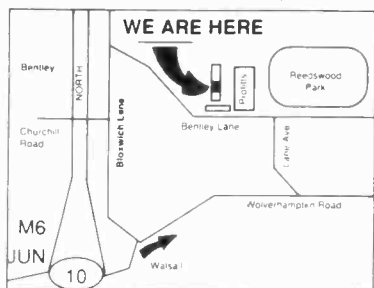

# TUBES TUBES TUBES

A Merry Christmas and a Prosperous New Year to all our Friends and Customers

*Possibly the largest range of television tubes, at the right price, in the UK.*

*Ring Irene or Jane for a quote*

**Callers Welcome**

Carriage and VAT extra



**EXPRESS TV**  
The Mill, Mill Lane,  
RUGELEY, Staffs WS15 2JW  
Tel: 0889-577600  
Fax: 0889-575600

### AMSTRAD HANDSETS

VCR4600, 4600MkII	11.75
VCR4700	17.63
VCR5200	11.75
VCR6100 (Indexer)	25.85
VCR6100 (Barcode Indexer)	29.38
VCR6200 Barcode	32.44
VCR9000 (Old type)	11.75
TVR 2	8.46
TVR 3	14.10
SDR400 (Equivalent)	11.05
SRD500	11.75
SRD510/520	13.81
TS90/99 Tower System	11.75
GOODMANS VCR102	11.75
PROLINE 5100TX	17.63

### AMSTRAD LOPTS

CTV1000 FB182K	11.75
CTV1400 FB165KA	11.75
CTV2000 FB171	9.40
CTV2000 FB171K	9.40
CTV2200 3722002	14.10
CTV2210 3722002	14.10
TVR 3 181297	13.51
CTM644 MkII 3714009	14.10
PC12-HRCD/D MSH1FCT31	14.10
PCW9512,8256,8512	7.05

### FERGUSON LOPT

MM06 00D4242001	4.70
-----------------	------

### AMSTRAD TUNERS

UE33-B01 VCR4600/4700	9.40
UE2-B31F CTV2200/2210	5.88
1810829 VCR5200	7.05
ENV87358F2 VCR7000	7.05
ENV87509F2 CTV1400	5.88

## Harrison Electronics

CENTURY WAY, MARCH, CAMBS PE15 8QW.  
FAX: (0354) 51416. TEL: (0354) 51289

### AMSTRAD IF UNITS

TPS7-B0006 VCR4600/4700	9.40
TPS7-L0002	14.10
1813766	14.10

### AMSTRAD MODULATORS

18196221 VCR5200	7.05
ENP-E730-2 VCR7000	5.88
VCR4600MkII, 4700	5.88
SRD100/200/400	5.88

### AMSTRAD VCR MECHANISMS 4500, 9000 (Old model)

CASSETTE HOUSING ASSY.	15.28
CYLINDER ASSY. (incl. Video heads)	25.26
CYLINDER LOWER DRUM ASSY. (Excl)	9.99

### 4600, 4700, TVR1,2,3

COMPLETE MECHANISM ASSY *(Excluding Video Heads)	35.25
*COMPLETE MECHANISM ASSY. (Excluding cylinder assy.)	29.38
MECHANISM DECK (Excl Cass. housing & Cylinder assy.)	18.80
CYLINDER ASSY. (incl. Video heads)	25.26
CYLINDER ASSY. (excluding Video heads)	20.56
CYLINDER LOWER DRUM ASSY. (Excluding Motor)	9.99
HEAD BASE ASSY. (Audio)	5.88
VMC100 - Various parts available, please phone for prices.	

### AMSTRAD MOTORS

Loading Motor MCB9B02	3.53
Drum Motor E20EL05	10.58
Capstan Motor LLN4B21	9.99
Capstan Motor JLN4B02	9.99
Tape Loading MCF9B02	9.99

### AMSTRAD PCB's

(Complete, fully populated)	
4500 Timer	14.10
4500 Systems Control	14.10
4600 Systems Control/Servo, Display & Control PCB's	
4600 Display	11.75
4600 Control	5.88
4600 Video & Audio	5.88
4600 Power Supply	14.63
4600MkII Main PCB Assy.	40.82
4600MkII Timer	14.10
4600MkII Control	5.88
4600MkII Head Amp	5.88
4600MkII Power Supply	4.70
4700 Main PCB Assy.	40.82
4700 Timer	14.10
4700 Control	5.88
4700 Head Amp Assy.	5.88
4700 Power Supply	4.70
5200 Timer & Channel Disp.	17.63
5200 Video	14.10
5200 Switch Panel	4.70
6000 Power Supply	7.05
6100 Mains PCB	29.38
6100 Audio PCB	7.05
6100 Power Supply	7.05
6100 Hybrid, Chrominance	9.40
6100 Hybrid, Luminance	9.40
7000 Switch PCB no:7	2.35
CTV1400 Switches, Presets & Tuner (ENV87358F2)	8.23
CTV1400 Switches, Presets & Tuner (ENV87509F2)	8.23
CTV2200 PCB no:3	3.53
CTV2200 PCB no:4	4.70
TVR 2 Main TV PCB	37.60
TVR 3 Main TV PCB	43.48
TVR 3 TV Power Supply	15.22
TVR 3 Head Amp Assy.	5.88
TVR 3 Video Power Supply	4.70
<b>10.95-11.7GHz LNB</b>	
2.3dB NF. 'N' CONNECTOR	17.63

### AMSTRAD SERVICE MANUALS

VCR4600	9.00
VCR4600MkII, 4700	9.00
VCR6000/6100	11.50
VCR7000	9.00
VCR8700	8.00
VCR8800	6.00
VCR9000/9004	9.00
VMC100	16.50
SRX100/200	4.70

### AMSTRAD COMPUTER OPERATORS MANUAL

PC1640	11.75
PC2286/2386	11.75

### AMSTRAD PC12MD VGA MONO MONITOR

Suitable for use with 2000/3000 series and any other VGA compatible PC 64.63

### AMSTRAD SOFTWARE

ACCOUNTSMaster	17.63
(Full accounts program for running small business on any PC)	
INFOMaster	17.63
(Easy to use Database, runs on PC)	
LINKMaster	11.75
Many AMSTRAD COMPUTER & PRINTER SPARES available, please phone for price.	

### PRICES INCLUDE VAT.

ALL ITEMS ARE BRAND NEW AND GUARANTEED

★ ★ SAME DAY DESPATCH ★ ★

Write or Phone for FULL catalogue.

★ ★ POST & PACKING ★ ★

VISA ★ ★ EXTRA ★ ★

## KONIG ELECTRONIC

## QUALITY

### REMOTE CONTROLS

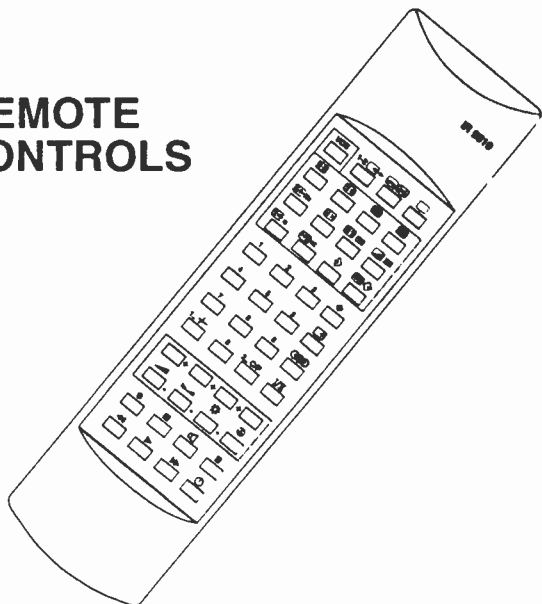

## IRWIN ELECTRONICS

## SERVICE

Trade Enquiries To:-  
Unit 200, Albyn Complex, Burton Road, Sheffield S3 8BX  
Phone: (0742) 739622/759909. Fax: (0742) 759909

# PAYS-UT.V.

SUPPLIERS OF WORKING  
USED TV'S, VIDEOS,  
MICROWAVES,  
FRIDGE FREEZERS,  
COOKERS +  
WASHING MACHINES

TEL: NOTTINGHAM 0602-500002

WE DELIVER ALL AREAS!



PHONE  
FOR DETAILS



EST. 1977

# J.W. HARDY

## YOUR ONE-STOP-SHOP

FOR THESE FINE BRANDED PRODUCTS  
- AND SO MUCH MORE ...

**Wolsey** SMATV

**DIAMOND AERIALS** UHF/FM

**GLOBAL COMMUNICATIONS** FIRST IF, SMATV

**J.W. HARDY** communications UHF AERIALS  
UHF AMPLIFIERS

**Labgear Cablevision** SMATV

**LENSON HEATH** SATELLITE  
ANTENNA

**PACE** SATELLITE  
RECEIVERS,  
DECODERS

**PALCOM** SATELLITE  
RECEIVERS

**PROMAX** TEST EQUIPMENT

**Split fixings** BOLTS  
PLUGS

**mungo** BOLTS  
PLUGS

**Teleste** SMATV

**TRIAx U.K.** UHF/HF  
AERIALS **TOWER CLIPS**

**UNIFIX** CLIPS

**VOLEX  
RAYDEX** COAX CABLES

- WE PROVIDE FULL TECHNICAL ASSISTANCE AND SERVICE BACK UP ON ALL OUR PRODUCTS
- SMATV - DISH SHARING - DESIGN CONSULTANT

Trace Price List available to bona fide TV Aerial and Satellite Dealers on proof of trading.

J.W. Hardy, 231 Station Road, Stechford,  
Birmingham B33 8BB. Telephone: 021-784 8478

### WE HAVE THE WIDEST CHOICE OF USED OSCILLOSCOPES IN THE COUNTRY

TEKTRONIX 7000 SERIES OSCILLOSCOPES Dual Trace Plug-in with TB from £200. Many Plug-in options available. 4 Traces. Differential etc. Plug-ins sold separately.	
Tektronix 2235 Dual Trace 100 MHz Delay Sweep	£800
PHILIPS 3065 - 2 + 1 Channels. 100MHz Dual TB Delay Sweep	£700
TEKTRONIX 475 Dual Trace 200MHz Delay Sweep	£550
H.P. 1722B Dual Trace 275MHz Delay Sweep	£550
H.P. 1715A Dual Trace 200MHz Delay Sweep	£500
TEKTRONIX 465 Dual Trace 100MHz Delay Sweep	£450
TEKTRONIX 2215 Dual Trace 60MHz Delay Sweep	£450
PHILIPS PM3217 Dual Trace 50MHz Delay Sweep	£400
HAMEG 605 Dual Trace 60MHz Delay Sweep	£400
TELEQUIPMENT D83 Dual Trace 50MHz Delay Sweep	£200
HITACHI V422 Dual Trace 40MHz	£225
WATSY 55705 3 Channel 40MHz Delay Sweep	£400
TRIO CS1830 Dual Trace 30MHz Delay Sweep	£300
KJKUSUJ 5530 Dual Trace 30MHz	£180
GOULD 051 100 Dual Trace 30MHz	£160
HAMEG 2018 Dual Trace 20MHz Component Tester	£260
GOULD 05300 Dual Trace 20MHz	£200
GOULD 052508 Dual Trace 15MHz	£125
TEKTRONIX 466 Dual Trace 100MHz Storage	£450
THIS IS JUST A SAMPLE. MANY OTHERS AVAILABLE	
PHILIPS PMS193 Programmable Synthesiser Function Generator 0.1MHz-50MHz. IEEE 488 As req.	£1500
MARCONI 2019 Synthesised AM/FM Sig Gen 80KHz-1040MHz	£2000
MARCONI 2018 Synthesised AM/FM Sig Gen 80KHz-520MHz	£950
EPIDANA 351D Microwave Frequency Counter 20Hz-18GHz	£950
RACAL 9921 Frequency Counter 3GHz	£300
RACAL/DANA 1991 Nanosecond Universal Counter	£800
RACAL 9302 RF Millivoltmeter True RMS 10KHz-1.5GHz	£450
RACAL 9301 A RF Millivoltmeter True RMS 10KHz-1.5GHz	£300
RACAL 9009 Automatic Mod Meter 100MHz-1.5GHz Wide Deviation	£250
H.P. Pulse Generator type 214B	£750
LYONS PG73N Pulse Gen. PRF 1Hz-20MHz	£150
GOULD Biomation K5000 Logic Analyser	£300
FARNELL P5G520H Synthesised Sig Gen AM/FM 100KHz-520MHz	£600
LEADER LSG216 AM/FM Sig Gen 2 ranges 0.1-30MHz & 75-115MHz	£400

### SPECTRUM ANALYSERS

HP 141T with 8555A & IF plug-in 10MHz-18GHz	£1800
HP 141T with 8554B & 8552B 500KHz-250MHz	£1300
HP 140T with 8554A & 8552A 500KHz-250MHz	£1000
HP 141T with 8556A & 8552B 20KHz-300KHz	£1000
HP 140T with 8553L & 8552A 1KHz-110MHz	£800
HP 180C with 8558B 100KHz-500MHz	£1500
HP 3582A 0.02Hz-25.5KHz	£2000
MARCONI TF 2370 1KHz-10MHz	£1500

FARNELL ISOLATING TRANSFORMERS GUS00 240V 500VA, un-used	£50
Isolating Transformer 500VA, un-used	£30

DATRON 1061A 6 1/2 digit AutoCal Multimeter with True RMS AC Current	£1250
DATRON 1065 5 1/2 digit AutoCal Multimeter, AC/DC Ohms with IEEE	£600
HEWLETT PACKARD 3490A Bench Multimeter, 5 1/2 digit AC/DC Ohms	£200
PHILIPS PM2534 Multi Function DMM 6 1/2 digit with GPIB/IEEE	£450
SOLARTRON 7150 - 6 1/2 digit, DMM with IEEE	£400
MARCONI Digital Frequency Meter 2430A 10Hz-800MHz	£125
MARCONI Digital Frequency Meter 2431A 10Hz-200MHz	£150
MARCONI Universal Counter Timer 2437 DC-100MHz	£175
MARCONI Universal Counter Timer 2438 DC-520MHz	£225
BLACK STAR Jupiter 500 Sine/Sq/Tri 0.1Hz-500KHz	£70
FEEDBACK F6600 Sine/Sq/Tri 0.1Hz-100KHz	£60
HP3311A Function Generator 0.1Hz-1MHz, Sine/Sq/Tri	£125
MULTIMETERS Handheld, M2355-32 range: AC/DC 10Amps Diode/Transistor Tester, Freq Counter	£32.50
FARNELL Electronic Load RB1030-35 1KW 30Amp 35 Volt	£600

HP B690B Sweep Osc with 86974 Plug-in, 26.5-40GHz	£300
RACAL/DANA RF Power Meter 9104	£400
RACAL/DANA 9341 Databridge Automatic LCR & Q	£350
WAYNE KERR B905 Automatic Precision Bridge 0.05%	£900
WAYNE KERR B424 Digital Component Meter, LCR	£450
WAYNE KERR B605 Automatic Component Bridge 0.1%	£350
FARNELL PSU TV570Hz, 70V 5A/30V 10A	£300
FARNELL PSU H60725 0-50V, 0-25 Amps Metered	£400
FARNELL PSU L30E 0-30V, 0-5 Amps Metered	£80
FARNELL B30/20 0-30V, 20 Amps	£250
FARNELL B30/10 0-30V, 10 Amps	£200
FARNELL 6155A 0-40V, 0-1.5 Amps Twice Metered	£130
H.P. 6209B 0-320V, 0.01 Amps Metered	£125
MARCONI TF2700 Universal LCR Bridge, Battery from	£150
AVO Valve Characteristic Meter VCM163	£300
FARNELL LAS20 RF Power Amp, 1.5-520MHz 300mW	£175
RACAL 9100 Absorption Watermeter 1MHz-1GHz 3W	£100

### NEW EQUIPMENT

HAMEG OSCILLOSCOPE HM1005 Triple Trace 100MHz Delay Timebase	£847
HAMEG OSCILLOSCOPE HM604 Dual Trace 60MHz Delay Sweep	£453
HAMEG OSCILLOSCOPE HM203 7 Dual Trace 20MHz Component Tester	£342
HAMEG OSCILLOSCOPE HM205 3 Dual Trace 20MHz Digital Storage	£453
All other models available - all oscilloscopes supplied with 2 probes	
BLACK STAR EQUIPMENT (P&P all units £5)	
APOLLO 10 - 100MHz Counter Timer Ratio/Period/Interval etc	£222
APOLLO 100 - 100MHz (As above with more functions)	£225
METEOR 100 FREQUENCY COUNTER 100MHz	£119
METEOR 600 FREQUENCY COUNTER 600MHz	£145
METEOR 1000 FREQUENCY COUNTER 1GHz	£189
JUPITOR 500 FUNCTION GEN 0.1Hz-500KHz Sine/Sq/Tri	£119
ORION COLOUR BAR GENERATOR Pal/TV/Video	£229
All other Black Star Equipment available	
OSCILLOSCOPE PROBES Switchable x1 x10 (P&P £3)	£12

Used Equipment - Guaranteed. Manuals supplied if possible  
This is a VERY SMALL SAMPLE OF STOCK. SAE or Telephone for list. Please check availability before ordering.  
CARRIAGE all units £16. VAT to be added to Total of Goods and Carriage.

## STEWART of READING

110 WYKHAM ROAD, READING, BERKS RG6 1PL

Telephone: 0734 268041 Fax: (0734) 351696

Callers Welcome 9am-5.30pm Mon-Fri (until 8pm Thurs)



# COLOUR TELEVISION TUBES

## SPECIAL OFFER

AS1-EAL AS1-JAR AS1-JRU AS1-JVJ  
AS1-JPE AS1-EAM AS1-EAK AS1-EBD

OUTSTANDING VALUE AT

# £52.50

PLUS CARRIAGE & VAT

SUPER QUALITY AND PERFORMANCE

12 months guarantee

OVER 150 VIDEO HEAD TYPES MANUFACTURED  
BY VISTA TO COVER MORE THAN 2000 VCR'S  
FIRST CLASS QUALITY

LARGE STOCK OF TV AND VCR SERVICE  
COMPONENTS AND ACCESSORIES AVAILABLE  
FROM OUR TRADE COUNTER



FOR CUSTOMER CARE AND SERVICE CALL

TUBES: 0429 837100

COMPONENTS: 0429 838057

FAX: 0429 837101



Vista Electronics Ltd

Unit 1B, Wingate Grange Industrial Estate, Wingate, Co. Durham, TS28 5AH.

P119 VISION-ON NEWS UPDATE JAN 1994  
**A PROSPEROUS NEW YEAR?**

To make 1994 even more successful than 1993 you need to turn-round more repairs in less time.

That's where 'FAULT-FACT-FILES' can help.

Each month you will receive at least 150 of the latest faults found on TV and VCR equipment, collated in an easy to use format and designed so that each new set slots straight into your filing system for fast easy access.

There's also our Help-Desk\* for those really elusive faults plus top tips giving you time-saving ideas.

Applications received before 31st Dec 1993 qualify for our special introductory offer of two FREE issues (14 for the price of 12) so act immediately.

After all, why spend hours on a repair if your competitors can do it in minutes.

This could be the best resolution you make for 1994.

**Happy New Year!**

For more information send a large (8 1/2 x 6) SAE.

\*Help Desk costs £2.50 per fault for subscribers to "FAULT-FACT-FILES" and £7.50 for non-subscribers. Money-back guarantee if we are unable to provide at least one possible solution for the symptoms described.

**SPECIAL INTRODUCTORY OFFER FIRST TWO ISSUES FREE!**  
 (Ends 31st Dec 1993)

WHEN YOU SUBSCRIBE TO 'FAULT-FACT-FILES'

- 1 Yr - £30 (min)
- 2 Yrs - £55 Save £5.00
- 3 Yrs - £80 Save £10.00
- 4 Yrs - £100 Save £20.00

TO APPLY SIMPLY SEND YOUR NAME, ADDRESS AND POSTCODE WITH A CHEQUE/P.O. FOR REQUIRED AMOUNT.

TO:  
 'VISION ON' (TV1)  
 16 HILLVIEW PARK  
 NEWTOWNABBEY  
 BT36 8HW.  
 Overseas add £10 per annum.

© VISION-ON 1993

**SONY TUBES** RE PROCESSED WITH ORIGINAL SONY GUNS

HIGH TEMPERATURE RE-PROCESSING of Sony, Mullard 45AX, 30AX, In-line, PiL, Mini (22.5) Neck and FST Tubes.

3701B22.....£25.00	A51-231X ITT.....£46.00	A51EBD00X.....£58.00
3702B22.....£48.00	A51-570X Mullard.....£46.00	A51EBV10X01.....£58.00
370KRB22.....£48.00	A51-580X Mullard.....£46.00	A51JAR00X.....£64.00
370LHB22.....£48.00	A51-590X Mullard.....£46.00	A51JKQ00X Sony.....£74.00
400EFB22 Sony.....£64.00	A56-540X Mullard.....£52.00	A51JUH10X Sony.....£74.00
510YUB22 (brand new).....£46.00	A56-701X ITT.....£48.00	A53JBW00X Sony.....£64.00
520SB22 Sony.....£64.00	A66-540X Mullard.....£56.00	A59EAF00X.....£64.00
560EGB22 Hitachi.....£48.00	A67-701X ITT.....£56.00	A59EAK00X Philips.....£64.00
560YB22.....£48.00	A34EAC00X.....£48.00	A64JK10X Sony.....£95.00
570HB22 Sony.....£64.00	A34JBU10X Sony.....£64.00	A66EAF00X.....£74.00
680DB22 Sony.....£85.00	A44JFZ10X Sony.....£78.00	A66EAK00X Philips.....£74.00
680EB22 Sony.....£85.00	A49JHT00X Sony.....£64.00	A68JMT10X Sony.....£95.00
	A49JLV10X Sony.....£74.00	A68JYK10X Sony.....£95.00
	A51EAF00X.....£58.00	AXM37-001.....£48.00
	A51EAK00X.....£58.00	AXT51-001.....£46.00
	A51EAL00X.....£58.00	

For tube types not listed please enquire  
 All Tubes Guaranteed 12 Months

All prices quoted are excluding VAT  
 Exchange CRT is required.

Callers welcome. Please phone first.  
 Delivery Available

**NEW TUBES IN STOCK - PLEASE PHONE FOR YOUR REQUIREMENTS**

**Very competitive, nationwide delivery and collection service**

**D.I.Y. Television Tube Polishing Kit**

Contains everything you need to Polish scratches and small chips on your CRT screens. All you require is an electric drill. Written instructions are provided. Guaranteed to work. Worldwide Delivery **Total Price £63.00 includes P&P and VAT** Available from Luton only

Your local stockists are:

**WEST ONE**

Distributors Ltd.  
 Chesham, Bucks.  
 Tel. 0494 778197

**WELL VIEW**

114-134 Midland Road.  
 Luton, Beds. U.K. LU2 0BL.  
 Tel. 0582 402499

**WELL VIEW**

Southampton, Hants.  
 Tel. 0703 449783

**WILTSGROVE LTD**

**NEW Definition BRAND PORTABLE 14' REMOTE TV**

21 PIN SCART  
 ON SCREEN DISPLAY,  
 VHF/UHF TUNER,  
 12 MONTHS GUARANTEE etc.

\* GUARANTEED LOWEST PRICE \*



WORKING GRADED STOCK

180 VIDEO TAPES  
 QTY Order 85p

ALL BOXED WITH INSTRUCTIONS

- SHARP RG292 stereo car radio cassette, 2 band with ans £17.00
- SHARP RG296 stereo car radio cassette, 3 band with ans £19.99
- SHARP JC105 personal cassette player £6.50
- SHARP JC130 personal radio/cassette player £7.50
- SHARP JC200 personal cassette player with auto/rev £9.50
- SHARP JC510 personal cass/auto rev/2 band radio £12.50

**MIDI-SYSTEMS**

Basic Systems from £25.00 Remote control sys. from £40.00  
 Systems with CD from £50.00

**VIDEO WORKING EX-RENTAL STOCK**

- Top loader video £35.00 Basic colour TV's from £25.00
- Front loaders with r/c from £45.00 Remote TV's with r/c from £35.00
- Twin speed VCR with r/c from £55.00 Teletext TV's with r/c from 45.00
- Thorn 8947 VCR with r/c £65.00

**EX-RENTAL FERGUSON 3001 CAMCORDER**

Back-space edit facility, records on standard VHS, recording time: 240 minutes, date insert facility, automatic Iris control, 6:1 motorized zoom lens, tape play back facility.  
 Only **£199**

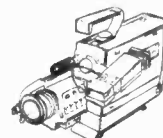

28-29 RIVER STREET, DIGBETH  
 BIRMINGHAM B5 5SA

TEL: 021 772-2733 FAX: 021 766-6100

**EXPORT ENQUIRIES WELCOME**

ALL STOCK SUBJECT TO AVAILABILITY, VAT & CARRIAGE

# DATAPART LTD

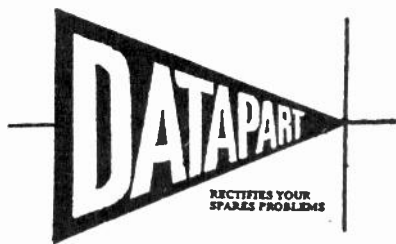

## JUST RELEASED!

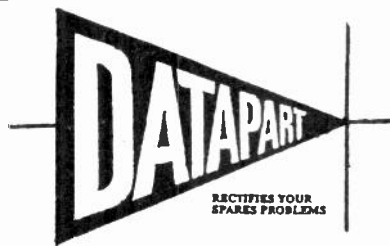

### 4TH EDITION CATALOGUE

OVER 500 PAGES OF SPARES FOR WHITE AND BROWN GOODS. ALL AVAILABLE BY RETURN OF POST. A FULL RANGE OF GENUINE AND PATTERN PARTS AVAILABLE

- |           |            |          |                 |           |               |
|-----------|------------|----------|-----------------|-----------|---------------|
| AEG       | CREDA      | HOTPOINT | MATSUI          | MOULINEX  | RUSSELL HOBBS |
| AIWA      | CROWN      | INDESIT  |                 | NEFF      | SAISHO        |
| AKAI      | DELONGHI   | ITT      |                 | NIKKAI    | SAMSUNG       |
| AKURA     | ELECTRA    |          |                 | NUMATIC   | SANYO         |
| AMSTRAD   |            |          |                 | PANASONIC | SERVIS        |
| AQUAVAC   |            |          |                 | PHILIPS   | SHARP         |
| ARISTON   |            |          |                 | PIONEER   | SONY          |
| BAUKNECHT | ELECTROLUX |          |                 |           | SWAN          |
| BELLING   | FERGUSON   |          |                 |           | TEFAL         |
| BENDIX    | FIDELITY   |          |                 |           | TOSHIBA       |
| BOSCH     | GEC        |          |                 |           | TRICITY       |
| CANDY     | GOBLIN     |          |                 | PYE       | VAX           |
| CANON     | HADEN      | JACKSON  |                 | ROWENTA   | WHIRLPOOL     |
| CARLTON   | HITACHI    | JVC      | MIELE           |           | ZANUSSI       |
| COLSTON   | HOOVER     | KENWOOD  | MORPHY RICHARDS |           |               |

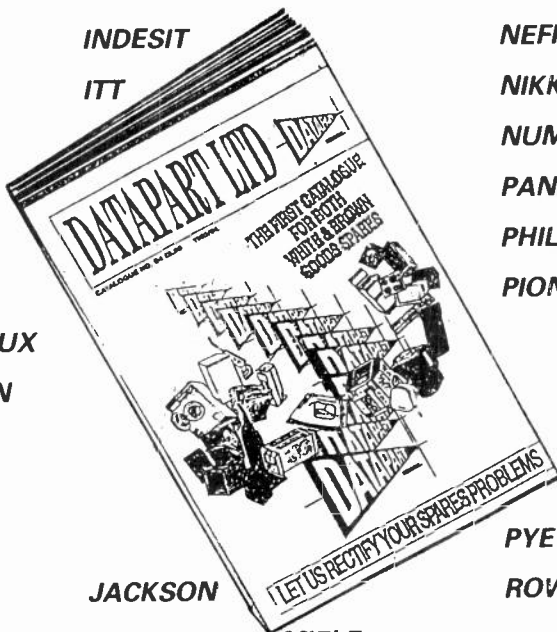

IF YOU REPAIR WHITE OR BROWN GOODS THEN THIS IS A *MUST*.  
NOW AVAILABLE AT A COST OF £6 TO NON ACCOUNT CUSTOMERS

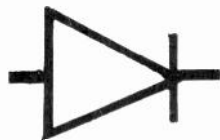

# DATAPART LTD

ELECTRON HOUSE,  
100 GREAT BARR STREET  
BIRMINGHAM B9 4BB



**SALES DESK 021 766 5551 24  
FAX FREE 0800 373 459 HOURS**



**AMSTRAD DMP4000** Entire printer assemblies including printhead, platen, cables, stepper motors etc. Everything but the electronics and case. Good stunner!! Clearance price just £5 REF: MAG5 or 2 for £8 REF: MAG8

**VIEWDATA SYSTEMS** Brandnew units made by TANDATA complete with 1200/75 built in modem, infra red remote controlled keyboard, BT approved, Prestel compatible, Centronics printer port, RGB colour and composite output (works with any TV) complete with power supply and fully cased. Price is just £20 REF: MAG20 Also some customer returned units available at £10 each REF: MAG10

**PPC MODEM CARDS** These are high spec plug in cards made for the Amstrad laptop computers. 2400 baud dial up unit complete with leads. Clearance price is £5 REF: MAG5P1

**INFRA RED REMOTE CONTROLLERS** Originally made for hi spec satellite equipment but perfect for all sorts of remote control projects. Our clearance price is just £2 REF: MAG2

**TOWERS INTERNATIONAL TRANSISTOR GUIDE.** A very useful book for finding equivalent transistors, leadouts, specs etc £20 REF: MAG20P1

**SINCLAIR C5 MOTORS** We have a few left without gearboxes. These are 12v DC 3,300 rpm 6"x4", 1/4" OP shaft £25 REF: MAG25

**UNIVERSAL SPEED CONTROLLER KIT** Designed by us for the above motor but suitable for any 12v motor up to 30A. Complete with PCB etc. A heat sink may be required £17.00 REF: MAG17

**VIDEO SENDER UNIT.** Transmits both audio and video signals from either a video camera, video recorder, TV or Computer etc to any standard TV set in a 100' range! (tune TV to a spare channel) 12v DC op. Price is £15 REF: MAG15 12v psu is £5 extra REF: MAG5P2

**\*FM CORDLESS MICROPHONE** Small hand held unit with a 500' range! 2 transmit power levels. Reqs PP3 9v battery. Tuneable to any FM receiver. Price is £15 REF: MAG15P1

**LOW COST WALKIE TALKIES** Pair of battery operated units with a range of about 200'. Ideal for garden use or as an educational toy. Price is £8 a pair. REF: MAG8P1 2 x PP3 reqd

**\*MINIATURE RADIO TRANSCEIVERS** A pair of walkie talkies with a range of up to 2 kilometres in open country. Units measure 22x52x155mm. Complete with cases and earpieces. 2xPP3 reqd £30.00 pair REF: MAG30

**COMPOSITE VIDEO KIT.** Converts composite video into separate H sync, V sync, and video. 12v DC operation. £8.00 REF: MAG8P2

**LQ3600 PRINTER ASSEMBLIES** Made by Amstrad they are entire mechanical printer assemblies including printhead, stepper motors etc etc. In fact everything but the case and electronics, a good stunner! £5 REF: MAG5P3 or 2 for £8 REF: MAG8P3

**PHILIPS LASER 2MW** helium neon tube. Brand new full spec £40 REF: MAG40 Mains power supply kit £20 REF: MAG20P2 Fully built and tested unit £75 REF: MAG75

**SPEAKER WIRE** Brown two core, 100 foot hank £2 REF: MAG2P1

**LED PACK** of 100 standard red 5mm leds £5 REF: MAG5P4

**JUG KETTLE ELEMENTS** good general purpose heating element (about 2kw) ideal for all sorts of heating projects etc. 2 for £3 REF: MAG3

**UNIVERSAL PC POWER SUPPLY** complete with flyleads, switch, fan etc. Two types available 150w at £15 REF: MAG15P2 (23x23x23mm) and 200w at £20 REF: MAG20P3 (23x23x23mm)

**OZONE FRIENDLY LATEX** 250ml bottle of liquid rubber, sets in 2 hours. Ideal for mounting PCB's, fixing wires etc. £2 each REF: MAG2P2

**\*FM TRANSMITTER** housed in a standard working 13A adapter! the bug runs directly off the mains so lasts forever! why pay £700? or price is £26 REF: MAG26 Transmits to any FM radio

**\*FM BUG KIT** New design with PCB embedded coil for extra stability. Transmits to any FM radio. 9v battery reqd £5 REF: MAG5P5

**\*FM BUG BUILT AND TESTED** superior design to kit, as supplied to detective agencies etc. 9v battery reqd £14 REF: MAG14

**TALKING COINBOX STRIPPER** originally made to retail at £79 each, these units are designed to convert an ordinary phone into a payphone. The units we have generally have the locks missing and sometimes broken hinges. However they can be adapted for their original purpose or used for something else?? Price is just £3 REF: MAG3P1

**100 WATT MOSFET PAIR** Same spec as 2SK343 and 2SJ413 (8A, 140v, 100w) 1N channel and 1P channel. £3 a pair REF: MAG3P2

**VELCRO** 1 metre length of each side 20mm wide (quick way of fixing for temporary jobs etc) £2 REF: MAG2P3

**MAGNETIC AGITATORS** Consisting of a cased mains motor with lead. The motor has two magnets fixed to a rotor that spin round inside. There are also 2 plastic covered magnets supplied. Made for remotely stirring liquids! you may have a use? £3 each REF: MAG3P3 2 for £5 REF: MAG5P6

**TOP QUALITY SPEAKERS** Made for Hi Fi televisions these are 10 watt 4R Jap made 4" round with large shielded magnets. Good quality general purpose speaker £2 each REF: MAG2P4 or 4 for £6 REF: MAG6P2

**TWEETERS** 2" diameter good quality tweeter 140R (would be good with the above speaker) 2 for £2 REF: MAG2P5 or 4 for £3 REF: MAG3P4

**AT KEYBOARDS** Made by Apricot these quality keyboards need just a small modification to run on any AT, they work perfectly but you will have to put up with 1 or 2 foreign keycaps! Price £6 REF: MAG6P3

**XT KEYBOARDS** Mixed types, some returns, some good, some foreign etc but all good for spares! Price is £2 each REF: MAG2P6 or 4 for £6 REF: MAG6P4

**PC CASES** Again mixed types so you take a chance next one off the pile! £12 REF: MAG12 or two identical ones for £20 REF: MAG20P4 component pack bargain 1,000 resistors + 1,000 capacitors (all same value) £2.50 a pack REF: MAG2P7

**1994 CATALOGUE  
OUT NOW**

**BULL'S  
BULLETIN BOARD**

**MASSIVE  
WAREHOUSE CLEARANCE  
FANTASTIC £20.00 REDUCTION**

**REFURBISHED PC BASE UNITS  
COMPLETE WITH KEYBOARD  
FROM ONLY £29.00  
AMSTRAD 1512 BASE UNITS  
GUARANTEED  
PERFECT WORKING ORDER.**

A LOW COST INTRODUCTION TO THE HOME COMPUTER MARKET.

**AMSTRAD 1512SD  
1512 BASE UNIT, 5.25" FLOPPY DRIVE AND  
KEYBOARD. ALL YOU NEED IS A MONITOR AND  
POWER SUPPLY. WAS £49.00**

NOW ONLY £29.00  
REF: MAG29

**AMSTRAD 1512DD  
1512 BASE UNIT AND KEYBOARD AND TWO  
5.25" 360K DRIVES. ALL YOU NEED IS A MONITOR  
AND POWER SUPPLY. WAS £59.00**

NOW ONLY £39.00  
REF: MAG39

**SOLAR POWER PANELS**

**3FT X 1FT 10WATT GLASS PANELS  
14.5v/700mA  
NOW AVAILABLE BY MAIL ORDER  
£33.95**

(PLUS £2.00 SPECIAL PACKAGING CHARGE)

TOP QUALITY AMORPHOUS SILICON CELLS HAVE ALMOST A TIMELESS LIFESPAN WITH AN INFINITE NUMBER OF POSSIBLE APPLICATIONS, SOME OF WHICH MAY BE CAR BATTERY CHARGING, FOR USE ON BOATS OR CARAVANS, OR ANYWHERE A PORTABLE 12V SUPPLY IS REQUIRED. REF: MAG34

ALSO 1FT X 1FT GLASS SOLAR PANELS 12v 200mA ONLY £15.00 REF: MAG15P3

**FREE SOFTWARE!**

Brand new, UNUSED top quality Famous brand licensed software discs. Available in 5.25" D5DD or 5.25" HD only. You buy the disk and it comes with free BRAND NEW UNUSED SOFTWARE. We are actually selling you the floppy disc for your own "MEGA CHEAP" storage facilities, if you happen to get software that you want/need/like as well..... you get a "MEGA BARGAIN" too!  
D5DD PKT10 £2.99 REF: MAG37 PKT100 £16.00 REF: MAG16  
HD PKT10 £3.99 REF: MAG43 PKT100 £26.00 REF: MAG26P1

LARGER QUANTITY PRICES AVAILABLE ON APPLICATION

\*\*\*\*\*WE BUY SURPLUS STOCK\*\*\*\*\*

TURN YOUR SURPLUS STOCK INTO CASH  
IMMEDIATE SETTLEMENT WE WILL ALSO QUOTE FOR  
COMPLETE FACTORY CLEARANCE  
COMING SOON

**1994 CATALOGUE**

PLEASE SEND 42P, A4 SIZED SAE FOR YOUR FREE COPY.  
MINIMUM GOODS ORDER 15.00 TRADE ORDERS FROM GOVERNMENT, SCHOOLS, UNIVERSITIES & LOCAL AUTHORITIES WELCOME. ALL GOODS SUPPLIED SUBJECT TO OUR CONDITIONS OF SALE AND UNLESS OTHERWISE STATED GUARANTEED FOR 30 DAYS. RIGHTS RESERVED TO CHANGE PRICES & SPECIFICATIONS WITHOUT PRIOR NOTICE. ORDERS SUBJECT TO STOCK. QUOTATIONS WILLINGLY GIVEN FOR QUANTITIES HIGHER THAN THOSE STATED.

\*SOME OF OUR PRODUCTS MAY BE UNLICENSABLE IN THE UK

**BULL ELECTRICAL**  
250 PORTLAND ROAD HOVE SUSSEX  
BN3 5QT

**MAIL ORDER TERMS: CASH PO OR CHEQUE  
WITH ORDER PLUS £3.00 POST PLUS VAT.**

PLEASE ALLOW 7 - 10 DAYS FOR DELIVERY  
TELEPHONE ORDERS WELCOME

TEL: 0273 203500

FAX: 0273 323077



**COMMODORE MICRODRIVE SYSTEM** mini storage device for C64's 4 times faster than disc drives, 10 times faster than tapes. Complete unit just £12 REF: MAG12P1

**SCHOOL STRIPPERS** We have quite a few of the above units which are 'returns' as they are quite comprehensive units they could be used for other projects etc. Let us know how many you need at just 50p a unit (minimum 10)

**HEADPHONES 16P** These are ex Virgin Atlantic. You can have 8 pairs for £2 REF: MAG2P8

**PROXIMITY SENSORS** These are small PCB's with what look like a source and sensor LED on one end and lots of components on the rest of the PCB. Complete with fly leads. Pack of 5 £3 REF: MAG: 3P5 or 20 for £8 REF: MAG8P4

**FIBRE OPTIC CABLE** Made for Hewlett Packard so pretty good stuff! you can have any length you want (min 5m) first 5m £7 REF: MAG7 thereafter £1 a metre (ie 20m is £22) REF: MAG1 Max length 250m.

**SNOOPERS EAR?** Originally made to clip over the earpiece of telephone to amplify the sound it also works quite well on the cable running along the wall! Price is £5 REF: MAG5P7

**DOS PACKS** Microsoft version 3.3 or higher complete with all manuals or price just £5 REF: MAG5P8 Worth it just for the very comprehensive manual! 5.25" only

**DOS PACK** Microsoft version 5 Original software but no manuals hence only £3 REF: MAG3P8 5.25" only

**FOREIGN DOS** 3.3-German, French, Italian etc £2 a pack with manual. 5.25" only REF: MAG2P9

**MONO VGA MONITOR** Made by Amstrad, refurbished £49 REF: MAG49

**CTM644 COLOUR MONITOR** Made to work with the CPC464 home computer. Standard RGB input so will work with other machines. Refurbished £59.00 REF: MAG59

**JUST A SMALL SELECTION** of what we have, to see more get our 1994 catalogue (42p stamp) or call in Mon-Sat 9-5.30

**HAND HELD TONE DALLERS** Ideal for the control of the Response 200 and 400 machines. £5 REF: MAG5P9

**PIR DETECTOR** Made by famous UK alarm manufacturer these are hi spec, long range internal units. 12v operation. Slight marks on case and unboxed (although brand new) £8 REF: MAG8P5

**WINDUP SOLAR POWERED RADIO** AM/FM radio complete with hand charger and solar panel! £14 REF: MAG14P1

**COMMODORE 64** Customer returns but ok for spares etc £12 REF: MAG12P2 Tested and working units are £69.00 REF: MAG69

**COMMODORE 64 TAPE DRIVES** Customer returns at £4 REF: MAG4P9 Fully tested and working units are £12 REF: MAG12P5

**COMPUTER TERMINALS** complete with screen, keyboard and RS232 input/output. Ex equipment. Price is £27 REF: MAG27

**MAINS CABLES** These are 2 core standard black 2 metre mains cables fitted with a 13A plug on one end, cable the other. Ideal for projects, low cost manufacturing etc. Pack of 10 for £3 REF: MAG3P8 Pack of 100 £20 REF: MAG20P5

**SURFACE MOUNT STRIPPER** Originally made as some form of high frequency amplifier (main chip is a TSA5511T 1.3GHz synthesiser) but good stripper value, an excellent way to play with surface mount components £1.00 REF: MAG1P1

**MICROWAVE TIMER** Electronic timer with relay outputs suitable to make enlarger timer etc £4 REF: MAG4P4

**PLUG 420?** showing your age? pack of 10 with leads for £2 REF: MAG2P11

**MOBILE CAR PHONE** £5.99 Well almost! complete in car phone excluding the box of electronics normally hidden under seat. Can be made to illuminate with 12v also has built in light sensor so display only illuminates when dark. Totally convincing! REF: MAG6P6

**ALARM BEACONS** Zenon strobe made to mount on an external bell box but could be used for caravans etc. 12v operation. Just connect up and it flashes regularly! £5 REF: MAG5P11

**FIRE ALARM CONTROL PANEL** High quality metal cased alarm panel 350x165x80mm. Comes with electronics but no information. £15 REF: MAG15P4

**SUPER SIZE HEATSINK** Superb quality aluminium heatsink 368 x 183 x 61mm, 15 fins enable high heat dissipation. No holes! £9.99 REF: MAG10P1P

**REMOTE CONTROL PCB** These are receiver boards for garage door opening systems. You may have another use? £4 ea REF: MAG4P5

**LOPTX** Line output transformers believed to be for hi res colour monitors but useful for getting high voltages from low ones! £2 each REF: MAG2P12 bumper pack of 10 for £12 REF: MAG12P3

**PORTABLE RADIATION DETECTOR**

**£49.99**

A Hand held personal Gamma and X Ray detector. This unit contains two Geiger Tubes, has a 4 digit LCD display with a Piezo speaker, giving an audio visual indication. The unit detects high energy electromagnetic quanta with an energy from 30KeV to over 1.2MeV and a measuring range of 5-9999 UR/h or 10-99990 Nr/h. Supplied complete with handbook.

REF: MAG50

# 1.5 MILLION PEOPLE USE M.C.E.S. PRODUCTS DAILY.

REMANUFACTURED:-

T.V. TUNERS, RF MODULATORS/BOOSTERS,  
GRUNDIG TUNER/I.F., ITT TUNER I.F. SAT  
TUNERS, L.N.B.s, VIDEO HEADS.

FREE PRICE LIST AVAILABLE.

**RING 061-746 8037**  
**FAX 061-746 8136**

## ADVERTISERS' INDEX

Aerial Techniques.....	185	J.J. Components.....	195
Anglian TV Wholesale ..	222	Manor Supplies.....	171
Antex .....	162	Marapet .....	200
A-Z Electronics.....	201	Mauritron.....	167
Besco .....	220	M.C.E.S.....	215
BK Electronic .....	164	Pays UTV.....	210
Bull Electrical .....	214	P.V. Tubes .....	162
Campion Wholesale TV Ltd.....	222	Redbank .....	216
Central TV Wholesale Ltd.....	217	Senz Components.....	228, IBC & OBC
Centrevision .....	216	Silverscreen .....	222
Coastal TV's .....	222	Stewart of Reading .....	211
Colourtrade .....	221	Swift TV Publications.....	209
Crewe Wholesale TV Ltd.....	218	Telecentre .....	222
CTV.....	218	Teleprice Ltd.....	223
Datapart Ltd .....	213 & 221	Tepco Electronics.....	218
East London Components .....	162	Turner Lyons .....	216
Economic Devices 192-193		TV International.....	218
Euras International Ltd	200	Vision On .....	212
Euro Vision .....	217	Vision World.....	220
Express TV's.....	209	Vista Electronics.....	211
GGL Components .....	163	Wellview .....	212
Grandata Ltd .....	154-161	Western Trade Services	220
Hardy, J.W.....	211	West Mids. TV .....	209
Harrison Electronics .....	210	Wessex Micro.....	215
Henry's Audio Elec. ....	200	Willowvale Electronics Ltd.....	IFC
Hussein Central TV .....	219	Wiltsgrove .....	212
Irwin Electronics.....	210	Woodham's TV Ltd.....	220
		W. Tree Trade	
		Warehouse .....	217

See next month's issue on  
how to get your **FREE** disk

or call now for details on  
**WorkShop Manager Plus**

The complete computer  
Job Tracking, Invoicing  
& Reporting system.

Specially designed for the  
TV, Audio, Video & Electronic  
Service Departments.

**Cut out this coupon and see below**

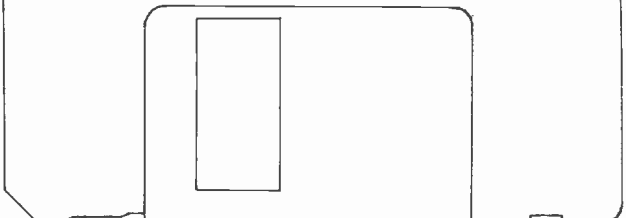

send your details to:  
**WMGR, 3 Ladymeade,**  
**Ilminster, Somerset TA19 OEA**  
**Tel: (0460) 55166 or Fax to: (0460) 54808**

MANCHESTER'S NO 1 WHOLESALER

# RED BANK UNIT 20

## HERE

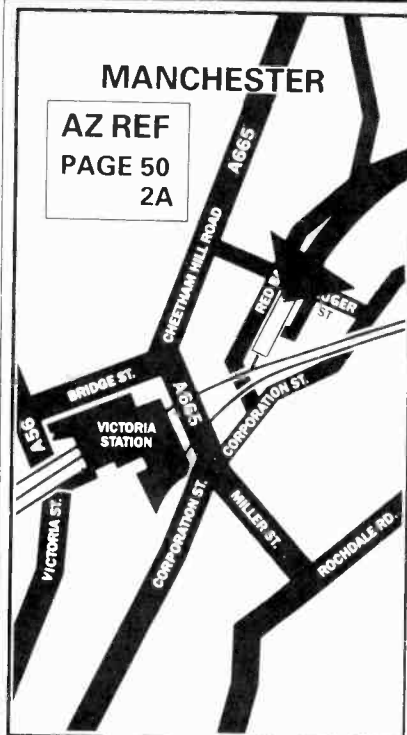

**OVER A 1000 SETS IN STOCK**

**BASIC TELEVISIONS FROM..... £5**

**WORKING TELETEXT FROM ..... £35**

**WORKING PANASONIC TEXT ..... £40**

**WORKING GEC/HITACHI TEXT ..... £40**

**FRONT LOADING VIDEOS FROM..... £20**

**REFURBISHED STOCK AVAILABLE**

**OPENING HOURS FROM**  
10AM TILL 5PM MONDAY TO FRIDAY

**UNIT 20, RED BANK ARCHES, RED BANK**  
**MANCHESTER M4 4HF**

— CHEQUE — ACCESS — VISA —

PHONE 061 832 4220  
FAX 061 834 6368  
PRICES SUBJECT  
TO  
VAT

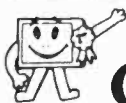

## CentreVision

CENTREVISION HOUSE · SLOPER ROAD · LECKWITH · CARDIFF · CF1 8AB

**HAPPY NEW YEAR**

**RE-STOCK AND SAVE**

**£££'s**



**50 WORKING FST INCLUDING**

**NICAM ON DISPLAY READY**

**FOR DIRECT RE-SALE**

**SALORA 5902 RECEIVERS**

**WORKING – £25.00**



**PHONE**

**0222 344754**



## MANUFACTURERS 'B' GRADED STOCK

**Televisions, Videos**  
**Audio, Music Centres**  
**Microwave Ovens**

Complete, reboxed, working  
Current model stock

**Turner Lyons Enterprises Ltd**  
**9 Howard Place,**  
**Shelton**

**Stoke on Trent ST1 4NN**

*Phone David or John*

**0782 285416**

# EUROVISION

25 Bradford Street, Walsall WS1 1PN  
Tel: 0922 22279 Fax: 0922 22279

## TV VIDEO AUDIO MICROWAVE WHOLESALE

**LOWEST  
PRICES**

**SMALL OR LARGE  
ORDERS  
WELCOME**

**HIGHEST  
QUALITY**

### TOP QUALITY EX-RENTALS ALWAYS IN STOCK

DELIVERIES THROUGHOUT THE UK

CALL NOW AND START  
SAVING WITH EUROVISION

**0922 22279** MULTI  
LINE

**24 HOUR ORDERING SERVICE**

EXPORT ENQUIRIES WELCOME

**B-grade Stock All Boxed, working  
If you require one item please read on:**

10" R/C Portable	£95
14" Basic Portable	£85
14" R/C Portable	£95
20" R/C	£119
20" Text	£139
21" FST R/C	£145
21" Fastext FST	£165
21" Nicam	£219
25" Nicam	£259
L/P Videos	£99
Stereo Midi System	£110
Microwave Oven	£50
TV & Video Stands	£3

**DISCOUNT  
ON  
QUANTITY**

**CD Midi Systems working (RRP £279) all boxed £129**  
**CD radio cassette, working £49**  
**Free Standing Gas Cookers £155**  
**Gas Hobs £39 Calor Gas Hobs £35**  
**All items unused & working**

**Customer returns in block.**  
**Example. Untested 3x21" FST 3x25" FST**  
**6xF/L Videos £40 each. Total £480+ VAT**  
**This price does not include handsets.**  
**Some in need of repair. Some working.**

**Ex-rental TV & Videos, all untouched.**  
**Basic £10 & £15 R/C £20 & £25 Text £25 & £30**  
**Videos T/L £20 F/L £25. All untouched.**

**W TREE WAREHOUSE**  
**UNIT 1, SUNSHINE MILLS, WORTLEY RD, LEEDS 12**  
**TEL: 0532 638804 FAX: 0532 310275**

# CENTRAL TV



## EX-RENTAL

- SUPERB RANGE OF TV'S & VCR'S
- THORN & GRANADA

● **DIRECT LOADS**  
**AVAILABLE FROM SOURCE**

**EXPORT ENQUIRIES WELCOME**

## 'B' GRADE SWITCH ON TO TOP QUALITY BRANDS

**PHONE TODAY FOR BEST RESULTS**

ALL SIZES OF SCREEN TV AVAILABLE, BOTH IN FAST  
TEXT & DIGITAL NICAM STEREO



### VIDEOS: CURRENT MODEL

Single, Twin Speed, Nicam S-VHS



### CAMCORDER

C FORMAT, FULL SIZE, 8mm  
MICROWAVES ● PORTABLE ● HIFI ●  
SATELLITE ● VIDEOCRYPT ●

**PORTABLE £100**

FULL REMOTE, BOXED

**CTV LONDON**  
Eley Estate, Nobel Road  
Edmonton N18  
TEL: 081-807 4090  
FAX: 081-884 1314

**CENTRAL TV WHOLESALE  
DISTRIBUTION LTD**  
369 Stratford Road, Sparkhill  
Birmingham B11  
TEL: 021-772 1591  
FAX: 021-766 6383



**SOUTH LONDON  
TRADE WAREHOUSE**

**NOW OPEN**

**MAJOR BRAND  
NAMES**

**BEST  
STOCK**

**BEST  
PRICES**

**WHOLESALE**

OF THORN + NON-THORN EX-RENTAL TV's  
& V.C.R., TESTED + UNTESTED 'B' GRADE +  
LIQUIDATION STOCK

**AUDIO:** Stocks of Audio, Midi + Mini Hi-Fi CD's  
Radio Cassettes, Walkmans, ALL TOP BRAND  
NAMES AT FRACTION OF RETAIL PRICE

**STOCK ALWAYS CHANGING**

**TEPCO ELECTRONICS LTD**

TEL 081-769 6149 Ask for Chris  
071-924 1606 Ask for Tony  
081-677 5749 Warehouse Line  
FAX 081-769 4952

**OPEN MON-SAT 9.30 TO 6pm**

**TV INTERNATIONAL**

**FOR**

**'B' GRADE  
AUDIO - VIDEO  
- MICROWAVES**

LARGE STOCKS, NEW - BOXED - COMPLETE.  
SOLD FULLY TESTED OR DIRECT - UNTESTED  
ALL MINT

**TEL. 0384 482 575**

**ASK FOR TRADE DEPT**

**FAX. 0384 265 236**

**PEARTREE LANE, DUDLEY,  
WEST MIDLANDS**

**OPEN 9.00 - 6.00**

**MONDAY - SATURDAY**



**C.T.V.**

UNIT 5. THE PHOENIX BUILDING. RUSHOCK  
TRADING ESTATE. DROITWICH ROAD.  
NEAR KIDDERMINSTER  
TELEPHONE: 0299-251522  
0836-585829/0860-809673 (24HR)

**SUPPLIERS OF HIGH QUALITY  
EX-RENTAL TELEVISIONS AND VIDEOS  
LARGE STOCKS ALWAYS AVAILABLE  
ALL AT COMPETITIVE PRICES**

Also available: 'B' Grade Products,  
Audio, Microwaves and Complete Range  
of Televisions and Videos

**OPEN: MON-FRI - 9.30-5.30**

**TEL:** 0299-251522  
0836-585829/0860-809673 (24HR)

**Fax: 0299-251543 EXPORT ENQUIRIES WELCOME**

FAX  
0270 505470  
OPEN MON-FRI  
9.30 TO 5.30



**CREWE WHOLESALE T.V. LTD**

**FREE DELIVERY**

**TO MOST AREAS OF THE UK**

**LARGE SELECTION OF  
WORKING TV's + VIDEOS**

**VIDEO'S - UNTESTED**

**HAPPY NEW YEAR PHONE ACCESS & VISA  
WELCOME**

**0270 · 582924**

**3 LINES**



**BRITAIN'S LARGEST INDEPENDENT  
PRESENTS THE LARGEST STOCK OF 'B' GRADE**

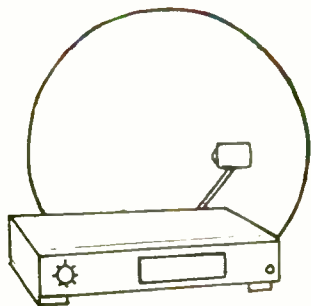

LTD

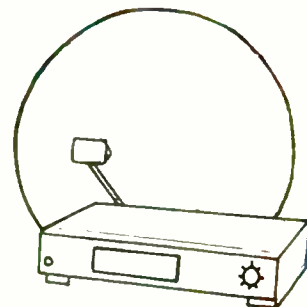

**HCTV WISHES ALL IT'S CUSTOMERS  
A HAPPY NEW YEAR**

## **NEW GRADED STOCK**

**MANUFACTURER TESTED, BOXED AND SEALED AS NEW**

**14" S+D**

**20" R/C**

**25" R/C**

**14" R/C**

**20" FASTEXT**

**25" FASTEXT**

**16" STD**

**21" R/C**

**25" NICAM**

**16" R/C**

**20" FASTEXT**

**28" FASTEXT**

**20" STD**

**21" NICAM**

**28" NICAM**

**PLUS A RANGE OF LONG PLAY AND NICAM VIDEO'S**

# **DON'T MISS OUT! PAY US A VISIT**

### **PRESTON**

139 Oakshott Place  
Walton Summit  
Ind Est  
Preston (M6 Junc 29)  
Tel: 0772 312101

### **BIRMINGHAM**

208 Bromford Lane  
Erdington  
Birmingham B24 8DL  
Tel: 021-327 3273 Fax: 021-322 2011

### **LONDON**

Unit 2  
The Royal London Est  
29/35 North Acton Road  
London NW10  
Tel: 081-961 5005

**FAX: 0274  
722229**

**BESCO LIMITED  
T/A**

**NORTH WEST ELECTRONICS  
ENTIRE RANGE OF EX-RENTAL TVs & VIDEOS**

**NEW STOCKS EVERY DAY, WORKING OR OFF THE PILE**

makes include: Sharp, Hitachi, Ferguson, Pye, NAT PAN, ITT etc.

Late models always available.

**KNOCKOUT PRICES ON COLOUR TVs**

**FERGUSION, PYE, HITACHI, PHILIPS, BUSH, ITT, etc.**

TELETEXT BARGAINS FROM **£30.00** (WORKING).

FERGUSION TX TELETEXT ONLY **£45**. PHILIPS/PYE TEXT ALWAYS AVAILABLE

**OVER 1000 COLOUR TV AND VIDEOS AVAILABLE**

RING OUR HOTLINES NOW FOR PRICES OR CALL IN, YOU WILL BE DELIGHTED

**Working Ex-Equipment Panels**

IF	Converger	Decoder	Line scan	Power	Frame
T20//22X	5	14	18	17	14
T26 X	5	16	20	17	X
Phillps G11 14.50	5	12	20	20	11.50

**All prices include Postage & Packing. But + VAT**

★ **IF THE PANEL YOU REQUIRE IS NOT LISTED PLEASE ASK** ★

Visa Welcome

Prices are plus VAT  
and based on quantity

Cheques accepted

Walker House, 16 Bottomley Street, Bradford BD5 7LJ

Ring Tony 0274 308186 – Open 6 days – 9am-5pm

**New WHOLESALE  
TV and VIDEO Warehouse**

Vision World (Cardiff) has just opened for business in the Cardiff Bay area. Many makes kept in stock including Thorn and Granada. If you're the type of business that likes competitive prices and a good service, then contact:

VISION WORLD (Cardiff)  
Unit 89 Portmanmoor Road  
Industrial Estate  
East Moors  
Cardiff CF2 2HB

**Tel: 0222 458989**

**WOODHAM TV LTD**

Wish all their customers a  
Happy & Prosperous New Year

Wholesalers of  
Thorn & Granada  
ex-rental TVs and Videos  
\*Working – Non-working

\*Many Special Offers  
Open Mon-Sat 9.30-5.30

**PHONE NOW**

**0245-32583**

UNIT 8, CUTLERS RD,  
SOUTH WOODHAM FERRERS,  
CHELMSFORD, ESSEX

# COLOURTRADE

ESTABLISHED 1973 - WHOLESALE ONLY

## NEW 'B' GRADE

Major Brands ONLY Satellite, Receivers, Decoders,  
Microwaves TV - Video - AUDIO



COMPLETE BOXED - WITH STAND - HANDSET - BOOK ETC  
MINT LATEST NICAM FASTEXT F.S.T.



### Phone 021-359 7020

FAX 021-359 6344

221-222 BRIDGE ST WEST, HOCKLEY,  
BIRMINGHAM B19 2HU

### WESTERN TRADE SERVICES

EST 14 YEARS

SUPPLIERS OF EX-RENTAL

TV & VIDEO

THORN AND NON THORN

#### SOUTH WEST

2A Barton Hill Road, Torquay,  
Devon TQ2 8JH

Tel: 0803 312222

Fax: 0803 326767

Delivering throughout Devon and  
Cornwall weekly

#### WALES

Unit 6, Islwyn Workshop,  
Portymaester Ind Est, Risca,  
Gwent

Tel: 0633 612667

DO YOU REPAIR WHITE GOODS?  
*THEN YOU SHOULD KNOW ABOUT*

## DATAPART

THEY HAVE THE LARGEST AVAILABLE  
RANGE OF GENUINE AND PATTERN PARTS

FOR MOST BRANDS OF :-

WASHING MACHINES

DISHWASHERS

REFRIGERATORS

COOKERS

VACUUM CLEANERS

KETTLES

IRONS

TOASTERS

MICRO-WAVE OVENS

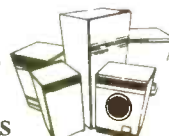

### DATAPART LTD



ELECTRON HOUSE,  
100 GREAT BARR STREET  
BIRMINGHAM B9 4BB



SALES DESK 021 766 5551 24  
FAX FREE 0800 373 459 HOURS

**ANGLIAN TV  
WHOLESALE**

**EX-RENTAL TVs & VCRs**

**THORN  
AND  
GRANADA  
STOCK**

**NEW  
'B' GRADE  
T.V., VIDEO  
AUDIO, MICROWAVE**

**BEST POSSIBLE PRICES  
EXPORT ENQUIRIES  
WELCOME  
& DELIVERY AVAILABLE  
RING FOR DETAILS**

**ANGLIAN TV  
WHOLESALE,  
NOW AT  
UNIT 4, BRECKLANDS  
BUSINESS CENTRE  
TAVERN LANE,  
EAST DEREHAM,  
NORFOLK  
(0362) 691611**

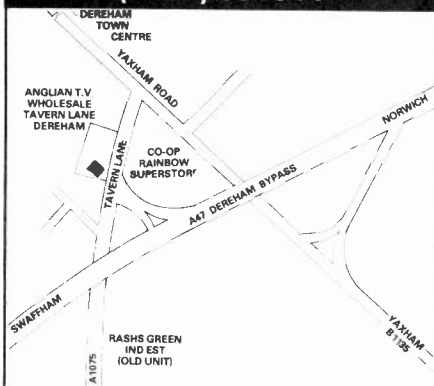

**TELECENTRE**

**NOW OPEN  
7 DAYS A WEEK  
FOR TOP QUALITY  
EX-RENTAL AND  
'B' GRADE TV'S  
AND VIDEOS.**

**WEEKDAYS OPEN  
TILL 9PM. WEEKENDS  
& EVENINGS BY  
APPOINTMENT.**

**15 MINS FROM  
JUNCTION 16 M6  
79A COLERIDGE WAY,  
CREWE.**

**TEL: 0270 589392**

**ACCESS AND  
VISA WELCOME**

**SILVERSCREEN  
VIDEOS**

**EX-RENTAL TV  
& VIDEOS  
THORN & GRANADA**

**Great deals on  
working and non-  
working videos  
and TV's**

Direct loads of  
white goods available

**UK DELIVERY  
AVAILABLE**

**- EXPORT ENQUIRIES -  
- WELCOME -**

**24 GOLD STREET  
TIVERTON  
DEVON EX16 6PY**

**TELEPHONE:  
0884 256257**

**AERIALS**

**FOR TV & FM RADIO, PLUS  
1000's OF MASTS,  
BRACKETS, LASHING KITS,  
CLAMPS, PLUGS, CABLES,  
OUTLETS, DIPLEXERS ETC.**

**AMPLIFIERS**

**FOR DISTRIBUTION  
SYSTEMS AND DOMESTIC.  
MAST HEAD OR SET BACK.  
WE HAVE ONE OF THE  
LARGEST RANGES,  
AVAILABLE FROM STOCK**

**MAIN DISTRIBUTORS**

**FOR ANTIFERENCE,  
LABGEAR, WOLSEY  
FRINGE, TRIAX, TELEVES,  
VOLEX-RAYDEX, KUBLER  
+ MANY MORE**

**COASTAL  
AERIAL  
SUPPLIES**

**UNIT X2 Rudford Industrial Estate  
Ford, Arundel**

**0903 723726**

**NO MINIMUM ORDER VALUE  
NEXT DAY DELIVERY ACROSS UK  
CARRIAGE FREE ON ORDERS £250+**



**CHAMPION  
WHOLESALE LTD.**

**QUALITY USED T.V.  
& VIDEO**

**COMPLETE RANGE OF  
T.V.'s AND VIDEOS  
MOST MAKES AND  
MODELS AVAILABLE**

**STOCK ARRIVING DAILY  
T.V.'s from £3.00  
Videos from £30.00  
Prices Ex-VAT**

**Free Delivery Service  
to most areas of the U.K.**

**UNIT 75, BARRACKS ROAD,  
SANDY LANE INDUSTRIAL ESTATE,  
STOURPORT-ON-SEVER,  
WORCESTERSHIRE DY13 9QB  
Just 10 Mins from  
M5 Junct. 6 Worc's North**

**For your export  
requirements contact us.**

**0299-879642 or 879643  
FAX: 0299 827984**



# TELEPRICE

LIMITED

LEADERS IN THE SUPPLY OF EX-RENTAL TV, VIDEO & AUDIO

**THE BIG FIVE**

**AINTREE**  
**IAN McCLELLAND**  
051 530 1285  
Unit 4 Graylaw Ind Est  
Wareing Road  
Aintree Liverpool L9 7AU

**SUNDERLAND**  
**BRIAN CADE**  
091 523 5554  
9A/B 94 Carrmere Road  
Leechmere Ind Est  
Sunderland SR2 9TE

**SANDIACRE**  
**JOHN JEYS**  
0602 491385  
Unit 8 Ascot Park Ind Est  
Lenton Street Sandiacre  
Nottingham NG10 5DJ

**GLOUCESTER**  
**KARLA REALE**  
0452 372808  
U 11D Barnwood Field  
Business Pk Barnett Way  
Barnwood Glos GL4 7RT

**FARNBOROUGH**  
**COLIN GORDON**  
0252 540814  
40 Invincible Road  
Farnborough  
Hants GU14 7QU

**SUNDERLAND**

**LIVERPOOL**

**NOTTINGHAM**

**GLOUCESTER**

**FARNBOROUGH**

CALL US FOR LATEST PRICES



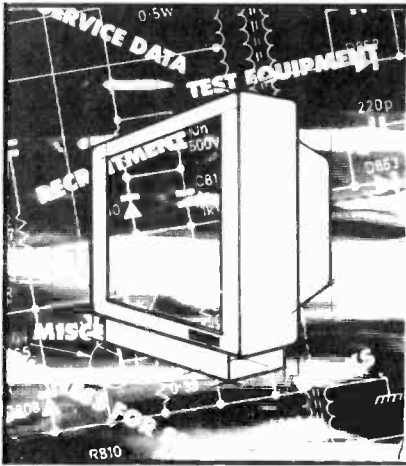

# TELEVISION CLASSIFIED

No other consumer magazine in the country can reach so effectively those readers who are wholly engaged in the television and affiliated electronic industries. They have a need to know of your products and services.

The prepaid rate for semi display setting is £12.00 per single column centimetre (minimum 3 cm). Classified advertisements £8.40 per line, box number £22.00 extra. All prices plus 17½% VAT. All cheques, postal orders etc., to be made payable to Reed Business Publishing. Advertisements, together with remittance, should be sent to The Television Classified, 11th Floor, Quadrant House, The Quadrant, Sutton, Surrey SM2 5AS.



PHONE 081-652 8339 FAX 081-652 8931



## SERVICE DATA

### INDEXES! INDEXES!

THOUSANDS SOLD WORLDWIDE

EDITION 10 of the complete indexes now published containing over 8,000 Faults listed in 12 Years of Television Magazine

Indexes are alphabetically listed by Make, Model, Fault, Ref and are now Available for just :

**£8.00** For Television & Satellite Faults

**£8.00** For Video, Camcorder & CD Faults

Or

**£15.00** For both sets complete

Please add **£1.50 (UK), £3.00 (Overseas)** to total order to cover post & packing.

A LOW COST UPDATE SERVICE IS ALSO AVAILABLE. FULL DETAILS DESPATCHED WITH ORDER.

To secure your copy/s please make Cheques/Postal Orders payable to:

**E.C.S.** 31 PRENTON ROAD WEST,  
PRENTON, BIRKENHEAD,  
MERSEYSIDE L42 9PY

**TIS, 76 Church St, Larkhall,  
Lanarks ML9 1HE, U.K.**  
offers you



### The Largest collection of SERVICE MANUALS TECHNICAL & REPAIR MANUALS

published anywhere on Earth: The Data Reference Manual lists & prices them for only £5.95 - with it you get FREE vouchers and the most comprehensive cross referencing of models to the correct chassis and manufacturers known, *What's more, we'll supply circuits for any listed VCR @ £7, CTV model @ £4 or chassis @ £6 (+£2).* Even better, we can supply Service Manuals costing up to £70 for little more than £7 each!

*Some bargains from our huge stocks*

Tunbridge's Pract TV Repairs & Kings CTV Servicing  
£16.95 each or both for only £30

McCormac's *Black Book!* Euro Scrambling for £32  
3 Pract. Guides on How to Buy, Sell, Service and Repair-  
VCR's - TV's - CD's £9.95 each or all 3 for £25

Thorn's own 'The PAL System' for only £9.95  
Huge illustrated IC Data Reference Manuals only £12.95 ea

Send your order now, or ask for full details, or  
Phone 0698 883334/888343 Fax: 0698 884825  
or Visa/Access details for immediate despatch

### FAST FIX Fault Index

Now in NEW A4 Book Format,  
containing over 200 pages.

Still thumbing through back issues of 'Television', looking for the cure to that frustrating fault? Why not let the FAST FIX Fault Index find it for you?

Covering the years 1982-Dec 1993 and listing over 3000 TV, Video, Camcorder, CP and satellite fault symptoms + hundreds of technical references from Television, FAST FIX could pay for itself after just one repair. All references are arranged alphabetically listing make, model, fault symptom and page reference. Regular updating takes place and all customers will be notified.

Complete FAST FIX index £16.00 inclusive.  
Overseas orders please add £3.00

**MONEY BACK GUARANTEE IF YOU ARE NOT COMPLETELY SATISFIED**

Send Cheques/Postal Orders, payable to  
J. Humphreys, 13 Manfield Avenue, St. Johns Park  
Hawarden, Clwyd CH5 3SB N. Wales  
For further details, tel: 0244 532961

## SERVICE MANUALS

Available for most makes of  
CTV - MTV - VCR - CAM - SAT - M/WAVE - AUDIO  
all at reasonable prices - and no VAT,  
WRITE OR TELEPHONE WITH YOUR REQUIREMENTS.

For comprehensive catalogue in the form of a floppy disc for use on IBM or compatible PC, and including money-saving vouchers,  
Send £2.50 & £1.00 p/p - No VAT.  
But please state size & format of disc reqd.

**D-TEC**

P0 BOX 1171, FERNDOWN, DORSET BH22 9YG  
Tel: 0202 870656

## TEK-HELP

HOT LINE FOR TV  
& VIDEO REPAIRS  
THOUSANDS OF  
FAULTS & CURES  
ALL MAKES

JUST THE COST OF  
A PHONE CALL

**0891 516 434**

48p PER MIN 36p CHEAP RATE

**STREECARDS CAN SAVE YOU  
£100's, EVEN £1000's, EVERY YEAR**

Each STREECARD entitles you to unlimited exchanges (1 at a time) for 1 year in either Library of your choice  
The 1st card in any Library costs £59.95  
Each card thereafter costs £49.95

**DATA LIBRARY TERMS**

You can now exchange manuals from the largest known collection of service/repair data in the world! Giant manual supplied FREE updated yearly, lists all the 1000's of available manuals.  
Single exchanges (1 card) cost £3.95  
Extra cards exchanges at the same time £2.95

**PC Games Library terms**

Your 1st choice can be anything on the market up to £60 inc. CD-ROM, thereafter from big regularly updated lists with well over 100 of the latest games, FREE hints/tips/Guides.  
Each single exchange (1 Streecard held) only £4.95  
Further exchanges at the same time £3.95 each

Join now using Access, Visa, etc. by phone or write for full details to:

**STREE (Est 1968)**

76 Church St, Larkhall, Lanarks ML9 1HE  
Tel: 0698 883334/888343 Fax: 0698 884825



**SERVICE MANUALS**

We have what is probably the largest range of Service Information available anywhere.

From the Earliest Valve Wireless to the Latest Video Recorders. Colour Televisions, Test Gear, Audio, Computers, Amateur Radio, in fact practically anything.

Originals or Photostats as available.

Also available. Our **FREE** catalogue detailing Hundreds of Technical Books and Repair Guides available.

Send 2 x 1st class stamps for your copy TODAY.  
**Mauritron Technical Services (TV),**

47A High Street,

Chinnor,  
Oxfordshire,  
OX9 4DJ



Tel: 0844 351694

Fax: 0844 352554.



**INFOTECH SYSTEMS**



**Special UK Offers this Month**

**TV Repairs to 1989**

10- 12"x17" binders (£299 set) containing circuits for every major CTV chassis PLUS 17 Big TV Repair Manuals (£150 set) PLUS Practical TV Repairs, Servicing TV & The PAL System for £399

**TV Repair & Service**

The above system PLUS your choice of £300 worth of CTV Service Manuals for £445

**VCR Repair & Service to 1989**

35 Fault Guides (£79.95 set) PLUS 7 Giant binders of VCR Diagrams (£225 set) PLUS Thorn's VCR Technical Manuals (£59.50) PLUS your choice of £200 worth of VCR Service Manuals + Beeching VCR Servicing for only £359

**The TVAR System**

3 Huge binders packed with circuits & layouts + 3 big Manuals cover servicing & repair data for hundreds of models; Audio systems, CD, Computers, CTV, HiFi, Satellite, Radio, VCR for late 1890's to 1993. (Vols 1&2 by return, Vol.3 in December 1993 after updating!) only £149

For full details & FREE Catalogue, write phone or fax to 76 Church St., Larkhall, Lanarks ML9 1HE, Tel:0698 883334/888343 Fax:0698 884825

**GERMAN SERVICE SHEET SPECIALISTS**

Our connections are world-wide. We furnish any kind of German, European and Japanese service sheet or manual. Thousands of different sheets and manuals in stock. For any enquiries

**DÖNBERG ELECTRONICS**  
Schoolmasters House, Rannalast,  
Co. Donegal, Republic of Ireland.  
Phone: 075 48275

**PLEASE ADDRESS ALL BOX NUMBER ENQUIRIES TO:**

BOX NO: ..... TELEVISION  
11<sup>TH</sup> FLOOR QUADRANT  
HOUSE THE QUADRANT  
SUTTON, SURREY SM2 5AL

**TRAINING**

If you require a home study course in the fundamentals of electronics, either to begin a career, pursue a hobby, or refresh your knowledge, a

**BASIC ELECTRONICS** course, from the Direct Personal Learning scheme, could be just what you're looking for. Contact: K. Sparrow etc . . . 11 Claydon Green Whitchurch BRISTOL Avon BS14 0NG Telephone: (0275) 835669

**TRANSFORMERS**

**TV LINE OUTPUT TRANSFORMERS**

PHONE 081-948 3702 FAX: 081-332 0583

ALBA . AMSTRAD . BUSH . DECCA . DORIC . BLAUPUNKT . FERGUSON . FIDELITY . GEC . GRUNDIG . GRANADA . HITACHI . HINARI . INDESIT . ITT . KIMARA . NIKKAI . MATSUI . MURPHY . OSAKI . NORDMENDE . LOEWE-OPTA . PANASONIC . PYE . PHILIPS . SANYO . SAISHO . SHARP . SONY . SOLOVOX . SUSUMU . TANDBERG . TELEFUNKEN . THORN . TRIUMPH . THOMSON . GOLDSTAR . BINATONE .

**FULL RANGE OF KONIG: VIDEO HEADS, BELT KITS, IDLERS, PINCH ROLLERS, TENSION BANDS. LARGE RANGE OF REMOTE CONTROLS IN STOCK**

TIDMAN MAIL ORDER LTD . 236 SANDYCOMBE ROAD . RICHMOND . SURREY . TW9 2EQ.  
Mon-Fri 9 am to 12.30 pm & 1.30-4.30 pm  
Approx. 1 mile from Kew Bridge. Sat 10 am to 11.45 am

# CLASSIFIED CLASSIFIED CLASSIFIED CLASSIFIED CLASSIFIED

## RECRUITMENT



### University of Brighton

Department of Learning Resources

### Video Engineering Posts

Two key engineering staff are required to work in the department which provides central media production facilities and associated engineering support to the University. Both jobs are of a highly practical nature and are primarily concerned with the maintenance and continuing development of the department's extensive range of video, audio and other AV equipment and facilities.

## Chief Engineer

up to £21,207 per annum

Ref: LR 529

To organise the technical workshop and maintain the broadcast standard video and audio production studios and editing suites. You will also play a key role in the future engineering development of the facilities. A background in broadcast engineering or comparable environment, with a sound knowledge of the maintenance of video and audio equipment to component level are essential.

## Senior Engineer

up to £18,495 per annum

Ref: LR 531

To ensure the maintenance of the extensive video replay network, based mainly on the Video-8 and VHS formats, and to contribute to general operational, maintenance and development work. Substantial experience in the maintenance of consumer video equipment to component level, preferably with knowledge of the Video-8 format and the desire to develop your expertise more broadly are essential.

For further details and an application form please contact the Personnel Department, University of Brighton, Mithras House, Lewes Road, Brighton BN2 4AT, or 24 hour answerphone: (0273) 642849 quoting the appropriate reference number. If you need further information, please telephone (0273) 642837

For an informal discussion about the post, please telephone Ian Spalding, Technical Facilities Manager, on (0273) 642776.

Closing date: 7 January



Working for equality of opportunity

## SPARES & COMPONENTS

### SURPLUS/REDUNDANT ELECTRONIC COMPONENTS WANTED

I/Cs - Tuners - Transistors - Valves - Diodes etc. any quantity considered - immediate payment.

ADM Electronic Supplies

Tel. 0827 873311. Fax 0827 874835

### RCS VARIABLE VOLTAGE D.C. BENCH POWER SUPPLY

1 to 24 volts up to 1.2 amp 1 to 20 volts up to 1 amp 1 to 16 volts up to 1.2 amps D.C. Fully stabilised Twin panel meters for instant voltage and current reading. Overload protection Fully variable. Operates from 240V A.C. Compact unit size 9" x 5 1/2" x 3ins. Post & Ins. £45 inc. VAT

### RADIO COMPONENT SPECIALISTS

337 WHITEHORSE ROAD, CROYDON SURREY, U.K. Tel: 081 684 1665 List. Large SAC. Delivery 7 days. Callers Welcome Closed Wed

## TUBES

# REBUILT CRTs

VDU - MONITOR - TV

Image Burn-In Removed From Screen Phosphors

B.S.I. Certification

N.G.T. ELECTRONICS LTD

120, Selhurst Road, London SE25 6LL

PHONE: 081-771 3535

Britain's Oldest Established Tube Rebuilder

## SOFTWARE

# RELAY

OMAGH LTD

COMPUTER SOFTWARE

### DO YOU RENT TELEVISIONS?

### DO YOU STILL USE A CARD SYSTEM?

### DO YOU FIND IT DIFFICULT TO KNOW YOUR ARREARS TOTAL AT ANY GIVEN TIME?

If you do then we recommend our computer TV and Video Rental package. This package includes

- \* automatic updating of each customer's record
- \* alphabetical print-out of each customer's arrears and payments missed
- \* total arrears immediately available
- \* easy to use and operate

### NEW HIRE PURCHASE PROGRAMME NOW AVAILABLE AS WELL.

These programmes operate on all IBM compatibles running under MS-DOS. Free demonstration discs available.

# CONTACT

WILLIAM J THOMPSON  
Donaghie Post Office  
Beragh Co. Tyrone  
Telephone Beragh 58214 (0662 7)

## TEST EQUIPMENT

# MÜTER · AT2 · BMR 95 · BMR 700

AT 2, Audi-Multi-Tester, 16 test-circuits for loudspeakers, tuners, amplifiers, headphones, tape recorders, mikes, boosters.

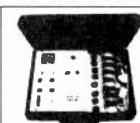

BMR 95

BMR 700

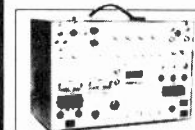

Regenerating Computers & Measurers for CRT's with cathode protection, gas clean-up aid, short repair; exhausted CRT's becomes bright and sharp again even if all other machines do not succeed.

car radios, CD-players; measurement of millivolt, drift, watt, performance; with generator, radio, signal tracer/injector, 13 volt supply etc.

United Kingdom: P & E Services, Llandudno, Tel. (0492) 549246, Fax 547880.

Ireland: Dönberg Electronics, Ranafast, Co. Donegal, Tel: 353 75 48275 and 48532. Fax: 353 75 71031.

New Zealand: TDON Ltd., Onehunga, Auckland. Tel. 6 68-9 07, Fax 668-4 99.

Germany: Ulrich Müter, Oer-Erkenschwick, Fax (0 23 68) 5 70 17.

## BUY DIRECT

From manufacturer C.E.D. 7A CRT Tester reactivator £195 inc base sockets or triple meter type £320 inc base sockets, satellite Signal strength meters professional selective tuning type £180 or Digital type £275. UHF Signal Strength meters £140 or Digital type £195 all signal strength meters are rechargeable and come complete with ni-cad batteries.

All brand new 12 months guarantee, p&p FREE, Callers welcome by appointment

CAPENER ELECTRONICS 0296 682030

Used Satellite Receivers from £30.

## FOR SALE

### FULLY REFURBISHED GAMA UK

Mint condition slim line front loader Videos for disposal to the trade, for further details ring 021 458 4093 or Fax 021 486 2980

# CLASSIFIED CLASSIFIED CLASSIFIED CLASSIFIED CLASSIFIED

## MISCELLANEOUS

## LINEAGE

### CAR RADIO CASSETTES

Do you turn away work on car radio cassettes because they have security codes.

Most radio cassettes can be decoded just by replacing the eeprom (memory IC) with that of a known code, or sending the original for recoding.

Send now for introductory offer, one of each of most popular eeproms plus comprehensive eeprom/radio decoding list. Offer includes Philips X2402P; Ford MN010; Blaupunkt Boston CC20 9346 **£17.63**

Original eeprom re-coding service **£4.99**  
Radios sent for decoding from **£16.69**  
Inclusive of VAT and p&p  
99% all radios covered

### RADIO DECODING EQUIPMENT

Our software package to run on all IBM and compatible computers including laptops and notebooks, consists of Ford, Philips, Blaupunkt, Pioneer, Clarion, Panasonic, plus many more may be added. Included is all necessary probes and interface (no batteries required). Reads and writes codes in seconds. No technical skill is needed...all help is built in. **£299 + VAT**

For technical or general information phone

**0543 572523**

**C.D.H. ELECTRONICS**  
3 Common Walk,  
Huntington, Cannock,  
Staffs WS12 4NB

### Microwave Oven Component Parts

Guaranteed Quality

Guaranteed Products

Competitive Price



AWI Ltd Samuel Whites Estate, Medina Road,  
Cowes, Isle of Wight, PO31 7LP  
Tel (0983) 296121 Telex (86736) Sortex G Fax: (0983) 296122

### CAR RADIO DECODING EQUIPMENT

Plug our decoder into your IBM or compatible computer, remove the base plate from the radio, place our probe onto the PCB and the code is instantly displayed. Changing the code or even fully reprogramming the eeprom is just as easy.

Easy to use software includes PCB layouts and help screens with full backup from our telephone helpline.

**PHONE US NOW FOR INFORMATION PACK AND FREE DEMO DISK**  
(Please state either 3.5" or 5.25" disk)

**Starter kit covering the three most popular brands**  
**£300 + carr & VAT**

EEPROM DECODING SERVICE: only £5 + VAT

(just send us the chip)

FORD 200€ RDS DECODED: for £10 + VAT  
(send front panel only)

### Electronic Sound Systems

62 High Northgate, Darlington, Co. Durham DL1 1UW  
Tel: 0325 484089 Fax: 0325 465921

### WIZARD DISTRIBUTORS

Spare + Components  
Always in stock  
Video heads for over 500 models  
Spare for over 20 manufacturers  
Hand sets for over 200 models  
TV Tubes new + regunned  
Plus much much more

Empress St Works  
Empress St  
Manchester M16 9EN  
061-872 5438, 061-848 0060  
Fax: 061-873 7365

### HOW THEY WORK! HOW TO TEST! HOW TO REPLACE!

Designed specifically for Domestic Appliance Engineers who want to enter the fast growing microwave Industry. Packed full of useful information, presented in a simple yet informative style

with comprehensive diagrams and illustrations. Fault finding procedures are included at the end of each section.

The book contains easy to follow electronic control systems

### SWIFTPARK LIMITED

113 LONDON ROAD, HORNDEN, WATERLOOVILLE, HANTS. PO8 0BJ



ORDER YOUR COPY TODAY!



We also supply microwave oven components

**AVO MULTIMETER** Model 8, £45.00. 500 volt meggers, £30.00. Prices plus VAT and p&p. Send SAE for lists of surplus instruments and scopes etc. A.C. Electronics, 17 Appleton Grove, Leeds LS9 9EN. Tel: 0532 496048.

**OCHRE MILL** Technical Services. Grundig TV spares for most models to 1985. Fast, friendly, helpful, sensible prices. Gt Lytpe Farm, Charlton, N. Malmesbury, Wilts. SN16 9DR. Tel: 0666 823228.

**PRIVATE RETAILER** has excellent part exchange colour televisions and videos to clear. Tel: 0494 814317.

**VIDEOCRYPT DECODER** Service sheet with smartcard contact details, Eurocrypt card interface, £12.00. E.M.O., Ramsbottom, Lancs. BL0 9AG. Tel: 0706 823036.

**WANTED. VALVES TRANSISTORS** especially manufactured EL34, KT66, KT77, KT88, PX4, PX25. Please post list of what you have, cash waiting. We also supply CRT for radars, scopes, monitors (not domestic TV) plus camera tubes, vidicon, magnetrons, image intensifiers and valves for audio, transmitting and television. Billington Export Ltd., 1E Gilmans Industrial Estate, Billingshurst, Sussex RH14 9EZ. Callers strictly by appointment only telephone 0403 784961. Fax 0403 783519.

### CRT FOR MONITOR, SCOPES, RADAR ETC (not domestic TV)

2J 3D P1	£12 00	1424A G1	£43 50
CV3946	£12 00	D14-270GH/50	£79 50
F21-12LC	£125 00	M31-190GR	£61 50
3JP1	£18 00	95447GM	£79 50
CV8897	£69 00	D15-100GH/97	£79 50
F31-12LD	£132 00	M31-191GW	£61 50
3RP1A	P O A	CME1431W	£21 00
D10-210GH	£53 00	D16-100GH/67	£79 50
LD708	£61 60	M31-271W	£61 50
3WP1	£18 00	CME1523W	£27 00
D13-611GH	£53 00	DG7-5	£53 00
LD729	£61 50	M31-325BH	£29 00
5AP7	P O A	CME2024W	£21 00
D13-611GM	£79 50	DG7-6	£61 50
M7-120W	£15 75	M36-141W	£61 50
7ABP33A	£18 00	CME3132GH	£31 50
D13-630GM	£53 00	DG7-32	£28 80
M14-100GH	£18 00	M40-120W	£61 50
12CSP4	£27 00	CRE1400	£27 00
D14-150GH	£79 50	DG7-36	£12 00
M14-100LC	£23 50	M44-120LC	£61 50
89L	£27 00	CV1587	£29 00
D14-173GM	£79 50	E4412-B-9	£29 00
M17-151GVR	£112 00	MV6-5	£47 00
190CB4	£43 50	CV1976	£47 00
D14-173GR	£79 50	F16-101GM	£61 50
M23-112GV	£61 50	SE5FP31	£41 00
1074H	£43 50	CV2302	£79 50
D14-181GM	£79 50	F21-130GR	£41 00
M31-182V	£41 00	SE5JP31	£41 00
1396P	£43 50	CV2472	£61 50
D14-200GM	£79 50	F28-130LDS	£41 00
M31-184W	£41 00	SE328P31	£41 00

Please add £5 p&p. in UK and 17.5% VAT. For overseas p&p please enquire. 10,000 pieces in stock, 400 types. Please enquire for any type not listed above. We also have in stock camera tubes, image intensifiers, magnetrons, vidicons and audio valves. We wish to purchase valves type KT66, KT77, KT88, PX4, PX25, DA100 Minimum order £50 UK, £100 Export. Callers strictly by appointment only.

### BILLINGTON EXPORT LIMITED Unit 1E,

Gillmans Industrial Estate,  
Billingshurst, W Sussex,  
RH14 9EZ, UK.  
Tel: 0403 784961  
Fax: 0403 783519

**TELEVISION CLASSIFIED LINEAGE** advertisements can be submitted on this coupon with a cheque made payable to Reed Business Publishing, Television Classified Room 11th Floor, Quadrant House The Quadrant Sutton, Surrey SM2 5AS. The charge is £8.40 per line plus 17½% (minimum £33.60 + VAT)

For Issue Dated ..... or next available. Total insertions ..... Total of Cheque £.....

Name ..... Address.....

..... Post Code ..... Tel Num ..... Signature .....



Debit my Access/  
Visa Card (delete)



--	--	--	--	--	--	--	--	--	--	--	--	--	--	--	--	--	--	--	--

Expiry Date

VAT Reg No 2388937 10

### BURGLAR ALARMS

**FREE TECHNICAL ADVICE**  
**FREE DESIGN GUIDE**  
**FREE 16 PAGE FULL COLOUR CATALOGUE & FREE DELIVERY**

TRADE ENQUIRIES WELCOME



2A EALING ROAD, AINTREE, LIVERPOOL L9 0LR

TEL: 051-523 8440  
FAX: 051-523 8121

<b>MARCONI COMPACT L.N.B.</b> 1.2DB £30 10.7 TO 11.7GHZ		<b>60cm BACK MESH DISH</b> £20, £5 post		<b>Switched Mode Trans 3112.</b> 338. 32642 Ferguson £1		<b>VIDEO AMSTRAD HANDSETS (EXPORT) £2.50</b> <b>WILL WORK IN HOME MARKET</b> 6.000 and 4.600 4.700 £5		<b>SEND FOR DATA</b> D2 MAC SATELLITE RECEIVER, LNB AND DISH. £50 (£10 Post)								
<b>SATELLITE RECEIVERS — New Ferguson BSB</b> Chassis with Tuner, Modulator etc Hand Set £1.50 £4 Post			<b>60cm SATELLITE DISH £35</b> Postage £5		<b>SATELLITE FINDER KIT AND LNB TESTER WITH METER</b> BOX £25		<b>PB500 Panic and Button Transmitter 180MHz</b> £1.00 <b>G11 CAP 250V, 470M</b> £1.35		<b>New Eprom for converting Ferguson BSB Receivers to D2 MAC and PAL — 99 channel is tunable and each one can be put into memory — also has menu.</b> £20 <b>PAL panel (to convert to PAL)</b> £20 <b>SEND FOR DATA</b>							
<b>SMALL SATELLITE TUNERS (950 to 1750 MHz), L.F. frequency 4000MH</b> ..... £9.00 each <b>VHF/UHF S.BAND TUNER</b> ..... £3.00 <b>NEW PLASTIC CASE 32 C.H. SAT-RECEIVER (no hand set)</b> ..... £35 (Post £5) <b>NEW METAL CASE SAT-RECEIVER, 32 C.H. WITH DOLBY B &amp; CHANNEL C (no hand set)</b> ..... £35 (Post £5) <b>DAM MAINS CHASSIS AMSTRAD MONITOR C</b> ..... £10 <b>UNIVERSAL TRIPLER, NEW TYPE</b> ..... £4.00 <b>VIDEO LEADS</b> <b>AMSTRAD Law O.P. Transmitters with Diode 2SD9453</b> ..... £1.00 <b>BU208A</b> ..... £1.00 <b>VITRO LAMPS, Long Lead</b> ..... 24p <b>HITACHI &amp; GEC FRAME, Thick Film</b> ..... £6.00 <b>FIDELITY SPLIT DIODE</b> ..... FCC2215AE ..... £20 FCC2015BE ..... £10 FCC2215BE ..... £10 <b>K30 FRONT PANEL TEL-TEX TYPE</b> ..... £5.00 <b>NEW G11 LINE OP PANEL</b> ..... £8.00 <b>PHILIPS YEARS AHEAD</b> <b>THE CREDIT CARD CALCULATOR Solar Powered</b> ..... £3.75 <b>NEW PHILIPS SBC 1833 Solar &amp; Battery Powered Calculator</b> ..... £8.00 <b>THORN PANEL TX9 REC &amp; REMOTE PANELS with Mains Trans</b> ..... £5.00 <b>TX10 REC &amp; REMOTE PANELS with Mains Trans</b> ..... £5.00 <b>TX100 FRONT PANEL</b> ..... £5.00 <b>TX10 TUBE BASE ON PANEL</b> ..... £3.00 <b>TX9IF</b> ..... £2.00 <b>THORN PANEL No.515-353, 548.02, 565-01, 509/102, 515/173, 508/161</b> ..... £5.00 <b>THORN TX STEREO SOUND O.P. PANEL (I.C. TA7227P)</b> ..... £1.00 <b>THORN VIDEO AERIAL AMP 01 M4-597-001</b> ..... £6.00 <b>ULTRASONIC TRANSDUCER</b> ..... 15p						<b>CAMCORDER SANYO NP22</b> 6v 1300mah Rechargeable Battery Pack £6.00		<b>SATELLITE UNIT</b> Video Out/Audio Out, L and R Polariser ± 35M/A and Decoder Socket £10				<b>Gas Soldering Irons</b> Variety Nickel Cadmium Batteries from Telephone Type to Sub-C.50p per cell. Mainly in packs of 6 to 8.  New Type £10.00  THORN FRAME IC TX100 etc IC TDA 3652 IS OBSOLETE REPLACEMENT TDA 3654 £1 EACH				
<b>TX100 REMOTE PANEL</b> No.564131C M293B/and SAA5012 £10 etc			144MHz Changed Over Relay Aerial 50p		6251 FRAME O/P THICK FILM HITACHI GEC £9.00 THICK FILM HITACHI HM9205A £4.00		PHILIPS UNIVERSAL BATTERY TESTER SBC 1695 £5.00		TX100 SWITCH MODE TRANS 5157/48 £5 AND 00D4252001 06D3082001							
NICAM UNIT — Ferguson made for ICC5 Chassis — home market and export — has circuit diagram and can be converted to most sets — £15. TOSHIBA Nicam panel & IF export only has the Toshiba chip set £8.50			TX 85 FERGUSON BATTERY MAINS CONVERTOR £5 each		TX9-TX100 FRONT PANEL £5 WITH REMOTE £10 NON REMOTE 8 push button £10		BATTERY CONVERTER FOR TA185 FERGUSON TX85 £8.00		STEREO SOLAR RADIO VHF AND MW £10.00							
LARGE Foacs Pots. Fits Pye, GEC, ITT, Decca 75p			TX90 TO TX100 FRONT PANEL £5 8 Button		TX90 TO TX100 8 BUTTON UNIT £4.00		ONE I.C. K35 Decoder £10.00 PHILIPS Deck Calculator £7.00		1000V AC 1000V DC ETC. PHILIPS METER ANALOG £11							
<b>BSB SAT/REC HALF COMPLETED. CHASSIS, TUNER AND MOD £5 + Post £3</b>			<b>PHILIPS NEW TYPE U/V HANDSET £10</b>		MIXED TOSHIBA HANDSETS FIVE FOR £12		REGULATED PWR. SUP. 500M A 1.5V-12V DC switched + & - £5.00		G11 470 MFD 250v £1.35 420M/400 £1 220M 3850 £1							
GLASS BEADS Diodes 200w/1.2A 50 for £1.00			Have you got Acid Rain in your garden? PH METER Video Power Supply for Amstrad. Last year mods. Mains Transformer for Amstrad Video 25p (£1 post)		LATEST VIDEO For Latest Philips, GEC, Pye and Hitachi, Front panel with memory chip and bush button and pots and LED's £6.00 NEW		MADE BY PLESSEY — MADE IN ENGLAND New public telephone exchange original price cost £299.00 Network exchange line (at home or in a small business) has two telephones and cables and NS5107 control unit <b>SPECIAL PRICE £54</b> Send for data		12 Volt Relays 35p with D/P changeover 3MOTRE ..... 30p							
G11 LOPT Panel £4.00 G11 Tip Switch £20.00 G11 IF Panel £3.00 G11 Decoder Panel £2.00 G8 Push Button Unit £2.00 G8 Con/Panel New Back Type £4.00			FERGUSON CHASSIS IKC-2000 £20 TX86 Chassis £14 TX90 Chassis 14" £15 8 PUSH BUTTON £15 Post each, £5		SALORA SAT RECEIVER CONVERSION KIT For models 24M60, 25M90, 28M90, SB1206E, SB1365 £15		DECODER C-CAM PHILIPS MADE for K40 CHASSIS IC No. TDA 3590 £5.00		LEAD SCART TO D PLUG ..... 50p							
GEC, HITACHI DECODER PANEL TBA810AS, TBA120, HA1/215A, UPC1365 £10			SCART TO SCART LEADS TX90 REMOTE PANEL IC TMS1000 AND M293 £12		5 Mixed AMSTRAD VIDEO MOTORS £5.00		56420A 20A/600V THYRISTOR £1.75		BRIDGES RECTIFIER Mixed BR-31 to 34 2 Amp to 5 Amp ..... 8 for £1.00							
SATELLITE TUNER UNIT 2427611 with Base Band, Video Out £6.00			TX10 6 way button unit £8.00 24v O 24v 3amp MAINS TRANSFORMER £3.00 10 MIXED FERGUSON CIRCUIT DIAGRAMS MSH1PCF99 £5.00		SATELLITE TUNER UNIT 2427611 with Base Band, Video Out £6.00		LCD VIDEO AMSTRAD HANDSET for models 1900 £8 each		G11 8 WAY TIP SWITCH WITH DARW ASS £10							
2433752 £20 2432984 2432871 2432801 2435016 2433952 2434393 2432211 T946A DS785B243 TFB3069D K4L O.P.T. K35 L.O.P.T. K40 2433452 2432904 2434451 £14			<b>SPLIT-DIODE</b> 2433752 £15 TX100 Green Spot £15.00 TX100 Yellow Spot L.O.P.T. £10.00 TX90 White Spot L.O.P.T. £15.00 Split Diode 110" £12.50 Orion 65-3M GEC 85-9793-6 TX9 Thorn 2432101-2 £5		2434141 EACH £10 2434492 2435066 2434493		36761 36881 2692120/10 37051 CTK Lopt 36212 33651 36072 36072 36362 36482 36761 36831 36832 36833 3692179 3692279		<b>TRANSFORMERS</b> 24357/01 £10 2435012 £10 FERGUSON 47003481 £10 AMSTRAD TVR3 LPTS £10 TFB3069D EQU TFB4009AN		AT2036/00 AT2048/11 AT2055 AT2076/35 AT2076/38 AT2076/51 CVC 820 CVC 800 AT2076/55 AT2076/71T AT2080/15 RCO ST CT3325 OT2041 FB165KA Orion 2076/51 2432461 2433451		SHARP MSH1CF09 £10 EACH FIT MOST SETS New Thorn Hand Set Type w/v (£10) 0004-235 002-01 VIDEO MOTOR for VT568 type VC62DD8 £8.00 AMP TUNER IF for VT568 Hitachi & GEC £9.00			
SATELLITE TUNER 950MHz-1750MHz £5.00			BURGLAR ALARM £2.00 with siren 9 VOLT		PHILIPS HAND SET G11 TEXT ULTRASONIC £10		G11 TEXT IN RED HAND SET £15.00		G11 HAND SET ULTRASONIC £10		PHILIPS RC5 EASY CONTROL £10		U/V 6, DIODE TRIPLERS £2.00			
TTT PANEL CMC 301 CMC 113 CMC 302 CMC 115 CMC £5.00 303 CMC 96/4			25 Way Plug and Socket with Case £1.50		TRV3 Amstrad Cassette Mechanisms. New with 2 motors and sound head. £15 £5. Amstrad Television Tuner UHF. Small, Fits most Amstrads. £6.		FERGUSON SAT HAND SET SR D1 SR D2 SR D3 SR D4		FERGUSON ICC5 STEREO O.P. PANEL IC, TDA8405 TDA8421 TBA1204 £10		NICAM M2II KIT MODULE £20.00 with data		4600 TO 8600 AMSTRAD VIDEO HAND SET WITH LCD £10		Burglar Alarm Has time delay to set £2 Mains Transformer £4.00 240v in 110v to 120v out 1 amp post £3	
VIDEO LEADS 4 for £1			<b>SENDZ SEE BACK PAGE</b>		<b>SENDZ SEE BACK PAGE</b>		<b>SENDZ SEE BACK PAGE</b>		<b>SENDZ SEE BACK PAGE</b>		<b>SENDZ SEE BACK PAGE</b>		<b>SENDZ SEE BACK PAGE</b>			



# SENDZ COMPONENTS

0702 338894  
(To order see back page)

LA11440	£1.00	<b>TUNER UNITS</b> TX90 TX190 Tuners with AE socket £7 Thorn TX Tuner V/Cap eqv to ELC1043 £4.50 Thorn TX10 Export V/Cap UHF, VHF £3.00 ENV 5783G2F UHF/VHF Small £4.00 NEW G8 Tuner V/Cap £3.50 ELC 2000 on Panel £2.50 EG613F £7.00 VHF/UHF 2 BE01545A £6.00 ELC2000 NEW £4.00 GEC Tuner V/Cap Hitachi After 1979 £8.00 ET548, ET547, ET541B £6.00 E1546 £6.00 E1598A UHF/VHF Miniature Tuner £5.00 Hitachi ELC1042 £6.00 ELC1043 £6.00 Monitor Astec UM1233 50p	PHILIPS RC5410P £8 HAND SET
M5848P HA5138 SP TAA7780 HA11465ANT UPC1373 M5867P M491BB1 M5044U550 M5868P MS0130 - 850 SP MS0143 - 011P	£2 £3 50p £2.00 50p £1.00 £3.00 £1.00 £1.00 £3 £1	UE33-B01 Amstrad UHF Tuner £5.00 VHF UHF EG522F £6.00 ASTEC UM1183 £10.00 V314 (VHF) £5.00 V334 £4.00 U321 £6.00 U341 UHF £5.00 U342 (UHF) £5.00 U343 Phono £5.00 U344 Coax £6.00 U343C £10.00 U342C £4.00 U411 UHF £4.00 UJF10 £8.00 UJ411 Tuner £8.00 UJ417 £5.00 UJ618 Tuner £5.00 UHF VHF Tuner 1500DKO £5.00 U743 Tuner £3.50 U744 Tuner £5.75 Fidelity Amstrad 2000 V/Cap Tuner £5.00 Small V/Cap Mitsumi UHF £4.00 - VHF £3.00 Portable & Rotary Tuners Sanyo & Mitsumi UHF £5.00 Mosfit UHF/VHF (new type) £8.00 UF2-B31 Fidelity V/Cap T/Unit £6.00 UHF VHF V/Caps on panel £3.00 HITACHI 20 Turn Pot 40p U321 ca panel £6.00	Turntable Satellite Modulator TV £1 Sound 5.5MHz MPM 1000T £1 Sound 6.0MHz MPM 1040 £1
Receiver TX100 Panel I.C. No. SA13035 - MA18440P1066 - SAA1100 - ICF8571P	£10	ICCS Ferguson Switch Mxd Trans 3112-338-52642 £4.00	ICC5 E/W COIL £2
20 off £2.00 High Voltage Condenser D5 to RNZ 1500V to 2KV	£2	12v DC and 24v DC power supply regulated ICC5 L.O.P.T. DST R8B243 DST R8B243 £10.00 each Thorn Mixed £10.00	EARLY BIRD SAT TUNER WITH 950-1750 MHz BASE BAND £8 WITH DATA
TX9 C CAM Decoder	£5.00	Ferguson Hand Set ICCS £5 IK2000 £5 IK7000	FERGUSON LOPT FST 24" TX100 - 260482 £15
4 Types Fidelity front panels with i.c. & pots BB 103 BB 105A x12 BB 105B x12 BB 105G x12 HB121a	£2.00 each 10p £1.00 £1.00 £1.00 10p	KT3/K30 T/Ext £12.50 KT3/K30 Full remote £15.00 Pvc & Philips handset KT3-K30 chassis No RC5150-RC5176-RC5071-RC5177 Special Price £13.00 RC4001 KT3 and Teletex £14.00 TX10 Hand Set Text £12.50 TX9 with Text £12.50 TX9 & TX10 button print £2.00 TX10 Focus Pots £5.50	LOPTS AMSTRAD 3714016 £5 3216001 £5
1A/1600V DG3P EQV - BY228 2 amp bridge rec. wire end SKE4G20/2 Eqv. BYX71/600 500ohs	10p 10 for £1.00 15p 15p	Mains Stand By Switch with Coil £1.00	TOSHIBA REMOTE CT9123 £4
6 Push button switch I.T.T. GEC CVC45 ETC	£3.00	PHILIPS UNIVERSAL HAND SET £12.00 RCS KT3 - K45 - £10.00	TV GAMES COMBINER SWITCH £1
Hitachi TV IC HA51338SP/3	£3.00	We have all parts for Philips Handsets	AMSTRAD SANKYO CAPSTAN MOTOR 6,000 £3
TT14 GEC TEX-DECODER 13 IC Panel with cable form	£9.50	RC5353 £10 RC5300 EACH RC5176 RC5177	AMSTRAD LOADING MOTOR 6,000 £1
PHILIPS Decoder SAA 1C 5020-5030 5040B-5050	£8.00	TEX1-TYPE Replace Hand Set for Philips KT3-K30, K4 etc. £12.50	GRUNDIG TRIPLER BG-2032-642-3002 £5
K40 Text Panel	£8.00	THORN HANDSETS 9000 - 9600 - TX9 - TX10 - TX100 Text and Non-Text £10.00	HAND SETS FOR 6000 SERIES AMSTRAD FOREIGN ORIGIN WITH L.C.D. £2.50
ICCS TUBE BASE ON PANEL ICCS DECODER PANEL ICCS TEXT PANEL	£5.00 £15.00 £15	PHILIPS RC5171 (HAND SET) £12.00	FERGUSON PAY HAND SET 4 FOR £1
K35 Decoder K35 Sound OP Thick Film Daughter K13 33122-127-43891	£8.00 £4.00 £3.00	K35-K4 HAND SET Repaired for £5.00	TOSHIBA REMOTE CT9233 AND CT938 £3
12 CH. K30 Tex Rec Front Panel with I.C.	£5.00	SANYO MAGMTRON Type 2M218H £10	TOSHIBA TV TUNER, IF ENV 57836 G2F £3
Plug in K4 Focus Pot K40	£1.00	B SKY B VHF TO IF £5 BLOCK CONVERTER	HITACHI STAND BY MAIN TRANS £10 2213881 AND L210049
Fidelity Tube Base with transistor & focus pot	£1.50	10 Panels Ferguson Mixed from TX9 to ICC5 £20	PHILIPS K35 ETC 12 WAY SWITCH WITH KNOBS 50p
TX10 Tube Base on Panel	£3.00	TV Aerial Ring Type 40p	60.40 SOLDER 500G £4
PHILIPS HAND SET K35-K4-K40, etc	£10	TX100 Remote Hand Sets £6	HIGH GAIN TV ANTENNA UHF-VHF BUILT IN 32DB AMP 12V DC/220 AC £9.25
Universal Tripler with small focus pot. Green type	£7.00	Philips Video Remote Hand Set Works most sets. No L.C.D. Display £5	AMSTRAD VIDEO FRONTS WITH FLAP LONG CHASSIS ALL MODELS MADE IN 1991 TO 1992 AND DECCA PRO LINE £3
THORN CASSETTE HOUSING PAS26805U	£18.00	ITT-Nokia Tuner IF RF-IF-Module 5829/02 58 £6	AMSTRAD VI VIDEO CASSETTE MECHANISM FITS 30 DIFFERENT MODELS - OSAKI - TAI TUNG - DECCA - AKAI ETC 1991 TO 1992 WITH SINGLE PLAY HEAD £20
LITHIUM BATTERY BR-2/3 Volts	20p	SEL-ITT HF-Module 2 UK 5828-04-10 £6	AMSTRAD 6000 HEAD WITH MOTOR LP £12
TUNER, SAT 2000 KHC	£8	01 M4-412-001-RU1 8 Way Pre sets for TX10-TX100 £3	AMSTRAD - LONG CHASSIS AND SHORT CHASSIS POWER SUPPLY £4 MODELS 1991 TO 1992
HITACHI IC D1514C 036 £3 D1514C 046 E MN1250B1C A ST6393 B11Y A FD6140805A00 C TMP47C 1637N H MS0442-553P H		01 V6-251-002 Text Panel ICC5 Ferguson £10	AMSTRAD - DOUBLE DECKER SWITCH MODE £8 POWER SUPPLY
International Rectifier EHT Diodes G7701HV34 6KV 3 for 8p 6A/600V Stud Diodes 20p BTW 92800R £3.00 6A/1000V Stud Diodes 20p 24A473 PNP/CP 10p DL 711 Mullard £1		Sharp Tuner and IF 1810587 PAL1 UK £3 Tuner IF UE90-BO 3 Amstrad £3	AMSTRAD - DOUBLE DECKER PANELS. DOUBLE DECKER FRONT £7
			AMSTRAD LONG CHASSIS DISPLAY PANEL 1992 TO 1993 £4
			AMSTRAD TUNER UE33-B01 £3 IF £2
			6 FOR £10 TX10 FOCUS UNIT
			CONVERSION KIT IIT TELETEXT £8 BURGLAR ALARM SIREN 12 VOLT 50p
			HANDSETS AMSTRAD EASY CONTROL MODELS 4600 TO 8600 £3 each
			FERGUSON THOMSON SAT HANDSET SRD1 TO SRD4 £2 each
			AMSTRAD NEW VIDEO DISPLAY PANELS ETC. YEAR OF MODELS 1991 TO 1992 - 20 FOR £10
			1993 TOSHIBA FAST TEXT HAND SET £3.50
			AMSTRAD IC FOR VIDEOS 6206 TO 8600 DISPLAY IC 14 DN 728 AND 14 DN 513
			AMSTRAD 6000 MODULE IC MN616 3AS AND 6367S
			TOSHIBA HEAT SYNC COMPOUND £6 FOR KILO DRUM

