

AUGUST 1993

£2.20

TELEVISION

SERVICING·VIDEO·SATELLITE·DEVELOPMENTS

**Simple Nicam
VCR Upgrade**

**Test Report:
Desoldering
tool**

VCR Clinic

**Amstrad MP3
TV Adaptor**

**Servicing the
Samsung
BT110**

**Shadowmask
Tube**

**TV Fault
Finding**

Serviceman's Guide to PCs

**FREE 32-page
CATALOGUE INSIDE**



A REED BUSINESS PUBLICATION





WILLOW VALE ELECTRONICS LTD

**NO
PART No?
NO
PROBLEM**



CALL NOW

**READING
0734 876444**

**MANCHESTER
061 682 1415**

**NOTTINGHAM
0602 870789**

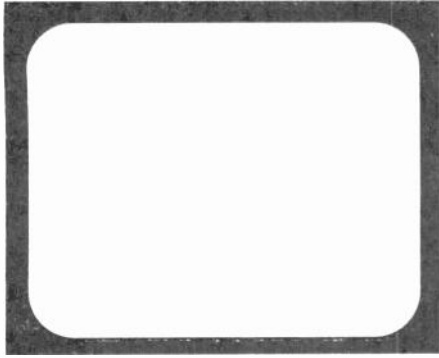

TELEVISION

**AUGUST
1993**

**Vol. 43, No.10
Issue 514**

On sale July 21st

COPYRIGHT

© Reed Business Publishing Ltd., 1993
Copyright in all drawings, photographs
and articles published in *Television* is
fully protected and reproduction or imita-
tion in whole or in part is expressly for-
bidden. All reasonable precautions are
taken by *Television* to ensure that the
advice and data given to readers are
reliable. We cannot however guarantee it
and we cannot accept legal responsibility
for it.

CORRESPONDENCE

All correspondence regarding advertise-
ments should be addressed to the
Advertisement Manager, "Television",
Quadrant House, The Quadrant, Sutton,
Surrey SM2 5AS. Editorial correspondence
should be addressed to "Television"
Editorial Department, Reed Business
Publishing, Quadrant House, The
Quadrant, Sutton, Surrey SM2 5AS.

INDEXES AND BINDERS

Indexes for Vols. 38 to 42 are available at
£3.50 each from Video Interface Products
Ltd., who can also supply a five-year con-
solidated index on computer disk. For
further details see page 709.

Binders that hold twelve issues of
Television are available for £5 each from
Television Binders, 78 Whalley Road,
Wilpshire, Blackburn BB1 9LF. Make
cheques payable to "Television Binders".

SUBSCRIPTIONS

An annual subscription costs £26 in the
UK, £30 overseas (by surface mail -
airmail quote on request). Send orders
with payment to Quadrant Subscription
Services Ltd., Oakfield House, Perry Mount
Road, Haywards Heath, Sussex, RH16
3DH.

Subscription hotline for 24-hour ordering
with Credit Card telephone 0622 721666
quoting INJ.

BACK NUMBERS

Some back issues are available at £2.75
each from Television Back Issues, Room
L323, Quadrant House, The Quadrant,
Sutton, Surrey SM2 5AS. Make
cheques/postal orders payable to Reed
Business Publishing Ltd. See box on page
707.

697 **Leader**

698 **Teletopics**

700 **TV Fault Finding**

Reports from Stephen Leatherbarrow, Steve
Cannon, Hugh MacMullen, Roger Burchett, Richard
Flowerday, Richard J. Avis, Nick Beer, Richard
Newman, Michael Dranfield and John Edwards.

704 **A Serviceman's Guide to PCs, Part 1**

David Botto

708 **What a Life!**

Donald Bullock

709 **Test Case 368**

710 **Modern TV Receiver Techniques, Part 8**

Eugene Trundle

How the shadowmask colour picture tube works
and its drive requirements, including a look at RGB
output stages.

714 **The Satmaster Pro PC Package**

Nick Beer

716 **A Simple Nicam VCR Upgrade**

Ian Martin

718 **Test Report: Denon SC7000 Desoldering Tool**

Steve Beeching

719 **Servicing the Samsung Model BT110**

J.W. Riggs

720 **Modifying the Amstrad MP3 TV Adaptor**

Brian Williams

723 **Next Month in Television**

726 **VCR Clinic**

Reports from Nick Beer, John Edwards, Noel E.
Evans, Alfred Damp, Michael Dranfield, Richard
Flowerday, Brian Storm, Ronald Aranha, Richard J.
Avis, Terry Lamoon, Richard Newman and Stephen
Leatherbarrow.

729 **Coaxial Cable RC Relay System**

Keith Wevill, B.Sc.

730 **Letters**

735 **Camcorner**

Reports from Simon Bodgett, Ronald Aranha, David
C. Woodnott, Brian Storm and John C. Priest.

736 **Long-distance Television**

Roger Bunney

738 **Satellite Notebook**

Nick Beer

739 **CD Player Casebook**

Reports from Mike Leach and Nick Beer.

**OUR NEXT ISSUE DATED SEPTEMBER
WILL BE PUBLISHED ON AUGUST 18**

Table with multiple columns containing electronic components such as resistors (BC107, BC108, BC109), diodes (2N6385, 2N6403), transistors (EY86, EY87), and integrated circuits (LA2000, LA2010). Includes sub-sections for Rectifier, Diodes, LED's, I.C. SOCKETS, CRYSTALS, VOLTAGE REGULATORS, and VALVES.

Table listing various electronic components and their prices. The table is organized into columns with component names and prices. A 'COMPUTER ICs' section is highlighted in a dark box on the right side.

Table listing various electronic components such as VCR Pinchrollers, Diode Split Transformers, Video Motors, Cassette Housing, and Motor Switches, with their respective part numbers, descriptions, and prices.

VIDEO SERVICE KITS

AMSTRAD

VCR700
Contents
 BELT SET PINCH ROLLER REEL IDLER VIDEO LAMP
 Order Code: SK41 £5.50

FERGUSON & JVC

3V42/43
 HRD455/HRD725
Contents
 BELT SET PINCH ROLLER CLUTCH MECHANISM TENSION BAND
 Order Code: SK37 £17.50
Economy Kit Contents
 BELT SET PINCH ROLLER SUPPLY CLUTCH TAKE UP CLUTCH
 Order Code: SK38 £9.50

3V58/59/64/65
 HRD170/180/210/230/300/320/370/400/430/530/700/750
 HRS5000
Contents
 BELT SET PINCH ROLLER IDLER ARM TENSION BAND
 Order Code: SK44 £8.50

3V29/3V30
 HR7200/7300/7350
Contents
 BELT SET PINCH ROLLER TENSION BAND IDLER TYRES
 Order Code: SK05 £6.00

3V35/36/38/39/49
 HRD110/111/120/225
Contents
 BELT SET PINCH ROLLER TENSION BAND IDLER TYRES
 Order Code: SK04 £5.50

3V31/3V42
 HR7600/7610/7650/7655
Contents
 BELT SET T/U REEL TABLE TYRE PINCH ROLLER REEL IDLER T/U CLUTCH T/U IDLER TENSION BAND VIDEO LAMP
 Order Code: SK33 £12.00
Economy Kit Contents
 BELT SET T/U REEL TABLE TYRE PINCH ROLLER REEL IDLER TYRE T/U IDLER TYRE T/U CLUTCH
 Order Code: SK34 £5.50

3V35/36/38/39/49
 HRD110/111/120/121/225
Contents
 BELT SET T/U REEL TABLE TYRE SUPPLY REEL TABLE TYRE PINCH ROLLER T/U CLUTCH T/U IDLER REEL IDLER TENSION BAND
 Order Code: SK35 £10.50
Economy Kit Contents
 BELT SET T/U REEL TABLE TYRE SUPPLY REEL TABLE TYRE PINCH ROLLER T/U CLUTCH T/U IDLER TYRE REEL IDLER TYRE
 Order Code: SK36 £6.50

3V29/3V30
 HR7200/7300/7350
Contents
 BELT SET T/U REEL TABLE TYRE SUPPLY REEL TABLE TYRE PINCH ROLLER REEL IDLER T/U CLUTCH T/U IDLER TENSION BAND VIDEO LAMP
 Order Code: SK31 £11.50
Economy Kit Contents
 BELT SET T/U REEL IDLER TYRE SUPPLY REEL TABLE TYRE PINCH ROLLER REEL IDLER TYRE T/U IDLER TYRE T/U CLUTCH
 Order Code: SK32 £5.60

3V44/45/48/53/54/55/57
 HRP50/HRD140/150/158/160
 HRD250/257/565/566/755
Contents
 BELT SET PINCH ROLLER CLUTCH MECHANISM TENSION BAND
 Order Code: SK39 £15.00
Economy Kit Contents
 BELT SET PINCH ROLLER
 Order Code: SK40 £9.50

FISHER

FVHP935/906/907/908/910/911/916/918
Contents
 BELT SET PINCH ROLLER IDLER GEAR IDLER UNIT TENSION BAND
 Order Code: SK57 £13.00
Economy Kit Contents
 BELT SET PINCH ROLLER IDLER TYRE
 Order Code: SK58 £5.00

FVHP615/618/620/622/710/711/715/716/720/721/722/725/
 730/830/840
Contents
 BELT SET PINCH ROLLER IDLER GEAR IDLER UNIT TENSION BAND
 Order Code: SK68 £12.50
Economy Kit Contents
 BELT SET PINCH ROLLER IDLER TYRE
 Order Code: SK69 £3.60

HITACHI

VT11/VT33
Contents
 BELT SET PINCH ROLLER TENSION BAND IDLER TYRES
 Order Code: SK08 £6.00

VT11/VT33
Contents
 BELT SET T/U REEL TABLE TYRE SUPPLY REEL TABLE TYRE PINCH ROLLER FF/REW IDLER CLUTCH PLATE TENSION BAND
 Order Code: SK45 £15.00
Economy Kit Contents
 BELT SET PINCH ROLLER FF/REW IDLER TYRE T/U REEL TABLE TYRE SUPPLY REEL TABLE TYRE
 Order Code: SK46 £4.50

VIDEO SERVICE KITS (Cont.)

HITACHI

VT52/61/62/63/64/65/85/86/640
Contents
 BELT SET PINCH ROLLER FF/REW ARM CLUTCH PLATE TENSION BAND
 Order Code: SK49 £14.00
Economy Kit Contents
 BELT SET PINCH ROLLER FF/REW IDLER
 Order Code: SK50 £3.25

VT400/405/410/13/14/15/18/420/25/26/28/430/31/35/48/450/498/
 510/520/25/26/530/35/36/540/545/46/48/570/75/576/580/85-88
Contents
 TIMING BELT PINCH ROLLER FF/REW ARM CLUTCH BASE TENSION BAND
 Order Code: SK52 £11.50

VT100/110/111/113/115/118/120/125/128/130/135/138/145/150/
 175/220/225/250/255/258/260/VTL30
Contents
 BELT SET PINCH ROLLER FF/REW ARM CLUTCH PLATE TENSION BAND
 Order Code: SK51 £15.00

PANASONIC

NV2000/NV2010 NV7000/NV7200/NV7600
Contents
 BELT SET PINCH ROLLER TENSION BAND IDLER TYRES
 Order Code: SK03 £6.25
Economy Kit Contents
 BELT SET PINCH ROLLER TENSION BAND IDLER TYRES
 Order Code: SK02 £5.50

NV300/NV330/NV333/NV340/NV366
Contents
 BELT SET PINCH ROLLER TENSION BAND IDLER TYRE
 Order Code: SK01 £5.50

NV2000/NV2010
Contents
 BELT SET PINCH ROLLER FF IDLER PLAY IDLER TENSION BAND VIDEO LAMP
 Order Code: SK13 £9.50
Economy Kit Contents
 BELT SET PINCH ROLLER IDLER TYRE PULLER TYRE
 Order Code: SK14 £4.50

NV7000/NV7200/NV7600
Contents
 BELT SET PINCH ROLLER IDLER UNIT PLAY IDLER TENSION BAND
 Order Code: SK11 £10.00
Economy Kit Contents
 BELT SET PINCH ROLLER IDLER TYRE CLUTCH TYRE
 Order Code: SK12 £4.20

NV300/NV330/NV333/NV340/NV366
Contents
 BELT SET PINCH ROLLER IDLER UNIT PLAY IDLER TENSION BAND
 Order Code: SK15 £8.00
Economy Kit Contents
 BELT SET PINCH ROLLER IDLER TYRE PLAY IDLER TYRE
 Order Code: SK16 £4.00

NVG7/NVG9/NVG10/NVG11/NVG12/NVG14/NVG15/NVG16/
 NVG18/NVG30/NVG120/NVG130/NVG400/NVH65 (PX/AC)/
 AG1810 (PK)
Contents
 LOADING BELT CAPSTAN BELT PINCH ROLLER IDLER TENSION BAND
 Order Code: SK27 £9.50
Economy Kit Contents
 LOADING BELT CAPSTAN BELT PINCH ROLLER IDLER TYRE
 Order Code: SK28 £4.50

NV332
Contents
 BELT SET PINCH ROLLER PLAY IDLER FF/REW IDLER TENSION BAND FF/REW TYRE
 Order Code: SK29 £13.00
Economy Kit Contents
 BELT SET PINCH ROLLER PLAY IDLER TYRE FF/REW IDLER TYRE
 Order Code: SK30 £5.10

NV230/250/260/280/430/450/460/470/650/810/890/
 AG1200PK/AG1500PK
Contents
 BELT SET PINCH ROLLER IDLER TENSION BAND
 Order Code: SK23 £7.00
Economy Kit Contents
 BELT SET PINCH ROLLER IDLER TYRE
 Order Code: SK24 £3.50

NV600/NV688
Contents
 BELT SET PINCH ROLLER PLAY IDLER FF/REW IDLER TENSION BAND
 Order Code: SK25 £13.00
Economy Kit Contents
 BELT SET PINCH ROLLER PLAY IDLER TYRE FF/REW IDLER TYRE
 Order Code: SK26 £6.50

NV730/NV770
Contents
 SLOT IN BELT LOADING BELT PINCH ROLLER IDLER UNIT TENSION BAND
 Order Code: SK19 £7.00
Economy Kit Contents
 SLOT IN BELT LOADING BELT PINCH ROLLER IDLER TYRE
 Order Code: SK20 £4.30

NV370/NV380/480/630/780/830/850/AG2100PK/AG2200PK
Contents
 BELT SET PINCH ROLLER IDLER TENSION BAND
 Order Code: SK21 £7.00
Economy Kit Contents
 BELT SET PINCH ROLLER IDLER TYRE
 Order Code: SK22 £3.50

NV777/NV788
Contents
 BELT SET PINCH ROLLER IDLER UNIT TENSION BAND
 Order Code: SK17 £7.50
Economy Kit Contents
 BELT SET PINCH ROLLER IDLER TYRE
 Order Code: SK18 £4.00

VIDEO SERVICE KITS (Cont.)

SHARP

VC381
Contents
 BELT SET PINCH ROLLER REEL IDLER TENSION BAND VIDEO LAMP
 Order Code: SK47 £9.00
Economy Kit Contents
 BELT SET PINCH ROLLER REEL IDLER TYRE
 Order Code: SK48 £5.00

VC500/VC571/VC581/VC582/VC583/VC584/VC5F3
Contents
 BELT SET PINCH ROLLER REEL IDLER TENSION BAND
 Order Code: SK6* £9.50
Economy Kit Contents
 BELT SET PINCH ROLLER REEL IDLER
 Order Code: SK61 £6.50

VC781/VC7810/VC7822/VC785/VC786/VC793/VC800/
 VCA100/VCA102/VCA104/VCA202
Contents
 BELT SET PINCH ROLLER REEL DRIVE UNIT TENSION BAND
 Order Code: SK64 £13.50
Economy Kit Contents
 BELT SET PINCH ROLLER REEL DRIVE UNIT TYRE
 Order Code: SK65 £6.25

VC681/VC682/VC684/VC685/VC693/VC699/VC6F3/VC700
Contents
 BELT SET PINCH ROLLER REEL DRIVE UNIT TENSION BAND
 Order Code: SK62 £13.50
Economy Kit Contents
 BELT SET PINCH ROLLER REEL DRIVE UNIT TYRE
 Order Code: SK63 £6.25

THIS MONTHS SPECIAL OFFERS

STK461	£6.00	STK7563F	£8.00
STK5332	£3.75	STK73410	£3.50
STK3333	£2.40	TAB205AH	£2.50
STK5422	£1.50	TAB210AH	£3.00
STK5476	£3.50	TAB215H	£3.00
STK7308	£3.50	TAB216H	£3.75
STK7348	£2.80	TIPL791A	£0.80
STK7358	£4.40		

VIDEO REEL MOTOR PU51381V £15.00
 3v29, 3v30, 3v31, 3v32, 3v39,
 8930, 8931, 8941, 8942, HR7200,
 HR7300, HR7600, HR7610,
 HR7650, HR7655

HITACHI VIDEO HEAD £11.00
 VT11, VT14, 16, 30, 33, 34, 330,
 340, 503, 640, 5030

PHILIPS VIDEO HEAD £16.00
 HS303, 3C4, 320, 700

HS306, 318, 710 £18.00
 HS300, 301, 302, 310 £17.00
 HS337, 347 £17.00

PHILIPS CASSETTE 'JIT ASSEMBLY' 69122366 £11.00
 DV186, 190, 286, 471, 562, 761, VR6180, 6182, 6185,
 VR6285, 6290, 6292, 6293, 6362, 6367, 6393, VR6467, 6468,
 6470, 6561, 6670, 6760, 6761, 687C, 6970

PRESSURE ROLLER ASSEMBLY £5.00
 DV186, DV190, DV286, DV486, DV471, DV582, DV571,
 DV761, VR6180, VR6182, VR6185, VR6285, VR6290,
 VR6291, VR6293, VR6362, VR6367, VR6390, VR6391,
 VR6393, VR6467, VR6468, VR6470, VR6561, VR6570,
 VR6581, VR6670, VR6676, VR6676, VR6676, VR6762,
 VR6870, VR6970, VR6975, VR86B1, 63SB7, 68SB4,
 71SB4, 72S38, 92SB31

VIDEO HEAD TESTER

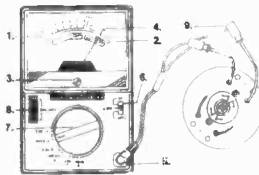

- Mechanical Position of Pointer
- Scale Plate
- Pointer Adjusting Screw
- Pointer
- Measuring Socket
- Power ON/OFF and Battery Check Switch
- Range Selector Rotary Switch
- CAL. ADJ. (calibration volume)
- Measuring Clip

	PRICE
YF-220 VHS	£30.00 + VAT
YF-225B BETAMAX	£29.00 + VAT

GRANDATA LTD

K.P. HOUSE, UNIT 15, POP IN COMMERCIAL CENTRE,
 SOUTHWAY, WEMBLEY, MIDDLESEX, ENGLAND
 Telephone: 081-900 2329 Telex No: 932 885 (Sunmit)
 Fax: 081-903 6126

Access & Visa Card accepted.

Open Monday to Saturday.

JUST ARRIVED

VIDEO HEADS

AKAI	
VSF600, VSF650	3800P
VP7100, VP7200, VP77	1500P
VS155, VS165	2600P
VS20, VS22, VS24, VS25, VS26, VS27, VS422, VS425, VS426, VS427, VSF10, VSP8, VSP9	1700P
VS240, VSP82, VS202	1500P
VS33	2600P
VSR9	1700P
AMSTRAD	
VCR8800, VCR8804, VCR9340	2400P
DD8900, DD8904, TVR4, VCR6200, VCR8600, VCR8602, VR8700	1300P
VCR8603, VCR8604, VCR8704, VCR8714	1350P
BAIRD	
VC14L	3000P
VHS82	7000P
BLAUPUNKT	
CR1000, CR1200, CR1500	4650P
CR1800	4100P
RTV321, RTV322	1700P
RTV330	2300P
RTV333	1000P
RTV338	2800P
RTV348	2700P
RTV404, RTV414	3000P
RTV635	3000P
RTV640	3000P
RTV750, RTV800, RTV900	3500P
RTV810	4400P
RTV910	4500P
JVC	
HRD330, HRD337, HRD440, HRD637, HRD641, HRD660, HRFC100	2200P
JVC AND FERGUSON	
8902/8903/8909/8912/8922	1000P
8923/8925/8929/8935	650P
8931/8933	750P
FV43H, HRD860	3800P
VC141L, HRD190, HRD610	3050P
FV44L	2200P
BR1600, HRD142, HRD156, HRD152	1550P
BR6200	720P
HRD154, HRD217, HRD321, HRD350, HRD521, HRD522, HRD525, HRD527, HRD550	1700P
HRD580, HRD620, HRD650	2900P
FIDELITY	
VR900, VR910	1600P
FISHER	
FVHD140, FVHD40, FVHP1, FVHP10, FVHP20	1600P
FVHP40, FVHS10	2100P
FVHP200, FVHP210, FVHP300, FVHP310	1200P
FVHP500, FVHP5100, FVHP730, FVHP830	2500P
FVHP980	2500P
FUNAI	
E1100, VIP5000	1200P
VCR5840, VCR8007, VIP2500A, VIP3000A, VIP6000, VIP150	2200P
VCR4530, VCR6000, VCR6100	1600P
VCR8103, VCR6000, VCR6100	1600P
VCR8103, VCR8107	2200P
VIP3000A MKII	1900P
GEC	
V4005H	2000P
GOLDSTAR	
GHV1232, 1233, 1241, 1242, 1243, 1244, 1290, 1291, 1295, 1296, 1891, VCP4130, 4300, 4301, 4305, 4306, 4310, 4311, 4315, 4316, 4320, 4321, 4326	1650P
GRUNDIG	
VS456	1700P
SE6110, SE9100, TVR4510, TVR5510, VS500, VS510, VS5180, VS6190, VS700, VS900	1800P
VS790, VS930, VS940	3800P
MVS660, SE6160, VERONA, VS660, VS6690	3500P
MVS710, MVS720, MVS910, SE9120, VS800, VSB10, VS910, VS920, SE7120, VS710, VS720	1800P
VS160, VS740	4400P
VS170	4600P
VS680	4600P
HINARI	
VCR34H, VTV200, VXL90	1850P
HITACHI	
VT15, VTP10, VTP30	1100P
VT16B, VT260, VT498	2700P
VT570, VT575, VT576, VT580, VT585, VT588	3400P
VT5600	1200P
VT60	1500P
VT660E	2600P
VT6700, VT6800	1200P
VTL30	2100P

VT522, VTM620, VTM622, VTM720, VTM722, VTM822	2000P
VTM725, VTM726, VTM728	1600P
ITT	
VR3520, VR3701, VR3719, VR3720, VR3721, VR3759, VR9720	2000P
VR3730, VR3731, VR3749, VR3907, VR3908	2700P
VR3918, VR3919, VR3938	1800P
VR396B	7000P
VR3984	2300P
VR3958, VR4993	650P
VR4913, VRP3833	650P
LUXOR	
9245, 9251, 9254	1225P
9255, 9256	2150P
9270, 9271, 9273	1800P
9272, 928217	2700P
9252	2500P
928017, 928077, 928097, 929107, 929117	1700P
9253	2500P
9281	2700P
9284, 9295, VR3701, VR3721, VR3731, VR3761	2100P
MATSUI	
VX600	1100P
VX750	1500P
VX990	1600P
MITSUBISHI	
HSE12, HSE22, MX1	2400P
HS411EZ, HS411GZ	2900P
HS273	1700P
HSB10, HSB20, HSE10, HSE20, HSE21, HSE41	2200P
HSB11, HSB21	2200P
HSB30	2400P
HSE31, HSB31, HSE32	2800P
HSE50	3300P
NATIONAL	
NV8050, NV8051	2800P
AG1000, AG1050, NV260	1650P
AG6010, AG6015	2500P
AG6840	2400P
NV200	850P
NVD80	5000P
NVF65, NVH75	3400P
NVF51	4200P
NVG19	2300P
NVJ33, NVL21, NVJ30	1800P
NVJ35	3000P
NVM1, NVM3, NVM5	4200P
AG2100, AG2200	700P
NVF65	3200P
N.E.C.	
DX2000	3400P
DS6000	3500P
DX1000, DX1600, N9040, N9053, N9055	2000P
DX4000, N9610, DX3000	3200P
N9052, N9530	3400P
N9110, N9120, N914C	2700P
VCP1	1700P
PVC2300, PVC240, PVC740, PVC744, PVC760, PVC764	1600P
SAMSUNG	
VM1560, VN1561	2200P
SANYO	
VHR7900	3600P
SHARP	
VC585, VC685	2300P
VC90ET	3900P
VFH815	2800P
SONY	
SLV373UB	3000P
TOSHIBA	
V660	2350P
V880MS	2600P
V700G	3700P
V500G, V509G	2500P
V9680	2900P
V300G, V301, V305, V309G	2550P
V61, V63	1700P
V110, V120, V130, V140, V210, V220	1800P

TELEVISION ON/OFF MAINS SWITCHES

Baur, Normende, Nova, Pioneer, Quelle, Saba, Salora, TEC, Thomson & Vega 375P

VIDEO MOTORS

HITACHI	
VT11, VT14, VT15, VT16, VT17, VT19, VT35, VT39, VT57, VT88 (capstan motor)	3100P
BANG & OLUFSEN	
VHS65, VHS90 (capstan motor)	3100P

LOADING MOTOR UNITS

ITT	
VR3605, VR3905, VR3955, VR3985	1100P
VP2826, VR3906, V43926, VR3976	1250P
VP3946, VR3906, VR3948, VR3986, VR3995, VR6948	1500P
JVC	
HRD110, HRD111, HRD120, HRD121, HRD225	1100P
HRD140, HRD150, HRD157M, HRD158MS, HRD160, HRD250, HRD257MS, HRD566, HRP50	1250P
HRD455, HRD725, N895	1500P
SABA	
VR6005, VR6014, VR7004, VR7011, VR8011, VR8014	1100P
VR6006, VR6007, VR608, VR6009, VR6018, VR7007, VR7018, VR9006	1250P
VR6016, VR6038, VR7016	1500P
TELEFUNKEN	
VR1925, VR1930, VR1940, VR1950, VR925, VR930, VR940, VR950	1100P
A920, VR2920, VR12970, VR7921, VR7926, VR7931, VR7971, VR975	1250P
VR1970, VR1980, VR7970, VR7980, VR970, VR980	1500P
THOMSON	
V320, V321, V323, V326, V4200, V4300	1100P
V342, V343, V352, V353, V360, V4210, V4230, V4260	1250P
V364, V368, V4400, V6000	1500P
THORN-FERGUSON	
3V35, 3V36, 3V38, 3V39, 3V49, 8943, 8944	1100P
3V44, 3V45, 3V48, 3V54, 3V55, 3V57, 8947, 8947B, 8948	1250P
3V43, 9845	1500P
TOSHIBA	
V55, V57	1100P
V65, V66, V67	1250P
V61, V63	1500P

CASSETTE HOUSING

AKAI	
VS35, VS53, VS55, VS66, VS75	2600P
FERGUSON	
FV31R	4300P
JVC & FERGUSON	
HRD515, HRD520, HRD527, HRD540, HRD550, HRD580, HRD600, HRD610, HRD620, HRD660, HRD670, HRD830, HRD840, HRD850, HRD860, HRD4050, HRD6600 & FV37H	1350P

IC TRANSISTORS

M491BB1	500P
SAAS243PE	800P
TIP112H	50P
UPC1488H	150P
STR4090A	650P

IC AND TRANSISTORS

BU506DF	120P
BUZ11	200P
BUZ80	200P
M494B1	700P
SAAS231	300P
SAAT293	550P
S2000A3	175P
S2000AF	175P
S2055A	175P
S2000AF	200P
S2530A	100P
TEA201BA	200P
UC3844	100P
UPC1185H2	400P

REMOTE CONTROLS

AKAI	
RC-V10A	1000P
RCV37B	1000P
V25A	1000P
BUSH	
2020T, 2114T, 2321T, 2514T	1000P
2020, 2114, 2321, 2514	1000P
DECCA	
RC70	850P
FISHER	
RC905B	1000P
GRANADA/REDIFFUSION	
UNIVERSAL, 79500C, 986700	850P
SATELLITE	1000P
MK4 TEXT, 70115G, 70133G, 70357E	850P
MK4A TEXT, 70375C	850P
95288E	1000P
94490D	1000P

REMOTE CONTROLS

GRUNDIG	
TP160E	1050P
TP200, TP300	1000P
TP400	850P
TP590-600	1050P
TP390, TP610	1050P
TP621	1050P
TP630, TP650	1000P
TP660	1050P
TP661	1050P
HITACHI	
CLE800-CLE830	900P
A617402/655602	1000P
A512120/230	1000P
A514790	1000P
A5088470	1000P
A518612	1000P
SCL002	1000P
C2096	1000P
A511940	1000P
655602H	1000P
ITT	
IFB13, 14, 15	900P
FS4	850P
RG305	900P
RG306	900P
FS9/1-10/1	900P
VS5 RUK	900P
VS4-1	900P
MULTICONTROL (17C20)	1000P
KORTING	
18279, 18396, 18460, 18521 SE	1000P
40540 VTS	1000P
LOEWE	
DC11	1000P
MATSUI	
010270601	1000P
VX770	1000P
METZ	
JAVA COLOR (6890)	1000P
COLOR (7156)	1000P
JAVA (7180)	1000P
MITSUBISHI	
939P/03607, 939P/03609	900P
NOKIA	
SATELLITE	
1000P	
NORDMENDE	
TC2336	1050P
CMC1, TC3519	1050P
OCEANIC	
390C9500	1000P
ORION	
RC53	1000P
PANASONIC	
EUR51200	900P
TC2200	900P
VSQ0357/NV730	1050P
TNQ1621	1000P
PHILCO	
CARVEL, CONCORDE, MERCURY	1000P
TELESTAR	
TC10	1000P
PHILIPS	
RC5002, 5154	900P
KT3 NON TEXT	900P
69117032	1050P
69117194	1050P
RC5991 UNIV	850P
RC3B	900P
KT3 TEXT	900P
RC5352	900P
RC5375	900P
RC5 STANDARD	900P
RC5901	900P
RC5903	900P
SABA	
T6772	1000P
TC319-320	1050P
TC356	1050P
TC358	1050P
TC360	1000P
TC365	1000P
SALORA	
SERIES L	1000P
86173	1000P

SANYO	
RC218, RC222, RC228, RC238	900P
JXGE	1000P
JXDE	1000P
VHR2300	1000P
RC628	1000P
SHARP	
G0121CESA, 123CESA, 204, 251	900P
SIEMENS	
FC616	1000P
FC631	1000P
FC742	1000P
SONY	
RM604, RM605, RM606	900P
32 CHANNEL	900P
RM613	900P
RM632, RM636	900P
TATUNG	
FXA	1000P
RC70	900P
FX70 FASTTEXT	850P
TELEFUNKEN	
FB632	1000P
FB639	1000P
THORN/FERGUSON	
3V35-42	900P
3V31-32	900P
3V57-58	1050P
TX10 TEXT	850P
TX10 STEREO TEXT	850P
TX9-90-100	850P
3V55, FV11	1050P
TX100 FASTTEXT	900P
TX100 STEREO FASTTEXT	900P
PROFESSIONAL	850P
TOSHIBA	
CT937	1000P
CT9117	1000P
201R4B	1000P
UNIVERSAL PROGRAMMABLE REMOTE CONTROL	
Controls up to 4 different devices which use infra red remote controls including TV, audio, VCR and satellite. (Need original remote control to program)	
Order code: IR100R	Price: 1950P

We stock Remote Controls for over 5000 different models. Ring for further details on 081-900-2329.

BACKUP BATTERIES

REPLACEMENT PHILIPS NI-CAD BACKUP BATTERIES		
Replaces Philips Part No's:		
138-10138, 138-10313. 1.2V - 90mAh	160P	
Replaces Philips Part No's:		
138-10229. 2.4V - 90mAh	260P	
REPLACEMENT FERGUSON NI-CAD BACKUP BATTERIES		
Replaces Ferguson Part No: 00E6-067-001.		
1.2V		
Used on: TX10	180P	
Replaces Ferguson Part No's: 00E6-066-001.		
2.4V		
Used on: 3V35, 3V56, 3V58, 3V65	375P	

LINE OUTPUT TRANSFORMERS

Description	Price	Order Code
HITACHI 2433752	1500P	LOT01
ORION 3714002	1500P	LOT02
FIDELITY ZX300	1500P	LOT03
FE TX100 90 DEG	1500P	LOT04
SABA 490007182	1500P	LOT05
FE TX90 WHITE	1650P	LOT06
ITT D307/37 EQ	1600P	LOT07
BLAUPUNKT 210	1600P	LOT08
GRUNDIG 2922010	1600P	LOT09
ITT CVC800/1/3	1500P	LOT10
ITTD218/37 EQ	1600P	LOT11
NORMENDE 5255	1600P	LOT12
SABA 81000 200	1600P	LOT13
SALORA T236 EQ	1650P	LOT14
SABA 811-50-24	1600P	LOT15

SABA 770223500	1600P	LOT16
TELEFUNKEN AT1	1450P	LOT17
TELEFUNKEN EQ	1400P	LOT18
SALORA FM0218B	1600P	LOT19
NORMENDE 5255	1600P	LOT20
ITT CVC 1150/1	1500P	LOT21
ITT COMPACT 80	1500P	LOT22
FE TX100 GREEN	1450P	LOT23
HINARI CT4/5 5113	1500P	LOT24
SELECO 6320410	1600P	LOT25
BLAUPUNKT 8667	1600P	LOT26
ITT COMPACT B1	1450P	LOT27
ITT CT3326 MUL	1500P	LOT28
ITT D066/37 EQ	1600P	LOT29
ITT 3546 EQ	1500P	LOT30
LUXOR 5810110	1600P	LOT31
SABA 845380920	1600P	LOT32
HITACHI 2434141 CP	1450P	LOT33
FE TX100 110 D	1700P	LOT34
HANTAREX 28021	1600P	LOT35
SHARP C3700 EQ	1600P	LOT36
HITACHI 2432981 CP	1500P	LOT37

We stock line output transformers for over 100 different models. Please ring 081-900 2329 for more information.

CASSETTE HOUSING

AMSTRAD	
VCR6000, VCR6100, VCR8600, VCR8602, VCR8603, VCR8604, VCR8700, VCR8704, VCR8714	
AIWA	
G900, HVG900, HVZ10	
FUNAI	
IV89, VCF2100, VCR2800, VCR4530, VCR4540, VCR5653, VCR5800, VCR5840, VCR5843, VCR6000, VCR6100, VCR6800, VCR6803, VCR7000, VCR8000, VCR8002, VCR8003, VCR8007, VCR8100, VCR8103, VCR8200, VCR8500, VIP150, VR68, VR150	
FINLUX	
VR3009	
GRANADA	
VHSF63	
HINARI	
VCR34, VTV100, VTV200, VXL200, VXL7, VXL8, VXL9, VXL10, VXL11, VXL19, VXL34, VXL90, VXL100, VXL200	
SHINTOM	
VCR4540	
TASHIKO	
VVF933, VVF93	
TATUNG	
TVR6111	
TENSAI	
TVP1000, TVP1050, TVP2000, TVP2050, TVR130, TVR140, TVR1800, TVR1900, TVR2000, TVR2100, TVR2600, TVR2700, VR2300, VR2350, VR2450, VR2500, VR4100	
Order code: CH21	Price: 1450P

Solder Mop 1.2mm x 10 metres	300P
Tubed Silicon Grease 50 gram	200P
Tubed Heat Sink Compound 25 gram	150P

UNIVERSAL HEAD EXTRACTOR TOOL
Hand tool designed for extracting hard to remove heads without damage to either the head or the mounting assembly. Adjustable so as to suit various brand heads.

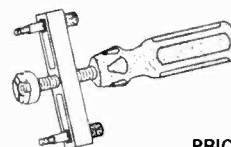

PRICE - £7

GRANDATA LTD

K.P. HOUSE, UNIT 15,
POP IN COMMERCIAL CENTRE,
SOUTHWAY, WEMBLEY,
MIDDLESEX, ENGLAND

Tel: 081-900 2329 Fax: 081-903 6126

SEE PREVIOUS PAGES FOR MORE
← GRANDATA BARGAINS



TOP TEL
PREPROGRAMMED REMOTE
CONTROLS 5 INDIVIDUAL
APPLIANCES
TV, VCR & SATELLITE ETC. 24.95



**PHILIPS UNIVERSAL
REMOTE**
CREDIT CARD SIZE 9.95
WORKS MOST PHILIPS SETS
BASIC FUNCTIONS
ENGINEERS MUST



POWERMID
NO WIRES, JUST PLUG IN AND
TRANSMIT BY YOUR REMOTE
CONTROL TO ANY ROOM IN
YOUR HOUSE! 44.95

REMOTE CONTROLS
AKAI VS10 15.95
FERGUSON T725 11.50
FERGUSON T732 11.95
FERGUSON T734 12.50
FERGUSON T738 11.95
FERGUSON T742 13.70
FERGUSON T785 13.95
FAST TEXT 13.95
FERGUSON T789 13.95
FAST TEXT 13.95

FERGUSON TX1012.95
NON TEXT12.95
FERGUSON TX10 TEXT11.95
FERGUSON TX10 STEREO15.95
FERGUSON TX100 TEXT11.95
FERGUSON ICCS16.95
FERGUSON 3V32/3511.95
FERGUSON 3V4314.50
FERGUSON 3V5515.30
FERGUSON 3RA115.45
FIDELITY CTV14S12.95
FIDELITY CTV22T14.95
FIDELITY CTV221012.95
FINLUX 1000 SERIES22.95
FINLUX RC300119.95
FISHER FTS 5610TX22.95
FISHER FTS 6310TX22.95
FISHER FTS 110TX22.95
FISHER FVHP 905/91022.95
GOLDSTAR OTMF 711017.95
GOLDSTAR 105 520D24.95
GOLDSTAR 105 523C24.95
GOLDSTAR GHV 122121.95
GOODMANS TX1100/120018.95
GRANADA UNIVERSAL12.95
GRUNDIG TP400 TEXT12.90
GRUNDIG TP650 TEXT14.25
GRUNDIG TP66021.95
HINARI CT719.95
HINARI CT1823.50
HINARI VXL 7/818.95
HINARI VXL 2019.45
HITACHI CE862F19.95
HITACHI CE871A17.95
HITACHI CE874A17.95
HITACHI CPT144617.50
HITACHI CPT155617.95
HITACHI CPT203814.95
HITACHI CPT217417.95
HITACHI CPT218815.25
HITACHI CPT221817.50
HITACHI CPT224615.25
HITACHI CPT250815.95
HITACHI CPT259617.95
HITACHI CPT288815.25
HITACHI VT800017.50
HITACHI VT930017.50
HITACHI VT1715.95
HITACHI VT636413.25
HITACHI VT120E13.95
ITT FS9/10 DIGI/VISION13.95
ITT RG30513.95
ITT RG30613.95
ITT TG312620.95
ITT VS413.95
ITT VSS TEXT15.95
MASPRO SE E-90/S15.95
MATSUI 144013.95
MATSUI 146518.50
MATSUI 289015.35

NEC N 831/33G11.50
NEC R883EG/EP11.50
NIKKAI NT1420/2123.50
ORION VH120421.95
ORION VH3050/60RC21.95
ORION VR2949/295721.95
ORION VSP2019.95
ORION VXL2021.95
PANASONIC EURS120014.95
PANASONIC EURS114236.50
PANASONIC EUR6414221.50
PANASONIC C71/C7421.50
PANASONIC TNQ1411/214.95
PANASONIC TNQ141913.95
PANASONIC TNQ162117.95
PANASONIC TX211234.95
GENUINE28.95
PANASONIC TX220021.95
PANASONIC TX223421.95
PANASONIC TX224421.95
PANASONIC TX246434.95
GENUINE28.95
PANASONIC TX2470/7221.50
PANASONIC TX2482/9221.50
PANASONIC TX330021.95
PANASONIC NV23012.50
GENUINE12.50
PANASONIC NV73015.25
PANASONIC NV87028.95
GENUINE28.95
PANASONIC NVG1028.95
GENUINE26.95
PANASONIC NVG1831.50
GENUINE23.45
PANASONIC NVG2129.95
GENUINE29.95
PANASONIC NVG4029.95
PANASONIC NVG4529.95
GENUINE22.50
PANASONIC NVL2844.50
PACE 600015.95
PHILIPS G11 I/R TEXT13.95
PHILIPS KT330 NON TEXT12.95
PHILIPS KT330 TEXT12.50
PHILIPS RC599112.95
PHILIPS RC5903 GENUINE12.95
PHILIPS 3A17.50
PHILIPS SIMPLE10.95
PHILIPS MINIATURE9.95
PHILIPS VR6362/713.25
PHILIPS VR646214.50
PHILIPS VR646713.25
PIONEER 505/52517.50
PROGRAMMABLE22.50
PYE DV464/0513.25
PYE DV662/0514.50

RANK T26A13.95
RANK T24A13.95
RANK T528A19.95
REDIFFUSION MKIV12.95
REDIFFUSION MKIVA12.95
SABA F560211.95
SABA F5603/411.95
SAISHO CT142R14.50
SAISHO CT149TX14.95
SAISHO VR1000/110015.25
SALORA 16J10/2015.90
SALORA 20J/2030/4015.90
SALORA 8617316.50
SALORA C20XZ117.95
SALORA SATELLITE19.95
SAMSUNG SV71615.50
SAMSUNG SV71715.50
SAMSUNG VV616/61715.50
SAMSUNG VV619/62615.50
SAMSUNG VV627/62915.50
SANYO CPT314417.95
SANYO E2 SERIES17.95
SANYO VHR 1100/120015.95
SANYO VHR 1300/230015.95
SANYO VHR 2700/310015.95
SENTRA VCR8000/810017.50
SENTRA VV84014.50
SOLAVOX 16F1913.95
SOLAVOX 20T1814.95
SOLAVOX 28R0915.95
SOLAVOX CML1415.95
SONY RM604/60614.95
SONY RM61329.50
SONY RM615/63214.50
SONY RM650/651/65217.95
SONY RM654/65717.95
SONY RM662/66321.95
SONY RM664/66521.95
SONY RM67014.95
TASHIKO 14D96216.95
TASHIKO 14D96616.95
TATUNG RC40/4514.95
TATUNG RC6014.95
TATUNG RC7012.50
TATUNG RC9014.95
TELEFUNKEN FB17027.50
TOP TEL24.95
TOSHIBA CT995616.95
TOSHIBA CT912817.95
TOSHIBA V5511.95
TOSHIBA V534A/B15.95

ALBA 6000X17.95
AMSTRAD 4500/900014.95
AMSTRAD 4600/470014.50
AMSTRAD 600017.95
AMSTRAD 700015.25
FERGUSON 3V00/398.75
FERGUSON 3V3223.50
FERGUSON 3V42/5517.50
FERGUSON 3V65/FV1126.95
FERGUSON 3V65/FV1217.95
FERGUSON FV1234.50
FERGUSON FV1341.50
FERGUSON FV2628.50
FERGUSON FV3126.50
FERGUSON FV31R27.95
FERGUSON FV3227.95
FISHER FVH450024.50
FISHER FVH615/91015.95
FISHER FVH72534.50
FISHER FVH906/91624.50
GOLDSTAR V1221/129015.95
GRUNDIG VS400/50017.30
HINARI VTR20017.95
HINARI VXL2/20/3517.95
HINARI VXL619.50
HINARI VXL6/9/9017.95
HINARI VXL10/11/1917.95
HITACHI 8000/970015.70
HITACHI VT113315.70
HITACHI VT171924.70
HITACHI VT63/6420.30
HITACHI VT6528.50
HITACHI VT120E21.95
HITACHI VT130E24.95
HITACHI VT150E33.95
HITACHI VT220E21.95
JVC HRD17017.95
JVC HRD25023.50
JVC HRD47027.50
JVC HRD54017.95
JVC HRD72534.50
JVC HRD75534.50
LOGIK VR950/95522.50
LOGIK VR96017.95
MATSUI VX60017.95
MATSUI VX73017.50
MATSUI VX735A17.50
MATSUI VV82015.25
MITSUBISHI HS301/30222.70
MITSUBISHI HS303/30521.50
MITSUBISHI HS30623.95
MITSUBISHI HS31824.50
NEC 9034/905319.95
ORION VHI19.50
ORION VHI319.95
PANASONIC NV23017.50
PANASONIC NV33317.50
PANASONIC NV36619.95
PANASONIC NV3709.95
PANASONIC NV43014.25

PANASONIC NV68827.70
PANASONIC NV73018.95
PANASONIC NV77818.95
PANASONIC NV78825.95
PANASONIC NV87037.30
PANASONIC NV2000/70008.95
PANASONIC NVG7917.30
PANASONIC NVG10/1217.30
PANASONIC NVG1826.70
PANASONIC NVG20/2124.95
PANASONIC NVG30/4024.50
PANASONIC NVG4534.50
PANASONIC NVL2538.50
PHILIPS VR618542.50
PHILIPS VR636740.70
PHILIPS 6460/65209.95
PHILIPS 6462/65609.95
GENUINE44.95
PHILIPS 6467 GENUINE40.70
PHILIPS 6750 GENUINE41.70
PYE DV46444.95
PYE DV46940.70
REDIFFUSION 62014.75
SAISHO VR705/80515.25
SAISHO VR320017.50
SAISHO VR350017.50
SAISHO VR360019.50
SAMSUNG V173023.50
SAMSUNG VV520/71017.50
SANYO VHR 1100/130018.95
SANYO VHR1110/120021.50
SANYO VHR 2300/320023.50
SCHNEIDER SV2021.50
SCHNEIDER SV24621.95
SENTRA 800016.95
SENTRA 840016.95
SONY C67/7117.95
SHARP VC9300/381/48114.75
SHARP VC581/88114.75
SHARP VC78732.50
SHARP VC814014.75
SOLAVOX 100016.95
SONY C5/8714.95
SONY SLC3021.50
SUSUMI XRS18.95
TASHIKO VVE921/219.95
TASHIKO VVE93218.95
TASHIKO VVE93422.50
TOSHIBA V55/578.75
TOSHIBA V73/38B14.95
TOSHIBA V93818.95

**REMOTES SUPPLIED ARE
EITHER "KONIG", "CME" OR
MANUFACTURERS OWN**

VIDEO HEADS

AKAI VS1517.95
AKAI VS434.50
ALBA 4000X16.95

**VIDEO HEADS ARE OF THE
BEST QUALITY AND ARE
BRANDED OR
MANUFACTURERS OWN**

**VIDEO HEADS ARE OF THE
BEST QUALITY AND ARE
BRANDED OR
MANUFACTURERS OWN**

**DOE TO UNFORESEEN CHANGES IN
MANUFACTURERS COSTS, WE
RESERVE THE RIGHT TO INCREASE
PRICES WITHOUT PRIOR NOTICE**

CASSETTE HOUSINGS
FERGUSON 3V65/FV11R22.50
FERGUSON FV31/FV31R36.45
FERGUSON FV37/FV37H17.50
HITACHI VT11E16.50
HITACHI VT64E21.50
PANASONIC NV333/36618.20
PANASONIC NV23032.85
PANASONIC NV73034.50

SERVICE AIDS
ALLEN KEYS (8 METRIC)4.95
ANTEX 17W IRON8.50
ANTEX 25W IRON8.75
ANTEX IRON STAND4.95
CIRCLIP KIT5.95
CLEAR TEST TAPE7.95
COLCLEN WIPES95
FIBRE CLEANING PEN2.95
HEATSINK COMPOUND1.55
ONYX SOLDER PUMP9.95
ONYX TIPS1.50
PERMABOND ADHESIVE3.95
PORTASOL31.95
PROFESSIONAL31.95
PORTASOL TIP3.95
SELF AMALGAMATING3.45
TAPE1.85
SILICON GREASE80
SOLDA MOP8.50
SOLDER 0.5KG 18SWG8.75
SOLDER 0.5KG 22SWG6.95
SPRING KIT1.25
SUPER GLUE1.45
UTILITY KNIFE1.25
WELLER GUN TIPS (2)1.25
WATCHMAKERS2.95
SCREWDRIVERS14.50
X1 PROBE KIT14.95
X10 PROBE KIT14.95

SUNDRIES
CTX EHT LEAD GENUINE8.25
MATSUI LEVER ASSY1.85
TX10 FOCUS UNIT8.50
98003 POSITOR1.35
98009 POSITOR1.35
98012 POSITOR3.35

TUNERS
PANASONIC TNV87510F231.95
T2208/T2225/T2C000/T2C024
T2213/T2284/TC8524.45
PHILIPS ELC200311.95
U32118.50
U411 (PHONO SKT)18.50
U411 (COAX SKT)19.75

VIDEO LEADS
CAMCORDER COPYING KIT9.95
SCART LEAD FULLY WIRED4.95
SCART LEAD TO 6 PHONO4.95
SCART COPYING KIT5.95
SCART TO 2 SCART SKT5.95

**ADVANTAGE OF CHEAPER
TELEPHONE COSTS**
* PHOTOCOPIY FACILITY
SAMSUNG SF1700£275.00
* 5 SHEET AUTOMATIC
DOCUMENT FEEDER
* AUTOMATIC FAX RECEPTION
* SIMPLE CONTROL SETTINGS.

**SCART SWITCHING
KIT16.95**
SCART TO 5 SCART SKT6.95
VIDEO COPYING KIT5.95
VIDEO FLY LEAD7.75

VIDEO REPAIR KIT
ALBA 400011.50
ALBA 600012.95
FERGUSON 3V2315.95
FERGUSON 3V29/3012.95
FERGUSON 3V31/3215.95
FERGUSON 3V35/3912.95
FERGUSON 3V44/4514.95
FERGUSON 3V64.6511.95
FISHER FVH615/71512.75
FISHER FVH90512.95
GOLDSTAR GVH122112.50
GOODMANS VCR100012.95
HITACHI VT800012.95
HITACHI VT930012.95
HITACHI VT11/33E14.95
HITACHI VT120/130E15.95
MITSUBISHI HS30617.95
PANASONIC G DECK7.75
PANASONIC NV23012.95
PANASONIC NV33312.95
PANASONIC NV37012.95
PANASONIC NV43012.95
PANASONIC NV73012.50
PANASONIC NV77711.95
PANASONIC NV2000/201022.50
PANASONIC NV700018.95
PANASONIC NVG10/1211.45
PHILIPS VR646011.75
PHILIPS VR646212.50
PHILIPS VR646721.50
SENTRA 800011.50
SOLAVOX 100011.50
SONY C5/711.15
SONY C69.50
* 5 SHEET AUTOMATIC
DOCUMENT FEEDER
* 10 AUTODIALS FOR EASE OF
USE

**MEMORY WORD DELETION &
BOLD PRINT**
* ABILITY TO CENTRE
BETWEEN MARGINS
CANON ES3£89.00
* 14 CHARACTER PER SECOND
DAISYWHEEL PRINTING
* SPELL CHECK FACILITY * 16K

CANON FAXPHONE£325.00
* 10 SHEET AUTOMATIC
DOCUMENT FEEDER
* HIGH VOLUME RECEPTION

WITH 100 METRE PAPER ROLL
* 16 AUTODIALS FOR EASE OF
USE
* AUTOMATIC GUILLOTINE
* PHOTOCOPIY FACILITY
* CANONS DE-CURL FEATURE
FOR FLAT FAXES
CANON FAX T50£469.00
* FULLY PORTABLE
ELECTRONIC TYPEWRITER
* FULL LINE OF CORRECTION

**WE OFFER A RANGE OF
MOBILE PHONES INC**

***** SPECIAL OFFER *****
NOKIA 101£149.00



TEXT MEMORY
* PAPER FEED, BOLD PRINT &
UNDERLINE FACILITY
* 10, 12, 15, CHARACTER
PITCH

CANON ES23£157.00
* 50K MEMORY
* 10, 12, 15, PS CHARACTER
PITCH

* 80,000 WORD SPELL

VERIFIER
* LCD DISPLAY
* 15 CHARACTERS PER
SECOND BIDIRECTIONAL
PRINTING
* 3.5" MS DOS DISK DRIVE FOR
UNLIMITED MEMORY
SHARP PA-W1410£329.00

**ALL MACHINES ARE COVERED
BY 12 MONTHS WARRANTY**

**THESE ARE A SMALL RANGE
OF OUR BUSINESS MACHINES
THAT WE SELL INC:**
CALCULATORS, COMPUTERS,
FAX MACHINES,
PHOTOCOPIERS & WORD
PROCESSORS
PLEASE RING FOR DETAILS
CELLULAR TELEPHONES

***** SPECIAL OFFER *****
NOKIA 101£149.00

**WE OFFER A RANGE OF
MOBILE PHONES INC**

**MOTOROLA, PANASONIC,
NEC, NOKIA, MITSUBISHI &
TECHNOPHONE**
FROM NEW & USED HAND
PORTABLES TO
MOBILES AND
TRANSPORTABLES
NO LONG TERM CONTRACTS &
A RANGE OF BILLING PLANS
TO SUITE EVERYBODY
PART EXCHANGE &
RECONNECTIONS ARE
WELCOME
WE ALSO PURCHASE SECOND
HAND EQUIPMENT

CELLULAR SPARES
ANTENNAE
3DB BODY MOUNT14.25
3DB GLASS MOUNT15.95
MAGNETIC MOUNT 3DB22.50
MITSUBISHI MTS11.50
MOTOROLA T/PORT19.95
MOTOROLA 8500X 1/4 WAVE9.95
MOTOROLA 8500X BUTTON9.50
MOTOROLA 8800X9.95
MOTOROLA 9800X19.95
PANASONIC F19.95
PANASONIC H SERIES14.95
PANASONIC I SERIES23.50
NEC P39.95
NOKIA 10114.95

BATTERIES
CLEARSTONE CTN500019.50
CLEARSTONE CTN900024.95
ERICSSON HOTLINE23.50
KOKUSAI KE10124.95
MITSUBISHI MT324.50
MITSUBISHI MTS24.50
MITSUBISHI MT7 700MAH23.95
MOTOROLA 4500X39.50
MOTOROLA 4800X SLIM27.50
MOTOROLA 8800X24.50
MOTOROLA 8500X 1000MAH23.50
MOTOROLA 8800X 1500MAH29.50
MOTOROLA 8800X 1300MAH23.95
MOTOROLA 8800X 1500MAH29.50
MOTOROLA PERSONAL 600MAH19.50
MOTOROLA PERSONAL 700MAH23.50
MOTOROLA PERSONAL SLIM39.50
MOTOROLA 9800X 600MAH19.50
MOTOROLA 9800X 700MAH23.50
MOTOROLA 9800X SLIM39.50
NEC 9A 70CMAH24.50
NEC 9A 100CMAH29.50
NEC P3 700MAH23.50
NEC P4 700MAH23.50
NOKIA 101 700MAH24.50
NOKIA 19023.50
NOKIA 620 TALKMAN39.50
NOKIA 1320 CITYMAN29.50
NOVATEL NVT4400 700MAH24.50
OKI 700 1000MAH24.95
OKI 900 1000MAH24.95

***** MINIMUM ORDER VALUE £5.00 *****

OKI 1150 1000MAH23.95
PANASONIC E/H SERIES32.50
PANASONIC F1 700MAH23.50
PANASONIC G SERIES24.95
PANASONIC I SERIES25.50
SONY CMH124.95
SONY CMH 33324.50
TECHNOPHONE TP227.50
TECHNOPHONE TP324.50
TECHNOPHONE TP405 700MAH23.50

BATTERY CHARGERS
DESK TOP TRICKLE MOTOROLA
TRANSPORTABLE38.95
MOTOROLA 8000/8800X23.95
MOTOROLA MICROTAC24.50
NEC P324.95
NOKIA 10124.95
PANASONIC E/H SERIES39.95
PANASONIC F24.95
SONY CMH 33324.95
TECHNOPHONE TP224.95
TECHNOPHONE TP30524.95
DESK TOP RAPID/COND
MITSUBISHI MTS44.50
MOTOROLA 8000 SERIES42.50
MOTOROLA 9800X42.50
NEC P342.95
NEC P444.95
NOKIA 10142.95
NOKIA 19044.95
PANASONIC F SERIES42.95
SONY CMH33344.95

BATTERY ELIMINATORS
CLEARSTONE CTN500014.50
ERICSSON HOTLINE14.50
MITSUBISHI MTS12.95
MITSUBISHI MT714.95
MOTOROLA 8000/8800X12.95
MOTOROLA 9800X12.95
NEC 9A12.95
NEC P312.50
NEC P412.95
NOKIA 10112.95
NOKIA 19012.95
OKI 70012.95
PANASONIC D SERIES12.95
PANASONIC F SERIES12.50
SONY CMH-114.95
MOTOROLA 800X14.50
TECHNOPHONE TP212.95
TECHNOPHONE TP40512.95

P.P. CHARGES:
COMPONENTS £1.00 PER ORDER UK
SERVICE MANUALS £1.25 EACH
CELLULAR TELEPHONES £5.00 PER
ITEM
OFFICE MACHINES £5.00 PER ITEM
EXPORT ORDERS P.P. CHARGES AT
COST

**WHEN ORDERING, PLEASE ADD P.P.
VALUE TO ORDER TOTAL THEN ADD
17% VAT TO THIS TOTAL**

**DELIVERY BY RETURN ON ALL STOCK
ITEMS**
*** MINIMUM ORDER VALUE £5.00 ***

ELC EAST LONDON COMPONENTS AUDIO TELEVISION VIDEO COMPONENTS AT VERY KEEN PRICES TEL: 081-472 4871 FAX: 081-503 5926

REMOTE CONTROLS FROM £9.99

**VIDEO BELT KITS
IDLER TYRES 50p**

VIDEO HEADS FROM £6.99

Over 200 models at very attractive prices.
**AKAI, AMSTRAD, FERGUSON, FISHER,
GOLDSTAR, HINARI, HITACHI, LOGI,
MATSUI, ORION, PANASONIC, SAISHO,
SHARP AND MANY MORE**

VIDEO SPARES

3V29 TAKE UP IDLER	£1.00p
3V29 FFW IDLER	£2.60p
3V59/65 RV1014 IDLER	£1.50p
3V23 LOADING ROLLER BAR	£3.99p
SHARP 005 & 006	£1.99p
SHARP V051 ASSEMBLY	£6.99p
VT11/14/17 IDLER	£1.99p
VT11 CLUTCH ASSEMBLY	£6.99p
VT100225/260 IDLER	£2.75p
NEC 9013 IDLER	£4.99p
SAIYO VHR3300 IDLER	£3.99p
AKAI VS105250 CLUTCH ASSEMBLY	£11.99p
SAISHO VR380 CLUTCH	£4.99p
MITSUBISHI H5337 F/F IDLER	£2.70p
ALBA LEMTRA PULLEY	£1.35p
MATSUI UNIVER POST	£1.25p
PANASONIC NV370 IDLER	£1.95p
FISHER 615 IDLER	£3.50p
FISHER GEAR ASSEMBLY	£4.50p
AMSTRAD PINCH WHEEL MOD KIT	£5.99p
UNIVERSAL TRIPLER	£4.99p
UNIVERSAL TRIPPER WITH FOCUS	£6.99p
HITACHI MODULE HM6251	£6.99p
CXC2410 TRIPLER	£16.99p
TENSION BAND FOR MOST MOD. FROM	£1.99p
CIRCUIT PROTECTOR ICP	50p
TX10 FOCUS UNIT	£7.99p
PHILIPS BACK-UP BATTERY	£1.50p
ALBA BATTERY - 1F 5.5V	£2.50p
TV SWITCHES FOR MOST MOD. FROM	£1.00p
SONY FUNCTION SWITCH	£1.00p
AK300	1.75
VS22/35	2.00
VS105/250	6.99
VR4000	1.50
AMSTRAD	1.80
VR6500	1.30
VR7000	1.00
FERGUSON	2.80
3V22	1.22
3V29/30/33	1.00
3V42/65	0.85
HRS0520/830	1.20
FISHERS	1.10
FYHP615/725	1.10
FYHP905/910	1.10
GRUNDIG	1.10
VS180	1.45
VS300	1.90
VS380	1.75
HINARI	1.10
VX13-20	1.25
VX14-35	1.50
HITACHI	1.30
VT11/23	1.30
VT52/65	1.75
VT110/220	1.80
MITSUBISHI	1.75
HS306/307	1.75
PHILIPS	2.40
VR6548	1.50
VR6367	1.50
SAMSUNG	1.50
VS105/250	1.50
SAIYO	2.15
VHR3300	2.05
SHARP	1.30
VC3835	1.30
VC3831	1.30
VC651/681	1.25
VC9300	1.50

LINE OUTPUT	SFX3489	19.99	AN3822K	7.99	LA7835	1.99	STK5720	6.00	TDA1516	4.00	UPC1378	2.20	2SB705	2.00
TRANSFORMERS	SFX3888	19.99	AN5151	6.99	M23881	9.99	STK5730	4.50	U13994	4.00	UPC1394	1.80	2SB715	2.00
DECCA	ST5767	19.99	AN5435	2.50	M490B81	8.50	STK6962	5.80	TDA1520	4.00	UPC1420	5.25	2SB817	2.00
100	TX3225	19.99	AN5515	2.99	M491B81	8.50	STK7216	7.00	TDA1521	3.50	UPC1470	2.00	2SB881	0.60
FERGUSON	TX3437	19.99	AN5521	2.99	M49481	8.50	STK7226	8.50	TDA1522	3.99	UPC1488	3.50	2SB882	0.60
TX85	TX3467	19.99	AN5522	1.99	M49500	8.50	STK7331	4.25	TDA1523	4.25	UPC1498	3.00	UPC1589	1.40
TX86	TX3835	19.99	AN5761	4.40	M45454L	2.99	STK7348	4.50	TDA1701	4.25	X2402P	4.25	2SB882	0.60
REDSPT	1420	17.99	AN7171	3.25	M45454L	2.99	STK7356	9.00	TDA1770	4.00	XG264A THY	7.00	2SB1010	0.75
WHITE SPOT	1480	17.99	AN7178	2.60	M45454L	2.99	STK8250	8.00	TDA1908	1.00	SG613 THY	11.00	2SB1016	0.80
TX98			BA3129	1.99	M45459L	3.99	STK9045	6.50	TDA2005	1.50	TRANSISTORS		2SC2454	0.25
TX99			BA3402	3.99	M45459L	4.50	STK9411	6.50	TDA2005	1.30	BC37	0.50	2SC2458	0.25
TX100			BA5402	2.50	M45464L	3.99	STK9412	5.99	TDA2030	1.30	BC368	0.30	2SC2459	0.25
BA6109			BA6219	1.80	M45464L	3.99	STR4121	5.99	TDA2170	3.00	BF869	0.60	2SC2461	0.75
BA6121			BA6229	1.99	M45469L	3.99	STR4115	6.50	TDA2270	3.25	BU208A	0.95	2SC2462	0.50
BA6209			BA6238	1.50	MB3320	2.00	STR9012	6.00	TDA2577	2.00	BU508A	0.95	2SC2463	0.60
BA6219			BA6239	2.99	M83731	2.99	STR41090	6.00	TDA2578	2.50	BU508DF	1.30	2SC2464	0.50
BA6229			BA6239	1.99	NB3322	2.99	STR44115	7.75	TDA2579	2.50	BU508DF	1.30	2SC2465	0.50
BA6238			BA6239	1.99	NC13306T3	3.99	STR40900	5.99	TDA2581	3.00	BU508DR	1.80	2SC2466	0.60
BA6239			BA6239	1.99	MDA2061	5.25	STR50020	6.50	TDA2582	3.00	BU903	1.80	2SC2467	0.85
BA6239			BA6239	1.99	MDA2062	4.99	STR50103	4.99	TDA2583	6.50	BU908	1.99	2SC2468	1.20
BA6239			BA6239	1.99	MDA2062	4.99	STR50115	6.50	TDA2653A	3.50	BU111A	0.85	2SC2469	1.00
BA6239			BA6239	1.99	MDA2062	4.99	STR50115	6.50	TDA2653A	3.50	BU111AF	1.20	2SC2470	1.25
BA6239			BA6239	1.99	MDA2062	4.99	STR50115	6.50	TDA2653A	3.50	BU111AF	1.20	2SC2471	1.25
BA6239			BA6239	1.99	MDA2062	4.99	STR50115	6.50	TDA2653A	3.50	BU111AF	1.20	2SC2472	1.25
BA6239			BA6239	1.99	MDA2062	4.99	STR50115	6.50	TDA2653A	3.50	BU111AF	1.20	2SC2473	1.25
BA6239			BA6239	1.99	MDA2062	4.99	STR50115	6.50	TDA2653A	3.50	BU111AF	1.20	2SC2474	1.25
BA6239			BA6239	1.99	MDA2062	4.99	STR50115	6.50	TDA2653A	3.50	BU111AF	1.20	2SC2475	1.25
BA6239			BA6239	1.99	MDA2062	4.99	STR50115	6.50	TDA2653A	3.50	BU111AF	1.20	2SC2476	1.25
BA6239			BA6239	1.99	MDA2062	4.99	STR50115	6.50	TDA2653A	3.50	BU111AF	1.20	2SC2477	1.25
BA6239			BA6239	1.99	MDA2062	4.99	STR50115	6.50	TDA2653A	3.50	BU111AF	1.20	2SC2478	1.25
BA6239			BA6239	1.99	MDA2062	4.99	STR50115	6.50	TDA2653A	3.50	BU111AF	1.20	2SC2479	1.25
BA6239			BA6239	1.99	MDA2062	4.99	STR50115	6.50	TDA2653A	3.50	BU111AF	1.20	2SC2480	1.25
BA6239			BA6239	1.99	MDA2062	4.99	STR50115	6.50	TDA2653A	3.50	BU111AF	1.20	2SC2481	1.25
BA6239			BA6239	1.99	MDA2062	4.99	STR50115	6.50	TDA2653A	3.50	BU111AF	1.20	2SC2482	1.25
BA6239			BA6239	1.99	MDA2062	4.99	STR50115	6.50	TDA2653A	3.50	BU111AF	1.20	2SC2483	1.25
BA6239			BA6239	1.99	MDA2062	4.99	STR50115	6.50	TDA2653A	3.50	BU111AF	1.20	2SC2484	1.25
BA6239			BA6239	1.99	MDA2062	4.99	STR50115	6.50	TDA2653A	3.50	BU111AF	1.20	2SC2485	1.25
BA6239			BA6239	1.99	MDA2062	4.99	STR50115	6.50	TDA2653A	3.50	BU111AF	1.20	2SC2486	1.25
BA6239			BA6239	1.99	MDA2062	4.99	STR50115	6.50	TDA2653A	3.50	BU111AF	1.20	2SC2487	1.25
BA6239			BA6239	1.99	MDA2062	4.99	STR50115	6.50	TDA2653A	3.50	BU111AF	1.20	2SC2488	1.25
BA6239			BA6239	1.99	MDA2062	4.99	STR50115	6.50	TDA2653A	3.50	BU111AF	1.20	2SC2489	1.25
BA6239			BA6239	1.99	MDA2062	4.99	STR50115	6.50	TDA2653A	3.50	BU111AF	1.20	2SC2490	1.25
BA6239			BA6239	1.99	MDA2062	4.99	STR50115	6.50	TDA2653A	3.50	BU111AF	1.20	2SC2491	1.25
BA6239			BA6239	1.99	MDA2062	4.99	STR50115	6.50	TDA2653A	3.50	BU111AF	1.20	2SC2492	1.25
BA6239			BA6239	1.99	MDA2062	4.99	STR50115	6.50	TDA2653A	3.50	BU111AF	1.20	2SC2493	1.25
BA6239			BA6239	1.99	MDA2062	4.99	STR50115	6.50	TDA2653A	3.50	BU111AF	1.20	2SC2494	1.25
BA6239			BA6239	1.99	MDA2062	4.99	STR50115	6.50	TDA2653A	3.50	BU111AF	1.20	2SC2495	1.25
BA6239			BA6239	1.99	MDA2062	4.99	STR50115	6.50	TDA2653A	3.50	BU111AF	1.20	2SC2496	1.25
BA6239			BA6239	1.99	MDA2062	4.99	STR50115	6.50	TDA2653A	3.50	BU111AF	1.20	2SC2497	1.25
BA6239			BA6239	1.99	MDA2062	4.99	STR50115	6.50	TDA2653A	3.50	BU111AF	1.20	2SC2498	1.25
BA6239			BA6239	1.99	MDA2062	4.99	STR50115	6.50	TDA2653A	3.50	BU111AF	1.20	2SC2499	1.25
BA6239			BA6239	1.99	MDA2062	4.99	STR50115	6.50	TDA2653A	3.50	BU111AF	1.20	2SC2500	1.25
BA6239			BA6239	1.99	MDA2062	4.99	STR50115	6.50	TDA2653A	3.50	BU111AF	1.20	2SC2501	1.25
BA6239			BA6239	1.99	MDA2062	4.99	STR50115	6.50	TDA2653A	3.50	BU111AF	1.20	2SC2502	1.25
BA6239			BA6239	1.99	MDA2062	4.99	STR50115	6.50	TDA2653A	3.50	BU111AF	1.20	2SC2503	1.25
BA6239			BA6239	1.99	MDA2062	4.99	STR50115	6.50	TDA2653A	3.50	BU111AF	1.20	2SC2504	1.25
BA6239			BA6239	1.99	MDA2062	4.99	STR50115	6.50	TDA2653A	3.50	BU111AF	1.20	2SC2505	1.25
BA6239			BA6239	1.99	MDA2062	4.99	STR50115	6.50	TDA2653A	3.50	BU111AF	1.20	2SC2506	1.25
BA6239			BA6239	1.99	MDA2062	4.99	STR50115	6.50	TDA2653A	3.50	BU111AF	1.20	2SC2507	1.25
BA6239			BA6239	1.99	MDA2062	4.99	STR50115	6.50	TDA2653A	3.50	BU111AF	1.20	2SC2508	1.25
BA6239			BA6239	1.99	MDA2062	4.99	STR50115	6.50	TDA2653A	3.50	BU111AF			

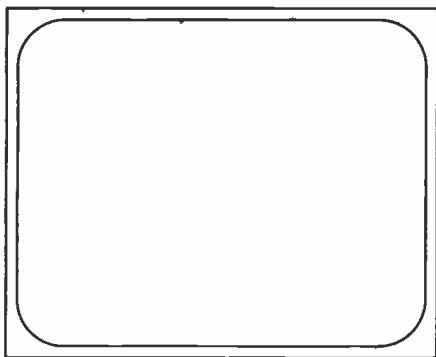

TELEVISION

The Right Business?

EDITOR

John A. Reddihough

PRODUCTION EDITOR

Tessa Winford

Please note that the telephone numbers below are for contact with the advertisement departments. Editorial enquiries should be sent to the editor at the address given on page 685 or faxed to 081 652 8956.

ADVERTISEMENT MANAGER

Carol Nobbs
081 652 8327

FIELD SALES EXECUTIVE

Patrick Irwin
081 652 3732

SALES EXECUTIVE

Pat Bunce
081 652 8339
Fax 081 652 8931

ADVERTISING PRODUCTION

Brian Chapman
081 652 8681
Fax 081 652 8917

PUBLISHING DIRECTOR

Susan Downey

SUBSCRIPTION ENQUIRIES

0444 445 566

SUBSCRIPTION HOTLINE

24-hour subscription ordering with credit card number phone 0622 721 666 and quote reference INJ.

COVER PHOTO

This month's cover photograph shows Steve Oldis using a PC in the Service Department. See article on pages 704-7.

Did you ever have the feeling that you're in the wrong business? It's common enough in our trade. With prices continually on the decline and customers harder to please, where's the profit? What are we all slaving away for? The consumer electronics retail trade has been doing poorly for several years now, the setmakers are boomed out and servicing struggles: equipment still goes wrong, but customers with several sets/VCRs put off doing anything about it or buy a give-away special offer. Maybe we should all be doing something else, but what? Well, as everyone will have probably noticed by now the video games market is the one that's been booming away. Last year Nintendo, the market leader, made a pre-tax profit of some £1bn. That's more than either IBM or Microsoft managed, and about as much as Matsushita, which is still the world's largest consumer electronics manufacturer, achieved. As another way of looking at it, Nintendo made twice the profit recorded by Sony on a sixth of turnover and with a tenth of the staff. Or a greater profit than all the US film makers put together. Quite an achievement for a company that for a hundred or so years had been quietly making playing cards. It's no wonder that more and more companies want to get into this field. Sega, a major firm in the arcade games industry, has already succeeded in doing so – and managed a sixty per cent profit increase last year.

It's particularly significant that the success of these two companies has not been achieved through competitive pricing. The games and the equipment required to play them – no nonsense about compatibility and common standards in this field – are decidedly expensive. No, the fact is that the companies have the right products and have made a success of their marketing. They have succeeded in a notoriously fickle market – selling to children. But of course once something becomes a craze in this market there's no stopping it. Until boredom sets in. Nintendo and Sega have got round that one by upgrading their games to maintain interest (and profits!). A further factor seems to be that once the habit catches on people go on playing: the age limit has yet to be determined, if there is one.

The other aspect of Nintendo and Sega's success is control of the software and hardware. You can devise a game to be played on a Nintendo games console but you have to get approval and pay a licence fee on every game you sell. And you don't get to do the manufacturing and packaging: Nintendo insist on doing that. Hence total quality and market control. There could possibly be grounds for action on the basis of restrictive trade practice, but no one has seen fit to try that so far. It's a complete contrast to the video games boom in the USA a decade ago. That came to an end when vast quantities of poor-quality games virtually destroyed the market. It seems that children are often less easy to fool than adults.

While all this has been going on, Philips and others have been less than successful with a product that should have far greater potential – CD-i. Maybe the games companies will help out here. Sega has introduced a dual CD player/Mega Drive games console which has been a success – an upgraded version is due in time for the next Christmas selling season. Nintendo is understood to be developing a next generation machine that will incorporate a CD player. It will be interesting to see what the games firms can do with CD-i. Meanwhile, a bit of shelf space for the games would help your profits no end and, come to think about it, the publishing aspect of the games phenomenon is also booming – there are at present at least twenty five magazines in the UK devoted to the interests of Nintendo and Sega games players. Cheerio?!



REED
BUSINESS
PUBLISHING

Teletopics

GOING DIGITAL

The Independent Television Commission has published a discussion document on converting to digital terrestrial TV. Use of the present TV frequency allocations could, with digital transmission, provide viewers with around a hundred channels. This would involve dropping the present analogue system. Such a course would be unacceptable in the immediate future, so the discussion is about ways of getting there eventually. The ITC feels that a notice period of at least ten years would be required before discontinuing the present services. Initially the commission favours a gradual introduction of digital TV, using a combination of simulcasting – duplicating present services in digital form – and the addition of new, digital channels. This could give viewers up to twenty extra channels, depending on the number of current transmitters in operation in the region – some areas are more congested than others, particularly the south and south east. Existing sets could continue to be used in conjunction with a receiver-decoder to convert the digital signal to conventional analogue PAL form. The ITC also feels that a European standard should be agreed before the start of digital TV transmissions.

NEWS

After a lengthy period of argument the European Community has agreed to a four-year, £180m plan to promote widescreen TV. The money will be made available to broadcasters and programme makers for equipment upgrading and the production of new programmes. It will be released subject to a matching investment being made by the recipient. Originally the idea was to link the Community initiative to the introduction of HDTV but the present move is limited to encouragement of the widescreen format.

Time Warner, Microsoft and cable TV operator TeleCommunications Inc. are to co-operate in the development of interactive TV in the USA. The system would give viewers access to films and games from a vast electronic library, enable various news and information sources to be selected and provide services such as shopping by television.

Video games should be available via TV before long. The Sega Channel is to be launched as a cable service in the USA early next year and is likely to appear in Europe as a satellite TV service shortly afterwards. The channel will make about fifty games available for downloading via a special tuner-decoder that can be plugged into a Sega Megadrive games system. The BBC however has scrapped plans to expand its BBC Select subscription service, in which more than £10m has been invested. Existing contracts and the three current services – the Executive Business Club, Accountancy Television and Legal Network Television – will be maintained. The number of subscribers failed to reach anything like the hoped for levels. 'Open access' programmes that can be recorded without an adaptor will continue to be broadcast.

A further report on the future of Channel 5 is due shortly from the ITC. It will consider three main options: a similar service to the one dropped last year; a narrower option based on local TV services; and the use of the frequencies for digital TV services.

In early June the BBC and Thomson demonstrated digital TV technology to the European parliament. Live satellite transmissions via Eutelsat I F4 used equipment developed by the BBC, Thomson-CSF Laboratories and other partners within the RACE programme. A compression system that reduces the data rate of an HDTV signal by a factor of thirty (from around 1,000Mbits/sec to about 30Mbits/sec), a digital sound coding system that provides five high-quality channels and a broadband optical network were included in the demonstrations.

DEVELOPMENTS

The European Launching Group for Digital Video Broadcasting (DVB), which has been co-ordinating European research and development work on digital TV systems, expects to reach agreement on a European standard by the end of the year. This could result in the start of services within two years. Meanwhile a likely specification for the US digital HDTV system has begun to emerge: 787.5 lines and 60 fields/sec without interlacing.

Xerox has developed a prototype LCD screen that provides a resolution similar to that of a laser printer. It has 6.3 million pixels and an apparent resolution of 300 dots per inch. Active-matrix, amorphous silicon thin-film-transistor technology is used. The US government Advanced Research Projects Agency provided aid.

BT researchers are developing a new video data compression algorithm that could increase the compression ratio by a factor of two hundred. The system works by second-guessing movement to increase substantially the amount of picture information discarded. It would be independent of the resolution of the original picture source.

Last month we mentioned (page 647) a ghost-cancellation system being developed by the ITC. It's based on a 24µsec pulse that's inserted in line 318, during the field blanking period. The pulse is no ordinary one however: it sweeps from 0Hz to 5MHz and is then cut off sharply. The rest of the line is left without modulation. To make use of the pulse the set has to contain a memory in which the basic pulse waveform is stored. This enables the set to compare the standard and the received pulse. After analysis of any reflections the set produces a mirror image of the ghost signal and uses this to achieve cancellation.

Ultra definition TV (UDTV) is another thing that was mentioned last month (page 638). This Japanese programme involves not just UDTV but versions 0-III, with a development period extending to the year 2015. The ultimate result would be a 4,000-line picture.

DOLBY SURROUND SOUND

BBC Manchester recorded the Corporation's first official Dolby Surround Sound production. The programme, 'For Those in Peril', was a documentary commemorating the fiftieth anniversary of the Battle of the Atlantic. It was shown on BBC-1 on May 30th.

Dolby Pro-Logic Surround Sound is a feature of two new Hitachi models, the C2574TN and C2874TN. Suggested prices are £850 and £950 respectively. They provide a total output of 55W r.m.s. in the Dolby Pro-logic mode and come complete with all the speakers required.

THEM DISCS

Philips and Paramount Pictures have agreed to make fifty films available in the CD-i format over the next two years.

The full-length films will have MPEG-compressed full-motion video, which gives 'better than VHS' picture quality. Each disc can store up to 72 minutes of video with digital stereo sound - the first will appear in the UK this autumn. Philips also plans to launch a series of CD-i music videos and interactive movies (the viewer can control how the plot develops). Prices will range from £15 to £50. A full-motion video (FMV) cartridge, Model 22ER9141, that will plug into the back of existing CD-i decks is to be launched. It will provide an additional 1.5Mbytes of memory for extra features.

Nimbus Records plans to launch its video CD format next spring. The system will enable the user to watch CD video movies via a TV set and hi-fi system - provided the CD player has a digital output socket (according to Nimbus a third of the world's 120 million CD players and eighty per cent of new players have one). A video adaptor unit containing MPEG expansion chips will be required between the player and the TV set - Nimbus hopes that future CD players will have this chip set built in as standard. Video CD discs will have up to 79 minutes of MPEG video. No price details have been announced.

3DO, the US-Japanese consortium that's planning to introduce an interactive multimedia system as a 32-bit competitor to CD-i, made several announcements during the Chicago Consumer Electronics Show in June. Panasonic intend to introduce a 3DO interactive multiplayer (IMP), Model FZ1, later this year, though a working prototype was not on display. AT&T has signed a 3DO hardware licence agreement and may develop a network version of IMP. Sanyo is also understood to have entered into a licence agreement. 3DO players will use an MPEG decoder developed by C-Cube Microsystems. Although

3DO talks of a US launch this autumn and a European launch next year, there seems to be doubt as to whether development work on the players could be completed in this short time. Crystal Dynamics of California has announced two 3DO games, 'Crash 'N Burn' and 'Total Eclipse': they will include full-motion video, 3D graphics, high-quality animation and multi-channel sound.

Kodak and Philips have entered into a licensing agreement for the mass-production of prerecorded Photo CD discs.

HARDWARE

JVC has launched a second multimedia player, the Wonder-mega Model RGM2, in Japan. It uses a 68000 processor and plays audio CDs, CD plus graphics discs, karaoke CDs, Sega Mega Drive and CD-ROM computer games and Wonderlibrary electronic books. Up to eight channels of PCM audio are provided. Price is the equivalent of £370 - no UK launch date has been suggested.

Panasonic has introduced an ultra-slim VHS-C camcorder, Model NVR50, at a suggested price of £900. Its slim shape has been achieved by using an 0.25in., 320,000-pixel CCD imager and a combined PCB for the camera and VCR sections. Features include digital picture effects, programmed auto-exposure, a long-play mode and index search.

AT&T intends to launch a videophone costing less than \$500 in the USA later this year. It will be a very considerable reduction in price compared with AT&T's first generation consumer videophone. New video signal compression technology is being developed to reduce the cost of the system.

<table border="1"> <tr><td>AC138</td><td>3.9%</td><td>2SA748</td><td>0.85</td><td>2SD2340</td><td>0.45</td><td>STK461</td><td>6.00</td></tr> <tr><td>AD161</td><td>0.50</td><td>2SA841</td><td>0.40</td><td>2SD355</td><td>0.35</td><td>STR1050</td><td>7.25</td></tr> <tr><td>AD162</td><td>0.50</td><td>2SA893</td><td>0.50</td><td>2SD400</td><td>0.48</td><td>STR2129</td><td>4.75</td></tr> <tr><td>BC108</td><td>0.07</td><td>2SA1011</td><td>1.35</td><td>2SD467</td><td>0.15</td><td>STK3042</td><td>4.20</td></tr> <tr><td>BC141</td><td>0.30</td><td>2SA1102</td><td>1.60</td><td>2SD525</td><td>0.65</td><td>STK3042*</td><td>4.75</td></tr> <tr><td>BC142</td><td>0.20</td><td>2SA1123</td><td>0.49</td><td>2SD560</td><td>0.40</td><td>STK3525</td><td>4.45</td></tr> <tr><td>BC307</td><td>0.08</td><td>2SA1175</td><td>0.40</td><td>2SD612</td><td>0.80</td><td>STK5332</td><td>1.80</td></tr> <tr><td>BC337</td><td>0.07</td><td>2SA1282</td><td>0.90</td><td>2SD836</td><td>0.10</td><td>STK5332</td><td>2.40</td></tr> <tr><td>BU546</td><td>0.07</td><td>2SA1307</td><td>1.50</td><td>2SD718</td><td>0.95</td><td>STR542</td><td>4.70</td></tr> <tr><td>BU131</td><td>0.30</td><td>2SB370</td><td>0.40</td><td>2SD725</td><td>3.50</td><td>STK5476</td><td>4.00</td></tr> <tr><td>BU132</td><td>0.30</td><td>2SB524</td><td>0.65</td><td>2SD836</td><td>0.75</td><td>STK7348</td><td>3.15</td></tr> <tr><td>BU243</td><td>0.38</td><td>2SB541</td><td>1.90</td><td>2SD856</td><td>0.55</td><td>STK73410</td><td>4.00</td></tr> <tr><td>BU246</td><td>0.65</td><td>2SB546</td><td>0.55</td><td>2SD1136</td><td>0.50</td><td>STAD11</td><td>3.50</td></tr> <tr><td>BUK33</td><td>0.50</td><td>2SB618</td><td>3.05</td><td>2SD1273</td><td>0.70</td><td>STAD11</td><td>3.80</td></tr> <tr><td>BUK35</td><td>0.50</td><td>2SB641</td><td>0.11</td><td>2SD1275</td><td>0.58</td><td>STAD11</td><td>2.50</td></tr> <tr><td>BU197</td><td>0.20</td><td>2SB649</td><td>0.38</td><td>2SD1278</td><td>0.58</td><td>STAD11</td><td>4.75</td></tr> <tr><td>BU259</td><td>0.70</td><td>2SB717</td><td>0.57</td><td>2SD1398</td><td>1.40</td><td>STR451</td><td>11.25</td></tr> <tr><td>H494</td><td>0.16</td><td>2SB861</td><td>1.50</td><td>2SD1426</td><td>2.05</td><td>STR5412</td><td>1.40</td></tr> <tr><td>BFE81</td><td>0.30</td><td>2SB1015</td><td>0.63</td><td>2SD1441</td><td>3.50</td><td>STR14090</td><td>5.90</td></tr> <tr><td>BFY51</td><td>0.80</td><td>2SB1016</td><td>1.10</td><td>AN318</td><td>4.40</td><td>STR50103</td><td>2.65</td></tr> <tr><td>BFY90</td><td>2.00</td><td>2SC377</td><td>0.77</td><td>AN511</td><td>3.50</td><td>STR59041</td><td>6.40</td></tr> <tr><td>BU24</td><td>1.35</td><td>2SC458</td><td>0.68</td><td>AN521</td><td>1.35</td><td>TA7157</td><td>1.20</td></tr> <tr><td>BU180</td><td>0.80</td><td>2SC591</td><td>3.20</td><td>AN522</td><td>1.35</td><td>TA7270</td><td>2.00</td></tr> <tr><td>BU106</td><td>0.85</td><td>2SC611</td><td>3.00</td><td>AN567</td><td>3.80</td><td>TA7280</td><td>2.75</td></tr> <tr><td>BU208</td><td>0.68</td><td>2SC667</td><td>3.00</td><td>AN673</td><td>2.25</td><td>TA7604</td><td>2.35</td></tr> <tr><td>BU208A</td><td>0.70</td><td>2SC941</td><td>0.12</td><td>AN7115</td><td>1.40</td><td>TAR205</td><td>2.90</td></tr> <tr><td>BU208A</td><td>0.80</td><td>2SC998</td><td>3.05</td><td>BA318</td><td>1.75</td><td>TAR207</td><td>1.65</td></tr> <tr><td>BU26A</td><td>1.10</td><td>2SC1008</td><td>0.20</td><td>BA658</td><td>3.60</td><td>TAR210</td><td>3.50</td></tr> <tr><td>BU407</td><td>0.65</td><td>2SC1103</td><td>0.50</td><td>BA130</td><td>1.50</td><td>TAR214</td><td>3.40</td></tr> <tr><td>BU409</td><td>1.10</td><td>2SC1123</td><td>0.49</td><td>BA5466</td><td>2.50</td><td>TAR215</td><td>3.00</td></tr> <tr><td>BU426</td><td>1.50</td><td>2SC1222</td><td>0.11</td><td>BA6219</td><td>1.20</td><td>UCPS14</td><td>0.50</td></tr> <tr><td>BU508A</td><td>0.85</td><td>2SC1277</td><td>0.38</td><td>BA156</td><td>1.35</td><td>UCP1320</td><td>2.00</td></tr> <tr><td>BU508B</td><td>1.35</td><td>2SC1382</td><td>0.30</td><td>HA1377</td><td>4.00</td><td>UCP1032</td><td>0.60</td></tr> <tr><td>BU508C</td><td>1.10</td><td>2SC1429</td><td>0.55</td><td>HA1227</td><td>1.50</td><td>UCP1185</td><td>4.00</td></tr> <tr><td>BU536</td><td>1.05</td><td>2SC1447</td><td>0.80</td><td>KA2.01</td><td>1.00</td><td>UCP1230</td><td>1.50</td></tr> <tr><td>BU526</td><td>1.45</td><td>2SC1514</td><td>0.42</td><td>KA2.63</td><td>1.50</td><td>UCP1363C</td><td>1.90</td></tr> <tr><td>BU108AF</td><td>1.20</td><td>2SC1569</td><td>0.55</td><td>LA1352</td><td>1.45</td><td>UCP1378</td><td>1.80</td></tr> <tr><td>BU508DF</td><td>1.35</td><td>2SC1674</td><td>0.15</td><td>LA1460</td><td>2.05</td><td>UCP1394</td><td>1.50</td></tr> <tr><td>BU111A</td><td>0.70</td><td>2SC1767</td><td>0.36</td><td>LA4.82</td><td>1.65</td><td>UCP1456</td><td>0.50</td></tr> <tr><td>BU111AF</td><td>0.85</td><td>2SC1815</td><td>0.12</td><td>LA4200</td><td>1.30</td><td></td><td></td></tr> <tr><td>BU112A</td><td>0.85</td><td>2SC1852</td><td>0.49</td><td>LA4440</td><td>1.18</td><td></td><td></td></tr> <tr><td>BU112AF</td><td>1.10</td><td>2SC1914</td><td>0.15</td><td>LA4660</td><td>1.30</td><td></td><td></td></tr> <tr><td>BU156A</td><td>0.80</td><td>2SC1983</td><td>0.90</td><td>LA4700</td><td>1.40</td><td></td><td></td></tr> <tr><td>TIP30C</td><td>0.25</td><td>2SC2007</td><td>0.22</td><td>LA6320</td><td>1.90</td><td></td><td></td></tr> <tr><td>TIP31A</td><td>0.25</td><td>2SC2027</td><td>2.20</td><td>LM318</td><td>1.15</td><td>815</td><td>0.20</td></tr> <tr><td>TIP32B</td><td>0.30</td><td>2SC2076</td><td>1.10</td><td>LM318</td><td>1.15</td><td>820</td><td>0.20</td></tr> <tr><td>TIP41A</td><td>0.35</td><td>2SC2236</td><td>0.25</td><td>LM318</td><td>2.25</td><td></td><td></td></tr> <tr><td>TIP47</td><td>0.45</td><td>2SC2278</td><td>1.00</td><td>LM4002</td><td>5.25</td><td></td><td></td></tr> <tr><td>TIP110</td><td>0.45</td><td>2SC2347</td><td>0.18</td><td>MS143P</td><td>1.40</td><td></td><td></td></tr> <tr><td>TIP112</td><td>0.85</td><td>2SC2500</td><td>0.25</td><td>MS220L</td><td>1.75</td><td></td><td></td></tr> <tr><td>TIP142</td><td>0.90</td><td>2SC2599</td><td>1.25</td><td>MS1172</td><td>2.60</td><td></td><td></td></tr> <tr><td>TIP1791</td><td>1.30</td><td>2SC2603</td><td>0.12</td><td>MS4884</td><td>4.50</td><td></td><td></td></tr> <tr><td>TIP2955</td><td>0.50</td><td>2SC2658</td><td>0.10</td><td>MB3731</td><td>2.80</td><td></td><td></td></tr> <tr><td>ME3400</td><td>0.25</td><td>2SC2688</td><td>0.30</td><td>MB3731</td><td>2.45</td><td></td><td></td></tr> <tr><td>ME3521</td><td>0.35</td><td>2SC2738</td><td>3.00</td><td>MB3731</td><td>2.45</td><td></td><td></td></tr> <tr><td>2M222</td><td>0.20</td><td>2SC2759</td><td>2.00</td><td>MC132</td><td>0.65</td><td></td><td></td></tr> <tr><td>2M1035</td><td>1.10</td><td>2SC3182</td><td>1.50</td><td>MC14426</td><td>2.50</td><td></td><td></td></tr> <tr><td>2M3773</td><td>1.50</td><td>2SC3262</td><td>3.60</td><td>MC14943</td><td>0.03</td><td></td><td></td></tr> <tr><td>2M6130</td><td>0.40</td><td>2SC3345</td><td>1.00</td><td>SA1293A</td><td>4.85</td><td></td><td></td></tr> <tr><td>2SA350</td><td>0.60</td><td>2SC3306</td><td>3.40</td><td>SA1293 B</td><td>5.15</td><td></td><td></td></tr> <tr><td>2SA606</td><td>2.85</td><td>2SC3883</td><td>2.80</td><td>SA1293 C</td><td>5.15</td><td></td><td></td></tr> <tr><td>2SA679</td><td>1.95</td><td>2SC4742</td><td>1.40</td><td>SAAS010</td><td>4.95</td><td></td><td></td></tr> <tr><td>2SA722</td><td>0.62</td><td>2SD198</td><td>1.60</td><td>SAAS243P</td><td>7.15</td><td></td><td></td></tr> </table>	AC138	3.9%	2SA748	0.85	2SD2340	0.45	STK461	6.00	AD161	0.50	2SA841	0.40	2SD355	0.35	STR1050	7.25	AD162	0.50	2SA893	0.50	2SD400	0.48	STR2129	4.75	BC108	0.07	2SA1011	1.35	2SD467	0.15	STK3042	4.20	BC141	0.30	2SA1102	1.60	2SD525	0.65	STK3042*	4.75	BC142	0.20	2SA1123	0.49	2SD560	0.40	STK3525	4.45	BC307	0.08	2SA1175	0.40	2SD612	0.80	STK5332	1.80	BC337	0.07	2SA1282	0.90	2SD836	0.10	STK5332	2.40	BU546	0.07	2SA1307	1.50	2SD718	0.95	STR542	4.70	BU131	0.30	2SB370	0.40	2SD725	3.50	STK5476	4.00	BU132	0.30	2SB524	0.65	2SD836	0.75	STK7348	3.15	BU243	0.38	2SB541	1.90	2SD856	0.55	STK73410	4.00	BU246	0.65	2SB546	0.55	2SD1136	0.50	STAD11	3.50	BUK33	0.50	2SB618	3.05	2SD1273	0.70	STAD11	3.80	BUK35	0.50	2SB641	0.11	2SD1275	0.58	STAD11	2.50	BU197	0.20	2SB649	0.38	2SD1278	0.58	STAD11	4.75	BU259	0.70	2SB717	0.57	2SD1398	1.40	STR451	11.25	H494	0.16	2SB861	1.50	2SD1426	2.05	STR5412	1.40	BFE81	0.30	2SB1015	0.63	2SD1441	3.50	STR14090	5.90	BFY51	0.80	2SB1016	1.10	AN318	4.40	STR50103	2.65	BFY90	2.00	2SC377	0.77	AN511	3.50	STR59041	6.40	BU24	1.35	2SC458	0.68	AN521	1.35	TA7157	1.20	BU180	0.80	2SC591	3.20	AN522	1.35	TA7270	2.00	BU106	0.85	2SC611	3.00	AN567	3.80	TA7280	2.75	BU208	0.68	2SC667	3.00	AN673	2.25	TA7604	2.35	BU208A	0.70	2SC941	0.12	AN7115	1.40	TAR205	2.90	BU208A	0.80	2SC998	3.05	BA318	1.75	TAR207	1.65	BU26A	1.10	2SC1008	0.20	BA658	3.60	TAR210	3.50	BU407	0.65	2SC1103	0.50	BA130	1.50	TAR214	3.40	BU409	1.10	2SC1123	0.49	BA5466	2.50	TAR215	3.00	BU426	1.50	2SC1222	0.11	BA6219	1.20	UCPS14	0.50	BU508A	0.85	2SC1277	0.38	BA156	1.35	UCP1320	2.00	BU508B	1.35	2SC1382	0.30	HA1377	4.00	UCP1032	0.60	BU508C	1.10	2SC1429	0.55	HA1227	1.50	UCP1185	4.00	BU536	1.05	2SC1447	0.80	KA2.01	1.00	UCP1230	1.50	BU526	1.45	2SC1514	0.42	KA2.63	1.50	UCP1363C	1.90	BU108AF	1.20	2SC1569	0.55	LA1352	1.45	UCP1378	1.80	BU508DF	1.35	2SC1674	0.15	LA1460	2.05	UCP1394	1.50	BU111A	0.70	2SC1767	0.36	LA4.82	1.65	UCP1456	0.50	BU111AF	0.85	2SC1815	0.12	LA4200	1.30			BU112A	0.85	2SC1852	0.49	LA4440	1.18			BU112AF	1.10	2SC1914	0.15	LA4660	1.30			BU156A	0.80	2SC1983	0.90	LA4700	1.40			TIP30C	0.25	2SC2007	0.22	LA6320	1.90			TIP31A	0.25	2SC2027	2.20	LM318	1.15	815	0.20	TIP32B	0.30	2SC2076	1.10	LM318	1.15	820	0.20	TIP41A	0.35	2SC2236	0.25	LM318	2.25			TIP47	0.45	2SC2278	1.00	LM4002	5.25			TIP110	0.45	2SC2347	0.18	MS143P	1.40			TIP112	0.85	2SC2500	0.25	MS220L	1.75			TIP142	0.90	2SC2599	1.25	MS1172	2.60			TIP1791	1.30	2SC2603	0.12	MS4884	4.50			TIP2955	0.50	2SC2658	0.10	MB3731	2.80			ME3400	0.25	2SC2688	0.30	MB3731	2.45			ME3521	0.35	2SC2738	3.00	MB3731	2.45			2M222	0.20	2SC2759	2.00	MC132	0.65			2M1035	1.10	2SC3182	1.50	MC14426	2.50			2M3773	1.50	2SC3262	3.60	MC14943	0.03			2M6130	0.40	2SC3345	1.00	SA1293A	4.85			2SA350	0.60	2SC3306	3.40	SA1293 B	5.15			2SA606	2.85	2SC3883	2.80	SA1293 C	5.15			2SA679	1.95	2SC4742	1.40	SAAS010	4.95			2SA722	0.62	2SD198	1.60	SAAS243P	7.15			<table border="1"> <tr><td colspan="2">VIDEO SPARES</td></tr> <tr><td>AKAI</td><td>VS1-5</td></tr> <tr><td>Video head</td><td>15.00</td></tr> <tr><td>Pinch roller</td><td>1.45</td></tr> <tr><td>Belt kit</td><td>3.00</td></tr> <tr><td>Reel idler</td><td>3.00</td></tr> <tr><td>Take/uidler</td><td>1.15</td></tr> <tr><td>Clutch</td><td>2.10</td></tr> <tr><td>Lamp</td><td>0.30</td></tr> <tr><td>Lamp+skt</td><td>0.75</td></tr> <tr><td>Loading belt</td><td>1.40</td></tr> <tr><td>Repair kit</td><td>19.23</td></tr> </table>	VIDEO SPARES		AKAI	VS1-5	Video head	15.00	Pinch roller	1.45	Belt kit	3.00	Reel idler	3.00	Take/uidler	1.15	Clutch	2.10	Lamp	0.30	Lamp+skt	0.75	Loading belt	1.40	Repair kit	19.23	<table border="1"> <tr><td colspan="2">FERGUSON JVC</td></tr> <tr><td>3D29 MR7200</td><td>6.40</td></tr> <tr><td>Video head</td><td>7.50</td></tr> <tr><td>Pinch roller</td><td>1.10</td></tr> <tr><td>Belt kit</td><td>2.25</td></tr> <tr><td>Reel idler</td><td>1.15</td></tr> <tr><td>Take/uidler</td><td>1.15</td></tr> <tr><td>Clutch</td><td>2.10</td></tr> <tr><td>Lamp</td><td>0.30</td></tr> <tr><td>Lamp+skt</td><td>0.75</td></tr> <tr><td>Loading belt</td><td>1.40</td></tr> <tr><td>Repair kit</td><td>19.23</td></tr> </table>	FERGUSON JVC		3D29 MR7200	6.40	Video head	7.50	Pinch roller	1.10	Belt kit	2.25	Reel idler	1.15	Take/uidler	1.15	Clutch	2.10	Lamp	0.30	Lamp+skt	0.75	Loading belt	1.40	Repair kit	19.23	<table border="1"> <tr><td colspan="2">PHILIPS</td></tr> <tr><td>VTR451</td><td>6.68</td></tr> <tr><td>6169 641B</td><td>6.18</td></tr> <tr><td>Video head</td><td>45.00</td></tr> <tr><td>Belt kit</td><td>1.30</td></tr> <tr><td>Pinch roller</td><td>6.85</td></tr> <tr><td>Clutch drive assy</td><td>4.75</td></tr> <tr><td>Clutch</td><td>4.85</td></tr> <tr><td>Pulley</td><td>11.40</td></tr> <tr><td>Ra+k assy</td><td>12.40</td></tr> <tr><td>Ca/ssette lift assy</td><td>18.50</td></tr> </table>	PHILIPS		VTR451	6.68	6169 641B	6.18	Video head	45.00	Belt kit	1.30	Pinch roller	6.85	Clutch drive assy	4.75	Clutch	4.85	Pulley	11.40	Ra+k assy	12.40	Ca/ssette lift assy	18.50	<table border="1"> <tr><td colspan="2">SAMSUNG</td></tr> <tr><td>VV110 712 720</td><td>2.00</td></tr> <tr><td>720 970 971 972</td><td>1.70</td></tr> <tr><td>Video head</td><td>15.10</td></tr> <tr><td>Pinch roller</td><td>3.50</td></tr> <tr><td>Idler wheel</td><td>1.55</td></tr> <tr><td>FF/ew clutch assy</td><td>12.25</td></tr> <tr><td>FF/ew clutch assy</td><td>11.85</td></tr> <tr><td>Belt kit</td><td>3.45</td></tr> </table>	SAMSUNG		VV110 712 720	2.00	720 970 971 972	1.70	Video head	15.10	Pinch roller	3.50	Idler wheel	1.55	FF/ew clutch assy	12.25	FF/ew clutch assy	11.85	Belt kit	3.45	<table border="1"> <tr><td colspan="2">MITSUBISHI</td></tr> <tr><td>VX17/D</td><td>4.75</td></tr> <tr><td>Video head</td><td>15.15</td></tr> <tr><td>Pinch roller</td><td>1.65</td></tr> <tr><td>Idler wheel</td><td>1.55</td></tr> <tr><td>FF/ew clutch assy</td><td>12.25</td></tr> <tr><td>FF/ew clutch assy</td><td>11.85</td></tr> <tr><td>Belt kit</td><td>3.45</td></tr> </table>	MITSUBISHI		VX17/D	4.75	Video head	15.15	Pinch roller	1.65	Idler wheel	1.55	FF/ew clutch assy	12.25	FF/ew clutch assy	11.85	Belt kit	3.45	<table border="1"> <tr><td colspan="2">SONY</td></tr> <tr><td>VX17/D</td><td>4.75</td></tr> <tr><td>Video head</td><td>15.15</td></tr> <tr><td>Pinch roller</td><td>1.65</td></tr> <tr><td>Idler wheel</td><td>1.55</td></tr> <tr><td>FF/ew clutch assy</td><td>12.25</td></tr> <tr><td>FF/ew clutch assy</td><td>11.85</td></tr> <tr><td>Belt kit</td><td>3.45</td></tr> </table>	SONY		VX17/D	4.75	Video head	15.15	Pinch roller	1.65	Idler wheel	1.55	FF/ew clutch assy	12.25	FF/ew clutch assy	11.85	Belt kit	3.45	<table border="1"> <tr><td colspan="2">SHARP</td></tr> <tr><td>VE361</td><td>9.60</td></tr> <tr><td>Video head</td><td>12.50</td></tr> <tr><td>Pinch roller</td><td>3.50</td></tr> <tr><td>Belt kit</td><td>1.15</td></tr> <tr><td>Repair kit</td><td>11.81</td></tr> <tr><td>Idler (D)</td><td>3.10</td></tr> <tr><td>Idler (R)</td><td>1.65</td></tr> </table>	SHARP		VE361	9.60	Video head	12.50	Pinch roller	3.50	Belt kit	1.15	Repair kit	11.81	Idler (D)	3.10	Idler (R)	1.65	<table border="1"> <tr><td colspan="2">KODAK</td></tr> <tr><td>VR11 33 34</td><td>10.00</td></tr> <tr><td>Video head</td><td>10.00</td></tr> <tr><td>Pinch roller</td><td>1.85</td></tr> <tr><td>Belt kit</td><td>1.95</td></tr> </table>	KODAK		VR11 33 34	10.00	Video head	10.00	Pinch roller	1.85	Belt kit	1.95	<table border="1"> <tr><td colspan="2">PANA</td></tr> <tr><td>VX10 330 340 350</td><td>6.25</td></tr> <tr><td>Video head</td><td>6.25</td></tr> <tr><td>Pinch roller</td><td>1.30</td></tr> <tr><td>Belt kit</td><td>1.20</td></tr> <tr><td>Ca/astan belt</td><td>1.30*</td></tr> <tr><td>Loading belt</td><td>1.50*</td></tr> <tr><td>*pk of 5</td><td>4.15</td></tr> <tr><td>Idler (D)</td><td>4.45</td></tr> <tr><td>Idler (R)</td><td>0.45</td></tr> <tr><td>Idler arm</td><td>4.75</td></tr> <tr><td>Repair kit</td><td>9.38</td></tr> </table>	PANA		VX10 330 340 350	6.25	Video head	6.25	Pinch roller	1.30	Belt kit	1.20	Ca/astan belt	1.30*	Loading belt	1.50*	*pk of 5	4.15	Idler (D)	4.45	Idler (R)	0.45	Idler arm	4.75	Repair kit	9.38	<table border="1"> <tr><td colspan="2">HITACHI</td></tr> <tr><td>VX10 330 340 350</td><td>6.25</td></tr> <tr><td>Video head</td><td>6.25</td></tr> <tr><td>Pinch roller</td><td>1.30</td></tr> <tr><td>Belt kit</td><td>1.20</td></tr> <tr><td>Ca/astan belt</td><td>1.30*</td></tr> <tr><td>Loading belt</td><td>1.50*</td></tr> <tr><td>*pk of 5</td><td>4.15</td></tr> <tr><td>Idler (D)</td><td>4.45</td></tr> <tr><td>Idler (R)</td><td>0.45</td></tr> <tr><td>Idler arm</td><td>4.75</td></tr> <tr><td>Repair kit</td><td>9.38</td></tr> </table>	HITACHI		VX10 330 340 350	6.25	Video head	6.25	Pinch roller	1.30	Belt kit	1.20	Ca/astan belt	1.30*	Loading belt	1.50*	*pk of 5	4.15	Idler (D)	4.45	Idler (R)	0.45	Idler arm	4.75	Repair kit	9.38	<table border="1"> <tr><td colspan="2">MITSUBISHI</td></tr> <tr><td>VX10 330 340 350</td><td>6.25</td></tr> <tr><td>Video head</td><td>6.25</td></tr> <tr><td>Pinch roller</td><td>1.30</td></tr> <tr><td>Belt kit</td><td>1.20</td></tr> <tr><td>Ca/astan belt</td><td>1.30*</td></tr> <tr><td>Loading belt</td><td>1.50*</td></tr> <tr><td>*pk of 5</td><td>4.15</td></tr> <tr><td>Idler (D)</td><td>4.45</td></tr> <tr><td>Idler (R)</td><td>0.45</td></tr> <tr><td>Idler arm</td><td>4.75</td></tr> <tr><td>Repair kit</td><td>9.38</td></tr> </table>	MITSUBISHI		VX10 330 340 350	6.25	Video head	6.25	Pinch roller	1.30	Belt kit	1.20	Ca/astan belt	1.30*	Loading belt	1.50*	*pk of 5	4.15	Idler (D)	4.45	Idler (R)	0.45	Idler arm	4.75	Repair kit	9.38	<table border="1"> <tr><td colspan="2">GRUNDIG</td></tr> <tr><td>TP150</td><td>10.00</td></tr> <tr><td>TP410</td><td>8.00</td></tr> <tr><td>TP421</td><td>10.00</td></tr> <tr><td>TP430/650</td><td>9.60</td></tr> <tr><td>TP431</td><td>10.00</td></tr> </table>	GRUNDIG		TP150	10.00	TP410	8.00	TP421	10.00	TP430/650	9.60	TP431	10.00	<table border="1"> <tr><td colspan="2">HITACHI</td></tr> <tr><td>RC140M</td><td>9.60</td></tr> <tr><td>RC132</td><td>9.60</td></tr> <tr><td>RC200</td><td>9.60</td></tr> <tr><td>RC301</td><td>9.60</td></tr> <tr><td>RC302</td><td>9.60</td></tr> <tr><td>RC303</td><td>9.60</td></tr> <tr><td>RC310</td><td>9.60</td></tr> <tr><td>RC311</td><td>9.60</td></tr> </table>	HITACHI		RC140M	9.60	RC132	9.60	RC200	9.60	RC301	9.60	RC302	9.60	RC303	9.60	RC310	9.60	RC311	9.60	<table border="1"> <tr><td colspan="2">PHILIPS</td></tr> <tr><td>RC134</td><td>9.60</td></tr> <tr><td>RC135</td><td>9.60</td></tr> <tr><td>RC138</td><td>10.00</td></tr> <tr><td>RC180</td><td>10.00</td></tr> <tr><td>RC300</td><td>8.10</td></tr> <tr><td>RC301</td><td>9.60</td></tr> <tr><td>RC303</td><td>9.60</td></tr> <tr><td>RC352</td><td>9.60</td></tr> <tr><td>RC5375</td><td>9.60</td></tr> <tr><td>RC5534</td><td>9.60</td></tr> <tr><td>RC5901</td><td>9.60</td></tr> <tr><td>RC5903</td><td>9.60</td></tr> </table>	PHILIPS		RC134	9.60	RC135	9.60	RC138	10.00	RC180	10.00	RC300	8.10	RC301	9.60	RC303	9.60	RC352	9.60	RC5375	9.60	RC5534	9.60	RC5901	9.60	RC5903	9.60	<table border="1"> <tr><td colspan="2">SONY</td></tr> <tr><td>RC140</td><td>9.60</td></tr> <tr><td>RC140TM</td><td>9.60</td></tr> <tr><td>RC141</td><td>9.60</td></tr> <tr><td>RC160</td><td>9.60</td></tr> </table>	SONY		RC140	9.60	RC140TM	9.60	RC141	9.60	RC160	9.60	<table border="1"> <tr><td colspan="2">MITSUBISHI</td></tr> <tr><td>VX10 330 340 350</td><td>6.25</td></tr> <tr><td>Video head</td><td>6.25</td></tr> <tr><td>Pinch roller</td><td>1.30</td></tr> <tr><td>Belt kit</td><td>1.20</td></tr> <tr><td>Ca/astan belt</td><td>1.30*</td></tr> <tr><td>Loading belt</td><td>1.50*</td></tr> <tr><td>*pk of 5</td><td>4.15</td></tr> <tr><td>Idler (D)</td><td>4.45</td></tr> <tr><td>Idler (R)</td><td>0.45</td></tr> <tr><td>Idler arm</td><td>4.75</td></tr> <tr><td>Repair kit</td><td>9.38</td></tr> </table>	MITSUBISHI		VX10 330 340 350	6.25	Video head	6.25	Pinch roller	1.30	Belt kit	1.20	Ca/astan belt	1.30*	Loading belt	1.50*	*pk of 5	4.15	Idler (D)	4.45	Idler (R)	0.45	Idler arm	4.75	Repair kit	9.38	<table border="1"> <tr><td colspan="2">SHARP</td></tr> <tr><td>VE361</td><td>9.60</td></tr> <tr><td>Video head</td><td>12.50</td></tr> <tr><td>Pinch roller</td><td>3.50</td></tr> <tr><td>Belt kit</td><td>1.15</td></tr> <tr><td>Repair kit</td><td>11.81</td></tr> <tr><td>Idler (D)</td><td>3.10</td></tr> <tr><td>Idler (R)</td><td>1.65</td></tr> </table>	SHARP		VE361	9.60	Video head	12.50	Pinch roller	3.50	Belt kit	1.15	Repair kit	11.81	Idler (D)	3.10	Idler (R)	1.65	<table border="1"> <tr><td colspan="2">SONY</td></tr> <tr><td>RC140</td><td>9.60</td></tr> <tr><td>RC140TM</td><td>9.60</td></tr> <tr><td>RC141</td><td>9.60</td></tr> <tr><td>RC160</td><td>9.60</td></tr> </table>	SONY		RC140	9.60	RC140TM	9.60	RC141	9.60	RC160	9.60	<table border="1"> <tr><td colspan="2">MITSUBISHI</td></tr> <tr><td>VX10 330 340 350</td><td>6.25</td></tr> <tr><td>Video head</td><td>6.25</td></tr> <tr><td>Pinch roller</td><td>1.30</td></tr> <tr><td>Belt kit</td><td>1.20</td></tr> <tr><td>Ca/astan belt</td><td>1.30*</td></tr> <tr><td>Loading belt</td><td>1.50*</td></tr> <tr><td>*pk of 5</td><td>4.15</td></tr> <tr><td>Idler (D)</td><td>4.45</td></tr> <tr><td>Idler (R)</td><td>0.45</td></tr> <tr><td>Idler arm</td><td>4.75</td></tr> <tr><td>Repair kit</td><td>9.38</td></tr> </table>	MITSUBISHI		VX10 330 340 350	6.25	Video head	6.25	Pinch roller	1.30	Belt kit	1.20	Ca/astan belt	1.30*	Loading belt	1.50*	*pk of 5	4.15	Idler (D)	4.45	Idler (R)	0.45	Idler arm	4.75	Repair kit	9.38	<table border="1"> <tr><td colspan="2">GRUNDIG</td></tr> <tr><td>TP150</td><td>10.00</td></tr> <tr><td>TP410</td><td>8.00</td></tr> <tr><td>TP421</td><td>10.00</td></tr> <tr><td>TP430/650</td><td>9.60</td></tr> <tr><td>TP431</td><td>10.00</td></tr> </table>	GRUNDIG		TP150	10.00	TP410	8.00	TP421	10.00	TP430/650	9.60	TP431	10.00	<table border="1"> <tr><td colspan="2">HITACHI</td></tr> <tr><td>RC140M</td><td>9.60</td></tr> <tr><td>RC132</td><td>9.60</td></tr> <tr><td>RC200</td><td>9.60</td></tr> <tr><td>RC301</td><td>9.60</td></tr> <tr><td>RC302</td><td>9.60</td></tr> <tr><td>RC303</td><td>9.60</td></tr> <tr><td>RC310</td><td>9.60</td></tr> <tr><td>RC311</td><td>9.60</td></tr> </table>	HITACHI		RC140M	9.60	RC132	9.60	RC200	9.60	RC301	9.60	RC302	9.60	RC303	9.60	RC310	9.60	RC311	9.60	<table border="1"> <tr><td colspan="2">PHILIPS</td></tr> <tr><td>RC134</td><td>9.60</td></tr> <tr><td>RC135</td><td>9.60</td></tr> <tr><td>RC138</td><td>10.00</td></tr> <tr><td>RC180</td><td>10.00</td></tr> <tr><td>RC300</td><td>8.10</td></tr> <tr><td>RC301</td><td>9.60</td></tr> <tr><td>RC303</td><td>9.60</td></tr> <tr><td>RC352</td><td>9.60</td></tr> <tr><td>RC5375</td><td>9.60</td></tr> <tr><td>RC5534</td><td>9.60</td></tr> <tr><td>RC5901</td><td>9.60</td></tr> <tr><td>RC5903</td><td>9.60</td></tr> </table>	PHILIPS		RC134	9.60	RC135	9.60	RC138	10.00	RC180	10.00	RC300	8.10	RC301	9.60	RC303	9.60	RC352	9.60	RC5375	9.60	RC5534	9.60	RC5901	9.60	RC5903	9.60	<table border="1"> <tr><td colspan="2">SONY</td></tr> <tr><td>RC140</td><td>9.60</td></tr> <tr><td>RC140TM</td><td>9.60</td></tr> <tr><td>RC141</td><td>9.60</td></tr> <tr><td>RC160</td><td>9.60</td></tr> </table>	SONY		RC140	9.60	RC140TM	9.60	RC141	9.60	RC160	9.60
AC138	3.9%	2SA748	0.85	2SD2340	0.45	STK461	6.00																																																																																																																																																																																																																																																																																																																																																																																																																																																																																																																																																																																																																																																																																																																																																																																																																																																																																																																																																																																
AD161	0.50	2SA841	0.40	2SD355	0.35	STR1050	7.25																																																																																																																																																																																																																																																																																																																																																																																																																																																																																																																																																																																																																																																																																																																																																																																																																																																																																																																																																																																
AD162	0.50	2SA893	0.50	2SD400	0.48	STR2129	4.75																																																																																																																																																																																																																																																																																																																																																																																																																																																																																																																																																																																																																																																																																																																																																																																																																																																																																																																																																																																
BC108	0.07	2SA1011	1.35	2SD467	0.15	STK3042	4.20																																																																																																																																																																																																																																																																																																																																																																																																																																																																																																																																																																																																																																																																																																																																																																																																																																																																																																																																																																																
BC141	0.30	2SA1102	1.60	2SD525	0.65	STK3042*	4.75																																																																																																																																																																																																																																																																																																																																																																																																																																																																																																																																																																																																																																																																																																																																																																																																																																																																																																																																																																																
BC142	0.20	2SA1123	0.49	2SD560	0.40	STK3525	4.45																																																																																																																																																																																																																																																																																																																																																																																																																																																																																																																																																																																																																																																																																																																																																																																																																																																																																																																																																																																
BC307	0.08	2SA1175	0.40	2SD612	0.80	STK5332	1.80																																																																																																																																																																																																																																																																																																																																																																																																																																																																																																																																																																																																																																																																																																																																																																																																																																																																																																																																																																																
BC337	0.07	2SA1282	0.90	2SD836	0.10	STK5332	2.40																																																																																																																																																																																																																																																																																																																																																																																																																																																																																																																																																																																																																																																																																																																																																																																																																																																																																																																																																																																
BU546	0.07	2SA1307	1.50	2SD718	0.95	STR542	4.70																																																																																																																																																																																																																																																																																																																																																																																																																																																																																																																																																																																																																																																																																																																																																																																																																																																																																																																																																																																
BU131	0.30	2SB370	0.40	2SD725	3.50	STK5476	4.00																																																																																																																																																																																																																																																																																																																																																																																																																																																																																																																																																																																																																																																																																																																																																																																																																																																																																																																																																																																
BU132	0.30	2SB524	0.65	2SD836	0.75	STK7348	3.15																																																																																																																																																																																																																																																																																																																																																																																																																																																																																																																																																																																																																																																																																																																																																																																																																																																																																																																																																																																
BU243	0.38	2SB541	1.90	2SD856	0.55	STK73410	4.00																																																																																																																																																																																																																																																																																																																																																																																																																																																																																																																																																																																																																																																																																																																																																																																																																																																																																																																																																																																
BU246	0.65	2SB546	0.55	2SD1136	0.50	STAD11	3.50																																																																																																																																																																																																																																																																																																																																																																																																																																																																																																																																																																																																																																																																																																																																																																																																																																																																																																																																																																																
BUK33	0.50	2SB618	3.05	2SD1273	0.70	STAD11	3.80																																																																																																																																																																																																																																																																																																																																																																																																																																																																																																																																																																																																																																																																																																																																																																																																																																																																																																																																																																																
BUK35	0.50	2SB641	0.11	2SD1275	0.58	STAD11	2.50																																																																																																																																																																																																																																																																																																																																																																																																																																																																																																																																																																																																																																																																																																																																																																																																																																																																																																																																																																																
BU197	0.20	2SB649	0.38	2SD1278	0.58	STAD11	4.75																																																																																																																																																																																																																																																																																																																																																																																																																																																																																																																																																																																																																																																																																																																																																																																																																																																																																																																																																																																
BU259	0.70	2SB717	0.57	2SD1398	1.40	STR451	11.25																																																																																																																																																																																																																																																																																																																																																																																																																																																																																																																																																																																																																																																																																																																																																																																																																																																																																																																																																																																
H494	0.16	2SB861	1.50	2SD1426	2.05	STR5412	1.40																																																																																																																																																																																																																																																																																																																																																																																																																																																																																																																																																																																																																																																																																																																																																																																																																																																																																																																																																																																
BFE81	0.30	2SB1015	0.63	2SD1441	3.50	STR14090	5.90																																																																																																																																																																																																																																																																																																																																																																																																																																																																																																																																																																																																																																																																																																																																																																																																																																																																																																																																																																																
BFY51	0.80	2SB1016	1.10	AN318	4.40	STR50103	2.65																																																																																																																																																																																																																																																																																																																																																																																																																																																																																																																																																																																																																																																																																																																																																																																																																																																																																																																																																																																
BFY90	2.00	2SC377	0.77	AN511	3.50	STR59041	6.40																																																																																																																																																																																																																																																																																																																																																																																																																																																																																																																																																																																																																																																																																																																																																																																																																																																																																																																																																																																
BU24	1.35	2SC458	0.68	AN521	1.35	TA7157	1.20																																																																																																																																																																																																																																																																																																																																																																																																																																																																																																																																																																																																																																																																																																																																																																																																																																																																																																																																																																																
BU180	0.80	2SC591	3.20	AN522	1.35	TA7270	2.00																																																																																																																																																																																																																																																																																																																																																																																																																																																																																																																																																																																																																																																																																																																																																																																																																																																																																																																																																																																
BU106	0.85	2SC611	3.00	AN567	3.80	TA7280	2.75																																																																																																																																																																																																																																																																																																																																																																																																																																																																																																																																																																																																																																																																																																																																																																																																																																																																																																																																																																																
BU208	0.68	2SC667	3.00	AN673	2.25	TA7604	2.35																																																																																																																																																																																																																																																																																																																																																																																																																																																																																																																																																																																																																																																																																																																																																																																																																																																																																																																																																																																
BU208A	0.70	2SC941	0.12	AN7115	1.40	TAR205	2.90																																																																																																																																																																																																																																																																																																																																																																																																																																																																																																																																																																																																																																																																																																																																																																																																																																																																																																																																																																																
BU208A	0.80	2SC998	3.05	BA318	1.75	TAR207	1.65																																																																																																																																																																																																																																																																																																																																																																																																																																																																																																																																																																																																																																																																																																																																																																																																																																																																																																																																																																																
BU26A	1.10	2SC1008	0.20	BA658	3.60	TAR210	3.50																																																																																																																																																																																																																																																																																																																																																																																																																																																																																																																																																																																																																																																																																																																																																																																																																																																																																																																																																																																
BU407	0.65	2SC1103	0.50	BA130	1.50	TAR214	3.40																																																																																																																																																																																																																																																																																																																																																																																																																																																																																																																																																																																																																																																																																																																																																																																																																																																																																																																																																																																
BU409	1.10	2SC1123	0.49	BA5466	2.50	TAR215	3.00																																																																																																																																																																																																																																																																																																																																																																																																																																																																																																																																																																																																																																																																																																																																																																																																																																																																																																																																																																																
BU426	1.50	2SC1222	0.11	BA6219	1.20	UCPS14	0.50																																																																																																																																																																																																																																																																																																																																																																																																																																																																																																																																																																																																																																																																																																																																																																																																																																																																																																																																																																																
BU508A	0.85	2SC1277	0.38	BA156	1.35	UCP1320	2.00																																																																																																																																																																																																																																																																																																																																																																																																																																																																																																																																																																																																																																																																																																																																																																																																																																																																																																																																																																																
BU508B	1.35	2SC1382	0.30	HA1377	4.00	UCP1032	0.60																																																																																																																																																																																																																																																																																																																																																																																																																																																																																																																																																																																																																																																																																																																																																																																																																																																																																																																																																																																
BU508C	1.10	2SC1429	0.55	HA1227	1.50	UCP1185	4.00																																																																																																																																																																																																																																																																																																																																																																																																																																																																																																																																																																																																																																																																																																																																																																																																																																																																																																																																																																																
BU536	1.05	2SC1447	0.80	KA2.01	1.00	UCP1230	1.50																																																																																																																																																																																																																																																																																																																																																																																																																																																																																																																																																																																																																																																																																																																																																																																																																																																																																																																																																																																
BU526	1.45	2SC1514	0.42	KA2.63	1.50	UCP1363C	1.90																																																																																																																																																																																																																																																																																																																																																																																																																																																																																																																																																																																																																																																																																																																																																																																																																																																																																																																																																																																
BU108AF	1.20	2SC1569	0.55	LA1352	1.45	UCP1378	1.80																																																																																																																																																																																																																																																																																																																																																																																																																																																																																																																																																																																																																																																																																																																																																																																																																																																																																																																																																																																
BU508DF	1.35	2SC1674	0.15	LA1460	2.05	UCP1394	1.50																																																																																																																																																																																																																																																																																																																																																																																																																																																																																																																																																																																																																																																																																																																																																																																																																																																																																																																																																																																
BU111A	0.70	2SC1767	0.36	LA4.82	1.65	UCP1456	0.50																																																																																																																																																																																																																																																																																																																																																																																																																																																																																																																																																																																																																																																																																																																																																																																																																																																																																																																																																																																
BU111AF	0.85	2SC1815	0.12	LA4200	1.30																																																																																																																																																																																																																																																																																																																																																																																																																																																																																																																																																																																																																																																																																																																																																																																																																																																																																																																																																																																		
BU112A	0.85	2SC1852	0.49	LA4440	1.18																																																																																																																																																																																																																																																																																																																																																																																																																																																																																																																																																																																																																																																																																																																																																																																																																																																																																																																																																																																		
BU112AF	1.10	2SC1914	0.15	LA4660	1.30																																																																																																																																																																																																																																																																																																																																																																																																																																																																																																																																																																																																																																																																																																																																																																																																																																																																																																																																																																																		
BU156A	0.80	2SC1983	0.90	LA4700	1.40																																																																																																																																																																																																																																																																																																																																																																																																																																																																																																																																																																																																																																																																																																																																																																																																																																																																																																																																																																																		
TIP30C	0.25	2SC2007	0.22	LA6320	1.90																																																																																																																																																																																																																																																																																																																																																																																																																																																																																																																																																																																																																																																																																																																																																																																																																																																																																																																																																																																		
TIP31A	0.25	2SC2027	2.20	LM318	1.15	815	0.20																																																																																																																																																																																																																																																																																																																																																																																																																																																																																																																																																																																																																																																																																																																																																																																																																																																																																																																																																																																
TIP32B	0.30	2SC2076	1.10	LM318	1.15	820	0.20																																																																																																																																																																																																																																																																																																																																																																																																																																																																																																																																																																																																																																																																																																																																																																																																																																																																																																																																																																																
TIP41A	0.35	2SC2236	0.25	LM318	2.25																																																																																																																																																																																																																																																																																																																																																																																																																																																																																																																																																																																																																																																																																																																																																																																																																																																																																																																																																																																		
TIP47	0.45	2SC2278	1.00	LM4002	5.25																																																																																																																																																																																																																																																																																																																																																																																																																																																																																																																																																																																																																																																																																																																																																																																																																																																																																																																																																																																		
TIP110	0.45	2SC2347	0.18	MS143P	1.40																																																																																																																																																																																																																																																																																																																																																																																																																																																																																																																																																																																																																																																																																																																																																																																																																																																																																																																																																																																		
TIP112	0.85	2SC2500	0.25	MS220L	1.75																																																																																																																																																																																																																																																																																																																																																																																																																																																																																																																																																																																																																																																																																																																																																																																																																																																																																																																																																																																		
TIP142	0.90	2SC2599	1.25	MS1172	2.60																																																																																																																																																																																																																																																																																																																																																																																																																																																																																																																																																																																																																																																																																																																																																																																																																																																																																																																																																																																		
TIP1791	1.30	2SC2603	0.12	MS4884	4.50																																																																																																																																																																																																																																																																																																																																																																																																																																																																																																																																																																																																																																																																																																																																																																																																																																																																																																																																																																																		
TIP2955	0.50	2SC2658	0.10	MB3731	2.80																																																																																																																																																																																																																																																																																																																																																																																																																																																																																																																																																																																																																																																																																																																																																																																																																																																																																																																																																																																		
ME3400	0.25	2SC2688	0.30	MB3731	2.45																																																																																																																																																																																																																																																																																																																																																																																																																																																																																																																																																																																																																																																																																																																																																																																																																																																																																																																																																																																		
ME3521	0.35	2SC2738	3.00	MB3731	2.45																																																																																																																																																																																																																																																																																																																																																																																																																																																																																																																																																																																																																																																																																																																																																																																																																																																																																																																																																																																		
2M222	0.20	2SC2759	2.00	MC132	0.65																																																																																																																																																																																																																																																																																																																																																																																																																																																																																																																																																																																																																																																																																																																																																																																																																																																																																																																																																																																		
2M1035	1.10	2SC3182	1.50	MC14426	2.50																																																																																																																																																																																																																																																																																																																																																																																																																																																																																																																																																																																																																																																																																																																																																																																																																																																																																																																																																																																		
2M3773	1.50	2SC3262	3.60	MC14943	0.03																																																																																																																																																																																																																																																																																																																																																																																																																																																																																																																																																																																																																																																																																																																																																																																																																																																																																																																																																																																		
2M6130	0.40	2SC3345	1.00	SA1293A	4.85																																																																																																																																																																																																																																																																																																																																																																																																																																																																																																																																																																																																																																																																																																																																																																																																																																																																																																																																																																																		
2SA350	0.60	2SC3306	3.40	SA1293 B	5.15																																																																																																																																																																																																																																																																																																																																																																																																																																																																																																																																																																																																																																																																																																																																																																																																																																																																																																																																																																																		
2SA606	2.85	2SC3883	2.80	SA1293 C	5.15																																																																																																																																																																																																																																																																																																																																																																																																																																																																																																																																																																																																																																																																																																																																																																																																																																																																																																																																																																																		
2SA679	1.95	2SC4742	1.40	SAAS010	4.95																																																																																																																																																																																																																																																																																																																																																																																																																																																																																																																																																																																																																																																																																																																																																																																																																																																																																																																																																																																		
2SA722	0.62	2SD198	1.60	SAAS243P	7.15																																																																																																																																																																																																																																																																																																																																																																																																																																																																																																																																																																																																																																																																																																																																																																																																																																																																																																																																																																																		
VIDEO SPARES																																																																																																																																																																																																																																																																																																																																																																																																																																																																																																																																																																																																																																																																																																																																																																																																																																																																																																																																																																																							
AKAI	VS1-5																																																																																																																																																																																																																																																																																																																																																																																																																																																																																																																																																																																																																																																																																																																																																																																																																																																																																																																																																																																						
Video head	15.00																																																																																																																																																																																																																																																																																																																																																																																																																																																																																																																																																																																																																																																																																																																																																																																																																																																																																																																																																																																						
Pinch roller	1.45																																																																																																																																																																																																																																																																																																																																																																																																																																																																																																																																																																																																																																																																																																																																																																																																																																																																																																																																																																																						
Belt kit	3.00																																																																																																																																																																																																																																																																																																																																																																																																																																																																																																																																																																																																																																																																																																																																																																																																																																																																																																																																																																																						
Reel idler	3.00																																																																																																																																																																																																																																																																																																																																																																																																																																																																																																																																																																																																																																																																																																																																																																																																																																																																																																																																																																																						
Take/uidler	1.15																																																																																																																																																																																																																																																																																																																																																																																																																																																																																																																																																																																																																																																																																																																																																																																																																																																																																																																																																																																						
Clutch	2.10																																																																																																																																																																																																																																																																																																																																																																																																																																																																																																																																																																																																																																																																																																																																																																																																																																																																																																																																																																																						
Lamp	0.30																																																																																																																																																																																																																																																																																																																																																																																																																																																																																																																																																																																																																																																																																																																																																																																																																																																																																																																																																																																						
Lamp+skt	0.75																																																																																																																																																																																																																																																																																																																																																																																																																																																																																																																																																																																																																																																																																																																																																																																																																																																																																																																																																																																						
Loading belt	1.40																																																																																																																																																																																																																																																																																																																																																																																																																																																																																																																																																																																																																																																																																																																																																																																																																																																																																																																																																																																						
Repair kit	19.23																																																																																																																																																																																																																																																																																																																																																																																																																																																																																																																																																																																																																																																																																																																																																																																																																																																																																																																																																																																						
FERGUSON JVC																																																																																																																																																																																																																																																																																																																																																																																																																																																																																																																																																																																																																																																																																																																																																																																																																																																																																																																																																																																							
3D29 MR7200	6.40																																																																																																																																																																																																																																																																																																																																																																																																																																																																																																																																																																																																																																																																																																																																																																																																																																																																																																																																																																																						
Video head	7.50																																																																																																																																																																																																																																																																																																																																																																																																																																																																																																																																																																																																																																																																																																																																																																																																																																																																																																																																																																																						
Pinch roller	1.10																																																																																																																																																																																																																																																																																																																																																																																																																																																																																																																																																																																																																																																																																																																																																																																																																																																																																																																																																																																						
Belt kit	2.25																																																																																																																																																																																																																																																																																																																																																																																																																																																																																																																																																																																																																																																																																																																																																																																																																																																																																																																																																																																						
Reel idler	1.15																																																																																																																																																																																																																																																																																																																																																																																																																																																																																																																																																																																																																																																																																																																																																																																																																																																																																																																																																																																						
Take/uidler	1.15																																																																																																																																																																																																																																																																																																																																																																																																																																																																																																																																																																																																																																																																																																																																																																																																																																																																																																																																																																																						
Clutch	2.10																																																																																																																																																																																																																																																																																																																																																																																																																																																																																																																																																																																																																																																																																																																																																																																																																																																																																																																																																																																						
Lamp	0.30																																																																																																																																																																																																																																																																																																																																																																																																																																																																																																																																																																																																																																																																																																																																																																																																																																																																																																																																																																																						
Lamp+skt	0.75																																																																																																																																																																																																																																																																																																																																																																																																																																																																																																																																																																																																																																																																																																																																																																																																																																																																																																																																																																																						
Loading belt	1.40																																																																																																																																																																																																																																																																																																																																																																																																																																																																																																																																																																																																																																																																																																																																																																																																																																																																																																																																																																																						
Repair kit	19.23																																																																																																																																																																																																																																																																																																																																																																																																																																																																																																																																																																																																																																																																																																																																																																																																																																																																																																																																																																																						
PHILIPS																																																																																																																																																																																																																																																																																																																																																																																																																																																																																																																																																																																																																																																																																																																																																																																																																																																																																																																																																																																							
VTR451	6.68																																																																																																																																																																																																																																																																																																																																																																																																																																																																																																																																																																																																																																																																																																																																																																																																																																																																																																																																																																																						
6169 641B	6.18																																																																																																																																																																																																																																																																																																																																																																																																																																																																																																																																																																																																																																																																																																																																																																																																																																																																																																																																																																																						
Video head	45.00																																																																																																																																																																																																																																																																																																																																																																																																																																																																																																																																																																																																																																																																																																																																																																																																																																																																																																																																																																																						
Belt kit	1.30																																																																																																																																																																																																																																																																																																																																																																																																																																																																																																																																																																																																																																																																																																																																																																																																																																																																																																																																																																																						
Pinch roller	6.85																																																																																																																																																																																																																																																																																																																																																																																																																																																																																																																																																																																																																																																																																																																																																																																																																																																																																																																																																																																						
Clutch drive assy	4.75																																																																																																																																																																																																																																																																																																																																																																																																																																																																																																																																																																																																																																																																																																																																																																																																																																																																																																																																																																																						
Clutch	4.85																																																																																																																																																																																																																																																																																																																																																																																																																																																																																																																																																																																																																																																																																																																																																																																																																																																																																																																																																																																						
Pulley	11.40																																																																																																																																																																																																																																																																																																																																																																																																																																																																																																																																																																																																																																																																																																																																																																																																																																																																																																																																																																																						
Ra+k assy	12.40																																																																																																																																																																																																																																																																																																																																																																																																																																																																																																																																																																																																																																																																																																																																																																																																																																																																																																																																																																																						
Ca/ssette lift assy	18.50																																																																																																																																																																																																																																																																																																																																																																																																																																																																																																																																																																																																																																																																																																																																																																																																																																																																																																																																																																																						
SAMSUNG																																																																																																																																																																																																																																																																																																																																																																																																																																																																																																																																																																																																																																																																																																																																																																																																																																																																																																																																																																																							
VV110 712 720	2.00																																																																																																																																																																																																																																																																																																																																																																																																																																																																																																																																																																																																																																																																																																																																																																																																																																																																																																																																																																																						
720 970 971 972	1.70																																																																																																																																																																																																																																																																																																																																																																																																																																																																																																																																																																																																																																																																																																																																																																																																																																																																																																																																																																																						
Video head	15.10																																																																																																																																																																																																																																																																																																																																																																																																																																																																																																																																																																																																																																																																																																																																																																																																																																																																																																																																																																																						
Pinch roller	3.50																																																																																																																																																																																																																																																																																																																																																																																																																																																																																																																																																																																																																																																																																																																																																																																																																																																																																																																																																																																						
Idler wheel	1.55																																																																																																																																																																																																																																																																																																																																																																																																																																																																																																																																																																																																																																																																																																																																																																																																																																																																																																																																																																																						
FF/ew clutch assy	12.25																																																																																																																																																																																																																																																																																																																																																																																																																																																																																																																																																																																																																																																																																																																																																																																																																																																																																																																																																																																						
FF/ew clutch assy	11.85																																																																																																																																																																																																																																																																																																																																																																																																																																																																																																																																																																																																																																																																																																																																																																																																																																																																																																																																																																																						
Belt kit	3.45																																																																																																																																																																																																																																																																																																																																																																																																																																																																																																																																																																																																																																																																																																																																																																																																																																																																																																																																																																																						
MITSUBISHI																																																																																																																																																																																																																																																																																																																																																																																																																																																																																																																																																																																																																																																																																																																																																																																																																																																																																																																																																																																							
VX17/D	4.75																																																																																																																																																																																																																																																																																																																																																																																																																																																																																																																																																																																																																																																																																																																																																																																																																																																																																																																																																																																						
Video head	15.15																																																																																																																																																																																																																																																																																																																																																																																																																																																																																																																																																																																																																																																																																																																																																																																																																																																																																																																																																																																						
Pinch roller	1.65																																																																																																																																																																																																																																																																																																																																																																																																																																																																																																																																																																																																																																																																																																																																																																																																																																																																																																																																																																																						
Idler wheel	1.55																																																																																																																																																																																																																																																																																																																																																																																																																																																																																																																																																																																																																																																																																																																																																																																																																																																																																																																																																																																						
FF/ew clutch assy	12.25																																																																																																																																																																																																																																																																																																																																																																																																																																																																																																																																																																																																																																																																																																																																																																																																																																																																																																																																																																																						
FF/ew clutch assy	11.85																																																																																																																																																																																																																																																																																																																																																																																																																																																																																																																																																																																																																																																																																																																																																																																																																																																																																																																																																																																						
Belt kit	3.45																																																																																																																																																																																																																																																																																																																																																																																																																																																																																																																																																																																																																																																																																																																																																																																																																																																																																																																																																																																						
SONY																																																																																																																																																																																																																																																																																																																																																																																																																																																																																																																																																																																																																																																																																																																																																																																																																																																																																																																																																																																							
VX17/D	4.75																																																																																																																																																																																																																																																																																																																																																																																																																																																																																																																																																																																																																																																																																																																																																																																																																																																																																																																																																																																						
Video head	15.15																																																																																																																																																																																																																																																																																																																																																																																																																																																																																																																																																																																																																																																																																																																																																																																																																																																																																																																																																																																						
Pinch roller	1.65																																																																																																																																																																																																																																																																																																																																																																																																																																																																																																																																																																																																																																																																																																																																																																																																																																																																																																																																																																																						
Idler wheel	1.55																																																																																																																																																																																																																																																																																																																																																																																																																																																																																																																																																																																																																																																																																																																																																																																																																																																																																																																																																																																						
FF/ew clutch assy	12.25																																																																																																																																																																																																																																																																																																																																																																																																																																																																																																																																																																																																																																																																																																																																																																																																																																																																																																																																																																																						
FF/ew clutch assy	11.85																																																																																																																																																																																																																																																																																																																																																																																																																																																																																																																																																																																																																																																																																																																																																																																																																																																																																																																																																																																						
Belt kit	3.45																																																																																																																																																																																																																																																																																																																																																																																																																																																																																																																																																																																																																																																																																																																																																																																																																																																																																																																																																																																						
SHARP																																																																																																																																																																																																																																																																																																																																																																																																																																																																																																																																																																																																																																																																																																																																																																																																																																																																																																																																																																																							
VE361	9.60																																																																																																																																																																																																																																																																																																																																																																																																																																																																																																																																																																																																																																																																																																																																																																																																																																																																																																																																																																																						
Video head	12.50																																																																																																																																																																																																																																																																																																																																																																																																																																																																																																																																																																																																																																																																																																																																																																																																																																																																																																																																																																																						
Pinch roller	3.50																																																																																																																																																																																																																																																																																																																																																																																																																																																																																																																																																																																																																																																																																																																																																																																																																																																																																																																																																																																						
Belt kit	1.15																																																																																																																																																																																																																																																																																																																																																																																																																																																																																																																																																																																																																																																																																																																																																																																																																																																																																																																																																																																						
Repair kit	11.81																																																																																																																																																																																																																																																																																																																																																																																																																																																																																																																																																																																																																																																																																																																																																																																																																																																																																																																																																																																						
Idler (D)	3.10																																																																																																																																																																																																																																																																																																																																																																																																																																																																																																																																																																																																																																																																																																																																																																																																																																																																																																																																																																																						
Idler (R)	1.65																																																																																																																																																																																																																																																																																																																																																																																																																																																																																																																																																																																																																																																																																																																																																																																																																																																																																																																																																																																						
KODAK																																																																																																																																																																																																																																																																																																																																																																																																																																																																																																																																																																																																																																																																																																																																																																																																																																																																																																																																																																																							
VR11 33 34	10.00																																																																																																																																																																																																																																																																																																																																																																																																																																																																																																																																																																																																																																																																																																																																																																																																																																																																																																																																																																																						
Video head	10.00																																																																																																																																																																																																																																																																																																																																																																																																																																																																																																																																																																																																																																																																																																																																																																																																																																																																																																																																																																																						
Pinch roller	1.85																																																																																																																																																																																																																																																																																																																																																																																																																																																																																																																																																																																																																																																																																																																																																																																																																																																																																																																																																																																						
Belt kit	1.95																																																																																																																																																																																																																																																																																																																																																																																																																																																																																																																																																																																																																																																																																																																																																																																																																																																																																																																																																																																						
PANA																																																																																																																																																																																																																																																																																																																																																																																																																																																																																																																																																																																																																																																																																																																																																																																																																																																																																																																																																																																							
VX10 330 340 350	6.25																																																																																																																																																																																																																																																																																																																																																																																																																																																																																																																																																																																																																																																																																																																																																																																																																																																																																																																																																																																						
Video head	6.25																																																																																																																																																																																																																																																																																																																																																																																																																																																																																																																																																																																																																																																																																																																																																																																																																																																																																																																																																																																						
Pinch roller	1.30																																																																																																																																																																																																																																																																																																																																																																																																																																																																																																																																																																																																																																																																																																																																																																																																																																																																																																																																																																																						
Belt kit	1.20																																																																																																																																																																																																																																																																																																																																																																																																																																																																																																																																																																																																																																																																																																																																																																																																																																																																																																																																																																																						
Ca/astan belt	1.30*																																																																																																																																																																																																																																																																																																																																																																																																																																																																																																																																																																																																																																																																																																																																																																																																																																																																																																																																																																																						
Loading belt	1.50*																																																																																																																																																																																																																																																																																																																																																																																																																																																																																																																																																																																																																																																																																																																																																																																																																																																																																																																																																																																						
*pk of 5	4.15																																																																																																																																																																																																																																																																																																																																																																																																																																																																																																																																																																																																																																																																																																																																																																																																																																																																																																																																																																																						
Idler (D)	4.45																																																																																																																																																																																																																																																																																																																																																																																																																																																																																																																																																																																																																																																																																																																																																																																																																																																																																																																																																																																						
Idler (R)	0.45																																																																																																																																																																																																																																																																																																																																																																																																																																																																																																																																																																																																																																																																																																																																																																																																																																																																																																																																																																																						
Idler arm	4.75																																																																																																																																																																																																																																																																																																																																																																																																																																																																																																																																																																																																																																																																																																																																																																																																																																																																																																																																																																																						
Repair kit	9.38																																																																																																																																																																																																																																																																																																																																																																																																																																																																																																																																																																																																																																																																																																																																																																																																																																																																																																																																																																																						
HITACHI																																																																																																																																																																																																																																																																																																																																																																																																																																																																																																																																																																																																																																																																																																																																																																																																																																																																																																																																																																																							
VX10 330 340 350	6.25																																																																																																																																																																																																																																																																																																																																																																																																																																																																																																																																																																																																																																																																																																																																																																																																																																																																																																																																																																																						
Video head	6.25																																																																																																																																																																																																																																																																																																																																																																																																																																																																																																																																																																																																																																																																																																																																																																																																																																																																																																																																																																																						
Pinch roller	1.30																																																																																																																																																																																																																																																																																																																																																																																																																																																																																																																																																																																																																																																																																																																																																																																																																																																																																																																																																																																						
Belt kit	1.20																																																																																																																																																																																																																																																																																																																																																																																																																																																																																																																																																																																																																																																																																																																																																																																																																																																																																																																																																																																						
Ca/astan belt	1.30*																																																																																																																																																																																																																																																																																																																																																																																																																																																																																																																																																																																																																																																																																																																																																																																																																																																																																																																																																																																						
Loading belt	1.50*																																																																																																																																																																																																																																																																																																																																																																																																																																																																																																																																																																																																																																																																																																																																																																																																																																																																																																																																																																																						
*pk of 5	4.15																																																																																																																																																																																																																																																																																																																																																																																																																																																																																																																																																																																																																																																																																																																																																																																																																																																																																																																																																																																						
Idler (D)	4.45																																																																																																																																																																																																																																																																																																																																																																																																																																																																																																																																																																																																																																																																																																																																																																																																																																																																																																																																																																																						
Idler (R)	0.45																																																																																																																																																																																																																																																																																																																																																																																																																																																																																																																																																																																																																																																																																																																																																																																																																																																																																																																																																																																						
Idler arm	4.75																																																																																																																																																																																																																																																																																																																																																																																																																																																																																																																																																																																																																																																																																																																																																																																																																																																																																																																																																																																						
Repair kit	9.38																																																																																																																																																																																																																																																																																																																																																																																																																																																																																																																																																																																																																																																																																																																																																																																																																																																																																																																																																																																						
MITSUBISHI																																																																																																																																																																																																																																																																																																																																																																																																																																																																																																																																																																																																																																																																																																																																																																																																																																																																																																																																																																																							
VX10 330 340 350	6.25																																																																																																																																																																																																																																																																																																																																																																																																																																																																																																																																																																																																																																																																																																																																																																																																																																																																																																																																																																																						
Video head	6.25																																																																																																																																																																																																																																																																																																																																																																																																																																																																																																																																																																																																																																																																																																																																																																																																																																																																																																																																																																																						
Pinch roller	1.30																																																																																																																																																																																																																																																																																																																																																																																																																																																																																																																																																																																																																																																																																																																																																																																																																																																																																																																																																																																						
Belt kit	1.20																																																																																																																																																																																																																																																																																																																																																																																																																																																																																																																																																																																																																																																																																																																																																																																																																																																																																																																																																																																						
Ca/astan belt	1.30*																																																																																																																																																																																																																																																																																																																																																																																																																																																																																																																																																																																																																																																																																																																																																																																																																																																																																																																																																																																						
Loading belt	1.50*																																																																																																																																																																																																																																																																																																																																																																																																																																																																																																																																																																																																																																																																																																																																																																																																																																																																																																																																																																																						
*pk of 5	4.15																																																																																																																																																																																																																																																																																																																																																																																																																																																																																																																																																																																																																																																																																																																																																																																																																																																																																																																																																																																						
Idler (D)	4.45																																																																																																																																																																																																																																																																																																																																																																																																																																																																																																																																																																																																																																																																																																																																																																																																																																																																																																																																																																																						
Idler (R)	0.45																																																																																																																																																																																																																																																																																																																																																																																																																																																																																																																																																																																																																																																																																																																																																																																																																																																																																																																																																																																						
Idler arm	4.75																																																																																																																																																																																																																																																																																																																																																																																																																																																																																																																																																																																																																																																																																																																																																																																																																																																																																																																																																																																						
Repair kit	9.38																																																																																																																																																																																																																																																																																																																																																																																																																																																																																																																																																																																																																																																																																																																																																																																																																																																																																																																																																																																						
GRUNDIG																																																																																																																																																																																																																																																																																																																																																																																																																																																																																																																																																																																																																																																																																																																																																																																																																																																																																																																																																																																							
TP150	10.00																																																																																																																																																																																																																																																																																																																																																																																																																																																																																																																																																																																																																																																																																																																																																																																																																																																																																																																																																																																						
TP410	8.00																																																																																																																																																																																																																																																																																																																																																																																																																																																																																																																																																																																																																																																																																																																																																																																																																																																																																																																																																																																						
TP421	10.00																																																																																																																																																																																																																																																																																																																																																																																																																																																																																																																																																																																																																																																																																																																																																																																																																																																																																																																																																																																						
TP430/650	9.60																																																																																																																																																																																																																																																																																																																																																																																																																																																																																																																																																																																																																																																																																																																																																																																																																																																																																																																																																																																						
TP431	10.00																																																																																																																																																																																																																																																																																																																																																																																																																																																																																																																																																																																																																																																																																																																																																																																																																																																																																																																																																																																						
HITACHI																																																																																																																																																																																																																																																																																																																																																																																																																																																																																																																																																																																																																																																																																																																																																																																																																																																																																																																																																																																							
RC140M	9.60																																																																																																																																																																																																																																																																																																																																																																																																																																																																																																																																																																																																																																																																																																																																																																																																																																																																																																																																																																																						
RC132	9.60																																																																																																																																																																																																																																																																																																																																																																																																																																																																																																																																																																																																																																																																																																																																																																																																																																																																																																																																																																																						
RC200	9.60																																																																																																																																																																																																																																																																																																																																																																																																																																																																																																																																																																																																																																																																																																																																																																																																																																																																																																																																																																																						
RC301	9.60																																																																																																																																																																																																																																																																																																																																																																																																																																																																																																																																																																																																																																																																																																																																																																																																																																																																																																																																																																																						
RC302	9.60																																																																																																																																																																																																																																																																																																																																																																																																																																																																																																																																																																																																																																																																																																																																																																																																																																																																																																																																																																																						
RC303	9.60																																																																																																																																																																																																																																																																																																																																																																																																																																																																																																																																																																																																																																																																																																																																																																																																																																																																																																																																																																																						
RC310	9.60																																																																																																																																																																																																																																																																																																																																																																																																																																																																																																																																																																																																																																																																																																																																																																																																																																																																																																																																																																																						
RC311	9.60																																																																																																																																																																																																																																																																																																																																																																																																																																																																																																																																																																																																																																																																																																																																																																																																																																																																																																																																																																																						
PHILIPS																																																																																																																																																																																																																																																																																																																																																																																																																																																																																																																																																																																																																																																																																																																																																																																																																																																																																																																																																																																							
RC134	9.60																																																																																																																																																																																																																																																																																																																																																																																																																																																																																																																																																																																																																																																																																																																																																																																																																																																																																																																																																																																						
RC135	9.60																																																																																																																																																																																																																																																																																																																																																																																																																																																																																																																																																																																																																																																																																																																																																																																																																																																																																																																																																																																						
RC138	10.00																																																																																																																																																																																																																																																																																																																																																																																																																																																																																																																																																																																																																																																																																																																																																																																																																																																																																																																																																																																						
RC180	10.00																																																																																																																																																																																																																																																																																																																																																																																																																																																																																																																																																																																																																																																																																																																																																																																																																																																																																																																																																																																						
RC300	8.10																																																																																																																																																																																																																																																																																																																																																																																																																																																																																																																																																																																																																																																																																																																																																																																																																																																																																																																																																																																						
RC301	9.60																																																																																																																																																																																																																																																																																																																																																																																																																																																																																																																																																																																																																																																																																																																																																																																																																																																																																																																																																																																						
RC303	9.60																																																																																																																																																																																																																																																																																																																																																																																																																																																																																																																																																																																																																																																																																																																																																																																																																																																																																																																																																																																						
RC352	9.60																																																																																																																																																																																																																																																																																																																																																																																																																																																																																																																																																																																																																																																																																																																																																																																																																																																																																																																																																																																						
RC5375	9.60																																																																																																																																																																																																																																																																																																																																																																																																																																																																																																																																																																																																																																																																																																																																																																																																																																																																																																																																																																																						
RC5534	9.60																																																																																																																																																																																																																																																																																																																																																																																																																																																																																																																																																																																																																																																																																																																																																																																																																																																																																																																																																																																						
RC5901	9.60																																																																																																																																																																																																																																																																																																																																																																																																																																																																																																																																																																																																																																																																																																																																																																																																																																																																																																																																																																																						
RC5903	9.60																																																																																																																																																																																																																																																																																																																																																																																																																																																																																																																																																																																																																																																																																																																																																																																																																																																																																																																																																																																						
SONY																																																																																																																																																																																																																																																																																																																																																																																																																																																																																																																																																																																																																																																																																																																																																																																																																																																																																																																																																																																							
RC140	9.60																																																																																																																																																																																																																																																																																																																																																																																																																																																																																																																																																																																																																																																																																																																																																																																																																																																																																																																																																																																						
RC140TM	9.60																																																																																																																																																																																																																																																																																																																																																																																																																																																																																																																																																																																																																																																																																																																																																																																																																																																																																																																																																																																						
RC141	9.60																																																																																																																																																																																																																																																																																																																																																																																																																																																																																																																																																																																																																																																																																																																																																																																																																																																																																																																																																																																						
RC160	9.60																																																																																																																																																																																																																																																																																																																																																																																																																																																																																																																																																																																																																																																																																																																																																																																																																																																																																																																																																																																						
MITSUBISHI																																																																																																																																																																																																																																																																																																																																																																																																																																																																																																																																																																																																																																																																																																																																																																																																																																																																																																																																																																																							
VX10 330 340 350	6.25																																																																																																																																																																																																																																																																																																																																																																																																																																																																																																																																																																																																																																																																																																																																																																																																																																																																																																																																																																																						
Video head	6.25																																																																																																																																																																																																																																																																																																																																																																																																																																																																																																																																																																																																																																																																																																																																																																																																																																																																																																																																																																																						
Pinch roller	1.30																																																																																																																																																																																																																																																																																																																																																																																																																																																																																																																																																																																																																																																																																																																																																																																																																																																																																																																																																																																						
Belt kit	1.20																																																																																																																																																																																																																																																																																																																																																																																																																																																																																																																																																																																																																																																																																																																																																																																																																																																																																																																																																																																						
Ca/astan belt	1.30*																																																																																																																																																																																																																																																																																																																																																																																																																																																																																																																																																																																																																																																																																																																																																																																																																																																																																																																																																																																						
Loading belt	1.50*																																																																																																																																																																																																																																																																																																																																																																																																																																																																																																																																																																																																																																																																																																																																																																																																																																																																																																																																																																																						
*pk of 5	4.15																																																																																																																																																																																																																																																																																																																																																																																																																																																																																																																																																																																																																																																																																																																																																																																																																																																																																																																																																																																						
Idler (D)	4.45																																																																																																																																																																																																																																																																																																																																																																																																																																																																																																																																																																																																																																																																																																																																																																																																																																																																																																																																																																																						
Idler (R)	0.45																																																																																																																																																																																																																																																																																																																																																																																																																																																																																																																																																																																																																																																																																																																																																																																																																																																																																																																																																																																						
Idler arm	4.75																																																																																																																																																																																																																																																																																																																																																																																																																																																																																																																																																																																																																																																																																																																																																																																																																																																																																																																																																																																						
Repair kit	9.38																																																																																																																																																																																																																																																																																																																																																																																																																																																																																																																																																																																																																																																																																																																																																																																																																																																																																																																																																																																						
SHARP																																																																																																																																																																																																																																																																																																																																																																																																																																																																																																																																																																																																																																																																																																																																																																																																																																																																																																																																																																																							
VE361	9.60																																																																																																																																																																																																																																																																																																																																																																																																																																																																																																																																																																																																																																																																																																																																																																																																																																																																																																																																																																																						
Video head	12.50																																																																																																																																																																																																																																																																																																																																																																																																																																																																																																																																																																																																																																																																																																																																																																																																																																																																																																																																																																																						
Pinch roller	3.50																																																																																																																																																																																																																																																																																																																																																																																																																																																																																																																																																																																																																																																																																																																																																																																																																																																																																																																																																																																						
Belt kit	1.15																																																																																																																																																																																																																																																																																																																																																																																																																																																																																																																																																																																																																																																																																																																																																																																																																																																																																																																																																																																						
Repair kit	11.81																																																																																																																																																																																																																																																																																																																																																																																																																																																																																																																																																																																																																																																																																																																																																																																																																																																																																																																																																																																						
Idler (D)	3.10																																																																																																																																																																																																																																																																																																																																																																																																																																																																																																																																																																																																																																																																																																																																																																																																																																																																																																																																																																																						
Idler (R)	1.65																																																																																																																																																																																																																																																																																																																																																																																																																																																																																																																																																																																																																																																																																																																																																																																																																																																																																																																																																																																						
SONY																																																																																																																																																																																																																																																																																																																																																																																																																																																																																																																																																																																																																																																																																																																																																																																																																																																																																																																																																																																							
RC140	9.60																																																																																																																																																																																																																																																																																																																																																																																																																																																																																																																																																																																																																																																																																																																																																																																																																																																																																																																																																																																						
RC140TM	9.60																																																																																																																																																																																																																																																																																																																																																																																																																																																																																																																																																																																																																																																																																																																																																																																																																																																																																																																																																																																						
RC141	9.60																																																																																																																																																																																																																																																																																																																																																																																																																																																																																																																																																																																																																																																																																																																																																																																																																																																																																																																																																																																						
RC160	9.60																																																																																																																																																																																																																																																																																																																																																																																																																																																																																																																																																																																																																																																																																																																																																																																																																																																																																																																																																																																						
MITSUBISHI																																																																																																																																																																																																																																																																																																																																																																																																																																																																																																																																																																																																																																																																																																																																																																																																																																																																																																																																																																																							
VX10 330 340 350	6.25																																																																																																																																																																																																																																																																																																																																																																																																																																																																																																																																																																																																																																																																																																																																																																																																																																																																																																																																																																																						
Video head	6.25																																																																																																																																																																																																																																																																																																																																																																																																																																																																																																																																																																																																																																																																																																																																																																																																																																																																																																																																																																																						
Pinch roller	1.30																																																																																																																																																																																																																																																																																																																																																																																																																																																																																																																																																																																																																																																																																																																																																																																																																																																																																																																																																																																						
Belt kit	1.20																																																																																																																																																																																																																																																																																																																																																																																																																																																																																																																																																																																																																																																																																																																																																																																																																																																																																																																																																																																						
Ca/astan belt	1.30*																																																																																																																																																																																																																																																																																																																																																																																																																																																																																																																																																																																																																																																																																																																																																																																																																																																																																																																																																																																						
Loading belt	1.50*																																																																																																																																																																																																																																																																																																																																																																																																																																																																																																																																																																																																																																																																																																																																																																																																																																																																																																																																																																																						
*pk of 5	4.15																																																																																																																																																																																																																																																																																																																																																																																																																																																																																																																																																																																																																																																																																																																																																																																																																																																																																																																																																																																						
Idler (D)	4.45																																																																																																																																																																																																																																																																																																																																																																																																																																																																																																																																																																																																																																																																																																																																																																																																																																																																																																																																																																																						
Idler (R)	0.45																																																																																																																																																																																																																																																																																																																																																																																																																																																																																																																																																																																																																																																																																																																																																																																																																																																																																																																																																																																						
Idler arm	4.75																																																																																																																																																																																																																																																																																																																																																																																																																																																																																																																																																																																																																																																																																																																																																																																																																																																																																																																																																																																						
Repair kit	9.38																																																																																																																																																																																																																																																																																																																																																																																																																																																																																																																																																																																																																																																																																																																																																																																																																																																																																																																																																																																						
GRUNDIG																																																																																																																																																																																																																																																																																																																																																																																																																																																																																																																																																																																																																																																																																																																																																																																																																																																																																																																																																																																							
TP150	10.00																																																																																																																																																																																																																																																																																																																																																																																																																																																																																																																																																																																																																																																																																																																																																																																																																																																																																																																																																																																						
TP410	8.00																																																																																																																																																																																																																																																																																																																																																																																																																																																																																																																																																																																																																																																																																																																																																																																																																																																																																																																																																																																						
TP421	10.00																																																																																																																																																																																																																																																																																																																																																																																																																																																																																																																																																																																																																																																																																																																																																																																																																																																																																																																																																																																						
TP430/650	9.60																																																																																																																																																																																																																																																																																																																																																																																																																																																																																																																																																																																																																																																																																																																																																																																																																																																																																																																																																																																						
TP431	10.00																																																																																																																																																																																																																																																																																																																																																																																																																																																																																																																																																																																																																																																																																																																																																																																																																																																																																																																																																																																						
HITACHI																																																																																																																																																																																																																																																																																																																																																																																																																																																																																																																																																																																																																																																																																																																																																																																																																																																																																																																																																																																							
RC140M	9.60																																																																																																																																																																																																																																																																																																																																																																																																																																																																																																																																																																																																																																																																																																																																																																																																																																																																																																																																																																																						
RC132	9.60																																																																																																																																																																																																																																																																																																																																																																																																																																																																																																																																																																																																																																																																																																																																																																																																																																																																																																																																																																																						
RC200	9.60																																																																																																																																																																																																																																																																																																																																																																																																																																																																																																																																																																																																																																																																																																																																																																																																																																																																																																																																																																																						
RC301	9.60																																																																																																																																																																																																																																																																																																																																																																																																																																																																																																																																																																																																																																																																																																																																																																																																																																																																																																																																																																																						
RC302	9.60																																																																																																																																																																																																																																																																																																																																																																																																																																																																																																																																																																																																																																																																																																																																																																																																																																																																																																																																																																																						
RC303	9.60																																																																																																																																																																																																																																																																																																																																																																																																																																																																																																																																																																																																																																																																																																																																																																																																																																																																																																																																																																																						
RC310	9.60																																																																																																																																																																																																																																																																																																																																																																																																																																																																																																																																																																																																																																																																																																																																																																																																																																																																																																																																																																																						
RC311	9.60																																																																																																																																																																																																																																																																																																																																																																																																																																																																																																																																																																																																																																																																																																																																																																																																																																																																																																																																																																																						
PHILIPS																																																																																																																																																																																																																																																																																																																																																																																																																																																																																																																																																																																																																																																																																																																																																																																																																																																																																																																																																																																							
RC134	9.60																																																																																																																																																																																																																																																																																																																																																																																																																																																																																																																																																																																																																																																																																																																																																																																																																																																																																																																																																																																						
RC135	9.60																																																																																																																																																																																																																																																																																																																																																																																																																																																																																																																																																																																																																																																																																																																																																																																																																																																																																																																																																																																						
RC138	10.00																																																																																																																																																																																																																																																																																																																																																																																																																																																																																																																																																																																																																																																																																																																																																																																																																																																																																																																																																																																						
RC180	10.00																																																																																																																																																																																																																																																																																																																																																																																																																																																																																																																																																																																																																																																																																																																																																																																																																																																																																																																																																																																						
RC300	8.10																																																																																																																																																																																																																																																																																																																																																																																																																																																																																																																																																																																																																																																																																																																																																																																																																																																																																																																																																																																						
RC301	9.60																																																																																																																																																																																																																																																																																																																																																																																																																																																																																																																																																																																																																																																																																																																																																																																																																																																																																																																																																																																						
RC303	9.60																																																																																																																																																																																																																																																																																																																																																																																																																																																																																																																																																																																																																																																																																																																																																																																																																																																																																																																																																																																						
RC352	9.60																																																																																																																																																																																																																																																																																																																																																																																																																																																																																																																																																																																																																																																																																																																																																																																																																																																																																																																																																																																						
RC5375	9.60																																																																																																																																																																																																																																																																																																																																																																																																																																																																																																																																																																																																																																																																																																																																																																																																																																																																																																																																																																																						
RC5534	9.60																																																																																																																																																																																																																																																																																																																																																																																																																																																																																																																																																																																																																																																																																																																																																																																																																																																																																																																																																																																						
RC5901	9.60																																																																																																																																																																																																																																																																																																																																																																																																																																																																																																																																																																																																																																																																																																																																																																																																																																																																																																																																																																																						
RC5903	9.60																																																																																																																																																																																																																																																																																																																																																																																																																																																																																																																																																																																																																																																																																																																																																																																																																																																																																																																																																																																						
SONY																																																																																																																																																																																																																																																																																																																																																																																																																																																																																																																																																																																																																																																																																																																																																																																																																																																																																																																																																																																							
RC140	9.60																																																																																																																																																																																																																																																																																																																																																																																																																																																																																																																																																																																																																																																																																																																																																																																																																																																																																																																																																																																						
RC140TM	9.60																																																																																																																																																																																																																																																																																																																																																																																																																																																																																																																																																																																																																																																																																																																																																																																																																																																																																																																																																																																						
RC141	9.60																																																																																																																																																																																																																																																																																																																																																																																																																																																																																																																																																																																																																																																																																																																																																																																																																																																																																																																																																																																						
RC160	9.60																																																																																																																																																																																																																																																																																																																																																																																																																																																																																																																																																																																																																																																																																																																																																																																																																																																																																																																																																																																						

SOLE DISTRIBUTOR

RA100 DESOLDERING STATION

WITH OUT IRON £185.65 + £12.00 p/p
 + vat £243.36 WITH IRON £259 +
 £12.00 p/p + vat £319.42 F.F.R.M.G.
 BY CREDIT CARDS PLEASE ADD 5%
 SURCHARGE ON LIST PRICE. ALLOW
 10 DAYS FOR DELIVERY IF PAYING
 BY CHEQUE. PLEASE READ ARTICLE
 'TELEVISION' ISSUE FEBRUARY
 1993 PAGE NO. 283

DON'T FORGET YOUR IDLER TYRES

ONLY £1.80 A PACK MINIMUM 3 PACKS

Philips VR6290/6291 BSU	E9 65
Philips chassis 'A' PSU repair kit	11 15
Philips chassis G110 BSU kit	6 35
Ferguson 2.4V Batteries (2 p/c)	9 15
Sharp VCC 113 cassette housing kit	6 35
VCR spring kit	5 75
VCR cleaning & washer kit	5 45
Fibre cleaning pencil	2 95
Refill for pencil (pk of 3)	1 50
Plastic trimming tools (pk of 3)	3 00
Audio video cleaning sticks (pk of 5)	1 50
GEC C1403H PSU kit	11 99

SPECIAL OFFER ENDS 13th 93

SUBJECT TO STOCK AVAILABILITY

BU SDBA (Philips) 10 p/c	7 20
BU T1AF (Philips) 10 p/c	5 50
BU 425A (10 p/c)	8 00
IC UA6056 each	

TV Fault Finding

Reports from Stephen Leatherbarrow, Steve Cannon, Hugh MacMullen, Roger Burchett, Richard Flowerday, Richard J. Avis, Nick Beer, Richard Newman, Michael Dranfield and John Edwards

Philips KT4 Chassis

This set was tripping. Not much of a problem you'd have thought – a line output stage fault or something connected to one of the chopper power supply's outputs. Not this time though. Try as I might, I couldn't find anything amiss on the secondary side of the power supply. So checks were made on the primary side. After testing various components I switched on and was quite taken aback – the set started up. Though the h.t. was low there was a picture and sound. There were also five or six hum bars on the screen. After much head scratching and the replacement of several perfectly good decoupling capacitors I decided to try replacing C2128, which couples the drive to the base of the chopper transistor. When a new 100µF, 50V capacitor had been fitted the h.t. came up nicely and the set was declared fit. S.C.

Sony KVX2132

The problem was crackling Nicam, but only on the video channel in the E-E mode. Very strange! Definitely a case where a call to Sony's ever efficient technical line at Cumbernauld was required. As usual they had the answer. We were told to replace or fit into vacant spaces in the PCB D1104 (DAN202K), Q1104 (DTC144EK), R1128 (1kΩ), R1130 (4.7kΩ) and C1128 (10µF, 50V). With the exception of C1128 these are all surface-mounted devices. They didn't say it would be easy! S.C.

Philips FL1.2 Chassis

This set was completely dead with only the power-on LED alight. Usually with this chassis the display will show, by means of flashing LEDs, where the source of the fault is likely to be. The most common thing is to find that the mute, Nicam and standby LEDs are lit, indicating that the set is in the protection mode. A check at L5381 in the protection control line produced a reading of 0.7V. This had triggered the protection circuit and shut the set down. So the set *was* in the protection mode, even though the LEDs weren't indicating this.

When the set is in the protection mode the cause of the fault can lie in one of six areas. The only sure way of determining which one is firing the protection circuit is to disconnect each in turn. The place to start is at the audio protection transistor Q7010: if there's a fault in the line output stage, or a fault somewhere else is loading the h.t. line, this transistor will conduct because of an imbalance between the +11V and -11V supplies generated by the chopper circuit. With Q7010 disconnected the h.t. reached 40V and the set remained lifeless.

I suspected the line output stage, but checks on the transistor and tuning capacitor were inconclusive. On closer examination I saw that the field shift transistors Q7512 and Q7513 were cracked and in a sorry state. They proved to be short-circuit. It seemed to me that the line output transformer had given up the ghost and taken these two transistors with it. Note that several types of transformer are used, depending on the type of tube fitted. This particular set had a Philips tube without DAF (dynamic focusing). When a

new transformer and field shift transistors had been fitted we had full h.t. – even with the audio protection transistor reconnected. Up came the raster but there was an EW fault. Replacing the BDT60F transistor Q7610 cured this final problem. S.C.

Philips G110 Chassis

This set wouldn't power up. It's not an uncommon complaint with this chassis. Unfortunately if the chopper transistor fails a power supply rebuild is necessary. A further problem is that the majority of the components are surface mounted. This wasn't going to be necessary here however. The h.t. was low at 20V, but obviously the power supply was working to some extent. I suspected a fault in the line output stage, and by disconnecting the h.t. feed to the transformer and fitting a dummy load the full h.t. was obtained. But there was nothing amiss in this area. When pin 3 of the transformer was disconnected the set started up and we had full h.t. and e.h.t. There was no 14V supply however as pin 3 provides the feed, hence no sound or raster.

What was happening was that the timebase generator chip was working in the start-up mode. It receives an initial supply from the chopper circuit, the 14V supply taking over once the line output stage gets going. Thus with the 14V supply disconnected the chip wasn't working at its full capacity. We had however established that the fault was connected with the 14V rail. The problem is that it feeds the 12V regulator, whose output goes all over the place. To isolate the cause of the fault we had to disconnect various feeds. In fact the faulty component was the BC858 transistor Q7284 in the audio protection stage – it's another surface-mounted device.

A tip for this chassis: before you start, get your SMD transistor kit ready. S.C.

Philips CP110 Chassis

We're experiencing, and have done for some time, a high failure rate with the mains rectifier's reservoir capacitor C2656 (150µF, 385V). It tends to go low in value, with the result that there's no start-up supply to the TEA1039 chopper drive chip IC7669. Pin 9 is the place to check. Around 14V should be found here. If this supply is low or absent, replace C2656 despite being able to measure 300V or more across it S.L.

Ferguson ICC7 Chassis

This set was dead with its 1.6AT mains fuse FP01 open-circuit and the BUH515 chopper transistor TP29 short-circuit. Checks failed to reveal any obvious causes for the failure of these devices. On replacing them the power supply still didn't work but at least there were no fireworks. As there were no shorts across the secondary lines we looked at the drive to TP29. This is produced by IP01 (TEA2261), which proved to be faulty. There's a d.c. connection between the base of TP29 and IP01, which was

presumably killed when TP29 went short-circuit – all ways. After replacing this device the h.t. appeared but the set still refused to produce results. RP62 (0.1Ω) in the 24V supply was open-circuit. A replacement finally brought the set back to the land of the living. **S.L.**

Matsui 2091

A dead set with h.t. present at the collector of the line output transistor directed our attention to the line driver stage. The 2SC2230 transistor here had 18V at its collector but no drive at its base. This comes from the TDA1940 chip IC401 which was without its supply at pin 4. Tracing the print back (we'd no manual) brought us to D407 which was open-circuit with 9V at its anode but nothing at its cathode. **S.L.**

Panasonic TC481

Intermittent loss of signals (no 12V supply) is caused by R545 (3.3Ω) developing a dry-joint. In the early stages of the fault the set will respond when tapped and continue working indefinitely. **R.B.**

Toshiba 261T4B

This set could be switched on and off but all one got was a rather loud grating noise from the line output transformer. A check showed that the h.t. at the transformer was low at only 50V. We suspected the transformer but found that the 2.4Ω resistor in series with its supply (R481) read 200Ω, though its colours were perfect. A replacement restored normal operation. **H.MacM.**

Philips CTX Chassis

This set had remote control. It came to us twice for much the same fault. On the first occasion there was no tuning memory. Simple that, the memory battery was flat. A week later it was back again, this time with no brightness or colour memory. It's the only time I've had to replace the M5840A chip. **H.MacM.**

ITT CVC25 Chassis

These sets are normally quite reliable. Every so often however this one didn't want to start – it would need a few pushes on the mains switch. The cause of the trouble was eventually traced to a very dirty line hold control. This potentiometer, R710, is on the little plug-in panel. **H.MacM.**

B and O 3316 etc

A large number of these sets are in use in this area. A common fault, which can be cured by a tap on the cabinet, is loss of sound and vision. It occurs only when the chassis is warm. The cause is a microscopic dry-joint on a couple of the TCA270S chip's pins. This chip resides in can E. It's a very difficult fault to trace because checking with a feather will produce it! **H.MacM.**

Mitsubishi CT21M1TX

The power supply would start up at switch on then immediately shut down. This sort of trouble is normally caused by a heavy overload, but checks for shorts across the outputs and subsequently disconnecting them individually failed reveal any. The run supply rectifier D905 and its associated safety resistor R905 were in order and replacement of the

TEA2261 power supply control chip made no difference. We eventually found that the opto-isolator PC951 was defective, a replacement restoring normal operation. In retrospect we should have gone for this first as the set had failed during a thunderstorm. **R.F.**

Tatung 190 Chassis

The complaint was "sound but no picture". We found that the line output stage wasn't working because there was no line drive at pin 26 of the TDA4505 chip IC101. Further scope checks around this chip showed that the line oscillator frequency at pin 23 was nearly 1MHz instead of 15.625Hz. The 2.7nF timing capacitor C111 had gone open-circuit, a replacement restoring normal operation. **R.F.**

Sony KV2212UB

The complaint was of random channel changing. We found that the cause was defective up-down switches in the top flap. **R.J.A.**

Salora J Chassis

I've seen many of these sets over the years. They still seem to work well. This one had peak brilliance at switch on however, then shut down. We traced the cause to an open-circuit in the thin wiring loom, at connection 1 where it meets the main board. **R.J.A.**

Sony K VX2121U (AE1 Chassis)

Loss of sync and/or picture caused us some difficulty. We eventually traced the cause to dry-joints on coil T101. It's on the right-hand side of signals panel A. **R.J.A.**

Samsung BT110/Alba PTV9C

We've had two of these sets in recently. The first one came from a dealer who replaced the fuse but found that the set remained dead. There was an output from the d.c. power supply, and when d.c. was connected across the battery terminals the set worked. But when the supply was fed to the d.c. jack it was dead. The cause of the trouble was a faulty changeover switch in the d.c. socket – it read 2MΩ from centre to the output.

The problem with the other set was no TV tuning – radio was fine. When the case had been removed we found that the PCB was cracked for some distance near the tuning/volume controls. This had already been attended to and there were no other breaks. The cause of the trouble was that the 6.8kΩ resistor R128 which feeds the 33V regulator IC102 was open-circuit. **N.B.**

Ferguson TX80 Chassis

If one of these sets fails to come on from standby, check whether the line output transistor is short-circuit and either RP01 (27kΩ) or RP36 (75kΩ, 3W) is open-circuit. **N.B.**

Fidelity ZX3000 Chassis

This set took upwards of an hour to come on. Faint pulsing from the power supply had been noted by the observant customer. A check at pin 9 of the TDA4600 power supply control chip IC8 showed that the 13.5V start-up supply was low. It built up from 4V to 10V, but this was not enough to start the set. The two 10kΩ resistors R82/3 and rectifier D7

in the start circuit were all o.k. As the voltage at pin 9 varied it seemed likely that the associated 100 μ F, 25V reservoir capacitor C87 was open-circuit. When it was removed we found that it had a discharge from its positive leg. **N.B.**

Panasonic TC431GR (M12C Chassis)

These excellent sets have proved to be very reliable but now have a stock fault. No go, often intermittent, can be caused by loss of the h.t. supply to the line driver stage because of dry-joints on the 680 Ω feed resistor R513. **N.B.**

Mitsubishi CT2141BM

The cause of an intermittently fading picture was loss of heater supply to the c.r.t. because of a dry-joint at pin 9 of the socket. All the pins were going the same way. **N.B.**

Ferguson A59F (ICC7 Chassis)

A number of early production sets suffered from poor focus because the focus lead connector came adrift from its socket on the c.r.t. base panel. Some customers have complained about lack of straightness of the verticals and horizontals with the very flat tubes fitted. There doesn't seem to be anything one can do about this. **N.B.**

Blaupunkt Milano IL32 (FM100 Chassis)

This set was dead. The relay could be heard to click on when the remote control unit was used to switch the set on from standby, and the standby LED was on. So at any rate the standby power supply was operating. There was no mains feed to the main chassis however as relay M865 was open-circuit on one pole. **N.B.**

Panasonic TC2110 (U5N Chassis)

The first problem with this set was an intermittent mains switch. Its remote contacts were faulty: if the switch button was flicked the set would more often than not work all right. A replacement switch put that right. The set then ran for about half an hour after which it died. The power supply relay wasn't working and I soon found that there was no supply to the remote control panel. This comes from a small transformer which is mounted in the bottom left-hand corner of the set. It had an open-circuit primary winding. **R.N.**

Philips CP110 Chassis

This set refused to start. I went through all the usual things without success. Scope checks then showed that there was a very damped waveform at the collector of the BUT11AF chopper transistor Tr7665. I eventually found that the BYD33D rectifier diode D6672 in the 32V supply on the secondary side of the circuit was faulty, reading about 1.5k Ω each way. A replacement restored normal operation. **R.N.**

Philips KT3 Chassis

This 16in. set was dead. When we removed the back we found that something had been spilt into it – something brown and gungy. We cleaned up generally and replaced various items, including the chopper transistor, but the set still failed to start up. We eventually found that the cause of the fault was a short between the primary and secondary sides of the chopper driver transformer. This had presumably occurred when the chopper transistor had failed. We

were subsequently told that the set was used in the kitchen, and that the offending substance was brown sauce. **M.Dr.**

Hitachi CPT1444

The LED channel display lit and the channel numbers could be changed. But there was no picture or sound. Before ordering a manual I decided to check the fuses and found that FS901 (1.6AT) behind the on/off switch was open-circuit. No contributory cause could be found. Note that if the fuse next to it, FS902, goes open-circuit there will be no channel display and no tuning, just a snowy raster. **M.Dr.**

Grundig CUC2400 Chassis

The man who traded in this set told us that another shop had taken a look and found that the tube was faulty. In fact R769 (15k Ω) on the c.r.t. base panel was open-circuit. A replacement restored the blue in the picture. **M.Dr.**

Osume CTV1486T

The symptoms with this set were intermittent loss of sync, a blank raster, no sound, switching to standby and the LED channel display going off. We eventually found that the output from the 5V regulator, IC105, was varying. The chip wasn't the cause of the trouble however. The standby transformer was faulty. **M.Dr.**

Alba CTV12

This set was dead though the channel indicator was alight. We eventually traced the cause to dry-joints on the line driver transformer. **J.E.**

Philips KT3 Chassis

The cause of intermittent tripping was eventually traced to the degaussing resistor. These devices usually rattle when they fail, but this one didn't. A very long test run after replacing it proved that the fault had been cured. **J.E.**

Mitsubishi BB1201B

No line or field lock was the problem with this set. Slight adjustment of the line oscillator coil L501 restored line lock but the field hold preset VR401 had to be replaced to restore field lock – there was a break in its track. **J.E.**

Philips 2A Chassis

There was an over bright raster with flyback lines and the first anode control had no effect. We found that the feed resistor R3473 (910k Ω) had gone open-circuit. **J.E.**

Hitachi CPT1456

This set was dead with the power supply screaming in agony. We found that the 2SD1453 line output transistor was short-circuit collector-to-emitter. Unfortunately the cause of its failure was the line output transformer. **J.E.**

Sony KVDX271

Sound all right but just a blank screen because there's no first anode voltage is becoming quite a common fault with these sets. You find that R807 (1k Ω , 1W) is open-circuit and D803 short-circuit. **J.E.**

MANOR SUPPLIES

MKV PAL COLOUR TEST GENERATOR FOR DOMESTIC TV & VCR.

TEST DEMONSTRATIONS AT 172 WEST END LANE



- ★ 40 different patterns and variations.
- ★ Fully interlaced sync pulses with correct picture blanking
- ★ EBU colour bars, BBC colour bars, whole rasters & split bars (specially useful for VCR service), white, yellow, cyan, green, magenta, red, blue and black
- ★ Chequerboard
- ★ Mono outputs with border castellations, cross hatch, grey scale, vertical lines, horizontal lines and dots, UHF modulator output plugs straight into receiver aerial socket.
- ★ Additional video output for CCTV & VCR.
- ★ Facilities for sound output.
- ★ Easy to build kit, standard parts. Only 2 adjustments. No special test equipment required.
- ★ Mains operated with stabilised power supply.
- ★ All kits fully guaranteed with back-up service.
- ★ Also available with VHF Modulator.

Price of Kit **£79.00**
Case (10" x 6" x 2 1/2") app **£19.00**
Optional Sound Module (6MHz or 5.5MHz) **£5.90**
Built & Tested in Case including Sound Module **£129.00**
Post/Packing £4.50
Add VAT 17.5% TO ALL PRICES

PAL COLOUR BAR GENERATOR (Mk4)

- ★ Output at UHF, applied to receiver aerial socket.
- ★ In addition to colour bars R-Y, B-Y etc.
- ★ Cross-hatch, grey scale, peak white and black level.
- ★ Push button controls, battery or mains operated.
- ★ Simple design, only five i.e.s on colour bar P.C.B.
- ★ Backup service available.

PRICE OF MK4 COLOUR BAR GENERATOR KIT **£39.00. CASE £5.80. BATT HOLDERS £4.20**

MAINS SUPPLY KIT £5.80 (Combined P&P £4.50)

VHF MODULATOR (CH 1 to 4) FOR OVERSEAS £6.80.
EASILY ADAPTED FOR VIDEO OUTPUT & C.C.L.V.

ADD VAT 17.5%

LINE OUTPUT TRANSFORMER TESTER

- ★ Saves time and money.
- ★ Checks short turns.
- ★ Simple to use
- ★ Reliable.
- ★ Battery operated.
- ★ Pocket size.

PRICE **£24.00**
POST/PACKING £2.50

ADD VAT 17.5%

INFRA RED REMOTE CONTROL TESTER

- ★ Pocket size.
- ★ L.F.D + audible indication.
- ★ Simple to use.

PRICE **£20.00**
POST PACKING £2.50

KITS AND PROJECTS

SAW IF AND TUNER UNIT complete and tested for video & audio outputs **£28.50** p.p. £1.80.
PAL DECODER KIT (Video to RGB) for Monitors **£27.00** p.p. £1.80.
PAL ENCODER KIT (RGB to Video) **£20.00** p.p. £1.80.
CRT TESTER & REACTIVATOR KIT For Colour & Mono complete with Case, Panel Meter Indicator - can be adapted for latest CRTs **£45.00** p.p. £4.50.

TV & VIDEO SPARES

REMOTE CONTROLS

Replacement for: Ferguson, Hitachi, Philips, Panasonic, Grundig, ITT, Sony, Sanyo, Granada, Sanyo + many others.
Phone for make and model no.

PHILIPS SPARES

MANUALS CF1, CTX-E, CTX S, CP90, CP110, GRIAX, G90AL, 2B, 3A, NC3-CR £7.50 p.p. £1.80, 2A £10.50 p.p. £1.80, K T3 £25.00 p.p. £1.80
SYSTEM 4 KT4, K40 £22.00 p.p. £3.00
BACK UP BATT. 2.4V £3.80 1.2V £2.00 p.p. 90p
K30, KT4, CTX-EHT Lead £4.90 p.p. £1.00

THORN/FERGUSON SPARES

9000 Series IF/Decoder tested **£10.00** p.p. £2.80
TX10 Focus control **£8.50** p.p. £1.80
TX9/10 Remote & tuning 1515N **£5.00** p.p. £1.80
TX10 Stereo Audio Board **£3.50** p.p. £2.50
TX100 Chopper TX **£15.80** p.p. £2.50

IC SELECTION

AN5521	£3.80	SAAS243	£23.50	TBA1205	£1.20	TDA2654	£5.70	TDA5510	£12.50
AN5900	£2.20	SAB3035	£6.80	TBA750	£2.20	TDA2655B	£8.60	TDA5850	£2.80
BA6209	£3.80	SAB3037	£8.80	TBA920	£2.80	TDA2670	£3.20	TDA8153	£7.80
BA6219	£3.80	SAF1032	£4.50	TBA950	£2.20	TDA2680	£3.80	TDA8170	£3.00
BA6229	£3.80	SAF1039	£2.20	TCA270	£1.80	TDA2690	£3.80	TDA8180 Kit	£7.50
BA6238A	£2.80	SL470471	£4.00	TC6300	£2.20	TDA2780	£4.50	TDA8190	£3.80
BA6239	£3.80	SL486	£3.20	TDI1035T	£2.40	TDI13190	£4.20	TDA8305	£6.80
CNX62	£4.80	SL490	£3.80	TDI1037	£1.90	TDA3301	£6.80	TDA8341	£4.20
FRG07	£7.20	SL1430	£2.40	TDI1044	£2.90	TDA3303	£6.80	TDA9403	£3.80
HA11211	£2.80	SL1432	£1.40	TDI1060	£3.80	TDA3330	£6.80	TDA9503	£3.80
HA11423	£2.10	SN76226DN	£1.80	TDI1382	£4.80	TDA3500	£6.80	TDA9513	£4.80
HA513385P	£11.80	SN76705	£9.80	TDI1705	£2.20	TDA3505	£4.50	TDA105A	£6.80
LA4445	£3.80	STK5325	£6.80	TDI1180	£2.20	TDA3510	£9.80	TEA1014	£3.50
LA7800	£1.80	STK5332	£6.80	TDI190Z	£2.20	TDA3540	£2.50	TEA1039	£2.80
LA7520	£2.80	STK5333	£18.40	TDI1432P	£5.70	TDA3541	£3.50	TEA2018A	£2.20
LA7801	£3.50	STK5338	£6.80	TDI1124	£6.80	TDA3561A	£5.80	TEA2029	£5.80
LA7820	£3.80	STK5337	£7.90	TDI1870A	£3.20	TDA3562A	£5.80	TEA2164	£3.95
LA7830	£2.80	STK5339	£6.80	TDI1701	£3.80	TDA3565	£3.80	TEA2165A	£6.80
M293B1	£11.80	STK5421	£6.80	TDI170	£3.20	TDA3566	£5.80	TMS100N21	£1.80
M490BB1	£14.80	STK5422	£8.30	TDI170	£6.80	TDA3571	£4.20	TMP47C432AP	£1.80
M491BB1	£9.80	STK5471	£6.40	TDI172	£9.80	TDA3576B	£9.80	8188	£21.95
M494	£9.80	STK5481	£5.80	TDI1908	£2.80	TDA3640	£5.20	TMP47C432AP	£1.80
MC13002P	£5.80	STK5482	£5.90	TDI1940	£3.20	TDA3650	£9.80	8189	£15.50
MDA2062	£3.80	STK5490	£7.40	TDI1950	£3.50	TDA3651	£4.20	TMP47C434N	£1.80
ML237	£3.80	STK6962	£3.80	TDI204	£2.80	TDA3653A	£3.80	3555	£16.80
ML926	£4.80	STK7308	£6.80	TDI2940	£7.80	TDA3653B	£3.20	TMP47C434N	£1.80
MN15425	£15.80	STK7348	£10.80	TDI2150	£3.20	TDA3654	£3.20	3559	£15.80
SAA1024	£5.80	STR3125	£4.80	TDI2270	£2.80	TDA3810	£5.50	TUA2000	£8.50
SAA1025	£5.80	STR441	£7.80	TDI2340	£2.20	TDI4420	£2.20	U4666	£14.80
SAA1124	£3.50	STR450	£6.80	TDI2548	£5.80	TDI4426	£3.20	UC3844N	£4.95
SAA1250	£3.80	STR451	£7.80	TDI2576A	£7.80	TDI4427	£3.20	UPC1363C	£5.80
SAA1251	£3.80	STR454	£5.80	TDI2577A	£4.80	TDI4442	£6.80	UPC1363CA	£5.80
SAA1293.02	£8.80	STR4211	£6.80	TDI2578	£3.80	TDI4443	£7.80	UPC1378	£1.80
SAA1293.03	£11.80	STR5412	£6.80	TDI2579	£3.80	TDI4500	£5.80	UPC1394	£3.80
	£16.80	STR40890	£6.80	TDI2581	£6.80	TDI4501	£7.80	UPC1420	£8.60
SAA5000	£6.80	STR50120	£10.80	TDI2582	£2.80	TDI4502A	£13.50	UPC1488	£3.20
SAA5010	£5.80	STR50103	£5.80	TDI2593	£1.50	TDI4503	£5.80	UPD1397C	£4.80
SAA5012	£5.80	STR54041	£6.80	TDI2594	£4.80	TDI4505	£6.80	IC p p 90p	
SAA5020	£5.80	STR58041	£6.80	TDI2595	£4.80	TDI4555	£9.80		
SAA5030	£6.80	STR6620	£7.80	TDI2620	£1.80	TDI4600	£3.85		
SAA5040	£6.80	TA7680AP	£5.80	TDI2611A	£6.80	TDI4601	£2.80		
SAA5050	£11.80	TA768TP	£5.80	TDI2640	£3.20	TDI4610	£6.80		
SAA5231	£7.80	TA768P	£6.80	TDI2653A	£3.20	TDI4950	£1.60		

LINE OUTPUT TRANSFORMERS p.p. £1.80

AMSTRAD 2200	£21.80	PHILIPS CTX-E/S	£24.80
B&O LX25000, 2800 A F2077/81	£28.80	PHILIPS KT4	£22.50
DECCA 100	£10.80	PHILIPS 2A	£25.80
FIDELITY ZX2000 CTV140	£15.50	PHILIPS K40	£27.50
FIDELITY ZX3000	£14.50	PHILIPS 3A, 2B	£23.80
HINARI CT4, CT5	£24.80	PHILIPS CF1	£23.80
HITACHI CPT1455, 1456, 1476, 1491	£19.50	PHILIPS CP90	£28.50
HITACHI CPT1446/46 PN2432981	£21.80	PHILIPS CP110	£29.80
HITACHI CPT12174/76/78	£18.90	PHILIPS GRIAX	£25.90
HITACHI PN2433752	£21.80	PHILIPS NC3	£22.50
ITT Compact B 110	£19.80	SAISHO/MATSUI 3714002	£21.80
ITT Compact 80, 110	£17.80	SANYO CBP2144, 2145, CPT6144	£28.80
ITT Compact 80, 90	£22.80	SANYO CTP7132 80P Chassis	£39.80
ITT Compact 80, 110 FST	£19.80	SONY KV1440/42, 1460/62	£39.80
ITT CVC 20	£9.80	SONY KV1882	£39.80
ITT CVC 25, 30, 32	£10.80	SONY KV2056, 2060	£39.80
ITT CVC 45	£9.80	SONY KV2092/96	£39.80
ITT CVC 800, 801, 803	£24.00	SONY KV21XRT4/XRU	£39.80
ITT CVC1100, 1206, Picos	£18.50	SONY KV2252/56, PL3	£39.80
ITT CVC1150, 1175	£22.80	SONY KV2704	£60.00
ITT CVC1200, 1201, Mm 2	£18.50	SONY KV2752/56, 2762/66, PL3	£48.00
ITT CVC1204	£11.50	THORN 9000	£9.80
ITT CVC1210/12.15/17	£17.80	THORN 9600	£9.80
JTT Digi 3, 110	£19.80	THORN ICC5	£24.00
ITT Core 100, 90	£19.80	THORN IX9	£23.50
ITT Core 110 FST	£19.95	THORN TX10 (Chopper)	£19.80
ITT TX326/7	£22.80	THORN TX85	£19.80
ITT TX3446	£22.80	THORN TX89	£23.50
ITT Monopoint A	£21.80	THORN TX89 14"	£19.80
ITT Core 110 FST	£19.95	THORN TX90 20"	£17.00
LOEWE Classic M124, M27	£33.00	THORN TX100, 110 Green Spot	£17.00
LOEWE Contur M27	£33.00	THORN TX100 90 EST Yellow Spot	£21.80
LOEWE Other (Quote model No.)	£21.80	THORN TX100 EST 16045L	£21.80
LUXOR P/N5810, 10.01	£33.00	THORN TX100 Blue Spot	£21.80
PHILIPS K13	£13.80	POST PACKING LOPTS	£1.80
PHILIPS K30	£22.80		

TRIPLERS EHT MULTIPLIERS p.p. £1.80

CONTINENTAL UNIVERSAL TPK & BG RANGE (Quote exact no.) **£13.80**
U.K. UNIVERSAL (best quality) **£7.80**
DECCA/TATUNG BG 200/44 TYFE **£7.80**
GRUNDIG BG 2077-642-1003/1004 **£16.80**
GRUNDIG BG 2087-642-1001/1002/1006 **£16.80**
THORN 9000 **£9.80**
MAINS TRANSFORMERS: 6.3 V (its CRT boost) **£6.80** p.p. £1.80
Mains Isolating 500VA **£51.25** p.p. £5.25
MISC: 455 CRYSTALS for handsets, 4 for **£2.00** p.p. 80p
DEGAUSSING ROD **£33.75** p.p. £3.50
TRANSPARENT VIDEO SERVICE CASSETTE **£6.80** p.p. £1.80

HOW TO ORDER: ADD p&p TO ORDER + VAT 17.5% TO THE TOTAL
PRICES ARE SUBJECT TO CHANGE WITHOUT NOTICE

Telephone 071-794 8751/794 7346
Fax 071-431 5778

MANOR SUPPLIES
172 WEST END LANE, LONDON NW6 1SD
CALLERS WELCOME AT SHOP
Mon-Fri 9.30-6pm - Thurs 9.30-1pm - Sat 9.30-5pm

A Serviceman's Guide to PCs

Part 1

David Botto

A computer, preferably a PC (Personal Computer), is rapidly becoming a 'must' in the service department. It will increase your profits, balance your accounts and keep VAT and tax records in impeccable order, taking the tedium out of book-keeping – in fact making it rather fun.

Neatly kept, accurate records printed out as a spreadsheet mean that your accountant will charge less for preparing your annual return for the tax people. A PC will produce letters and customers' bills with minimum effort. How often have you laboriously typed or written the same phrases or paragraphs? A stock phrase or paragraph can be rapidly recalled from the PC's memory and inserted into the document you are preparing. You can store a list of every video/TV fault you've ever encountered or read about in a computer. To recall the required information, just type in the make and model and the monitor's screen will instantly display what you want.

The service engineer has just so much energy to use during a day. With a PC you can avoid those energy-wasting arguments with Mrs. Whoever about what was done to her TV set and when: touch the keys and within seconds the screen will show the date of the last repair, the amount charged and the work done. Press another key and a copy of the original bill will be printed out.

The IBM PC was introduced in 1981. Today the term PC

is generally applied to any computer that will run IBM programs. IBM and IBM-compatible computers (PC clones) have become the accepted standard for business use. More software programs are available for them than for any other type.

As a result of fierce competition, PC prices have fallen by almost fifty per cent during the last year or so. This hasn't happened with Apple Mac and Acorn computers. So if you don't already own a PC, now is the time to buy one.

There's a certain mystique about computers. They are nothing more than super-fast adding machines that process binary signals however. Any mathematical problem can be solved by the process of addition, and this is just what a PC does. The engineer who services colour TV sets, VCRs and camcorders will experience no difficulty in gaining an understanding of PC principles. Table 1 explains some commonly used computer terms that puzzled me and may puzzle you. PC terms are spelt the American way, for example program rather than programme.

What's Inside?

Fig. 1 shows in block outline form the items that go to make up a typical PC installation. But remember that, as with TV sets and VCRs, the layout and design of individual

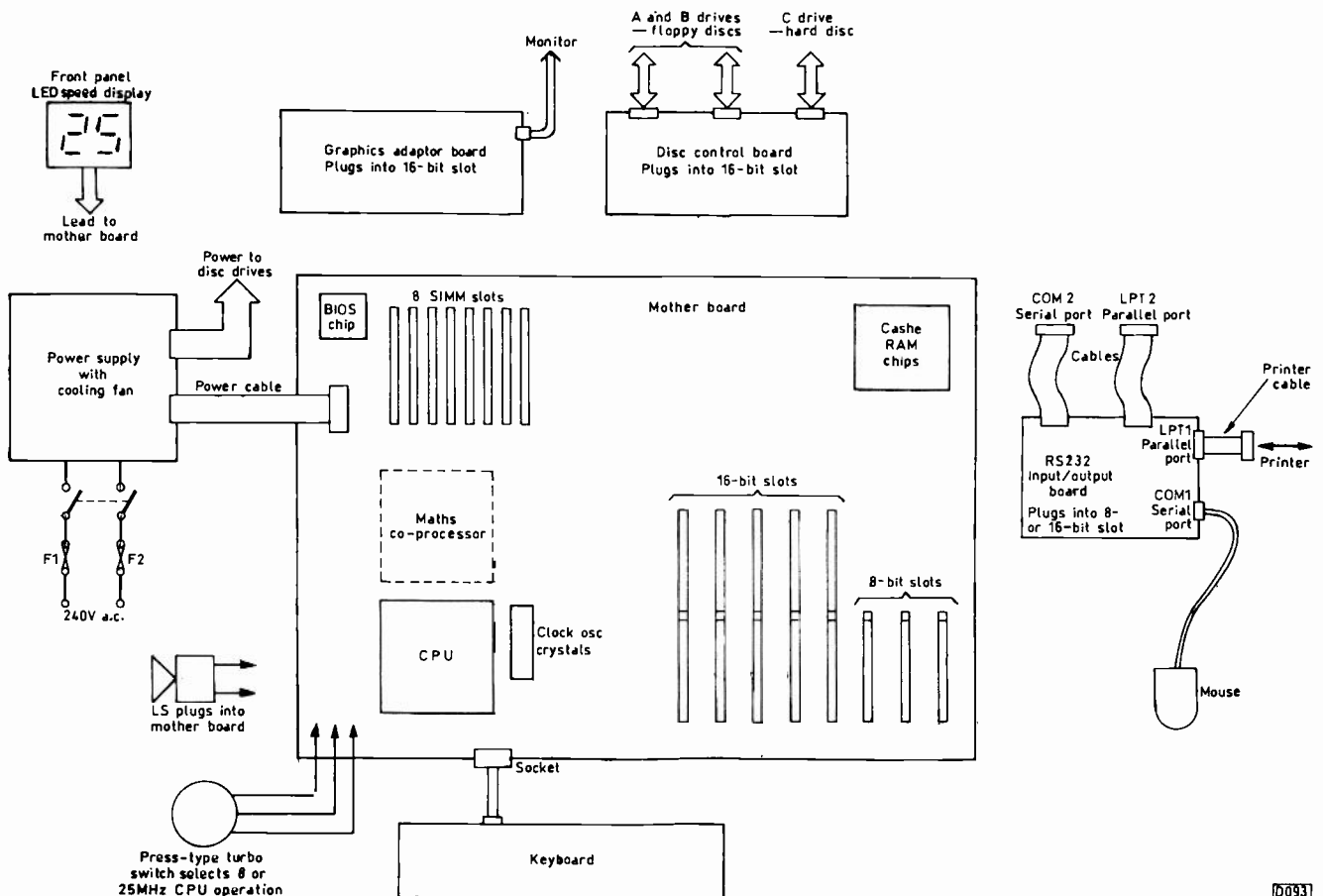

Fig. 1: Block outline of a typical IBM-compatible PC.

models can vary considerably. The basic principles remain the same however.

The 'system unit' is the case that houses the computer. It includes the mains-fed power supply that provides outputs for the mother board and the disc drives. A quiet cooling fan is incorporated. You've a choice between a desktop computer case, a floor-standing mini tower case, a midi tower or a full tower system. Tower computers are popular because they don't take up desk space and have plenty of inside room for future hardware expansion.

The mother board holds the CPU (central processing unit) which can be regarded as the computer's brain. It processes information, in digital form of course, in accordance with instructions contained in a program. The 80286, 80386 and 80486 are popular CPU chips (micro-processors).

Because the 386 and 486 microprocessors use high-speed clock oscillators the PC's basic memory chips can't respond to CPU instructions and data fast enough. So with these CPUs the binary data stored in the memory chips is preloaded into a small, faster memory area that's known as the processor 'cache RAM' or 'cache memory'. A turbo switch enables two clock oscillator speeds to be selected, 8MHz or 25MHz.

A maths co-processor can be added on the mother board. Don't expect an improvement in the PC's performance unless a program that's designed for use with a co-processor is used. Examples include CAD packages, some spreadsheet programs, many graphical programs and number-crunching mathematics programs. Note that the 80486DX chip has a built-in cache memory and maths co-processor.

Thus the mother board has the main electronic circuitry, plus various expansion slots. The computer's RAM (Random Access Memory) chips are mounted on plug-in modules known as Single In-line Memory Modules (SIMMs) or Single In-line Packages (SIPs). Eight slots for SIMMs are shown in Fig. 1. Not long ago a PC would have a typical memory capacity of 1Mbyte. Today a minimum of 4Mbytes is desirable. Plugging extra PCBs into these slots provides additional memory capacity or facilities.

The RS232 board, known as the serial/parallel input/output interface, plugs into the mother board. It provides typically one-four serial data ports so that devices such as a mouse, light pen or scanner can be connected. It also drives Centronics compatible parallel data line ports (labelled LPT1, LPT2 etc.) that provide links to devices such as a printer, a modem – or another computer.

The Graphics Adaptor board also plugs into the mother board. It drives the monitor. Although a monochrome monitor is appropriate for business use, it's worth investing in a high-resolution colour monitor. Choose your monitor carefully: go for one that produces deep, rich colours without fringing around white letters.

The currently popular super VGA colour monitors provide a resolution as high as 1,024 x 768 pixels with 16 colours, or 800 x 600 pixels with 256 colours. Line scanning frequencies – higher than used in TV sets – are typically between 30 and 38kHz. Field scan rates may range between 45 and 85Hz. Early colour monitors responded to digital input signals. This limited the range and quality of the colours that could be produced, because the signals changed in distinct digital steps. Today's analogue monitors produce far superior colours.

A 14in. super VGA interlaced monitor, set to 640 x 480 pixels with 16 colour modes, is suitable for service department use. If you intend to use the PC for desktop

publishing, or with a CAD (Computer Aided Design) package, a 17 or 20in. high-resolution, non-interlaced monitor is desirable. With a TV receiver an interlaced display is necessary because of the limited signal bandwidth. For some PC applications however the signal bandwidth may be 80MHz or higher.

A screen glass anti-glare filter is a 'must'. Don't take chances with precious eyesight. A good filter screen protects the user from ultraviolet rays, eliminates external light reflections and improves the sharpness of letters. Buy one that has an anti-static chassis earthing lead and complies with the new EC legislation.

In the arrangement shown in Fig. 1 a Small Computer Systems Interface (SCSI) PCB, or 'Scuzzy' as it's called, plugs into mother board to provide links to the discs. It controls the outputs to and inputs from a hard disc drive (drive C) and 3.5in. microfloppy and/or 5.25in. floppy disc drives (drives A and B). An alternative to the SCSI board is an Integrated Drive Electronics (IDE) board – these are becoming popular. With an IDE board some circuitry that was once in this area is moved into the hard disc drive unit.

The Hard Disc Drive contains several aluminium platters. Each one has a thin magnetic surface that can store many Mbytes of digital data, including the computer's Disc Operating System (DOS). The floppy disc drives are used to back-up information, to store additional data and load programs etc. on to the hard drive.

A program that's known as the Basic Input/Output System (BIOS) is contained in a chip on the mother board. When you switch the PC on, the BIOS first carries out some test routines. It then orders the DOS program that's stored on the hard disc to load itself into the RAM chips. The BIOS chip also contains other programs that give orders to the system hardware.

The Keyboard

The older 'standard' keyboard is now obsolescent. You need a modern 102-key (UK) enhanced version. Before buying a keyboard, satisfy yourself that the keys have a firm, positive feel.

The Mouse

This is a small device that you roll around on the desk surface to control the movement of the cursor on the screen. When the required function or Window's icon is covered by the cursor you select it by pressing the button on top of the mouse. Get a mouse matt: it's inexpensive and makes it much easier to use a mouse.

The Disc Operating System

The Disc Operating System (DOS) program is stored on the hard disc. When the PC is switched on it first 'boots up'. This expression comes from the old saying to 'lift yourself up by your bootstraps'. You see a changing series of numbers and statements on the screen. The PC is testing its functions, booting itself up and giving itself instructions. It then loads the DOS into the RAMs connected to the mother board.

There's also on the hard disc a collection of statements in a file known as the CONFIG.SYS. After loading the DOS into the RAMs the computer reads this file and immediately carries out the CONFIG.SYS instructions. These specify vital DOS settings, such as the number of files DOS can have open, and the keyboard settings.

The computer then searches the hard disc for a file called AUTOEXEC.BAT. This orders the DOS to load certain commands into the RAMs, and sets what is known as a 'path' for certain programs. Type a few keystrokes and these programs are instantly available. AUTOEXEC.BAT commands also set the time and date, mouse control and other factors.

The DOS program acts as a general manager. It controls the flow of digital data between the various disc drives, and translates the instructions received by the computer from its electronic bits and the installed software program. Instructions typed on the keyboard make DOS talk to BIOS which in turn tells the CPU what to do.

Three popular disc operating systems are MSDOS 5 (Microsoft DOS no. 5), IBM's new OS/2.0 and Digital Research's DRDOS 6.0. They are all good and you won't go wrong with any of them. When you buy a PC or a separate hard disc you may find that an operating system has already been installed.

My personal choice is DRDOS 6.0 which includes DiskMAX, a program that's claimed to double the hard disc storage capacity, TaskMAX and MemoryMAX. It also has ViewMAX, an optional user-friendly graphical interface, and a comprehensive set of excellent instruction manuals.

Buying a PC

How much PC power will you need? Not enough means that the machine won't meet your needs. Too much means that hard-earned money has been wasted on features you'll never use. The nice thing about a PC however is that additional RAM and plug-in expansion PCBs are easy to add – make sure that the PC has plenty of expansion slots before you buy it. With many PCs you can update, usually by changing the mother board, to a faster, more powerful CPU.

My minimum recommendation for service department use is a PC with a 25MHz 80386 CPU and 4Mbytes of RAM. Anything less will soon become obsolete. Buy one with a high-quality hard drive which has a minimum storage capacity of 60Mbytes. For the larger business 120Mbytes or more is advisable.

You'll also need at least one 3.5in. floppy disc drive. A full tower system will have space for several floppy disc drives and additional hard drives. A 5.25in. floppy disc drive can be fitted if you wish, but 5.25in. discs are now on their way out.

Building a PC

A profitable undertaking for the service engineer is to build your own PC. The one that I'm using to write this article was assembled from separate PCBs in a full tower case. The PCBs and parts are all readily available. You don't even need a soldering iron, as everything plugs into the mother board or connects by means of plug-in leads.

Not only will you save money: the finished unit will not be just a mysterious box of tricks. You'll know how it operates and, if necessary, will be able to service it yourself. To call in a computer engineer to fix a faulty PC is expensive, as is a maintenance contract. A PC is easier to repair than a VCR or a camcorder, and is a lot more reliable. The TV engineer will naturally be quite at home should the monitor require attention.

Another point is that PC construction, installation and servicing offer an extra and profitable source of income for the competent service engineer.

Several companies have available complete PC kits. With one of these everything is to hand when construction starts, and the completed unit will be as good as any other one on the market. Another advantage of buying a kit rather than separate items from different suppliers is that a help line is available should a problem arise.

At the time of writing Maplin has reasonably priced IBM compatible desktop kits. Maplin and Watford Electronics can supply individual boards and components with which to build your own desktop or tower PC.

Constructing and testing a DIY PC will be the subject of a separate article later.

Printers

Printer prices have dropped to an all time low. The dot-matrix type, in which the printed letters are formed by a series of dots made by pins that strike through a ribbon, is the most economical type. You can get from 9-pin types (draft quality) to 24-pin types that provide good, clear near letter or letter-quality print. Prices range from about £100 upwards.

Inkjet and Cannon's Bubblejet printers produce better results. PaintJet colour printers are available at around £700-£800. Laser printers produce the best quality printing. They are more expensive to buy and cost more to run, though at the time of writing prices continue to fall.

The Daisywheel printer is now virtually obsolescent. New ones are still available however. They are low cost devices that are cheap to run. The Daisywheel printer uses the same technology as a top-quality electronic typewriter, with superb print. Its drawbacks are slowness and inability to print graphics and drawings.

Some printers are noisy. If this worries you a sound-proof acoustic lid can be fitted – but this may cost more than the printer! Before buying a printer try to see (and hear) it working.

Paper is handled either in the form of continuous sheets with tear-off holes or via a sheet feeder. The sheet-feeder is probably the best arrangement for the service department: it saves the bother of having to separate the sheets and tear off yards of sprocket holes.

Bundled Software

'Bundled software' is supplied with many PC systems. It may consist of an operating system program with integrated software to provide wordprocessor, spreadsheet, database and other facilities. Personally I think it best to buy or build your own PC system at the most advantageous price then select software programs to suit your particular requirements.

CLI and GUI

Software programs come on floppy or microfloppy discs with instruction manuals. You load the program into your computer and store it permanently on the hard disc. You can choose between text-driven Command Line Interface (CLI) and point-and-click Graphic User Interface (GUI) software programs. Before making your choice, try to see both types in action.

If you are happy with a screenful of little coloured pictures (icons in computer jargon), you may favour GUI (Windows). With GUI you move the screen pointer to the icon that represents the required program, function or setting, then click a mouse button to select it. Many computer enthusiasts love GUI with its pretty pictures.

Windows programs require a lot of hardware – hefty chunks of hard disc space and many Mbytes of RAM. You also need to buy and install Microsoft's Windows 3.1 program plus a DOS operating system. The quoted system requirements for Microsoft Windows 3.1 are 7Mbytes of hard disc space and a minimum of 2Mbytes of RAM.

Other Windows programs require more RAM and plenty of hard disc space, while at least a 386 CPU and preferably a 486 type is desirable. The state-of-the art Windows NT program calls for yet more Mbytes of hard disc space plus, it seems, at least 8Mbytes of RAM and a 486 CPU.

With DOS-based CLI programs you start with a clear screen at the DOS prompt (C). A few brief keystrokes select the desired program. In a business context the competent touch-typist who doesn't need to look at the keyboard will probably prefer a DOS-based program (the incompetent two-finger basher who does look at the keyboard will also be happy with CLI, and to hell with the icons – editor!). It's easier than using a mouse to chase little icons over the screen.

Next Month

In the concluding instalment we'll consider software programs that are suitable for the forward-looking service engineer who wants to boost his income. We'll also discuss several wordprocessing, spreadsheet and CAD packages, modems/fax programs and virus prevention programs helpful to the video/TV engineer.

Table 1: Some computer terms

AT PC: Advance Technology PC – has an 80286, 80386 or 80486 CPU.

Batch file: File containing a sequence of commands. Typing in the name of the file loads the desired program.

Boot: The start-up process when a PC is switched on. The PC tests itself then loads the disc operating system from the hard disc into RAM.

Bus: An expansion lead that carries data between different sections of the computer.

Centronics port: Usually called a parallel port. Used to feed data into and out of a computer. Often feeds a printer.

Crash: Program failure where the PC locks solid. You must then reboot the computer (see below).

Default setting: Settings/colours used by a PC automatically unless you chose something different.

Disc cache: Section of memory used to store a copy of binary data recently read from the hard disc.

DPI: Dots per inch – the resolution of a printer.

FAT: File Allocation Table. Found at the start of every disc. Contains information used by the DOS to locate file entries.

File: Section of data stored on a disc for retrieval by the PC.

Mailmerge: Enables customers' names and addresses held

in a database to be inserted at any desired point in a standard letter. This gives the impression of a personal letter.

Memory terms: One byte is eight bits, a nibble four bits. A RAM is a random access, i.e. read/write, memory. A ROM is a read-only memory. An 'extended memory' (one Mbyte and above) cannot be addressed by DOS, though 80286/386/486 CPUs can in a special mode. An 'expanded (EMS) memory' is one that uses a bank-switching procedure to give access to up to 32Mbytes of memory in 64Kbyte chunks.

Multitasking: Running two or more programs together.

Macro: A time-saving way of recording a keystroke sequence that can be recalled when needed.

Pixel: Pixture element – each dot on the screen.

Program: A series of instructions that tell the CPU and thus the computer what to do.

Reboot: Force the PC to repeat its start-up procedure.

RS232: International standard for serial port operation.

WIMP: Stands for Windows, icons, mouse and pointers.

XT PC: Extra Technology PC. Has the older 8088 or 8086 CPU.

BACK COPIES

We have available a limited stock of the following issues of *Television*:

1992 February, April, May, July, August, September, October, November and December

1993 January, February, March, April, May, June and July

Copies are available at £2.75 each including postage. Send orders to:

Reed Business Publishing,
Television Back Issues,
Room L323,
Quadrant House,
The Quadrant,
Sutton,
Surrey SM2 5AS.

Make cheques/postal orders payable to Reed Business Publishing Ltd.

What a Life!

Donald Bullock

Life has been easier since son Steven started to work with me. What has distressed me a bit however is the speed with which he's picked up technical knowledge that took me forty years to acquire. But it does mean that I can slip off to Spain whenever I like, in the knowledge that life in the workshop goes on – just as long as I slip back often enough to sweep the floor, wash the teacups, empty the dustbins and tackle the tricky ones that pop up now and again. The fax machine has proved to be a boon to us, but one thing I could do with is a set of the last fifty or sixty copies of *Television*. Can anyone oblige?

Mr Nutt's Problems

We have been in this business a long time now – to the extent that we've had the valued custom of four generations of some local families. Those whom I moan about are a minority. It's just the relentless dedication with which they afflict us! Take Mr. Nutt for example. He's the paranoid smallholder who is convinced that everyone is watching him and eavesdropping. The other day he called in with his Philips 16in. portable – it's a KT3 chassis set.

"My neighbour has aimed a dish transmitter at my place" he confided. "But I've got him rumbled. This old set lets me know whenever he listens in to us. The picture turns into a transmitter. I want you to build something into the set to stop him."

Now I know Mr. Nutt of old. Apart from this fixation he's perfectly sane. Arguing with him about it is useless. "All right Mr. Nutt" I said, "leave it with us."

For the first ten minutes the set suffered from intermittent line collapse. I confidently resoldered the pins of the line output transformer but this made no difference. I then found, by tapping and flexing the chassis, that the cause of the trouble lay somewhere in the area around the U470 sync and U450 power modules. Resoldering every doubtful joint on the two panels and lightly cleaning the edge contacts again failed to cure the problem. So I finally switched off the workshop lights, drew the blinds, felt my way back to the chassis and began tapping about on it. As I did so I noticed a spark. When I switched the lights back on again I found that it had come from one leg of the degaussing resistor R292. It was dry-jointed, though it looked all right. Resoldering it cured the trouble.

Nostalgia

I was going to study the circuit to see why R292 should have had this effect but the phone went and Greeneyes came in with the tea. She was just in time to hear me being less than enthusiastic about attending to a satellite TV system.

"What's the matter with you?" she asked. "When I came to work with you as your secretary colour TV was just starting and you sailed into colour servicing quite cheerfully. It's not at all like that now." Steven wanted to know what it was like in the early days, which always gets me going.

When I started there was only monochrome BBC in Band I. Most of the sets were of the t.r.f. type, gramophone records were shellac 78s and classy homes had radiograms.

Then ITV started up in Band III, bringing signal problems the like of which we'd never seen before, and

programme converters that sat on the top of the set. They too caused problems galore. Cyldon and Brayhead subsequently came up with a family of rotary tuners that were designed to be fitted into the sets. When converting a set for ITV reception we first had to make sure that we had the right tuner. Then, armed with braces and bits, we'd cut a huge hole in the side of the customer's highly polished and valued TV set, hoping against hope that our conversion would be satisfactory.

All sorts of things could blight our plans. If we weren't careful, the bulky tuner wouldn't align with the hole we'd made. But the most common headaches were that the Band III signal available, from Birmingham in our case, wouldn't be enough, or that the pictures obtained would be heavily patterned. Sometimes the neighbours would experience patterning.

In this area every conversion was a chancy business. As the ITV signal was dicey and weak, service calls multiplied. "Poor ITV" was a common complaint, and we'd trot off with a pocketful of r.f. amplifier valves. The Mullard PCC84 was the most common one, but there were also UCC84s and ECC84s, and some of the more exclusive brands like Murphy and Ekco used Mazda valves – the 30L1 to start with, then later the higher-gain 30L15. It wasn't long before we resorted to the dodge of using the high-slope 30L15 whenever a low-emission r.f. amplifier valve had to be replaced. It meant adjusting the r.f. padders in the tuner, something that was supposed to be taboo, but the effect was little short of miraculous – until the valve's emission settled at a lower level.

Most Mazda valves had metal skirts and fitted rigidly into the special holders. They seemed to present instability problems however. Trying to calm an Ekco i.f. strip was a difficult business. I settled for using Hunt's paper capacitors connected between the screen grids and chassis, followed by careful realignment. I never did find an answer for use with the red, metal-cased Mullard EF50 valves. They seemed to be determined to float regardless.

But the picture quality with those early Ekco and Murphy sets was remarkable for their day. Our favourite was the Ekco 327. There was a scramble for it every time one came in part exchange. Eventually we all had one.

Relaying these things to Steven suggested to me why he's so bright and receptive to the latest developments while I'm less so. "Your brain is like a brand new computer loaded with miles and miles of virgin tape" I said. "Mine's an old valve model with the tape worn out by repeated erasure of redundant technical knowledge. I used to know countless valve equivalents, and furthermore which pin was connected to which electrode in them all. I can still remember dozens of them. All useless knowledge now, taking up space in my napper. Same with all the technical tips and ruses for scores of radio and TV brands that are now just memories. There's hardly any room left for all the new-fangled things you pick up so easily!"

Later, I heard Steven talking to Greeneyes as they looked through an ancient photo album he'd found.

"Dad looks bright and young in these pictures" he said. "Funny what happens as time passes."

I poked my head around the door. "That old Decca you're stuck on – the one with no luminance. You can put your scope and meter away. Just pop in another luminance delay line. There's one in that old Tatung chassis you couldn't fix. And that Bush 2020T that's still giving you problems even though you've changed the TDA3562A. Take it out and fit a Telefunken one – or do the mod. Oh, and that Saba you were waiting for help to lift it off the bench: I've popped it in the van for you."

Test Case 368

Workshop Sage, dragged away from his bench to the reception desk, was confronted by a customer who wanted an instant quote for video head replacement in a fairly ancient Panasonic front-loading VCR. Quizzed as to how he knew that the heads were faulty, Mr. Wells explained that the diagnosis had been made some months earlier by another dealer who was no longer in business. Mr. Wells mentioned that the dealer had twice boosted the heads. This puzzled Sage somewhat. He'd heard of picture tubes being boosted, but not video heads. What wonder technology had the now defunct dealer used?

Anyway, Sage went off to consult price lists and suchlike and came back with alternative prices for pattern, rebuilt and Panasonic original drums. Mr. Wells accepted the lowest of the three quotes, which was probably wise in view of the age of the machine. So an upper drum assembly was ordered and the machine was taken to the waiting-spares rack.

The job of fitting the replacement, when it arrived, was given to Sherlock who had said that he wanted more experience in this side of servicing. Before he fitted the drum Sherlock checked out the machine. During playback of a known good tape all the classic symptoms of worn heads were seen – there were worms, dots and streaking in the picture. The machine's own recordings were very much worse. So there was no doubt that the heads were in need of replacement. Donning his cotton gloves, Sherlock soon had the old drum out and the new one in. He'd changed one upper drum before, so he knew the ropes reasonably well. He also found that the back tension was far too high, as it often is with Panasonic VCRs.

Sage wouldn't let him use the alignment tape for setting up! He was given a colour-bar cassette, with an

assurance that it was a perfectly acceptable substitute. Sherlock then set about the mechanical alignment, which is not difficult provided the necessary test equipment – primarily an oscilloscope and a good format-standard tape – is available. With this vintage of machine there's no fancy auto-tracking system to worry about. The job progressed well, a good straight-edged r.f. envelope pattern being obtained with minimal tweaking of the entry and exit guides. Lateral adjustment of the audio/control head assembly then enabled best tracking to be made to coincide with the tracking control's centre position. At the end of the session the quality of the playback picture was excellent for an old machine and Sherlock was well pleased with the results of his efforts. His pride evaporated within minutes however!

The trouble occurred when Sherlock did a test recording and then viewed the playback picture. It was marred by steaking and white/black inversion effects. These were similar to those present before the drum had been replaced, though they were not quite so bad. Sherlock tried another tape, with exactly the same results. Cleaning the heads didn't help at all, and Sherlock began to suspect that he'd fitted a faulty drum. There wasn't another one in stock with which to carry out a substitution test, and almost every idea that occurred to Sherlock had to be discounted because the playback performance was so good. The back tension was rechecked and found to be correct, as were the lead-out connections from the new heads. Time for a consultation!

While Sherlock described the setting-up and alignment procedures he'd gone through since fitting the replacement drum, Sage looked at the playback picture with a recording made by the machine itself. It was very plain to Sage where the trouble lay, and how the previous service department had 'boosted' the performance of the worn heads. If it's not plain to you, give it some thought before turning to page 739 for the solution!

TELEVISION INDEX & DIRECTORY and REPRINTS SERVICE



A computerised index to *TELEVISION* magazine covering volumes 38 to 42 (1988 – 1992) is now available. It contains over 3500 references to TV/VCR fault reports and articles, with synopses. It includes a TV/VCR spares guide, an advertisers list and a directory of trade & professional organisations. The software is easy to use and very quick. It runs on any IBM or compatible PC with 512K RAM and a hard disc.

Price: £30 (specify 5.25" or 3.5" format)

Reprints of articles from *TELEVISION* back to 1986 are also available: ordering information is provided with the index, or can be obtained from the address below. Hard copy indexes of

TELEVISION are available for volumes 38 to 42 at £3.50 each.

Please allow up to 28 days for delivery. All the above prices include UK postage and VAT where applicable.

Cheques should be made payable to Video Interface Products.

Video Interface Products Ltd., 1 Vineries Close, Cheltenham GL53 0NU, UK

Modern TV Receiver Techniques

Part 8: The Shadowmask Tube

Eugene Trundle

The basic operating principles of the shadowmask colour tube have remained unchanged since it first came into use in the USA some forty years ago. There have however been many refinements and improvements in that time.

Basic Mode of Operation

Three cathodes, one for each of the primary colours red, green and blue, are heated in a vacuum. Under these conditions electrons are emitted from the surface coating of the cathodes. They are formed into sharply-focused beams which are accelerated towards the screen. As they emerge from the gun, the beams are deflected from side to side and from the top to the bottom of the screen to trace out the raster. This beam deflection has to be synchronised with that in the camera or other picture source, for which purpose sync pulses are added to the picture information. Deflection is carried out by generating magnetic fields in the neck of the tube. Synchronised, sawtooth-waveform currents are passed through coils (the scanning yoke) around the neck of the tube to produce these fields. The line-frequency current waveforms produce side-to-side deflection and the field-frequency waveforms top-to-bottom deflection.

As the beams emerge from the neck into the bowl of the tube they are accelerated by a very high voltage so that they strike the phosphor-coated screen at high velocity. Thus bombarded, the red, green and blue phosphors glow brightly, forming a pattern of light, shade and colour. Continuously refreshed with new information, the screen displays coloured, moving pictures.

The key to the operation of a colour picture tube is the shadowmask, which is mounted about a centimetre behind the phosphor-coated glass screen. Precision-aligned with the vertical stripes of red, green and blue light-emitting phosphor on the rear surface of the screen, the shadowmask acts as a filter to ensure that each of the three beams strikes only the coloured phosphor assigned to it. By using the red, green and blue drive waveforms to modulate the intensity of the three beams the amount of each type of light produced at the tube screen is continuously varied. In various proportions, the combination of red, green and blue light can produce white, grey and almost any colour that occurs in nature. Cutting off a beam removes that colour, while cutting off all three beams leaves us with black. Though we take it for granted, the colour TV picture tube is a truly amazing piece of precision technology.

Driving the Tube

Most of the 'hardware' within a conventional TV set is concerned with control of the tube and the scanning process rather than signal handling. Thus the circuitry we've looked at so far in this series represents only a small proportion of the cost and bulk of a set's contents.

Apart from the easily obtained power to heat the tube's cathodes, it's necessary to generate high voltages to modulate, focus and accelerate the electron beams, and to provide precision generators of the sawtooth currents that flow

through the deflection coils. All this depends in turn on the provision of a closely-stabilised and efficient power supply. Much of the energy produced by this power supply is dissipated as heat in the shadowmask and in the tube drive system. Despite this, the shadowmask tube looks set to remain for many years to come the standard TV picture display system. Only in somewhat specialised applications, e.g. for very small and very large pictures, is it being usurped by other technologies such as LCD devices. In taking a closer look at the operation of the shadowmask tube, we'll start at the back end.

The Electron Gun

The electron gun generates, modulates, focuses and accelerates the three electron beams. The process starts with a tungsten heater that's buried in but insulated from a cylindrical cathode. This has a coating that consists of a mixture of oxides of barium, strontium and calcium. When heated to over 1,000°K this coating emits electrons which form a cloud, or space charge, around the cathode. Closely surrounding the cathode and spaced about 0.1mm from it is the so-called grid, in practice a nickel cylinder with a closed end except for a pinhole in the centre (see Fig. 1). The beam emerges from this pinhole, its intensity being controlled by the potential difference between the grid and the cathode. In practice the grid is held at a fixed voltage of around zero while the cathode voltage is varied above and below some 140V, thus altering the effective grid bias. The more negative-going the cathode voltage with respect to the grid the greater the electron current flow, since this is equivalent to making the grid more positive with respect to the cathode. (The beam consists of electrons that carry a negative charge: they are thus attracted to a point at a more positive voltage.)

The electron beam is brought to a sharp focus, or crossover, just beyond the grid by the electron-lens effect of the grid and the next electrode, the first anode (often referred to as the screen grid), which is held at a constant potential of a few hundred volts. The purpose of the next electron lens is to focus an image of this sharp crossover point at the phosphor screen. It's done by two or more cylindrical electrodes which, as shown in Fig. 1, are held at progressively higher voltages.

After the initial crossover, the diverging beam of electrons is pre-focused by the lens formed by the first and second anodes. The main electron lens consists of the cylindrical anodes two and three, which are usually operated at about 5kV and 25kV respectively. The beam of electrons

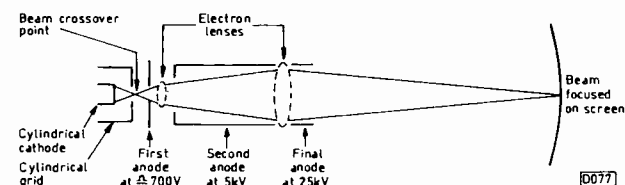

Fig. 1: Basic arrangement of a picture tube electron gun.

diverges until it reaches a point between these two electrodes, then begins to converge again, being brought to a focal point at the phosphor surface behind the tube's faceplate (screen). By adjusting the voltage applied to the second anode the focal length of this second electron lens is altered, enabling the beam to be precisely focused at the screen. The focus control takes the form of a potentiometer which in modern sets is generally integrated with the line output transformer.

What we have described so far is the basic electrode system. Various more complex arrangements have been designed. They depend on the tube's neck diameter and the characteristics of the deflection fields. Fig. 2 shows a lens system with five anodes. This is often used in narrow-neck, wide-angle tubes to compensate for the small lens diameters for each beam.

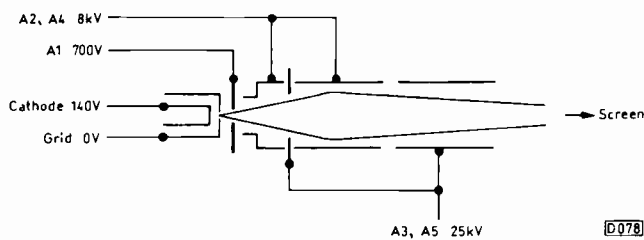

Fig. 2: This combination of a high uni-potential and a bi-potential lens gives reduced spherical aberration in the lens system as a whole.

With a conventional electron gun structure the three cathodes are mounted close together side-by-side and the accelerating and focusing electrodes are common to all three beams, though with separate apertures for each beam: the effect is of three small electron-lens systems side-by-side.

Other types of tube, notably the Sony Trinitron, have a single, large-diameter electron-lens system that's common

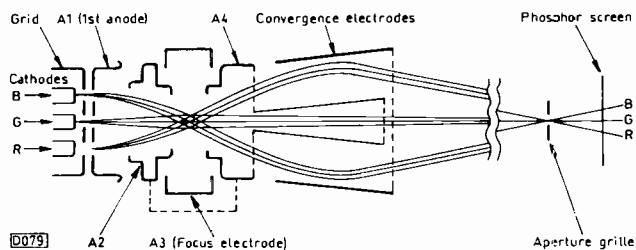

Fig. 3: The Trinitron gun system, which has a common electron lens for all three beams.

to all three beams. Fig. 3 shows the basic arrangement. Here the three beams cross over in the centre of the gun. The single, large lens system focuses the electrons in each beam, the following convergence electrode system setting the outer (blue and red) beams so that all three beams converge at the shadowmask (in the Trinitron the shadowmask takes the form of an aperture grille). With a conventional tube this convergence function is performed by magnets, as we shall see next.

Beam Alignment and Landing

During manufacture of the picture tube the phosphors are laid down on the faceplate – in effect printed – with reference to fixed points for each beam at its deflection centre (the centre of the area under the influence of the deflection fields), since seen from the shadowmask and

screen the deflection centre is the apparent origin of the beam. To ensure that each beam lands on only the correct phosphor stripes, the beams must be prealigned after leaving the gun and before entering the deflection fields. This can be done by means of a pair of two-pole magnet rings that move the positions of all three beams in the horizontal plane. The rings are adjusted for correct colour purity, i.e. so that the beam from one gun doesn't spill over on to the adjacent phosphor stripes, 'staining' the colour reproduction.

In effect the colour picture consists of three separate red, green and blue images which must be overlaid exactly and kept in registration at all points over the screen. To take up tolerances in tube manufacture, a means of adjusting the positions of the images traced out by the two outer beams (red and blue) so that they are precisely overlaid with the green image produced by the centre beam (green) is generally provided. Again this is done by means of ring magnets, a pair of four-pole magnets and a pair of six-pole ones. Their magnetic fields affect only the paths of the outer beams and can move them in either direction, either together or differentially, the adjustment being known as static convergence. Aim for no colour fringing at or near the centre of the screen.

In some types of tubes, notably Philips ranges, these beam alignment magnets are neither visible nor manually adjustable: during manufacture they are induced in a magnetic ring that's mounted at the end of the electron gun assembly. With most other types of tube the external ring magnets are aligned and sealed at the factory, and are not intended to be adjusted or disturbed during the life of the tube.

Beam Deflection

We have seen how the beams are generated, modulated, focused and aligned with respect to each other: they amount to a sort of three-colour pen that can be used to trace out the picture. This tracing action is carried out by the powerful magnetic fields produced in the neck of the tube by the deflection yoke, a double pair of saddle-wound (usually) coils on a ferrite former. The yoke is a tight fit on the tube's neck and embraces part of the flared section of the tube where the neck opens out into the bowl. Vertical lines of magnetic force deflect the beams horizontally while horizontal flux lines produce vertical deflection. With sawtooth current waveforms at the correct frequencies flowing in the in the line and field deflection coils, a rectangular raster is traced out on the screen. So long as the scanning is synchronised with the video information, the image is correctly positioned with everything on the screen in the right place and correctly proportioned.

Dynamic Convergence

As we've seen, the primary purpose of the scanning yoke is to deflect the beams. In a monochrome tube with a single beam the yoke generates homogeneous (evenly spaced) magnetic fields in the tube's neck. With a colour tube the yoke has two secondary but very important functions: it has to correct for the inherent pincushion distortion that occurs when a relatively-flat, rectangular screen is scanned; and it must converge the beams so that the images they produce coincide over the entire screen area, at the edges as well as the centre.

Pincushion correction is achieved by precision shaping of the magnetic field density in the tube's neck. Dynamic convergence as it's called is also a function of magnetic flux

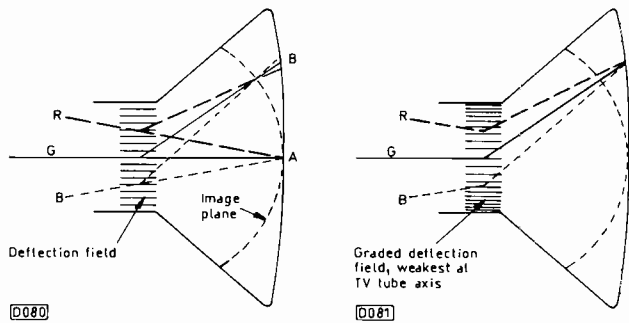

Fig. 4 (left): With a uniform deflection field the three beams converge at point A in the centre of the screen, because the screen and the image plane coincide here. Near the edge of the screen (point B) the three beams are no longer in registration – being beyond the image plane they diverge. The beam approach angles in the neck of the tube have been exaggerated to illustrate this.

Fig. 5 (right): By using a specially-tailored deflection field of graded density, each beam's deflection angle is slightly different, ensuring convergence of all three beams across the width of the screen. Again the beam approach angles have been exaggerated.

tailoring in the deflection field – see Figs. 4 and 5.

Fig. 4 shows the effect of a uniform horizontal deflection field in a cross-section of the tube. The three beams converge at the centre of the screen: since each beam is affected equally by the magnetic flux, convergence is maintained along an arc called the image plane. Away from the centre the beams diverge, striking the screen out of registration with each other, the misregistration increasing towards the edges of the screen. Fig. 5 shows how the design of the deflection yoke can prevent this: the flux density of the magnetic field varies across the neck of the tube so that the angle through which each beam is deflected depends on the path it takes through the deflection zone. The outer (blue and red) beams can especially be seen to pass through 'magnetic gradients' as they are being deflected. The result is that the three beams converge at the same point on the screen at all horizontal deflection angles.

For vertical scanning a barrel-shaped field is required to achieve the same effect. Fig. 6 shows the astigmatic flux fields required for vertical and horizontal beam deflection. The yoke is designed to produce these fields, and is closely matched to the tube with which it is intended to be used: many yokes are sealed on to the tube, forming an integral part of the picture-tube assembly.

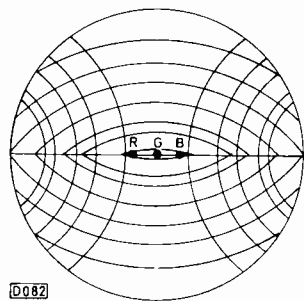

Fig. 6: Cross-section of the tube neck at the deflection centre, where the neck opens out into the bowl. The lines show the astigmatic fields required to retain correct convergence of the beams over the entire screen area.

In general, tube sizes up to 53cm (21in.) have 90° deflection angles and no need for external pincushion-correction circuitry in the scan-drive circuits. Larger screen sizes employ deflection angles of around 110° and require an amplitude-modulated line scan drive (EW correction) to cancel out the inherent pincushion distortion in the raster. We'll examine these correction circuits when we come to the timebases later in this series.

Earlier colour tubes required elaborate dynamic convergence correction arrangements (a separate yoke assembly and coil on the tube neck) and raster correction systems. Spot defocusing at the edges of the picture was a particular problem. Improvements in electron lens design and the use of computers to design precision deflection yokes has rendered this unnecessary.

The Shadowmask

All consumer-type, direct-view picture tubes have shadowmasks with vertical slots. Most have a matrix of slots as shown in Fig. 7(a): Trinitron tubes have an aperture grille

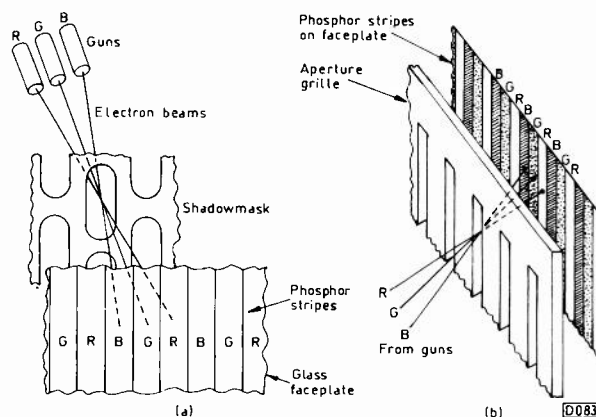

Fig. 7: Slot mask/phosphor stripe screen system used with a conventional tube (a), alternative aperture-grille arrangement used in Sony Trinitron tubes (b).

with long, continuous slots as shown in Fig. 7(b). With large Trinitron grilles there are three very fine (three-micron diameter) wire cross-braces to keep the assembly rigid, especially when hot. The principle of the shadowmask is illustrated in Fig. 8: it depends on the slightly different approach angles of the three beams to intercept and block beam electrons heading for the 'wrong' phosphor – we've already seen that the beams are prealigned to ensure that their approach angle to the shadowmask is correct.

In doing its job the shadowmask absorbs over 75 per cent of the energy of the beams, dissipating it as heat – between 5W and 25W depending on tube size and picture brightness. This heating results in expansion of the steel shadowmask, bringing with it the risk of doming or bulging and consequent picture colour impurity. Various measures can be taken to combat this. First the whole mask is held in a spring- or swing-support system for controlled expansion. Blackening the mask assists dissipation, while a surface coating of ceramic material can be applied to stiffen it. Instead of using steel, a metal called invar can be used: it's more expensive and difficult to work, but has a lower coefficient of expansion.

Degaussing

If the shadowmask, its mounting system or the tube's rimband becomes magnetised, beam landing is upset and

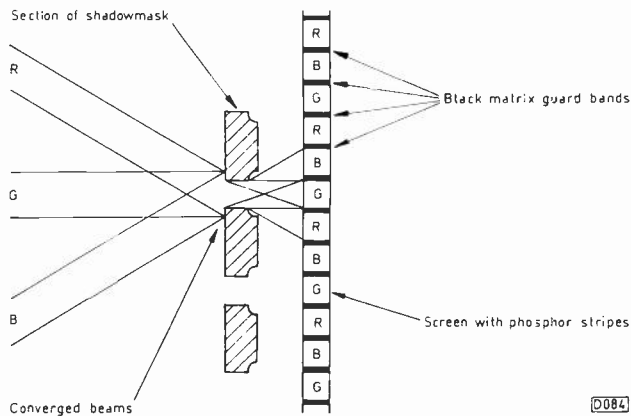

Fig. 8: Illustrating the filter action of a shadowmask. The electron beams are wider than the slots in the shadowmask and are sharply 'chopped' by them. The beam approach angles have been exaggerated to help show the effect. The same principle is used by the Trinitron tube's aperture grille.

the result is colour impurity. A magnetic shield inside the tube acts as a barrier to ambient fields such as that of the Earth. This, the mask and the rimband are magnetically neutralised at each switch-on from cold by a degaussing coil harness mounted on the outside of the tube's bowl. At switch-on the coils are briefly energised by a 50Hz a.c. mains current that decays to virtually zero within a second or so as the control element heats up.

The Phosphor Screen

The phosphors used are chemical compounds, based on zinc- and oxy-sulphides, that glow when bombarded by electrons. Each phosphor is dyed (pigmented) in its own emissive colour in order to increase the absorption of ambient light. The screen is thus made darker and less reflective, improving the picture contrast – especially when the screen is being viewed in high ambient light conditions. For the same reason the spaces between the red, green and blue phosphor stripes, present to provide guard bands against the effect of slight horizontal beam-landing errors, are filled with a carbon- or graphite-based black pigment. This is called black matrixing: with more recent tube designs there have been improvements in the way in which the black pigment is deposited on the screen, giving better

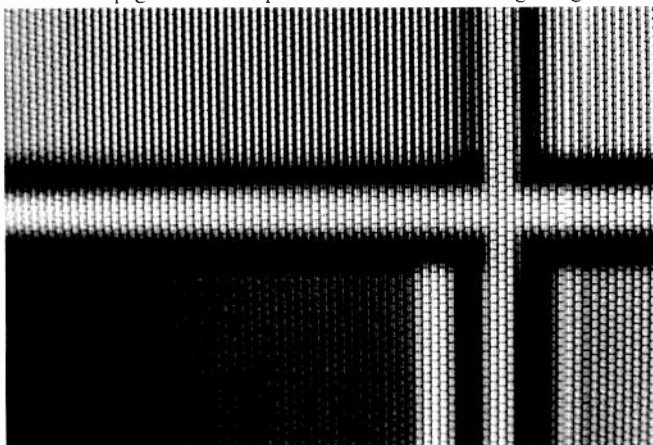

Fig. 9: Phosphor stripes in action on the faceplate of a TV picture tube. The black matrix stripes between the colour phosphor stripes can be seen. Though the phosphor stripes are continuous vertically, the lozenge-shaped shadowmask perforations are visible, breaking the colours into elongated dots.

resolution, saturation, brightness and white uniformity. Fig. 9 shows a close-up of part of a test pattern on a 68cm screen.

Each phosphor stripe is about 180 microns wide: an RGB triplet, with black guard bands, is typically 800 microns (0.8mm) wide in a large-screen picture tube. With smaller tubes (say 51cm and less) the stripe triplet is about 600 microns wide. Obviously the stripe pitch is a limiting factor for picture definition, and small screens cannot resolve the full detail available with a broadcast transmission or an S-VHS or Hi-8 tape recording. For special purposes, e.g. for high-resolution picture monitors and computer VDUs, tubes with a finer stripe pitch – down to 300 microns/0.3mm – are available. Their price is correspondingly high.

The back of the phosphor layer is sprayed with a coat of shiny, conductive aluminium, just like a mirror. This serves three purposes. It reflects the phosphor light forwards, forms a barrier for harmful ions (heavy charged particles) in the electron beam, and equalises the electrostatic charge over the entire screen area. The back of the aluminium layer is in turn coated with a black pigment to absorb heat radiated from the nearby shadowmask and dissipate it in the large heatsink/exchanger formed by the tube's glass faceplate.

The Faceplate

To withstand the huge atmospheric pressure upon it, the glass faceplate of even a relatively small tube is 12.5mm (0.5in.) thick at the centre, more at the edges and corners. It's made of darkened glass, the transmission factor being typically fifty per cent. Although this light-filtering effect halves picture brightness, the contrast is improved: while the picture light passes through the glass only once, reflected ambient light (from the viewing area) has to pass through twice. This makes the screen appear darker, improving the perceived picture contrast.

Apart from providing the viewing area, the glass faceplate acts as a barrier to X rays and provides implosion protection. X-ray radiation occurs when metalwork is under electron bombardment at a high enough potential. Any X-ray radiation is contained within the tube by including strontium carbonate in the glass mix from which the tube's envelope is made. Protection against implosion is provided by the sheer strength and thickness of the glass, aided by the rimband which contains the outward pressure of the faceplate edges due to the tension within it.

Because of the need to keep the aperture grille in tension, the faceplate of the Trinitron tube has a dead-flat vertical profile: the curvature in the horizontal plane corresponds to a section of a large cylinder. Other types of tube have a front profile that matches a small section of a large sphere, with in some cases a flatter central section.

Miscellaneous Features

A graphite-based conductive coating is applied to both the inner and the outer surfaces of the picture tube's bowl. In conjunction with the glass envelope of the tube as the dielectric, a capacitor is thus formed: it acts as a reservoir/smoothing capacitor for the e.h.t. supply. Sometimes the charge held may be suddenly released in the form of a flashover – a spark between electrodes within the tube. This suddenly-released energy can be life threatening to

semiconductor devices in the TV set/monitor. Its effect is minimised by making the internal conductive coating resistive (to reduce and dissipate the surge) and by providing spark gaps and series resistors on the tube base panel to intercept the voltage spike when a flashover occurs.

The e.h.t. connection is made to the internal conductive coating. The beam current thus returns to chassis via the relatively high-impedance e.h.t. system. By including a resistor at the earthy end of the e.h.t. system the beam current can be monitored to provide protection in the form of beam-current limiting via the tube drive circuits and/or some other arrangement such as shutting down the tube drive.

Before it's sealed the tube is pumped to a high vacuum. During the life of the tube however gases are liberated from the electrodes and chemicals within it: they are absorbed by the gas-hungry getter, which is made of a barium compound and is activated by r.f. heating after evacuation of the tube.

Widescreen Tubes

The new generation of widescreen tubes (16:9 aspect ratio) do not differ in principle from the latest types of

conventional tubes. But the large deflection angle and the huge variation in beam path length from the corners to the centre make high demands on the electron gun and the beam-converging deflection yoke. They are overcome by enhanced design along the lines already described.

Viewfinder Technique

An interesting colour display technique is used in the viewfinder section of some consumer-type camcorders. It retains the high definition and low power consumption of a small monochrome tube but provides colour pictures by means of a rotating colour wheel between the face-plate and the viewer's eye. This filter-wheel has red, green and blue segments and rotates at 150 r.p.m. RGB video signals are fed to the tube sequentially, in synchronism with the rotation of the wheel. The results are very good.

Next Month

In the next instalment we'll take a look at projection systems and various types of LCD devices, including the three-panel LCD projector systems now coming into favour for large picture displays.

The Satmaster Pro PC Package

Nick Beer

The original Satmaster computer program was designed to run on IBM PCs and any one hundred per cent compatible machines. Its basic purpose is to facilitate the design of and simulate a satellite system on screen via a link budget calculation, enabling you to check various 'what if' possibilities presented to it. It can calculate azimuth, elevation, compass bearings, polar mount settings, and circular and rectangular aperture beamwidths, providing full graphical plotting of theoretical lobe patterns.

Data is provided on the majority of satellites required. As the program provides set-up angles and data for dish installations it's an ideal way for those unfamiliar with such matters to learn about the subject. In addition to data such as magnetic variations for Europe, noise temperature versus noise figure and all manner of other items Satmaster contains a 20,000 word technical guide. Throughout operation a help facility is available via the F1 key.

Subsequently an expanded version called Satmaster Pro was introduced. As a way of evaluating it we'll first consider the differences between the two. At the start however I must say that the Pro version is not a replacement for the original one, but rather a version that's aimed at a somewhat different section of the satellite fraternity.

Advantages

The Pro version offers the following advantages with respect to the basic version:

(1) Extra data, including world, Far East and European CCIR climatic zone maps; more town and country files, mainly for the Middle East and South Africa; world

seasonal temperature and water vapour density maps (helpful for predicting atmospheric absorption); and apex and polar elevations for each town.

(2) Laser printer support, enabling superb quality graphs, maps and charts to be obtained from the program.

(3) Automatic calculation of rain fade margins, and taking linear or circular polarisation into account in link budget analysis.

(4) Calculation of rain attenuation, atmospheric absorption and cross-polar discrimination – particularly helpful in areas where rainfall is high and with installations where the elevation is low.

Performance

The menu layout is more friendly and logical than with the basic version. Operation is simple: menus pull down from the header bar and escape takes you backwards – all standard stuff for the computer operator. There's no mouse support however.

The country and town files provide latitude and longitude figures for major towns and cities, but some files are more detailed than others. For most people this won't be noticeable, but users in some parts of the world will find the information somewhat sparse – there are no country files for India, Sri Lanka, Russia, Singapore and South America. Town and country listings can easily be added via the editor however, and advice is given in the user manual on how to obtain such data.

The satellite data files and graphics are detailed for our

part of the world, but those in America for example will not find data on their satellites. A noteworthy point however is that when you ask for a listing of data on satellites above the horizon for a given plot all satellites are listed, not just those detailed in the satellite files.

The following craft are covered: Arabsat 1B and 1C; Astra 1A and 1B; DFS Kopernikus; the Eutelsat II series; Hispasat 1 and 2; the Intelsat K and VI series; Marco Polo 1 and 2; TDF 1 and 2; Tele-X; Telecom II; and TV-Sat 2. Satellite files can be edited and new ones created.

Link Budget

Although both versions have the ability to calculate link budgets it would not do to omit mention of the incredible detail and power of calculation they offer. Under this menu one enters the site and satellite data followed by link budget parameters and obtains a remarkable set of results, which can be tailored to CCIR grade 4 or 5 requirements. One can follow on by calculating beamwidths and plotting lobes for circular or rectangular apertures. This menu allows printouts to be made.

Business Use

Effort has gone into making the program directly and instantly usable for those in the satellite business. Your business header can be fed in during the set-up procedure and is thus present on hard copies. As the Pro version can be used with a laser printer, professional-looking paperwork can be produced for estimates etc. You can provide simulated representations of the performance of a given system throughout the year by correlation with the vapour density and seasonal temperature maps and data for example.

Installation

Any one hundred per cent IBM compatible PC with at least 384K of RAM and using DOS higher than 3.1 will run the program. About 1Mbyte of hard disc space is used. The program comes in compressed form on a 3.5in. floppy disc. To install it on the hard disc is simplicity itself. From DOS select the drive in which the floppy disc has been inserted, type INSTALL C: or just INSTALL then press enter. A directory called SATPRO will be created. To run the program select this directory from DOS (cd/SATPRO) then type SATMAST.

Findings

The program is very well presented and is designed for easy, logical operation. Thought has been given to operation. Data can often be retained from one operation to another and there's out-of-range parameter rejection and advice on suitable values, cursor or single key facility selection within menus and so on. Anyone can use this program!

Some graphics are not too clear however and the varying scale of maps is disappointing. One or two items could have been presented more clearly – for example with the Far East rain climatic zone map what is a zone boundary and what is a coastline is at first sight barely discernible. The use of shading or colour would remove such confusion.

Some of the points I have made about omissions may seem unduly fussy, but the Satmaster Pro is intended for world-wide use. The fact that the program is upgradeable means that data can be added however – a super feature. So long as you have the location and satellite data the Pro will

do the calculations.

The Satmaster Pro program has two distinct characters, passive and active. The former consists of an extensive database which can be used in the active mode or as a source of facts and figures. The active role consists of its ability to carry out calculations. This enables even the most demanding system engineer to design an installation with great confidence.

Thus Satmaster Pro has great potential for both institutional and industrial training, while specialist satellite installers will find it very useful. In all fairness however one would find it difficult to convince a small dealer installing only Astra systems supplied as packages that it would have practical benefits for him. The potential for installation work is in working out what would be required to achieve superior results. Unfortunately at present price seems to be the main consideration here, and Sat Pro can't help with this!

Manufacturers and distributors of equipment could make use of both programs to provide technical data for inclusion with their products, thereby helping installers and assisting with decisions about the suitability of particular products under given conditions.

Use with a portable PC would provide invaluable help for those aligning portable links around the world.

And aside from its business uses the program is a fascinating plaything for anyone interested in satellite reception.

The versions I've tried were Satmaster 4.02 and Satmaster Pro 1.12. Although the instruction guide supplied seemed a bit thin and was apparently 'temporary' it provided just the right amount of prompting in addition to that on-screen. The technical and help guides can be printed from the floppy disc.

The Satmaster (version 4) and Satmaster Pro programs are available from Swift Television Publications, 17 Pittsfield, Cricklade, Swindon SN6 6AN (telephone/fax 0793 750 620) at £35 and £69 plus postage respectively. More recently a Satmaster Pro for Windows version has become available at £99 plus postage. The package includes anti-piracy measures and updates are available for earlier versions.

SERVICES/ADDRESSES

Electrotech Distribution, one of the UK's largest satellite equipment distributors, is expanding its range and setting up a service and repair centre. The latter will take on general service and repair work for any satellite related equipment and will be available to anyone in the trade, not just Electrotech customers. Phone no. is 081 830 0366, address 33 Fapcote Trading Estate, Dudden Hill Lane, London NW10 2DJ. The company considers that present standard repair charges of around £65 for out-of-guarantee receivers are 'far too high – particularly in view of what's inside a receiver and what normally goes wrong'.

Daewoo has set up a service and spares operation to support brand sales which start in August. Address is Daewoo Electronic Sales UK Ltd., Unit 640, Winners Triangle, Wokingham, Berks RG11 5TP. Spares ordering telephone number is 0734 695666. Spares for OEM products should be obtained from the original distributor.

Euras International Ltd. has moved to Euras House, 51 Bristol Road, Keynsham, Bristol BS18 2BA. Telephone 0272 860 900, fax 0272 860 343, videotext 0272 860 007.

Satellite Solutions is running a series of one-day courses on installing motorised dish systems. They are being held at various venues around the country during July-August. Details can be obtained from Debbie Halliday on 0604 670 900. The first one is at South Mimms on July 22nd.

A Simple Nicam VCR Upgrade

Ian Martin

Many stereo VCRs without a built-in Nicam decoder must be in use. Some appear on the second-hand market. My own machine, a Panasonic NV830, is one of these. It has performed very well for several years with only a change of heads. Rather than replace it with a newer, Nicam model I decided to add an external decoder.

Adding Nicam has been described in *Television* on various occasions, so I'll just give some brief details that could also be applied to other non-Nicam stereo VCRs. Instead of using the Sendz decoder, as Michael Harris described in the May issue, I used a Nicam decoder that was salvaged from a damaged TV receiver. Any self-contained module or salvaged board should in fact be suitable, as the principles remain the same.

One advantage of modifying the NV830 in the manner described here is that it still continues to record f.m. audio on the linear mono track whilst simultaneously recording the Nicam sound on the hi-fi stereo tracks. As the machine has track selector buttons, either f.m. mono, Nicam stereo or Nicam left channel or right can be selected for playback. Thus the machine is capable of dual-language operation should this feature ever be used in the UK.

The Conversion

Fortunately the Nicam decoder panel I used already had 12V and 5V regulators, so all that was required was to provide an unregulated input. A redundant Ferguson BSB receiver case and power transformer were thus used to house and power the Nicam board. As luck would have it, the only other thing required was an i.f. input signal, the panel supplying buffered stereo audio outputs. The decoder normally provides Nicam reception, f.m. being selected instead by a switch signal. I avoided the complexity of

adding a switch by not using the decoder's f.m. audio output, retaining the VCR's own audio for recording on the linear mono track.

If we cut the mono f.m. audio feed to the recording amplifiers for the hi-fi tracks and add the decoded Nicam sound at this point we can let the VCR do the switching. Panasonic, and probably many other manufacturers, had produced machines of this vintage for use with the German Zwi-tone stereo system. Because of this there's a simple mono link connecting the left- and right-hand hi-fi channels. It can easily be removed. Fig. 1 shows a block diagram of the whole system while Fig. 2 shows the relevant part of the NV830's f.m. audio sub-circuit board.

When plug P4303 is disconnected there is no f.m. feed to the hi-fi channels. Removal of the wire link next to D4318 then separates the left- and right-hand channels. The Nicam left and right inputs can be connected to P4303 via suitable coupling capacitors, the f.m. feed to the plug being cut. I connected the right channel to pin 1 and the left to pin 4. Matching the levels of the Nicam and f.m. audio signals can be done by using simple resistive potential dividers or altering the gain of the op-amps in the Nicam decoder. To be honest however I didn't bother to adjust the Nicam signal level (it's about 3dB higher) as the NV830 has a manual record-level control.

If you don't want to modify the audio sub-board you could connect the Nicam stereo signals to the external audio phono input sockets instead and set the machine permanently to the 'simulcast' mode. A mono version of Nicam would then be recorded on the linear audio track instead of the f.m. mono signal. This would be no great loss as the linear track's output will probably never be used.

The input to the Nicam decoder was taken from the VCR

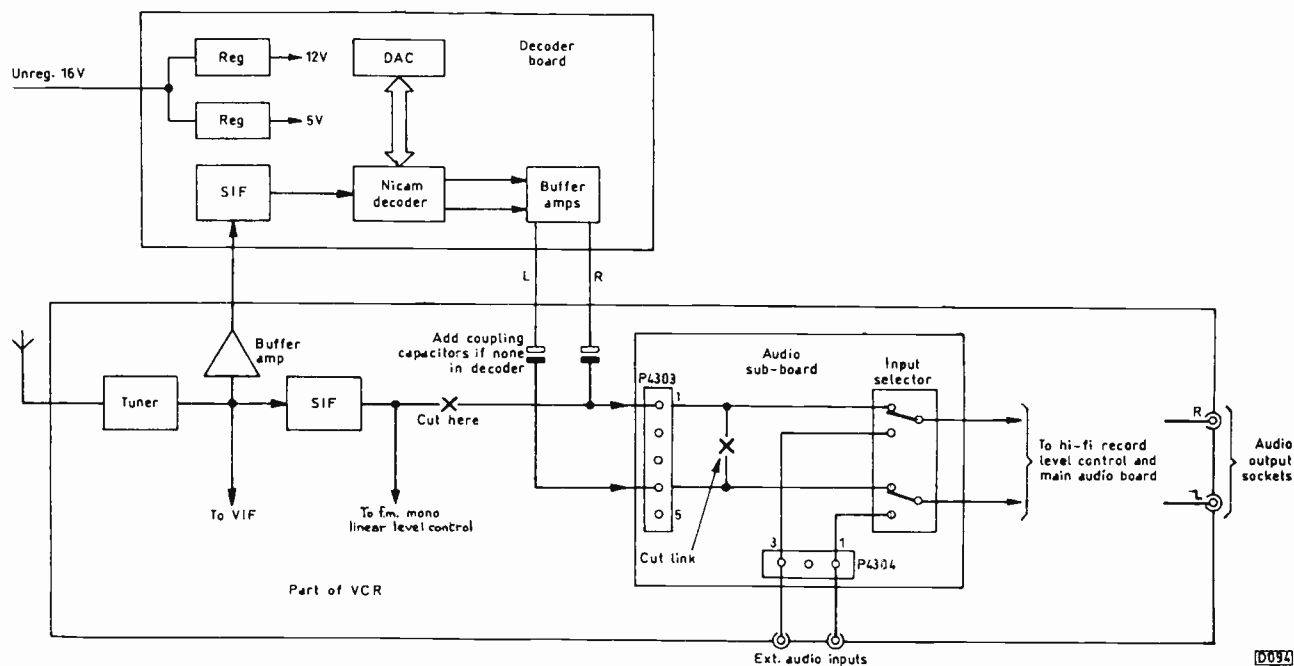

Fig. 1: Block diagram of the complete system.

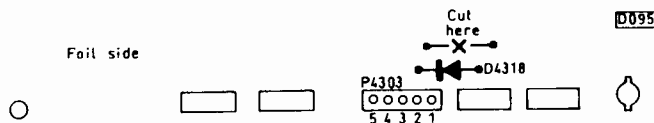

Fig. 2: Modifications to the audio sub-circuit board. Remove the existing P4303 plug then connect the Nicam inputs as follows: pin 1 right channel; pin 2 right earth; pin 3 left earth; pin 4 left channel. Pin 5 was not used (it previously provided audio muting).

tuner's i.f. output pin. I added an emitter-follower stage as a buffer, though a simple high-value resistor might do. Buffering is necessary because the additional load will otherwise spoil the vision i.f. signal's h.f. response. Without buffering there was a slight loss of the higher video frequencies: this could not be seen on recordings but was noticeable in the monitor mode.

Help Wanted

Can anyone supply a circuit diagram for, or technical assistance with, the Excel 20in. monitor made by Niven of Andover? All costs would be covered. J. Howells, Protech Audio Visual, 4 Kingsway Road, Fallings Park, Wolverhampton WV10 0SD. 0902 728 242.

I am trying to obtain a digital display and circuit board, part no. 13VE001C, or a digital display only, part no. F1P8KM8A, for the Saisho Model VR705. Can anyone supply or suggest a source? M. Zwierzanski, 92 Locks Crescent, Portslade, East Sussex BN41 2AD. 0273 420 040.

Wanted: A Connoisseur tone arm with head shell. Trevor Smith, 41 Clifton Road, Wallington, Surrey SM6 8AN. 081 773 2660.

Wanted: Circuit diagram and instruction manual (photocopies will do) for the Tektronix 5110 scope and 5A19 and 5B10 plug-in units. S. Beukes, PO Box 5963, Durban, South Africa, 4000.

Wanted: LOPT for the Matsui Model 1460. John G. Collyer, 17 Riverside Court, Longford Close, Grundpont, Oxford OX1 4NG. 0831 641 877.

Wanted: Circuit diagram or service manual for the Nord-Mende FG3360 PAL colour signal generator and the Rohde and Schwarz HUZ-BN 15012/2 v.h.f. field strength indicator. P. Gascoyne, Shaunton, Main Street, West Hanney, Wantage, Oxon OX12 0LH. 0235 868 695.

Wanted: Russian version of the Vega 402D circuit diagram. Does anyone know of equivalents for TR9/10 on the TB board, or a source of spares for these sets? Can anyone suggest a cure for intermittent field bounce with the Thorn 9600 chassis? S. Quick, 51 Robin Gardens, Waterlooville, Hants PO8 9XF. 0705 232 264.

Wanted: Philips UV616S/6456 four-band TV tuner. J. Evans, 7 Shap Drive, Warndon, Worcs WR4 9NY.

Wanted: Capstan motor for the Hitachi VT17E and service manuals for the Akai VS427EK and Panasonic NV780E (photocopies would do). P. Thomas, 5 Lingfield Green,

Just three cables are required to link the VCR to the decoder. These are for the i.f. input and the left and right audio outputs. All should of course be individually screened. I earthed the screen of the i.f. lead at the VCR tuner end and the screens of the audio leads at the decoder end. This avoids hum loops. No additional switches or indicators were required as all the signals are available within the VCR which already has switches and indicators as part of its audio mode selection system.

In Conclusion

The hardest part of the project was hiding the decoder box! It can be tucked down behind the VCR, under the TV set. The performance of the upgraded VCR is good, enabling me to record stereo (and Dolby stereo) programmes without any noticeable audio playback degradation. It has given the old machine a new lease of life.

Darlington, Co. Durham DL1 1DD.

Wanted: Pin connections for the Mitsumi TIF5-E31P-8630/40T satellite tuner head and a copy of the first edition of *European Scrambling Systems* by J. McCormac. J.G. McCormack, 920 Manchester Road, Castleton, Rochdale OL11 2SR.

Wanted: New or used remote control unit for the Sony SLC9 VCR. Colin McCormick, 23 Shapleys Gardens, Staddiscombe, Plymouth, Devon PL9 9TY. 0752 405201 (evenings).

Wanted: Technical information on the Sweda electronic cash register type 350: IC14 is getting hot. Also ON811, ON812 or PG780G chips for the Sweda 2550 cash till. Steven Nicholson, 77 Deerlands Avenue, Parson Cross, Sheffield S5 7WS.

Wanted: Circuit diagram, parts list and any other information for the Fisher CA345 hi-fi amplifier. T. Edwards, 11 Birch Grove, Windsor, Berks.

Wanted: Manual or circuit diagram for the TI Crypton Motorscope Mk. V or VI, also an 0.15µF, 3.5kV capacitor for this motor servicing item. Brian West, 5 Yew Tree Walk, Clifton, Shefford, Beds SG17 5HN. 0234 267 433 day, 0462 815 421 evenings.

Wanted: Any information (manuals/circuits) for the IBM VGA Models 8503, 8512, 8513, 8514, 8515, 8518 and 9515. Has anyone seen technical information for Sega/Nintendo systems? S.P. Skinner, 432 Stratford Road, Shirley, Solihull, W. Midlands B90 4AQ. 021 744 3811.

Wanted: J17 sound de-emphasis circuit for use with French Telecom 2A/B. Brian Webb, 42 Westways, Havant, Hants PO9 3LN. 0705 474 938.

Wanted: Service sheet or any other service information for a Supervision Filmnet/Rt1 4 decoder, or same type of decoder for spares. A.S. Dhada, 180 Headfield Road, Savile Town, Dewsbury WF12 9JH. 0924 466 439.

Wanted: Any service information and sales brochures for pre-1960 Dynatron equipment. John Howes, 11 Crendon Park, Southborough, Tunbridge Wells, Kent TN4 0BE. 0892 537 288.

Test Report: Denon SC7000 Desoldering Tool

Steve Beeching

Desoldering tools can generally either suck or blow: the Denon SC7000 can do both. In terms of its size and weight the SC7000 is similar to the instant soldering irons, with bent copper wire tip, used by many service technicians. This is the whole point of the SC7000: instant operation for intermittent rather than continuous use. It's not that instant as there's a warm-up time of a couple of minutes or so. In practice the sample I used for this review took about thirty seconds to reach its set temperature then another minute for the tip to reach the working temperature.

Operation

As with any hand-held gun type of tool there's a trigger. This one operates a pump for either desoldering or hot-air soldering. There's an on/off mains switch at the bottom, where the mains cable enters the unit. A small vertical slider at the side controls the blowing/suction action: maximum blow at the top position, reducing as the slider is moved downwards, with a fixed suction setting at the bottom. The temperature control at the rear provides variation over the range 300-450°C. I found that 420°C is a suitable temperature for most applications.

In the suck mode solder is drawn into a small cartridge which is mounted in the cut-out at the top. A pair of sliding knobs at either side, top rear, enable it to be released – to change the cartridge is quick and easy. Two cartridges come with the tool, so the user can whip a full one out and pop a clean one in without unduly delaying the job in hand. Several tips are available: the one I used had a tip size of 2.5mm with a 1mm hole. A set of cleaning pins of different sizes is provided to poke down the hole in the tip if it becomes clogged.

On Test

I first set the tool to suck for desoldering at just over 400°C. I also cleaned the tip: otherwise reflow of the soldered joints would be impaired as they wouldn't be wetted.

Ordinary chips whose pins pass through holes in the PCB were no problem at all. I sat the heated tip on to the i.c.'s leg so that the leg went inside the tip as the solder melted. When the trigger was pressed the solder disappeared into the cartridge. Once all the legs had been dealt with in this way I gave each one a little wiggle, using small pliers, to free it from the print. The chip was then removed. Finally the desoldering tool was used to clean any excess solder from the print – solder wick would do as well for this purpose of course.

VCR motor drive chips present a different problem. Because of the cooling effect of their thick legs there is often print damage when a desoldering tool such as a wick of spring-loaded sucker is used. A heated desoldering tool is without doubt the only way of removing chips of this type safely – particularly the ones found in camcorders.

Surface-mounted devices require different treatment. This is where the ability to switch between suck and blow comes into its own. Three-terminal devices such as diode blocks and transistors can be lifted in two stages. First, use

suction to remove the solder. I found that applying a small amount of flux solder to the pads considerably helped reflow. Then switch to blow to heat the pads, using tweezers to tilt the device to release two legs then ease off the other one. A similar technique works with small dual in-line i.c.s. Desolder the pads along one side, then blow hot air on to them while gently easing this side of the device from the print. An advantage with this approach is that when the component's pads are eased up there's not enough solder left to bridge between the pads and the print, so that they come off cleanly. Then simply heat the other side of the device with hot air, lifting it off when the solder melts. Print cleaning completes the job. With such a device it's always difficult to decide whether removal of the solder from all the pads would be better. If you do this only a thin film of solder will be left bonding each pad to the print: the film is more likely to break than the print. On the other hand the presence of plenty of solder on the pads stores heat during reflow, making it easy to lift the device. It's a question of judgement.

Sucking then blowing can cause problems, as the previously sucked up solder can be blown out, splattering everywhere. There are two ways of avoiding this. First, to blow the loose molten solder into a container, out of the way. Alternatively fit a clean cartridge – as previously mentioned doing this is quick and simple. This is probably a good time to poke the cleaning rod down the spout, blowing at the same time, to remove any loose debris clinging to the internal surfaces.

When solder paste is used for resoldering, the hot-air blower can be used to reflow it. I found that the air flow has to be adjusted once or twice during this process to find a compromise between paste reflow and a howling gale that blows it all over the place.

As with all desoldering tools, efficient operation depends on the solder holder and pump. Regular cleaning is essential. The operating manual tells you clearly how to dismantle the unit and clean it – though some of the spelling leaves a bit to be desired.

As I said at the start, the SC7000 is intended for intermittent use. After ten-fifteen minutes the handle becomes too hot to hold. Thus a rest period is enforced while the user rushes off to immerse his/her hands in a tub of cold water. . .

The pump is a diaphragm device and does vibrate. I didn't find this excessive or disruptive, though it does mean that you can't carry on a telephone conversation while the device is being used.

Conclusion

Apart from that the tool is a very useful item to have in the workshop for removing and replacing i.c.s in TV sets and VCRs. It does not readily stretch to camcorder use without the optional SMD accessory kit that was unfortunately not available at the time of our evaluation. The SC7000 is available from Farnell Electronic Components Ltd., Canal Road, Leeds, West Yorkshire LS12 2TU (telephone no. 0532 636 311) under part no. 226889 at £285 (one-off price) plus VAT and postage. Farnell stock all the spares for it, including a comprehensive range of tips.

Servicing the Samsung Model BT110

J.W. Riggs

This is a 5in. monochrome TV receiver incorporating an a.m./f.m. radio section. Two other models, the Alba PTV9C and Goodmans Q9001, incorporate the same chassis and are identical in appearance.

The power options are as follows: mains operation via an unregulated mains adaptor; operation via internal batteries (1.5V x 6); or operation from a car/caravan battery. There have been two versions, the main difference being in the type of u.h.f. tuner fitted. The early version (mainly Goodmans sets) used type TEB5736VJID, the later version type EBU5731BL. These tuners are not compatible. The later version also has an earphone socket and provision to adjust the field hold control via a hole in the side of the cabinet.

Circuitry

The power supply circuit is shown in Fig. 1. It uses a series regulator, with the regulating transistor Q701 (KSD288) connected in series with the negative side of the supply. Q702 (KSC815C or KTC1815) is the driver and Q703 ((KSA539C or KTA1015) the error detector. R706/R704/D702 provide a start-up feed. The regulated output across C701 is 10.2V. Since the internal batteries provide only 9V, when these are used a boost diode (D406) is brought into operation in the line output stage to generate the required 10.2V across C415.

There are only five other transistors. Q401 (KSC1008C or KTC1959) is the line driver which is RC coupled (with a d.c. restorer) to the base of the KSD362R line output transistor Q402. Q501 (KSC2310 or KTC2229) is the video output transistor. Q101 (KSC1674C or KTC1923) is the SAWF driver. Q601 (KSC815C or KTC1815) is used for a.m./f.m. switching.

Most of the circuitry is contained in four chips. IC01 (KIA7792P), which is on a separate panel, is the a.m./f.m. radio receiver. IC101 (KA2913A) is the TV sound/vision i.f. strip. IC201 (KIA7313) or KA2212) is the audio amplifier. IC301 (KA2133) is the timebase chip, providing an output at pin 9 for the line driver transistor and an output at pin 8 to drive the field scan coils (there is feedback to pins 3 and 6).

Faults

The following list of faults is based on experience gained whilst repairing a large number of these receivers.

No mains operation: Mains adaptors tend to run fairly hot in normal operation and are prone to failure. Replacement will normally restore power.

No power (mains or battery operation): Check whether Q701 (KSD288) is open-circuit. The TIP41A is a suitable replacement.

If necessary check D702, D701, R706, Q702 and Q703.

You sometimes find that the on/off switch has worn contacts. Also check the print between the switch and the d.c. input socket for cracks.

Fuse F701 (2A) can blow for no apparent reason.

L.T. voltage high: There should be 10.2V across C701. If the voltage is high, try adjusting VR701. If this has no or

only very little effect, VR701 could have gone high in value or have an open-circuit centre contact.

No internal battery operation: Check whether boost diode D406 (SR306) is open-circuit.

No raster: Check the c.r.t. heater (pins 3 and 4). If o.k., check for 250-300V at pin 5 (first anode) of the c.r.t. If this supply is missing, check R414 (1.2k Ω). D408 (1N4004) may be short-circuit if R414 is open-circuit, also C414 (0.01 μ F, 400V) may be faulty. Occasionally replacing these components results in R414 burning up because there's internal leakage in the c.r.t.

If the KSD362R line output transistor Q402 is hot, check whether the FR104 (or PS104R) efficiency diode D404 is short-circuit.

If there's no line drive at the base of Q401, check the voltage at pin 9 of IC301 (KA2133) – the reading here should be 0.4V. If this voltage is missing, before replacing the chip check that its 10V supply is present at pin 4. Absence of this voltage is often due to the safety resistor R509 (1 Ω , 0.5W) being open-circuit for no apparent reason – it's mounted on the c.r.t. base panel. Alternatively L401 (330 μ H) may have gone open-circuit.

No line hold, or line jitter: Replace C406 (47 μ F, 16V).

Field roll or excessive height: Check C309 (1,000 μ F) and VR301 (10k Ω).

Low u.h.f. gain: Check the aerial socket and adjacent print. L104 (2.3 μ H) may have gone open-circuit, Q101 then acting as a wideband amplifier with low gain.

Check for a break in the print between the i.f. output from the tuner and C108.

Check the value of the a.g.c. preset VR105 (10k Ω).

The tuners are fairly reliable. A replacement is worth trying as a last resort.

No sound: Check for an open-circuit loudspeaker, also the earphone socket if one is fitted.

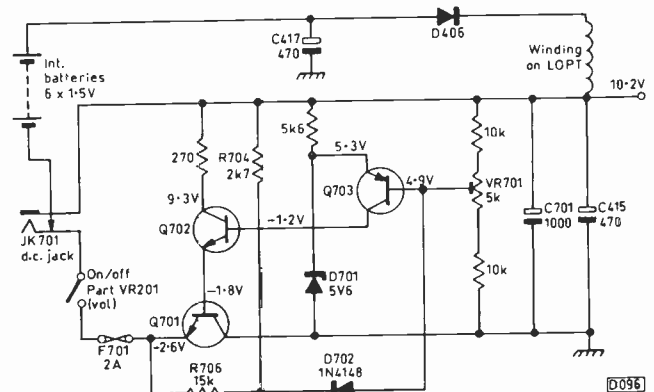

Fig. 1: The simple power supply circuit. An adaptor is required for mains operation. Note that the regulator transistor Q701 is in series with the negative side of the supply.

Modifying the Amstrad MP3 TV Adaptor

Brian Williams

The Amstrad MP3 TV adaptor was designed to enable various computer monitors – the Amstrad CPC6128, Philips 8833 and CBM 1084 – to be used for TV reception as well. It has been available as a surplus equipment item from various sources. At the time of writing this Bull Electrical have the MP3 in stock. The experimenter, TV-DXer or someone who requires TV from his monitor when this is not being used for its usual purpose will find the MP3 of interest.

The modifications outlined in this article are all simple and easy to carry out. There are many possibilities. For example, if a monitor is not available a u.h.f. modulator can be added and the adaptor used with a standard TV set: this has the advantage that any signal processing modifications required can be carried out in the adaptor, leaving the TV set unmodified.

The MP3 is an ideal item for the newcomer to DX-TV. There's plenty of room for additions within the case, and the PCB is easy to work on.

The modifications described here include the addition of a tuning meter, a.f.c. normal/defeat switching, positive/negative-going baseband video switching, modulation of the output to u.h.f., extension of the tuning range to include the ATV band, and adding a narrowband i.f. stage.

General Notes

The adaptor requires an external 12V power supply; consumption is around 180mA. Fig. 1 shows a suitable circuit using a 78 type series regulator, a transformer, a bridge rectifier and a handful of other components. It may

be possible to obtain the 12V supply from your monitor or TV set, but don't do anything that will interfere with the built-in safety arrangements. The supply must be regulated.

The adaptor generally comes with a few instructions and diagrams. One advertiser even included a couple of 6MHz filters to replace the 5.5MHz ones.

Individuals will want to decide for themselves what use to make of the modifications suggested here. The front

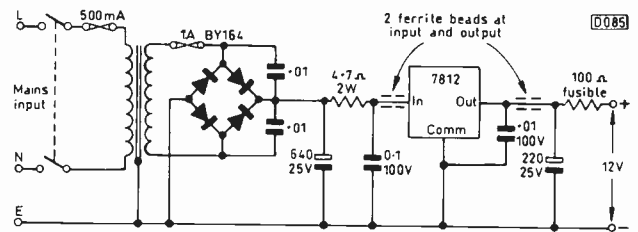

Fig. 1: Suitable 12V power supply. The transformer's secondary winding should provide 12-18V a.c. (two 6.3V windings connected in series and in phase can be used). Put a 3A fuse in the three-pin mains plug.

panel has enough room for all the suggested modifications, which can be carried out without removing the PCB from the case.

Portable operation from a car battery is feasible. This would be of interest to the TV-DXer who likes to take his rig to a local high spot – or a quiet r.f. location! In this case battery power can be saved by snipping out the 560Ω resistor R406 which supplies the sync generators – these are

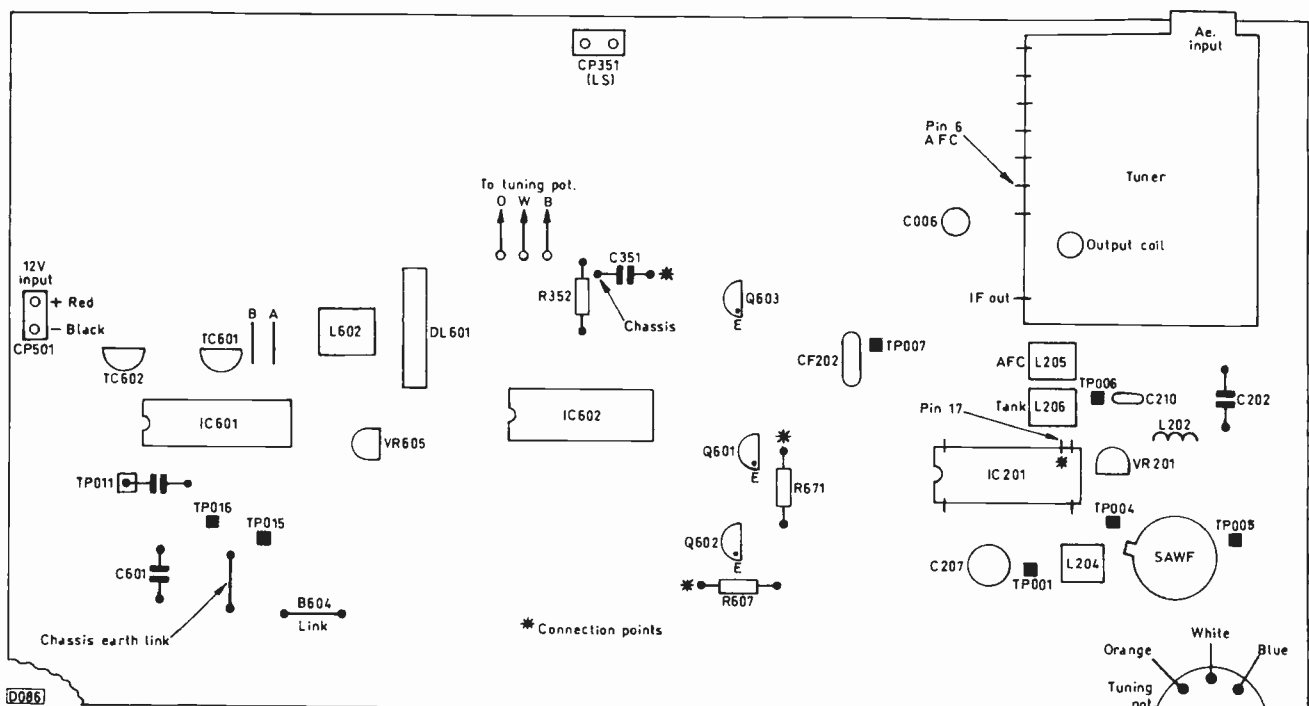

Fig. 2: Top side of the PCB, showing items relevant to the modifications described in this article.

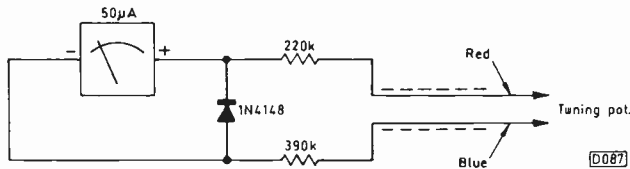

Fig. 3: Adding a tuning meter. Connect the red lead to the slider (centre tag) of the tuning potentiometer and the blue lead to its earthy end (blue wire). Earth the screen near the potentiometer, leaving it open at the meter end.

not needed when RGB outputs are not used.

The one drawback of the MP3 is the lack of any tuning indication. Fortunately the Maplin 4in., 50µA meter, part no. RX54J, fits nicely in the hollow in the case. Some may prefer to use an 'outboard' tuning potentiometer with a scale. The integral tuning potentiometer however is geared down and is entirely suitable, with the suggested modification, for use with a tuning meter.

For normal UK TV reception it's a good idea to remove the 5.58MHz dot/pattern and intermodulation filter CF202 and short-circuit coil L202. Otherwise the 6MHz sound may suffer from distortion on peaks.

The inclusion of a switchable wide/narrow bandwidth i.f. stage is highly recommended for DX reception. The difference narrow-bandwidth operation makes with a weak signal has to be seen to be believed. It is also useful where two DX signals are so closely spaced that there's cross-modulation. During a summer SpE opening for example there are often signals in channels R1 and R2 simultaneously. Narrow-bandwidth i.f. operation will separate them nicely. Note that this mode of operation will remove the colour and sound with say ch. E2 reception.

Fig. 2 shows items on the top/component side of the PCB relevant to the modifications described in this article.

Adding a Tuning Meter

You can easily fix the 50µA Maplin meter, stock no. RX54J, by its own terminal screws to the top of the MP3's case, in the gap. Fig. 3 shows the connections. When wiring it up, leave plenty of flex to allow the top cover to be taken off.

To calibrate it, open the meter carefully then reverse the scale plate, which can be marked in pencil with the positions of the various R and E channels or whatever. Be

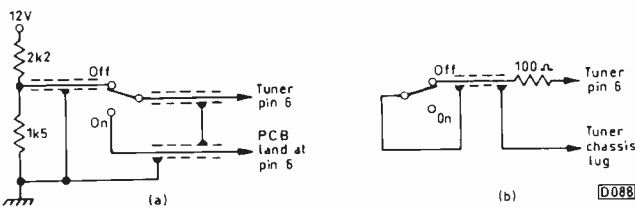

Fig. 4: A.F.C. on/off switching arrangements, (a) boffin's way, (b) lazy man's way.

careful not to drop anything down the gap of the meter movement.

Mount the resistors directly at the meter's terminals, then cover them with insulating tape. Use miniature twin screened flex. The diode is not essential, but does away with any worries should the meter be wired incorrectly. Because of the use of preferred value resistors, slight juggling may

be necessary to get the meter to read full scale when the tuning potentiometer is set to maximum voltage (about 33V). In my experience it's best not to use a preset for this purpose, as this will lead to eventual calibration inaccuracies (unless a very high-grade component is used).

ATV Reception

A simple modification enables the varicap tuner's i.f. coverage to be extended down to 435MHz. Cut the blue wire from the earthy end of the tuning potentiometer at the point where it is connected to the PCB, then solder it to one of the tuner's earth lugs. The purist may prefer to link out R003. This entails removal of the PCB, which is easy enough.

The extent of the tuner's coverage will depend on manufacturing tolerances, component values, setting up etc. Both my MP3s will cover the ATV band however.

AFC on/off

This facility is required when a tropospheric opening brings many Band III signals. With the a.f.c. wired so that it is permanently on, the tuner won't receive a weak signal when there's an adjacent stronger one. The modification is an essential one for the serious DX-TV enthusiast.

There are two ways of going about it. First the boffin's way, see Fig. 4(a). Two resistors and a miniature, single-pole changeover toggle switch are required. Use screened wire for the connections to the switch. There's plenty of room to mount it on the front panel. Earth all the screens at a single point – the tuner can lug. Unsolder the tuner's a.f.c. pin (see Fig. 2) from the print carefully, or cut the pin so that soldered connections can be made to both sides.

The alternative is the lazy man's or brute-force way, see Fig. 4(b), though there seem to be no ill effects after carrying out the modification in this way and making daily use of it for over six months. An on-off toggle switch is used to short pin 6 of the tuner to chassis via a 100Ω resistor, thus defeating the a.f.c. action. Solder the resistor to pin 6, connecting it to the switch via a screened lead. This action removes most of the power from the relevant place within IC201 and seems to work well. The current drain through R221 (22kΩ) is negligible.

Baseband Video Switching

Switching for positive-going vision is required if you want to receive French system L signals. There's room on the front panel for two independent phono sockets for this purpose, and ready-made buffer stages are present.

Negative-going baseband composite video (i.e. not RGB) can be tapped from the emitter of Q601. Its emitter load resistor R671 (560Ω) is marked on the PCB and a soldered joint can be made to the leadout wire. If only a negative-going signal is used, link B604 is a more convenient tap-off point. Use a miniature screened lead: there's a chassis link that can be used to earth the screen. It's in order to take a d.c. output from this point, going to a 75Ω load resistor. The result will be a lower d.c. voltage at the emitter of Q601, but this doesn't seem to have any adverse effects – sync clipping is a danger if capacitive coupling (say 47µF) is used. I found that a.c. coupling to the Hitachi VT11 VCR led to problems with the automatic ext/int switching – a d.c. connection must be used with this VCR.

Positive-going baseband video can be tapped from the emitter of Q602, i.e. from across R607 (820Ω). Note that there's a 47pF coupling capacitor (C601) connected to this

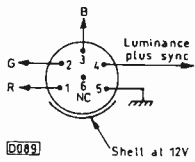

Fig. 5 (left): DIN socket connections, looking into the socket from the plug side.

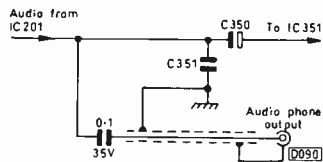

Fig. 6 (right): Adding a phono audio output socket.

point – it feeds the chroma signal to IC601, which is used when RGB outputs are required. C601 can be ignored or taken out if required – it must be left in if the DIN output is required. As before, use a miniature screened lead.

If preferred, instead of using two separate sockets take the feeds via a front-panel mounted changeover switch to a single output phono socket.

The DIN Socket

Fig. 5 shows the connections to the DIN socket on the MP3's front panel. I removed it as it wasn't compatible with the plug to the other equipment I have. If you use it, note that the shell is at +12V while pin 5 is the earth connection.

Adding a UHF Modulator

A standard u.h.f. TV receiver can be used as the monitor if a u.h.f. modulator is added to the MP3. Note however that it won't be possible to resolve system B/G sound. The MP3 has an integral system B/G sound system which gets around this problem so long as the original 5.5MHz crystals are left in place.

Various u.h.f. modulators are available from advertisers in this magazine. The Astec UM1289 is a good choice. Note that some modulators operate with a 5V instead of the usual 12V supply. If you use one of these a regulated 5V supply will have to be provided. You can run a 7805 directly off a 7812, and this will suffice.

The UM1289 presents no undue problems. With other types a check should be made on the standing d.c. voltage at the inputs – this will determine the polarity of any electrolytic capacitor used to tap the outputs from Q601 and Q602. Likewise the audio input – see Fig. 6.

Adding an Audio Phono Socket

A phono socket can be fitted to the front panel to provide an audio output for a tape recorder, VCR, etc. Use a screened lead as shown in Fig. 6, and an 0.1µF coupling capacitor. Take the output from the jungle chip IC201 – nearly everything in this receiver is done inside IC201! The electronic volume control works on pin 29 of this chip and cannot be 'got at'. This means that you can only tap from the chip audio that's controlled by the front-panel volume control. Thus any sound that's recorded via the phono socket is affected by the front-panel volume control: a suitable level will have to be found by trial and error. Solder the 0.1µF coupling capacitor to the right-hand side of C351, looking at the top of the PCB - see Fig. 2.

Narrowing the IF Bandwidth

This is the largest modification, but as previously mentioned is very well worth doing for DX operation. With

the circuit shown in Fig. 7 the i.f. passband will be narrowed to about 2.8MHz. Two alternative circuits are provided to suit different requirements.

A simple but quite effective i.f. filter is shown in Fig. 8. It will narrow the passband to about 3.5MHz. This is achieved by setting the cores of the two coils to the same frequency at the centre of the passband.

Both circuits are easy to incorporate in the MP3 and can be built 'ugly' fashion on to the corner of the tuner can, occupying some space near C202 (0.01µF). This capacitor couples the tuner's i.f. output to the base of Q201, a low-gain buffer/amplifier that drives the SAW filter.

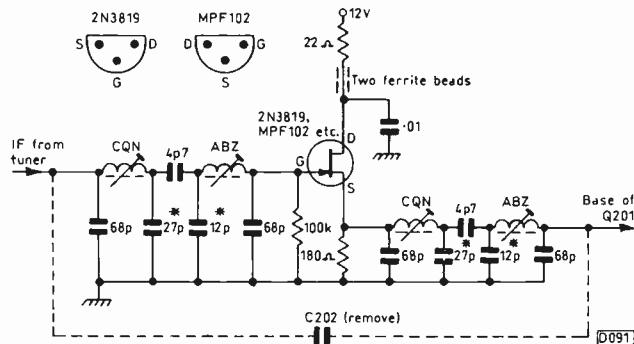

Fig. 7: Extra i.f. stage to reduce the passband to about 2.8MHz. Leave C202 in position when a switch is used to select a narrow or wide bandwidth (see text).

You can obtain coils from various sources or wind them yourself with the aid of a grid-dip oscillator (all right, a f.e.t.-dip oscillator!). I used Toko coils, type TKXCA34732CQN or alternatively KXCAK3347AHC, with internal 27pF capacitor, in position CQN, and type KXCAK2499ABZ with internal 12pF capacitor in position ABZ. Electronically the difference between the two circuits is the provision of a buffer/amplifier and use of doubled up coils in Fig. 7. Both circuits work well and there has been no hint of instability. If i.f. instability should be experienced a possible cure would be to increase the value of R204 from 27Ω to say 56Ω or 68Ω. But first look for the cause in the added circuitry. Note that Q201's emitter is not decoupled, so there's a degree of negative feedback in this stage.

To incorporate either circuit in the MP3 all that's necessary is to remove C202. It can be cut out, leaving enough leadout wire to make solder connections to the added circuit. This saves having to take the PCB out of the case to gain access to the underside. Note that the Toko coils incorporate capacitors as indicated above: they are marked with asterisks in Figs. 7 and 8.

You might wish to include switching so that either narrow- or normal-bandwidth operation can be selected. I use a simple single-pole changeover toggle switch for this purpose, the switching being done at the input end. Use a short length of good-quality miniature coaxial cable to connect the signal to the switch. Having a common input at

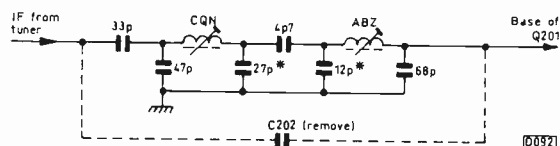

Fig. 8: Simple i.f. filter to reduce the passband to about 3.5MHz.

the base of Q201 introduces no coupling of any consequence.

It might be possible to find room for the old Philips G8 chassis i.f. selectivity module, type U800. I use these successfully in another rig. They are ready-made, three-stage i.f. amplifiers. All that need be done is to provide 12V and switch the module in/out of circuit. As an upmarket approach, small 12V relays with DPDT contacts could be used.

General Hints

(1) Setting the a.g.c. crossover potentiometer RV201. Disregard the procedure in the leaflet! If a signal generator is available, feed 40µV at about 210MHz into the aerial socket and adjust RV201 so that the signal is seen just to drop from the level at the anticlockwise position. If a signal generator is not available, use a weak but stable off-air u.h.f. signal. First adjust RV201 (use an analogue meter on the 2.5V range) for 0.9V at the potentiometer (NOT at the tuner's a.g.c. pin). Then make slight final adjustment with an off-air signal.

(2) It's desirable to provide reverse-polarity protection in the MP3. This is easy to do: solder a hefty diode, BY127 or similar, across the power input plug CP501 (see Fig. 2) with its cathode to the positive connection. A fuse must be included in series with the positive (red) lead: 250mA is suitable.

(3) Note that the contrast and colour controls on the front panel work only when RGB outputs from the DIN socket are used.

(4) Opening the top of the case is not as simple as the instructions imply! After removing the three screws, ease the top front of the case upwards so that the lugs inside are released. Don't attempt to force the case open by pushing the slots at the rear.

To remove the PCB from the bottom part of the case first pull off the front knobs (except the tuning one), then push down the plastic latches at each side of the PCB and ease it forwards and upwards. Watch the bandswitch as it is loose on its mounting. Pull off the power and speaker plugs carefully.

Note that the tin plate fixed in the top cover is a magnetic shield to help prevent purity errors with a nearby tube, as the speaker's magnet is of the open type.

(5) French system L signals have a.m. audio which can't be demodulated by the MP3. There's no easy answer to this one! Possibilities are a separate receiver that takes the i.f. directly from the tuner, or a receiver similar to a scanner tuned to the off-air signal.

CORRECTION

Our apologies for the printing error that occurred in last month's issue. The drawing for Fig. 5, page 637, appeared as Fig. 1 on page 655 and vice versa.

Next Month in TELEVISION

HELP WITH THE ICC5 CHASSIS

The ICC5 was the first Thomson designed chassis to be used in Ferguson TV sets. It caused much concern amongst those used to traditional Ferguson designs. J. LeJeune provides fault-finding guidance based on a lot of bench experience with this chassis.

SIMPLE TRANSFORMER TESTER

It's helpful to be able to test a transformer before going to the trouble of obtaining and trying a replacement. This simple tester can be used with LOPTs and other types of transformer. A scope is used as the monitoring device - some waveforms show what to expect.

MORE ON PANASONIC'S DIGITAL CHASSIS

Start of a short series that will describe the circuitry used in the Panasonic Euro 1 digital TV chassis. In this initial instalment Ray Meadows looks at the power supply and timebase output stage circuitry.

VHS VCR SERVICING

Regular maintenance will prolong the life of any VCR. It can be done during quiet periods. John Coombes provides a schedule for regular checks on VHS machines.

ALTERNATIVES TO THE CRT

In the next instalment in his current series Eugene Trundle describes alternative display systems to the c.r.t. They are based on the LCD, either as a directly viewed device or as a light valve.

FERGUSON FAULT NOTES

Alex Mason reports on recent Ferguson chassis including the new TX90 (Models B39 and B49F).

PLUS ALL THE REGULAR FEATURES

ORDER FORM

To.....
(Name of Newsagent)

Please reserve/deliver the September issue of TELEVISION (£2.20), on sale August 18th, and continue every month until further notice.

Name.....

Address.....

ECONOMIC DEVICES 32 TEMPLE STREET, WOLVERHAMPTON, WV2 4AN

15/80H	3.83	2SC1573	0.26	2SD637	0.12	BC119	0.00	BD175	0.29	BF960	0.27	CD4001	0.14	M50115AP	3.24	SK64F104	0.97	TA7205P	0.00	TD1200	0.91	TD18180	5.35
15/85S	3.84	2SC15730	0.26	2SD667	0.26	BC139	0.33	BD179	0.34	BF966	0.61	CD4011	0.21	M51102L	1.77	SK64F210	0.97	TA7207P	1.68	TD1270	1.79	TD18190	3.30
17052	3.20	2SC1675	0.09	2SD669	0.55	BC140	0.21	BD189	0.41	BF970	0.30	CD4013	0.34	M51231P	2.03	SK65F310	0.68	TA7210P	1.58	TD1412	0.77	TD18953	2.13
17053	2.38	2SC1685	0.17	2SD669A	0.63	BC141	0.34	BD190	0.31	BF939	0.35	CD4016	0.14	M51393AP	4.64	SL1430	1.41	TA7214P	3.74	TD1470	0.00	TD18102	4.98
17088	2.38	2SC1740	0.12	2SD716	1.11	BC147A	0.06	BD201	0.40	BF841	0.44	CD4021	0.43	M51515L	2.61	SL1431	1.70	TA7217AP	3.27	TD1470P	0.00	TD18109	1.24
17089	3.39	2SC1741	0.17	2SD718	1.45	BC148	0.12	BD203	0.46	BF879	0.60	CD4052	0.22	M51521L	0.54	SL1432	1.90	TA7222	1.24	TD1506	4.59	TD18104	1.87
17127	1.77	2SC1815	0.14	2SD734	0.24	BC148A	0.06	BD232	0.46	BF890	0.61	CD4053	0.20	M52128L	0.48	SL471	1.70	TA7222AP	1.27	TD1510	3.23	TD18109	2.15
1N4001	0.04	2SC1826	0.72	2SD762	1.51	BC148B	0.04	BD234	0.25	BF90A	0.77	CD4066	0.30	M5231P	0.55	SL490	2.31	TA7227P	2.02	TD1512	3.17	TD18104	1.49
1N4002	0.07	2SC1827	1.00	2SD774	0.43	BC149	0.04	BD237	0.30	BF921	0.43	CD4069	0.17	M52316P	1.48	SN29764AN	1.99	TA7230P	1.75	TD1515A	2.54	TD18164	2.96
1N4003	0.05	2SC1845	0.20	2SD787E	0.26	BC149C	0.04	BD238	0.11	BF986	0.53	CD4070	0.14	M54532	0.00	SN7474N	0.38	TA7233P	1.95	TD1516Q	3.56	TD18165	5.23
1N4004	0.07	2SC1846	0.51	2SD837	0.90	BC157	0.13	BD239	0.29	BF92A	0.48	CN62A	0.94	M54543L	1.32	SN76013ND	7.99	TA7240AP	0.00	TD1518Q	3.32	TIC106D	0.55
1N4005	0.06	2SC1923	0.14	2SD841	1.61	BC159	0.06	BD241	0.41	BFX85	0.55	CRC3M	2.62	M54544L	1.87	SN7666N	1.07	TA7240P	2.46	TD1670A	2.81	TIC106M	0.75
1N4006	0.06	2SC1942	3.33	2SD856	0.94	BC160	0.00	BD243	0.39	BFY50	0.34	CR02AM	2.17	M54548L	3.29	SN7666N	1.26	TA7241	2.40	TD1701	4.86	TIC45	0.59
1N4007	0.06	2SC1959	0.11	2SD869	3.28	BC161	0.27	BD243A	0.43	BFY51	0.34	CV12E	2.70	M54644BL	3.30	SN76705AN	1.70	TA7243P	0.00	TD1770	0.00	TIL100	0.52
1N4148	0.04	2SC1969	2.46	2SD870	2.96	BC167	0.42	BD243C	0.55	BR100	0.17	CX109	7.05	M54648L	6.31	SR2M	0.00	TA7250	4.03	TD1870	3.37	TP110	0.36
1N4448	0.06	2SC1983	0.87	2SD871	5.08	BC171B	0.14	BD244A	0.34	BR101	0.98	DTA124EF	0.13	M54898AP	19.47	ST341M	2.38	TA7267P	2.02	TD1904	1.21	TP112	0.10
1N5061	0.38	2SC2001	0.14	2SD880	0.48	BC177	0.14	BD244C	0.42	BR103	0.98	DTA144EF	0.17	M58485P	5.95	ST4401	2.30	TA7270	1.68	TD1905	0.94	TP112H	0.58
1N5402	0.12	2SC2029	0.00	2SD882	0.43	BC178	0.11	BD245C	0.72	BR303	1.22	ER1400	2.15	MB3730	2.38	ST441C	2.80	TA7270P	1.95	TD1908A	1.74	TP120	0.57
1N5404	0.13	2SC2073	0.51	2SD898B	2.97	BC182	0.06	BD246C	0.71	BRX44	1.02	HAI1235	1.68	MB3731	2.20	STK0029	5.88	TA7271P	1.95	TD19140	2.17	TP121	0.42
1N5406	0.12	2SC2078	0.77	2SD904	5.95	BC182A	0.00	BD278A	0.56	BRV56	0.43	HAI1244	3.83	MB3732	2.47	STK0039	7.11	TA7273	3.21	TD19150	0.86	TP126	0.48
1N5408	0.12	2SC2141	1.48	2SD913	0.38	BC182L	0.06	BD317	0.67	BSS38	0.23	HAI124A	1.21	MC13002	0.00	STK0040	7.40	TA7274	2.72	TD1920	1.85	TP29E	0.46
1N914	0.04	2SC2166	1.27	74LS00	0.21	BC182BL	0.06	BD318	0.10	BT120	1.28	HAI1243	2.02	MC13002P	5.74	STK0059	9.75	TA7280	2.11	TD19203V	0.00	TP137	0.48
1S1555	0.22	2SC2168	0.85	7805	0.28	BC183	0.06	BD380	0.34	BT129	3.26	HAI1440	2.92	MC1310P	0.85	STK025	9.61	TA7281	0.00	TD19204	1.27	TP2955	0.83
1S2076	0.29	2SC2236	0.25	7805T022	0.00	BC184	0.09	BD433	0.29	BT139600	1.14	HAI166A	3.43	MC1327AP	1.62	STK043	6.00	TA7299	2.34	TD19205	1.36	TP29C	0.30
2N2219A	0.27	2SC2271	0.22	7808	0.30	BC184L	0.04	BD434	0.34	BT151/500R	3.40	HAI1713	1.24	MC1330AIP	1.26	STK3042	6.90	TA7313AP	0.62	TD19206	1.06	TP29E	0.55
2N2222	0.22	2SC2274	0.22	7812	0.30	BC184LC	0.10	BD435	0.38	BT151800	1.15	HAI1741	6.77	MC1350P	1.82	STK3062	8.88	TA7317P	0.93	TD19209	2.29	TP3055	0.77
2N2905	0.21	2SC2274K	0.22	7815	0.30	BC204	0.37	BD436	0.32	BU205	1.07	HAI1745	5.10	MC1352P	1.45	STK4131	7.79	TA7325P	0.45	TD19220	3.72	TP30C	0.17
2N2926G	0.37	2SC2314	0.33	7818	0.41	BC207B	0.23	BD437	0.32	BU208A	1.16	HAI3001	1.68	MC1358P	1.58	STK4141	9.31	TA7343AP	0.72	TD19230	0.00	TP31	0.00
2N3053	0.36	2SC2335	1.43	7905	0.34	BC212	0.06	BD438	0.31	BU208D	1.53	HAI3108	0.87	MC14439P	0.00	STK4142	8.21	TA7358P	0.78	TD19230H	0.61	TP31A	0.32
2N3054	0.98	2SC2458	0.12	7912	0.43	BC212B	0.06	BD441	0.34	BU236A	1.36	HAI3118	0.87	MC1452BCP	1.70	STK4162M	9.51	TA7358P	0.68	TD19230V	1.05	TP31B	0.30
2N3055	0.77	2SC2482	0.34	AA119	0.36	BC212L	0.06	BD442	0.29	BU406	0.68	HAI3119	2.03	MDA2062	2.21	STK4171	10.50	TA7360P	2.62	TD19240	0.00	TP31C	0.44
2N3442	1.00	2SC2547E	0.24	AA143	0.13	BC213	0.11	BD510	1.34	BU406D	1.02	HAI3403	4.66	MJ2955	0.97	STK4181 II	12.85	TA7609P	1.95	TD19270	2.55	TP32A	0.38
2N3702	0.11	2SC2565	0.40	AC127	0.11	BC214	0.00	BD529	0.97	BU407	0.53	HAI374A	0.00	MJ2982	2.29	STK4181A	12.46	TA7630	0.00	TD19270	1.68	TP32C	0.39
2N3704	0.14	2SC2570A	0.29	AC141K	0.46	BC214L	0.09	BD530	1.10	BU407D	0.97	HAI377	2.42	MJ3300S	0.82	STK4332	5.54	TA7630P	1.87	TD19250	0.00	TP33	0.00
2N3773	1.02	2SC2757	1.46	AC176K	0.30	BC237	0.10	BD535	1.43	BU426A	0.96	HAI388	2.63	MJ3300S	0.68	STK4352	1.70	TA7640AP	0.98	TD19250	3.76	TP33A	0.92
2N3819	0.34	2SC2581	3.05	AC187	0.16	BC237A	0.00	BD536	0.48	BU426E	2.13	HAI389	2.52	MJ3305S	0.51	STK437	8.30	TA7676P	4.25	TD19250	0.88	TP33C	0.80
2N3904	0.11	2SC2632	0.43	AC187K	0.33	BC237B	0.05	BD5675	0.30	BU500	1.09	HAI392	1.61	MJ340	0.50	STK4392	5.92	TA7680AP	3.81	TD19251	0.72	TP34	0.00
2N4444	3.22	2SC2655	0.25	AC188	0.36	BC238	0.11	BD677	0.51	BU508A	0.95	HAI397	2.63	ML237B	0.00	STK441	11.54	TA7698AP	5.93	TD19260	5.95	TP34C	0.89
2N6292	0.62	2SC2671	0.68	AC188K	0.82	BC238B	0.05	BD707	0.32	BU508AF	1.27	HAI398	2.33	ML923	14.26	STK459	10.27	TA7705P	1.68	TD19267A	2.55	TP41A	0.38
2SA1015	0.10	2SC2688	0.30	D149	0.52	BC239	0.04	BD839	0.97	BU508D	1.27	HAI452	4.86	MM1405VFK	11.08	STK461	10.49	TA7769P	1.43	TD19277	0.00	TP41B	0.31
2SA1016	0.17	2SC2785	0.12	AD161	1.02	BC252B	0.07	BD901	0.51	BU508DF	1.49	HM6232	10.36	MM14435VX	14.35	STK4843	11.10	TA8205	3.89	TD19277A	4.25	TP142	0.37
2SA1020	0.43	2SC2791	5.44	AD162	0.96	BC300	0.48	BD902	0.51	BU508V	1.32	HM6251	9.52	MM1435VXII	10.66	STK5211	15.78	TA8210H	4.74	TD19278A	2.55	TP42A	0.34
2SA1020Y	0.43	2SC2791	5.44	AD162	0.96	BC300	0.48	BD902	0.51	BU508V	1.32	HM6251	9.52	MM1435VXII	10.66	STK5211	15.78	TA8210H	4.74	TD19278A	2.55	TP42A	0.34
2SA1095	7.44	2SC3153	2.37	AF127	0.59	BC302	0.36	BD912	0.63	BU536	1.60	ICH281	0.26	MPSA42	0.23	STK5325	5.92	TA8591N	6.67	TD19281	5.75	TP47	1.51
2SA1102	2.54	2SC3156	6.28	AF139	0.29	BC303	0.28	BD912	0.63	BU536	1.60	ICH281	0.26	MPSA42	0.23	STK5325	5.92	TA8591N	6.67	TD19281	5.75	TP47	1.51
2SA1143	0.17	2SC3182	3.25	AF239	0.43	BC307	0.06	BD968	1.16	BU608	1.66	KAZ101	0.60	MPSA56	0.12	STK5326	6.20	TA8550	0.00	TD19281Q	15.10	TP1791A	0.11
2SA1143	0.17	2SC3182	3.25	AF239	0.43	BC307	0.06	BD968	1.16	BU608	1.66	KAZ101	0.60	MPSA56	0.12	STK5326	6.20	TA8550	0.00	TD19281Q	15.10	TP1791A	0.11
2SA1143	0.17	2SC3182	3.25	AF239	0.43	BC307	0.06	BD968	1.16	BU608	1.66	KAZ101	0.60	MPSA56	0.12	STK5326	6.20	TA8550	0.00	TD19281Q	15.10	TP1791A	0.11
2SA1143	0.17	2SC3182	3.25	AF239	0.43	BC307	0.06	BD968	1.16	BU608	1.66	KAZ101	0.60	MPSA56	0.12	STK5326	6.20	TA8550	0.00	TD19281Q	15.10	TP1791A	0.11
2SA1143	0.17	2SC3182	3.25	AF239	0.43	BC307	0.06	BD968	1.16	BU608	1.66	KAZ101	0.60	MPSA56	0.12	STK5326	6.20	TA8550	0.00	TD19281Q	15.10	TP1791A	0.11

SPECIAL OFFERS - ENDS 30/08/93 OR WHILE STOCKS LAST

BU 208A x 5	3.50	TDA 2600 x 2	3.95
BU 426A x 5	3.50	TDA 2579A x 2	5.00
BU 508A x 5	5.00	TDA 352A x 2	3.99
BU 508AF x 5	5.00	TDA 365A x 2	2.20
BUT 11AF x 5	3.25	TDA 4501H x 2	2.49
U 321 TUNER x 2	3.00	TDA 4601 x 2	2.50
VIDEO FAULT FINDING GUIDE	9.99	TDA 4610D x 2	2.95
SEMI CONDUCTOR DATA BOOK	9.99	TDA 4501H x 2	2.49

THE GREENWELD

1993

SUPER SENSATIONAL SUMMER SALE

This has to be the **BEST VALUE EVER SALE!** Never before has so much been offered to so many for so little! 48 pages crammed full of quite staggering offers! Discounts you would not believe! Astounding Bargains! Amazing Deals! As the UK's Biggest and Best Surplus & New Electronics Mail Order Supplier, we have the largest stocks, the lowest prices and the fastest service. Don't miss out - stocks move FAST, so place your order today by phone, fax, post or in person!

The Order Form is on Page 45, and ordering details on page 46

INSIDE!!

*Video Processors
Less than half price!*

*Victor Vicki PC
Under £100!!*

*Hanimex Graphic
Writer 75% off!*

*Fire Detectors
£2.50 each!*

*Switch mode power
supplies from £2!*

CD's - £3.95 each

*Massive discounts on
multimeters*

There are only 3 special conditions if you order from these pages:

1. The **MINIMUM GOODS VALUE IS £12** (although this can include goods from any of our lists or catalogues)

2 **POST & PACKING CHARGE IS £3.00**

3 Free gifts and reduced price offers from previous lists are not available with sale goods

Regrettably, we cannot accept orders for Sale Goods that do not meet these requirements

**GREENWELD ELECTRONICS LIMITED 27 PARK ROAD SOUTHAMPTON SO1 3TB
TEL: (0703) 236363; FAX 236307; BBS 236315**



SUPER SENSATIONAL SUMMER SALE

GREENWELD

27 Park Rd. Southampton SO1 3TB
Tel: 0703 236363 Fax: 236307
All one off and pack prices INCLUDE V.A.T. Qty. prices do not.

AMSTRAD PC1640 COMPUTER

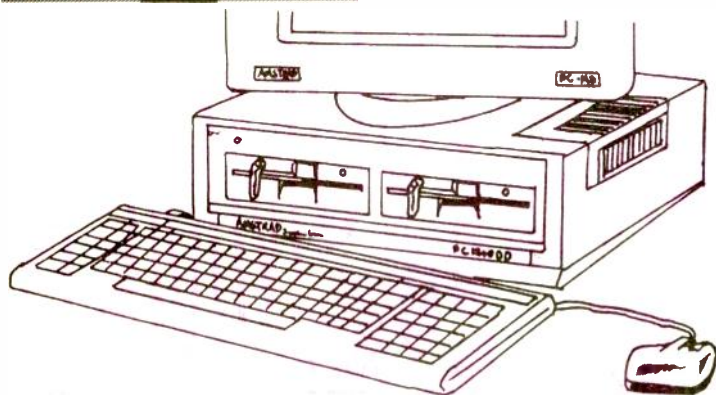

Brand new full spec base unit, keyboard, mouse and manual (no monitor) Standard PC1640 with 640k RAM and 2 x 5.25" disk drives, only being sold so cheaply because we have no monitors to go with them. Actually worth more as spares (work it out - keyboard £25, 2 disk drives £50, case £20, motherboard £25, mouse £5) but as they're taking up lots of room and we haven't the time or space to take them all apart, you gain an absolute bargain!

£99.95

SALE OFFER



Any 4 pieces of software on page 3 with every PC1640!

AMSTRAD GX4000

HOME ENTERTAINMENT SYSTEM

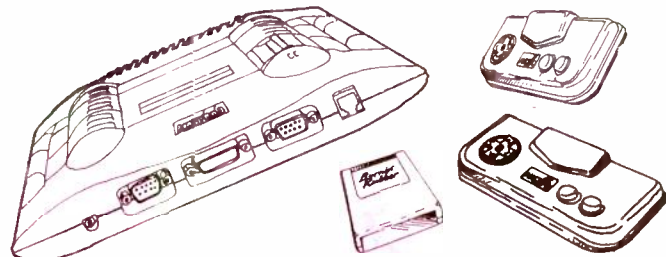

- *Games Console
- *2 Control Paddles
- *TV lead
- *Burnin' Rubber Cartridge
- *Power Supply
- *Instruction Books

Super games console that never really hit the big time - but it's a beautifully made piece of kit with loads of features, originally selling for around £100 - and the cartridges were £25!

The console itself measures 250x160x40mm and has a myriad of inputs and outputs to cater for most devices. Inputs: 2 paddles with 9 pin D sockets (supplied), also 15 way D sckt for analogue joysticks and 6 way aux modular socket for light pen/gun etc. Outputs are 8 pin RGB monitor sckt; SCART sckt, UHF output to phono sckt; and a stereo sound 3.5mm jack socket. It can be powered by the AC adaptor supplied (11V @ 500mA) or 5V from MM12/CM14 monitors.

Inside the plastic case, the PCB 205x147mm contains a wealth of goodies: Z80A CPU in socket, AY-3-8912 sound chip, 168 pin dedicated chip, UM1234 UHF modulator, games cartridge socket, 7805 on a heatsink + a dozen transistors.

EXCEPTIONAL VALUE AT **£29.95**

SALE PRICE £14.95

See Page 33 for details of **VICTOR PC** just received

Dataspectrum

Z5138 Modem serial interface and software package. Plugs directly into spectrum edge connector. Baud rates 1200/75, 75/1200, 300/300. Allows use of Prestel, Viewtext user-user comms with suitable modem. Includes Prestel telesoftware downloader. Main menu options include: Transmission Format selection, Prestel ID storage, Viewdata mode entry, Teletype mode entry, Frame processor, Mailbox editor, Save. Complete and new with cassette and user guide in plastic case. **Only £7.00**

SALE PRICE £3.50

Z8953 Complete unit with power supply and comprehensive instructions. Designed to add the facilities of error correction, speed buffering, encryption (optional) and a battery backed data store with a printer port to existing modems capable of speeds up to 2400 baud. Easy to use. (Send £5 returnable deposit for user manual for further information) **£20.00**

SALE PRICE £10.00

Z9012 Memorex MRX IV 1/2" computer tape. 600 ft on 175mm dia spool. 6250BP1. In case, in sealed poly bag. List £7.49

Our price **£3.50** 50 + 2.00
SALE PRICE £1.00

Z5123 Modem. Fully functional brand new and boxed. Standard 160 x 100mm Eurocard with DIN41612 connector. Only 300 baud, but at the price we're asking represents superb value for money!! Supplied complete with wiring details - needs ±12V.

Price **REDUCED TO £8.00**
SALE PRICE £3.95

QUICKSHOT MOUSE

High quality optomechanical mouse by Bondwell

- * Microsoft compatible
- * IBM PC XT or AT compatible
- * Hardware selectable mouse standard
- * Programmable resolution 29-1450 DPI
- * High tracking speed 500 mm/s
- * Silicone rubber coated tracking ball

Includes

- * Universal mouse driver
- * Performance Test Programme
- * D9-D25 connector adaptor

ORDER CODE QS158

PRICE REDUCED TO £19.95

SALE PRICE £14.95

Z9010 Tape streamer. Tandberg TDC3319. Internal fitting (same size as 5 1/4" disk drive). Takes DC600 tapes. Unsure of capacity - possibly 60Mb. Does anyone know?

Price **£250.00**

SALE PRICE £100

Magnetic card reader head - used for detecting when credit card or similar is swiped. Made by DRH. Type no 01.635. No other info (but our technical expert is working on it)

Order Code **Z2121**

Prices **£2.00** 100 + £1.00

SALE PRICE 2/£1.00

Atari 2600 Games Console



These popular consoles are complete, refurbished units with joystick, power supply, TV lead **£29.95** and games cartridge (Centipede).

SALE PRICE £14.95

Z8940 2400 ft of superb quality used 0.5" tape on 10" reels 6250 CPI. Various manufacturers. Supplied in carrier. New, they cost £12.00. Could probably be used as video tape - we're checking this out. Meanwhile, why not buy a few reels - useful as cheap 'twine' for tying up garden plants etc!!

Price **Only £2 a reel**
- or come and collect **100 for £50 + VAT**

SALE PRICE £1.00

CROSSTALK

XVI

Another super software deal! - We've purchased a number of the best selling 'CROSSTALK XVI' data communication packages. New and sealed containing a 5 1/4" disk and 182 page manual. PC DOS V3.61, last selling for around £60 - our Special Price

£17.95

Order Code: Z5495

SALE PRICE £8.95

PC-MIX

Z5444 Multitasking Interface Executive for the IBM PC and compatibles. Enables up to 3 programs to be run simultaneously. 96 page handbook and 5.25" disk £4.95

SALE PRICE £3.50

See Page 33 for details of **WINDOWS SOFTWARE** just received

WORDS & FIGURES

Features Include:

Spreadsheet

- 1-2-3 1A compatible WKS files
- 9999 rows by 256 columns
- Supports 1-2-3 1A functions, macros
- Protected and hidden cells
- Horizontal or vertical split screen
- Move, copy, transpose ranges
- Sparse matrix data storage
- Supports LIM: Expanded Memory
- Uses 8087, 80287 math coprocessor

Word Processor

- Include "live" spreadsheet data in document
- Two-line headers and footers
- Bold, underline shown on-screen
- Global find and replace
- Right & left justify, centering
- Automatic reformat, word wrap
- Import text from ASCII files
- Supports over 200 printers

Auditor

- Toggle from worksheet to audit display with a single command
- Pinpoint circular references
- Identify source of other errors

Data Management

- Three-key data sort
- 7 database statistical functions
- Query using up to 32 search criteria, wild card parameters

Graphics

- Line and XY graphs, scatter plots, pie, bar and stacked bar charts
- Superset of 1-2-3 1A type fonts
- High-resolution display (EGA, Hercules)
- High-resolution output to printers and plotters

Requirements: DOS 2.0 or higher, 256K RAM two disk drives, monochrome or color display

Printers: Text—over 200 including Epsoms, IBM, Tandy, HP LaserJet™ and many others; Graphics—Epson, HP LaserJet, PostScript™ printers, and others

3 1/2" disk version available; requires 1 disk drive

WORDS & FIGURES by LIFETREE

Comes with 546 page manual and spread out menu + disks, all in a library case

Z5442 5.25" version

Z5443 3.5" version

ONLY £14.95
SALE PRICE £9.95

'INDIVIDUAL' Tutors

Nicely boxed sets for IBM PC's with handbook and disk

Z5446 Learn to type 3.5" £3.95

SALE PRICE £2.50

Z5447 Learn to type 5.25" disk only £1.95

SALE PRICE £1.00

Z5448 Learn to use DOS 5.25" £3.95

SALE PRICE £2.50

Z5449 Learn to use DOS 3.5" £3.95

SALE PRICE £2.50

Z5450 Learn to use your PC 5.25" £3.95

SALE PRICE £2.50

Z5451 Learn to use your PC 5.25" disk only £1.95

SALE PRICE £1.00

C64 GAMES CONSOLE

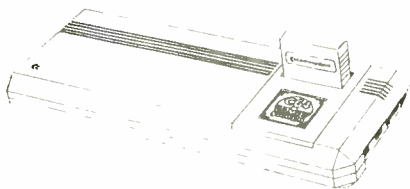

TY1 Clearing final stocks of this popular console. They are customer returns, and are sold "as seen" - no test, no guarantee, except they are complete. Final reduction to £20

SALE PRICE £15



Z1101 Sinclair P15/G Pack. 7 cassettes (no library cases) in a boxed set with over 100 games, all with documentation.

ONLY £2.95

SALE PRICE £1.50

Z1102 Sinclair Soft888 pack. 6 cassettes, all in library cases in a boxed set. Oh Mummy, Treasure Island, Punchy, Disco Dan, Crazy Golf, Alien Destroyer.

ONLY £2.95

SALE PRICE £1.50

SPECTRUM +2 LIGHT GUN

Action Pack - complete with lead software and instruction book

£6.95

SALE PRICE £2

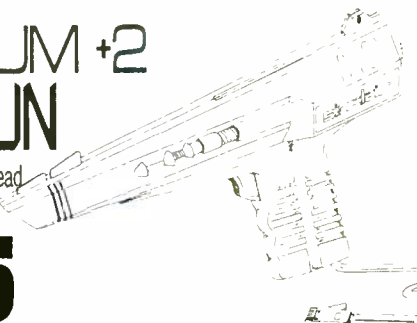

4**SUPER SENSATIONAL SUMMER SALE****GREENWELD**27 Park Rd. Southampton SO1 3TB
Tel: 0703 236363 Fax: 236307
All one off and pack prices **INCLUDE V.A.T.** Qty. prices do not.

ZONEPHONE ZAPPED!!!

You've probably seen in the press the much hailed personal phone has been a dismal flop - with 3 different systems and the restraints imposed on its use meant it had little practical value. Failure seemed inevitable - but there's a silver lining to every cloud and it's an ill wind that blows nobody any good, etc, etc ... we've purchased some of the goods with more to follow.

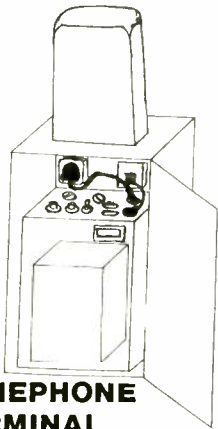

ZONEPHONE TERMINAL

Z8956 These were the units screwed to various buildings throughout the UK which you stood next to whilst making a phone call with your incredibly useful handset! Too bad if you weren't in range (99.9% of the UK wasn't!) but it was a nice toy while it lasted. There was a lot of clever technology involved, and we're selling these at probably about 1% or

2% of their real cost! So what do you get for your money?

Well, a lot of case for a start - in the outer steel case (a) 480 x 300 x 150mm with fibreglass aerial case on top (b) 250 x 160 x 75mm there's another steel case (c) 325 x 245 x 130mm and inside this there's a plastic box (d) 200 x 15 x 75mm.

(a) contains a metal surface mounting 13A socket and a BT line socket

(b) has 2 whip aerials 200mm long terminated in PL259 plugs*

(c) contains 8V 3.8Ah sealed lead acid battery, mains transformer (10V 2A Sec), mains filter and a plethora of plugs and sockets mounted on top - 3 BNC and 2 x 9 pin 'D' type, also 2 fuseholders, a lead with 13A plug and another lead with BT plug, and a power on/ off toggle. Screwed to the inside of the lid is a PCB 250 x 160 with lots of nice bits - 64180 CPU, 27C256 EPROM, 5256-15 256k RAM x 3, LM2940, LM317T, BD680 x 2, 3.6V AA size lithium cell in holder, about 30 various linear/ logic chips, 3 xtal's etc. etc. (You're getting great value for money here!)

(d) contains the Tx/Rx panel 170 x 135mm. Lovely bit of kit, this, all surface mount - about 20 chips Inputs

and outputs are taken to 2 min PCB sockets.

There's another panel the same size in this box, with lots of hi-tech devices - 2 x TMS77C82 programmable 8 bit microcontroller, 77C01, TMS320MC10FNL 16/ 32 bit signal processor, LM2984 triple 5V output regulator and another 10 chips, 4 'D' plugs/ sockets and lots of other bits. And that's about it!

Previously £17.95 & £12.95

SALE PRICES

COMPLETE LESS AERIALS & FIBREGLASS CASE

Z8956 Z8985

£13.95 £9.95

VERSATILE TIMER UNIT

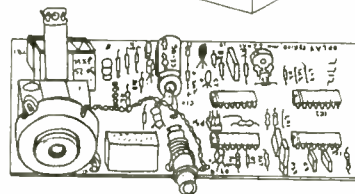
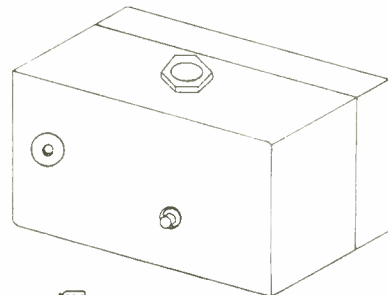

Z5438D Here's an interesting bit of kit. In a white 2 part ABS case 145x85x75mm is a timer PCB 142x70mm. Mains is applied directly to the board and the seemingly unnecessarily complicated timer (4 chips where one would do) enable times from 1min to 2 hrs (can be extended). There are 2 heavy duty relays with 10A contacts, a piezo sounder and MBC indicator. The unit, made by Energy Conservation Systems was designed to switch off lights. Supplied with original instructions + some useful data and ccts from our technical dept.

Previously £4.95
SALE PRICE £3.95

CABLE TV RECEIVER

Z9135 Made by Cabletime, model 280, this unit is brand new and boxed with a smart black plastic case 220x150x60mm. It has a **6 digit starburst LCD** with internal character generator and I²C bus at the front and 3 push buttons on top with well for remote control (not included). 3 connexions on back - TV co-ax skt, input co-ax skt and 16 pin IDC data plug, 2 core mains cable 2m long. Inside, the high quality PCB 187x133mm is packed with useful components: mains transformer, 2xW005 bridges, 7805 & 7812 v. regs, smoothing caps, fuse + holder, 2 xtal's, 7 small signal transistors, 4 green 5mm LED's. TDA5930, 4093 & 89C51 PROM in skt. **IR receiver LED with integral pre-amp** made by Mitsumi. I²C bus interfaced channel selector/**UHF modulator unit**, ceramic filters, presets, R's, C's etc. Great component value

- and all for

Previously £4

SALE PRICE £2.95



CABINET SPEAKERS



Z9121 Dark veneered wood finish, size 330x217x116mm. Single wide range 4R speaker. Max total output 20 watts music power. Ideal as extension speakers for kitchen, workshop, etc. **Only £12.95 per pair.**

HOME ALARM SYSTEM

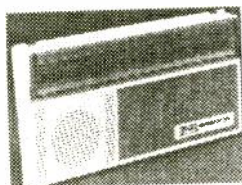

Sophisticated hi-tech fire and burglary control system that will:

- Automatically dial a pre-programmed telephone number
- Play the relevant synthesized speech message
- Set off a visual/audible alarm
- Allow up to 32 transmitters to be used
- Program entry, exit and delay times
- Program user codes

No wiring required! Designed to ensure ease of operation for the user by responding with spoken instructions.

Detectors (not supplied) communicate with the panel by radio transmitter

Comprehensive instructions supplied - more info on request.

group 4
SECURITAS

Giving the world a sense of security

NORMAL SELLING PRICE £300

Previously £79.95

SALE PRICE £49.95

Xtra Special

Development Boards

Uniqard PCB's for RAM/ROM

129PCB012 6U-160 extender **£3**

129PCB014-112 horiz mntg **£2**

Star Buy!!

STEREO CAR RADIO/CASSETTE

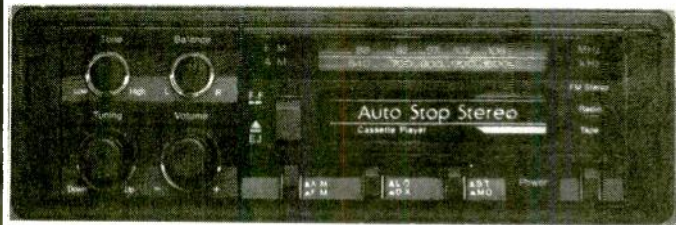

B002 JCS2228
RADIO/CASSETTE PLAYER

DIN standard mounting car radio/cassette player unit with metal tuner. Analog tuning with AM/FM, Local/Distant and Mono/Stereo push button selectors. Overall tune, volume and balance controls, Auto stop cassette mechanism with fast forward control. Orange back-lighting.

Output power... 8.5W per channel RMS
 ... 20W per channel peak
 FM range... 88-108MHz
 ... 540-1600kHz
 AM range... 540-1600kHz
 Power... 13.8Vdc negative earth
 Dims... 140 x 178 x 50mm (body)

Featured in our 1993 Catalogue at £44.95 - now offered at nearly half price! Buy now while stocks last!

£24.95
 12+ 14.00

SALE PRICE £19.95

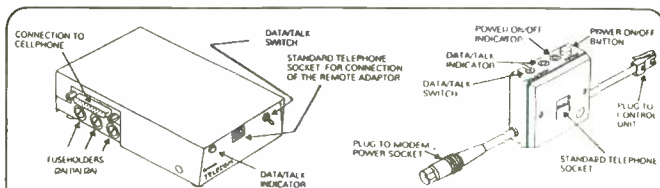

DATA INTERFACE

Z8976D DS1000 data interface for using cellular phones for fax transmission. Comes in 2 parts: a) Control Unit in a steel case 170x102x45mm with connections to cellphone and remote adaptor and b) Remote Adaptor, which is a BT socket that has plugs to the control unit and modem, a standard telephone skt, data/talk switch and indicator, and on/off button and indicator. Must have cost a fortune. Brand new and boxed, we're selling these for the useful parts - relays, pot cores chips, plugs, sockets etc.

The whole lot, with data for just **£5.95** 100+ 3.50

SALE PRICE £3.00

CABLEVISION CALAMITY !!!

Seems like Visionhire became a bit overstocked on their cablevision consoles - we've just purchased a quantity of these superb brand new units which contain some great electronics and as ever can offer them at an absolute BargainPrice!

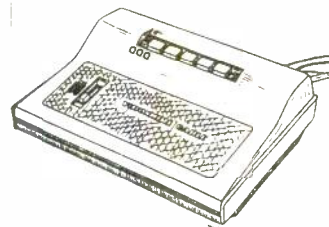

Two tone brown case (dimensions as shown) contains PCB 192x195mm with easily removed UHF modulator made by Labgear (Sound and Vision); video pre-amp; stabilized power supply and all the decoding circuitry (9 transistors and TBA673 chip).

On the front of the case is a cable/off air switch and 5 push buttons (4 channels and on/off mains switch). There are 4 cables coming from the rear (these alone are worth what we are asking for the whole thing!) - 2m mains lead, 1.5m 8 core screened cable with 9 pin plug, 2m video in lead with coax plug and 2m video out lead with coax socket. As you would expect from a company like Visionhire, everything is top quality. The case can easily be utilised for other purposes - the dark brown inserts on the front are both easily removable, if required. Please note the low price we are asking in no way reflects their true worth - they're taking up a lot of space, so we need to shift them quickly!!

Z8939 £6.95 100+ 3.50 1k+ 2.50. Add VAT to quantity prices

SALE PRICE £2.50

VISTEL CLEARANCE

Visual telephone + "Ansaphone" for deaf people. Keyboard + 40 character LCD display in case 340x450x137mm. All sorts of facilities - full details in earlier supplements. Although complete with handbook, there is no guarantee they work.

SALE PRICE £20.00

FIRE DETECTOR
75% OFF!!



Z5371 Simplex rate-of-heat rise and 135°F detector, model 4255. A rise of more than 15°F per minute, or if temp reaches 135°F will close contacts. Supplied boxed with installation instructions. These normally sell for around 18.00. Our price **£10.00** 100+ 5.50

Z5391 Apollo series 30 heatrise fire detector. Set temp 60°C. Supply 17-28V. DP around 18.00 Our Price **£9.50**

SALE PRICE - EITHER TYPE
£2.50

MULTIBAND RADIO

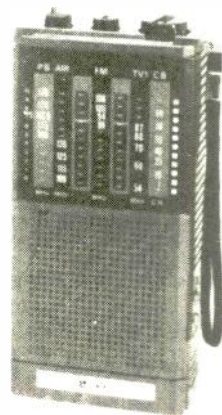

This compact piece of equipment 200 x 95 x 50mm comes in an attractive metallic grey case with controls on top - tuning, on/off and volume, squelch. The telescopic aerial extends to 500mm and can be rotated in any direction. The 3 wavebands are:

- 1) CB, channels, 1-80
- 2) TV1 54-87 MHz & FM 88-108 MHz
- 3) AIR 108-145 MHz & PB 145-176 MHz

The large 3" full range speaker delivers 280mW of undistorted power. There is an earphone jack and DC adaptor jack. The unit is powered by 4 x AA cells. All this technology for just **£17.95** 10+ 11.90
 Order Code **MB100**

SALE PRICE £14.95

Become a Bargain List Subscriber!
 A new list every month for just **£6** a year. See page 47 for details

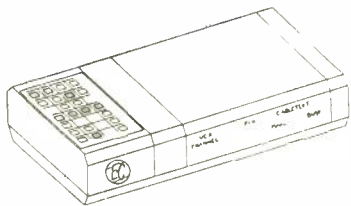

Z8970 Remote control cable TV unit made by GEC. Attractive black plastic case 205x120x40mm with membrane pushbutton keypad (22 keys). Front panel has 4x5mm red LED's to indicate status and a dual 7 seg display to show channel. On the 195x102mm PCB is a small regulated power supply (12V & 5V) derived from Z5226 plug in PSU (not supplied). The main chip is a KS49429 and there are also TBA120T, ULN2003B, 4049 + 4.000MHz crystal & 3 small signal transistors as well as the IR detector diode. 2 screened cases contain (a) a PCB with some filter circuitry utilizing surface mount technology, few small chokes, couple of trimmer caps and input and output sockets; and (b) the infra red decoding circuitry using a TDA3047 chip. Regrettably, we don't have any remote controllers, but these units offer great value for money - just **£5.95 each**

SALE PRICE £3.95

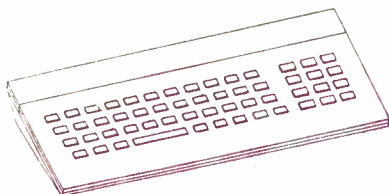

Z8963 Tandata "Homedeck". These are later versions of Z8963 and are (a) smaller and (b) remote controlled. The two tone grey case is 270x110x28mm and has a full qwerty keyboard and separate numeric keypad. Inside, on the PCB are a few components to transmit the data via 2 IR LED's to the receiver. The unit is powered by a PP3 battery. Super value at just **£3.00**

SALE PRICE £2.00

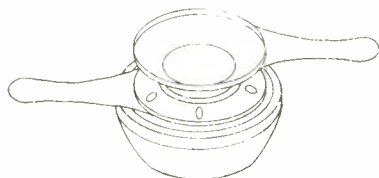

Z5200 Spirit Burner. Very useful in science labs or for the home experimenter. Chromed steel container 93mm dia x 48mm high has absorbent material covered in wire mesh. Adjusting lever allows variations in temperature. Complete with 70mm dia dish for heating substances in. **Only £2.50**

SALE PRICE £1.00



Z5499 UM1233 Astec UHF modulator, brand new, full spec. Currently being sold for around **£6.00**

OUR PRICE £2.00
SALE PRICE £1.00

Viewdata Terminal/Modem



Tandata TD1100 alphanumeric Viewdata/Prestel Adaptor. These units were used with a home banking system. The console was hooked up to your TV and telephone line, and by using the standard qwerty keyboard with separate numeric keypad, you could access your account. The well styled black and grey case 300x180x75/40 has a 75 key keyboard connected inside by a DIL plug to the main PCB. This has mounted on it the modem sub-panel + 3 relays, UM1286 Astec colour modulator with sound, + SAA5020, 5050, 5070, SY6504, 68B10, MCM51101P45, 2x2114 & 2732 EPROM all in sockets, as well as over 20 other LS and linear chips, transistors etc. There's a back up nicad battery and a regulated power supply. On the rear panel is an on/off rocker switch, UHF output socket, printer skt (15 way D), and cassette DIN socket for recording data.

There are 3 leads attached; 4m long mains lead with 13A plug, 4m long BT lead with old-style plug, and a 3m long TV co-ax lead.

All in all, a versatile, useful compact unit either to use as it is or for the parts within. The component value alone is over £60, so you can see what a bargain this is - it even comes with a photocopied handbook!!

Order Code Z8963. The whole unit as described for just **£12.95**

SALE PRICE £5.00

SOUND ACTIVATED SWITCH

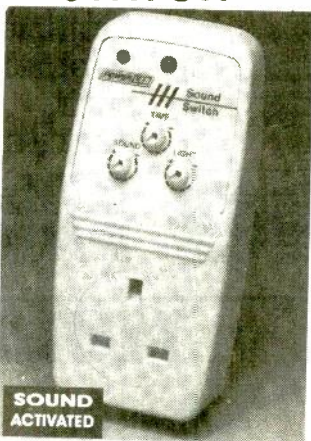

F605 AML768

SOUND ACTIVATED SWITCH

Plug-in sound activated switch, ideal for switching on lights automatically. On detection of a sound above a preset level power will be switched on to the built-in socket for a preset length of time. A photo transistor with control prevents the switch from activating during daylight. Controls: Sound level, time, light level

Power 220/240Vac 50Hz
 Max load 500W

Superdeal Price

£12.95

SALE PRICE £9.95

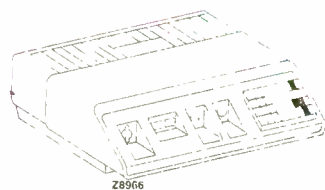

Z8966 Prestel set less monitor. This cased unit 420x430x100mm made by Phillips, model HU01 contains all the logic and control circuitry for Prestel - the monitor (not supplied) sits on top. On the back panel there is an 8 pin DIN socket for text output to monitor, mains outlet to monitor and an 8 pin DIN printer socket. There's also a mains lead and old type lead to telephone socket. On the front panel there is a detachable (on curly lead) keypad (20 keys) on/off keyswitch, tape and keyboard sockets and indicator lamps. Inside there's a large transformer and power supply and 4 PCB's - one is a modem panel; one has 8048 and SBB2626 in sockets + 15 other chips, transistors etc; the third has SAA5030/5042/5020/5050, a bit of memory (2x2114) + a few other chips. The fourth panel has SAA5010 in socket, 9xBSX20, 4xBC548/558. All boards are interconnected with plugs and sockets. These units are complete but not new and may well be in working order - but we're selling them for the parts value only - just **£16.00**

SALE PRICE £4.95

Xtra Special
INTERFACES
 Z5130 Spectrum £1.00
 Z5131 Dragon £1.00
 Z5132 CBM £1.00
Star Buy !!

TELEPHONE LEADS AND HANDSETS

Z5361 Curly lead, new. BT handset plug one end, 4 spade terminals the other. Pale grey. DP 4.11 **Our Price £2.00**

Z5362 4 core telecom lead 3m long with BT line plug one end, 4 way socket the other. DP 4.40. **Our Price £2.00**

Z4309 BT 'breakout' lead. One end has moulded housing with 6 pin BT plug and socket. Other end has 6 pin FCC68 plug (as used on some computers). Overall length 3m
Price £2.20

Z5500 Telephone handset in pale grey with black 4 core lead. No plug **£2.00**

Z5512 Ivory telephone handset, 4 way curly cord with spade terminals which can be unplugged (unusually) from handset. **£2.50**

Z5360 New brown telephone handsets by BT, complete with curly cord and 4 way socket. **£4.50**

ALL HALF PRICE

Z9118 Phillips Sopho K8 Telephone System. Brand new wall hung unit, still in original packing until we undid it to find out exactly what it was. Just plug in to the mains, add your lines, buy a few handsets and you've saved a packet!! Wired for 3 lines and 8 extensions. Max capacity 5 lines and 12 extensions (Extensions can be bought second hand for £25-40 each) **Our price (1 only) £175.00**

SALE PRICE £75.00

GREENWELD 27 Park Rd. Southampton SO1 3TB
 Tel: 0703 236363 Fax: 236307
 All one off and pack prices INCLUDE V.A.T. Qty. prices do not.

SUPER SENSATIONAL SUMMER SALE

7

HANIMEX

Electronic Graphic Writer

Professional OHP transparencies at your fingertips...

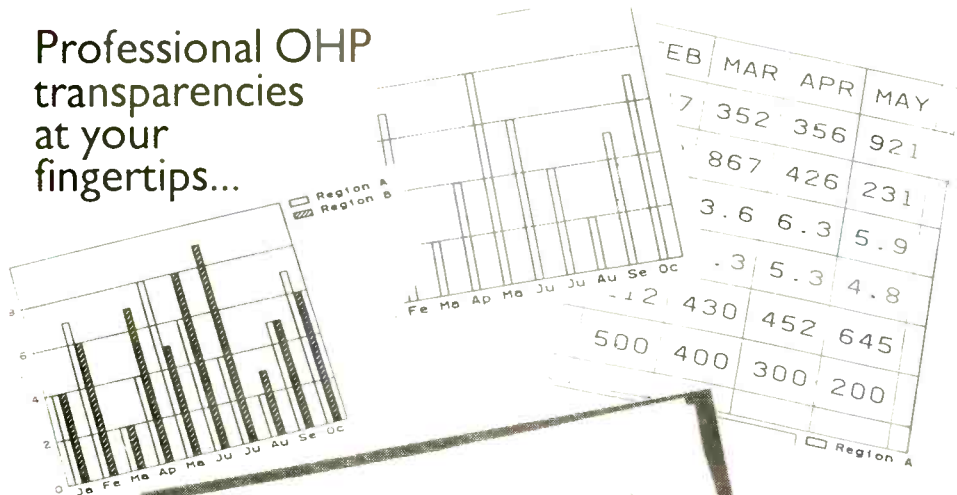

HELVETICA
 standard
 Bold
 Bold
 italic



TEXT

Portions of the keyboard are printed in your own fonts and in 15 different colours.

PRINTS ON PAPER OR CLEAR FILM IN UP TO 4 COLOURS

Interchangeable pen facility allows choice of colour with paper or acetate film option. Use ballpoint pen set with A4 paper, or special felt tip OHP pen set with A4 size OHP transparency film. Both sets available in set of four colours Black, Blue, Green and Red. Pens easily changed for multi colour productions.

3-MODE OPERATION

TYPE MODE: Characters, Numbers and Symbols are printed immediately on pressing the keys.
LINE MODE: A line of characters is entered into the line memory. Up to 16 Characters can be arranged on the LCD display and then corrected before printing.
EDIT MODE: Allows for easy editing of the page memory. Add, delete, insert words or graphics as you wish then press 'PRINT' to automatically produce the amended version.

MEMORY

LINE MEMORY 250 Byte
 PAGE MEMORY 3k Byte 1800 Byte for characters
 1200 Byte for graphs and layout

4 GRAPH MAKING FUNCTIONS

Layouts (for tables) bar graphs, Linear Graphs and Pie Charts easily and accurately produced in choice of three sizes with multi-colours if desired. It is possible to enter into page memory a maximum of two layouts and/or three graphs (Bar, Linear, Pie) for a Maximum of five.

18 FONTS IN 9 TYPE SIZES

Choose from Gothic Courier and Helvetica outline type faces each in plain or italic, and each available in nine character sizes ranging from 75 characters per line to 8 per line. Letters may be printed in **Standard**, **Half bold** or **Full bold**.

COMPACT, PORTABLE AND CONVENIENT

Measuring a mere 320 mm (W) X 60 mm (H) X 260 mm (D) and weighing 2.3 kg (excluding batteries) the Hanimex OHP Graphic Writer will travel anywhere. Takes four size 'D' 1.5V Alkaline Batteries fitted with 6V DC input for use with AC Mains Adaptor. (Batteries and AC Mains Adaptor available extra)

Price INCLUDES mains PSU + FREE OHP set containing 10 OHP sheets and 2 x 4 colour pen sets!!

ORIGINAL SELLING PRICE £299!!

Order Code HAN101

SALE PRICE £69.99



EVERYTHING ON THIS PAGE 2 FOR THE PRICE OF 1

SURFACE MOUNT LED'S

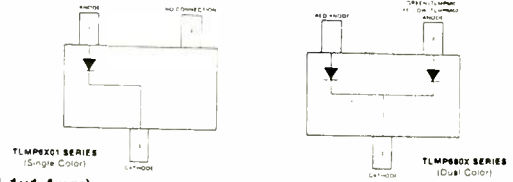
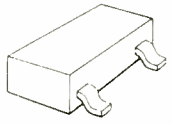

These LED's are in a SOT23 package (2.9x1.1x1.4mm)

CODE	PART NO	COLOUR	SPEC	£2 PACK	100+	1k+
Z2671	TFS056	Red	1.6mcd @ 10mA	12	.08	.06
Z2672	TFS059	Green	1.6mcd @ 10mA	12	.08	.06
Z2673	TLMP6301	Orange	0.5mcd @ 10mA	15	.06	.045
Z2674	TLMP6311	Red	1.6mcd @ 10mA	12	.08	.06
Z2675	TLMP6401	Yellow	0.5mcd @ 10mA	15	.06	.045
Z2676	TLMP6411	Yellow	1.6mcd @ 10mA	12	.08	.06
Z2677	TLMP6501	Green	0.5mcd @ 10mA	15	.06	.045
Z2678	TFS021	Red/Green	0.5mcd @ 10mA	8	.12	.09
Z2679	TLMP6802	Red/Yellow	1.6mcd @ 10mA	6	.16	.12
Z2680	TLMP6803	Red/Orange	1.6mcd @ 10mA	6	.16	.12
Z2681	TLMP6811	Red/Green	1.6mcd @ 10mA	6	.16	.12

KS106 A mixed pack of 100, containing most of the above types for just £8.95

SUBMIN LED'S

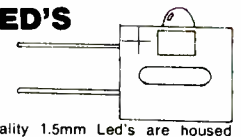

These excellent quality 1.5mm Led's are housed in a 6.2x5x2.4mm package with built in resistor for 5V operation (add 470R resistor for 12V). Available in Green (DP £1.73) or red (DP £1.16).

Z2135 Red 3/£1 100+ 0.15
Z2136 Green 2/£1 100+ .25



Z2461 PC mntg packaged red LED - mounts at right angles to PCB. 10.5x8x3.9mm. LED is 3mm. Ore type 9301A. Pack of 10 £1.00 100+ 0.05; 1k+ 0.04

Z1934 Stackable red LED - white casing round 6x3.5mm. Pack of 10 for £1.00

A couple of small matching rectangular LED's, 3.8 x 1.75 mm :

Z2500 Green Pack of 12 £1 100+ .05 1k+ .04
Z2501 Red Pack of 12 £1 100+ .05 1k+ .04

Z1845 Rectangular LED 7 x 2.5 Red. Unusual size by Hewlett Packard type LMP301.
Price Pack of 12/ £1.00

Z1464 3 way white* (lights up red) 7.5mm . 20p 10/ 1.40

Z1932 Red square LED with rounded corners. 5mm. Pack of 15 for £1.00

Z1933 Thin rect. red LED - 5x1.5mm. Pack of 20 £1.00

MINIATURE LED'S



These LED's have axial leads

CODE	PART NO	COLOUR	SPEC	£2 PACK	100+	1k+
Z2691	TFS065	Red 1.8mm	2.8mcd @ 10mA	10	.10	.07
Z2692	TFS066	Red 1.8mm	2.8mcd @ 10mA	10	.10	.07
Z2693	TFS068	Green 1.8mm	4.5mcd @ 10mA	10	.10	.07

STANDARD LED'S

These LED's have radial leads

CODE	PART NO	COLOUR	SPEC	£2 PACK	100+	1k+
Z2682	MV6052	Red 5mm	0.7mcd @ 20mA tint/undiffused	25	.045	.03
Z2683	SL35091G	Orange 3mm	16mcd @ 10mA	16	.06	.04
Z2684	HLMP3850	Yellow 5mm	150mcd @ 20mA untint/undiffused	12	.075	.05
Z2685	HLMP3950	Green 5mm	150mcd @ 20mA untint/undiffused	12	.075	.05
Z2686	TLMP7413	Yellow 5mm	150mcd @ 20mA untint/undiffused	12	.075	.05
Z2687	TLMP7513	Green 5mm	150mcd @ 20mA untint/undiffused	12	.075	.05
Z2688	TLMP7313	HE Red 5mm	150mcd @ 20mA untint/undiffused	12	.075	.05
Z2689	LST712L	Orange/Green 5mm	4mcd @ 20mA milky/diffused	10	.09	.06
Z2690	XC5549R	Red 5mm	4mcd @ 10mA tinted/undiffused	30	.04	.025
Z2694	TLMP5401*	Yellow 5x2mm	4mcd @ 20mA tinted/undiffused	15	.055	.035

*These have an interlocking moulding incorporated to enable accurate alignment when stacked.

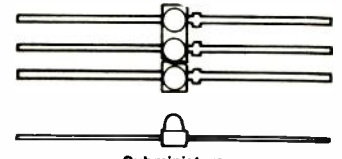

Subminiature (Last digit of Type No. denotes array length)

Z2571 Hewlett Packard sub-min red LED array type HLMP6204. Strip of 4 x 1.8mm LED's, easily separated if required. DP 1.27. Our Price: Pack of 6 £2.00

Z2091 Red 5mm square, Lilon type LTL9223A. Pack of 12 £1.00; 100+ 0.038; 1k+ 0.03

Z2098 Red 7x2.55mm rectangular by Senior type SE6511D. Pack of 12 £1.00; 100+ 0.038; 1k+ 0.03

Z2095 Red 5mm square with rounded corners by Phillips type HR444LD. Pack of 12 £1.00; 100+ 0.038; 1k+ 0.03

Z2096 Clear infra red 4.5x1.5mm rectangular, Honeywell type 8406. Pack of 8 £1.00; 100+ 0.06; 1k+ 0.04

Z2097 Red 5x2mm rectangular by GI, type MV57123. Pack of 12 £1.00; 100+ 0.038; 1k+ 0.03 .

Z2182 Standard 5mm red LED with 18mm leads, bent at right angles. 18/ £1.00 100+ 0.03 1k+ 0.02 10k+ 0.015.



Hermetically sealed, TO46 case

CODE	PART	COL	RATING	£2 PK	100+
Z2764	TLMP9210	GRN	3.0 mcd@20ma	15	.07
Z2765	TLMP9310	YELL	3.0 mcd@20ma	15	.07

Z5501 Panel 71x27mm with dual 7 seg LED+red and green rect LED's. Pack of 10 £2.00

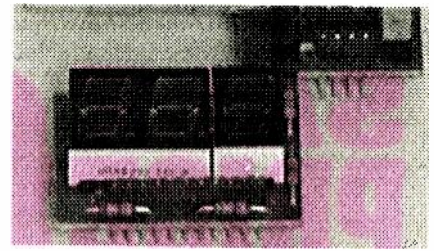

Z5502 Another, this time with a dual and single 7 seg LED+red and green rect LED's. Pack of 8 £2.00

CODE	TYPE	COLOUR	SIZE	SPECIFICATION	TU/DU	QTY	£2 PACK
Z2907	HLMP0401	YELLOW	2.5X7MM	0.9MCD @ 10MA	TD	1900	12
Z2908	HLMP0504	GREEN	2.5X7MM	0.9MCD @ 10MA	TD	296	12
Z2909	HLMP1321	HE RED	3MM	6.0MCD @ 10MA	TU	1700	16
Z2910	HLMP1421	YELLOW	3MM	6.0MCD @ 10MA	TU	100	12
Z2911	HLMP1521	GREEN	3MM	4.2MCD @ 10MA	TU	400	12
Z2912	HLMP3050	RED	5MM	2.0MCD @ 20MA	TU	6880	30
Z2913	HLMP3316	HE RED	5MM	20.0MCD @ 10MA	TU	1192	15
Z2914	HLMP3416	YELLOW	5MM	20.0MCD @ 10MA	TU	5444	12
Z2915	HLMP3517	GREEN	5MM	6.7MCD @ 10MA	TU	1514	14
Z2916	HLMP3519	GREEN	5MM	10.6MCD @ 10MA	TU	2172	12
Z2917	HLMP3862	YELLOW	5MM	8.0MCD @ 10MA	TD	200	14
Z2918	HLMP4610	HE RED	5MM	2.0MCD @ 10MA	TD	8422	25
Z2919	MV54123	GREEN	2X5MM	1.0MCD @ 20MA	TD	592	15
Z2920	MV6051	RED	5MM	0.4MCD @ 20MA	UD	4400	15
Z2921	MV64520	GREEN	5MM	12.0MCD @ 20MA	TU	514	12
Z2922	MV6752	HE RED	5MM	17.0mcd @ 20MA	TU	19112	20
Z2923	TF5012	HE RED				2416	20
Z2924	TF5031	HE RED	5MM	6.3MCD @ 10MA	TD	56170	25
Z2925	TF5032	RED	5MM	10.0MCD @ 10MA	TD	1564	20
Z2926	TLMP5001	RED	2X5MM	INTERLOCKING	TD	2775	20
Z2927	TLMP5301	HE RED	2X5MM	INTERLOCKING	TD	12823	15
Z2928	TLMP5501	GREEN	2X5MM	INTERLOCKING	TD	3600	15
Z2929	TLMP5801	RED/GRN	2X5MM	INTERLOCKING	TD	567	10
Z2930	TLMP7003	UB RED	5MM	200.0MCD @ 20MA	UU	1278	10
Z2931	TLMP7005	UB RED	5MM	300.0MCD @ 20MA	UU	924	8
Z2932	TLMP9710	HE RED	TO46	3.0MCD @ 20MA	H	95	12

H = Hermetic; TU/DU = Tinted/Untinted/Diffused/Undiffused

Traffic Light LED modules. Plastic moulding 15x10x7.5mm that have 2 x 3mm LED's mounted in them. Ideal for railway modellers etc.

Z2855 Red and Orange
Z2856 Red and Green
Z2857 Green and Yellow
All the same price - any mix, 10 for £2.00

Panel mntg LED's in chrome bezel, with long leads. Require 6mm hole

Z2744 Yellow Pack of 6 £1.00
Z2745 Green Pack of 6 £1.00

Z2860 3mm red diffused IR LED. No other info, so 10 for £1

EVERYTHING ON THIS PAGE FOR THE PRICE OF 1



(B) (i) PHOTOTRANSISTORS, INFRA RED

All are in TO18 hermetically sealed cases.

CODE	PART NO	ImA	mW/cm	£2 PK	100+ QTY
Z2766	TDET800W	0.3	5	10	.10
Z2767	TDET801W	0.5	5	10	.10
Z2768	TDET802W	2.5	5	10	.10
Z2769	TDET803	4	5	10	.10
Z2770	TDET804	7	5	10	.10

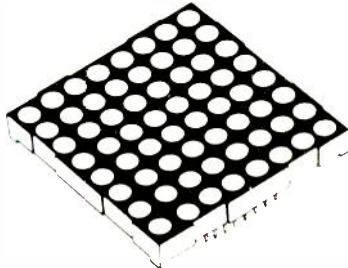

(C) LED BLOCKS

CODE	PART NO	SIZE (MM)	MATRIX	COLOUR	PRICE
Z2759	TFB3358C	35	5X8	YELLOW	1.60
Z5469	TFB3458C	35	5X8	GREEN	1.60
Z2760	TFB3758A	35	5X8	HE RED	1.60
Z5470	TFB3758C	35	5X8	HE RED	1.60
Z2761	TFB5357A	51	5X7	YELLOW	1.80
Z5471	TFB5357C	51	5X7	YELLOW	1.80
Z5474	TFB5457A	51	5X7	GREEN	1.80
Z5475	TFB5457C	51	5X7	GREEN	1.80
Z5478	TFB5757A	51	5X7	HE RED	1.80
Z5479	TFB5757C	51	5X7	HE RED	1.80
Z5472	TFB5388A	58	8X8	YELLOW	3.50
Z5473	TFB5388C	58	8X8	YELLOW	3.50
Z5476	TFB5488A	58	8X8	GREEN	3.50
Z5477	TFB5488C	58	8X8	GREEN	3.50
Z5480	TFB5788C	58	8X8	HE RED	3.50

The suffix A or C to the part number indicates common anode and common cathode respectively.

Z1847 4 Photo:transistor SDP8405 with data.

Price £1.00

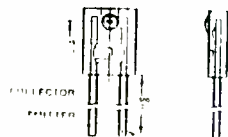

Z1846 2 pairs of infra red emitter/ receiver SDP8406/ 8506 by Honeywell with comprehensive data.

Price £1.00



Z2122 Vactel Type VTL 10DI - IR emitter and detector can be removed from the plastic housing if required. An extremely cheap version of TIL100/TIL38!

Pack of 5 £1.00 100+ 0.10 1k+ 0.07

Z1743 TIL143 Opto slotted switch. These have cropped leads and some are ex-equip. but are all working.

Price Pack of 3/ £1.00



Z1499 Opto slotted switch on small (25x26mm) panel Type P850 75p

Z1500 Opto reflective switch type OPB6076 with 3pin connector 75p

PS4005 Opto slotted switch £1.00

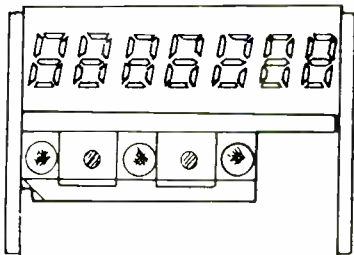

Z2658 LED module. An interesting little PCB 50x35mm that has mounted on it a 7 digit 7 segment red display, and a plastic moulding under which are 3 surface mount LED's, one each red, yellow and green. On the back of the PCB is a SED5031M chip. Offered without info at present, although we are working on it. Believed to have been the display on a mobile phone. **Only £1 each**

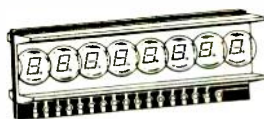

Z2903D Red LED PCB mounted display - 12 bubble digits 0.11" high. Full data supplied. **Only £1.50** 100+0.80

Z415 Display. 8 digit LED multiplexed. With data. 31 x 16mm.

Price 80p

Z5501 Panel 71x27mm with dual 7 seg LED + red and green rect LED's. **Pack of 10 £2.00**

Z5502 Another, this time with a dual and single 7 seg LED + red and green rect LED's. **Pack of 8 £2.00**

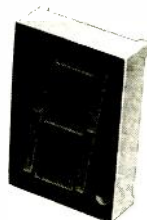

Z1855 7 seg LED 81720R - giant 1" digit. red. common cathode **£1.00**

Z2722 7 seg LED, MAN74A 0.3" CC red. A tube of 25 for £3.50 500+ 0.10

Z2435 Single 7 seg LED 10mm high digit. Type LN514RK. Common cathode. **4 for £1.00; 100+ 0.15; 1k+ 0.10**



Z2434 Dual 7 seg LED, type TDDR5250 by TFK. Red common anode 13mm digit height. DP 1.14. Our special low price (we have 10000 to clear) **2 for £1.00; 100+ 0.25; 1k+0.18**

Z2905D Red 2 digit 0.5" display as above. Common cathode **2 for £1.00 100+ 0.50**

Z2906D As above but common anode **2 for £1.00 100+ 0.50 1k+0.35**

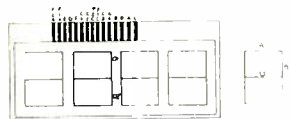

Z2362 MS463M 0.6" common cathode 4 digit multiplexed display on PCB 70x30 with 15 way connector. Intended for digital clock use. Supplied with pin out. **ONLY £1.50**

Z2904D Red 3.5 digit 0.5" PCB mounted LED display. Common anode multiplexed output and stackable with full data. **£1.00 100+0.50**

Z1361 Right angle DIL socket for mounting 7 seg displays (takes our MAN6740 dual digit). Extremely high quality. **Prices: 40p 10+ 0.26 100+ 0.17.**

NEON INDICATORS

Top quality range by IMO - they are cheap because they're 110/120V - but we supply a suitable resistor for mains operation



Type A - Panel mounting 33 x 15mm with 0.25" tags. Clip fix. requires 25 x 12.5mm cut-out

Z1899 Green **5 for £1 100+ 0.10 1k+ 0.06**

Type B - Panel mounting 36.5 x 26.5mm with 0.25" tags. Clip fix. requires 30 x 22.5mm cut-out

Z1901 Red **(Any mix) 5 for £1**

Z1903 Amber **100+ 0.10 1k+ 0.06**



Type C - Small round face 10mm dia. Clip fix. requires 9mm dia hole

Z1905 Red **(Any mix) 5 for £1**

Z1906 Green **100+ 0.10 1k+ 0.06**

Z1908 White

Type D - Large round face 13.5mm dia. Clip fix. requires 12.5mm dia hole

Z1910 Green **(Any mix) 5 for £1**

Z1912 White **100+ 0.10 1k+ 0.06**

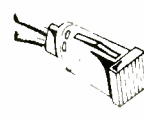
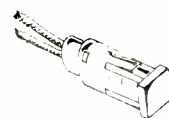

Type E - Small square face 10.5mm. Clip fix. requires 9.5mm dia hole

Z1914 Green **(Any mix) 5 for £1**

Z1915 Amber **100+ 0.10 1k+ 0.06**

Z1916 White

Type F - Large square face 13.5mm. Clip fix. requires 12.5mm dia hole

Z1917 Red **(Any mix) 5 for £1**

Z1918 Green **100+ 0.10 1k+ 0.06**

Z1919 Amber

Z1920 White

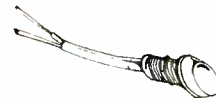

Type G - Small round face 7.5mm dia. threaded body. requires 6.5mm dia hole

Z1921 Red **5 for £1; 100+ 0.10; 1k - 0.06**

Price:

Type H - Body dia 17.5mm - chrome bezel. Wire ends

Z2066 Clear **5 for £1.00**

Price **100+ 0.10 1k+ 0.06**

K700 Pack of indicators, types A-G. May include any of those listed above. Great value for money! **20 for £2.50**

Z459 Neon bulbs 5.5mm dia x 15mm long - wire ended 30V neons at a great saving over normal prices! Made by VCH International. **In packs of 100 at £4.00 10+ 3.00**

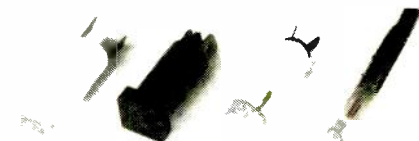

Z511 Mains neon, clear 0.25" tabs require 15mm hole. **Prices: 20p 10/ 1.30 100/ 10.45**

Z514 As above, but 110V red. Same prices.

Z517 Mains neon, orange. Square face. Req 12mm hole. **Prices: 20p 10/ 1.30 100/ 10.45**

Z518 Mains neon, white. 0.187" tabs. Req 15mm hole. **Prices: 20p 10/ 1.30 100/ 10.45**

Z529 Mains neons - 90V neon + resistor with clear sleeve over and leads 70mm long. Some have dry joints.

Price **100/ £6.00**

EVERYTHING ON THIS PAGE FOR THE PRICE OF 1

LED INTEGRATED DISPLAYS

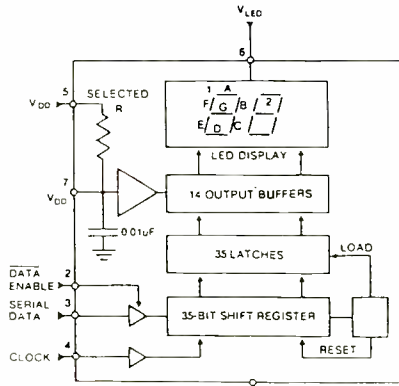
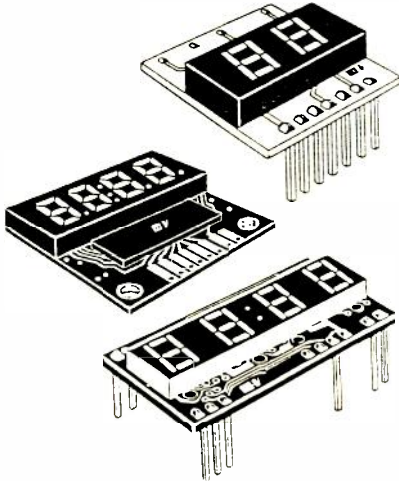
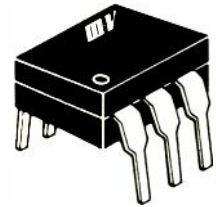

FIGURE 1—Block Diagram



(A) OPTOCOUPLERS

(i) Transistor

CODE	PART NO	VOLTS (RMS)	CTR% MIN	NOTE	£2 PK 100+ QTY
Z2773	4N35	2500	100		10 .12
Z2775	CNY1711	3000	63		10 .12
Z2777	CNY33	1770	20		10 .12
Z2779	CNY47	2000	20		10 .12
Z2780	CNY47A	2000	40		10 .12
Z2782	CNY51	4000	100		10 .12
Z2783	H11A2	1060	20		10 .12
Z2788	H11A3	1770	20		10 .12
Z2790	H11A520	4000	20		10 .12
Z2791	H11A550	4000	50		10 .12
Z2792	H11AA2	1770	10	D	6 .20
Z2793	H11AG1	4000	300	A	6 .20
Z2794	H11AV1	4000	100		10 .12
Z2795	H11AVIA	4000	100	B	10 .12
Z2796	H11AV3	4000	20		10 .12
Z2797	H11AV3A	4000	20	B	10 .12
Z2800	H11D4	1770	10		10 .12
Z2822	H11F2	1770		C	10 .12
Z2826	H11J3	NO INFO			20 .06
Z2835	MCT2	1060	20		10 .12

Notes: A: CMOS CTR @ 1mA
 B: GULLWING
 C: FET - NO OTHER DATA
 D: AC INPUT

K845 Mixed pack containing many of the above, plus others in quantities too small to list. 25 for £2.95

(ii) Darlington

CODE	PART NO	VOLTS (RMS)	CTR% MIN	£2 PK100+ QTY
Z2771	4N30	1060	100	8 .13
Z2772	4N31	1060	50	10 .10
Z2778	CNY35	1060	10	10 .10
Z2781	CNY48	1500	600	6 .16
Z2798	H11B2	1770	200	8 .13
Z2799	H11B3	1700	100	8 .13
Z2823	H11G1	2500	1000	4 .25
Z2824	H11G3	1500	200	8 .13
Z2825	H11G46	4000	500	6 .16
Z2831	MCA230	2500	100	8 .13
Z2832	MCA231	2500	100	8 .13
Z2835	MCA255	2500	200	6 .16

K846 Mixed pack containing many of the above, plus others in quantities too small to list. 25 for £3.95

(iii) Triac/SCR

CODE	PART NO	VOLTS (RMS)	Itr mA MAX	Vb	NOTE	£2PACK100+ QTY
Z2774	4N39	1060	14	200	S	6 .16
Z2776	CNY30	1770	11	200	S	6 .16
Z2783	GE3009	7500	30		T	6 .16
Z2784	GE3010	7500	15		T	6 .16
Z2785	GE3012	7500	5		T	6 .16
Z2786	GE3021	7500	15		T	6 .16
Z2836	MOC3009	7500	30		T	6 .16
Z2837	MOC3011	7500	10		T	6 .16
Z2838	MOC3012	7500	5		T	6 .16
Z2840	MOC3021LP	7500	15		TP	6 .16

Note: S = SCR T = Triac P = Surface mount pins
 K847 Mixed pack containing many of the above, plus others in quantities too small to list. 20 for £3.95

(iv) Schmitt

CODE	PART NO	VOLTS (RMS)	Itr mA (MAX)	£2PACK100+ QTY
Z2827	H11L2	2500	10	3 .35
Z2828	H11L3	2500	5	3 .35
Z2830	H11N1	3750	3	3 .35

A selection of 2 & 4 digit red and green displays with on board serial data in/parallel data out chips. Designed to operate with minimal interface. TTL compatible. Wide power supply operation. Direct current drive. Comprehensive data available - see below for details.

CODE	TYPE	COLOUR	DESCRIPTION	QTY	PRICE
Z2888	TSM4307	RED	2-DIGIT 0.3"p	429	£1.00
Z2889	TSM4507	RED	2-DIGIT 0.5"p	873	£2.40
Z2890	TSM5032	RED	2-DIGIT 0.3"	543	£1.00
Z2891	TSM5032P	RED	2-DIGIT 0.3"p	354	£1.00
Z2892	TSM5052	RED	2-DIGIT 0.5"	131	£1.40
Z2893	TSM5052P	RED	2-DIGIT 0.5p	955	£1.40
Z2894	TSM5232P	GREEN	2-DIGIT 0.3"p	654	£1.10
Z2895	TSM5252	GREEN	2-DIGIT 0.5"	14	£1.50
Z2896	TSM5252P	GREEN	2-DIGIT 0.5"p	14	£1.50
Z2897	TSM5732	HE RED	2-DIGIT 0.3"	663	£1.10
Z2898	TSM5735P	HE RED	4-DIGIT 0.3"p	74	£2.00
Z2899	TSM5752	HE RED	2-DIGIT 0.5"	98	£1.50
Z2900	TSM6232P	GREEN	2-DIGIT 0.3"p	248	£1.10
Z2901	TSM6732P	HE RED	2-DIGIT 0.3"p	358	£1.10

The p suffix indicates pcb with 0.1" pitch pins

Individual data sheets are supplied with each device, and a booklet, Z2999 is available with applications data + program listing on all the devices, price £2.00

K848 A pack of 10 assorted of the above types £5.00



Z2163 4 Digit multiplexed LCD. 50 x 30mm probably for an electronic balance-symbols include balance pens, 5 stage bar graph, lb's and kg's etc. Digit height 12mm Self adhesive pad on back. 13 pin PCB connector. **£2.00**



Z1637 LCD Display - Direct drive 3 1/2 digit with 'LO-BATT'. 12.7mm high digits Op voltage 4-12 RMS or 32Hz type. Consumes only 25µA with all segments on. Trade price £7.97 each Supplied with data, but no edge connector.

Prices **£1.00** 25+ 0.65 100+ 0.50



Z2119 4 digit LCD 12.5mm high with low battery and clock symbol. Complete with edge connector.

Price **£1.50** 25+ 0.95 100+ 0.65

Z4115 8 digit 12.7mm high LCD and holder. These are 14 segment devices allowing alphanumeric display. Normally costing over £15.00 we are offering these for just **£4.50**

Z2432 LCD 8 digit 10mm high. Single sided 36 way edge connector. **Only £2.00** 100+ 1.00 1k+ 0.80

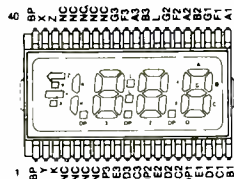

Z2655D Clock or 3 1/2 digit LCD with 40 way connector. 12.7mm character height like H1331CC, DP 4.70. **Our price £2.00**



Z5287 Here's an oldie - we had a batch of these some time ago - the 'Tyrometer' - used to indicate tyre pressures on HGV's, this is the pod that fitted into the drivers cab. On the front panel are two small push and a toggle switch. Inside is a PCB with 11 miniature wire ended bulbs, a choke, 2 caps and a buzzer. There's a short length of 14 way ribbon cable, too. **£3.95**

GRAPHIC & DOT MATRIX DISPLAYS



LM225 Hitachi 640x200 dot matrix LCD for PC's, WP's, and industrial equipment. Module size 270x150x13mm. Display area 239x104mm. Dot size 0.32x0.46; pitch 0.49. Has on board 16 x HD61100 & 4 x HD61103 chips. Reduced from £39.50. **Now only £25.00**

SALE PRICE £14.95

Z5424D Graphic module LCD by Hitachi type LM212. Viewing area 240 26mm. Overall size 270 63mm. Similar to LM211 but narrower, for which we have data (supplies). £20

SALE PRICE £12.95

Z5489 20x2 dot matrix display by Toshiba, type TLC501 with 2xHD44100 & HD44780A00 chips on board. Fitted with 14 pin IDC type plug. PCB 115x37mm. £7.00

SALE PRICE £4.95

Z5460 Epson dot matrix display type EG2401A. Display area 139x39mm. Overall size 178x69mm. No data at present £15.00

SALE PRICE £9.95

Z5458 Epson 20 character x 8 line LCD, model EA-Y-20080AT, with backlight. This is the same spec (apart from the size) of our Z4372. Overall size 140x95mm. Display area 83x63mm. Supplied with comprehensive data. £25.00

SALE PRICE £14.95



(D) LCD DOT MATRIX MODULES

All with HD44780 controller (and HD44100 on larger displays)

CODE	PART No.	SIZE	CHAR	HT	PRICE
Z5482D	TLCM1620	16X2	5X7	4.27	6.00
Z5484D	TLCM2011	20X1	5X7	5.20	4.60
Z5486D	TLCM4021	40X2	5X7	5.20	9.50

A data sheet is included in the price.

Application notes: A 16 page booklet is available, price £2.00 order code Z2842

SALE PRICE 25% OFF

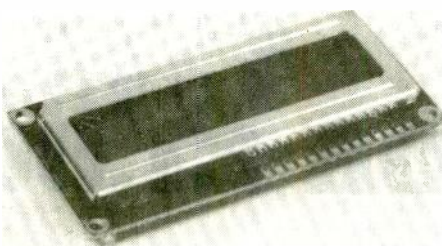

Z5096 16 character x 1 line Very similar to our Z1814 but slightly larger character -6.3x3.15 (8x5 dots) Type LCDM16166 by Refac. Supplied with data. Uses Hitachi HD44780A00 chip.

Price £8.00

SALE PRICE £4.95



Z1731 NEC Vacuum Fluorescent Display FIP8B11 8 digit multiplexed output 10mm high Heater voltage 2V grid/anode voltage 24V. (Use Z4248 transformer to power)

Price £3.00

SALE PRICE £1.00

Z5459 Futaba 16 character x 2 line vacuum fluorescent display, type 162-BY-C1Z. Supplied with pin out. Next month's 'Guardian' will have some driver circuits shown. Only £2.50

SALE PRICE £1.00

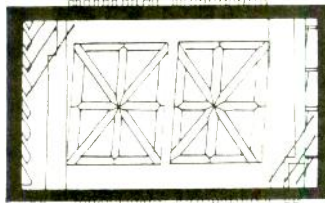

Z5118 Giant 30mm fluorescent 2 character green star burst display. 88 x 49 x 8mm Futaba type 2-JY-02Z Needs 3V and 10-18V Data supplied. Only £2.00

SALE PRICE £1.00



Z2586 6" 4W fluorescent tubes. T5 miniature. DP 1.95 Our Price £1.00 100+ 0.70

SALE PRICE 4 FOR £1.00

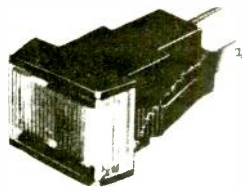

Lampholders - rectangular snap in type that take LES bulb. Needs 16.1x11.6mm cut-out. DP (1978) 92p
Z5193 Red 3/£1.00 100+0.15

SALE PRICE 6 FOR £1.00

PIR SENSOR

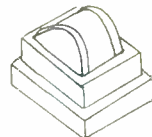

Z2700 PIR sensor. Extremely neat basic sensor (no electronics) in plastic moulding 33x28x30mm. Supplied with circuits and lots of information. Has 10m range. 164° angle of view. <1mW power consumption. £9.95

SALE PRICE £7.95



Z1921 Large square face 13.5mm. Clip fix, requires 12.5mm dia hole. Red. Price: 5 for £1.00; 100+0.10; 1k+0.06.

SALE PRICE 10/£1



Z2172 40 character x 1 line LCD by Optrex (Japan) High quality double height display with 192 character ROM other characters can be displayed by generation in RAM Other features include cursor with control, blink character scroll display, read and write display data, single +5V supply data and power inputs by one 16 pin 0.05" SIL socket, pin outs star tard and compatible with other Optrex displays, contrast control, easily interfaced with either 4 or 8 bit uP's. Supplied complete with data. Dimensions Characters are 5 x 12 dot arrays measuring 3.2 x 10mm Display size 170 x 17.5mm. Module size 220 x 40mm DP over £50.00 **Our Price £15.00**

AMAZING REDUCTION! 80% OFF! SALE PRICE £3.00

Z2659 LCD module. Probably intended for use in mobile phones. Size 44x28mm. One row of 10 digits + a load of Japanese characters. Uses 2xOKI M5259 chips. No other data (yet) £2.50

SALE PRICE £1.00

Z5352D Densitron alphanumeric LCD module 40x1 character type H2572HT. Farnell's price 29.28 - **Superdeal Price: £9.95**

SALE PRICE £6.95

Xtra Special
18 PIN IC SOCKETS
1000
(ONE THOUSAND)
ONLY £10
Star Buy !!

Xtra Special
FUSES/HOLDERS
Z1395 15mm fuseholder 10/£1
Z2528 Thermal Fuse 152C 6/£1
Star Buy !!

Xtra Special
25way D plugs
Z5081 100 £5
Z5080 144 £5
Star Buy !!



SUPER SENSATIONAL SUMMER SALE

GREENWELD

27 Park Rd. Southampton SO1 3TB

Tel: 0703 236363 Fax: 236307

All one off and pack prices INCLUDE V.A.T. Qty. prices do not.

High Quality Audio/ Video Leads

Packed in poly bags with header cards, these 'Nu-Way' leads are offered at a surprisingly low price. 16 types available all 2m long except * which are 1.5m long. All connectors on all leads are screened - none of your cheapo plastic plugs here!!

Code	Type	Description	1 +	25 +
Z5033	677	PL259 + 5 pin DIN 180° plug to phono plug + 5 pin DIN 180° plug	£1.64	0.82
Z5034	686	PL259 + 2 phono plugs to phono plug + 5 pin 180° plug	£1.96	0.98
Z5035	687	Phono plug + 5 pin 180° plug both ends	£1.24	0.62
Z5037	680	PL259 + phono plug to BNC plug + 3.5mm plug	£2.46	1.23
Z5038	685	PL259 + phono plug both ends	£2.12	1.06
Z5039	683	PL259 + 2 x phono plug to BNC plug + 5 pin DIN 180° plug	£2.62	1.31
Z5040	VTV015*	BNC plug + 3.5mm plug to 6 pin DIN plug	£1.77	0.88
Z5051	VTV025*	PL259 + phono plug to 6 pin DIN plug	£1.43	0.71
Z5052	691	6 pin DIN plug to 5 pin DIN 180° plug + phono plug	£1.04	0.52
Z5053	669	PL259 + phono plug to 2 phono plugs.	£1.72	0.86
Z5054	672	PL259 + 5 pin DIN 180° plug to 3 phono plugs.	£1.96	0.98
Z5055	675	PL259 + 5 pin DIN 180° plug to PL259 + 2 phono plugs	£2.36	1.18

SALE PRICE ANY 4 £2.00



Z4186 3m multicore lead terminated both ends with 50 way centronics (IEEE-488) socket. Ideal for stripping down for flex - total 150m of multicoloured 7/0.2. Connectors alone worth £12.80

Price Only **£9.95**

SALE PRICE £2.50

PL616	DC adaptor lead for Walkman, 1.8m long		
Price	30p	100 + 0.15	
PL528	2 pin DIN line socket to phono plug 0.2m long.		
Price	20p	100 + 0.10	
PL708	Video lead. PL259 plug to F type plug. 3m low loss coax.		
Price	85p	100 + 0.45	
PL508	5 pin DIN - 3 pin DIN audio lead 1.2m long.		
Price	40p	100 + 0.20	

ALL HALF PRICE MIXED PACK 5 OF EACH £3



Z4353 6 way DIN lead. 1.5m lead terminated one end with a 6 pin DIN plug. Bare wires the other end

Prices Pack of 4/£1.00; 100/£12.00; 1000/£90.00

SALE PRICE 8 for £1

Z5332 PC keyboard cable - standard heavy duty high quality curly lead with 5 pin DIN plug one end, push in connectors the other. Ex-new equipment. £2.00

SALE PRICE £1.00

NORMAL PRICE £7.95

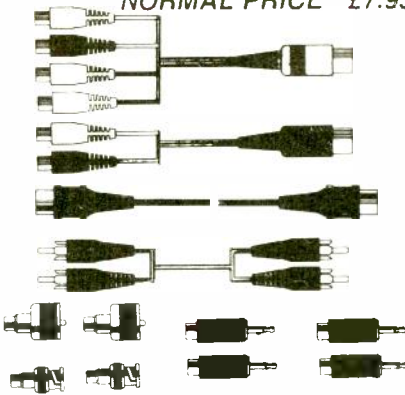

SALE PRICE £4.00

T120A Video/audio dubbing kit.

- ★ 1 screened lead - 5-pin DIN plug to 5-pin DIN plug. Mirror image. 1.5m.
- ★ 1 twin, screened lead - 2 phono plugs to 2 phono plugs. 1.5m.
- ★ 1 twin, screened lead - 2 phono sockets to 5-pin DIN. 180mm.
- ★ 2 twin, screened leads - 4 phono sockets to 5-pin DIN. 180mm.
- ★ 2 adaptors - phono socket to PL259 (UHF plug)
- ★ 2 adaptors - phono socket to BNC plug
- ★ 4 adaptors - phono socket to 3.5mm jack plug

Z4350 A set of 3 different pairs of test leads, offering great value! - a) 67mm long, 2mm probes both ends; b) 110mm long, 2mm probes one end, 4mm plugs the other; and c) 90mm long silicon rubber, 2mm probes one end, shrouded 3mm sockets the other. All are red and black pairs. All three for just £2.00

SALE PRICE £1.00

Z5401 Spider leads - like our P0650 at 99p, but they are grey. 2m long and have a 1.3mm power plug (for Walkmans) as well as the normal 2.1 and 2.5 power plugs, and 2.5/3.5 jack plugs. 2 For £1.00 100+ 0.24; 1k+ 0.16

SALE PRICE 4 FOR £1.00

Z5387 Car power lead - cigar plu one end, 2.1mm power plug the other. 2m long £1.75 100+ 1.00

SALE PRICE £1.00

Z5417 Scoop purchase on 5PIN DIN - 5PIN DIN leads - 1.2m long, moulded on plug, black lead. Pack of 10 £2.95

SALE PRICE £1.50

Z5087 Lead - 6 PIN DIN to 3 coloureu phono plugs (video + L and R audio) using flat splittable screened lead. Nice and long-2M. Cheap enough to cut the DIN plug off and reterminate with phonos!

Price 2/£1.00 10+ 0.35 100+ 0.25

SALE PRICE 4 for £1

BULK DEAL ON HIGH QUALITY 2.5mm AND 3.5mm SCREENED PLUGS & SOCKETS BY ADASTRA!

- P9 3.5mm mono plug ~~36p~~ 10 for £2; 100+ 0.10; 1k+ 0.06
 - P10 2.5mm mono plug ~~34p~~ 10 for £2; 100+ 0.10
 - P11 3.5mm enclosed mono chassis skt ~~36p~~ 20 for £2; 100+ 0.05; 1k+ 0.035
 - P12 2.5mm enclosed mono chassis skt ~~36p~~ 20 for £2; 100+ 0.05; 1k+ 0.035
- Also 1/4" stereo jack plug at less than half normal price!
- 5 for £2** 100+ 0.25; 1k+ 0.18

25% OFF ALL THESE PLUGS AND SOCKETS!

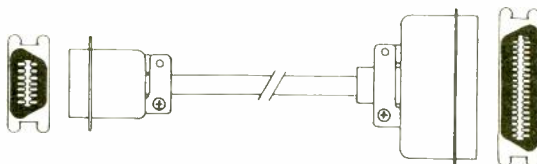

NORMAL PRICE £5.95

T190B **£2.00**

14-way Centronics plug to 36-way Centronics plug. MSX printer lead
Length 2m

SALE PRICE 2 FOR £1.00

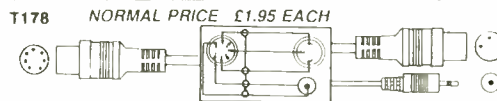

T178 NORMAL PRICE £1.95 EACH

7-pin DIN plug to 3-pin DIN plug and 2.5mm jack plug Colour grey
Length 1m

5 FOR £1.00

SALE PRICE 10 FOR £1.00

CAT PRICE £2.58



T108 BUC12 BNC plug to PL259 (UHF) plug
Length 1.2m

CLEARANCE PRICE £1.00; 100 FOR £50.00

SALE PRICE 2 FOR £1.00; 100 £30

SPECIAL OFFER ON ARGOS BOOKS

All titles on this page only £2.50 each

Save up to £19.80 when buying 4 titles + FREE BBC or GO FORTH book!

AMAZING MODELS!

Peter Holland
 Making working models is fun but it can be expensive.

In Amazing Models! Peter Holland, a modeller, draughtsman and inventor, describes with the aid of full size, detailed drawings, how to make amusing and ingenious models using only the most simple household materials. Paper clips, drinking straws, old ballpoint pens, cotton buds, balsa wood and plastic lids are just some of the items which you can use for the construction of these amazing machines.

RUBBER BAND POWER

297 x 210mm ILLUSTRATED 64 PAGES
 ISBN: 0 85242 966 5 1989 REPRINTED 1990
£4.95 PB

BALLOON POWER

297 x 210mm ILLUSTRATED 64 PAGES
 ISBN: 085242 965 7 1989 REPRINTED 1990
£4.95 PB

AMAZING ROBOTS

297 x 210mm ILLUSTRATED 48 PAGES
 ISBN: 1 85486 041 0 1991 **£5.95 PB**
 Peter Holland gives full instructions for making six working robots. You can cut out and make the robots from the 8-page card section in the book, and the detailed full-sized drawings are easy to follow. An ideal and unique book, both for fun and educational use

The Compact Lathe

STAN BRAY
 210 x 148 mm
 ILLUSTRATED
 192 PAGES
 ISBN 1 85486 013 5
 1990 £7.95 PB

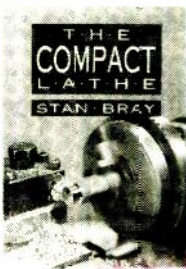

Compacts, or portable lathes, are purpose-designed tools of remarkable ingenuity. Relatively inexpensive, self-contained and adaptable to a broad range of machining techniques, they are ideal for the model engineer. Stan Bray comprehensively introduces the components, the machining operations and facilities which will enable the operator to achieve the highest standards of lathe work 'an invaluable guide and source of useful information' *Mechanical Incorporated Engineer*

Installing Radio Control in Boats

JOHN CUNDELL
 248 x 185 mm ILLUSTRATED 64 PAGES
 ISBN 1 85486 022 4 1990 **£5.95 PB**

Building and fitting radio control equipment into a model boat is something that most people can undertake with some degree of success. However, there are always better ways of enhancing performance and reliability. In this book, John Cundell explains the process of choosing and installing radio control systems in all types of model boats

Learning to Fly Radio Control Helicopters

DAVE DAY
 248 x 185 mm ILLUSTRATED 64 PAGES
 ISBN: 1 85486 025 9 1990 **5.95 PB**

Radio control helicopters are the fastest growing aspect of the hobby. Unfortunately many modellers attempting to become proficient with these machines meet with failure due to ignorance of the design, mechanics setting-up and flying methods. In this book Dave Day explains the basics of learning to fly these exciting aircraft

AMAZING ROBOTS!

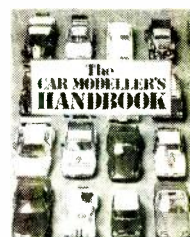
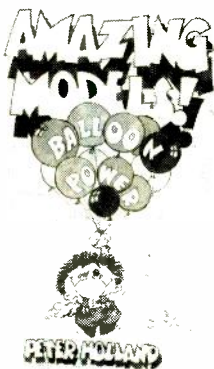

THE CAR MODELLER'S HANDBOOK
 Mat Irvine
 210 X 145mm
 ILLUSTRATED 160 PAGES
 ISBN: 1 85486 046 1 1991
£6.95 PB

An up-to-date and comprehensive guide to all aspects of building

and finishing model cars.

Mat Irvine covers building a basic kit, simple and complex detailing, building dioramas and using accessories, and painting and decal application. He also gives history of the model car market and discusses the 'collectability' of the model kit.

Illustrated throughout, the book is an essential reference for all car modellers worldwide.

Electronic Projects for Model Boats

KEN GINN
 210 x 145 mm ILLUSTRATED 144 PAGES
 ISBN: 1 85486 033 X 1990 **£6.95 PB**
 A comprehensive guide containing detailed information on how to make a variety of electronic projects which can connect to your radio control system. Projects covered include a servo checker, speed controller, battery tester, dual nicad charger, switcher, and many more

Flying R/C Gliders

GEORGE STRINGWELL
 248 x 185 mm ILLUSTRATED 64 PAGES
 ISBN: 0 85242 995 9 1990 **£5.95 PB**
 George Stringwell helps you to get started in the hobby. Full of sensible and practical advice, the book covers slope and thermal soarers, counselling on becoming safely airborne with your first model, and intermediate and more advanced glider flying



R/C Aircraft Q & A Book

PETER SMOOTHY
 210 x 148 mm
 160 PAGES
 ISBN: 1 85486 001 1
 1989 **£6.95 PB**
Radiomodeller magazine's column 'Hotline' is regularly voted by its readers the best section of the magazine.

In this book, Peter Smoothy, 'Hotline' supremo, has gathered together in thematic form, a selection of the most relevant questions and answers from the column. From engines to safety, and from building to flying, covers all the information you need to master the hobby

R/C Vintage Model Aeroplanes

PETER RUSSELL
 248 x 185 mm ILLUSTRATED 64 PAGES
 ISBN: 0 85242 996 7 1989 **£5.95 PB**
 Peter Russell answers the question 'What is Vintage?' and describes the international history of model flight. He next covers the vintage subject and gives details on building and covering, engines and fuel. This is an essential handbook for all vintage enthusiasts



Electric Flight Handbook

HELMUT MEYER
 210 x 145 mm
 ILLUSTRATED
 96 PAGES
 ISBN: 1 85486 040 2
 1990 **£6.95 PB**

The rapid growth of R/C electric flight means new techniques and operating requirements are constantly being introduced. Includes information on battery packs, motors, gearboxes, propellers and servos among others, and provides vital tips on performance

Sensing & Control Projects for the BBC
 Thomas Nunns

An introduction to FORTH

FREE! - with any 4 books from this page, your choice of:

"Sensing and Control Projects for the BBC" (Published at £5.95) or "Go Forth" (Published at £8.95)

Full information on these two books is contained in Bargain List 90

Radio Control Scale Boats

JOHN CUNDELL
 248 x 185 mm ILLUSTRATED 64 PAGES
 ISBN 1 85486 021 6 1990 **£5.95 PB**
 For every five model boats constructed, four are of scale subjects. In this book John Cundell describes how to choose a model type, what scale to build in, where to obtain plans, kit availability, hull construction methods, materials and adhesives, propulsion, radio control and other useful information and advice

PACKS - PACKS - PACKS - PACKS

All our packs contain top quality, brand new full spec components (unless otherwise stated) and represent incredible value for money! How do we do it? By purchasing bankrupt stocks and manufacturers surplus. It's too costly to sort and catalogue all these parts, hence these outstanding packs at extraordinarily low prices - so stock up now!!

Please note most packs are calculated by weight: quantities quoted are approximate, but we do try to ensure contents are at least the number specified.

LOOK AT THIS!
 Some great offers here!
 Look especially at the
 'EXTRA SPECIAL' boxes
 - up to 65% discount!

SEMICONDUCTORS

K708 Voltage Regulators. This is an excellent pack, made up from a huge variety of +ve, -ve, fixed and variable regulators from 1.2V to 37V, 100mA to 5A plastic and metal.

PRICE: 25 for £6.95

SALE PRICE £5.00

K709 Bridge Rectifiers. Another superb value pack - could include anything from half amp to 35A, 25V to 1000V plastic and metal.

PRICE: 20 for £6.95

SALE PRICE £4.50

K710 SCR's & TRIACS. Big mixture could include all types from TO92 plastic up to DO5 stud mounting with a chance of everything in between! 25V to 1000V, 100mA to tens of amps. Marvellous value.

PRICE: 25 for £ 5.95

SALE PRICE £3.50

**EXTRA SPECIAL
 PACK PRICE**

K547 Zener Diodes. Glass and plastic, 250 mW to 5W ranging from 3V to 180V. All readily identifiable, with list supplied.

PRICE: 100 for £4.95

£2.00

K575 Plastic Power pack. Mainly TO126 and TO220 transistors, SCR's Triacs, etc. All new full spec marked devices offering fantastic value. Lots of TIP and BD types.

PRICE: 50 £7.95

SALE PRICE £4.50

K576 Mixed pack of TO220 and 4 pin power mosfets with data and pinouts. Types may include: 2N7004/5/6/14, IRF620/710/720/820, IRF9520/9620, VN0300D etc.

PRICE: Pack of 25 £8.00

SALE PRICE £4.50

**EXTRA SPECIAL
 PACK PRICE**

K517 Transistor pack. 100 assorted full spec. marked plastic devices PNP NPN RF AF. Type numbers include BC114, 117, 172, 182, 183, 198, 239, 251, 214, 255, 320, BF198, 55, 394, 2N3904 etc, etc. Retail cost £16.00+

Special low PRICE: £5.95

£2.50

K536 74 Series Pack. "On board chips" for you to desolder containing many LS and other types. 3Good mix.

PRICE: 100/ £4.00

SALE PRICE £2.50

K711 74 Logic Pack. All brand new full spec devices from basic gates to complex logic. May include 54 & 64 types as well as 74 in L, LS, S, ALS, H, HC, HCT, etc.

PRICE: Pack of 100 £6.50

SALE PRICE £4.50

K537 IC Pack - A mix of linear and logic chips, from 6 to 40 pin. All are new and marked but some may not be full spec.

PRICE: /100 £7.50

SALE PRICE £4.50

**EXTRA SPECIAL
 PACK PRICE**

K711 74 Logic Pack. All brand new full spec devices from basic gates to complex logic. May include 54 & 64 types as well as 74 in L, LS, S, ALS, H, HC, HCT, etc.

PRICE: Pack of 100 £6.50

£3.50

K560 We've now collected together enough semis to offer this pack again - it was extremely popular a couple of years ago. All types of semiconductor included - diodes, transistors, I.C.'s etc all new full spec and marked Qty. is approximate depending on the number of power devices included.

PRICE: Pack of approx 100 £5.95; 300 £12.95 1000 £42.95

K851 74F fast logic. Types included 00, 02, 04, 08, 51, 74, 158, 240, 244, 245, 280, 373 + stacks more. Over 25 types.

PRICE: Pack of 100 £6.50

SALE PRICE £4.50

K852 74HC. Nice selection of highspeed CMOS logic including 00, 05, 151, 157, 245, 273, 280, 423, 451, 4053, 4060. Over 25 types.

PRICE: Pack of 100 £7.00

SALE PRICE £4.75

K853 74HCT. Super mix of these popular chips - about 30 different types including 00, 04, 10, 14, 126, 138, 158, 163, 240, 241, 244, 245, 273, 373, 377, 563, 573, 688. List price over £50!

PRICE: Pack of 100 £8.00

SALE PRICE £5.50

K854 74LS. Probably the most popular series - this pack has a great selection of over 80 types - far to many to list here, but includes many complex (expensive!) logic devices, would cost over £40 if bought separately.

PRICE: Pack of 100 £6.00

SALE PRICE £4.25

K855 4000 CMOS - all sorts in here, gates, complex logic - a big selection including 42, 50, 60, 70, 76, 73, 4512, etc. about 20 different types.

PRICE: Pack of 100 £6.00

SALE PRICE £4.25

CAPACITORS

**EXTRA SPECIAL
 PACK PRICE**

K544 Mullard polyester caps. cosmetic imperfections, electrically OK. Wide range of values from 0.01 to 0.47uF in 100, 250, 400V working.

PRICE: 200/ £4.75

£2.00

EXTRA SPECIAL PACK PRICE

K528 Electrolytic Pack . Axial and radial some ready cropped for PCB mounting. This pack offers excellent value for money. Good range of values and voltages from 0.47uF to 1000uF. 6V to 100V.
PRICE: 100/ £4.50

£2.25

K546 Polystyrene/Mica/Ceramic Caps. Lots of useful small value caps up to about 0.01uF in voltages up to 8kV. Good variety.
PRICE: 100/ £2.75

SALE PRICE £1.75

K901 Mylar's - a good variety of the small 50 and 100V types - nearly all values in the E12 series from 0.001 to 0.082uF.
PRICE: Pack of 200 £3.50

SALE PRICE £2.50

K902 Mylar's - a selection of larger values, all 50V from 0.1 to 0.47uF.
PRICE: Pack of 50 £2.00

SALE PRICE £1.50

EXTRA SPECIAL PACK PRICE

K582 Polystyrene Caps. An amazing range of values from a few pF to .01. Tolerances 20% Voltages to 500V.
PRICE: Pack of 200/ £4.00

£2.00

K518 200 Disc Ceramic Caps Big variety of values and voltages from a few pF to 2.2uF; 3V to 3kV.
PRICE: £2.00

SALE PRICE £1.30

K530 100 Assorted Polyester Caps. All new modern components radial and axial leads. All values from 0.01 to 1uF at voltages from 63 to 1000V!
Super value at: £3.00

SALE PRICE £2.50

K714 Power Supply Capacitors. All cans, mostly computer grade including popular values like 10,000uF 40V etc. Big mix of values and voltages up to 100V or more and 50,000uF.
PRICE: for box of 25 £12.50

SALE PRICE £10.00

K549 Trimmer Capacitors. A nice selection of small value caps ranging in value from a few pF to 100pF or more, various dielectrics.
PRICE: Pack of 20 £1.75

SALE PRICE £1.50

K548 Tant bead capacitors. About a dozen different types from 0.1uF to the rather pricey 100uF, voltage from 6-50V.
PRICE: 50 for £3.00

SALE PRICE £2.50

RESISTORS

K540 Black in stock! after a long absence, we can again supply this popular assorted resistor pack - mostly 1/4 & 1/2W, some larger. Big range of popular values, all with full length leads.
PRICE: Pack of 500 £2.95.

SALE PRICE £2.00

EXTRA SPECIAL PACK PRICE

K531 Precision Resistor Pack . High quality close tolerance R's with an extremely varied selection mostly 1/4W and 1/2W tolerances from 0.1% to 2% - ideal for meters, test gear etc.
PRICE: 250/ £3.00

£1.50

K523 Resistor Pack . 1000 - yes 1000 mainly 1/2W 5%, 10% & 20% carbon/carbon film resistors with preformed leads for PCB mounting. Fair range of preferred values.
PRICE: only £2.95

SALE PRICE £1.50

EXTRA SPECIAL PACK PRICE

K572 Resistor Networks. both SIL and DIL in here, from 6 to 16 pin. Plenty of popular values like 1K, 4K7 and 10K and a good sprinkling of many other values.
PRICE: Pack of 100 £4.50

£2.00

K503 100 Wirewound Resistors. From 1W to 12W, with a good range of values.
PRICE: £3.50

SALE PRICE £2.00

K525 Preset Pack. Big, big variety of types and sizes-sub-min, min and std, MP, slider, multiturn and cermets are all included. Wide range of values from 20R to 5M 100 assorted
PRICE: £6.75

SALE PRICE £3.50

K505 20 Assorted Potentiometers. All types including single, ganged, rotary and slider.
PRICE: £2.30

SALE PRICE £1.20

K827 Cermet trimmers. An excellent range of multiturn miniature cermets from 10R to 2M.
PRICE: Pack of 50 £7.95

SALE PRICE £4.50

K828 "Lo-ohm" wirewound pack. Values less than 10R are always popular and this pack contains only resistors between 0R1 and 10R.
PRICE: Pack of 50 £4.30

SALE PRICE £2.50

OPTOELECTRONICS

K701 110V Indicators. This pack of neon indicators comprises round and square panel mounting types in red, green, amber and clear.
PRICE: Pack of 20 £2.50

SALE PRICE £1.75

K539 LED Pack . Not only round but many shaped LED's in this pack in red, yellow, green, orange and clear. Fantastic mix.
PRICE: 100/ £6.50

SALE PRICE £3.95

K524 Opto Pack . A variety of single point and 7 segment LED's (incl. dual types) of various colours and sizes, opto isolators, numicators, multi digit gas discharge displays, photo transistors, infra red emitters and receivers.
PRICE: 25 asstd. £4.50

SALE PRICE £3.00

K806 LED Pack contains only red LED's round, square, rectangular etc, from 3mm to 7x 2.5mm.
PRICE: 100/ £5.00

SALE PRICE £3.00

EXTRA SPECIAL PACK PRICE

K801 Seven seg. LED pack . Big variety of sizes in this pack . May include Red and green also overflow/polarity displays, single/ double digit also 7/8/9 digit. magnified displays . Sizes from 0.11" to 0.8".
PRICE: 20 peices for just £ 3.95

£1.95

K804 Lamp Pack. A superb quality pack containing a wide variety of small lamps. Many different types - wire ended bi-pin, slide, MBC, MES, LES, TI, wedge, miniflange etc in voltages from 2.5V to 220V. Most are marked with voltage/ current
PRICE: Pack of 50 £ 4.00

SALE PRICE £2.50

16**SUPER SENSATIONAL SUMMER SALE****GREENWELD**27 Park Rd. Southampton SO1 3TB
Tel: 0703 236363 Fax: 236307
All one off and pack prices **INCLUDE V.A.T.** Qty. prices do not.**SWITCHES & RELAYS**

EXTRA SPECIAL PACK PRICE

K532 Relay pack . We've now built up enough surplus relays to offer this popular pack once more. Could contain anything from 2V to 250V coils, SP to 6 pole contacts switching up to 10A.
PRICE: 20 for £6.95

£3.50

W4700 Push button banks. An assortment of latching and independent switches on banks from 2 to 7 way DPCO to 6PCO. A total of at least 100 switches.
PRICE: 100/£6.95

SALE PRICE £3.50

K592 Pack of 25 miniature rocker and lever switches from page 125 of the 1991 catalogue.
PRICE: £4.00

SALE PRICE £3.00

K593 Pack of 25 push and slide switches from page 125 of the 1991 catalogue.
PRICE: £3.50

SALE PRICE £2.50

K520 Switch pack. 20 different assorted switches - rocker, slide, push, rotary toggle, micro etc. Amazing value.
PRICE: £2.50

SALE PRICE £2.50

K542 Reed Relays. Mostly DIL single pole & double pole also some changeover, these are manufacturers rejects, but a good proportion work. 5V to 50V coils. 50 assorted.
PRICE: £3.30

SALE PRICE £1.50

K715 DIP Switch pack tremendous selection of DIP switches mostly from page 121 of 1991 catalogue. everything from 1 - 9 way at astonishingly low price.
PRICE: Pack of 20 £3.25

SALE PRICE £2.00

K824 Rocker switches, both miniature and standard, single and double pole illuminated red/green/amber and plain Fantastic value.
PRICE: Pack of 20 £4.95

SALE PRICE 100 £6.00

K825 as above but also included some illuminated push switches.
PRICE: Pack of 20 2.95

SALE PRICE £1.95**PLASTIC/SLEEVING**

K564 PCB Stand - Offs. A mixture of 8 different styles and sizes from 4.5 to 12.7 mm high.
PRICE: 100/£2.95

SALE PRICE £2.00

K826 Jumbo pack of plastic stand - offs & a few cable clips and bits and peices. 1000 parts.
PRICE: £9.95

SALE PRICE £6.00

K533 Silicon Rubber Sleeves. 15mm long 5.5mm bore, 1mm wall.
PRICE: 100/ 50p

SALE PRICE £0.40**HEATSHRINK SLEEVING**

K843 This normally expensive sleeving offered at a fraction of normal trade prices. A pack of 10m, black and clear with at least 5 different sizes from 3.5 to 4.2 mm dia. for just
£3.95.

SALE PRICE £3.00**CONNECTORS**

K557 Terminal Blocks. In all shapes and sizes, solder and screw from single way to 12 way in many different current ratings.
PRICE: 20/ £2.95

SALE PRICE £2.25

K803 PCB pack with/without ears, straight and right angle from 10 to 64 way.
PRICE: Pack of 20 £5.50

SALE PRICE £3.00

K802 Pack of DIN41612 connectors. These popular PCB connectors come as 32/64/96 way Both plugs and sockets, some with pins missing normally costing £1- £3 each.
PRICE: Pack of 25 £8.00

SALE PRICE £5.00

K836 DIL Socket Pack A super selection of DIL IC sockets from 8 to 64 way, low profile and standard mntg, turned pin tinned, gold plated, wire wrap and solder terminals
PRICE: 100 for £14.95

SALE PRICE £9.95

K705 PCB Headers. SIL & DIL PC mounting header plugs straight and right angle mostly 0.1" pitch in a variety of ways from 3 to 30
PRICE: Pack of 100/£6.00

SALE PRICE £4.00

K837 Lead pack. Assortment of signal and power leads terminated with a variety of plugs and sockets
PRICE: 25 for £3.95

SALE PRICE £2.00

K562 Edge connectors. Mostly 0.1 pitch some 0.15, 0.156 and 0.2 as well Single / double sided / tinned / gold plated solder/ wirewrap / PC connections
PRICE: Pack of 20 £3.95

SALE PRICE £2.20**MOTOR+GEAR PACK**

K579 This pack contains 10 assorted battery powered motors (mostly 3V) + 90 gears etc. 16 - 60 mm dia. + worms and shafts amazing value.

PRICE: £7.95**SALE PRICE £6.95****HARDWARE**

K553 2BA Screw mix . Mostly steel, few brass / nylon etc, cheesehead, hex, countersunk , slot and pozi , mainly in lengths from 7 - 63mm. Excellent selection.

PRICE: 100/ £2.60**SALE PRICE £2.00**

K552 4BA screws - Super mix of types mostly steel, with round pan, cheese, c/s heads in lengths from 5mm to 50mm great value.

PRICE: 200 for £2.75**SALE PRICE £2.00**

K811 6BA Screws. Nearly all pan head pozi in plated steel. Lengths to 16mm.
PRICE: Pack of 100 £1.50

SALE PRICE £1.20

K807 M3 Screws. Good selection of sizes including a few brass. Most heads. Lengths to 35 mm.

PRICE: Pack of 100 £1.50**SALE PRICE £1.20**

K808 M4 Screws. Huge variety! Pan, c/s, cheese, set, slide, pozi. From 4-50mm long. All steel, plated, black / hi-tensile.

PRICE: Pack of 100 £1.60**SALE PRICE £1.30****K809** M5 Screws. As above.**PRICE: Pack of 100 £2.00****SALE PRICE £1.60**

K833 M6 pack. Excellent value - contains screws in various lengths and head. Mostly steel, some hi-tensile.

PRICE: pack of 100 £ 4.50

SALE PRICE £3.00

K830 M8 screws and bolts. Good assortment from 16-90mm long, c/s hex, pozi some hi-tensile. All steel.

PRICE: pack of 50 £3.80

SALE PRICE £2.30

K831 M10 Bolts. Mostly hi-tensile hex head lengths from 16 - 90mm

PRICE: Pack of 20/ £3.20

SALE PRICE £2.00

K832 M12 Bolts. Mostly high tensile hex head. Lengths from 40 - 15mm

PRICE: Pack of 10/£2.40

SALE PRICE £1.70

K820 Large bolts and set screws. Could weigh as much as 150g each (up to 16mm dia x 90mm long) Practically all are steel Many different heads.

PRICE: Parcel weighing 5kg £10.00

SALE PRICE £7.00

K527 Hardware Pack This has a large variety of PK (caps) and self tapper screws from 2 x 1.5" up to 8 x 1.25 also washers, some BA metric and whit. Screws plus other miscellaneous brackets, captive nuts and bits and peices 1kg (up to 1000 peices)

PRICE: 1kg £4.00

SALE PRICE £2.50

K581 Copper Clad Board A selection of single and double sided, mostly fibreglass in useful sizes.

PRICE: 200 sq ins £3.00

SALE PRICE £2.00

K535 Spring Pack. Approx 100 assorted compression, extension and torsion springs up to 22mm in diameter and 30mm long.

PRICE: £1.70

SALE PRICE £1.00

K595 Big mix of screws - very few BA mostly metric BSF Whitworth DZU etc. Tremendous variety of heads - cheese, cs, pan, hex, allen round etc. As for size, well we've seen some as small as 3mm and a few as long as 80mm. There's even some 12.5 mm dia in this pack! You'll probably also find a few odd clips washers, nuts etc. too.

PRICE: 500gm pack £2.70

SALE PRICE £2.00

K717 Keyboard caps - a wide variety of sizes and colours from 17 x 16 mm to 25 x 25 mm. Some long ones too. Most have words - some numbers.

PRICE: Pack of 100 assorted £3.50

SALE PRICE £1.50

SURFACE MOUNT

K577 Surface mount FETs including SM versions of 2N4301, 4392, 4857 5488/9/60/1, also 2N7001/2 etc. Big variety at a low price.

PRICE: Pack of 50/ £4.00

SALE PRICE £3.00

KS102 Transistors - about a dozen different types plus a few diodes, mostly SOT23. Type numbers include BCF29/30, BSR15, BC856, BCV71 BCW29/71/72/81. Supplied with code sheet.

PRICE: Pack of 100 for £3.00

SALE PRICE £2.00

KS103 Resistors. 0.125W 2% in a range of values from 3R3 to 10M. Although there is a fair range (about 50 values) many are E24.

PRICE: Pack of 1000 for £3.00

SALE PRICE £2.00

KS104 Capacitors - over 20 different values from 1pF to 470nF.

PRICE: Pack of 100 £4.00

SALE PRICE £3.00

KS107 3 values only of tants: 1uF, 4uF and 22uF. Pack of 30, 10 each value with DP of 12.70 for just £3.00

SALE PRICE £2.00

KS105 Surface mount coil pack, only a few different values 70, 80, 120, 150 and 180uH.

PRICE: Pack of 50 assorted £3.00

SALE PRICE £2.50

EXTRA SPECIAL PACK PRICE

KS106 Surface mount LEDs. This really is an excellent pack, containing a great selection of red, green, yellow and orange LEDs, including some dual types (red/green and red/yellow) mostly SOT23 package.

PRICE: 100 for £8.95

£4.40

FUSES & HOLDERS

K555 Fuses. A marvellous selection of 15, 20, 25 and 32mm fuses both carriage and wire ended in quick blow and antisurge varieties. May be anything from 32mA to 50A.

PRICE: 100/£3.95

SALE PRICE £2.50

K834 Thermal fuses 104, 109, 121 & 152°C, some with cropped leads.

PRICE: Pack of 20 £2.95

SALE PRICE £2.00

K713 Fuse holders. Panel and chassis mounting from basic clip to high current enclosed types for 15, 20 and 32mm fuses.

PRICE: Pack of 50 £4.00

SALE PRICE £2.50

MISCELLANEOUS

K541 Printed Curcuit boards. A wide variety of high quality printed curcuit boards including audio, RF, digital etc all covered in components - resistors, capacitors, transistors, IC's LED's switches etc, etc. A big pack of 2Kg.

PRICE: only £7.00

SALE PRICE 5KG £10.00

K712 Crystals. Mostly HC60 and HC18U in a wide variety of frequencies from a few hundred kilohertz to many megahertz and the odd crystal oscillator module or two

PRICE: 20 for £4.95

SALE PRICE £3.00

K829 Transducers. Piezo, electromagnetic, permanent magnet in assorted sizes from 15mm dia upwards. Lovely mix.

PRICE: Pack of 25 £3.50

SALE PRICE £3.00

K506 This one's an absolute gem! Contains a selection of conventions and switch mode power supplies, including AA12531, Z660, Z5307/8 + Lots more! Parcel of 10 originally selling for £40 +.

PRICE: £25.00

SALE PRICE £15.00

K835 New transformer pack. All mains, primary, secondary range from 6-35V, 0.5 to 3A.

PRICE: Pack of 12 £10.00

SALE PRICE £7.00

K574 Wire link pack. A wide range of sizes from 3mm to 50mm for use with Breadboards or PCBs. Some are bare, a few are not preformed.

PRICE: per pack of 250 £1.00

SALE PRICE £0.50

K561 Coils and Chokes. Pot cores, IF cans, open wound coils, chokes, etc from a few uF upwards in a wide variety of sizes and values.

PRICE: 50/£2.80

SALE PRICE £2.00

K844 A small parcel of miniature chokes by Greendale. 8 values from 1uF to 68mH, either radial 11x8mm or axial 10x4mm.

PRICE: Pack of 25 £2.60

SALE PRICE £1.80

18

SUPER SENSATIONAL SUMMER SALE

GREENWELD 27 Park Rd. Southampton SO1 3TB
Tel: 0703 236363 Fax: 236307
All one off and pack prices INCLUDE V.A.T. Qty. prices do not.

SAM POWER SUPPLY & MODULATOR



Z9111 Never heard of the SAM Coupé Computer? Well, the holding company SAMCO went bust, and now someone is trying to resurrect it - but the liquidators were anxious to turn piles of stock into cash, so we purchased all remaining stocks of the Astec made PSU's and can offer them at an amazing price! Inside the 170x150x70mm grey and black vented case is a linear power supply (240V ac in; 5V 2A & 12V 0.1A dc out) PLUS a UM1286 UHF colour TV + sound modulator! There are 3 leads: 2.2m phono to co-ax; 2m mains & 1.9m output lead fitted with a 6 pin DIN plug. All brand new stock. All this for just

£9.95 100+ 4.40

SALE PRICE £4.95

SPECTRUM +3 PSU

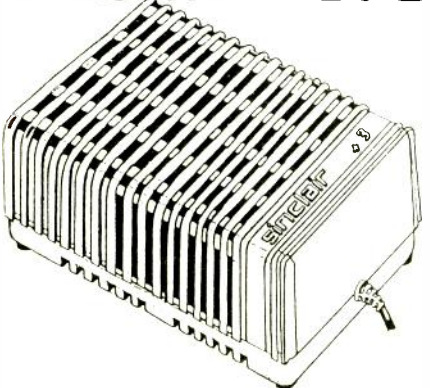

Brand new product - our scoop purchase of these linear power units enable you to buy at less than one third the normal price! Attractively cased in a black vented plastic case 155x102x70mm, they have a 1.3m mains lead and an output lead 2m long fitted with a 6 pin DIN plug. Input: 220/240V ac. Output: +5V @ 2A; +12V @ 0.7A; -12V @ 50mA. Z9110

£9.95 100+ 4.50

SALE PRICE £4.95

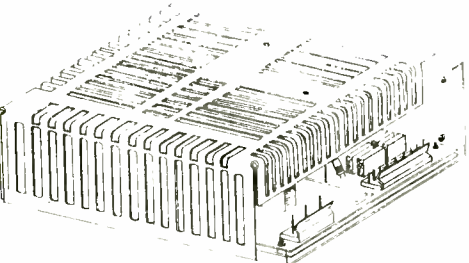

Z9114 This is a super unit 168x110x50mm in its steel case. Again, removed from gaming machines and tested before despatch. Std mains input. Outputs: +5V 3A; +12V 3A; -5V 0.5A; +12V 0.3A. Excellent Value at

£12.50 100+ 5.75

SALE PRICE £5.95

SWITCH MODE PSU's

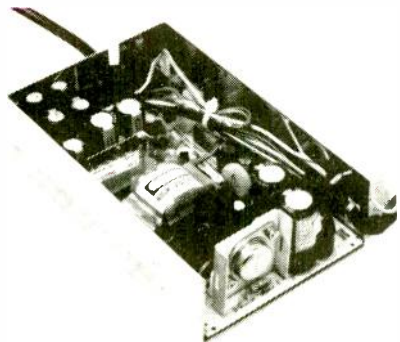

AA12531 Switch mode PSU by Astec partially cased. 160x104x45mm overall with 160x100mm Eurocard PCB. Inputs and outputs are on colour coded flying leads. Input 115/230V 50/60Hz. Outputs: +5V @ 5A; +12V @ 0.15A. Total wattage 50W.

£8.95; 25+ 5.43; 100+ 4.53

SALE PRICE £2.50

Conversion Kit

K725 This kit converts the AA12531 PSU into a much more versatile supply, giving +5V @ 2.5A; +12V @ 2A; -12V @ 0.1A and -5V @ 0.55A. Complete set of parts and full instructions £3.50 Instructions only (K726) £1.00



Farnell NO55P Power Supplies

We've taken delivery of these popular supplies from several different sources, and now have the following models available. All are switch mode 115/230V input rated 55 watts max. Size of cased units 182x112x55mm, uncased size 160x100x40mm.

Z5304 Model 326, cased. Outputs: +5V 3A; +12V 0.1A; -12V 0.1A. Price £12.95

SALE PRICE £6.95

Z5334 Model 314. Outputs: +5V 3.5A; +12V 3A -12V 1A. Price £14.95

SALE PRICE £7.95

LIGHT UP YOUR LAYOUT

K692 Super deal for modelers - we supply a mains power supply, 100 miniature lamps for wiring into your railway layout or dolls house, and 100m of flex. Circuits and details of how to wire up the lamps in series/parallel are provided. Everything for just £19.95

SALE PRICE £14.95

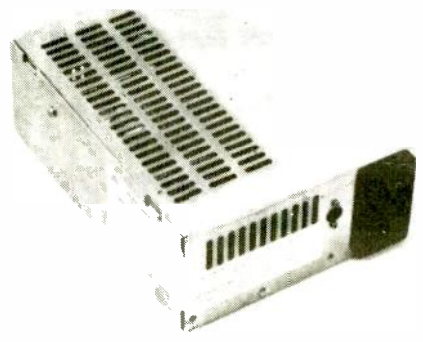

BM41012 Superb switch mode PSU made by Astec. Enclosed case 175x136x65mm with switched and fused IEC mains inlet. 160x80mm PCB with output pins extended to external connector. Input 115/230V 50/60Hz. Outputs: +5V @ 3.75A; +12V @ 1.5A; -12V @ 0.4A. Total wattage 65W

£14.95; 25+ 11.70; 100+ 9.75

SALE PRICE £9.95

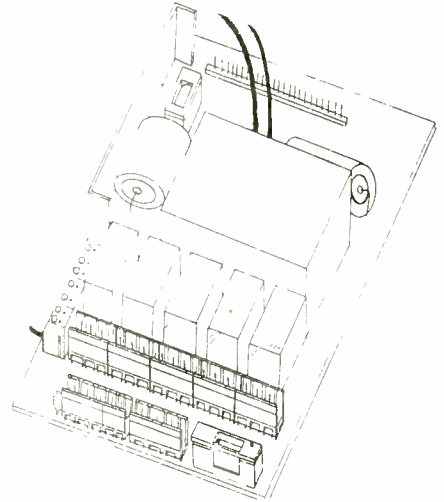

MODEL RAILWAY CONTROL AND SWITCHING UNIT

This ready built versatile piece of equipment allows:
* Full forward and reverse control of trains using regulated and smoothed supply (1.5A)*
* Requires 3 components (supplied) to be soldered to each panel.
* Relay control of 5 separate circuits, (10A changeover contacts; ideal for points operation)
* Powering of auxiliary equipment - 2 separate 5V 1A outputs.

A mains powered panel 185x105mm contains all electronics. All voltages are fully stabilised and both input and output are fused.

Connections, both input and output are by screw terminals which are clipped onto the on-board pins.

The five 12V relays are controlled by transistor circuits which require only 5V 30mA, supplied by the on board power supply.

Supplied uncased with circuit and wiring diagram. (SAE for free copy.)

Suitable black ABS plastic case £3.50
Order Code Z8897 Price reduced to £14.95

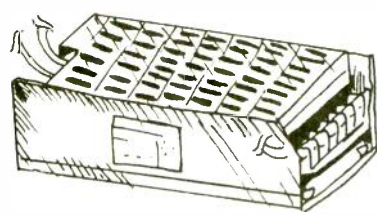

Z9109 Although these PSU's are boxed and look in excellent condition, we don't believe they are brand new. However they are all full spec working units made by Source Electronics Ltd, model HSE250-30 and offered at a cost substantially below the market price. The units are fully cased and measure 380x125x65mm. Standard mains input and 3 useful outputs: +5V @ 30A, +12V @ 8A and -12V @ 1A. Maximum total wattage is 250 watts. These would cost around £200 from a distributor - Our price £24.95.

SALE PRICE £19.95

SALE PRICE £9.95

**SWITCH MODE
POWER SUPPLY
BONANZA
ALL IN THIS BOX
HALF PRICE**

- Z5504** 197x98mm PCB 50 watt unit: +5V 5A; +12V 1A; -5V 0.5A; -12V 1A. **£9.95**
- Z5503** 126x76mm PCB. 30 watt unit: +5V 4A; -5V 1A. **£4.95**
- Z5505** 205x102x45mm uncased unit rated 120W. +5V 6A; +12V 2A; -12V 1A. Also has a number of leads attached, one with a 15 way D socket, and a small PCB with LM339 and other bits on it. **£14.95**
- Z5508** Cased unit for monitor 205x130x60mm by Source Electronics Ltd, model HSL80-47. Rated 80 watts. +70V 0.9A; +6.3V 0.7A; +15V 1A; -15V 0.4A. **£16.95**
- Z9133** Cased unit 380x128x75mm rated 500 watts by Source Electronics Ltd, model SAX500-02. +28V 16A; +5V 6A, also + and - sense. Super robust unit. **£39.95**

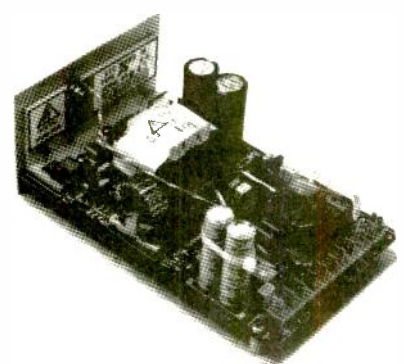

Z8887 Made by STC, this 160x100mm panel is attached to an aluminium chassis. 165x102x65mm and has a single 5V 6A output. Supplied with connection details, we can offer these at a fraction of their normal cost.

Price £5.95 10+ 4.30 100+ 3.43
SALE PRICE £2.00

Z8888 A larger version of the above, PCB 220x100mm and chassis 225x102x65mm providing a single 5V 10A output. Supplied with connection details.

Price Only £8.95 10+ 6.50 100+ 5.20
SALE PRICE £3.00

Z5280 Neat switch mode PSU on panel 120x100mm and only 32mm high. Mains input via skt supplied, 3 outputs on socket are +5V@2A; +12V@0.3A; -12V@0.2A. These have been removed from equipment, but are clean and in full working order **£7.50**

SALE PRICE £3.75

Z5418 Switch mode power supply - brand new unit, as fitted in Z8945 micronet terminals (which are now sold out) This is a 60 watt unit on a panel 280 x 240mm (although 120 x 240mm is unused). Each unit is supplied with a final test sheet, listing output voltages and currents which are, typically, +12v 2A; +5v 4A; +5v 0.25A; -12V 0.5A; 13.8V 0.1A (trickle charger output). 115/230v ac Input. **Excellent value at £14.95**

SALE PRICE £7.95

Couple more 125 watt cased SMPSU's by Source in small qty's:
Z9136 +5V 10A; +12V 4A; +12V 1.5A; -12V 0.5A. **£17.95**

SALE PRICE £9.95

Z9137 +5V 2.5A; -12V 0.25A; +16V 4.5A (Useful for battery charger?) **£17.95**

SALE PRICE £8.95

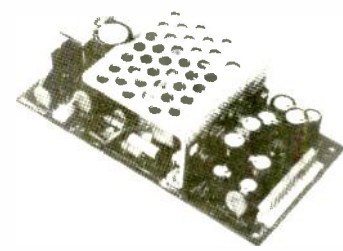

Z5256 Switch mode PSU made by Tamura Corporation. Board 195x100mm with outputs on PCB pins. Input 120/240V ac; Outputs: +5V @ 7.5A; +12V @ 1.25A (2A peak); -12V @ 0.1A. **All this for just £12.95**

SALE PRICE £6.95

DC-DC CONVERTERS

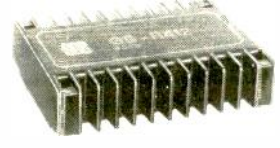

Z5406D High efficiency step down power regulator module by SGS. This is a GSR400 type, as listed by Farnell at £41.11 each. Output is 7V @ 4A from a DC input of 10-46V. Possible uses include battery charger. **Our special price - just £5.75**

SALE PRICE £3.00



Two 5 watt regulators PCB mounting. D-C-DC converters. These are encapsulated in a 51x51x10mm package with output pins on 0.1 pitch. These are ex-equip but guaranteed DP £59.75

Z1893 Input 48V (43-52V), output 5V 1A
Price £2.50 100+ 1 00

Z1894 Input 48V (43-52V), output 12V 420mA
Price £2.50 100+ 1 00

**EITHER TYPE
SALE PRICE 2 for £1**

Z8890 DC-DC CONVERTER BOARD
These panels 220 x 195 require 50V DC Input for 5V 19.5A output. Inputs and outputs on DIN41612 connector. These brand new panels made by STZ are now being offered at just: **Prices £7.95** 25+ 5.20 100+ 3.89

SALE PRICE £2.95

Z5411 Marconi panel 225x195mm. No info on this PSU, but it's got some really nice bits on it - 2x2N3716 TO3 transistors, 13 BCY71, 2XBC107, BFW43, BFX29, LM317K and LM33K TO3 variable voltage regs some high power zeners, pot cores, R's, C's etc., toggle switch with locking device. **Great value at £3.95B**

SALE PRICE £2.00

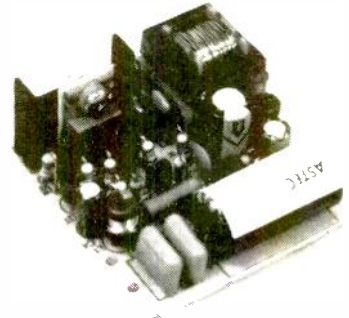

Z660 Astec switch mode PSU type AA7271. This small PCB, just 50x50mm will accept 8-24V Input and give a stable 5V dc at up to 2A output. The 6 transistor circuit provides current overload protection, thermal cut-out and excellent filtering. Offered at a remarkably low price.

Price £5.00
SALE PRICE £2.50

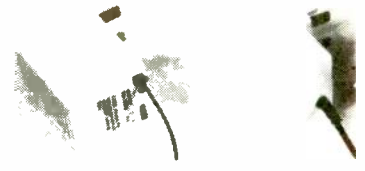

Z5278 Plug in wall type 24V ac 100mA output on 2m lead **£1.75** 100+ 1.10

SALE PRICE £1.00

Z9115 Double Ringer by Weir. Right angle panel 190x72x46mm with 2x2BUV46 MOSFET's, 3xBF471, some small signal T's, 3xLM358, 75453, R's C's etc. There are 7 wires leading to the inverter transformer which looks about 50VA. This unit was probably designed to take a low level signal and turn it into ringing current - about 75V 25Hz, but we have no further data. **Only £4.00**

SALE PRICE £1.75

Z5292D 'Power one' power supply. Conventional unit, 120/240V input, output 15V @ 1.5A fully stabilized. Part enclosed size 123x102x54mm. Comprehensive data supplied **£10.00**

SALE PRICE £4.95

Z5293D 'Power One' power supply. Conventional unit, 120/240V input, outputs +5V @ 2A; + or -12V @ 0.4A; -5V @ 0.4A. Each output uses a 723 regulator and has a preset for adjusting voltage. With data **£14.50**

SALE PRICE £7.50

The other item is a high quality 12V 2A power supply kit with current limit protection. This comprises a ready built PCB - you just need to add the power transistors supplied. It comes with a full circuit and instructions, but you'll need a 16V transformer and a heat sink. **Order Code Z5298 Price £3.50**

SALE PRICE £1.75

Z5413 KRP PCB mounting power source 90x65x23mm. 220V ac in ±15V 100 mA DC out. Some of these are ex-equip. DP around 30.00 **Our price £5.00**

SALE PRICE £2.50

Z5404 Stabilized power supply panel 140x85mm. AC Input is rectified and smoothed and is taken via a couple of regulator transistors and a relay to a 12 way terminal block. Probably 24V. **Only £2.25**

SALE PRICE £1.00

20

SUPER SENSATIONAL SUMMER SALE

GREENWELD

27 Park Rd. Southampton SO1 3TB
Tel: 0703 236363 Fax: 236307
All one off and pack prices INCLUDE V.A.T. Qty. prices do not.

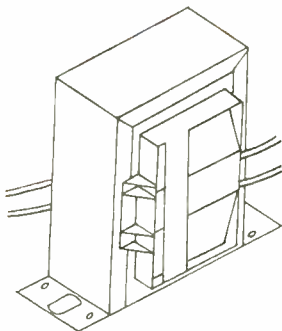

Z5206 Super transformer for railway and other modellers. Mains primary, secondary 16V 3A. Size 50x55x60mm high 61mm FC. Great value for money only £3.00 100+ 2.00 1k+ 1.50

SALE PRICE £2.00
BOX OF 60 £80

Z4369 Very useful 18VA mains transformer with 0-6, 0-6 secondary, each at 9VA giving 6V or 3A or 12V or 1.5A PCB mounting 65 x 52 x 28mm

Excellent value £2.50
SALE PRICE £1.25

Z2305 Neat 6VA PCB mounting low profile mains transformer 53 x 44 x 22mm Primary 0-120V, 0-120V. Secondary 0-15V, 0-15V, each at 0.2A. DP £8.33

£2.50 100+ 1.80
SALE PRICE £1.00

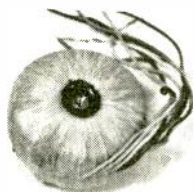

Toroidal Transformers made by Belclere. These are all physically the same size, rated at 35VA but have different windings as listed below 75mm dia x 33mm thick. Fixing by means of a tapped bush. All mains primaries.

Z4290 Type TR7353 5V 1.4A and 12-0-12V or 120mA.
Price £2.50

SALE PRICE £1.00

Z4291 Type TR7252 12V or 130mA, 12V or 80mA, 5-0-5V or 600mA.
Price £2.50

SALE PRICE £1.00

Z5520 15VA toroidal transformer in screened case with mounting plate by Avel-Lindberg. Bridge rect connected. Pri: 0-120, 0-120; Sec: 0-9, 0-9 @ 7.5VA per winding. £3.50

SALE PRICE £2.50

Z2643 Oscillator transformer has push, pull and feedback windings and a secondary of around 385 turns, giving a ratio of about 100:1. As used in high frequency voltage converter circuits. 2 for £1.00

SALE PRICE 5/£1

Z7012 27V 4A Chassis mntg Pri 0-240V Size 98x83x73mm. DP around 18.00 Our Price £9.00

SALE PRICE £4.95

Z7013 40V 1.5A chassis mntg. Pri 0-240V Size 79x65x58mm. DP around 7.00 Our Price £4.00 100+ 2.50

SALE PRICE £2.00

Z7014 12V 1.5A PC or drop through mntg. Pri 0-240V Size 57x48x52mm DP around 6.00 Our Price £3.50 100+ 2.00

SALE PRICE £2.00



Z2450 Tadiran AA size battery 3.6V PC mounting. Date code 6/89. DP on these is 5.17. Our price £2.00 25+ 1.50 100+ 1.20

8 FOR £5



Z2307 Lithium battery 1/2 AA size, PC mounting 3.7V, 0.85Ah. Individually boxed with instructions. DP £4.57.

Our price £2.50

SALE PRICE £1.25

Z2452 Lithium battery - inorganic type by Tadiran, type TL5104. AA size, 3.6V PC tabs. Date code 06/88 £1.70

2 FOR £1.50

Z2453 As above, but type SL360, date code 4/87. £1.50

2 FOR £1.50

Z2719 Lithium battery, Varta 6201 3V 1500mAh PC mntg 60mm long x 11.2mm dia. DP 6.00+ Our Price £2.00

SALE PRICE £1.00

Z2720 Lithium Battery, Vidor G06/53, 3V 1400mAh PC mntg. 50mm long x 15mm dia, individually boxed. DP 6.00+. Our Price £2.00

SALE PRICE £1.00

Z2721 Lithium battery 11mm long x 12.5mm dia. 3V 160mA PC mntg. DP 3.73. Our Price £1.20

2 FOR £1.20



Z2451 Tadiran 0.5AA size battery, 3.6V PC mntg. Date code 8/86. DP 4.58 Our price £1.75 25+ 1.35 100+ 1.05

2 FOR £1.50

Xtra Special

FINAL CLEARANCE

BIB ACCESSORIES

BCC8 Comp term mnce kit - soft & stiff brush, cleaning fluid, air-blast, antistatic liquid, cleaning cloths £2.95

BCC11 Liquid static eliminator in spray can + cloth £1.00

Both for £2

Star Buy !!

Z4248 Mains transformer, 110/ 240V input via PCB pins. Secondary, 6.5V or 8VA; 22V or 8VA, 22V or 1VA; 1.5-0-1.5V or 1VA. Nicely made by Skot.

Price £3.00

SALE PRICE £1.20

Z4213 25V 1.5A Clamp type 70 x 57 x 47mm terminated with wires.

SALE PRICE £1.75

ANOTHER SUPPLY OF YUASA LEAD ACID BATTERIES!



Z8920 Type NP10-6 rated 6V 10A, size 150x95x50mm. Not new, but regularly maintained and full spec. Last time we had these, they flew out the door, and we had many disappointed customers! Don't miss out on this batch - only £12.00 each

SALE PRICE £8.00

Z9131 12V 24Ah sealed lead acid battery by Dryfit. Not new, but only used for about a year and kept carefully maintained. Size 125x166x175mm. DP 59.33 Our Price £30.00

SALE PRICE £15.00

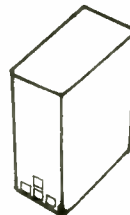

Z4149 Ex-mobile radio Ni-cad batteries, discarded because they either have broken cases and od/or a dud cell - but at the price being asked they are amazing value! Pack of 8 cells, like AA but 73mm long, in a tough plastic case. Either use as a 10V battery pack, or remove from case and use cells individually. Each cell rated 1.25V 900mA. £3.50

SALE PRICE £1; 10/£6

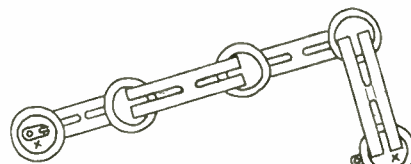

Z5329 A set of 5 Ni-Cad button cells 23diax5mm joined together in series in an L shape (easily split into singles) giving out 6V @ 250mA. Removed from new equipment. DP £4. Our Price £1.50; 100+ 0.80.

2 FOR £1.50



Z4216 Much sought after 4.8V 150mA batteries with PCB mounting tags on 25mm pitch. Battery size 25 x 16 dia. Ideal for paralleling. Some corrosion.

Prices reduced to 50p each 25+ 0.35 100+ 0.25

BOX OF 25 £3



Z1830 Saft 40 RF310 back up Nicad battery PC mounting on 70 x 22.5mm centres. Rated 3.6V. 10mAh (20mA). Overall size 76 x 28 x 8mm.

Price £2.00

SALE PRICE £1.00

LITHIUM BATTERIES

The popular 'coin' type, now available at excellent prices. Individually blister packed Qty prices exclude VAT

CR2016	£1.00	10+	0.66
CR2025	£1.00	10+	0.66
CR2032	£1.00	10+	0.66

NI-CAD BATTERIES

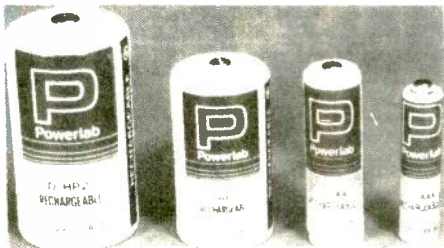

Code	Type	Rating	1+	25+	100+
X131	AAA	180mA/H	£1.20	0.85	0.62
X132	AA	500mA/H	£0.99	0.72	0.55
X133	C	1.2A/H	£2.20	1.76	1.20
X134	D	1.2A/H	£2.30	1.82	1.23
X135	PP3	110mA/H	£3.95	3.26	3.10

10% OFF ALL BATTERIES!!

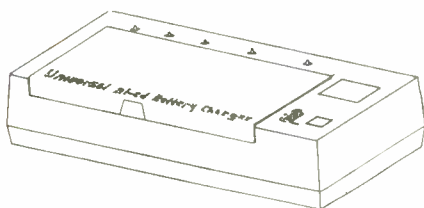

A123 NI-CAD CHARGER

Neat attractive instrument will charge 4 different sizes of battery: AA, C, D and PP3 either singly or in any combination. Charge time 7-8hrs for AA, 14-16 hrs for others. Test facility to check if battery needs charging. Size 210x100x50mm
PRICES £6.95 10+ 4.12

SALE PRICE £4.95

Xtra Special

HEADPHONE COVERS

Z5547 Large

Z5548 Small

Either size

10prs for £1

Star Buy !!

VERO CLEARANCE

We've stopped selling veroboard and accessories, as imported stripboard is just as good and far cheaper. So grab a Bargain - all remaining stocks at HALF PRICE - and that's half the 1991 cat price - now over 2 years old!

Type	Description	Qty	Was	Now
03-0109	211x213 double sided veroboard	39	11.07	£5.53
02-0134	95x455 plain veroboard	12	4.42	£2.21
10-2445	100x160 DIP board	40	7.07	£3.53
03-0026	100x160 Square pad board	24	7.87	£3.93
03-2989	100x160 do with ground plane	44	10.57	£5.28
10-27563	100x160 microboard	18	8.45	£4.22
18-56070	single sided pins 1.32mm*	119	1.24	62p
18-56071	double sided pins 1.32mm*	54	1.55	52p
18-56067	wirewrap pins single sided*	6	3.97	£1.98
18-56068	do double sided*	55	3.97	£1.98
22-0230	Pin insertion tool for 1.02mm pins	41	3.55	£1.77
22-0229	do for 1.32mm pins	27	3.55	£1.77
10-2445	160x100 DIP breadboard	47	6.92	£3.46
806-21021	156x113 DIP breadboard	17	5.80	£2.90
10-27564	234x160 fibreglass DIP board	7	18.86	£9.43
801-21084	148x74 VQ board	122		£1.95

*All pins are in packs of 100

ALL ABOVE VERO HALF PRICE

Keyboard Enclosure



J063 High quality keyboard enclosure 550 x 225 x 70mm with black aluminium mask Top professional quality - made by Data Packaging Normally £38.69

Our price **£11.00**

SALE PRICE £5.00

METER CASE

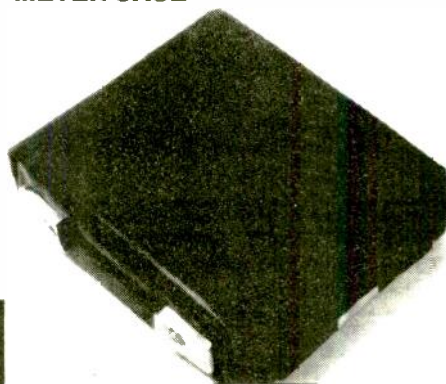

Z4224 Meter case 135 x 120 x 45mm, suitable for our smaller models

Price **£1.00**

SALE PRICE 2 FOR £1

Z5165 Zonephone Case. These are black simulated leather cases that held the portable phone. Size 190x50x30mm, they have a Velcro fastener along the length, a belt strap and a detachable swing handle with one of those trendy keyring type connectors. I suppose you could keep your pac-a-mac in it - or even use it as a pencil case! 2 for £1.00

SALE PRICE 5 for £1

Z5142 Vacuum moulded case 225 x 175mm. Ideal for storing software/ audio cassettes, etc. 3/ **£1.00** 100+ 0.22

SALE PRICE 6 for £1

Z5125 Potting box PB105B 75 x 50 x 35mm. List price 48p. Our Price 4 for **£1.00** 25+ 0.14 100+ 0.09

SALE PRICE 8 for £1

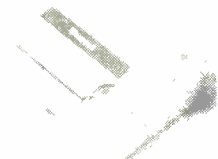

Z5288 Polycarbonate grey sealed box 82x80x55mm with clear lid (DP 9..11!). Inside is a steel panel with loud 12V buzzer and a PCB with push button (operates when lid is removed) a green LED and IN4005. There's a 12mm hole in the side of the box and a cable gland to fit. Exceptional value at **£4.00**

SALE PRICE £2.00



Z8969 Superb heavy duty steel instrument case finished in light grey 426x290x78mm with 4 plastic screw on feet. This was an isolan repeater for use on a data network, and although the contents have been removed (before being used), the front and back panel remain, the former having 4 oblong red LED's and the latter a fused, suppressed IEC mains inlet, on/off DP rocker switch and 2 x 15 way D sockets joined to 16 way IDC skts with a short length of ribbon cable. There's a 60mm circular cut-out for a speaker on one side and mounting pillars in the base. Just look around and see the price this type of high quality case normally costs! - somewhere around the £30-£40 mark - then compare it to our low, low price - just **£9.95**

SALE PRICE £6.95

22

SUPER SENSATIONAL SUMMER SALE

GREENWELD

27 Park Rd. Southampton SO1 3TB

Tel: 0703 236363 Fax: 236307

All one off and pack prices **INCLUDE V.A.T.** Qty. prices do not.



Z5306 Adastra 8 ohm 10 watt white 135mm dia boxed horn speaker, model H52. Adjustable bracket. Very similar to our PS109 @ £6.50, but at a much better price **£3.95** 25+ 2.75

SALE PRICE £3.50

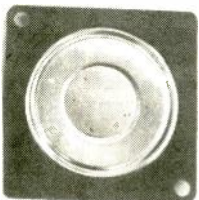

Z578 Super flat speaker 30 x 30 x 3mm by Fuji, rated 16R 0.4W. DP £1.50.

Our Price 60p 25+ 0.35 100+ 0.22 1k+ 0.15

SALE PRICE 4 FOR £1

Z533 Danavox transducer - used as a speaker in pocket pagers. Impedance 50R. 20mm dia leads 90mm long. Extremely high quality unit.

Prices 50p 10/ 3.65 50/ 14.80

SALE PRICE 4 FOR £1



P111D

8 x 5 inch plastic horn speaker with built-in line matching transformer for 70 and 25V line and 8Ω usage. Transformer tapped at 2, 4, 8 and 16W for 70V line and 1, 2, 4 and 7.5W for 25V line, selectable by rotary switch on rear. Mounting bracket fully adjustable for angle and direction. All white plastic.

Size 8" x 5"
Output: 70V line 2, 4, 8 or 16W
25V line 1, 2, 4 or 7.5W
8Ω 16W

SALE PRICE £9.95



Z8988 Super high power siren. Std 5" 5W 8R gold horn mounted on an ABS box (ourV216) which contains the driver PCB. Can supply either single or swept tone and works from 6-28V **£8.00**

SALE PRICE £5.95



SB5 CAR SPEAKERS. 4" air suspension unit with centre coaxial tweeter and crossover. All black plastic cabinet. Shelf or door mounting.

Power nom 7W
Power max 20W
Impedance 4Ω
Size of speaker 4" coaxial
Magnet weight 10oz
Dims 120 x 120 x 90mm

REDUCED TO **£8.00**

SALE PRICE £5.00

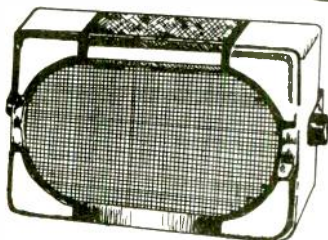

High quality foreground music speaker providing excellent music quality for pubs, clubs, etc. Ported bass reflex system contains a 5 1/4" bass driver, 1" soft dome mid and two piezo tweeters. Modern styled all moulded cabinet. Complete with adjustable wall mounting bracket. Supplied in pairs.

power nom 30W
power max 80W
Frequency response 80 - 20000Hz
Sensitivity (SPL) 87dB @ 1wm
Speakers 5 1/4" bass, 1" mid, 2 x 1" piezo tweeters
Overall impedance 4Ω
Dims (each) 275 x 170 x 125mm
Weight (each) 1.8kg

P114B LOUDSPEAKERS

Exceptional quality and value!

Originally sold for over £75 per pair!

OUR PRICE **£39.95**
SALE PRICE £35.00

40 WATT TWEETER

Z5516 55mm Dia, 3R5 impedance. Ideal replacement for many speaker systems **£4.00**

SALE PRICE £2.50

ALARM BOXES

Z5396 24V DC buzzer housed in a bright red surface mounting MK switch box 80x78x40mm with louvred front panel **£2.00**

Z5397 24V LES lamp with red bezel mounted in MK switch box 80x78x40mm with red fascia plate **£2.00**

Z5398 As Z5396 but with white fascia plate **£2.00**

Z5399 As Z5397 but with red box **£2.00**

Z5400 MK surface mntg box in red with 24V buzzer and lamp. Red fascia plate marked 'FIRE ALARM' **£3.50**

ALL ALARM BOXES HALF PRICE

SOUNDERS & SIRENS

A range of piezo-ceramic sounders made by STC. These are top quality units with extremely high output, up to 115dBm. Now reduced even further to 1/4th the original 1 off trade price!!



Current consumption 10mA
Frequency 2.7KHz
Pulsing frequency 204 10Hz selectable
Sound level at 1 metre 85dB(A)
Dimensions 60 x 33 x 70mm
Z108 U25ORD1D2, 24V, level 85dBm **£1.70**
Z109 U25ORD1D2H, 24V, level 90dBm **£2.00**

EITHER TYPE SALE PRICE £1.00



A parcel of piezo and magnetic transducers

Code	Manf'r	Type	P/M	Size	£1 Pack	100+
Z2176	Murata	PKM25-6AO	P	25 x 8	6	0.08
Z2180	Star	OMB-12A	M	15 x 22	4	0.12

* P - Piezo; M - Magnetic

EITHER TYPE SALE PRICE 2 PACKS £1

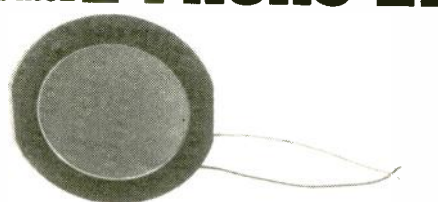

Z1429 Murata piezoelectric speaker type VSB41D25. Only 2mm thick x 50mm dia, weight 3.3gm. Freq. res. 500Hz-20kHz. Z=1.2k at 1kHz. Max input 200mW. Normally **£2.33**

Our prices 75p each 10+ 0.52 100+ 0.40

SALE PRICE 3 FOR £1

Burglar Alarm Bell

Z9138 A loud motor driven bell for home or industrial security systems.

Features include: Internal NiCd battery to drive bell in the event of cable being cut; internal anti-tamper switch; output for external strobe; selectable positive or negative return for control panel type; positive or negative ring control.

Dimensions: Gong diameter 185mm, bracket diameter 220mm, assembled thickness 75mm. Requires additional weather proof case for external mounting. **£12.95**

SALE PRICE £9.95

Z9139 Similar to above but requires small 12 volt sealed lead acid battery (not included). **£9.95**

SALE PRICE £7.95

RADIO SCANNERS - Send SAE for full details of our range of high quality scanners at great prices!

HELIX MATHS SET

Colourful 4 piece set - protractor, 15cm rule, 45 and 60 degree set squares in bright primary colours, in a handy pouch

Big Discounts for quantity!
 100+ 0.45
 1000+ 0.35

99p
 Order Code Q86013



(a) Stationery products - mostly as used in plotters.
Pental Rolling Writers. These line point cartridges are essentially complete pens without an outer casing, so can be used as they are. Current price is around 60p. Now look at our prices! (State 2nd choice)
 Z23199 Black
 Z23201 Blue
 Z23200 Red
 Prices (any mix) **30p each**
 24 + 0.20 96 + 0.15

ANY COLOUR 12 FOR £1

Z01268 Staedtler/Mars lumochrom leads Pack of 12 in dispenser Blue 2mm Fits all standard lead holders
 Prices **30p** 10 + 0.20 50 + 0.15
 Z01158 Tube of 12 x 2H leads 2mm dia
 Prices **25p** 10 + 0.17 50 + 0.12
 Z01159 Tube of 12 Green leads 2mm dia
 Prices **30p** 10 + 0.20 50 + 0.15

ALL LEADS HALF PRICE

SPECIAL OFFERS FROM HELIX

A range of 'Clearance Lines' offering super value for money on top quality product



A10000 Economy maths set - 2 set squares, protractor, 15cm rule all in bright colours together with compasses and an eraser in a rigid see-through pack.
 Only **£1.50**

H40 Lettering guide value pack. Contains 4 popular sizes - 5mm & 10mm upper and lower case and 20 & 30mm upper case only. Supplied in compartmentalized clear plastic case. **£1.99**

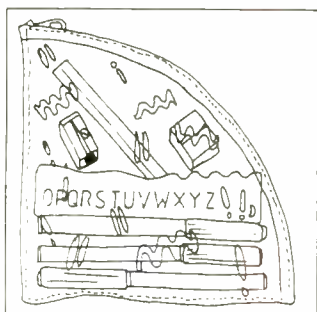

R55 Wedge Pencil Case - Great for younger children! 2 shape templates, 2 letter stencils, 5 felt tips, pencil, eraser and sharpener all in a colourful clear zip case!

OUR PRICE £2.20

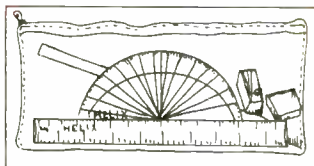

A01 Mini maths set - clear zip pencil case with rule, protractor, pencil, rubber and sharpener.

OUR PRICE 99P

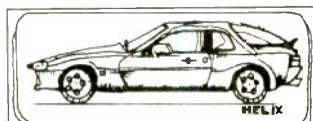

A30 Car Pencil Tin 180x75x20mm

OUR PRICE 99P



Y93021 Helix erasers. Good quality rubbers in blue, yellow and red, each 50x23x10mm. In boxes of 36 for **£3.95**



R08 Magic Pencil Box - amaze your friends - a box within a box makes things disappear

OUR PRICE £1.99

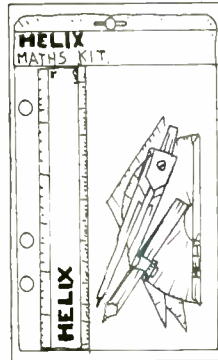

Q86 Small maths set - colourful rule, 2 set squares, protractor, and a pair of compasses.

OUR PRICE 99P

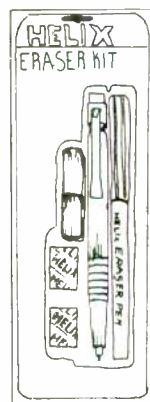

E50 Eraser kit - 5 different retillable pencil

OUR PRICE 99P

Xtra Special CONTACTORS

Z5154 240/415V 32A 3p £4
 Z5155 240/415V 50A 2p £3
 Z2354 240/415V 10A £1
 Z5260 16A 400V 4p £1.50

Star Buy !!

Xtra Special MICROSWITCHES

Z4370 20A - 1c/o, 1b 4/£1
 Z5158 10A 380V 1m 1b 2/£1
 Z5191 2A thermal CB 2/£1
 Z5192 3A thermal CB 2/£1
 Z2084 Skeleton spco 5A 8/£1
 Z2166 Low I 1m 12/£1
 Z2486 15A spco 4/£1
 Z2487 15A 380V 2/£1.50
 Z2488 5A roller lever 2/£1
 Z2489 5A air operated 2/£1.50
 Z2490 As above, double 2/£3.50
 Z2491 Sp heavy duty 4/£1
 Z2499 Limit sw, 1m 1b 8/£1
 Z2947 65mm lever 2/£1

Star Buy!!

25% OFF ALL HELIX CLEARANCE LINES

SUPER CD OFFERS!

All CD's listed on these two pages are just

£3.95 each!

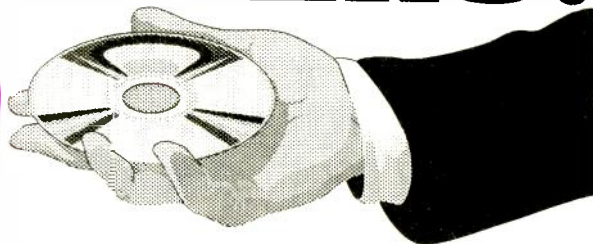

Regrettably, at this low price, we cannot list individual tracks.

JHD003 La Toya Jackson
JHD005 Chris De Burgh
JHD006 Bee Gees
JHD007 Paul Anka
JHD012 The Ultimate Surfing Album
JHD013 Beach Hits
JHD014 Howard Keel
JHD015 Neil Sedaka
JHD016 Duke Ellington
JHD017 Showaddywaddy
JHD018 Kim Carnes
JHD019 Immaculate Mixes
JHD020 The Taste of Brazil
JHD022 Donna Summer
JHD023 Just The Two of Us
JHD025 Bay City Rollers
JHD026 Gloria Gagnor
JHD027 Amii Stewart
JHD028 Heatwave-Boogie Nights
JHD031 Paul Young & The Q-Tips
JHD035 Val Doonican
JHD037 Heat Energy
JHD040 Sabrina
JHD042 Soul of the 80s
JHD043 Dance of The 80s
JHD044 Shirley Bassey
JHD045 Pavarotti
JHD046 Carreras
JHD047 Domingo
JHD048 Sandie Shaw
JHD049 The Bachelors
JHD050 Kiri Te Kanawa
JHD051 Chris Andrews
JHD054 Chris Farlowe
JHD055 Anita Ward
JHD056 Hazel O'Connor
JHD057 Shirley Bassey vol 2
JHD058 Greyhound
JHD060 Jimmy James & The Vagabonds
Bidhu
London Invasion
Wild Connections
Roy Harper
Python Lee Jackson
Gary US Bonds
Elvis Presley
Steve Harley
Carl Douglas
Tina Turner
Gibson Brothers
Ottowan
Immaculate Mixes Vol 2
60's Mixes
70's Mixes
Disco Mixes

SYM013 ORFF Carmina Burana
SYM014 MUSSORGSKY Pictures
SYM015 MOZART Sym No. 40
SYM016 MENDELSSOHN Sym No. 4
SYM017 HOLST The Planets
SYM018 BERLIOZ Sym Fantastic
SYM019 HAYDN The Suprise
SYM020
SYM021 GREIG Peer Gynt Suits
SYM022 GERSHWIN Rhap in Blue
SYM023 DEVORAK Symphony No. 9
SYM024 BEETH Sym No. 9
SYM025 BEETH Sym No. 6
SYM026 BEETH Sym No. 5
SYM027 BEETH Piano Sonatas
SYM028 RAVEL Bolero etc
SYM029 ROSSINI etc
SYM030 BORODIN etc
SYM031 DEBUSSY
SYM032 J.S.BACH Violin C
SYM033 BRAHMS Sym No. 1
SYM034 STRAUSS Piz Polka
SYM035 BIZET Carmen Suit
SYM036 MOZART Sym No.41
SYM037 CHOPIN Eludes
SYM038 HANDEL Water Music
SYM039 BEETH The Emperor
SYM040 BEETH Sym No. 3
SYM041 DVORAK
SYM042 OVERTURES
SYM043 J.S.BACH
SYM044 LISZT
SYM045 MENDELSSOHN
SYM046 HAYDN
SYM047 SAINT-SAENS
SYM048 R.STRAUS
SYM049 STRAVINSKY
SYM050 SCHMANN&GREG
SYM051 BEETH The Great Composer
SYM052 TCHAIK The Great Composer
SYM053 BALLET MUSIC Highlights
SYM054 VIRTUOSO PIANO
SYM055 VIRTUOSO VIOLIN
SYM056 MOZART The Great Composer
RODRIGO
QUIETNIGHTS
J.S.BACH
TCHAIKOVSKY
ELGAR
BRAHMS
SCHUMANN
MENDELSSOHN
TCHAIKOVSKY
PAVAROTTI SINGS VERDI
BRUCH/PAGANINI
VIVALDI
PLACIDO DOMINGO
LUCIANO PAVAROTTI
PUCCINI La Boheme
VERDI Aida
PUCCINI
VERDI La Traviatta
ROSSINI
BEETHOVENS SYM 5+7
BEETHOVENS SYM 6+8
BEETHOVEN SYM 9 CHORAL
M.CALLAS & L.BERNSTEIN

GRF001 60'S VOL 1
GRF002 60'S VOL2
GRF003 COUNTRY GIANTS VOL1
GRF004 COUNTRY GIANTS VOL2
GRF005 LOVE SONGS VOL1
GRF006 LOVE SONGS VOL2
GRF007 THIS IS SOUL
GRF008 KING OF ROCK AND ROLL
GRF009 ROCK AROUND THE CLOCK
GRF010 THE JAZZ SELECTION VOL1
GRF011 THE JAZZ SELECTION VOL2
GRF012 BIG BAND SOUND VOL1
GRF013 BIG BAND SOUND VOL2
GRF014 FATS DOMINO
GRF015 GENE CHANDLER
GRF016 BING CROSBY
GRF017 JUDY GARLAND
GRF018 JONNY AND THE HURRICANES
GRF020 CRUISIN VOL1
GRF021 LITTLE RICHARD
GRF022 NINA SIMONE
GRF023 JOHN LEE HOOKER
GRF024 DEL SHANNON
GRF025 MUDDY WATERS
GRF027 KENNY ROGERS
GRF028 BOB MARLEY
GRF029 MUD FEATURING LES GRAY
GRF030 THE DRIFTERS
GRF031 THE SHANGRI-LAS
GRF032 WILLIE NELSON
GRF033 RAY CHARLES
GRF035 CARL PERKINS
GRF036 LOUIS ARMSTRONG
GRF037 CRUSIN VOL2
GRF038 NAT KING COLE
GRF039 DUKE ELLINGTON
GRF040 MANTOVANI
GRF041 WESTERN THEMES
GRF042 SHIRELLES
GRF043 SURFIN'SAFARI
GRF044 FRANKIE LAINE
GRF045 OHIO PLAYERS
GRF046 SANTANA
GRF047 JAMES BROWN
GRF048 GLADYS KNIGHT
GRF050 JERRY LEE LEWIS
GRF051 LAMBADA
GRF052 GENE PITNEY
GRF053 BILLY OCEAN
GRF054 FRANKIE VAUGHAN
GRF055 GENE VINCENT
GRF056 ACKER BILK
GRF057 ULTIMATE WORKOUT
GRF058 WAYLON&WILLIE NELSON
GRF059 MEMPHIS SLIM
GRF060 LIGHTNING HOPKINS
GRF062 LENA HORNE
GRF063 CHARLIE PARKER
GRF064 ELLA FITZGERALD
GRF065 DIZZY GILLESPIE
GRF066 OAK RIDGE BOYS
GRF067 JIMMY DORSEY
GRF068 TOMMY DORSEY
GRF069 WOODY HERMAN
GRF070 JOHNNY PAYCHECK
GRF071 SUMMER LOVIN
GRF072 FREDDY FENDER
GRF073 FARON YOUNG

SYM001 PACHELBEletc
SYM002 TCHAIKOVSKYetc
SYM003 WAGNER Overture
SYM004 VIVALDI 4 Seasons
SYM005 TCHAIK Sym No 6
SYM006 TCHAIK Ballet
SYM007 TCHAIK Violin Concerto
SYM008 SIRELIUS Fintandia
SYM009 SCHUBERT The Trout
SYM010 SCHUBERT Sym No. 5 & 8
SYM011 RIMSKY-KORS Schcherazade
SYM012 PROKOFIEV Romeo & Juliet

GRF074 MICKEY GILLY
GRF075 BILLIE HOLIDAY
GRF076 GLENN MILLER
GRF077 CAB CALLOWAY
GRF078 DIXIELAND JAZZ
GRF079 BIX BEIDERBECKE
GRF080 SCOTT JOPLIN
GRF081 AL JOLSTON
GRF082 GEORGIE FAME
GRF083 PETULA CLARKE
GRF084 KINGS OF GYPSY MUSIC
GRF085 ART TATUM
GRF086 JIMMIE LUNCEFORD
GRF087 BENNY CARTER
GRF088 FLETCHER HENDERSON
GRF089 DJANGOREINHARDT
GRF090 LIONEL HAMPTON
GRF091 ELLA FITZGERALD
GRF092 EARL HINES
GRF093 COLEMAN HAWKINS
GRF094 SONGS OF HOAGY
CARMICHAEL
FATS WALLER
MAURICE CHEVALIER
AL BOWLLY
NOEL COWARD
GRACE FIELDS
SIDNEY BECHET
JOE LOSS
BESSIE SMITH
REGGAE HITS VOL 1
REGGAE HITS VOL 2
TRUCKING GREATS
RVING BERLIN SONGBOOK
HITS FROM THE MUSICALS
GEORGE GERSHWIN
COLE PORTER SONGBOOK
JAMES BOND
SOUTH PACIFIC
MY FAIR LADY
3WEST SIDE STORY
THE SOUND OF MUSIC
ATMOSPHERIC SYNTHESIZER
6SWEET SOUL MUSIC 1
7SWEET SOUL MUSIC 2
8WHOLE LOTTA SHAKIN'GOIN
ON

GRF119 ROCK AND ROLL IS HERE TO
STAY
GRF120 SEND ME THE PILLOW
GRF121 BLUE EYES CRYIN IN THE RAIN
GRF122 LETS TWIST AGAIN
GRF123 SAVE THE LAST DANCE FOR
ME
GRF12 4WHEN THE SAINTS GO
MARCHING
GRF125 ONE O'CLOCK JUMP
GRF126 WHEN YOUR LOVER HAS
GONE
GRF127 I GOT IT BAD AND THAT AINT
GOOD
GRF128 IT DONT MEAN A THING
GRF129 STOMPIN' ATTHE SAVOY
GRF130 WILL YOU STILL LOVE ME
GRF131 DEDICATED TO THE ONE I
LOVE
GRF132 SANTANA
GRF133 SOCA DANCE
GRF134 JOHN TRAVOLTA

GRF138 BOB MARLEY
GRF139 SWITCHED TO CLASSICS
GRF140 ANDREW LLOYED WEBBER
RGF147 SPACE THEMES
GRF148 QUIET NIGHTS IN
GRF149 ITS IN HIS KISS

GRF151 BOXCAR WILLIE
GRF152 GLENN MILLER
GRF153 SOUND OF VANGELIS
GRF154 THE HAUNTING PAN FLUTE
GRF155 POP OPERA
GRF156 MUSIC OF THE MOVIES
GRF157 SOUSA-GREAT HITS
GRF158 EROTIC DREAMS
GRF159 THE MIGHTY WURLIZER

GRF160 HITS OF THE PET SHOP BOYS
GRF161 ISLEY BROTHERS
GRF162 B.B.KING
GRF163 TECHNO RAVE
GRF164 BROOK BENTON-ENDLESSLY
GRF165 ITALIAN LOVE SONGS
GRF166 HITS OF 1960
GRF167 HITS OF 1961
GRF168 HITS OF 1962
GRF169 HITS OF 1963
GRF170 HITS OF 1964
GRF171 HITS OF 1965
GRF172 HITS OF 1966
GRF173 HITS OF 1967
GRF174 HITS OF 1968
GRF175 HITS OF 1969
GRF176 THE FOUNDATIONS GREATEST
HITS
HITS OF THE 70'S VOL1
HITS OF THE 70'S VOL2
MARTHA REEVES
BRIAN POOLE OF THE
TREMELOES
CONNIE FRANCIS
GLENN CAMPBELL GREATEST
HITS

GRF177
GRF178
GRF179
GRF180

GRF181
GRF182

GRF185 MIKE PENDERS &THE
SEARCHERS
GRF186 THE FORTUNES
GRF187 SHOWADDYWADDY

GRF189 TRINI LOPEZ
GRF190 ALLEGRO MILANA PLAY A
TRIBUTE
GRF191 GERRY AND THE
PACEMAKERS
GRF192 HOLLYWOODS GREATEST HITS
GRF193 INSPARATIONAL SAX
GRF194 MIDNIGHT GUITAR
GRF195 THE MAGICAL MUSIC OF BERT
BACHARACH
DOO WOP CLASSICS
LES MISSEABLES
TELEVISION GREATEST HITS
JIM REEVES
GARY GLITTER
GRF200 STEEL DRUM
GRF201 SOUND OF HAWAII
GRF202 HITS OF THE SHADOWS
GRF204 DONOVAN
GRF207 ALAN PRICE
GRF209 THE ULTIMATE HOUSE
GRF210 DISCO EXPLOSION
GRF211

GRF213 THE RUBETTES
GRF214 SWITCHED ON COUNTRY
GRF215 THE PLATTERS

GRF218 KE & TINA TURNER

BAL001 CHA CHA
BAL002 SAMBA
BAL003 WALTZ
BAL004 FOX TROT
BAL005 TANGO

BAL007 LATIN
BAL008 RHUNBA-BOLERO

PAT201 JUNIOR PARTY MEGAMIX
PAT301 PRAISE
PAT911 TOP 20 VOLUME 1
PAT914 CHRISTMAS PARTY
PAT918 TOP 20 VOLUME2
PAT929 TOP 20 VOLUME3
MER001 MADONNA VOL 1
MER002 MADONNA VOL 2
MER003 MARC BOLAN VOL1
MER005 BRYAN ADAMS
MER006 MARC BOLAN VOL 2
MER007 ELKIE BROOKS(PEARLS 3)
MER008 SKY VOLUME 1
MER009 SKY VOLUME 2
MER010 BUCKS FIZZ
MER011 MOTOR HEAD

CD-ROM's

More and more software is becoming available on CD-ROM - and once you've purchased a suitable drive, it's an incredibly cheap way of buying shareware. We can supply a Mitsumi CD ROM drive kit which is Kodak Photo CD compatible (multi-session) with the following spec. We can vouch for it's speed and reliability, as we have one fitted to one of our computers. Look at these features:

- Slide Top Loading
- Mscdex Supported
- Multi Media Support
- Audio Playback
- Direct Interface to PC/AT
- 380 Millisecond access

Full data on request

PRICE
£222.22

SHAREWARE CD-ROM's

MIN2 Well balanced material, 7,700 files, 630Mbytes. **£29.95**

MIN3 Latest disk, over 85% 1992 files. 6,600 files, 550Mbytes **£29.95**
Two further disks are due out soon.

Bargain List Subscribers Only -
Why not become a Subscriber now? - see page 30 for details

FREE
**MIN2 disk with
ROM drive kit!**

Also the popular **Soundblaster V2 Pro**. This amazingly versatile package will give you stereo music, voice, game port, midi, CD-ROM interface. Supplied with Sereo Card, Audio cables, 3.5" disks, Manual + lots of exciting software - Indy 500, Lemmings, Text to speech, multimedia encyclopaedia (really amazing - includes still & moving pictures + sound). We'll send you more info on request.

The whole package for just

£149.95



Z611 Finned heatsink 86x27x38/20mm fitted with 2 x 7805 5V 1A voltage regulators - brand new. Only **£1.00**

SALE PRICE 2 for £1

Solder



Z5099 Ersin multicore HMP (high melting point) solder, 22 swg on 500g reels. Composition: 5% tin, 93 52% lead, 1.5% silver. Melting temp 301 C. Rec. bit temp 350 C DP £18.00.

Our price **£8.00**

SALE PRICE £5.00

STEREO CASSETTE PLAYER

Z5405 High quality heavy duty all metal construction stereo cassette player mechanism, probably intended for continuous background music. This is a lovely bit of kit - starts playing as soon as a cassette is inserted. Has fast forward, rewind and eject keys. It's bi-directional, and the sensing circuit automatically reverses the tape at the end. Has a Canon motor and works off 12V DC. Great value at **£4.95**.

SALE PRICE £3.95

Z5488 9V stereo cassette deck mech. Record/replay and erase heads, 6 push buttons - fwd, rev, play, rec, pause and stop. Only **£2.95**

SALE PRICE £1.00

Z8885 TAPE DECK PANEL. A type of telephone answering machine believed to have been used as an alarm system - a recorded message was sent down a BT line if premises were being entered illegally. Steel chassis 245x220x35mm contains PCB 228x145mm and an 8 track cassette unit almost identical to Z4307. This is attached to the panel by 3 screws and is easily removable, being connected to the PCB with a 5 way socket. The output from the tape head is fed into an MC3301 quad op-amp. The PCB also has 10 CMOS gates, 3 relays, isolator transformer, several transistors, R's, C's etc. 12 way connector for BT line, 12V supply etc, also plug and socket arrangement for Auto/ Manual and Bell delay. Made by Munford & White PLC. Price: Reduced to **£7.95**

SALE PRICE £3.95

Z5246 Mains synchronous motor with easily accessible gearbox giving a final speed to the 5.5mm dia 12 toothed gearwheel of 0.2RPM (12 revs per hour). Only **£3.95**; 100+ 2.50

SALE PRICE £2.00

Z5488 9V stereo cassette motor 35mm dia x25mm. Only **£1.00**; Box of 200 **£65**

Xtra Special

K857 MASSIVE CONNECTOR PARCEL

Z5085 1000	Z5084 100
Z2154 100	Z2158 1000
Z5086 1000	Z2157 1000
Z5083 100	Z2160 100
Z5082 100	Z2156 294
Z2155 100	
Z5081 100 25W D Plug	
Z5082 200 25W D Plug	

TOTAL 5194 Parts!

£25

Star Buy!!

Z5427 Tachometer. Here's a nice little unit at a fraction of its true worth - made by Transicon Inc, this will give an accurate voltage for any given speed. Gradient 1.55V/1000RPM. Only **£8.00**

SALE PRICE £4.95

Fans



Z4056 'Patriot' fan. High quality cooling fan for mounting into equipment 170mm dia x 51mm Only problem is they operate on 48V ac (but still work down to 24V).

Price **£3.00**

SALE PRICE £1

Z5006 120mm Fan Guard, 110mm FC Chrome plated steel

Price **£1.20** 25+ 0.70

SALE PRICE 5 for £1

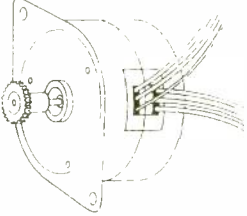

Z5045 Superb little 12V motor by Airpax 35mm dia x 21mm deep with a 16 tooth 9.5mm dia gear wheel mounted on the 2mm dia spindle. FC 42mm, 7.5° 48 step. Supplied with data. 100+ DP 9.04. Our Price **£3.00**; 100+ 2.00

SALE PRICE £1.50

Z5487 Mabuchi hi-torque 9V cassette motor 35mm dia x 25mm Only **£1.00**; Box of 200 **£65**

SALE PRICE 2 FOR £1

HIGH QUALITY LOW COST SOLDERING IRON + STAND



Y061DA Mains element with interchangeable bit (std Antex CS types fit). Rated 15 watts. Ideal general purpose BS approved iron. **£4.95**

SALE PRICE £3.95

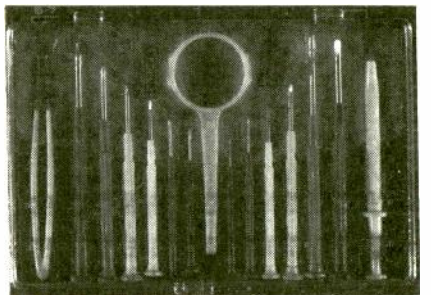

18068 Colourful precision tool set - clear hinged plastic case 210x135mm contains 15 instruments with coloured plastic handles - tweezers, pick up tool, 37mm magnifying glass (not plastic), 6 each pozi and straight screwdrivers. Great value at

£5.95

SALE PRICE £4.95



Z314 Precision spring bow compasses 88mm long. Max circle dia 70mm. Replaceable pencil lead and steel tip

Price **£1.00**

SALE PRICE 2 for £1

TV Stand

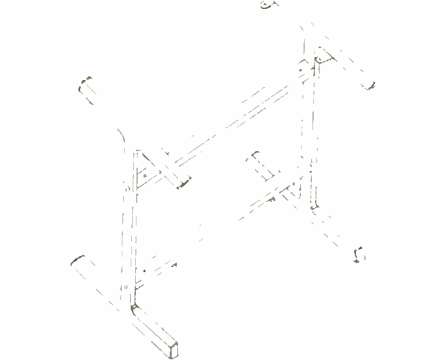

Z8930 TV/Video/Hi-Fi stand. Satin finish steel side pieces with black ends held apart by veneered timber. Overall dimensions 485 wide x 350 deep x 450 high.

A bargain at £2.50 100+ 1.25

SALE PRICE £1

EVERYTHING ON THIS PAGE **2** FOR THE **1** PRICE OF **1**

15,000 RELAYS TO CLEAR - ALL AT ROCK BOTTOM PRICES!

Code	Volts	Coil R	Contacts	MFCTR	Type	Size	Notes	Qty	Price
Z202	3V	35R	Spco@3A		AZ535	32x20x11	Low profile	83	£1.00
Z2400	3V	130R	Spb@1A	Gentech	G42F	33x16x11	PC Mntg	46	£1.00
Z1718	3-24V	Solid State	Spm@4A	Huntleigh	SMT2000/3	43x25x70	Solid State	366	£1.00
Z3009	5V	60R	Spco@8A	Schrack	RP110005	28x24.7x11	Pc Mntg	184	£2.68
Z2406	5V	130R	Spb@1A	Elliott	36876/5	32x15x10	Pc Mntg reed	429	£1.00
Z2402	5V	170R	Spb@1A	Clare	CUPV10201	25x10.9x9	Pc Mntg reed	45	£1.00
Z2310	5V	370R	SPB	AX	400FxX091	10.5x32.5x13	Pc Mntg reed	1067	£0.50
Z2405	5V	470R	Spm@500m A	Clare	PRMEL5005AB	20x7x5	Dil reed	193	£1.00
Z2407	5V	470R	Dpm@1A	Hamlin	HE262A7780	32x12x9	Pc Mntg reed	16	£1.00
Z2401	5V	500R	Spm@1A	AX	175A-4	32x9.5x15	Pc Mntg reed	42	£1.00
Z2408	5V	500R	Dpco@1A	Clare	HGR2M	40x25x10	Pc Mntg mercury	42	£1.00
Z2403	5V	520R	Spm@500m A	AX	132A-4	20x7x7	Dil reed	60	£1.00
Z1958	5V	1200R	Spco	Hamlin	HE3321CO500	23x7x8	Sil reed	26	£1.50
Z2174	9V (5-12V)	410R	4pco@2A30 V	Aromat	DS4E-S DC9V	35x10x10	Pc Mntg 0.1"	104	£3.00
Z2350	12V	68R	Spm@15A			26x24x36	Open .25" Tabs	322	£1.00
Z2848	12V	70R	Sp/5kV 10mA	Kilovac	K43B234	53x17 Dia	2 Wires for coil	36	£3.00
Z2409	12V	370R	Spb/spm1A	Clare	Cupv10302	31x14x9	Pc Mntg reed	22	£1.00
Z2120	12V	710R	Spdt@1A 28V	Taiko	NXE-12K	15.6x10.6x10	Dil Pc Mntg	375	£2.00
Z2545	12V	1000R	Spm 200V.5A	Pickering	97-1-A-12	19x11x10	Dil reed	256	2/1.00
Z2413	12V	1500R	Spco@1A	AX	481F	32x10x10	Pc Mntg Mercury	353	£1.00
Z2411	12V	800R	Spm@1A	Hamlin	HE221A7080	32x10x9	Pc Mntg reed	1334	£1.00
Z2497	12V	110R	Dpco@10A	IMO	60.32	32x35x39	Plug in 8 tags	36	£2.50
Z5179	12V	110R	3pco@ 10A	IMO	60.43	32x35x39	Pc Mntg	21	£1.50
Z2843	12V	285R	Spco' 10A	Omron	G2L	28x11x25.5	Ex equip Pc Mntg	191	3/1.00
Z2137	12V	200R	Spm@5A	Omit	TV5/S-112DM	29x12x20	Pc Mntg	21	£1.50
Z280	24V	288R	Spm@ 500mA	Omron	G68-1114P	20x9x9	Dil Pc Mntg	44	£1.00
Z2048	24V	435R	2pco@ 10A	IMO	60.12	32x35x63	Octal	16	£2.50
Z275	24V	480R	Dpco@ 10A	Relco	MR54-2	35x35x55	Octal	49	£2.50
Z258	24V	520R	3pco@ 10A	B&R	D43	53x37x36	11 Pin plug in	18	£2.50
Z2941	24V	600R	4pco@ 5A	Guardian Elec	1315P	34x28x21	Pc Mntg	2520	3/2.00
Z250	24V	700R	Dpco@ 1A	Perivale	PC2	30x24x19	Plug in continental	35	£0.80
Z2638	24V	974R	Dpco@2A	Omron	G2V/BT47	21x10x11	Dil Pc Mntg	292	4/1.00
W834	24V	1050R	Dpco@2A	RS346-839	346-839	21x10x11	Dil Pc Mnt	70	£1.00
Z2637	24V	1170R	Spco@16A	Ped	11-794-135-740	29x12x25	Pc Mntg	11	£1.30
Z2164	24V	1200R	Spco@8A	Zetter	AZ692-052-52	27.5x25.8x11	Pc Mntg	7148	£0.75
Z2418	24V	1200R	Spco@5A	Oub	SS124D	21x17x15	Pc Mntg	29	£1.00
Z2417	24V	1200R	Dpco@2A	Oub	SS224D	18x10x12	Pc Mntg	35	£1.00
Z2419	24V	2000R	DPCO@1A	National	AE1324	30x20x10	Pc Mntg	45	£1.00
Z230	24V	2600R	Spm@1A	Electrotherm	GR1011	20x11x10	Pc Mntg Reed	82	£0.60
Z2639	24V	8000R	Spm@1A	Hamlin	HE221A2490	32x10x9.5	Pc Mntg Reed	800	£1.60
Z2416	24V	11K	Spm@1A	Hamlin	HE221A4860	32x10x0.9	Pc Mntg Reed	639	£1.00
Z218	26.5V	675R	Dpco@1A	Stc Hi-G	2B-8075	22x20x10	Sealed S Tags	62	£1.00
Z2422	36V	4300R	Spco@1A		AZ1530-Oay	26x14x11	Pc Mntg	563	£1.00
Z252	48V	2500R	2Pco@1A	Perivale	PC2	30x24x19	Plug in Continent	99	£0.60
Z253	48V	2500R	4Pco@1A	Perivale	PC4	30x30x19	Plug in Continent	98	£0.80
Z2424	48V	3000R	Dpco@1A	ITT	A2446	29x16x13	Pc Mntg	53	£1.00
Z3010	48V	3000R	6Pco@		V23030-C2026	40x37x9	Pc Mntg		£1.00
Z2496	48V A.C	630R	4Pco@3A	Omron	MY4	27x20x41	Plug in Cont	15	£1.00
Z219	50V A.C	750R	4Pco@3A	Izumi MY4	RY4S-EC	35x27x21	Plug in Cont	409	£1.00
Z2425	110V	10K	3Pco@10A	Ferne	RCP11	35x35x56	11 Pin	73	£2.00
Z261	240V AC	12K	2Pco@7.5a	P&B	KU11A15	46x36x31	8 Pin Plug in	158	£3.00

EVERYTHING ON THIS PAGE 2 FOR THE PRICE OF 1

Toggle Switches



Z1710 Toggle switch double pole on/off rated 10A 250V ac. Threaded bush with plastic and metal nut, also can be clipped in panel.

Price **£1.50**

Z1711 Another toggle switch, very similar to above. No rating printed on body, but looks about 10A. This one does not have a clip fix.

Price **£1.20**



Toggle switches by Bonella. High quality, high current, solder tags. All are rated 10A 250V ac

Z352 Type N11LNZ SPCO (4 tags) Metal dolly **56p**

Z354 Type N41LNZ DPCO (6 tags) Metal dolly **84p**

Above 4 types less 25% for 25+ , less 50% for 100+

Rotary Switches

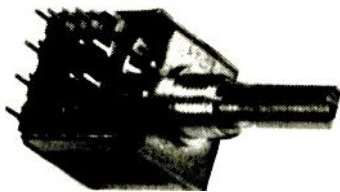

Z1522 Switch, Alps SRS 40 way. As used in CB's for channel switching. Body 20x20mm. 6mm dia shaft with M9 fixing nut. Not sure if these are binary or BCD. 7 bits per step. Data sheet supplied. **£1.00**

Keyboard Switches



Z1523 PCB mounting illuminated keyboard switch. High quality single pole reed with 5V lamp made by FR. Model 18 x 18mm. No tops unfortunately.

Price **3/ £1.00**

Z1393 PCB mounting keyboard switch with in built yellow LED SP. Size. 12.5 x 12.5mm. No tops.

Price **5/ £1.00**



Z2167 Keyboard switch, single pole clip-in type with standard + stem for cap. 13.6 x 12.9mm 7.5mm pitch DP 75p

Our low price **6 for £1** 100 + 0 10

Rocker Switch



Z1819 Rocker switch in black plastic SP on/off rated 16A 250V ac. Needs 30 x 12mm cutout

Price **Pack of 4/ £1.00**

Z2596 Keyswitch by Lorlin. 1p3w with 2 keys. For low current up to 1A. **£2.00**

Z2597 Keyswitch by Lorlin. 2p5w with 2 keys. PC mntg for low current up to 1A. **£2.50**

Z2853 8 position DIL switch - AMP type 435802-9. Gold plated. Pack of 5 **£2.00**; 100+ 0.25

Z2863 Min high quality push to make switch, overall 19mm long, body 6.4mm dia. 4mm fixing. Plunger 2.6mm dia x 4.5mm long. Pack of 5 **£2.00**

Z2699 Push to make switch, like our W435 only non-locking. Black top. Normally 52p. **Special offer price 8 for £2.00.**

Microswitches



Z4370 Burgess 20A microswitch. Incorporates 2 switches into one housing 20 x 12.5 x 17.5mm - 1 changeover and 1 break.

Price **2/ £1.00** 100 + 0.25

Z2084 Skeleton microswitches. SPCO, 5A rating. Two 3 5mm mounting holes on 10mm centres. They are designed to be mounted side by side - in theory the number is only limited by the length of bolts available! (each switch is 5mm thick)

Price **Pack of 4 for £1.00** 100 + 0.15



Z2165 Omron miniature type SS rated 3A 250V. Single break contact operated by bent lever

Price **5 for £1** 100 + 0.12 1k + 0.08

Z2166 Omron standard type VL631C. These are for signal switching, contact rating 0.1A 125A AC/30V DC. Single make contact.

Price **6 for £1** 100 + 0.09 1k + 0.05

Z5158 High current microswitch by Siemens, model 3 SE3 rated 10A 380V AC Fully shrouded screw terminals (4): 1 pair make and 1 pair break terminals. Overall size 28 x 30 x 32

Price **£1.50**

Joystick Switch



Z004 Skeleton Joystick, switch type. Good quality, made by AB. Brass spindle has 44mm long black plastic handle attached. Body has 4 mounting holes. These really are a fantastic bargain!! **ONLY £1.00**

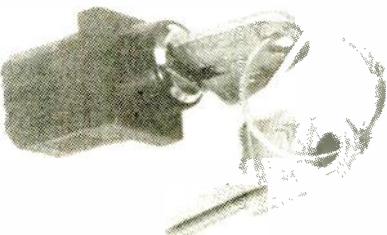

Z2168 Superb quality British made (TOK) Gold plated DPCO contacts. Key can be removed in either position. PC mounting or clip fix - needs 15x15mm cut-out. Ideal for alarms etc

Price **£1.95** 25 + 1.20 100 + 0.80

POINTS SWITCHES



Great switch bargains for railway modellers - these small switches 18mm wide and 12mm high (excluding lever) and just 4mm thick with 14mm FC come in two versions:

Z2363 2 position, 2 pairs make and 2 pairs break. Pack of 5 **£1.00** 100+ 0.10

Z2364 3 position, 6 pairs contacts (2 pole 3 way). Pack of 5 for **£1.00** 100+ 0.10

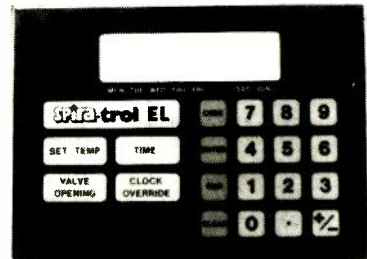

Z1797 Membrane keyboard 155 x 113mm with 80 x 22mm aperture for display from case Z4245. 22 keys. Output to 11 way flexible connector. Self adhesive.

Price **Only £1.00**



Z4354 Computagraph Colorwriter panel 352 x 67 x 12mm. Ally frame supports a membrane keyboard which has 22keys. On the rear of the panel are 6 yellow submin LED's, a 3mm red LED and 2 x 19W edge conns.

Price **£1.00**



Z4363 Membrane keyboard 225 x 84mm with 11 keys - 1-9 & 2 others. Output (common bus) on 12 way ribbon cable. Could be cut down to 95 x 70mm if only 1-9 needed.

Price **60p** 100 + 0.30

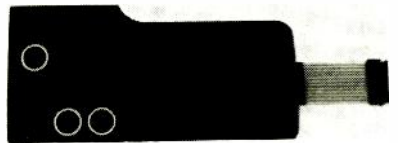

Z4116 24 way (8x3) membrane keypad. Large (200x90mm) area - these were originally used as a teaching aid. Overlay template and pinout supplied. **Now only £2.00**

Neat keypads in various styles by ORCOM, both with encoded and matrix outputs. All PCB's have room for coder chip (74C922) to be fitted. All feature 0-9 keys and other characters as shown. Output via 20 pin plug. Data supplied.

(a) No chip fitted:
Z5107 3 x 4 (* #) **£2.00**

Z9134 Cherry UB70 keyboard, low cost 67 key, std qwerty + F1-5 etc. New and boxed **£3**

Z5440 2 keypads. These are packed in pairs - both have 12 keys, but the legends are different: (a) 0-9, * and # and (b) MO LI MU B LO S F WU A and a couple of symbols. They have the graphite coated rubber membrane, but no PCB. **Only £1.50**

SUPER SWITCH SENSATION!

K838 A nice parcel of ALPS high quality push switches as used with mounting brackets. Enormous variety from DPCO to 10 pole changeover locking and nonlocking including PC mounting + solder lag, all on standard 4mm mounting. Different colours too. Whats more, there's a big selection of buttons to fit them- round, square, oblong etc in red and black. All at a knock-out price - 100 assorted switches + 100 assorted knobs £7.95.
 Pack of 1000 switches + knobs £49.95
 Pack of 10000 switches - no knobs 300.00



Switches in K838 available separately as follows

Code	C'tact	Pins	L/M	E2 Pack	100+	1K+	Qty
Z2801	10PCO	PCB/ST	L	12	10	.058	600
Z2802	8PCO	PCB/ST	M	16	.08	.056	815
Z2803	6PCO	PCB/PCB	L	20	.07	.044	6k4
Z2804	6PCO	PCB/PCB	M	20	.07	.044	2k4
Z2805	6PCO	PCB/ST	L	20	.07	.044	9k4
Z2806	4PCO	LPCB/ST	M	25	.05	.034	4k4
Z2807	4PCO	LPCB/ST	L	25	.05	.034	480
Z2809	4PCO	PCB/ST	M	25	.05	.034	7k1
Z2811	4PCO	PCB/PCB	M	25	.05	.034	3k8
Z2812	2PCO	EPCB/ST	L	40	.03	.022	12k
Z2813	2PCO	EPCB/ST	M	40	.03	.022	4k2
Z2814	2PCO	LPCB/ST	L	40	.03	.022	5k9
Z2815	2PCO	LPCB/ST	M	40	.03	.022	600
Z2816	2PCO	PCB/ST	L	40	.03	.022	5k8
Z2817	2PCO	PCB/ST	M	40	.03	.022	10k3
Z2818	2PCO	PCB/PCB	L	40	.03	.022	3k5
Z2819	NO CONTACTS		M	100	.01	.007	9k4

Contacts used:

Contacts: number of changeover switches

Pins: (All on 4mm pitch; contacts on both sides of switch as listed)

- PCB PCB mounting
- LPCB stand of PCB mounting (8.5mm)
- EPCB stand of PCB mounting (24mm)
- ST solder tags

L/M: locking or momentary (non locking)

E2 packs: Qty of switches for £2 (other prices per switch)

QTY: total quantity in parcel

SALE PRICES
Pack of 100 £3.95
Pack of 1000 £25
Pack of 10,000 (no knobs) £175

TIMER SWITCH

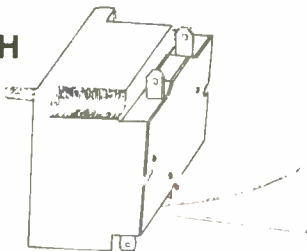

Z5174 Timer switch by Diehl of Germany. Superb gearc mains motor, (1 rev per 12 hours) operates a cam that switches 2 change over contacts with centre - off positions rated 16A 250V. Size 60x54x43mm. Spindle ls 14x6mm dia
 Only £3.00 100+ £1.50.

SALE PRICE £1.00

Pressure Switches



These are operated by very low air pressure - just blowing down the tube will operate the SPCO microswitch within. Useful in a 'spark free' environment.

Z024 80mm dia x 45 total depth. SPCO switch rated 16A 250 Vac 80p

Z025 Similar to above, but 37mm thick 80p

Z4200 Pressure switch model LDQ by Actu. Can be activated by gas or air at very low pressure. Range 13 - 150mm w.g. Switch is a SPCO micro switch rated 230V 2A. Precision instrument overall dia 110mm x 48mm £2.00

SALE PRICE
Pack of 2 of each type £2.00

ALL KEYBOARDS £3!!



Z8848 Keyboard by Cherry Room for 104 keys, all normal keys (65) fitted Chips on board LS373 x 2, LS374, LM3086 x 2 LS138 x 3, 555, LS08, 6805 Size 442 x 175mm
PRICE: £10.00



Z8842 Tatung VT4100 keyboard. Cased 85 key units with separate numeric keypad With circuit. Has 2 or 3 broken key tops. 450 x 65 x 125mm
Price £9.95



Z8852D Keyboard. Superb brand new high quality keyboard with LCD displaying 1 line of 10 characters and a further line with various symbols, 100 keys, inc separate numeric keypad. Chips on board are 2x74HC05, 80C48. LCD + driver chip are easily removed. **Amazing low price - only £10.00**

ASCII KEYBOARDS



Z8933 5 1 key QWERTY keyboard by McMurdo O'com with 6 bit ASCII encoded parallel output. Measuring 240 x 115mm makes it ideal for rack mounting applications. With control, shift and shift lock keys this keyboard can generate all 128 standard ASCII codes. The keyboard requires a +12V and +5V power supply connected via a 20 way header type plug. The remaining connections on the plug are DSR, DTR and STR, the strobe and data set ready are switchable to be negative or positive going pulses. The controlling IC is a General Instrument AY-5-3600-PRO chip.

Price £8.50

Z8934 As above but supplied in a vacuum formed grey plastic case 280 x 185 x 60mm

Price £12.00



Z8863 Keyboard. High quality unit made by Micro Switch 69 pale grey and blue keys 6 red 5mm LED's, 15 varicous LS chips and socketed D8048 by Intel. Output via 7 way plug and there's a 4 way edge connector too Keyboard frame is 317 x 128mm. PCB on which it's mounted is 285 x 170mm
PRICE: £10.00

Xtra Special
KEYSWITCHES
 Z2107 sp 4w 2A 250V £1
 Z2596 1p3w 2 keys 1A £1
 Z2597 2p5w 1A 2keys £1
Star Buy!!



Z8922 Made by Devlin, this keyboard has 94 keys (18 without caps; 20 with removable tops) and runs off a single 5V supply. Serial ASCII output + switch to emulate AT and XT keyboards.

Price £12.00

Xtra Special
SLIDE SWITCHES
 Z301 / 3 / 4 / 5 / 6
 10 OF EACH
 PACK OF 50 **£2**
Star Buy!!

TV SWITCH

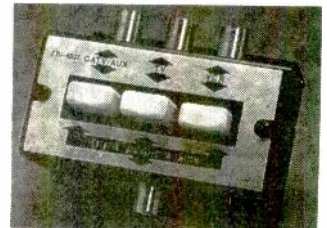

T123A Push button selector switch to give 3 inputs to one TV - co-ax skt inputs, co-ax plug output. Auto substitution of 75R load when channel not in use. Size 90x47x39mm
 Normally £3.99
£2.00

TEMPERATURE SWITCHES
 Temperature sensitive switches designed to protect components or equipment from damage by overheating. Snap action bi-metallic disc operates the normally open contact. Switch resets when temperature falls.
 Z2533 130°C
 All the same price - £1.00 each; 25- (any mix) 0.60;

SALE PRICE 3 for £1.00

30

SUPER SENSATIONAL SUMMER SALE

GREENWELD

27 Park Rd. Southampton SO1 3TB

Tel: 0703 236363 Fax: 236307

All one off and pack prices INCLUDE V.A.T. Qty. prices do not.

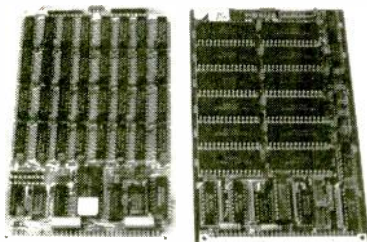

MASSIVE DISCOUNTS!

A collection of Eurosize panels (160x100mm) with 64 way DIN plugs fitted.

Z5092 8xHM3-6514-9 RAM + few other chips £1.00

SALE PRICE 40p

Z5089 32xTC5514AP-3 1kx4 static RAM + few other chips etc £3.00

SALE PRICE £1.20

Z5090 12xM5M5165P-15L 8kx8 static RAM plus few other chips £4.00

SALE PRICE £1.50

Z5100 16xHM6167LP-8 + few other bits £2.00

SALE PRICE 80p

Z5101 2xM5M5165P-10C + few other chips £1.50

SALE PRICE 60p

Z5262 8x2764 in skts + 10 LS chips £4

SALE PRICE £1.50

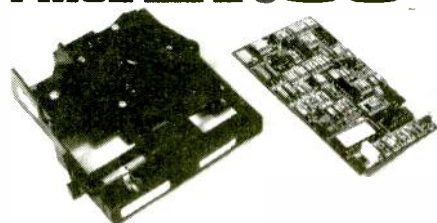

Z5364 Coin acceptor unit. Moulded plastic case 140x130x50mm (believed used in payphone) which has several coils embedded into it. As a coin passes over the coils, the circuitry on the 135x76mm PCB generates a pulse train. PCB contains MM9504, 82S126 in skt, CMOS 4001x2, 4053, KM2902 quad op-amp, LM2903 dual comparator, 5 small signal transistors, 4 small chokes, R's, C's etc. Only £2.95 100+ 1.75

SALE PRICE £1.00

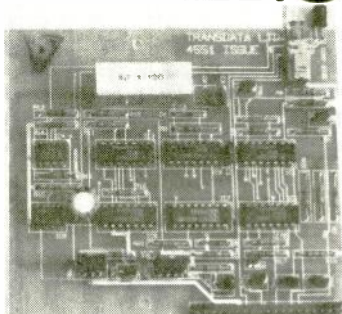

Z653 Control PCB, 140x115mm with 2x4013, 4020, 4011, 4081, 4071, 8211, LM3909, 2af02.003TIP130, 5x2N3906, switch, C'S R's, LED etc. £1.50

SALE PRICE 2 FOR £1

Z631 PCB 170x135mm with 2xLM324, 2xILQ74; 2xMC14416; 4519; 2x4510; 2x4099; 4001; 4584; 2x741; HC14LS05; 74125; 2 relays, Rs, Cs, etc.

Price Reduced to £1.50

SALE PRICE 2 FOR £1.00

Z629 Occasionally we obtain repeat supplies of panels - this one was featured on B/L 30, and is 170x35 with 2xMC3419 loop interface 4510, LS505, LS514, 4584 all in sockets, also LM324, 4519, 2x4099, 4013 plus 2x4.5V DPCC BT type relays. Also 64 way DIN plug, 2 bridge rects, 6 transistors, Rs, Cs, etc.

Price Reduced to £1.00 100 + 0.30

SALE PRICE 3 FOR £1.00

JIMMY
the electronic football game of skill



Z817 Exciting electronic football game - Waddingtons' 'JIMMY'. Brand new models in full working order, but without plastic peripherals, stickers etc. Red plastic case 420mm long x 93mm wide contains keypad and 7 segment LEDs to keep score either end. The centre section 'players' are represented by red 5mm LEDs, 14 altogether. The main chip is the TMS1000, programmed to make odd noises whilst playing and a tune when a goal is scored. Also inside are 13 plastic transistors, 57mm 8R speaker, power supply socket, Rs, Cs etc. Powered by 2x PP3 batteries. Solo or dual play. Supplied with instruction sheet, playing field complete with coloured 'players'. Good fun to play as a game with good value for the electronics within. Originally retailed at £19.95.

Price Only £5.00

SALE PRICE £2.50

Z5432 Nice little surface mount module. PCB 70x51 has sub panel 56x26mm plugged into 2x18SIL skts. On it are 10 IC's ic. On the main panel are 4 big chips - TMS320, CF34035 & 6, 77C82; 4 xtals - 8MHz, 970, 2048 & 19660.9kHz + some smaller chips - ZN429, TL431C etc. Complete panel for £3.00

SALE PRICE £1.00

Z4294 Neat panel 213 x 37mm with 5 keyboard switches, 3 red LEDs and a DL1416 4 digit LED display with built in memory. There's half a metre of grey ribbon cable attached to a 34 way IDC socket.

Reduced to £3.00

SALE PRICE £2.00

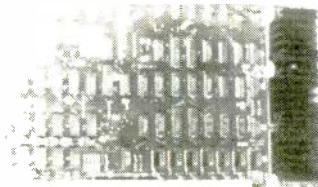

Z4300 Nice panel 330 x 170mm with 3 chunky heatsinks 47 x 36 x 32mm, each with TO220 voltage reg. Also 56 x 74 series ICs including L + LS 3x40W IDC plugs, few tants etc. Attached to the board are 2 x 0.5m long twisted and flat ribbon cables terminated in 50 way IDC sockets.

Price £4.00

SALE PRICE £2.00

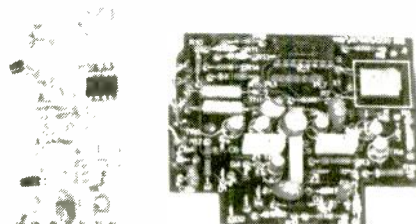

Z4319 Small panel 85 x 43mm with 555 timer, BS107 FET, BC109, 3 x BFW43, 47µF 35V tant + other Rs, Cs etc.

Price 3/ £1.00 100 + 0.15

SALE PRICE 10 FOR £1.00

Z4318 Ex - BT tone divider PCB. Panel 84 x 69mm has on it 2559 tone divider chip, 3 579545 Xtal, 7 small signal transistors, tants, Rs, Cs, etc. Produces required tones for telephone system

Price £1.00 100 + 0.30

SALE PRICE 5 FOR £1.00

Z5203 Relay panel - some panel, this! 50, yes 50 DPCC 24V DC min relays, Omron type G2V (our type W834) on PCB 230x160mm with 2xDIN41612 64 way plugs. At 1 off prices, this would cost around £100, but you can have a complete panel at just 20p per relay - that's only £10.00!

SALE PRICE £5.00

Z5372 Small PCB 102x51mm with 8.4V 170mAh nicad button cell (list 7.31), a DPCC relay and a few other bits £3.00

SALE PRICE £1.50

Z5204 Diecast housing 252x140x25mm (subscriber module) contains PCB with lots of nice high frequency bits, much of which is contained within 2 diecast boxes bolted on to the board. Most of the transistors (there are 17 of them) are BF980, BFR90A/91A BFW92 etc. Single output socket, 2 DIN41612 plugs. Great value at £4.50

SALE PRICE £2.00

Z5301 Panel from Z4113 Contains all components, including transformer. Believed unused - some are very dusty. £3.00.

SALE PRICE £1.00

Z5411 Marconi panel 225x195mm. No info on this PSU, but it's got some really nice bits on it - 2 x 2N3716 TO3 transistors, 13 BCY71, 2 x BC107, BFW43, BFX29, LM317K and LM337K TO3 variable voltage regs, some high power zeners, pot cores, R's, C's etc., toggle switch with locking device.

Great value at £3.95B

SALE PRICE £1.50

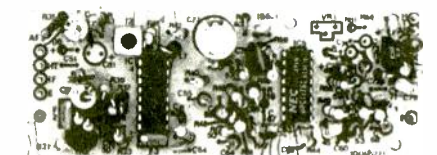

Z910 391 x 39mm. This panel has soldered in components - TCA4500A and TBA651R, AM radio with IF amp. Probably complete RF section of radio, as IF's and trimmer are on board + R's, C's, etc.

Price 60p

SALE PRICE 5 FOR £1.00



Z493 D Module. As above, but PCB has 3 x BC184L, BD124, Rs, Cs etc.

Price £2.00

SALE PRICE 5 FOR £2.00

1/2 MEG MEMORY BOARD

Z8900 Massive panel 460 x 400mm smothered in chips. Could be a complete computer judging by the IC's on the board. Made by Whitechapel Computer Works. Contains at least the following (some panels have extra chips):

64 x 4164-15 RAM's; over 200 74LS, F and other logic chips; 3 x 4016-3, 2 x 8253-5, 8251, 2 x 5516, 6 xtals, 3 x 'D' Plugs and sockets, 3 x DIN 64 way socket, + R's, C's etc. Price equivalent to 4164's @ 30p each and rest of chips @ 3p each!

Price £25.00

SALE PRICE £10.00

RADIO SCANNERS - Send SAE for full details of our range of high quality scanners at great prices!

Z5140 As listed in BL75, but we've found some of these serial parallel interface cards for the Apple II complete with comprehensive 22 page booklet. It provides full serial RS232C output + a fully decoded 8 bit parallel output port. Excellent value at £5.00

SALE PRICE £3.00

Z5408 Heatsink 152x50mm with 4 x T03 devices mounted on it: 2 x 7805CK 5V 1.5A voltage regs (DP 2.00) and 2 x BUY18S, a 200V 15A NPN transistor, in our cat at 2.30. So the total value is 8.60. **our special price £2.50**

SALE PRICE £1.00

Z5263 Panel 80x60mm with FPT100A phototransistor, LM324 quad op amp. 24V SPCO heavy duty relay. BC546, diodes, R's and C's. Smashing little board **only £1.00**

SALE PRICE 2 FOR £1



Z4368 Panel 310 x 90mm with 20 CMOS chips, 3 x MC1488, 2 x MC1489, 6 x C251 opto isolators and a 64 pin chip MB60504.

Reduced to **£2.00**

SALE PRICE £1.00



Z4279 Interesting little panel (75mm x 40mm) with 16 position BCD channel switch (24 pins), 2 dual green 7-segment displays: 2 min keyboard switches, and a short A4093. Attached by a short length of ribbon cable is a second panel (same size) with 4518, 4019 and 2 x 5068 chips. Supplied with circuit.

Price **Only £2.20**

SALE PRICE £1.00

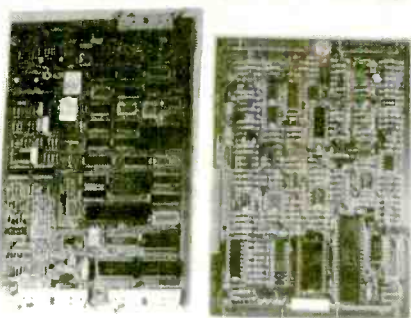

Controller Boards

PCB 175 x 122mm containing a wealth of components - 80C39 CPU, 4 x TL066, TL094, CMOS and 74 series chips, 8 x T0126 transistors, 13 T092 transistors and lots of R's and C's etc - also a 3V lithium battery. 3 connectors on it go to (a) card reader (b) motor panel & (c) display panel which is identical to our Z027 (P111 of Catalogue).

Order Code **Z5047**
 Reduced to **£2.00** 100+ 1.00

SALE PRICE 4 FOR £2

Z5048 Panel 275 x 178mm containing some excellent components: 2 x D8243 I/O expander, 8035 CPU, 8253 timer, 2651 USART all in sockets, 2 x 2111A-4 RAM, 25 mostly CMOS chips, 8 x T0126 transistors, 5 x T092 transistors, R's, C's etc, 26V IDC plug, 2 x 34W IDC plugs, 2 xtals.

Only **£3.00**

SALE PRICE £1.00

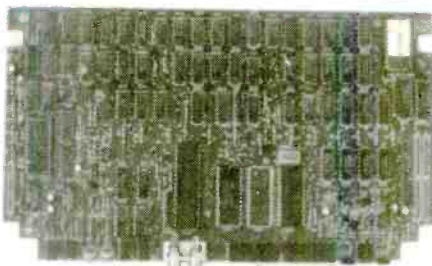

Z672 Newbrain motherboards. Complete but probably faulty **£3.50**

SALE PRICE £2.00

Z674 Newbrain data. Interfaces and connector pin out i/p, o/p, port map, cct diagram + data on CP420C. (This lot replaces cct diag only for 75p) **£2.00**

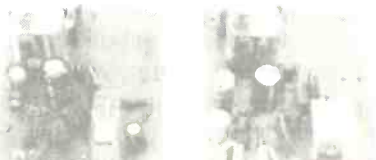

Z925 DPCO 12V 185R relay, 12V DPCO relay with heavy duty contacts, SC146D 400V12A triac, 555 timer, 11 x 1N4001, 2N5061 SCR, 3 x 2N37043, Rs, Cs, etc.

Price **£1.90**

SALE PRICE 3 FOR £2.00

Z926 Similar to above, but instead of heavy duty relay, a T2800D 400V 12A triac and C122D 400V 12A SCR. Both boards 100x75mm **£1.85**

SALE PRICE 3 FOR £2.00

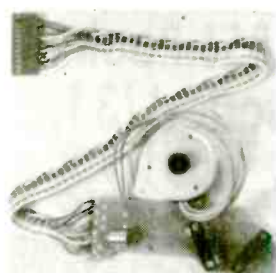

MOTOR PANELS

PCB 92x31mm with mercury tilt switch, 2VTL 10D2 opto slotted switches, length of 11 core cable with socket and stepper motor as described above.

Order Code **Z5046**
 Prices **£3.50** 100+ 2.20

SALE PRICE £1.50

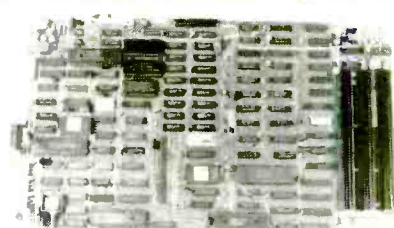

HIGH QUALITY ICL COMPUTER PANELS - 2 types, the first a mother board and the second a panel which plugs into the first.

Z4209 Panel 360x210mm covered in high quality chips: 8085AHC, 8255, 8257, 8251Ax2, 8253 -5, 8275, 8202A, 2732, 2716, all in sockets; 18x41116-2 + other mainly LS chips + min switches, LED's, oscillator, large tants, 3x50 way double sided edge connectors. Amazing value at only **£16.95**

Reduced to **£9.95**

SALE PRICE £5.00



Z5093 Tilt display. Plastic housing 200x95x45mm contains PCB 195 x70mm with 8 7-seg HP LED'S type 5082-7651, red 0.43 CA; 16 5mm red leds, 8255 programmable interface and other chips etc.

Price **£2.50**

SALE PRICE £1.00



1W Amplifier - mono

Z914 Audio amp panel 95 x 65mm with TBA820 chip. Gives 1W output with 9V supply. Switch and vol control. Just connect battery and speaker. Full details supplied

Prices **Only £1.50** 25+ 0.80 100+ 0.60

SALE PRICE 2 FOR £1 BOX OF 128 £35

1W Amplifier - Stereo

Z915 Stereo version of above 115 x 65mm, featuring 2 x TBA820M and dual volume control.

Prices reduced to **£3.00** 25+ 1.80 100+ 1.20

SALE PRICE £1.00 BOX OF 64 £35

Z974 Mixer Amp Panel 115 x 115mm and gives 1W O/P from a TBA820M chip. There are 2 inputs, one via a pre-amp, from phono sockets and separate volume controls. A third pot is used to fade from one input to the other. There are also 2 4p 3w rotary switches. Attached to the PCB by flying leads is a panel on which are mounted the 2 Input sockets, 2 x 5 pin DIN sockets and 2 pin DIN speaker socket. A data sheet is supplied.

Price **Only £2.50**

SALE PRICE £1.00



Z1699 Mini inverter - This handy PCB 31 x 23mm uses a 2 transistor circuit to provide a 60V peak ac supply (20V dc (a 1mA) from a 3-7V dc input. Can be used to drive Z1637 LCD or for powering vacuum displays. Originally used in Newbrain computer.

Price **3/ £1.00**

SALE PRICE 10 FOR £1



Z5283D Metal detector panel 185x115mm. This is the complete PCB from an expensive (£80+) "treasure detector" - just add wire coil and meter to make a working unit. Circuit uses 15 transistors and 3 IC's. There are 5 pots and a rotary switch. Detailed Info supplied. **£12.95**

SALE PRICE £9.95

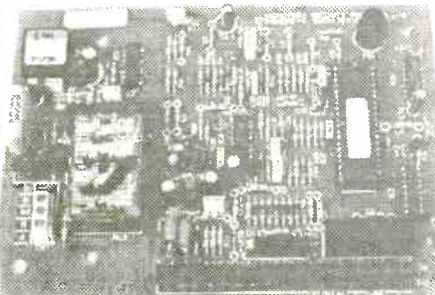
ALARM PANEL

Z5515 Brand new panel 165x127 by Microtech Security. These are for use in an alarm unit (Digicom 8) and contain some excellent parts. However they need a programmed PROM to make the board functional. 12V supply. 8 inputs. Connexion to BT line via opto-isolators. Useful parts include 2 min 12V DP relays; 2 larger Omron DPCO 12V relays and a Clare mercury wetted relay. Chips: LM567; LM324; ULN2003A. Wiring diagram included. Individually boxed. Great value at **£3.00**

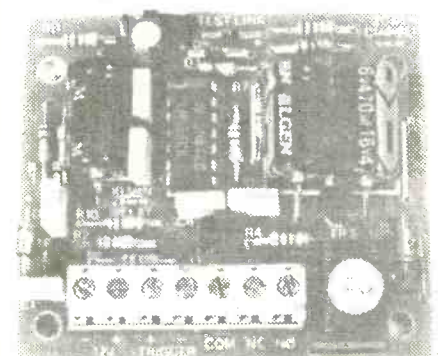
TIMER PANEL

Z5514 Universal bell timer. Panel 63x55mm uses a 556 + 3 transistors to provide both 10 minute delay and 20 min cut off timers, with ability to disable one or other. +ve or -ve trigger. SPCO relay. 12V operation. Supplied bagged with adhesive stand-offs and connexion data. **£5.95**

Xtra Special**BBC SOFTWARE**

Z4333 Micro Maestro 5.25" disk + tape + C60 stereo cassette + handbook. Concert pitch **£2**

Z4334 As above but B flat **£2**

Z4326 Music Master. Mic to attach to recorder + processor + 5.25" disk + handbook 40t **£3**

Z4327 As above but 80t **£3**

Z4328 Recorder Tutor - 5.25" disk, 38p handbook, C90 cassette with 52 tunes **£2**

Z4329 Ensemble Pack **£1**

Z4330 Duet Pack **£1**

Star Buy!!**25% OFF THESE TWO PANELS****Xtra Special****HEATSINKS**

Z2590 TO5 copper 17diax20 16/£1

Z5338 Black finned 38x20x40 6/£1

Star Buy!!**Xtra Special****TRIPLERS**

K856 Pack of 8
assorted (3 types)

£2.50**Star Buy !!****Xtra Special**

Z2651 16.384M 20/£2

Z2665 55M 3/£1

Z1653 2.4576M 3/£1

Z1654 8.863256 5/£1

Z2079 14M 3/£1

Z2151 2.45760M 3/£1

Star Buy!!**Xtra Special****Suppressors & Filters**

Z2444 Protector 14A 5/£1

Z003 Potted, fused 5/£1

J057 6A IEC inlet £1.00

Star Buy!!**Xtra Special****MK 13A SOCKETS**

Z5010 Unswitched 2/£1.50

Z5011 45A Cooker sw £2

Z5012 Term unit £1

Star Buy!!**Xtra Special****1% CAPACITORS**

Z4428 2.2uF 100V

Z4425 1.0uF 100V

5 of each £1**Star Buy!!****Xtra Special****SEMIS**

LAS1905 5V 5A regulator £1.50

7211 4 digit LCD driver £1

Z2321 25A 400V SCR+diode £1.50

Z5244 78M24. Box of 100 £8.00

Z2651 Crystal Reel of 1000 £50

Z2858 40A 800V Diode 4 for £2.50

Z1661 27C32 12/£1

Z1662 8050AH 4/£1

Star Buy !!**Xtra Special****CALIPERS**

Y024 6" Inside & Outside

1 pair of
each for **£2.50**

Star Buy!!**Xtra Special****SPEAKERS**

Z5266 45mm 15R 6/£1

Z945 5x3" 80R 1W 2/£1

Z578 30mm 16R 0.4W 5/£1

Z5275 57mm 8R 6/£1

Z5267 57mm 75R 6/£1

Z5419 63mm 4R 8/£1

Z533 20mm 50R 3/£1

Star Buy !!

GREENWELD 27 Park Rd. Southampton SO1 3TB
Tel: 0703 236363 Fax: 236307

All one off and pack prices **INCLUDE** V.A.T. Qty. prices do not.

SUPER SENSATIONAL SUMMER SALE **33**

VICTOR

vicki 86 XT PC

We have a limited quantity of these high quality units - the beautifully styled beige base unit measures 395x330x130mm and is fitted with an 8086 motherboard with 640k base memory, 3.5" 720k disk drive, 75mm dia speaker and a fan cooled switch mode power supply unit. There are 5 8 bit expansion slots and room to fit a further drive. Socketry includes 9 pin D for standard mono monitor, 25 way D parallel and 9 way D serial ports, 7pin DIN keyboard socket and power inlet. The keyboard is a standard PC XT layout, but some keycaps need to be changed for English version (Intended for the German market; stickers supplied). Excellent build quality - steel case cover with plastic fascia.

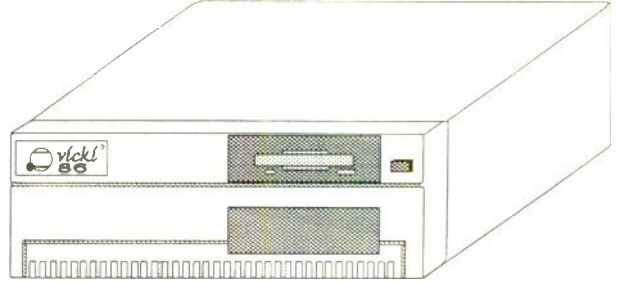

SALE PRICE

£99.95

WINDOWS SOFTWARE SCOOP!!

All brand new product in sealed packages at enormous savings!

Microsoft Windows 3.0

Supplied on 5 3.5in 1.44mb Disks
With 640 Page Manual

Order Code **Z9151**

OUR PRICE £14.95

BUY BOTH FOR JUST

£34.95

PFS: Window Works

Integrated package featuring word processor with page layout, chart editor, database, comms module, address book and label maker. Supplied on 3 3.5in 720k disks. Needs 4Mb hard disk space on a 286 or better. Lots of on screen help. Less than a year ago it sold for over £100!!

Order Code **Z5554**

OUR PRICE £24.95

SOME MORE GOODS JUST ARRIVED



Z5560 Ni-Cad battery pack. 10 'C' size cells contained in 2 tubes - easily taken apart if required. Rated 12V 1700mAh. Only **£6.95**.

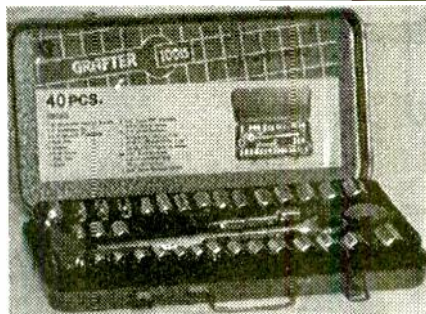

Z9155 40 piece socket set by 'Graftor'. Good selection of sockets at a modest price - 5/32 - 9/16 & 4-14mm + handle, extn, adaptor etc, all in a hinged metal case **£6.95**

HEADPHONES



H8 Excellent quality Adastra stereo headphones with boom microphone. Freq. response 20-20,000Hz, 32R Impedance. Microphone 600R. 2m leads fitted with 3.5mm plug for mic, and 3.5 mm plug + adaptor for headphones. Padded earpieces and leatherette headband.

SALE PRICE £4.95

RADIO SCANNERS - Send SAE for full details of our range of high quality scanners at great prices!

HUGE REDUCTIONS IN AUDIO/VIDEO PROCESSORS SUPER QUALITY PRODUCT FROM HAMA



The purpose of video film editing by copying is to improve, and not to diminish, the quality of the original. Yet what is the use of editing out a bungled scene, only to find that copying results in a sharp deterioration of the image quality? This would be totally counter productive. The Audio Video Processor AV 125, described on pages 166-167, polishes up the video signals while they are being copied so that there is no deterioration in quality. On the contrary, flat colours become brilliant, and fuzzy edges become sharply defined, for superb presentations that appeal to the viewers. But there are those who do not have such ambitious aims and also wish to save money. Hama has taken such needs into account with their "beginner's" model which offers remarkable capabilities at a very reasonable price.

Audio Video Processor AV 140
 Corrects the video colour signals from recorders or cameras while copying from tape to tape. Both colour intensity and contrast can be continuously changed. A record player, CD player or cassette deck can be connected to add a new source of sound to the original sound in any variable mixing ratio. A microphone connection is also provided. A significant benefit: Two copies can be simultaneously produced!
 40140

LIST PRICE £179.99

SALE PRICE £79.95

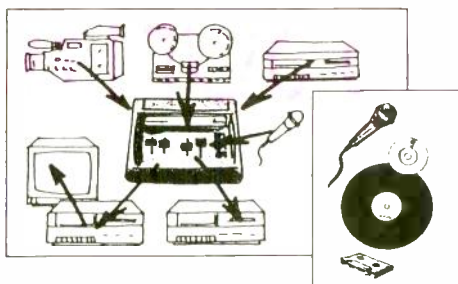

It couldn't be easier

Video film copying is child's play with the HAMA AV 140. Two Euro-AV sockets establish the contact between the playback and recording units. And there is no longer any replugging if the copying direction is to be reversed. Simply push the input key to decide whether copying is from unit 1 to unit 2, or vice versa. Two LEDs indicate the selected direction. And with the bypass switch you can decide whether the signals require enhancement or not. Everything is under your complete control, and the results can always be checked on the monitor which displays either the original or the enhanced picture.

To get the best from your home movies, you'll need the book and the video...



Video Fascination
 The New Guide to Better Video

Superb quality large format (A4) 256 page hardback book full of tips, procedures and equipment produced by Hama. Not just a showcase for their excellent quality goods, but lots of useful information, including how to produce a finished video - storyboard, planning, shooting, editing. Excellent value of £14.95. Order Code 97426

To accompany the book, a 40 minute video has been produced, showing how to achieve the best results from your camcorder. £14.95. Order Code 97598

SALE PRICES:
 (Only when purchased with one of these processors)
£7.50 each

Audio Video Processor AV 142
 This model extends the scope of the AV 140 (see left) by definition, brightness and fades while copying a video film. A screen splitter compares the original picture with the settings that have been adjusted on the screen. The AV 142 offers added scope in the sound area. The mixing ratio between the original sound of the video can be continuously varied with an external sound source such as a record, CD, cassette or microphone. Furthermore, the microphone signal is separately variable from the record, CD or cassette signal. And obviously, the sound can be either stereo or mono. Perfect pitch adjustment with bass and treble tone. Up to 4 copies can be simultaneously produced.

40142

LIST PRICE £259.99
SALE PRICE
£129.95

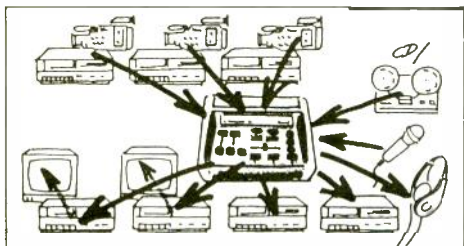

Xtra Special

RESISTORS

Z2104 1R 6w WW 20/£1
Z2105 50R 15W WW 5/£1
Z2106 225R 23W WW 4/£1
Z1877 0R1 11W WW 18/£1
Z1878 0R27 11W WW 18/£1
Z4402 1R 25W WW 4/£1
Z2701 6R8 5W MC 20/£2
Z2702 8R2 5W MC 20/£2

Star Buy !!

Xtra Special

CAPACITOR CLEARANCE

Z2319 47uF 25V axial 1000/£12
Z4343 2200uF 40V can 100/£5
Z4346 15,000uF 25V can 100/£25

Star Buy !!

Xtra Special

Z4135
STEREO
HEADPHONES

£1

Star Buy!!

Xtra Special

**VIDEO HEAD
CARE KIT
2 for £1**

Star Buy!!

Xtra Special

CAPACITORS

Z1539 4.7nF 380V cer 30/£1
Z5218 22000uF 16V 3/£1
Z4277 25uF 450V 50Hz £2
Z1965 0.01 disc 120/£1
0.22uF 1kV axial 20/£1
Z822 800uF 250V can 3/£1
Z5379 2200uF 35V Ax 15/£1.50

Star Buy !!

Xtra Special

ODDS & ENDS

Z5414 Antistatic warning label. 2000/£5
Z5268 Cord Set £1.75
Z2339 100mH 10A coil 6/£1
Z5060 Italian C60 tape + 32 page book 2 for £1
Z4199 Timer £1.50
Z035/6 Term unit £2
Z5270 Ribbons 4/£1
Z5368 Aerials 5/£1
Z2648 UHF Tuner 3/£1

Star Buy!!

Xtra Special

HARDWARE

Z5144 25D covers 20/£1.50
Z5142 Vacuum case 6/£1
Z2175 4x0.5" pozi pan screws
Z5408 Heatsink with 2x7805 & 2xBUY18S (both TO3) £1.00
Z07007 Sleeved grommet 120/£1
Z2311 Knobs, solid black ally 6/£1
Z4283 Sealing strip 50m/£3
Z5349 32mm conduit clamp 12/£1
Z5149 Self amalgamating tape 125m x 13mm £5
Z5164 As above but 21mm wide £7

Star Buy!!

Xtra Special

SWITCHES

Z2166 microswitch 12/£1
Z2341 DIL switch 10/£1
Z2499 limit switch 8/£1
Z2491 microswitch 4/£1
Z1522 CB switch 2/£1
Z2492 cased uswitch 2/£1.50

Star Buy !!

Xtra Special

Z655 PLASTIC PUMP
(from cream dispenser)

10 for £1

Star Buy!!

Xtra Special

Superb Sub-min mic
Z2642 Ideal for bugs, etc
Size 10x7x4mm

3 for £1

Star Buy!!

Xtra Special

LEADS

at ludicrous prices

Z5416 25D p-25D s £1
Z5087 6pin-3phono 4/£1
Z5433 25D s-10w miniDINp 2/£1
Z2346+Z5169 Cable mntg 3w p + skt with 2m 6A lead £1.50pr

Star Buy !!

Xtra Special

SWITCHES

Z1816 Min PCB togg SPCO 6/£1
Z1837 Illum DP push £1
Z2167 sp keyboard 12/£1
Z2108 4p3w rot 6/£1
Z2140 4p3w rot 8/£1
Z2361 HD push c/o 6/£1

Star Buy !!

EVERYTHING ON THIS PAGE 2 FOR THE PRICE OF 1

Code	Type	Description	List	Our Price	Semiconductors	
Z6124	ICM7170IPG	CMOS µP real time clock - µs to years	8.95	£4.50	We've found a number of odd devices whilst clearing out a store, all offered at silly prices.	
Z6125	IRF740	400V TO220 10A 125W MOSFET	2.09	£1.00		
Z6126	IRFR014	TO252 HEXFET 60V 33A 25W	1.07	2/£1.00	(a) Diodes	
Z6127	L4885CX	?		£1.00		
Z6128	LM2902D	Quad op-amp	0.82	3/£1.00	Z2746 ITT907	Pick
Z6129	LM2903N	Dual low power comparator	0.76	3/£1.00	Z2747 ITT920	anywhere
Z6130	LM293N	Dual comparator		£1.00	Z2748 ITT12601	at 500
Z6132	LM336B25	Voltage ref diode TO92 2.5V	4.58	£2.50	Z2749 XK3117	for
Z6133	LP365N	Quad low power programmable comparator 4000ns	0.90	2/£1.00	Z2750 BAX12A	£5.00
Z6134	MC1489AP	Quad RS232 line driver	0.45	4/£1.00	Z2751 OAZ201	Min 100 of
Z6135	MC3486P	Quad diff RS422/3 line receiver	1.08	2/£1.00	Z2752 TI621425	one type
Z6137	OP07EP	Precision op amp	0.92	2/£1.00		
Z6138	2N4392	TO18 FET, N, 40V 300mW	1.23	3/£2.00	Z2753 1N5361A plastic 27V 5W zener. 6 for £1.00	
Z6139	6N139	Darlington single opto coupler 400%	1.30	3/£2.00	Z2754 Stud mounting rectifier, no nuts. 16F40 400V 16A 4 for £1.00	
Z6140	BD436	4A PNP TO126 32V 36W	0.68	3/£1.00	Z2755 Stud mounting zener 1S5056 rated 10W 5.6V. 3 for £1.00	
Z6141	BF869	50mA NPN TO202 250V 5W	0.66	3/£1.00	Z6123 BB105B varicap diode 17.5pF @ 1V; 11.5pF @ 3V. Pack of 3 £1.00	
Z6143	CDP1871ACE	RC IC?	13.86?	£5.00	Z2756 SD2 pair of recifiers connected thus:	
Z6144	D8753H	?		£10.00		
Z6145	DG417DJ	Precision SPST CMOS analogue switch	1.76	2/£1.00	400 for £2.00	
Z6146	MC6809P	8 bit CPU	2.17	£1.00	Z2757 S03 as above. Same price	
Z6147	MCT2E	Transistor opto coupler 2.5kV 20%	0.45	4/£1.00		
Z6148	MK4501N-12	512x9 Biport FIFO 120ns	4.78	£2.50		
Z6149	NM58274CN	µP real time clock	7.93	£4.00		
Z6150	N82S129AN	1k bipolar RAM (256kx4)	1.95	£1.00		
Z6151	NM1630	Quad translator 5-15V logic isolation	10.10	£5.00		
Z6152	NMA0505S	?		£2.00		
Z6153	NMC9346N	E²PROM	1.43	3/£2.00	(b) Integrated Circuits	
Z6154	OP27GS	Low noise op-amp SM	3.17	£1.50	Z6101 LM305H +4.5V to +40V 45mA TO99 voltage regulator. 3 for £1.00	
Z6156	PALCE29MA16H-25	29 input, 16 prog output		£5.00	Z6102 LM306H voltage comparator £1.00	
Z6157	RC5534ANB	wide bandwidth, low noise op amp	1.18	2/£1.00	Z6103 SN76033N audio amp £3.00	
Z6159	S17660DJ	?		£1.00	Z6104 SN76023ND audio amp £2.00	
Z6160	TIBPAL22V10ACNT	22 input 1 time prog PLD	£10.00	£3.00	Z6105 MC8500P £2.00	
Z6161	TL7705ACP	+5V µP power supply supervisor	£1.75	£1.00	Z6106 MC2116J-15L £1.00	
Z6162	TL7705AID	do		£1.00	Z6107 SH3011 8 pin TO3 device. Voltage reg? £1.50	
Z6164	TLC272CD	dual do	1.17	3/£2.00	Z6108 MC68008L8 £2.00	
Z6166	TMS9129NL	?		£10.00	Z6109 7107 DPM £3.00	
Z6167	UC3524AN	Enhanced SMPSU circuit	1.53	3/£2.00	Z6111 1DAC80-CB1-V-C D/A converter £1.00	

SM = Surface Mount (there may be some SM not so indicated - we're working from a list rather than the devices themselves).

Yet another parcel of semi's - this one has been in stock for some time, but haven't time to sort and list it!

Code	Type	Case	Description	Qty	Price
Z2874	723	TO99	V. Reg. +2V to 37V 0.1A	260	3/£1.00
Z2875	TAG306/400	TO66	Triac 6A 400V	100	3/£1.00
Z2876	TAG310/400	STUD	Triac 10A 400V	34	3/£2.00
Z2877	TAG3/400	TO66	SCR 5A 400V	74	3/£1.00
Z2878	40430	TO39	Unknown	750	5/£1.00
Z2879	TAG240/500	TO220	Triac 6.5A 500V	250	3/£1.00
Z2880	TAG06/200	TO18	SCR 0.8A 200V	94	5/£1.00
Z2881	2S323	TO18	Transistor	1300	£2.00
Z2882	2S324	TO18	do	500	£2.00
Z2883	BC177A	TO18	do	275	10/£1.00
Z2884	2N4905	TO3	do	90	£2.00
Z2885	2N5108A	TO39	do	156	2/£1.00
Z2886	2N3019	TO39	do	30	2/£1.00
Z2887	2N2223	TO5	dual do	34	£1.00

CODE	TYPE	DESCRIPTION	QTY	LIST	OUR PRICE
Z6168	7905CT	-5V 1A TO220 Regulator	353	42p	8/£2
Z6172	81LS95		396		£1.00
Z6173	VT7C122-15	22 Pin Dii	300		£1.00
Z6174	MCM6064P12	28 Pin Dii	150		£1.00
Z6175	AM9517A-4DC	40 Pin Dii	58		£1.00
Z6176	82S09	28 Pin Dii	94		£1.00
Z6177	MJ2813	28 Pin Dii	175		£1.00
Z6178	P8275		16		£1.00
Z6180	TIBPAL6R4-25CN		9	1.64	£2/1.50
Z6181	TIBPAL16L8-15CN		30	1.64	£2/1.50
Z6182	PAL10H8CN		10		£2.00
Z6183	PALCE26V12H-25PC		12		£2.00
Z6284	AM26LS31	16 Pin Dii	29		£1.00
Z6187	AM26LS32		41		£1.00
Z6188	AM9122-25		10		£1.00
Z6189	PALC18U8Q-25CN		20		£2.00
Z6190	Z80A S10-2		6		£1.00
Z6191	MK3887N-4		35		£1.00
Z6192	Z80A CTC		25		£1.00
Z6193	P21256-12	256K Dynamic RAM	238	3.00	£1.00
Z6194	CDM6264E3	28 Pin Dii 64K static RAM	150	3.00	£1.00
Z6195	MK3885N-4		150		£1.00
Z6196	Z80 SIO-1		13		£1.00
Z6197	P82530-6		5		£1.00
Z6198	VT7C122-12		102		£1.00

Don't miss the Bargains - Become a Subscriber!

CODE	TYPE	DESCRIPTION	QTY	LIST	OUR PRICE
Z6169	Z80ACTC	Counter timer and controller	100	1.99	£1.00
Z6170	P82510	High Intergration CMOS UART	41	19.27	£5.00
Z6171	SAB80535-N (plcc)	8 bit CPU,256 bits RAM, 12MHz	65	8.46	£2.50
Z6179	M80C31F (plcc)	8 bit CPU,128 bits RAM, 12MHz	52	2.64	£1.00
Z6199	V20 MICRO	(8609H9V20) NEC	13		£3.00
Z6200	ET12BC	A-D CONVERTER	5		£1.00
Z6202	27C64Q-200	64K EPROM 12.5V Vpp CMOS	80	4.11	£2.00
Z6203	2764D	64K EPROM	65	3.99	£2.00
Z6204	Z80CPU	8 Bit CPU	7	3.00	£1.00
Z6205	51R90035BQ1	24 Pin Device by SEEQ	16		£1.00
Z6206	PAL20R6BCNS	Hex 20 Input and/or Gate Array	55		£1.00
Z6207	MK2716J-8	16 K EPROM	34	5.28	£1.00
Z6208	AM2764A-2	12.5V PGM EPROM 64K	26	3.99	£2.00
Z6209	TMS2732A-35J	32K EPROM	51	4.70	£1.50
Z6210	TMS2764-25JL	64K EPROM	10	3.99	£2.00

LATE ARRIVALS

Stocks listed on this page have only recently arrived, and although not included in our SALE they represent such good value for money, we thought you'd like to see them anyway

Amazing Clock & Min/Max Temp Modules!



Z5558 LCD Min/max electronic thermometer module. Reads -5 to +50C (23-122F) Resolution 0.1. Accuracy ±1C. Uses single AA 1.5V cell. Size 68x35x24mm. 13mm display. Supplied with comprehensive instructions.

SUPER BARGAIN BUY - ONLY £3 100+ 2.00



Z5557 Clock module with timer and two alarms. Displays day, hour, min and AM/PM. Overall size 48x32x7mm; display 10mm.

AMAZING PRICE! £3 100+ 2.00

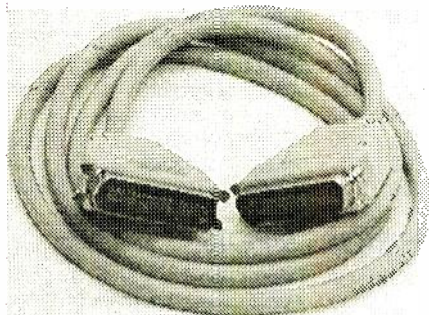

Z5555 Centronics lead - 36 way plug both ends, 1.8m long **£2.50**

Some more surplus from Adastra:

Z5553 Intercom lead - 15m of twin flex wound on a handy frame with a 2.5mm plug either end. Great value at **60p**; 100+ 0.25; 1000+ 0.20

XLR connectors - high quality brass chassis mounting:

Z3012 3 pin socket with release catch **£1.00** 100+ 0.60

Z3013 3 pin plug **80p** 100+ 0.50

Z3014 Standard 75R BNC Plug Cat price 99p Superdeal 5 for **£2.00** 100+ 0.25 1000+ 0.20

FIBRE OPTIC CABLE

Just purchased 40,000m of 0.2mm dia top quality fibre optic cable. Ideal for modellers and experimenters. Last time we had this (Winter 91/92) it whizzed out the door - so don't leave it too long before ordering!

Tech Spec: 1310nm - 0.32-0.39dB/km
1550nm - 0.22-0.24dB/km.

Sold in the following packs:

Z3015 10m **£2.00**

Z5559 100m **£12.00**

Z9153 1000m reel **£85**

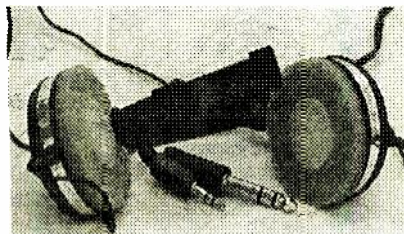

Z5560 These headphones have excellent quality transducers, although the gimmicky fold-up style leaves a bit to be desired. Supplied with mini plug + adaptor to std size. **£3.95**

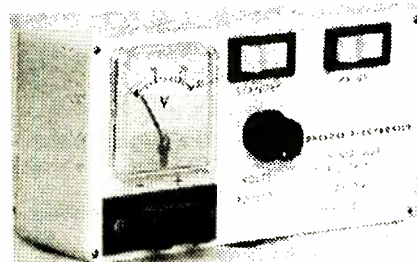

BENCH POWER SUPPLY

Z9154 Well made by Wednesday Electronics, this variable output PSU has std mains input and 0-30V DC 1.5A output. Line regulation 0.01%/V; Load regulation 0.1%; Ripple rejection 65dB; Quiescent current 3.5mA; Output noise 150µV; Size 168x82x55mm. Individually boxed with instruction leaflet.

PRICE £29.95

We're re-offering some red LED displays which have appeared in previous lists; now at much reduced prices.

CODE	TYPE	SIZE	CA/CC	DP	QTY	£2PACK	100+	1000+
Z3001	S806RWB	20mm	CA	RH	792	8	.12	.08
Z3002	LTS312R	0.3"	CA	BOTH	1325	15	.08	.05
Z3003	3719	0.3"	CA	RH	1075	20	.05	.03
Z3004	3729	0.3"	CA	RH	9807	20	.05	.03
Z3005	MIP4710	0.43"	CA	RH	1705	20	.05	.03
Z3006	MAN4710A	0.43"	CA	RH	1441	20	.05	.03
Z3007	MIP4720	0.43"	CA	LH	977	20	.05	.03
Z3008	MIP4920	0.43"	CA	NONE	3983	20	.05	.03

MORE POWER SUPPLIES!

Nice parcel of PSU's, -2 switch mode, 2 linear.

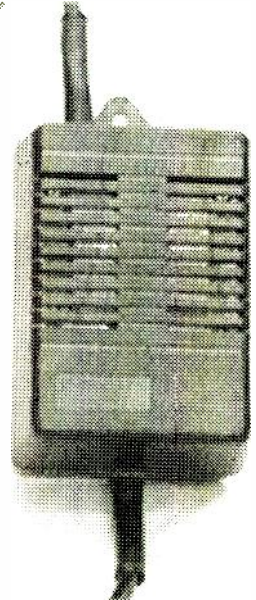

Z5549 Black plastic cased transformer 102x77x70mm with single 'keyhole' hook for hanging on wall. 2m long 3 core mains cable and 2m long output lead terminating in 3 pin socket. 240v ac input, 18v 2.15A ac output. Room inside for bridge, cap and regulator if required. **£4.95**

Z5550 Similar to above, but output lead has 4 way socket. This one is rated 230v ac input, 12v+12v each at 1A ac output. **£4.95**

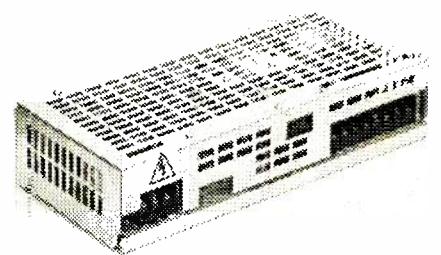

Z9148 QUEL Powerline switch mode PSU. Ventilated case 267x120x57mm. Input: 42-56V DC. Output: +5V 25A; -5V 4A; +12V 4A; -12V 4A; +24V 4A. Max. output power 200 watts. **£ 9.95**

Z9145 As above, but input 115/230vac (or 325v DC). Outputs: +5v 25A; -5v 4A; +12v .3A; -12v 3A; -48v 2A. Max output power 200 watts. **£19.95**

1/3rd OFF ALL ITEMS ON THIS PAGE

Bi-Pak Clearance 1/3rd off all remaining Bi-Pak product - please give alternatives where possible, as stocks are low on some items

SEMICONDUCTOR PACK

An incredible assortment of devices ranging from small signal diodes through transistors, ICs, regulators, SCRs, triacs, small signal, power, AF, RF. All are new full spec devices, so this pack offers really great value:

Table with 3 columns: Code, Description, Price. Includes items like VP917 Pack of approx 200 Transistors, 4A, with data. £8.00 and VP918 Pack of approx 1000 Transistors, 4A, with data. £30.00

TRANSISTORS

Table with 4 columns: Pack No, Qty, Description, Price. Lists various transistor types such as PNP, NPN, and Sil Transistors with their respective prices.

Table with 4 columns: Pack No, Qty, Description, Price. Lists NPN and PNP Transistors like BFY50/51 and BD244AX.

ICS

Table with 4 columns: Pack No, Qty, Description, Price. Lists various ICs including 74LS00, 74LS74, CD4001B, and 741P 8 pin.

74 SERIES SALE 'ROCK BOTTOM' PRICES

Table with 4 columns: Pack No, Qty, Description, Price. Lists 74 series TTL ICs and other components like 74111 Dual J-K Master Slave and 74121 Monostable Multi Vibrator.

CAPACITORS

Table with 4 columns: Pack No, Qty, Description, Price. Lists C280 Capacitors metal foil mixed values and Electrolytics all types.

Table with 4 columns: Pack No, Qty, Description, Price. Lists Electrolytics, Miniature layer metal Capacitors, Tantalum Bead Capacitors, and various other capacitor types.

RESISTORS & POTS

Table with 4 columns: Pack No, Qty, Description, Price. Lists Assorted resistors, Carbon resistors, 0.25-0.5W performed mixed, and Precision resistors.

MINIATURE CARBON FILM RESISTORS 0.25 & 0.5W 5%

Resistance values from 1Ω-10megΩ. Available in lots of 100 pieces per value. To order state R100 0.25W or R200 0.5W, plus resistance required. eg R1001k = 0.25W 1k.

BI-PAK PRICE PER 100 PIECES R100 £1.00 per pack. R200 £1.30 per pack.

RESISTOR DEVELOPMENT PACK

R199 100 of each value individually packed from 1R to 10M 1/4W 5% resistors. Total 8,500 would normally cost £85.00. Special low price £45.00

1/3rd OFF ALL ITEMS ON THIS PAGE

A range of miniature pots with spliced 6mm shaft. Body is 17mm dia. and fixing requires a 7mm hole.

Code	Qty	Description	Price
BP633	4	50k lin.	£1.00
BP634	4	100k lin.	£1.00
BP636	4	5k log.	£1.00
BP638	4	50k log.	£1.00
BP639	4	100k log.	£1.00
BP640	4	1M log.	£1.00
BP641	10	Assorted lin values.	£2.00
BP642	10	Assorted log values.	£2.00
VP144	4	100k lin multi turn Pots, ideal variable cap tuning.	£1.00
VP145	10	Assorted Pots, inc dual and switched types.	£1.00
VP148	30	Pre-sets, horizontal and vertical mixed values.	£1.00
VP273	10	10k Lin rotary potentiometers, slim spindle.	£1.00
VP23	10	40mm track slider pots. 100k lin.	£1.00

TOOLS

Vice

VP95 Plastic miniature vice with suction base. £1.75

Rules

VP405 Steel Rules 1 x 4", 1 x 10", measuring ins and mm. 2 for £1.00

VP89 2m/6ft steel tape measure. ABS plastic case. Autopush return. £1.75

Hacksaw

VP406 Junior hacksaw and 3 blades + Hobby knife and 2 blades. £1.00

Hex wrenches

VP410 18 pc Hex Wrench keys. AF sizes in wallet. £1.50

Pliers, Snips & Cutters

VP417A Miniature 4" adjustable wrench. Forged alloy steel. £2.25

VP417 6" adjustable wrench. Forged alloy steel. £2.50

VP415 5" grip locking pliers. £3.00

VP414 End Action Stripping Pliers, adjustable jaws. £1.00

VP221 Miniature Long-nose pliers. £1.55

Snipe & Combination Pliers. 5" red insulated handles. £4.50

VP412 Crimping Pliers, Wire Strippers and Bolt Cutters. £2.00

VP571 4½" pliers. Green insulated handles. £1.95

VP570 4" end nippers. Blue insulated handles. £1.95

VP418 8" tin snips. Hardened steel spring joint. £2.00

Screwdrivers

VP218 Watchmakers Screwdriver Set 6 pieces. £1.75

VP425 7 pc high quality screwdriver set. £8.00

VP426 7 pc high quality screwdriver set 1000V. £12.50

VP427 6 pc cushion grip screwdriver set chrome steel. £4.00

VP103 6pc STANLEY screwdriver set, flat and crosspoint. £3.50

VP422 Screwdriver 400mm long No 2 crosspoint, extra long reach. £3.00

VP421 Screwdriver 400mm long 6mm flat blade, extra long reach. £3.00

VP420 'Chubby' screwdrivers, flat blade 4.5 & 6mm. 2 for £1.50

VP419 'Chubby' screwdrivers, crosspoint No 1 & 2. 2 for £1.50

VP575 Ball Grip Ratchet Screwdriver with 2 flat, and 2 pozidrive bits. £2.50

Files

VP407 10 pc Needle File Set. £3.00

Soldering

VP258 1 Multicore Solder, 5m total, 18 and 22SWG. £1.00

VP247 15W 'Lightweight' high quality low cost soldering iron. 1.7m lead. £3.50

VP491 12V 15W soldering iron, 4.3m lead with car cigar type plug for mobile use. £3.00

OPTO

Pack No	Qty	Description	Price
VP26	15	Small 0.125" red LEDs.	£1.00
VP28	10	Rectangular 0.2" red LEDs.	£1.00
VP*30	6	Red 7 seg CC 14mm x 7.5mm RDP FND353 LED Display.	£2.00
VP131	4	Green 7 seg CA 0.6" LDP XAN6520 LED Display.	£2.00
VP133	6	Red overflow 0.6" 3 x CA 3 x CC 6630 50 LED Display.	£2.00
VP*34	5	Green overflow 0.6" CA XAN 6530 LED Display.	£2.00
VP138	20	Assorted LED Displays our mix with data.	£5.00
VP147	1	Pair Opto Coupled Modules with data.	£0.60
VP*99	4	DL707R LED display CA.	£1.00
VP203	15	Triangular shape LEDs mixed colours.	£1.00
VP207	10	Small 3mm yellow LEDs.	£1.00
VP243	3	Tricolour LEDs rectangular, 5mm, red, green, yellow.	£1.00
VP266	10	Large 5mm orange LEDs.	£1.00
VP279	10	OCP71 Photo Germanium Transistor PNP.	£1.00
Code	Qty	Contents	Price
VP284	2	Opto-isolator IL74-4N27, single.	£1.00
VP285	1	Dual Opto-isolator ILD74.	£1.00

INDICATORS

Code	Qty	Description	Price
1534	5	T 1½ LES Bulbs 6V 0.36W.	£1.00
1535	5	T 1½ LES Bulbs 6.5V 1W.	£1.00
1536	5	T 1½ LES Bulbs 14V 0.75W.	£1.00
1542	5	MES Round 12V 2.2W.	£1.00
1539	5	MES Round 6.5V 0.15A.	£1.00
1552	5	Panel mounting bezel. High quality black plastic with recessed aperture. 6mm dia. For use with 3mm LED.	£1.00
1553	5	As above, but with convex end.	£1.00
VP578	3	12V indicator. Red, 8mm dia x 30mm long. 220mm long wires.	£1.00
VP579	3	Panel mounting 3mm Green LED in chrome holder. Needs 7mm hole.	£1.00

DIODES & SCRS

Pack No	Qty	Description	Price
VP29	30	Assorted volt Zeners, 50mW-2W.	£1.00
VP30	10	Assorted volt Zeners, 10W coded.	£1.00
VP31	10	5A SCRs TO66, 50-400V, coded.	£1.00
VP32	20	3A SCRs TO66, up to 400V, coded.	£1.00
VP33	100	Silicon Diodes like IN4148.	£1.00
VP34	200	Silicon Diodes like OA200/BAX13-16, 40V.	£1.00
VP35	50	1A IN4000 Diodes all good uncoded.	£1.00
VP49	30	Assorted Silicon Rectifiers 1A-10A mixed volts.	£1.00
VP141	40	IN4002 Silicon Rectifiers 1A, 100V preformed pitch.	£1.00
VP184	3	4A 400V Triacs plastic.	£1.00
VP187	10	SCRs 800mA 200V	

Code	Qty	Contents	Price
BP814	10	7482	£1.00
BP816	10	7484	£1.00
BP817	8	7491	£1.00
BP818	8	7492	£1.00
BP819	8	7493	£1.00
BP820	8	7494	£1.00
BP821	8	7495	£1.00
BP822	8	7496	£1.00
BP828	5	74141	£1.00
BP829	8	74151	£1.00
BP830	8	74153	£1.00
BP831	8	74155	£1.00
BP832	8	74156	£1.00
BP833	8	74157	£1.00
BP834	8	74160	£1.00
BP835	8	74161	£1.00
BP836	8	74164	£1.00
BP837	8	74165	£1.00
BP840	8	74174	£1.00
BP841	8	74175	£1.00
BP842	5	74181	£1.00
BP843	8	74182	£1.00
BP844	8	74191	£1.00
BP845	8	74193	£1.00
BP846	8	74195	£1.00
BP847	8	74196	£1.00
BP848	8	74197	£1.00
BP849	8	74199	£1.00
BP850	10	74LS11	£1.00
BP852	10	74LS20	£1.00
BP853	10	74LS26	£1.00
BP854	10	74LS33	£1.00
BP855	6	74LS42	£1.00
BP856	8	74LS55	£1.00
BP857	8	74LS73	£1.00
BP858	8	74LS74	£1.00
BP859	8	74LS76	£1.00
BP860	6	74LS93	£1.00
BP861	8	74LS95	£1.00
BP862	6	74LS122	£1.00
BP863	6	74LS148	£1.00
BP865	8	74LS173	£1.00
BP866	6	74LS221	£1.00
BP868	6	74LS275	£1.00
BP869	8	74LS279	£1.00
BP870	6	74LS393	£1.00

1/3rd OFF ALL ITEMS ON THIS PAGE

VP194	50	2N5064 plastic TO92 OA91 point contact germanium diodes uncod.	£1.00
VP195	50	OA47 gold bonded germanium Diodes uncod.	£1.00
VP196	50	OA70-79 detector germanium Diodes.	£1.00
VP197	50	OA90 type germanium Diode uncod.	£1.00
VP198	40	BA248 Silicon Diode 350V 2A fast recovery.	£1.00
VP222	20	3A stud Rectifiers, 50-400V assorted.	£1.00
VP264	4	3A 400V Bridge Rectifiers.	£1.00
VP265	25	OA10 germanium Diodes.	£1.00
VP274	12	SCRs (Thyristors) 1A 100-400V TO39.	£1.00
VP275	3	5A 400V SCRs, TO220, TIC106D.	£1.00
VP276	5	SCRs standard type 5-16A to 400V.	£1.00
VP277	4	Triacs 2A 400V TO39.	£1.00
VP278	4	6A 1000V plastic Silicon Rectifiers.	£1.00

MISCELLANEOUS

VP872 4 channel light sequencer, chassis version. PCB 143 x 41mm ready assembled for immediate use. Takes up to 200 watts per channel. 4 mode settings. Variable speed control. Each channel individually fused. Just wire in lamps and mains to connector blocks on PCB. £12.95
 VP873 Wireless Babyphone. Small PCB 55 x 20mm contains ready built transmitter operating from 88-108MHz. Operates from PP3 battery. £7.95

VP875 Speaker terminal. Pax panel 60 x 20mm has phono socket and 2 screws. FC52mm Pack of 4 £1.00

ZON X-81 SOUND UNIT

The ZON X-81 sound unit is completely self-contained and especially designed for use with the ZX-81. It just plugs in: no dismantling or soldering.
 No power pack, batteries, leads or other extras. Manual Volume Control on panel - ample volume from built-in loudspeaker.
 Standard ZX-81 - 16K Rampack or printer can be plugged into ZON X-81 Sound Unit without affecting normal ZX-81 operation.
 Huge range of possible sounds for games or: Music, Helicopters, Sci-Fi, Space Invaders, Explosions, Gunshots, Drums, Planes, Lasers, Organs, Bells, Tunes, Chords, etc. or whatever you devise!
 Uses 3-channel sound chip giving programme control of pitch, volume of tones and noise, all with envelope control.
 Easily added to existing games or programmes using a few simple 'BASIC' lines.
 Full instructions with many examples of how to obtain effects and the programmes, supplied.
 Fully guaranteed. £9.95

LOPT TESTER

Dynamic Line Output Transformer Tester. This invaluable piece of test equipment will allow an engineer to test LOPTs under working conditions. It has been designed by a TV engineer with 30 years experience and is both simple to use and effective. Mains operation. £19.95

Tool Sets

VP514	6 pc min. screwdriver set, crosspoint 2.4; 3mm; flat 1.4; 2.4; 3mm.	£1.65
VP513	6 pc min. screwdriver set, sizes 1.4; 1.8; 2.4; 3; 3.8mm.	£1.65
VP512	5 pc min. tool set, 3 hex key wrenches; 2 crosspoint screwdrivers.	£1.75
VP511	5 pc min. wrench set, sizes 4; 4.5; 5; 5.5; 6mm.	£1.75
VP510	5 pc min. nut driver set, sizes 3; 3.5; 4; 4.5; 5mm.	£1.75
VP490	41 pc T-bar socket driver bits set. High quality steel set consists of: 1 pc T-bar magnetic driver handle. 3 pc Phillips bits, Nos 1, 2 & 3 4 pc Slotted bits, Nos 3-4, 6-8, 8-10, & 10-12. 4 pc Allen bits, Nos 3/32 1/8 9/32 & 3/16. 2 pc Square Recess bits, Nos R1 & R2. 6 pc Torx Bits, Nos T-10; 15; 20; 25; 30 & 40. 9 pc Metric Sockets, 5; 6; 7; 8; 9; 10; 11; 12 & 13mm. 9 pc SAE sockets 3/16" 7/32" 1/4" 9/32" 5/16" 11/32" 3/8" 7/16" 1/2". 1 pc 1/4" Socket adaptor. 1 pc Bit adaptor. 1 pc 90° Offset adaptor. Housed in matt steel box. 40 tools in 1 box.	£9.95

Wirestrippers

VP573	Wirestrippers with adjustable stop for 12-26g.	£1.20
-------	--	-------

WIRE & FLEX

Pack No	Qty	Description	Price
VP17	50	Metres PVC single strand wire, mixed colours.	£1.00
VP18	30	Metres PVC multi strand wire, mixed colours.	£1.00
VP19	40	Metres PVC single/multi strand wire, mixed colours.	£1.00

BATTERIES & CAGES

VP178	5	Assorted battery holders & clips, PP3/9, AA/D, etc.	£1.00
VP904	2	Battery cage to take 10 'AA' cells. Uses PP3 connector.	£1.00
VP905	6	Battery cage to take 1 1/2 'AA' cell. Solder tags.	£1.00
205	5	Battery cage to take 4 'AA' cells, 2 each side in line.	£1.00
VP238	4	AA Ni-cad Batteries 1.25V 500mAh CR MA.	£4.00
VP239	2	C-HP11 Ni-cad Batteries rechargeable.	£3.50
VP240	2	D-HP2 Ni-cad Batteries, rechargeable.	£4.00
VP912		Large battery clips with insulated red and black handles. Rated 30A. Overall length 75mm. Per pair 75p.	
VP913		Gun type probes - pull on lever to open jaw. Takes 4mm plugs. Red and black. Per pair	£1.95

MICS, SPEAKERS, EARPIECES

1338	2	Crystal mic insert 23mm dia x 12mm	£1.00
------	---	------------------------------------	-------

VP908	2	Magnetic mic holder for CB mic.	£1.00
VP909	1	2" dia speaker, 8R 0.3W	£1.00
1918	1	2 1/2" dia speaker 80R 0.3W	£1.00
VP910	1	4" dia high power speaker for bass applications. Frequency range 50-8000Hz, max power 20W 8R.	£9.95
VP911	1	8" 8R speaker, max 12W. 60-15000Hz.	£7.95
VP525	1	8Ω earpiece, magnetic, 2.5mm plug.	£0.25
VP526	1	8Ω earpiece, magnetic, 3.5mm plug.	£0.25
VP260	1	9" x 6" elliptical 8Ω 10W RMS speaker. Freq res 60-10000Hz. Gauss 10000. Centre HF cone.	£4.50
VP260A	1	2.25" transducer waterproof speaker. Polyester film diaphragm. Moisture resistant, 8Ω 300mW RMS freq res 20-20000Hz.	£1.00

CASSETTES ETC

VP232	1	Cassette head cleaner/demagnetizer in case.	£2.00
VP230	10	C90 Cassette tape. 2 x 45 minute, low noise.	£6.00

FUSES/HOLDERS

VP176	30	Fuses 20mm and 1.25" glass, assorted values.	£1.00
-------	----	--	-------

BUZZERS, SIRENS

VP107	1	Piezo buzzer miniature, 12V.	£1.25
VP83	1	Electronic buzzer 6V 25mA.	£0.95
VP84	1	Electronic buzzer 9V 25mA.	£0.95
VP85	1	Electronic buzzer 12V 25mA.	£0.95

CONNECTORS

Pack No	Qty	Description	Price
---------	-----	-------------	-------

2.5mm Jack



1696	3	2.5mm Metal screened jack plug	£1.00
------	---	--------------------------------	-------



1706	5	2.5mm Black plastic jack plug	£1.00
------	---	-------------------------------	-------

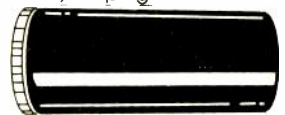





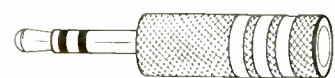





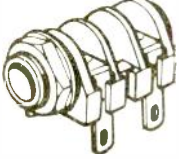
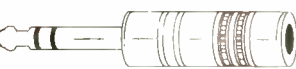
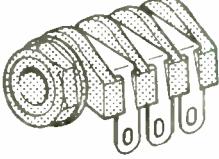



















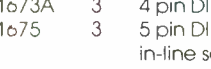

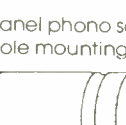

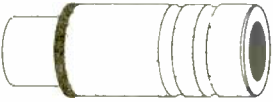

1676	4	2.5mm In-line jack socket	£1.00
------	---	---------------------------	-------

3.5mm Jack

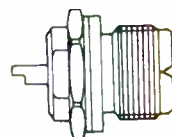

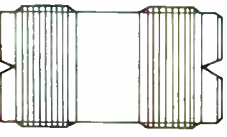
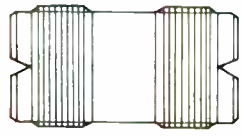
1746A	2	3.5mm Metal stereo plug	£1.00
-------	---	-------------------------	-------

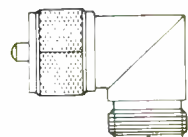
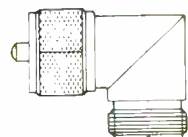
1/3rd OFF ALL ITEMS ON THIS PAGE

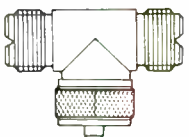
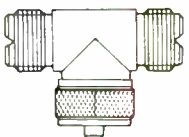
- | | | | | | | | | | | | | | | |
|-------|---|--|-------|--|--|-------|--|--|--|---|-------|---------------------------------|--|-------|
| 1628 | 5 | 3.5mm Chassis mounting socket, enclosed | £1.00 |  | 1664 | 3 | 1/4" socket. Mono switched. Panel mounting. Black Plastic. | £1.00 |  | 1736 | 1 | Panel mounting. 3 pin XLR plug. | £1.00 | |
| 1677 | 4 | 3.5mm In-line socket. Black plastic | £1.00 |  | 1669 | 3 | 1/4" socket. Stereo switched. Panel mounting. Black Plastic. | £1.00 |  | 1737 | 1 | Panel mounting. 3 pin XLR plug. | £1.00 | |
| | | | | 1/4" Jack | | | | | DIN | | | | | |
| 1701 | 2 | 1/4" stereo Jack Plug. Metal; screened. | £1.50 |  | 1669A | 4 | 1/4" socket. Stereo switched. Panel mounting. Black Plastic. | £1.00 |  |  | 1689 | 6 | 2 pin DIN plug. | £1.00 |
| 1707 | 4 | 1/4" stereo Jack Plug. Black plastic. | £1.50 |  | 1673A | 3 | 4 pin DIN in-line socket. | £1.00 |  |  | 1689A | 6 | 2 pin DIN speaker plug, single piece. | £1.00 |
| 1707A | 3 | 1/4" high quality plastic stereo plug with cord grip. | £1.50 |  | 1665 | 2 | 1/4" socket. Built in DPDT switch for headphones Stereo. | £1.00 |  |  | 1691 | 4 | 4 pin DIN plug. | £1.00 |
| 1678A | 4 | 1/4" high quality plastic mono plug with cord grip. | £1.50 |  | Phono | | | |  | 1693 | 4 | 5 pin DIN 180° plug. | £1.00 | |
| 1678 | 3 | 1/4" mono in-line socket. Black plastic. | £1.00 |  |  | 1665 | 2 | 1/4" socket. Built in DPDT switch for headphones Stereo. | £1.00 |  | 1694 | 4 | 5 pin 'Domino' plug. | £1.00 |
| 1679 | 2 | 1/4" mono in-line socket Metal. | £1.00 |  |  | 1665 | 2 | 1/4" socket. Built in DPDT switch for headphones Stereo. | £1.00 |  | 1627 | 3 | 7 pin DIN plug. | £1.00 |
| 1680 | 3 | 1/4" stereo in-line socket. Black plastic. | £1.00 |  |  | 1660 | 8 | Panel mounting phono socket with plastic surround. | £1.00 |  | 1673A | 3 | 4 pin DIN in-line socket. | £1.00 |
| 1681 | 2 | 1/4" stereo in-line socket. Metal. | £1.50 |  |  | 1660A | 4 | Panel phono socket single hole mounting | £1.00 |  | 1675 | 3 | 5 pin DIN 240° in-line socket. | £1.00 |
| 1658 | 3 | 1/4" socket. Mono switched. Panel mounting. Metal. | £1.00 |  |  | 1682 | 3 | In-line phono socket. Metal screened. | £1.00 |  | 1655 | 4 | 5 pin DIN 240° socket. Chassis mounting. | £1.00 |
| 1659 | 2 | 1/4" socket. Stereo unswitched. Panel mounting. Metal. | £1.00 |  |  | 1687 | 6 | In-line phono socket. Plastic in assorted colours | £1.00 |  | | | | |
| 1640 | 0 | 4mm socket. Black | £1.00 |  |  | 1708 | 3 | In-line phono plug. Metal screened | £1.00 |  | 1717 | 2 | SO239SH chassis mounting socket single hole fixing. | £1.00 |
| 1703 | 2 | Car aerial plug. | £1.00 |  |  | 1718 | 2 | PL259 double ended line connector. 2 sockets back to back. | £1.50 |  | 1718 | 2 | PL259 double ended line connector. 2 sockets back to back. | £1.50 |
| 1666 | 3 | Car aerial chassis mounting socket | £1.00 |  |  | 1720 | 5 | PL259 reducer for PL259 plug. | £1.00 |  | 1721 | 2 | Right angle coupler for PL259 and SO239. | £1.50 |
| 1733 | 2 | Car aerial plug. | £1.00 |  |  | 1722 | 1 | T-Adaptor. 2 x PL259 sockets to 1 x PL259 plug. | £1.50 |  | 1760 | 2 | TNC plug. | £1.00 |

1/3rd OFF ALL ITEMS ON THIS PAGE

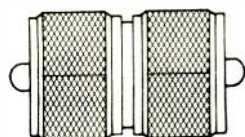

1723 2 Double end line connector. 2 x PL259 plugs back to back. £1.50



1732 1 BNC line socket. £1.50

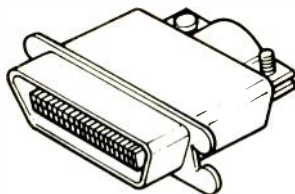

1759 1 IDC amphenol connectors. 36 way plug. £2.00

DC Power



1644 3 2.5mm DC in-line plug. £1.00

1645 3 3.1mm DC in-line plug. £1.00

1646 3 2.1mm DC in-line plug. £1.00



1741 2 3.5mm plug to phono socket. £1.00



1744 2 2.5mm plug to 3.5mm socket. £1.00



1764 2 3.5mm mono plug to 3.5mm stereo socket. £1.00

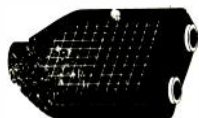

1779 1 1/4" mono plug to 2 x 1/4" mono socket. £1.50

Power

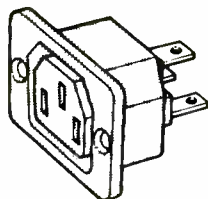

1630 2 3 pole mains outlet. 6A 250V Panel mounting socket. £1.50

1632 2 2 pole mains outlet. 6A 250V Panel mounting socket. £1.50

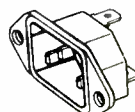

1638 2 Mains inlet. 3 pin EEC Panel mounting plug. 6A 250V. £1.00

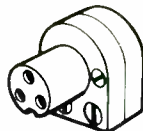

1639 1 3 pin right angled in-line Bulgin socket. £1.50



1641 1 6 pole Bulgin in-line socket, mains connector. £1.50

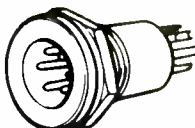

1642 1 6 pole Chassis mounting plug. Bulgin mains inlet fits 1641. £1.50



1643 2 3 pole Chassis mounting Bulgin plug. £1.50

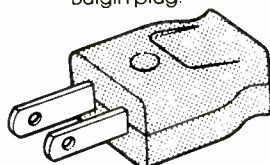

1667 3 2 pin AC mains socket. USA type panel mounting. £1.00

1711 3 2 pin USA type flat pin plug. Plastic £1.00

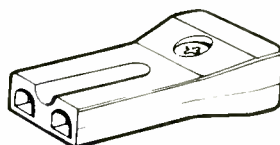

1713 3 cassette mains in-line socket in black plastic with guide. £1.00

VP226 20 DIN chassis sockets metal 2-8 pin 180° 240° 360° mixed. £2.50

VP227 18 DIN in-line sockets plastic 2-8 pin 180° 240° 360° mixed. £2.50

VP484 1 Pair line socket and chassis plug Euro style 6A 250vac. £1.00

VP485 1 Scart plug, 21 way Euro Video plug. £1.00

VP486 1 2 x 23 way edge connector and matching PC board, blanked at pin 3 as for ZX81, etc. £1.00

LEADS & TELEPHONE ACCESSORIES

VP300 10m Speaker lead, 2 pin DIN socket. £1.00

VP301 2m video lead coax socket - coax socket + 2 adaptors. £1.20

VP302 3m 4 core cable individually screened 5 pin DIN plug - 5 pin DIN plug. £1.80

VP303 TV extension lead. Coax plug - coax plug, white. £1.00

VP304 1.5m 4 core cable individually screened 5 pin DIN plug - tinned open end. £1.00

VP305 1.5m cable 5 pin DIN plug - 3.5mm jack plug pin 1 & 4 connection. £1.00

VP306 2m typewriter/calculator lead 3 pin plug, angled European IEC configuration, 6A 250Vac. 2 for £2.00

VP307 60cm patch lead, PL259 plug - PL259 plug. £1.00

VP308 1.2m patch lead, PL259 plug - PL259 plug. £1.50

VP309 1.2m lead, 4 phono plugs - 4 phono plugs. £1.50

VP310 20cm lead 2 x 2 pin DIN plug - stereo in-line jack socket. £1.00

VP311 2m lead, scart plug - 5 pin DIN plug and 2 BNC plugs. £6.00

VP312 1.2m video lead, BNC plug - phono plug. £1.50

VP313 3m headphone lead, 3.5mm jack plug - 3.5mm jack socket. £1.00

VP314 2m coax lead, BNC plug - BNC plug, 75Ω. £3.00

VP315 2m coax lead, BNC plug - UHF plug, 70Ω. £3.00

LEADS & CABLE

Code	Qty	Description	Price
397	1m	2 core oval mains cable, 2.5A.	25p/m
VP301A	1	Phono plug to coax plug lead 2m long	£1.00
366	1	Enamelled copper wire 38swg, 2oz reel.	£1.20
383	1	Tinned copper wire 16swg, 4oz reel.	£1.70
382	1	Tinned copper wire 18swg, 4oz reel.	£1.70

SWITCHES & RELAYS

Code	Qty	Description	Price
1991A	1	Calculator keypad 24 way + data matrix output.	£2.00
1973	5	Min slide switch DPDT.	£1.00
1974	4	DPDT slide switch.	£1.00
1965	2	1p 12 way rotary switch.	£1.00
1965A	1	Rotary switch, 25mm dia, 5 wafers. 1p 12 way each.	£2.00
1962	2	Min latching push button 3A SPST, red top.	£1.50
1963	2	Min latching push button 3A SPDT, red top.	£1.50
1995	1	Heavy duty push - foot action 6A DPDT.	£2.50
VP174	5	DIL switches 1 & 2 way slide, 6 way SPST, assorted.	£1.00
VP114	1	Coax Antenna Switch, 3 way.	£4.75
VP115	1	High pass filter/suppressor CB/TV.	£0.50
VP281	4	Plug-in relays, mixed volts, etc.	£1.00

1/3rd OFF ALL ITEMS ON THIS PAGE

HARDWARE

(a) Fasteners (steel)

Code	Qty	Description	Price
839	25	1" OBA cheesehead screws	95p
840	25	1/2" OBA cheesehead screws	75p
842	25	1" 2BA cheesehead screws	70p
843	25	1/2" 2BA cheesehead screws	55p
844	25	1/4" 2BA cheesehead screws	65p
847	25	1/4" 4BA cheesehead screws	35p
848	25	1" 6BA cheesehead screws	50p
850	25	1/4" 6BA cheesehead screws	30p
863	25	1/2" 8BA cheesehead screws	40p
864	25	1/4" 8BA cheesehead screws	35p
865	25	8BA nuts	30p
859	25	OBA washers	15p
860	25	2BA washers	15p
861	25	4BA washers	15p
866	25	8BA washers	15p
851	25	OBA solder tags	45p
854	25	6BA solder tags	35p

(c) Knobs (all for 1/4" spindles)

Code	Qty	Description	Price
1101	4	Black plastic knob with calibrated metal skirt. 30mm dia x 18mm high.	£1.00
1109	3	As above, but 28mm dia x 16mm high.	£1.00
1111	3	Similar to above without black inlay 24mm dia x 17mm high.	£1.00
1113	4	Matches 1101, but with indicator line.	£1.00
1115	6	Pointer knob with skirt. Black plastic silver insert. 22mm dia x 14mm high.	£1.00
1115A	10	Slider 19 x 13 x 13mm. 4mm slot.	£1.00
VP474	12	Slider Pots knobs, black/chrome, push fit.	£1.00

DATA BOOK

BPX6 Excellent value TTL data book. Includes H, L S & LS. A5 format. 116 pages, giving mechanical data, Interchangeability Guide, Function Selection Guide, and pin outs of TTL from 7400-74670. As this was published some years ago, the very latest types do not appear, but at the price, this book offers superb value. Price Only £1.50

TRANSFORMERS

(All have mains primary)

Code	Qty	Description	Price
2036	1	0-17V 250mA	£2.30
2034	1	0-35V 1.7A	£4.90
2042	1	0-25V 2A	£4.40
2035	1	0-55V 2A	£8.95
2043A	1	20-0-20V 500mA	£3.80
2031	1	0-19-25-33-40-50V 500mA	£7.50
2032	1	0-19-25-33-40-50V 1A	£9.30
2038	1	Miniature driver, Primary 20k. Secondary 2k CT	£1.20

(b) Heatsinks

Code	Qty	Description	Price
873A	3	TO3 black finned sink 46 x 46 x 20mm	£1.00
877	10	TO18 Black push fit. 13 dia x 6mm	£1.00
VP42	10	Black heatsinks fit TO3 and TO220 drilled.	£1.00
VP43	4	Power-fin heatsinks 2 x TO3, 2 x TO66.	£1.00
VP44	15	Assorted heatsinks TO1; TO3; TO5; TO18; TO220.	£1.00

(d) Cases

Code	Qty	Description	Price
161	1	4" x 2 1/4" x 1 1/2" aluminium box. 102 x 57 x 38mm.	£1.30
1o5	1	7" x 5" x 2 1/2" aluminium box. 178 x 127 x 63mm.	£2.70
166	1	8" x 6" x 3" aluminium box. 203 x 152 x 76mm.	£3.50

(e) Miscellaneous

Code	Qty	Description	Price
2	.	Solder - 3 yds of 22g solder in handy dispenser.	£1.00

BULK PACKS FOR LARGE USERS

(See relevant pack numbers for full details of contents.)

VP1	Resistors	20,000	£35
VP2	Pre-formed resistors	20,000	£35
VP10	Polyester Caps	10,000	£50
VP11	Electrolytics	10,000	£80
VP200	OC71	5,000	£70
VP145	Assorted Pots	1,000	£50
VP42	Heatsinks	1,000	£50
VP224A	74 Series inc LS - gates & complex logic, all new in tubes.	1,000	£60

These transistors are part of Bi-Pak's stock. Offers are invited for those un-priced:

Type	Qty	100+	Description	Price
2N696	550	0.10	2S012	26
2N708	276	0.07	2S013	31
2N718	942	0.10	2S302	310
2N726	6500	0.15	2S303P	63
2N743	532	0.15	2S304	67
2N914	200	0.70	2S306	343
2N929	161	0.07	2S324	35
2N1131	500	0.20	2S3210	4087
2N1132	485	0.21	2S389A	100
2N1488	20	0.50		
2N1613	40	0.12		
2N2193	350	0.19		
2N2217	220	0.28		
2N2218	758	0.10		
2N2218A	656	0.10		
2N2219A	133	0.10		
2N2220	500	0.08		
2N2221	740	0.08		
2N2221A	420	0.08		
2N2368	374	0.09		
2N2411	287	0.40		
2N2412	517	0.19		
2N2711	3170	0.09		
2N2904A	680	0.10		
2N2904	1115	0.09		
2N2906A	5000	0.10		
2N2906	200	0.10		
2N2906	4500	0.10		
2N3011	899	0.09		
2N3114	1800	0.85		
2N3416	96	0.09		
2N3708	592	0.03		
2N3710	3223	0.03		
2N3711	3858	0.03		
2N3789	26			
2N3792	41			
2N4058	2388	0.03		
2N4061	480	0.03		
2N4099	82			
2N4901	10	0.40		
2N4911	23	0.60		
2N4914	9	0.40		
2N4915	44	0.45		
2N5295	2030	0.18		

2N6286	15			
2N6289	104	0.22		
2N6403	10			
BD196	50	0.50		
BD206	25	0.20		
BD208	55	0.20		
BD235	100	0.15		
BD236	200	0.16		
BD239	600	0.18		
BD240	500	0.17		
BD244	1000	0.17		
BD312	145	0.17		
BD508	400	0.37		
BD609	127			
BD1540	10			
BD1560	10			
BD2550	10			
BET885	400			
BFX29	476	0.10		
BFX48	250	0.10		
BFX86	155	0.10		
BFX87	87	0.10		
BF119	160	0.19		
BF152	700	0.09		
BF153	1724	0.09		
BF159	2565	0.10		
BF160	6460	0.10		
BF181	840	0.12		
BF186	155	0.12		
BF254	3000	0.10		
BF255	1178	0.11		
BF257	541	0.12		
BF337	826	0.12		
BF355	2260	0.12		
BF496	1000	0.12		
BF595	3000	0.07		
BF679S	1000			
BF742	216			
BFR52	500	0.08		
BFT83	505			
BFX29	476	0.10		
BFX48	250	0.10		
BFX86	155	0.10		
BFX87	87	0.10		
BIP20	33			
BIP20	46			
BRV56	372	0.17		
BSY10	880	0.08		

CV7001	134			
CV7086	25			
CV7644	50			
CV7735	197			
CV9507	1000			
CV9507	2000			
CV9790	950			
FB0320	47	0.20		
FB0223	47	0.20		
FT432	6			
IRF132	300	0.60		
MC7724	76			
ME1120	12000			
MPSA06	2273	0.07		
MPSA56	26750	0.07		
MJE340	595	0.15		
MJE521	97	0.28		
MJ490	140	0.50		
MJ3000	2			
OC41	81	0.15		
OC42	2245	0.15		
OC42	935	0.15		
OC45	145	0.15		
OC70	500	0.15		
OC71	1700	0.17		
OC72	208	0.15		
OC73	400	0.15		
OC75	200	0.15		
OC75N	470	0.15		
OC76	11550	0.15		
OC79	73	0.15		
OC82	530	0.15		
OC200	600	1.80		
RCA16083	100	1.00		
TIP29C	60	0.12		
TIP30A	1470	0.12		
TIP30B	1354	0.12		
TIP30C	590	0.12		
TIP32B	96	0.12		
TIP30A	102	0.12		
TIP62B	96			
TIS90	4000	0.07		
TIP111	22	0.20		
TIP112	55	0.20		
TIP117	42	0.20		
TIP126	15	0.20		
TX504	643	3.08		

NOTE: PRICES EXCLUDE VAT

CLEARANCE OF CAPACITORS AND PRESETS

C280 POLYESTER CAPACITORS. All new and boxed, 250V working. Samples free on request.

Value	100	1000
5.6nF	.02	.015
10nF	.02	.015
12nF	.02	.015
15nF	.02	.015
13nF	.02	.015
27nF	.02	.015
33nF	.02	.015
63nF	.02	.015
82nF	.02	.015
120nF	.03	.02
150nF	.03	.02
180nF	.03	.02
330nF	.04	.03
390nF	.04	.03

ELECTROLYTICS, axial leads.

Value	100	1000
10µF 160V	.03	.02
47µF 16V	.03	.02
22µF 16V	.04	.03

PRESETS

100R	V AB	.03	.02
220R	V AB	.03	.02
1K	V AB	.03	.02
4K7	V AB	.03	.02
47K	V AB	.03	.02
47K	V Piher	.04	.03
47K	H AB	.03	.02
47K	H Piher	.04	.03
47K	M AB	.03	.02

We also have large quantities of many values of pots, especially switched and dual types which we are clearing at 10p each.

LOGIC PROBE

Suitable for displaying the logic state of each gate of TTL, CMOS etc. Logic state displayed in light and sound. Pulse enlargement capability allows pulse detection down to 25ns. Supplied with comprehensive instruction manual

Order Code Y132

SPECIAL PRICE

£8.88



Working voltage: 4-16V
 Thresholds: Hi: 70% Vcc; Lo: 30% Vcc
 Input Z: 1M. Max input freq: 20MHz

MICROPHONE

M9 Adastra general purpose mic with stand. Omni directional, 500R. Freq Res. 100-8000Hz. Sensitivity 76dB±4dB. To clear at

£1.00

AMPLIFIED SPEAKER SYSTEM

Order Code

A179P

Output Power 2x2W

Freq. Res. 50-12kHz

Speakers 2x2 1/4"

Size (folded)

107x51x70mm

SUPER VALUE!



Foldable, designed to give portable radios, cassettes or CD players a high quality boosted sound output. Amp can be switched in or out. Powered by 4xAA cells or external supply (neither included)

OUR PRICE £5.95

SALE PRICE £4.95

9 BAND RADIO RECEIVER

Order Code B118C

Frequency Coverage:

FM 87.5-108.5MHz

MW 522-1620kHz

LW 150-281kHz

SW1 4.5-5.1MHz

SW2 5.82-6.2MHz

SW3 7.1-7.5MHz

SW4 9.45-9.9MHz

SW5 11.45-11.95MHz

SW6 17.45-18.06MHz

Uses 2xAA cells

Size 170x60x30mm

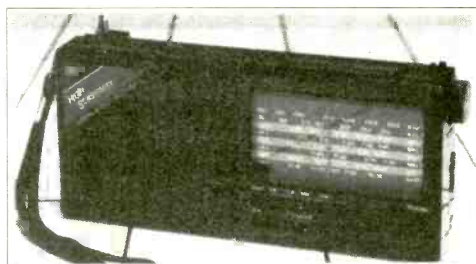

Compact receiver covering FM, MW, LW and 6 SW bands (19, 25, 31, 41, 49 & 60m). Built in ferrite rod + telescopic aerial. Tuning LED, earphone skt.

Great spec. at a low, low price! **£12.95**

SALE PRICE £10.95

AMPLIFIED UHF/VHF/FM AERIAL

Order Code T143A

Dish can be rotated to pick up best signal, then boosted using built in amp with gain control - can also be used with external aerial.

Gain..... 20dB VHF; 30dB UHF
 Gain Control 0-30dB
 Max Output level..... 100dBuV
 Power..... 12V DC
 Size..... 340x220x110mm

£9.95

SALE PRICE £8.95

Y136C INSULATION TEST UNIT

Intended for use with the M260 and M266 clamp ammeters, but now they are no longer available - however instructions are included to use with almost any digital meter

Original Selling Price £45+

£12.95



500Vdc insulation test unit designed for use with the M260 (Y136B) and M266 (Y136A) digital clamp ammeters. Unit plugs directly into the meter sockets. Insulation resistance readings directly on clamp meter display. Complete with leads, instruction manual, battery and carrying case.

Measuring voltage 500Vdc
 Measuring ranges 100k-20MΩ ±2%
 10MΩ-1999MΩ ±4%

Batteries 4 x AA (supplied) Dims 90 x 70 x 50mm

SALE PRICE £6.95

Xtra Special

LEARN 3 LANGUAGES FOR £2

Z5060 Italian
 Z5062 Portugese
 Z5064 Russian

90 minute tape + 32 page handbook for each language

Star Buy !!

Xtra Special

HARDWARE

Z1834 4BA solder tags 1000/£3
 Z592 Yellow tape 3mmx66m 5/£1
 Z1440 Screws 4x8mm 1000/£1
 Z2170 Veropins DS for 0.15 1000/£1
 Z2333 Ceramic beads 3.4mm od 400/£1
 Z2335 Stand offs 24mm, 3.5mm thread 12/£1
 Z2336 Stand offs 11mm, 2.5mm thread 20/£1
 Z2337 Screws 6BAx12mm pozi/pan 1000/£3

Star Buy !!

Xtra Special

CONNECTORS

Z042 2 pin DIN spkr skt 50/£1
 Z598 PC IEC skt 3/£1
 Z1987 75R conn 3/£1
 Z2055 8pin DIN skt 12/£1
 Z2021 BNC 3/£2
 Z1714 5pin DIN 240 - box of 36 £1.00
 Z2504 PS2 k/b adaptor £1

Star Buy !!

46**SUPER SENSATIONAL SUMMER SALE****GREENWELD**27 Park Rd. Southampton SO1 3TB
Tel: 0703 236363 Fax: 236307All one off and pack prices **INCLUDE V.A.T.** Qty. prices do not.**Sale prices for items from Bargain List 85 (Yellow Pages)**

Z5 Z5201 2/£1
Z4100 £1.00
Z2819 £1.00
Z5435 £1.50
Z5437 £9.95

Z8 All half price except T120A

Z9 All half price

Z10 All half price

Z11 All half price

Z12 All half price

Z13 BP701 Less 10%
Mags no discount
£3.95

K693 Rest half price for packs & 1-offs.

Z14 All half price

Z15 All half price

Z16 All half price

Z25 All half price

Z26 All half price

Z27 Manuals less 25%
Rest half price

Sale Prices for items from Bargain List 90 (Green Pages)

Z5 All half price

Z6 All half price

Z7 All half price

Z8 All half price

Z9 All half price

Z10 All half price

Z11 All half price

Z12 All half price

Z13 All half price

Z14 All half price

Z15 All half price except T120A

Z17 RW6T £14.95
RW62 £14.95
Z5491 -4 £3.95
ALL4 £12.00
Z4357 £12.95
Z8891 £13.95

Z18 All half price

Z19 Manuals less 25%

Z20 All half price

Z21 BP324/320 less 10%
BP701 less 10%
Mags no discount
Rest half price

Sale prices for items from MAIN CATALOGUE

P3-8 10% OFF

P9 10% OFF Retail price

P10-17 10% OFF

P18-33 10% OFF

P34-38 10% OFF

P39-42 10% OFF

P43-44 10% OFF

P48-54 10% OFF

P69-74 5% OFF

P75-76 10% OFF

P77 10% OFF Retail price

P79-84 10% OFF

P89-91 5% OFF

P92-93 5% OFF

P94-99 5% OFF

P116-7 10% OFF

P122-5 5% OFF

P133 5% OFF

P134-7 5% OFF

P148-9 10% OFF

P150-5 5% OFF

We buy surplus stock for cash!

To keep our wide range of customers happy, we constantly need to procure more goods. We'll consider not just electronic components and equipment, but hardware, tools, stationery, modelling goods, photographic and books. All goods must be in reasonable quantities and suitable for re-sale. Write with details, samples and price required to: The Managing Director, Greenweld Electronics Ltd, 27 Park Road, Southampton, SO1 3TB

Where items are not included, it is because they appear in this brochure, or they are sold out.

Thank you for ordering from GREENWELD - we appreciate your custom. This space is for any suggestions or messages. Please feel free to comment on any aspect of our goods and service

ORDERING INFORMATION

Please use the order form on page 45. Single prices and packs of components with the price shown in bold include VAT - bulk or quantity prices exclude VAT which must be added at 17.5% or the current rate. If different. Payment is accepted by cash (sellotape coins to card), Mint GB postage stamps, PO, cheque, Giro transfer, Transcash, foreign currency bank notes, Access, Visa and Connect. We also accept book and record tokens for any goods and gift vouchers from any of the national chain stores. Add postage at the sale rate of £3.00 per order or £9.50 for next day delivery for any quantity of goods. Next day delivery applies to credit card and cash orders to UK mainland south of Edinburgh providing the goods required are in stock. Allow clearance time for large cheques.

Check List for Ordering:

Fill in your Name and Address which must include the postcode

Write order clearly and legibly and include prices. Don't forget to include postage and packing charge. Please keep a copy of your order.

If ordering by credit card, ensure all 16 digits (13 for some Visa cards) are written down, and the expiry date. All credit card transactions are authorised and processed electronically, to combat fraud.

If ordering by fax, please include daytime telephone number in case of illegibility.

If paying by cheque, please remember to sign it.

Send the completed order to:

Greenweld Electronics
27 Park Road
Southampton
SO1 3TB
United Kingdom

Most orders are despatched within a day or two, but some may be delayed because of temporary non-availability of goods. If this is going to be more than a week, we will advise you.

How to contact us:**By Post****In Person****By Phone****By Fax****By EMail****By Giro**

Use the address above

At the address above

(0703) 236363 (Ansaphone outside normal business hours)

(0703) 236307 (24hrs a day, 365 days a year)

CompuServe 100014, 1463 (This is not accessed every day, so if your order is urgent, please use phone or fax)

Use a transfer form to send details of your order to us, or pay by Transcash at any PO. Our account number is 207 9194

RETURNS

We are finding customers are returning goods that are not faulty; not wanted and/or ordered incorrectly. **Regrettably, we cannot accept any goods without a returns number.**

Goods returned for any other reason (including goods alleged to be faulty but found to be working) will carry a 10% handling charge with a minimum of £2, unless being exchanged for other goods, in which case return post and packing must be paid. Any refunds made will be by credit card if that was the method of purchase, or by cheque for any other method of payment.

TERMS AND CONDITIONS

Our terms and conditions of trading are shown on page 162 of our 1993 Catalogue. A copy of this page will be sent on receipt of a self addressed stamped envelope.

OVERSEAS CUSTOMERS: Outside the European Community (including Channel Islands) deduct VAT. EC customers who can supply their VAT number may also deduct VAT, otherwise VAT is payable at the UK rate on all orders to member states of the EC. Foreign postage rates apply to Eire and Channel Islands.

1994 CATALOGUE

Be one step ahead! Order your 1994 Catalogue NOW and be first in the queue when they are despatched in late September! Next years edition will be bigger and better than ever before - many more new lines to cater for our customers' ever widening range of interests! Look out for big new additions of video accessories, CD's and books! Included will also be our famous Bargain List, containing an amazingly diverse range of surplus products - so don't miss out, Order Now. And if you want to be sure of keeping up with our offers, become a Subscriber. Our monthly mailings contain the Greenweld Guardian, details of our latest purchases with exclusive offers, deals and competitions. As the UK's biggest supplier of new and surplus electronic components and equipment, we have the skills, the manpower and the money to bring you the best ever deals! There's a space on the Order Form to reserve your copy.

Get it from GREENWELD - you know it makes sense!

The Greenweld Guardian

Our monthly newsletter contains technical articles from Paul Kerman, news of our products and views from customers, and can be yours for just £6 a year UK, £12 Overseas. Just look what you get by being a Subscriber:

- 1st Class reply paid Order Form
- Latest Bargain Lists, including details of goods not advertised elsewhere
- Special Offers only available to Subscribers
- Competitions and Free Gifts
- Priority Service

If you are a modeller or constructor, or have an interest in computing, electronics, mechanics - or just have an eye for a Bargain, then you need to subscribe.

Just tick the appropriate box on the Order Form for a year's supply of Superdeals!

Thank you for taking the time to look through our brochure; this SALE edition has a print run of almost 150,000 as it is being included with several different monthly magazines, and demand for some products will almost certainly outstrip supply.

Because of the staggered publication dates it could mean that although you may have only just received your copy, stocks of the more popular items might well be running low. Please place your order as soon as possible to avoid disappointment. If you are calling in personally, please check before travelling long distances the items you require are available. We will reserve stock if requested.

6 STUNNING METER OFFERS!!

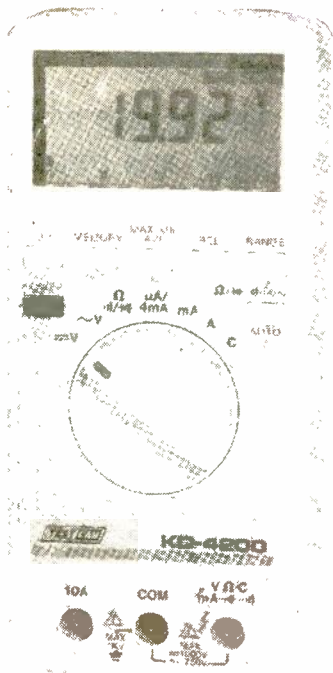

10MΩ MULTIMETER

- * 3,999 count resolution
- * 40 segments bargraph
- * Max., min. and average function
- * Ratio measurement function
- * Error correction function
- * Relative magnitude function

NORMAL SELLING PRICE £120!

Previously £49.95
SALE PRICE £39.95

Y130 or Y130A (temp probe not included)

AC volts	0-4-40-400-750Vac ± 1%
DC volts	0-400m-4-40-400-1000Vdc ± 0.5%
AC current	0-40m-400-10Aac ± 2%
DC current	0-40-400m-10Adc ± 1%
Resistance	0-400-4k-400k-4M-40MΩ ± 1%
Frequency (Y130 ONLY)	0-10k-65kHz TTL level (5V)
Temperature (Y130A ONLY)	-50 to 1200°C
Dims	165 x 78 x 35mm

10MΩ Order Code M818B

- ★ 40 point analogue bargraph display
- ★ 3.75 digit 17mm LCD display
- ★ Autoranging voltage and resistance
- ★ High and low frequency ranges
- ★ True RMS AC voltage and current
- ★ Diode and continuity test
- ★ Data hold switch
- ★ Built and tested to IEC 348
- ★ Fully shrouded test leads

NORMAL SELLING PRICE £75

Previously £34.95

SALE PRICE £29.95



Battery, instruction manual and carrying case included.

AC volts	0-40-400-750Vac ± 1.5%
DC volts	0-400m-4-40-400-1000Vdc ± 0.5%
AC current	0-4m-40m-400m-2-10A ac ± 1.5%
DC current	0-4m-40m-400m-2-10A dc ± 1.2%
Resistance	0-4k-40k-400k-4M-20MΩ ± 0.8%
Frequency	0-4k-40k-400kHz ± 2%
Dims	187 x 87 x 34mm

Y123PA

10MΩ PROBE MULTIMETER

- ★ 3.5 digit 8mm LCD display
- ★ Fully autoranging
- ★ Display hold facility
- ★ Probe styling
- ★ Auto polarity and zero



Previously £19.95
SALE PRICE

£17.95

Complete with extended probe, fully shrouded test leads and vinyl carrying wallet

AC volts	0-2-20-200-500Vac ± 1.2%
DC volts	0-200m-2-20-200-500Vdc ± 1.0%
Resistance	0-200-2k-20k-200k-2M-2MΩ ± 1.0%
Dims	160 x 35 x 20mm

Y123AC

- * 3.75 digit 25mm LCD display (2999 count) with 40 point bargraph
- * True RMS measurement
- * Auto/manual ranging
- * 20A ac/dc measurement capability
- * Frequency measurement
- * Memory mode for relative measurement
- * Data hold
- * Diode test
- * Full overload protection

NORMAL SELLING PRICE £89.95

Previously £39.95

SALE PRICE £32.95

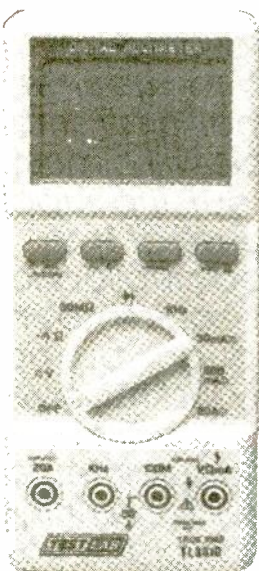

AC voltage Auto	0-20-200-700Vac ± 1%
Manual	0-30-300-700Vac ± 1%
DC voltage Auto	0-200m-2-20-200-1000Vdc ± 0.7%
Manual	0-300m-3-30-300-1000Vdc ± 0.7%
AC current	0-30m-300m-20Aac ± 1.8%
DC current	0-30m-300m-20Adc ± 1%
Resistance Auto	0-200-2k-20k-200k-2MΩ ± 0.8%
Manual	0-300-3k-30k-300k-3M-30MΩ ± 0.8%
Frequency	10Hz to 20kHz ± 0.5%
Dims	190 x 85 x 40mm

- ★ 19 ranges
 - ★ 3½ digit 12mm LCD display
 - ★ Signal injector function
 - ★ Diode test
 - ★ Fuse protection
 - ★ Automatic polarity and zero
 - ★ Test leads with 4mm plugs
- Battery and instruction manual included.

OUR BIGGEST SELLING INSTRUMENT!!
SUPERDEAL PRICE
£16.95

AC volts	0-200-750Vac ± 1.2%
DC volts	0-200m-2-20-200-1000Vdc ± 0.8%
DC current	0-200μ-2m-20m-200m-2A ± 1.0%
Resistance	0-200-2k-20k-200k-2MΩ ± 0.8%
Signal injector	50Hz square wave, 5V peak to peak
Dims	126 x 70 x 24mm

10MΩ MX190

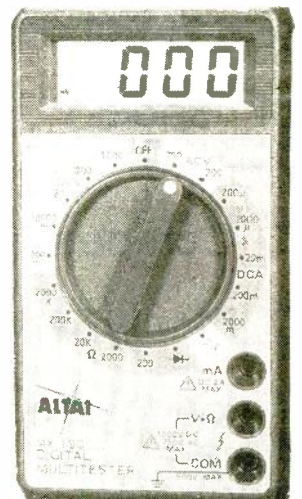

RADIO SCANNERS - Send SAE for full details of our range of high quality scanners at great prices!

VCR Clinic

Reports from Nick Beer, John Edwards, Noel E. Evans, Alfred Damp, Michael Dranfield, Richard Flowerday, Brian Storm, Ronald Aranha, Richard J. Avis, Terry Lamoon, Richard Newman and Stephen Leatherbarrow,

Ferguson 3V30/JVC HR7300

The problem was no reel drive. I found that CP2 in the supply to the 10VT05 reel driver chip IC12 was open-circuit while the chip itself, a hybrid device, had burnt up. The cause of all this was an intermittently short-circuit reel motor. **N.B.**

NEC9033

The fault symptom I've had with a couple of these machines has been low, varying sound. The sound is low because the audio/control head wears out: it varies because the pinch roller is barrelled, as a result of which the tape moves out of position. **N.B.**

Panasonic NV2000

The customer's complaint was that there were no deck functions. This was because the cassette didn't sit right down on the left-hand side when the carriage closed. The cause of the problem was that the cassette balance spring on this side was very weak – part no. VMB0730. **N.B.**

Ferguson FV61LV

There were a number of faults with this brand new, centre-mechanism machine, some of them intermittent. Here's the list: excessive fast-wind torque (to the extent that once-wound tapes were too tight to play!), no tape end sensing, failure to accept a cassette, failure to eject a cassette, no capstan operation and switching off with no mechanical movement. Just about every operation is controlled by the ST90T30-QFP80 servo microcontroller chip IT01. It's a many-legged, four-sided flatpack device mounted on the lower PCB. We found that it was thermally faulty. **N.B.**

GoldStar GSE1891I

The customer said that this machine had for some time refused to eject cassettes. On the last occasion he'd used a breadknife to force it to release the cassette. As a result, the right-hand mount for the synchronisation bar and gears had broken. Obtaining replacement parts turned out to be a bit of a problem. In the process I learnt that the usual cause of the problem is broken gears. Not this time though! I eventually obtained the part number for the side piece required from GoldStar technical. CPC then supplied both sides as a kit. They were easy to fit – unlike many carriages, this one is very simple and easy to reassemble. **N.B.**

Akai VS425EK

There were two faults on this machine. First, the customer complained that very intermittently it would chew a tape on eject. A new belt, clutch and mode switch cured that. I also noticed that there was a nasty graunching when the cassette was ejected, the blinder moving very urgently. Investigation showed that the graunching came from the mechanism only when the front was fitted – to be more

specific when the blinder was lifted to eject the cassette.

I carried out the eject spacer modification – fitting the spacer under the front rack lug on the left-hand side – and noticed that the synchronising gear (arm loading BLK, item 43) that links the drive from one side of the carriage to the other was buckled on the right-hand side, where the blinder lifting lever sits. When this had been replaced everything ran as smooth as silk. **N.B.**

Panasonic NVJ30

This machine couldn't be tuned in the E-E mode. Because of an instruction from the timer microcontroller chip IC7501, which handles tuning, it was locked in the Band I mode. The instruction comes via IC7502 (MN12C261D5) which was faulty – it provides parallel switching lines from the serial data fed to it. **N.B.**

Samsung VI710

There was no go at all. While plenty of unregulated voltage reached the STK5333 multiregulator chip no supplies left it. A replacement restored normal operation. **N.B.**

Philips DMP Series Decks

A common failure with these decks is the rather unusual pinch roller assembly. The rubber roller seems to decompose rather alarmingly. Symptoms vary – poor or varying sound or tracking for example or tape damage. **N.B.**

Alba VCR3000X

There were no functions and no displays. This is not unusual – replace C821. When this had been done the machine came to life but wouldn't accept a cassette. Fortunately I've had this one before. It's usually due to microcontroller lock-out. Load the tape by rotating the carriage motor by hand, then press the power on/off button followed by the eject button. The cassette will then be ejected and future instructions will be obeyed. **J.E.**

JVC HRD610

The playback picture had five thin tracking lines spaced equally apart across the picture and the sound was muted. The cause was that the exit guide was loose. Slight adjustment of the guide's height, followed by tightening the grub screw, corrected the fault. It's worth noting that a defective mechacon chip can produce almost identical symptoms – but in this case the audio track will be erased whilst you are looking at the symptom. **J.E.**

Panasonic NVG7

There was vertical rolling when a known good tape or a self-recorded one was played back. In addition the tape would be crinkled along its bottom edge. The pinch roller

was glossy and tape ridges were evident. A new roller cured both problems. **J.E.**

Akai VS35

This machine would stop at random in the record mode. The tape would remain threaded and the pinch wheel would be engaged on the capstan shaft. To try to simulate the fault we disconnected the take-up reel pulses while the machine was working correctly. The machine stopped, but the pinch wheel was disengaged and the tape was released from the drum. So absence of the reel pulses was not the cause of the problem. We next tried stopping the capstan motor physically, whereupon the normal stop mode was entered. So the capstan department was not the cause of the fault. When the drum was stopped physically the symptoms matched those of the fault condition. So we had a drum servo fault.

We replaced the BU2735S servo chip IC503 but after recording for two hours the fault reappeared. Voltage and waveform checks were of no use because of the intermittent nature of the fault. So we replaced the motor circuit board on the lower drum assembly. Numerous test recordings proved that the fault had been cured. **J.E.**

Akai VS55

As there was no record colour, checks were carried out around the LA7330 chroma processing chip IC400. The video input, filter input and output, sync signals and d.c. levels appeared to be o.k. but there was no record output signal at pin 9. We then found that the frequency of the 4.433MHz voltage-controlled oscillator was erratic – about 1.2kHz low on average. Because of failure of the oscillator to lock, the colour-killer was active. Careful monitoring of the oscillator's control voltage (nominally 2.2V) at pin 15 showed that it was about 100mV low. After some further checks we found that steering diode D401 had a reverse leakage of 50kΩ. A replacement restored normal operation. **N.E.E.**

Sony SLVX10

"No sound" it said on the job card that accompanied one of these machines. When we inserted a cassette and pressed the play button there was a snowy picture and of course no sound. There was little improvement when the tracking control was adjusted – capstan servo symptoms appeared on the screen instead. The audio circuit is centred on the LA7294 chip IC201, pin 12 being the mute input. We found that the mute action, which is controlled by the syscon chip, was in operation. As there was a servo problem we checked for CTL pulses at pin 10 of the servo processing chip IC351: they were missing. This took us back to pin 4 of the LA7123 CTL pulse amplifier chip IC352, where the pulses were also missing. After carrying out voltage checks we decided to replace IC352. This restored a beautiful picture along with sound as the mute was released by the syscon chip.

Another of these machines was brought in because of intermittent failure to record the sound. We set it to record and connected a scope to the bias oscillator's output point. After an hour or so oscillation suddenly stopped. The switched supply for the 2SD734 bias oscillator transistor Q2001 comes from pin 1 of the LA7294 chip IC201. A voltage check here produced a reading of only 0.6V. When Q2001's collector was disconnected the voltage at pin 1 of IC201 rose to the correct figure. We found that Q2001 had a 40Ω leak between its collector and emitter, though it behaved perfectly at times, especially when cold. When a

new transistor was fitted the machine worked without any further problems – because of stock shortages we used a 2SD774. **R.A.**

Amstrad VCR4600

When a function was selected the mechanics would start but the machine would almost instantaneously power down. Scope checks on the supply lines showed that there was a large negative-going pulse on the 5V rail. As a result, the supply to the microcontroller chip was being regularly removed. Thus functions wouldn't latch on. Our first suspect, the 5V regulator, proved to be o.k. The culprit was eventually found to be the bridge rectifier. **A.D.**

Samsung SI1260

This machine came in with a fully laced tape inside. When it was powered it refused to unlace the tape. We eventually found that the cause of the problem was D212, which was open-circuit. It provides IC206 with a -15V supply. **A.D.**

Ferguson 3V42/JVC HRD455

This one could apply to other models which use the same deck. We found that during the last part of the loading cycle, as the pinch roller starts to pull in, the loading motor would slow down and struggle to complete the loading sequence. The cause was traced to the grease on the lower drum casting – the bit with the V blocks. Though it wasn't as hard as in some models it was nevertheless very sticky, impeding the slant pole base. To cure the problem clean the grease off with solvent then apply a smear of graphite grease. **M.Dr.**

Akai VSF410

There was no clock display and no manual or remote functions would operate. The machine would accept and play a prerecorded tape however. The supplies to the operation PCB were all o.k., and the timer microcontroller chip's two clock oscillators were running. But there was no activity at any other pin. Voltage checks showed that the 'not power down' input at pin 5 was low, putting the chip into its idle mode as though the mains supply had failed. Tracing back to the power-down detector circuit brought us to transistor TR203 which had an open-circuit collector. A replacement restored normal operation. **R.F.**

Samsung SI1260

As soon as the machine was powered the loading motor would run in the eject direction, stopping only when the syscon microcontroller chip decided that a fault condition was present and shut down the switched supplies. Attention was eventually turned to the mode switch, where the voltage at pin D never rose above 1.8V regardless of the position of the mechanism. This pin is effectively the cassette-up switch – so the machine must have thought the cassette housing was down even though it wasn't. A new mode switch (part no. 63579-101-026) provided a complete cure. **R.F.**

Akai VS485

Apart from a hum bar, and picture disturbance that appeared only when the loading motor ran, i.e. when ejecting or inserting a cassette, this machine performed normally.

Scope checks showed that there was significant ripple on the IDL 10V supply. There was a smaller amount of ripple on the IDL 5V line. As the ripple was at 50Hz it seemed that there was an open-circuit rectifier diode somewhere in the supply, but investigation showed that D9 was short-circuit while the fusible resistor FR6 (0.1Ω) was open-circuit. Aren't these resistors expensive?!

R.F.

Panasonic NVF70

As these machines age, particularly the mechanics (G mechanism with review motor), various squeaks and rattles can arise. This is particularly the case with models, such as this one, that have jog shuttle dials. A delightful series of shrieks, whines, rattles and buzzes can be demonstrated. Replacement of the tension unit (part no. VXA3516) and the soft brake (VXL1873) usually restores relatively quiet operation.

B.S.

Panasonic NVFS90

The complaint, a very unusual one with these machines, was of poor picture quality. An abundance of faint, flickering lines were present in the background of the playback picture. The condition was even worse in the LP mode. I decided to check on the HQ pack. As I removed the screening can X3301, the crystal associated with the 1H delay CCD chip IC3302, came out of the board. Resoldering it back into the board restored the normally excellent playback picture.

B.S.

Matsui VX6600Y

No E-E picture with normal sound is becoming a very common fault with this model. Check inductor L4801 which goes open-circuit.

T.L.

Akai VS427

No playback sound caused us some problems. The sound circuits were being switched off because the main microcontroller chip was sending out the wrong signal. Must be the chip we thought, but to be on the safe side we tried a new front operations panel. This cured the fault. The μPD75216A-268 timer microcontroller chip IC1 was the culprit, a replacement restoring the sound.

T.L.

Hitachi VT410

The problem was poor or very noisy eject. In this model the cassette carriage is driven by the capstan motor via a series of cogs and gears. The cause of the fault was the worm on the right-hand side of the carriage, part no. 6435571. As a precaution I also replaced the worm wheel assembly, part no. 6896971.

R.J.A.

Akai VSF33

Low or no clock display was caused by the fact that the power supply wasn't oscillating. Akai has a modification sheet and kit, AV10015, part no. EX744015JOAP, to correct this.

R.J.A.

Philips VR6293

This machine had a tendency to eject tapes at odd intervals. The customer had put up with this for some time, complaining only when the machine failed completely. Total

failure was caused by a power supply fault – a new 3.3Ω resistor was all that was required to put this right. I then called up the service test program, which indicated that the drum motor had stopped although the machine was working perfectly. I was able to catch the machine in the fault condition just once, when it was switched on from cold one morning: the drum gave a little kick then refused to turn again, after which the machine shut down. Various component replacements in the drum motor driver stages failed to cure the fault, so a new lower drum was eventually tried. This provided a complete cure. I'm finding that motors which cause this sort of fault are becoming very common.

R.N.

Sharp VC581

This machine had been looked at by a dealer who had decided that it was not worth repair. It eventually came to me via a neighbour. As there was no take up I looked at the idler wheel. This had been changed, but was not making contact with the take-up spool or the reel motor. There was too much clearance between the idler and the motor, and the idler was fouling the motor fixing screws. After removing the motor I realised that it could be fitted in either of two ways. When it was turned through 180° and refitted the machine worked. A good clean up and a new set of belts completed the repair, saving what turned out to be a very good machine from the scrap heap.

R.N.

Panasonic NVL20

This machine produced very poor E-E pictures that could be cleared by tapping the tuner and r.f. converter. As MCES were on holiday I removed the tuner and converter and had a look inside. I found a large number of dry-joints along the output pins in both units and very carefully resoldered them. When the units had been refitted the machine worked perfectly and didn't even need to be retuned.

R.N.

Ferguson 3V53/JVC HRD755

This hi-fi machine wouldn't switch on. It would accept a cassette but wouldn't eject it. The clock was flashing away and could be set, but basically the machine was dead. No faults could be found when initial checks were carried out in the power supply. I then found that the on line didn't go low when the on button was pressed. The switch itself was o.k., but the power-on output from the microcontroller chip IC202 didn't change. If a shorting lead was used to take the line low the machine made an attempt to start and various supply lines became active. A replacement microcontroller chip, type M50742-621, put matters right.

R.N.

Hinari VXL5

The video signal was low, smeary and contained crushed sync pulses in the playback and E-E modes. Sound was not affected. As we didn't have a manual we carried out scope checks back from the r.f. modulator. Things were clearly wrong around Q306, where we found that C353 (47μF, 16V) was short-circuit. It appears to be a video signal coupling capacitor.

S.L.

Sharp VCA5011HM

The cause of failure to accept a cassette was incorrect voltages around the BA6238AM chip IC803. D805, type HZS12EB3, was short-circuit. A standard 12V zener diode in this position restored normal operation.

S.L.

Coaxial Cable RC Relay System

Keith Wevill, B.Sc.

I was very interested in Alan Beech's IR remote control relay article in the June issue as I had for some time been considering something similar. My interest in the subject started when my brother wanted to be able to control his VCR and satellite receiver from the bedroom.

The difference between Alan's system and what I had been contemplating is that rather than fit extra cables I wanted to use the coaxial lead between the VCR downstairs and the TV set in the bedroom to carry the remote control signals. This approach presents a number of problems, but the solution described here overcomes them and means that no extra wiring is required.

The main problems with using the coaxial lead are in avoiding interference to the u.h.f. signal and powering the IR receiver. Separate supplies could be used for the IR receiver and the LED driver, but if a single supply can be used the overall system is simpler, with only a small receiver unit next to the remote-controlled TV set and just one on/off switch. The method I use to power the receiver is similar to the way in which a line-powered aerial preamplifier is supplied via the coaxial downlead, with a minor modification to enable the control signals to be sent down the coaxial lead without interrupting the power.

Fig. 1 shows the circuit. I haven't shown the IR receiver, the LED driver or the mains supply circuit as these can be the same as in Alan's system. In fact almost any IR receiver and LED driver can be used. The receiver I used in my initial experiments was designed for remote-control versions of the Ferguson TX9/TX10 chassis, the driver and LEDs being taken from a scrap remote-control unit. The only receiver requirements are that it should operate at 5V, with a quiescent consumption of less than 10mA, and that it should provide positive-going output pulses. Many chips and discrete circuits fit these requirements.

Power for the IR receiver comes from the 12V regulator and is fed to the coaxial lead via a 100Ω, 2.5W resistor and a 1μH choke. The resistor has two functions. First, it limits the maximum current. Secondly, it allows the control signals to be extracted. The choke presents a low impedance to the d.c.

supply and the control pulses, and a high impedance at u.h.f. It thus isolates the power and the control signals from the u.h.f. signal path. Capacitive coupling is used for the u.h.f. signals to prevent the VCR or the TV set's aerial connector shorting the d.c. supply. At the remote-control end the d.c. feed and the control signals are similarly separated, using a capacitor and choke. The choke also removes some of the h.f. components of the remote control signal, thus minimising interference to the u.h.f. feed.

The BC108 transistor at the IR receiver end of the link is used to transmit the pulses down the coaxial line, being switched on whenever the output from the IR receiver goes high. This connects the two 100Ω resistors across the line. As a result, a 40mA pulse is transmitted down the line. This produces a 4V pulse across the 100Ω, 2.5W resistor at the LED driver end. It's coupled by the 0.022μF capacitor to the base of the BC558 pnp transistor, which inverts the pulse to provide the input for the IR LED driver. This capacitive coupling prevents damage to the LEDs should a short occur on the line.

The IR receiver is powered by the 5V regulator, whose d.c. input comes via the choke, 100Ω resistor and 1N4002 diode. The latter is included to isolate the d.c. input when the line goes low during pulse transmission. The 10μF capacitor supplies the regulator during the brief period when a pulse is being transmitted. The IR receiver should not consume more than about 10mA, otherwise the voltage drop along the line may result in the input to the regulator falling below the minimum value of 8V.

Construction and Use

Construction is not critical, but all leads that carry the u.h.f. signal should be kept as short as possible. Although transistor types have been quoted, there's nothing critical about them. Virtually any npn transistor that can carry 40mA can be used to drive the line, while almost any pnp transistor can be used to provide the output to the LED driver.

The circuit can be used with Alan Beech's system by inserting it between the output of the BC547 emitter-follower buffer stage and the 1kΩ resistor that's in series with the base of the LED driver transistor. As mentioned above, the 5V supply for the SL486 IR receiver chip comes from the 78L05 regulator that's powered via the coaxial lead.

For correct operation of this system it's essential that there is a d.c. path via the inner conductor between the connections at each end of the link. There should be no or a very high d.c. resistance across the cable. Some aerial sockets include a series isolating capacitor which must be shorted out for the system to function. Any series resistance, for example a resistive splitter, will reduce the voltage of the pulse transmitted down the line. The maximum series resistance that can be tolerated before problems occur is approximately 700Ω.

No picture interference has been seen with the unit in use, but this could occur with a weak signal. If so try increasing the value of the chokes or the 100Ω series resistors. Don't increase the values too much as this could impair the operation of the system.

It should be possible to use more than one IR receiver unit fed from a single power supply, but check that the input to the 5V regulators doesn't fall below 9V otherwise the operation of the system may be impaired.

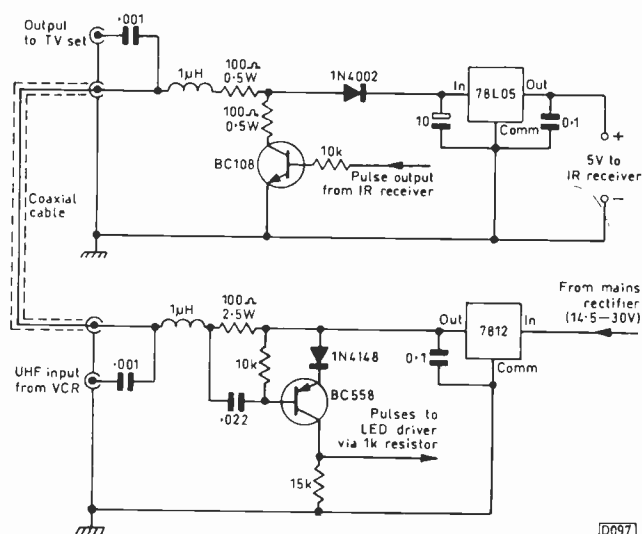

Fig. 1: Circuit diagram.

Letters

CITY AND GUILDS SCHEMES

I am writing this in reply to Andrew Woods' letter in the June issue, under the heading 'Training Inadequacies'. Mr. Woods expressed two main concerns, with the relevance to the industry of the City and Guilds 2240 Electronics Servicing schemes and with the value of 'paper qualifications' in general. On behalf of the City and Guilds of London Institute I would like to update you and your readers about the 2240 schemes in particular and perhaps dispel some concerns that may be current about qualifications.

The 2240 schemes comprise three parts. They were fully revised in 1985-86. As a result they incorporated practical assignments and course-work assessments in addition to written examinations. Parts 1 and 2 were revised again in 1989-90, to put them into a 'competance-based' format. The new syllabus thus covers both the knowledge and skills required to perform certain tasks. At the same time compulsory practical tests, administered through the Electronics Examinations Board (EEB), were introduced at all three levels in order to increase the practical aspects of these qualifications.

When introducing new qualifications or revising existing syllabuses the City and Guilds of London Institute always consults a wide range of representatives from the industry concerned and from the educational sector in order to take into account current needs. In the case of 2240 the schemes are specifically designed to complement practical experience in industry, so that learning and knowledge are put into practice. Naturally further time and experience in an industry will enhance an individual's abilities.

City and Guilds is very proud of its vast range of qualifications, which cover most industries at all levels. The awards, together with our involvement in the National Vocational Qualifications initiatives, play an important part in working towards a better trained and more competent workforce.

*Di Walster, Divisional Manager, Division 13,
Electrical and Electronic Engineering,
City and Guilds of London Institute,
46 Britannia Street,
London WC1X 9RG.*

MUTER REACTIVATOR TIP

Here's a tip for anyone who, like us, bought a Muter c.r.t. analyser/reactivator and found it impossible to buy the 9-pin plug to make up an adaptor. The solution lies inside the old Waltham ST30 stereo music centre. There are three suitable plugs here. They fit the Muter lead a treat.

*J. Howells, Protech Audio Visual,
Fallings Park, Wolverhampton.*

SCRATCHES

I was rather perturbed by the May issue front cover photograph, which shows Eugene Trundle's video monitoring jig. It is arranged to record a mechanical fault with a VCR that's standing on its side on a bare bench. So what, you may ask?

How many times have you had to try to talk your way out of the fact that a piece of equipment you accepted for repair

has a scratch which wasn't there to start with? My credibility has taken a few knocks over this one, thankfully a long time ago. Now when I have to put a unit on its side etc. I use what was previously a liner from an old velvet curtain, folded a couple of times. I also point out to the customer any scratches and other marks on the unit when it's accepted for repair, thereby eliminating any complaints later.

*M.K. Hayter,
Moseley, Birmingham.*

FITTING MULTIPINNED COMPONENTS

Here's a 'dodge' I use when fitting multipinned components such as line output transformers, chips etc. With a suitably sized twist drill I slightly countersink each hole by hand. You will find that components slide in quite easily when this has been done.

*K. Wright,
Preston, Lancs.*

VIDEOCRYPT PATTERNING

I read with interest Chris Watton's article 'A Western' in the June issue. Chris says that he doesn't know whether patterning caused by VideoCrypt decoders occurs in areas that don't use channel 25. It does!

A large proportion of the area in which I work is served by the Bilsdale transmitter, which uses channels 29 and 23 for ITV and Channel 4 respectively. Patterning caused by a VideoCrypt decoder is a common problem with satellite installations in this area. The purpose of this letter is to provide some tips for others who are plagued by the problem.

First, use of the highly-screened type of coaxial cable normally employed for the LNB to satellite receiver feed for other r.f. runs can provide a solution due to the high screening factor. Secondly I find that a little experimentation with lead positioning, particularly the satellite receiver's mains lead, can also help.

With the ever-increasing use of scart sockets, the approach I have adopted with my own equipment is as follows. The aerial signal is connected directly to the TV receiver via a low-loss signal splitter, the second feed going to the VCR for off-air recording of terrestrial TV channels. The Pace 9200 satellite receiver is not connected to the TV set or VCR at r.f., being hooked up via the scart sockets, one to the VCR, one to the TV set. This prevents any patterning on ITV or Channel 4, as happened previously when the 'standard' way of interconnecting equipment was used. I do have an r.f. feed from the satellite receiver to the VCR, but this is purely so that the VCR's r.f. output socket can be used to feed a distribution amplifier for sets in other parts of the house.

Finally there's a small modification that can be done to Pace receivers of the IRD type: it can also sometimes help to prevent patterning. Inside the receiver you'll see a crystal at the rear, right-hand side of the decoder board. If it is stood up on the board, remove it and lay it flat. Fit wire links in the holes at either side and solder them to the body of the crystal. You'll find that this has already been done in some receivers.

*Andrew Tebbutt,
Salthurn-by-sea, Cleveland.*

SAFETY

Your June issue appears to show a technician working on a live TV set with both bare hands. The test equipment shows

readings and oscillograms, so we must assume that there is life of some sort in the set. It's very bad practice to have both hands in the back of a set like this. Even though you may be on a rubber mat and the supply is mains isolated via an RCD you can still receive a lethal shock from even a relatively small voltage, since any shock received will be across your heart muscle.

*L. Mackenzie, T.Eng.,
Edinburgh.*

Editor's note: A point worth emphasising though Richard's left hand is not actually in contact with the chassis – it's at rest on the workbench. The photograph, being two-dimensional, fails to make this clear.

SONY MAINS SWITCH

I often seem to see an article in *Television* soon after having had to solve a similar problem the hard way. Examples that come to mind include the Philips 'C' wrap mechanism (March 1992) and the tuning of a locked-out 3V55 (February 1993, page 253). More recently (May) Steve Cannon's article 'It's only the on-off switch' seemed relevant when I was called to attend to a dead Sony KV2090. Before taking the back off I indicated that the cause is rarely the switch, expecting a power supply problem. But this time it was the mains switch!

A phone call to the nice people at SES referred me to the nice people at Sony Special Operations. For those who have not come across this matter, the switch (part no. 1-554-762-21) was the subject of a callback some time ago. A check on the set's serial number revealed that it hadn't been modified, so Sony arranged for the replacement to be carried out, free of charge to the owner.

It shows that one should start with the very obvious sometimes!

*Peter Delaney, B.Sc.,
Wargrave, Berks.*

NIKKAI BABY 10

In the May issue L. Mackenzie cast doubt on the alternative regulator I suggested (RS type LT1084CP-12) as a replacement for the AL2411 in the Nikkai Baby 10. May council for the defence reply?

Two different samples of original Baby 10 working regulators gave me measured outputs of 10.85V (not 10.4V). The RS 12V regulator with the recommended series diode produced 10.9V, making L. Mackenzie's dire predictions rather unlikely.

I have since used the variable output version of the RS device (LT1084CP, stock no. 265-320) which requires about 180k Ω from pin 1 to chassis for the correct output and no series diode (I used a 220k Ω preset to enable precise adjustment to be carried out). This is cheaper than the fixed 12V version, but runs hotter and is best mounted on the metal side plate behind the mains transformer.

Another increasingly common fault with these sets is the appearance of what look like hum bars after an hour or so of mains operation. It's easy to blame the AL2411 again (or that useless Avis modification) but closer inspection shows that the 'hum bars' are random, vary with picture content and disappear if the signal is attenuated! The cause of the problem is overheating of the TA7680AP i.f. chip IC101 inside the screened case by the tuner. My simple remedy is to cut a suitable rectangle from an old screening cover and bend it, by trial and error, so that one end presses flat against the top of IC101 (heatsink compound helps) while

the other end is soldered along the inside edge of the i.f. screening compartment, nearest the front of the set, before replacing the top cover. This is crude but is easier than it sounds – and it works!

I rest my case, m'lud.

*Chris Avis,
Exeter.*

PHILIPS VR6870 POWER SUPPLY

In a letter in your January issue I pointed out that two VCR Clinic reports misidentified a capacitor in the power supply of the Philips VR6870 VCR. Once again I have to return to the same subject. In the June issue Clinic there is reference to a 10V zener diode identified as D4. But D4 is a BYV10-20 rectifier diode. The BZX79C10 zener diode is D3.

*R.R. Hamilton,
Ashted, Surrey.*

CIRCUS TRICKS

"I'll give you sixty quid for that video in the window" he said.

It was priced at £85, but I said I'd let it go for £75.

He explained that he was from the circus up the road, and would take it without guarantee for £60.

I patiently explained the sale of goods act, pointing out that I couldn't sell the VCR without a guarantee. But I could reduce it from three months to one for £70.

He then said that the shop up the road had one for £50 with a 12-month guarantee.

Being doubtful about this, I asked why he hadn't bought it instead of trying to buy one from me for £70?

He replied that they wouldn't sell it to him. When I tried to understand the logic of this he took from his pocket the "sixty quid". It turned out to consist of circus tickets.

I showed him the door.

*S. Woodbridge-Smith, Argyle TV and Video,
Peeverell, Plymouth.*

BEST OF BOTH WORLDS

Some time ago I wrote on the subject of commentary-free TV sound. Sky Sports now provides such a service. One subcarrier has the complete sound while with another only the effects microphone is live during actual play. With a football match for example the pre-match, half-time and post-match chit-chat are normal but during play there are only the crowd sounds. Sheer bliss!

On giving the matter more thought I realise that my objections were not so much to the commentators, more to the 'special guests' who, though experts and like talking, are certainly not commentators. Anyway, you can now have Sky Sports on two channels, one with commentary and one without.

*Gus Cusick,
Preston, Lancs.*

BACK INJURY

Following previous published letters more and more engineers have been in touch with us about suing for back injuries caused by lifting heavy TV sets. This is just to let others know that we can provide advice and suggest possible legal representatives. Keep writing in!

*Harry and Pam Todd,
37 Northdene, Chigwell, Essex IG7 5JS.
Telephone 081 500 1433.*

1.5 MILLION PEOPLE USE M.C.E.S. PRODUCTS DAILY.

REMANUFACTURED:-

T.V. TUNERS, RF MODULATORS/BOOSTERS,
GRUNDIG TUNER/I.F., ITT TUNER I.F. SAT
TUNERS, L.N.B.s, VIDEO HEADS.

FREE PRICE LIST AVAILABLE.

RING 061-746 8037
FAX 061-746 8136

PAYS-UT.V.

**SUPPLIERS OF WORKING
NEW + USED
TV'S, VIDEOS,
MICROWAVES +
FRIDGE FREEZERS.**

TEL: NOTTINGHAM 0602-500002
LONDON 081-568 8182

WE DELIVER ALL AREAS!



**PHONE
FOR DETAILS**



SONY TUBES RE PROCESSED WITH ORIGINAL SONY GUNS

**HIGH TEMPERATURE RE-PROCESSING of Sony, Mullard 45AX,
30AX, In-line, PiL, Mini (22.5) Neck and FST Tubes.**

3701B22 £25.00	A51-231X ITT £46.00	A51EBD00X £58.00
3702B22 £48.00	A51-570X Mullard £46.00	A51EBV10X01 £58.00
370KR22 £48.00	A51-580X Mullard £46.00	A51JAR00X £64.00
370LHB22 £48.00	A51-590X Mullard £46.00	A51JK000X Sony £74.00
400FB22 Sony £64.00	A56-540X Mullard £52.00	A51JUH10X Sony £74.00
510YUB22 (brand new) £46.00	A56-701X ITT £48.00	A53JBW00X Sony £64.00
520SB22 Sony £64.00	A66-540X Mullard £56.00	A5GEAF00X £64.00
560EB22 Hitachi £48.00	A67-701X ITT £56.00	A59EAK00X Philips £64.00
560YB22 £48.00	A34EAC00X £48.00	A64JKJ10X Sony £95.00
570HB22 Sony £64.00	A34JBU10X Sony £64.00	A66EAF00X £74.00
680DB22 Sony £85.00	A44JFZ10X Sony £78.00	A66EAK00X Philips £74.00
680EB22 Sony £85.00	A49JHT00X Sony £64.00	A68JMT10X Sony £95.00
	A49JLV10X Sony £74.00	A68JYK10X Sony £95.00
	A51EAF00X £58.00	AXM37-001 £48.00
	A51EAK00X £58.00	AXT51-001 £46.00
	A51EAL00X £58.00	

For tube types not listed
please enquire
All Tubes Guaranteed
12 Months

All prices quoted are
excluding VAT
Exchange CRT is
required

Callers welcome.
Please phone first
Delivery
Available

**NEW TUBES IN STOCK - PLEASE PHONE
FOR YOUR REQUIREMENTS**

**Very competitive, nationwide delivery
and collection service**

D.I.Y. Television Tube Polishing Kit

Contains everything you need to Polish scratches and small chips on your CRT screens
All you require is an electric drill. Written instructions are provided. Guaranteed to work.
Worldwide Delivery **Total Price £63.00 includes P&P and VAT** Available from Luton only

Your local stockists are:

WEST ONE
Distributors Ltd.
Chesham, Bucks.
Tel. 0494 778197

WELL VIEW
114-134 Midland Road,
Luton, Beds, U.K. LU2 0BL.
Tel. 0582 402499

WELL VIEW
Southampton, Hants.
Tel. 0703 449783

18 BROOKWOOD ROAD, SOUTHFIELDS, LONDON SW18 5BP.

TEL: 081-877 3492/877 3518 FAX: 081-877 3518

BELT KITS

A range of belt kits in stock from 60p to £2.40. Makes for most models available including: Akai, Amstrad, Ferguson/JVC, Fisher, Funai, GEC, Goldstar, Granada, Grundig, Hitachi, JVC, Matsui, Mitsubishi, Nikkai, Panasonic, Philips, Sanyo, Saisho, Salora, Schneider, Sentra, Sharp, Sony, Tashiko, Toshiba.

Sanyo, Tensai, etc - Please state model and make.

VIDEO MOTORS

A range of Reel Motors made by Ferguson, Hitachi, Sony, Sharp & Panasonic are available, please state model and make.

We stock capstan motors, makes include Ferguson/JVC, Hitachi and Sharp.

Also available are Ferguson Mode Control Motors, please state make, model.

Mode Motor Assembly 3V35-49 at **£12.50**

Sharp Reel Motor Pulley only **£1.20**
Replacement of plastic pulley on a number of Sharp Reel Motors with the above metal pulley gives better rewind/FF performance.

MAINTENANCE KITS

Available for: Alba, Amstrad, Ferguson, Fisher, Goldstar, Goodman, Granada, Hinar, Hitachi, JVC, Matsui, Mitsubishi, Nikkai, Panasonic, Philips, Saisho, Salora, Schneider, Sentra, Sharp, Sony, Tashiko, Toshiba.

LINE OUTPUT TRANSFORMERS

- LOPT Hitachi CPT174.78 **£17.50**
- LOPT Hitachi CPT1476 **£18.00**
- LOPT Hitachi CPT12276 etc **£19.00**
- LOPT Matsui 1440 **£18.00**
- LOPT Matsui 1450 **£22.00**
- Decca 100 **£9.50**
- ITT CVC25/30/32 **£9.50**
- ITT Compact 80 Series 110 **£11.50**
- ITT Compact 80 Series 90 **£9.50**
- ITT CVC1204 **£11.50**
- ITT CVC800/1/3 **£11.50**
- ITT CVC1100 **£11.50**
- ITT CVC1150/1175 **£20.00**

Other ITT transformers available

Fidelity all models up to 20" ZX3000 **£15.50**
Fidelity Panel for ZX2000 **£1.00**
Fidelity 22" ZX3000 **£18.50**
CRT Anode Lamp from **£12.50**
Hinar CT4/5 & TVA1 **£19.50**
Philips KT3 **£14.50**
Thorn TX100 Green Spot 110 **£17.75**
Ferguson TX90 LOPT specify size screen **£17.75**
Sony - Please state model for price

PINCH ROLLERS

A range of Pinch Rollers is in stock, most of them @ £2.80. Makes include: Akai, Amstrad, Ferguson, Fisher, Funai, GEC, Goldstar, Grundig, Hitachi, Hitachi, I.T.T., JVC, Marantz, Mitsubishi, NEC, Nordmende, Orion, Panasonic, Philips, Samsung, Sanyo, Schneider, Sharp, Sony, Tensai, Thomson, Toshiba etc. Please state model and make.

Philips Pinch Roller for models VR6180, 6185, 6285, 6362, 6367, 6467, 6468, 6470, 6561, 6670, POA 6760, 6761, 6870 **£6.00**

BACK-UP BATTERIES

- Philips 1.2V Back up Battery **£1.75**
- Philips 2.4V Back up Battery **£2.80**
- Ferguson TX10 **£2.00**
- Ferguson TX10 1.2 **£2.10**
- Ferguson TX10 2.4 **£3.58**
- 5V Back Up Cap **£1.85**

TV ON/OFF SWITCHES

ITT, Philips, Decca, Thorn, Fidelity, Grundig, Sony and Hitachi. State model for price.

SONY PUSH SWITCH 80p

- Limiter Post Assembly **£1.75**
- Makes & Models: Hinar! VXL4 **£19.75**
- Matsui VX730, 735, 735A, 755, **£11.50**
- £21.50
- £16.50
- £20.00

OTHER SPARES

- Universal Video Copying Kit **£15.50**
- Universal Copying Kit (Scart) **£1.00**
- Universal Camcorder Kit **£18.50**
- VCR Anode Lamp from **£12.50**
- CRT Anode Lamp from **£19.50**
- Video Tape Splicing Kit **£12.95**
- Hiachi TV Frame Module HM6251 **£14.50**
- Hiachi TV Frame Module HM6232 **£17.75**
- Cassette Housing Assembly Ferguson 3V35, 36, 38, 39, 42, 43, 44 **£22.50**
- Cassette Loading Roller Assembly 3V23, 3V31, 3V32 **£3.50**
- Degaussing Positor Blue **£4.00**
- Degaussing Positor White **£1.30**
- Degaussing Positor Hitachi **£3.40**
- Degaussing Positor Philips **£3.00**
- Cassette Housing Assembly Hitachi VT 11 **£2.75**
- End Sensor for Hitachi VT63, 64, 65 (Pair) **£1.60**
- Cassette LED Sensor for Panasonic etc **£0.60**
- I.C. Circuit Protectors **£5.90**
- Clear Service Cassette **£6.00**
- Video Idlers Spring Kit **£5.95**
- Video Washer & E Clip Kit **£6.00**

Universal Video head Puller **From £7.90**
Akai VS22 Series Power Board **£28.00**
Soldering Iron 25W **£9.50**
Multimeter **From £11.50**

MANY OTHER VIDEO AND TV SPARES IN STOCK

Back Tension Bands in Stock for Akai, Fisher, Hitachi, Ferguson, JVC, Mitsubishi, Panasonic, Sanyo and Sharp.

VIDEO HEADS

AMSTRAD, FERGUSON, HITACHI, PANASONIC, SANYO, SHARP, FISHER, HINARI, ALBA, MITSUBISHI, ORION, SAISHO, SAMSUNG, TOSHIBA. State Model No. Price from **£7.50**

IDLER ASSEMBLY

FERGUSON, FISHER, HITACHI, PHILIPS, PANASONIC, SANYO, SHARP, AKAI, SAMSUNG, MITSUBISHI, NEC, In Stock. Price on Application Wide Range Available.

L18205... SCART SWITCHING UNIT.

At the push of a button it is now possible to link your AV & audio systems together via the commonly used Scart sockets. No more unplugging, just a simple push-button operation allowing recording & playback of up to five different appliances. **£14.50**

SATELLITE SPARES

SATT DISHES, LNBs, CABLES, SATT FINDER KITS, INSTALLATION KITS, etc **NOW IN STOCK**

- IDB LNB **£35.00**
- Dual LNB both outputs H/V **£52.00**
- 63cm Dish **£19.75**
- 80cm Dish **£39.50**
- 100cm Dish **£59.00**
- Other items in stock **P.O.A.**

REMOTE CONTROLS

Bush, Ferguson, Grundig, I.T.T., Philips, Pye, Sony, Hitachi, Matsui, Logik, Panasonic, Saisho, Salora, Samsung, Tashiko, Talung, Toshiba. Various models TV & Video. **From £10.00**

MANY HITACHI TV REMOTE CONTROLS NOW IN STOCK.

STATE MODEL FOR PRICE

One for all Mk 3, 4, 6, **From £18.50**
Toppel Universal RVC **£28.00**
Fox **£22.50**

TRIPLERS

Universal Tripler **£6.20**
Universal Tripler with focus unit **£9.50**
Decca 120/130 series tripler **£8.50**
Ferguson 9000 triplers **at £4.50**
Thorn TX10 Focus Unit Kit **£10.00**
Grundig Trips **POA**

Prices subject to change without notice. Please add £1.25 per order for p&p and then add 17.5% VAT. POSTAGE VARIES ON HEAVY ITEMS. SEND A4 SAE FOR LIST

84A236	£2.75	17915	10.80	M51164	£1.40	SA4500	£3.00	SRK5730	£5.25	TA1607	£3.50	TD4190	£2.50	25C2564	£3.00	BC1214I	£0.05	TP147	£0.95
84A402	£1.90	17918	10.80	M5138P	£5.00	SA4501C	£5.80	SRK6962	£3.20	TA1670AP	£3.70	TD42002	£1.40	25C2570	£5.00	BC1227	£0.07	TP1791A	£1.50
AN103	£1.60	17924	10.80	M5139P	£1.50	SA4501D	£6.60	SRK7372	£6.00	TA1670P	£2.70	TD42003	£1.30	25C2577	£1.50	BC1238	£0.07	2TR604	£0.25
AN2140	£2.50	84504	£3.00	M5139S	£4.25	SA4502	£5.80	SRK7376	£5.10	TA1671	£4.20	TD42004	£1.15	25C2582	£2.95	BC1257	£0.07	2TR650	£0.70
AN2460	£1.30	84524	£2.00	M51401	£0.95	SA4503	£10.00	SRK7388	£5.75	TA1672P	£4.00	TD42005	£1.70	25C2621	£1.25	BC1308B	£0.07		
AN253P	£1.80	84540Z	£2.40	M51412	£1.10	SA4504A	£5.00	SRK7309	£5.45	TA16729	£2.40	TD42005S	£2.95	25C2631	£3.00	BC1327-25	£0.07		
AN261P	£1.80	84540Z	£2.40	M51413	£1.10	SA4504B	£3.50	SRK7348	£6.45	TA16739P	£2.95	TD42006V	£1.95	25C2632	£2.00	BC1328	£0.07		
AN261P	£1.80	84540Z	£2.40	M51414	£1.10	SA4505	£5.00	SRK7354	£6.50	TA16740	£2.00	TD42007	£1.15	25C2635	£1.95	BC1329	£0.07		
AN261P	£1.80	84540Z	£2.40	M51415	£1.10	SA4506	£10.00	SRK7358	£6.50	TA16740	£2.00	TD42008	£1.15	25C2638	£2.95	BC1332	£0.07		
AN261P	£1.80	84540Z	£2.40	M51416	£1.10	SA4507	£10.00	SRK7378	£4.75	TA16758	£2.00	TD42030H	£2.00	25C2639	£2.00	BC1332	£0.07		
AN261P	£1.80	84540Z	£2.40	M51417	£1.10	SA4508	£3.50	SR1996	£3.40	TA16768	£1.50	TD42030V	£1.75	11011CP	£2.00	BC1335	£0.07		
AN261P	£1.80	84540Z	£2.40	M51418	£1.10	SA4509	£11.00	SR1997	£3.50	TA16769	£1.50	TD42032	£1.95	25C1402	£0.45	BC1341	£0.07		
AN261P	£1.80	84540Z	£2.40	M51419	£1.10	SA4510	£10.00	SR1998	£16.00	TA16781AP	£3.75	TD42151	£3.00	25C15-9	£3.75	BC1342	£0.07		
AN261P	£1.80	84540Z	£2.40	M51420	£1.10	SA4511	£10.00	SR1999	£8.00	TA16787	£2.00	TD42161	£1.75	IMS1944ZNL	£2.00	BC1343	£0.07		
AN261P	£1.80	84540Z	£2.40	M51421	£1.10	SA4512	£3.50	SR1999	£5.95	TA16796A	£1.85	TD42170	£3.20	IMS1952	£2.50	BC1344	£0.07		
AN261P	£1.80	84540Z	£2.40	M51422	£1.10	SA4513	£3.50	SR1999	£3.40	TA16798AP	£1.85	TD42170	£3.20	IMS1956	£2.20	BC1345	£0.07		
AN261P	£1.80	84540Z	£2.40	M51423	£1.10	SA4514	£3.50	SR1999	£14.00	TA16799	£1.50	TD42170	£3.20	IMS1963NL	£2.00	BC1346	£0.07		
AN261P	£1.80	84540Z	£2.40	M51424	£1.10	SA4515	£3.50	SR1999	£1.90	TA16799	£1.50	TD42170	£3.20	IMS1963NL	£2.00	BC1347	£0.07		
AN261P	£1.80	84540Z	£2.40	M51425	£1.10	SA4516	£3.50	SR1999	£1.90	TA16799	£1.50	TD42170	£3.20	IMS1963NL	£2.00	BC1348	£0.07		
AN261P	£1.80	84540Z	£2.40	M51426	£1.10	SA4517	£3.50	SR1999	£1.90	TA16799	£1.50	TD42170	£3.20	IMS1963NL	£2.00	BC1349	£0.07		
AN261P	£1.80	84540Z	£2.40	M51427	£1.10	SA4518	£3.50	SR1999	£1.90	TA16799	£1.50	TD42170	£3.20	IMS1963NL	£2.00	BC1350	£0.07		
AN261P	£1.80	84540Z	£2.40	M51428	£1.10	SA4519	£3.50	SR1999	£1.90	TA16799	£1.50	TD42170	£3.20	IMS1963NL	£2.00	BC1351	£0.07		
AN261P	£1.80	84540Z	£2.40	M51429	£1.10	SA4520	£3.50	SR1999	£1.90	TA16799	£1.50	TD42170	£3.20	IMS1963NL	£2.00	BC1352	£0.07		
AN261P	£1.80	84540Z	£2.40	M51430	£1.10	SA4521	£3.50	SR1999	£1.90	TA16799	£1.50	TD42170	£3.20	IMS1963NL	£2.00	BC1353	£0.07		
AN261P	£1.80	84540Z	£2.40	M51431	£1.10	SA4522	£3.50	SR1999	£1.90	TA16799	£1.50	TD42170	£3.20	IMS1963NL	£2.00	BC1354	£0.07		
AN261P	£1.80	84540Z	£2.40	M51432	£1.10	SA4523	£3.50	SR1999	£1.90	TA16799	£1.50	TD42170	£3.20	IMS1963NL	£2.00	BC1355	£0.07		
AN261P	£1.80	84540Z	£2.40	M51433	£1.10	SA4524	£3.50	SR1999	£1.90	TA16799	£1.50	TD42170	£3.20	IMS1963NL	£2.00	BC1356	£0.07		
AN261P	£1.80	84540Z	£2.40	M51434	£1.10	SA4525	£3.50	SR1999	£1.90	TA16799	£1.50	TD42170	£3.20	IMS1963NL	£2.00	BC1357	£0.07		
AN261P	£1.80	84540Z	£2.40	M51435	£1.10	SA4526	£3.50	SR1999	£1.90	TA16799	£1.50	TD42170	£3.20	IMS1963NL	£2.00	BC1358	£0.07		
AN261P	£1.80	84540Z	£2.40	M51436	£1.10	SA4527	£3.50	SR1999	£1.90	TA16799	£1.50	TD42170	£3.20	IMS1963NL	£2.00	BC1359	£0.07		
AN261P	£1.80	84540Z	£2.40	M51437	£1.10	SA4528	£3.50	SR1999	£1.90	TA16799	£1.50	TD42170	£3.20	IMS1963NL	£2.00	BC1360	£0.07		
AN261P	£1.80	84540Z	£2.40	M51438	£1.10	SA4529	£3.50	SR1999	£1.90	TA16799	£1.50	TD42170	£3.20	IMS1963NL	£2.00	BC1361	£0.07		
AN261P	£1.80	84540Z	£2.40	M51439	£1.10	SA4530	£3.50	SR1999	£1.90	TA16799	£1.50	TD42170	£3.20	IMS1963NL	£2.00	BC1362	£0.07		
AN261P	£1.80	84540Z	£2.40	M51440	£1.10	SA4531	£3.50	SR1999	£1.90	TA16799	£1.50	TD42170	£3.20	IMS1963NL	£2.00	BC1363	£0.07		
AN261P	£1.80	84540Z	£2.40	M51441	£1.10	SA4532	£3.50	SR1999	£1.90	TA16799	£1.50	TD42170	£3.20	IMS1963NL	£2.00	BC1364	£0.07		
AN261P	£1.80	84540Z	£2.40	M51442	£1.10	SA4533	£3.50	SR1999	£1.90	TA16799	£1.50	TD42170	£3.20	IMS1963NL	£2.00	BC1365	£0.07		
AN261P	£1.80	84540Z	£2.40	M51443	£1.10	SA4534	£3.50	SR1999	£1.90	TA16799	£1.50	TD42170	£3.20	IMS1963NL	£2.00	BC1366	£0.07		
AN261P	£1.80	84540Z	£2.40	M51444	£1.10	SA4535	£3.50	SR1999	£1.90	TA16799	£1.50	TD42170	£3.20	IMS1963NL	£2.00	BC1367	£0.07		
AN261P	£1.80	84540Z	£2.40	M51445	£1.10	SA4536	£3.50	SR1999	£1.90	TA16799	£1.50	TD42170	£3.20	IMS1963NL</					

AMP KITS

30 WATT SINGLE CHANNEL

30 watt rms into 8ohm, 20HZ-20KHZ harmonic distortion 0.1%, sensitive to 150MV, mic sensitivity 50MV, 36V x 2 psu's required complete with base, treble and volume controls and heat sink.

Our Price : £8.00 each

Our Ref : EE/W8P7

120+120 WATT STEREO AMP

240 watts rms into 4 ohm, 10KZ-20KHZ, harmonic distortion less than 0.01%, sensitivity 3MV (phono), 130MV (aux), 2 x 30V psu's required

Our Price : £30.00 each

Our Ref : EE/W30P3

30 WATT STEREO AMP

30 watts rms into 8ohm, harmonic distortion 1%, sensitivity 3MV (phono), 130MV (tuner), signal to noise 80db, 36V x 2 psu's required

Our Price : £16.00 each

Our Ref : EE/W16P1

300 WATT MONO AMP

300 watt rms output, harmonic distortion less than 0.05% 10KHZ. 2 x 60V psu's required

Our Price : £40.00 each

Our Ref : EE/W40P3

AMSTRAD MP3

A complete fully tunable VHF/UHF TV receiver with RGB and composite video out, audio on internal speaker. Intended for use with CTM644 colour monitor but can be used with monitors that have a 15.825kHz line frequency. Needs 12V DC psu. **BRAND NEW AND CASD.**

Our Price : £19.00

Our Ref : TV/V19P1

WE HAVE HUNDREDS AND HUNDREDS MORE STOCK LINES - TOO MANY TO LIST IN ONE ADVERT ! CHOOSE FROM...

AERIAL AMPLIFIERS	FANS
AEROSOLS	FUSES
ALARMS	GLUE GUN AND GLUE
AMPLIFIED SPEAKERS	HEADPHONES
ANALOGUE MULTIMETERS	HEATSHRINK SLEEVING
APPLIANCE LEADS	HI FI SPEAKERS
BATTERIES AND HOLDERS	IONISERS
BATTERY CHARGERS	LED'S
BOOKS	LASERS AND LASER PSU'S
BOXES AND CASES	LOGIC PROBES
CAMCORDER BITS	LOUD AND MARINE SPKRS
CAPACITORS	MICROPHONES
CAR AMPS, RADIOS & SPKRS	PIR LIGHTS AND DETECTORS
CB SPEAKERS AND PSU'S	POWER SUPPLIES
COMPUTER BITS	POWER AMPLIFIERS
CONNECTORS	RADIOS
DESOLDER PUMP	SERVICE AIDS
DIGITAL MULTIMETERS	SOLDERING EQUIPMENT
DISCO LIGHTING	STEAM ENGINES
DISPLAYS	TRANSISTERS
DUBBING KIT	TRANSFORMERS
DRILLS	WIRELESS MICROPHONES

MINIMUM GOODS ORDER £5.00 TRADE ORDERS FROM GOVERNMENT, SCHOOLS, UNIVERSITIES & LOCAL AUTHORITIES WELCOME. ALL GOODS SUPPLIED SUBJECT TO OUR CONDITIONS OF SALE AND UNLESS OTHERWISE STATED GUARANTEED FOR 30 DAYS. RIGHTS RESERVED TO CHANGE PRICES & SPECIFICATIONS WITHOUT PRIOR NOTICE. ORDERS SUBJECT TO STOCK. QUOTATIONS WILLINGLY GIVEN FOR QUANTITIES HIGHER THAN THOSE STATED.

THIS MONTHS SPECIAL OFFERS

COMMODORE 64 & PSU

Once again available due to a bulk purchase. Commodore 64 together with Power Supply, supplied and tested in working order.

Our Price: £50.00 Ref: TV/W50P1

PIR MOVEMENT DETECTOR

Once again we have acquired stocks of this popular line and are able to offer you a very high quality and professional detector at only ***£15.00***. Range: 20 Mtrs with a 90° arc. Day and Night Mode Dimensions: 15cm x 9cm x 11cm. New and boxed complete with installation guide.

Our Price: £15.00

Our Ref : TV/W15P2

ELECTRIC MOTOR - 3 PHASE

GEC Alpak Induction Motor. This is an extremely well made industrial 3 phase motor **BRAND NEW & UNUSED.** Supplied with full installation and maintenance literature.

Our Price: £60.00

Our Ref : TV/W60P1

PORTABLE ALARM SYSTEM

'PAL' Portable Multi Bean Scanning System. Lockable Stand-alone PIR unit with removable keys (3 supplied). This unit uses a PP3 battery and when activated emits a piercing SHRILL! The units scans the room and memorises the layout. Should this change, the alarm is triggered. There is a 60 second exit delay.

Our Price: £17.00

REF : TV/W17P1

CAR PHONE HANDSETS YUPPIES LOOKOUT!!

Brand New High quality handsets originally intended for use with Phillips Mobile Phone System. We have acquired a number of these handsets, supplied in two parts, speaker and combined phone rest unit plus handset with LCD display, LED indicators and push button dialling. 6 additional keys as well as the conventional 12 numeric keypad. No transmitter/receiver. 5 Mtr 12 core black cable attached. Excellent Dummy Mobile Phone!!!

Price: £6.00 each

Ref : TV/W6P3

MINI MULTI TESTER

Mini multi-tester with 9 ranges. AC Volts up to 1000. DC Volts up to 500. Ohms/mA ranges. 1K ohm/V. Ideal for pocket or toolbox use and at only £5.00 each - replaceable!!

Our Price: £5.00

Our Ref : TV/W5P2

HEAT DETECTOR

This is a Japanese made combination type heat detector which could be linked to a suitable fire alarm panel. 105mm dia. 30V operational.

Our Price: £4.00 Our Ref: TVW4P1

SOME OF OUR PRODUCTS MAY BE UNLICENSABLE IN THE UK

BULL ELECTRICAL

250 PORTLAND ROAD HOVE SUSSEX BN3 5QT

MAIL ORDER TERMS: CASH PO OR CHEQUE WITH ORDER PLUS £3.00 POST PLUS VAT.

PLEASE ALLOW 7 - 10 DAYS FOR DELIVERY TELEPHONE ORDERS WELCOME

TEL: 0273 203500 FAX: 0273 323077



USEFUL POWER SUPPLY - £5.00

14.5V DC @ 400Ma battery charger Plug in type with sleeved pins. Lead terminates in 3 pin din plug, easily removable. Originally intended for mobile phone charging. (Large quantities available)

Our Price : £5.00 each

Our Ref : TV/W5P8

AMSTRAD PRINTER MECHS

We have both Amstrad LQ3500 and Amstrad DMP4000 printer mechanisms. No case or electronics but complete with print head. Ideal for replacement. The mechanism comes with two high quality stepper motors which together with the print head are worth much more than we are selling the whole unit for!!!! This unit could also be utilised for a number of other projects including coil winding, laser scanning(*) etc.

(Quantity Prices available on application)

AMSTRAD LQ3500 units

Our Price : £10.00 each

Our Ref : TV/W10P5

AMSTRAD DMP 4000 units

Our Price : £20.00 each

Our Ref : TV/W20P3

MANY MORE SPECIAL OFFERS IN OUR REGULAR NEWSLETTERS

PC CORNER

PC CASES desk top case +psu £51.60 ref BPC/C1 Deluxe slimline case +psu £60.00 ref BPC/C2. Minitower case +psu £51.60 ref BPC/C3. Deluxe midi case +psu £90.00 ref BPC/C4. **MONITORS** Mitac 14" SVGA 39DP £174.00 ref BPC/MO2. Mitac 14" SVGA 28DP £202.00 ref BPC/MO1. **MEMORY** 256K Simm 70ns £8.40 ref BPC/M11. 1MB Simm 70ns £26.40 ref BPC/M12. 4MB Simm 70ns £96.00 ref BPC/M13. **MOUSE** 2 button serial mouse with 3.5" s/ware £8.40 ref BPC/M16. 3 button serial mouse with 3.5" s/ware £9.60 ref BPC/M17. **KEYBOARDS** 102 AT UK standard keyboard £18.60 ref BPC/M14. Deluxe keyboard 102 AT UK £26.40 ref BPC/M15. **SOFTWAREMS DOS 5 OEM version** £39.60 ref BPC/M18. **MS WINDOWS 3.1 OEM version** £42.00 ref BPC/M19. **6 286-16** Headland chipset £46.80 ref BPC/MB1. 386SX-33 Acer chipset £82.80 ref BPC/MB2. 386SX-40 UMC with 64K cache £110.00 ref BPC/MB3. 486SX-25 UMC with 64K cache £191.00 ref BPC/MB4. 486DX-33 UMC with 256K cache £378.00 ref BPC/MB5. 486DX-66 UMC with 256K cache £515.00 ref BPC/MB6. **FLOPPY DRIVES** 1.44mb 3.5" drive £32.34 ref BPC/DD05. 1.2mb 5.25" drive £38.40 ref BPC/DD02. 3.5"-5.25" mounting kit £5.00 ref BPC/DD07. **HARD DRIVES** 42MB IDE 17ms £99.00 ref BPC/DD01. 89MB IDE 16ms £166.00 ref BPC/DD02. 130MB IDE 15ms £215.00 ref BPC/DD03. 213MB IDE 14ms £298.00 ref BPC/DD04. **VIDEO CARDS** 256K C&T 8 bit SVGA card £22.20 ref BPC/VC01. 512K Trident 9000 16 bit SVGA card £31.20 ref BPC/VC02. 1MB Trident 8900 16 bit SVGA card £45.00 ref BPC/VC03. 1MB Cirrus AVGA3 16 7M colours £48.00 ref BPC/VC04. 1MB Tseng multimedia £82.80 ref BPC/VC05. **ADD ON CARDS** Multi I/O card 2s. 1p. 1g. 2fdd. 2hdd £11.00 ref BPC/AOC01. ADLIB sound card with speakers £37.00 ref BPC/AOC02. Orchid sound card with speakers £63.00 ref BPC/AOC03.

EXAMPLES OF COMPLETE SYSTEMS

386SX-33 SYSTEM

386SX-33 board at £82.80. case £51.60. 2MB ram £52.80. 42MB drive £99.00. SVGA colour monitor £174.00. 102 keyboard, £25 build fee if required. Total £579.34

486DX-33 SYSTEM

486DX-33 board £378.00. case £51.60. 2MB ram £52.80. 89MB drive £166.00. 512 SVGA card £31.20. 3.5" FDD £32.34. multi I/O card £11.00. SVGA monitor £174.00. 102 keyboard £18.60. £25 build fee if required. Total £939.84

ALL PC PARTS AND SYSTEMS ARE GUARANTEED FOR 1 YEAR PARTS AND LABOUR.

IN SUSSEX?

CALL IN AND SEE US!!

TURN YOUR SURPLUS STOCK INTO CASH. IMMEDIATE SETTLEMENT. WE WILL ALSO QUOTE FOR COMPLETE FACTORY CLEARANCE.

MUCH MUCH MORE IN OUR 1993 CATALOGUE. PLEASE SEND 41P, A4 SIZED SAE FOR YOUR FREE COPY.

Camcorner

*Reports from Simon Bodgett,
Ronald Aranha, David C. Woodnott
Brian Storm and John C. Priest*

Ferguson FC06

There was intermittent sound because the tape shifted in height as it ran across the audio head: the cause of the problem was the pinch roller. **S.B.**

Sony CCDTR55

This 790g wonder had a cassette stuck in it. Pressing the eject button had no effect, though motor noise and mechanical movement could be heard for a while, followed by shut-down and then the caution indicator blinking. When we opened the unit we found that the camera block could be separated from the VTR section. The machine unloaded without problem when an external d.c. voltage was applied to the loading motor, so the load/unload mechanism seemed to be all right.

We next checked for reel pulses at the syscon chip IC601 on board VS37. These and the head switching pulses were present, but in comparison with another machine the capstan motor movement seemed to be much too fast. A check showed that the capstan FG pulses at pin 62 of IC601 were missing. They come from the CX20115A chip IC503, which produced no output pulses at pin 12. The d.c. voltage here was also incorrect. A new CX20115A chip restored normal operation. It's an SMD, so special care is required. **R.A.**

Sony CCDV90E

We had to attend to this camcorder on three occasions. It showed the no power symptom, i.e. no display in the LCD window. On the first two occasions the LCD appeared and all other functions were restored when the lithium battery, which is used to store day and date information, was removed then replaced. On the third occasion manipulating the lithium battery made no difference. So voltage checks were carried out around IC151 (μ PD7503G) and reset transistors Q156/8/9 on board FD4P. No abnormal readings were found, but when C153 (1 μ F) was momentarily shorted the LC display came on. Shorting C153 makes Q159's collector, which is connected to IC151's reset pin, go high. On the assumption that IC151 was not able to reset internally we fitted a replacement. Everything then functioned normally. **R.A.**

Sony CCDTR75E

The reported fault was that there were no functions and a tape was stuck in the mechanism. After removing the tape and checking for any obvious mechanical problems we inserted a cassette. It seemed to load correctly but when we tried there were no functions and the tape was once more stuck. After several more attempts at loading it became clear that the cause of the problem was a capstan fault. In fact the capstan motor didn't turn – it merely twitched. A new CXA1127AM capstan drive chip restored normal operation: one of its three-phase drive outputs had failed. **D.C.W.**

Bauer VCC526AF

The complaint with this full-size VHS Panasonic clone was that it produced noise on the sound with recordings. We

soon found that the noise was there during playback as well – the lower capstan motor bearing was worn to the extent that the rotor scraped against the motor's windings. When the capstan shaft was rotated by hand the noise was not evident: the symptom occurred only when sideways pressure from the pinch roller was present. A new set of bearings cured the problem. **D.C.W.**

Sony CCDF375E

There was no playback sound. A check with another machine proved that sound was being recorded. The playback audio f.m. signal from the video heads passes via the servo/syscon PCB, where there are a buffer stage and a stage of amplification. The 0.01 μ F coupling capacitor between the two stages, C401, was open-circuit. **D.C.W.**

Panasonic NVS5B

The complaint was of a 'cinemascope viewfinder'. On inspection we found that the fault was lack of height in the electronic viewfinder display. Recordings made and then played back on another machine proved that the camera operation was o.k., and an AV link to a monitor to display the live picture proved that the fault was within the EVF unit.

The EVF PCB is fitted inside the camcorder's right-hand side casing. Viewfinder brightness and focus controls are accessible through a small oval hole sealed with a rubber cap. There's also a height control on this PCB, but it's not within reach of the adjustment hole. A little judicious pressure on the PCB, using a plastic probe inserted through the hole, cured the fault intermittently however. There was obviously a dry-joint somewhere.

The palmgrip casing was dismantled to gain access to the EVF PCB, which was then removed and examined. The cause of the fault would probably lie in the area of pins 1 and 5 of IC801 and resistors VR801 (height) and R802/R827. But despite a close examination, using a x10 headband magnifier, no fault could be seen. We decided to apply a small bead of rework flux to each suspect joint in the area, using a sharpened matchstick, and then use a Weller hot-air soldering tool to heat each joint in turn until the solder flowed. During this operation the surface-mounted components were held in place with fine tweezers, to prevent them moving while the solder was fluid.

When we reassembled the camcorder and tested it we found that the fault had been cleared completely. This was confirmed by several periods of recording and playback with 'rough' handling and vibration to try to recreate the fault. Everything was o.k.

A week later another NVS5 arrived in the workshop with exactly the same fault. It also responded to the reflow treatment. **J.C.P.**

Panasonic NVS5B

Intermittent no zoom was the complaint with this palm-corder. When we stripped it down we found that simply touching the flexicable between the process CBA and the main CBA produced the fault. A new flexicable (VWJ049S) cured the fault. **B.S.**

Long-distance Television

Roger Bunney

The 1993 Sporadic E (SpE) season got off to a dismal start. As I write this in early June there have been few signals to excite or captivate. An interesting reception was a possibly Arabic double-hop signal floating under a single-hop signal from Yugoslavia: whenever a signal is present from the 'Yugoslavian' area it's always worth checking for Arabic signals. The absence of an SpE opening in April and the late start of the season in May, plus the closeness of the last sunspot peak, suggest that the 1993 season will be poor and will fizzle out early. The following log shows what May produced by way of SpE signals:

- 12/5/93 CST (Czechoslovakia) ch. R1; CIS (Russia) R1; JRT (Yugoslavia) E3, 4; ARD (Germany) E4; RAI (Italy) IA, B; RTP (Portugal) E3; TDF (France) L2.
- 13/5/93 RAI IA; SVT (Sweden) E2; NRK (Norway) E2; CST R1, 2.
- 14/5/93 RUV (Iceland) E4; NRK E3; SVT E2; RTP E3.
- 16/5/93 Suspected JTV (Jordan) or IRIB (Iran) E3.
- 17/5/93 JRT E3; Arabic ch. E3/4 signals 1610-1615.
- 18/5/93 RAI IA.
- 21/5/93 NRK E2; SVT E2, 3.
- 25/5/93 CIS R1, 2.
- 26/5/93 CIS R1, 2; RAI IA.
- 27/5/93 TVE (Spain) E3; RTP E3; MTV (Hungary) R1, 2; CST R1; ORF (Austria) E2a; SVT E3; DR (Denmark) E3.
- 30/5/93 NRK E2, 3, 4; SVT E2, 3, 4; CIS R1-4; TVP (Poland) R2.
- 31/5/93 DR E3, 4; CIS R2; JRT E3.

Tropospheric activity was noted on the 7/8th and 11/12th, with Band III/u.h.f. reception of German and Scandinavian signals in the north east, then on the 22nd/23rd with reception of French and Benelux signals in the south/south east.

Tim Anderson (St. Leonards) reports that several DXers have received on their scanners a tropospheric scatter signal at 36-83MHz, with at times weak audio. The signal is always present and has been received across the southern UK and as far north as S. Wales. Can anyone suggest the source?

My thanks to Iain Menzies (Aberdeen), David Glenday (Arbroath), Brian Williams (Penarth), Peter Schubert

(Rainham), Simon Hamer (Powys) and Tim Anderson (St. Leonards) for sending in reception reports.

News Items

Planning permission: The RSGB recently provided details of planning law changes that may affect readers seeking permission to erect a TV-DXing mast. It states in Annex 4 of PPG8 para 1 of the Department of the Environment/Welsh Office document *Planning Policy Guidance Note 8 – Telecommunications (PPG8)*, issued last December, that generally potential interference is irrelevant to planning applications since other controls exist to deal with interference. It's thus unlikely that permission would be refused on interference grounds, whether the equipment is to be used for transmission or not. Should an application be refused solely on the grounds of anticipated interference, if an appeal is made the planning authority must produce detailed evidence of interference or anticipated interference, together with reasons for there being 'no reasonable remedies that would be satisfactory'.

Holland: A new station, TV Zuid-Holland, is due to start up in Rotterdam this autumn. It is intended to provide a feed for cable systems but will also operate a 30kW e.r.p. u.h.f. transmitter with output from the 180m Waalhaven harbour PTT tower. Transmissions, on a channel still to be decided, will be in the clear.

Baltic states: The BDXC News reports that there are now two high-powered Band I transmitters in Latvia, Riga ch. R3 (150kW) and Kuldiga ch. R1 (10kW). The UIET test pattern used has the identification 'LATVIJAS TV' for local Latvian channels or 'UT' for the Ostankino (Moscow) service. The identification 'OP C' means that the signal originates from the Kalingrad region. At times the pattern is transmitted without identification. A new US-financed commercial station, 'Baltic TV', is now in operation at Vilnius, Lithuania.

Belgium: The ARTE/21 service is now being transmitted from Anderlues on ch. E61. The ARTE service has scrambled vision but clear sound. When ARTE programmes are not being transmitted the feed is taken from either RTBF-1 or Sport 21. Apart from Brussels ch. E45 the former Tele 21 transmitters now carry the RTBF-1 service or Sport 21. A new main transmitter is under construction at St. Pieters-Leeuw, some 15km south west of Brussels: it will carry the Wavre replacement transmissions and should be on air by the end of the year.

Amateur radio: On February 6/7th there was, as previously reported here, an attempt to bounce 50MHz signals via the moon between the US West Coast and Europe. I heard nothing on my scanner but others were more successful and heard weak signals. It seems that stacked Yagi aerials were

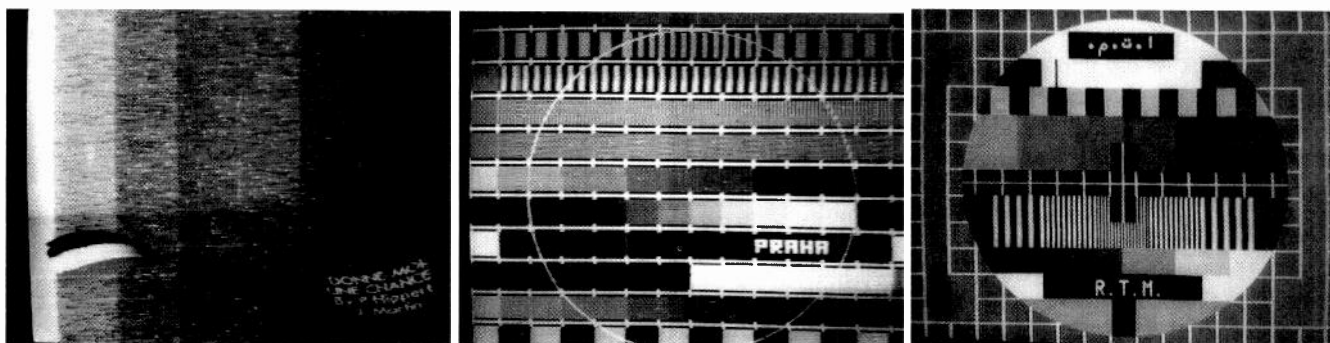

Left: A sound-in-sync signal received from Ireland via Eutelsat II F4 at 7°E during rehearsals for the 1993 Eurovision song contest. Centre: A familiar test pattern, received this time via a Pace satellite receiver. Right: The RTM (Morocco) test pattern received via Eutelsat II F3 at 16°E. All reception by Andrew Sykes in Yorkshire.

the best bet for reception. The least that was required was a six-element array cut to frequency. Polish amateurs can now use the 50-52MHz band, with SSB/CW at up to 10W. At least a hundred stations should be in operation by the time that this is read. The Ukraine is also to allow 50MHz operation, probably by mid-summer.

Sunspots: The minimum count in sunspot cycle 22 is expected to be in 1997, with cycle 23 peaking in the year 2000. Time flies! Thanks to *Six News* for this information.

Satellite TV

The mystery of the Space Shuttle pictures via Houston TV/NASA TV has been cleared up: the satellite link was via Intelsat 504 at 31.4°W. This satellite is now in an inclined orbit, having been moved from 40.5°W last spring.

The BBC SNG unit UKI-17 is in operation in Yugoslavia and can often be seen feeding back via Eutelsat II F1 at 13°E – try 11.68GHz. Another new SNG identification is Starbird UKI-94, also seen at 13°E.

Astra 1C was successfully launched on May 11th and was seen on test while being moved to 19.2°E. Telecine Romandie has been given permission by the Swiss authorities to transmit its Cinevision service via an Astra transponder, with subcarriers for German, French, Spanish, Italian and English sound. A decision has still to be made on the encryption system: the subscription would be about 15 swiss francs (£6) a month.

Red Hot Dutch has been granted a licence to broadcast in Denmark. Although the supply of equipment for viewing it is illegal in the UK, it's not illegal to view the programmes. The encryption system is Enigma, a variant on VideoCrypt.

A Turkish channel, ATV, was due to go on air via Intelsat II F2 at 10°E on June 14th. An English-language channel, Wire TV, is seen in the clear via Intelsat 601 at 7.5°W (11.5GHz horizontal). Programming includes live Bs from various parts of the UK.

We've had Gorizont and Ekran: now we have Coupon, a new group of three broadcasting satellites that provide global coverage with transponders which are available for lease. Its phased aerial system provides steerable-beam up and down links with a variable e.i.r.p. of 30-50dBW. The system should be in operation early next year.

Intelsat is to lease three Express class satellites from Russia, operations starting next summer. The satellites will be positioned over the Atlantic, Pacific and Indian Oceans, each one having ten C band and two Ku band transponders.

The Deutsches Bundespost has withdrawn from Eurosat, which means that the project – for a new DBS service from 0°W – is likely to be abandoned.

The Middle East Broadcasting service via Eutelsat II F1 13°E now carries teletext.

Satellite Reception for DXers

With the gradual reduction in the number of Band I TV transmitters in operation in recent years and increasing interference in this band, satellite TV has seemed to many DXers, including the writer, to be the best alternative way of seeking unusual signals. At my valley location, where tropospheric reception has never been outstanding, a 1.5m dish on a small site in the back garden gives me any TV that's being down-linked in the Ku band from – in my partially screened position – 16°E to 40°W. A clearer view to the east would offer an even more exotic fare. The dish can provide a vast number of signals, even 'real DX' such as the Israeli TV spot beam aimed at Tel Aviv! The signals are available day and night, all year round, and are constantly changing.

OFFERS FOR THIS MONTH!

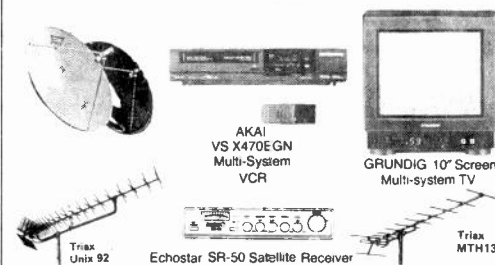

Aerial Techniques celebrates its 14th year of successful trading with several special offers to customers, both old and new

Grundig P27-549/12 Multisystem 10" screen tv, covers Bands 1, 2 & 3, UHF and cable channels, Systems PAL I (for UK); PAL B/G (for Europe); SECAM L (for France); SECAM B/G; D/K etc. NTSC 3.58 & 4.43MHz; 12-24v DC & Mains operation complete with infra-red remote control £339.00

Triax MTH13 High Gain 13 element W/B Band 3 Aerial £39.95

Triax Un x 92 element High Gain (17dB) Anodised UHF Aerial, available in Groups A, B, C/D, E, K & Wideband £58.00

Akai VS X470EGN Multisystem VCR, covers Bands 1, 3 & UHF. Systems PAL I (for UK); PAL B/G (for Europe); SECAM L (for France); SECAM B/G; D/K etc. NTSC 3.58 & 4.43MHz. DX 4 head: Long Play, Multi-voltage; 8 event-1 year timer £499.00

SATELLITE DXERS motorised package, comprises Echostar SR-50 manually tuned receiver, 90cm spun aluminium Dish, 0.9dB LNB, feedhorn, polariser, actuator and indoor positioner (1.2m Dish option available) £499.00

(All prices are inclusive of Vat, Carriage & Insurance delivery £9.00 on large items)

Serving the TV and Satellite trade, the retail and enthusiast sector, we have been providing an expert and knowledgeable sales with a free consultancy service for over 14 years. We sell both the usual and often requested, together with the unusual and rarely asked for, if we've not got it then it's made we WILL obtain it. Terrestrial or Satellite – we're there.

Our CATALOGUE at £1 samples some but not all that we can supply, send for your copy today. UK & overseas despatch normally ex stock within 24 hours, we'll accept the usual credit cards, cash, cheques, P.O.s – as convenient. Ring daytime with your query or late on our 24 hr phone or send in your fax and we'll get back to you shortly.

11 Kent Road, Parkstone, Poole, Dorset BH12 2EH
Tel: 0202 738232 Fax: 0202 716951

Aerial Techniques

What's required for practical, cheap satellite DX-TV reception? First, obviously, a dish: it should be at least 90cm in diameter, though 60cm Astra dishes have been pressed into use. There are two basic types, offset and prime focus. The offset type has the advantage of null shadowing since the electronics are on an arm beneath the dish. For it to traverse the Clarke Belt (where the geostationary satellites are in orbit) the dish has to be mounted on a tracking mechanism. This can be either an horizon-to-horizon or a polar mount.

The assembly required at the dish's focal point consists of a feed horn, a wideband magnetic polariser to convert the incoming vertically- and horizontally-polarised signals to a common plane, and an LNB (low-noise block) which converts the Ku band signals to an i.f. of 950-1,750MHz for linking via coaxial cable to the receiver. The LNB will have a gain of typically 50-60dB: the noise figure should be well under 1dB. Note that the sections of the Ku band used for TV transmissions are 10.95-11.7GHz (FSS - fixed satellite service), 11.7-12.5GHz (DBS) and 12.5-12.7GHz (telecom).

We'll take this further next month.

Warning

An Australian reader recently ordered a copy of the book *European Scrambling Systems* from a UK source. On arrival at Melbourne the book was seized by the Attorney General's Department for consideration by the Literature Classification officer as a possible prohibited import. Some five weeks later it was released. Several countries seem to be touchy about encryption, hacking and industrial espionage. Anyone ordering publications from abroad should note that problems may be encountered.

Satellite Notebook

Nick Beer

A worrying factor with the introduction of IRDs is what will eventually happen to equipment with a VideoCrypt circuit fault? At present manufacturers don't supply spares for the VideoCrypt circuit. Thus either the equipment has to be returned for repair or a complete new PCB has to be obtained. A recent experience with a Finlux/Cambridge unit made me think about the problem. The unit was brand new with a faulty i.c. in the VideoCrypt circuit. I couldn't get the device of course. No great surprise, except that the chip was included in the parts list with no specific note about availability. In some units it's easy to isolate the VideoCrypt circuitry which is on a separate PCB that can be removed and linked across, but in this IRD all the circuitry is on one double-sided PCB – the current Pace PRD800/900 IRDs are also built in this way.

It worries me that there are circuits which dealers cannot repair in items they are selling. If this policy is continued throughout the life of a VideoCrypt unit, customers and dealers will be at the mercy of the manufacturer with respect to repairability. Should a manufacturer decide that he won't repair a unit over say five years old, or quote a high price for doing so, there will be no chance of a second opinion.

I can only see the situation in the satellite and terrestrial subscriber-service field getting worse: more decoders, more services and thus more that has to be sent away. I would be very interested to know what manufacturers' long-term policies on such matters are, but a statement on current policy is about all that you can get. In fairness, I suppose that licensed VideoCrypt manufacturers have to abide by the rules laid down by the licensor.

Problems

It was perhaps predictable that, having in a previous column extolled the virtues of Manhattan LNBS, I would soon have a problem with one of them. Sure enough I did – and no ordinary problem either. Our installation chap had fitted an 80cm Lenson Heath dish on an az/el mount, with an 0-8dB Manhattan LNB and a Racal feed/polariser. This lot was to be used with a B and O LM satellite receiver built into an MX3500 TV set. Because of a supply problem at B and O, there was a delay of a couple of weeks before the LM unit could be installed.

I called to fit the LM receiver, did so then started to set it up. To start with I had problems because I couldn't move up or down the menus with the fast-wind keys, though I noticed that I could do so with the step keys. When I selected the video tuning menu, I got a slim strip across the top of the screen instead of a large black-backed menu. A ha! The software has been changed and no-one's told me! A check with the installation guide that comes with the unit confirmed this. Interesting that to move up a menu you press the forward step key while to move down you press the backwards step key, the complete opposite of what you'd expect and of what was previously the case!

The new screen layout is sensible: the picture is no longer obliterated by the menu when you carry out tuning. Another thing that I noticed is that the Astra 1C channels

are pretuned in amongst the 1A and 1B channels: the first 24 presets are tuned to the horizontal channels and the second 24 to the vertical channels. This means that there are at present lots of blank channels in amongst the used ones and that the majority of favourite channels are in the 20s.

Anyway, back to the installation. Having set up the polarisation current on about ten channels I noticed some faint beat bars across the picture, with satellite reception only. These became worse, causing corrugation of the entire image, including the menus. There was also a faint 1kHz tone with the sound. Then the colour disappeared from the on-screen displays and the program list option disappeared from the main menu. A hard reset cured the menu problems, but the only way to remove the vision problem was to let the unit cool down. I popped in another LM unit and everything was fine – for about half an hour. As I didn't have a scope or manual with me I decided to try another power supply module, in case there was hum/poor regulation with a supply used by the satellite unit. This seemed to cure the problem, but it was back within another three-quarters of an hour. So I replaced the LNB, using the customer's own ladder to battle through overgrown cotoneaster. At last the problem had been cured: I can only assume that something in the LNB was drawing too much current.

Buzzes with a Pace PRD900

One of our rental customers, who has a Luxor 9272 VCR and 5587 colour set, purchased a Pace PRD900 system from us and installed it himself. He then complained of a buzz on the sound, via the VCR at r.f. only, i.e. in the E-E mode and therefore also on recorded satellite material. This was indeed the case, and was a nuisance as the customer said. A Salora 5902 system he'd previously rented didn't produce the problem.

Checks showed that the 9272 was correctly aligned r.f.- and i.f.-wise, and that the problem was present with other PRD800 and PRD900 IRDs. Another 9272 made no difference. It appeared that the problem was to do with the satellite receiver's video modulation level. I contacted Pace technical, who said that it was not a known problem and couldn't offer any advice. Without a manual at the time, I decided that a home-brew modification was the only solution – unless the customer decided to buy a different system.

I found the r.f. modulator's video input and fitted a 47Ω resistor in series with it. This had virtually no effect. After trying several different values I had to go up to about 180Ω before the video level and the buzz could be reduced. During a subsequent call Pace confirmed that the video modulator incorporates a.g.c., hence my problem. The resistor remains in place and the customer is delighted with the result, despite being apprehensive about having to have his unit modified. This doesn't get to the root of the trouble of course, though it does provide a solution. The contrast control built into the receiver failed to provide a cure, but after adding the 180Ω resistor its range enabled the buzz to be reduced to an undetectable level.

And finally . . .

Here's a little tale to cheer you up. A satellite/aerial installer I know specialises in MATV and SMATV work. He was called some distance to look at an Astra SMATV head end that had not long since been installed by a large, reputable company for a local authority. The strange complaint was that Eurosport was the only Astra channel available. A check with a compass and meter soon showed why: the dish was pointing at Eutelsat II F1. Oops!

CD Player Casebook

Reports from Mike Leach
and Nick Beer

Kenwood DPM6630

This machine was brought in with two discs stuck in the mechanism. One was in the six-disc magazine, the other in the single-disc tray assembly. Nothing happened when the open/close button was pressed to open the tray or the eject button was pressed to open the magazine. Initially I thought that there might be a power supply fault, but checks in this department showed that everything was in order. Perhaps the LA6510 loading motor drive chip was faulty? As the same type of chip is used as the bus/tracking driver I interchanged the two. This made no difference. I removed the two discs by unwinding the mechanism by hand, after gaining access to the series of gears at the bottom of the mechanism. When this had been done there was still no movement from the mechanism, so checks were made around the system microcontroller chip IC7. As a high of around 0.7V was obtained at pins 35 and 36 when eject or open/close was pressed I came to the conclusion that IC7 was probably faulty, but a replacement wouldn't alter the situation.

Having provision for a tray and a six-disc magazine, the mechanism used in this player is very complicated. Several switches dotted around it tell the main microcontroller what the mechanism is doing. If the mechanism goes out of sync the microcontroller chip gets thoroughly confused. The result can be complete lock-out, which is what had happened. Part of the plastic chassis had broken, affecting the series of cogs driven by the loading motor. The only cure is a complete new plastic chassis, part no. 10-2994-11. If nothing on the main chassis is actually broken Kenwood advise fitting the counter-measure parts part no. W05-0434-00. This should rectify any other problems that might occur should a disc get stuck. It won't

however rectify problems such as the one we had. If the plastic is broken, the mechanism must be replaced. M.L.

JVC RCX510

There was no CD sound from this portable music system. It read the TOC all right and went into the play mode, but nothing came from the speakers. The tape and radio functions were o.k.

I stripped the unit down to gain access to the CD board in order to carry out some voltage checks, plug checks, etc. When this had been done my first move was to give the CD board a gentle twist while in the play mode to see if any cracks in some of the finer print showed up. No luck: the fault remained the same. Then I spotted the cause of the problem. It was a fault I've not had before. Two or three of the data processor chip's pins had come away from the board and weren't making proper contact. Very careful soldering in this area restored normal operation, after which all was fine. M.L.

Toshiba RT8089

This CD/radio/cassette unit would read the TOC but when it was asked to play it would spin up then rotate the disc backwards at high speed. There was evidently a focus fault, and we found that the focus servo couldn't be set up because of an offset error caused by the optical unit. After fitting and setting up a new unit the results were superb. A new cassette belt was also required on the PB deck: the old one had wrapped itself around the single motor's pulley, stressing both decks! N.B.

Answer to Test Case 368

— see page 709 —

ing video heads indeed! You cannot boost a video head. But some compensation for the loss of inductance as the heads wear can be achieved by reducing the recording current. This is a temporary measure only, because the probability of further wear occurs. And once the playback inductance is also impaired there's no alternative to fitting new upper drum. On two occasions the previous dealer had reduced the luminance writing current in order to get the best from the deteriorating heads. The new, highly-inductive heads called for a much greater writing current than the old worn ones, but Sherlock had not checked and reset the luminance writing current after replacing the video

head assembly. With the adjustment made correctly, the Panasonic VCR's recordings played back as well as the test tape.

The moral of this story is always to check the recording current after fitting new heads. This is important even where the presets haven't been disturbed. The optimum current depends to some extent on the characteristics of the individual heads. The new ones may not be identical to the originals when they were new. The same applies with rotary hi-fi audio heads, while with a stationary (longitudinal-track) audio head it's essential to check the bias level after replacing the head assembly.

It turned out that the one VCR whose drum Sherlock had previously replaced was a later type with no provision for manual adjustment of the recording current.

Published on the third Wednesday of each month by Reed Business Publishing Ltd, Quadrant House, The Quadrant, Sutton, Surrey SM2 5AS. Filmsetting by Marlin Graphics, 2-4 Powerscroft Road, Sidcup, Kent DA14 5DT. Printed in England by BPC Magazines Division, Carlisle Web Offset, Cumbria. Distributed by IPC Marketforce, Kings Reach Tower, Stamford Street, London SE1 9LS (071 261 5000). Sole Agents for Australia and New Zealand - Gordon and Gotch (Asia) Ltd., South Africa - Central News Agency Ltd. "Television" is sold subject to the following conditions, namely that it shall not, without the written consent of the Publishers first having been given, be lent, resold, hired out or otherwise disposed of by way of Trade at more than the recommended selling price shown on the cover, excluding Eire where the selling price is subject to currency exchange fluctuations and VAT, and that it shall not be lent, resold, hired or otherwise disposed of in a mutilated condition or in any unauthorised cover by way of Trade or affixed to or as part of any publication or advertising, literary or pictorial matter whatsoever. ISSN 0032-647X.

HOW TO INCREASE YOUR PROFITS, IMPROVE YOUR SERVICE, WITH COST EFFECTIVE TEST EQUIPMENT.

HAMEG OSCILLOSCOPES

HAMEG are Europe's top selling DUAL TRACE OSCILLOSCOPES. Select from four superb models. All, with the exception of the HM 1005, incorporate a useful COMPONENT TESTER. Size - all models - 285mm x 145mm x 380mm. Clear display 8cm x 10cm. Mains supply: 110/220/240V AC 50/60Hz. All supplied with 2 PROBES, a COMPREHENSIVE MANUAL and a 2 YEAR WARRANTY.

HM203-7 20MHz STANDARD

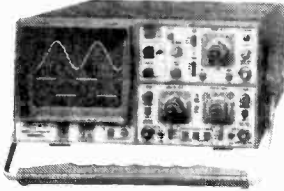

- SPECIFICATION**
- 2 Channels
 - Bandwidth: DC - 20MHz
 - Sens: Ch.1, Ch.2, 1mV/cm
 - Timebase: 0.1s - 20ns/cm
 - Triggering: DC - 40MHz
 - Active TV - Sync - Separator
 - Variable hold-off
 - Trigger LED indicator
 - Calibrator: 1KHz Square wave
 - Component tester
 - Plus many features

Price £362.00 + £63.35 V.A.T. FREE Specialist Carrier Delivery

SPECIFICATIONS

- 2 Channels
- Bandwidth: DC - 60 MHz
- Sens: Ch.1, Ch.2, 1mV/cm
- Timebase: 2.5s - 5ns/cm
- Triggering: DC - 80MHz
- Active TV - Sync - Separator
- After delay trigger
- Sweep delay
- Delay line
- Trigger LED indicator
- Calibrator: 1KHz & 1MHz Sq. Wave
- Component tester

HM604 60MHz UNIVERSAL

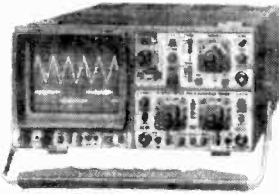

Price £653.00 + £114.28 V.A.T. FREE Specialist Carrier Delivery

HM1005 100MHz UNIVERSAL

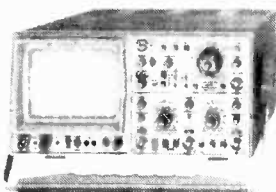

- SPECIFICATION**
- 3 Channels - UP TO 6 TRACES
 - Bandwidth: DC - 100MHz
 - Sens: Ch.1, Ch.2, Ch.3, 1mV/cm
 - Timebase A: 2.5s - 5ns/cm
 - Timebase B: 0.2s - 5ns/cm
 - Triggering DC - 130MHz
 - After delay trigger
 - Delay line
 - Trigger LED indicator
 - Overscan LED indicator
 - Active TV - Sync - Separator
 - Calibrator: 1KHz & 1MHz Sq. Wave

Price £847.00 + £148.23 V.A.T. FREE Specialist Carrier Delivery

HM205-3 20MHz DIGITAL STORAGE

- SPECIFICATION**
- Digital Storage
 - Analogue real time (Same as 203-7)
 - Bandwidth: DC - 20MHz
 - Sens: Ch.1, Ch.2, 1mV/cm
 - Timebase Digital: 5s - 1µs/cm
 - Triggering DC - 40MHz
 - Active TV - Sync - Sampling
 - Max sampling rate: 2 x 20MHz
 - Memory: 2 x 2048 x 8 Bit
 - Dot joiner
 - Printer/plotter output

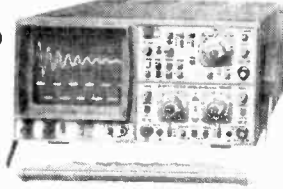

Price £653.00 + £114.28 V.A.T. FREE Specialist Carrier Delivery

BLACK STAR COLOUR PATTERN GENERATOR THE 'ORION' THREE-IN-ONE PAL VHF/UHF - PAL VIDEO COMPOSITE - R.G.B.

The Orion is a compact, bench instrument offering a wide range of patterns and facilities at a truly low cost.

In addition to a switchable sound carrier facility which allows use with the majority of PAL TV systems, the Orion provides highly flexible TGB outputs, ensuring compatibility with most video monitors.

More than 50 pattern combinations can be selected, including those for testing static and dynamic divergence, video amplifier linearity, colour purity, general colour performance, focus etc.

A separate video input to modulate camera signals; fully variable RF and video output levels facilitating AGC testing; trigger output allowing easy triggering of difficult oscilloscope waveforms; external sound modulation input via DIN connector for frequency response testing of TV sound systems; adjustable wide frequency coverage of VHF and UHF TV bands.

Indispensable in the manufacture, test, and servicing of televisions, and computer and video monitors.

FEATURES

- Colour bars, purity, greyscale, crosshatch, dots, focus, etc.
- VHF/UHF Channels.
- 5.5MHz, 6.0MHz, 6.5MHz Sound Carriers.
- Internal/External Sound.
- External Video Output.
- Trigger Output.
- PAL B, D, G, H, I, K.
- Separate R, G, B and sync. O/P's.
- RGB @ TTL & 1V.
- Green + 0.3V Syncs.
- Composite Video Output.
- Variable RF/Video Output.
- Switchable Video Polarity.
- Mains powered 220/240V AC 50/60Hz.
- Size: 98 x 219 x 240mm.

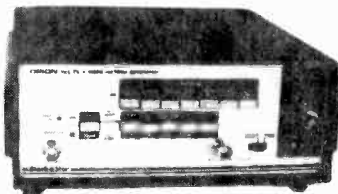

Price £229.00 + £40.08V.A.T.

NEW! DEGAUSSING COIL

A very effective degaussing coil, ideal for degaussing TV tubes, computer monitors, oscilloscopes etc.
Mains Power: 220/240 50/60Hz.
Size: 355 x 355 x 24mm.

Price £46.00 + £8.05V.A.T.

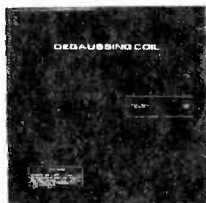

B & K PRECISION CRT ANALYSER-RESTORER

The number one CRT Test Instrument. Over 5000 U.K. Television engineers wouldn't be without it.

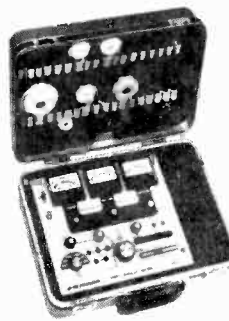

* All CRT's checked identically, including all in-line and one gun types * Tests all three guns of colour CRT's simultaneously under actual operating conditions (model 490) * Exclusive multiplex technique (model 490) * Measure true dynamic beam current that actually passes through G1 aperture to screen * Measures all shorts and leaks - preserving more CRT's * Tests focus electrodes lead continually finding faults that other testers miss * Uses most powerful restoration method known with minimum danger to CRT * rejuvenated CRT's guaranteed as new for two years * Obsolescence proof - perpetual set up chart updated and new adaptors developed * Tests and rejuvenates VDU's and oscilloscope tubes * A range of over 40 CRT base adaptors available * Increase profit * Pays for itself in months.

Prices

Model 490 Tri-dynamic three meter instrument inc. 6 common adaptors..... £559.00 + £97.83V.A.T.
Without adaptors..... £496.00 + £86.80V.A.T.
Model 480 Single meter instrument inc. 6 common adaptors..... £425.00 + £74.38V.A.T.
Without adaptors..... £360.00 + £63.00V.A.T.

SADELTA SIGNAL STRENGTH METERS

The Sadelta Field Strength Meters have been designed to facilitate the dish alignment of satellite TV systems and aerial alignment of VHF/UHF television and radio systems. Signal levels can be accurately measured on the TC402-D, TC90 AND TC80, allowing the evaluation of signal conditions for satisfactory operation. All models have a clear LCD direct frequency readout, coupled to a multiturn tuning control enabling precise channel identification.

TC402-D VHF & UHF

FEATURES

- Three bands:
- Low VHF: 45-170MHz
- High VHF: 170-450MHz
- UHF : 450-862MHz.
- Digital display for direct frequency readout.
- Built-in monitor loudspeaker AM/FM.
- Signal measurement from 20µV to 3V.
- Powered by eight 1.5V AA batteries.
- Fully portable with sturdy carrying case.



Price £289.00 + £50.57 V.A.T.

TC90 VHF-UHF-SAT.

FEATURES

- Five bands:
- Low VHF : 45-110MHz
- High VHF : 110-300MHz
- Hyper VHF : 300-470MHz
- VHF : 470-862MHz
- Satellite : 950-1750MHz.
- Digital display for direct frequency readout.
- Signal measurement VHF/UHF 20µV to 3V.
- Signal measurement satellite -70dBm to -10dBm.
- Audible indication of satellite signal level.
- Built-in monitor loudspeaker AM/FM (not satellite).
- Powered by rechargeable battery (complete with charger 220/240V AC).
- Fully portable with sturdy carry case.



Price £499.80 + £87.47 V.A.T.

NEW! TC80 SATELLITE

The TC80 incorporates three unique features: video composite output; audio output with built in loudspeaker; ramp and RF signal outputs, which enable an oscilloscope to be used as a spectrum analyzer.

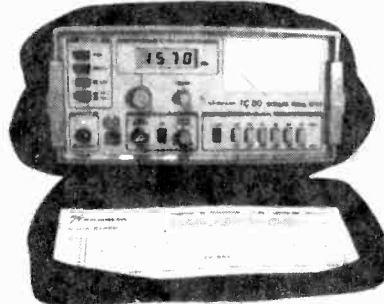

TC-80 IN ITS STURDY CARRY CASE

- 4 digit LCD freq. display
- Freq. range 950 to 1750MHz
- Sweep mode sweeps entire freq. band for rapid satellite location
- Tone select switch for audible tone proportional to signal strength
- Measurement from 40 to 100dBµV
- Audio demodulation with internal loudspeaker
- Video demodulation
- Rear SCART connector for A/V connection
- Oscilloscope/spectrum analyzer output
- Sound tuning 5 to 8MHz
- LNC PSU 14V or 18V
- LNC current measurement
- Internal rechargeable battery with charger

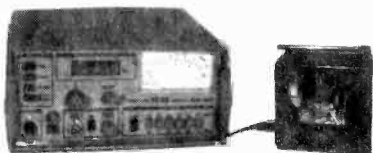

TC-80, USING A LCD TV AS A MONITOR

Price £490.00 + £85.75V.A.T.



U.K. POST PAID, export enquiries welcome. Visa/Access or cheque with order, payable B. K. Electronics. Official Orders welcome from Govt. Depts., colleges, P.L.C.s etc. Large (A5) S.A.E. for technical leaflets of complete range. Credit card orders are accepted by phone, fax or post. Delivery normally within seven days.



B. K. ELECTRONICS
UNITS 1 & 5 COMET WAY, SOUTHEND-ON-SEA
ESSEX SS2 6TR
Tel: 0702 - 527572 Fax: 0702 - 420243

DIRECT FROM THE MANUFACTURER

RE-BUILT TV TUBES
VIDEO-HEADS
REMOTE-CONTROLS
SUPPLIERS OF TV/VCR SPARES
OUTSTANDING VALUE FROM
ONE OF THE UK'S LARGEST
BSI APPROVED MANUFACTURERS
OF RE-BUILT TUBES
STOCKS AVAILABLE



VISTA
ELECTRONICS



Unit 1B, Wingate Grange Industrial Estate,
 County Durham, TS28 5AH

Tel: 0429 837100

Fax: 0429 837101

WE HAVE THE WIDEST CHOICE OF USED OSCILLOSCOPES IN THE COUNTRY

TEKTRONIX 7000 SERIES OSCILLOSCOPES
 Dual Trace Plug-in with TB from £200. Many Plug-in options available: 4 Traces, Differential etc. Plug-ins sold separately.

PHILIPS 3070 Dual Trace 100MHz Delay Sweep Trig View Clever Cursors Liquid Crystal display £800
 KIKUSUI COS6100M 3 Channel -Ch4/Ch5 Trig 100MHz Delay Sweep £550
 HITACHI V1050F Dual Trace 100MHz Dual TB with 4 Channel Mode £450
 TEKTRONIX 475 Dual Trace 200MHz Delay Sweep £400
 H.P. 1715A Dual Trace 200MHz Delay Sweep £500
 TEKTRONIX 465 Dual Trace 100MHz Delay Sweep £450
 H.P. 1740A Dual Trace 100MHz Delay Sweep £400
 PHILIPS PM3217 Dual Trace 50MHz Delay Sweep £400
 HITACHI V650F Dual Trace 60MHz Delay Sweep £400
 TELEQUIPMENT D83 Dual Trace 50MHz Delay Sweep £200
 GOULD OS 3000A Dual Trace 40MHz Delay Sweep £200
 KIKUSUI 5530 Dual Trace 30MHz £160
 GOULD OS1100 Dual Trace 30MHz £160
 GOULD OS300 Dual Trace 20MHz £200
 GOULD OS250B Dual Trace 15MHz £125

THIS IS JUST A SAMPLE - MANY OTHERS AVAILABLE

PHILIPS PMS193 Programmable Synthesiser/Function Generator 0.1MHz-50MHz IEEE-488 As new £1500

MARCONI 2019 Synthesised AM/FM Sig Gen 80KHz - 100MHz £2000
MARCONI 2018 Synthesised AM/FM Sig Gen 80KHz - 520MHz £950
 EIP 545 Microwave Frequency Counter 10Hz - 18GHz £1400
 EIP/DANA 351D Microwave Frequency Counter 20Hz - 18GHz £950
 RACAL 9921 Frequency Counter 3GHz £300
 HP 339 Distortion Measuring Set 10Hz - 110KHz £1500
 RACAL/DANA 1991 Nanosecond Universal Counter £800
 RACAL 9302 RF Millivoltmeter True RMS 10KHz - 15GHz £450
 RACAL 9301A RF Millivoltmeter True RMS 10KHz - 1.5GHz £300
 RACAL 9009 Automatic Mod Meter 10MHz - 1.5GHz Wide Deviation £250
 H.P. Pulse Generator type 214B £750
 LYONS PG73N Pulse Gen. PRF 1Hz - 20MHz £150
 MARCONI 2610 True RMS Voltmeter £800
 GOULD Biomation K500D Logic Analyser £500
 FARNELL PSG520H Synthesised Sig Gen AM/FM 100KHz-520MHz £600
 LEADER LSG216 AM/FM Sig Gen 2 ranges 0.1+30MHz & 75-115MHz £400

SPECTRUM ANALYSERS

HP 141T with 8555A & IF plug-in 10MHz-18GHz £1800
 HP 141T with 8554B & 8552B 500KHz-1250MHz £1300
 HP 140T with 8554L & 8552A 500KHz-1250MHz £1000
 HP 141T with 8556A & 8552B 20Hz-300KHz £1000
 HP 140T with 8553L & 8552A 1KHz-110MHz £800
 HP 182C with 8558B 100Hz-1500MHz £1500
 MARCONI TF 2370 1KHz-110MHz £1500

FARNELL ISOLATING TRANSFORMERS GU500 240V 500VA, un-used £50

DATRON 1061A - 6 1/2 digit Autocal Multimeter with True RMS AC Current £1250
 DATRON 1065 - 5 1/2 digit Autocal Multimeter, AC/DC/Ohms with IEEE £600
 HEWLETT PACKARD 3490A Bench Multimeter, 5 1/2 digit, AC/DC/Ohms £200
 PHILIPS PM2534 Multi Function DMM 6 1/2 digit with GPIB/IEEE £450
 MARCONI Digital Frequency Meter 2430A 10Hz-80MHz £125
 MARCONI Digital Frequency Meter 2431A 10Hz-200MHz £150
 MARCONI Universal Counter Timer 2437 DC: 100MHz £175
 MARCONI Universal Counter Timer 2438 DC: 520MHz £225
 BLACK STAR Jupiter 500 Sine/Sq/Tri 0.1Hz - 500KHz £70
 FEEDBACK FG600 Sine/Sq/Tri 0.01Hz - 100KHz £60
 HP3311A Function Generator 0.1Hz-1MHz, Sine/Sq/Tri £125
 MULTIMETERS Handheld M2355-32 ranges AC/DC, 10Amps, Diode/Transistor Tester Freq. Counter £32.50

FARNELL Electronic Load RB1030-35 1KW 30Amp 35 Volt £600

HP 8690B Sweep Osc with 86974 Plug-in, 26.5-40GHz £300
 RACAL/DANA RF Power Meter 9104 £800
 RACAL/DANA 9341 Databridge Automatic L.C.R. & Q £350
 WAYNE KERR 8905 Automatic Precision Bridge 0.05% £900
 WAYNE KERR 8605 Automatic Component Bridge 0.1% £350
 AVO AC/DC Breakdown Leakage & Ionisation Tester RM215L/2 £600
 FARNELL PSU TV570MHz, 70V SA/30V 10A £300
 FARNELL PSU H60125 0-60V, 0-5 Amps Metered £400
 FARNELL PSU L30E 0-30V, 0-5 Amps Metered £80
 FARNELL B3020 0-30V, 20 Amps £250
 H.P. 6255A 0-400V, 5-5 Amps Trace Metered £130
 H.P. 6209B 0-320V, 0.0-1 Amps Metered £125
 TELEQUIPMENT CT71 Curve Tracer £150
 MARCONI TF2700 Universal LCR Bridge, Battery from £150
 AVO Valve Characteristic Meter VCM163 £300
 PHILIPS PMS509 Colourbar Generator £225
 FARNELL LA520 RF Power Amp, 1.5-520MHz 300mW £175
 RACAL 9100 Absorption Wattmeter 1MHz-1GHz 3W £100

NEW EQUIPMENT

HAMEG OSCILLOSCOPE HM1005 Triple Trace 100MHz Delay Timebase £847
 HAMEG OSCILLOSCOPE HM604 Dual Trace 60MHz Delay Sweep £653
 HAMEG OSCILLOSCOPE HM203 7 Dual Trace 20MHz Component Tester £362
 HAMEG OSCILLOSCOPE HM205 3 Dual Trace 20MHz Digital Storage £653
 All other models available - all oscilloscopes supplied with 2 probes

BLACK STAR EQUIPMENT (P&P all units £5)
 APOLLO 10 - 100MHz Counter Timer Ratio/Period/Time interval etc £222
 APOLLO 100 - 100MHz (As above with more functions) £325
 METEOR 100 FREQUENCY COUNTER 100MHz £109
 METEOR 600 FREQUENCY COUNTER 600MHz £135
 METEOR 1000 FREQUENCY COUNTER 1 GHz £178
 JUPITOR 500 FUNCTION GEN 0.1Hz-500kHz Sine/Sq/Tri £110
 ORION COLOUR BAR GENERATOR Pa/Tv/Video £229

OSCILLOSCOPE PROBES Switchable x1 x10 (P&P £3) £11

Used Equipment - Guaranteed Manuals supplied if possible.
 This is a VERY SMALL SAMPLE OF STOCK, SAE or Telephone for list. Please check availability before ordering.
 CARRIAGE all units £16. VAT to be added to Total of Goods and Carriage.

STEWART of READING

110 WYKEHAM ROAD, READING, BERKS RG6 1PL
 Telephone: 0734 268041 Fax: (0734) 351696
 Callers Welcome 9am-5.30pm Mon-Fri (until 8pm Thurs)



The Euras System
 is the largest
 repair tips database
 for CD, TV and
 video in Europe.

Solutions at your fingertips.

The System
 has over 100,000
 repair tips for
 10,000 models
 from 250
 manufacturers
 and is conveniently
 available as
 manuals,
 stand alone PC
 or videotext.
 The System now
 also boasts
 technical service
 data for computers
 from SAMS
 Computerfacts,
 available
 as manuals.

EURAS

Euras International Limited
 Euras House, 51 Bristol Rd
 Keynsham, Bristol BS18 2BA
 England
 Telephone 0272 860900,
 Fax 0272 860343

EST. 1977

J.W. HARDY

YOUR ONE-STOP-SHOP

FOR THESE FINE BRANDED PRODUCTS
- AND SO MUCH MORE . . .

Wolsey SMATV

DIAMOND AERIALS UHF/FM

GLOBAL COMMUNICATIONS FIRST IF. SMATV

J.W. HARDY communications UHF AERIALS
UHF AMPLIFIERS

Labgear Cablevision SMATV

LENSON HEATH SATELLITE
ANTENNA

PACE SATELLITE
RECEIVERS

PALCOM SATELLITE
RECEIVERS

PROMAX TEST EQUIPMENT

Spit fixings BOLTS
PLUGS

mungo BOLTS
PLUGS

Teleste SMATV
TRIAx U.K. UHF/VHF
AERIALS **TOWER CLIPS**

UNI FIX CLIPS **VOLEX
RAYDEX** COAX CABLES

- WE PROVIDE FULL TECHNICAL ASSISTANCE AND SERVICE BACK UP ON ALL OUR PRODUCTS
- SMATV - DISH SHARING - DESIGN CONSULTANT

Trace Price List available to bona fide TV Aerial and Satellite Dealers on proof of trading.

J.W. Hardy, 231 Station Road, Stechford
Birmingham B33 8BB. Telephone: 021-784 8478

WILTSGROVE LTD

Definition BRAND

PORTABLE 14' REMOTE TV
21 PIN SCART, ON SCREEN DISPLAY,
VHF/UHF, 12 MONTHS GUARANTEE etc.

* GUARANTEED LOWEST PRICE *,
CALL NOW FOR DETAILS

VAST QUANTITY OF "B" GRADE
WORKING MIDI SYSTEMS from £25
14", 20", 21" TV'S TO BE CLEARED

WORKING EX-RENTAL STOCK

PORTABLE TV'S
REMOTE / TELETEXT TV'S
LONG & SHORT PLAY VCR'S etc.

HUGE RANGE OF SPARES
VIDEO HEADS, REMOTE CONTROLS,
CASSETTE HOUSINGS, IC'S, FUSES,
BELT KITS, IDLERS, PINCH ROLLERS etc.
AT AN AFFORDABLE PRICE.



28-29 RIVER STREET, DIGBETH
BIRMINGHAM B5 5SA



TEL: 021 772-2733 FAX: 021 766-6100

EXPORT ENQUIRIES WELCOME

COMPONENTS For TV * Video Audio * Computer

THIS IS JUST A SMALL SAMPLE OF STOCK
We can supply spares for many makes of equipment. WRITE
Encl. s.a.s. please) or PHONE
FOR A "PRICE & AVAILABILITY"
on your requirements. **0452 526883**

IC SELECTION

ANS753	TA7256P	£4.49
AN8553	TA7273P	£4.54
AY3912P	TA7288P	£3.59
BA4236L	TA7324	£2.89
BA5426	TA7656BP	£1.89
BA6258N	TA7794	£2.58
CA741CE	TA8400P	£4.95
CDP6818AE	TA8410K	£4.97
CN652A	TA8530	£1.74
DS1488N	TBA800	£0.99
DS75150N	TBA810P	£1.16
DS75154N	TBA810S	£1.62
H11L3	TBA820L	£1.50
H1137W	TC840	£3.33
HA12006	TDA1001B	£2.86
HA12413	TDA1020	£2.64
HA13007	TDA1035T	£2.59
HD8455P	TDA1044	£3.55
KIA7217AP	TDA1170D	£4.98
LA3160	TDA1180P	£3.49
LA3361	TDA1518Q	£4.63
LA4480	TDA1906A	£2.06
LA7016	TDA2003	£2.44
LA7910	TDA2541	£2.49
LM1203N	TDA2593	£3.45
LM733CN	TDA3653B	£3.33
LM833	TDA4420	£2.71
MS4544L	TDA4510	£3.75
MS4548L	TDA4600-2	£2.95
MS4567P	TDA4601	£2.49
MA86049H	TDA4950	£2.15
MK4564N	TDA7350	£5.21
MP4504	TDA8140	£3.49
MSM6242B	TDA8170	£3.47
MC1377P	TEA2000	£4.33
MC145029CP	TL431	£1.85
ME2901	UM6502	£5.05
NE555CDP	UM6522	£6.99
PE255A	UM8272A	£14.09
PC713V	UPC1277	£4.23
SA41124	UPC1379H	£2.45
SED9403CAC	UPC1397C	£3.94
STR4332	UPD039LC	£12.39
STK5451	ZX8400APS	£4.63
STK5481	14DN475G	£19.25
ST78620	77C296-200	£2.48
TA7226P	4116-2N	£1.89
IC PROTECTORS (F or N Ranges)		each £0.79

COMPUTER SPARES

AMSTRAD	PHILIPS	
Car. Capacitor 2200pf/4Kv	Serv Manual 9M7513	£2.99
Printer Armature (PCW 9512)	Serv Manual CM8833 (Mk 1)	£4.71
User Manual (CPC464)	IC 6569 VIC (Sp Offer)	£19.95
Serv. Manual (PCW9512)	IC 8565 VIC	£23.96
Serv. Manual (PC1640)	IC 906114-01 PLA	£9.24
IC C025913 DMA (ST)	IC DRAM MB81416-12	£4.99
IC C024947 (XE/L)	Modulator 251916-02	£18.76
Thermistor (ST-PSU)	Serv. Manual (C64/C64C)	£14.99
Serv. Manual (ST-PSU)	User Manual (C64)	£4.25
(ST520/1040)	XTAL 17 73447MHz	£4.99

Most Amstrad, CBM, Philips parts available - plus selected Acorn, Atan, Sinclair & others
MONITOR LEAD - Amiga to Scart I/P £8.29

TRANSISTORS

2SA1706	£1.85	2SK301	£1.85
2SA2331	£1.59	3U498A	£4.99

TV/MONITOR LINE OUTPUT TRANSFORMERS

ATARI SM125	£19.65
COMMODORE 1084-P/SP etc	P.O.A.
PHILIPS CM8533/CM8833 etc	£24.94
PHILIPS CM1134/2/62	£28.51
Ferguson TX90 14" 90"	£23.99
Ferguson TX100 20" 90"	£22.25
Ferguson TX100 22" 76" 110"	£20.51
Ferguson TX100 51cm FST	£23.95
GEC C2089H/90H/C2288 to 2291H/C2294H	£22.35
Hitachi CPT1463/CPT1623/24/26/44/45	£22.99
Hitachi CPT2036/48/78/CPT2234/36/CPT2246/78	£22.35
Matsushita 1480A/1481/1481B	£22.25
Salisho CT414X etc. (Supply No. on L.O.T.)	P.O.A.

Many other Line O/P Transformers available

AUDIO SPARES

AMSTRAD MX200/CDX400 (FUNAI) CASSETTE DOOR	each
£3.64	
PHILIPS CST427 SERVICE MANUAL	£4.50
PHILIPS D8458 SERVICE MANUAL	£3.49
SHARP RGF278, 281, 284 MAIN BELT	£1.40
TOSHIBA STU2/L MAINS TRANSFORMER	£9.99

TV SPARES

AMSTRAD TVR2 SERVICE MANUAL	£17.39
GEC/HITACHI FRAME MODULE HM6251	£9.29
PHILIPS 96009 Deg. POSISTOR (White)	£1.34
COL DISTAR C154361/4441/1/CT12162X2172X On/Off SWITCH	£6.49
SAMSUNG C1537V/CX558WT On/Off SWITCH	£6.05

VIDEO SPARES

SHARP VC381/385/VC9300 CAPSTAN MOTOR	£34.99
Large range of Video Heads, Idlers, Belt Kits, Pinch Rollers from stock plus much, much more. Please contact us.	
We also stock REMOTE CONTROLS + Many General Components	

We are pleased to serve both the Trade and End User.

DO NOT ADD VAT TO THE PRICES SHOWN - BUT PLEASE ADD £1.20 P&P

SPECTRUM & QL CHIPS

* SPECIAL OFFER *

TMS4532N4L DRAM (Spec)	(1+)	(5+)
ZX8302 ULA (QL)	£0.99	£0.89
ZX8401 ULA (Spec)	£6.49	£4.99
40054 ROM (1+)	£5.44	£4.89
74LS00 TTL (QL)	£1.19	£0.99
74LS157 TTL (Spec)	£0.15	£0.10
74LS245 TTL (QL)	£0.30	£0.25
74LS245 TTL (QL)	£0.39	£0.35

All items subject to availability - Prices can change without notice.

ORDER BY POST OR PHONE

We accept payment by VISA, Access, DELTA, SWITCH, Cheque or P.O.



MAIL ORDER ONLY to:

MARAPET (TVH)
1 HORNBEAM MEWS
GLOUCESTER GL2 0UE

DO YOU REPAIR WHITE GOODS?

THEN YOU SHOULD KNOW ABOUT

DATAPART

THEY HAVE THE LARGEST AVAILABLE
RANGE OF GENUINE AND PATTERN PARTS

FOR MOST BRANDS OF :-

WASHING MACHINES

DISHWASHERS

REFRIGERATORS

COOKERS

VACUUM CLEANERS

KETTLES

IRONS

TOASTERS

MICRO-WAVE OVENS

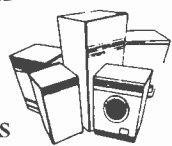
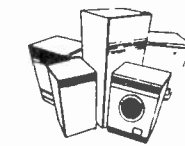

DATAPART LTD

ELECTRON HOUSE,
100 GREAT BARR STREET
BIRMINGHAM B9 4BB



SALES DESK 021 766 5551 24
FAX FREE 0800 373 459 HOURS

NEW *The Pirates' Guide to the Galaxy!*
FREE Eye Patch!
with every order for ...

John McCormac's
EUROPEAN SCRAMBLING SYSTEMS 3
Circuits, Tactics and Techniques

What this remarkable 480 page book can do for you ... **Only £32 (plus post!)**
 (for obvious reasons we cannot list specific programme hacks!)

- Learn how the *four* VideoCrypt hacks work! Is it pirate-proof?
- Discover how a scrambling system is constructed from a few basic techniques
- Glean new decoder circuits, eg Filmnet video, RTL4-V, Discret, Filmnet digital audio, SAVE etc.
- Gain an expert's insight into piracy and counter-piracy eg Dragon and Tiger teams, offensive and defensive hacking, reverse engineering etc.
- Explore video manipulative systems such as Nagra Kudelski System, VideoCrypt-S, Cryptovision and Digicrypt. Also includes B-MAC hacks on video and access control systems
- Read about the black arts of signal security.

WARNING
 The information contained in this book is for educational use only. Swift Television Publications, the publishers and the author do not assume any liability for the use or misuse of the information provided. In some countries the unauthorised use of certain circuits and techniques may be prohibited by law.

Swift Television Publications
 17 Pittsfield, Cricklade, Wilts, SN6 6AN Tel or Fax 0793 750620

Please send me _____ copies of *European Scrambling Systems 3* at £32 each. Postage per book, UK add £2.50 Europe add £5 Rest of World add £13

Name _____
 Address _____
 Postcode _____

I enclose cheque/PO for £ _____ made payable to Swift Television Publications or please debit my Access/Visa card

No _____
 Express _____

ADVERTISERS' INDEX

Aerial Techniques	737	J.J. Components	699
Anglian TV Wholesale	752	Manor Supplies	703
A-Z Electronics	733	Marapet	742
Besco	744	MCES	732
BK Electronics	740	Pays UTV	732
Bull Electrical	734	P.V. Tubes	696
C & K Electronics	749	Repo TV	749
Campion Wholesale TV Ltd	752	Redbank	750
Central TV Wholesale Ltd	749	Sendz Components	759- OBC
Centrevision	746	Silverscreen	746
Coastal TV's	752	Stewart of Reading	741
Colourtrade	751	Swift TV Publications	743
Crewe Wholesale TV Ltd	746	Telecentre	752
CTV	748	Teleprice Ltd	747
Datapart Ltd	742	Trac Satellite Systems	743
East London Components	696	TV Direct	752
Economic Devices	724-725	TV International	748
Electra TV	751	Vista Electronics	741
Euras International Ltd	741	Well-View	732
GGL Components	694-695	Western Trade Services	750
Grandata	686-693	West Mids. TV	746
Hardy, J.W.	742	Willowvale Electronics Ltd	IFC
Hussein Central TV	745	Wiltsgrove	742
ICS Intertext Group	696	Woodham's TV Ltd	750
Instavision	751	W. Tree Trade Warehouse	748

TRAC BSB Receiver Conversions

NEW *Philips BSB D2MAC Chip*

Also available for Ferguson, Decca, and Tatung BSB Receivers

- 35 Fully programmable channels
- On Screen Graphics
- 16.9 Format with Panning
- Live programme information
- All audio channels accessible
- Digital quality stereo sound

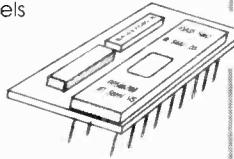

The new software is supplied on a plug in sub panel with two additional IC's, full instructions, and user manual. Ideal for reception from TDF1 and TVSAT using your existing BSB squarial / compact dish, or other clear D2MAC transmissions with the appropriate antenna

£39.00
 Plus £3.50 P&P

Ferguson PAL and D2MAC Conversion

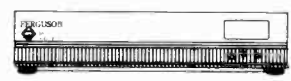

CONVERSION KIT. Comprises a fully assembled and tested PAL/MAC sub assembly PCB, plug in software upgrade, assembly instructions and new user manual

£49.00
 Plus £3.50 P&P

Features

- 60 Fully programmable channels with Remote Control
- On Screen Graphics with Live Programme Information
- Pre-set for most popular PAL, D2MAC and DMAC Transmissions
- Selectable LNB type
- External 12 volt switch facility

D2MAC

- Superb digital quality sound
- Preferred Language facility
- Covers all D2 and DMAC Audio channels
- Background / Foreground sound mix facility
- Switchable 16.9 with optional panning
- Outputs in RGB, Video, Audio, UHF.

PAL

- Fully Tunable Audio per channel
- Videocrypt (Sky) decoder interface
- 14 / 18 Volt LNB switching
- Outputs in Video, Audio, and UHF

On Screen Menus
 A total of 15 different on screen menus make programming exceptionally easy.

Accessories and Dish Kits

2 in 1 out mechanical AB switch	£15.95
Electronic A/B Switch (D2PAL Rx Only)	£19.95
I.F. Splitter : 2 receivers from 1 dish	£13.50
Squarial : Original quality Matsushita	£20.00
Marconi 35cm Compact dish / DBS LNB	£39.00
Marconi 60cm mesh / FSS LNB	£59.00
Lenson Heath 60cm mesh / FSS LNB	£67.50
Lenson Heath 80cm mesh / FSS LNB	£99.00
Decoder lead : DIN to SCART	£7.50

Satellite System Components

Over 500 different items in stock

Feed Horns, Polarizers, Polarotors, OMT's, Transitions
 Accessories, Amps, Splitters, Cable, Connectors, Fasteners,
 Antennas : Offset up to 1.00Mtr. Prime Focus up to 2.00 Mtr.
 LNB's : Dual, Triple, FSS, DBS, Telecom, Voltage switching, Twin.
 Large and small Polar heads Ground and wall mounts
 Linear Actuators (Jacks), H to H mounts, Positioners
 Receivers, Decoders

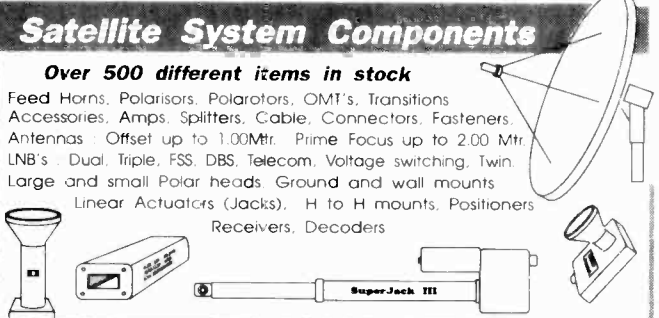

Ordering is easy..
 Simply phone or fax the numbers below. We are happy to accept payment by Cheque, Visa & Access, and will accept Purchase Orders from Government Departments, Local Authorities, and Educational Establishments.
 Fully insured overnight delivery service available for mail order purchases. Cash and carry for personal callers.

All prices include VAT.   

Please note, technical queries and advice by phone only.

REMEMBER : We stock all major brands of satellite equipment, and try wherever possible not to be undersold. So before you buy, give us a ring and see if we can match your best quote.

TRAC SATELLITE SYSTEMS

Commerce way Skippers Lane
 Middlesbrough Cleveland TS6-6UR

 0642 468145 / 452555 FAX 440927



FAX: 0274
722229

BESCO LIMITED
T/A
NORTH WEST ELECTRONICS
ENTIRE RANGE OF EX-RENTAL TVs & VIDEOS

NEW STOCKS EVERY DAY, WORKING OR OFF THE PILE

makes include: Sharp, Hitachi, Ferguson, Pye, NAT PAN, ITT etc.

Working VHS video from £35.00. Late models always available.

KNOCKOUT PRICES ON COLOUR TVs

FERGUSION, PYE, HITACHI, PHILIPS, BUSH, ITT, etc.

TELETEXT BARGAINS FROM £30.00 (WORKING).

FERGUSON TX TELETEXT ONLY £45. PHILIPS/PYE TEXT ALWAYS AVAILABLE

OVER 1000 COLOUR TV AND VIDEOS AVAILABLE

RING OUR HOTLINES NOW FOR PRICES OR CALL IN, YOU WILL BE DELIGHTED

Working Ex-Equipment Panels

IF	Converger	Decoder	Line scan	Power	Frame
T20//22X	5	14	18	17	14
T26 X	5	16	20	17	X
Phillips G11 14.50	5	12	20	20	11.50

All prices include Postage & Packing. But + VAT

★ IF THE PANEL YOU REQUIRE IS NOT LISTED PLEASE ASK ★

Visa Welcome

Prices are plus VAT
and based on quantity

Cheques accepted

Walker House, 16 Bottomley Street, Bradford BD5 7LJ

Ring Tony 0274 308186 – Open 6 days – 9am-5pm

REPRINTS...

A ready-made sales aid

If you are interested in a particular article or advertisement, you should take advantage of our reprint service.

We offer an excellent, reasonably priced service.

For further details and a quotation (minimum no. 250) contact:

**Jan Crowther, Room 1006, Quadrant House,
The Quadrant, Sutton, Surrey SM2 5AS, UK**

Telephone: 081-652 8229 Fax: 081-652 4728

**BRITAINS LARGEST INDEPENDENT
PRESENTS THE LARGEST STOCK OF 'B' GRADE**



LTD

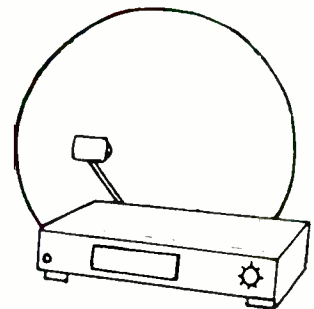

**THE TV & VIDEO WHOLESALERS
WITH A FRIENDLY SERVICE**

**Satellite
IRD Receivers**

Wide
choice
of makes

**A selection of
Nicom TVs &
Nicom videos
are available**

Camcorders

Ferguson Hitachi
JVC Panasonic
Sanyo Sharp
Sony Telefunken

Special offers:
Unserviced camcorders from £45
(minimum order 5)
Fully tested camcorders from £75
(minimum order 5)

**Graded TVs
available:
DECCA, ITT,
MITSUBISHI,
SANYO, TATUNG**

**Graded VCRs
available:
AKAI,
FERGUSON
ITT, PANASONIC
SONY ETC.**

TOP QUALITY EX-RENTAL TV's & VCR's
MASSIVE STOCK OF EX-RENTAL UNITS AVAILABLE AT EXCELLENT PRICES

DON'T MISS OUT, PHONE NOW!

(PRICES EXCLUDE VAT)

PRESTON

139 Oakshott Place
Walton Summit
Ind Est
Preston (M6 Junc 29)
Tel: 0772 312101

BIRMINGHAM

208 Bromford Lane
Erdington
Birmingham B24 8DL
Tel: 021-327 3273 Fax: 021-322 2011

LONDON

Unit 2
The Royal London Est
29/35 North Acton Road
London NW10
Tel: 081-961 5005

SILVERSCREEN VIDEOS

**EX-RENTAL TV & VIDEOS
THORN & GRANADA**

VIDEOS

Working Top Loaders	From £35
„ Front Loaders	From £45
Non Working	From £25
„ „ Front Loaders	From £35

TV's

Basics	From £15
Teletext	From £40
FST	From £60

UK DELIVERY AVAILABLE

- EXPORT ENQUIRIES WELCOME -

**24 GOLD STREET, TIVERTON
DEVON EX16 6PY**

TELEPHONE: 0884 256257



**CREWE
WHOLESALE
TV LTD.**

CREWE

Large selection of working TVs
including working F.S.T.s

Videos – working or untested

**EXPORT
INVITED**

William St., Crewe, Cheshire
Tel: 0270 582924
Fax: 0270 505470
Open Mon-Fri 9.30-5.30

BLACKBURN

Guaranteed untested stock
Plus selection of working TVs

Deliveries every
Monday and Thursday

Working and untested
Prices lists available

School Lane, Guide, Lancashire
Tel/Fax: 0254 264489
Open Mon, Tue, Thu, Fri 10.00-4.00
Sat 10.00-1.00

CentreVision

CentreVision House · Sloper Road · Leckwith · Cardiff · CF1 8AB

TO CUSTOMERS OLD AND NEW

CALL IN NOW AT CENTREVISION AND SAVE

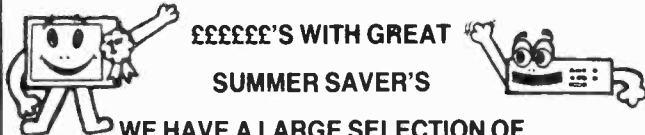

**WE HAVE A LARGE SELECTION OF
WORKING TELEVISIONS ON DISPLAY**

**OUR SHOWROOM IS FILLED WITH TOP QUALITY FST
INCLUDING NICAM STEREO**

CTV WORKING	from £18.00
CTV WORKING TEXT	from £35.00
CTV WORKING FST	from £55.00

WE ALSO HAVE A LARGE SELECTION OF VCR's

TOP LOADING VCR WORKING	from £40.00
FRONT LOADING VCR WORKING	from £50.00
B-GRADE TELEVISIONS BOXED 28" & 24"	
SATELLITE RECEIVERS	from £18.00

PHONE NOW ON 0222 344754

**WE WILL LOOK FORWARD TO MEETING YOU
ALL THE ABOVE PRICES ARE + VAT**



W.M.T.V.

THE LARGEST INDEPENDENT WHOLESALERS
IN WALSALL – SUPPLIERS OF HIGH QUALITY
EX-RENTAL TVs AND VIDEOS TO THE TRADE
AT COMPETITIVE PRICES

ALSO AVAILABLE: NEW B-GRADE PRODUCTS –
TVs, VIDEOS, AUDIO & MICROWAVES –
ALL TESTED & BOXED

1/2 Mile of Junction 10 M6. Easy Parking Facilities

UNIT 3, BENTLEY LANE BUSINESS PARK

BENTLEY LANE, WALSALL WS2 8TL

Tel: 0922 724542. Fax: 0922 722208

Mobile: 0860 499495 (24 Hours)

**OPEN:
MON-FRI,
9-6pm
SAT 9-2pm
SUNDAY BY
APPOINTMENT
DELIVERY
SERVICE
THROUGHOUT
THE COUNTRY**

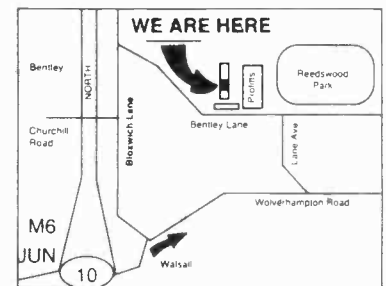

TELEPRICE

LIMITED

SWITCH ON!
TO QUALITY
EX-RENTAL TV
& VCR. PLEASE
RING FOR DETAILS

AINTREE

UNIT 2, RACECOURSE IND. EST.
ORMSKIRK ROAD, AINTREE
LIVERPOOL L9 5AL. TEL:
051 530 1285 IAN MAC

LEEDS

UNIT F2, COFFEE HALL
TRADING EST., COFFEE HALL
RD, LEEDS LS1 3JL. TEL:
0532 422774 KE

AVONMOUTH

5 PORTVIEW ROAD
AVONMOUTH, BRISTOL
BS11 7LQ. TEL:
0272 235093 KARLA REALE

GLASGOW

9 COLQUHOUN AVENUE
HILLINGTON IND. EST.
GLASGOW G52 4BN. TEL:
041 883 2610 IAN DORAN

NOTTINGHAM

UNIT 8, ASCOT PARK
INDUSTRIAL ESTATE
SANDIACRE, NOTTINGHAM. TEL:
0602 491385 JOHN JEYS

SUNDERLAND

9A/B, 94 CARRMERE RD
LEECHMERE IND. EST.
SUNDERLAND SR2 9TE. TEL:
091 523 5554 BRIAN CADE

SOUTH LONDON

22 FRANTHORNE WAY,
OFF RANDLESDOWN ROAD, BELLINGHAM,
LONDON SE6 3BS. TEL:
081-695 0877 JAMES MAYE

FARNBOROUGH

40 INVINCIBLE ROAD
FARNBOROUGH
HANTS GU14 7QU. TEL:
0252 540814 COLIN GORDON



C.T.V.

**UNIT 5, THE PHOENIX BUILDING, RUSHOCK TRADING ESTATE,
DROITWICH ROAD, NEAR KIDDERMINSTER**

TELEPHONE: 0299-251522 0836-585829/0860-809673 (24 HR)

**SUPPLIERS OF HIGH QUALITY EX-RENTAL
TELEVISIONS AND VIDEOS**

LARGE STOCKS ALWAYS AVAILABLE

ALL AT COMPETITIVE PRICES

**Also available: 'B' Grade Products, Audio, Microwaves
and Complete Range of Televisions and Videos**

OPEN: MON-FRI - 9.30-5.30

**TEL: 0299-251522
0836-585829 / 0860-809673 (24 HR)**

Fax: 0299-251543

EXPORT ENQUIRIES WELCOME

TV INTERNATIONAL

FOR

**'B' GRADE AUDIO
LARGE STOCKS
NEW - BOXED - COMPLETE
SOLD FULLY TESTED
OR DIRECT - UNTESTED
- ALL MINT -**

TEL. 0384 482 575

FAX. 0384 265 236

**PEARTREE LANE, DUDLEY,
WEST MIDLANDS**

**OPEN 9.00 - 6.00
MONDAY - SATURDAY**



**B-grade Stock All Boxed, working
If you require one item please read on:**

10" R/C Portable	£95
14" Basic Portable	£85
14" R/C Portable	£95
20" R/C	£119
20" Text	£139
21" FST R/C	£145
21" Fasttext FST	£165
21" Nicam	£219
25" Nicam	£259
L/P Videos	£99
Stereo Midi System	£110
Microwave Oven	£50

**DISCOUNT
ON
QUANTITY**

**B Grade Electric Built-in ovens £125
Free Standing Gas Cookers £155
Gas Hobs £39 Calor Gas Hobs £35
All items unused & working**

**Customer returns in block.
Example. Untested 3x21" FST 3x25" FST
6x F/L Videos £40 each. Total £480+ VAT
This price does not include handsets.
Some in need of repair. Some working.**

**Ex-rental TV & Videos, all untouched.
Basic £10 & £15 R/C £20 & £25 Text £25 & £30
Videos T/L £20 F/L £25. All untouched.**

**W TREE WAREHOUSE
UNIT 1, SUNSHINE MILLS, WORTLEY RD, LEEDS 12
TEL: 0532 638804 FAX: 0532 310275**

REPO

WE HAVE A NEW SOURCE OF EXCELLENT SETS. WHY NOT CALL IN FOR A CHAT?

We supply good quality working stock from a range of makes and models of both TV and video.

We have been here for many years and generally supply people on a regular basis.

We hold large stocks – but no order is too small.

REPOSSESSED TV CENTRES LTD, DAISY WORKS, 345 STOCKPORT ROAD, LONGSIGHT, MANCHESTER M13 0LF.

Easy parking. Almost opposite main police station.

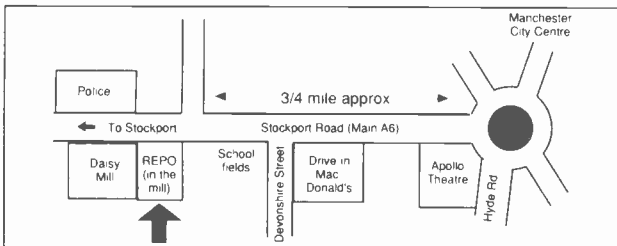

A TO Z ref. D1 61
061 274 3409 061 273 2854 Fax: 061 273 4486
ACCESS - VISA - CHEQUE - SWITCH - CASH

C & K ELECTRONICS

Good range of TV's & Videos
 Off the Pile or Working

WORKING

Top Loaders	from £35.00
Front Loaders	from £45.00
Teletext TV's with remote	£45.00
Basic TV's	from £15.00
Portables	from £45.00

Used Video Spares Available

24/26 High Street
 Brownhills, Walsall
 West Midlands
 WS8 6EQ
 (Near A5 Cannock)
 ☎ 0543-376689

C

K

CENTRAL TV EX-RENTALS

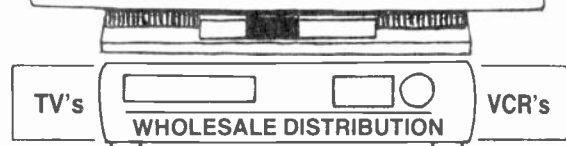

- SUPERB RANGE OF TV'S & VCR'S ●
- THORN & GRANADA ●
- DIRECT LOADS AVAILABLE FROM SOURCE ●

- Camcorder C-Format, full size & 8mm, from £200
- Microwaves from £35
- Portable TV from £40
- HiFi from £35
- Satellite ex-rentals from £20+
- Large stock of Sanyo Walkman stereo from £5 + Sony CD

Many more in stock
 Batteries all sizes, POA
 TV/Video cabinet, POA
 TV/Video stand Qty price from £3
 TV/Video remote from £5
 If you need used parts for TV/Video, or none working, please phone us!!!

SUMMER OFFER
NON WORKING - TVs, VIDEOS
 PANASONIC TEXT TVs 10 FOR £100
 FINLANDIA TEXT/ REMOTE TVs 10 FOR £100
 MIXTURE OF GRANADA TVs 10 FOR £100
 PORTABLE TVs FROM £25 EACH
 VIDEOS MINIMUM QUALITY £25 EACH

WORKING STOCK
 10 X TEXT TVs £400
 10 X 26 TEXT TVs £300
 10 X F/L VIDEOS £350
 10 X F/L VIDEOS £550

EXPORTS ENQUIRIES WELCOME

SWITCH ON TO TOP QUALITY BRAND OF...



PHONE TODAY FOR BEST RESULTS

ALL SIZES OF SCREEN TV AVAILABLE BOTH IN FAST TEXT & DIGITAL NICAM STEREO VIDEOS: CURRENT MODEL

SINGLE, TWIN SPEED, NICAM S-VHS

ALL PRICES ARE SUBJECT TO VAT

CTV LONDON
 Eley Estate, Nobel Road
 Edmonton N1B
 Tel: 081-907 4090
 Fax: 081-884 1314

CENTRAL TV WHOLESALE DISTRIBUTION LTD
 369 Stratford Road, Sparkhill
 Birmingham B11
 Tel: 021-772 1591
 Fax: 021-766 6383



MANCHESTER'S NO 1 WHOLESALER

RED BANK UNIT 20

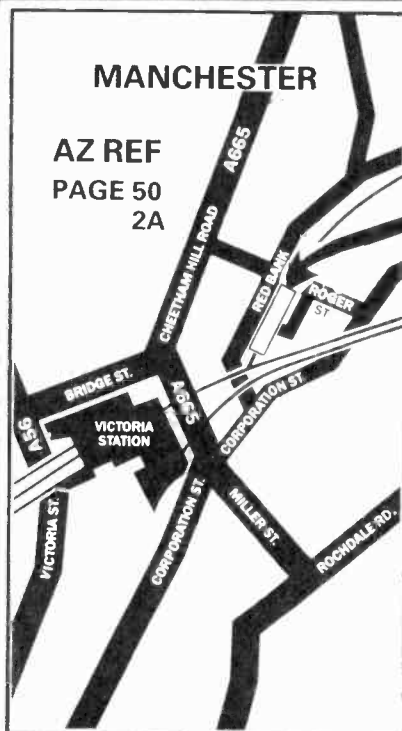

AZ REF
PAGE 50
2A

WHERE CAN YOU FIND WORKING STOCK, READY FOR YOUR SHOWROOM? LESS HASSLE MORE PROFIT!

HERE

OVER A 1000 SETS IN STOCK
BASIC TELEVISIONS FROM £5
TELETEXT FROM £35
FRONT LOADING VIDEOS FROM £35

OPENING HOURS FROM
10AM TILL 5PM MONDAY TO FRIDAY

UNIT 20, RED BANK ARCHES, RED BANK
MANCHESTER M4 4HF

— CHEQUE — ACCESS — VISA —

PHONE 061 832 4220
 FAX 061 834 6368
 PRICES SUBJECT
 TO
 VAT

WOODHAM TV LTD

— **NOW OPEN** —

New wholesalers of
 Thorn & Granada
 ex-rental TVs and Videos

- * Working — Non-working
- * Many Opening Offers

Open Mon-Sat 9.30-5.30

PHONE NOW

0245-325383

UNIT 8, CUTLERS RD,
 SOUTH WOODHAM FERRERS,
 CHELMSFORD, ESSEX

EST 14 YEARS

WESTERN
TRADE
SERVICES

2A BARTON HILL ROAD
 TORQUAY
 DEVON
 TEL: 0803 312222
 FAX: 326767

DELIVERIES TO DEVON-CORNWALL WEEKLY

NOW OPEN IN WALES

WESTERN
TRADE
SERVICES

UNIT 6
 ISLWYN WORKSHOP
 PORTYMISTER IND ESTATE
 RISCA GWENT
 MP1 6NP
 TEL: 0633 612667
 FAX 0633 601245

SUPPLIERS OF EX-RENTAL
THORN & NON THORN
TV & VIDEO

INSTAVISION LTD

UNIT 1-19 LOWER HIGH STREET
WEDNESBURY
WEST MIDLANDS
WS10 7AL
Tel: 021-556 6434 Fax: 021-505 2619

**ECONOMY
RANGE SETS
From £12**

**TELETEXT
From £40**

**F.S.T.
From £60**

**VIDEOS
From £35**

MAY I EXPLAIN SOME GOOD REASONS WHY YOU SHOULD COME TO US

1. GOOD STOCK OF CLEAN SETS ALREADY SWITCHED ON JUST READY FOR YOUR SELECTION. IT MAKES SO EASY TO CHOOSE YOUR STOCK.
2. WE NEVER EXAGGERATE OUR STOCK AND UNNECESSARILY CALL YOU IN.
3. WE ARE VERY COMPETITIVE IN OUR PRICES AND FAIR DISCOUNT ON QUANTITY PURCHASE.
4. UNTESTED STOCK IS GENUINE NO CHEATING AT ALL.
5. STOCK VARIES FROM VERY CHEAP RANGE TO VERY MODERN SETS.
6. VERY FRIENDLY TEAM TO ASSURE YOU BEST POSSIBLE SERVICE

SELF RECOMMENDATION IS NO PRAISE, YOU SHOULD FIND OUT YOURSELF BY PAYING US A VISIT

ELECTRA TV LTD

Unit 5, Santa Pod, Nr Poddington Airfield, Hinwick,
Wellingborough, Northants NN9 7JQ.
Telephone 0234 782944

Rediffusion MK4/MK4A

Working TVs Off the pile
Basic £30.00 Basic £20.00
Teletext £45.00 Teletext £30.00

Price list for spares

Line board 90/110 working £10.00 each
Power board 90/110 working £10.00
Used handsets working £6.00
Brand new handsets £9 + 90p p&p

Also other spares available.

Export enquiries welcome.

Please note we only deal in Rediffusion MK4/TVs and MK4A

COLOUR TRADE

ESTABLISHED 1973 - WHOLESALE ONLY

NEW 'B' GRADE

ONLY

**MAJOR BRANDS
SATELLITE,
RECEIVERS,
DECODERS**

LATEST
NICAM
FASTEXT
F.S.T

**TV - VIDEO - HIFI
COMPLETE BOXED - WITH STAND
- HANDSET - BOOK - ETC - MINT**

Phone 021-359 7020

FAX 021-359 6344

221-222 BRIDGE ST WEST, HOCKLEY,
BIRMINGHAM B19 2HU

ANGLIAN TV WHOLESALE

EX-RENTAL TVs & VCRs

THORN AND GRANADA STOCK

'B' GRADE
T.V., VIDEO
AUDIO, MICROWAVE
NEW
MAJOR BRANDS
COMPLETE MINT
AND BOXED

BEST POSSIBLE PRICES
EXPORT ENQUIRIES
WELCOME

RING FOR DETAILS
ANGLIAN TV
WHOLESALE,
NOW AT
UNIT 4, BRECKLANDS
BUSINESS CENTRE
TAVERN LANE,
DEREHAM, NORFOLK
(0362) 691611

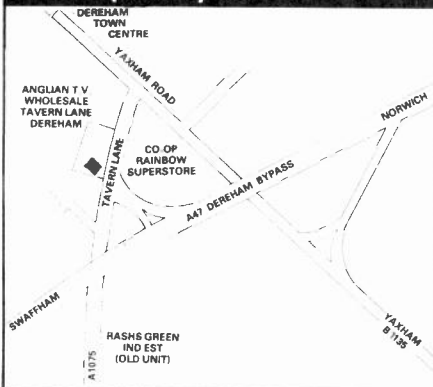

TELECENTRE

NOW OPEN
7 DAYS A WEEK
FOR TOP QUALITY
EX-RENTAL AND
'B' GRADE TV'S
AND VIDEOS.
WEEKDAYS OPEN
TILL 9PM. WEEKENDS
& EVENINGS BY
APPOINTMENT.
15 MINS FROM
JUNCTION 16 M6
**79A COLERIDGE WAY,
CREWE.**
TEL: 0270 589392
ACCESS AND
VISA WELCOME

AERIALS
FOR TV & FM RADIO, PLUS
1000's OF MASTS,
BRACKETS, LASHING KITS,
CLAMPS, PLUGS, CABLES,
OUTLETS, DIPLEXERS ETC.

AMPLIFIERS
FOR DISTRIBUTION
SYSTEMS AND DOMESTIC,
MAST HEAD OR SET BACK.
WE HAVE ONE OF THE
LARGEST RANGES,
AVAILABLE FROM STOCK

MAIN DISTRIBUTORS
FOR ANTIFERENCE,
LABGEAR, WOLSEY
FRINGE, TRIAX, TELEVES,
VOLEX-RAYDEX, KUBLER
+ MANY MORE

**COASTAL
AERIAL
SUPPLIES**
UNIT X2 Rudford Industrial Estate
Ford, Arundel
0903 723726
NO MINIMUM ORDER VALUE
NEXT DAY DELIVERY ACROSS UK
CARRIAGE FREE ON ORDERS £250+

CAMPION WHOLESALE LTD.

**QUALITY USED T.V.
& VIDEO**
COMPLETE RANGE OF
T.V.'s AND VIDEOS
MOST MAKES AND
MODELS AVAILABLE
STOCK ARRIVING DAILY
T.V.'s from £3.00
Videos from £30.00
Prices Ex-VAT

Free Delivery Service
to most areas of the U.K.
UNIT 80, BARRACKS ROAD,
SANDY LANE INDUSTRIAL ESTATE,
STOURPORT-ON-SEVERN,
WORCESTERSHIRE DY13 9QB
Just 10 Mins from
M5 Junct. 6 Worc's North

For your export
requirements contact us.

0299-879642 or 879643
FAX: 0299 827984

TV DIRECT

WHOLESALE AND
EXPORTERS
OF QUALITY TV
AND VIDEO

ALL ENQUIRIES DEALT
WITH PROMPTLY

★ **BEST PRICES** ★
RING ROB NOW

★ **0374 193983 24hrs** ★

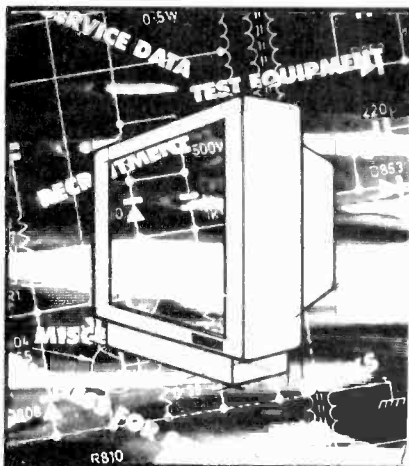

TELEVISION CLASSIFIED

No other consumer magazine in the country can reach so effectively those readers who are wholly engaged in the television and affiliated electronic industries. They have a need to know of your products and services.

The prepaid rate for semi display setting is £12.00 per single column centimetre (minimum 3 cm). Classified advertisements £8.40 per line, box number £22.00 extra. All prices plus 17½% VAT. All cheques, postal orders etc., to be made payable to Reed Business Publishing. Advertisements, together with remittance, should be sent to The Television Classified, 11th Floor, Quadrant House, The Quadrant, Sutton, Surrey SM2 5AS.



PHONE 081-652 8339 FAX 081-652 8931



SERVICE DATA



"STREE" DATA LIBRARY



76 Church St, Larkhall, Lanarks, ML9 1HE
Phone/Fax (0698) 883334 or Phone (0698) 888343

With the ever increasing cost of Service Manuals and sheets, what the everyday electrician/engineer needs is a fast, reliable and, most of all, a cheap way to get hold of all the information he requires. Now there is!

**Borrow any Service Manual for £3.95
regardless of its size or cost**

With a stock of tens-of-thousands of different manuals in stock at all times, we are the largest dedicated Library Service to handle SERVICE MANUALS in the world.

HOW DOES IT WORK?

When you join, you get any Service Manual you wish which is currently available in the UK as well as a FREE copy of the Data Ref' Guide (From TIS, our sister company). This manual is now yours to keep until you wish to exchange it for another one. You can make as many exchanges as you want during the year, at a cost of £3.95 a time.

We stock info' on CTV's, VCR's, Computers, CD's, Satellites, Hi-Fi's, Test-Equip'...etc..

Yearly Membership:	£49.00
Exchange Fee:	£3.95

INDEXES! INDEXES!

THOUSANDS SOLD WORLDWIDE

EDITION 10 of the complete indexes now published containing over 8,000 Faults listed in 12 Years of Television Magazine

Indexes are alphabetically listed by Make, Model, Fault, Ref and are now Available for just :

£8.00 For Television & Satellite Faults

£8.00 For Video, Camcorder & CD Faults

Or

£15.00 For both sets complete

Please add £1.50 (UK), £3.00 (Overseas) to total order to cover post & packing.

**A LOW COST UPDATE SERVICE
IS ALSO AVAILABLE.
FULL DETAILS DESPATCHED
WITH ORDER.**

To secure your copy/s please make Cheques/Postal Orders payable to:

E.C.S. 31 PRENTON ROAD WEST,
PRENTON, BIRKENHEAD,
MERSEYSIDE L42 9PY

FAST FIX Fault Index

Now in NEW A4 Book Format,
containing over 200 pages.

FAST FIX contains several thousand TV, Video, Camcorder, CD and Satellite fault symptoms from TV Magazine covering the years 1981 - June 1993 inclusive and is arranged alphabetically listing Make, Model, Fault Symptom and Page Reference.

Complete FAST FIX index £16.00 inclusive. Overseas orders please add £3.00.

FAST FIX IS REGULARLY UPDATED AND ALL NEW ORDERS WILL RECEIVE A FREE UPDATE VOUCHER TO COVER THE FIRST UPDATE

Send Cheques/Postal Orders, payable to:
J. Humphreys
13 Mansfield Avenue
St. Johns Park
Hawarden, Clwyd CH5 3SB N. Wales

For further details, tel: 0244 532961

SERVICE MANUALS

For most U.K. European, Far East & USA types of
TV - VIDEO - CAM - SAT - M/WAVE - CD
and all at reasonable prices.

VCR circuits also available separately for some models
Some examples from thousands of video manuals available.

These are all complete at £10 each

PANASONIC NV-FS100, L20, NV-MC10, MC20, MC30,
MS50, ORION D500, D1000/1100, D1200, D1500, D2000,
FERGUSON FV11R, FV12L, FV13H, FV14T, FV20B, FV30B.

DAEWOO, DVP1171, 1373 DVR4167, 4561, 5166

For other makes & models phone for price & availability.

All U.K. orders subject to £1 p&p. No VAT

D-TEC

PO BOX 1171, FERNDOWN, DORSET BH22 9YG.
Telephone: 0202 870656

AMSTRAD, LOGIK, MATSUI-SAISHO FAULT FINDING GUIDE

Covers hundreds of faults on a wide range of television and video recorders. Professionally compiled in easy to locate format. SAVES TIME AND MONEY by pin pointing faults in record time.

SEND £9.95 + £1.00 p.p.
TO

R. ROWLAND
438 Poynters Rd, Luton,
Beds. LU4 0TW

MAURITRON TECHNICAL PUBLICATIONS

A selection from our range of Technical Books and Guides for the TV & Video Trade

TELEVISION EQUIVALENTS.	<i>New Book lists Exact Equivalent for Many different Makes.</i>	Order MP-150. £5.00
TELEVISION CHASSIS GUIDE.	<i>Identify your TV chassis from the model number.</i>	Order MP-18. £5.00
VIDEO RECORDER & CAMCORDER EQUIVALENTS.		Makes A - J. Order MP-217. £5.00
	<i>Lists all known models and their Equivalents. New 2 Volume Set.</i>	Makes K - Z. Order MP-218. £5.00
VIDEO RECORDER FAULTS	<i>Repair Guide for Beginners. Know where to start looking!</i>	Order MP-5. £3.00
VHS VIDEO RECORDER PRINCIPLES	<i>Essential Theory on the Principles of operation of VHS</i>	Order MP-58. £3.00
CMOS DATABOOK	<i>Detailed Specification on the 4000 Series with circuits.</i>	Order MP-10. £5.00
TTL DATABOOK.	<i>Detailed Specification on the 7400 Series with circuits.</i>	Order MP-34. £5.00
TRANSISTOR EQUIVALENTS AND TESTING MANUAL.	<i>Includes Testing Procedure.</i>	Order MP-24. £3.00
POWER SUPPLIES, STABILISERS & VOLTAGE REGULATORS.	<i>Includes Circuits</i>	Order MP-9. £3.00
REMOTE CONTROL CIRCUITS - TV.	<i>Dozens of Remote Control Circuits for Colour TV's.</i>	Order MP-167. £10.00
MANUFACTURERS EQUIVALENTS.	<i>Know which Makers Trade Names are the Same.</i>	Order MP-220. £3.00
VIDEO HEAD CLEANING KIT.	<i>Unique Kit with Comprehensive Instructions on how to do it right.</i>	Order VHCK. £4.00
VIDEO TEST JIG.	<i>Run the machine and gain access to the mechanics as well.</i>	Order VTJ. £15.00
SCART EUROCONNECTOR SYSTEM.	<i>Detailed Pinout Specifications of this interface.</i>	Order MP-21. £3.00
SWITCH MODE PSU IC TYPE TDA-4600.	<i>Comprehensive Details of this popular TV PSU IC.</i>	Order MP-37. £6.00
TELETEXT REPAIR MANUAL.	<i>Covers the SAA range as used in many Sets.</i>	Order MP-38. £6.00
P.C. HARD DISC DRIVE REFERENCE MANUAL.	<i>Specifications of Hundreds of Hard Discs.</i>	Order MP-84. £5.00
CITIZENS BAND RADIO CIRCUITS MANUAL.	<i>Covers Dozens of popular models.</i>	Order MP-40. £10.00
RECORD PLAYER SPEED DISC.	<i>Lets you accurately align any turntable speed.</i>	Order MP-8. £1.00
CITIZENS BAND RADIO DATA REFERENCE BOOK.	<i>Technical Specifications of C.B. IC's.</i>	Order MP-165. £5.00
TELEPHONE CODE LOCATION GUIDE.	<i>Find the Town from the Phone Code.</i>	Order MP-19. £5.00
VALVE AMPLIFIERS CONSTRUCTION MANUAL.	<i>Full Building Details for Vintage Buffs.</i>	Order MP-173. £5.00
VINTAGE WIRELESS SERVICING.	<i>2 Volume set covers Vintage Servicing in detail.</i>	Order MP-22+35. £6.00
OFFICE EQUIPMENT EQUIVALENTS.	<i>Complete Cross Reference for all Photocopier or Fax.</i>	Order MP-200. £6.00
REEL TO REEL TAPE RECORDER SERVICING.	<i>Details on Reel Servicing for Collectors.</i>	Order MP-201. £5.00

SERVICE MANUALS

WE HAVE THE MOST COMPREHENSIVE LIBRARY OF SERVICE MANUALS AVAILABLE ANYWHERE.

From the Earliest Valve Wireless to the Latest Video Recorder. Originals or Photostats as available.

Colour Televisions, Video Recorders, Test Gear, Audio, Computers, in fact practically anything.

If you need a Service Manual, Give us a call.

MAURITRON PUBLICATIONS (TV)

8 Cherry Tree Road,
Chinnor, Oxfordshire,
OX9 4QY



Phone your Credit Card Order
for Immediate Despatch



Access, Visa, Mastercard, Eurocard, Connect.

Tel:- (0844) 351694

Fax:- (0844) 352554

Further Titles detailed in our FREE Catalogue. Send A5 S.A.E. for your copy TODAY!

TELEVISION SERVICING

1991-92

Covering 247 Models From 43 Manufacturers

ISBN: 0 951 3897 7 7

£85.00

VIDEO SERVICING 1989-90

TWO 336 Page Volumes

Covering 236 Models From 44 Manufacturers

ISBN: 0 951 3897 2 6

£138.00

TELEVISION SERVICING

1989-90 - While Stocks Last

Covering 461 Models From 43 Manufacturers

ISBN: 0 951 3897 1 8

£65.00

SATELLITE SERVICING

1991-92

Covering 251 Models From 68 Manufacturers

ISBN: 0 951 3897 8 5

£65.00

TELEVISION SERVICING

1987-88

Reprographic Edition of Original Book

ISBN: 0 951 3897 0 X

£55.00

SATELLITE SERVICING

1987-90

Covering 127 Models From 42 Manufacturers

ISBN: 0 951 3897 6 9

£65.00

All Books Contain:

CIRCUIT DIAGRAMS : SCOPE READINGS : VOLTAGE TABLES :
ESSENTIAL PART NUMBERS : ALIGNMENTS & ADJUSTMENTS :
TROUBLE SHOOTING GUIDES

POST, PACKING & INSURANCE

1 Book £4.00
2 or more Books £7.00



Note: Video Servicing 1989-90 is a TWO volume set and is therefore £7.00 delivery.

Professionally Produced with the Manufacturers Full Co-operation

Send for full list of models.

U-VIEW

4 South Parade, Bawtry, Doncaster,
Yorkshire, England. DN10 6JH
Tel: 0302 719997 Fax: 0302 719995

TELEVISION

Subscribe to the magazine
that experienced electronics
professionals never miss

Whatever your interest in the world of television electronics, there's a wealth of news, advice and hard information for you in *TELEVISION*.

TELEVISION offers you a definitive guide to today's TV electronics business.

keeping you up-to-date with new developments in TV, video and satellite - whilst furnishing you with 'hands-on' advice and information on the latest equipment.

SUBSCRIBING IS SIMPLE

Complete the coupon and return it to us at *TELEVISION*. Reed Business Publishing, FREEPOST, 9th Floor, Quadrant House, The Quadrant, SUTTON, Surrey CM2 5BR

Please send me TELEVISION

- One Year at a cost of £26
 Two Years at a cost of £49 **SAVE £3**
 Three Years at a cost of £70 **SAVE £8**

Name _____

Title _____

Company _____

Address _____

Postcode _____

Telephone Number _____

- Servicing solutions
- TV fault finding
- New Products
- VCR clinic
- Satellite TV
- Equipment reviews

- Readers' letters
- CD players casebook
- Components
- News and comment
- And much more!

4 WAYS TO PAY

1 I enclose a cheque for £_____ made payable to
Reed Business Publishing Ltd

2 Please charge my:

- Access Visa
 Diners Club American Express

Expiry Date _____

3 Please invoice me/my company

Order No. _____

4 Or alternatively just ring our credit card hot-line on
0622 721666 and quote reference *IJ2*

Are you registered for VAT, Yes No

If yes, please supply your registration Number

Please send a VAT receipt

Signature _____ Date _____

Prices apply to UK, Isle of Man, and Channel Islands only.

CLASSIFIED CLASSIFIED CLASSIFIED CLASSIFIED CLASSIFIED

Technical Information Services

76 Church Street, Larkhall, Lanarks, ML9 1HE

Phone (0698) 883334 or (0698) 888343 Mon-Fri 8.30am - 6.00pm, or Fax (0698) 883334
All orders under £20.00 add £2.00p&p, Under £30.00 add £2.50, Over £30.00 Post Free



We Stock the World's Largest Selection of



SERVICE MANUALS SHEETS & CIRCUITS

Only £5.95 for Data Ref Guide 4th Edn. (Inc.s CTV, VCR & Audio Chassis Guides & Cross-Reference)
Send a Large SAE for your FREE Quote or Phone/Fax Us

A Selection Of Titles From Our Stock Of Over 200

(Send a Large SAE for our FREE Catalogue)

Practical TV Repairs 2nd Ed.	£16.95	VCR Serv'ing by Beeching 4th Ed.	£16.95	Microwave Servicing	£9.95
CTV Servicing by King	£16.95	Practical Radio Serv' & Repair	£12.95	Spectrum Repair Guide	£5.00
The PAL System	£9.50	Serv'ing TV & Video Equipment	£25.00	BBC Micro A B + & Peripherals	£25.00
TV & VCR Technology	£14.95	Serv'ing Audio & Hi-Fi Equip'	£25.00	Buy, Sell & Serv'ing Used CD's	£9.95
TV & Video Engineer's P.B.	£14.95	Buy, Sell & Serv'ing Used VCR's	£9.95	Elec'ic Power Supply Handbook	£7.95
Buy, Sell & Serv'ing Used TV's	£9.95	Hi-Fi Servicing	£9.95	*Euro' Scramb' Systems 3rd Ed.*	£30.00
Data Communications P.B.	£14.95	World Satellite TV & Scramb' M'ds	£24.95	Install Aim & Repair Satellite TV	£12.50

Fast, Friendly Service with Low Prices, Huge Choice & High Quality

THE VINTAGE WIRELESS COMPANY LTD

FOR EVERYTHING IN
VINTAGE VALVE
TECHNOLOGY

Everything for Vintage Radio,
Electronics and Audio by Mail Order

Valves, Books, Magazines,
Components, Service Sheets, Radios,
Amplifiers, Tuners, etc.

Send £3.25 for Catalogue Pack and
Sample Newsheet.

Credit cards
accepted.

Vintage Wireless Company
Tudor House, 20A Cossham Street,
Mangotsfield, Bristol BS17 3EN.

Retail showroom open every
Saturday 10am to 1pm.

Tel: 0272 565472 (24 hours)
Fax: 0272 575442 (24 hours).

GERMAN SERVICE SHEET SPECIALISTS

Our connections are world-wide. We furnish any
kind of German, European and Japanese service
sheet or manual. Thousands of different sheets and
manuals in stock. For any enquiries

DÖNBERG ELECTRONICS
Schoolmasters House, Rannafast,
Co. Donegal, Republic of Ireland.
Phone: 075 48275

TRAINING

If you require a home study course in
the fundamentals of electronics, either
to begin a career, pursue a hobby, or
refresh your knowledge, a

BASIC ELECTRONICS
course, from the Direct Personal
Learning scheme, could be just what
you're looking for. Contact:
K. Sparrow etc. . . . 11 Claydon Green
Whitchurch BRISTOL Avon BS14 0NG
Telephone: (0275) 835669

MISCELLANEOUS

CAR RADIO CASSETTES

Do you turn away work on car
radio cassettes because they
have security codes.

Most radio cassettes can be
decoded just by replacing the
eeprom (memory IC) with that of a
known code, or sending the
original for re-coding.

All popular makes including
Philips, Ford, Pioneer, Clarion,
Grundig, Blaupunkt, Fisher, JVC,
Alpine, Volvo, etc.

Send now for introductory offer,
one of each of most popular
eeproms + comprehensive
eeprom/radio decoding list. Offer
includes Philips X2402P: Ford
MN010: Blaupunkt Boston CC20
9346: £17.63

Original eeprom re-coding service
£10.00

Radio's sent for decoding from
£20.00
Inc. of VAT and p&p

RADIO DECODING EQUIPMENT

We will beat any genuine written
quotation for supplying a com-
puter or software to decode radio
cassettes, ring us first.

For technical or general
information phone
0543 572 523 or 0831 806 574.

C.D.H. ELECTRONICS
3 Common Walk, Huntington,
Cannock, Staffs WS12 4NB
C.D.H. ELECTRONICS

TUBES

REBUILT CRTs

VDU - MONITOR - TV

Image Burn-In Removed From Screen Phosphors

B.S.I. Certification

N.G.T. ELECTRONICS LTD.

120, Selhurst Road, London SE25 6LL

PHONE: 081-771 3535

Britain's Oldest Established Tube Rebuilder

BRAND NEW TUBES.

ALL SIZES.
FROM 75p TO £1.50 PER CM. PLUS
VAT & PP.

POWER PRODUCTS,
CLEARANCE WAREHOUSE, 30, ST
THOMAS ST, REDCLIFF, BRISTOL,
BS1 6J2.

TEL: 0272 - 268969.

CLASSIFIED CLASSIFIED CLASSIFIED CLASSIFIED CLASSIFIED

MISCELLANEOUS

HOW THEY WORK! HOW TO TEST! HOW TO REPLACE!

Designed specifically for Domestic Appliance Engineers who want to enter the fast growing microwave industry. Packed full of useful information, presented in a simple yet informative style with comprehensive diagrams and illustrations. Fault finding procedures are included at the end of each section.

The book contains easy to follow electronic control systems

SWIFTPARK LIMITED

113 LONDON ROAD, HORNDEAN, WATERLOOVILLE, HANTS. PO8 0BJ

£14.95
plus £1.25 P & P

ORDER YOUR COPY TODAY!



We also supply microwave oven components

FOR SALE

EASINGTON ELECTRONICS

PLEASE ADD £1.50 PP TO ORDER PLUS 17.5% VAT. ORDERS BY POST TO 11 BEDE STREET EASINGTON COLLIERY PETERLEE CO DURHAM OR CALL IN MON TO FRI 9.00AM-5.30PM MINIMUM ORDER £5.00. PARTS SUBJECT TO AVAILABILITY. PRICES SUBJECT TO CHANGE WITHOUT NOTICE

BELT KITS		PULLEY BLOCKS	
AMSTRAD 4600-6200	£1.26	AKAI VS240	£10.04
AMSTRAD 8000-6100	£1.42	SHARP VC851(BLACK) (G)	£5.60
AMSTRAD 7000	£1.26	SHARP VC781(WHITE) (G)	£8.62
FERGUSON 3V28	£0.79	SHARP 11221128 (G)	£4.71
FERGUSON 3V3E/38	£0.83		
FERGUSON 3V42444/4548	£0.55	ON OFF SWITCHES	
FERGUSON 3V64/85/FV10	£0.85	PHILIPS UNIVERSAL	£0.94
FISHER 710710/722	£1.08	FERGUSON TX100	£1.17
FISHER 906/910/911	£0.82	SONY 21MM	£3.87
HITACHI VT11/53	£1.04	SONY 26MM	£3.86
HITACHI VT120/30	£1.40		
HITACHI VT528/284/86	£1.22	CASSETTE LAMPS	
SANYO VHR1100/2300	£0.96	FERGUSON WITH PLUG	£0.36
PHILIPS VR6363	£0.86	SHARP 9300	£0.56
		VIDEO HEADS	
PINCH ROLLERS		AKAI VS240	£18.89
AMSTRAD 4500 MOD KIT	£3.17	AMSTRAD 7000	£14.18
SHARP VC105/606	£2.44	AMSTRAD 6000	£16.74
FERGUSON 3V28/30	£2.37	AMSTRAD 4600	£12.25
PHILIPS 6470	£4.60	AMSTRAD VCR9000	£13.42
		FERGUSON 3V29	£7.44
IDLERS		FERGUSON 3V30/31	£7.44
AKAI VS240 IDLER WHEEL	£1.53	FERGUSON 3V4445	£14.95
FERGUSON 3V29/30 (G)	£1.81	FERGUSON 3V58	£26.82
FISHER 910/710	£3.91	GOLDSTAR 1243	£14.30
FISHER GEAR 910	£4.87	HITACHI VT120/220	£21.96
FISHER GEAR 710	£4.87	HITACHI VT130/339	£26.00
HITACHI VT11/53	£1.09	HITACHI VT64/83	£19.83
PANASONIC VXP0599	£1.17	PANASONIC NVG30	£20.14
PANASONIC VXP0621	£1.92	PANASONIC NV333	£7.44
PHILIPS 6482	£2.02	PHILIPS 6460	£8.28
SENTRA PULLEY TOP GX800	£1.27	SAMSUNG VB510/620	£16.72
SENTRA GX800	£4.94	SANYO VHR1300/2300	£17.42
SHARP VC9300/981 (G)	£3.37	SENTRA 8000	£16.74
SHARP VC387/8581 (G)	£3.37	SHARPVC381	£13.07
		SHARP VC681	£13.07
LOPTY		REMOTE CONTROLS	
FERGUSON TX100GRN SPOT	£12.03	RC790 FERGUSON 734-742	£7.50
FERGUSON TX90 WH SPOT	£16.80	RC304 BUSH 12020, 2114T, 2321T	£8.49
HINARI CT4	£12.91	RC300 PHILIPS RC5991	£8.19
HITACHI CPT2048	£14.37	RC401 GRUNDIG TP400TXT	£8.19
HITACHI CPT1476	£12.81	RC901 HITACHI A514790	£8.19
		RC200 PANASONIC EUR51200	£8.19
MISCELLANEOUS		RC305 IIT RG305(WITH MUTE)	£8.19
ORION LIMITER POST	£0.90		
BACK UP BATTERIES			
PHILIPS 1.2V	£1.39		
PHILIPS 24V	£2.81		



Phone your Credit Card Order for Immediate Despatch



PHONE 091 527 0903 OR 091 527 0587

CAR RADIO DECODING EQUIPMENT

Plug our decoder into your IBM or compatible computer, remove the base plate from the radio, place our probe onto the PCB and the code is instantly displayed. Changing the code or even fully reprogramming the EEPROM is just as easy.

Easy to use software includes PCB layouts and help screens with full backup from our telephone helpline.

SEND FOR FREE DEMO DISK

Recent national press coverage has resulted in increased sales, so we can now offer a starter kit enabling you to decode the three most popular brands of radio for only £300 + carr & VAT.

EEPROM DECODING SERVICE: only £5 + VAT (just send us the chip)

Electronic Sound Systems

62 High Northgate, Darlington, Co. Durham DL1 1UW
Tel: 0325 484089 Fax: 0325 465921

TRADE ONLY

MICROWAVE OVEN PARTS

MAGNETRONS · DIODES · TRANSFORMERS
LAMPS · FUSES · MICROSWITCHES

PHONE NOW FOR PRICE LIST

A.W.I. MICROWAVE OVEN COMPONENTS

Samuel Whites Estate, Medina Road,
Cowes, Isle of Wight PO31 7LP

Telephone: 0983 296121

Fax: 0983 296122

EAST LONDON TV/VIDEO SUPPLIER

Working Basic	From £25.00	SPARES FOR GRANADA STOCK
Working Text	From £50.00	VHF/UHF CONVERTERS
Working VCR	From £50.00	ELECTRONIC SIGNBOARDS
Non Working VCR	From £25.00	NEW HI-FI EQUIPMENT
Non Working TV	From £15.00	DOUBLE CASSETTE WITH CD
		S.E.C.A.M. TRANSCODER

THE EXPORT SPECIALIST
JOMILL ENTERPRISES
UNIT A, 357 MILE END ROAD
LONDON E1 4PA

TEL/FAX: 081 983 4792 or TEL: 081 983 0517

TOP BRAND NAME RETURNS.

Colour Televisions, Microwaves, Irons,
Camcorders, Toasters, De-Humidifiers, Fans
Video Recorders. All current models.
Phone 0227-772875 Fax 0227-773099.

TRAINING

THE EASY ROUTE INTO BROADCASTING

Learn from professionals with worldwide broadcast experience. 50 Lessons on VHS video with printed manuals & practical demos on all aspects of broadcast technology. S.A.E. for A4 brochure WARRISTON BROADCAST TRAINING CENTRE, BALLPLAY ROAD, MOFFAT, DG10 9JU. TEL. 0683 20943

TEST EQUIPMENT

MÜTER · AT2 · BMR95 · BMR700

AT 2, Audi-Multi-Tester, 16 test-circuits for loudspeakers, tuners, amplifiers, headphones, tape recorders, mikes, boosters.

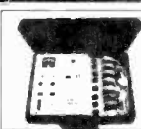
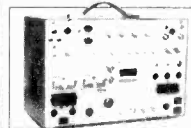

BMR
95
BMR
700



Regenerating Computers & Measurers for CRT's with cathode protection, gas clean-up aid, short repair; exhausted CRT's becomes bright and sharp again even if all other machines do not succeed.

United Kingdom: P & E Services, Llandudno, Tel. (0492) 549246, Fax 547880.

Ireland: Dönberg Electronics, Ranafast, Co. Donegal, Tel./Fax (075) 48275.

New Zealand: TDON Ltd., Onehunga, Auckland, Tel. 668-907, Fax 668-499.

Germany: Ulrich Müter, Oer-Erkenschwick, Fax (02368) 57017

CLASSIFIED CLASSIFIED CLASSIFIED CLASSIFIED CLASSIFIED

SPARES & COMPONENTS

AMSTRAD HANDSETS VCR4600, 4600MkII 11.75 VCR4700 (Not long play) 17.63 VCR5200 11.75 VCR6100 (Indexer) 25.85 VCR6100 (Barcode Indexer) 29.38 VCR9000 (Old type) 11.75 TVR 2 13.22 TVR 3 17.63 SRD500 11.75 TS90/99 Tower System 11.75 AMSTRAD LOPTS CTV1000 FB182K 11.75 CTV1400 FB165KA 11.75 CTV1401 3714002 14.10 CTV1409 3714002 14.10 CTV2000 FB171 9.40 CTV2000 FB171K 9.40 CTV2200 3722002 14.10 CTV2210 3722002 14.10 TVR 2 1810951 13.51 TVR 3 181297 13.51 CTM644 MkII 3714009 14.10 PC12-HRCD/D MSH1FCT31 14.10 PCW9512,8256,8512 7.05 FERGUSON LOPT MM06 00D4242001 4.70 AMSTRAD TUNERS UE33-B01 9.40 UE2-B31F 5.88 1810829 7.05 ENV87358F2 7.05 ENV87509F2 5.88 UVE33-F01-VHF-UHF 14.10 UVE33-F02 VHF-UHF 14.10 1813766 VHF-UHF 14.10	AMSTRAD MODULATORS 18198221 7.05 ENP-E730-2 5.88 VCR4600MkII,4700 5.88 SRD100/200/400 5.88 AMSTRAD SERVICE MANUALS VCR4600 9.00 VCR4600MkII,4700 9.00 VCR8700 8.00 VCR8800 6.00 VCR9000/700 9.00 AMSTRAD OPERATING MANUAL PC1640 11.75 AMSTRAD VCR MECHANISMS 4500,9000 (Old model) 15.28 CASSETTE HOUSING ASSY. 15.28 4600,4700,TVR1,2,3 COMPLETE MECHANISM ASSY. (Excluding Video Heads) 35.25 COMPLETE MECHANISM ASSY. (Excluding cylinder assy.) 29.38 MECHANISM DECK (Excluding Cass. housing assy. & Cylinder assy.) 18.80 CASSETTE HOUSING ASSY. 15.28 CYLINDER ASSY. (incl. Standard play Video heads) 25.26 CYLINDER ASSY. (excluding Video heads) 20.56 CYLINDER LOWER DRUM ASSY. (Excluding Motor) 9.99 HEAD BASE ASSY. (Audio) 5.88 AMSTRAD IF UNITS TPS7-B0006 9.40 TPS7-L0002 14.10 1813766 14.10	AMSTRAD MOTORS Loading Motor MCB9B02 3.53 Drum Motor E20ELG5 10.58 Capstan Motor LLN#B21 9.99 Tape Loading MCF9B02 9.99 AMSTRAD PCB's (Complete, fully populated) 4500 Timer 11.75 4500 Systems Control 9.40 4600 Systems Control/Servo, Display & Control PCB's 29.38 4600 Display 11.75 4600 Control 5.88 4600 Video & Audio 17.63 4600 Power Supply 14.63 4600MkII Main PCB Assy. 40.82 4600MkII Timer 14.10 4600MkII Control 5.88 4600MkII Head Amp Assy. 5.88 4600MkII Power Supply 4.70 4700 Main PCB Assy. 40.82 4700 Timer 14.10 4700 Control 5.88 4700 Head Amp Assy. 5.88 4700 Power Supply 4.70 5200 Timer & Channel Disp. 17.63 5200 Video 14.10 5200 Switch Panel 4.70 7000 Switch PCB no:7 2.35 CTV1400 Switches, Presets & Tuner (UE2-B31F) 8.23 CTV 1400 Switches, Presets & Tuner (ENV87358F2) 8.23 CTV1400 Switches, Presets & Tuner (ENV87509F2) 8.23 CTV2200 PCB no:3 3.53 CTV2200 PCB no:4 4.70 TVR 1 Control Panel & Presets 7.05 TVR 2 Main TV PCB 37.60 TVR 3 Main TV PCB 43.48 TVR 3 TV Power Supply 15.22 TVR 3 Head Amp Assy. 5.88 TVR 3 Video Power Supply 4.70	VMC100 - Various parts available, please phone for prices. MITSUBISHI/SALORA Various Videos PCB's and Cassette Housings available - see our full list for parts and prices. BSR DECK SM103/104 Linear tracking Record Deck 17.63 CARTRIDGE/STYL CZ800-1/ST800-1 2.94 SANYO VHR1110. 1150, 1300, 1700, 2300 FUITEK F501 Replacement Video Heads 7.05 AMSTRAD PC12MD VGA MONO MONITOR Suitable for use with 2000/3000 series and any other VGA compatible PC 64.63 AMSTRAD SOFTWARE ACCOUNTSMASTER Lan 17.63 (Full accounts program for running small business on any PC) INFOMASTER 17.63 (Easy to use Database, runs on PC) AMSTRAD COMPUTER & PRINTER SPARES - Many spares available, please phone for price.
---	--	---	---

Harrison Electronics
 CENTURY WAY, MARCH, CAMBS PE15 8QW.
 FAX: (0354) 51416. TEL: (0354) 51289

PRICES INCLUDE VAT.
 ALL ITEMS ARE BRAND NEW AND GUARANTEED
 ** SAME DAY DESPATCH **
 Write or Phone for FULL catalogue.
****POST & PACKING****
****EXTRA****

DERKS TRADING
 YOUR PROCUREMENT OFFICE IN SINGAPORE
 TV & VIDEO SPARES
 ELECTRONIC COMPONENTS
 CONSUMER ELECTRONICS
 TV's, VCR's, CAMERAS
 '35/36 CARPENTER ST. #04-00
 ABS BUILDING, SINGAPORE 0105
 TEL: 7763585 FAX: 7783363

SURPLUS REDUNDANT ELECTRONIC COMPONENTS WANTED
 IC's - Tuners - Transistors - Valves - Diodes etc. any quantity considered - immediate payment.
 ADM Electronic Supplies
 Tel. 0627 873311. Fax 0627 874835

WANTED

URGENT

required for export on regular basis (Shipping arranged). New or B Grade TV's and Video's. Must have combined VHF and UHF tuners or else multi system type. Apply Box Number A2230. You will be contacted immediately

VIDEOCRYPT DECODER Service sheet with smartcard contact details Eurocrypt card Interlace £12.00. E.M.O., Ramsbottom, Lancs, BL0 9AG. TEL: 0706 823036.

PRIVATE RETAILER has excellent part exchange colour televisions and videos to clear. Tel 0494 814317.

ASSORTED VACUME Pump for sale 4, leybold type, 2 Genevac rotary piston, 1 Speedvac Mercury diffusion complete, 3 oil Diffusion ring 081-800 3226 after 6pm anytime weekend.

RECRUITMENT

BRITISH SERVICE ENGINEER With 15 years experience, city and guilds certifies and good knowledge of modem TV and VCR seeks secure position Abroad or UK. Box No. A2611.

BI TEL SOUTH WALES

GOOD DEALS ON TV & VIDEOS
 ALSO USED SPARES INC TUBES

Unit 11, Taveners Estate,
 Caerleon, Newport, Gwent.
 (3 miles from M4, Junc. 25)
 Ring Bob for prices on:
0633 430040

TRANSFORMERS

TV LINE OUTPUT TRANSFORMERS
 PHONE 081-948 3702 FAX: 081-332 0583

ALBA . AMSTRAD . BUSH . DECCA . DORIC . BLAUPUNKT . FERGUSON . FIDELITY . GEC . GRUNDIG . GRANADA . HITACHI . HINARI . INDESIT . ITT . KIMARA . NIKKAI . MATSUI . MURPHY . OSAKI . NORDMENDE . LOEWE-OPTA . REDIFFUSION PYE . PHILIPS . SANYO . SAISHO . SHARP . SONY . SOLOVOX . SUSUMU . TANDBURG . TELEFUNKEN . THORN . TRIUMPH . HUANYU . GOLDSTAR . BINATONE .

FULL RANGE OF KONIG: VIDEO HEADS, BELT KITS, IDLERS, PINCH ROLLERS, TENSION BANDS. LARGE RANGE OF REMOTE CONTROLS IN STOCK

TIDMAN MAIL ORDER LTD . 236 SANDYCOMBE ROAD . RICHMOND . SURREY . TW9 2EQ.
 Mon-Fri 9 am to 12.30 pm & 1.30-4.30 pm
 Sat 10 am to 12 noon
 Approx. 1 mile from Kew Bridge.

MARCONI COMPACT L.N.B. 1.2DB £30 10.7 TO 11.7GHZ		60cm BACK MESH DISH £25, £5 post		VIDEO AMSTRAD HANDSETS (EXPORT) £3.50 WILL WORK IN HOME MARKET 6.000 and 4.600 4.700 £6		SEND FOR DATA D2 MAC SATELLITE RECEIVER, LNB AND DISH. £50 (£10 Post)					
SATELLITE RECEIVERS — New Ferguson BSB Chassis with Tuner, Modulator etc Hand Set £1.50 £4 Post		60cm SATELLITE DISH £35 Postage £5		Replaces 90% of Philips Handsets Philips Video RTV Handsets with LDC display AV5661 AV5659 £6		SATELLITE FINDER KIT AND LNB TESTER WITH METER BOX £25					
SMALL SATELLITE TUNERS (950 to 1750 MHz), L.F. frequency 4000MHz £9.00 each VHF/UHF S. BAND TUNER £3.00 NEW PLASTIC CASE 32 C.H. SAT-RECEIVER (no hand set) £35 (Post £5) NEW METAL CASE SAT-RECEIVER, 32 C.H. WITH DOLBY B & CHANNEL C (no hand set) £35 (Post £5) DAM MAINS CHASSIS AMSTRAD MONITOR C £10 UNIVERSAL TRIPLER NEW TYPE £4.00 VIDEO LEADS £1.00 AMSTRAD Line O.P. Transistors with Diode 2SD455 £1.00 BU208A £1.00 VIDEO LAMPS, Long Lead 29p HITACHI & GEC FRAME, Thick Film £6.00 FIDELITY SPLIT DIODE FCC2215AE £20 FCC2015BE £10 FCC2215BE £10 K20 FRONT PANEL TEL-TEX TYPE £5.00 NEW G11 LINE OF PANEL £5.00 PHILIPS YEARS AHEAD THE CREDIT CARD CALCULATOR Solar Powered £3.75 NEW PHILIPS SBC 1833 Solar & Battery Powered Calculator £8.00 THORN PANEL TX9 REC & REMOTE PANELS with Mains Trans £5.00 TX18 REC & REMOTE PANELS with Mains Trans £5.00 TX100 FRONT PANEL £5.00 TX10 TUBE BASE ON PANEL £3.00 TX9IF £2.00 THORN PANEL No. 515-353, 548-02, 565-01, 599/102, 515/173, 508/161 £5.00 THORN TX STEREO SOUND O.P. PANEL (I.C. TA7277P) £1.00 THORN VIDEO AERIAL AMP 01 M4-597-001 £6.00 ULTRASONIC TRANSDUCER 15p IN LINE 12-36 VOLT SUPPLY 4.000 MRD 20p		CAMCORDER SANYO NP22 6v 1300mah Rechargeable Battery Pack £6.00		NOT WORKING NEW PROFESSIONAL SATELLITE NO HAND SET METAL CASE WITH METER, DOLBY CHANNEL C WITH POLARIZER SUPPLY £20 £5 post SEND FOR DATA AND PHOTO		BSB or D2-MAC 35cm DISH and LNB 11.7 to 12.7 £15					
TX100 REMOTE PANEL No. 564131C M293B/and SAA5012 £10 etc		Philips Stereo Headphones No. SBC 3140 144MHz Changed Over Relay Aerial £4.00 6251 FRAME O/P THICK FILM HITACHI GEC £9.00 THICK FILM HITACHI HM9205A £4.00 TX 85 FERGUSON BATTERY MAINS CONVERTOR £5 each TX9-TX100 FRONT PANEL £5 WITH REMOTE £10 NON REMOTE 8 push button £10		SATELLITE UNIT Video Out/Audio Out, L and R Polariser ± 35M/A and Decoder Socket £10		Gas Soldering Irons New Type £10.00 Variety Nickel Cadmium Batteries from Telephone Type to Sub-C 50p per cell. Mainly in packs of 6 to 3. HITACHI UHF-VHF SMALL TUNER £5.00 ETS98A £5.00 ETS95A £5.00		THORN M49481 on Remote Panel £5 THORN FRAME IC TX100 etc IC TDA 3652 IS OBSOLETE REPLACEMENT TDA 3654 £2.00			
NICAM UNIT — Ferguson made for ICC5 Chassis — home market and export — has circuit diagram and can be converted to most sets — £15.		LARGE Foacs Pots. Fits Pye, GEC, ITT, Decca 75p		PHILIPS UNIVERSAL BATTERY TESTER SBC 1695 £5.00 BATTERY CONVERTER FOR TA185 FERGUSON TX85 £8.00 ONE I.C. K35 Decoder £10.00 PHILIPS Deck Calculator £7.00 REGULATED PWR. SUP. 500M/A 1.5V-12V DC switched + & - £5.00 ITT Tuner & IF. Can HF-module 2 UK £10.00 KT3-K30 IF £5.00 STR5481 £5.00		TX100 SWITCH MODE TRANS 5157/48 £5 AND 00D4-252-001 06D3-082-001 STEREO SOUND RADIO VHF AND MW £10.00 1000V AC 1000V DC ETC. PHILIPS METER ANALOG £11 G11 470 MFD 250v £1.35 220M 3850 £1					
BSB SAT/REC HALF COMPLETED. CHASSIS, TUNER AND MOD £5 + Post £3		GLASS BEADS Diodes 200v/1.2A 50 for £1.00		PHILIPS NEW TYPE U/V HANDSET £10		TX100 Push Button Unit 16 CH £10.00 WIRE PIPE stud detector £4.00 MICROWAVE leak detector £4.00 WIRE & PIPE detector £4.00		CAR ADAPTOR fused 3 Amp Long Lead with plug for TV etc 25p 500 off, 15p Each CASSETTE MAINS SOCKET, Print LEADS 30p Socket, Print Type 20p TELEPHONE LEAD 3 Metre 30p LEAD SCART TO D PLUG 50p BRIDGES RECTIFIER Mixed BR-31 to 34 2 Amp to 5 Amp 8 for £1.00			
G11 LOPT Panel £4.00 G11 Tip Switch £20.00 G11 IF Panel £3.00 G11 Decoder Panel £2.00 G8 Push Button Unit £2.00 G8 Con/Panel New Back Type £4.00		MIXED TOSHIBA HAND SETS FIVE FOR £12 EACH 10 off £1.00 MDA2062		Have you got Acid Rain in your garden? PH METER Video Power Supply for Amstrad. Last year model. Mains Transformer for Amstrad Video £5.00 £1.50 25p (£1 post) DAMAGED AMSTRAD 1640 Colour Monitor Chassis £6 + post £3.		DECODER C-CAM PHILIPS MADE FOR K40 CHASSIS IC No. TDA 3590 £5.00 56420A 20A/600V THYRISTOR £1.75		NEW LUXOR SATELLITE ANTENNA POWER DRIVER £15.00 T6070V TX9 Transistor £1.00 1 METRE SCART LEAD £1.00			
LATEST VIDEO For lamps Philips, GEC, Pye and Hitachi, Front panel with memory chip and bush button and pots and LED's £6.00 NEW		FERGUSON CHASSIS IKC-7000 £2 IKC-2000 £20 TX85 C Chassis £5 TX90 White Spot 20" REMOTE £20 TX90 Chassis 14" 8 PUSH BUTTON Post each, £5		TX100 FRONT PANEL £5 8 Button		LCD VIDEO AMSTRAD HANDSET for models 1900 £8 each ITT BG2032-642A TRIPLER £5.00 ITT/NOKIA RF IF MODULE £20 COAX PLUG TO PHONO LEADS £1 SCART TO SCART LEAD £1 TV GAMES AERIAL VIDEO COMBINER SWITCH £1.50		VIDEO SCART TO SCART ALL PIN, LONG LEAD £3.00 ALL PINS TX90 TX925 TX100 Mains Switch with Stand-by and Lead 50p each BURGLAR ALARM USE INFRA RED DETECTOR WIDE AND SHORT ANGLE WALL MOUNT £8 WITH RELAY			
GEC, HITACHI DECODER PANEL TBA10AS, TBA120, HA1215A, UPC1365 £10		SCART TO SCART LEADS TX90 REMOTE PANEL IC TMS1000 AND M293 £12		5 Mixed AMSTRAD VIDEO MOTORS £5.00		SATELLITE TUNER UNIT 2427611 with Base Band, Video Out £8.00		TX10 8 way button unit £8.00 24v 0.24v 5amp MAINS TRANSFORMER £3.00 10 MIXED FERGUSON CIRCUIT DIAGRAMS MSH1FCF09 £7.77			
2433752 £20 2432964 2432871 2432301 2435016 2433952 2434393 2432211 T9048A D5T85B243 TFB3069D K4 L.O.P.T. K35 L.O.P.T. K40 2433452 2432904 2434451		SPLIT-DIODE 2433752 £15 TX100 Green Spot £15.00 TX100 Yellow Spot L.O.P.T. £10.00 TX90 White Spot L.O.P.T. £15.00 Split Diode 110" £12.50 Orion 65-3M GEC 85-9793-6 TX9 Trans 2432101-2 £5 2434141 EACH 2434492 2435066 2434493		TOSHIBA DST 186N243 £10 FTB-4023AD £10 CP90 Philips Split Diode £10.00 2435141 £15 2432491 £10 2435065 £15		TX85 2435701 2434393 2435016 2435014 £10 2436797 £15		TRANSFORMERS 2435701 £10 2435012 £10 FERGUSON 47003481 £10 AMSTRAD TVR3 LPTS £10 TFB3069D EQU TFB4009AN		AT203600 AT207655 AT204811 AT207671T AT2055 AT207635 RCO ST CT3325 AT207638 OT2041 AT207651 FB165KA Orion CVC 820 207651 CVC 800 2432461 2433451 SHARP MSH1FCF09 £10 EACH 0004-235 002-01 VIDEO MOTOR for VT568 type VC62DD5 AMP TUNER IF for VT568 Hitachi & GEC £9.00	
SATELLITE TUNER 950MHz-1750MHz £5.00 ITT PANEL CMC301 CMC 113 CMC302 CMC115 CMC £5.00 303 CMC964		BURGLAR ALARM £2.00 with siren 9 VOLT		PHILIPS HALOGEN LIGHT. NEW. NO ON/OFF SWITCH. NO HANDLE WITH CORD. BLACK IN COLOUR £5		PHILIPS HAND SET G11 TEXT IN RED G11 TEXT ULTRASONIC £10		G11 HAND SET ULTRASONIC £10 PHILIPS RC5 EA5Y CONTROL £10			
VIDEO LEADS 4 for £1		RELAYS 35p 5V-12V-24V-48V Large and Small		TRV9 Amstrad Cassette Mechanisms. New with 2 motors and sound head. £15 TVR3 Power Supply. £5. Amstrad Television Tuner UHF. Small, Fits most Amstrads. £6.		4600 TO 8600 AMSTRAD VIDEO HAND SET WITH LCD £10		NICAM MKII KIT MODULE £20.00 with data			
SEL ITT HFB254F2 Front Panel £15.00		25 Way Plug and Socket with Case £1.50		PHILIPS SBC 522 RGB1 GENERATOR £90 PHILIPS SBS 850 ANALOG MULTIMETER £11.50 PHILIPS SBS 521 RF SIG GENERATOR £90.00 FERGUSON TX110 — IK2 and IK7 MANUAL £1 each		FERGUSON ICC5 STEREO O.P. PANEL ICs TDA8405 TDA8421 TBA1204 £10		Burglar Alarm Has time delay to set £2 Mains Transformer 64.00 240v in 110V to 120v out 1 amp post £3			
DECCA — GEC — ITT 6 push button £5.00		SENDZ SEE BACK PAGE		PHILIPS SBC 522 RGB1 GENERATOR £90 PHILIPS SBS 850 ANALOG MULTIMETER £11.50 PHILIPS SBS 521 RF SIG GENERATOR £90.00 FERGUSON TX110 — IK2 and IK7 MANUAL £1 each		FERGUSON ICC5 STEREO O.P. PANEL ICs TDA8405 TDA8421 TBA1204 £10		Burglar Alarm Has time delay to set £2 Mains Transformer 64.00 240v in 110V to 120v out 1 amp post £3			

SENDZ COMPONENTS

0702 338894
(To order see back page)

L.A11440	£1.00	TUNER UNITS TX90 TX100 Tuners with AE socket Thorn TX Tuner V/Cap eqv. to ELC1043 £7 Thorn TX10 Export V/Cap UHF, VHF £4.50 ENV 57836G2F UHF/VHF Small NEW G8 Tuner V/Cap £3.00 ELC2000 on Panel £2.50 EG613F £7.00 VHF/UHF 2 BEOTS45A £6.00 ELC2000 NEW £4.00 ELC2003 £4.00 GEC Tuner V/Cap Hitachi Alter 1979 ETS48, ETS47, ETS41B £8.00 ETS46 £6.00 ETS98A UHF/VHF Miniature Tuner Hitachi £5.00 ELC1042 £6.00 ELC1043 £6.00	Sweep Tuning TX90 Remote Panel No 139-001 I.C.S. M293B1 and TMS 1000N 21-L £12.00	HITACHI LOPT 2434002 £22
HA515133 SP -1 AND -3 FAA7750 HA 311485 UPC1373 M58657P M4911B1 M50441/550 M58658P	£3 50p £1.00 £1.00 £3.00 £1.00 £1.00	Monitor Astec UM1233 50p	Turntable Satellite Modulator £1 Sound 5 MHz MPM 1000T £1 Sound 6 MHz MPM 1040 £1	EARLY BIRD SAT TUNER WITH 950-1750 MHz BASE BAND £8 WITH DATA
M50430 - 850 SP M50143 - 011P Receiver TX100 Panel I.C. No. SAA3035 - MAB3840P D006 - SAA1060 - PC18571P	£3 £1	UE33-B01 Amstrad UHF Tuner £5.00 VHF/UHF EG522F £6.00 ASTECCUM183 £10.00 V314 (VHF) £5.00 v334 £4.00 U321 £6.00 U322 £8.00 U341 UHF £6.00 U342 (UHF) £5.00 U343 Phono £5.00 U349C £6.00 U34C £10.00 U411 UHF £4.00 UVF10 £8.00 U.V.411 Tuner £5.00 U.V.417 £5.00 UHF/VHF Tuner 1500 DKO £5.00 U743 Tuner £7.00 Fidelity/Amstrad 2000 V/Cap Tuner £5.00 Small V/Cap Mitsumi - UHF £4.00 VHF £3.00	Safe Block £5.00	FERGUSON LOPT FST 24" TX100 - 260482 £20
20 off £2.00 High Voltage Condenser IN5 to RNZ 1500V to 2KV	£2	Portable & Rotary Tuners Sanvo & Mitsumi UHF £5.00 Moshi UHF/VHF (new type) £8.00 UE2-131 Fidelity V/Cap 17/Unit £6.00 UHF - VHF V/Caps on panel £3.00 HITACHI 20 Turn Pot £4p U321 ca panel £6.00	Ferrog RF Filter Clamp for CoAx Cable Cost £2.50 Circuit for detecting R.F. Send for circuit using clamp (25p each)	LOPTS AMSTRAD 3714016 £5 3216001 £5
TX9 C CAM Decoder	£5.00	U341 UHF £6.00 U342 (UHF) £5.00 U343 Phono £5.00 U349C £6.00 U34C £10.00 U411 UHF £4.00 UVF10 £8.00 U.V.411 Tuner £5.00 U.V.417 £5.00 UHF/VHF Tuner 1500 DKO £5.00 U743 Tuner £7.00 Fidelity/Amstrad 2000 V/Cap Tuner £5.00 Small V/Cap Mitsumi - UHF £4.00 VHF £3.00	Ferguson TX85 £2.00 TX86 £2.00 Switch Mod Transformer £2.00 TX98 £2.00	TOSHIBA REMOTE CT9123 £4
4 Types Fidelity front panels with i.c. & pots £2.00 each BB 103 10p BB 105A x12 £1.00 BB 105B x12 £1.00 BB 105G x12 £1.00 BB121a 10p		ICCS L.O.P.T. DST 88H243 £10.00 each DST 85H243 £10.00 Thorn Mixed £10.00	ICCS Ferguson Switch Mod Trans 3112-338-326+2 £4.00	TV GAMES COMBINER SWITCH £1
1A/1600V DG3P EQV - HY 228 2 amp bridge rec. wire end SKE3G202 Exp. HYX71/600 500ms	10p 10 for £1.00 15p 15p	ICCS L.O.P.T. DST 88H243 £10.00 each DST 85H243 £10.00 Thorn Mixed £10.00	Ferguson Hand Set ICCS Mod £8.00 IK2000 £8.00	AMSTRAD SANKYO CAPSTAN MOTOR 6,000 £3 AMSTRAD LOADING MOTOR 6,000 £1
6 Push button switch I/TI GEC CVC45 ETC	£3.00	Ferguson Hand Set ICCS Mod £8.00 IK2000 £8.00	KT3/K30 17Text £12.50 KT3/K30 Full remote £15.00 Pw & Philips handset KT3-K30 chassis No RCS150-RCS176-RCS071-RCS177. Special Price RC4001 KT3 and Teletex £13.00 RC4001 KT3 and Teletex £14.00 TX10 Hand Set Text £12.50 TX9 with Text £12.50 TX9 & TX10 button print £2.00 TX10 Focus Pots £5.50	GRUNDIG TRIPLER BG-2032-642-3002 £5
Hitachi TV IC11A51338SP3	£3.00	Mullard Video Modular, Application, video tape recorders, TV cameras, video games, closed circuit TV, C.C.I.R. system. Data supplied £10.00 D85 250v AC mains filter 0.1+(03x2)11" £2.5p leader & earth clip 25p NEW U321 Mullard £4.00	Mains Stand By Switch with Coil £1.00	HAND SETS FOR 6000 SERIES AMSTRAD FOREIGN ORIGON £4 WITH L.C.D.
TT14 GEC TEX-DECODER 13 IC Panel with cable form	£9.50	ASTEC UM1623 VHF £2.00 VHF/UHF Tuner S Band £3.00 ENV-5765G2 VHF/UHF £5.00	PHILIPS UNIVERSAL HAND SET £12.00 RCS5 KT3 - K45 - £10.00	FERGUSON PAY HAND SET 4 FOR £1
PHILIPS Decoder SAA IC 5020-5030 5040B-5050 K40 Text Panel	£8.00	Change over switch co ax type box with lead 50p UH745 BAV £5.00 UHF Tuner and IF in one can (small) £5.00	We have all parts for Philips Handsets RCS353 £15.00 RCS300 £12.00 RCS176 £12.00 RCS177 £12.00	TOSHIBA REMOTE CT9233 AND CT938 £3
ICCS TUBE BASE ON PALEL ICCS DECODER PANEL	£5.00 £15.00	Co-Ax Belling Lee Plug 14p Co-Ax Splitter £1.00 Infra Red Emitting Diode 20p NE286H Small Neon Lamps GEC & Philips 5p Mullard 5 Watt Amps. LP1162 (New) £75	TEXT-TYPE Replace 1 Hand Set for Philips KT3-K30, K4 etc. £12.50	TOSHIBA T/V TUNER. IF ENV 57836 G2F £3
K35 Decoder K35 Sound OP Thick Film Daughter K13 33122-127-43891	£8.00 £4.00 £3.00	Change over switch co ax type box with lead 50p UH745 BAV £5.00 UHF Tuner and IF in one can (small) £5.00	THORN HAND SETS 9000 - 9600 - 1X9 - TX10 - TX100 Text and Non-Text £10.00	HIFACHI STAND BY MAIN TRANS £10 2213881 AND L210049
12 CH. K30 Tex Rec Front Panel with I.C.	£5.00	85-4538-3 Tatung GEC 8 Button Unit Print £5.00 Type 1990 to 1992	PHILIPS RC5171 (HAND SET) £12.00	PHILIPS K35 ETC 12 WAY SWITCH WITH KNOBS 50p
Plug in K4 Focus Pot K40	£1.00	Philips Handset IC £3.00 SAA3010P £3.00 MAB8461/W063 £3.00	K35-K4 HAND SET Repaired for £5.00	60.40 SOLDER 500G £3.75
Fidelity Tube Base with transistor & focus pot	£1.50	BG 2087 - 642 - 1005 Tripler Grundig £7	SANYO MAGMTRON Type 2M2181 £10	HIGH GAIN T/V ANTENNA UHF-VHF BUILT IN 32DB AMP 12V DC/220 AC £11.50
TX10 Tube Base on Panel	£3.00	Ferguson Hand Set for IK 2000 and IK 7000 £8	Microwave Oven Condenser 1.5 MFD 2kV £3	AMSTRAD VIDEO FRONTS WITH FLAP LONG CHASSIS ALL MODELS MADE IN 1991 TO 1992 AND DECCA PRO LINE £4
PHILIPS HAND SET K35-K4-K40, etc	£10	M58484P £2.00	10 Panels Ferguson Mixed from TX9 to ICCS £20	AMSTRAD 6000 HEAD WITH MOTOR LP £12
THORN CASSETTE HOUSING PAS26805U	£18.00	FERGUSON ICs Ferg. TX982 £3.00 TMP47C 634N 2685 £3.00 ST6391B1/B2 ICC7 £4.00	TV Aerial Rang Type 40p	AMSTRAD - LONG CHASSIS AND SHORT CHASSIS POWER SUPPLY £4 MODELS 1991 TO 1992
LITHIUM BATTERY BR-2/3 Volts	20p	CMC 301 front panel £5.00 CMC 303 front panel £5.00	Philips Video Remote Hand Set Works most sets. No L.C.D. Display £6	AMSTRAD - DOUBLE DECKER SWITCH MODE £8 POWER SUPPLY
TUNER. SAT 2000 KHC	£8	International Rectifier EHT Diodes G770/HV34 6KV 3 for 8p 6A/600V Stud Diodes 20p 6A/1000V Stud Diodes 20p	IT1-Nokia Tuner IF RF-IF-Module 5829 02 58 £6 SEL-ITT HF-Module 2 UK 5828-04-10 £6 01 M4-412-001-RU1 £3 8 Way Pre-sets for TX10-TX100 01 V6-251-402 Text Panel ICCS Ferguson £10	AMSTRAD - DOUBLE DECKER PANELS. £10 FOR IF - TUNER MODULATOR PANEL REST OF PANELS £5 each DOUBLE DECKER FRONT £7
HITACHI, IC D1514C 036 £4 D1514C 046 £3 MN1250BJC £3 ST6393 B1/Y £3 HD614885A30 £4 TMP47C1637N £3 M50442-5535P £3		International Rectifier EHT Diodes G770/HV34 6KV 3 for 8p 6A/600V Stud Diodes 20p 6A/1000V Stud Diodes 20p	Sharp Tuner and IF 1810587 PAL1 UK £3 Tuner IF UE30-B03 Amstrad £3	AMSTRAD LONG CHASSIS DISPLAY PANEL 1992 TO 1993 £4
International Rectifier EHT Diodes G770/HV34 6KV 6A/600V Stud Diodes 20p 6A/1000V Stud Diodes 20p	3 for 8p £3.00 10p			AMSTRAD TUNER UE33-B01 £3 IF £2
				6 FOR £10 TX10 FOCUS UNIT
				CONVERSION KIT I/TI TELETEx £8

**DISH AND LNB
SUITABLE FOR D2 MAC**

£15
POST £5 + VAT

New Eprom for converting
Ferguson BSB Receivers to
D2 MAC and PAL – 99
channel is tunable and each
one can be put into memory
– also has menu. £20
PAL panel (to convert to
PAL) £20
SEND FOR DATA.



**CHASSIS SUITABLE
FOR CONVERSION TO
D2 MAC £10 HANDSET £1.50
POST £4 + VAT**

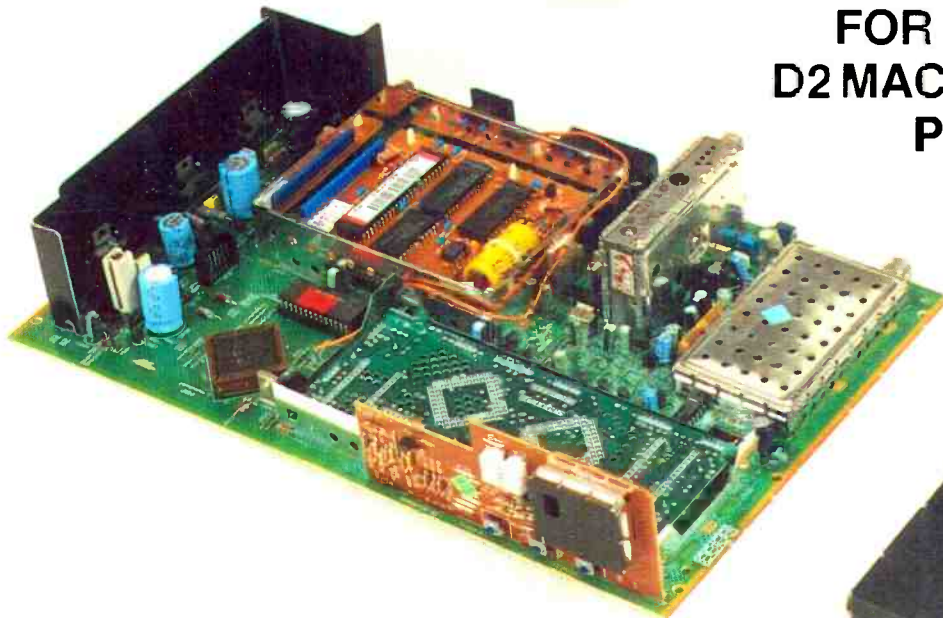

**MARCONI
LNBS 1-2dB
NEW TYPE
FOR
ASTRA
£30**

Photo by Photo Line

SENDZ COMPONENTS

63 BISHOPSTEIGNTON, SHOEBURYNESSE, ESSEX SS3 8AF
NORMALLY SAME DAY SERVICE • SUBJECT TO AVAILABILITY
No accounts • Technical information by telephone only • No credit cards
Unless specified add £1.70 P/P to small orders • Additional charges for
heavier items • Specific P/P charges are PER ITEM • For UK addresses please
add 17½% VAT to TOTAL OF GOODS + P/P • This applies for the EC unless
VAT No. is given • EXPORTS – P/P at cost • Postal Order/Cheque with order.
Callers to shop – 212 London Road, Southend • Open 9.30-1, 2.15-5.
Tel: 0702 332992 • Fax: 0702 338805 • GVMT/School orders on official headings