

DECEMBER 1979

55p

TELEVISION

SERVICING-VIDEO-CONSTRUCTION-DEVELOPMENTS



Introduction
to W.D.W.S



PLUS DEALING WITH COLOUR DECODERS

PHD COMPONENTS
RADIO & TV COMPONENT DISTRIBUTORS
UNIT 7 CENTENARY ESTATE
JEFFRIES RD ENFIELD MIDDX
MAIL ORDER ONLY TELEX 261295

ALL COMPONENTS OFFERED SUBJECT TO AVAILABILITY. WE RESERVE THE RIGHT TO SUBSTITUTE REPLACEMENTS SHOULD THE ORIGINAL PART BE OUT OF STOCK OR UNAVAILABLE! PLEASE ADD 0.35p per parcel post and packing.

SEMICONDUCTORS

AA113	0.16	BC117	0.20
AA116	0.16	BC118	0.20
AA117	0.16	BC119	0.50
AA119	0.16	BC125	0.20
OA91	0.12	BC126	0.20
OA92	0.12	BC136	0.20
OA202	0.18	BC137	0.40
BA100	0.18	BC138	0.40
BA102	0.10	BC139	0.40
BA130	0.15	BC140	0.40
BA154	0.10	BC142	0.40
BA155	0.20	BC143	0.40
BA164	0.12	BC147	0.15
BA164	0.12	BC148	0.20
BA164	0.12	BC149	0.15
BA164	0.12	BC153	0.15
BA164	0.12	BC154	0.15
BY206	0.20	BC157	0.15
IN4148	0.04	BC158	0.15
BY126	0.20	BC159	0.15
BY127	0.15	BC160	0.40
BY133	0.22	BC161	0.40
BY164	0.50	BC170	0.15
SKB2/08	1.00	BC171	0.15
BY236	0.15	BC172	0.20
BYX10	0.18	BC177	0.20
IN4001	0.10	BC178	0.20
IN4002	0.10	BC179	0.20
IN4003	0.12	BC182L	0.15
IN4004	0.12	BC183L	0.15
IN4005	0.12	BC184L	0.15
IN4006	0.14	BC184LC	0.15
IN4007	0.16	BC186	0.30
IN5407	0.33	BC187	0.30
BR100	0.50	BC203	0.15
BR101	0.60	BC204	0.15
BR139	0.60	BC205	0.15
TC1160N	1.50	BC206	0.15
BT119	2.50	BC207	0.15
BT120	2.50	BC208	0.15
2N444	0.80	BC209	0.15
BYX 71/600	1.50	BC212L	0.15
TV106/2	1.50	BC213L	0.15
BYX88CZV7	0.10	BC214L	0.10
BZV88 3V0	0.10	BC225	0.10
BZV88 3V3	0.10	BC226	0.10
BZV88 3V6	0.10	BC227	0.10
BZV88 3V9	0.10	BC228	0.10
BZV88 4V3	0.10	BC251A	0.10
BZV88 4V7	0.10	BC301	0.10
BZV88 5V1	0.10	BC303	0.10
BZV88 5V6	0.10	BC307	0.10
BZV88 6V2	0.10	BC308	0.10
BZV88 6V5	0.10	BC327	0.10
BZV88 7V5	0.10	BC328	0.10
BZV88 8V2	0.10	BC337	0.10
BZV88 9V1	0.10	BC338	0.10
BZV88 10V	0.10	BC547	0.10
BZV88 11V	0.10	BC141-10	0.10
BZV88 12V	0.10	BD115	0.10
BZV88 13V	0.10	BD124	0.10
BZV88 15V	0.10	BD131	0.10
BZV88 18V	0.10	BD132	0.10
BZV88 18V	0.10	BD133	0.10
BZV88 20V	0.10	BD134	0.10
BZV88 22V	0.10	BD144	2.50
BZV88 27V	0.10	BD159	0.10
BZV88 33V	0.10	BD238	0.10
BZV88 35V	0.25	BD380	0.10
BZV88 3V2	0.25	BD441	0.10
BZV88 3V1	0.25	BD537	0.10
BZV88 10V	0.25	BD538	0.10
BZV88 11V	0.25	BD507	0.10
BZV88 12V	0.25	BD508	0.10
BZV88 13V	0.25	BD181	0.10
BZV88 15V	0.25	BD182	0.10
BZV88 16V	0.25	BD709	0.10
BZV88 18V	0.25	BD710	0.10
BZV88 20V	0.25	BD442	0.10
BZV88 22V	0.25	BD379	0.10
BZV88 24V	0.25	BF115	0.10
BZV88 27V	0.25	BF118	0.10
BZV88 30V	0.25	BF152	0.10
BZV88 33V	0.25	BF154	0.10
BZV88 36V	0.25	BF157	0.10
BZV88 39V	0.25	BF158	0.10
BZV88 47V	0.25	BF160	0.10
BZV88 72V	0.25	BF163	0.10
AC107	0.35	BF167	0.10
AC127	0.50	BF173	0.10
AC127/01	0.60	BF179	0.10
AC128/01	0.60	BF180	0.10
AC141	0.50	BF181	0.10
AC141K	0.60	BF182	0.10
AC142	0.40	BF183	0.10
AC142K	0.60	BF184	0.10
AC176	0.60	BF185	0.10
AC176/01	0.60	BF194	0.10
AC186	0.40	BF195	0.10
AC187K	0.60	BF196	0.10
AC188	0.60	BF197	0.10
AC188K	0.60	BF198	0.10
AD140	1.50	BF199	0.10
AD142	1.50	BF200	0.10
AD143	1.50	BF224	0.10
AD145	1.50	BF240	0.10
AD145	1.50	BF241	0.10
AD161/2	1.00	BF256LC	0.10
AD162	0.50	BF257	0.10
AD162	0.70	BF258	0.10
AD262	1.50	BF271	0.10
AF114	0.60	BF273	0.10
AF115	0.60	BF274	0.10
AF125	0.60	BF282	0.10
AF126	0.60	BF306	0.10
AF127	0.60	BF337	0.10
AF127	0.60	BF338	0.10
AF139	0.60	BF355	0.10
AF238	1.00	BF459	0.10
AF238	1.00	BF459	0.10
AF116	0.80	BF425	0.10
AF117	0.80	BF426	0.10
AF118	0.80	BF427	0.10
AF121	0.80	BF428	0.10
AF124	0.80	BF429	0.10
AF125	0.80	BF430	0.10
AF126	0.80	BF431	0.10
AF127	0.80	BF432	0.10
AF128	0.80	BF433	0.10
AF129	0.80	BF434	0.10
AF130	0.80	BF435	0.10
AF131	0.80	BF436	0.10
AF132	0.80	BF437	0.10
AF133	0.80	BF438	0.10
AF134	0.80	BF439	0.10
AF135	0.80	BF440	0.10
AF136	0.80	BF441	0.10
AF137	0.80	BF442	0.10
AF138	0.80	BF443	0.10
AF139	0.80	BF444	0.10
AF140	0.80	BF445	0.10
AF141	0.80	BF446	0.10
AF142	0.80	BF447	0.10
AF143	0.80	BF448	0.10
AF144	0.80	BF449	0.10
AF145	0.80	BF450	0.10
AF146	0.80	BF451	0.10
AF147	0.80	BF452	0.10
AF148	0.80	BF453	0.10
AF149	0.80	BF454	0.10
AF150	0.80	BF455	0.10
AF151	0.80	BF456	0.10
AF152	0.80	BF457	0.10
AF153	0.80	BF458	0.10
AF154	0.80	BF459	0.10
AF155	0.80	BF460	0.10
AF156	0.80	BF461	0.10
AF157	0.80	BF462	0.10
AF158	0.80	BF463	0.10
AF159	0.80	BF464	0.10
AF160	0.80	BF465	0.10
AF161	0.80	BF466	0.10
AF162	0.80	BF467	0.10
AF163	0.80	BF468	0.10
AF164	0.80	BF469	0.10
AF165	0.80	BF470	0.10
AF166	0.80	BF471	0.10
AF167	0.80	BF472	0.10
AF168	0.80	BF473	0.10
AF169	0.80	BF474	0.10
AF170	0.80	BF475	0.10
AF171	0.80	BF476	0.10
AF172	0.80	BF477	0.10
AF173	0.80	BF478	0.10
AF174	0.80	BF479	0.10
AF175	0.80	BF480	0.10
AF176	0.80	BF481	0.10
AF177	0.80	BF482	0.10
AF178	0.80	BF483	0.10
AF179	0.80	BF484	0.10
AF180	0.80	BF485	0.10
AF181	0.80	BF486	0.10
AF182	0.80	BF487	0.10
AF183	0.80	BF488	0.10
AF184	0.80	BF489	0.10
AF185	0.80	BF490	0.10
AF186	0.80	BF491	0.10
AF187	0.80	BF492	0.10
AF188	0.80	BF493	0.10
AF189	0.80	BF494	0.10
AF190	0.80	BF495	0.10
AF191	0.80	BF496	0.10
AF192	0.80	BF497	0.10
AF193	0.80	BF498	0.10
AF194	0.80	BF499	0.10
AF195	0.80	BF500	0.10
AF196	0.80	BF501	0.10
AF197	0.80	BF502	0.10
AF198	0.80	BF503	0.10
AF199	0.80	BF504	0.10
AF200	0.80	BF505	0.10
AF201	0.80	BF506	0.10
AF202	0.80	BF507	0.10
AF203	0.80	BF508	0.10
AF204	0.80	BF509	0.10
AF205	0.80	BF510	0.10
AF206	0.80	BF511	0.10
AF207	0.80	BF512	0.10
AF208	0.80	BF513	0.10
AF209	0.80	BF514	0.10
AF210	0.80	BF515	0.10
AF211	0.80	BF516	0.10
AF212	0.80	BF517	0.10
AF213	0.80	BF518	0.10
AF214	0.80	BF519	0.10
AF215	0.80	BF520	0.10
AF216	0.80	BF521	0.10
AF217	0.80	BF522	0.10
AF218	0.80	BF523	0.10
AF219	0.80	BF524	0.10
AF220	0.80	BF525	0.10
AF221	0.80	BF526	0.10
AF222	0.80	BF527	0.10
AF223	0.80	BF528	0.10
AF224	0.80	BF529	0.10
AF225	0.80	BF530	0.10
AF226	0.80	BF531	0.10
AF227	0.80	BF532	0.10
AF228	0.80	BF533	0.10
AF229	0.80	BF534	0.10
AF230	0.80	BF535	0.10
AF231	0.80	BF536	0.10
AF232	0.80	BF537	0.10
AF233	0.80	BF538	0.10
AF234	0.80	BF539	0.10
AF235	0.80	BF540	0.10
AF236	0.80	BF541	0.10
AF237	0.80	BF542	0.10
AF238	0.80	BF543	0.10
AF239	0.80	BF544	0.10
AF240	0.80	BF545	0.10
AF241	0.80	BF546	0.10
AF242	0.80	BF547	0.10
AF243	0.80	BF548	0.10
AF244	0.80	BF549	0.10
AF245	0.80	BF550	0.10
AF246	0.80	BF551	0.10
AF247	0.80	BF552	0.10
AF248	0.80	BF553	0.10
AF249	0.80	BF554	0.10
AF250	0.80	BF555	0.10
AF251	0.80	BF556	0.10
AF252	0.80	BF557	0.10
AF253	0.80	BF558	0.10
AF254	0.80	BF559	0.10
AF255	0.80	BF560	0.10
AF256	0.80	BF561	0.10
AF257	0.80	BF562	0.10
AF258	0.80	BF563	0.10
AF259	0.80	BF564	0.10
AF260	0.80	BF565	0.10
AF261	0.80	BF566	0.10
AF262	0.80	BF567	0.10
AF263	0.80	BF568	0.10
AF264	0.80	BF569	0.10
AF265	0.80	BF570	0.10
AF266	0.80	BF571	0.10
AF267	0.80	BF572	0.10
AF268	0.80	BF573	0.10
AF269	0.80	BF574	0.10
AF270	0.80	BF575	0.10
AF271	0.80	BF576	0.10
AF272	0.80	BF577	0.10
AF273	0.80	BF578	0.10
AF274	0.80	BF579	0.10
AF275	0.80	BF580	0.10
AF276	0.80	BF581	0.10
AF277	0.80	BF582	0.10
AF278	0.80	BF583	0.10
AF279	0.80	BF584	0.10
AF280	0.80	BF585	0.10
AF281	0.80	BF586	0.10
AF282	0.80	BF587	0.10
AF283	0.80	BF588	0.10
AF284	0.80	BF589	0.10
AF285	0.80	BF590	0.10
AF286	0.80	BF591	0.10
AF287	0.80	BF592	0.10
AF288	0.80	BF593	0.10
AF289	0.80	BF594	

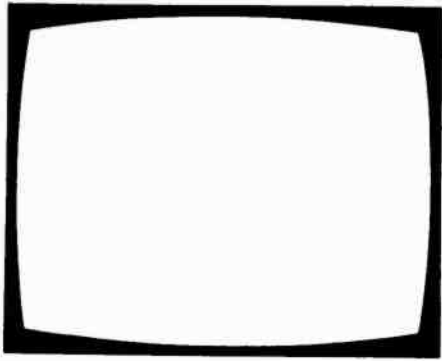

TELEVISION

December
1979

Vol. 30, No. 2
Issue 350

COPYRIGHT

© IPC Magazines Limited, 1979. Copyright in all drawings, photographs and articles published in *Television* is fully protected and reproduction or imitation in whole or in part is expressly forbidden. All reasonable precautions are taken by *Television* to ensure that the advice and data given to readers are reliable. We cannot however guarantee it and we cannot accept legal responsibility for it. Prices are those current as we go to press.

CORRESPONDENCE

All correspondence regarding advertisements should be addressed to the Advertisement Manager, "Television", King's Reach Tower, Stamford Street, London SE1 9LS. Editorial correspondence should be addressed to "Television", IPC Magazines Ltd., Lavington House, Lavington Street, London SE1 0PF.

SUBSCRIPTIONS

An annual subscription costs £9.50 in the UK, £10.50 overseas (\$21 Canada or USA). Send orders with payment to IPC Services, Oakfield House, Perrymount Road, Haywards Heath, Sussex.

BINDERS AND INDEXES

Binders (£3.75) and Indexes (45p) can be supplied by the Post Sales Department, IPC Magazines Ltd., Lavington House, 25 Lavington Street, London SE1 0PF. Prices include postage and VAT. In the case of overseas orders, add 60p.

BACK NUMBERS

Some back issues are available from the Post Sales Department, IPC Magazines Ltd., Lavington House, 25 Lavington Street, London SE1 0PF at 75p inclusive of postage and packing.

QUERIES

We regret that we cannot answer technical queries over the telephone nor supply service sheets. We will endeavour to assist readers who have queries relating to articles published in *Television*, but we cannot offer advice on modifications to our published designs nor comment on alternative ways of using them. All correspondents expecting a reply should enclose a stamped addressed envelope.

Requests for advice in dealing with servicing problems should be directed to our Queries Service. For details see our regular feature "Your Problems Solved". Send to the address given above (see "correspondence").

this month

- 65 Leader**
- 66 Teletopics**
News, comment and developments.
- 68 Footnote on the Pye 713/715/717 Chassis** *by Harold Peters*
Following Mike Phelan's series, some notes on the evolution of these chassis to assist with stock problems, and a few more tips.
- 71 ITT's New Remote Control System** *by A. J. Edwards*
A concise account of this latest state-of-the-art remote control system which uses infra-red light for transmission with pulse code modulation for the commands. The receiver i.c. has been designed to make the system flexible, so that it can be adapted for use with new developments such as digital synthesized tuning, Prestel, etc.
- 74 TV Servicing: Beginners Start Here . . . Part 27** *by S. Simon*
This time we tackle the most complex subject yet in the series – the PAL colour decoder, with emphasis on the various things that can be responsible for the no colour symptom.
- 78 Introduction to VDUs** *by Andrew Parr, B.Sc., C.Eng., M.I.E.E.*
The worlds of TV and the computer are coming closer together, with the VDU the meeting point. An account of the way in which computer data is processed for display on the c.r.t. screen, and the ways in which the system can be used for graphics design etc.
- 83 Equipment Review: The Technalogs PG6RF Pattern Generator** *by Roger Bunney*
A new version provides colour bars in addition to monochrome patterns. An add-on unit is also available.
- 84 Tapez-Les** *by Les Lawry-Johns*
After a somewhat surrealistic start, Dennis's GEC colour set brings us down to earth. Troubles then centre around faulty line output transformers – and female logic.
- 86 Readers' PCB Service**
- 87 Fault Notes** *by Robin D. Smith*
More hints and tips worth noting.
- 88 Vintage TV: The Bush Model TV22** *by Malcolm Burrell*
Renovation of a Bush Model TV22 dating from 1951, with a detailed look at the line output stage.
- 90 Long-Distance Television** *by Roger Bunney*
Reports on DX reception and conditions. This month's beginners' section goes into MS reception.
- 93 Servicing in the Field, Part 2** *by George Wilding*
This time how to tackle faults on the signals side – weak contrast, no signals, wrong colours etc.
- 95 Next Month in Television**
- 96 Of TTL and CMOS Gates and Cabbages and Kings . . . Part 2** *by Andrew Parr, B.Sc., C.Eng., M.I.E.E.*
This concluding part deals with the use of CMOS logic devices and the choice between TTL and CMOS.
- 98 Test Case 204**
- 99 Your Problems Solved**

OUR NEXT ISSUE DATED JANUARY WILL BE
PUBLISHED ON DECEMBER 17

THE UNBEATABLE BRIARWOOD SERVICE

EX-EQUIPMENT SPARES

MISC. S/Output Trans.
£1 + VAT + £1 P&P
F/Output Trans.
£1.25 + VAT + £1 P&P.
Scancoils £1.50 + VAT
+ £1 P&P. Other
spares available, please
write or phone for details.

MONO TUBES

(tested)
19" Ringuard £3.00
23" Ringuard £4.00
20" Ringuard £5.00
24" Ringuard £6.00
+ £5.00 P.&P.

MONO TUNERS

6-button integrated all
at £4.00
U.H.F. P/Button D/S
£3.50. U.H.F. P/Button
S/S £4.00. Rotary £3.00
+ £1 P&P.

MONO LOPTS

All D/Standard Lopts
at £4.00 + £1 P.&P.
All S/Standard at
£4.00 + £1 P.&P.

MONO PANELS

i.e. Philips, Bush etc.
£3.50 + £1 P.&P.
Quotations for
complete
S/hand chassis if
required. (Diff. prices)

PLEASE ADD 15% V.A.T.
TO ALL ITEMS AND
OVERSEAS AT COST.
CASH WITH ALL ORDERS.

VALVES (MONO & COLOUR)

PCL82	0.10	30C1	0.10	PCC189	0.10	EF183	0.10	PL504	0.25	ECL80	0.10
PCL83	0.25	30C17	0.10	30C15	0.10	EF184	0.10	6/30L2	0.10	PL509	1.00
PCL84	0.10	PCF802	0.10	30C18	0.25	6BW7	0.10	30PL1	0.25	PY500	1.00
PCL85	0.10	PCF805	0.25	PC97	0.20	EH90	0.10	30PL13/4	0.10	GY501	1.00
PCL86	0.10	PCF806	0.10	PC900	0.10	DY802	0.10	30FL1/2	0.25	PL508	0.50
PFL200	0.10	PCF808	0.25	EF80	0.10	PY800/1	0.10	ECC82	0.10	PCF200	0.50
PCF801	0.10	PCF80	0.10	EF85	0.10	PL36	0.25	ECC81	0.10	EY51	0.15

Please note there is 25p Postage and Packing per order.

WE DO NOT SELL RUBBISH
AT BRIARWOOD TV

D/STANDARD COLOUR SPARE PANELS

	IF	LUM	CHROMA	EHT	REG	CON	S/OUTPUT	POWER	L/TB	F/TB
Bush/Murphy	5.00	5.00	6.50	—	—	5.00	1.50	5.00	—	—
GEC/Sobell	5.00	5.50	—	—	—	5.00	—	—	—	7.50
Philips	5.00	7.00	—	—	—	5.00	—	—	—	5.00
Decca	5.00	9.00	9.00	—	—	5.00	2.00 (19" only)	6.00	—	5.00
Thorn 2000	5.00	5.00	5.00	6.50	6.50	7.00	—	6.50	10.00	5.00
Pye	7.00	6.00	7.00	—	—	5.00	—	—	—	5.00
Baird	6.50	8.50	7.00	—	—	5.00	—	—	—	5.00

Postage & Packing £1.25

S/STANDARD COLOUR SPARE PANELS

	IF	LUM	CHROMA	VIDEO	CON	POWER	L/TB	F/TB
Bush 184	9.50	—	—	12.00	6.00	6.00	12.00	—
GEC Hybrid	6.00	6.50	—	9.00	5.00	—	—	12.00
Philips G6 S/S	9.50	—	—	10.00	5.00	—	—	6.00
Thorn 3000	6.00	6.00	—	6.00	5.00	20.00	20.00	6.00
Pye 691/693	6.00	6.00	—	8.00	5.00	—	15.00	5.00
Thorn 3500	6.00	6.00	—	6.00	6.50	20.00	20.50	6.00

Postage & Packing £1.25

Korting and other foreign
panels available on request.

COLOUR TUBES

19" £18.00
19" A49, 192 £20.00
20" £20.00
22" £22.00
25" £18.00
26" £28.00
Plus P&P £5.00

NEW
Rebuilt tubes
available on request.

COLOUR TUNERS

Bush £5.00
GEC £5.00
Philips G6 S/S £5.00
Thorn 3000 £5.00
Pye 691 £5.00
Some new tuners in stock,
can supply on request. Many
Foreign Tuners also available
on request. Plus P&P £1.

COLOUR LOPTS

Most Lopts available
from £5.00. Both
British & Foreign
makes. Please ring
or write.
P&P per Lopt £1.

MISC.

S/Output transformer
from £1.50.
F/Output from £1.25.
Scancoils from £5.00.
P&P £1.
Other spares available on
request.

THORN 1500 TUNERS

NEW SPECIAL OFFER
AT £8.00

Postage & Packing £1.00

MAIL ORDER T.V.s. IN GOOD WORKING ORDER

COLOUR				MONO					
Pye	19"	£60.00	22"	£65.00	26"	£75.00	20" & 24" S/S	£16.00	Pye, GEC, Bush etc.
GEC	19"	£60.00	22"	£65.00	26"	£75.00	20" & 24" D/S	£14.00	Pye, GEC, Bush etc.
Bush	19"	£80.00	22"	£80.00	26"	£90.00	19" & 23" D/S	P/button £12.00	Pye, GEC, Bush etc.
Philips	G6	—	22"	£63.00	26"	£70.00	19" & 23" D/S	Rotary £8.00	Pye, GEC, Bush etc.

Many other makes & models available.
Please ring or write for information.

**PERSONAL CALLERS
WELCOME.**

Please note there is 15% V.A.T. on all the above prices.
Plus £8 P&P. England, Wales & Scotland for colour T.V.'s.
Inland N. & S. Ireland P&P £15. P&P £5 for mono T.V.'s
to England, Wales & Scotland. Inland N. & S. Ireland £7
per set.

Briarwood T.V. Limited
Britain's Mail Order
T.V. Specialists

BRIARWOOD

THE PROFESSIONAL CHOICE. NATIONWIDE

NEW SPARES

TYPE	PRICE £	TYPE	PRICE £	TYPE	PRICE £	TYPE	PRICE £	TYPE	PRICE £	TYPE	PRICE £	DIODES	E.H.T. TRAYS MONO	
AC107	0.20	AF170	0.25	BC172	0.08	BD222/T1P31A	0.24	OC45	0.20	1N4001	0.04	1N4001	0.04	950 MK2 1400 2.00
AC113	0.17	AF172	0.20	BC173	0.12	BD225/T1P31A	0.37	OC46	0.35	1N4002	0.04	1N4002	0.04	1500 18" 19" stick
AC115	0.17	AF178	0.49	BC177	0.12	BD225/T1P31A	0.25	OC70	0.22	1N4003	0.06	1N4003	0.06	2.37
AC117	0.24	AF180	0.60	BC178	0.12	BD225/T1P31A	0.39	OC71	0.28	1N4004	0.07	1N4004	0.07	1500 24" 5 stick 2.48
AC125	0.20	AF181	0.30	BC179	0.12	BD234	0.34	OC72	0.35	1N4005	0.07	1N4005	0.07	Single stick Thorn TV
AC126	0.18	AF186	0.29	BC182L	0.09	BD222	0.73	OC74	0.35	1N4006	0.08	1N4006	0.08	11.16K 70V 0.75
AC127	0.19	AF239	0.43	BC183L	0.09	BDX22	0.73	OC74	0.35	1N4007	0.08	1N4007	0.08	TV20 2 MT 0.75
AC128	0.17	AU113	1.29	BC184L	0.09	BDX32	1.98	OC75	0.35	1N4148	0.03	1N4148	0.03	TV20 16K 18V 0.75
AC131	0.13			BC186	0.18	BDY18	0.75	OC76	0.35	1N4751A	0.11	1N4751A	0.11	
AC141	0.23	BA130	0.08	BC187	0.18	BDY60	0.80	OC77	0.50	1N5401	0.12	1N5401	0.12	
AC142	0.19	BA145	0.14	BC209	0.11	BF115	0.24	OC78	0.13	1N5404	0.12	1N5404	0.12	
AC141K	0.29	BA148	0.17	BC212	0.09	BF121	0.21	OC81	0.20	1N5406	0.13	1N5406	0.13	
AC142K	0.29	BA155	0.08	BC213L	0.09	BF154	0.12	OC810	0.14	1N5408	0.16	1N5408	0.16	
AC151	0.17	BAX13	0.05	BC214L	0.09	BF158	0.19	OC82	0.20					
AC165	0.16	BAX16	0.08	BC237	0.07	BF159	0.24	OC820	0.13					
AC166	0.16	BC107	0.10	BC240	0.31	BF160	0.23	OC83	0.22					
AC168	0.17	BC108	0.10	BC281	0.24	BF163	0.23	OC84	-0.28					
AC176	0.17	BC109	0.10	BC262	0.18	BF164	0.17	OC85	0.13					
AC176K	0.28	BC113	0.09	BC263B	0.20	BF167	0.23	OC85	0.13					
AC178	0.16	BC114	0.12	BC267	0.19	BF173	0.21	OC123	0.20					
AC186	0.26	BC115	0.10	BC301	0.22	BF177	0.26	OC169	0.20					
AC187	0.21	BC116	0.10	BC302	0.30	BF178	0.24	OC170	0.22					
AC188	0.20	BC117	0.11	BC307	0.10	BF179	0.28	OC171	0.27					
AC187K	0.30	BC119	0.22	BC337	0.11	BF180	0.30	OA91	0.05					
AC188K	0.30	BC125	0.12	BC338	0.09	BF181	0.34	BRC4443	0.65					
AD130	0.50	BC126	0.09	BC307A	0.10	BF182	0.30	R2008B	1.50					
AD140	0.65	BC136	0.12	BC308A	0.12	BF183	0.29	R2010B	1.50					
AD142	0.73	BC137	0.12	BC309	0.14	BF184	0.23	R2305	0.38					
AD143	0.70	BC138	0.21	BC547	0.09	BF185	0.29	R2305/BD222	0.37					
AD145	0.70	BC139	0.21	BC548	0.11	BF186	0.30	SCR957	0.65					
AD149	0.64	BC140	0.24	BC549	0.11	BF194	0.09	TIP31A	0.38					
AD161	0.40	BC141	0.22	BC557	0.11	BF195	0.09	TIP32A	0.36					
AD162	0.40	BC142	0.19	BD112	0.39	BF196	0.12	TIP3055	0.53					
AD161 }		BC143	0.19	BD113	0.65	BF197	0.10	T1590	0.19					
AD162 }	1.30	BC147	0.07	BD115	0.30	BF198	0.11	T1591	0.19					
AF106	0.42	BC148	0.07	BD116	0.47	BF199	0.14	TV106	1.09					
AF114	0.23	BC149	0.07	BD124	1.30	BF200	0.28							
AF115	0.22	BC153	0.12	BD131	0.32	BF216	0.12	OC22	1.10					
AF116	0.22	BC154	0.12	BD132	0.34	BF217	0.12	OC23	1.30					
AF117	0.30	BC157	0.10	BD133	0.37	BF218	0.12	OC24	1.30					
AF118	0.40	BC158	0.11	BD135	0.26	BF219	0.12	OC25	1.00					
AF121	0.33	BC159	0.11	BD136	0.26	BF220	0.12	OC26	1.00					
AF124	0.33	BC160	0.22	BD137	0.26	BF222	0.12	OC28	1.00					
AF125	0.29	BC161	0.22	BD138	0.26	BF221	0.21	OC35	1.00					
AF126	0.29	BC167	0.09	BD139	0.40	BF224	0.12	OC36	0.90					
AF127	0.29	BC168	0.09	BD140	0.28	BF256	0.37	OC38	0.90					
AF139	0.39	BC189C	0.09	BD144	1.39	BF258	0.27	OC42	0.45					
AF151	0.24	BC171	0.08	BD145	0.50	BF259	0.27	OC44	0.20					

All transistors, IC's offered are new and branded. Manufactured by Mullard, I.T.T., Texas, Motorola etc. Please add 15% VAT to all items and overseas at cost P & P U.K. 25p per order, overseas allow for package and postage. Cash with all orders. All prices subject to alteration without notice.

TELEVISION SALE DISCOUNT FOR QUANTITY

Please note all mono sets sold as 100% comp. No broken/masks, no broken panels etc. Colour sets sold with good c.r.t.s and 100% comp. Working Mono £3.00 extra. Working Colour £15.00 extra. Supplied in 1's or 100's.

MONO Rotaries 19" & 23"		S/S 20" 24"	
GEC	£3.00	Bush 313 etc.	£12.00
Thorn 950 etc.	3.00	Pye 169 chassis	12.00
K.B.	3.00	Thorn 1500	12.00
Pye	3.00	GEC series 1 & 2	12.00
Thorn 1400	4.50	Decca MS series	12.00
D/S P/B 19" 23"		S/S COLOUR	
Thorn 1400	7.00		
Bush 161 etc.	7.00		
Baird 660 etc.	7.00		
Philips 210 etc.	7.00		
Pye Olympic etc.	7.00		
D/S P/B 20" 24"		S/S COLOUR	
Bush	10.00		
GEC	10.00		
Philips	10.00		
Pye	10.00		
Thorn	10.00		

MAINS DROPPERS

Mono	
Bush 161	60p
Philips 210 30+125+2K85	50p
Philips 210 118R+148R	48p
Thorn 1400	75p
GEC 2018	58p
Thorn 1500	70p
Colour	
Bush A823	72p
Pye 723 27Ω+56Ω	57p
GEC 2110-41Ω	45p
GEC 2110-12R5+12R5	47p
GEC2110-27R5	45p
Thorn 3500	58p
Thorn 8000	58p
Thorn 8500	54p
Philips G8 47R	30p
Philips G8 2.2+68	42p

All plus VAT at 15%

E.H.T. TRAYS MONO

950 MK2 1400 2.00
1500 18" 19" stick
1500 24" 5 stick 2.48
Single stick Thorn TV
11.16K 70V 0.75
TV20 2 MT 0.75
TV20 16K 18V 0.75
IC's
SN76013N 1.20
SN76013ND 1.00
SN76023N 1.20
SN76023ND 1.00
SN76226DN 1.50
SN76227N 1.20
TBA341 0.97
TBA520Q 1.10
TBA530Q 1.10
TBA540Q 1.45
TBA550Q 1.40
TBA560CQ 1.50
TBA570Q 1.00
TBA800 1.00
TBA810 1.50
TBA920Q 1.50
TBA990Q 1.50
TCA270SQ 1.45
TCA270SA 1.45
TCA1327B 1.00

E.H.T. TRAYS COLOUR

Pye 731 5.20
Pye 691/693 4.50
Decca (large screen)
CS2030/2232/2630/2632/2230/2233/2631 5.00
Philips G8 520/40 5.30
Philips 550 5.30
GEC C2110 5.50
GEC Hybrid CTV 5.10
Thorn 3000/3500 5.00
Thorn 8000 2.42
Thorn 8500 4.75
Thorn 9000 5.50
GEC TVM 25 2.50
ITT/KB CVC 5/7/8/9 5.10
RRI (RBM) A823 5.00

Bang & Olufsen 4/5000 Grundig 5010/5011/5012/6011/6012/7200/2052/2210/2252R Tandberg (radionette) Autovox 6.80 Grundig 3000/3010 Saba 2705/3715 Telefunken 709/710/717/2000 6.80 Korting 6.80

WHY NOT TRY OUR EXPRESS MAIL ORDER ON ANY OF THE ITEMS LISTED.

EXPORT COLOUR & MONO T.V.s AVAILABLE READY FOR USE OVERSEAS

TELEVISION

Briarwood House Preston Street Bradford West Yorkshire BD7 1NS Tel. Bradford 306018 (STD code 0274)

BRIARWOOD TELEVISION LTD

Britain's Mail Order TV Specialists

BRITAIN'S LARGEST SUPPLIERS OF
BRITISH AND CONTINENTAL
LINE OUTPUT TRANSFORMERS

12 Months Guarantee. Please add 15% VAT
to all items. P & P £1.00.

Various other models available on request

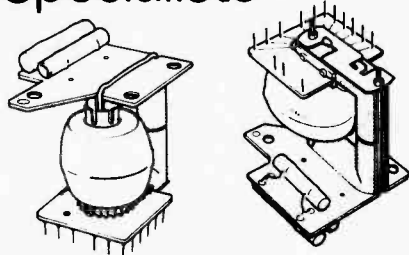

Set Manufacturer	Chassis/Model	Price £	Set Manufacturer	Chassis/Model	Price £
Pye	731	12-50	Scantic	2621-1/2621-2	12-50
Philips	G8	9-50	Scantic	Chassis 32.631 -- Series 2	
Philips	K70			2635-1/2635-3/	
Decca	30 (Bradford)	9-25		2636/2636-2/	12-50
Decca	1730	9-25		2636-4/2637/	
Decca	80	9-00		2638/2639/	
Decca	100	9-00		2645/1805-6482	
Decca Mono	MS1700/2020/ 2001/2401	8-00	B & O (Beovision)	3100/3300/3400	13-00
Korting	51763/51765 -- 22"		B & O (Beovision)	3100/3300/3400	
	52665/52666 -- 26"	12-00		EHT Transformer	14-50
	52865/52866 -- 26"		B & O (Beovision)	3500/3600/4000/	
Korting	53701/02/08/09			5000/6000	12-50
	54701/02/07/08/547	11-20	Tandberg	CTV 1/2/2-2/	
	55606/55700/02/			Colour 102/103/	12-50
	711/735/747			104/105/106	
ITT	CVC25/30/32	9-00	Telefunken	CTV 55552	
Grundig	1500/2000/2500/ 3000/3010	12-50	Autovox 90°	Chassis 711A	12-00
Grundig	5010	13-00		Chassis 2682/2683/ 2684/2282/2283/ 2284	12-00
Grundig	5010 EHT Transformer	14-50	Autovox 110°	Chassis 2693/2694	12-00
Grundig	Series 5005/ 2222/6000/6010/8000	12-50	Siemens	2221-1/222-2/ 2621-1/2621-2/ 2622-1/2622-2/ 2623-1/2623-2/ 2624-1/2624-2	12-50
Luxor	Chassis 32.617 -- Series 2		Zanussi	B2222-2/3	11-20
	2031-1/2031-2/ 2227-1/2227-2/ 2229-1/2229-2		Baird	B2223-2/3	11-20
	Chassis 56.307 -- Series 1 & 2		Salora	27" 110°	
	22307/22309/22317			BP-CTV 225 & 265	12-00
	26305/26307	12-00		BP-7-663291/ BP-7-663691	
	Chassis 56347 -- Series 1		Indesit Mono	ED/B24	8-50
	TV 22347-22 17-1			EG/B	
	22349-2219-1				
	26345-2615-1				
	26347-2617-1				
	26349-2619-1				
	26347-2227-1				
Luxor	Chassis 32.621 -- Series 1	12-50			

6 MONTH GUARANTEE

p & p 1-00

INSERTS (WINDING)

PYE 691 or 697	Small	3-65
PYE 691 or 697	Large	5-10
Bush CTV 25 Mk 3	Underwind	7-25
Philips K70	Underwind	8-00

Decca CTV 25	(Non Tripler Type)	
	Overwind	8-50
	Underwind	7-25
Philips G6 S/S or D/S	Underwind	7-90
	Overwind	8-50
	Philips G6 Overwind on Exchange basis only	
EMO 90° Winding		7-90

MONO

Bush 161V Series	8-45	Philips 210, 300	8-45
Bush 313 Series	8-45	PYE 368	8-45
Decca DR1 to DR24	8-45	PYE 169 or 569	8-45
GEC Series 1-2	8-45	BUSH 816	12-00
ITT K13 VC 200	8-45		

Briarwood House, Preston Street, Bradford
West Yorkshire BD7 1LU
Tel: (0274) 306018

CAMPBELL ELECTRONICS Limited

Unit E5, Halesfield 23
Telford, Salop
TF7 4QX

Tel: Telford (STD 0952)
585799/584373

Telegrams CAMELEC
Telex CHAMCOM 35191

DISTRIBUTORS OF SPECIALIST SPARES TO RADIO & TELEVISION SERVICE DEPTS; NATIONWIDE

Your source to better components

ITEMS SHOWN WITH * INDICATES THESE ARE SOLD IN PACKS OF 5

TRANSISTORS																							
NPN										PNP													
part	part	part	part	part	part	part	part	part	part	part	part	part	part	part	part	part	part	part	part	part			
AC127	.48	AF236	1.00	BC118	.49	BC173	.14*	BC484	1.00	BD150B	1.29	BF123	.23	BF222	.23	BF450	.42	BU111Y	2.50	R1038	2.10	TIP126	.73
AC128	.58	AF2765	1.20	BC125	.20*	BC178	.19*	BC485	1.20	BD150C	.84	BF154	.20*	BF224	.16*	BF458	1.00	BU126	2.10	R1039	2.10	TIP127	1.12
AC141	.48	AL102	2.90	BC126	.20*	BC179	.19*	BC486	1.20	BD163	.73	BF156	.43	BF240	.16*	BF459	1.00	BU204	1.80	R2008	1.50	TIP2955	1.19
AC142	.40	AL113	2.90	BC135	.20*	BC182L	.14*	BC548	1.14*	BD186	.48	BF158	.39	BF241	.15*	BF441	.32	BU205	1.80	R2009	1.99	TIP3085	1.29
AC153	.57	AU103	2.11	BC136	.20*	BC183L	.14*	BC549	1.14*	BD187	.77	BF160	.59	BF255	.25	BF482	.33	BU206	1.59	R2010	1.80	TIS43	.40
AC178	.59	AU106	2.09	BC137	.20*	BC184L	.14*	BCX31	.25	BD182	.69	BF167	.48	BF256	.50	BF482	.31	BU208	2.50	R2029	1.90	TIS91	.80
AC187	.38	AU108	2.06	BC140	.39	BC186	.20*	BCX32	.24	BD183	.78	BF173	.50	BF257	.49	BF481	.30	BU208/02	2.99	R2030	1.93	TIS92	.59
AD149	.00	AU110	2.90	BC142	.39	BC187	.25*	BCX33	.22	BD187	.66	BF177	.50	BF258	.49	BF442	.49	BU209	2.41	R2265	2.05	TX300	.22
AD161	.75	AU111	2.90	BC149	.33	BC212L	.15*	BCX34	.27	BD201	.76	BF178	.26	BF259	.45	BF450	.80	BU407	2.80	R2305	8.00	TX300	.19*
AD162	.75	AU112	2.40	BC143	.39	BC213L	.15*	BCX36	.27	BD222	.35	BF179	.49	BF262	.49	BF459	.49	E1222	.39	R2306	9.00	40636	1.75
AF115	.80	AU113	2.90	BC147	.15*	BC214L	.15*	BCY70	.18*	BD225	.45	BF180	.49	BF271	.52	BF485	.49	ME8001	.28	R2540	3.00	2N497	.40
AF116	.80	AU110	1.29	BC148	.10*	BC237	.15*	BCY72	.19*	BD233	.47	BF182	.50	BF273	.19*	BF488	.43	MJE520	4.5	TIP30	.58	2N2905	.51
AF117	.80	BC107	.18*	BC149	.15*	BC238	.14*	BD115	.49	BD234	.45	BF183	.50	BF274	.24	BF450	.49	MJE2955	1.49	TIP31	.37	2N3055	.74
AF118	.59	BC108	.18*	BC153	.15*	BC239	.12*	BD116	.71	BD237	.59	BF184	.49	BF234	.43	BF451	.50	MJE3055	1.29	TIP32	.40	2N3703	.20
AF125	.59	BC109	.18*	BC154	.15*	BC307	.14*	BD131	.69	BD238	.50	BF185	.49	BF236	.49	BF452	.50	OC28	2.40	TIP33	.61	2N3704	.23
AF126	.61	BC113	.15*	BC157	.15*	BC327	.15*	BD132	.80	BD435	.78	BF194	.15*	BF237	.49	BF453	1.19	OC35	2.00	TIP34	.74	2N3705	.19*
AF127	.80	BC114	.15*	BC158	.15*	BC337	.14*	BD133	.69	BD437	.75	BF195	.14*	BF238	.49	BF454	.65	OC38	2.10	TIP41	.43	2N3706	.19*
AF139	.80	BC115	.20*	BC159	.15*	BC338	.14*	BD135	.68	BD509	.58	BF196	.14*	BF255	.80	BF459	.49	OC44	.40	TIP42	.80	2N3707	.19*
AF178	1.54	BC118	.20*	BC160	.39	BC394LC	.22	BD136	.58	BD510	.49	BF197	.14*	BF262	.47	BU105/01	1.69	OC45	.43	TIP47	.94	2N5298	.69
AF180	1.80	BC117	.19*	BC161	.20*	BD140	.24	BDX32	2.17	BF198	.14*	BF198	.14*	BF263	.47	BU105/02	1.64	OC71	.49	TIP112	9.00	2N5298	.77
AF181	1.61	BC118	.19*	BC172	.19*	BC463	.65	BD150A	.69	BF115	.59	BF199	.14*	BF422	.47	BU108	1.80	OC72	.49	TIP117	1.00	2N5496	.61
										BF121	.21	BF200	.21	BF423	.51	BU110	3.00	OC78	.37	TIP121	.66	2SC1172Y	2.90

THYRISTORS, SILICON SWITCHES, DIACS

BFT42	.49	BT109	1.20
BFT43	.49	BT118	1.24
BR100	.59	BT119	2.48
BR101	.59	BT120	2.48
BRCA443	1.30	BT120	2.48
BRY39	.59	CI06D	1.10
BT106	1.50	OT112	1.50
T106	1.30	TIC46	.80

BRIDGE RECTIFIERS

B40	1.05	KB501	1.40
BY194	.80	KB502	.58
BY179	.83	KB504	.54
BYW21	1.98	KB506	1.28
BYW24	2.50	KB508	.52
BYW61	3.20	KB510	.74
BYW62	3.20	KB512	.86
BYW64	4.70	KB514	.82
ITT3CD	.60	KB516	.82

DIODES AND RECTIFIERS

AA112	.20*	BA115	.22	BAX16	.08*	BY206	.19*	BYX10	.20*	IN4007	.16*
AA116	.18*	BA145	.16*	BY126	.20*	BY207	.22*	OA47	.18*	IN4148	.06
AA117	.18*	BA155	.20*	BY127	.15*	BY210/400	.40	OAB1	.10*	IN4448	.34
AA119	.16*	BA156	.20*	BY133	.22*	BY210/800	.50	IN4001	.10*	IN5401	.24
AA143	.20*	BA202	.18*	BY175	1.84	BY227	.40	IN4002	.10*	IN5404	.32
AA144	.14*	BA218	.18*	BY182	1.03	BY251	.35	IN4003	.12*	IN5408	.42
AY102	2.99	BA316	.40	BY184	.84	BY255	.38	IN4004	.12*	IT744	.06*
AY106	2.30	BA317	.44	BY187	1.00	BY298	.70	IN4005	.12*	ITT2002	.38
BA102	.35	BAX13	.16*	BY199	.33	BY299	.72	IN4008	.14*		

ZENER DIODES

400mW BZ88 TYPE	.12*
Values 2.4V - 82V	
1W BZX61 TYPE	.25*
Values 3.3V - 200V	
10W (STUD MOUNTING)	1.30
Values 4.7V - 200V	

INTEGRATED CIRCUITS

BRCM200	3.34	SN72723L	2.20	TAA851	2.00	TCE1400 (5 Stick)	3.80	TCE3000, 3500	7.00
BRCM300	3.42	SN78003N	2.90	TAA873	2.18	TCE1500 (3 Stick)	3.80	TCE 4000	7.90
BRC1330	.80	SN78013N	1.90	TAA890	2.85	TCE1500 (5 Stick)	4.30	TCE 8000	3.00
BT222	6.21	SN78013ND	1.90	TAA700	1.61	ITT CVC 5, 7, 8 & 9	6.40	TCE 8500	6.00
BT18018	2.97	SN78023N	1.90	TBA720A	2.64	ITT CVC 20, 30	6.40	TCE 9000	6.90
C500	3.87	SN78023ND	1.61	TBA750	2.00	GEC 2028, 1040	6.40	RR1 Dual Standard CTV	8.00
CA270AE	3.90	SN78033N	1.90	TBA800	1.62	GEC 2110	6.40	RR1 A823	6.90
CA270BE	3.70	SN78110N	1.90	TBA810AS	2.22	GEC 2100	6.40	RR1 A6238	6.90
CA505	1.81	SN78226N	1.98	TBA810S	2.22	GEC 2200	6.40	RR1 2718	4.30
CA758E	4.10	SN78227N	1.70	TBA820	1.80	PYE 691 993	5.50	GRUNDIG 5010/6010/880	6.40
CA920A	2.86	SN78228N	1.50	TBA890	3.94	PYE 731 (4 lead)	6.40	GRUNDIG 3000	6.40
CA2121	2.40	SN78630P	1.70	TBA920	3.23	PYE 731 (5 lead)	6.40	KORTING	6.40
CA3098E	4.46	SN78532N	2.00	TBA940	3.09	PYE 713, 15, 17	6.40	SIEMENS TVK31, 51/2	6.40
CA3090Q	1.96	SN78533N	2.00	TBA950A2	3.07	PHILIPS 520,540,550	6.40	SABA/TFK/SITA/DORIC	6.40
ETT8016	3.20	SN78544N	2.00	TBA970	4.09	PHILIPS 550 (long lead)	6.40	TANBERG TV2.2, TVC M6	6.40
ETT8016B	3.20	SN78546N	2.00	TBA990	2.93	PHILIPS G9	6.40	EUROTRAY	6.00
LM1351	2.00	SN78666	1.30	TBA1440G	3.33	DECCA CS1730, 1830	4.00	CONVERSION BRACKET A	4.40
LM1370	2.38	TAA350A	2.80	TBA1441	3.33	DECCA CS2030, 2230 etc.	6.40	CONVERSION BRACKET B	4.40
MC1307P	2.80	TAA550A	.80	TCA270	3.00	DECCA CS1910, 2213	6.40	TV18 EHT STICK	1.80
MC1310P	2.20	TAA550C	.80	TCA290A	3.23	DECCA 80/100/Telep	6.40		
MC1327AP	3.27	TAA550C	.80	TCA290A	3.23				
MC1327P	1.50	TAA570	1.98	TCA420A	3.00				
MC1330P	1.00	TAA591	2.77	TCA440	1.98				
MC1349P	1.99	TAA611B	2.83	TCA640	2.97				
MC1351P	1.98	TAA630S	2.50	TCA650	3.42				
MC1352P	1.65	TAA661B	2.63	TCA730	3.22				
MC1358P	1.80	TAA700	3.91	TCA750	2.43				
MC7724CP	1.80	TBA231	1.29	TCA800	3.12				
ML2378	2.60	TBA240A	4.87	TCA820	2.27				
SA4570	2.68	TBA325	1.67	TCA830S	2.13				
SA4700	4.90	TBA395	3.34	TCA900	3.00				
SA560S	3.30	TBA396	2.78	TCA910	2.94				
SA5570S	3.30	TBA440C	3.30	TCA940	1.90				
SA5580	3.64	TBA440N	3.30	TCE100P	3.54				
SA5590	3.64	TBA480	2.20	TDA440	3.33				
SA5660	4.20	TBA500	2.63	TDA440N	3.33				
SA5670	4.20	TBA510	2.63	TDA1170	3.81				
SC9503P	1.80	TBA520	2.00	TDA1412	1.00				
SC9504P	1.84	TBA530	2.00	TDA2522	4.18				
SC9506P	3.20	TBA550	2.20	TDA2530	2.77				
SL437F	7.20	TBA550	2.80	TDA2560	3.83				
SL9018	5.40	TBA520C	2.34	TDA2590	2.88				
SL9178	6.99	TBA570	2.90	TDA2600	2.93				
SL918A	6.99	TBA641A12	2.71	TDA3950	4.57				
SN16848N	2.60	TBA641B11	3.99	TMS3848NC	2.37				
SN16861NG	2.60	TBA641B1X1	3.00	ZTK33A	.72				

VARICAP TUNERS DELAY LINES, CRYSTALS, etc

ELC 1043 05	7.40	ELC 1043 06	7.40
U321 (Philips G11)	7.81	Delay line DL50	4.50
Delay line DL50	4.50	Delay line DL80	4.30
Luminance Delay Line For TBA560	1.80	Transistor AT4041/37	1.68
Linearity Coil AT4042/02	1.80	Linearity Coil AT4042/04	1.80
Colour Crystal 4 433619 M Hz	2.00	Focus Resistor (Thick Film) 10M, 30M, 47M	.98

SERVICE AIDS

SERVISOL	.75	60/40 18SWG	1.68
FREEZER	.75	1/2 Kilo	8.56
AIR SPRAY CLEANER	.75	2 1/2 Kilo	31.25
FAM CLEANER	.75	2 1/2 Kilo	31.25
SILICONE GREASE	.75		
SOLDER MOPS	.63		

REPLACEMENT DROPPERS

PHILIPS G8	.59
PHILIPS G8 (47R)	.50
PHILIPS 210	.90
TCE 1500	.90
GEC 2018	.70
RR1 640	.80
TCE 8000A	.90
DECCA 20	1.43
PYE 731	1.00
TCE 1400	1.10
RR1 A823	.90
GEC 2110(12R5 + 12R5)	.68
TCE 3500	.85

VALVES

**QUARTZ LCD
5 Function**

Hours, mins, secs., month, date, auto calendar, back-light, quality metal bracelet.

£6.65

Guaranteed same day despatch. Very slim, only 6mm thick.



M1

**SOLAR QUARTZ
LCD 5 Function**

Genuine solar panel with battery back-up. Hours, mins., secs., day, date. Fully adjustable bracelet. Back-light. Only 7mm thick.

£8.65

Guaranteed same day despatch.



M2

**QUARTZ LCD
11 Function** SLIM CHRONO

6 digit, 11 functions. Hours, mins., secs., day, date, day of week. 1/100th, 1/10th, secs., 10X secs., mins., Split and lap modes. Back-light, auto calendar. Only 8mm thick. Stainless steel bracelet and back. Adjustable bracelet. Metac Price

£10.65 Thousands sold! Guaranteed same day despatch.



M3

**QUARTZ LCD
ALARM 7 Function**

Hours, mins., secs., month, date, day. 6 digits, 3 flags plus continuous display of day and date or seconds. Back-light Only 9mm thick.

£12.65

Guaranteed same day despatch.



M4

**MULTI ALARM
6 Digits 10
Functions**

- Hours, mins., secs.
- Months, date, day.
- Basic alarm.
- Memory date alarm.
- Timer alarm with dual.
- Time and 10 country zone.
- Back-light.
- 8mm thick.

£18.65



M5

**FRONT-BUTTON
Alarm Chrono
Dual Time**

6 digits, 5 flags, 22 functions. Constant display of hours and mins., plus optional seconds or date display. AM/PM indication, month, date. Continuous display of day. Stop-watch to 12 hours 59.9 secs., in 1/10 second steps. Split and lap timing modes. Dual time zones. Only 8mm thick. Back-light. Fully adjustable open bracelet. Guaranteed same day despatch



£22.65

M6

**SOLAR QUARTZ LCD
Chronograph with
Alarm
Dual Time Zone
Facility**

6 digits, 5 flags, 22 functions. Solar panel with battery back-up. Stop-watch to 12 hours 59.9 secs., in 1/10 sec., steps. Split and lap timing modes. Dual time zones. Alarm. 9mm thick. Back-light. Fully adjustable bracelet.

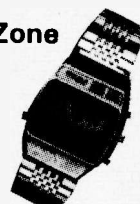

£27.95

M7

**ALARM CHRONO
with 9 world
time zones**

- 6 digits, 5 flags.
- 6 basic functions.
- 8 further time zones.
- Count-down alarm.
- Stop-watch to 12 hours 59.9 secs.
- in 1/10 sec. steps.
- Split and timing modes.
- Alarm.
- 9 mm thick.
- Back-light.
- Fully adjustable bracelet.

£29.65



M8

**SOLAR QUARTZ LCD
Chronograph**

Powered from solar panel with battery back-up. 6 digit, 11 functions. Hours, mins., secs., day, date, day of week 1/100th, 1/10th, secs., 10X secs., mins. Split and lap modes. Back-light, auto calendar. Only 8mm thick. Stainless steel bracelet and back. Adjustable bracelet. Metac Price

£13.65

Guaranteed same day despatch.



M9

**QUARTZ LCD
Ladies Day Watch**

Only 25 x 20mm and 6mm thick. Hours, minutes, seconds, day, date, backlight and auto calendar. Elegant metal bracelet in silver or gold fully adjustable to suit very slim wrists. State colour preference.

£9.95

Guaranteed same day despatch.



M15

**QUARTZ LCD
Ladies Fashion Watch**

Elegant bracelet in bronze/gold finish or silver colour. Hours, mins, secs, day, date, backlight and auto calendar. Adjustable for the slimmest of wrists. State colour preference.

£14.95

Guaranteed same day despatch

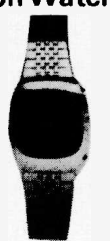

M17

**QUARTZ LCD
Ladies Cocktail Watch**

Highly functional watch which also suits those special occasions. Beautifully designed with a very thin bracelet which retains strength as well as elegance. Hours, mins, secs, day, date, backlight and autocalendar. Bracelet fully adjustable to suit slim wrists. State gold or silver finish.

£19.95

Guaranteed same day despatch

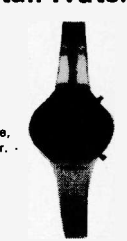

M18

**HANIMEX
Electronic
LED Alarm Clock**

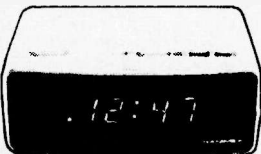

Features and Specification: Hour minute display. Large LED display with p.m. and alarm on indicator. 24 Hours alarm with on off control. Display flashing for power loss indication. Repeatable 9-minute snooze. Display bright/dim modes control. Size: 5.15" x 3.93" x 2.36" (131mm x 11mm x 60mm) Weight: 1.43 lbs (0.65 kg). AC power 220V.

£10.20 Thousands sold!

Mains operated.

Guaranteed same day despatch.

M13

**EXECUTIVE ALARM
WATCH**

6 Functions plus Alarm: Conference signal, 5 minute snooze alarm. Conference signal sounds 4 secs., before main alarm to give advance warning and an option to cancel. Snooze sounds 5 mins., after main alarm and is always preceded by the conference signal.

£14.95

M60



**MACY QUARTZ
ANALOGUE**

Automatic Calendar Day and Date infinite bracelet. This mans watch has elegance as well as the robust appearance provided by a watch with traditional features. Accuracy is provided by a quartz crystal powered by a long life miniature battery.

£24.95

M21



Metac price breakthrough for an Alarm Chronograph with Dual Time only

£18.95



OUTSTANDING FEATURES

- **DUAL TIME.** Local time always visible and you can set and recall any other time zone (such as GMT). Also has a light for night viewing.
 - **CALENDAR FUNCTIONS** include the date and day in each time zone.
 - **CHRONOGRAPH/STOPWATCH** displays up to 12 hours, 59 minutes, and 59.9 seconds.
 - On command, stopwatch display freezes to show intermediate (split/lap) time while stopwatch continues to run. Can also switch to and from timekeeping and stopwatch modes without affecting either's operation.
 - **ALARM** can be set to anytime within a 24 hour period. At the designated time, a pleasant, but effective buzzer sounds to remind or awaken you!
- Guaranteed same day despatch. **M16**

HOW TO ORDER

Payment can be made by sending cheque, postal order, Barclay, Access or American Express card numbers. Write your name, address and order details clearly, enclose 40 pence per single item for post and packing or the amount stated in the advert. All products carry 1 year written guarantee and full money-back 10 day reassurance. Battery fitting and electronic calibration service is available to customers at any Metac shop. All prices include VAT currently at 15%.

Metac Wholesale:

Trade enquiries - send for a complete list of prices for all the goods advertised plus many more not shown also minimum order details.

Telephone orders: Credit card customers can telephone orders direct to Daventry (03272) 76545 or Edgware Rd. 01-723 4753 24 hours a day.



Service Enquiries 03272-77659

CALLERS WELCOME Shops open 9-30am-6.00

Metac

**ELECTRONICS
& TIME CENTRES**

North & Midlands
67 High Street, DAVENTRY
Northamptonshire
Telephone: 03272 76545

South of England
327 Edgware Road
LONDON W.2
Telephone: (01) 723 4753

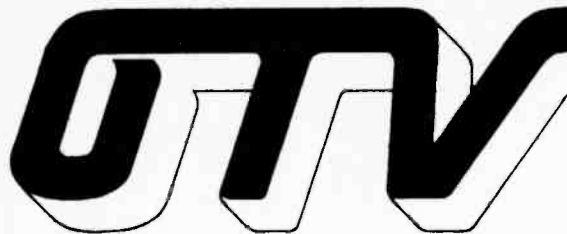

THE LARGEST STOCKS OF

GENUINE PART-EXCHANGED COLOUR T.V.'s IN THE COUNTRY

— UNDER ONE ROOF.

REGULAR LARGE DELIVERIES EVERY WEEK INCLUDE—

Philips 511/512/G8 etc., Bush, Murphy, Thorn 3000/3500/8000/8500, GEC all models, Pye Varicap, Grundig, Telefunken, Saba, Decca Bradford, Nordmende, B. & O., Emo, Finlux, Luxor, Korting, Hitachi, Sanyo, Toshiba, etc., etc., etc.

STOCK UP NOW FOR THE COMING BUSY PERIOD.

SINGLE STANDARD T.V.'s FROM **£20** + VAT

SPECIAL OFFER WHILE STOCKS LAST. ASSORTED DUAL STANDARD COLOUR T.V.'s IN LOTS OF TEN, ALL AT **£5** EACH.

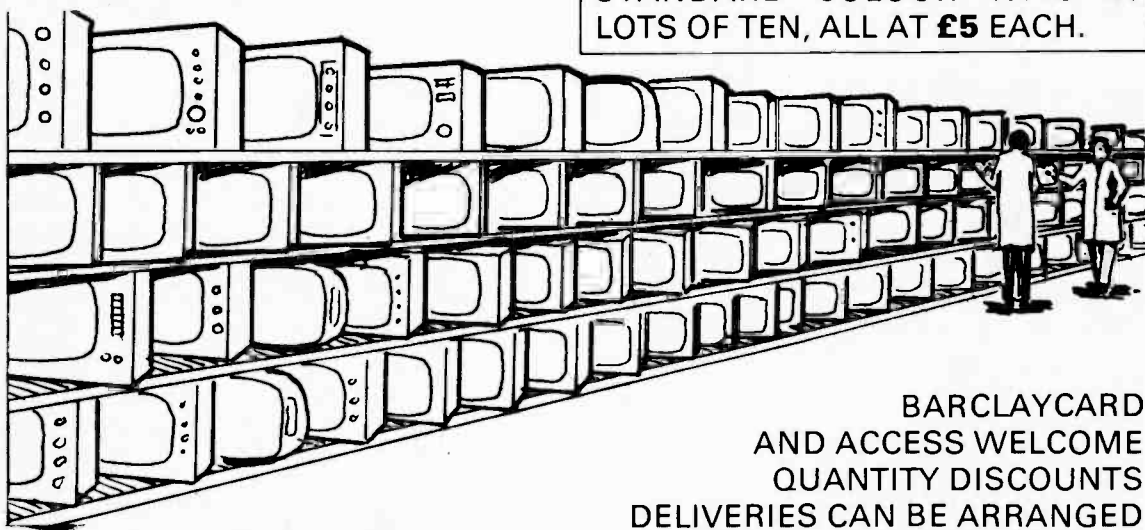

BARCLAYCARD AND ACCESS WELCOME
QUANTITY DISCOUNTS

DELIVERIES CAN BE ARRANGED

SUPERB TESTING FACILITIES AVAILABLE

OTV TELEVISION LTD,
144A Lea Bridge Rd,
London E5 9RB.
Tel: 01-985 6111/8687

OPEN MON.-SAT.

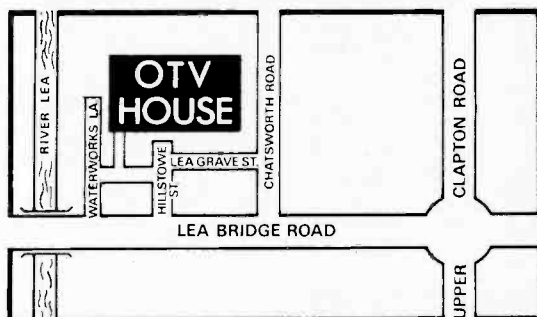

We specialise in Export

Enquiries invited from the Middle East and Third World Countries.

TRANSISTORS, ETC.

Type	Price (£)	Type	Price (£)	Type	Price (£)	Type	Price (£)	Type	Price (£)	Type	Price (£)	Type	Price (£)	Type	Price (£)
AC107	0.48	AU103	2.40	BC192	0.56	BC377	0.29	BD234	0.58	BF222	0.51	BPX29	1.82	MPSU05	0.66
AC117	0.38	AU107	2.76	BC204*	0.39	BC394	0.39	BD235	0.63	BF224 & J	0.22	BR101	0.53	MPSU06	0.76
AC126	0.38	AU120	2.40	BC205*	0.39	BC440	0.52	BD236	0.63	BF240	0.32	BR103	0.64	MPSU05	1.26
AC127	0.54	AU113	2.80	BC206*	0.37	BC441	0.59	BD237	0.68	BF241	0.31	BR303	1.06	MPSU06	1.32
AC128	0.46	BC107*	0.16	BC207*	0.39	BC461	0.78	BD238	0.68	BF244*	0.51	BRC4443	1.76	MPSU06	0.82
AC128K	0.55	BC108*	0.15	BC208*	0.37	BC477	0.30	BD253	1.58	BF245*	0.43	BRY39	0.60	MPU131	0.59
AC141	0.65	BC109*	0.16	BC209*	0.39	BC478	0.25	BD410	1.85	BF254*	0.48	BRY56	0.44	OC26	1.90
AC141K	0.70	BC113	0.22	BC211*	0.36	BC479	0.25	BD411	1.85	BF255*	0.48	BRY56	0.44	OC28	1.49
AC142	0.60	BC114	0.22	BC212*	0.17	BC548*	0.13	BD433	0.65	BF256*	0.49	BT106	1.50	OC29	1.60
AC142K	0.65	BC117	0.24	BC212L*	0.17	BC548*	0.13	BD436	0.70	BF257*	0.44	BT109	1.99	OC31	1.25
AC151	0.61	BC118*	0.25	BC213*	0.16	BC549*	0.15	BD437	0.74	BF258*	0.52	BT116	1.45	OC32	1.25
AC152	0.36	BC117	0.30	BC213L*	0.16	BC550*	0.24	BD438	0.75	BF259*	0.54	BT119	5.18	OC36	1.25
AC153	0.42	BC118	0.34	BC214*	0.18	BC556*	0.23	BD519	0.88	BF262	0.73	BU102	3.35	OC44	0.68
AC153K	0.52	BC119	0.24	BC214L*	0.18	BC557*	0.16	BD520	0.88	BF263	0.88	BU105	1.80	OC45	0.63
AC154	0.41	BC125*	0.30	BC225	0.42	BC558*	0.16	BD599	0.67	BF270	0.47	BU105/02	1.95	OC70	0.55
AC176	0.45	BC126	0.30	BC237*	0.16	BC559*	0.17	BD600	1.23	BF271	0.42	BU108	2.98	OC71	0.75
AC178	0.81	BC132	0.20	BC238*	0.15	BCY10	0.30	BD663BR	0.85	BF272A	0.80	BU126	2.91	OC72	0.73
AC179	0.55	BC134	0.22	BC239*	0.22	BCY30A	1.06	BDX18	1.86	BF273	0.33	BU204	2.50	OCB1	0.83
AC187	0.56	BC135	0.21	BC251*	0.26	BCY32A	1.19	BDX32	2.95	BF274	0.33	BU205	2.58	OC81D	0.95
AC187K	0.55	BC136	0.22	BC252*	0.26	BCY34A	1.02	BDY16A	0.53	BF336	0.63	BU206	2.59	OC139	1.30
AC188	0.52	BC137	0.20	BC253*	0.39	BCY72	1.27	BDY18	1.55	BF337	0.65	BU208	2.75	OC140	1.35
AC188K	0.51	BC138	0.35	BC281A*	0.28	BD115	1.35	BDY20	2.29	BF338	0.68	BU407	1.38	OC170	0.80
AC193K	0.70	BC140	0.36	BC282A*	0.28	BD123	1.50	BDY38	1.38	BF355	0.72	BUV77	2.50	OC171	0.82
AC194K	0.74	BC141	0.44	BC283*	0.28	BD124	1.85	BF115	0.48	BF362	0.49	CI06D	0.80	OC200	3.90
ACY17	1.20	BC142	0.35	BC287*	0.20	BD130Y	1.56	BF117	0.45	BF363	0.49	CI06F	0.43	OC201	3.95
ACY19	0.95	BC143	0.38	BC288*	0.28	BD131	0.88	BF120	0.55	BF367	0.29	CI11E	0.46	OC202	2.40
ACY28	0.98	BC147*	0.12	BC286	0.48	BD132	0.88	BF121	0.85	BF369	0.43	D40N1	0.64	OC205	3.95
ACY39	2.02	BC148*	0.12	BC287	0.49	BD133	0.70	BF123	0.68	BF457	0.46	E300	0.42	OC207	2.40
AD140	1.79	BC149*	0.13	BC291	0.27	BD135	0.37	BF125	0.58	BF458	0.46	E122	0.42	OC208	2.40
AD142	1.90	BC152	0.42	BC294	0.37	BD136	0.37	BF127	0.51	BF459	0.52	E224	0.19	R2008B	2.72
AD143	1.78	BC153	0.48	BC297	0.40	BD137	0.40	BF127F	0.78	BF459	0.52	E224	0.19	R2008B	2.72
AD149	1.42	BC157*	0.41	BC300	0.62	BD138	0.42	BF152	0.19	BF594	0.16	GET872	0.46	R210B	2.79
AD161	0.66	BC177*	0.41	BC301	0.38	BD139	0.46	BF158	0.25	BF597	0.27	ME0402	0.18	R2323	0.75
AD161/162	1.22	BC158*	0.12	BC302	0.86	BD140	0.50	BF159	0.27	BF597	0.27	ME0402/02	0.18	R2323	0.75
AD162	0.71	BC159*	0.14	BC303	0.64	BD144	2.24	BF160	0.20	BF600	0.29	ME0602	0.18	ST110	0.85
AF114	0.35	BC160*	0.82	BC304	0.44	BD145	0.75	BF161	0.84	BF601	0.30	MJ2955	1.30	TIC44	0.25
AF115	0.35	BC161	0.58	BC307*	0.17	BD150A*	0.91	BF163	0.65	BF602	0.29	MJ3000	1.68	TIC46	0.35
AF116	0.41	BC167B	0.15	BC308*	0.14	BD155	0.50	BF164	0.95	BF605	0.33	MJ3040	0.65	TIC47	0.45
AF117	0.42	BC168B	0.14	BC309*	0.18	BD157	0.81	BF166	0.50	BF606	0.29	MJ3050	0.65	TIP29A	0.47
AF118	0.98	BC169C	0.15	BC317*	0.15	BD158	0.75	BF167	0.38	BF607	0.29	MJ3050	0.65	TIP29A	0.47
AF121	0.68	BC170*	0.15	BC318*	0.15	BD159	0.68	BF173	0.35	BF608	0.29	MJ3050	0.65	TIP30A	0.50
AF124	0.38	BC172*	0.15	BC319*	0.17	BD161	0.87	BF177	0.36	BF609	0.29	MJ3050	0.65	TIP31A	0.51
AF125	0.38	BC173*	0.14	BC320*	0.17	BD163	0.67	BF178	0.46	BF610	0.30	MJ5021	0.95	TIP31C	0.67
AF126	0.38	BC173*	0.22	BC321A&B	0.18	BD185	0.66	BF179	0.58	BF611	0.42	MJE2955	1.20	TIP32C	0.72
AF127	0.86	BC174A & B		BC322	0.28	BD186	0.88	BF180	0.53	BF612	0.48	MJE2955	1.20	TIP32C	0.72
AF139	0.58	BC176	0.26	BC323	1.15	BD175	0.50	BF181	0.53	BF613	0.55	MJE3055	1.22	TIP33A	0.84
AF147	0.52	BC177*	0.20	BC327	1.16	BD177	0.58	BF182	0.44	BPW11	1.02	MJF102	0.40	TIP33A	0.84
AF149	0.45	BC178*	0.22	BC328	1.16	BD178	0.92	BF183	0.42	BPW30	2.88	MPS3702	0.33	TIP33A	0.84
AF178	1.35	BC178*	0.20	BC337	0.17	BD181	1.94	BF184	0.64	BPW59	0.19	MPS3705	0.30	TIP33A	0.84
AF179	1.35	BC179*	0.28	BC338	0.17	BD182	2.10	BF185	0.42	BPW60	0.20	MPS3705	0.30	TIP33A	0.84
AF180	1.35	BC182*	0.15	BC340	0.19	BD183	1.34	BF186	0.42	BPW90	0.55	MPS3705	0.30	TIP33A	0.84
AF181	1.33	BC182L*	0.15	BC341*	0.17	BD184	2.30	BF187	0.42	BPW90	0.55	MPS3705	0.30	TIP33A	0.84
AF188	1.48	BC183*	0.14	BC348A & B		BD187	1.20	BF188	0.42	BPW90	0.55	MPS3705	0.30	TIP33A	0.84
AF202	0.27	BC183L*	0.14	BC349B	0.17	BD189	0.71	BF197	0.15	BFY51	0.37	MPSA55	0.43	TIP33A	0.84
AF239	0.73	BC184*	0.15	BC350*	0.24	BD222	0.91	BF198	0.29	BFY52	0.36	MPSA56	0.45	TIP33A	0.84
AF240	1.40	BC184L*	0.15	BC350*	0.24	BD222	0.91	BF199	0.29	BFY53	0.38	MPSA93	0.66	TIP33A	0.84
AF279S	0.91	BC186	0.36	BC351*	0.22	BD225	0.91	BF199	0.29	BFY53	0.38	MPSA93	0.66	TIP33A	0.84
AL100	1.30	BC186	0.25	BC352A*	0.24	BD232	0.91	BF200	0.25	BFY90	1.98	MPSU01	0.51	TIP33A	0.84
AL103	1.85	BC187	0.27	BC360	0.59	BD233	0.82	BF218	0.42	BPX25	1.62	MPSU01	0.51	TIP33A	0.84

Alternative gain versions available on items marked*

For matched pairs add 20p per pair.

LINEAR IC's		DIODES		VDR's, etc.		VALVES			
Type	Price (£)	Type	Price (£)	Type	Price (£)	Type	Price (£)		
BRC1330	0.93	SN76008KE	2.58	AA113	0.17	BY114	0.60	6X4	1.20
CAB100M	2.44	SN76013N	1.66	AA119	0.21	BY118	1.10	DY802	0.75
CA3005	1.85	SN76013ND	1.40	AA129	0.28	BY126	0.20	EC82	0.75
CA3012	1.45	SN76018KE	2.58	AA143	0.18	BY127	0.21	EC82B	0.75
CA3014	2.23	SN76023N	1.68	AA149	0.28	BY130	0.35	EC83	0.95
CA3018	0.71	SN76023ND	1.40	AA213	0.42	BY140	1.40	EC83B	0.95
CA3020	1.89	SN76033N	2.20	AA215	0.35	BY164	0.75	EC84	0.85
CA3028A	0.80	SN76110N	2.20	AA217	0.28	BY178	2.80	EC84B	0.85
CA3028B	1.09	SN76115N	1.62	AA219	0.28	BY179	0.83	EL80	0.82
CA3046	3.78	SN76116N	1.78	AA220	0.35	BY179	0.83	EL81	0.82
CA3048	0.70	SN76126N	2.10	AA221	0.35	BY184	0.44	EL82	0.82
CA3065	1.74	SN76131N	2.10	AA222	0.35	BY184	0.44	EL83	0.82
CA3068	1.90	SN76132N	1.61	AA223	0.35	BY189	5.30	EL84	0.94
CA3130S	1.57	SN76802N	1.92	AA224	0.35	BY190	4.90	EL90	3.08
FCM111	2.40	SN76850P	0.97	AA225	0.35	BY206	0.26	EL90A	3.08
LM3909	1.98	SN76853N	1.38	AA226	0.35	BY238	0.25	EY81	1.20
LM3909-14	1.65	SN76854AN	1.85	AA227	0.35	BY238	0.25	EY81B/87	0.67
LM1303N	1.03	SN76854AN	1.85	AA228	0.35	BYX10	0.30	PCC84	0.61
LM1307P									

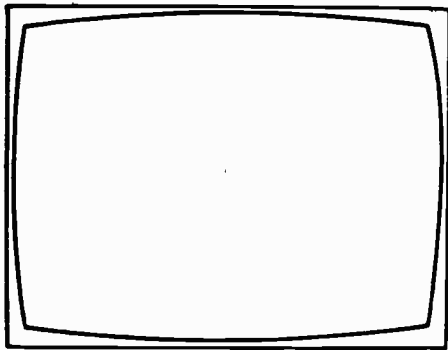

TELEVISION

EDITOR

John A. Reddihough

ASSISTANT EDITOR

Luke Theodossiou

ART EDITOR

Roy Palmer

ADVERTS MANAGER

Roy Smith 01-261 6671

CLASSIFIED ADVERTS

Colin R. Brown 01-261 5762

Muddling through

"He's a genius with a screwdriver and a bit of string." "It works o.k. if you know which knob to twiddle." That's the sort of thing we tend to admire, isn't it? The person who somehow or other has the knack of getting things to work. There's a belief that this sort of thing contributed more than a little to winning two world wars. If you can extemporize and twiddle effectively the advantages can be enormous, especially in a crucial situation.

Improvisation and practical know-how have served us well, and often seem to be a way of life in the UK's engineering industries. The Yanks are pretty good at it too. Some of their smaller TV stations are said to be kept going by means of string and chewing gum. When things go wrong, you call in Bill or Ed who's got a reputation for being a bit of a genius at this sort of problem. He thinks up a solution and everyone says "what's wrong with that?!" It happens time and time again on the production line, and keeps things moving.

This seems to be something of a way of life in much of the English speaking world's engineering industry, and has given us many advantages. Just think, for example, of the number of inventions and innovations that have arisen from what started off as a piece of bungling! Observation, inspiration and a certain knack: what haven't these achieved!

One can't help wondering however whether the problems of the UK's engineering industries may have something to do with this tradition. Others somehow seem to be able to get their mass production lines tamed and working in a manner that ends up in highly reliable products. Cars, TV sets, VCRs, cameras, and so on and so forth. You don't have to fiddle with them, and no one has to remember at which point a slight tap with a hammer is required. It's all very dispiriting. Lacking that atmosphere of inspired muddling through. And not quite playing the game!

Unfortunately however we live in the era of the consumer. People are no longer amused by the antics of the genius in dirty trousers. They expect things to work first time and go on working. If not, they won't come back for more. They'll buy something from you know where.

Professional engineers – and the engineering institutions – are well aware of these problems of course and are engaged in seeking solutions. It's been suggested for a start that in time only the properly qualified will be able to practise, and that something like the Medical Council will be empowered to strike from the list any engineer found wanting. Such an approach may work, but is likely to be a long term one. It could also beg the question of how you assess the competence of someone working with a fast changing technology.

At a more fundamental level there's the problem of engineering management and the structure of our society – the rigid blue and white collar demarcation and so on. And the problems of communication that arise from all this.

It's been said, rather unkindly perhaps, that the way to get ahead is to be incompetent at doing something. If you're the only one who can't do it very well, you get put in charge so that you do the least damage. Hand him the admin to do and he can't muck things up too much. It's also been said that people rise to their level of incompetence. If someone's obviously good at something, he's a candidate for promotion. Until he lands in a position which he can't manage very well, where he stays.

Perhaps in our free and easy society we'll never get it quite right. The good engineering manager needs to be a man of many skills. He must obviously understand the processes, specifications and requirements of his particular production unit, he must be able to understand the accountant's point of view or they'll all go bust, he must appreciate the marketing side's requirements, and he must be able to handle the personnel problems that inevitably arise. That's a tall order. But without good engineering management, modern mass production plant just won't operate effectively.

There is of course another side to the problem. Growing union power has sometimes coincided with increased reluctance to be adaptable. Just think of all that expensive ENG equipment stored away. It seems to be reinforcing the unfortunate two separate worlds structure of industry.

COVER

Our cover this month shows the Apple II computer's keyboard plus the VDU display. The computer was provided by Strathand Ltd., 44 St. Andrew's Square, Glasgow. Photos by Andrew Parr.

Teletopics

ITT RETRENCHMENT

Retrenchment seems to be the order of the day in the European TV setmaking industry. During the past year or so there have been several major moves in the UK industry, including Thorn's closure of its Bradford plants, with production concentrated at Enfield and Gosport, and the Rank-Toshiba and GEC-Hitachi links. Moves on the continent have included the cessation of TV set production by Tandberg and link ups between Thomson-Brandt-NordMende and Philips-Grundig. Now comes news from ITT of plant closures, with concentration of production in three plants, one each in the UK, France and Germany. ITT say they are at present Europe's third largest TV manufacturer, producing some 700,000 sets a year. Production at ITT's Basildon plant is running at around 200,000 sets a year, and ITT claim to have 10 per cent of the UK market for colour receivers.

The UK ITT plants facing closure are at Kearsley, Lancashire (at the end of March) and Hasting (mid-1980). Kearsley is to be retained as a regional sales, service and distribution centre, but closure of the assembly lines at the two plants will involve the loss of some 900 jobs. Increased production at Basildon is expected to create some 150 extra jobs. The fact is however that with simpler, more compact TV chassis and increased automation a large number of jobs in the industry have been lost.

One area in which ITT plans to expand is in the production of Prestel equipped TV sets and associated equipment. ITT is the first setmaker to start volume production of a 16in. colour set equipped for use with Prestel - Model TXV16. This is priced at £975, though the price is expected to fall to around £825 next year as production builds up. ITT also have a 26in. model, a printer unit which produces in seconds a printed copy of the displayed Prestel page, and both a small and a large, editing keyboard to enable the user to write his own pages. The printer is priced at £550 at present, but should come down to the £400 level. Production is running at 100 sets a week and is expected to build up to over 1,000 a week next year. ITT comment that they were held up until recently by a shortage of i.c.s for Prestel use.

Some facts released recently by Mullard's Economic and Market Research Department help to put the overall world TV production scene into perspective. Total world production of colour sets in 1978 reached 30 million. Of these, 10.2 million were produced in W. Europe, 8.5 million in Japan and 7.75 million in the USA. Production and sales in W. Europe were roughly in balance. Japan exported nearly 3 million sets, and over 2.25 million sets were imported by the USA. Quotas have been imposed by the USA in recent times, so with Japanese setmakers looking for markets elsewhere and the ending of the PAL licensing restrictions this year, combined with market saturation, one can appreciate the jittery state of setmakers in W. Europe.

Even with the current moves towards plant rationalisation, most W. European setmakers remain much smaller than their Japanese competitors. It's interesting that ITT had earlier been considering joining forces with another European setmaker, and had got as far as talks with

Thomson-Brandt. Eventually however ITT came to the conclusion that the scale of its combined European operations was sufficient for it to remain independent. As part of the rationalisation plan, the UK, French and German plants will each produce assemblies for use in all sets.

VIDEO DISC MOVES

Philips and Sony have concluded a comprehensive agreement permitting them to use each other's patent rights freely over a wide range of products, including optically (laser) scanned audio and video discs. Up till now, Philips and Sony have been developing laser-scanned disc systems independently. The aim of the agreement is to achieve interchangeability of products.

The Philips/MCA video disc system has been test marketed in two areas (Atlanta and Seattle) in the USA for several months now, and substantial increases in disc prices have been announced following heavy initial losses. Feature film disc prices have been increased from \$16 to \$25 and other discs from \$6 to \$16. The price of the player is also to be increased.

In preparation for the European launch of the Philips/MCA video disc system in 1981, discussions are taking place with a view to designating the Mullard Blackburn plant as the European production centre for video discs. It's hoped that pilot production will commence in the second half of 1980. This could involve a multi-million pound investment over a period of five years or so.

Meanwhile BSR, Thorn, Plessey/Garrard, Pioneer, Sharp, Toshiba, General and NEC have all taken out licences with RCA giving them access to RCA's Selectavision video disc system.

MULLARD TV DEVELOPMENTS

Mullard have announced a single-chip PAL decoder i.c., type TDA3560. This 28-pin LSI i.c., in a DIL package, incorporates all the facilities required for processing the chrominance and luminance signals, and provides direct drive to the RGB output stages. We've tried out pre-production samples of the i.c. in the *Television* colour receiver project and obtained excellent results. Details for using the i.c. in a simplified decoder will be published in due course.

Mullard are also to introduce a new low-cost colour TV projection system, called the Empress. The viewing screen has a diagonal measurement of 1.25m (about 4ft.) and the projector employs a Schmidt optical system. The resolution is better than 500 lines. Old-timers will need no introduction to Schmidt optical systems!

EUROPEAN SATELLITE TV

An agreement has been reached between France and W. Germany to bring into operation a jointly run TV satellite service. The satellite launch is expected to be in 1983, with full operation of the system in 1985. Each country is to build an identical satellite, with a third held in reserve, and

the total cost of the operation is expected to be around £150 million. The cost of buying and installing a viewer's parabolic aerial is put at about £220.

THORN ACQUIRE REW

Thorn have acquired REW, which operates a number of specialist audio/video shops in the London area. Thorn Television Rentals aims to expand the REW operation, which will play a part in the development of the video side of the business. Thorn opened its first specialist video shop, Vista Video, about a year ago in Nottingham.

IPC VIDEO RELEASES

IPC Video have released in videocassette form two films featuring Joan Collins – *The Stud* and *The Bitch*. The latter is at present running in the West End of London, and this is the first occasion on which a major motion picture has been released in prerecorded videocassette form simultaneously with its general release. A major motion picture? Well, that's what IPC Video call it. In fact it got lousy reviews.

TRANSMITTER OPENINGS

The following relay stations are now in operation:

Armitage Bridge (W. Yorkshire) BBC-1 ch. 58, Yorkshire Television ch. 61, BBC-2 ch. 64. Receiving aerial group C/D.

Biddulph (Staffs) Granada ch. 30, BBC-1 ch. 34, BBC-2 ch. 67. Wideband aerials covering Bands IV/V are required.

Carradale (Strathclyde) Scottish Television ch. 41, BBC-2 ch. 44, BBC-1 ch. 51. Receiving aerial group B.

Caversham (Berks) BBC-1 ch. 49, BBC-2 ch. 52, Southern Television ch. 56. Receiving aerial group C/D.

Cragg Vale (W. Yorkshire) BBC-1 ch. 58, Yorkshire Television ch. 61, BBC-2 ch. 64. Receiving aerial group C/D.

Luddenden (W. Yorkshire) BBC-1 ch. 57, Yorkshire Television ch. 60, BBC-2 ch. 63. Receiving aerial group C/D.

Ravenscar (N. Yorkshire) BBC-1 ch. 58, Tyne Tees Television ch. 61, BBC-2 ch. 64. Receiving aerial group C/D.

All the above transmissions are vertically polarised.

In addition, modifications have recently been carried out to the BBC/IBA transmitters at the Taff's Well relay station, extending the coverage.

VIDEO DEVELOPMENTS

The main activity on the VCR front remains the extension of playing times. Akai launched a new cassette at the recent Berlin Radio Show, giving four hours' playing time from a standard VHS-format machine. The cassette has a longer length of thinner tape. In the USA, JVC have introduced a dual-speed VHS machine which gives two or six hours' recording time at the flick of a switch. Naturally the slower speed involves some loss of quality. The VCR (Model HR6700U) has a sophisticated programmable timer-tuner unit which allows for up to six recordings over eight channels during a seven-day period. Sharp have also introduced a two-speed VHS VCR – with a programmable timer/tuner having a 49-programme capacity... It also has a smart looking LCD clock.

Meanwhile Sony have introduced an updated version of their Betamax VCR. The new Model SL8080 will gradually replace the SL8000. It offers the added features of

programme search and cue and review. The latter offers instant playback. The price is expected to be similar to the older machine.

More technical details are available on the two LVR systems previewed recently. The tape speed with the Toshiba system is 6m/sec while BASF use a tape speed of 4m/sec. The BASF cassette has 600m of chromium dioxide tape which takes 2.5 minutes to run through before stopping and reversing. Changeover from one longitudinal track to the next takes 22msec with the Toshiba machine and 100msec with the BASF machine. BASF use a contact winding system to make the high-speed stop-reverse-go process possible: since the back-and-forth shifting is accomplished without entrapping air in the wound tape, BASF say there's no slippage. Toshiba use an endless-tape arrangement, with two spools in the cassette. The BASF VCR produces a stable playback picture on the TV screen half a second after the play push-button is activated. For further details, see *Teletopics* in the last two issues.

BOOK OF AUDIO

A sumptuous book entitled "*Newnes Book of Audio*" has just been published by Butterworths at £4.95 – and a Book of Video is planned. The audio book surveys the current state of audio technology and is aimed at enabling the hi-fi enthusiast to get the best out of his equipment. The book is written by a group of technical authors many of whom will be familiar to readers of this magazine – Gordon King and Vivian Capel for example. There are 120 editorial pages, including a directory of manufacturers and suppliers.

CEEFAX UPDATE

The BBC is now using a new second-generation computer system to control its Ceefax teletext transmissions. The system incorporates three separate computers in a complex configuration, and has been named Selene – after the Greek moon goddess. The new BBC-2 teletext magazine, called Orbit, has been introduced at the same time. Another major innovation is called Polyglot, which takes account of most known accents and combination accents used in foreign languages while remaining completely compatible with existing teletext decoders.

LINK UP WITH THE COMPUTER

The worlds of TV and the computer seem to be getting closer and closer. Thorn and ICL have now joined forces to develop a viewdata system which will enable a viewdata equipped TV set to be linked to an ICL 1900 computer. The system is to be known as Thorn-tel and will enable any sort of display, including graphics, or enquiry system to be set up. The TV set will retain its off-air capability.

Meanwhile, in the US Texas Instruments have made a major breakthrough in getting FCC approval for a home computer that can be linked directly to a conventional TV set. The output from the computer (type TI99/4) is fed to an r.f. modulator (type TI900) and thence to the TV set.

SECOND SPTS SEMINAR

The first Satellite Private Terminal Seminar (SPTS), held in Oklahoma City last August, was apparently a great success. It's to be followed by a second seminar in Miami next February. The aim of all this activity, under the guidance of Bob Cooper, is "making low-cost satellite TV happen".

Footnote on the Pye 713/5/7 Chassis

Harold Peters

STOCK faults on these sets were dealt with by Mike Phelan in last month's issue. A problem with these sets is to know the degree of interchangeability there is between early and late models – particularly if you have to carry a minimum stock for repair purposes. First let's identify the chassis.

The 713 is the earliest, with no focus potentiometer on the c.r.t. base panel, rotary controls, a unipotential c.r.t. (see below) and a four-button tuner. Models are the Pye CT200 and Invicta CT7018.

The 715 came during the middle part of the production run. This has a focus potentiometer on the c.r.t. base panel, rotary controls, a four-button tuner and a conventional c.r.t. Models are the Pye CT200/1 and Invicta CT7018/1.

The 717 was the final version. Again there's a focus potentiometer and conventional c.r.t., but this time there are slider controls and a six-button tuner. Models are the Pye CT218, Ekco CT818 and Philips G18C570.

The unipotential tube fitted in the 713 chassis is the A47-342X (470DUB22), which cannot be interchanged with later versions. Unipotential indicates that the focus and first anode electrodes are operated at a similar voltage, which is obtained from D657/C655 in the line timebase. The 715/717 chassis are usually fitted with the conventional A47-343X (470EMB22) tube imported from Toshiba. By conventional, we mean that the focus electrode is operated at about 3.5kV. The degaussing arrangement used with this tube consists of a pair of coils on flat bobbins, mounted on a steel band strapped around the bowl. Towards the end of the production run the tube was replaced by an M.E.C. (Matshushita Electric Corporation) version. This is electrically similar to the Toshiba one but unable physically to carry the steel degaussing strap, which was replaced by two large conventional coils. So although these two tubes are electrically interchangeable and the M.E.C. degaussing fits the Toshiba tube, you may be in trouble if you try to fit the steel band around the M.E.C. tube.

The later type of e.h.t. doubler with five leads can be used in the 713 chassis provided the focus lead is well insulated and tucked out of the way.

The 715/717 series uses a high-impedance brightness control circuit, the 713 chassis a low-impedance brightness control circuit. Since half the circuit is on the control panel and the other half on the chroma panel, a wrong combination will

give either uncontrollable brightness or uncontrollable dimness . . . The best bet is to stock the later boards (715/717 chassis) coded 20/2. If it's necessary to fit one to an earlier set, straddle R310 (33kΩ) and R483 (47kΩ potentiometer – preset brightness control) with a 10kΩ potentiometer and adjust this for the correct brightness range (see later). In the 713 chassis R310 is 3.9kΩ and R483 4.7kΩ.

Early on in the production run the design of the TBA560 chrominance/luminance signal processing i.c. was improved – in two stages. The original TBA560 was fitted to boards coded 20, and was soon replaced by the TBA560A on boards coded 20/1. These two devices cannot be interchanged without a lot of work on the peripheral components. Happily the TBA560C, the currently available device, can be fitted in place of the TBA560A with no circuit change and, if you are lucky, without realignment either.

The tuners, i.f. and detector modules are interchangeable with their counterparts in the large-screen 731 and 725 etc. chassis. Towards the end of the run of the large-screen chassis however, the detector module was modified to accept ceramic sound filters in place of coils on the board itself. These detector modules can be recognised by the absence of the "Crystal Palace" trap (L162) at the i.f. end, and are not advised as replacements on the 713 etc. except in dire emergency.

Since the beam limiter (see Fig. 6, page 27 last month) works via the contrast control, it's essential to make sure that the brightness control cannot overload the set by misuse. Hence the inclusion of the preset brightness control R483, which is mounted vertically on the chroma board. To set up, measure the beam current with a meter (AVO 8 etc.) set to 1mA connected across the c.r.t.'s green cathode protection resistor R905 on the tube base panel. Turn off the red and blue guns, using the switches on the convergence panel, and display a test pattern or similar still picture. Adjust R483 for 400 μA with the user brightness control at maximum and the contrast and colour controls at minimum. Then set the beam limiter control R221 on the i.f. panel for 850 μA with the brightness, contrast and colour controls turned fully up. Beware of a false reading. The correct one is the first one reached from R221 being fully anti-clockwise. The second, false, reading will result in low l.t. (below 11.5V d.c.).

Fuse blowing (see plan of fuses, Fig. 1) is a common problem, the mains fuse (F526, 1.6A) being a persistent offender, particularly in areas where the mains supply is rough. A useful dodge is to fit a VDR across the set side of the on-off switch. This is effectively open-circuit unless the mains voltage surges to a point where the glow switch would normally trip: it then conducts to clip the peak. This stops the glow switch tripping on mains voltage transients, but leaves the set fully protected against persistent over-voltage due to a fault. A suitable VDR is used in the Philips/Pye G11 chassis (R1307, service code number 116 27041 – or its RS equivalent). The degaussing circuit fuse F542 is not fitted in early sets.

LARGE-SCREEN CHASSIS (731 ETC.)

Mike Phelan reports that he's had to replace R898/R899, the parallel connected resistors in the diac firing circuit in the power supply, on a number of occasions recently. The resistors may look reasonable, but seem to decompose, changing value (82kΩ, later changed to 56kΩ with other power supply modifications). The symptoms can be anything from a jittery picture to low h.t. or a dead set, and may be intermittent. Use a replacement rated at 2W. ■

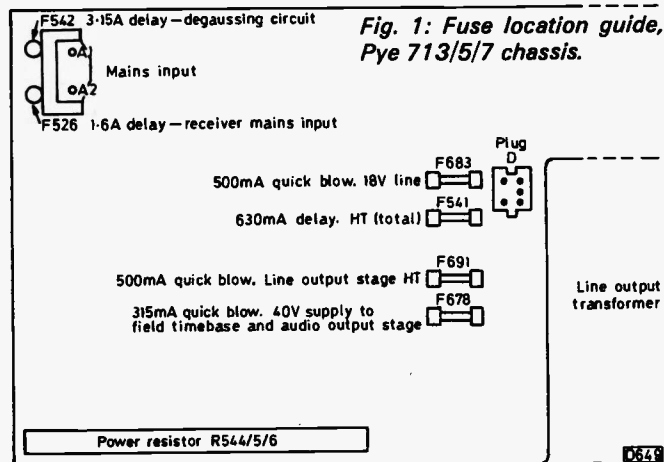

MANOR SUPPLIES

PAL COLOUR BAR GENERATOR

plus CROSS HATCH KIT (Mk. 4)

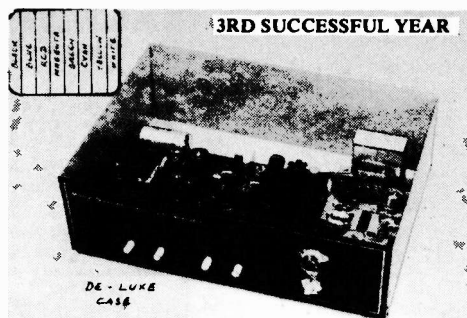

- ★ Output at UHF, applied to receiver aerial socket.
- ★ In addition to colour bars R-Y, B-Y etc.
- ★ Cross-hatch, grey scale, peak white and black level.
- ★ Push button controls, battery or mains operated.
- ★ Simple design, only five i.c.s. on colour bar P.C.B.

PRICE OF MK4 COLOUR BAR & CROSS HATCH KIT £40.25 + £1.25 P/Packing. DE-LUXE CASE £5.95. ALUMINIUM CASE £2.95, BATT HOLDERS £1.70, ALTERNATIVE STAB. MAINS SUPPLY KIT £5.55.

ALSO THE MK3 COLOUR BAR GENERATOR KIT FOR ADDITION TO MANOR SUPPLIES CROSS HATCH UNITS. £28.75 + £1.15 p.p. CASE EXTRA £1.75. BATT. HOLDERS £1.70.

- ★★ Kits include drilled P.C. board, with full circuit data, assembly and setting up instructions.
- ★★ All special parts such as coils and modulator supplied complete and tested, ready for use.
- ★★ Designed to professional standards.
- ★★ Demonstration models at 172 West End Lane, NW6.
- ★★ Every kit fully guaranteed.

MK4 DE LUXE (BATTERY) BUILT & TESTED £66.70 + £1.50 P/Packing.

VHF MODULATOR (CHI to 4) FOR OVERSEAS £4.00.

INFORMATION ON VIDEO TAKE-OFF FOR C.C.T.V.

(ABOVE PRICES INCLUDE 15% VAT)

MANOR SUPPLIES

TELETEXT KIT (MK2)

(INCORPORATING MULLARD DECODER 6101VML)

- * EXTERNAL UNIT, PLUGS INTO AE SOCKET.
- * LATER SPEC (DOUBLE HEIGHT, BACKGROUND COLOUR ETC).
- * INFRA-RED REMOTE CONTROL (MULLARD 5000 SYSTEM) STATION SELECTION, TEXT MIX, TIME, DOUBLE HEIGHT, HOLD, MUTE CLOCK, REVEAL RESET ETC, ETC.
- * INCLUDES COMPLETE & TESTED 6101 VML (MULLARD) DECODER, SAW FILTER IF PANEL & 32 BUTTON REMOTE CONTROL HANDSET.
- * EVERY KIT EASY TO ASSEMBLE & FULLY GUARANTEED.
- * WORKING MODEL AT 172 WEST END LANE, N.W.6.

FURTHER DETAILS ON REQUEST

COLOUR. UHF & TELEVISION SPARES

NEW 'TELEVISION' COLOUR RECEIVER PROJECT ALL PARTS AVAILABLE AT PRESENT. POWER, SIGNAL & TIMEBASE. SEND OR PHONE FOR LIST. WORKING DEMONSTRATION SET NOW ON SHOW WITH TELETEXT.

NEW SAW FILTER IF AMPLIFIER PLUS TUNER COMPLETE AND TESTED FOR T.V. SOUND & VISION £32.80 p.p. £1.10. T.V. PORTABLE PROJECT PARTS AVAILABLE. SEND OR PHONE FOR LIST. WORKING MODEL AT 172 WEST END LANE, NW6.

TV TEST GENERATOR UHF MODULATOR £4.00 p.p. 40p.

CROSS HATCH UNIT KIT, AERIAL INPUT TYPE, INCL. T.V. SYNC AND UHF MODULATOR. BATTERY OPERATED. ALSO GIVES PEAK WHITE & BLACK LEVELS. CAN BE USED FOR ANY SET

£12.65 p.p. 50p. (ALUM CASE £2.30 p.p. 80p.) COMPLETE TESTED UNITS READY FOR USE (DE LUXE CASE) £25.00 p.p. £1.25.

ADDITIONAL GREY SCALE KIT £3.35 p.p. 35p.

STAB MAINS POWER SUPPLY FOR ABOVE £5.50 p.p. 80p.

UHF SIGNAL STRENGTH METER KIT £19.40 (ALSO VHF VERSION) ALUM CASE £1.75, DE-LUXE CASE £5.60 p.p. £1.25.

CRT TESTER & REACTIVATOR PROJECT KIT FOR COLOUR & MONO £25.00 p.p. £1.60.

"TELEVISION" COLOUR SET PROJECT (1974) SPARE PARTS STILL AVAILABLE. ALTV. IF COMPL. & TESTED £16.80 + £1.25 p.p.

PHILIPS 210 300 Series IF Panels £2.90 p.p. £1.25.

PHILIPS 210, 300 Series Frame T.B. Panels £1.15 p.p. 75p.

PHILIPS 19TG 170 Series Timebase Panels £2.90 p.p. £1.25.

BUSH A823 CONVERGENCE PANEL £7.60 p.p. £1.25.

BUSH A823 (A807) Decoder Panel £8.65 p.p. £1.25.

BUSH A823 SCAN CONTROL PANEL £2.90 p.p. 80p.

BUSH A823 IF PANEL (EXPORT VERSION) £3.25 p.p. 95p.

BUSH Z718 BC6100 SERIES IF PANEL £5.75 p.p. 80p.

BUSH A816 IF PANEL (SURPLUS) £1.90 p.p. 80p.

BUSH 161 TIMEBASE PANEL A634 £4.40 p.p. £1.25.

GEC 2010 SERIES TIMEBASE PANEL £1.15 p.p. 95p.

GEC 2040 Surplus Panels, ex-rental. Decoder £5.75, Timebase £2.88 p.p. £1.25.

DECCA CTV25 Single Stand. IF Panel £4.40 p.p. 75p.

DECCA Colour T.V. Thyristor Power Supply. HT, LT etc. £4.40 p.p. £1.40.

BUSH TV 312 IF Panel (Single I.C.) incl. circuit £5.75 p.p. 75p.

BUSH TV Portable Eleven Volt Stab. Power Supply Unit £4.40 p.p. £1.10.

PYE 697 Line T.B. P.C.B. for spares £3.68 p.p. £1.25.

THORN 3000 POWER LINE TB PCB £5.75 each p.p. 85p.

THORN 3000 VID, IF, DEC, FTB SALVAGED £5.75 ea. p.p. £1.00.

THORN 8000/8500 POWER/SALV. SPARES £2.88 p.p. 60p.

THORN 8000/8500 TIME BASE, SALV., SPARES £5.52 p.p. 90p.

THORN 9000 LINE T.B. SALV., SPARES £8.62 p.p. £1.38.

MULLARD AT1022 Colour Scan Coils £6.90 p.p. £1.30, AT1023/05 Convergence Yoke £2.90 p.p. 95p, AT1025/06 Blue Lat. 90p p.p. 40p, Delay Lines, DL1E £1.00, DL50 £4.00 p.p. 80p.

PHILIPS G9 Signal Board Panels for small spares £4.80 p.p. £1.00.

PHILIPS G9 Signal Board Panels for small spares £4.80 p.p. £1.15.

etc., and circuits £4.25 p.p. £1.20, or incl. yoke, £5.65. G8 Decoder panels salvaged £4.25. Decoder panels for spares £2.00 p.p. £1.15.

VARICAP UHF MULLARD U321 £8.97, ELC1043/05 £6.35 p.p. 40p., G.I. type (equiv. 1043/05) £4.00 p.p. 40p. Control units, 3PSN £1.40, 4PSN £1.75, 5PSN £2.00, 6PSN £2.10, Special Offer 6PSN £1.15 p.p. 40p.

TAA 550 58p p.p. 20p. Salv. UHF varicap tuners £1.75 p.p. 40p.

BUSH "Touch Tune" assembly, incl. circuit £5.75 p.p. 85p.

VARICAP UHF-VHF ELC 2000S £9.80, p.p. 75p.

VHF ELC 1042 £6.90 p.p. 40p.

UHF/625 Tuners, many different types in stock. UHF tuners transisted. incl. s/m drive. £3.28, Mullard 4 position push button £2.88 p.p. £1.10 etc.

TRANSISTORISED 625 IF for T.V., sound, tested. £7.82 p.p. 75p.

RBM 774 250R Mains Droppers, four for £1.15 p.p. 40p.

LINE OUTPUT TRANSFORMERS. New guar. p.p. 95p.

SPECIAL OFFER

BUSH 145 to 1865 series	£8.50	BUSH TV 125 to 139	£3.25
BUSH, MURPHY A816 series	£9.80	GEC 2114J/FINELINE	£5.50
DECCA DR 121/123,		GEC 448/452	£1.75
20/24, MS1700, 2001, 2401	£7.85	THORN 1590/1591	£5.50
DECCA MS2000, 2400	£6.70	KB VCI, VCII (003)	£3.25
FERG., HMV, MARCONI, ULTRA		MURPHY 849 to 939	£3.25
900, 950, Mk. 1		COLOUR LOPTS p.p.	£1.10.
950II, 1400, 1500, 1580	£6.80	BUSH 182 to 1122 etc.	£11.30
GEC 2000, 2047 series, etc.	£8.50	MURPHY Equivalents	£11.30
INDESIT 20/24EGB	£8.50	DECCA "Bradford"	
ITT/KB VC2 to 53, 100, 200, 300	£8.50	(state Model No. etc)	£10.15
MURPHY 1910 to 2417 series	£8.50	GEC 2028, 2040	£11.30
PHILIPS 19TG170, 210, 300	£8.50	GEC 2110 Series	£12.20
PYE 368, 169, 769 series	£8.50	ITT CVC 5 to 9	£7.80
PYE 40, 67 series (36 to 55)	£7.85	PYE 691, 693, 697	£20.50
PAM, INVICTA, EKCO,		PHILIPS G8	£10.15
FERRANTI equivalents as above.		THORN 3000/3500	
SOBELL 1000 series	£8.50	(Scan or EHT)	£7.85
STELLA 1043/2149	£8.50	THORN 8500	£12.50

OTHERS AVAILABLE. PRICES ON REQUEST.

THORN MONO SCAN COILS (850 to 1500) £3.25 p.p. 95p.

THORN 950 3 Stick Tray £1.15 p.p. 55p. Most others available.

6-3V CRT Boost Transformers £3.70 p.p. 85p., Auto type £2.10 p.p. 50p.

CALLERS WELCOME AT SHOP PREMISES (Tel: 01-794-8751)

THOUSANDS OF ADDITIONAL ITEMS AVAILABLE NOT NORMALLY ADVERTISED

MANOR SUPPLIES
172 WEST END LANE, LONDON, N.W.6.

NEAR: W. Hampstead Tube Sta. (Bakerloo & Jubilee)
W. Hampstead British Rail Sta. (Richmond, Broad St.) (St. Pancras, Bedford) Bus Routes 28, 159
Mail Order: 64 GOLDERS MANOR DRIVE, LONDON N.W.11.

ALL PRICES INCLUDE VAT AT 15%

Technical Training in Radio, Television and Electronics

Start training TODAY and make sure you are qualified to take advantage of the many opportunities open to trained people. ICS can further your technical knowledge and provide the specialist training so essential to success.

ICS, the world's most experienced home study college has helped thousands of people to move up into higher paid jobs - and they can do the same for you.

Fill in the coupon below and find out how!

There is a wide range of courses to choose from, including:

City and Guilds Certificates:-

Telecommunications Technicians,
Radio, TV and Electronics Technicians,
Electrical Installation Work,
Technical Communications,
Radio Amateur,
MPT General Radio Communications Certificate.

Diploma Courses:-

Electronic Engineering,
Electrical Engineering,
Computer Engineering,
Radio, TV, Audio Engineering, Servicing and Maintenance. (inc. Colour TV)
New Self-Build Radio Courses with Free Kits.

Colour TV Servicing

Technicians trained in TV Servicing are in constant demand. Learn all the techniques you need to service Colour and Mono TV sets through new home study courses which are approved by a leading manufacturer.

The ICS Guarantee

If you are studying for an examination, ICS will guarantee coaching until you are successful - at no extra cost.

POST OR PHONE TODAY FOR FREE BOOKLET.

I am interested in.....

Name.....

Address.....

Phone No:.....

ICS International Correspondence Schools,
Dept. P285, Intertext House,
LONDON SW8 4UJ. Tel 622 9911
(all hours)

ARE YOU IN THE DARK? ..ABOUT OUR COLOUR T.V. PANEL EXCHANGE REPAIR SERVICE



FULL RANGE OF
THORN · RBM · PHILIPS
PYE · INVICTA · GEC
DECCA · TELPRO
AND MANY OTHER MAKES

90 DAY GUARANTEE ON ALL REPAIRS
SAME DAY POSTAL SERVICE

We employ a large skilled Staff, who utilise some of the most sophisticated Test equipment available, inclusive of AUTOMATIC FAULT FINDING COMPUTERS together with specially designed SERVICING JIGS which in short means to you:-

HIGH QUALITY REPAIRS - AT LOW COST



ONE OFF
OR



100 OFF · NO ORDER TOO
LARGE OR SMALL

SEND FOR PRICE LIST

SEND FOR CATALOGUE
BLOCK DISCOUNTS FOR TRADE CONTRACTS

TO

Campbell Electronics Ltd.

Factory Unit E5, Halesfield 23, Telford · Shropshire · TF7 4QX
Telephone: Telford (0952) 584373, Ext. 2. Telex 35191 Chamcon

TV LINE OUTPUT TRANSFORMERS

by FAST RETURN OF POST SERVICE

MONO LOPTS

Most makes supplied

£7.90 TRADE

£8.50 RETAIL

p&p 70p each item

COLOUR LOPTS

Phillips G8, ITT CVC5-9, Decca Bradford series 10 & 30
£8.35 TRADE £9.50 RETAIL

p&p 70p each item

WINDINGS p. & p. 50p each item

Bush colour. (Hybrid quadrupler version)

£6.25

Decca CTV19/25 (non-tripler version)

Primary £6.25

EHT £7.20

Phillips G6 (dual & single standard)

Primary £6.25

(EHT winding on exchange basis only)

EHT £7.20

Pye 691, 693 & 697 (please state which)

Primary £4.60

EHT £3.10

EMO 90 degree

Primary £6.25

PRICES INCLUDE 15% VAT

S.A.E. all enquiries

All lopts and windings are new and guaranteed for 6 months.

PAPWORTH TRANSFORMERS

80 Merton High Street
London SW19 1BE

Barclaycard and
Access welcome



01-540 3955

ITT's New Infra-red Remote Control System

A. J. Edwards*

THE present generation of ultrasonic remote control systems use a band of frequencies of approximately 32-45kHz, the bandwidth being limited by the need to fit it between the harmonics of the line timebase. Because of the Doppler effect, the number of separate control frequencies that can be used within this bandwidth is limited to about 30 – sufficient nevertheless to provide remote channel selection, control of brightness, colour and volume, and operate a teletext system. A number of coding systems have been devised to enable the same or a greater number of commands to be incorporated in the bandwidth using fewer frequencies, but these suffer from problems due to room reflections – if a reflected signal arrives at the TV set at a significantly different time to the main signal, the effect can be malfunction or non-operation of the remote control system. A solution to these problems is to use infra-red instead of ultraviolet frequencies for transmission. Until recently this approach suffered from a cost penalty, but infra-red transducers are now available at a very competitive price.

Pulse Code Modulation

The latest remote control system developed by ITT employs infra-red for the transmission link and pulse-position modulation to code the commands. The principle of pulse-position modulation has been described in these pages before, in connection with the Plessey remote control system (see *Television* November 1978 and April 1979). All that's required is to define two different time intervals between pulses: one interval is taken to be a logic 1 and the other logic 0. This means that the commands are digitally coded, the number of commands of which the system is capable depending on the number of digits used, i.e. the length of the digital "word". The ITT system uses a ten-digit word, for which eleven transmitted pulses are required (since each digit is the interval between two pulses). The use of ten bits gives a possible total of 1,024 commands. Additional pulses are added to provide error protection and other features, the transmitted word actually consisting of 14 pulses.

Fig. 1 shows the details of the transmitted word and the time intervals corresponding to 0 and 1.

Processing the Received Word

The first pulse of the word (the preliminary pulse) sets the a.g.c and clipping levels within the remote control receiver, enabling the system to work over a very much larger range than would otherwise be possible. The SAA1251 receiver i.c. detects this pulse and starts a timing sequence which expects another pulse to arrive one time period ($\pm 15\%$) later. Since such a pulse doesn't arrive, the i.c. rejects the initial pulse as a random event, i.e. it's not taken to be part of the actual command. The second (start) pulse starts a similar timing sequence, the i.c. measuring the time till the

arrival of the third pulse. This time is taken to be the nominal period for a 0, and multiples of it as being either a 1 or the end of word bit (the period to the stop pulse). This arrangement corrects for any frequency offset in the oscillator used in the transmitter unit. The receiver unit then uses this measured period to open "windows" for data acceptance.

To reduce susceptibility to noise, the receiver i.c. accepts a received command as valid only if it fulfills the following conditions: (a) The input period is $100\mu\text{sec}$ ($\pm 15\%$). (b) All pulses arrive within the acceptance windows. (c) No pulses arrive between the acceptance windows. (d) A valid word of 10 data bits (eleven pulses) followed by a stop pulse bit is received. This checking/validation procedure provides a system which is virtually immune to malfunction due to extraneous sources of infra-red light, e.g. the sun, electric fires, lighting and so on.

Transmitter Circuit

Since the system is tolerant of a frequency error of 15%, only one stable reference is required. The obvious place to include this is in the receiver unit, where it can be interfaced with other arrangements, e.g. a frequency synthesizer tuning system. The oscillator used in the transmitter unit is thus a simple RC type incorporated within the SAA1250 transmitter i.c. To minimise drain on the battery used in the transmitter unit, the oscillator is powered only when a command is detected by the keyboard input circuit. The circuit of the transmitter unit is shown in Fig. 2.

When the transmitter i.c. detects an input from the keyboard, it starts the oscillator and times out a 20msec delay to allow for keyboard switch bounce. It then transmits the 14-pulse word appropriate to the command requested. If the key is held depressed, the command is retransmitted at 130msec intervals.

Since each word consists of 14 $10\mu\text{sec}$ pulses, the word being repeated at 130msec intervals, the output stage duty cycle is approximately 0.1%. Thus for a peak infra-red LED current of 2A, only 2mA is drawn from the battery. Adding the transmitter output stage current and the i.c. current (approximately 4mA) gives a total active transmitter current of 6mA, which is well within the capability of a 9V layer battery of the PP3 type. The

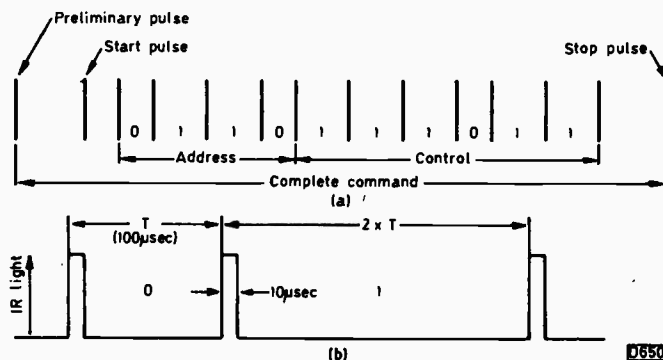

Fig. 1: (a) The transmitted command word. (b) Pulse timing for a 0 and a 1.

*Applications Department, ITT Semiconductors, Fooks Cray, Kent.

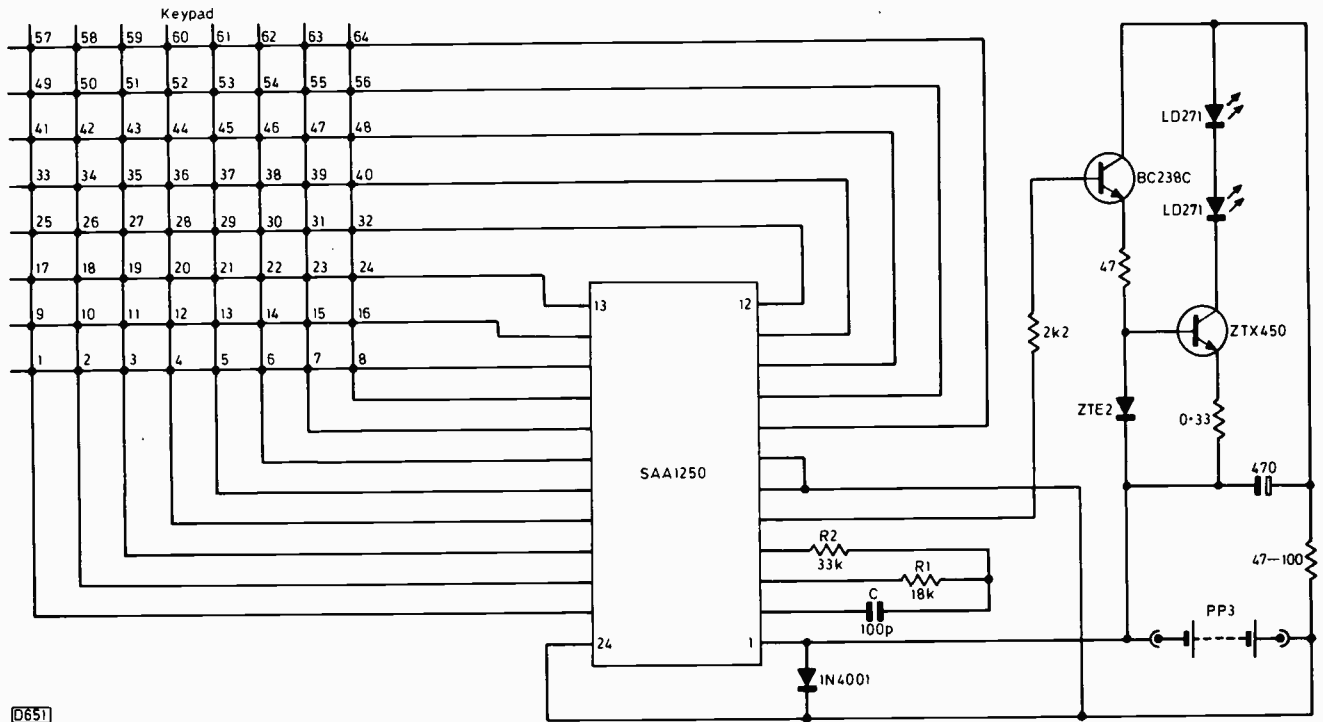

Fig. 2: Typical transmitter circuit. Components R1 and C in the oscillator circuit must be close tolerance types – the combination of R1 and C should have a tolerance of better than 4.5%. R2 may be a 5 or 10% type.

quiescent current consumption is only some $10\mu\text{A}$. The battery life should thus be not significantly less than its shelf life.

Since the transmitter uses a 9V supply, it's convenient to use a couple of infra-red LEDs in a current-driven series configuration, thus reducing the component count and the power consumption. If an operating range of greater than 20m or so is required, more LEDs and more complicated drive circuitry can be employed. The configuration shown allows for falling battery voltage with age and use. This is an important factor since, as the power for the LEDs comes from the $470\mu\text{F}$ storage capacitor, the first word would otherwise have more power than succeeding words in a continuous command.

Receiver Circuit

In the receiver unit a large-area pin diode such as a BP104 or TIL100, incorporating in its encapsulation a filter compound to reduce sensitivity to visible light, converts the infra-red signals to electrical ones. The photodiode is connected directly to the TEA1009 preamplifier i.c., whose first task is to bias the photodiode so that it always has the same d.c. voltage conditions, thus taking care of the effects of sunlight, room lighting, etc. The following high-gain wideband amplifier in the i.c. is a.c. coupled, via the external $0.01\mu\text{F}$ capacitor between pins 4 and 5, to the clipping stage, which removes noise and feeds a clean signal to the SAA1251 receiver i.c. The first pulse to arrive from the transmitter is used to reset the photodiode's d.c. conditions, compensating for variations in transmitter range. The first pulse also sets the clipping level within the TEA1009, thus determining the signal-to-noise discriminating level. Hence the importance of the preliminary pulse from the transmitter, without which the system's range of operation would be very much reduced – especially close to the TV set.

The SAA1251 i.c. first carries out the checking/validation procedures previously described. To provide a

timing reference, the i.c. incorporates an oscillator which operates with an external crystal. This may be an ordinary 4.43MHz crystal for normal systems, or a 4MHz type where the remote control system is to be integrated with a frequency synthesizer tuning system. The validated data is then processed in various ways. The 1,024 possible commands are split into 16 groups of 64 commands, and any particular receiver i.c. will be looking for only its own 64 commands. This splitting into groups is done by using the first four bits of the transmitted word as an address, and the remaining six bits as the command itself. The receiver i.c. checks the address bits and if these don't correspond to its own programme it doesn't act upon the command (other than to change its format and feed it out on to a serial data bus). If the address is correct for the receiver, the appropriate control action is initiated.

Commands

Ten commands are used for analogue controls. The analogue control outputs from the i.c. are of the usual variable mark-space ratio type. Eight consist of the usual up and down (volume up and down etc.) commands, the other two being sound mute and picture normalise. A further 17 commands are allocated to programme selection: 16 give direct access to a programme via a latched, 4-bit parallel bus, the remaining command providing sequence control, stepping the programme number upwards. In addition, commands have been allocated to switch the receiver on and off, and to set or reset a spare flip-flop whose output can be used to activate a top-cut tone control or any other switched function. Most of these commands can also be fed to the receiver i.c. from a keyboard mounted in the set – thus all is not lost if the transmitter fails to operate.

Remote TV receiver control uses very few of the available 1,024 commands – in fact it doesn't even come close to making full use of a single address. The remote control system is thus capable of being adapted to new developments and technology as these arrive. In this

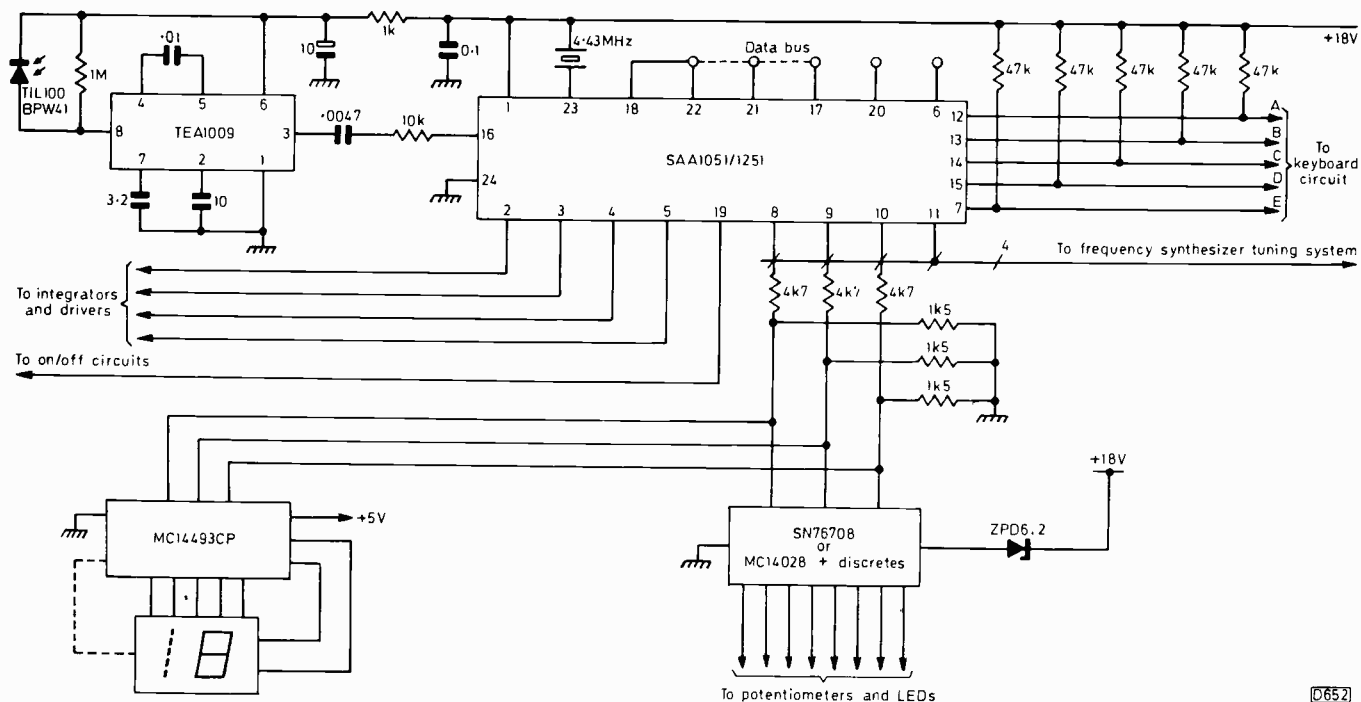

Fig. 3: Typical receiver circuit. The outputs from pins 17 (serial data) and 21/22 (clock pulses) can be used to drive sub-systems. Pin 20 is the output from an additional memory within the i.c., while pin 6 provides an output from the i.c.'s control unit. The SAA1251 can be used in four different operational modes by connecting pin 18 to either pin 1, pin 21, pin 22 or pin 24. In these different modes, the i.c. responds to different addresses in the command word.

connection, an i.c. is being developed to enable the remote control system to be interfaced directly with various other systems, giving remote teletext and viewdata control.

The new ITT remote control system is optimised for use

with infra-red radiation as the transmission link. It's thus considerably faster than systems which can be used with either an ultrasonic or an infra-red link, and consumes considerably less power. ■

★ NEW ★ COLOUR BAR GENERATOR

U.H.F. AERIAL INPUT PATTERN GENERATOR CPG6-RF

All Facilities of our PG6RF

PLUS COLOUR BARS.

Produces 7 invaluable patterns.

**Robust, Battery Powered, Pocket Sized Unit,
Plugs Straight into Aerial Socket.**

W H I T E	Y E L L O W	C Y A N	G R E E N	M A G E N T A	R E D	B L U E	B L A C K
-----------------------	----------------------------	------------------	-----------------------	---------------------------------	-------------	------------------	-----------------------

FEATURES:

- ★ CROSSHATCH GRID
- ★ DOT MATRIX
- ★ VERTICALS
- ★ HORIZONTALS
- ★ WHITE RASTER
- ★ GREYSCALE

★ **PLUS PAL COLOUR BARS;**
ONLY 3 SIMPLE ADJUSTMENTS.

★ PG6RF OWNERS; Buy Add-On 'C6' Unit!

ORDER NOW!

PG6RF KIT £25.87 BUILT £33.35 – As per TV Review, Jan. 1979

C6 KIT £18.98 BUILT £26.45 – Add-on Colour to PG6RF

CPG6RF KIT £42.55 BUILT £63.25 – Both above combined.

These prices INCLUDE P & P and 15% VAT. Export VHF versions available.

In response to demand we have produced an add-on Colour Bar unit C6 to upgrade the PG6RF to PAL COLOUR. A MUST for TV construction or servicing! Available as a KIT or BUILT & TESTED. Kit includes all components and ready built modulator etc. Hundreds sold, reliable design.

Full 12 month guarantee on built units.

MAIL ORDER ONLY

Quantity Discount on application

ACCESS ORDERS WELCOME

ALSO AVAILABLE:

TECS: TECHNLOGICS EXPANDABLE COMPUTER SYSTEM.

Full Colour Teletext; full facility Microprocessor-based, Aerial Input Decoder with extensive computing facilities. The most versatile decoder on the market. Expandable from a simple teletext decoder to a full professional computer/information centre. Send large S.A.E. for details.

SEND ALL ORDERS OR ENQUIRIES TO TECHNLOGICS LTD. (DEPT. TV)
8 EGERTON STREET, LIVERPOOL L8 7LY. Tel: 051-724 2695.

TV Servicing: Beginners Start Here...

Part 27

S. Simon

TACKLING THE COLOUR DECODER

HAVING discussed tube drive, and the way in which the three beams in a colour tube are controlled by the various assemblies mounted on the tube's neck, we come to the subject of decoders – the way in which the transmitted colour signal is sorted out into its various components and processed. To get to grips with this we need to consider first what's involved in transmitting a colour signal.

Transmitting a Colour Picture

We've seen that a colour picture can be displayed by adding together suitable proportions of the three primary colours red, green and blue. So we could use three cameras, each incorporating a filter so that it's sensitive to only one primary colour, and feed the outputs to three transmitters and three aerials. At the receiving end we could have three aerials, three receivers and a projection system to combine on a screen the outputs from the three tubes (red, blue and green). Fine, but hardly practical. Apart from being expensive, this approach would be wasteful of air space, calling for three channels to provide a single picture.

Right at the start of colour TV, it was decided that the colour transmissions should occupy the same channel bandwidth as the existing monochrome transmissions, and that the colour signal should be added to the monochrome one in such a way that monochrome receivers would continue to function happily, simply ignoring the extra colour information. As we saw in Part 24, we can use a basic monochrome signal, which is more strictly referred to as the luminance (i.e. brightness) signal, for which the abbreviation Y is used, plus three colour-difference signals. The monochrome receiver ignores the colour-difference signals, while the colour receiver uses them to adjust the drives to the colour tube's three guns.

The colour camera must clearly be able to recognise the primary colours and produce primary-colour signals: and so that monochrome viewers are happy, it must also provide a luminance signal. The luminance signal can be simply produced by adding together certain proportions of the primary-colour signals. These are 30% red, 59% green and 11% blue, these proportions corresponding to the characteristics of the human eye. Once this has been done, it's again a simple matter to do a little more signal mixing to get B – Y, R – Y and G – Y.

Since these signals are in set proportions, it's not necessary to transmit them all. Y has to be transmitted for the benefit of monochrome viewers. The transmission of two of the colour-difference signals as well will give us our colour display – the third colour-difference signal can be recreated in the receiver by adding together proportions of the other two. In practice, B – Y and R – Y are transmitted,

and G – Y is obtained in the receiver by matrixing as it's called.

Some other facts assist in the bandwidth economy drive. The human eye is sensitive to brightness detail but not to fine colour detail. So we don't need the full monochrome vision bandwidth (5MHz for the UK 625-line system) for our colour-difference signals. We can chop them down to 1MHz (double-sideband) and modulate them on to a suppressed subcarrier placed somewhere towards the higher frequency end of the monochrome channel bandwidth.

Why a "suppressed subcarrier"? It's not our purpose to go into transmitter details here, but briefly by using the suppressed subcarrier technique there's no extra colour signal at all when no colour is present in the scene, thus minimising possible interference to the monochrome picture.

Just one subcarrier for two signals (R – Y and B – Y)? Yes. Again we can't go into transmission theory, but if we arrange that the two signals are in quadrature with one another, i.e. there's a 90° phase difference between them, a single subcarrier will suffice – the technique is known as quadrature/amplitude modulation (QAM).

So we've got one suppressed subcarrier carrying two relatively narrow-band colour-difference signals (the chrominance signal for short). We've still got to fit it into the monochrome channel bandwidth. Due to the line structure of the picture, there are unused gaps, at regular intervals, in the monochrome channel bandwidth. If we select our colour subcarrier frequency carefully, the chrominance signal will fit into these gaps. Hence the rather surprising looking chrominance subcarrier frequency of 4.43361875MHz (4.43MHz for short). This is related to the line frequency (15.625kHz), and is chosen to minimise interference effects on monochrome receivers by cancelling to some extent on a line-by-line basis.

The Complete Colour Signal

What have we got so far then? A luminance signal which corresponds to the monochrome vision signal, a sound signal and sync pulses of course as usual, plus a chrominance signal (when colour is present) which consists of two colour-difference signals combined through a quadrature modulation process and inserted into the luminance channel bandwidth, towards the h.f. end. Is anything else needed? There's one more complication. The use of a suppressed subcarrier means that an oscillator, operating at the subcarrier frequency, is required in the receiver to assist with the chrominance demodulation process. It's vital that this oscillator is synchronised with the transmitter's subcarrier oscillator, and for this purpose a

burst (six cycles) of oscillation at the subcarrier frequency is transmitted during the back porch period, immediately following the line sync pulse, when otherwise there's no video information being transmitted. For obvious reasons, this is called the burst. Remember that it's present for a brief interval only, during the line flyback period, and that it's present only when a colour picture is being transmitted.

Returning to our colour receiver, the job of the decoder is to sort this lot out, producing from the burst and the chrominance signals three separate colour-difference signals. Always assuming that the picture being transmitted is a colour one of course: with no colour there are no colour-difference signals and the colour tube is driven as if it was a monochrome one.

Enter PAL

Before we take a look at a typical decoder arrangement, one extra complication has to be considered – PAL. The problem with the use of QAM is that any spurious signal phase shifts will cause incorrect colours. This is obviously a serious matter. The PAL technique, used for the UK, most W. European and many other colour services, was devised to overcome this problem. The technique consists of inverting the polarity of one of the colour-difference signals (in practice $R - Y$) on alternate picture lines: the use of a line duration delay line (the chrominance delay line) plus summing networks in the receiver than makes it possible to cancel out the effects of phase shifts (this is not a 100% accurate technical account of what actually happens, but we've got to keep the theory as simple as possible). This adds to the complexity of the decoder of course: a PAL decoder must have a delay line, a summing network, a switch to re-invert the polarity of the $R - Y$ signal – and a means of synchronising this switching with that carried out at the transmitter.

Operation of the Decoder

Right, now let's turn to the decoder. The best way of seeing what takes place here is to use a block diagram (Fig. 1). We'll start with the i.f. signal, which incorporates the luminance and chrominance signals (also the sound signal, but we're not concerned with that here). This is applied to one or more detectors to give us a video frequency signal. Only one detector is necessary, but an extra one is often used to make it easier to filter out the components of the composite signal, and also to minimise the generation of beat frequencies which can cause patterning (e.g. mixing the 6MHz sound signal and the 4.43MHz colour signal can produce a spurious output at $6 - 4.43 = 1.57\text{MHz}$).

The next step is to separate the luminance and chrominance components of the composite video signal. Fortunately this doesn't have to be a 100% process, and some simple filtering suffices. A notch filter tuned to the chrominance subcarrier frequency (4.43MHz) will effectively remove the chrominance from the luminance channel, which is shown across the top in Fig. 1, while a high-pass filter will ensure that the main signal component passed to the colour decoder consists of the chrominance signal.

The Luminance Channel

The luminance channel is a simple enough affair consisting, in addition to the filter, of amplification as necessary and the luminance delay line. The latter is required to keep the luminance and chrominance signals in

step since, as we pointed out in Part 25, the chrominance signal takes longer to pass through its narrower bandwidth circuitry than the luminance signal takes to pass through its wider bandwidth circuitry. We can forget about the luminance signal then, noting simply that at some later stage it must be added to the colour-difference signals in order to get the primary-colour signals required to give us the actual colour picture.

Burst Gating and Blanking

Turning to the decoder proper, the first obvious thing required is amplification of the chrominance signal. At an early stage, the burst signal must be separated out. It's not required in the chrominance/colour-difference signal path, where it could interfere with any clamping arrangements used in the output stages, so it's simply blanked out. Conversely, the chrominance signal is not wanted in the burst channel, where it would interfere with synchronisation of the reference oscillator. So a simple gate is used to allow the burst signal only through to its own detector.

The Burst Channel

Let's stay with the burst signal for a minute or two since there are some important points to be made here. First, while the amplitude of the chrominance signal will be varying as the colour-difference signals vary, its phase also varying as a result of the QAM process, the amplitude of the burst signal will be constant – except for changes due to variations in signal strength. This provides us with a convenient method of applying a.g.c. – or automatic chrominance control (a.c.c.) as it's generally called. We can use a simple half-wave rectifier to detect the amplitude of

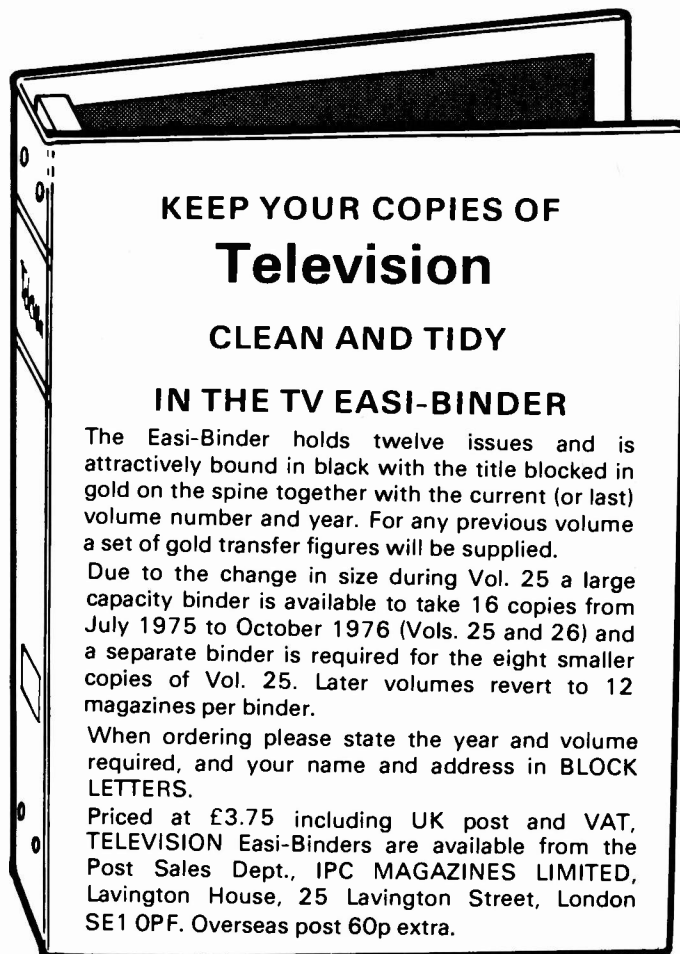

**KEEP YOUR COPIES OF
Television
CLEAN AND TIDY
IN THE TV EASI-BINDER**

The Easi-Binder holds twelve issues and is attractively bound in black with the title blocked in gold on the spine together with the current (or last) volume number and year. For any previous volume a set of gold transfer figures will be supplied.

Due to the change in size during Vol. 25 a large capacity binder is available to take 16 copies from July 1975 to October 1976 (Vols. 25 and 26) and a separate binder is required for the eight smaller copies of Vol. 25. Later volumes revert to 12 magazines per binder.

When ordering please state the year and volume required, and your name and address in BLOCK LETTERS.

Priced at £3.75 including UK post and VAT, TELEVISION Easi-Binders are available from the Post Sales Dept., IPC MAGAZINES LIMITED, Lavington House, 25 Lavington Street, London SE1 0PF. Overseas post 60p extra.

the burst signal, and use this to control the gain of the first chrominance amplifier. The amplitude of both the burst and the chrominance signals will be stabilised as a result.

Secondly, the burst signal is used to synchronise the frequency and phase of the decoder's reference oscillator. The process employed is very similar to flywheel line sync: the burst detector compares the phase of the bursts and the signal from the reference oscillator, and produces a control signal to pull the reference oscillator into lock. For this to be effective, it's vital that no chrominance signal, with its phase variations, gets through to the burst detector. So the shape and timing of the pulse used to open the burst gate are important. In many decoders there are controls to adjust this, and incorrect setting will result in colour faults. It's also vital for the pulses to be present. These are obtained from the line timebase (usually — the sync pulses themselves can alternatively be used to generate the gating pulse), since the gating has to be done at line frequency. No gating pulses equals no burst input to the burst detector and no output from it. Since the colour-killer works off the burst detector output, via the d.c. amplifier (if present) and the ident amplifier, no gating pulses will also mean no colour. So for the no colour fault you might have to check back to the line timebase: in the Thorn 8000 chassis for example the 33k Ω pulse feed resistor R404 often goes open-circuit to cause this trouble. We'll get back to the colour-killer in a moment. First it's necessary to say something about the phase of the bursts.

Since it's unmodulated, the burst's amplitude remains constant — except for variations due to signal strength changes. You might think its phase remains constant too, especially as it's used to synchronise the phase of the reference oscillator. In fact, due to the PAL switching at the transmitter, the phase of the burst varies by $\pm 45^\circ$ line-by-line. This doesn't affect the reference oscillator synchronisation, due to the long time-constant of the filtering components used. There is nevertheless an output from the burst detector at line frequency due to the PAL switching. This is called the "burst ripple". It's amplified by the ident amplifier and used to control the line-by-line switching of the PAL switch.

The Colour Killer

When the transmitted signal is a monochrome one, no burst is included. This provides us with a simple means of identifying whether or not the signal is a colour one. Why should this be necessary? Simply because if the chroma channel is left operative during a monochrome transmission, coloured noise could mar the colour set's monochrome display. So we want to switch the chrominance channel off on monochrome and switch it on with colour. We can do this quite simply by noting whether the burst is present, rectifying it and using the resultant d.c. potential to forward bias one of the chrominance amplifier transistors. In practice it's easier to rectify the ident amplifier's output instead — with no burst there's no ident so the effect is the same, but we can get a larger d.c. output by rectifying the ident signal.

Chrominance Signal Demodulation

Let's assume then that the burst signal is reaching the burst detector, and that the control loop is holding the reference oscillator in phase and frequency synchronisation with the transmitter's subcarrier oscillator. What do we do with the reference oscillator's output?

Synchronous detectors are used to demodulate the R — Y and B — Y signals. This means that the detectors are timed

— they are not simple half-wave rectifiers. The reference oscillator output is used to do the timing. As we've seen, the two transmitted colour-difference signals are modulated on to the suppressed subcarrier in quadrature. So a quadrature (90°) shift is required in the feed from the reference oscillator to one of the colour demodulators. This is usually to be found in the feed to the B — Y detector.

PAL Switch

The effect of the PAL switching can be reverted by inverting the R — Y signal feed to the R — Y detector or alternately inverting the reference signal feed to the R — Y detector line-by-line. In our block diagram the reference signal feed is shown passing through the PAL switch. The latter is driven by more pulses from the line timebase, with the output from the ident stage used to synchronise the switching.

The demodulated R — Y and B — Y signals are fed to the various matrixes shown, so that at the end of the chain we get the required R, G and B signals — or three colour-difference signals if the set uses colour-difference tube drive.

The Chrominance Channel

Now let's backtrack down the chrominance channel. We left the chrominance signal at the point where the burst signal had been blanked out. It's usual to provide a user colour control which operates at some point in the chrominance channel. Colour-killing we've already dealt with, so the only point left is the chrominance delay line and the add/subtract networks.

Delay Line Circuit

Since the delay time of the chrominance delay line is exactly one line, we can feed the chrominance signals from successive lines to the add/subtract network. Due to the line-by-line inversion of the R — Y signal, we get separated B — Y and R — Y outputs from the network and also cancellation of spurious phase shift effects. We're simplifying somewhat, but the purpose of these articles is not to provide precise theoretical explanations but to provide enough information to enable fault conditions to be understood.

The important thing from a fault point of view is that the amplitude and phase of the direct and the delayed signals fed to the add/subtract network must be identical, otherwise the addition and subtraction will be incorrect and the effect will be blinds on the display — since there will be errors in the outputs on a line-by-line basis. Controls are usually provided to enable the amplitude and phase of the inputs to the add/subtract network to be set up correctly.

This is one form of blinds. Another and more severe form occurs should the PAL switch stall, due say to the absence of the triggering pulse or, more likely, a defective transistor in the bistable circuit used as the active part of the switch. If for some reason the PAL switch is operating in the wrong phase, the result will be green faces.

Decoder Faults

When it comes to decoder faults, generalisation is hampered by the very wide divergence in the circuitry used in different decoders. Certain faults do apply in general, for example blinds due to incorrect alignment of the circuitry around the chrominance delay line, also troubles due to

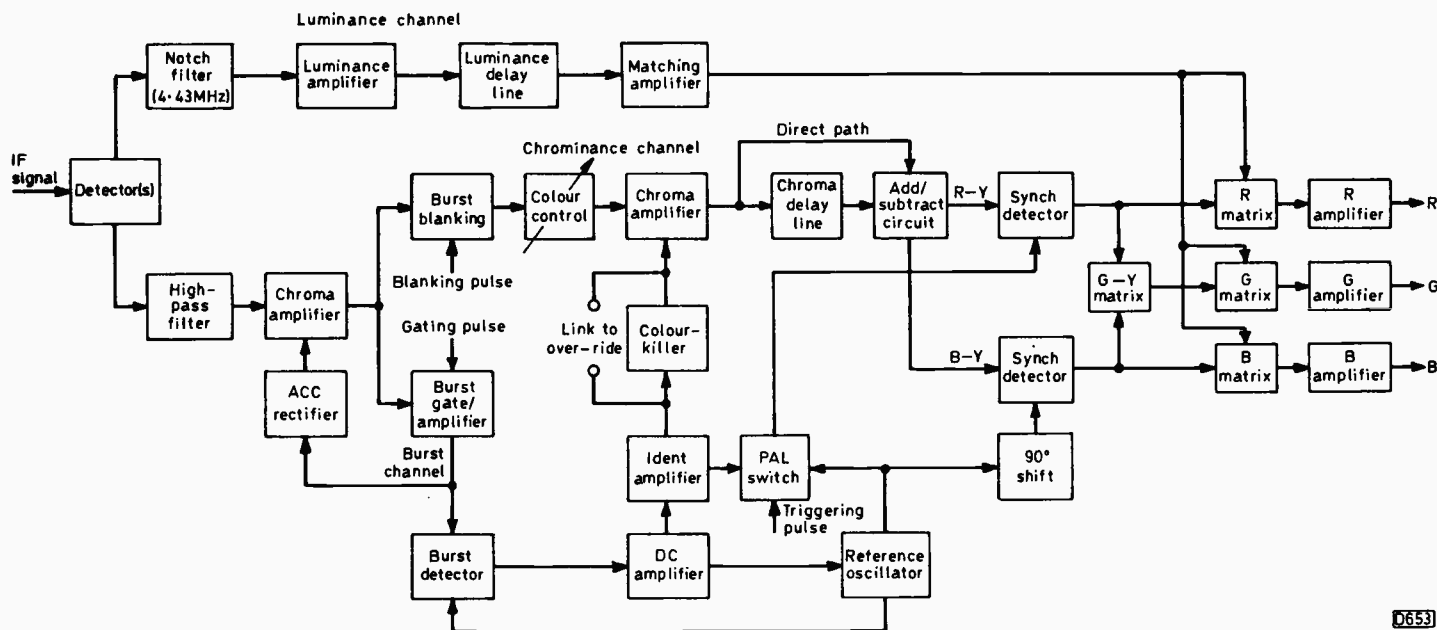

Fig. 1: Block diagram of a typical discrete component decoder.

incorrect burst gating. In some sets you get incorrect timing of the PAL switch, giving a vertical band of incorrect colour down one or other side of the screen. Probably the most common fault however is no or intermittent colour. What do you do?

Remember for a moment that the R - Y, the B - Y and the burst detectors are all of the synchronous type. This means that both inputs must be present in order to obtain an output. Furthermore the reference oscillator must be operating at the correct frequency. So no colour could be due to no output from the reference oscillator, no burst signal, failure of the colour-killer circuit to switch the chrominance channel on, or failure of the signal to get through the chrominance channel. Quite a lot of things to check you might think. In practice a single check tells you quite a lot. It's always possible to over-ride the colour-killer, thereby switching on the chrominance channel. Doing this will produce one of three results: (a) correct colour; (b) still no colour; (c) unsynchronised colour (bands of incorrect colour across the screen). Let's take these in turn.

Correct colour means that the colour killer is not working or there's insufficient output from the ident amplifier (low gain here may be due to mistuning or faulty decoupling): you've proved that the reference oscillator, the burst and the chrominance channels are all operative.

Still no colour means that there are still a number of things to check - the presence of burst gating pulses, that the reference oscillator is working, and that the burst and chrominance channels are operative. A scope is often essential when confronted with this situation. Note however that if the ident stage is operative, the burst channel and reference oscillator must be in order.

Unsynchronised colour means that the reference oscillator is working at the wrong frequency. There's usually a set oscillator frequency control. If adjusting this doesn't improve matters, check the burst detector (unbalanced diodes?), the d.c. amplifier (leaky transistor?) and the reference oscillator circuit (faulty capacitors?).

Reliability

There may seem a lot that can go wrong in the decoder. Most decoders are pretty reliable however - since except for a very few early ones they use transistor and/or i.c. circuitry, thus operating at low voltages and with little heat

dissipation. Faults that are particularly difficult to trace are likely to be due to print defects or dry-joints.

Convergence and Degaussing

Finally, there are one or two points still to be made on the subject of convergence circuitry (see last month).

In dealing with dynamic convergence circuitry we made the point that the energy used is derived from the timebases. This is something that can be overlooked, and sometimes fools even the experienced. What we are getting at is that partial or complete collapse of the line or field scan can be the result of a fault somewhere in the convergence circuitry.

Take the Rank A823 solid-state chassis for example. In the event of line or field collapse on this chassis one does not immediately leap to the relevant timebase, looking for defective transistors, transformers etc. - in fact changing the line output transistors in this chassis is no joke. In the event of line collapse, showing up as severe lack of width, it's much easier to check up on something else. That something else is the R/G horizontal tilt control 7RV3 (a 7Ω preset), which may not be the obvious thing to check. It's the second potentiometer from the left at the top when the convergence panel is swung up in the operating position, viewed from the rear. The wiper of this control is the earth return path for the line scan current you see.

A similar state of affairs can occur with the field scan, where almost total collapse may well be due to a defective control (6RV2, 5Ω, vertical scan balance) or a poor connection to the pincushion phase control 6L20. These two components are on the scan control panel - the small subpanel on the upper right side, carrying the shift controls etc.

One more little hint. Whilst the degaussing coils are arranged around the bowl of the tube, the associated components may be elsewhere. On this Rank chassis for example they are mounted on the power supply panel. There's a black plug which connects to a socket on the power board: it supplies the tube heaters and the degaussing coils. If this plug is left disconnected (say after removing and refitting the decoder panel) a cloud of smoke will arise from a resistor (8R5, 680Ω) on the power supply panel when the set is switched on - because the degaussing coils are not connected, leaving this poor little resistor across the mains input.

Introduction to VDUs

Andrew Parr, B.Sc., C.Eng., M.I.E.E.

ONE of the interesting side effects of the wider use of integrated circuits is the blurring of the traditional dividing lines between various electronics subjects. A striking example of this is the Visual Display Unit, which neatly straddles many electronic disciplines.

A visual display unit (or VDU as we shall call it) is a device primarily designed to display data from a computer, but the techniques involved are used in many other areas like teletext and communications. To the user, a VDU is a c.r.t. on which data is displayed: it can be considered as a replacement for a computer print out where a permanent copy is not required.

The essential components of a VDU are shown in Fig. 1. Let's assume that our VDU is to display 24 rows of characters, each row containing 72 characters (a common standard). Incidentally we shall refer to "rows" of characters to avoid confusion with TV lines. Data from the computer must be stored prior to its display, so the VDU's store must be able to hold 24×72 characters = 1728 locations. Each character is sent from the computer as an 8-bit code, so the store consists of 1728 locations each capable of holding 1 byte (1 byte = 8 bits). As we shall see later, it's convenient to consider the store as being arranged in the same manner as the display, and to have each location addressed by an X address determining the character position in a row, and a Y address determining the row (see Fig. 2). The location 57, 18 thus refers to the 57th character along the 18th row.

Having got the data from the computer to the store, we must now display it. This is done by the block labelled the display logic, in conjunction with the TV monitor. There have been many ingenious schemes for displaying characters on a c.r.t., some of the more interesting ones being described below. The majority of VDUs nowadays

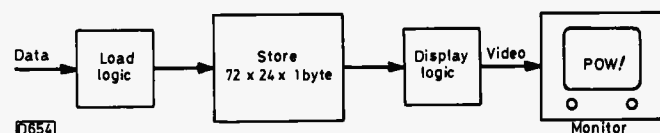

Fig. 1: Basic VDU block diagram.

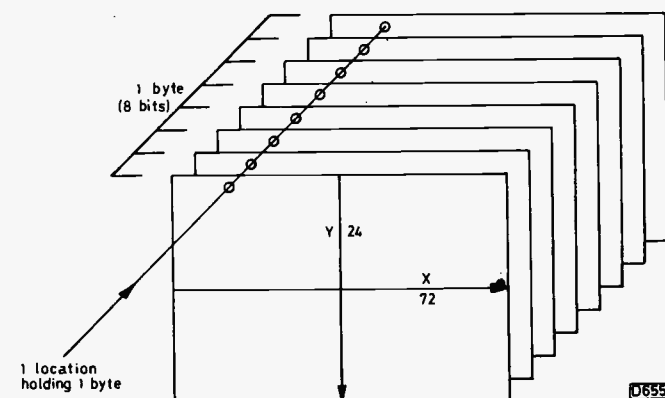

Fig. 2: Representation of a VDU's data store.

use a perfectly ordinary CCTV monitor. The signal used to drive the c.r.t. in these VDUs is thus a normal composite video signal, and this technique is known as a raster-scan VDU.

Historical Diversion

Early VDUs used deflection plates to move the electron beam of the c.r.t. and thus trace out the display. By the use of the tube's blanking grid, the electron beam could be turned off between letters. Two techniques using this method are shown in Fig. 3.

Fig. 3(a) uses the beam to trace out the letter, the control logic producing tortuous voltages to drive the X and Y deflection plates so that the required shape is drawn out. Fig. 3(b) shows a method using a small raster at each character position, with correctly timed bright-up pulses being used to produce the characters. This technique is similar to that employed by the raster-scan VDUs used today, but requires a specially designed display unit.

These early VDUs were about the size of a large filing cabinet, and cost about ten times as much as a computer printer. So early VDUs were considered a luxury and something of a status symbol. Today however a VDU using a few i.c.p.s can be built for a fraction of the cost of a printer. It's now considered a luxury to have a printer, and VDUs are supplied wherever possible.

Raster-scan VDUs

The vast majority of modern VDUs employ a normal CCTV monitor. The display appears as a white character on a black background (or vice versa). The video signal fed to the c.r.t. therefore consists of white pulses at the correct points along each TV line. Fig. 4 shows a typical display and the corresponding pulses.

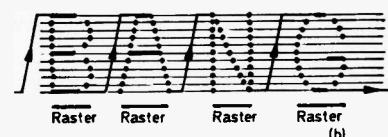

Fig. 3: Early VDU schemes.

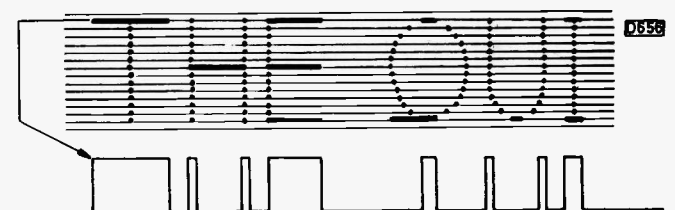

Fig. 4: Raster-scan VDU display, with the corresponding video pulse waveform.

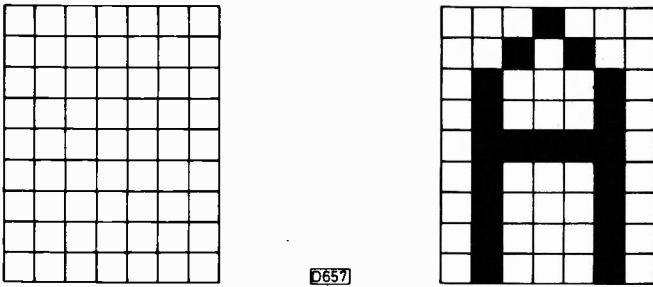

Fig. 5: Seven by nine dot matrix, showing how the letter A is formed.

To standardise the display, each character cell is broken down into a matrix of dots. Common arrangements are 7 x 10, 7 x 9, and 5 x 7. Each line of the matrix corresponds to a line of the TV raster (for larger characters, each dot can be repeated for several successive TV lines). Fig. 5 shows a matrix block of 7 x 9 dots, and the dot pattern for a letter A.

A row of characters consists of a row of character cells as shown in Fig. 6. Each cell corresponds to one location in the VDU's store. Each row of characters will be traced out one line at a time, so we get:

- line 1 character 1 row 1
- line 1 character 2 row 1 etc. to
- line 1 character 72 row 1
- line 2 character 1 row 1
- line 2 character 2 row 1 etc. to
- line 9 character 72 row 1, then
- line 1 character 1 row 2 etc.

and so on for all rows.

The characters are stored in the VDU's store in the form of an 8-bit logic word, and are converted to the dot matrix by a special ROM (read-only memory) i.c. called a character generator. Ideally, this would give us all 63 dots

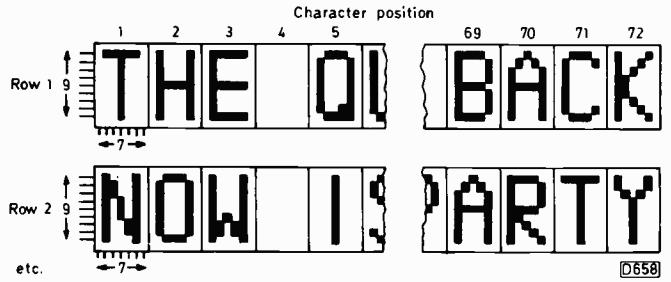

Fig. 6: Character cells.

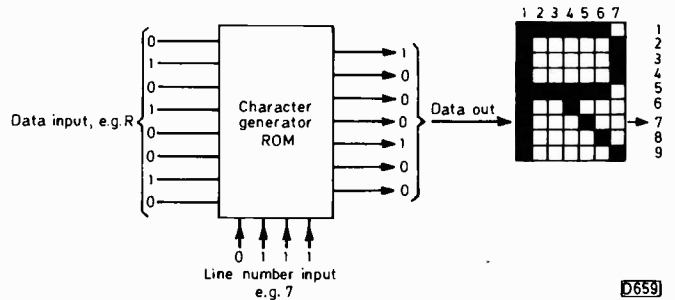

Fig. 7: Operation of a character generator ROM.

of a character cell at once when presented with an 8-bit code. Unfortunately pin considerations make this impossible (40-pin i.c.s being the largest readily available). We don't require all 63 dots at once however. As we saw above, we draw one line of a character at a time. All we require from the ROM therefore is the data for one line.

A logic diagram of a typical ROM is shown in Fig. 7. There are two inputs: an 8-bit data input representing the character required, and a 4-bit input telling the ROM which line we want. The seven outputs give us the 7 dots for the selected line of the selected character.

Suppose we are displaying the letter R, and that we are drawing the 7th line. Our inputs are the data for R,

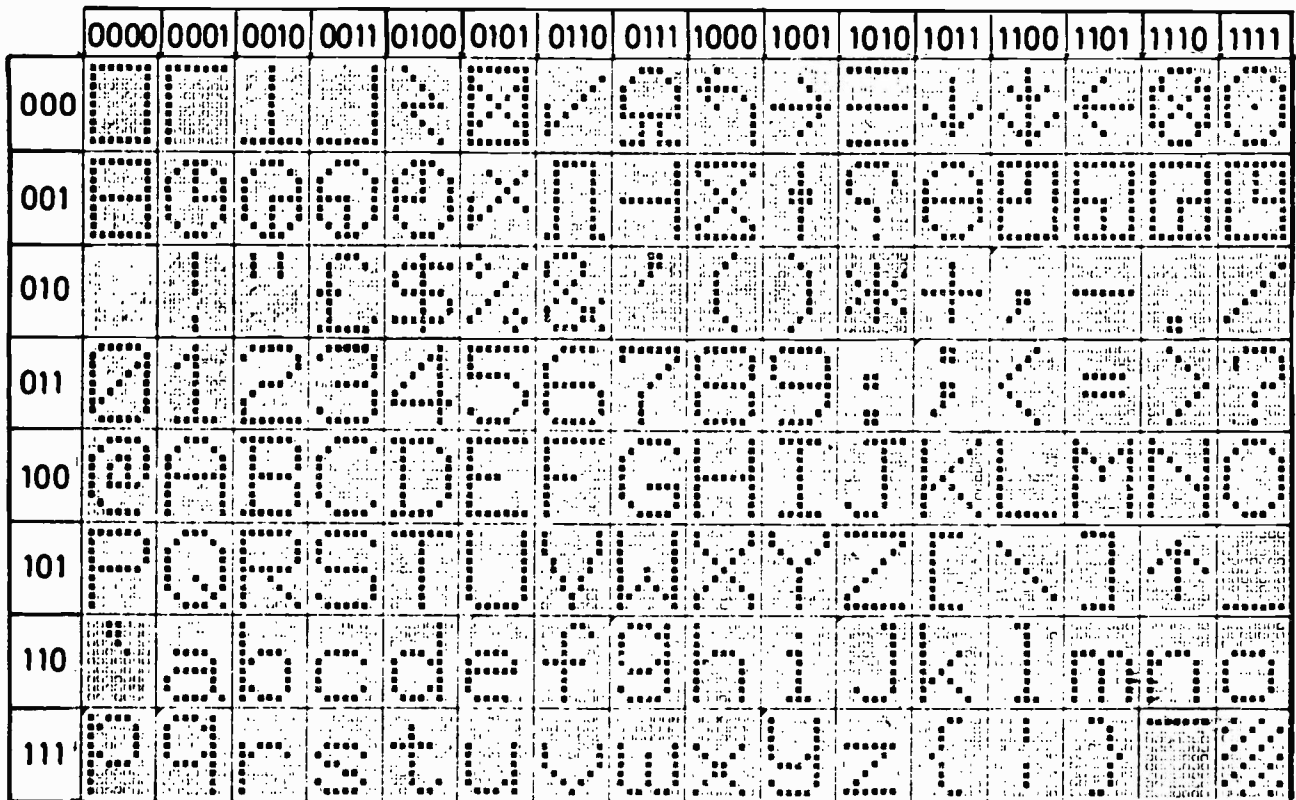

Fig. 8: The MCM6576 character generator ROM's character set.

"01010010", and our line, which is 7, "0111". The ROM gives us 1000100 which is the dot pattern for the seventh line of letter R. To summarise: we provide the ROM with the data and the line number; it gives us the seven dots for that line.

A typical character generator ROM is the MCM6576, whose character set is shown in Fig. 8. This ROM uses a 7-bit data input (ignoring parity) giving 128 characters. The most significant three bits are obtained from the vertical column at the left-hand side of the array, and the least significant four bits from the horizontal row at the top. The code for 6 is thus 0110110 (or 36 in hexadecimal).

At this point we must remember that a TV picture is time related. The position of any point on the screen is defined by its line number and by its time from the line sync pulse. The seven dots from the ROM need to be scanned in sequence to turn them into a video signal. This is done by loading them into a shift register at the start of the character, then shifting them out at the correct rate (see Fig. 9). Having converted the seven dots for one line of one character into video, we now move on to the next character and repeat the operation. At the end of the line we start again. This is achieved by a simple, if somewhat lengthy, timing chain.

We have already described how the data is held in a store with an X address (corresponding to the character position) and a Y address (corresponding to the character row). The timing chain has to provide: (a) An X address to the store. (b) A Y address to the store. (c) A lines number to the character generator ROM. (d) The load and shift (clock) pulses for the shift register in Fig. 9.

The basis of a VDU timing chain is shown in Fig. 10. We shall assume that the VDU displays 24 rows of 74 characters per row, and uses a 7×9 dot matrix.

The chain starts with a clock generator. The clock pulses go to a sync pulse generator, and also to the shift register to convert the ROM data to a video signal. After seven clock pulses we move on to the next character in the row, so we have a divide-by-seven counter. This controls the loading of the shift register, and steps the X address counter. The displayed character is thus stepped on after each seven dots.

When we come to the end of the line, we step on the line number counter. This counts up to nine to provide the line number to the ROM. When all nine lines have been displayed, we step the Y counter, and start again at line 1, character 1 on the next character row.

We now have the correct video coming out of the shift register, and all that remains is to add the sync pulses and provide a buffer amplifier to drive into a 75Ω line.

Fig. 10 is somewhat simplified, ignoring details such as blanking periods and the gap between rows. All raster-scan VDUs use the same basic arrangement however. Not surprisingly, special i.c.p.s called c.r.t. controllers have been developed for the implementation of the timing chain and control.

Loading the Store

We have seen how we can convert the data in an X, Y addressed store into a VDU display. To be of any use however, we must be able to load the data into the store in the first place. This falls naturally into two parts: data transmission from the computer to the VDU, and the internal arrangement of the store itself. We will deal with the latter first.

Data from the computer is normally loaded into the store in one of two ways. The first is called scroll mode. In this mode, the data is loaded along the bottom row of the VDU (i.e. row 24), and when the computer sends a "new row"

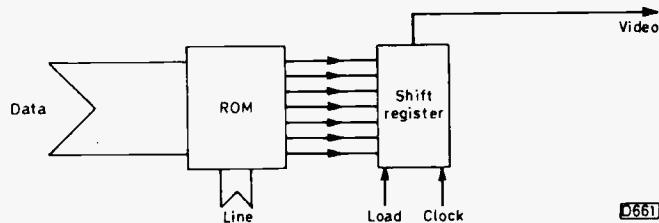

Fig. 9: Use of a shift register to convert the ROM's output to a serial video signal.

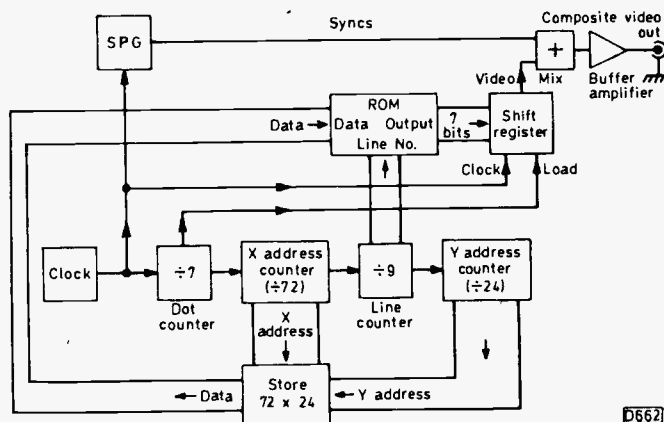

Fig. 10: Detailed VDU block diagram.

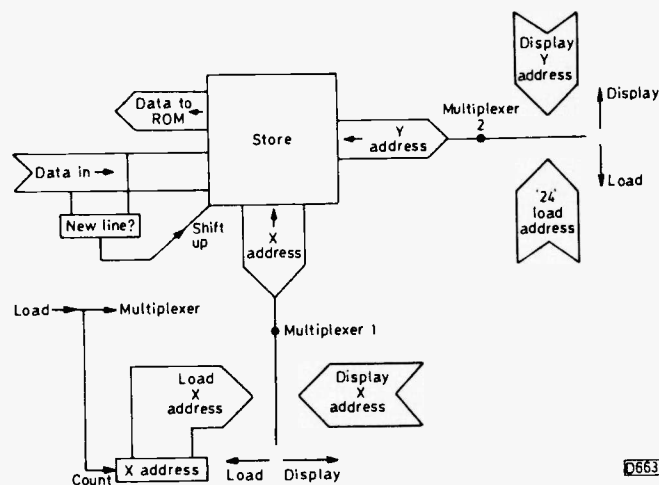

Fig. 11: Logic for scroll-mode operation.

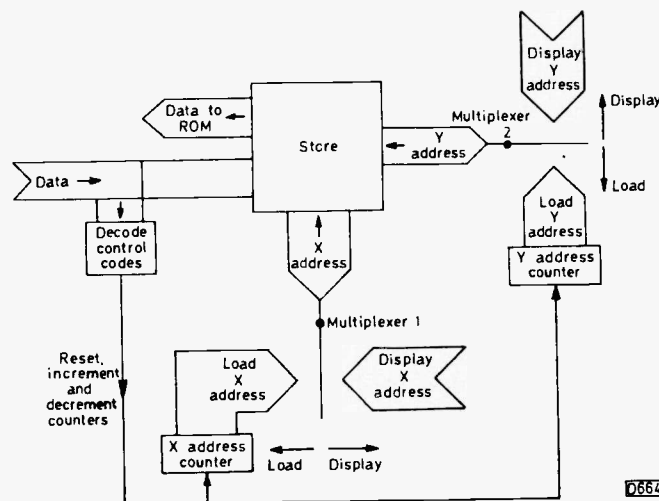

Fig. 12: Logic for page-mode operation.

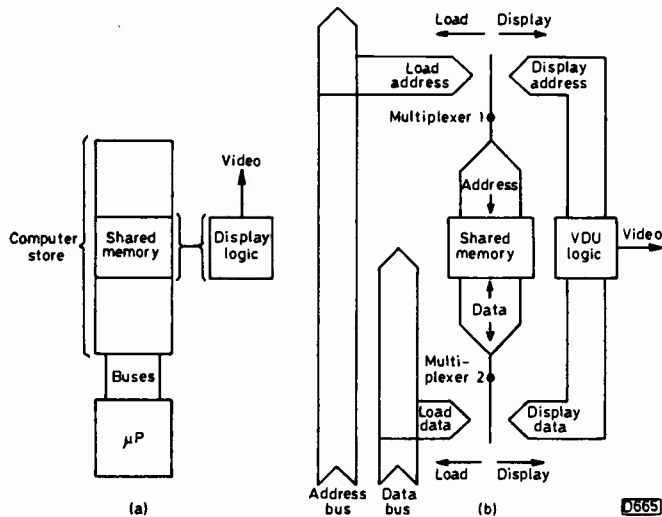

Fig. 13: (a) Basic memory-mapped VDU arrangement. (b) Detailed block diagram of a memory-mapped VDU.

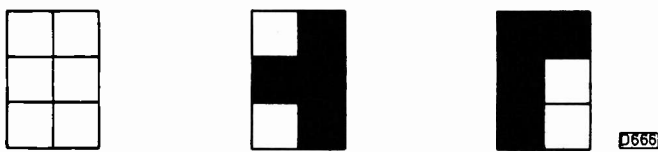

Fig. 14: Graphics character cell.

signal all rows move up by one (i.e. row 24 goes to row 23 and so on, row 1 now being last). The screen thus resembles a sheet of paper scrolling up from a typewriter. Hence the name.

The logic required to achieve this is quite simple (see Fig. 11). Two multiplexers select the X and Y addresses from the timing chain except when data is being loaded. When data is sent to the store, the multiplexers change the X and Y addresses to the load logic. The Y address is simply "24"; the X address is a counter incremented each time a character is loaded. The incoming data is checked to see if it means "new row". If it does, the logic shifts all the store data up by one row and resets the X address counter to the first character position again.

Scroll mode is very easy for a programmer to control, but has many limitations. It cannot be used for example to display fast changing data, or to construct mimic diagrams. Greater versatility is given by the operating mode called page mode.

In page mode, a single character can be written in any position on the screen. The current writing location is defined by the X, Y coordinates of a cursor, and control codes are used to move the cursor. The control codes commonly provided are:

Cursor home	(i.e. X = 1, Y = 1, top left of screen)
Cursor up	(decrement Y)
Cursor down,	(increment Y)
Cursor left	(decrement X)
Cursor right	(increment X)
Cursor return to start of row	(i.e. X = 1, Y unchanged)
Cursor at	(X, Y)

In the absence of any cursor control, the cursor continues normal movement by incrementing X after each character is loaded. Using cursor control, static displays are provided, and individual bits of data can be changed without affecting the rest of the screen.

The logic required to achieve page mode is, of necessity, more complex than for scroll mode. The basis is shown in

Fig. 12. We now have two counters for load purposes: one for the X address and one for the Y address. These are selected by the two multiplexers when data is to be loaded into the store. Control codes are decoded and used to increment, decrement and reset the X and Y counters.

In both the scroll mode and page mode it will be noticed that there is a clash of interests between the timing chain reading from the store and the load logic writing into the store. The load logic always wins, and the brief flicker on the screen is not normally noticed unless data is being loaded continuously. Careful use of buffer registers in the design can reduce the flicker considerably. Commercial VDUs will usually operate in both the scroll and page mode, selection being done by special control codes.

If the VDU is an integral part of a computer system, a simple technique called a "memory-mapped VDU" can be used. The VDU data store is part of the store of the computer, as shown in Fig. 13(a), and the computer has access to each location by the normal fetch, store instructions.

The arrangement is shown in more detail in Fig. 13(b). The VDU display logic produces video in a similar manner to Fig. 10, but when the computer wishes to have access to the store the address and data multiplexers change over to the computer address and data bus lines. When the transfer of data is complete, the multiplexers switch back to the VDU display logic.

Memory-mapped VDUs are inherently a form of page mode, since each location can be changed independently. Programs to drive memory-mapped VDUs are simple to write, as each position on the screen corresponds to a store location. The computer can also read back data from the store, which can be useful in some programs. Unfortunately the address and data buses in a computer need to be quite short, and a memory-mapped VDU can only be implemented as an integral part of a computer.

Graphics

VDUs are widely used for mimic diagrams and games. In these applications the VDU must be able to draw rudimentary pictures in addition to the normal alphanumeric symbols.

Simple low-resolution graphics can be obtained by using the dot matrix to form various block shapes which can be assembled as required. A common arrangement is the normal character cell split into the six blocks shown in Fig. 14. These are normally taller than the alphanumeric symbols, bridging the gap between rows to allow large solid areas to be drawn. Teletext uses low-resolution graphics to good effect for titles and illustrations.

High-resolution graphics are used where fine details are required. Examples are graphs and some games. In high-resolution graphics, each and every dot in the character block can be selected by the program. One common technique is to have several 8-bit data codes reserved for "user defined" displays, allowing the program to define a particular character. This approach is very useful if you want a stagecoach and cacti for a cowboy game. A second common approach is to increase the range of the addressing, so that each and every dot can be addressed and given the state "1" for on or "0" for off. A typical high resolution VDU would allow addressing of 500 x 200 individual dots.

Programming for high-resolution graphics is obviously more complex, but the results are very impressive. Often "intelligent" VDUs employ an internal microprocessor to provide functions like "draw a line from 256, 18 to 40,

187", or "draw a circle centre 48, 42 radius 18". The internal microprocessor works out the relevant dots to be illuminated.

Colour

Colour adds a new dimension to VDU displays, and is especially useful where attention needs to be drawn to part of the screen. Colour VDUs employ a three gun c.r.t. similar to domestic TV sets, giving a choice of eight colours: red, green, blue, yellow, cyan, magenta, black, white. Conveniently, eight colours can be represented by three binary bits.

The simplest means of programming a colour VDU is to do colour changes by control codes. A control code will appear as a black on the screen, so colours can be changed at each space between words or at gaps in graphics. Teletext uses this technique to define colours, but it has several limitations. It's not possible to use different colours within a word, and normally the background colour is fixed. In graphics, the colour control code will appear as a gap between different colours. Teletext uses the "hold" control code to maintain colours over control codes, but this is a bit laborious.

Greater versatility can be obtained by increasing the length of the data word to two bytes. The first byte defines the character or graphics symbol as before. The second byte is split into two 4-bit nibbles. One defines the character colour, the other the background colour. There are now no restrictions on the colours, and each letter in a word can have a different colour background. The one disadvantage of this technique is that the data store needs to be double the size (X by Y by two bytes), with a corresponding cost penalty.

Colour VDUs normally use commercial colour monitors. PAL encoders and decoders are used where long cable runs are necessary between the VDU logic and the monitor, but it is normally preferred to run separate RGB and sync signals rather than composite video. Very rarely, domestic u.h.f. receivers are used, but the results are somewhat inferior to direct video drive. The setting of the convergence on a colour VDU monitor is very important, as the crisp edges of VDU signals readily show any convergence errors.

Data Transmission

The final problem is the transmission of the data from the computer to the VDU. A character is represented by 8 bits, so we can send the data along 8 lines (called parallel transmission) or by an 8-bit pulse train on one line (called serial transmission). These two techniques are summarised in Fig. 15.

Parallel transmission is faster than serial transmission, but is obviously more expensive as eight times as many cores and eight times the electronics are needed. As economics govern most things, serial transmission is almost used universally used.

Computers and VDUs operate internally in parallel however, so at each end of a serial link we need a device to convert from parallel to serial and vice versa. In its simplest form this consists of the shift registers shown in Fig. 16. Data is loaded into SR1, then clock 1 shifts it on to the line one bit at a time. Clock 2 loads the data into SR2, where it's available for reading in parallel. Special i.c.p.s are available for this conversion, quaintly called UARTs (Universal Asynchronous Receiver/Transmitters).

The data format is shown in Fig. 17. In the quiescent

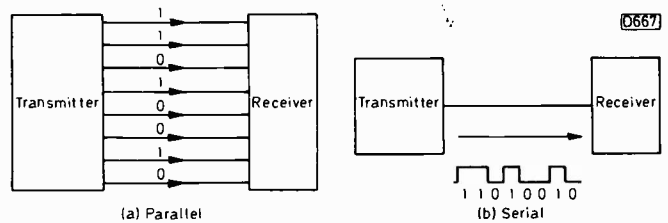

Fig. 15: Parallel and serial data transmission.

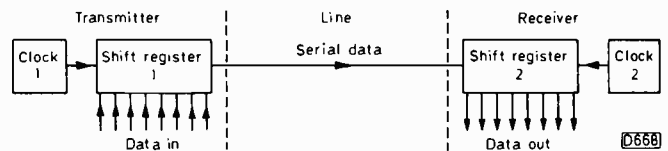

Fig. 16: Parallel to serial conversion.

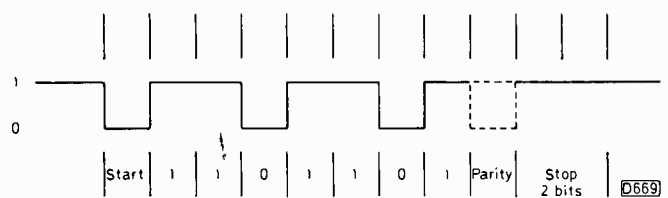

Fig. 17: Serial data format.

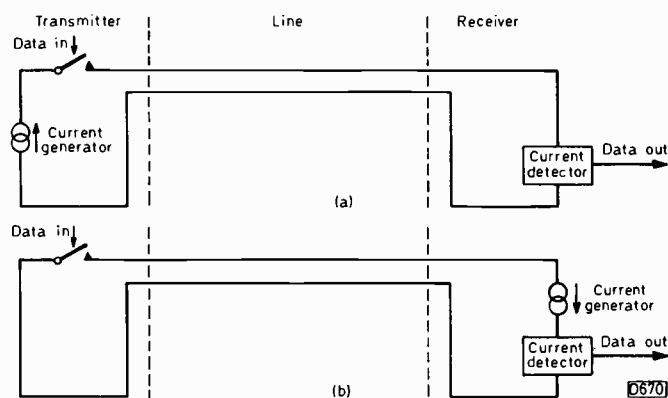

Fig. 18: The 20mA current loop system. (a) With active transmitter and passive receiver. (b) Passive transmitter and active receiver.

state, the line is at a 1. The first bit is a 0 start bit, followed by seven data bits and one parity bit. Two stop bits indicate the end of the character.

If the link is to work correctly, clocks 1 and 2 must match, although the data format does provide a certain amount of synchronisation. The speed of transmission is measured in "Baud", where one Baud is one bit per second. A computer teletype operates at 110 Baud. Since one character takes 11 bits, including the start and stop bits, a teletype will print 10 characters per second. Most VDUs operate at 1200 Baud.

There are three standards used to define signal levels on a serial link. The most common is the 20mA current loop summarised in Fig. 18(a). The data is carried as current pulses, 20mA representing a 1 and 0mA a 0 (and the start bit). Because it's a current loop, this system provides excellent noise immunity.

Unfortunately, no one has ever made the 20mA current loop official, so inconsistencies exist between different equipment. In particular, no one has stated specifically at which end of the line the 20mA is generated. Fig. 18(a) has an active transmitter and passive receiver; Fig. 18(b) has a passive transmitter and active receiver. Little communi-

cation can take place if the transmitter and receiver types do not match!

The second and third standards are almost identical. V24 is a European standard and RS232 an American standard. These use voltages rather than current, and represent a 1 by a negative voltage and a 0 by a positive voltage:

	V24	RS232
Binary 1	-3V to -15V	-6V to -15V
Binary 0	+3V to +15V	+6V to +15V

In general, V24 and RS232 devices are compatible. I.c.p.s are available which convert direct from TTL and CMOS signals to V24/RS232 standards.

Uses

VDUs are mainly employed as computer output terminals. They are very versatile devices however, and the two examples below illustrate other uses.

Word processors are a current boom industry. Text for correspondence, forms or literature is typed on to a VDU screen. Errors can be corrected, standard phrases inserted, and modifications carried out on the screen. When the text is correct it's printed out on a normal printer. In addition, copies of the text can be stored on magnetic tape or disc for future use.

VDUs can also be used as part of a creative design procedure. Computer Aided Design (CAD) was originally developed in the American aircraft industry, but is now appearing in many drawing offices. Very high-resolution VDUs using techniques similar to Fig. 13(a) are used, in conjunction with special keyboards and light pens, to produce engineering drawings. The drawings are stored in



An example of what can be achieved by high-resolution graphics - a computerised dollar bill.

coordinate form, and can be enlarged, sectioned and rotated in any place. Completed drawings can be fed out to X, Y plotters for hard copy, or direct to numerically controlled machine tools. Management of drawings is simplified, because all masters are kept on computer discs. To give an idea of the size of the problem, a medium sized engineering works may utilise over 1,000,000 engineering drawings including revisions.

Acknowledgement

The author would like to thank Strathand Ltd., 44 St. Andrews Square, Glasgow for their assistance and for the use of the Apple II computer used in the illustrations in this article.

Equipment Review: Technalogs PG6RF Pattern Generator

Roger Bunney

LAST January I reviewed the Technalogs PG6RF pattern generator. This provides grey scale, peak white raster, vertical line, horizontal line, dot and crosshatch patterns. I recommended it as excellent value in view of the useful patterns it provides, its low consumption of only 6mA from a PP3 battery, and its competitive price. Some while later a printed board add-on unit providing colour bars became available. This is powered from an additional 6V source, and interfaces with the PG6RF main board via ten wires from one of the i.c.s and an additional single connection between two points on the respective boards. It fits neatly into the Vero box which houses the unit. I've recently added one of these boards to the basic unit and tried it out.

Construction is simplicity itself, though care must be taken when soldering the 17.734MHz crystal into circuit to avoid overheating the leadout wires. If the C6 (as it's called) is being built as an add-on unit to an existing PG6RF pattern generator, the IC10 pad on the unit will require ten wire connections to link it to IC4 on the main PG6 board, also a further wire between pin 10 of IC9 and the emitter of Tr1. The original on-off switch is replaced with a two-pole two-way (centre off) switch. This is rotated through 90°,

giving a centre off position, the original patterns to one side, and coded PAL colour bars with the switch in the other position and the pattern selector switch set to the grey-scale position. Mechanical fixing involves drilling four holes in the PG6 board to match the corresponding holes in the C6 board: one-inch pillars are provided to give adequate spacing. Take care to match the C6 access holes for VR1 and VR2 on the PG6 board.

Alignment is also a simple matter. A small trimmer TC1 is adjusted for the 4.43MHz colour subcarrier at a given point, using a scope, or alternatively for locked colour bars of maximum saturation displayed on a colour set's screen.

If the complete CPG6RF kit is obtained, construction is similar except that IC4 is mounted in position IC10 on the C6 board, sixteen wires being used to link the two positions.

The colours provided are the standard white, yellow, cyan, green, magenta, red, blue and black. The separate 6V power source referred to above is provided by an integral four HP7 "pen cell" plastic container. Some 20mA is drawn from this. The r.f. output is similar to that described in the previous review.

As a kit, the C6 add-on unit costs £18.99 inclusive of VAT - the complete CPG6RF costs £42.55 in kit form. Versions with a v.h.f. output are available for use in overseas countries using systems B and I.

For the serviceman, one improvement that could be made would be to fit an instrument case handle on the upper cover of the ABS Vero box to make the unit easier to carry around.

The price of the C6 and the CPG6RF, the weight, size and appearance, make it an attractive and versatile piece of test equipment which I can fully recommend. Certainly the technical performance is unmatched at this sort of price. ■

connected across the supply to prevent it rising above 47V – it's designed to short out, which is why it is not of a more manly type. When it's found shorted (as we found it) one tiptoes around a bit. Whilst the makers say that failure of D51 can be due to C601 becoming open-circuit, we're more inclined to look closely at the line output transistor since a collector to emitter short here will slap a sizeable chunk of h.t. straight on to the poor little zener. Sure enough, the BU108 was short-circuit.

A new one was fitted, after a struggle, at which point Dennis departed to do some shopping: he said he'd call back in an hour or so. The agony then started.

We thought we were being careful, unhitching the tripler and checking the lines before chancing mains application. All seemed well, so we connected a meter across the fuse holder and switched on. The meter swung across to over 3A, and instead of falling started to rise. We hurriedly removed the prod and carefully rechecked the h.t. line and the line output stage. The new little zener was short-circuit, but the new BU108 seemed o.k.

We next decided to chase the cause of the burnt 4.7kΩ resistors on the top of the transformer, though we were inclined to think that this was a legacy from some previous incident. The resistors read right, but we thought we'd change them and check the circuit with them out. There appeared to be a resistance reading where there shouldn't be one, and step by faltering step took us to the line output transformer winding – which had a leak to the core. "Oh dear" we said, "fancy that. Dennis will be pleased."

We had a replacement transformer in stock, and after a tussle it went in. I still don't like double-sided print, and will tell Arnold one of these days when and if I tie up alongside him. So the transformer was fitted and we decided that it would be better to fit a 3.15A supply fuse and stick a voltmeter on the emitter of the BU108 instead of a new zener. We crossed our fingers and eyes and switched on. The meter said 40V, and the sound came up normally. "Oh goody" we said. "Now we can hook up the tripler."

So we did that and fitted a little zener. This was a bad mistake. There was a hum and the zener burnt out. The tripler was faulty after all, the new BU108 was no longer new.

Dennis appeared with his shopping and his wife. "Not finished it yet?"

I looked sick. "I hope you've got plenty of money left after your shopping." He looked sick.

I told him the sorry tale. The tripler felt sick and this made the output transformer and the output transistor feel sick which made the zener and fuse fail and now I'd just lost another transistor and zener so I felt sick. While this was happening other sick sets were coming in, and I felt like volunteering to become a kamikaze pilot and end it all in one reckless dive. Actually I didn't, which is why I'm sitting here tapping away on this typewriter. We'll draw a veil over the rest of that day's happenings.

Female Logic

Monday dawned dull and drizzly, and whatever good spirits we started with swiftly vanished.

"Our set is too big to bring in. Can you call? It's probably only a fuse." Since they also said it was a 26in. Philips colour set (G8) I was inclined to believe this, but it still seemed a long way to go (several miles) to replace a fuse – at my age. Anyway we set out with our box of fuses etc.

On the way we had to negotiate a roundabout. As there was nothing coming from the right I proceeded around it. A

car appeared from an entry on the left, straight across my path. I had to brake hard and so did the other vehicle – a car driven by a middle aged lady. She looked at me indignantly.

"I nearly hit you. Why can't you drive more carefully?" I thought this a little bit much, since she should have given way.

"It was your place to give way – to traffic coming from the right" I pointed out.

"Normally yes" she snapped. "But certainly not to an old vehicle like yours. Mine is much newer and you should have given way to me."

I'm always defeated by feminine logic, and this was about the most logical thing I'd ever heard.

"Very sorry ma'am" I said, touching my forehead as I didn't have a hat to raise. "It won't happen again. *I'll smash straight into you next time!*"

So on we went, bawling and shouting obscenities at all and sundry until we finally arrived at Lower Higham.

I rang the bell of number nineteen and waited . . . and waited.

Finally a cheerful lady appeared from around the side of the house. "I'm round the back dear, so I didn't hear you round the front."

That's the second one I thought, but meekly followed her around the back and through the kitchen.

The set was in a room leading off the hall, and the hall was cluttered up with bits of central heating gear. This meant I'd be hard put to it to take the set away if I had to. The size of the set was another good reason.

Off came the back and we went straight behind the left side plug cover to the 3.15A fuse. It was intact, and our spirits sank a bit. With the mains switched on the tube heaters lit up and the voltage appeared at the fuses on the power board. This meant that in all probability the 800mA fuse on the right side line scan board was open-circuit. It was.

I removed the screening cover from the line output transformer and put the ammeter across the fuse holder. It read 2A and there was a spark inside the transformer winding. This was as expected and feared, since the one thing I hadn't brought along was a line output transformer. Fool.

I weighed up the alternatives and made the wrong decision. "You need a transformer. I'll have to go back to the shop to get one. Won't be long – I hope."

I was. All sorts of things needed sorting out, but I finally arrived back at Upper Lowham or somewhere, anyway at number nineteen. Round the back and through the kitchen. Hubby had arrived home by this time.

"Transformer eh? Thought it might be. Mind if I watch you fit it?" So we settled down to replace the transformer. Out with the panel and lay it on a newspaper to save the carpet from the droppings of my soldering gun. Make a note of the connections as my memory is feeble. I can still remember some things though. Like it's 1969.

It didn't take long to fit the new transformer, but it was one of those without the tripler nipple. The nipple is easy to remove from the original, so off it came and was swiftly plonked on with no trouble (I thought) and securely soldered into place. Refit the panel, check that all plugs are in position except the tripler (oh no, not again), stick in the 800mA fuse and switch on. The sound came on for a split second and then plonk, the fuse blew. Once again I felt sick.

The tripler wasn't connected so that was out. I'd also checked the line output transistors, the transducer etc.

Investigation showed that one of the line output transistors was short-circuit but not the other. Rummage in

box to find another BU205, thinking why, why, why? Out came the faulty transistor and in went the new one. Check around with the ohmmeter, and get some funny readings as the emitter of the other transistor was correctly connected to chassis but so was its collector, which suggested that it was short-circuit. I'd only just checked it when the heatsinks were off however and it read right then. A shorted tuning capacitor? No.

Just as I was about to die, I looked at the top line drive panel and there on the top right was a thin sliver of solder from the chassis screw to the 1Ω base resistor. I felt a bit awkward.

"Some clumsy bugger has let some solder fall on the panel where it shouldn't be."

"Yes, I saw it drop when you were soldering on that nipple. I thought you saw it too and it didn't matter." Funny how some people are good at things and others never quite get the hang of it.

With the short cleared, the tripler could be connected and a picture displayed. A pretty grim picture it was too.

"We've never had good colour on this set. The other people said there was nothing that could be done."

I couldn't quite understand this, since the tube seemed quite good. Resetting the drive controls and the first anode presets restored a very reasonable grey scale, and a touch

on the convergence made an immense improvement. When the colour was turned up, faces looked like faces and not like burnt toast.

So the job was wrapped up, and we regained a little of our shattered confidence – until we looked at the picture again and found that the red had dropped out. Out tools, off back (again), and check the colour drives. Horrible dry-joint on the red amplifier base. Resolder and recheck. Wrap up (again) and get out quick.

Back at the Ranch

"You've been a long time. I don't know: it seems to take you longer and longer to do these outside jobs lately. Are they all that hard to sort out?"

"I don't know either. I never seem to do anything right first time."

"Perhaps it's your age. Can't you take some of that stuff that fortifies the over fifties?"

"I do. Sometimes I take whisky, sometimes brandy. Both fortify me. What does fortify mean anyway?"

"How do I know? You'd better get on with mum's set though. If she doesn't have her telly tonight she'll go barmy."

Oh! I do love my mother in law . . .



All boards are epoxy glassfibre and are supplied ready drilled and roller-tinned.

Any correspondence concerning this service must be addressed to READERS' PCB SERVICES LTD, and not to the Editorial offices.

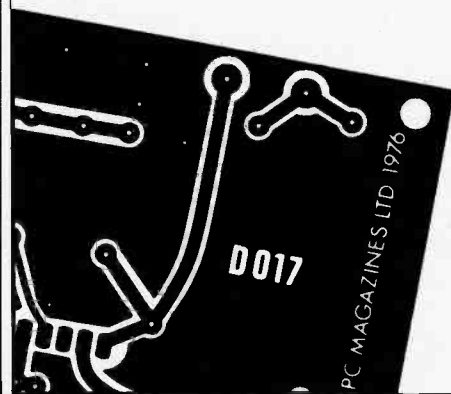

TELEVISION READERS PCB SERVICE

Issue	Project	Ref. no.	Price
November 1976	Ultrasonic Remote Control	D007/D008	£3.24 per set
December 1976	IC Sound Circuits for the Constructor	D009	£1.44
		D017	£1.44
		D022	£3.24
March 1977	Teletext Decoder Power Supply	D011	£10.53
May 1977	Teletext Decoder Input Logic	D030	£3.30
May 1977	Single-chip SPG	D031	£0.79
June 1977	Wideband Signal Injector	D012	£8.51
June 1977	Teletext Decoder Memory	D013	£8.62
July/Aug 1977	Teletext Decoder Display	D038	£1.70
August 1977	Logic State Checker	D021	£1.43
September 1977	Teletext Decoder Switch Board	D027	£4.36
September 1977	Teletext Decoder Mother Board	D041	£6.50
October 1977	Teletext Decoder IF Board	D045	£7.03
Feb/March 1978	On-Screen Clock	D046	£2.76
April/May 1978	CRT Rejuvenator	D048	£9.15
May/June 1978	Test-Pattern Generator	D051	£8.62
Aug/Sept 1978	Diagnostic Pattern Generator	D052	£3.83
October 1978	Colour Receiver PSU Board	D053	£10.75
January 1979	Colour Receiver Signals Board	D054/5	£5.43 per set
February 1979	Commander-8 Remote Control System	D049	£17.13
March 1979	Colour Receiver Timebase Board	D062	£13.50
July 1979	Colour Pattern Generator	D063	£9.15
September 1979	Teletext Decoder Options Board	D064	£8.50
August 1979	Teletext Decoder New Mother Board	D065	£5.00
August 1979	SimpleSync Pulse Generator	D067	£4.00
September 1979	New Teletext Signal Panel	11331	£8.00
October 1979	Teletext Keyboard	D057	£3.50
October 1979	Teletext Interface Board	D058	£5.00
November 1979	Colour Receiver Remote Control	D066	£5.00

To:- Readers' PCB Services Ltd. (TV), Fleet House, Welbeck St., Whitwell, Worksop, Notts.

Please supply p.c.b.(s) as indicated below:

Issue	Project	Ref.	Price

Prices include VAT and post and packing. Remittance with order please.

NAME _____

ADDRESS _____

Post Code _____

Fault Notes

Robin D. Smith

A Sizzling Rank A823 Chassis

The customer's complaint about a Bush colour set fitted with the A823 chassis was that he could hear a nasty "sizzling" noise coming from the back, though the sound and vision seemed to be normal. We ran the set for about half an hour, and found that there was arcing around the line output stage. The tripler was discovered to be literally melting away, the "yellow gunge" leaking on to the main chassis. I've had many faulty triplers, but never seen one like this.

After cleaning away the mess and replacing the tripler, we obtained very good results for a set some six years old. While soak testing however I noticed that there was an intermittent single jagged line from the top to the bottom running down the left-hand side of the screen, together with misplaced blue field convergence and what appeared to be desaturated colour (every other line missing). This was eventually traced to pin 3 of plug/socket 7Z1 on the convergence loom being open-circuit. The set ran perfectly after repairing this, and the customer was amazed to see the state of the tripler. He'd not noticed the other fault, which could have been created accidentally while we were replacing the tripler.

A cautionary note on this chassis incidentally. If you find a faulty line driver transistor (5VT12, BD131 – 5VT7 on the earlier A802 panel) it's advisable to check that the associated driver transformer damping components are in order. The 0.22 μ F capacitor (5C40/5C25 depending on panel) tends to go short-circuit, while the 22 Ω resistor (5R54/5R35) goes open-circuit. These components are mounted very close together, the heat from the resistor tending to discolour the capacitor – this probably helps to shorten its life.

Tripping: ITT CVC45/1 Chassis

A new ITT set fitted with the CVC45/1 chassis kept tripping. Now this is a fairly recent chassis, and as we've had little experience of it to date we decided to consult the Technical Liaison Officer at ITT. To determine whether the fault is in the power supply or the line output stage, the procedure is to remove plug S, thus disconnecting the h.t. feed to the line output stage. Then check whether the 127V h.t. is present across pins 4 and 7 of plug R on the switch-mode power supply control panel. If so, the power supply is in order. The next thing to do is to disconnect the tripler and reconnect plug S. On doing this the tripping stopped, a new tripler restoring normal results.

GEC C2110 Series

We've mentioned various faults on the GEC C2110 series chassis in previous articles. Here are three more points worth noting:

(1) If the colour seems to be slightly desaturated, with the appearance that every other line is not the correct colour, slightly adjust the delay line circuit phase control L204 for correct colours on a test pattern. It's mounted on the

chrominance/luminance panel PC446. I don't bother with test equipment for this adjustment, relying on my eyes and experience. This decoder is very reliable, and further adjustments are not usually required.

(2) Field flyback lines with a poor looking tube is usually due simply to the first anode controls P508/509/510 being set too high. Just turn them down equally, and the problem should disappear. If necessary check the series feed resistors R507 and R506.

(3) An interesting fault came our way recently. The h.t. voltage was approximately 170V instead of 190V, while the 40V l.t. was correspondingly low. This turned out to be due to the diac D701 on the power supply panel failing to trigger the thyristor at the correct point.

Thorn 3500 Chassis: Fast Tripping

A Thorn colour receiver fitted with the 3500 chassis came to us with the symptom no results, the overload cut-out tripping very fast. It didn't take long to discover that both diodes (W603/4) in the 30V supply rectifier circuit were short-circuit, but after replacing these the trip was still operating. Fitting a replacement power supply panel proved that the cause of the trouble was in the power supply, and after many checks we discovered that the mains transformer T601 had shorting turns.

GEC Hybrid Colour Chassis

The trouble with a hybrid GEC colour set was varying tube drive outputs, giving all sorts of different colours. The output panel had had a lot of work done on it by previous "engineers", and as the faults would appear with just the slightest tap of the output valves I decided that the best course would be to change the valve bases. Removing these from the the double-sided print is not the easiest of jobs, but we eventually managed to replace them without damaging any of the print.

After tidying up various solder joints and replacing R416 (18k Ω) which feeds the screen grids of the three PCL84s and had fallen in value, the panel was replaced and the set switched on. The result was that the 220 Ω HT2 smoothing resistor R64 on the power supply blew up, emitting a nasty pong. All connections were double checked, and after fitting a new resistor we switched on again. Another nasty bang, and R64 bit the dust once more. What was happening? There must be a short somewhere that was not there before. A careful look round revealed a three-inch length of solder that some idiot (not me!) had dropped on one of the other panels – it was tracking across between h.t. and chassis. After getting rid of this and fitting yet another R64 we had the set working very well, with no more colour flashing.

ITT CVC25 Chassis

For personal viewing I've recently changed to an ITT Model CVC25: after all, it's one of my perks to have a new set occasionally. The articles on the chassis by E. Trundle earlier this year were most informative. I've had many of the faults described, but only on earlier production sets. Anyway, the new set performed well until three weeks ago, when chronic pincushion distortion at the sides appeared. As I've mentioned before, one's own set tends to receive attention last and it was only while watching "One Million Years BC" that I decided enough was enough – no prizes for guessing why! It turned out that the pincushion preset control R901 (470 Ω) on the EW modulator panel was open-circuit. Roll on the re-run on "One Million Years BC"...

Vintage TV: The Bush Model TV22

Malcolm Burrell

THE start of post-war TV in the UK came with the reopening of the Alexandra Palace transmitter, serving the London area, in 1946. The only channel then in use was what is now known as channel B1, and under favourable conditions pictures from the 17kW e.r.p. transmitter could be received over a radius of 50 miles from London. TV came to the midlands in 1949, to the north in 1951 and, by 1952, had arrived in Scotland and Wales. This brought all five Band I channels into operation.

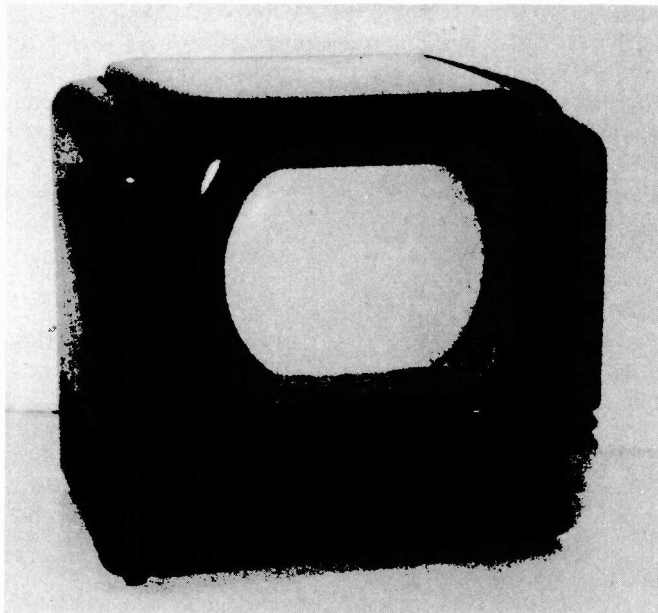

The renovated Bush Model TV22, dating from 1951.

At the start, most TV sets were of the t.r.f. type, with a complete vision and sound front-end tuned specifically to one channel. This complicated attempts at mass production, and necessitated expensive modification when a set was taken to a different part of the country. The obvious need was for five-channel receivers.

Years before the man with the gong had converted his cinemas into bingo halls and got into TV set manufacture, Bush Radio Ltd. with its Christmas tree trade mark was an independent producer of TV sets and other receiving equipment (the name comes from Shepherd's Bush in W. London incidentally). Amongst the TV receivers they'd been producing was a t.r.f. set bristling with red metal-clad valves of the EF50 variety, using a compact a.c./d.c. chassis. One of the cheaper models (the TV12) introduced a distinctive break with tradition in using a Bakelite instead of a wood cabinet. The result was a light, streamlined set which, with its nine inch tube, didn't dominate the living rooms of the early 1950s in the way that other monsters tended to do. It still needed development however.

In February 1951, Messrs. Asbury, Wright and Lloyd of Bush presented a paper to the then Television Society (the Royal came later) describing their new baby. Most sets with nine inch, round screen c.r.t.s had hitherto used only a limited part of the screen, to get an almost rectangular picture about 7½in. wide. The Bush TV22 however used a "Double-D" mask, i.e. one with curved sides, giving an

8½in. line scan. The e.h.t. was increased (to 8kV) to give a brighter picture, line timebase radiation was reduced by the use of elaborate screening, sound quality was improved, and the receiver section was able to cover the entire band of five channels. The aim was to do all this at lower cost than previously. (The initial release date of the TV22 had been June 1950 incidentally.)

Restoration

I've recently been working on the restoration of a Bush TV22 dating from 1951 – see the accompanying photos. The main chassis holds the sync separator, power supply, timebases, sound output stage and the c.r.t., the receiver section being in the removable lower deck. All the original capacitors, which were wax covered and had become rather leaky, had to be replaced. With some difficulty, a new tube had been obtained and fitted some years before, and the rubber mask, which had become hard and brittle, had been reinforced with car body filler. The Bakelite cabinet was cleaned with rubbing compound and then re-polished, the final outcome being quite a nice little set.

The original version of the receiver unit used B7G valves of the EF91 (pentode) and EB91 (double diode) variety. This was the type initially fitted in the set, though the original receiver unit had disappeared some years ago – it was a wonderful chassis for use in constructing amplifiers . . . I managed to obtain one of the later versions, using EF80 valves, as a replacement.

The aerial input is connected by way of screw terminals. The signal is coupled via tuned circuits to an r.f. amplifier stage, and is then taken to a single pentode oscillator/mixer

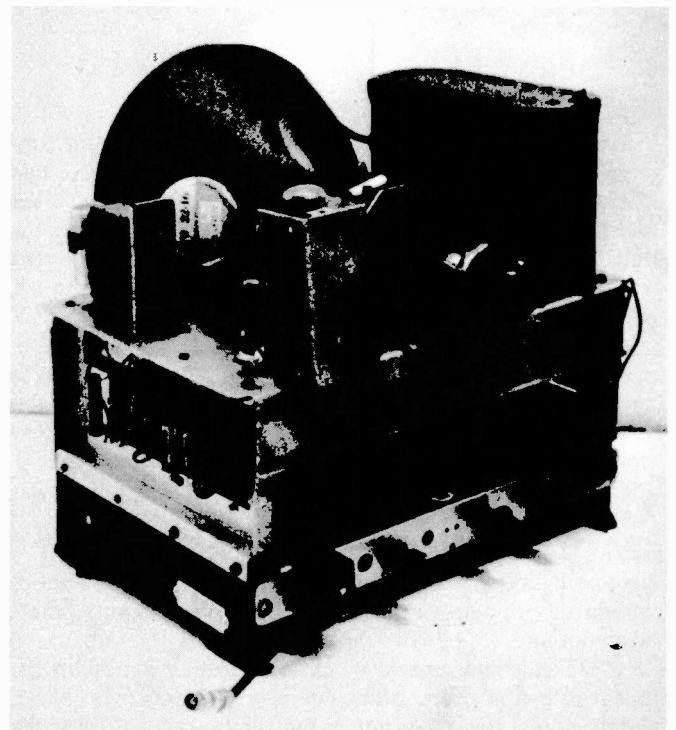

The innards of the renovated TV22.

Long-distance Television

Roger Bunney

TV signals via all four modes of long-distance signal propagation – F2, Sporadic E, tropospheric and MS – were received here at Romsey during September. The SpE reception was as follows:

- 1/9/79 An unidentified programme on ch. R1.
- 2/9/79 RTVE (Spain) channels E2 and 3.
- 3/9/79 RTVE E2; RAI (Italy) IB.
- 6/9/79 RTVE E2.
- 18/9/79 A good late morning opening, with TVP (Poland) R1 and 2, CST (Czechoslovakia) R1, and SR (Sweden) E2.

There were three main periods of improved tropospheric activity. The E. German Brocken ch. E6 transmitter was received via tropospheric ducting all morning on the 5th. More general reception from DFF (E. Germany) was present on the 11th, with ch. E5, 6 and 11 signals and also W. German signals at both v.h.f. and u.h.f. On the 16th, Hugh Cocks phoned to report that conditions were good with several Swiss channels including E4. This ducting continued into the following day, when more German signals were received here.

There were also improved F2 conditions during the month. The 2kHz whistle at 46.15MHz, usually indicative of the presence of African Band I signals during the early evening, was very strong on the 10/11th, and a weak Rhodesian ch. E2 signal was received here on the 10th. The m.u.f. started to rise quite considerably after the 20th. Hugh reported South American signals at up to 45MHz, and I've heard various signals here during the early/mid afternoon period at up to around 40MHz. There were African signals (which I just missed) again on the 23rd – Hugh reported two, one of which was a football match which was present for nearly two hours. An interesting logging on the 27th, from about 1755, consisted of a frequency grating (I

assume via F2) from a southerly direction. The transmitter itself seemed to be in trouble, with flashing, loss of video and other problems. The signal faded away after 1820, with no identification.

There was the usual daily MS reception, and as I write this towards the end of the month a slow-moving high-pressure system is giving the promise of another spell of enhanced tropospheric reception. Altogether an interesting and varied month.

Several clues have come in concerning earlier reception queries. The new identification that several enthusiasts have noted on the DFF (E. German) test pattern is "DFF1 Radio DDR 1": Mike Allmark (Leeds) logged this on August 6th. The weak signals noted between chs. E2 and R1 (at approximately 49MHz) are thought to be from a JRT (Yugoslavian) relay – I saw this signal on June 21st, with the Fubk test pattern. Kevin Jackson wrote to the Yugoslavian authorities querying reception of a ch. E3 outlet: apparently this was from a 25W relay at Pisvir, the only E3 outlet in the TV Sarajevo network. Well done Kevin!

Dave Palmer (Lowestoft) has received a ch. R2 news caption containing lettering not unlike Greek text. Can this be Bulgaria? Last month I reported reception of fluttery signals on August 12th: Kevin Jackson, using crossed Band I dipoles, noted MS signals on the 12th/13th including several Band III signals from ORF (Austria), NRK (Norway), DFF and TVP.

Two Dutch DXers received the RTA (Algerian) ch. E5 (Band III) signals previously mentioned – on June 28th. Ryn Muntjewerff's reception was clearest, there being greater interference farther south in Holland. At Hillegon RAI ch. D was received instead. Regarding the suspected reception of Gabon, reported last month, apparently RTVE ch. E3 was being watched at the time, when for about 45 seconds the test card came up over RTVE. The signal was recorded on a VCR and subsequent study suggests that "RTG" (i.e. Radio Television Gabonaise) is present at the top of the card. Rhodesia was received later on the same afternoon.

EBU Transmitter List

The latest EBU transmitter list, which includes all transmitters down to even milliwatt outlets and is up-dated with bi-monthly supplements, is now available. It's the most accurate list available, and most useful for DXers. The cost

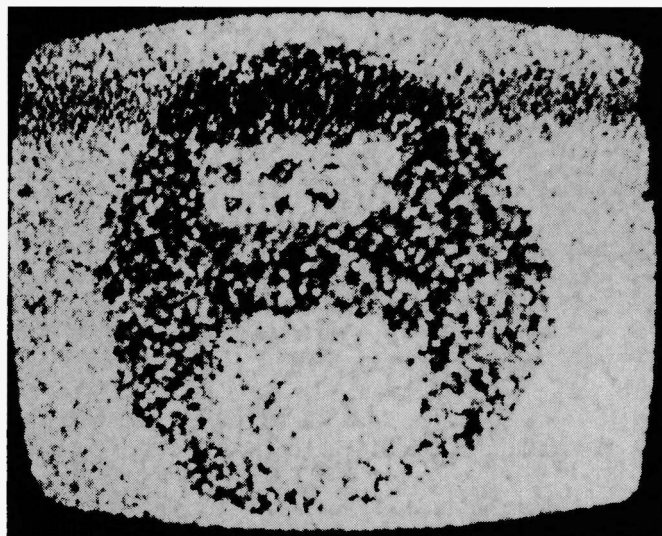

The Russian Stat-T satellite received in South Africa by Ian Roberts. Signal/noise ratio some 15dB.

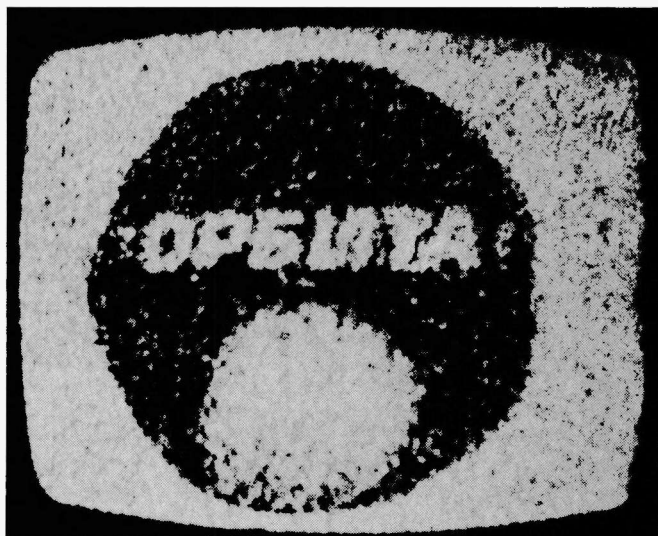

Improved reception of the Stat-T satellite, with 23dB signal/noise ratio. Display on 9 in. c.r.t., with slope detection.

is 450 Belgian Francs, and payment can be made via a Banker's draft to the European Broadcasting Union, Technical Centre, 32 Avenue Albert Lancaster, B-1180, Bruxelles, Belgium.

VCR Operation

I've been giving thought to the advantages of using a VCR for DX-TV work – as noted above, it proved helpful with the suspected Gabon reception. Two enthusiasts have written to us on this subject recently. James Burton-Stewart (North Bucks) has been using a Sony Betamax machine which seems to work well on weak signals. Good results have also been obtained feeding the machine from an up-converter. It's interesting that an unstable French signal could be played back with better sync.

John Neary (Dukinfield) had the loan of a Ferguson VHS VCR to record examples of DX-TV signals for a lecture. He recorded some three hours of SpE signals altogether, which provided an impressive demonstration. He used a four-element wideband Band I aerial plus amplifier, feeding the machine via a Labgear up-converter, with a Panasonic 14in. colour set to monitor the reception. The results were very good, and the freeze frame facility was a decided advantage.

If anyone else has experience of using a VCR to record DX signals, particularly weak, fluctuating ones or SpE signals with extremes of signal strength, I'd be interested to hear from them.

Satellite Reception

Ian Roberts (S. Africa) has been receiving video signals from the Russian Stat-T satellite, at 714MHz, and has sent in some photographs of his results. A standard TV set and a five foot dish with three-element horizontal pick-up are being used, initially with a three-transistor (BFW92) preamplifier giving a gain of 34dB. The first shot shows earlier reception, with a signal-to-noise figure of 15dB. A rebuilt head amplifier and a receiver-side amplifier, plus an extra i.f. preamplifier in the set, gave considerable improvement – a signal/noise figure of approximately 23dB was achieved. A narrow-band preamplifier using a couple of BF679 transistors is to be tried and should give an improved noise performance: a PLL to detect the f.m. video, using an NE561B i.c., is also being considered.

The programme times are 1100-1700 (S. African time). It seems that there's reduced signal strength towards the end of the transmissions, possibly due to the satellite receiving less solar power as a result of reduced sunlight. Ian comments that the sign-off is abrupt, with no test card following it. Congratulations to Ian on this achievement! Unfortunately for us, Stat-T is over the UK horizon – we'd have to go as far east as Greece for line of sight.

From our Correspondents . . .

Chris Wilson (Potters Bar) has just returned from a holiday in Czechoslovakia and comments that two out of three aerials there look as if they are home made. He's starting on a programme of experimental work with sync separators etc. for DX. The notch filter circuit he kindly sent in (see Fig. 1) uses a couple of varicap diodes and can thus be employed as a masthead unit.

Michael Pettigrew (Wicklow, Eire) is experiencing trouble with interference from r.f. welding equipment, strangely at u.h.f., where it drifts over much of the band. V.H.F. is clear, and Michael has had a most satisfactory DX season, including reception of Rhodesia.

**CONTINENTAL AERIAL SPECIALISTS, RETAIL AND TRADE.
GOLDEN ANODISED, WEATHER PROTECTED, SUPERB ARRAYS.
GUARANTEED FOR FIVE YEARS.
GOLDEN QUALITY IN A PLASTIC AGE.
ALL PARTS (EXCEPT COAX) EXCHANGEABLE FOR 7 DAYS.
10% DISCOUNT OFF MOST AERIALS
SPECIAL PROMOTION OFFER
15% + DISCOUNT ON PLEMI RANGE**

For new glossy, highly graphic lists & brochures send 40p & stamp only. 40p credit on 1st order.

AGENTS FOR
FUBA & PLEMI

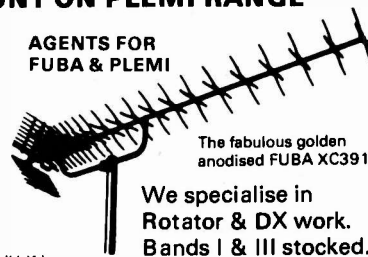

The fabulous golden anodised FUBA XC391

Stockists of the finest aerials available in Britain:
STOLLE FM aerials (W.Ger.)
FUBA TV & FM aerials (W.Ger.)
PLEMI TV aerials (Hol.)
UKW FM aerials (E.Ger.)
ANTIFERRENCE TV & FM aerials (U.K.)

We specialise in
Rotator & DX work.
Bands I & III stocked.

ASTRA (GOLDEN D.I.Y.) AERIALS

A friendly family firm. Our 25th. Jubilee Year.

D.I.Y. AERIAL SPECIALISTS FOR ALL DOMESTIC TV & FM RECEPTION
Weather exposed part of U.K.? Scotland, Wales, West Country etc. Gales, salt air corrosion problems? Want to install your aerial and forget it?
The continental aerial range from Germany and Holland having proved so fantastically successful, we are in future recommending continental aerials (especially Fuba) as our first choice for customers. In short we offer quality in a plastic age.
Anodised against corrosion, guaranteed for five years, robust, high gain, easy to assemble, eye-catching superb aerials, what else, in truth could we recommend?
Over 3,000 aerials stocked: All Bands: Masts: Lashings: Wall Brackets: Rotators: Televertas: Diplexers and Triplexers: You can now mix Band 4 and Band 5, or lower Band 5 with higher Band 5, or mix FM with either, 1.5db loss approx.: Padded outlets: Directional splitters: Coax, white or brown: 300 ohm cable.

Many of our customers come from recommendation.

53 WHITEHORSE ROAD, CROYDON, SURREY.

Nr. Gloster Pub & Garage
Open 9.00-5.30 MON-SAT.
Closed 12.30-1.30 But Open ALL day Sat. 24 hr. answering service

Tel: 01-684 4300

01-684 5262

FM & TV AERIALS AND ROTATORS ON DISPLAY

LOOK! Phone: LUTON
BEDS. 38716

**OPPORTUNITIES
TRADE SALES**

**ALL SETS GUARANTEED
COMPLETE**

OVER SIX HUNDRED SETS

ALWAYS IN STOCK

Pye 20T, Philips G8;

Ferguson 3-3k5

Murphy, Bush, Decca, GEC

All from

£35.00 £50.00

Square Screen, Mono's from

£5.00 ALL MODELS

Sets for spares from

£2.00

All include VAT

OPPORTUNITIES

9A, Chapel Street, Luton, Beds.

LUTON 38716

9.30-6.00 p.m. Weekdays, 10.30-1.00 p.m. Sundays.

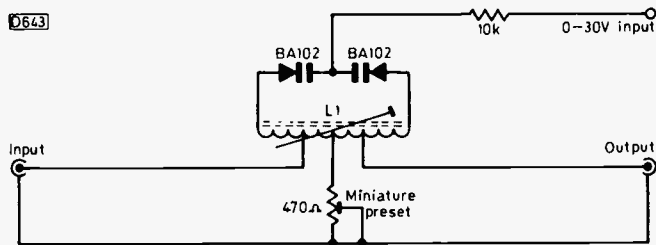

Fig. 1: Varicap tuned notch filter for use in Band I. Coil L consists of nine turns of 26 s.w.g. enamelled wire wound on a 1/4 in. former, tapped at turns 4, 5 and 6.

Finally, a word of warning from Arthur Milliken (Wigan). He left the aerial connected to his National Panasonic TV set during a thunderstorm, with the result that the front end was damaged. So don't leave the aerial connected during thundery conditions, especially if the tuner is a transistor type.

DX-TV for the Beginner - 4

Distant TV signals, say upwards of 600 miles, are present briefly every day of the year, being received on all channels in Band I and at times in Band III. We're not talking now of SpE signals, but of those propagated via MS (meteor shower/scatter) reflection. The reflection still occurs within the E layer, but the mechanism is different.

Throughout the day and night, the Earth is bombarded with particles from space, a few of these very large but the vast majority small. These small particles, perhaps the size of a pebble or less, burn up on entering the layers around the Earth, leaving a fiery trail which can often be seen. More importantly for us, the electron density of this ionised trail is sufficient to reflect incident v.h.f. signals. The meteorite burns up quickly, and its trail is equally short lived, so that MS signals are relatively weak and of short duration. As the reflection occurs in the E layer however it means that the reflection will be over a similar distance to SpE propagation, i.e. 600-1,300 miles or so. MS signals can sometimes be strong, but the average daily quota will be of low strength and of only a few seconds duration.

It follows from this that the receiving system must be of high gain if the average MS signals are to be resolved. A high-gain aerial however will have a directional characteristic, and won't be much use if one is awaiting random MS signals. Better therefore to use an aerial with a relatively wide forward pickup lobe, since this will gather such random signals over a wide arc. I personally favour the use of a two-element array facing east, since this will give coverage from Scandinavia in the north east to Yugoslavia in the south east. Alternatively one could use an omnidirectional aerial consisting of wideband dipoles mounted at right angles to each other, horizontally, connected via a wideband combiner such as the Antiference CS100 or Labgear CM6011/OS to a single down lead.

Band I MS reception is particularly rewarding for me, since it allows daily reception of sorts from a great many countries, and one can normally expect to receive specific transmitters. I've found for example that the East German ch. E4 signal with its characteristic test pattern can be expected daily here. With the PM5544 test pattern being used by so many transmitters these days, weak MS signal pings can be difficult if not impossible to identify. MS reception can occur at any time during the 24-hour period - subject to transmitters being in operation - but there's a tendency for early morning MS to be superior in the number and strength of the signal pings.

In addition to random MS, there are also regular meteor showers that generally arrive at certain dates and times which can be calculated. The major showers are listed in the various Astronomical year books and occur as follows:

Quadrantids	Early January.
Lyrids	Mid April.
May Aquarids	Early May.
Perseids	End July/mid August.*
Orionids	Mid/late October.*
Taurids	Early November.
Leonids	Mid November.*
Geminids	Early/mid December.*

*These showers often produce spectacular results.

If a major shower is particularly intense, reception can be quite dramatic with signals lasting for perhaps a minute or so. With a large number of reflected signals however, several fluctuating signals may be seen simultaneously.

Our comments so far refer to Band I. If a meteor trail is particularly intense, Band III signals may be seen. These may be of equal strength to Band I signals and at times rather more stable and slower fading. The best channels for Band III MS reception are E5, R6 and E6. A higher-gain array is necessary for Band III reception, and one must accept the fact that signals arriving "off beam" will be lost. MS signal pings in Band III are much rarer than in Band I however, so that the Band III MS DXer must sit and wait for much longer periods.

Aerial amplifiers are essential for MS reception, with a gain of say 15dB in Band I and 30dB in Band III.

My first experiences of MS reception were at my parents' house, where a 19in., 405-line Sobell receiver was used for reception of BBC-south on ch. B3. When the Rowridge transmitter closed at the end of "The Queen", I found that it was often possible to see and hear pings of the Scottish late news if the receiver was left on!

On a memorable occasion some years later, the Russian 0249 pattern suddenly appeared for some five seconds, with a further ping lasting some four seconds ten minutes afterwards, while I was watching ch. E5/R6. MS is about the only way in which Russian Band III signals are going to arrive at my valley location in Hampshire, only some 75ft. a.s.l.!

For MS work the receiver must of course have high gain. Of more importance perhaps is that it should have efficient sync performance - since MS signals last for only a second or so, rapid line and field locking are essential. Another requirement is to minimise noise. One of the simplest means of achieving maximum gain with minimum noise is to restrict the i.f. bandwidth - there's also the added benefit of improved selectivity.

It's quite easy to reduce the i.f. bandwidth by interposing one of the inexpensive vision selectivity modules from the Philips G8 chassis in the feed from the tuner to the i.f. strip. This small single-transistor unit has four tuned circuits which can be peaked by tuning to a weak signal and setting the cores for maximum gain. Connection details for this unit were given in Hugh Cocks' recent article on receiving French TV. The unit is usually available from Manor Supplies - send s.a.e. for details.

With older chassis, careful increase in the values of coupling components in the sync circuits can often give considerable improvement.

A word of warning however. Unless you're knowledgeable about TV receiver electronics, the rear cover should be left in place - there are dangerous high voltages around.

Servicing in the Field

Part 2

George Wilding

LAST month's article outlined the best approach to diagnosing TV power supply and timebase faults quickly in the customer's home: this time let's consider faults in the signal amplifying stages, from the tuner right up to the tube.

Weak Signals

One of the more common complaints with all types of set is a weak, grainy picture. The problem may simply be due to an inadequate, misaligned or damaged aerial of course, but assuming that the coaxial connections are in order, that there's no dodgy plug and socket combination on the skirting behind the sideboard, and that a sensitivity or a.g.c. preset control isn't misadjusted, the first suspect must be the r.f. amplifier. Make sure that wobbling the coaxial plug in its socket doesn't reveal a fault in the latter—many sockets are of the printed circuit type, and frequently develop a hairline crack in the print connection to the centre pin or even to the surround. Aerial isolating capacitors hardly ever give trouble, but when sockets are pushed into holders on cabinet backs, as in many Rank models, the coaxial lead can be pulled away from its termination at either end.

If you're at all suspicious about the aerial, first try with only the inner lead connected to the set: improved results are a sure indication of aerial trouble. To convince the customer, which is not always an easy task, show the results obtained with a set-top aerial — or even the meter lead. In my area, which is not too far from the local transmitter, I can get fair results when holding a meter lead in the right position. If the results from the aerial are little if any better, you've made your point.

Transistor r.f. amplifiers don't give much trouble, though the transistor may be damaged by lightning.

No Signals

Complete loss of vision and sound, but with car and other interference getting through, is due to failure of the local oscillator or mixer: the bandwidth of such interference is so wide that it can break into the i.f. section and get amplified there. It's sometimes found that the tuner will provide an output on the higher frequency channels only: this is usually due to the oscillator itself, whether a valve or a transistor.

Complete loss of vision and sound, but without any interference present, is usually due to a fault in the i.f. circuit or to loss of the supply to the i.f. strip or the tuner. A condition that can be misleading is when the vision signal does not get through the i.f. strip though the sound signal does — at reduced level.

If the i.f. strip uses valves, look for burnt out resistors, especially around frame-grid pentodes of the EF183/4 type. These tend to develop control grid-screen grid shorts, as a result of which excessive current flows through the screen grid feed and cathode bias resistors. Next try new valves. If this doesn't restore the output, check the detector diode. This will be found in the final i.f. transformer can, but can usually be checked by making resistance checks in both directions across appropriate coil tags and chassis, or at the signal feed points to the next stage. Such readings will be

affected by associated components, but if you get a marked resistance variation between readings the diode can be considered operational — after all, we're looking for complete loss of signals, not reduced contrast and sound levels. Detector diodes in sets using transistor i.f./video circuitry very rarely break down. What does kill a detector diode is a sparkover in a d.c. coupled video output valve — particularly where a PCL84 is used in the video output stage.

Complete loss of output — or possibly no vision, reduced sound output — from a transistor i.f. strip is also quite rare and, when encountered, is generally due to failure of one particular transistor. Note however that the defective transistor may be in the a.g.c. circuit rather than being one of the i.f. amplifier transistors. Should the controlled stage(s) in the i.f. strip saturate as a result of a fault in the a.g.c. circuit, they won't be able to respond to the signal input.

If you have the circuit or are familiar with the particular chassis, it's a simple matter to check the transistor voltages. Even if you don't have the circuit, voltage checks should clearly indicate which stage is faulty. With an npn transistor for example the emitter voltage should be several volts at most, the base voltage 0.5-0.6V higher, and the collector voltage, depending on the value of decoupling resistor used, something approaching the supply rail potential. To check whether an i.f. transistor is operational, temporarily short its base to chassis (assuming that the emitter is connected to chassis rather than, as in a few early designs, being returned to the supply line): the emitter voltage should then disappear and the collector voltage rise. If the transistor gives these normal indications of d.c. amplification, it can be taken to be operational.

Note however that you may find the transistor(s) to which a.g.c. is applied saturated as a result of an a.g.c. fault — indicated by the base, emitter and collector voltages being almost the same, with a reading of only a fraction of a volt between the collector and emitter. This is generally due to a defective a.g.c. amplifier stage, as a result of which excessive forward bias is applied to the controlled stage(s).

This fault can and does occur in chassis such as the Thorn 1500, where (see Fig. 1) an npn a.g.c. amplifier transistor is held saturated under no signal conditions. Apart from causing the controlled stage(s) to saturate, failure of the a.g.c. circuit to work normally can result in faults such as cross-modulation when a strong signal is present.

Lack of Contrast

Weak contrast is seldom due to a fault in a transistor i.f. strip. Valve i.f. strips often produce this fault however — due to failure of the contrast control to reduce the negative a.g.c. voltage sufficiently when fully advanced, usually because of an increased value resistor in the contrast control circuit. A simple check for this is to short the a.g.c. line to chassis. If the gain increases markedly, the contrast control circuit is implicated. A less common cause of this trouble is when the a.g.c. clamp diode goes open-circuit. As a result, the normal contrast range is covered by only a fraction of the contrast control's movement, the picture

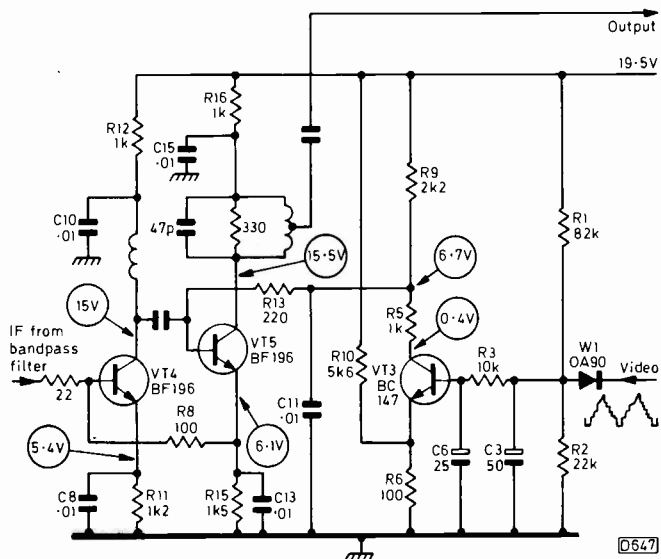

Fig. 1: A.G.C. is applied to the first two i.f. transistors (VT4/5) in the Thorn 1500 chassis. W1 is the a.g.c. detector, which rectifies the negative-going sync pulse tips, and VT3 the a.g.c. amplifier. If VT3 goes open-circuit, VT4 and VT5 will be driven to saturation, giving the no signals symptom.

becoming unstable and badly blurred with the control turned up beyond this point.

Should shorting a valve a.g.c. line fail to restore normal contrast, the next step must of course be to try new valves. Check any discoloured resistors, which will almost certainly have changed value.

Weak contrast can also be the result of a video circuit fault – a defective valve (especially the PFL200), a defective electrolytic capacitor, or a changed value resistor (particularly in a pentode video output stage). It's important to note all symptoms, since a dried up electrolytic in a video circuit will affect the lower frequencies more noticeably. There could therefore be streaking across the picture following large black or white areas, with probably impaired field lock. In fact, inability to stop the picture rolling may well be the customer's only complaint, since with the capacitor drying up gradually, over a period of months, the picture quality deterioration may have gone unnoticed.

It never fails to astonish one how poor a monochrome or colour picture can become before the user decides that something must be done about it. In most cases for example you will find that after restoring a dead colour set to life the picture is tinted one way or another, the height is excessive, or the focus and/or convergence are well away from optimum. The brightness and saturation may also be set too high.

Called to see a colour set fitted with the Thorn 3000 chassis recently – an aerial extension lead was required – I found that there was hardly any blue in the picture, due to leakage across the tube's blue gun first anode switch. These switches often give trouble in older 3000s, pulling down the relevant first anode voltage and thus reducing that gun's output. The customer was aware that the colour wasn't very good, but said what she mainly noticed was that old monochrome films were a "funny colour" instead of black and white.

In most cases, on turning down the colour control to show what should be a monochrome picture you'll find, to the customer's surprise, that it's pinkish or blueish – excessive green seems to be more often noticed.

Returning to electrolytics, check any miniature wire-ended types that are mounted close to high temperature

components or valves. With canister types, look for signs of end cap swelling or slight white deposits around the rims of soldering tags. Whilst in valve circuits an equivalent can be stabbed across a suspect, this should not be done in a transistor circuit with the set switched on since the initial heavy charging current could damage the transistor's base-emitter junction. If a capacitor is at all suspect, it's best to change it.

Apart from electrolytics, video circuits normally include small-value compensating capacitors across the transistor emitter or valve cathode bias resistor. If one of these goes open-circuit or becomes dry-jointed, the effect is most noticeable as a reduction in the stage's h.f. response. It's important to use correct value replacements, otherwise the definition is likely to be impaired or a form of ringing instigated. This is especially so when peaking coils are present in the circuit.

As well as affecting stage gain, changed value resistors sometimes restrict the normal brightness range. Furthermore, incorrect biasing of a video output pentode or transistor will result in high-amplitude sections of the signal being handled on a non-linear section of the characteristic – towards cut-off. The sync pulses will be cramped therefore, while there will be great difficulty in separating the two darkest sections of the test card grey scale. Especially in older receivers using an output pentode, take a look at the biasing resistor(s) if the tonal range towards black is poor and the sync performance is below par.

Low Brightness

In colour and monochrome sets of all types, it's often found that the required brightness level is not obtained even with the brightness control set to maximum. Since brightness control is affected in so many different ways, it's difficult to generalise about this. The place to start of course is at the tube base, to find out which voltage(s) is/are incorrect, tracing back as necessary. In hybrid colour sets using colour-difference drive, replacing the PL802 luminance output valve will generally restore correct brightness range. The same principle holds for a monochrome set using a d.c. coupled video output valve of course. In colour sets there may well be an incorrectly adjusted preset brightness or beam limiter control.

Concentrating on monochrome sets, failure to obtain a peak white raster will be the result of one or other of four fault conditions: (a) insufficient c.r.t. first anode voltage; (b) excessive cathode voltage; (c) insufficient grid voltage; (d) an open-circuit beam limiter diode in the feed to the cathode

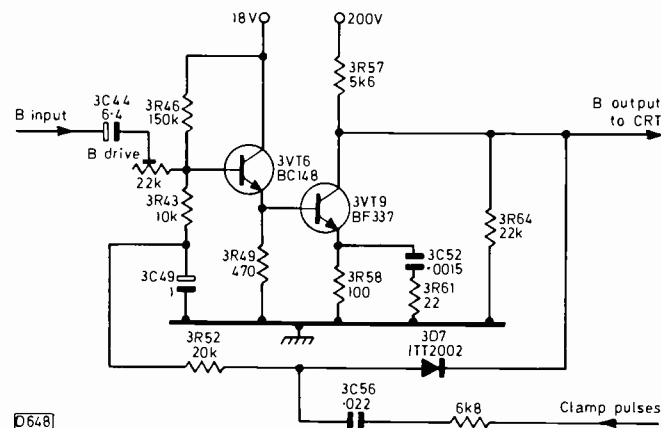

Fig. 2: Typical RGB channel with feedback clamp (Rank A823A chassis). Defective transistors or a clamp circuit fault will result in incorrect colours. With no clamp pulses there'll be excessive brightness.

– this one is very rare however. Without the manual, and without knowing what the correct voltage figures are, what's the best course of action?

First, short-circuit the tube's grid and cathode with the blade of a screwdriver. You've now removed all bias from the tube, and if this results in a peak white raster the first anode voltage is adequate. If this shorting action doesn't increase the brightness level, the tube's biasing is likely to be in order and the first anode voltage low. In this event, snip one of the leads to the first anode decoupling capacitor – even a small leak in this will reduce the first anode voltage enormously, since it's obtained from a high-voltage point. If this restores full brightness, the fault is located: it's always worth checking the associated feed resistor however, since the extra current drain may have increased its value. Alternatively, the capacitor may be in order, the resistor having simply changed value. If in any doubt about this, shunt the meter on a medium- or high-voltage range across the suspect resistor. If the brightness level increases, it can be safely assumed that the resistor is above its correct value. One way or another then, the possibility of low first anode voltage can be quickly checked.

Incidentally, we suggested snipping one of the decoupling capacitor's leads. It's best to snip the leads of suspect components rather than endeavouring to unsolder and free a lead. It's far quicker, much less likely to damage the component, and a solder blob quickly puts matters right.

Having established that the first anode voltage is adequate, how do you discover whether the tube's cathode voltage is high or its grid voltage low? With a d.c. coupled output pentode, the odds are that the valve is low emission. To check whether the valve is d.c. coupled, partly withdraw it from its holder, when moving it to one side or the other will momentarily put it out of action. If this blacks the screen out, the valve is d.c. coupled. Assuming that the valve itself is in order, its high anode voltage could be due to low screen grid voltage or high cathode voltage. If you don't know what these voltages should be, inspect the appropriate resistors. If at all discoloured, check their resistance value. A particularly common offender in older valve receivers is the resistor sometimes used to stabilise the output valve's biasing – connected from the h.t. rail or the screen grid to the cathode. This is likely to affect the sync as well, since it alters the biasing when it changes value (going low).

Where the resistors in the output stage – whether valve or transistor – are of the correct value, attention will have to be turned to the tube's grid circuit.

Wrong Colours

Excessive or inadequate red/green/blue in a colour set calls for a similar approach. Check the c.r.t. base voltages to find out which one differs from the others. Say you've a Thorn 3000 set with insufficient blue. If the blue first anode voltage is lower than the red and green first anode voltages, you've found the basic cause of the trouble. As mentioned earlier, check the switch, then as necessary the decoupling capacitor and the preset control and its series resistor. If the first anode voltages are all much the same, find out which cathode/grid voltage differs from the others.

With RGB tube drive, it may be necessary to check back from the output transistor to its driver, since these are d.c. coupled. In some chassis, such as the Rank A823, the Decca series 10, the ITT CVC5 and the Thorn 3000, there's a feedback clamp (see Fig. 2) which may need to be checked. If the diode goes open- or short-circuit, there's an excess of the colour concerned: if the feedback resistor goes open-circuit, again there'll be excessive red, green or blue.

next month in

TELEVISION

SPECIAL VIDEO ISSUE

This month we seem to have been on something of a computer kick. So as another change we thought that next month we'd turn to the video side of things.

● CAMERAS

... for the domestic video user are becoming cheaper. David Matthewson takes a look at the current types on offer, what they can do and how they do it.

● PROJECTS

A neat all-purpose approach to monitor/receiver adaptation, devised by Steve Beeching, with specific details on adapting the Sony KV2000UB colour receiver for the purpose.

John de Rivaz shows how to salvage an old N1500 for use as a rewind machine. Andrew Parr provides a neat design for a portable CCTV test box to simplify the testing of CCTV installations. And Ian Pawson describes a d.c.-d.c. converter to enable the 12V "Dryfit" type lead-acid batteries used in portable video recorders to be recharged from a car battery.

● REVIEWS

A visit to the Video Tradex Exhibition and a look at Hitachi's VHS VCR.

WHAT ELSE

The remote control plus teletext option for the latest *Television* colour receiver project and ...

ALL THE REGULAR FEATURES

ORDER YOUR COPY ON THE FORM BELOW:

TO.....
(Name of Newsagent)

Please reserve/deliver the JANUARY issue of TELEVISION (55p), on sale December 17th, and continue every month until further notice.

NAME.....

ADDRESS.....
.....
.....

Of TTL and CMOS Gates and Cabbages and Kings . . .

Part 2

Andrew Parr, B.Sc., C.Eng., M.I.E.E.

CMOS LOGIC

TTL was so successful that it had the logic market to itself for five years – and five years is a long time in electronics! In the early 1970s however a new logic system started to appear. It was called CMOS (complementary metal oxide semiconductor, i.e. using insulated-gate field effect transistor technology) and was heralded as the perfect system. It would work on any supply from 3V to 15V, and use very little power. The power supplies required for TTL had to be stabilised and able to provide a current measured in amps: those for CMOS could be crude and had to provide only milliamps, even for very large systems. Noise immunities of 6V were quoted, and easy designs with fan-outs of 50.

My first encounter with CMOS was in 1973, when a CMOS automation scheme was delivered to one of the works in a certain nationalised industry which employs me. Like many other users of CMOS, my first experiences were not encouraging. CMOS has a very high input impedance – several tens of Megohms, and one thing you must not do with it is to apply inputs to the gates when the power supply is not present. The human body gets charged to several kV, through friction with cloths. This charge normally causes no problems, since it discharges quickly through low-impedance routes to earth in a circuit. With CMOS however there are no such low-impedance routes, and we found that whenever we picked up a board zap went a couple of gates. A situation in which we could not rely on spare boards was obviously not acceptable, and we modified the whole system by adding 100k Ω resistors to 0V at each vulnerable gate input. At one stage we were calling CMOS “TTL with a death wish”, and one engineer put a sign on the logic panel saying “this system will self-destruct in three weeks”. All very sad.

As was to be expected, CMOS got a bad press and a bad reputation in many industries. In a very short time however the semiconductor industry had revamped CMOS, and the B series came out. This will operate with a supply of up to 20V but, more importantly, protection has been added to the inputs, allowing it to be treated like any other component (well, almost). The Motorola version was manufactured near my home in Scotland, and the plant came to be known locally as the McMOS factory. Someone must have heard, because that became the trade name!

Basic Circuits

As already mentioned, the basis of CMOS is the field effect transistor – the enhancement type of insulated-gate f.e.t. (IGFET). Fig. 1(a) shows a simple IGFET transistor circuit. When the gate voltage is low, a p-channel IGFET presents an almost infinite impedance between its source and drain: when the gate voltage is high, the source-drain impedance is low. The IGFET can thus be regarded as a perfect switch, and can be represented as shown in Fig. 1(b). This simple circuit is an inverter, giving a 0 output for

a 1 input and vice versa. It should be emphasised that the gate input is a voltage input, and the input impedance is several Megohms.

Given a perfect switch, it's easy to make logic gates. Fig. 2 shows NOR and NAND gates using MOS transistors, and their switch equivalents. The circuits shown so far have one disadvantage however. When the output is at 1, the circuit draws negligible current: when the output is at 0, current flows through the pull-up resistor. An ideal logic element should draw the same current in both states, in order to minimise power supply noise.

Fig. 3(a) shows the basic CMOS inverter stage. This time the p-type IGFET occupies the pull-up resistor position and is arranged in a totem-pole configuration with an n-type IGFET (hence complementary MOS). This gives the normally open/normally closed switch arrangement shown in Fig. 3(b). The current drawn by the logic gate itself is now negligible, the only current drawn from the supply being that taken by the output load. If this is another gate input, the load will also be negligible and we have a gate operating on a microamp.

For reasons that are not relevant here, it's easier to achieve high chip densities using CMOS. Thus LSI chips such as microprocessors and large RAMs tend to use CMOS technology.

With its early teething troubles sorted out, CMOS seems set for a healthy future.

Use of CMOS

In some respects CMOS is very easy to use. Unlike TTL, it can be run on any supply from 3V to 18V (15V for A series devices). The current drawn is negligible, and the simple power supply circuit shown in Fig. 4 will operate quite a large logic system. Again unlike TTL, it's relatively immune to supply noise.

In the static condition, CMOS draws little current. As it switches, the charging and discharging of stray capacitance causes current pulses on the supply. As the logic gets busier the current rises, until at around 1MHz CMOS is drawing much the same current as an equivalent TTL assembly. CMOS is thus best suited for low-speed logic applications. At the time of writing CMOS will operate only up to 5MHz, so it cannot match Schottky TTL (yet!).

On paper the noise immunity of CMOS is around 45% of the supply. The transfer characteristic is shown in Fig. 5, and it can be seen that it's tidier than TTL. In my experience of using TTL and CMOS in the electrically noisy environment of a steelworks however, TTL seems to give less problems than CMOS. I've not managed to decide exactly why this is so, but I think it's connected with the input impedance of the gates. It would seem easier to move 1M Ω by 6V than 4k Ω by 0.4Volts against a gate's will. There's room for research here into what makes a gate have good noise immunity.

Compared with its early days, CMOS is now quite idiot proof, and circuits no longer need to be assembled in operating theatres with technicians in earthed aluminium space suits. There are however a few precautions that should be taken.

CMOS is (or should be) supplied in conducting foam to protect the chip from static. The chip should be left in the foam until needed, and the CMOS chips should be the last thing to be placed in the circuit. The use of i.c. sockets is strongly recommended for the mercenary reason that most suppliers will not replace chips that have been soldered in place. If the chips are soldered in, the soldering iron bit must be earthed. When handling CMOS I usually earth

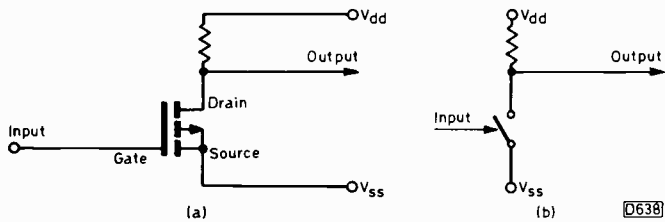

Fig. 1: (a) MOS field effect transistor inverter stage. (b) Equivalent switch circuit.

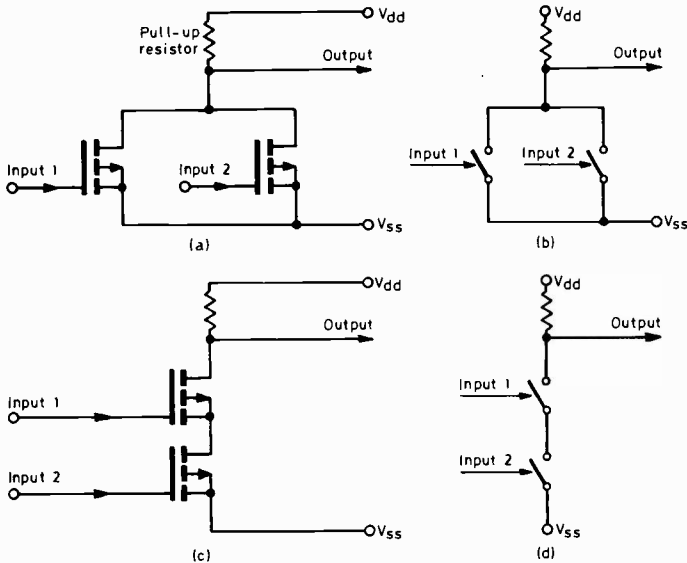

Fig. 2: (a) MOS NOR gate. (b) Switch equivalent. (c) MOS NAND gate. (d) switch equivalent.

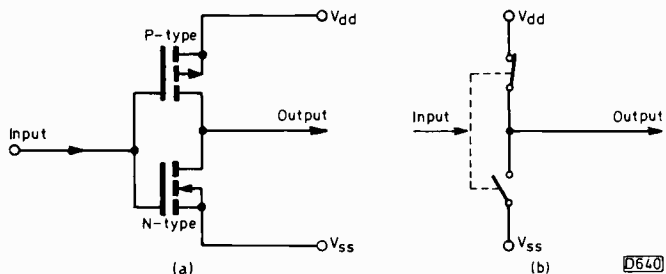

Fig. 3: (a) CMOS inverter stage. (b) Switch equivalent.

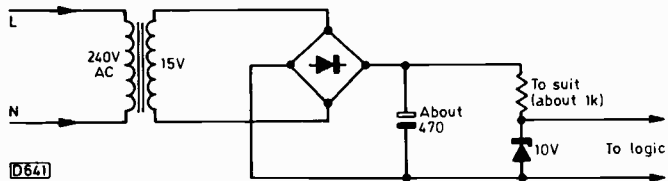

Fig. 4: Power supply for use with CMOS circuitry.

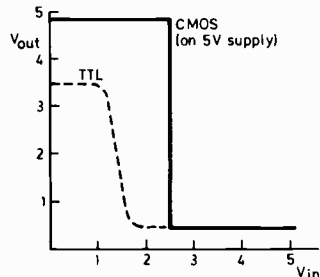
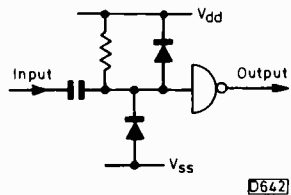

Fig. 5 (left): CMOS transfer characteristic. Fig. 6 (right): Protection with clamp diodes.



supply rail. The output voltage thus rises (or falls) by about 1V for every 2mA of current sunk (or sourced) by the output.

The permissible load is thus fixed by two factors. The first is how far you can permit the output to be degraded in your particular application. If you're interfacing to some transistors and also some logic, you will be able to draw only a mA or so without adversely affecting the noise immunity. If you are driving only gate loads however you can draw several mA.

The second constraint is the power dissipation. If you load several mA on to an output, the dissipation will rise (given by I^2R). The total device dissipation must not exceed 200mW. Some quick sums will show that the device can withstand a short on any output to any rail: this is not recommended however.

There are a few essential "don'ts" for CMOS.

Don't apply voltage to an input if the supplies are not present. This is certain death.

Don't leave unused inputs floating. The high input impedance guarantees that they will pick up some noise and cause interesting results. Tie them to another used input or a supply rail (which rail will depend on the gate function).

Don't take any input to a source more positive than the supply, or more negative than 0V. This can easily occur with capacitive coupling to give edge triggering, so in this case use clamp diodes as shown in Fig. 6.

The labelling of CMOS is not quite as logical as TTL. All chips have a code in the range 4000, so a typical code might be:

- (a) Manufacturer. CD is RCA, MC is Motorola.
 - (b) Type of device. 4012 is a dual-input NAND gate.
 - (c) Series - A or B.
 - (d) Packaging. E is the common dual-in-line plastic package.
- A typical device type number therefore is CD4012BE.

TTL OR CMOS - THE CHOICE

At the end of the day, which logic system best suits your need? Let's start with the cases where you have little or no choice.

If your logic is to be run on batteries, use CMOS - provided its slightly lower speed is acceptable. If you're out for high speed on batteries I would rethink your scheme - even low-power Schottky is really high power as far as a PP3 battery is concerned.

If you're using complex LSI chips like microprocessors and large memories, again use CMOS. You have no choice, as TTL technology is limited to MSI.

If you're out for speed, use TTL. It's more predictable and can go ten times as fast as CMOS. As speed rises, CMOS loses its low power consumption advantage anyway.

If your system is likely to be abused by non-technical people, use TTL. The industry I work in has some of the worst conditions, and I've seen TTL operating under dust layers where you could not make out the chips. I've also seen TTL survive 24V on the 5V rail for a few seconds. It carried Apollo to the moon, and that's good enough for me!

For the average logic system there's little to choose and it's largely a matter of personal preference. If you've detected a slight pro-TTL bias you are correct - but this is mainly due to my experience. There's honestly little difference nowadays. The future however would seem to lie with CMOS. As industry calls for even more complex chips which only CMOS can provide, it seems likely that TTL will lose its present supremacy. ■

myself by wrapping an earthed wire around my watch strap. I don't think this is really essential, as I have changed CMOS on site without bother, but at the bench the trouble is minimal.

Unlike TTL, the 1 and 0 logic levels are not fixed by the saturation voltage of a transistor. In an "on" state, the outputs look like a 500Ω resistor connected to the relevant

TEST CASE

204

Each month we provide an interesting case of television servicing to exercise your ingenuity. These are not trick questions but are based on actual practical faults.

A fairly early and well used Decca colour set fitted with the 10 series Bradford chassis was brought into the workshop with the complaints of colour smearing accompanied by a drift towards a yellowish tinge after the set had been on for a time. The set had given no previous trouble at all, and the sound was still good.

A Philips PM5519 pattern generator was connected to the set, and with a white raster there was certainly more than a mere trace of grey-scale imbalance. On decreasing the brightness control setting, a yellowish shade was noted. We switched over to colour bars, and found that the transitions between the colours were a trifle hazy: after a while there was a slight flickering effect on some of the colours.

The chassis employs a discrete component decoder, with RGB drive to the c.r.t. cathodes. Each RGB channel consists of a driver and output transistor, with the input signal fed in via a 5 μ F electrolytic capacitor and a feedback clamp circuit to stabilise the black level. A 2k Ω preset control is included in the collector circuit of each output transistor for grey-scale setting up purposes. We've had trouble with these presets before, in the form of varying resistance between the wiper and track, so we decided to work in some cleaning fluid and then set up the grey scale. All went well until we came to adjust the blue drive control VR241: to get anywhere near Illuminant D, the preset control had to be at one end of its travel. Ohmmeter checks were carried out, revealing that the presets themselves had responded to the cleaning treatment and that their values were correct.

Since the outputs are d.c. coupled to the c.r.t. cathodes, we next checked the values of the resistors in the blue output stage. There were no problems here, so the two transistors in the blue channel were replaced. Once more it was impossible to achieve an acceptable grey scale however, and at this point we found that the setting of VR241 tended to be unstable, the degree of grey-scale error apparently changing as the control was rotated.

Which important component had been overlooked? See next month for the solution and a further item in the series.

SOLUTION TO TEST CASE 203 — page 45 last month —

Being associated with an acoustics engineer, we decided to seek his views on the problem of the ringing Decca set mentioned last month. He set up some very expensive looking equipment in the young couple's home, with a microphone at the place where they normally view (about 9ft. from the set), and came up with some startling results as shown in the accompanying spectrogram (Fig. 1).

The top horizontal line, at 0dB, refers to a 60dB sound pressure level (SPL). The vertical scale corresponds to 10dB per main division, and the horizontal scale to 5kHz per

main division. The microphone was thus picking up a 15,625Hz line frequency component at a SPL of no less than 60dB (this is about the average level at which the sound of a TV set normally operates!), a second harmonic component of 32,250Hz at a SPL of 37dB, and a third harmonic component of 46,875Hz at a SPL of 32dB. By extending the horizontal scale, other harmonics of diminishing amplitude were also detected!

My old ears and those of our senior technician and, indeed, the acoustics engineer failed to respond to these upper-frequency sound components, but those of the married pair of significantly younger years were very sensitive to the shrill sounds, which were obviously causing them distress.

Having invested in some expensive research, we decided to see how other sets fared in this respect. We found that all receivers radiate the line timebase fundamental frequency plus harmonics, but at differing levels — mostly about 10dB below the Decca set. The cause is basically magnetostriction in the core of the line output transformer and the scanning yoke. After a good deal of experimentation (we made no money out of this deal!), we found that the intensity of the radiation from the Decca set could be reduced by using capacitors different from those we had earlier replaced in the line output stage. We eventually managed to reduce the radiation level by about 10dB, and although the couple could still vaguely detect the line whistle it was no longer distressing to them — and no worse than that from most other sets.

It seems nevertheless very wrong to me that sets should produce such a high whistle level which is "tolerable" only because the average viewer's ears are unable to detect it. If it was at a lower frequency, it would certainly be classified as well within the range of annoyance and steps would have to be taken by designers to mute it!

Judged from a few sample receivers of different makes, the average level of the 15,625Hz component is around 50dB (corresponding to about speech conversation level). This is affected by microphone positioning, the set's position in the room and the room's acoustic properties. Hard, undamped walls for example tend to reflect the whistle and "amplify" it.

Regarding the reduction in level achieved by changing the capacitors, we can conclude only that some capacitors "whistle" more than others, depending upon their electrostatic-mechanical properties!

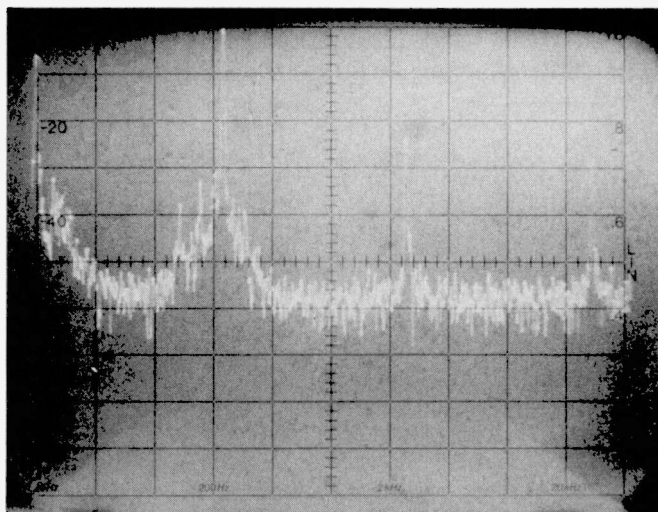

Fig. 1: Spectrogram of the line frequency ringing produced by the Decca CTV25 mentioned in test case 203. The set up used to obtain this included a B & K 2209 sound pressure meter fed via a third-octave filter and a Hewlett Packard 1616 spectrum analyser switched to the 100Hz filter.

Your PROBLEMS solved

Requests for advice in dealing with servicing problems must be accompanied by a 50p postal order (made out to IPC Magazines Ltd.), the query coupon printed below and a stamped addressed envelope. We can deal with only one query at a time. We regret that we cannot supply service sheets nor answer queries over the telephone.

THORN 1500 CHASSIS

There's an unusual fault on this set – the picture expands at the top and bottom. I've tried turning down the height control, but the picture keeps expanding. The picture does not disappear when the brightness is turned up, so I assume that the e.h.t. is o.k.

If the picture is narrow and expands vertically at high brightness levels, the line output valve and transformer are suspect. If the height is unaffected by the brightness control setting and the vertical scan is, as far as can be seen, linear, the height stabilising VDR Z1 (00E5-100/001) and the height control are suspect. If however the field linearity is poor, the chances are that the linearity feedback path has become high resistance or maybe open-circuit – check C81, the top linearity control R104 and R100.

ITT VC51 CHASSIS

The sound is o.k. but the picture sometimes doesn't appear, due to lack of line drive (line output valve overheating). The difficulty is that when a voltage reading is taken at pin 1 (triode anode) of the PCF802 line oscillator valve the line timebase suddenly starts to run, the picture then appearing. When the fault is present there seems to be no voltage at pin 6 (pentode anode) of the PCF802 – there should be 130V here. The 47k Ω load resistor then has no voltage at one side, but when the test probe is applied to the other side the line timebase suddenly starts up, with a picture a few seconds later. The load resistor has been replaced without altering the situation and I'm now stumped.

This problem often causes confusion. It's almost always due to the polystyrene feedback capacitor C121 (800pF) in the line oscillator stage. Replace with an 820pF silver mica type. On very rare occasions the electrolytic capacitor that smooths the supply to the line oscillator can cause the same trouble. This is C110 (16 μ F).

THORN 1591 CHASSIS

The trouble is that the raster is an inch in at each side. The voltages seem o.k., the Lt. line being set correctly at 11.6V. A new line output transistor cured the fault temporarily, but five hours later the raster was narrow again.

The trouble could well be due to the boost diode W11 going high resistance. A fast-acting type must be used, the MR854 being suitable. If replacing this doesn't cure the fault, check for leakage in W13, W14, C110, C111 – this would load the line output stage.

THORN 3500 CHASSIS

The e.h.t. tripler has been replaced – the previous one was faulty – but the brightness is low when set up as prescribed in the manual. A reasonably bright picture (a rather hazy glare rather than proper brightness) can be obtained by adjusting the beam limiter control for 2.5V instead of 1.3V across the beam current sensing resistor R907, which is correct in value incidentally. Also the size of the picture is inclined to alter at extreme contrast control settings.

Everything points to excessive current demand in the line output stage due to heavy damping. In view of the fact that the original tripler failed, it's likely that the e.h.t. transformer T503 or, less likely, the scan transformer T504 has shorting turns. First however eliminate from suspicion the choke (L504) in the shift circuit. This can be done by removing it to see whether the operation of the set then returns to normal.

RANK A823 CHASSIS

The problem with this set is black bands across the picture following anything white. The problem is present on both colour and monochrome. The grey scale is o.k. and the convergence good.

The effect is present to some degree on most colour sets, due to slightly inadequate video signal clamping. It's usually aggravated by grid current in an ageing tube. If the 18V decoder supply stabilising zener diode 8D1 and the h.t. smoothing electrolytic 8C10 (600 μ F) on the power supply board are in order, we suspect that the root of the trouble is a gassy c.r.t.

ITT VC200 CHASSIS

The trouble is that R162 has burnt out and the value cannot be read. Please let me know the value and the reason for the fault.

R162 is a 1.5k Ω resistor rated at 2W. It's connected across the line linearity coil L63 to provide damping, and probably burnt out because the coil is open-circuit. We usually fit a 4W RS Components wirewound resistor in this position.

PYE 725 CHASSIS

The set has been correctly set up for 185V h.t., but the picture starts to pulsate after fifteen minutes from cold. In case the over-voltage circuit had altered slightly, the setting up was readjusted and a meter was then left across the 185V line. After fifteen minutes, the line started to rise to over 200V, when the set was switched off to avoid damage. The three presets RV916, RV917 and RV879 had no effect on the rising voltage. What's the cause of this rising voltage?

The usual cause of this trouble is that the thyristor mains rectifier D888 is going into the diode mode when warm. Replacement should cure the trouble – use a 2N4444 or OT112.

QUERY COUPON

Available until 17th December, 1979. One coupon, plus a 50p (inc. VAT) postal order, must accompany EACH PROBLEM sent in accordance with the notice above.

TELEVISION DEC. 1979

B & O 3400 CHASSIS

There's a colour fault on this set. Complete loss of colour may last for a full evening, then return the following day – usually about five minutes after switching on.

There are many possible causes of no colour on this chassis, but by far the most common one is failure of one of the high-voltage transistors in the decoder. You may find BF110 or BF178 types fitted – the latter should be used for replacements. The transistors to check are 4TR13 and 4TR6/7/8. The faulty transistor will be betrayed by the following voltage readings: collector at the 60V supply line voltage, emitter voltage zero, base voltage high.

ITT CVC2 CHASSIS

There's quite a good picture except that verticals, i.e. factory chimneys, are bent and captions pull. This condition can be cured by reducing the brightness until the picture is too dark for normal viewing. The setting of the beam limiter, the connections to the tube coating, and most of the components in the line output stage have been checked.

We suggest you first check the components that affect the biasing of the sync stages – Rf38 and Rf40 which bias the base of the sync separator, Rf44 which biases the base of the sync pulse amplifier, and Cf27 which smooths the supply to these stages. Rh50 which feeds the flyback pulses to the flywheel sync circuit is worth checking, also the flywheel sync diodes Dh1/2 and Ch20 which smooths the supply to the line oscillator.

PYE 691 CHASSIS

Shortly after the picture appears, the brightness increases. Two or three minutes later the picture slowly returns to normal brightness, but a convex margin appears on the left-hand side of the raster with some vertical stretching when the picture contains much blue. The performance is otherwise well up to standard.

The PL509 line output valve or the PY500 boost diode may be ageing – both may need replacement. Alternatively, suspect the beam current limiter control of having altered. To adjust this according to the book is involved. If you note the present position however and move it slightly either way no harm will befall. Try for a position giving less width variation with a dimmer picture.

VARIABLE SUPPLY

I'd like to be able to apply a variable input voltage to a set which keeps on blowing its fuses – not the mains fuse – with the aim of supplying enough voltage at low current to be able to test various parts of the set without the fuses popping off. Any ideas?

Any variable autotransformer (variac) will do provided it's capable of supplying 2A (500W) or more – the higher the current rating the better. If you're lucky you may find a surplus one at around £15 or so. There are a couple of transformers in the RS range. It's a good idea to incorporate an RS type moving-iron ammeter and voltmeter, and provide fuse protection. Ensure that in use the common variac terminal is connected to mains neutral.

GRUNDIG 5010

The set worked o.k. after replacing the TA16090 scan thyristor, but after three days R546 (220k Ω) in the feed to the c.r.t. first anode presets burnt out. This was replaced, but as soon as the e.h.t. starts to develop it immediately burns out.

When the scan thyristor is replaced it's as well to renew the components in its gate circuit – C515/L515/R515. These are very inaccessibly mounted midway down the main board, near the heatsink. Otherwise the e.h.t. can rise to over 30kV, taking the first anode voltage up with it and usually producing picture foldover. If this doesn't cure the problem, it will be necessary to check the components in the width regulator circuit. When things have returned to normal, check the three presets themselves as they usually suffer along with R546 – if in doubt, replace all three.

THORN 1400 CHASSIS

The picture is quite stable when the set is first switched on, with good contrast etc. Within about three minutes however the picture develops a judder, flickering up and down. If the height is reduced by about an inch, the top and bottom of the picture become stable, but as soon as the height is restored the judder recommences.

The first suspect must be the field timebase valve (PCL805) itself. If a new one doesn't cure the fault, check the height control and the two resistors in series with it (R103 and R133), also C104 (1 μ F) which decouples R133. The two 18k Ω resistors R113/4 in the cross-coupling network are also suspect.

RANK A823 CHASSIS

This set works correctly for the first two hours after switching on, then simultaneously loses brightness and colour, with picture ballooning. The fault seems to be temperature dependent, with a long cool down period before normal viewing is restored. With the fault present the e.h.t. drops to about 10kV, with a noticeably reduced spark at the tripler input. The first anode supply is also reduced, but the h.t. remains unchanged. I suspect the tripler.

The tripler could be responsible, but only if the h.t. and flyback voltages are equally distributed between the two line output transistors during the fault. We say this because this fault is commonly due to one half of the line output stage becoming short-circuit, as a result of failure of one of the BU105 line output transistors or one of the 0.0047 μ F flyback tuning capacitors 6C5/6. If 6R6 and 6C4 are present, they should be removed when carrying out the repair. Be sure to rebalance the stage with 6L4/5 as described in the manual.

PYE 569 CHASSIS

The trouble is very loud intercarrier buzz on sound – the picture is perfect. I've tried adjusting the quadrature coil L11 and replaced the TAA570 intercarrier sound i.c., but the fault remains.

The usual cause of this trouble is L11's tuning capacitor C43 (100pF) going faulty. The capacitor is inside the can, but an external replacement will do.

Published on approximately the 22nd of each month by IPC Magazines Limited, King's Reach Tower, Stamford Street, London SE1 9LS. Filmsetting by Trutape Setting Systems, 220-228 Northdown Road, Margate, Kent. Printed in England by Carlisle Web Offset, Newtown Trading Estate, Carlisle. Distributed by IPC Business Press (Sales and Distribution) Ltd., 40 Bowling Green Lane, London EC1R 0NE. Sole Agents for Australia and New Zealand – Gordon and Gotch (A/sia) Ltd.; South Africa – Central News Agency Ltd. Subscriptions: Inland £9.50, Overseas £10.50 per annum payable to IPC Services, Oakfield House, Perrymount Road, Haywards Heath, Sussex. "Television" is sold subject to the following conditions, namely that it shall not, without the written consent of the Publishers first having been given, be lent, resold, hired out or otherwise disposed of by way of Trade at more than the recommended selling price shown on the cover, excluding Eire where the selling price is subject to VAT, and that it shall not be lent, resold, hired out or otherwise disposed of in a mutilated condition or in any unauthorised cover by way of Trade or affixed to or as part of any publication or advertising, literary or pictorial matter whatsoever.

TV LINE OUTPUT TRANSFORMERS (Prices include VAT at 15%) Discount to Trade Post and Packing 70p

<p>BUSH TV123 TV124 TV125 or U TV128 TV134 TV135 or R TV138 or R TV139 TV141 TV145 TV148 TV161 TV165 TV166 TV171 TV175 TV176 TV178 TV181 or S TV183 or D TV183S TV183SS TV185S TV186 or D TV186S TV186SS TV1910 TV191S TV193D TV193S TV198 TV307 TV313 TV315 Price £8.50</p>	<p>MURPHY V843 all models to V979 V153 V159 V173 V179 V1910 V1913 V1914 V2014 or S V2015D V2015S V2015SS V2016S V2017S V2019 V2023 V2027 V2310 V2311C V2414D V2415D V2415S V2415SS V2416D V2416S V2417S V2419 V2423 A774 All complete with valve base Price £10.30</p>	<p>DECCA MS1700 MS2000 MS2001 MS2400 MS2401 MS2402 MS2420 Price £8.50</p>	<p>PYE 58 64 59 68 60 75 61 76 62 77 63 80 81 93 83 94 84 95/4 85 96 86 97 92 98 150 161 151 170 155 170/1 156 171 160 171/1 Chassis G24T230a ... 189, 173 RV293B 388 589, 573 769 Price £8.50</p>	<p>GEC 8T454 8T455 8T455DST 2000DST ... all models to 2044 2047 ... all models to 2084 2104 or/1 2105 or/1 Price £8.50</p>	<p>SOBELL ST196 or DS ST197 ST290 ST297 1000DS ... all models to 1102 Price £8.50</p>	<p>THORN GROUP Ferguson, H.M.V., Marconi, Ultra, By Chassis: 800, 850, 900, 950/3, 960, 970, 950/1, 950/2, 1400, 1500, 1500, 1580, 1590, 1591, 1612, 1712 Or quote model No. Price £8.50 1600, 1615 1690, 1691 Price £10.20</p>	<p>KB-ITT By Chassis: VC1 VC2 VC3 VC4 VC11 VC51 VC52 VC52/1 VC100 VC100/2 VC200 VC300 Price £8.50</p>	<p>INDESIT 20EG8 24EG8 with rectifier holder Price £9.51</p>	<p>COLOUR TRANSFORMERS DECCA CS1730, 1733, 1830, 1835 £9.51 DECCA 30 Series Bradford Chassis £9.51 DECCA 80, 100 Series £9.51 GEC Dual STD Hybrid £11.59 GEC Single STD Hybrid £11.59 GEC Single STD Solid State £9.51 ITT CVC 1 to CVC 9 £9.51 ITT CVC 20 £10.63 ITT CVC 30, CVC 32 £9.51 PYE/EKCO 725 Chassis £9.51 PYE/EKCO 731, 735, 737, 741 Chassis £9.51 PYE/EKCO 713, 715 Chassis £11.35 PHILIPS G8, G9 Chassis £9.51 PHILIPS 570 Chassis £11.35 THORN 3000, 3500 EHT and SCAN £8.50 THORN 8000, 8000A, 8500, 8800 £10.02 THORN 9000 £12.14 TELPRO All Models £9.51 RANK A823, A823A, A823B £11.35 TANDBERG CTV 2-2 AT2063/00 £9.51 PYE/EKCO 691 to 697 Printed circuit type £15.26 PYE/EKCO 691 to 697 Wired Type P.O.A.</p>
<p>BUSH MURPHY A816 Chassis TV309 TV311 V2029 V2427 Price £10.30</p>								<p>WINDINGS Post & Packing 40p BUSH Colour Hybrid Quadripler type £6.25 RANK T20A, Z179 chassis £6.83 PHILIPS G6 EHT Overwind £7.20 PHILIPS G6 Primary £8.00 PYE 691 to 697 EHT Overwind* £3.07 PYE 691 to 697 Primary Winding* £4.80</p>	

*Please state Printed Circuit version or Wired version.
Korting, B & O, Grundig, Autovox in stock.

<p>Tidman Mail Order Ltd., 236 Sandycombe Road, Richmond, Surrey. Approx. 1 mile from Kew Bridge. Phone: 01-948 3702</p>	<p>Hamond Components (Midland) Ltd., 416, Moseley Road, Birmingham B12 9AX. Phone: 021-440 6144.</p>
<p>MON-FRI 9 am to 12.30 pm. 1.30 pm to 4.30 pm. SAT 10 am to 12 pm. Closed Wednesday afternoon</p>	<p>MON-FRI 9 am to 1 pm. 2 pm to 5.30 pm.</p>
<p>Contact your nearest depot for service by-return. Callers welcome. Please phone before calling.</p>	

COLOUR TUBES

(FULLY TESTED)

19"		£17.00
19" A49/192		£18.00
20"		£18.00
22"		£20.00

Plus Postage/Packing £8.00 per tube

MAIL ORDER COLOUR TELEVISIONS

(GOOD WORKING ORDER)

PYE	26"	£75.00	
GEC	19"	£55.00	22" £60.00
BUSH	19"	£70.00	22" £75.00

Postage/Packing per set G.B. £8.00
Ireland £15.00
OTHER MAKES AVAILABLE
All prices inclusive of V.A.T.

Cash with order please to:-

Scarborough T.V. Trading Ltd.
Ridings House, Depot Lane, Seamer Road,
Scarborough, North Yorkshire.
Telephone: 0723 68087

ARE YOU

USING YOUR SPARE TIME PROFITABLY?

If not, you're losing money. Money that you could be making by selling used colour televisions from home in the evenings. In fact, provided you start correctly and know exactly how to operate, you can easily earn a substantial CASH INCOME with a starting capital of less than £20. Our new unique publication "How to Deal Successfully in Used Colour Televisions" enables you to follow in the footsteps of many experts who have a great deal of combined experience in this lucrative home business, and who have "pooled" their knowledge to help you. After all, to follow the advice of someone who has travelled the ground before you, is to be given the best possible start. And the hundreds of valuable trade secrets, hints, tips and suggestions in the guide show exactly how anyone of average intelligence can succeed immediately.

Every aspect, from securing the first television right through to rapid expansion of sales, is covered with the detailed knowledge of experts to ensure certain success. Indexed information on almost all makes of television is presented in clear tabular form, describing performance, reliability, price and service. In particular, the tips on expanding the business are very practical, and are almost automatic when put into practice. Pages of unique advice on advertising ensure that maximum sales are secured, and sources of supply are described in detail - for both televisions and new/used spares. Monochrome sets are also covered, as are "invisible" cabinet repairs. Plus FREE on-going advice and FREE regular updating service.

You can start tomorrow - but you'll need our guide. The latest big illustrated edition is out now, and costs just **£4.95** - a small price to pay for financial independence!

SAME DAY SERVICE

CITY PUBLISHING, HAYWORTH ROAD, SANDIACRE, NOTTINGHAM NG10 5LL

To: City Publishing, Hayworth Road, Sandiacre, Nottingham NG10 5LL.
Please send by return post "How to Deal Successfully in Used Colour Televisions".
I enclose cheque/p.o. for **£4.95**.

NAME.....
ADDRESS.....
.....

BIG NEW EDITION
OUT NOW!

Manufacturers Surplus Components FIT THE RIGHT PART

300 mixed $\frac{1}{2}$ and $\frac{1}{4}$ watt resistors £1.50
 150 mixed 1 and 2 watt resistors £1.50
 300 mixed Capacitors, improved pack, most types £3.75
 100 mixed Electrolytics £2.20
 300 mixed Printed Circuit mounting Components for various TVs, resistors, caps etc. £1.50
 300 printed circuit Resistors $\frac{1}{2}$ to 4 watt £1.00
 100 High Wattage TV resistors, Wirewound etc. £2.75
 100 mixed miniature Ceramic and Plate Caps £1.50
 100 mixed polystyrene capacitors £2.20
 25 mixed Pots and Presets £1.20
 25 mixed TV Presets £1.00
 20 assorted TV VDRs and Thermistors £1.20
 10 assorted TV Convergence Pots £1.00
 20 assorted TV knobs, includes push button, chrome, control types etc. Mostly Thorn and ITT £1.00
 10 assorted Valve Bases, B9A, ceramic, EHT, etc. £1.00
 20 assorted Sync Diodes blocks for various TVs £1.00
 25 assorted Pulse Caps high voltage £1.25
 10 Spark Gaps £1.00
 20 assorted Zener Diodes 1 watt and 400MW £1.50
 100 Mixed Diodes, includes zener, power, bridge, varicap, germanium, silicon etc. All full spec. £4.95

NEW
 4-433 C.T.V. Crystals
 Long Leads £1.00 each
 3 for £2.50

Why Buy Expensive Triplers!
 Repair your old 5 and 3 sticks at a Fraction of the Cost.
 10 Replacement Rectifier Sticks (Thorn). £1.00

Special TV Bargain Parcels

Lots of useful parts including damaged panels, tuners, components etc. 10lb for £7.50
Hardware Pack
 Includes BA nuts and bolts, nylon, posidrive, self-tapping "P" clips, cable markers, clamps, fuse holders etc. £1 per lb.

THORN SURPLUS

3500 Series Scan Coils, new and boxed, complete with convergence yoke, purity assembly, static controls, leads and sockets £5.25
 3500 Focus units with metrosil £1.50
 3500 "625" line VHF Kit for wired systems £9.50
 4 Knobs black with chrome caps to fit ITT, Thorn, GEC and most small diam. shafts 60p per set
 950 bottom panel complete with i.f.'s switch etc. £3.00
 950 line transformer (not Jellypot) £2.50
 Convergence Pots with knobs. 5 Ω , 10 Ω , 20 Ω , 30 Ω . 8 of 1 type £1.00. 8 of each £3.50

SAVE THAT TUBE.

Fit our C.R.T. Isolating Transformer. Ideal for HTR./Cath. Shorts. 200-220-240 inputs. 750-900 MA outputs with thermal cutout. Made for Thorn 4000 C.T.V. but works O.K. on other sets. £2.00 each 3 for £5.00

MISCELLANEOUS

Phillips G8 Tube Base Panels
 Complete, but PCB's cracked, ok for spares. Focus, base, leads, plugs etc. 2 for £1*

Bush CTV 25 Quadrupler Remo type Q25B. equiv. to ITT. TU25 30K. with mounting brackets. £4.25 each. 3 for £10

GEC single standard, hybrid chassis. convergence panel. Brand new, complete with plugs and leads £2.50

Focus unit with lead, for above chassis £1.50

ITT Featherlight Super. Side Chassis, with controls, V. Cap Tuning Panel, Regulator, P/Button Switches, Bridge Rec. etc., etc. £3.50
 I.C. for above £1.00

SPECIAL OFFER

GEC transistor rotary tuners with slow drive, AE Skt. and leads **2010 Series** £1.50

KB VC3 VHF tuner with valves £1.50

KB VC3 transistor tuner "UHF" £1.50

ITT VC200 transistor tuner (Phillips type) £1.50

ITT CVC5 power panel. New but five resistors never fitted £1.50

Pye 697 line and power panels, damaged or some bits missing but invaluable for spares £2.00

Pye mono mains droppers with fusible link. 147 Ω + 260 Ω 50p 3 for £1.00
 69 Ω + 161 Ω 50p 3 for £1.00

Decca "Bradford" C.T.V. triplers 25KV £3.00 each 4 for £10

Portable TV EHT Sticks "Siemens TV 18 KV". Fit most portables 50p each 3 for £1.00

Pye 18" CT200 V. Cap P/B Assembly with leads and plug £2.50

EMO. On/off switch £1.00

G.E.C. S/S Hybrid Focus Assembly with lead £1.50

2 x Coax Sockets on plates suitable for various Continental T.V.s 50p

1.9 Amp T.V. Cutouts Suitable for DECCA and THORN sets. 60p each. 3 for £1.50

White Ceramic TV Resistors
 20 Ω 18W, 180 Ω 11W, 13 Ω 11W. 10 of any one type £1.20
 10 of each type £3.00

2.2k fusible, vertical mounting Screen Feed resistors 9 watt 8 for £1.00

0.47 Ω $\frac{1}{2}$ watt emitter resistors 40 for £1.00

10 μ F 400V modern Small Type 8 for £1.00

4.7 μ F 63V 20 for £1.00

1000 μ F 16V 10 for £1.00

Bias Caps 330 μ F 25v 10 for £1.00

470 μ F 25V 10 for £1.00

4,500 μ F 35V cans 80p each

R.S.M. 100 μ F + 32 μ F + 32 μ F 300V 50p each

Avoid Lethal Shocks
 Buy our specially designed

EHT Probe, removes high voltage charges from tubes, caps, etc. Heavily insulated with lead and earth connector. 60p each

B9A P.C. valve bases 20 for £1.00

EY87/DY87 EHT bases 10 for £1.00

C.T.V. Tube bases 5 for £1.00

20mm Antisurge Fuses. 800MA, 1A, 1.25A, 1.6A 12 for £1.00

2A, 2.5A, 3, 15A 100 for £7.00

TR1 thermistors 6 for £1.00

TH3 thermistors 10 for £1.50

Aluminium Coax Plugs 8 for £1.00

Metall Coax Couplers 8 for £1.00

200V 1A Diodes 10D2 (equivalent to 1N4003) 20 for £1.00

Miniature "Terry" clips ideal for screwdrivers and small tools etc. 40 for £1.00

Low profile 16 pin quill

I.C. Sockets (to fit most "Q" series I.C.) 12 for £1.00

Cassette Motors self regulating. 9V, make unknown type 9FM 90p

Rediffusion/Doric Mk 13 5 stick Triplers can be modified for other sets £1.00

Portable T.V. Batt. Leads with Croc Clips and flat 2 pin socket Fits BRC sets £1.50

Miniature Level/Batt. Meters as fitted to many cassette recorders 90p

Also:- **Miniature Mains Transformers** 4.5V-0-4.5V at 250Ma 80p each. 3 for £2.50

ULTRASONIC TRANSDUCERS

Transmitter and receiver. 40 kHz 14 mm diam. £4.25 pair

LOUDSPEAKERS

2 $\frac{1}{4}$ " Round 8 Ω 70p
 2 $\frac{1}{4}$ " Round 20 Ω 90p
 2 $\frac{1}{2}$ " Round 8 Ω 80p
 6" x 4" Elliptical 8 Ω £1.25

PROTECT YOUR PROPERTY

Buy a "SENTINEL" Smoke and Gas Detector. Uses TGS105 plug in sensor, housed in 3 $\frac{1}{2}$ " diameter diecast box. 24V. Convertible to 12V. Will activate lamp or relay.

With Data and Circuit £16.95
 Suitable 24V Relay £1.00

De Luxe Fibre Glass Printed Circuit Etching kits

Includes 150 sq. ins. copper clad F/G. board. 1 lb ferric chloride 1 dalo etch resist pen. Abrasive cleaner. Etch tray plus instructions.

Special Price £4.95.

1 lb F.E. C1 To mil. spec. £1.25

5 lb FE. C1. To mil. spec. £5.00

150 sq. in. Single sided board £2.00

150 sq. in. Double sided board £3.00

500 Watt Dimmer Switch

Toroidal mains suppression, fused with satin aluminium knob, white.

ONLY £3.45.

ZENERS

400MW. 4-3V, 4-7, 6-8, 7-5, 30V 10 of one type 80p

1-3W. 12V, 13V, 18V, 10 of each type £3.00

10 of one type £1.00

10 of each type £2.50

DIACS BR100 6 for £1.00

STABILIZERS TAA550 4 for £1.00

GEN. PURPOSE DIODES

IN4000 30 for £1.00 IN4003/10D2 20 for £1.00

IN4002 25 for £1.00 IN4148 20 for £1.00

TRANSISTOR PACKS

Our Transistor Packs are even better than before! **100 NEW AND MARKED TRANSISTORS** including BC238, ME0412, BF274, BC148, BC182L, BC338 and, or other similar types. A random analysis of these packs yielded between 98 and 106 transistors of 17 to 20 different types with our average total retail value of £14 - £16. **OUR PRICE ONLY £4.95**

200 transistors as above but including BD131, 2N3055, AC128, BFY50, BC154, BF394, BC184L, etc.

ONLY £9.95

BY476 (BY176) 18kV. 2.5Ma EHT REC 60p each 3 for £1.50

Send 40p P. & P. on all above items; send Cheque or P.O. with order to:-

SENTINEL SUPPLY DEPT. TV

149a Brookmill Rd., Deptford, London SE8

(Mail Order address only. Callers by appointment) Trade enquiries for quantity welcome.

Surplus stocks purchased for cash.



General Electric Company (U.S.A.)* Professional Large Screen TV Projection

The new look in TV Production.

You get new dimensions of viewer impact and operating flexibility with a rear-projection background for news-weather-sports and special effects using a General Electric (U.S.A.) Professional Large Screen Color TV Projector.

The projected background visually displays virtually any signal from a video source, and eliminates production restrictions and video problems possible with electronic backgrounds.

For data display, such as election returns or stock prices, the projector can

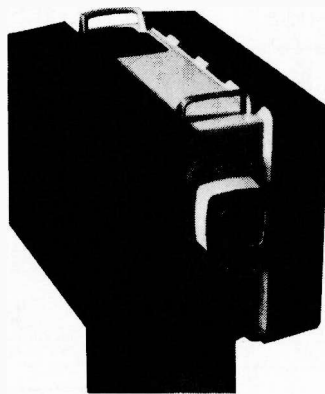

display signals from an alphanumeric character generator. Also, use it to preview new programming impressively for sponsors and agencies.

Join the major U.S. TV network and local stations in the U.S. (shown above, WTMJ-TV) and other countries which have put this versatile new production approach to work. For application data, telephone J.P. Gundersen, (U.S.) 315-456-2562. Or write: VDEO, General Electric Company (U.S.A.), Electronics Park 6-206, Syracuse, NY 13221. U.S.A.

GE (U.S.A.) Professional Large Screen Television Projector Specifications

COLOR PROJECTORS

Model	Light Output in Lumens			Resolution** in Lines per Picture Height		Input Power Req.		Scan Standards****	Video Input***
	Open Gate, Min.	Modulated, Min.	Modulated, Typ.	Min. Horiz.	Min. Vert.	Watts	Volt-Amps.		
PJ 5000	550	220	280	750	300	1200	1600	525 li./60 fps; 625 li./50 fps	(1)
PJ 5050	1250	500	650	750	300	1600	2150	525 li./60 fps; 625 li./50 fps	(1)
PJ 5800	550	200	280	750	600	1200	1600	875 lines, 60 fps	(2)
PJ 5850	1250	500	650	750	600	1600	2150	875 lines, 60 fps	(2)
PJ 5100	550	200	280	750	650	1200	1600	1023 lines, 60 fps	(2)
PJ 5150	1250	500	650	750	650	1600	2150	1023 lines, 60 fps	(2)

MONOCHROME PROJECTORS

PJ 7000	1000	600	750	800	400	1000	1350	525 li./60 fps; 625 li./50 fps	(3)
PJ 7050	1700	1000	1250	800	400	1000	1350	525 li./60 fps; 625 li./50 fps	(3)
PJ 7055	3300	2000	2400	800	400	1500	2000	525 li./60 fps; 625 li./50 fps	(3)
PJ 7800	1000	600	750	800	650	1000	1350	875 lines, 60 fps	(3)
PJ 7850	1700	1000	1250	800	650	1000	1350	875 lines, 60 fps	(3)
PJ 7855	3300	2000	2400	800	650	1500	2000	875 lines, 60 fps	(3)
PJ 7100	1000	600	750	800	750	1000	1350	1023 lines, 60 fps	(3)
PJ 7150	1700	1000	1250	800	750	1000	1350	1023 lines, 60 fps	(3)
PJ 7155	3300	2000	2400	800	750	1500	2000	1023 lines, 60 fps	(3)

Line Power, All Projectors: 117 or 240 v., ±10%, 50/60 Hz

**Resolution measurements made with wide-band video input.

***Video Input Key: (1) NTSC or RGB. (2) RGB. (3) Wide-Band.

****For use at other scanning rates, contact General Electric (U.S.A.) (VDEO) for special application/model information.

GENERAL  **ELECTRIC**
U.S.A.

*Not connected with the English Company of a similar name.

TV'S TV'S TV'S

THOUSANDS OF MONO TV'S IN STOCK

All makes - all sizes from £1.15. Square screens from £6.90. Clearance of 25" D/STD CTV'S (Philips 500 and GEC 2028 only). Checked complete £16.10 each, add £8 p/pkg. Earlier model S/STD (Philips 511, GEC 2040, Pye Hybrid etc) Singles tested tube & checked complete £39.10.

Quantities from £27.60 each
Singles working £48.30 each
Add £6 p/pkg

More recent S/STD CTV'S always in stock (Pye Varicaps, Bush Integrated, Thorn 3500/8000, Decca Bradford, GEC 2100, Korting, Grundig, Luxor, Japanese etc). Sold with tube tested from £46, working from £64.40.

Ring for quotations

EX-TV SPARES

RANK BUSH MURPHY 184 SERIES ETC

Decoder (Single IC) or Line Board	£13.80
I.F. Panel or Power Panel	£9.20
Convergence Panel	£6.90
Tuners	£6.90
Complete EHT Stack	£20.70

GEC HYBRID 2040/1 SERIES AND PYE HYBRID CHASSIS

Decoder or DCA (Inc. Valves)	£13.80
I.F. Panel or Convergence Panel	£9.20
Line Panel	£16.10
Tuners	£6.90

PHILIPS 511

I.F. Panel	£9.20
Tuners	£6.90
Lopt	£9.20

Any above add £1.60 postage & packing
RING FOR QUOTATIONS ON OTHER SPARES

COLOUR TUBES

(fully tested)	
25"	£18.40
19"	£20.70
22"	£25.30
26"	£29.90
Plus £4.00 p/pkg.	

MONO PANELS/TUNERS

Most types	£3.45
£1 p/pkg.	

VEGA MONOCHROME TUBES

(Brand new USSR Manufacture in Maker's Box with 12 months Guarantee)
20" Size £15.53
24" Size £17.83
Add £2.50 p/pkg.
Discounts for orders over five.

MULLARD COLOUREX/MAZDA NEW LIFE TUBE REBUILDS

(Callers only)
One year guarantee.
Any size only £30.65 plus old glass.

SPECIAL OFFER

20"/24" Single/STD PYE/EKCO/PHILIPS TYPE 230 (Plastic back) Re-furnished with good cabinet and brand new USSR tube (12 month guarantee).
20" Model £32.20
24" Model £34.50
Add £4.00 p/pkg.

ALL PRICES ARE INCLUSIVE OF VAT.

TRITEL GROUP

NORTHERN

Thornbury
Roundabout
Leeds Road
Bradford 3
Tel: (0274) 665670

SCOTLAND

Peacock Cross
Industrial Estate,
Burnbank Road
Hamilton.
Tel: (0698) 282141

LONDON

395/397 Albany Road
Off Waltham Road
LONDON SE5
Tel: (01) 703 4040

WEST

Unit 4a
Bulwark Industrial
Estate, Chepstow.
Nr. Bristol.
Tel: Chepstow
(02912) 6652

MIDLAND

48/52 Pershore
Street,
Birmingham 5.
Tel: (021) 622 1023

SOUTHERN

Watling Street
Hockcliffe, North
Dunstable (on A5)
Tel:
Leighton Buzzard
(0525) 210788

MAIL ORDER SEND CWO (CHEQUES OR UNCROSSED PO'S) TO ANY BRANCH

NOW AT LAST ...

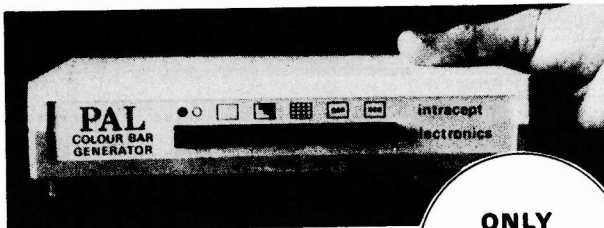

ONLY
£59.50
INCLUSIVE

A TRULY PORTABLE COLOUR BAR GENERATOR KIT!

- Yes, truly portable - runs (for up to 10 hours) on it's own built-in rechargeable battery OR direct from mains via Power Unit supplied.
- Small enough to be carried in a Tool Case, it measures only 205mm x 143mm x 40mm, and weighs a mere 500g.
- Push button selection provides:
 - Peak White Raster.
 - Linearised Grey Scale.
 - Crosshatch.
 - Standard 75% Saturated 100% Amplitude Colour Bars.
 - Red Raster.
- Modulated UHF Output fixed at Channel 45 (Approx). Just send £59.50 INCLUSIVE for a complete kit including a professionally finished Case, Ready Built Power Unit/Charger, Ni-Cad Battery Drilled & Tinned P.C.B., Crystal, 11 I.C's & Holders, Push-Button Switch Assy., Resistors, Capacitors, Transistors, Diodes, Sockets, Wire, Nuts & Bolts.

to: **INTRACEPT ELECTRONICS LTD.,**
203 Picton Road, Liverpool L15 4LG.
Tel. 051-733 3042.

New Spares Service from W.M.T.V. Ltd.

Tested Ex-Equipment Valves

DY802/86/87	10p
ECC82	10p
ECL80	8p
EF80	8p
EF85	8p
EF183	8p
EF184	8p
EY86/87	10p
PCC85	15p
PCF80	10p
PCF802	12p
PCL82	12p
PCL84	15p
PCL85/805	15p
PFL200	15p
PL36	20p
PL504	25p
PL508	30p
PL509	80p
PL519	£1.00
PL802	£1.20
PY500	40p
PY800/81/801	15p
6F23	20p
30FL1/2	25p

Many more available.
15% V.A.T. to be added to prices shown.

Postage paid on orders over £2.00.

Orders under £2.00, please add 10p per valve, p&p.
Discount of 10% on orders over £20.00.
Large quantities of untested valves sold, prices on request.

Ex-Equipment Colour Tubes

19" A49 12ox	£18.00
20"	£20.00
22" A56-12ox	£22.00
25" A63-12ox	£15.00
26" 90°	£24.00

Please add £4.00 p&p per C.R.T.
Please add 15% V.A.T. to all items ordered, then add postage indicated.

MANY MORE SPARES AVAILABLE
PLEASE WRITE OR PHONE NOW.

PERSONAL CALLERS WELCOME.

W.M.T.V. TRADE SALES LTD.

92, High Street, Kings Heath,
BIRMINGHAM, B14 7JZ

Mail Order Protection Scheme

The Publishers of *Television* are members of the Periodical Publishers Association which has given an undertaking to the Director General of Fair Trading to refund monies sent by readers in response to mail order advertisements, placed by mail order traders, who fail to supply goods or refund monies owing to liquidation or bankruptcy. This arrangement does not apply to any failure to supply goods advertised in a catalogue or in a direct mail solicitation.

In the unhappy event of the failure of a mail order trader readers are advised to lodge a claim with *Television* within three months of the date of the appearance of the advertisement, providing proof of payment. Claims lodged after this period will be considered at the Publisher's discretion. Since all refunds are made by the magazine voluntarily and at its own expense, this undertaking enables you to respond to our mail order advertisers with the fullest confidence.

For the purpose of this scheme, mail order advertising is defined as:—

'Direct response advertisements, display or postal bargains where cash had to be sent in advance of goods being delivered'. Classified and catalogue mail order advertising are excluded.

TELEVISION ELECTRONIC DISTRIBUTION (SPARES) LTD.

412a Hanworth Road, Hounslow, Middlesex
Telephone: 01-572 4668

PANEL REPAIR/EXCHANGE SERVICE TRADE ONLY

BERRYVISION 510

EMO

THORN 2000 Series, 3000/3500 Series,
8000/8500/8800/9000 Series.

GEC Solid State 2110 Series.

PHILIPS G8 G9

RBM A802/823 AV (Ultrasonic)

DECCA Solid State 80 Series/Hybrid 30 Series.

GRUNDIG 5010/6010 GB

PYE 691, 697, 713, 723, 731

SONY 1800UB

TRADE REPAIRS ON ALL SONY COLOUR T.V.'s
VERY COMPETITIVE PRICES.

3 MONTHS WARRANTY ON PANELS FROM
DATE OF OUR INVOICE.

DISCOUNT FOR BULK PANEL ORDERS.
CATALOGUE AVAILABLE ON REQUEST.

SOUTHERN IRELAND DEALERS

We are the largest stockists in the south of Ireland
of clean used T.V. sets.

**PYE - BUSH - PHILIPS - FERGUSON - KORTING
DECCA ETC.**

UHF/VHF Mono from **£18.00** each
Colour from **£125**

All Sets Tested & Cabinets Polished.

Over 2,000 sets in stock.

Visit our warehouse and see for yourself.

Irish stockists for the new 'Tyne' colour sets.

T.V. WHOLESALE DISTRIBUTORS LTD.

E.D.I. House, Kylemore Park West Industrial Estate,
Dublin 10. Tel. 264139 or 267995.

QUALITY TV'S ALWAYS AVAILABLE

GOOD STOCKS OF MODERN COLOUR
QUANTITIES OR SINGLES

COME TO THE BEST IN THE WEST

TELETRADERS

ST. LEONARDS WAREHOUSE
ST. LEONARDS ROAD, NEWTON ABBOT, DEVON
Telephone: (0626) 60154

T.V. REPLACEMENT CAPACITORS PLASTIC FILM CAPACITORS

250v AC Mains filter type. To meet the requirements of BS 2135 (Class X
suppression applications) Life tested at 375v AC at 85 deg. C.

0.047mfd	35p	0.1mfd	40p
0.33mfd	55p	1.0mfd (three wire type)	80p

1000v. DC. General purpose type. Metallised polypropylene, encapsulated. Axial leads.

0.047mfd	27p	0.1mfd	34p
0.22mfd	46p	0.47mfd	62p

2kV Peak Flyback capacitors. Encapsulated, with axial leads.

1500pF	40p	4700pF	40p
5200pF	40p	8200pF	50p

ELECTROLYTIC CAPACITORS

Solder Tag and P.C. Type

600mfd 250v.	G8	150p
600mfd 300v.	G8	182p
600mfd 300v.	GEC	175p
600mfd 300v.	A823	162p
600mfd 300v.	Z179	160p
600mfd 300v.	G9	160p
400mfd 350v.	8000	154p
470mfd 250v.	G11	132p
800mfd 250v.	G9	167p
200 + 300mfd 350v.	691	205p
300 + 300mfd 300v.	A640	190p
400 + 400mfd 350v.	Decca	280p
150 + 150 + 100mfd 300v.	1500	160p
175 + 100 + 100mfd 400/350v.	3500	204p
200 + 400 + 50mfd 325v.	A818	230p
200 + 200 + 150 + 50mfd 300v.	GEC	200p
300 + 300 + 100 + 32 + 32mfd 300v.	Z146	243p
300 - 300 + 300 + 150 + 100 + 50mfd 325v.	GEC	300p
1000mfd 63v.	3500	82p
2200mfd 63v.	G9	95p
1250mfd 50v.	189	60p
4700mfd 25v.	1590	73p
1000 + 1000mfd 40v.	Pye	82p
1000 + 2000mfd 35v.	GEC	97p
2500 + 2500mfd 30v. (PC)	A823	107p

The above prices are for single items. Quantity discounts allowed.
CASH WITH ORDER PLEASE!

All the above prices include postage and VAT at 15%.

P.E. WHITE 22 York Road, Camberley,
Surrey. GU 15 4HR.

Electronic components in small quantities are our speciality

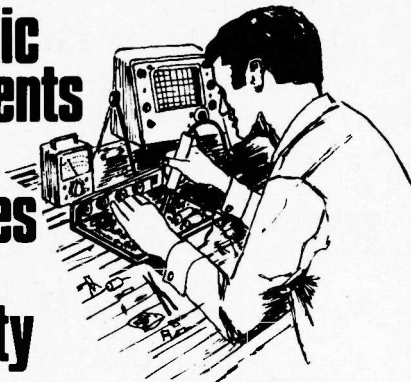

Our name is probably a new one to you, but we've been supplying technicians, workshops and hobbyists for a long time now. The personal service we give seems to have been appreciated, so we are now offering a component service nationally. We don't give world shattering discounts, but our prices are very competitive; and our stock goes right through the range down to the most mundane plug or socket, which many suppliers don't even bother with. And if you only want one item - we'll sell you only one. At GEAR you're known by your name and not a number, and any problems you have - just write or 'phone and our engineers are there to help. That's what personal service is all about.

SEND SAE OR PHONE FOR FREE COMPONENT/PRICE LIST.
 PRICES INCLUDE VAT & POST & PACKING - NO EXTRAS TO PAY.
 All components are manufacturers full spec. devices. (min. order by post £1.)

The Moor, Falmouth, Cornwall. Tel. 0326 312321.



TV. & AUDIO SERVICE CENTRE

WE STOCK THE PRODUCTS OF

EAGLE
 WELLER
 DRAPER
 SPIRALUX

KNIPEX
 SERVISOL
 BARNARD'S
 & BABANI

NEWNES
 JAYBEAM
 LIDEN PLASTICS
 GREENPAR

B. BAMBER ELECTRONICS

5 Station Road, Littleport Cambs.
 Telephone: (0353) 860185

1980 ELECTRONICS CATALOGUE now available price 75p + 20p postage. If you send £1.55 you will receive our catalogue plus six bi-monthly shortform catalogues to keep you up to date with prices and special offers.

We're giving away

Trade secrets

FOR EX-RENTAL COLOUR AND MONO TELEVISION

West Midlands T.V. Trade Sales Ltd.
 021-444-6464
 92 HIGH STREET
 KINGS HEATH
 BIRMINGHAM B14 7JZ

★ NOW OPEN ★
 New Warehouse at
 37-39, Jamaica St.
 Bristol.
 0272-48266

Why not call in and see us... A relaxed friendly atmosphere, together with a choice of hundreds of sets at low, low prices. Colour from £15. Mono from £2. Also stands, spares, etc. Send an S.A.E. or phone, for our current price lists and area map showing how to find us. Export enquiries welcome.

N.G.T. COLOUR TUBES

First Independent Rebuilder with B.S.I. CERTIFICATION

(Certificate No. 004)

12 month's guarantee: 4 year option

Tubes are processed using high temperature pumping schedules giving high definition and long life. They are then fitted with an implosion safety system approved by the British Standards Institution.

N.G.T. ELECTRONICS LTD.,
 120, SELHURST ROAD., LONDON S.E.25
 Phone: 01-771 3535.

20 years experience in television tube rebuilding.

EX RENTAL COLOUR TV's. THE BEST DEAL IN LONDON

OVER 2,000 in STOCK. MANY WORKING.

THORN BUSH DECCA PYE GEC PHILIPS KORTING GRUNDIG

Delivery arranged ★ Working sets available ★ Complete lorry loads available
 ★ Excellent stocks of Mono ★ Export our speciality.

Low, Low prices for genuine trade buyers, call and see for yourself, we would like to meet you or phone 01-997 8833/2298

Colin Butler TV Wholesale, Servier House, Horsenden Lane South, Perivale, Middx.
 (New industrial estate behind Perivale underground station)

STANDERD T.V. TUBE

**HIGH QUALITY COLOUR AND
MONO-CHROME REPLACEMENT
TUBES AT COMPETITIVE PRICES.**

- ★ Complete New Gun fitted to every Tube.
- ★ Two year Guarantee
- ★ Every Tube Electrically Tested.
- ★ Every Tube Picture Tested.
- ★ Supplier to Major Rental Companies.

19", 20" £22
22" £25
25", 26" £28

**11-29, Fashion Street,
London E1**

**Ring Standard T.V. Tube Reguner
Tel. 01-247 3097**

VIEW WELL WITH WELLVIEW TV TUBE REBUILDS

Exchange Mono

	our price	+VAT	15%	total price
CME 1601-1602	£9.30		£1.39	£10.69
A44/120WR	£9.30		£1.39	£10.69
A50/120WR	£9.30		£1.39	£10.69
AW59/23W	£11.00		£1.65	£12.65
A61/120WR	£11.00		£1.65	£12.65

NEW MONO TUBES..

20" = £15.80 inc. VAT 24" = £17.20 inc. VAT

Exchange Colour

	our price	+VAT	15%	total price
A44/270X-271X	£27.00		£4.05	£31.05
A47/342X-343X	£27.00		£4.05	£31.05
A49/120X	£27.00		£4.05	£31.05
A51/110X	£27.00		£4.05	£31.05
A55/14X	£32.00		£4.80	£36.80
A56/120X	£32.00		£4.80	£36.80
A63/120X	£36.00		£5.40	£41.40
A66/120X	£36.00		£5.40	£41.40
A67/120X	£36.00		£5.40	£41.40
A67/200X	£36.00		£5.40	£41.40

18 month full guarantee (Established ten years).

Send cash or cheque together with old tube with your order.

Carriage=£4.50 including VAT

**ALSO YOUR VALVE SUPPLIER
NEW AND BOXED
(inclusive of VAT)**

DY802=74p	ECC82=64p	EF183=78p
EF184=64p	PCC89=72p	PCF802=98p
PCL82=78p	PCL84=92p	PCL805=97p
PFL200=£1.15	PCL86=97p	PL504=£1.38
PL509=£2.82	PL519=£2.92	PY88=70p
PY800=70p		PY500A=£1.52

Postage and Packing 10p per valve. All orders over £10 Free of charge.

WELLVIEW TUBES LTD.,

Unit 7, KING ROAD,
CHARFLEET INDUSTRIAL ESTATE,
CANVEY ISLAND,
ESSEX
TELEPHONE CANVEY ISLAND 66372

TELEVISION TUBE SHOP

NEW TUBES AT CUT PRICES

EUROPEAN TYPE Nos.

	Price £	VAT £
A28-14W.....	18.95	121%
A31-19W/20W.....	19.95	2.37
A31-120W/300W.....	17.95	2.49
A31-410W/510W.....	17.95	2.24
A34-100W.....	18.50	2.24
A38-160W.....	17.50	2.31
A44-120W.....	18.75	2.19
A50-120W.....	17.95	2.34
A59-23W.....	18.95	2.24
A61-120W.....	18.95	2.37

U.S.A./JAP. TYPE Nos.

9AGP4.....	19.50	2.44
190AB4/C4.....	17.50	2.19
230ADB4.....	28.50	3.56
230DB4/CT468.....	24.00	3.00
240AB4A.....	17.95	2.24
CT507.....	17.95	2.24
CT512.....	27.50	3.44
310DGB4/DMB4.....	23.00	2.88
310EUB4.....	19.95	2.49
310EYB4.....	18.75	2.34
310FDB4.....	19.95	2.49
310FXB4.....	17.50	2.19
310GNB4A.....	23.50	2.94
310HCB4.....	23.50	2.94
340AB4.....	19.50	2.44
340AYB4.....	25.25	3.15
340Rb4/CB4.....	24.50	3.06
340AHB4.....	24.50	3.06

**Some Rebuilt Japanese
& European Types
Available at
£14.00 + VAT £1.75**

COLOUR TUBES
(New & Coloured)

12VARP22.....	62.50	7.81
330AB22.....	65.00	8.12
470FUB22B.....	85.00	10.62
A44-271X.....	65.00	8.12
A47-342X.....	69.50	8.89
A47-343X.....	69.50	8.89
A49-191X.....	59.50	7.44
A51-220X.....	64.00	8.00
A56-120X.....	69.50	8.89
A63-120X.....	69.50	8.89
A66-120X.....	75.00	9.37
A66-140X/410X.....	70.50	8.81
A67-120X.....	82.00	10.25
A67-140X/200X.....	69.50	8.89
A67-150X.....	75.00	9.37

ALL TUBES TESTED BEFORE
DESPATCH & GUARANTEED
FOR 12 MONTHS! 4 YEAR
GUARANTEES AVAILABLE ON
MOST TYPES

CARRIAGE

Mono £3.00 Colour £4.00

Mainland only. Overseas Rates on
Application.

TELEVISION TUBE SHOP LTD.
52 BATTERSEA BRIDGE RD.,
LONDON, SW11.
Tel. 228 6859/223 5088

EMO - EUROSONIC - GRUNDIG - TELETON + ALL BRITISH MAKES
ETC., ETC. ● ALL SPARES READILY AVAILABLE ● REBUILT TUBES
CREDIT AVAILABLE — TRADE ONLY

Almost any TV Component supplied by return "off the shelf" e.g. LOPTX -
EHT trays - droppers - OSC coils - switches - cans - smoothers - I.C.'s, etc., etc.
NEW - COMBI LOPTX NOW AVAILABLE.

**YOU CAN BE 95% SURE WE CAN SUPPLY ANY
TV COMPONENT BY RETURN
IF YOU NEED SPARES FAST - RING NOW!**

ACCESS AND BARCLAYCARD ACCEPTED.

S.A.E. FOR FREE SERVICE CATALOGUE.

**TELE-PART (WTON) THE TELECENTRE, WORCESTER ST.,
WOLVERHAMPTON (0902) 773121**

PLEASE MENTION

TELEVISION

WHEN REPLYING TO

ADVERTISERS

SMALL ADS

The prepaid rate for classified advertisements is 21p per word (minimum 12 words), box number 60p extra. Semi-display setting £4.00 per single column centimetre (minimum 2.5 cms) All cheques, postal orders etc., to be made payable to Television, and crossed "Lloyds Bank Ltd". Treasury notes should always be sent registered post. Advertisements, together with remittance, should be sent to the Classified Advertisement Manager, Television, Rpm 2337, IPC Magazines Limited, King's Reach Tower, Stamford St., London, SE1 9LS. (Telephone 01-261 5846).

Publishers Announcement

Due to increases which may have taken effect since this issue went to press, we strongly advise readers to check with advertisers the prices shown, and availability of goods, before purchasing.

TELEVISIONS to the Trade. Large quantities of Mono from £2.00; Square Screen from £6.00. Colour T.V.s Working from £65. R.B.M., GEC, PYE, Thorn etc. Phone Scarborough 0723-68087-65451. Scarborough T.V. Trading, Ridings House, Depot Lane, Seamer Road, (A64) Scarborough.

SETS & COMPONENTS

COLOUR TV's

Many working for disposal, trade only. All sizes and makes available. Mono sets also available.

Ingartone (London)

24 Dames Road, Forest Gate, London E7. Tel: 01-555 5569

Ingartone (Bristol)

28 St. Thomas St., Bristol 1. Tel: 0272 211179

MAINS DROPPERS AND CAN CONDENSERS

Philips G8 4752	43p
Philips G8 2-2-6852	63p
Philips 210 118-148-Loop52	63p
Philips 210 30-125-2K852	74p
Philips GT23 6-124-842	74p
Thorn 3500	74p
Thorn 1500 350-20-148-1500-31752	90p
Thorn 1400	80p
Thorn 8000 56-1K-47-1252	90p
Pye 725 27-562	63p
R.B.M. TV161 250-14-1562	70p
GEC 2010 8-15-17-70-63-1882	90p

2010 Covers 2013 2014 2017 & Sobell 1010 10A 13 & 1014

Bush TV165-166-171-175-176-178 70p

Murphy V1910-1913-1914-2014-2310-2311-2312 2314 70p

Bush A823 68-562 90p

TV Condensers: - 200 + 200 ± 100 mfd 300V	45p each
150-100-100-100-150M 325V	£2.00
150-150-100M 300V	£1.60
175M 400V 100-100M 350V	£2.05
400-400M 350V	£2.65
All 2500-2500m 30V	80p
Can 4700m 25V	85p
Cond 2200m 40V	65p
BDX32	£1.98
	£1.70

Post Free, Cash with order, VAT paid.

Durham Supplies

367 Kensington Street, Bradford 8, West Yorkshire

C.T.V. Panels Ect lists S.A.E. No Callers. Sole, 37 Stanley St., Ormskirk, Lancs. L39 2DH.

COLOUR PANEL EXCHANGE SERVICE

BRC 3000 - 3500 8000 - 8500
Philips G8 and GEC 2110 series.

Free delivery in London area on Exchange Panels. Large stock of BRC 3500 series spares. New and S/H BRC Panels for sale. Immediate exchange on repairable panels.

Catalogue available on request.

KAY JAY TV SERVICE

34, Clauson Avenue, Northolt. Phone 864 0350.

VALVE BARGAINS

ANY 1-20p, 5-80p, 10-£1.25, 50-£5.50

ECC82, ECH84, EH90, PFL200, EF80, EF183, EF184, PCF80, PCF802, PCL82, PCL84, PCL85/805, PY81, PY800, PY88, PL36, PL504, 6F28, 30PL14.

COLOUR VALVES 60p EACH

PY500/A, PL508, PL509, PL519.

Postage & Packing 30p, no VAT

VELCO ELECTRONICS

9 Mandeville Terrace, Hawtishaw, Via Bury, Lancs.

LOOK!

THORN 3000/3500 TRIPLERS

High Quality Silicon Replacement Units
One Year Guarantee; Same Day Despatch
ONLY £3.95 inc. P.P. Add 59p V.A.T.
Quotes for larger quantities on request.

WING ELECTRONICS

13 Middle Road, Harrow HM, Middx.

RECONDITIONED Pye Hybrid Colour TV's, to the following spec: New regunnew tube (2 year Gtee). Solid state CDA panel, new boost caps, new tower valves, new thermistors, etc, trade price £149 including VAT. CASTLEGATE TV, 64 Castlegate, Grantham, Lincs. Tel: 0476 66869.

COLOUR TUBES

Rebuilt with new electron gun, to British Standard. High temperature pumping.

Here is what you pay.

17-18-19 inch.....	£29.00
20 inch.....	£30.00
22 inch.....	£32.00
25 inch.....	£34.00
26 inch.....	£38.00

Guarantee 2 years.

Exchange basis.

Prices negotiable for contracts.

Old Colour tubes purchased.

Carriage £5.00.

TELESTAR TUBES

575c Moseley Road, Birmingham B12 9BS.

Tel: 021-440 5712.

20 AX & P.I.L. TUBE

Colour Tubes..... from £25
20 AX all sizes..... from £25
Toshiba P.I.L. All Sizes..... from £25
S/S COLOUR SETS..... from £60
S/S & D/S MONO..... from £5

RING: JEFFRIES 01-845 2036

S/S Colour £30, Mono Push Button £3. Plus VAT. Phone Southend 559895. Any time.

P. V. TUBES

12 months guarantee

Colour tubes supplied on a 'glass for glass' basis. Callers ring to arrange to bring your glass for on the spot exchange from our stocks

Lancashire/W. Yorks. deliveries by arrangement

Carriage extra per tube: Portables £1.00; Mono £3.50; Colour £4.50; incl. VAT

REBUILT MONO	REBUILT COLOUR		
A28-14W 11" (Pencil)	17" 18" 19" 20"		£28
A31-410W 12"	22"		£30
A31-120W 12" (Pencil)	25" 26"		£34
A31-18W 12"	26" 110"		£36
A31-10W 12"			
A34-100W 14" (Pencil)		NEW MONO	
A38-160W 15" (Pencil)	A31/510 12"		£17
A44-120WR 17"	Replaces A31/120	Mullard	
A59-23W 23"	A31/410	2 year	
A50-120WR 20"		warranty	
A61-120WR 24"	A34/510 14"		£18.50
	Replaces A34/100		
	A50/120WR 20"		£12
	A61/120WR 24"		£13.50

NEW MULLARD COLOUREX TUBES

ALL SIZES IN STOCK

SEND S.A.E. FOR PRICE LIST

NEW VALVES

Type	Price	Valve prices include 15% VAT	Type	Price	
30FL1/2	£1.28		PL36	82p	
0Y802	89p	EF184	83p	PCC85	82p
DY86/7	80p	EH90	77p	PCC89	87p
ECC81	53p	EL34	£1.84	PCC189	87p
ECC82/3	83p	EL84	£2.56	PCF80	83p
ECC85	51p	EL509	£2.56	PCF86	87p
ECC88	74p	EY86/87	£2.56	PCF200	£1.83
ECC89	80p	EZ81	51p	PCF801	81p
ECC90	77p	EZ80	51p	PCF802	83p
ECC92	87p	EZ81	51p	PCF805	£1.89
ECH81	58p	EZ81	51p	PCF805	£1.89
ECH84	£1.02	GY501	£1.43	PCF808	71p
ECL80	82p	GZ34	£1.78	PCF808	£1.74
ECL82	82p	KT66	£3.58	PCH200	£1.23
ECL86	77p	PC86	77p	PCL82	75p
ECL86	83p	PC88	77p	PCL84	85p
ECL86	81p	PC92	85p	PCL805/85	87p
EF80	41p	PC97	77p	PCL86	87p
EF85	41p	PC900	77p	PL500	£3.37
EF86	82p	PCC84	31p	PFL200	£1.28
EF183	83p				

ALL VALVES ARE UNUSED - BOXED - AND GUARANTEED

Post & Packing charges 14p for 1 valve - 7p for each Additional valve - 2p extra for large valves - max. 80p. Post free orders over £20 - any parcel insured extra 10p.

P. V. TUBES

Regd. Office Tel (0254) 38521 and answering service.

38A Water Street, Accrington, Lancashire. BB5 6PX

V.A.T. No. 291-1937-45.

TELECARE T.V. DISTRIBUTION LTD. BRISTOL AND NORTHERN IRELAND

Due to a New Policy in purchasing we are able to OFFER most makes of Colour & Mono at Lower Prices than ever before.

We can supply any quantity, nothing too big or too small. Trade only.

TELECARE BRISTOL

Unit 3 Whitby Road, Brislington, Bristol. Phone 0272 712569

NORTHERN IRELAND

Bellanaleck Co' Fermanagh, Northern Ireland. Phone Florencecourt 388

TV TUBE REBUILDING

Faircrest Engineering Ltd., manufacture a comprehensive range of equipment for processing all types of picture tubes, colour and mono. Standard or custom built units for established or new businesses. We export world-wide and have an excellent spares service backed by a strong technical team.

Full training courses are individually tailored to customers requirements.

For full details of our service contact Neil Jupp

FAIRCREST ENGINEERING LTD.

Willis Road, Croydon CR0 2XX
Tel: 01-689 8741 01-684 1422/3

URGENT TRADE NOTICE

Large quantities of good quality mono and colour TV receivers for sale, at competitive prices.

WHY not come to us where your custom will be welcomed and appreciated.

WE supply receivers to all parts of the UK, and to EIRE. All export enquiries welcomed.

TV WHOLESALE SUPPLIES

35 Shipston Road, Stratford-on-Avon.
TEL: 0789 4424

T.V. SPARES, PANELS AND MANUALS

PHILIPS · GRUNDIG

TELEVIEW 01-994 5537
194, Acton Lane, London W.4.

REPLACEMENT TV PANELS and MODULES

I.F. Filter/Gain Module for Philips 570, PYE 713-725-735 etc.

£11.45

Solid State C.D.A. Panel for Pye Hybrid

£20.50

Audio Module (LP1162 equivalent) for Pye Hybrid

£6.60

As used by many of the big companies. All designed and manufactured by us. Beware of copies. No special equipment or knowledge needed to fit them. Prices include VAT and carriage. Normally available ex-stock. Despatch same day by 1st class post. Personal callers welcome. C.W.O. or credit to established business. Discounts 5 or more, ask for details.

LED Co.

THE PANEL PEOPLE
189a Livingstone Rd, Thornton Heath,
Surrey CR4 8JZ
Tel: 01-653 7575

TELEVISION AERIALS

The full range of quality BASIC aerials, amplifiers, lashing kits, cables, mast rotators and accessories can be supplied at extremely competitive prices, normally from stock. Representative examples are shown. For quotations on specific items or general and technical application queries, please write enclosing S.A.E. For new comprehensive catalogue and price lists, send 20p extra.

ANTIFERRENCHE HC2011R 13-element Wideband Band III array (175-230MHz) £24.80

WOLSEY HG36 Multi-director 18dB high gain UHF array (state group) £27.96

LABGEAR CM6036/DA indoor very high gain amplifier, ideal DXing, 30dB gain (40-880MHz) £49.99

As above, but CM6014 20dB version (both with inbuilt mains power supply) £40.99

LABGEAR CM7025 High gain UHF amplifier (29dB in Group A) £16.88

Matching power supply for above unit CM8001 £13.25

GPO Quality 75 ohm high pass Filter - 40dB attenuation below 40MHz £4.50

All prices include VAT, post & packing.
The proprietor Roger Burney and his associate David Martin will be happy to advise on specific installations and allied problems, drawing on their in-depth knowledge of reception engineering. A mains powered version of the single channel amplifier (JULY Television) is now available to order at £18.80 inclusive of VAT post & packing. Send S.A.E. for details. BASIC: Aeriate, Antiferrence, Jaybeem, Maxview, Wolsey, Premier Industries.

SOUTH WEST AERIAL SYSTEMS

10 Old Boundary Road, Shaftesbury, Dorset.
Tel: (0747) 4370

PLEASE MENTION

TELEVISION

WHEN REPLYING TO ADVERTISEMENTS

TURN YOUR SURPLUS capacitors, transistors, etc., into cash. Contact Coles-Harding & Co., 103 South Brink, Wisbech, Cambs. 0945 4188. Immediate settlement.

MAINS DROPPER RESISTORS

POWER SECTIONS

Type 11 12 Watts 40p ea.
4R7, 7R5, 10R, 12R, 15R, 18R, 22R, 27R, 33R, 39R, 47R, 56R, 68R, 75R, 82R, 100R, 120R, 150R, 180R, 220R.

Type 12 18 Watts 46p ea.

2K5 2K85

COMPLETE UNITS

Philips G8 2R2 + 68R 57p
Philips 210 118 + 148 + link 57p
Thorn 1500 350 + 20 + 148 + 1500 + 317 86p
Thorn 3000/3500 6 + 1 + 100 72p
Thorn 8000 56 + 1K + 47 + 12 86p
Thorn 8500 50 + 40 + 1K5 92p
GEC 2018 10 + 15 + 19 + 70 + 188 92p
Bush/Murphy TV161 250 + 14 + 156 69p

VAT inclusive. Add 15p P&P for orders below £1.00

ACORD ELECTRONICS LTD.,
45 Stoke Road, Guildford, GU1 4HT

DXTV EQUIPMENT of all kinds supplied. Overseas enquiries welcome. Hugh Cocks, Bre Cottage, Staplecross, Robertsbridge, E. Sussex. Tel: 058083-317.

VALVE LIST

ALL VALVES FULLY TESTED

Five valves or over postage paid
Under five valves postage 6p each

DY66/87	15p	PC900	8p	PCL82/805	20p
EB91	12p	PCC84	8p	PL36	20p
ECC82	10p	PCC85	20p	PL504	25p
ECL80	8p	PCC89	8p	PY32/38	15p
EF80	8p	PCC189	8p	PY81/890	15p
EF85	8p	PCC205	15p	PY801	20p
EF183	10p	PCF80	8p	U191	15p
EF184	10p	PCF86	15p	6F23	15p
EH90	13p	PCF805	20p	6/30L2	15p
EY86/87	15p	PCL82	15p	30F5	10p
PC66	15p	PCL83	15p	30FL4	20p
PC88	15p	PCL84	15p	30PL4	15p

AND MANY MORE AVAILABLE

S. W. ELECTRONICS

114 Burnley Road, Rawtenstall, Rossendale, Lancs.

PYE HYBRID CDA panels, tested and working. £5 incl. P. & P. Castlegate TV, 64 Castlegate, Grantham, Lincs.

REBUILT CATHODE RAY TUBES IN

S. WALES

All tubes are now guaranteed for 2 years

	Exchange Price	V.A.T. @ 15%
A44 270X-A44 271X	£30.00	£4.50
A47 342X-A47 343X	£30.00	£4.50
A49 120X-A49 192X	£30.00	£4.50
A51 110X-A51 220X	£30.00	£4.50
A55 14X	£33.00	£4.95
A56 120X-A56 140X	£33.00	£4.95
A63 120X-A63 200X	£36.00	£5.40
A66 120X-A66 140X	£36.00	£5.40
A67 120X-A67 150X	£38.00	£5.40

20AX and P.I.L tube prices are available on application.

For further details contact: **C.R.T. Services**
Tel. Llanwern (0633) 412112

RE-BUILT COLOUR TUBES

19" **£29.50** MONO 20" **£30.50**
22" **£32.50** 20" 24" 25" **£34.50**
26" **£38.50** £16

One Year Guarantee.

MATRIX TV LTD.,

112 Essex Road, London N1. Tel: 226 1111

QUALITY REBUILT TUBES

HIGH TEMPERATURE PUMPING

COLOUR (2 year Guarantee) from **£34**
MONO (Including thin necks) from **£12.50**

4 year Optional Guarantee

Agents in Harrow, West London, Croydon, Anglia.

Send or phone for full list and terms.

WELTECH PICTURE TUBES

Unit 3-10 Wembley Commercial Centre,
East Lane, Wembley, Middx.
01-908-1816

Southern Valve Co.,

2nd Floor, 6 Potters Road, New Barnet, Herts.
Tel: 01-440 8641 for current prices & availability, all popular valves stocked. NO CALLERS, SAE Lists. Cash with order. Same Day Postal Despatch.

Valves, Tubes, Aerials etc by LEADING-MAKERS. Send SAE Lists or Phone for current prices. Counter or MAIL ORDER. NO COD. Speedy Despatch assured. No order under £1.

Philip Beerman, 6 Potters Road, New Barnet, Herts.
Tel: 01-449 1934/5 (1934 Recording Machine).

SERVICE SHEETS

SERVICE SHEETS, Radio, TV, etc., 10,000 models. Catalogue 24p plus SAE with orders-enquiries. Telray, 154 Brook Street, Preston, PR1 7HP.

SERVICE SHEETS from 50p and S.A.E. Catalogue 25p and S.A.E. Hamilton Radio, St. Leonards, Sussex.

G.T. THE TECHNICAL INFORMATION SERVICE

76 CHURCH STREET, LARKHALL, LANARKS ML9 1HE.

Over 200 different colour T.V. service manuals in stock.
1000's of other manuals in stock for immediate delivery.

S.A.E. brings quotations, newsletter, bargains, details these and other T.V. offers by return. Any service sheet £1 + large s.a.e. by return.

FREE £4 OFF VOUCHERS
send very large s.a.e. and £2 for our 2 GIANT SERVICE SHEETS & MANUALS CATALOGUES

NEW PUBLICATIONS FROM T.V. TECHNIC . . . plus extra manuals.

Complete British Colour T.V. Repair System **£52** (£65 abroad).

(3 Repair Manuals & 3 Giant Circuit Diagram/layout collections in luxury binders).

Complete Mono T.V. Repair System **£42** (£53 abroad).

(4 Repair Manuals & 2 Giant Circuit Diagram/layout collections in luxury binders).

SERVICE SHEETS. SERVICE MANUALS PRACTICAL AND TECHNICAL BOOKS

COVERING COLOUR & MONO TELEVISIONS, RADIOS,
RECORD PLAYERS, TAPE RECORDERS, ETC.

SERVICE SHEETS £1.00 PLUS S.A.E. SERVICE MANUALS ON REQUEST.

BOOKS

PRICES INCLUDE POSTAGE U.K. ONLY

TVT '78 TRANSISTOR EQUIVALENT & DATA BOOK. (A TO Z). 272 Pages	£3.25
TVT '78 TRANSISTOR EQUIVALENT & DATA BOOK. (2N, 2S, ETC.). 392 Pages	£4.25
NEWNES COLOUR TELEVISION SERVICING MANUAL by G. J. King. Vol. 1	£8.50
NEWNES COLOUR TELEVISION SERVICING MANUAL by G. J. King. Vol. 2	£8.50
NEWNES COLOUR TELEVISION SERVICING MANUAL by G. J. King. Vol. 3	£9.50
COLOUR TELEVISION SERVICING by G. J. King. 2nd Edition	£9.80
COLOUR TELEVISION THEORY by G. H. Hutson	£7.50
LONG DISTANCE TV RECEPTION FOR THE ENTHUSIAST by R. Bunney	£1.70
COLOUR TV WITH REFERENCE TO THE PAL SYSTEM by G. N. Patchett	£6.40
VIDEOTAPE RECORDING: THEORY AND PRACTICE by J. F. Robinson 2nd Edition	£9.95
TELEVISION SERVICING HANDBOOK by G. J. King. 3rd Edition	£7.25
BEGINNERS' GUIDE TO TELEVISION by G. J. King. 5th Edition	£3.45
BEGINNERS' GUIDE TO COLOUR TELEVISION by G. J. King. 2nd Edition	£3.45
CATHODE-RAY OSCILLOSCOPE AND ITS USES by G. N. Patchett	£4.40
SERVICING WITH THE OSCILLOSCOPE by G. J. King. 2nd Edition	£6.65
TOWERS' INTERNATIONAL TRANSISTOR SELECTOR. 2nd Update	£10.35

COLOUR TV MANUALS

COVERING FOLLOWING MAKES
PLEASE SEND S.A.E. FOR QUOTATION

ALBA, BRC, BUSH, DECCA, GEC,
DEFIANT, MARCONI, EKCO, PYE,
FERGUSON, DYNATRON,
NATIONAL, HITACHI, INVICTA,
ITT/KB, RGD, GRUNDIG, SOBELL,
STELLA, SONY, MURPHY,
PHILIPS, HMV, ULTRA & OTHERS.

CIRCUIT DIAGRAM MANUALS

We supply circuit diagrams for televisions in Giant Binders,
covering most British 'Single' and 'Dual Standard' models, con-
sisting of 2 volumes on colour and 1 on black & white. Price
£12.50 each plus £2 post or all 3 for £37.50 post free.

WE STOCK NEW AND SECONDHAND EDITIONS OF "RADIO AND TELEVISION SERVICING" BOOKS.
FROM 1965-66 EDITION UP TO DATE. PRICES ON REQUEST.

BACK ISSUES OF FOLLOWING MAGAZINES AVAILABLE. CURRENT PRICE PLUS 25p POSTAGE PER COPY.
P. WIRELESS, P. ELECTRONICS, E. ELECTRONICS, TELEVISION, ELECTRONICS TODAY, ELEKTOR

BELL'S TELEVISION SERVICES

190, KINGS ROAD, HARROGATE, N. YORKSHIRE. TEL. HARROGATE (STD 0423) 55885

OPEN TO CALLERS DAILY 9.00 a.m. TO 5.00 p.m. (HALF DAY WEDNESDAY) PLEASE INCLUDE AN S.A.E. WITH ENQUIRIES

LARGE SUPPLIERS OF SERVICE SHEETS AND COLOUR MANUALS

TV Monos, Radios, Tuners, Tape Recorders, Record Players, Transistors, Stereograms, all at 75p each + S.A.E.,
except Colour TVs from £1 and Car Radios £1.25.

State if Circuit will do, if sheets are not in stock. All TV Sheets are full length 24 x 12, not in Bits & Pieces. All other Data full lengths.
Free Fault Finding Chart or TV Catalogue with order. Crossed PO's Returned if Sheets Not in Stock.

C. CARANNA, 71 BEAUFORT PARK, LONDON NW11 6BX. 01-458 4882. MAIL ORDER

FOR SALE

TELEVISION TELETXT DECODER, assembled though still needs aligning, £65. ono. M. J. Hillier, 2 Manor Cottages, Mount Lane, Lockerley, Romsey, Hants. SO5 0JS. Tel: 0794 40830.

DUE TO BEREAVEMENT 26" colour Television project aligned not tuned, in Cabinet also Heathkit Oscilloscope. What offers. Lawson, 31 Belmont Ave., Smithies, Barnsley, South Yorks. S712AR.

NEW BACK ISSUES of 'Television' available 75p each post free. Open P.O./Cheque returned if not in stock - BELL'S TELEVISION SERVICES, 190 Kings Road, Harrogate, N. Yorkshire. Tel: (0423) 55885.

GRUNDIG Security Camera Type FA123 Video/RF outputs unused surplus to requirements. £100. Potters Bar 57783 after 6pm.

FOUR PHILLIPS/MULLARD projection optics with MW6/2 Tubes & Coils. Correction plates: CP85, 825, & 2 off 1270 (4' screen) £10 each: Offers; Tel: 01-346 0420.

WANTED

NEW VALVES and CRT's required, PCL805, PL504, PL509, PY500A etc. Cash waiting. Bearman, 6/8 Potters Road, New Barnet, Herts. Tel: 01-449 1934/5.

WANTED—Second Hand scope and Colour Bar Generator details to Clifton Electrics, 16 Alma Vale Road, Clifton, Bristol. Tel: 34791.

WANTED Workshop Manual for Grundig 717 GB. Television (London Area) 01-579 7218.

EDUCATIONAL

BETTER JOB! BETTER PAY!

GET QUALIFIED WITH ICS IN:
COLOUR & MONO TV SERVICING
COLOUR & MONO TV ENGINEERING
COLOUR & MONO TV MAINTENANCE
PLUS: Telecommunications, radio, electronics, electrical engineering, technical communications, radio communications, etc., etc.,

NEW: Self-build radio courses with free kits

Train in your own home, in your own time with ICS, the world's most experienced home study college.

**RETURN THIS COUPON TODAY
FOR FREE BROCHURE!**

ICS

Int Correspondence Schools
P284 Intertext House, Stewarts Rd,
London SW8 4UJ. Tel: 01-622 9911

Name

Address

TELEVISION & VIDEO SYSTEMS SERVICING

15 MONTHS full-time Diploma course to include a high percentage of practical work.

- ELECTRONIC PRINCIPLES
- MONO & COLOUR TELEVISION
- CLOSED CIRCUIT TELEVISION
- VIDEO CASSETTE RECORDING
- DIGITAL TECHNIQUES
- TELETXT & TV GAMES

Shortened courses for applicants with suitable electronics background.

Next session starts January 7th.

(Also available 2½ year course in Marine Electronics & Radar for employment as ships Radio Officer.)

Prospectus from:

**LONDON ELECTRONICS
COLLEGE**

**Dept: TT12, 20 Penywern Road,
London SW5 9SU. Tel. 01-373 8721.**

Now is your chance to become a Closed Circuit Television Studio Engineer.

By taking a twenty-four week full time course

under TOPS, the Training Opportunities Scheme. It starts 28th January 1980 at North-umberland County Technical College, Ashington.

What do you learn? The course is intended to meet the needs of technicians who would like to follow a career in industrial and educational closed circuit television studios or audio visual aid centres.

The syllabus includes: television techniques and engineering, presentation skills, programme control, reprography, graphics, studio layout and settings, and film animation and photography.

On completion of the course, you will sit a City and Guilds examination, or its equivalent.

Would it suit you? You should be aged 19 or over, and hold a City and Guilds 272 or 222 radio, television and electronic certificate.

Or you may have an electronic background in the Services, industry or aviation.

You must have been away from full time education for a total of two years and not have been on a TOPS course in the last three years.

You should be looking for a job, or be prepared to leave your present one to take up training.

TOPS allowances. Tuition is free and you'll receive a TOPS tax free weekly allowance.

Travelling and/or lodging allowances may also be paid in approved circumstances. TOPS courses are open to men and women.

Get the facts. Just telephone or send this coupon to Pam Parker, Manpower Services Commission, Training Services Division, District Office, 62-68 Grey Street, Newcastle-upon-Tyne NE1 6AF. Telephone Newcastle 610932, extension 36 or 34.

Name _____

Address _____

Telephone _____ 021/006

TOPS
TRAINING OPPORTUNITIES SCHEME

MSC Manpower Services Commission

NEW TELEVISION TUBE REBUILDERS

Require an experienced engineer and knowhow in the field of television tubes. Good salary plus commission.

Tel: 01-701 6697/01-703 9673. Mr. Aron.

MISCELLANEOUS

VIDEORECORDER SERVICE and Technical consultancy - B & B Electronics, Newark 76895. Call Steve Beeching.

RIGONDA AGENTS. For all spares and repairs. Fast despatch trade service available. 01-476 1928. Star Radio, 272 Barking Road, London, E13.



BELLS AND SIRENS
CARTERS SIREN £5.95
INDUSTRIAL SIX INCH BELL £9.52
PRICES INCLUSIVE.
SEND CHEQUE, P.O. to:
CWAS ALARM
11 Denbrook Walk,
Bradford BD4 6QS



12v D.C.

6 to 12v D.C. SAE for full price list of Professional Burglar Alarm Equipment.

REDUNDANT STOCK FOR DISPOSAL

Decca 26" School's Model Monochrome Television Receivers for VHF reception 40-140 MHz in wood cabinets with double doors and on Unicol trolley stands. Approximately 1,900 sets between 7-10 years old distributed over 1,400 London Schools; bids will be considered for whole or part of this quantity. Can be adapted to Video Monitors. A model can be viewed at the ILEA Centre for Learning Resources - please contact Mr. R. Bruce on 01-735 7660 Extension 258, for an appointment. If you wish to tender for these items please write for forms to the **Contracts Office, GLC Supplies Department, Tottenham Hale Dept, Ferry Lane, London N17 9NQ.**

LADDERS

ALUMINIUM Roof Crawlers, 12ft. - 24ft. Aluminium ext. up to 62½ft. Leaflets. Ladder Centre (TEL3) Halesfield (1) Telford. Tel: 586644. Callers Welcome.

BOOKS & PUBLICATIONS

FULL REPAIR data any named T.V. £5.30, with circuits, layouts, etc. £7. (AUST) 76 Church Street, Larkhall, Lanarks ML9 1HE.

ELECTRONIC MAILORDER LTD.

VALVE BARGAINS

Any 5-80p, 10-£1.50, 50-£6.00 Your choice from the list below.

ECC82, EF80, EF183, EF184, EH90, PCF80, PCF802, PCL82, PCL84, PCL85, PCL805, PL504, PY81/800, PY88, 30PL14, 6F28, PFL200.

Colour Valves - PL508, PL509, PL519, PY500/A. All tested, 65p each.

Aerial Splitters - 2 way, 75 OHMS, Inside Type, £2.50

AERIAL BOOSTERS

Aerial boosters can produce remarkable improvements on the picture and sound, in fringe or difficult areas.

B11 - For the stereo and standard VHF/FM radio.

B12 - For the older VHF television - Please state channel numbers.

B45 - For Mono or colour this covers the complete UHF Television band.

All boosters are complete with Co-ax plugs & sockets. Next to the set fitting.
Price £5.70 each.

MULLARD CAPACITORS

100 CZ80/1 capacitors values from .01uF to 1.5uF, 250V/w.

Good mixed selection. Price £1.50.

ALL PRICES INCLUDE VAT. P & P 30p PER ORDER. EXPORTS WELCOME AT COST.

62 BRIDGE STREET, RAMSBOTTOM,
BURY, LANCS.
TEL: RAMS (070 682) 3036.

DISPLAY ELECTRONICS

REGUNNED COLOUR TUBES 2 YEAR GUARANTEE

Up to 19".....	£29.50
20".....	£31.50
22".....	£33.50
25".....	£35.50
26".....	£37.50

The above prices are for standard 38mm Delta Gun Types. Prices on application for P.I.L. Tubes etc. Some types available without pre-supply of glass.

REGUNNED MONO TUBES 2 YEAR GUARANTEE

20".....	£11.00
24".....	£13.00

Carriage/Packing £3.00 on mainland.
Please add 15% VAT to all orders.

COLOUR T.V. SPARES

Most parts for Decca's stocked

LOPT		
DECCA	10/30	£10.80
	80/100	£10.20
	Mono	£12.00
PHILIPS	G8	£12.90
ITT	20/25/30	£11.90
BUSH	A774	£15.00

TUNER CONTROL UNITS

DECCA		
4 Button		£7.90
6 Button		£8.90
Exchange 2230 Tuner Unit		£10 (5 Butt.)

Complete working THORN 3000 models

£79 (callers only)

Ex-equip panels

for 3000 and BRADFORD

See our NEW Catalogue for details.

Hundreds of correct spares listed.

Send stamp for free copy.

New 1590 or 1591 speakers £4.90.

Prices include 15% VAT

Package/Posting 30p per order but Transformers and Panels 80p.

BOTTOMLEY'S TELEVISION

11 Leeds Road, Hipperholme,
HALIFAX (0422) 202979

Callers Phone first. Exit 26 M62

BIRMINGHAM AND DISTRICT DEALERS/ENGINEERS

NEWS FLASH

HIGH VACUUM
QUALITY
REBUILT TELEVISION
PICTURE TUBES

COMPETITIVE PRICES

CONTRACT TERMS
AVAILABLE

2 YEAR GUARANTEE

E.G.

17" 18" 19"	£29.50 + VAT £4.43
20"	£32.50 + VAT £4.86
22"	£34.00 + VAT £5.10
25"	£37.00 + VAT £5.55
26"	£40.00 + VAT £6.00

PIL Tubes our speciality.

All Prices For Tubes available on a Sound "Glass for Glass" basis otherwise £20 surcharge

C.W.O. Carr./Ins. £6.50

"Old Glass Purchased"

TUBESURE LTD.

Unit 111, Middlemore Industrial Estate,
Middlemore Road, Smethwick,
West Midlands. Telephone: 021-558 7777.

CALLERS WELCOME

Late night Thursdays until 8pm
Saturdays until midday.

N.B. Customers intending to collect orders are requested to telephone in advance:— even popular types may be out of stock for short periods.

V.D.U./RADAR TUBES

We have supplied British and Foreign Airlines with rebuilt V.D.U. Tubes for several years and also have Radar Display Tubes operating on British Airfields.

Home and export enquiries for Radar Display Tubes manufactured from new (with phosphors to specification) are invited.

**WATERLOO ROAD,
UXBRIDGE,
MIDDLESEX**

Telephone: Uxbridge 55800

COLOUR TUBES

STANDARD
TUBES

METAL BAND
TUBES

Rebuilt with new Electron Guns to British Standard 415/1972. Clause 18.2.

SUFFOLK TUBES LIMITED

214, PURLEY WAY
CROYDON, SURREY
01-686 7951

Britain's Largest Independent
TV Tube Rebuilder

EHT 5 Stick 18 or 20KV Triplers (ITT)

BD253 £1.00 3 amp 1 1/4 Fuses 2p Long wires 300 Mixed Carbon Film Resistors 5 of each type 1/4 Watt 1R to 2 Meg - ITT £1.50 Red & Green L.E.D.s mixed large and small 14 for £1.00 Convergence Panel for GEC 2040 11 pots 5 coils 2-Resistors E.T.C. New £1.50 (Reject Varicap Units) ELC1042/ELC1043 50p ELC2000 £1.00 10 Watt LP1173 £1.00 IF LP1170 50p AM/EM T/Unit 50p (Seconds) ATT025/08 Blue Lateral Ass. 15p 10 Watt Mullard Amps New £2.00 BD 207 30p TIP 31 or TIP 31A 20p TIP 2955 50p 2N3583 250V/1A 40p Output Transistor BY190 40p (MJE2021) NPN 80V/5A 15p (SJE5451) (661 pair 80W/5A pair 28p (660 90V 40V 2A O.P. Trans B0375/6 pair 20p BZV 15/12R PYE 30p BD226 25p BD238 25p MJE 1661 25p XTALS T/V 4.433.610KHz 50p BYX 38/600R 50p BT138 Triacs 10a/600V 65p RCA40506 Thyristors 50p MJE 2955/15A 50p TIP 41A-42 pair 40p G11 Phillips Thyristors 60p PYE Thyristors 85p 2N4444-0T112 BT116 SP8385 Thorn 25p 5 amp 300V Thyristors 25p BRC 4443 65p SCR 957 65p BD561-2 pair 30p BC365 10p BD 131 25p BD183 PYE FRAME O/P. 50p AC187-8K pair 40p 6 Way Ribbon Cable 20p per meter 210PF/8KV 10p 330PF/8KV 10p 4.7NF5KV 10p 6200PF/2000V 10p 180PF/6KV 10p 1000PF/10KV 10p 1000PF/12KV 10p 1200PF/12KV 10p 270PF/8KV 10p 160PF/8KV 10p .1MFD 400V 5p .1MFD 800V 8p .1MFD 2000V 15p	EHT (S) Stick 18 or 20KV Triplers (ITT) £1.50 new 3 amp Diodes approx. voltage 1200 7p 3500 6 push button units for Thorn 3500 Varicap tuning £1.00 Varicap F.M. Tuner Tuning range 78.5 to 108MHz (I.F. Panel with circuit) £2.00 6 position 12.5K V/Resistor Unit for Varicap 50p Thorn Mains Lead & ON/OFF switch & Control Panel with Slider Pots 75p TBA 120A 30p TBA 120B 30p TBA 120AS 30p TBA 120SB 30p TIP 161NPN 50p EHT Lead & Anode Cap 75p	Star Aerial Amps Channel B or C £4.00 2200/35 15p 2000+2000/35 25p 2500+2500/63V 50p 4700/25 25p 4700/30 35p 4700/40 50p 1250/50 10p 33/350 6p 100/63 8p 10/350 8p 47/50 5p Bush Rank £2.50 6 push button unit FDR V/cap 1000+ 25p 2000m/35V 25p TBA 520 £1.00	DE Solder Pumps £6.00 TCE527 20p TCE340 20p TCE157 20p Y716 20p SN76226 50p BD253 £1.00 BY190 50p Plug and Sockets 3 & 6 Pin Printed Circuit Type pair 10p FRONT END FOR MUSIC CENTER Size 13" x 3 1/2 VHF/M.W./L.W. 4 Push Button, Unit 7 Transistors, V/Condenser, 10 Coils, Rod Aerial, I.C. Decoder CA758E. (No Power Supply and O/P Stage). Circuit Supplied £6.00 (New)
	.01MFD 600V 5p .01MFD 1000V 8p .0047/500V 8p .0022 1500V 8p .47 250 A/C 8p .47 1000V 35p .047 1000V 8p .22/250AC 8p 1500/100V 25p 10/500V 15p .47/100V 5p 330/25V 5p 680/40V 8p 22/350V 7p 330/100V 10p 15/450V 10p 47/450V 12p 470/16V 8p 470/25V 8p 470/40V 10p 470/63V 15p 470/100V 15p 220/25V 6p 220/40V 6p 220/63V 10p 160/25V 5p 330/16V 5p 100/16V 5p 2.2/160V 5p 10/40V 5p TBA 920 £1.00 TBA 920Q £1.50 TBA 480Q £1.00 5 x 3 Speaker 80R or 50R 50p G9 Speakers 70R £1.00 TBA 625 £1.00 TBA 550Q £1.50 TBA 540 £1.00 TBA 5400 £1.00 TBA 530Q £1.00 TBA 990 £1.00 SBA 550B £1.50 SN76003 £1.00 No Heat Sink SN 76003N £1.75 SN 76023N £1.50 SN 76033 £1.50 TBA 800 60p TBA 810S £1.00 TCA 270 £1.00 TCA 270Q £1.00	TCA 275Q £1.00 CA 270 75p TBA 720A £1.50 TBA 510Q £1.50 SN76115N 50p TAA 700 £2.00 TAA570 £1.50 TBA 396 £1.00 SAS 570S £1.50 SN76666 £1.00 SN76660 50p SN76227 50p SN76544N 75p TBA641BX1 £1.50 CA920 AW £1.00 TBA 750 £1.00 TAA 550 20p SN76131N 50p SN76001 £1.00 TBA560CQ £1.00 SN76530P 50p SN76650N 50p TDA1170 85p TBA 651 75p BTT822 £1.50 BTT8224 £1.50 22/40 5p 1500/40 10p .005/1500V 5p 47/100V 8p BU124 Portable T/V Line Scan Trans. 50p UHF Aerial Socket and Leads PYE, ITT & THORN 35p BD386 30p	.05/100 3p 4.7/50V 5p 4/350 5p 1000/25 10p 4.7/100 6p 2.2/100 6p 1000/10 5p 8/350 5p 1/250 5p 1/100 5p 6MHz Filters 25p 3300/40 15p 3300/25 5p 1500/25 10p 1/350 5p 220/10 5p 680/100 10p 220/16 5p 47/63 5p 33/63 5p 2.2/63 5p 22/100 8p 4.7/63 5p 1000/40 10p 100/450 30p 22M 350V 20p 33.000 20p PUA758PC £1.00 MC1349P 50p TCEP100 £1.00 TCE120CQ £1.00 22/100V 5p 100/350V 20p .47/250V 8p 10/350 10p

SENDZ COMPONENTS

2 WOODGRANGE CLOSE, THORPE BAY, ESSEX

Reg. Office Only.

Callers by appointment only.

Add 15% VAT.

Add 30p P. & P.

Add postage for all overseas parcels.

Belling Lee CO AX Plug Non Solder Type 14p 100 mixed 20mm Fuses £2.00	AU113 £1.00 BU 205 £1.00 BU 108 £1.00 BU 208 £1.00 BU 500 £1.00 BU 126 £1.00 R2008B £1.00 R2010B £1.00	NEW VHF/UHF on panel ELC2060 £4.50 Phillips T/Units UHF New £2.00 VHF/UHF AEG £2.50 Varicap NSE Removed from new panels VHF Varicap Units NSF AEG removed from Print Panels £1.00 New 49.00 21.900MHz VHF Varicap (NSF) AEG New 49.00 21.900MHz £2.00 4 Push Button T/Units UHF MULLARD £2.00 AE Isolating Sockets UHF & Lead PYE & THORN ITT 35p DECCA 1730 Doubler £1.00 Transistor UHF Units with AE Socket and leads GEC 2000 Rotary type NEW £2.00 7 button Varicap tuning heads Variable Resistor with Fascia Plate 7 Lamps £3.00 PYE 6 push button unit for Varicap Tuning £2.50 4 push button unit (for Varicap Tuning) 20K New 50p DECCA Bradford Tuner 5 Button New £2.75 BB 105 UHF BB 103 VHF BA 182 Varicap diodes 5p each BTY80 20p 3 amp Diodes 300V 10p 3 amp Diodes 100V 7p 1 amp Bridges 100V 20p 1 amp 400V 20p 3 amp Bridge 25p W005M Bridge 15p 194-N30 Replacement for BU204 75p 121-1015 Replacement for BU208A £1.00 200+200+100 325V 70p BY 127 10p IN4005 4p	BY 206 7p IN4006 5p IN4007 5p BY210/400 5p BY210/800 10p BY176 50p BY133 10p BA159 10p BY184 25p BY187 50p TV 20 50p TV 18 EHT 40p Rectifiers Sticks & lead & Anode Cap BYF3214 20KV Rectifier Sticks 25p each BYF3123 18KV Wire ends 25p BA 248 6p BSS 68 20p BYX55/350 10p BT106 S/Type 50p BT 106 95p BT 116 95p BT 119 95p BT 109 70p BT 146 750V 25p Thyristors 8A/800V 2N6399A 30p Thyristors 8A/400V 52600D 30p Y827 Diodes 30p Bridge Rec B30C 600A6 12p B30C 500 12p BC 147C 2N3566 BC 148B BF198 BC 149C BF274 BC 195 BSY79 BC 108 BC327 BC 107 BC213LA BF594 BC212LT BC 158 BF195 2N2222 BC182L 2N390 BF594 2N4355 BC183 T1591 BC238A 2SK30A BC454 BC455 7p each TIS90 15p
GRUNDIG 3000/3010 SIEMENS TVK52 Triplers £3.00 Triplers-DECCA £3.00 CS 2030 CS 2230 CS 2232 CS 2233 CS 2630 CS 2631 CS 2632 THORN-Needs Mod No 1400. 1500 Stud Multipliers £1.00 Triplers-PHILIPS 520.540.550 £3.00 Triplers-ITT CVC5 CVC20/25/30 CVC7 CVC8 CVC9 £3.00 LP1174/35 DECCA LP1194/42 PYE Triplers £4.00 G2100 GEC Tripler TVM25 £2.00 THORN 3500 THORN 8500 Focus Unit DECCA Focus Unit (Large or small) £1.00 each 4 Push Button Units 1400-1500 THORN £3.50 4 Push Button Unit 8500 THORN £3.50 300 Mixed condensers £1.50 300 Mixed resistors £1.50 30 Pre-Sets £0.50 100 W/W Resistors £1.50 40 Mixed Pots £1.50 20 Slider Pots £1.50 10 Different Types Mixed Electrolytics 150 £2.00 DP Push Button Switch ON/OFF 10p Mains ON/OFF Push Button T/V 20p Mains ON/OFF Rotary T/V 12½p Mains Dropper THORN 6R+1R+100R 35p Mains Droppers 6R+161 PYE 40p AD 161 AD 162 Pair 60p 147+260 PYE 40p (731) 3R+56R+27R 50p 100 Mixed Diodes £1.00 Mixed Bulbs 45p RCA 16572 RCA 16573 O/P Trans Pair 40p ZTK 33B 6p 100 Mixed Transistors 75p 1 LBs Mixed Components £1.50 BU 105/04 £1.00	EHT Rectifier BY212 10p 3 OFF G770/HU37 EHT 10p 12KV 2 M/A Small 20p EHT RECS 12KV 2 M/A Large 30p EHT RECS EHT REC USED IN THORN 1400.1500 Triplers (x80/150) 10p CSD 118xMH Rec THORN 3500 10p 220M/450V THORN 50p 700M/250V THORN 35p 175+100+100 350V 3500 THORN £1.50 400+400.350V DECCA 80p 470+470.250V 40p 100+200 325V 40p 200+200+100+32 350V 70p 150+200+200.300V 70p 731 PYE 600/300V & BUSH 75p each 200+200 350V 60p 400M 400V 40p 400M 350V 50p 800M 250V 30p AE Power supply 15V £1.00 BF 127 BC 303 BF 264 BRC 2108 BF 180 BC 336 BF 181 BF 157 BF 182 BC 161 BC 300 BC 460 AC 128 BC 350 BC 350 E1222 BF 178 BSY95A BF 257 BFT 43 BF 137 with heat sink BF 185 TIP 29A BF 200 TIP 32 BD 253 AC 153K 20p each GEC Sound O.P. Panel I.C. O.P. £2.50 AC 176K AC 153K Pair 40p UHF Varicap Units+VHF NEW ELC 1043/05 £4.00 ELC 1043/06 £4.00 THORN Varicap UHF 3.500 £3.50 New EQV ELC 1043/05 DECCA UHF Varicap New eqv EIC 1043/05 £4.00 VHF/UHF AEG Varicap (New) £3.50 G8 PHILLIPS £3.50 UHF Varicap replacement		

SENDZ COMPONENTS

2 WOODGRANGE CLOSE,
THORPE BAY, ESSEX

Reg. Office Only.

Callers by appointment only.

Add 15% VAT.

Add 30p P. & P.

Add postage for all overseas parcels.

2 pairs = £1.20
+ 018 VAT.
+ 030 P & P = £1.68