

SERVICING·VIDEO·CONSTRUCTION·COLOUR·DEVELOPMENTS

Television

JULY 1975

40p

**Larger
size
More
pages**

**Large-screen
TV OSCILLOSCOPE**

A
TV
PROJECT

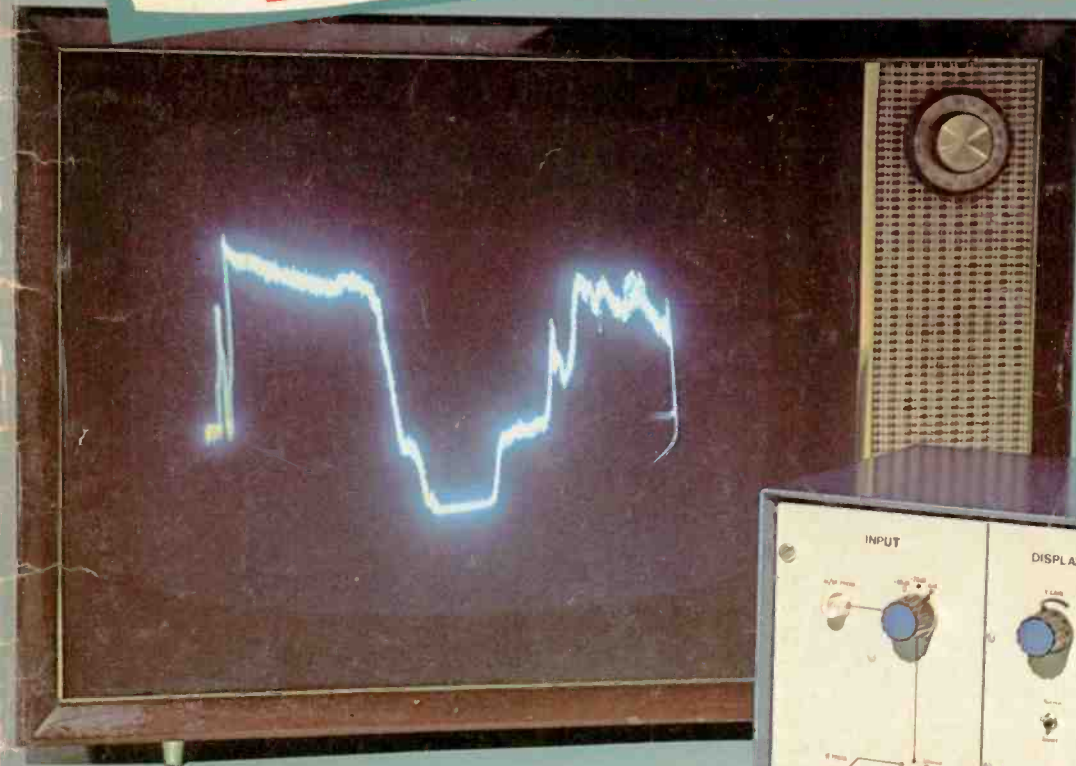

plus:

SERVICING: PHILIPS G6 COLOUR CHASSIS

VIDEO: SIGNAL EXTRACTION FOR VCRs

DEVELOPMENTS: NEW RANK COLOUR CIRCUITRY

NEW SERIES: CEEFAX/ORACLE RECEPTION TECHNIQUES

TRANSISTORS, ETC.		Type Price (£)	Type Price (£)	Type Price (£)	DIODES	LINEAR INTE-GRATED CIRCUITS	DIGITAL INTE-GRATED CIRCUITS	ZENER DIODES
Type Price (£)	Type Price (£)	Type Price (£)	Type Price (£)	Type Price (£)	Type Price (£)	Type Price (£)	Type Price (£)	400mW 3.0-33V 12p each
AC107 0.35	BC177 0.20	8F241 0.22	MPSU56 1.26	2N3133 0.54	AA113 0.15	CA3045 1.35	7400 0.20	1.3W 3.3-100V 18p each
AC117 0.24	BC178 0.22	8F244 0.18	MPSU55 1.26	2N3134 0.60	AA119 0.09	CA3046 0.70	7401 0.20	
AC126 0.25	BC178B 0.22	8F256 0.45	OC26 0.38	2N3232 1.32	AA129 0.20	CA3065 1.90	7402 0.20	
AC127 0.25	BC179 0.20	8F257 0.49	OC35 0.59	2N3250 1.02	AA143 0.10	MC1307P 1.19	7404 0.24	
AC128 0.25	BC179B 0.21	8F258 0.66	OC36 0.64	2N3254 0.28	AAZ17 0.12	MC1310P 2.94	7406 0.45	
AC141 0.26	BC182L 0.11	8F259 0.93	OC42 0.55	2N3323 0.48	BA100 0.15	MC	7408 0.25	
AC141K 0.27	BC183 0.11	8F262 0.70	OC44 0.25	2N3391A 0.23	BA102 0.25	1327PQ 1.01	7410 0.20	
AC142 0.20	BC183K 0.12	8F263 0.70	OC45 0.32	2N3501 6.99	BA110 0.30	MC1330P 0.76	7411 0.25	
AC142K 0.19	BC183L 0.11	8F273 0.16	OC70 0.32	2N3702 0.13	BA115 0.12	MC1351P 0.75	7412 0.28	
AC151 0.24	BC184L 0.13	8F336 0.35	OC71 0.32	2N3703 0.15	BA141 0.17	MC1352P 0.82	7413 0.50	
AC152 0.25	BC186 0.25	8F337 0.35	OC72 0.32	2N3704 0.15	BA145 0.17	MC	7416 0.45	
AC153K 0.28	BC187 0.27	8F458 0.60	OC73 0.51	2N3705 0.11	BA154 0.13	1358PQ 1.85	7417 0.30	
AC154 0.20	BC208 0.12	8F459 0.63	OC75 0.25	2N3706 0.10	BA155 0.16	MC1496L 0.87	7420 0.20	
AC176 0.25	BC212L 0.12	8F597 0.70	OC76 0.35	2N3707 0.13	BA156 0.15	MC3051P 0.58	7425 0.37	
AC178 0.27	BC213L 0.12	8F597 0.70	OC81 0.53	2N3715 2.30	BA157 0.25	MFC	7430 0.20	
AC187 0.25	BC214L 0.15	8F939 0.24	OC81D 0.57	2N3724 0.72	BAX13 0.06	4000B 0.43	7440 0.20	
AC187K 0.26	BC238 0.12	8F941 0.30	OC139 0.76	2N3739 1.18	BAX16 0.07	MFC	7441 0.85	
AC188 0.25	BC261A 0.28	8F961 0.30	OC140 0.80	2N3766 0.99	BAY72 0.11	4060A 0.70	7445 1.95	
AC188K 0.26	BC262A 0.18	8F979 0.24	OC170 0.25	2N3771 1.70	BB105B 0.52	MFC6040 0.91	7447 1.30	
AC193K 0.30	BC263B 0.25	8F979 0.24	OC171 0.30	2N3772 1.90	BB105G 0.45	NE555 0.72	7450 0.20	
AC194K 0.32	BC267 0.16	8F979 0.24	OC200 1.30	2N3773 2.90	BB110B 0.45	NE556 1.34	7451 0.20	
AC2Y8 0.25	BC268C 0.14	8F979 0.24	OC201 1.30	2N3774 2.90	BR100 0.50	PA263 1.90	7454 0.20	
AC3Y9 0.68	BC294 0.37	8F979 0.24	OC202 1.30	2N3790 4.15	BY100 0.22	SL414A 1.91	7460 0.20	
AD140 0.50	BC300 0.60	8F979 0.24	OC203 1.30	2N3794 0.20	BY103 0.22	SL901B 3.84	7470 0.33	
AD142 0.52	BC301 0.35	8F979 0.24	OC204 1.30	2N3819 0.35	BY126 0.16	SN197B 5.12	7472 0.38	
AD143 0.51	BC303 0.60	8F979 0.24	OC205 1.30	2N3820 0.49	BY127 0.17	76001N 1.45	7473 0.44	
AD149 0.50	BC307B 0.12	8F979 0.24	OC206 1.30	2N3823 1.45	BY130 0.23	76003N 2.92	7474 0.48	
AD161 0.48	BC308A 0.10	8F979 0.24	OC207 1.30	2N3866 1.70	BY140 1.40	SN	7475 0.59	
AD162 0.48	BC309 0.15	8F979 0.24	OC208 1.30	2N3877 0.25	BY164 1.68	76013N 1.95	7489 4.32	
AF114 0.25	BC323 0.68	8F979 0.24	OC209 1.30	2N3904 0.16	BY176 1.68	SN76013	7490 0.65	
AF115 0.25	BC377 0.22	8F979 0.24	OC210 1.30	2N3905 0.18	BY206 0.31	ND	7491 1.10	
AF116 0.25	BC441 1.10	8F979 0.24	OC211 1.30	2N3906 0.15	BY212 0.15	76023N 1.95	7492 0.75	
AF117 0.20	BC461 1.58	8F979 0.24	OC212 1.30	2N4032 0.43	BY212 0.15	SN	7493 0.65	
AF118 0.50	BCY33 0.36	8F979 0.24	OC213 1.30	2N4033 0.54	FSY11A 0.30	76023N 1.95	7494 0.85	
AF121 0.32	BCY42 0.16	8F979 0.24	OC214 1.30	2N4036 0.52	FSY41A 0.40	SN76023	7495 0.85	
AF124 0.25	BCY71 0.22	8F979 0.24	OC215 1.30	2N4046 0.35	OA10 0.20	ND	7496 1.00	
AF125 0.25	BCY88 2.42	8F979 0.24	OC216 1.30	2N4058 0.17	OA47 0.07	SN	74100 2.16	
AF126 0.25	BD115 0.65	8F979 0.24	OC217 1.30	2N4123 0.13	OA81 0.12	76033N 2.92	74121 0.60	
AF127 0.25	BD123 0.98	8F979 0.24	OC218 1.30	2N4124 0.15	OA90 0.08	SN	74122 0.80	
AF139 0.35	BD124 0.80	8F979 0.24	OC219 1.30	2N4126 0.20	OA91 0.07	76227N 1.46	74150 1.44	
AF147 0.35	BD130Y 1.42	8F979 0.24	OC220 1.30	2N4236 1.90	OA95 0.07	SN	74151 1.15	
AF149 0.45	BD131 0.45	8F979 0.24	OC221 1.30	2N4248 0.12	OA200 0.10	76530P 1.05	74154 1.66	
AF178 0.55	BD132 0.50	8F979 0.24	OC222 1.30	2N4284 0.19	OA202 0.10	SN	74164 2.01	
AF179 0.60	BD135 0.40	8F979 0.24	OC223 1.30	2N4286 0.19	OA210 0.29	76533N 1.20	74192 2.05	
AF180 0.55	BD136 0.46	8F979 0.24	OC224 1.30	2N4288 0.13	OA223 0.78	SN	74193 2.30	
AF181 0.50	BD137 0.48	8F979 0.24	OC225 1.30	2N4289 0.20	S2M1 0.22			
AF186 0.40	BD138 0.50	8F979 0.24	OC226 1.30	2N4290 0.14	TV20 1.85	76666N 0.90		
AF239 0.40	BD139 0.55	8F979 0.24	OC227 1.30	2N4291 0.18	IN914 0.07	TAA300 1.76		
AF279 0.84	BD140 0.62	8F979 0.24	OC228 1.30	2N4292 0.20	IN914E 0.06	TAA320 0.94		
AL100 1.10	BD144 2.19	8F979 0.24	OC229 1.30	2N4392 2.84	IN184 0.12	TAA350A 2.02		
AL102 1.10	BD145 0.75	8F979 0.24	OC230 1.30	2N4392 2.84	IN184 0.12	TAA435 0.85		
AL103 1.10	BD163 0.67	8F979 0.24	OC231 1.30	2N4392 2.84	IN184 0.12	TAA450 2.70		
AL113 0.95	BD183 0.56	8F979 0.24	OC232 1.30	2N4392 2.84	IN184 0.12	TAA550 0.55		
AU103 2.10	BD222 0.78	8F979 0.24	OC233 1.30	2N4392 2.84	IN184 0.12	TAA570 2.02		
AU110 1.90	BD234 0.75	8F979 0.24	OC234 1.30	2N4392 2.84	IN184 0.12	TAA611A 1.70		
AU113 2.40	BD410 1.65	8F979 0.24	OC235 1.30	2N4392 2.84	IN184 0.12	TAA611B 1.85		
BC107 0.12	BD519 0.76	8F979 0.24	OC236 1.30	2N4392 2.84	IN184 0.12	TAA630Q 4.18		
BC107A 0.13	BD520 0.76	8F979 0.24	OC237 1.30	2N4392 2.84	IN184 0.12	TAA630S 4.18		
BC107B 0.14	BD599 0.75	8F979 0.24	OC238 1.30	2N4392 2.84	IN184 0.12	TAA661B 1.32		
BC108 0.12	BDX18 1.45	8F979 0.24	OC239 1.30	2N4392 2.84	IN184 0.12	TAA700 4.18		
BC108B 0.13	BDX32 2.55	8F979 0.24	OC240 1.30	2N4392 2.84	IN184 0.12	TAA840 2.02		
BC109 0.13	BDY18 1.78	8F979 0.24	OC241 1.30	2N4392 2.84	IN184 0.12	TAA861A 0.49		
BC109C 0.14	BDY20 0.99	8F979 0.24	OC242 1.30	2N4392 2.84	IN184 0.12	TAD100 2.66		
BC113 0.13	BF115 0.20	8F979 0.24	OC243 1.30	2N4392 2.84	IN184 0.12	TBA120S 0.99		
BC114 0.20	BF117 0.45	8F979 0.24	OC244 1.30	2N4392 2.84	IN184 0.12	TBA240A 2.97		
BC115 0.20	BF120 0.55	8F979 0.24	OC245 1.30	2N4392 2.84	IN184 0.12	TBA281 2.28		
BC116 0.20	BF121 0.25	8F979 0.24	OC246 1.30	2N4392 2.84	IN184 0.12	TBA480Q 1.90		
BC117 0.20	BF123 0.28	8F979 0.24	OC247 1.30	2N4392 2.84	IN184 0.12	TBA500 1.99		
BC119 0.29	BF125 0.25	8F979 0.24	OC248 1.30	2N4392 2.84	IN184 0.12	TBA500Q 2.00		
BC125 0.22	BF127 0.30	8F979 0.24	OC249 1.30	2N4392 2.84	IN184 0.12	TBA510 1.99		
BC126 0.20	BF158 0.25	8F979 0.24	OC250 1.30	2N4392 2.84	IN184 0.12	TBA520Q 3.34		
BC132 0.15	BF159 0.27	8F979 0.24	OC251 1.30	2N4392 2.84	IN184 0.12	TBA530 2.71		
BC134 0.20	BF160 0.22	8F979 0.24	OC252 1.30	2N4392 2.84	IN184 0.12	TBA530Q 2.71		
BC135 0.19	BF161 0.45	8F979 0.24	OC253 1.30	2N4392 2.84	IN184 0.12	TBA540 3.21		
BC136 0.20	BF162 0.45	8F979 0.24	OC254 1.30	2N4392 2.84	IN184 0.12	TBA540Q 3.21		
BC137 0.20	BF163 0.45	8F979 0.24	OC255 1.30	2N4392 2.84	IN184 0.12	TBA550Q 4.10		
BC138 0.20	BF167 0.25	8F979 0.24	OC256 1.30	2N4392 2.84	IN184 0.12	TBA560C 4.09		
BC142 0.30	BF173 0.25	8F979 0.24	OC257 1.30	2N4392 2.84	IN184 0.12	TBA		
BC143 0.35	BF177 0.30	8F979 0.24	OC258 1.30	2N4392 2.84	IN184 0.12	560CQ 4.10		
BC147 0.13	BF178 0.33	8F979 0.24	OC259 1.30	2N4392 2.84	IN184 0.12	DY87 0.39		
BC148 0.12	BF179 0.33	8F979 0.24	OC260 1.30	2N4392 2.84	IN184 0.12	E891 0.30		
BC149 0.14	BF180 0.35	8F979 0.24	OC261 1.30	2N4392 2.84	IN184 0.12	EC82 0.41		
BC152 0.25	BF181 0.33	8F979 0.24	OC262 1.30	2N4392 2.84	IN184 0.12	EF80 0.41		
BC153 0.20	BF182 0.44	8F979 0.24	OC263 1.30	2N4392 2.84	IN184 0.12	EF183 0.53		
BC154 0.20	BF183 0.44	8F979 0.24	OC264 1.30	2N4392 2.84	IN184 0.12	EF184 0.53		
BC157 0.15	BF184 0.26	8F979 0.24	OC265 1.30	2N4392 2.84	IN184 0.12	EH90 0.55		
BC158 0.13	BF185 0.26	8F979 0.24	OC266 1.30	2N4392 2.84	IN184 0.12	PC86 0.67		
BC159 0.15	BF194 0.15	8F979 0.24	OC267 1.30	2N4392 2.84	IN184 0.12	PC88 0.76		
BC161 0.48	BF195 0.15	8F979 0.24	OC268 1.30	2N4392 2.84	IN184 0.12	PC89 0.58		
BC167B 0.15	BF196 0.15	8F979 0.24	OC269 1.30	2N4392 2.84	IN184 0.12	PCF80 0.47		
BC168B 0.13	BF197 0.17	8F979 0.24	OC270 1.30	2N4392 2.84	IN184 0.12	PCF86 0.58		
BC169C 0.13	BF198 0.20	8F979 0.24	OC271 1.30	2N4392 2.84	IN184 0.12	PCF801 0.58		
BC170 0.15	BF199 0.25	8F979 0.24	OC272 1.30	2N4392 2.84	IN184 0.12	PCF802 0.63		
BC171 0.15	BF200 0.35	8F979 0.24	OC273 1.30	2N4392 2.84	IN184 0.12	PCL8		

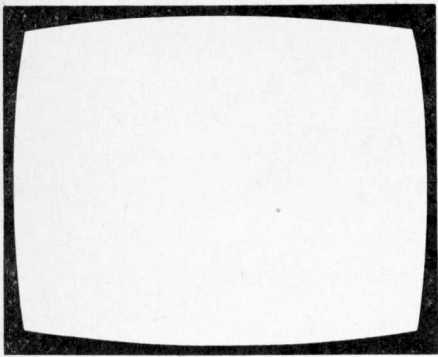

Television

SERVICING
VIDEO
CONSTRUCTION
COLOUR
DEVELOPMENTS

VOL. 25
NO. 9
ISSUE 297
JULY
1975

COPYRIGHT

© IPC Magazines Limited, 1975. Copyright in all drawings, photographs and articles published in *Television* is fully protected and reproduction or imitation in whole or in part is expressly forbidden. All reasonable precautions are taken by *Television* to ensure that the advice and data given to readers are reliable. We cannot however guarantee it and we cannot accept legal responsibility for it. Prices are those current as we go to press.

CORRESPONDENCE

All correspondence regarding advertisements should be addressed to the Advertisement Manager, "Television", Fleetway House, Farringdon Street, London EC4A 4AD. All other correspondence should be addressed to the Editor, "Television", at the same address.

SUBSCRIPTIONS

Publisher's Subscription Rate for one year to the UK is £5.80, to the USA and Canada \$15.50, and to the rest of the world £5.65 including postage. Enquiries to Subscription Department, IPC Magazines Ltd., Carlton House, 66-68 Great Queen Street, London WC2 5DD. Phone 01-242 4477. International Giro facilities Account No. 5122007. Please state reason for payment "Message to payee". Binders (£1.90) and Indexes (30p) can be supplied by the Post Sales Department at the same address. Prices include postage and VAT.

BACK NUMBERS

We regret that we are unable to supply back numbers of *Television*. Readers are recommended to enquire at a public library to see copies. Requests for specific back numbers of *Television* can be published in the CQ Column of *Practical Wireless* by writing to the Editor, "Practical Wireless", Fleetway House, Farringdon Street, London EC4A 4AD.

QUERIES

We regret that we cannot answer technical queries over the telephone nor supply service sheets. We will endeavour to assist readers who have queries relating to articles published in *Television*, but we cannot offer advice on modifications to our published designs nor comment on alternative ways of using them. All correspondents expecting a reply should enclose a stamped addressed envelope.

Requests for advice in dealing with servicing problems should be directed to our Queries Service. For details see our regular feature "Your Problems Solved".

this month

- 390 Teletopics**
News and developments.
- 395 Line Scan**
New products reviewed.
- 396 Ceefax/Oracle Reception Techniques, Part 1**
An introduction to teletext.
by Steve A. Money, T.Eng. (CEI)
- 399 Servicing Television Receivers**
Beginning a guide to common faults on the Philips G6 chassis.
by L. Lawry-Johns
- 406 Video Take-off for VCRs**
A practical method of extracting a video frequency signal from the receiver circuits.
by Keith Cummins
- 408 Long-Distance Television**
Reports of DX reception and news from abroad.
by Roger Bunney
- 412 Large-Screen TV Oscilloscope, Part 1**
Converting a monochrome receiver into an oscilloscope for the display of TV and low frequency signals.
by D. Haley, C.Eng. MIEE
- 416 Readers' Letters**
- 418 Dealing With Corona and Allied Troubles**
Tracing and curing corona and e.h.t. arcing faults.
by Vivian Capel
- 420 CCTV, Part 16**
Camera tubes used in CCTV installations.
by Peter Graves
- 424 Service Notebook**
Notes on interesting faults and servicing techniques.
by G. R. Wilding
- 426 Inside Rank's New 18" Colour Sets**
A description of the novel timebase and c.r.t. supply circuits used with the in-line gun tube featured in the new Z718 chassis.
by R. Fisher
- 432 Quick-heat CRTs**
Describing the construction of the Quick-heat gun and precautions necessary when making replacements.
by Harold Peters
- 433 Your Problems Solved**
A selection from our Readers' Query Service.
- 435 Test Case**
Can you solve this servicing problem?

OUR NEXT ISSUE DATED AUGUST WILL
BE PUBLISHED ON JULY 21

TV'S AND SPARES TO THE TRADE MONOCHROME TELEVISIONS

BBC 2 Dual Standard TV's (19", 23") in batches of 10 – £2.00 each. (makes include Bush, Thorn, Philips, Pye/Ekco, Baird). Many with transistorised tuners.

GEC 2000, Thorn 950 series, Bush 141, Philips Style 70, Baird 600 and 700 series all at £6.00 each.

Thorn 1400, Bush 160/170 series, Philips 210, Pye-Ekco Olympic etc., Baird 673, Push Button – all at £12.50 each.

20" and 24" square screen Dual Standard sets – Thorn, G.E.C. etc., 20" – £15.00, 24" – £16.50.

20" and 24" Single Standard Thorn 1500, G.E.C., Bush Acoustic, 20" – £17.50, 24" – £19.50.

1. Discounts for quantities.
2. All monochrome spares supplied free of charge.
3. All tubes guaranteed.
4. All cabinets very good.
5. All sets "walk and talk".
6. All sets guaranteed complete inside and out.
7. Delivery and VAT extra.

Portable TV 16" Thorn UHF – £15.00 working
– £12.50 untested

COLOUR TELEVISIONS

Colour T.V.'s 19" and 25".

Makes include Thorn 2000, Bush CTV25, Decca CTV 19/25", Pye-Ekco, Baird 700 and 710 series, Philips G6, GEC 2028.

All sets guaranteed complete inside and out – Cabinets first class and tubes guaranteed – From £65.00 each.

20", 22" Colour Televisions are always available in varying quantities – please telephone for availability and cost.

Please Note:-

1. We deliver anywhere by our own transport.
 2. All goods are blanket wrapped in our vans.
 3. All orders with half deposit, balance on delivery after inspection.
 4. Cheques most welcome.
 5. Any quantity supplied.
 6. We do not sell rubbish, and we stand by our guarantees.
 7. We aim to please.
 8. All spares supplied free of charge (Mono only).
- N.B. Special arrangements for delivery to North and South Ireland and world-wide exports orders welcomed.

TEST BENCH FACILITIES ALWAYS AVAILABLE

MISCELLANEOUS ITEMS

Large quantities of stereograms – fridges – deep freezers – Hoovermatics, radios etc., – always at hand – prices on request.

	COLOUR	MONO
Scan Coils	All dual standard £5.00+£1.00 post & packing	All makes £2.00 inclusive
Valves	All colour valves 40p each plus 5p post and packing per valve.	All mono valves 10p each plus 2p each post and packing
Tubes	19" – £15.00 } 22" – £22.00 } 25" – £20.00 }	19" – £3.00 } 20" – £4.50 } 23" – £4.00 } 24" – £6.00 }
Cabinets	19" – £12.00 } 22" – £16.00 } 25" – £14.00 }	Post, insurance, packing £5.00 All cabinets – £5.00 including post, packing and insurance
LOPT's	All dual standard colour £5.50 plus £1.00 post, packing. All makes available.	All dual standard mono £2.50 plus £1.00 post, packing. All makes available.
Panels	IF, Decoder and Convergence – frame output for all dual standard models from £7.50+£1.50 post, packing. All models available.	IF, Line timebase £3.00 plus £1.00 post, packing. All dual standard models in stock.
Slot meters	10p meters – £1.50 each including postage and packing.	
Speakers	6" x 4" 5" Round 8" x 2" 30p each plus 10p postage and packing.	

PLEASE ALLOW 2 WEEKS DELIVERY. S.A.E. PLEASE FOR ENQUIRIES. ALL STOCK EX-EQUIPMENT.

BARCLAYCARD, ACCESS & PROVIDENT WELCOME

MAIL ORDER SERVICES

Black/White Televisions

Working		Untested – but guaranteed complete with good tubes	
19" – £9.50		19" – £4.00	} Postage packing and insurance £3.50 each Prices include V.A.T. N.B. All tubes guaranteed
23" – £12.50		23" – £5.00	
20" – £20.00		20" – £15.00	
24" – £24.50		24" – £19.00	

Colour Televisions

Working		Untested – but guaranteed complete with good tubes	
19" – £85.00		19" – £70.00	} Postage packing and insurance £9.00 each. Prices include V.A.T.
22" – £125.00		22" – £90.00	
25" – £130.00		25" – £95.00	

Thorn 2000, Bush CTV25, Philips G6, GEC2028, Baird 700, Decca CTV25

Portable BBC2 16" Televisions (Monochrome) – Working	£19.50	} Postage packing and insurance £3.00. Prices include V.A.T.
Untested	£15.00	

MAIL ORDER SPARES Special Offer – Brand new spares

BRC 2000 panels, video, convergence, and regulator – only £12.50+£1.50 postage and packing.
 Bush CTV 25 Line timebase-tower unit including LOPT and valves Mk. I and II only – £18.00+£3.00 postage and packing.
 BRC single standard colour 4 button tuners colour and mono – £7.50+£1.00 postage and packing.
 UHF Vari-cap tuner units – £6.50+£1.00 postage and packing. KB VC Series LOPT £2.50 including postage and packing.
 VHF Vari-cap tuner units – £7.50+£1.00 postage and packing. Bush 125 and 135 IF Panels – £3.50+75p postage and packing.
 Pye-Ekco CTV Tripler units – £6.25+75p postage and packing. Thorn 850 IF Panels – £2.50+£1.00 postage and packing.
 Philips G8 Tripler units – £7.50+75p postage and packing. GEC 2000 IF Panels – £3.50+£1.00 postage and packing.

EX-EQUIPMENT

Tuners

COLOUR

All dual standard colour push button – rotary and integrated models in stock at £4.50+£1.00 postage and packing.

MONO

All VHF tuners available at £2.00+£1.00 postage and packing.
 All UHF tuners for dual standard models in stock. Push button – £3.50+£1.00 postage and packing.
 Rotary – £2.50+£1.00 postage and packing.
 Integrated (UHF & VHF) £4.50+£1.00 postage and packing.

Comprehensive list of capacitors, resistors etc., too numerous to mention. Prices on request.

HOOVERMATICS AND VACS.

HOOVER WASHERS

HOOVERMATIC 3174	£35.00
3444	£37.00
65	£34.00
3334	£37.00
3301L	£39.00
3304	£39.00

Should you desire to see our factory during the process of reconditioning this can be arranged on a mutually convenient date.

All prices quoted are subject to current V.A.T. assessment.

Delivery extra.

HOOVER VACUUM CLEANERS

119	£16.50	612 Senior	£19.50
1334	£19.00	652 Senior	£23.00

All Hoovermatics are supplied with brand new formica working tops.
 All machines are stripped and stove enamelled as a matter of course.

All washers are supplied with a plastic bag on delivery, and for £1.00 extra per machine a complete cardboard jacket can be supplied to suit your individual requirements for packaging and transport.

Individual orders can be despatched by BRS at an additional cost of £7.00 which includes postage, packaging and insurance.

Delivery can be effected to any part of the country within two to three weeks and special delivery arrangements are available for Northern Ireland (once per month), Scotland, London, Wales, West Country and East Anglia (once per fortnight).

All goods may be inspected at the above premises any time, and special arrangements can be made for dealers to travel up to Harrogate on Sunday if necessary when we will make ourselves available to your requirements.

We will be happy to quote you a price and specification against any other washing machines you require of any make.

It may be of interest to you to note that in fifteen years of trading we, ourselves, have never satisfactorily found a company who would consistently maintain a high standard of reconditioned machines and vacuums. We then decided some months ago that the only way was to do our own, and I think you will find that the standard is continually high, with first-class service offered.

GUARANTEE

We guarantee all our items against faulty workmanship but as in all houses things occasionally are bound to go wrong. As there has to be a measure of integrity between customer and client we would hope that you yourselves would replace at your own expense little things like broken belts and hoses etc., but we ourselves will without equivocation replace free of charge any machine with a major fault. All items are guaranteed for six months.

Please note prices of Hoover Mark 3 and Mark 3A are subject to such vagrancies in the trade that it is impossible to give a firm price. We could, however, quote you against your individual requirements when these machines are available.

Other models supplied – prices on request.

Specification supplied on request.

TRADE DISTRIBUTORS
5 COMMERCIAL STREET, HARROGATE, YORKSHIRE
 Telephone: (STD 0423) 3498 and 62347

when you
want spares
yesterday...



YOU NEED
A FRIEND!

same-day despatch
is as near as
your telephone
- try it!

Stockists of genuine manufacturers spares for Rank Bush Murphy ...
CES ... Pye ... Philips ... Invicta ... Pam ... Ekco ... Ferranti
BRC ... Ferguson ... Ultra ... Marconi ... HMV ... Stockists of
TELEPART SPARES for Decca ... KB ... GEC ... Sobell ...
Masteradio ... RGD etc. Line output transformers ... EHT rectifier trays
Scan coil assemblies ... Frame and sound outputs ... Dropper sections
Entertainment valves ... Transistors and integrated circuits ...
Components ... Cathode ray tubes ... Meters ... Test equipment ...



4-5 THE BROADWAY - HANWELL LONDON W7
74 MAXWELTON RD - PAISLEY RENFREW
42 WEST END - STREET SOMERSET

01-567 5400
041-887 4949
045-84 2597

Ask for your free copy of our 68 page catalogue.

COLOUR 25 KV TRIPLERS

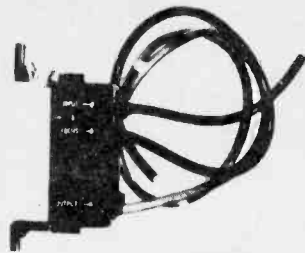

£1.70

REPLACEMENT TRIPLERS

TS25, 11TAZ	£3.00
G8 TRIPLERS	£3.00
COLOUR SCAN COIL	£3.00
I.C. SN76544N	£1.00
NU105 Transistors	50p
DECCA CS1730	£1.00
E.H.T. RECTIFIER STICKS X80/150D	10p
PYE TRANSISTOR TUNER UNITS VHF, UHF. No push button assembly	£1.50
PHILIPS UHF UNIT	£1.50
6 OR 4 PUSH-BUTTON UHF TUNER UNIT PYE	£3.00
UHF AERIAL ISOLATING CO-AX SOCKETS & LEAD	30p
22 MFD, 315 V/W Condensers	
25 MFD, 300 V/W, 470MFD 35 V/W	
10 MFD, 250 V/W	
180 PF 8Kv	10p
200+100 MFD, 325 V/W	30p
300+300+100+150, 350 V	70p
200+200+100, 325 V/W	40p
200+100+50+100	40p
300+200+100 MFD, 350 V/W	50p
200+200+100 MFD, 350 V/W	50p
100 W/W Resistor	£1.00
300 Mixed Condensers	£1.00
350 Mixed Resistors	£1.00
40 Mixed Pots	£1.00
5 Slider Pots	55p

COLOUR TV COMPONENTS

MANUFACTURERS DISCARDED MATERIALS

VHF or UHF Varicap Tuners	£1.20
Line o.p. Panels	£1.20
Decoder Panels	£1.00
G8 Type Yoke	50p
Frame Panels	75p

PLEASE ADD 25% V.A.T. TO ALL ORDERS

Money returned if not completely satisfied

SENDZ COMPONENTS

2 WOODGRANGE CLOSE
THORPE BAY, ESSEX

5% P.P. ON ALL ORDERS

Reg Office Only - No Personal Callers Please

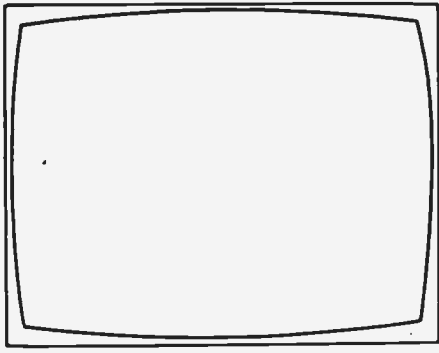

Television

THE INIQUITOUS 25%

What does the viewer get from his television set? Primarily, news and entertainment. The same in fact as he gets from his morning newspaper. Both are parts of what are called the media, the various means whereby the lines of communication are kept open between society and the individual, and between different groups and different interests within society. It is generally considered that communications are essential to the sort of society in which we have chosen to live: that a free society requires a variety of sources of information which are available to all. It is for this reason that newspapers, magazines and books are not taxed: they are considered to be an essential feature of our very way of life. Yet what they provide is in essence the same as what television provides, radio too for that matter: news and information, instruction and entertainment. But when it comes to the means of receiving radio and television transmissions we find that the highest rate of VAT is now applied.

This seems to us to be a serious error, on more than one set of grounds. But let's stick for the moment with this business of communications. To start with, television broadcasting may have been a thing of mainly curiosity value. In the days that is when the number of sets in the country, all tuned to Ally Pally, were numbered in thousands. Today however television reaches almost everyone and is considered an essential part of modern life. Not just by those who do the viewing, but also by those who avail themselves of the opportunity to reach the public at large in a way that gives the greatest impact. If the Prime Minister wishes to address the nation, he goes to the TV studios to do so. Remember President Roosevelt's famous war-time fireside chats? Winston Churchill's speeches to rally the nation? For maximum impact, they were broadcast over the air. The point needs no further emphasis: radio and TV services are essential components of modern life in a free country.

Yet the means whereby the public gains access to broadcasting is taxed as a luxury, at the new 25% rate, along with jewellery, fur coats and perfume. The Chancellor said he was increasing the taxes on "things we could all do without". His comments were heard by the public over their radio and television sets.

Quite apart from this basic principle, the TV industry has every reason to be outraged at the treatment it has received. The car industry, much more of a "luxury", gets off, presumably because the government is proposing to pump £1,000 million into British Leyland to stop it collapsing. Is the message then that our industry must get itself into a like mess before it can expect to receive reasonable treatment from chancellors? The ups and downs of taxes and credit conditions have played havoc with the trade over many years. But this latest blow comes at a time when the industry is already suffering from a severe downturn, with layoffs and factory closures. This is no way to encourage an industry that has managed well enough so far – without calls for state handouts. What will happen when the Chancellor decides the time is right for the next boom: a flood of imports from you know where to satisfy the demand our ravaged home industry will be unable to supply?

The iniquitous attack on the domestic radio and TV receiver industry goes even further, taking in servicing, components, and the supply of aerials. Taxes on servicing have always struck us as unfair and economically unsound. For a start they are regressive: it's the old age pensioner who, trying to get the last out of an ancient receiver, is most likely to have to pay for two or three new valves or a new line output transformer. And whilst anyone buying a piece of electronic equipment realises that some expenditure on repairs will sooner or later be necessary, it seems unfair subsequently to impose taxes on this – especially at an ever increasing rate. From the economic viewpoint, we are in the era of conservation and production aimed towards exports. Surely servicing should be encouraged, not penalised? If the government's intention is to cut the public's spending, it makes sense to help and in fact encourage people to keep old equipment going.

All in all the 25% VAT applied to TV goods seems wholly wrong. If precedent is anything to go by there will be another budget in the Autumn. That opportunity should be taken to remove this imposition on people's access to TV broadcasting.

EDITOR

Lionel E. Howes

ASSISTANT EDITOR

John A. Reddihough

TECHNICAL EDITOR

Geoffrey C. Arnold

ART EDITOR

Peter Metalli

ADVERTS. MANAGER

Roy Smith 01-634 4293

CLASSIFIED ADVERTS.

Colin R. Brown 01-634 4301

teletopics

TI INTRODUCE TIFAX DECODER

A recent seminar held by Texas Instruments to introduce their Tifax Ceefax/Oracle decoder system throws the spotlight once again on teletext transmission and display systems. The first such system to be developed anywhere in the world was the BBC's Ceefax system which was announced in October 1972. At much the same time the IBA was developing the similar Oracle system and subsequently, in July 1973, a BREMA committee was set up to produce a single standard for a teletext system for the UK. Agreement on a unified standard was announced in March 1974 and in September 1974 the government gave permission to the broadcasting authorities to start experimental transmissions for a two year period. Texas Instruments Ltd., Bedford have been at work on Ceefax/Oracle decoder design since April 1973 and the outcome of this is their Tifax system. This will be offered to setmakers as a complete module for inclusion in new sets. One of the most important aspects of the system is the simple interfacing between the module and the rest of the TV set: the only inputs the module requires are composite video, a line flyback pulse feed for synchronisation and a 5V supply, while the signal and blanking outputs it provides are designed for simple connection to a cascade video output stage.

Texas Instruments are keeping their options open on the final design details however. One reason is that the final decisions have yet to be taken by the broadcasting authorities on the transmission parameters. It is in fact early days yet, with the entire system still undergoing evaluation. In this connection James Redmond, BBC Director of Engineering, had some interesting comments to make at the seminar. The BBC's transmissions since last September have demonstrated that the UK system works well at u.h.f. With exports in mind however it was decided to test the system at v.h.f. as well since most TV transmissions in Europe and elsewhere are in Bands I, II and III. Consequently tests have been conducted in Sweden and Germany. The Swedish tests were handled by the BBC in conjunction with the Swedish broadcasting and PTT authorities. The tests in Germany were conducted jointly by the BBC, the IBA, the British receiver industry, the Institut für Rundfunktechnik (German broadcasting research institute) and the German Bundespost. Advanced information on the results of the German tests is apparently very encouraging. It was found that wherever reasonable television pictures could be received, Ceefax reception was also satisfactory: where Ceefax failed, the television picture

was either poor or there was considerable multipath interference. The same sort of results have been obtained from the Swedish tests. In both cases it was found that Ceefax reception would be satisfactory over at least 95% of the service area of the transmitters tested.

The main aim of Texas's presentation seems to have been to try to get things speeded up. It was emphasised that there is exciting export potential for the UK developed teletext system and that the possibilities should be exploited as soon as possible. With this we are in agreement. Progress to date has been rapid, but a lengthy period of testing and gestation could result in the present impetus being dissipated. Meanwhile, work on similar systems elsewhere in the world is progressing.

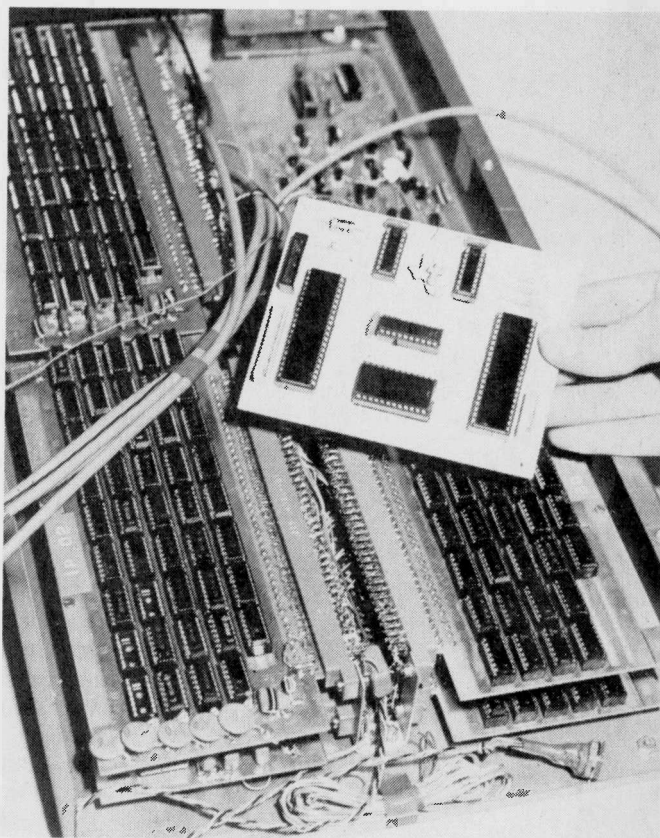

A Tifax module using LSI i.c.s could be arranged on a 6 x 4in board. This photograph compares such a module with the present type of experimental Ceefax decoder using large numbers of standard digital i.c.s.

One factor that will determine the public's interest in teletext transmissions is the cost of the necessary decoding circuitry, which brings us back to Tifax. The Tifax approach is certainly a simple one, with the input to the decoder at video frequency and the output direct to the c.r.t. drive circuits. Texas suggest that the cost of their decoder module to setmakers is likely to be about £50 initially for orders in thousands. This could add £100 to the price of a colour set able to display the normal transmissions, the Ceefax/Oracle transmissions on a blank background or the teletext display superimposed on the picture. Texas point out however that with electronic devices and assemblies the price falls substantially as production increases. By the time the total production of Tifax decoders reached the million mark a cost to the setmaker of about £10, putting some £20 on the price of a receiver, is envisaged. Texas are hopeful that this could be the situation by 1978. If it is we would certainly expect Ceefax/Oracle to become established as a normal part of TV in the home. The system is also capable of further development: with the addition of further logic the television set could be used to produce its own TV games, to act as a calculator and to provide projector display. There are other possibilities if the receiver can be interfaced with the telephone system. We have our reservations about some of these however.

Sample Tifax modules should be available to setmakers by the end of this year, with production commencing in the first quarter of 1976. The accompanying photograph illustrates the likely difference between a 6 by 4in Tifax module using LSI i.c.s and the present generation of experimental decoders using massive quantities of standard digital i.c.s. It is not clear however exactly how far Texas have gone in designing the LSI i.c.s that will make this dramatic reduction in size and cost possible. One feature of the module will be a special ROM (read only memory i.c.) to provide character rounding, i.e. to modify the coarse stepped shape of character (letter or number) diagonal strokes inherent with an interlaced display.

The Tifax decoder is primarily intended for use in new sets, being supplied to setmakers as a fully tested subassembly for insertion in sets during production. There seemed to be reluctance by both Texas and the setmakers present at the seminar to consider its use in adaptors for existing sets. One reason for this is that the limiting factor for the whole system is the bandwidth and phase response linearity of the receiver's i.f. strip. We would have thought that most modern colour sets would have been adequate in this respect however. Other reasons given were the safety angle and the fact that interference problems can arise when signals are being generated and fed into TV sets. We would have thought however that if the system is to get off the ground rapidly and into peoples homes it will be essential to provide adaptors so that the millions of existing television sets can be used with it. The problems seem far from insuperable. We remember how it was said that a very high standard of engineering would be necessary when transmissions started on Band III, and that hit or miss methods would never do; then the same thing was said over again but even more so when transmissions were to be started at u.h.f. In the event the trade coped without the terrible problems that were anticipated arising, as it subsequently took colour in its stride. There is no reason to believe that videotape and teletext will turn out to be the exceptions.

An adaptor would be a rather more expensive proposition than an in-set module, requiring its own tuner, i.f. strip and modulator. These items are already in large-scale

production however (assuming the use of a tuner as modulator) and we have no doubt that if the main setmakers don't come up with adaptors, others will.

It is understood that Plessey, GEC and Ferranti have been carrying out discussions with a view to joint development and production of LSI i.c.s for Ceefax/Oracle decoding, and an announcement is expected from Mullard before long – Mullard decoder designs have been available for some time now.

PIL COLOUR TUBE RANGE EXTENDED

The range of Mazda PIL self-converging, in-line gun colour tube/deflection coil assemblies has been extended with the announcement of 110° deflection angle types. The new tubes are the 22in A56-610X and 26in A67-610X. The present A51-162X 20in 90° tube is used with the Thorn 9000 chassis and in the Korting 20in colour receiver. A 16in 90° PIL tube is also now in production. A 110° 20in tube will be added to the range in due course.

TRANSMITTER OPENINGS

The following relay transmitters are now in operation:
Bala BBC-2 channel 26, BBC-Wales channel 33. Receiving aerial group A.

Findon (W. Sussex) ITV channel 41 (Southern Television programmes), BBC-2 channel 44, BBC-1 channel 51. Receiving aerial group B.

Hawick (Borders) ITV channel 23 (Border Television programmes), BBC-2 channel 26, BBC-1 channel 33. Receiving aerial group A.

Oliver's Mount (Scarborough) BBC-1 channel 57, ITV channel 60 (Yorkshire Television programmes), BBC-2 channel 63. Receiving aerial group C/D.

Tonypandy BBC-Wales channel 55, BBC-2 channel 62. Receiving aerial group C/D.

All these relay transmissions are vertically polarised.

TEST CARD BOOK

Those interested in long-distance (DX) television and what goes on in other parts of the world will find the book just published on the test cards used by the various broadcasting authorities throughout the world a valuable guide. For further details see Roger Bunney's *Long-Distance Television* column.

NEW TV SETS

Thorn have now introduced a number of models using their new colour chassis which were mentioned last month. The first model to be fitted with the 9000 chassis and the 20in PIL tube is the Ferguson 3722. The HMV Model 2726 is Thorn's first 110° 26in model, fitted with the 4000 chassis. There is a new 17in model fitted with the 8000 chassis, the Ferguson 3727, while three models fitted with the 22in 8800 chassis have been introduced, the HMV 2725 and Ultra Models 6725 and 6726.

A new colour portable receiver has been introduced by **Korting**: this is of interest in being the first set to use the 16in version of the PIL colour tube.

There are three models in the **ITT Feather-touch** range which features pressure-sensitive panels for channel change instead of the previous push-button selectors. These are the 20in Model CK503, 22in Model CK603 and 26in Model CK803. They are fitted with the new CVC9 chassis which

is a slightly modified version of the well established CVC8 chassis.

The 18in JVC Model 7445GB is fitted with a 110° black-matrix/phosphor dot shadowmask tube and features touch tuning. A single push-button switch controls the colour saturation, brightness and contrast and can be set to give optimum viewing under daylight or artificial lighting conditions.

NEW GENERATION OF TV ICs FROM PHILIPS/MULLARD

Details of the latest i.c.s for TV set use in the Mullard/Philips range are beginning to emerge. These devices are not yet being used in current production TV chassis but it is nevertheless of interest to review them in order to see how TV chassis design may change. Some of the new devices incorporate completely novel features. It is simplest to deal with them under the various sections of the receiver for which they have been designed.

IF Strip: Either the TDA2540 or TDA2541 forms a complete vision i.f. strip, incorporating a three-stage i.f. amplifier with a.g.c. applied to each stage, synchronous vision and a.f.c. demodulators, a gated a.g.c. system, white spot inverter and video preamplifier. The difference between them is that the TDA2540 provides an a.g.c. output for use with npn transistor tuners while the TDA2541 provides an a.g.c. output for use with pnp transistor tuners. The only tuned circuits required are the quadrature coil, a coil for the a.f.c. demodulator, and the input bandpass filtering.

Sync Processors: There are two options here, either the use of a TDA2570 sync separator plus TDA2580 line generator i.c., or a combined TDA2590 sync separator and line generator i.c. (the field generator is combined with the field output i.c., see below).

The TDA2570 is a particularly interesting device. The output from its sync separator section is used to synchronise an integrated oscillator operating at twice line frequency (31.25kHz). The output from this is divided by two to give line sync pulses and by 625 to give field sync pulses. Burst gating pulses are also derived from the 31.25kHz oscillator. This is a particularly accurate and stable system. Anti-top-flutter and split-picture prevention circuits are incorporated. The i.c. recognises non-standard signals and automatically switches in the field sync pulses from these in place of the field sync pulses obtained via the divider chain. The associated TDA2580 line generator i.c. incorporates a phase-controlled oscillator, a duty-cycle (ratio of pulse output duration to time between the beginning of successive pulses) control circuit to stabilise the width, either via a switched-mode power supply or a self-stabilising line output stage, and start current and overload protection.

The alternative TDA2590 is a replacement for the well known TBA920 incorporating extra features. The outputs are: field sync pulses; burst gating/blanking pulses; and a line drive waveform which can be used with either transistor or thyristor line output stages.

There is full VCR compatibility whichever option is selected.

Field Timebase: Again there are two options, the TDA2650 or TD2600. The TDA2650 incorporates the field generator and a class B power output stage which is capable of supplying sufficient deflection power for black-and-white or small-screen colour receivers. It will provide half the deflection current for a large-screen, 110° colour c.r.t., the other half being supplied by a discrete transistor stage. Scan correction and amplitude control are incorporated.

The TDA2600 is intended for use in larger-screen colour sets and uses entirely different techniques. To enable an integrated circuit to provide the necessary power, switching techniques are used. This means that the dissipation is less than half that of the equivalent class B circuit. The power output stage is driven by a modulator which in turn is driven by the generator and also a preamplifier which applies linearity correction and in addition compensates for load variations due to temperature.

Sound Output: The TDA2610 audio output i.c. can be driven by either of the two industry standard intercarrier sound i.c.s, the TBA120S or TBA750A. Although a 4W class B output stage is used, current stabilisation is incorporated so that the current drain is, as with a class A output stage, constant. This reduces the chip dissipation and ensures that there is no chance of sound-on-vision when the power supply for the vision and sound stages is derived from the line output transformer.

Tuner Control: Three i.c.s, types TDA2620, TDA2630 and TDA2631, have been designed for use with touch-tuning/varicap tuner arrangements.

Power Supply: The TDA2640 is the first time we have come across an i.c. designed specifically as a controller/driver for use in switch-mode TV power supply circuits. An integrated oscillator either runs free under the control of an external RC circuit or is triggered by line frequency pulses. The oscillator's output varies the duty cycle of a modulator stage. This drives an output stage which controls the switching device in the power supply regulation circuit. Over-voltage and excess current protection are incorporated.

Decoders: There are three options for colour decoder arrangements. The current TBA560C/TBA540/TCA800 three i.c. decoder design is to be retained. In addition there are new four and three i.c. designs.

The second option aims at achieving maximum performance. The i.c.s are the TDA2500 luminance channel, TDA2510 chrominance/burst amplifier channel, and the TDA2520 which incorporates the reference oscillator and its control loop, the PAL switch and ident stage, the chrominance synchronous demodulators and the G-Y matrix. An interesting feature of this latter i.c. is that the reference oscillator operates at twice the subcarrier frequency, i.e. 8.86MHz: a digital divider then splits the signal to give two exactly 90° phase displaced 4.43MHz reference signals for the demodulators, i.e. there is no need for a coil to give the 90° phase shift required. The output impedance of the luminance delay line driver stage in the TDA2500 is especially low, ensuring that matching to the line is not affected by i.c. spreads. These three i.c.s provide a complete decoder giving colour-difference signal outputs. When RGB outputs are required a TBA530 matrixing i.c. can be added, resulting in a four i.c. decoder.

The final option is to use the TDA2560 which contains both the luminance and the chrominance/burst channels and the TDA2522 which is similar to the TDA2520 except that it includes a colour-killer detector stage. These two i.c.s provide all the decoding required for colour-difference c.r.t. drive. Again a TBA530 is necessary to obtain RGB outputs, resulting in a three i.c. decoder.

UK TV LICENCES

The Television Licence Record Office reports that the latest figure for total UK TV licences is 17.5 million of which 40% (7 million) are for colour receivers. It is estimated that some 600,000 unlicensed sets are in use.

COLOUR, UHF & TELEVISION SPARES

"TELEVISION" CONSTRUCTOR'S SIGNAL STRENGTH METER. WORKING DEMONSTRATION MODELS ON SHOW. ALL PARTS AVAILABLE PHILIPS G8 SURPLUS VIS. SELECT. PANEL 25p, VIS. GAIN PANEL 25p, MULLARD ELC1043 NEW VARICAP TUNER £4.50 p.p. 25p. MAINS TRANSFORMER FOR CRT REACTIVATOR PROJECT £4.00 p.p. 50p.

"TELEVISION" CONSTRUCTOR'S COLOUR SET PROJECT. NEW MARK II DEMONSTRATION MODEL WITH LATEST IMPROVEMENTS. TWO SETS WORKING AND ON VIEW AT 172 WEST END LANE, N.W.6. TREMENDOUS RELIABILITY SUCCESS OVER A YEAR. CALL, PHONE OR WRITE FOR UP-TO-DATE COLOUR LISTS.

SPECIAL OFFER I.F. Panel, leading British maker, similar design to "Television" panel. Now in use as alternative incl. circuit, and connection data, checked and tested on colour £13.80 p.p. 50p. Also DECODER panel checked and tested on colour, full details. £15.00 p.p. 55p. CROSS HATCH unit kit, new design £3.85 p.p. 15p.

MAINS TRANSFORMER 280W, for "Television" Colour Set. In successful use for over a year in completed sets £10.00 p.p. 90p.

P.C. BOARDS. Convergence 3 for £2.75 p.p. 45p. Time Base £1.25, Power £1.50 p.p. 40p. R.G.B. Varicap, C.R.T. Base 75p p.p. 25p.

PACKS (incl. p.p.). No. 2 £4.90, No. 5 £1.05, No. 9 49p, No. 12 37p, No. 13 35p, No. 14 £11.00, No. 15 £2.48, No. 16 £11.10, No. 17 £2.95, No. 19 £2.70, No. 21 £10.40, No.22 £2.20, C.R.T. Shields £2.25 p.p. 75p, Pack No. 23 £2.95, Pack No. 24 £1.40. ELC1043 £4.50, p.p. 25p. AE Isol 30p, TAA550 54p p.p. 10p. New type Audio Unit £2.75 p.p. 20p.

PACK No. 18, Components £8.50 p.p. 45p, also "add-on" Stabiliser Unit Kit for either 40V or 20V £3.00 p.p. 25p.

Field & Line Blanking Mod. Kit 30p, Beam Limiter Mod. Kit £1.30. CABLE 7 x 0.2 mm Screened 10 yds for 70p. Colours, 15p p.p. 10p. Line Osc. Coil 50p. 500 ohm Contrast 25p, 100 ohm W.W. 25p, 250 ohm 25W 30p, A1 Slide Switches (Break before make) 3 for 48p.

Ident Coil 50p. p.p. 12p. 100 + 200 + 200uF 350V £1.00 p.p. 25p. G.E.C. 2040 decoder panels suitable for "Television" decoder parts incl. DL20, crystal, ident coil, etc., £3.50 p.p. 45p.

CRT HEATER TRANSFORMERS 6-3V 1A £1.35 p.p. 35p. PYE 697 Line T.B. for "Television" set parts £1.50 p.p. 45p.

GEC 2040 Field/Line T.B. panels for "Television" parts £1 p.p. 45p. MULLARD AT1023/05 convergence yoke. New £2.50 p.p. 45p.

MULLARD DLIE delay line. New £1.25 p.p. 30p. PHILIPS G6 single standard convergence panel, incl. 16 controls, switches etc., and circuits £3.75 p.p. 45p, or incl. Yoke £5.00.

PHILIPS G8 decoder panel part complete £2.50 p.p. 45p. Field and Line Osc. Panels for spares 75p p.p. 35p.

VARICAP/VARACTOR ELC 1043 UHF tuner £4.50 p.p. 25p. Varicap tuners salvaged, VHF or UHF £1.50 p.p. 25p. Control units, 3PSN £1.25, 4PSN £1.80, 5PSN £2.30 p.p. 20p.

UHF/625 Tuners, many different types in stock. Lists available. UHF tuners transist. £2.85, incl. s/m drive, indicator £3.85; 6 position, or 4 position pushbutton £4.50 p.p. 45p.

MURPHY 600/700 series UHF conversion kits in cabinet plinth assembly, can be used as separate UHF receiver £5.50 p.p. 75p.

PHILIPS 625 I.F. panel incl. cct 50p p.p. 40p. FIREBALL TUNERS Ferg., HMV, Marconi. New £1.25 p.p. 25p.

TURRET TUNERS, KB "Featherlight" VC11, Philips 170 series. GEC 2010 £2.50. AB Dual Tandem, suitable Ferguson, Baird, KB, etc. 75p. Pye 110/510-PAM, Invicta, Miniature, increm. £1.00 p.p. 45p.

TBA "Q" I.C.s 520, 530, 540 £2.50, 550, 560C, 920, 990 £3.50 p.p. 15p. LINE OUTPUT TRANSFORMERS. New guar. p.p. 50p.

BUSH 105 to 186SS, etc.....£5.40

DECCA DR95, 101/606, DRI 2, 3, 121/123, 20/24, 2000.....£5.40

EKCO, FERR. 418, 1093 series...£5.40

FERG., HMV, MARCONI, PHILCO, ULTRA, THORN 850, 900, 950, 1400, 1500 series £4.90

GEC 302 to 456, 2000 series.....£5.40

KB VC2/9, 51, 52, 53, 100, 200.....£5.40

MURPHY 849 to 2417, etc.....£5.40

P/SCOTT 960, COSSOR 1964...£4.70

PHILIPS 19TG121 to 19TG156 £5.40

PHILIPS 19TG170, 210, 300.....£5.40

PYE 11U, 20, 30, 40, 67, 169, 368, 569, 769 series.....£5.40

PAM, INVICTA, EKCO, FERRANTI equivalents.....£5.40

SOBEL 1000 series.....£5.40

STELLA 1043/2149.....£5.40

THORN 850 Time Base Panel, Dual Standard 50p p.p. 45p.

MULLARD Scan Coils Type AT1030 for all standard mono 110° models, Philips, Stella, Pye, Ekco, Ferranti, Invicta £2.00 p.p. 45p.

PHILIPS G8 Tripler (1174/31) £5.40. GEC 2040 series £1.75 p.p. 45p.

CALLERS WELCOME AT SHOP PREMISES

MANOR SUPPLIES

172 WEST END LANE, LONDON, N.W.6.

(Near W. Hampstead tube stn: 28, 59, 159 Bus Routes) 01-794 8751

Mail Order: 64 GOLDERS MANOR DRIVE, LONDON, N.W.11.

PLEASE ADD NEW 25% RATE FOR V.A.T.



"I MADE IT MYSELF"

Imagine the thrill you'll feel! Imagine how impressed people will be when they're hearing a programme on a modern radio you made yourself.

Now! Learn the secrets of radio and electronics by building your own modern transistor radio!

Practical lessons teach you sooner than you would dream possible.

What a wonderful way to learn – and pave the way to a new, better-paid career! No dreary ploughing through page after page of dull facts and figures. With this fascinating Technatron Course, you learn by building!

You build a modern Transistor Radio... a Burglar Alarm. You learn Radio and Electronics by doing *actual projects you enjoy* – making things with your own hands that you'll be proud to own! No wonder it's so fast and easy to learn this way. Because learning becomes a hobby! And what a profitable hobby. Because opportunities in the field of Radio and Electronics are growing faster than they can find people to fill the jobs!

So fast, so easy, this personalised course will teach you even if you don't know a thing today!

No matter how little you know now, no matter what your background or education, we'll teach you. Step by step, in simple easy-to-understand language, you pick up the secrets of radio and electronics.

You become a man who *makes* things, not just another of the millions who don't understand. And you could pave the way to a great new career, to add to the thrill and pride you receive when you look at what you have achieved. Within weeks you could hold in your hand your own transistor radio. And after the course you can go on to acquire high-powered technical qualifications, because our famous courses go right up to City & Guilds levels.

Send now for FREE 76 page book – see how easy it is – read what others say!

Find out more now! This is the gateway to a thrilling new career, or a wonderful hobby you'll enjoy for years. Send the coupon now. There's no obligation.

No soldering – yet you learn faster than you ever dreamed possible.

Yes! Faster than you can imagine, you pick up the technical know how you need. Specially prepared step-by-step lessons show you how to: read circuits – assemble components – build things – experiment. You enjoy every minute of it!

You get everything you need. Tools. Components. Even a versatile Multi-meter that we teach you how to use. All included in the course AT NO EXTRA CHARGE! And this is a course anyone can afford.

POST TODAY FOR FREE BOOK

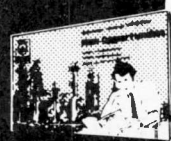

To: ALDERMASTON COLLEGE
DEPT. CT07 READING RG7 4PF
Also at our London Advisory Office, 4 Fore Street Avenue,
Moorgate, London EC2Y 5EJ. Tel: 01-628 2721
Yes, I'd like to know more about your course. Please send me free details – plus your big, 76-page book that tells about all your courses.

CTV07

NAME

ADDRESS

POST CODE



HOME OF BRITISH INSTITUTE OF ENGINEERING TECHNOLOGY

T.V. TRANSFORMER SUPPLIES

SPECIAL SPARES WHOLESALERS TO THE TV SERVICE ENGINEER

3 Green Parade, Whitton Road, Hounslow, Middx. TW3 2EN

Telephone 01-898 4083/0210

MAINS DROPPERS each	TAA 630	£3.82	TBA 750	£1.24	SN 76013N	£1.93	LOPT'S COLOUR each
BRC 1400 48p	TAA 700	£3.80	TBA 750Q	£1.34	TBA 120A	65p	BUSH
BRC 1500 48p	TAA 840	£1.84	TBA 920	£3.88			CTV 25 Mk. 3
BRC 3500 32p	TAD 100	£1.85	TBA 920Q	£3.90	LOPT'S MONO	each	CTV 162
BRC 8000 44p	TBA 480Q	£1.84	TBA 990	£3.89	PHILIPS		CTV 167 (not Mk 1
BRC 8500 48p	TBA 500Q	£2.42	TBA 990Q	£3.89	170 Series	£5.52	or 2)
PHILIPS 210 (pr) 68p	TBA 510Q	£2.42	TCA 270Q	£4.26	210 Series	£5.37	CTV 174
BUSH colour S/S	TBA 520Q	£3.07	TCA 160B	£2.07	BUSH		CTV 182S
56ohm 68ohm	TBA 530	£2.60	TCA 160C	£2.23	141 to 178	£5.91	CTV 184S
PHILIPS G8	TBA 530Q	£2.62	SAA 570	£1.27	KB Chassis No.		CTV 187CS
GEC 2000	TBA 540	£2.99	TAA 611	£1.93	VC2/VC3	£5.52	DECCA
GEC 2028	TBA 540Q	£3.00	TBA 800	£1.75	VC4/VC51	£5.52	CS 2220
BUSH 161 ser	TBA 550	£4.14	SN 76013ND	£1.75	VC52/VC53	£5.52	CS 2225
	TBA 550Q	£4.24	SN 76666	£2.25	VC100	£5.52	CS 2227
I.C.'S. each	TBA 560C	£4.14	RCA 3065	£1.55	VC1	£5.52	CS 2520
TAA 350	TBA 560CQ	£4.24	RCA 1330	55p	VC11 featherlight	£5.69	
TAA 300	TBA 570	£1.41	MC 1327Q	£2.35	GEC 2000/2064	£5.58	
TAA 310A	TBA 570Q	£1.48	76530P	£2.45	BUSH S/S		
TAA 320	TBA 673	£2.07	SN 76227N	£1.30	Printed Cir.	£6.44	
TAA 350A	TBA 690Q	£2.23	SN 76013N	£2.45	PYE P/C		
TAA 550	TBA 700Q	£2.23	SN 76544N	£2.29	160 161 150	£5.69	
TAA 570	TBA 720AQ	£2.38	SN 76003N	£2.56	151 155 156	£5.69	

WE HAVE MANY MORE LINES IN STOCK. CAPACITORS, VALVES, EHT TRAYS MONO AND COLOUR. THERMAL CUT-OUTS. SERVICE AIDS. HEAT SINK COMPOUND. AMBERSIL. ELECTROLUBE. SERVISOL PRODUCTS. ASK FOR FREE CATALOGUE. STOCK ITEMS SAME DAY DISPATCH.

THE UM4 "COLOURBOOSTER" UHF/625 LINE

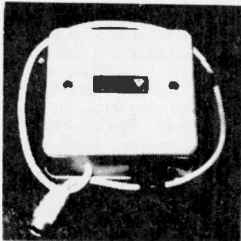

CAN PRODUCE REMARKABLE IMPROVEMENTS IN COLOUR AND PICTURE QUALITY IN FRINGE OR DIFFICULT AREAS WITH SIGNIFICANT REDUCTION IN NOISE (SNOW).

HIGH GAIN - VERY LOW NOISE
FITTED FLY LEAD - INSTALLED IN SECONDS
HIGHEST QUALITY COMPONENTS
IVORY PLASTIC CASE 3 1/4 x 3 1/4 x 1 1/2 CORK BASE
CHANNELS: Group A, Red code 21-33
Please Group B, Yellow code 39-51
Specify Group C-D, Green code 52-68
EQUALLY SUITABLE FOR BLACK AND WHITE

Also the M4 DUAL BAND VHF UNIT
BOOSTS ALL BAND III and ANY SPECIFIED
BAND I CHANNEL SIMULTANEOUSLY
NOMINAL GAIN 16-18 DB BOTH BANDS

PRICES BOTH TYPES:
Battery model £5.13 Mains version £7.81
Including VAT & postage.

TRANSISTOR DEVICES LIMITED
6 ORCHARD GDNS., TEIGNMOUTH, DEVON
Telephone: Teignmouth 4757

REBUILT COLOUR TUBES ALL SIZES AVAILABLE

Full range of rebuilt mono tubes available, Standard, Rimband and Twin Panel.

- ★ Complete new gun fitted to every tube.
- ★ 12 months' guarantee.
- ★ 18 years' experience in tube rebuilding.
- ★ Trade enquiries welcomed.

N.G.T. ELECTRONICS LTD.
20, Southbridge Road, Croydon, Surrey
Telephone: 01-681 7848/9

VALVE BARGAINS

Any 5 50p, 10 75p, 50 £3.30,
100 £6.40. Your choice from
the following list:
ECC82, ECL80, EB91, EF80,
EF183, EF184, PC86, PC88,
PC97, PC900, PCC84, PCC89,
PCC189, PCF80, PCF802,
PCF805, PCL82, PCL84, PCL85,
PCL805, PCL86, PFL200, PL36,
PL504, PY33, PY81, PY800,
PY88, EH90, 30FL1, 30FL2,
30PL14.
Colour Valves 25p each
PL508, PL509, PY500/A.

Press 4 Button UHF Tuners
£2.50.

AERIAL BOOSTERS

We make three types of Aerial Boosters all for set top fitting, with Co-ax Plugs and Sockets.

B11 - For Stereo and Standard VHF Radio.
B12 - For the older VHF Television, please state BBC1 and ITV Channels.
B45 - For mono or colour, this covers the complete UHF band.
All Boosters are complete with Battery and take only minutes to fit.

Price £3.40 each

All prices subject to 25% V.A.T. P. & P. under £1 15p., £1 to £3 20p. Above £3 25p.

ELECTRONIC MAIL ORDER LTD.,
62 BRIDGE ST., RAMSBOTTOM, BURY, LANCs.

LINE SCAN

NEW PRODUCTS REVIEW

AMONG several new instruments added to the Heathkit range this year are two of particular interest to anyone engaged in television servicing.

10 MHz OSCILLOSCOPE

The Heathkit IO-4530 Oscilloscope features d.c.-10MHz vertical bandwidth at a sensitivity of 10mV/cm, wide-band triggering capability and a calibrated X-channel input, thus providing full X-Y facilities. This instrument has been designed with the TV service technician particularly in mind, and is one of the few single-trace 'scopes available with two input channels.

The Y-input attenuator goes from 10mV/cm to 20V/cm in eleven steps in a 1-2-5 sequence. A variable vertical sensitivity control provides continuous coverage between steps and also gives a range extension up to about 50V/cm. The calibration accuracy is within 3% and the input impedance 1M Ω shunted by about 38pF.

Turning to the X-axis, basic timebase sweep rates range from 0.2s/cm to 200ns/cm in seven decade steps. A continuously variable control gives interpolation plus extension at the slow-sweep end to about 2s/cm. A sweep magnifier can be switched in to provide a $\times 5$ increase at any speed. Calibration accuracy is $\pm 5\%$, degraded to $\pm 7\%$ when the sweep magnifier is in use. External horizontal input sensitivity is 20mV/cm to 2V/cm via a 3-step attenuator over a bandwidth of d.c.-1MHz. The variable control extends this to about 20V/cm. Accuracy is $\pm 3\%$, phase shift less than 5° at 100kHz, and input impedance 1M Ω in parallel with about 40pF.



The triggering circuits are digitally controlled and operate with a vertical deflection of 5mm or greater, depending upon the input signal frequency. Modes available are Automatic (at zero crossing ± 5 mm) and Normal (triggering point adjustable over eight divisions), with positive and negative slope selection in each case. Triggering at mains frequency or from an external source is also possible, and selection of d.c., a.c. and TV coupling is provided. The maximum external triggering sensitivity is 0.5V, with an input impedance similar to that of the external horizontal input.

The IO-4530 uses a 130mm (5in) round cathode ray tube with a P31 phosphor giving a green, medium-short persistence trace. An 8 \times 10cm graticule is fitted. All power supplies are fully regulated, consumption being 65W from 110-130 or 220-260V a.c. mains.

Dimensions, excluding the dual-purpose carrying handle/stand, are 162 \times 325 \times 488mm (6.4 \times 12.8 \times 19.2in) and the weight is approximately 11kg (24lb).

The price of the K/IO-4530 kit is £176.00 including 8% VAT and delivery within the United Kingdom.

HIGH VOLTAGE PROBE

The Heathkit IM-5210 High Voltage Probe Meter is intended for fast, convenient measurements of TV tube voltages. It is lightweight, portable and handles d.c. voltages up to 40kV with a reading accuracy of $\pm 3\%$. An 800M Ω series multiplier resistor is used, giving a circuit loading at full scale deflection of 50 μ A. To protect the meter movement, an on-off switch in the handle short-circuits it during transit and connecting up.

The IM-5210 is 381mm (15in) long, 48mm (1.9in) wide and 38mm (1.5in) high, and weighs about 0.22kg (8oz). The price of the kit is £12.00 including 8% VAT and delivery within the UK.



Further details of both these instruments are available from Heath (Gloucester) Ltd., Bristol Road, Gloucester GL2 6EE, telephone 0452-29451 or from the London Heathkit Centre, 233 Tottenham Court Road, London W1P 9AE, telephone 01-636 7349.

CEEFAX / ORACLE

reception techniques

Steve A. MONEY T. Eng. (CEI)

PART 1

DURING the past few months many readers will have become aware of the two rows of bright dots that appear in the blanking interval at the top of television pictures received from many of the u.h.f. 625-line transmitters. If you haven't yet noticed these dots it is probable that they are just off the upper edge of the receiver screen and may be seen if the picture height is reduced slightly. What are these two rows of mysterious dots with their ever changing patterns? In fact they are the data signals for the BBC CEEFAX and IBA ORACLE teletext transmissions.

What is teletext?

For readers who may not have heard about teletext, it is a system for transmitting written information by using the same signal that carries the television picture. When an appropriate decoder unit is employed at the receiving end it becomes possible to extract this information and display it on the television screen in the form of printed characters and symbols. Thus we are beginning to catch up with the science fiction writers who once

described newspapers which were presented via the television set.

Originally the BBC CEEFAX (See Facts) and the IBA ORACLE (Optional Reception of Announcements by Coded Line Electronics) systems used different methods of coding the data and different display formats for the text information, so that separate decoder systems would have been needed for each system. During 1974 however, after both systems had been tried out over the air, the BBC, IBA and receiver manufacturers met together and devised a common standard for the transmission of text with television in which the best features of the two original systems were incorporated. In the autumn of 1974 government permission was obtained for the BBC and IBA to broadcast full scale test programmes prior to the possible introduction of a regular service in perhaps two years.

At the present time receiver manufacturers are busy developing decoder systems for receiving teletext. In some cases the decoder will be built into the television set as an integral part of the receiver system. In other cases the decoder is likely to be a separate unit which may be used with any standard 625-line receiver. At first the special receivers or decoder units are likely to be relatively expensive with typical prices for separate decoders being quoted at some £150 to £200 (excluding VAT). Eventually

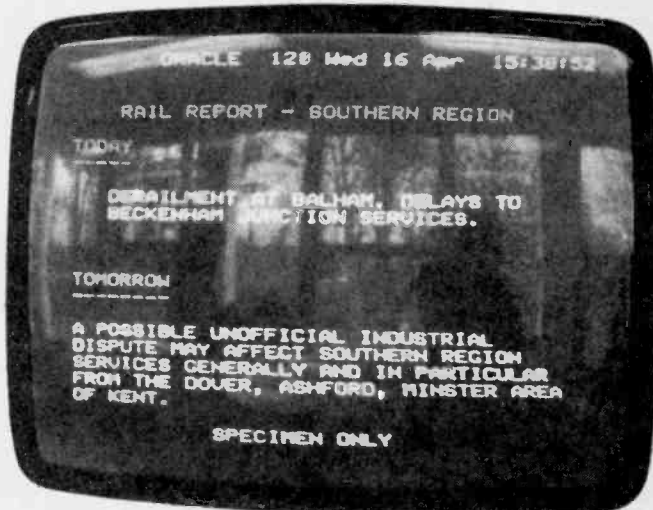

Two typical pages from the experimental ORACLE transmissions. On the left, the News Index - a second index covers the Travel and Leisure Guide. On the right is a specimen news item page.

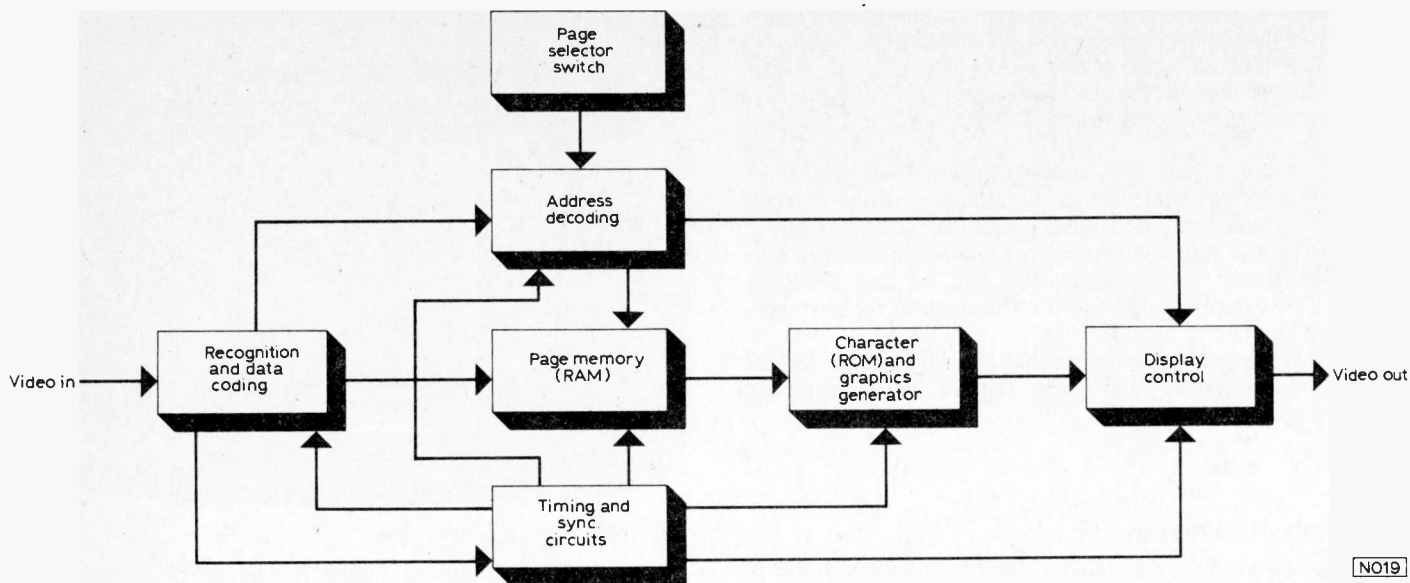

Fig. 1: The block diagram of a typical decoder system.

by using large scale integrated circuit techniques it is expected that the price will fall rapidly in the same way that the cost of electronic calculators has dropped in the past year or two.

Keen electronics enthusiasts will no doubt wish to experiment with building their own decoders for teletext reception. The cost of the components for a basic decoder system is likely to be in the region of £100. In this series of articles the techniques involved in receiving, decoding and displaying the CEEFAX/ORACLE signals will be explained.

What will you see?

Assuming that by some means you have obtained and fitted a decoder to your television set let us now consider what you are likely to be able to see on the screen.

Basically the teletext signal provides pages of written text information from which the viewer is able to select a particular page and display it on his television screen. A typical page contains up to 24 horizontal rows with 40 letters, numbers or symbols in each row. This will provide some 150 to 200 words of reading matter, which is roughly equivalent to the first two paragraphs of this article.

Each television channel is capable of carrying up to eight so called magazines, each containing 100 pages of information. During the trial period it is likely that only one or two magazines will be transmitted on any one television channel and the number of pages in each magazine will probably be limited to about 60.

The information presented on a page may be an index, news items, sports reports, weather, radio and TV programme guide, stock market prices, top records, travel news, etc. In addition to written text it is also possible to make up simple pictures, such as weather maps or share market graphs, by using a graphic display facility where each letter space is divided up into a combination of six square boxes which may be black or white according to the signal code received. This feature will be discussed in more detail when we examine the method of displaying the data in a later article in this series.

Fitting in the data

It may seem surprising that so much extra information can be added to the television channel without affecting the quality of the picture signal. In practice of course there are several lines of the television signal which carry no actual picture information. These lines occur during the field blanking interval.

Some of these blank lines are in fact already occupied by test signals which are used to help the engineers monitoring the picture quality and to identify the source of the transmitted programme. For the teletext transmissions two lines in each field of the picture signal are used. At present these are lines 17 and 18 on even fields together with lines 330 and 331 on odd fields.

Each of these line periods is used to carry the data for one complete row of 40 teletext characters together with address and synchronising signals. As a result 100 rows of characters giving about four pages of information are sent out every second. At this rate therefore a full 100-page magazine could be transmitted every 25 seconds. Because of this sequential method of transmission a viewer may have to wait up to 25 seconds after he has selected a page before the desired page is displayed on the screen.

Normally the set of pages is repeated continuously so that viewers can select and display a page of data at any time. When the desired page of information is detected by the decoder the data for that page is stored in a memory unit so that it can be displayed on the screen continuously until a new page is selected. In some decoder systems the data for the page will be updated every time that particular page of data is received.

What's in the decoder?

At this point we can take a look at what the viewer would need to have in his decoder unit to enable him to receive and display the CEEFAX/ORACLE transmissions.

A block diagram showing a typical arrangement of the main functional units of a decoder system is given in Fig. 1.

The memory

The heart of any teletext decoder is the memory unit which is used to store the page, or part of a page, of data to be displayed on the screen. For a full page display this memory unit must be able to store 960 words each made up of seven bits of binary data.

One possibility for the memory unit might be a core store using ferrite rings similar to those used for the memory in a computer. Most magnetic core memories however are rather slow in operation and very greedy for power. Commercial decoders are likely to make use of integrated circuit Random Access Memory (RAM) devices.

Basically a RAM consists of a large array of memory cells, together with circuitry to enable any individual cell to be selected for either writing data into or reading out the data stored. Each cell can be set either on or off and represents one bit of the data so that the memory will contain nearly 7000 cells for a full page unit.

Since RAM devices are relatively expensive at present an alternative approach which might be attractive to the amateur constructor would be to use large integrated circuit shift registers. The shift register also contains a large number of memory cells but these are not directly addressable and the data circulates through the memory by moving from one cell to the next each time a clock pulse is applied.

In a later article in this series we shall be taking a closer look at these two techniques and their relative advantages and disadvantages.

Producing the display

Once the desired page of data has been captured and stored in the memory unit it must be converted into a display consisting of rows of characters on the television screen so that the viewer can read the information. The characters are produced on the screen by generating a pattern of dots in each character space on the screen.

A typical character format is shown in Fig. 2. Here the letter 'A' has been produced by selectively lighting up dots arranged in a 5×7 array and using seven lines of the television picture scan. Displayed characters would in fact normally be 14 lines high on the actual picture with seven lines displayed on each alternate field scan and interlaced in the same way as the television picture itself.

The required pattern of dots for each of the possible characters to be displayed is contained in a memory device similar to the RAM used for the page memory but in this case the device is a Read Only Memory (ROM). All of the patterns of dots for a complete set of alphabetic and numeric characters and symbols are programmed into the ROM when it is manufactured so that the user merely has to apply the appropriate address signals to obtain the dot pattern for any of the characters in the set provided.

Graphics

For the graphic mode of operation a similar ROM device could be used but a cheaper method is to use standard logic circuits to generate the required patterns.

Apart from the character and graphic generator devices, additional control logic is required to form the proper display format with its rows of characters and also to control the flow of data into and out of the page memory. To provide the correct drive for the picture tube the dot pattern signals must be converted into an appropriate video signal. When the decoder is a separate unit, this video must next be mixed with the received picture and syncs and modulated onto a u.h.f. carrier. This complete television signal can then be fed to the aerial input of a standard TV receiver, which will display both picture and data.

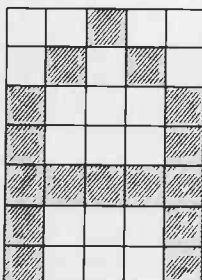

NO20

Fig. 2: A typical character format, the letter A. In practice each row is scanned twice, on successive fields, so that the letter displayed is formed of fourteen horizontal lines, brightened up in the appropriate places.

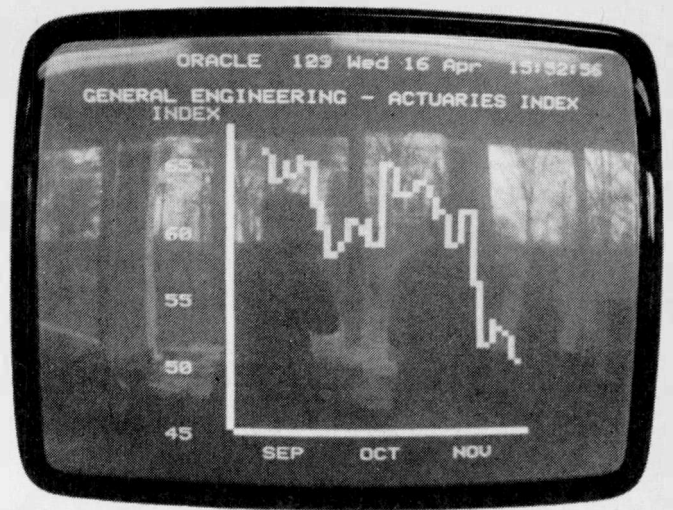

A typical ORACLE graphics display. The last block on the right of the graph is the smallest area that can be individually addressed, and represents one-sixth of the area of one character.

Decoding the signal

Before the data can be displayed on the screen, or even stored in the page memory, it must first be extracted from the incoming television signal.

For a start the decoder must be able to recognise the CEEFAX/ORACLE signal so that the picture signal can be ignored since it would produce a completely garbled display. To help in this process a special recognition code is sent at the beginning of each line of teletext data. This code when detected also tells the decoder the precise timing of the start of the following data to ensure correct decoding.

In addition to the start code the line of data also carries a row address code which tells the decoder which row is being transmitted so that the data can be placed in its correct location in the memory and be displayed at its proper position on the screen.

The first row of data for each page also carries a page number code. The decoder compares this code with the page number selected by the viewer and stores the page of data received after the codes match.

When the incoming data is received it is in serial form with the eight bits of data for each character or address code following one another in time. The eight bits of data for each character are then collected together to form an eight bit parallel data word for later use in the decoder system.

Interference

Interference affects the analogue picture signals and the digital data signals in quite a different way. In the one case, the amount of interference that can be tolerated is determined solely by how poor a picture the viewer will accept. In the other, mutilation of the incoming data signals can have a more disastrous effect. If too many characters are wrongly received the display will degenerate into gibberish unless some precautions are taken at the receiver.

To reduce the possibility of errors appearing in the displayed data, additional bits are transmitted which enable the decoder to recognise errors and cause a blank to be displayed rather than an incorrect character. The more vital parts of the data, such as the address codes, are more heavily protected so that the decoder can not only detect errors but even correct some of them.

In the next article we shall be taking a more detailed look at the make-up of the data signals for a typical row of data and examine the recognition or "framing" code and the methods by which it is detected and used.

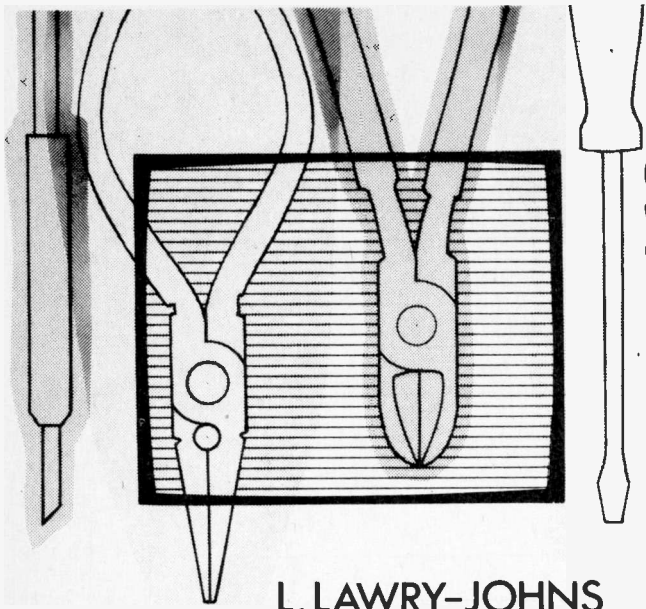

L. LAWRY-JOHNS

SERVICING TELEVISION RECEIVERS

PHILIPS G6 CHASSIS

THE original dual-standard version of the G6 chassis, with all its protection circuits and other devices, was a fearsome albeit reliable brute and was the first colour set we had to handle. Personally I was scared to death of it to start with and spent quite a lot of time with the layout and the circuit diagram trying to familiarise myself with its peculiarities so as not to be at a loss when the first call came. The more I pondered on this and that the more confused I became, having the distressing ability to forget within a matter of minutes things I thought I had absorbed: I had the same trouble with VAT, also with anything else which is on paper. Thus handicapped, in the early hours I put down the Philips manual and took up my *Reader's Digest*.

When the first call for service came I took about everything I could think of and actually managed a smile when the customer opened the door.

"Have you a toothache" he asked?

"Only a headache" I reassured him.

This was a few years ago, but I remember it far better than any written word. The trouble was that everything on the screen looked cyan, and normal people seemed to have come from another planet or looked as I felt.

"No red", I chattered. On checking at the tube base a very low voltage was found at pin 4, the red gun first anode pin. Within minutes the 2.2M Ω feed resistor had been replaced and the red restored. "Fantastic" said the customer and the smile on my face showed that my headache had departed, as I was about to do when the picture went off completely.

Sickened, I once more removed the rear cover – without breaking the field hold knob – to find there was no supply to the line output stage. As nothing seemed to have any life in this compartment I turned to the left side supply source where R1073 had sprung open. The resistor looked all right so back it went on its spring with a dab of solder. Switch on, voltage at both ends, lovely. But no picture and nothing doing in the line output stage. In my confusion I had forgotten the switch on the screening box. This makes when the cover is on. On operating the switch manually the juice came through, the PL509 line output valve went green and the resistor sprung apart again.

Slapping the resistor back on and fitting a new PL509 restored normality for about a week when back we went to replace the PY500.

Many enthralling incidents have occurred since those first days, but the reader will be deprived the recounting of these to return to more relevant matters.

Cleaning up the Design

The early models had several features which were left out of later versions, such as the tube protection circuit which cut off the

line output stage when the field timebase failed (shades of projection TV circuitry here... see September 1955 issue) and led us on a gay dance looking for a line timebase fault when the trouble was due only to a defective ECC81 in the field oscillator stage. The idea was to prevent field collapse damaging the tube due to the concentration of the beam into a single horizontal line. Very few receivers will still be found with this feature.

Another early feature which was discontinued in later versions was the colour on/off button on the front. It should not be confused with the button on the c.r.t. base assembly – this knocks off the luminance to enable the background controls to be set up.

The process of cleaning up the chassis continued with the dropping of dual-standard facilities. The resultant G6 single-standard chassis is much easier to work on (or did we just get used to the basic design that no longer appeared so fearsome?).

The convergence system is another example of the chassis' development. Originally this was a large box which slotted into the left side of the cabinet. Later it became a smaller panel which was exposed when a front screw was slackened to enable part of the slatted woodwork to be removed.

To detail every difference however would take up far too much space.

Line Output Stage Faults

Apart from fairly easily identified faults in other parts of the receiver such as colour changes due to dry-joints or leads actually off the panels (oh yes!) the majority of the faults encountered will be in the line output stage.

Now the first thing to remember about the e.h.t. compartment is that it contains two valves which can emit X rays. Thus while the set is operating the screening *must* be in position. This precaution was proclaimed loud and long years ago but now that we take the non-valve e.h.t. tripler system for granted it is easy to forget the danger still present in earlier designs which employ the cumbersome but efficient thermionic e.h.t. rectifier and shunt stabiliser. The cover must not be removed therefore unless one knows that the line output stage is not functioning (as outlined earlier in relating our first experience) as the safety switch may have been shorted out.

The PL509 and PY500 are in a separate compartment forward of the transformer box and are covered by a domed wire mesh secured by two swing clips.

The faults which usually occur are as follows.

Picture slow to appear, lacking width, poor focus and bad convergence. If the original valves are still fitted or the valves have been in for some time it is highly prudent to replace them both at the same time. The extra cost is well justified. The fact that a new valve has been fitted recently is no justification for not suspecting it.

When there is no picture at all and the line output stage seems

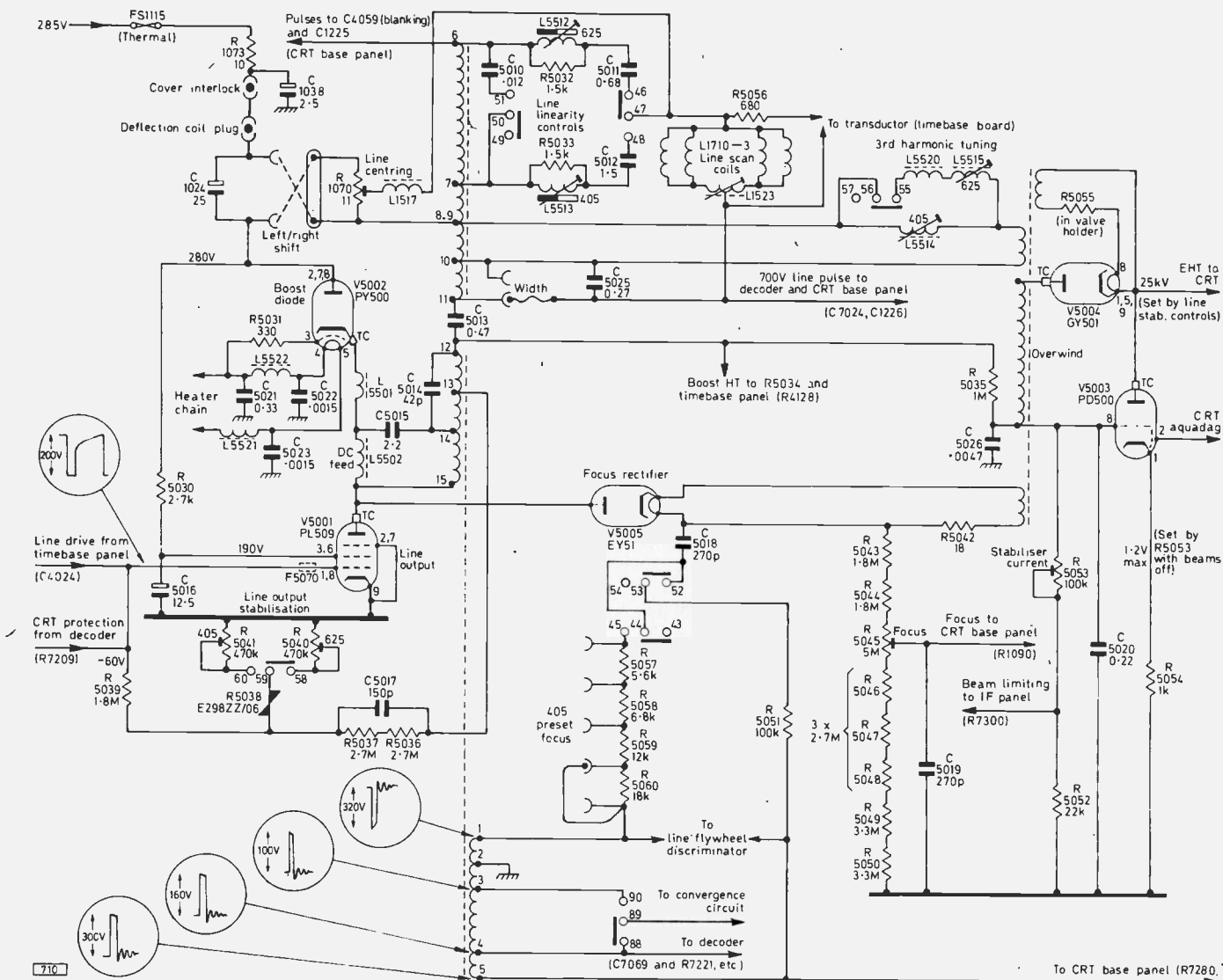

Fig. 1: Line output stage, e.h.t. and focus supply circuit. The system switch is shown in the 625-line position. R5040 and R5041 (line stabilisation controls) are 220kΩ in later versions. C5014 may be 100pF, 20pF or, in later production, omitted: where present it is a good idea to remove it. C1038 and C5026 were not fitted in early models. R1073/FS1115 and C1038 are on the lower chassis (power supply section). R4042 may be wired between V5005 heater and the junction C5018/R5043 and the heater winding on the line output transformer. R5037 and R5036 are 3.3MΩ on single-standard models.

dead although there is h.t. at the PL509 and PY500 top caps suspect the PL509's screen grid feed resistor (R5030, 2.7kΩ) which can go open-circuit at odd times.

A picture which fluctuates, sometimes quite regularly, on off, on off, with varying focus and usually a corresponding noise from the e.h.t. compartment, will be due to a faulty PD500. Replacement involves some screw slackening and a bit of heaving about but is no real problem. Check for corrosion at the point where the GY501 and the PD500 are joined. Remember to replace the screening before testing as the peg on the cover has to engage the h.t. supply switch on the upper left.

Non-operation of the line output stage can also be the result of a shorted boost line capacitor (C5013, 0.47μF). As this is returned to the h.t. line there is no overheating when it shorts. Another cause of no e.h.t. is when the d.c. feed coil (L5502) to the anode of the PL509 is defective.

When the valves are not responsible for lack of width, resistors R5036 and R5037 should be checked as they can change value. R5039 is also suspect. Capacitor C5017 can cause fluctuating width and this can be misleading as it tends to suggest poor e.h.t. regulation.

EHT Shunt Stabiliser

The object of the PD500 shunt stabiliser valve is to present the e.h.t. rectifier with a constant load. On dark scenes the e.h.t.

current is low and without the stabiliser the e.h.t. voltage would tend to rise, resulting in a smaller picture. The circuit is so arranged however that on dark scenes the PD500 conducts more heavily, thus drawing more current from the GY501 and keeping the e.h.t. sensibly constant. On light scenes the tube draws more current and without the stabiliser the e.h.t. would tend to fall, causing the picture to expand. As the stabiliser grid is backed off under these conditions however the PD500 draws less current, the total drain is more or less the same and the picture remains the same size.

The 1kΩ resistor R5054 is the one on top of the e.h.t. compartment. A meter connected across it will indicate the current drawn by the PD500. The correct reading is 1.2V with the beam switches off. R5053 is set to produce this 1.2V and correct beam limiter operating conditions (the earthy end of R5053 connects to R5052 and also goes back to the i.f. panel where it is connected via R7300 to the beam limiter control R7301). By beam switches we mean the A1 (or G2) switches on the convergence panel. If R5053 is not set correctly the stabilisation won't work properly, with a dull picture, ballooning on advancing the brightness control, etc. The beam limiting system operates via the a.g.c. circuit.

Focus Faults

Whilst poor focus can be due to the line output stage valves

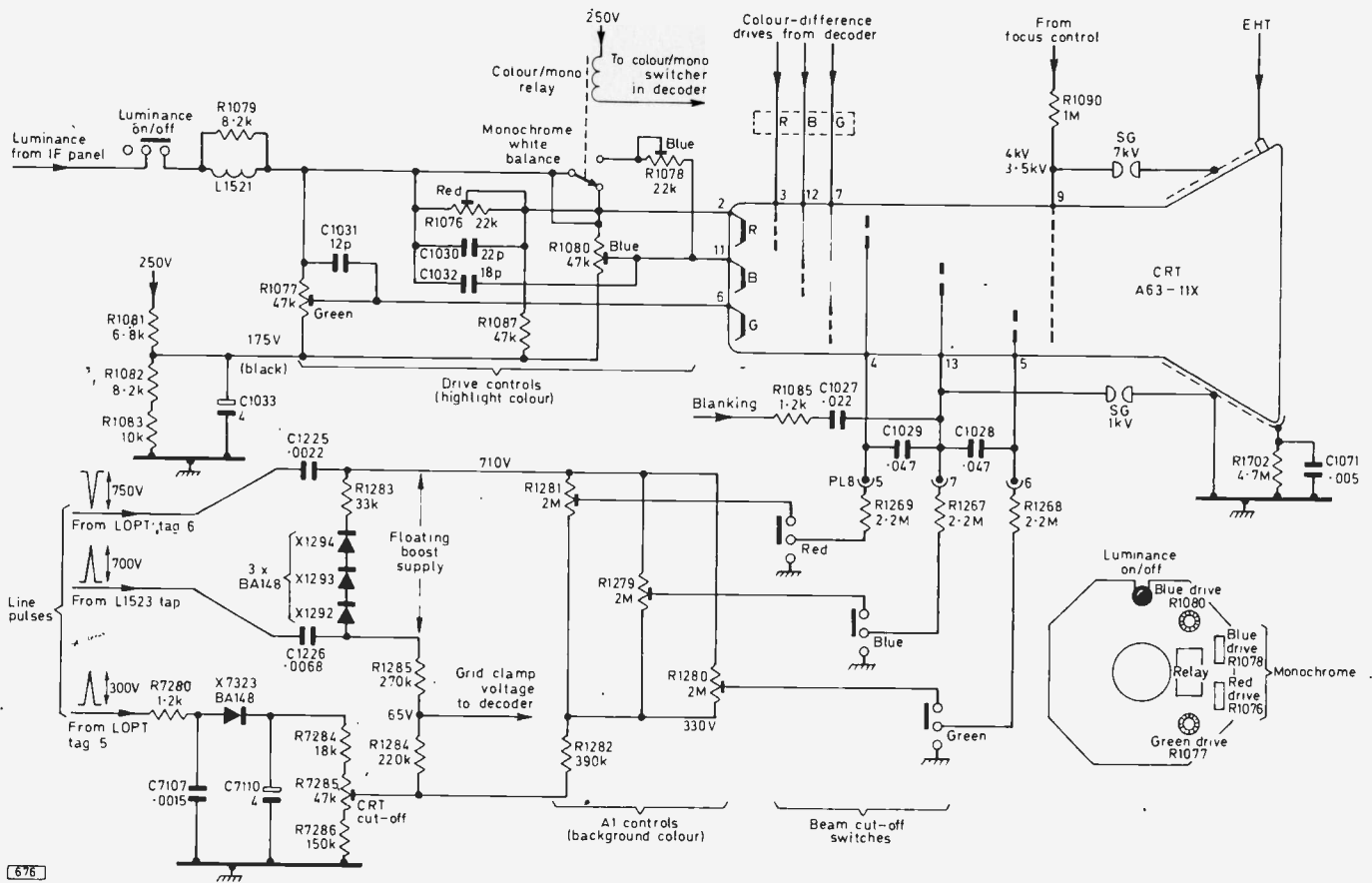

Fig. 2: C.R.T. supply and drive circuits. The first anode presets and switches are mounted on the convergence box. The colour/monochrome relay switch is shown in the colour (relay energised) state – R1076 is shorted out and R1078 is open-circuit in this condition: on monochrome R1076 is brought into circuit to reduce the red drive while R1078 provides increased blue drive. This arrangement was fitted in early production only. In later versions R1282 is 220k Ω , R1284 180k Ω and R7284 is deleted.

there are times when the picture size is right and does not vary. This could well indicate that all is not well around the focus network. Some 4.5kV is required at pin 9 of the c.r.t. base for sharp focus. This is the pin which has the insulation around it to prevent eager little fingers getting burnt.

In these receivers the focus potential is not derived from the e.h.t. system. A separate focus rectifier (EY51) is employed, its anode being connected to the PL509 anode contact on the line output transformer. From its cathode a chain of high-value resistors eventually connects to chassis. The focus control is the third resistor from the cathode. Obviously then if one of the first two resistors changes value, going high, the focus potential available will fall below that required. Focus control adjustment will "take up the slack" at first but the time will arrive for a check on the resistor chain to reveal which of the resistors has departed from the ranks of the righteous. Decomposition of the resistors can occur which can make the focus fluctuate above or below the norm. The control itself is not above suspicion but seems to survive pretty well. If, as happens, one of the resistors on the earthy side of the control goes open-circuit the focus will be poor and adjusting the control will have no effect.

Striations

Another trouble spot involving resistors is in the line linearity circuit. There are two linearity coils in dual-standard sets, one in single-standard versions. The damping resistor(s) are 1.5k Ω and if they go high-resistance the resultant ringing produces vertical rulings down the left side of the screen, fading away towards the centre. We have said resistors but as 405 is unlikely to be still in use R5033 should not cause concern.

The Line Output Transformer

The line output transformer is a fairly expensive item and is no

easy job to replace. It should not be suspected lightly therefore. Early models employed a 42pF capacitor (C5014) across one of the windings and this was inclined to go short-circuit giving the effect of shorted turns in the transformer.

It is a good idea to clip this capacitor out and leave it out. Referring again to early models, disconnect the connection from R7209 on the decoder board (c.r.t. protection) to the PL509 control grid and leave it off. If you happen to be dealing with a no raster fault this action may produce a nice white (well nearly white) line across the screen to indicate that you have been a silly billy to suspect the line output stage and that the fault is in the field timebase after all.

Don't forget to check the boost capacitor C5013 – I know you would have checked this first, but you may not have been able to find it since it can be inside or underneath the housing.

Line Oscillator

There is nothing mysterious about the line oscillator: just a nice ordinary PCF802 in an ordinary circuit. Apart from the system switch in early versions the only item likely to give trouble is the PCF802 itself. No nasty capacitors that leak or short (well they haven't to date so far as we are concerned, not like some we could mention). Thus apart from an occasional valve change for line hold troubles or non-operation, the stage has proved pretty well trouble free.

Setting up the Line Hold

Mark you, if the adjustments have been disturbed or a component change made the setting up procedure is not all that straightforward and merely adjusting the core of L4501/2 may not produce a reliable hold. It is necessary first to disconnect one reference waveform by shorting the junction of R4071-R4075 to chassis. Then adjust the core of coil L4501/2 to produce a

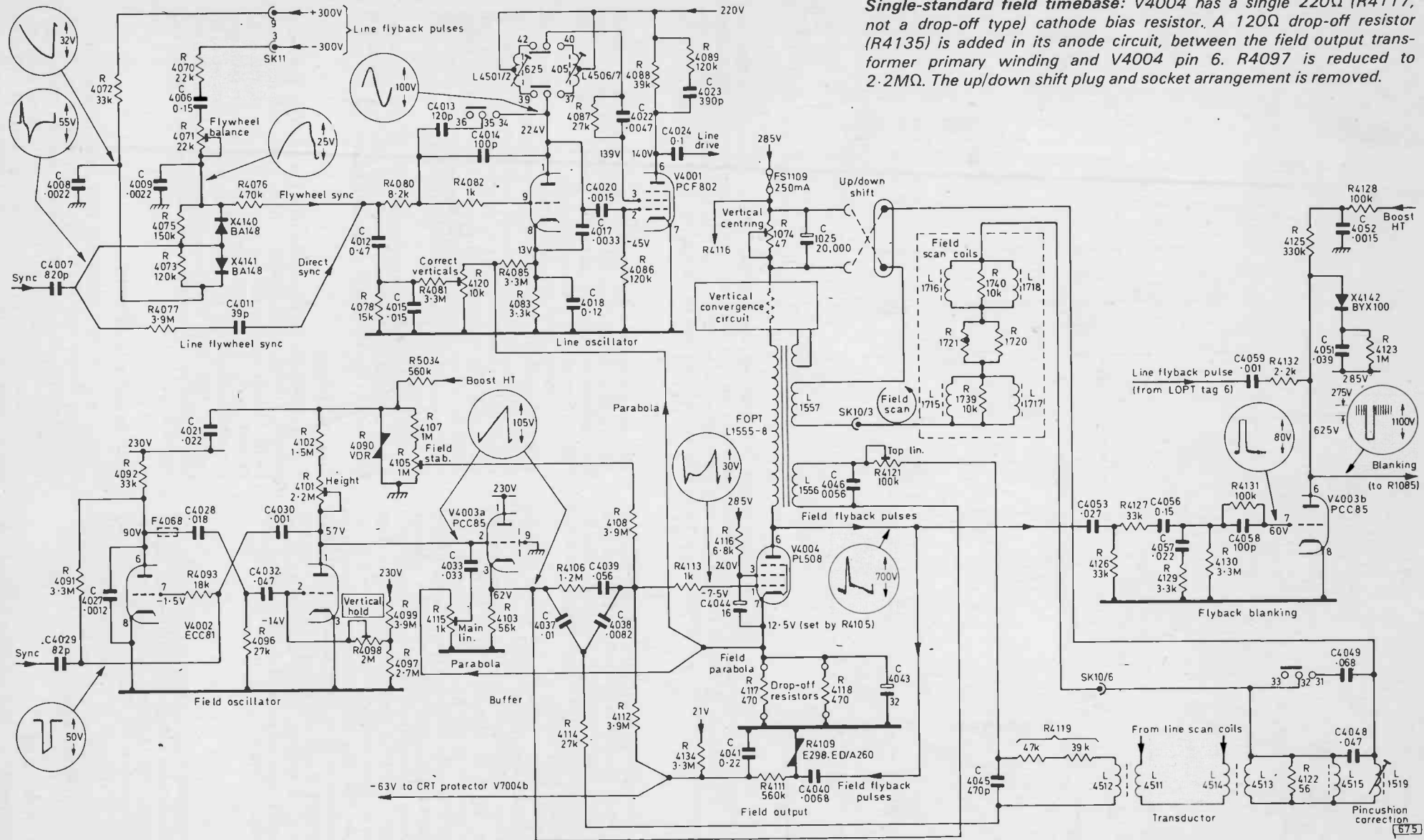

Fig. 3: Circuit diagram of the timebase printed panel, with the 405/625 line switching shown in the 625-line position. In later versions R4075 is 130kΩ and R4134 and the c.r.t. protection circuit are deleted.

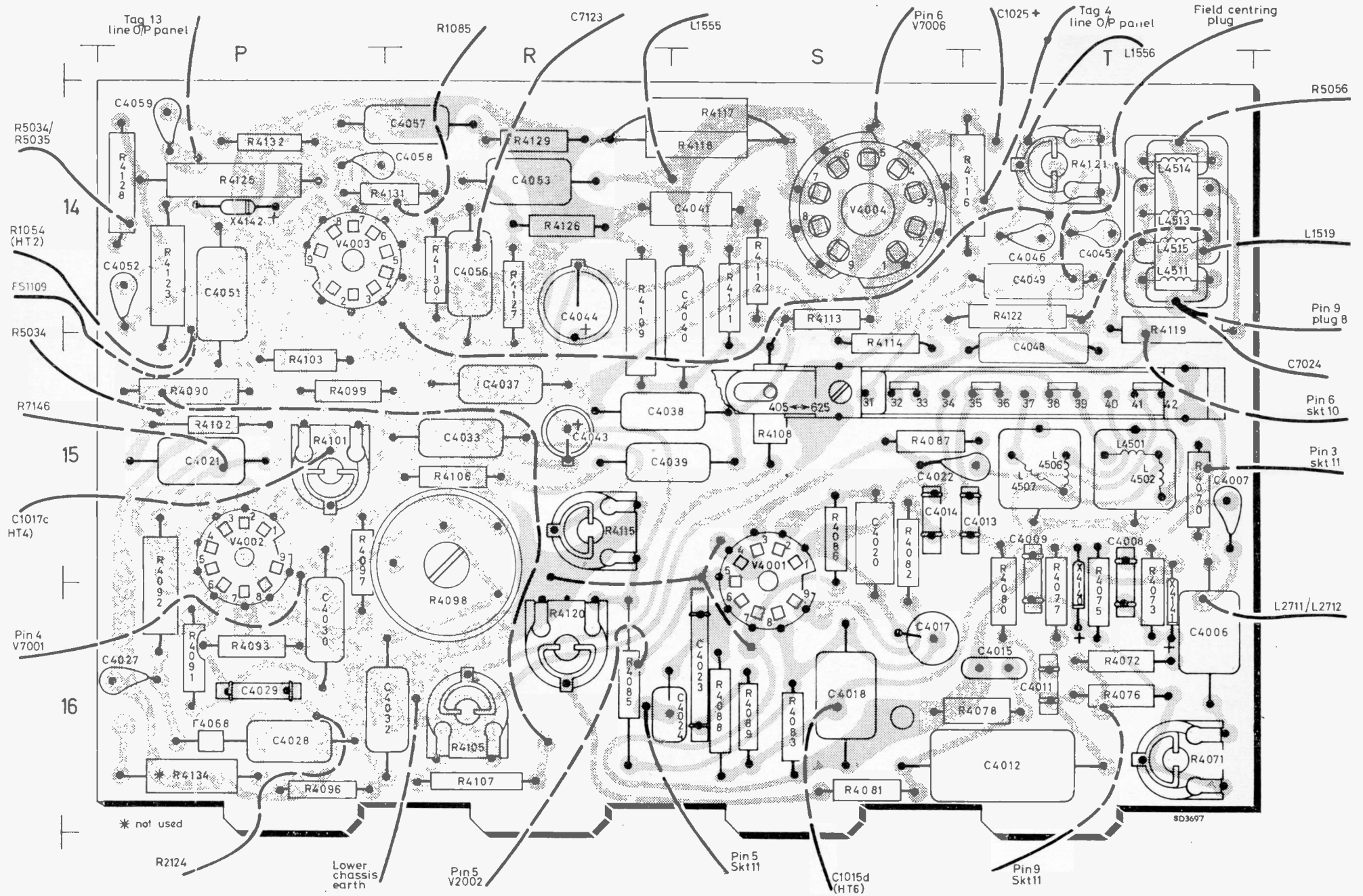

Fig. 4: Layout of the timebase printed panel, viewed from the component side.

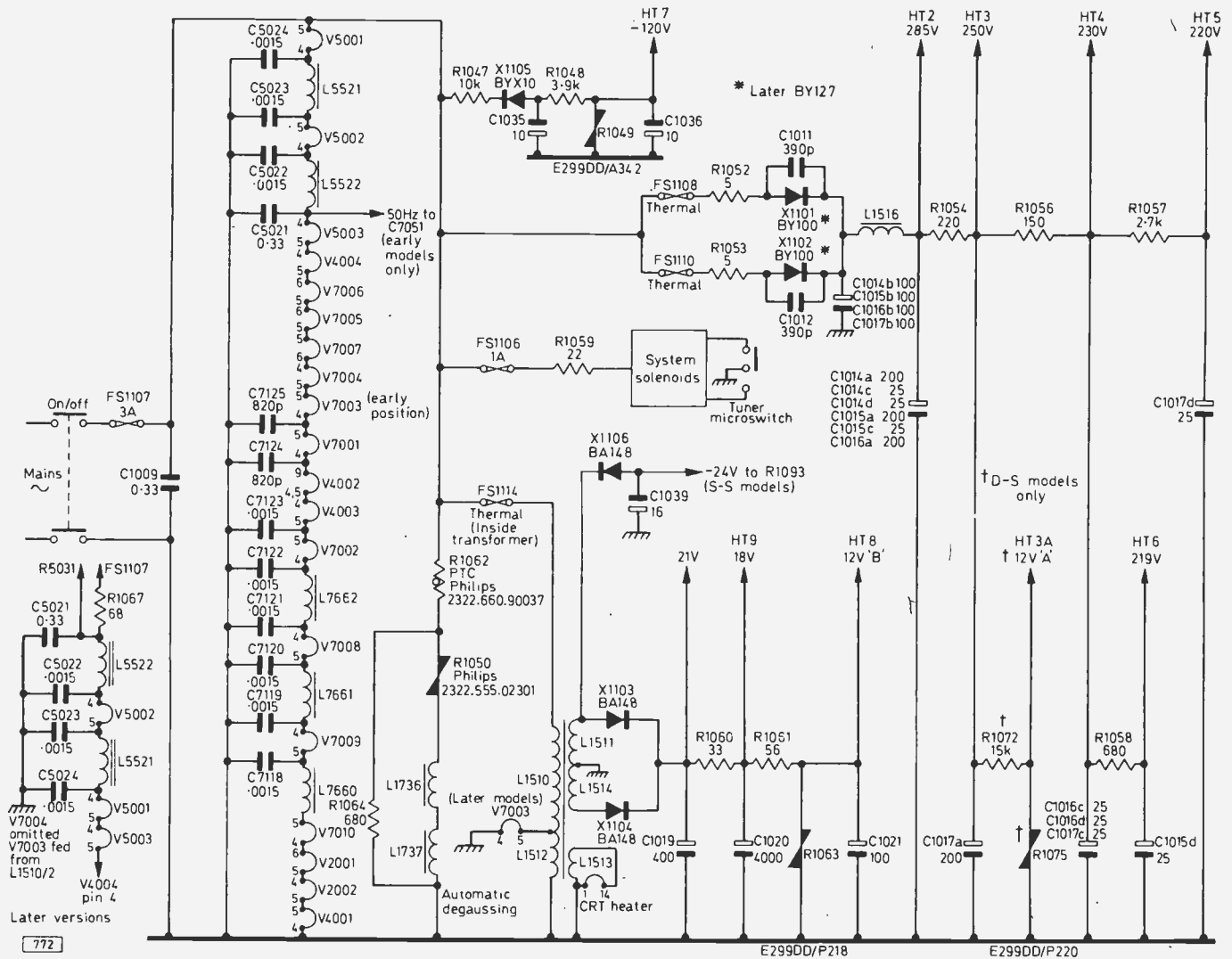

Fig. 6: Power supply circuits. The h.t. rail voltages are slightly higher on single-standard chassis.

hovering picture. Remove the short from the junction of the two resistors and then short pin 2 of V2002 (line sync pulse amplifier on i.f. panel) to chassis. Set R4071, again for an almost locked picture. Remove the short and you should have a locked picture come rain or shine.

The Field Timebase

If the field timebase does give trouble, and it hasn't given us much, the first suspects must be the valves, particularly the ECC81 multivibrator. This can give rise to several fault conditions ranging from total field collapse (thus a single horizontal line across the centre in all but early models where R7209 should be disconnected as outlined earlier) to a jittery picture or loss of hold. There is a buffer stage between the ECC81 and PL508, employing half a PCC85 (V4003). Speaking for ourselves only, we have not had to replace one of these to date. Having said that, we'll probably from now on be plagued with PCC85 trouble, but never mind.

When the field hold control has to be adjusted in the same direction until it reaches the end of its travel, resistor R4099 will probably be at fault (going high) but the ECC81 should nevertheless be the first suspect.

Output Stage Bias

The PL508 output valve can cause some queer symptoms – apart from total collapse or reduced scan – and one must bear in mind the fact that a stabilising circuit is used in the field output stage of these receivers. This is of much the same type as is

common in valve line output stages, and a field output stabilising control (R4105) is provided. Now the trouble with this is that it can be wrongly set without any apparent field scan non-linearity yet nevertheless leaving the PL508 with incorrect bias. Whenever any work is carried out in the field circuit therefore it is necessary to adjust the control – for a voltage of 12.5V at the cathode of the PL508. It should not be assumed from this that the valve is without the normal[†] cathode resistor(s). From the cathode to chassis there are usually two cathode bias resistors, of 470Ω each. There are also two controls, one of 1kΩ (R4115) and one of 10kΩ (R4120). If the PL508 develops internal leakage between its cathode and grid the resultant heavy cathode current can overheat the 470Ω resistors so that one or both drop off their tags. If both drop off the 1kΩ control is left and develops a high voltage across it. This overstrains the decoupling electrolytic C4043 which can pop off and make a mess. Thus one thing leads to another and the drill is to fit a new PL508 and, having replaced the capacitor and resistors, set up the stabilising control R4105 as outlined above.

Bottom Compression

Bottom compression can be caused by the cathode electrolytic C4043 or the screen decoupler C4044 drying up. Whilst the former is a natural suspect the latter is often overlooked, as are the h.t. electrolytics, when compression of the lower part of the raster is being investigated. Note that the two cathode bias resistors of 470Ω each were later replaced by one 220Ω resistor (R4117).

CONTINUED NEXT MONTH

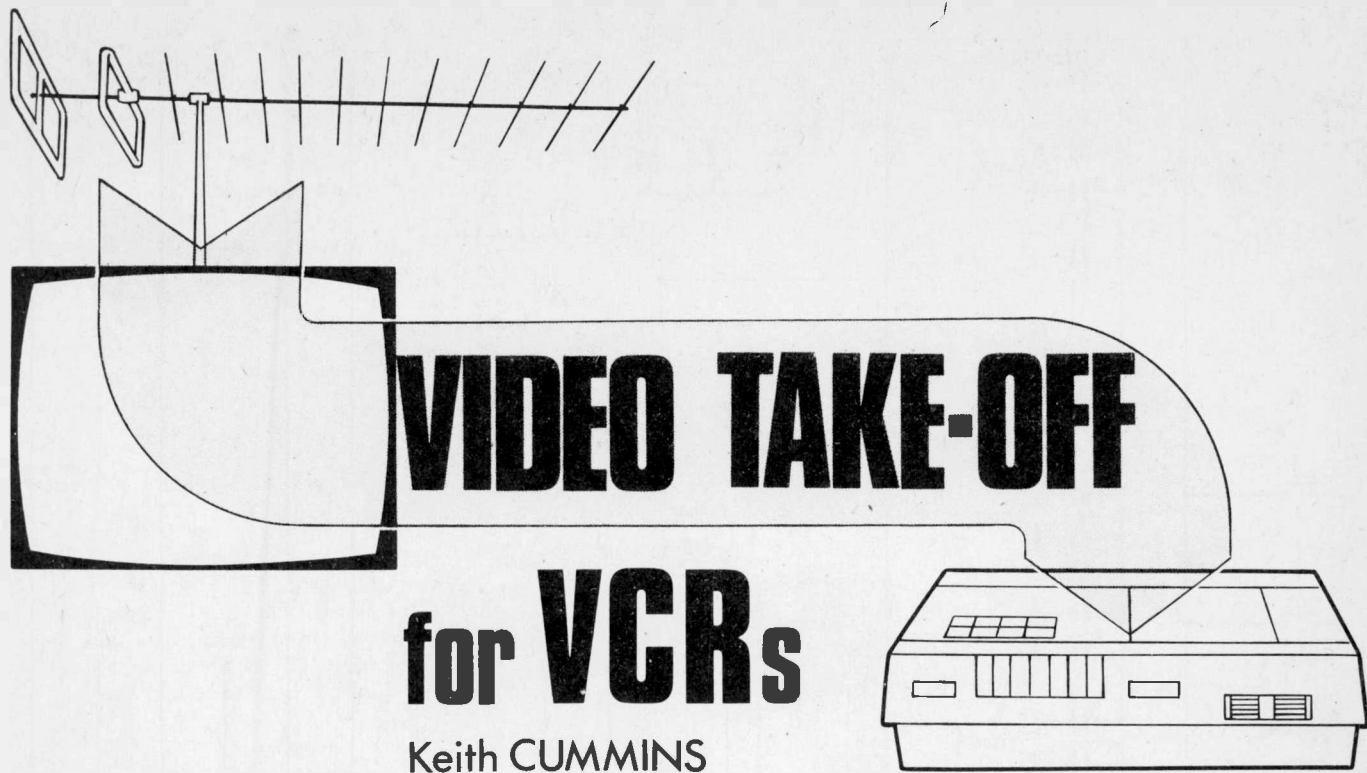

VIDEO TAKE-OFF

for VCRs

Keith CUMMINS

THE videocassette recorder is becoming a more and more familiar piece of equipment. Some types include a tuner unit and timer so that they can record TV programmes off-air without the need for a TV receiver to provide an input signal. There are other types however that call for a video input, though for playback they may be fitted with an r.f. modulator which gives a u.h.f. output suitable for direct connection to the aerial socket of a TV receiver. The purpose of this article is to describe how a video signal can be satisfactorily extracted from a TV set to provide an input for this latter type of VCR.

Note that system compatibility means that a colour signal can be extracted from a monochrome receiver, recorded and replayed in colour through a colour receiver: thus the receiver from which the signal is taken does not have to be a colour one in order to record in colour. The only thing one has to watch in this case is the tuning of the monochrome receiver concerned – it needs to be carefully set up.

The VCR will normally require a positive-going video signal input of between 1-2V peak-to-peak – the video standard is actually 1V peak-to-peak. The connection to the machine is usually made via a multi-cable which carries the sound signal(s) and has a 75Ω coaxial inner for the video signal. The connection must be isolated from the mains supply.

What we have to provide therefore is a positive-going video signal of 1V minimum peak-to-peak amplitude into an impedance of 75Ω. To handle a colour signal adequately we must ensure that the bandwidth is a full 5MHz – in order to accommodate the colour subcarrier and its sidebands.

The first decision to be made when setting about modifying a receiver is just where to extract the composite video waveform. Generally speaking it is best to do this in the stage following the vision demodulator. The 6MHz sound signal may well have been filtered out at this point while the contrast control will often come at a later point in which case contrast control adjustments will not affect the signal fed to the VCR. It is important to note the signal polarity and amplitude since this will determine the design of the buffer amplifier required.

We must not forget the sound signal of course. Generally speaking this causes no problems – the signal can be tapped directly from the top end of the volume control and fed to the VCR. This approach fails only where the volume control is used to vary the d.c. bias applied to a sound integrated circuit. We will return to this problem later.

Let us consider in detail the design of the buffer amplifier. Its connection must obviously be such that the normal working of the receiver is not degraded in any way. D.C. coupling is not essential since the VCR will be designed to accommodate an a.c. coupled video signal. Inevitably the earthy side of the video output must be connected to the receiver's chassis, so it is essential to isolate the receiver from the mains. Thus if the receiver has a non-isolated chassis – as most do – a suitable isolating transformer must be fitted and precautions taken to ensure that if it is mounted outside the receiver it cannot be inadvertently dispensed with.

The video signal present at the point we have selected in the receiver will generally have an amplitude of less than 1V peak-to-peak. It will not be very small however, normally not below 300mV. The buffer amplifier requires a voltage gain of between one and four therefore and in addition may have to invert the signal to make it positive-going.

Basically where inversion is necessary a one transistor amplifier can be used followed by an impedance converter. The latter can be an emitter-follower, but we have to be careful to ensure that this stage will operate satisfactorily into 75Ω.

The bare bones of an amplifier are shown in Fig. 1. Tr1 is the inverting amplifier, with negative feedback applied to its emitter as a result of the uncoupled resistor R2. Its gain is determined therefore by the ratio of R1 to R2 which in this case is about 3.5. Tr2 is an emitter-follower d.c. coupled to Tr1. The emitter load resistor is R3 and the output is coupled by C1 into the load impedance RL. Also shown is the stray capacitance C2.

Now this looks fine and simple until we come to put it into practice. In order to keep the dissipation in Tr2 reasonable R3 has to have a fairly high value, say 330Ω. With a positive-going video signal applied to its base Tr2 will conduct and current will flow in R3, C2 and RL – C1 is simply a d.c. blocking capacitor, and this will charge as well. When the signal falls steeply in the negative direction however – and we are talking in terms of MHz

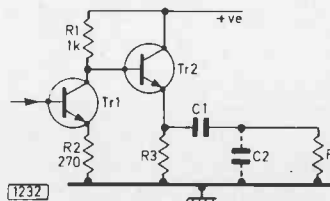

Fig. 1: Basic buffer amplifier circuit. The stray capacitance C2 degrades the performance, necessitating a different circuit approach.

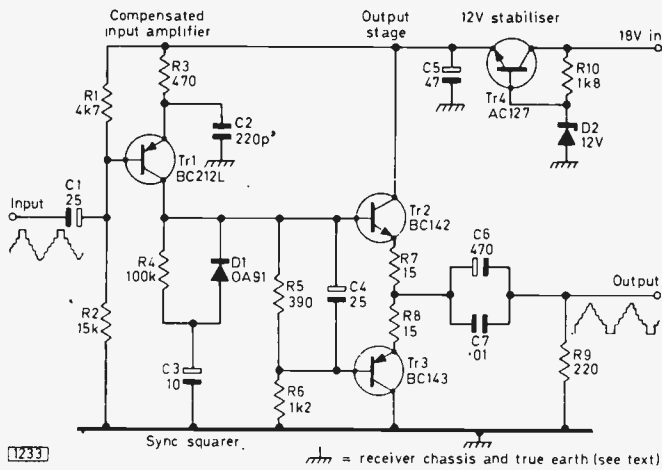

Fig. 2: The final circuit evolved, for video interfacing between a Sony Model KV1800UB and a JVC-Nivico VCR.

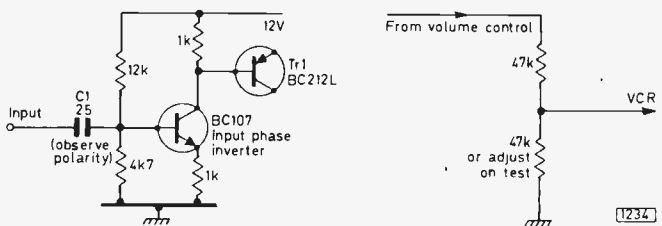

Fig. 3 (left): Suggested additional stage for a non-inverting amplifier.

Fig. 4 (right): Obtaining the sound signal for the VCR.

remember – the charge in C2 will tend to maintain Tr2's emitter voltage. In consequence Tr2 will cut off and C2 can then discharge only via R4 and R3 in parallel. The time-constant may well be too long, degrading the video signal.

A solution to this problem is to use two complementary emitter-follower stages operating in push-pull. This gives an immediate advantage in that the standing current can be much less and thus the power drain on the receiver reduced.

Fig. 2 shows the complete circuit of the buffer amplifier we fitted to a Sony 18in. Model KV1800UB colour set to enable it to feed a signal to a JVC-Nivico VCR.

A negative-going signal of about 0.5V peak-to-peak is available at the output of the emitter-follower which in this set follows the vision demodulator. Our amplifier stage has to invert the signal therefore and provide a gain of two.

A stabilised 12V power supply for the amplifier is obtained from Tr4, R10 and zener diode D2. This circuit is fed from the nominal 18V line in the receiver. In other sets the supplies available may well be different, but this stabiliser circuit should be able to deal with input voltages between 15V and 25V without modification. Tr4 should be fitted with a heatsink if the input voltage is in the higher range. The 12V rail is decoupled by C5.

The negative-going video signal is fed to Tr1 base via C1, with R1 and R2 providing base bias. Negative feedback is provided by R3 whose value determines the stage gain. The d.c. path for Tr1's collector current is via R5 and R6. The bases of the two output

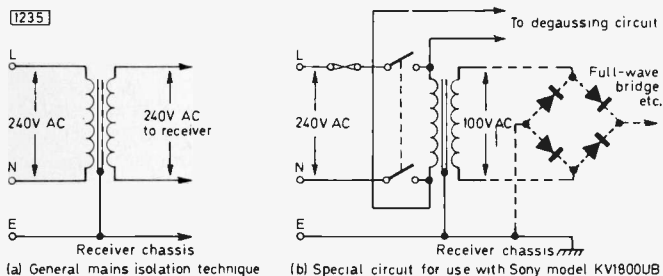

Fig. 5: Methods of mains isolation.

transistors are connected to either end of R5, the voltage across this resistor providing the forward bias for both transistors. The bases of Tr4 and Tr5 are a.c. linked by C4, so that each base receives the same video drive. The circuit is designed so that the emitters of the output transistors take up a voltage level of about half the supply voltage; this ensures that the circuit is symmetrical and operates under the most linear conditions.

The emitter resistors R7 and R8 limit the maximum current drain under short-circuit conditions. C6 and C7 in parallel couple the video signal to the output. This arrangement is used to ensure that excessive inductance in C6 is bypassed by C7, thus maintaining the output at the higher video frequencies. R9 is included to enable C6 to charge even if a VCR is not connected – thus if a machine is plugged in while the receiver is switched on excessive charging current cannot be drawn from the VCR input.

Returning to the earlier part of the circuit, R6 forms the load resistance of Tr1 along with the input impedances of Tr2 and Tr3 in parallel. Diode D1, shunted by R4 and connected to C3, forms a clipper circuit which squares off the bottom of the video waveform present at this point. Since this part of the waveform consists of sync pulses only, the sync pulses only are squared. They could well be square already, but it is possible for distortion to occur in this area and if we are to obtain a satisfactory video recording it is essential to have the best possible sync pulse shape. This simple circuit works very well. D1 conducts on the negative signal peaks, connecting C3 to Tr1 collector and damping the circuit heavily.

No circuit is free from stray capacitance, so the basic amplifier has a falling h.f. response. To compensate for this C2 is included – it reduces the emitter feedback in the first stage as the frequency increases, thus increasing the h.f. gain. Its value can be experimentally determined by hooking a 'scope to the amplifier output and selecting a value which restores the 4.43MHz burst signal to its correct proportions. This approach has always worked satisfactorily: the value shown is correct for this application.

If signal phase inversion is not needed the unity-gain input inverter stage shown in Fig. 3 can be added. This replaces R1 and R2 in Fig. 2. The polarity of C1 will depend on the relative voltages present between the take-off point and the base of the BC107: check this before making the final connection.

If greater gain is required R3 can be reduced in value. The value of R2 will also have to be adjusted in order to maintain the correct d.c. condition (6V) at the emitters of Tr2 and Tr3.

As with all modifications, a certain amount of juggling may be needed in order to obtain the optimum performance from the type of receiver being adapted.

In the case of transistorised receivers the sound take-off circuit shown in Fig. 4 should be suitable. A receiver using a valve audio circuit may have a larger signal present at a higher impedance. In this case try taking the sound signal to the VCR via a 470kΩ resistor connected to the top end of the volume control. Where a sound i.c. with a d.c. volume control arrangement is used it may not be possible to tap off a sound feed which is independent of the volume control. A compromise value buffer resistor may then be needed.

The JVC VCR used has its own r.f. modulator so that playback can be via the aerial socket of any receiver. There was no need therefore to investigate the possibility of feeding audio and video signals from the VCR into the appropriate sections of the receiver.

Finally, a further note on the mains isolating transformer, which is essential. The usual method of modification includes fitting a three-core mains lead so that the receiver chassis is effectively earthed. Fig. 5(a) shows the method generally adopted while Fig. 5(b) shows the technique used with the Sony Model KV1800UB which previously employed a mains autotransformer – the isolating transformer for this modification was specially wound to order and fitted inside the cabinet in place of the autotransformer.

Note that special care must be taken with any modification involving mains isolation, since safety is concerned. Receiver manufacturers will accept no liability for the safety of a set which has been modified. Thus where modifications are concerned the safety aspects fall directly into your lap. ■

LONG-DISTANCE TELEVISION

ROGER BUNNEY

It is remarkable how reception conditions fluctuate from day to day. We can often see short bursts of various signals in Band I throughout the day for several successive days, and yet there can follow a day or more when the spectrum is completely devoid of short signal bursts. At such times one's thoughts turn to the possibility of an open-circuit feeder in the receiving system and it's certainly a good idea to check coaxial joints, especially if there are coaxial plugs/free sockets outside since a slight touch of corrosion can often result in considerable signal reduction. For my part since I live close to a busy road there is always the check with ignition interference from cars; also the usual though weak signals from the NOS Lopik outlet on ch. E4. I've experienced several such "no-signal" days during April, and apart from several pointers to the coming Sporadic E season little of note has been received. SpE signals received here include CST (Czechoslovakia) ch. R1 on the 10th; TVE (Spain) chs. E2 and 4, also on the 10th; and SR (Sweden) ch. E2 on the 20th. MS (Meteor Shower/Scatter) reception also had its moments, with a cross-section of the main European Band I outlets received during the early morning period. At the time of writing (23rd) there are indications of improved Tropospheric reception in Band III and at u.h.f., thanks to a slow-moving high-pressure system.

Ian Beckett (Buckingham) also noted a good SpE opening on the 7th, with TVE and a suggestion of RTP (Portugal) as well. Going back to March, we have now received several reports of an Aurora on the 27th. Both Hugh Cocks and Charles Oliver (Dartford) experienced this. Charles noted signals of sorts on most Band I channels, including Ruislede (Belgium) ch. E2 and, also on ch. E2, the TVE vertical bar pattern. Both signals were received from the north, indicating signal reflection from the Auroral sheet.

It has again been a busy month, with plenty of news. In the interests of space therefore I shall again bypass my reception log.

News Items

First news of new network operations often comes from publicity handouts issued by various equipment manufacturers. Several have come to hand this month.

Pakistan: The TV authority has ordered over one and a half million dollars' worth of equipment as a first step in starting colour operations. It is expected that colour programme transmissions will commence later this year. There are currently five stations in operation.

Oman: The TV network being constructed by Pye TVT will have four transmitters, all in Band III. The transmitters will be at Salala (300kW e.r.p.), Mudavy (1.7kW e.r.p.), Midway and Shelin (both 140kW). The studio centre at Salala is to be connected to the main transmitter by a microwave link. From its 160 metre tower, a two-hop microwave link will feed Midway, while a specialised off-air pickup system will be employed to feed the other network transmitters. The network completion date is expected to be during May 1976 though the main Salala area should be receiving TV programmes by the November 15th National Day.

Korea: Pye TVT is supplying additional equipment for colour working to the TV centre at Seoul. This is the latest phase in widening Korea's TV coverage.

Iraq: Pye TVT has received an order worth three quarters of a million pounds for the supply of vision and link equipment for the Baghdad studio centre.

Nigeria: EMI Sound and Vision has received a 4.2 million pound contract to supply a complete television system to the oil rich Kwara state. A studio complex will be situated at the state capital, Ilorin, with five transmitting sites throughout the state giving full regional coverage. To start with operation will be in monochrome, but with colour capability. The four regional transmitters will re-radiate off-air signals from the Ilorin transmitter which will be microwave linked to the main studio complex. Each regional transmitter will be able to transmit local news, each site being provided with its own telecine unit. The TV service is to be controlled and operated by the Kwara State Broadcasting Service.

Spain: Marconi is to supply further colour cameras to the main TVE studio centre at Prado del Ray near Madrid.

We also understand that TVE is to expand its network with new microwave links. Incoming programmes from Madrid at Valenca will be relayed to Desierto and then on to Javalambre. Another link will be to Cabo Quejo on the shore of the Bay of Biscay and then on via other links to Oviedo. It is assumed that new transmitters will be established at these sites.

USSR: The Moscow TSS TV channels are to be altered, TSS-1 moving to ch. R3, TSS-2 to ch. R8, TSS-3 to ch. R1 and TSS-4 to ch. R11. The reason given is "to avoid interference". In addition, the following u.h.f. channels have been allocated: Krasnoperekopsk ch. R32, Veshintos ch. R33, Valmiera ch. R33, Tolyatti ch. R30, Yedinty ch. R31.

New Zealand: The whole New Zealand broadcasting structure changed on April 1st. The functions of NZBC, which ceased to operate, have been divided between three corporations, one for radio and two for television (TV1 and TV2). TV2 is due to start operations in early July. The Broadcasting Council of New Zealand has been set up as a legislative and governing body and with the aim of ensuring that the three corporations are complementary and competitive. TV1 is based on Wellington and Dunedin, TV2 on Auckland and Christchurch. Whereas TV1 has almost national coverage, the coverage of TV2 will be restricted for some years. TV1 is in effect the old NZBC TV network, TV2 being the newly established alternative service.

Although working with the new Radio New Zealand system, commercial stations will continue to operate as at present but with greater freedom to provide programmes for local communities. Details from Doug McFadyen.

Australia: Colour transmissions (PAL) started on March 1st. Australian channels 3, 4, 5 and 5A (between Bands I and III) are to be phased out to enable f.m. sound broadcasting to start in Band II. U.H.F. TV transmissions are to start in due course

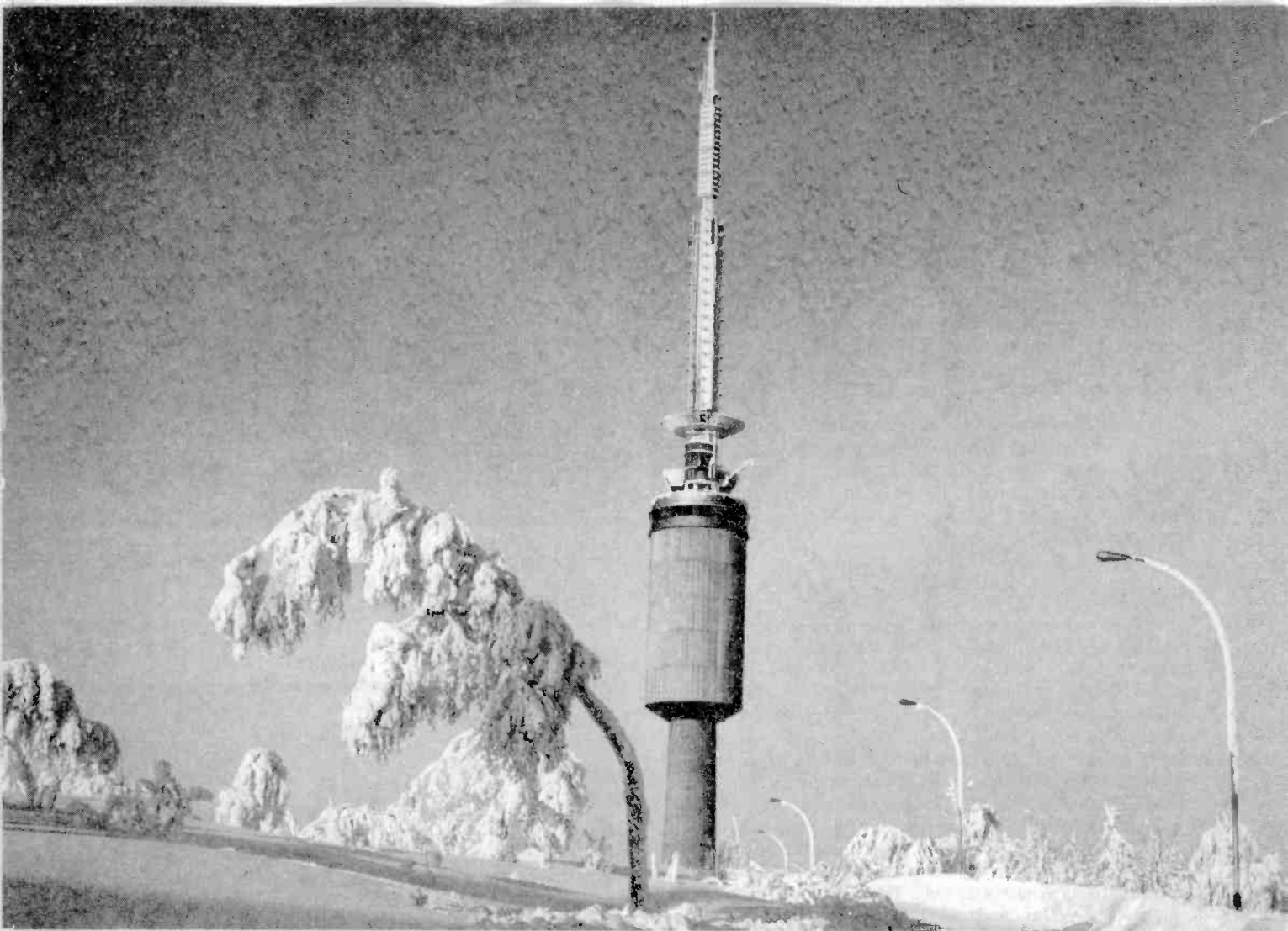

An attractive, if unseasonal, view of the Tryvann TV Tower near Oslo, Norway. Transmissions are on channel E6, with 100kW e.r.p.

Courtesy Nera Company.

between channels 28-32 and 39-63.

RETMA Test Card

The WTFDA inform us that the well known RETMA test card is to be renamed. In future it will be known as the EIA Resolution Chart or EIA Pattern. EIA is the Electronics Industries Association.

Correspondence

As usual Clive Athowe (Norwich) has been very active. He has been able to clear up one mystery: the PM5544 test card observed on ch. R1 with a new identification has been confirmed as belonging to CST (Czechoslovakia). The identification is "BR-PRAHA". Whilst on the subject of Czechoslovakia, Igor Hajek (University of Lancaster) has corrected a point made in our May column. In connection with the "RS-KH" identification Kavci Hory means Jackdaw Hills, not Magpie Hills. Sorry, I'm not too genned up when it comes to ornithology!

**LONG-DISTANCE
TELEVISION**

TELEVISION JULY 1975

Michele Dolci (Bergamo, Italy) has confirmed that Tele Monte Carlo (TMC) is transmitting Italian language programmes at u.h.f. Bergamo will shortly have its own pirate relay transmitter – in the surrounding hills. It will relay TMC at about 400MHz.

Moving further east, Hetesi Laszlo (Hungary) tells us that MT often uses the small crosshatch pattern/grid. Care is necessary therefore when logging this (it may not be CST).

V. V. Merchant, VU2VJ, of Bombay tells us that his local ch. E4 transmitter uses the Telefunken T05 test card without identification. It is possible apparently to receive Lahore ch. E4 (Pakistan) in Bombay, especially in screened locations. Mr. Merchant tells us he will be writing in greater detail later on TV conditions in his area. We await his letter with considerable interest.

A newcomer to this hobby, Graham Harrison (St. Leonards on Sea, Sussex), has written to tell us about the aerial system he is using. He has a directional Band I array fitted with an AR40 rotor unit. The array is mounted at 30ft. on a Hill's Telemast. In addition he is using an omnidirectional Band I array in his loft.

Benelux

In brief: the Benelux DX Club tells us that there is a new NDR-1 transmitter operating on ch. E7 with 25kW e.r.p. at Visselhovede; the BFBS (British Forces Broadcasting Service) plans new transmitters at Bielefeld, Herford, Minden, Lubbecke and Detmold in West Germany; Belgian Army TV transmitters operate in West Germany at Bensburg (chs. E29 and E51, both 600W), Arolsen (ch. E37, 2W) and Spich (chs. E46 and E53, both

LONG-DISTANCE TELEVISION

50W); there are new GDR (East German) u.h.f. transmitters in operation at Cottbus (ch. E23) and Tannenbergstal (ch. E21).

Receiving Band II

We received a 'phone call recently from Mr. Norton (Essex) telling us of another means of receiving Band II television transmissions on channels R3, R4, R5 and IC. This can be done by using the Philips portable TV set fitted with the T6 chassis. It is made in Italy and the tuner has fully continuous tuning through Band II (TV).

Australian TV

Over the past nine months we have received increasing mail from an enthusiastic number of DX-TV followers in Australia. George Palmer (Queensland), Nicholas Earley (Melbourne), Michael Glisson (Victoria), Robert Copeman (Sydney) and Anthony Mann (Perth), also Doug McFadyen (New Zealand), have all been telling us of a really excellent SpE season "down under". Long-hop signals have been commonly experienced this year, with 2,000 mile hop signals not uncommon. Indeed there is a possible 4,000 mile signal: Doug suspects he received ABW-2 (Perth) ch. 3 in New Zealand on January 8th.

Doug has also been at work on aerial construction, including a Band I stacked bowtie array using a form of Trumatch dipole on a hinged screen reflector assembly. The sketches he has sent show a magnificent array and we hope to be able to include a photograph in due course.

It seems that there has been a very good year down under and I hope this indicates that our coming season will be good as well. They too have their problems: the PM5544 test card is in very common use, even to the extent of being logged on Christmas Day with the identification "Merry Christmas"! We feature this month a couple of off-air shots taken by George Palmer who is famed for his late 1950s F2 DX-TV.

East European Review

In a recent issue of *International Broadcast Engineer* Mihaly Mitreg described various aspects of television in Eastern Europe. A summary follows.

Experimental television in Albania began in the late 1960s, with a small transmitter (50W) operating on ch. R2 from the Radiodiffusion Albanaise headquarters in Tirana. The numbers of receivers in use grew enthusiastically, especially when it was realised that programmes from neighbouring countries – Yugoslavia, Greece and Italy – could be received well. In recent years the network has been extended through the country, with higher powered transmitters and a three studio complex at Tirana. The ch. IC transmitter is received from time to time in the UK and Europe during favourable SpE conditions.

Television in Bulgaria started in November 1959. Today there is a network of 19 main transmitters and many repeaters. Bulgaria (Boghlarsokie Televidenie) was received in the UK some years ago on ch. R2 and there is certainly a chance of receiving the ch. R1 or R2 outlets under favourable conditions.

Over three million TV sets are in daily use in Czechoslovakia, served by a first network of high-power v.h.f. transmitters plus several hundred relay stations and a second u.h.f. network which is slowly expanding. With the large number of relays, Ceskoslovenska Televize is one of the most extensive networks in

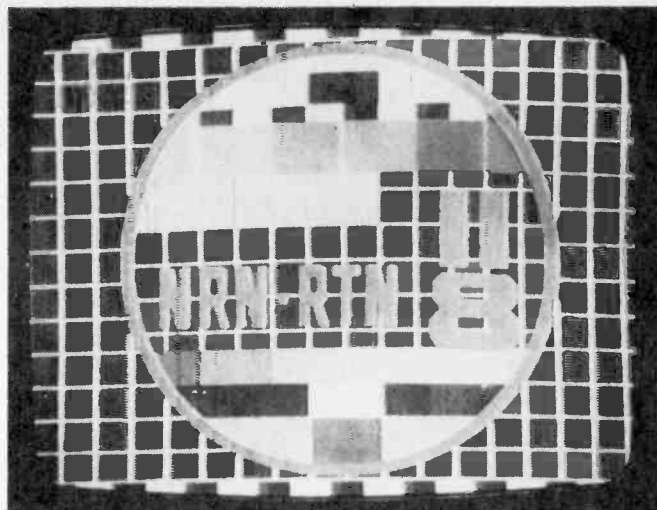

Test card used by NRN (ch. 11) and RTN (ch. 8), N.S.W., Australia. NRN (Northern Rivers TV Ltd.) and RTN (Richmond Tweed TV Ltd.) are commercial TV stations.

Courtesy George Palmer.

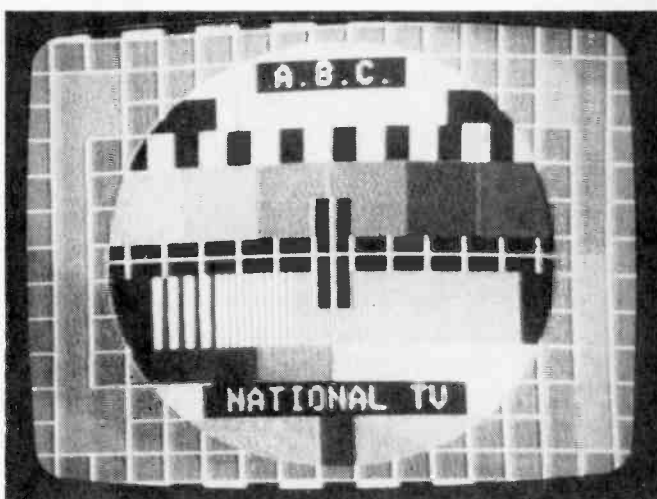

PM5544 test card as used by ABDN (ch. 2), N.S.W., Australia. ABDN is an ABC (Australian Broadcasting Commission) regional station at Grafton/Kempsey.

Courtesy George Palmer.



ARD Identification caption. West Germany.

Courtesy Garry Smith.

LONG-DISTANCE TELEVISION

the eastern bloc. A restricted commercial air time is allowed. CST is well received in the UK and still uses the monoscope test card introduced in the early 1960s. An identification can be seen on the card on rare occasions – when a transmitter leaves the network test to originate its own slide.

The German Democratic Republic (GDR) has some four million TV sets in use. Unlike the other eastern countries the CCIR System B/G is used, i.e. E channels instead of the OIRT R channels. The Berlin Koenig transmitter opened in December 1952, Leipzig in 1955, followed by Dresden, Cottbus, Helptenberg and Schwerin. Further transmitters followed and a second service now operates at u.h.f. The Deutscher Fernsehfunk headquarters is at Berlin-Adlershof. The use of System B means that those across the border can view DFF transmissions – and vice versa. The GDR uses Secam colour however (PAL is used in West Germany of course). The authorities on each side of the border keep each others' audiences in mind in arranging the programmes, and several W. German transmitters transmit special programmes to the GDR. The Brocken transmitter high in the Hartz mountains puts an excellent signal into W. Germany – and during good Tropospheric conditions into the UK as well! The ch. E34 outlet can often duct a signal into Eastern England when there is no sign of the nearer West German transmitters.

Magyar Radio es Televizio (Hungary) provides television for both the MT-1 and MT-2 networks from studios on the Szabadsag highway at Budapest. From an early 25kW transmitter operating on ch. R1, a relay network was quickly developed (from 1959) and has recently encroached into the u.h.f. spectrum. Some two million receivers are in use. The Hungarian EMV Company has provided all the transmitters. This year heralds a considerable expansion of MT-2 into Band IV – the programme is due to be completed in 1978. The ch. R1, R2 and R4 outlets are often received in the UK.

The Polish television service – Polskie Radio i Telewizja – covers the vast tracts of Poland with a first programme at v.h.f. and an expanding second programme which is transmitted at v.h.f. and u.h.f. The service started in July 1954 from a ch. R2 transmitter at Warsaw. TVP is received at excellent strengths in the UK during SpE openings and has also been received in Band III and at u.h.f. via Tropospherics.

Televiziuna Romina went on air in 1957 from a ch. R2 transmitter at Bucharest, the network expanding slowly. More recently a second network has been started. There are a considerable number of relay stations, giving coverage over the whole country. The low-powered (600W) ch. R1 transmitter at Bacau is a main station originating its own programme schedule (though this now appears to be off the air). The Rumanian ch. R2 and R3 outlets at Bucharest and Oradea are often received in the UK.

This summary will be concluded next month.

Test Card Book

Just as this column was finished the long awaited test card book arrived from the printers! I will review this thoroughly next month when I've had time to study it closely. Initial examination reveals a really excellent work – an essential for the DX-TV enthusiast. I counted well over 250 photographs.

The book costs only £1.30 including postage from HS Publications, 7 Epping Close, Mackworth Estate, Derby DE3 4HR.

next month in

Television

● VIDEOTAPE RECORDING

A number of videotape recorders intended for the domestic and educational markets are now available. To handle such machines it is necessary to understand the specialised circuit techniques used and the mechanical arrangements. This is the first part of a new series explaining the technicalities of videotape recorders.

● THORN 9000 CHASSIS

Thorn's new 9000 colour chassis, built around the PIL colour tube, employs much novel circuitry. Particularly interesting is Thorn's Syclops combined line output/power supply regulation circuit. How this and the unusual field timebase work will be explained.

● OVER-VOLTAGE PROTECTION

With the advent of solid-state chassis using stabilised power supplies came the need for over-voltage protection – to stop the h.t. or e.h.t. rising excessively in the event of a fault in the regulator circuit. Many different techniques, producing different symptoms when they come into operation, are in use. A comprehensive guide will be provided.

● LARGE-SCREEN TV OSCILLOSCOPE

Part 2 deals with construction of the control unit power supply, layout and drilling of the front panel, and the Y deflection amplifier.

● ELECTRONIC LOGIC

Those who followed our TV games series will already have come across logic circuitry: those who are now plunging into the peculiarities of Ceefax/Oracle decoding will shortly have to do so. We have produced a guide therefore, in mainly diagram form, covering the various logic elements and what they do.

PLUS ALL THE REGULAR FEATURES

ORDER YOUR COPY ON THE FORM BELOW:-

TO.....
(Name of Newsagent)

Please reserve/deliver the AUGUST issue of TELEVISION (40p), on sale July 21st, and continue every month until further notice.

NAME.....

ADDRESS.....

.....

THE continuing changeover to domestic colour TV reception has produced a good supply of redundant yet serviceable monochrome receivers. The idea of converting some of these to large-screen oscilloscopes has definite attractions, and has prompted a number of letters to *Television* asking for information on such a project.

In the present series of articles it is intended to describe how a standard black and white television receiver may be converted into a large-screen oscilloscope which will be of use for the display of TV waveforms for demonstration or lecture purposes, as well as for the servicing of television receivers. Because sampling techniques are used to overcome the limitations of bandwidth inherent in the deflection circuits used on television receivers, the oscilloscope can only be used for the display of television waveforms locked to transmitted signals, or for low frequency waveforms below 4kHz.

The design provides a number of useful facilities for demonstrating TV waveforms and for servicing television receivers, so that the complete equipment becomes a basic TV oscilloscope. The following main features are provided:

- (1) Signals at i.f. from any part of the receiver under test may be fed to the oscilloscope and displayed either as a line waveform or as a picture, thus providing an immediate check on the functioning and quality of the r.f. and i.f. signal circuits.
- (2) The line sync pulse can be displayed and expanded to cover the whole screen of the oscilloscope, thereby enabling such information as the colour burst signal on colour receivers to be checked.
- (3) The field timebase, line timebase and sound signals may be displayed to check timebase synchronisation and linearity and to check the correct functioning of the sound circuits.
- (4) Signals from the video circuits may be fed to the oscilloscope and displayed either as a line waveform or as a picture.
- (5) The system will function on both 405- and 625-line standards.
- (6) Although primarily intended for the display of television signals the display will function on audio signals from 10Hz to 4kHz. Hence the TV sound channel can be checked using a signal generator.
- (7) Signals at i.f. from the tuner of the oscilloscope can be fed into the i.f. of a faulty receiver as a check on tuner faults.

With these facilities available on the TV test oscilloscope the malfunctioning section of a TV receiver can be quickly isolated and checked.

The oscilloscope makes use of an old monochrome dual standard receiver. Although either 405 or 625 standards may be used, a dual standard is recommended so that any TV receiver can be repaired with the equipment. Of course if the equipment is required exclusively for display purposes it is only necessary to use a single line standard. The selection and modification of the receiver is dealt with later.

The project is built up step by step each month with some construction and testing needed each time. However, for those wishing to have some idea of the complexity of the equipment, it comprises: a dual standard receiver incorporating a few minor modifications, and a small instrument case containing the sampling circuits and power supplies. The system employs 30 transistors and 3 integrated circuits. The complete equipment is shown in our cover photograph.

LARGE-SCREEN TV OSCILLOSCOPE PROJECT PART 1

Bandwidth limitations

With all large screen magnetic deflection displays, the main limitation is the bandwidth of the Y deflection circuits due to the inductance of the deflection coils. The -3dB bandwidth of the receiver used in the prototype is 10Hz to 4kHz. To increase the usefulness for television waveform monitoring purposes a line sampling system has been devised which enables a form of stroboscopic image of the TV line waveform to be displayed on the 50Hz timebase. This makes use of the fact that the line and field scans of the television system are rigidly locked together.

Samples of the signal level are taken progressively along each successive TV line and held for one line period. When displayed on a 50Hz (field locked) timebase a composite line waveform is built up from 300 or so samples, one from each line. By varying the rate at which the sample pulse progresses along the line, an expansion facility is achieved. This allows the line sync and colour burst signals to be displayed as a full width trace on the c.r.t.

The r.f. and early i.f. stages of a receiver under test are checked by feeding signals from them into the i.f. amplifier of the oscilloscope for waveform or picture display. Also scan waveforms, R, G, and B video signals, etc., can be monitored for presence or absence of signal, although accurate measurement would require some form of prior calibration.

The frequency response in the Y direction needs to extend to about 4kHz (-3dB) but even this modest response is difficult to obtain from field deflection coils having an inductance of 30-40mH. It was found necessary to use the lower inductance line coils for Y deflection and retain the field scan intact as a 50Hz timebase. To put the timebase in the normal horizontal plane it is therefore necessary to rotate the deflection yoke through 90° on the tube neck. This fact should be borne in mind when selecting a suitable receiver. The direction of possible rotation is immaterial since connections to either set of coils may be reversed to obtain the correct polarity of display and timebase.

The receiver used in the prototype was a 19" Bush TV115, but all modifications to the receiver are made at fairly accessible points in the circuit so that almost any make or model should be satisfactory. Obviously, if 405- and 625-line operation is required, a dual standard set must be selected. All the additional circuitry, including a mains isolating transformer, is housed in the separate case.

System diagram

The functional diagram of Fig. 1 shows the additional stages and switching involved. A four pole rotary switch is used to change over the line coils from the existing line output

SCREEN SCOPE

D. HALEY

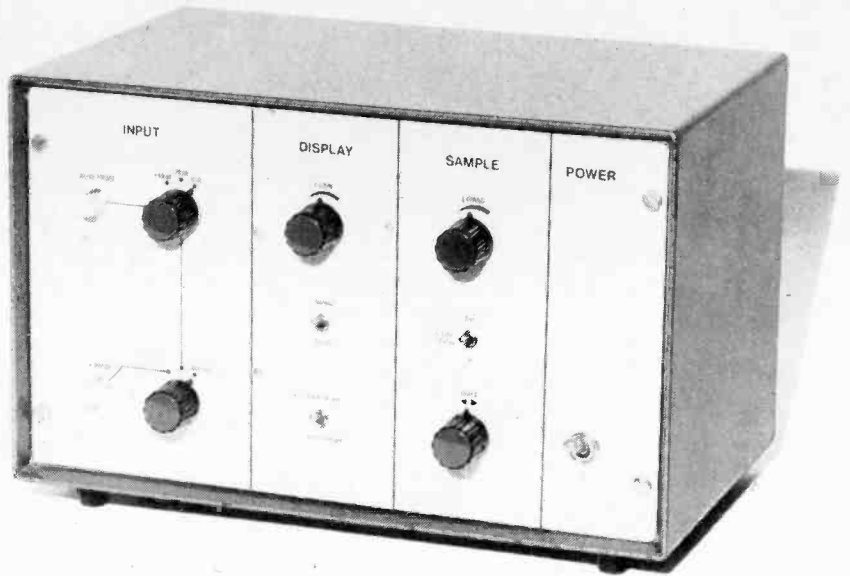

transformer to the new Y deflection amplifier for waveform display. This switch also operates a relay which removes the video modulation from the cathode ray tube. Although only two switch conditions are required for picture and oscilloscope operation, a three position make before break switch is used. A dummy load must be provided for the line output transformer when the deflection coils are connected to the Y amplifier. This load is connected in parallel with the line scan coils during the first switch transition to reduce arcing. The second switch transition connects the line coils to the Y amplifier while the dummy load remains connected to the line output transformer.

A second three position switch, mounted on the control box, selects the input and mode of operation of the oscilloscope circuits. In position 1 (i.f.) relay RLA is energised, connecting the i.f. probe input to the i.f. amplifier. Video signals from the oscilloscope vision detector are also connected to the sample and

hold circuit. In this position signals at i.f., from the mixer output onwards of a faulty receiver, can be monitored. The probe is fed into the i.f. preamplifier, which has a gain of 10 times, enabling a high impedance attenuating probe to be used for connection to high impedance circuits. The sample and hold circuit is connected to a low signal level on the video amplifier to display the line video waveform, or the signal can be displayed as a picture in the normal way.

The second position on the operating mode switch is a.f./v.f., which connects the a.f./v.f. probe directly to the sample and hold circuits for display of line frequency waveforms from the receiver under test. For display of field and audio frequency waveforms via the probe, the sampling circuits are bypassed by the Line/Field switch. The third operating mode is Internal which allows the oscilloscope received signal to be displayed for comparison or demonstration purposes.

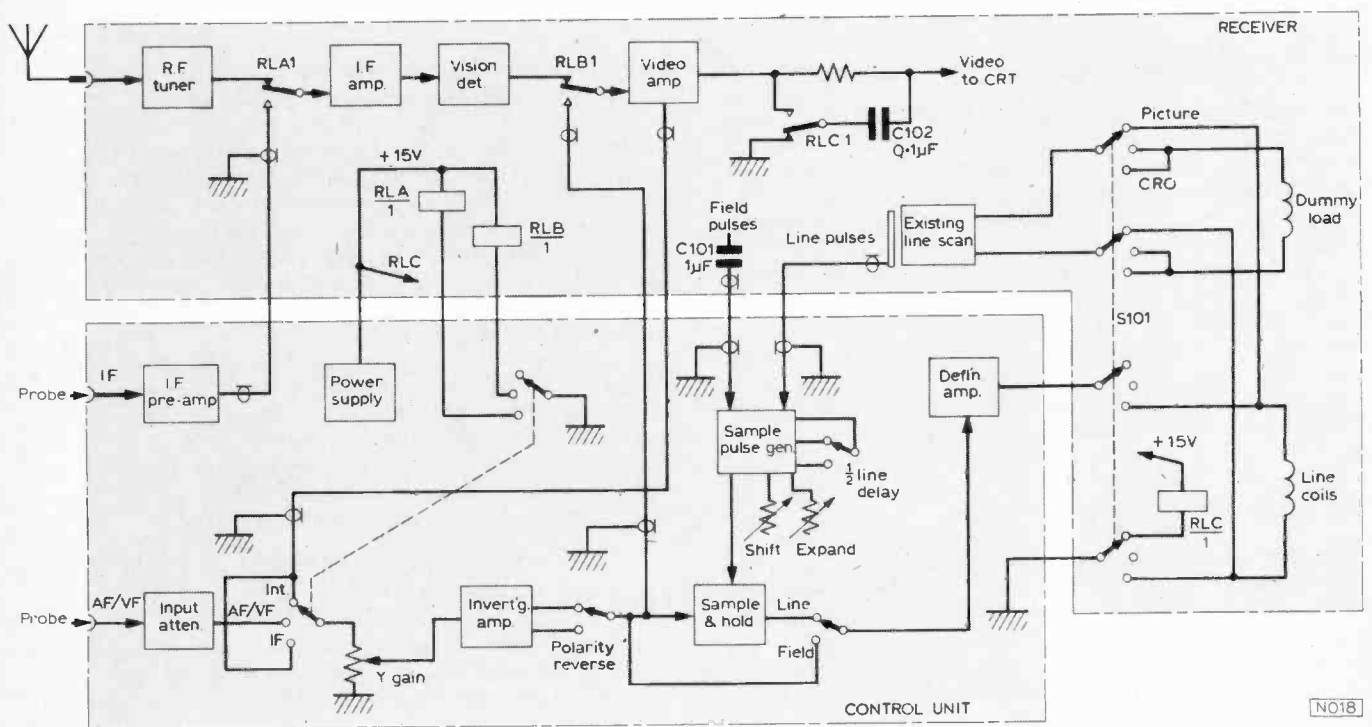
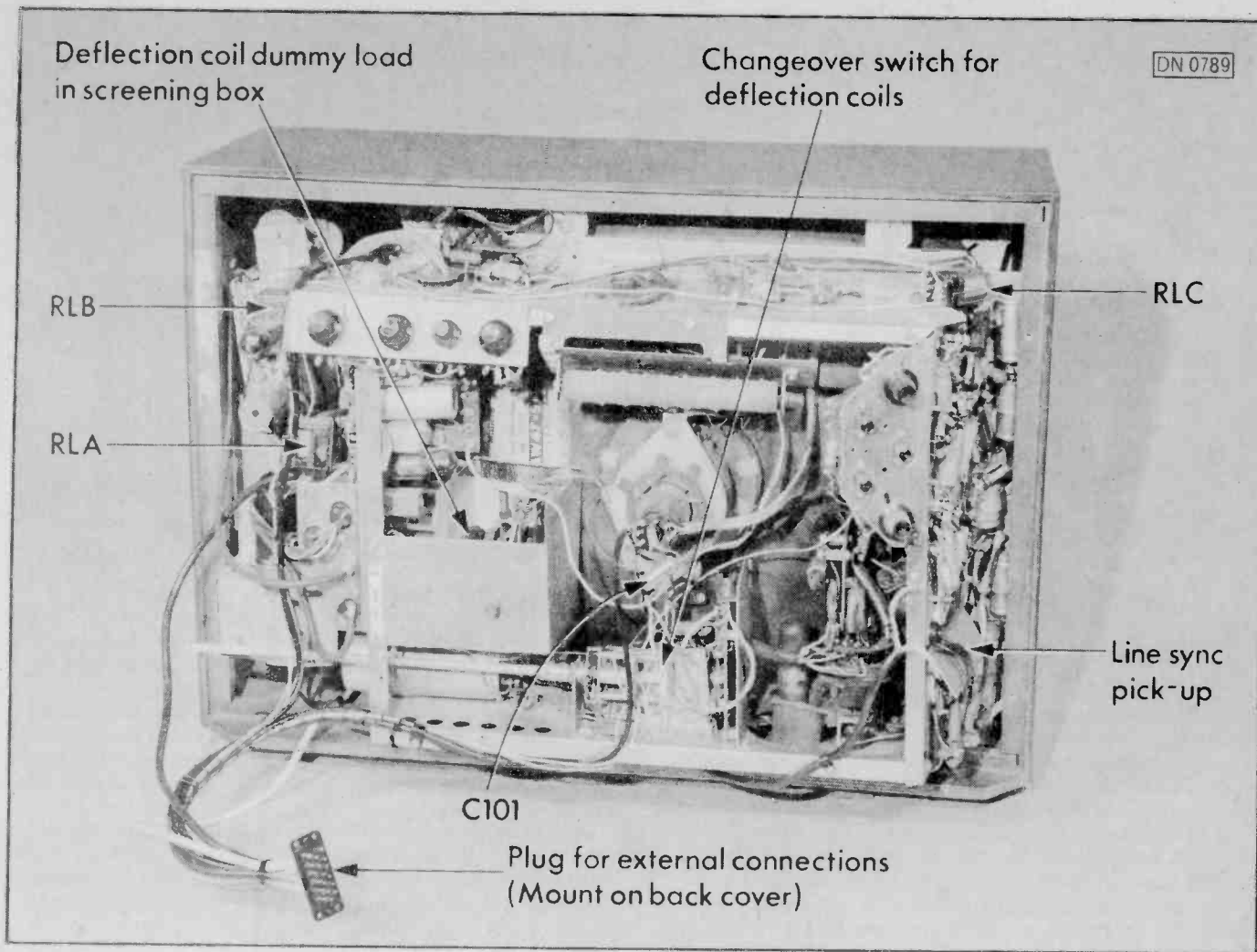

Fig. 1: Functional diagram of the complete oscilloscope system.



Rear view of the modified TV receiver used in the prototype oscilloscope, with additional components identified.

Receiver modifications

The main consideration influencing the selection of a suitable receiver for this project is the mounting of the deflection coils and whether these can be easily rotated through 90° on the c.r.t. neck. This is necessary in order to bring the line coil deflection into the vertical plane, since the lower inductance line coils are best suited to Y deflection.

If the oscilloscope is required for 405-line and 625-line servicing or display, then a dual standard set must be used. The rotation of the coils through 90° will mean that when a picture is displayed it will be on its side, but as this will only be required as a check from time to time, it should not cause too much inconvenience. One vital point to check before doing any modifications is that the receiver is fully operational.

Line-scan switching

The switch used for changeover switching of the line coils should be positioned near the line scan transformer in order that the high voltage leads involved can be kept as short as possible. Each pole of the switch should be carried on a separate wafer, with adequate spacing between. The mechanical details of mounting the switch, as with most of the modifications to the receiver, will depend to a large extent on the particular model of receiver being used, and so must be left to the ingenuity of the reader. On the receiver used in the prototype the switch was mounted on a bracket bolted to the chassis near the line output

transformer, with a spindle extension to bring the control out on the right-hand side of the cabinet (see photographs).

The next step is to find a suitable mounting position for the dummy coils which provide a load for the line scan circuits when operating as an oscilloscope. A spare deflection yoke is used for this purpose, and it should be mounted in the nearest available space to the line output transformer. Here again, no precise details of mounting can be given as this will depend on the particular receiver used. It will almost certainly be necessary to construct a screening box to prevent the magnetic field from the dummy load affecting the c.r.t. trace.

The wiring information for the scan changeover switch is shown in Fig. 1. Disconnect the line scan coils from the line output transformer. Connect the two leads from the line output transformer to two poles of the changeover switch. The two leads from the other two poles will be taken to the Y amplifier output. Link the switch contacts as shown and connect the line coils and dummy load to the appropriate contacts.

Tube modulation

The only other component associated with this part of the circuit is the relay used for removing the modulation from the cathode ray tube, and this should be mounted as close as possible to the tube gun circuits. This relay connects a $0.1\mu\text{F}$ capacitor between the tube modulation electrode (grid or cathode) and chassis via a pair of normally closed contacts. The coil of the relay is connected between the +15V supply and chassis via the

switch section connected to the earthy side of the Y deflection amplifier output. The relay is energised when the switch is in the "Picture" position.

IF and Video relays

Two other relays are necessary for circuit selection in the receiver, both operated from switches on the control box. The first is to change over the i.f. amplifier input from the existing tuner output to the output of the probe preamplifier. I.f. signals from a receiver under test can then be fed into the oscilloscope for waveform or picture display. This relay must be mounted close to the i.f. amplifier input from the tuner. A single pole changeover contact assembly is required, with the i.f. amplifier input lead taken to the contact arm, and the i.f. signal from the control box taken to the normally open contact by a coaxial cable, the other contact being connected to the r.f. tuner output.

The third relay performs a similar function on the video signal at the input to the video amplifier. This is necessary so that when a video waveform from a receiver under test is being displayed, it can also be fed into the oscilloscope sync pulse separator circuits.

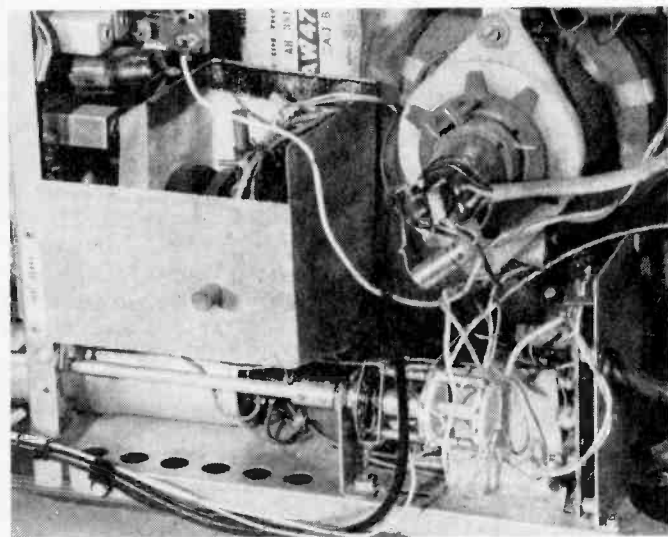

Close-up of the line-scan switching and dummy load. The switch used here had two wafers only, but is no longer widely available.

★ Components list

RECEIVER MODIFICATIONS

C101 1 μ F C102 0.1 μ F
 RLA, RLB, RLC S.p.c.o. 12V d.c. coil with sockets if used.
 S101 4-pole 3-way rotary switch. Make before break contacts. (See text.)
 Knob and extension spindle for S101.
 Scan coils for dummy load.
 18-way plug and socket. (See text.)

One lead on each relay coil is taken to the +15V supply, the others going to the input selector switch in the control box. A video signal also needs to be fed out to the control unit. This can be taken from the cathode or emitter of the video amplifier.

Sync pulse extraction

It is necessary to extract line and field pulses from the scan circuits to drive the sample and hold waveform generator. Field pulses are available at the cathode ray tube grid, where a large negative pulse from the field scan generator is used for blanking out the field scan flyback. It is fed to the control unit through a 1.0 μ F capacitor and a length of coaxial cable.

The line pulses are obtained by taping a small piece of stripboard on the inside of the line scan unit screen. The pulses will be positive-going, relative to chassis. All the tracks on the piece of stripboard should be connected together and to the inner conductor of a length of coaxial cable leading to the control box. The board should be wrapped in insulating tape, and taped or tied to the inside of the screening box, close to the line output valve.

All the leads connecting the receiver to the control box are terminated in an 18-way plug mounted on the receiver back cover. Connections from there to the control box are via a mating socket and cableform. The 240V mains supply to the receiver is taken through an isolating transformer mounted in the control box, with the lead laced into the same cableform. The plug and socket used must therefore be suitable for 240V a.c., otherwise a separate connector should be used for the mains supply.

Next month we deal with construction of the control unit power supply, front panel layout and drilling, and the Y deflection amplifier.

AUTOMATIC TRANSISTOR TESTER

Television, May, 1975. Page 312.

SEVERAL readers have queried the functioning of the meter circuit in this unit when testing pnp transistors. The secret lies in remembering that a moving coil voltmeter is in fact measuring current in a known resistance (the meter movement plus multiplier). In other words it measures the effect of the voltage, rather than the voltage itself.

Let us assume that we have two transistors for test, one npn and one pnp, with identical h_{FE} . In each case, the transistor under test TrX plus Tr3/Tr4 or Tr1/Tr2 form a regulator circuit which produces a base current I_B of $1 \div h_{FE}$ mA. Since R5/R6 is the same for both circuits, V_1 will also be identical in both cases

(assuming the V_{BE} drop of each TrX to be the same).

In the two simplified circuits shown here it will be seen that the only difference, other than circuit polarities, is in the position of the base bias tap feeding TrX. If we assume that the total current I_T is the same for both circuits, the difference in the meter currents I_M for the two circuits is equal to I_B . For an npn transistor with $h_{FE} = 30$, I_B is $33\mu A$ and $I_M = I_R = 980\mu A$. For a pnp transistor with similar h_{FE} and I_B , $I_M = I_R + I_B = 1013\mu A$. The difference is just over 3%, which is insignificant in this application.

In fact, I_T is not the same for both circuits, due to the effect of the voltage drop across the meter resistance. This means that I_R is greater for the pnp case than for npn, increasing the difference quoted above by an amount depending upon the meter drop. For a typical value of 100mV, it would add about 1.5%.

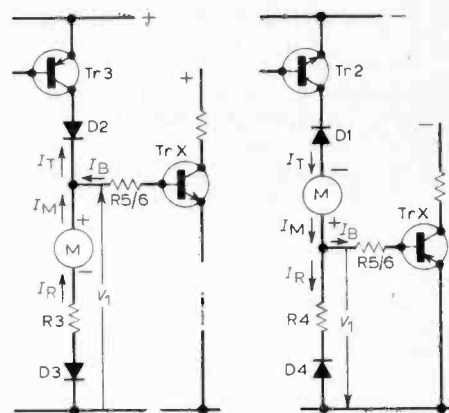

Simplified meter circuit:
 (Left) Testing an npn transistor.
 (Right) Testing a pnp transistor.

Letters

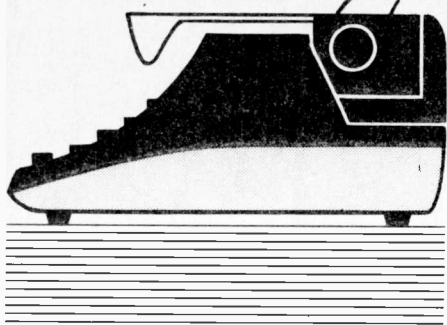

STANDARD GRAPHICAL SYMBOLS – THE BSI REPLIES

The Editorial in the March issue of *Television* implies that the BSI is responsible for making unnecessary changes to well-known graphical symbols.

It must be realised that “BSI” in this context is a committee composed of representatives from industry, the PO and BBC and the Services (Navy, Army and Air Force) to mention only a few interests. The BSI provides the secretariat and arranges for the publication of the symbols after they have been circulated to all the leading makers’ and users’ associations for comment and agreement.

Standardisation of graphical symbols is not a matter restricted to the UK but is international and is organised by the IEC (International Electrotechnical Commission) at which the UK delegation has taken a leading role. The published international symbols have received majority approval by the member countries (over 40 in number).

The Editorial is really complaining of changes in well-known UK symbols, particularly the resistor and the diode. It would have been more just if it had complimented the hard work of the British committee as a result of which there have been so few changes from British practice in order to achieve complete agreement with the published international symbols.

Personally I prefer the zig-zag for the resistor symbol; it is perhaps more difficult to draw than the small rectangle but stands out and is easily recognised. Unfortunately the zig-zag was widely used as the symbol for a winding in many European countries and there had to be a change if there was to be international agreement and no confusion.

The change to the diode symbol was for quite a different reason. The solid black arrowhead when reproduced by modern methods (e.g. Xerox) nearly always appears as an open triangle. This led to a new “guiding principle”, that a filled in symbol should not be used to denote a different device from that shown by an open symbol. It logically follows that it is a pity to waste time filling in an arrowhead which will appear, in reproduction, as an open triangle. Draw it as an open triangle! Hence the change.

To conclude, the “standardisers” referred to in the Editorial are not a collection of impractical theorists. They are the people who are using the symbols every day in their particular industry and realise that for world trade international standardisation is essential. – **Col. J. Reading, Chairman of the Sub-committee on Symbols for diagrams and for use of equipment, BSI, London W1A 2BS.**

Editorial comment: We appreciate Col. Reading’s explanation of the problems involved in reaching agreement on standard symbols. One of our original criticisms was that the standards keep changing. Presumably this is as international agreement spreads. But an important point as we see it is that for the efficient, economical servicing of mass-produced domestic electronic equipment ranging in age from a week or two to ten years or more it is essential for those involved to have readily understood circuitry. Properly printed manuals are the norm here, not photostats. It seems to us that “the man in the DER van” is being asked to adapt to changes introduced in order to take into account all manner of types of equipment, from sources all over the world, that he will never encounter.

The problem of international standardisation is a difficult one indeed, and is particularly pertinent with the need for our domestic producers to manufacture increasingly for the international market. But standardisation has not yet reached the stage where we all speak the same language! Manuals still have to be translated. It helps of course if the circuit diagrams are internationally understood: but the traditional symbols are. One can imagine a strange new system indeed arising if every possibility for international misunderstanding has to be taken into account.

The standard of circuit drafting in many countries – admittedly this is to widen the discussion – is worse than our own. For example the continentals happily draw their chassis symbols pointing upwards, downwards, to the left or to the right so that it is impossible to see at a glance the a.c. and d.c. circuit paths. The biggest help would be if draftsmen were to be trained, internationally, to recognise basic circuit blocks – the various basic forms of amplifier, oscillator, cross-coupled circuits and so on – and to draw them in a standard manner. Particularly in view of the growing complexity of electronic circuits.

“TELEVISION” COLOUR RECEIVER DECODER SETTING-UP

I am having difficulty in setting up the *Television* colour receiver decoder – the problem seems to have baffled several constructors in this locality. The decoder can be aligned as suggested by David

Robinson (*Television*, January 1974), but I feel that a lot of the adjustments in this procedure are not as accurate as they could be. We have used a colour generator and cannot get enough errors by deliberate misadjustment of the burst coil to produce strong Hanover bars. I am not happy about setting up the delay line circuit – either by David Robinson’s method or the instructions given in the September 1973 issue of *Television*. I suspect that there are mistakes or missing steps in the September instructions. One thing I don’t follow is the instruction to link Tr5 emitter to D15 cathode, adjust the saturation and then L10 for minimum output. Where does one set the saturation to? This affects the zero point of L10. After shorting the delay line it says adjust L10 to minimise line by line twitter with change of chrominance amplitude. What chrominance? Adjustment of C38 is just as confusing. I would expect R75 to give a null point at pin 5 (R–Y output) of the delay line and L13 likewise. I have rewound the ident coil and this is operating correctly on test. – **Les Wong (Dunedin, New Zealand).**

David Robinson comments: Although I did not design the *Television* colour receiver or write the original setting-up instructions I did write the article on aligning the decoder using only a multimeter, having had experience of this type of decoder. I hope the following comments will be of help to readers faced with the problems outlined by Mr. Wong.

(1) Alignment accuracy. Alignment by the method I suggested, using the test card, is not quite as accurate as can be achieved using a colour alignment generator. Similarly however setting the tone controls of a high fidelity system by ear is less accurate than checking the response with an audio sweep generator, microphone and chart recorder! The fact is that my method, carefully followed, will give a picture which displays no discernible decoding errors.

(2) Producing Hanover bars by misadjusting the burst coil. I am not sure whether you have the delay line in use when you say you cannot get strong Hanover bars. With the delay line in operation the bars will not be very prominent because the action of the delay line circuit removes them. If the bars are not prominent with the burst coil misadjusted and the delay line circuit not aligned they will surely be negligible when alignment is complete. If strong bars are not produced by detuning the burst coil with the delay line out of circuit I will be very surprised.

(3) The link from Tr5 to D15 in the original procedure is made in order to use the reference oscillator output as an artificial chrominance input. I suggest adjusting the saturation control for a convenient signal level and then setting L10 for minimum output at point 1E.

(4) I agree that the instructions for adjusting C38 in the original procedure are not clear. My procedure is based on the fact that if the phase of the reference oscillator has been set to be correct for the

R-Y channel (in my step 14) then if the B-Y reference signal is set by C38 to minimise the bars on the blue picture the two reference signals' must be in quadrature. This can be done with either a colour bar generator or an off-air transmission of course.

(5) R75 is the delay line drive control. It is set to null out the Hanover bars. This setting corresponds to equal amplitude of direct and delayed signals fed to the demodulators.

Finally, while the original September 1973 instructions may not be too clear there were no mistakes or missing steps.

LINES AT TOP OF SCREEN

I read with interest the advice in *Your Problems Solved* (March) on the subject of lines across the top of the screen with a Pye group hybrid colour receiver. We have experienced several cases where this has been due to the wirewound NS amplitude control RV41 in the pincushion distortion correction circuit going open-circuit. The control is on the convergence board. If your reader has no luck after following your advice I suggest he tries this possibility. — M. Thomas (*Brixham, Devon*).

FLASHOVER KILLS I.C.

The sound from a Philips colour receiver fitted with the latest version of the G8 chassis disappeared after one hour and could be heard only faintly by listening close to the loudspeaker grille. These sets employ a TBA750 intercarrier sound/audio preamplifier i.c. and the fault can be caused by c.r.t. flashover energy reaching pin 1. Accordingly we decided to replace the i.c., but this is no small job. To act as a solder sucker we got out our old workshop Goblin vacuum cleaner (1952 vintage), complete with pipe, and taped to the end a sawn-off RS switch cleaner spout to do the actual sucking. The spout was loose, so an old $\frac{1}{2}$ in. brass coupler was used to stop it wobbling — just slide it over the $1\frac{1}{2}$ in. thin tube and gently tighten against the screw top. A bit of wire was kept handy to clear the holes of solder. After removing the old TBA750 the new one was pushed in and soldered and a small 470pF ceramic capacitor added between the slider of the volume control and chassis — this should be mounted on the print side of the panel as close as possible to the associated coupling capacitor C3134 and the adjacent chassis point. CES tell us that adding this capacitor reduces the likelihood of further damage at pin 1 due to flashovers. The replacement restored sound and if done carefully it's hard to tell that the i.c. has been exchanged. — N. Birkett (*Feock, Nr. Truro, Cornwall*).

Editorial comment: The 470pF capacitor is coded C3130 and is added in the manner described in later production. It will subsequently be incorporated on the

component side of the board. The capacitor also prevents unwanted pick up of public service transmissions in the audio stages.

COLOUR CRT TROUBLE

The following trouble with a Bush Model CTV5022 may be of interest to other readers. From new the picture was not very bright, giving the impression that the black-level clamp was not working — tests carried out proved everything here to be in order however. On night scenes there was a purple hue over the picture; the grey-scale tracking was perfect however while a replacement decoder panel made no improvement. From new the colours were very good on bright scenes. Then after about a month the picture would appear in green whenever the set was switched on. This fault would clear after an hour or so, but later the fault "green faces" would appear, giving the impression that the PAL switching was out of phase. All faults were cured by replacing the c.r.t., after which the set worked perfectly. — W. F. Kidd (*Dublin 11*).

STRANGE HAPPENINGS

Last summer I encountered precisely the same effect described by Steven Knowles in his article "A Watery TV Fault" in the March issue of *Television*. I was investigating a weak picture plus wavy verticals fault and on removing the aerial plug obtained from the cable half a breakfast cup of water. For some reason when the aerial had been installed about four years previously the engineer had omitted the aerial terminal box top plate and instead had packed the box with a mineral compound. This had deteriorated, letting in the rain. A run of 30 yards of downlead was involved and this had to be renewed as the copper outer braid had in many places perished.

I have encountered equally as strange circumstances which could happen anywhere. The following is no fabrication I assure you. I am some 30 miles from Skriais, Isle of Skye, but being fairly high up have a direct air path across the sea and over the Isle of Raasay. There is thus excellent signal strength with an aerial more than three feet above ground. For convenience my aerial is on an eight foot fencing post. Last spring my picture began to grow paler day by day over a period of a couple of weeks. I experiment a lot with Band I aerials and my installation is not usually more than three months old. So the aerial was the last thing I suspected. I changed a few valves, cursed the tube, and being rather busy settled for sticking an AF239 preamplifier between the aerial and the set. This brought us back to normal. A week later however the picture started to roll and went very dim — without loss of sync. I took the downlead and meter outside the house and checked for leakage across the dipole and for continuity — plug

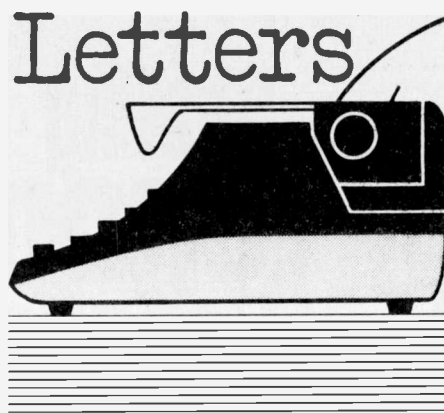

endings to dipole elements. All seemed to be in order. Despite this I felt a "thing" about the aerial and ran the feeder through the bedroom window to a spare set which normally operates with a few feet of wire on top of the wardrobe. This set then rolled away merrily and gave a dim, dim picture. The dipole terminal box, seemingly sound and tight, was on inspection found to be packed solid with baby earwigs! It was impossible to clean, and had to be thrown away. Out of curiosity I slit the coax and found they had travelled 19in. up the semi-air spaced insulation. I made a right job of putting up a new dipole element and feeder and next day, scouts' honour, my coal merchant from 60 miles away arrived for the first time in 13 months with three tons of coal and drove right through the coax, tooting merrily!

Another point of interest. A friend in the south going to live overseas came to see us and brought an old set "in case it was any use for spares". It had ceased to function some eight years previously and the TV engineers to whom he took it had told him it would cost too much to repair as the boost line had, for some reason they could not see on first examination, gone negative. Since then it had been lying in an out-house. It was a Murphy Model V230 and I recalled a paragraph in *Television* mentioning that this unusual little set of earlier days ran on a negative boost line. Fortunately I had the circuit in *Radio and Television Servicing*. Recently I got the set out of my bothy and, searching through my junk pile, enjoyed the exercise of restoring it to its original state — except that for a while I had to wire the pentode section of a PCL82 as a triode until I could unearth a 6L18 for the field output stage (also from an old set lying in a bothy!). — R. A. Ball (*Plockton, Wester Ross, Scotland*).

Editorial comment: The Murphy V230 dates from 1955. The 150V negative boost rail was used to supply the cathodes of the line the field output valves, the field generator, the c.r.t. grid, the brightness control (c.r.t. cathode circuit), the vision interference limiter arrangement (variable 10F1 video amplifier suppressor grid voltage) and as bias for the grid of the audio amplifier grid (20L1 triode section). Just in case anyone gets confused!

Dealing with CORONA & ALLIED TROUBLES

Vivian CAPEL

AT one time a ragged vertical white line down the left-hand side of the screen was a very familiar sight to service engineers. With the use of modern methods of line output transformer construction and improved components however its incidence has been considerably reduced. Nevertheless it is still encountered with older models and also from time to time in newer ones. The symptom often sends the inexperienced technician off in search of a tube of silicone grease, which is then without more ado liberally smeared over the e.h.t. points in the receiver. Usually the fault remains, but if by some remote chance it has been cleared a sticky surface is left on which dust and dirt will settle, giving rise to further trouble shortly afterwards.

How do corona discharges arise? When the scanning current flows in the deflection coils and the line output transformer the voltage rises in a linear manner. At the end of the forward scan however the spot must return rapidly to the left-hand side of the screen. As a result, rapid voltage and current reversals occur in the coils and transformer, and it is during this flyback period that high pulse voltages are produced. If the conditions are favourable, a discharge may then take place; and as the voltage build up is greatest towards the end of the flyback it is at around this point, i.e. towards the left-hand side of the screen, that the discharge occurs. Since it will occur at roughly the same point during each flyback, the visible result on the screen is a series of white splashes that add up to a ragged vertical line on the left-hand side (see Fig. 1). In some cases the discharge path is long, introducing a delay which shifts the position of the vertical line into the following scanning stroke. It may then appear nearer the centre of the screen or even to the right. This is much less common however. Occasionally two or more bands may be seen, due to separate discharge paths of different lengths.

On v.h.f. it is sometimes noticed that when a normal picture is being received there is no sign of corona on the screen but when the tuner is rotated to a blank channel or the aerial is disconnected the ragged line appears. The corona is occurring at all times of course but the effect is suppressed when a picture is being displayed.

One reason for this is that the tube is biased back by the sync pulses which occur during the flyback period and provide flyback trace suppression. As the corona discharge takes place during this period it too is suppressed – to be visible it must be of sufficient amplitude to overcome the effect of the blanking. Thus with effective suppression a weak discharge will not produce a visible effect.

Another reason is the action of the a.g.c. circuit. The interference signal gets into the vision circuits via the r.f. and/or i.f. stages which pick up the radiation from the line timebase. With the receiver tuned to a strong signal its gain is reduced by the a.g.c. action. The effect of the corona interference is also reduced therefore. It follows that corona is more likely to be observed when a weak signal is being received rather than a strong one, and even more so when there is no signal since in this case there is no a.g.c. action and there are no sync pulses to provide flyback suppression. On u.h.f., corona interference is in

opposite polarity to the vision signal modulation.

As with all faults it is best to find the cause rather than to adopt random measures. The discharge takes place between conductors in close proximity but at widely different potentials. It can pass through ordinary insulation – for example corona can occur between an e.h.t. rectifier valve and an insulated lead lying across it, the discharge passing right through the insulation and the glass of the valve. Similarly, discharges can occur from the line output transformer e.h.t. overwinding and from the rectifier's anode lead.

Unlike arcing (see later) corona does not produce heat which damages the insulation, and in most cases the only thing needed to cure it is simply to reposition the leads of the components responsible. First however we have to trace the source. The discharge results in ionisation of the air in the immediate vicinity, producing a faint blue glow. This is what must be looked for then. Darkness is required in order to observe it properly, so the chassis should be turned away from the workshop window and any bench lamps or other forms of lighting switched off. If there is still too much light, drape a blanket over the back of the set and observe from one side. Be careful when doing this as other discharges of a rather painful nature may take place.

The corona discharge may be in such a position, or of such a weak nature, that it is still difficult to see the blue glow. Since the discharge usually increases if the atmosphere is damp or humid, try breathing heavily over the line output transformer and associated components. This may intensify the corona sufficiently to make it temporarily visible, but again care must be taken.

Another point which assists diagnosis is the fact that the discharge point gives off sound at line frequency. If a doctor's stethoscope (with a plastic rather than a metal collector) can be obtained it can be a big help. A toy stethoscope will do just as well but failing these a length of insulated tubing can be used. It needs to be of fairly large bore, at least 5mm., and should be flexible and not liable to flatten on bends. Rubber or plastic tubing should do the trick. Hold one end to the ear while searching with the other for the sound source.

Leads in contact with the e.h.t. rectifier or its anode lead are possible sources. Sometimes the casing of the e.h.t. overwinding on the line output transformer cracks, exposing the windings: corona can then take place between them and any nearby object. Where the covering is of wax or pitch the remedy is simply to melt the surrounding material so that it runs down into the crack, filling it.

Width and linearity coils are often a source of corona discharge. They have iron-dust cores in which stiff wires are set so that the core can be moved in or out to provide the required degree of control. Sometimes a discharge will take place internally between the coil, through its former, and the iron-dust core. More often it occurs between the edge of the coil to the section of the core outside the former. A simple way in which this can be overcome in many cases is to push the core to the other end of the coil, where the same degree of control will be obtained but minus discharge.

Points or spikes on soldered joints can result in corona. This was a common source of the trouble when wire-ended rectifiers of the EY51 type were used – some years ago – because the connections were made by means of solder "buttons". A wire protruding from the solder, or a spike of solder drawn off by an insufficiently hot iron, would produce discharges. The base type valve rectifiers that superseded the wire-ended ones are less prone to the trouble but a spiky joint coupled with the presence of a low-potential component in close proximity can give the same trouble on a more modern assembly.

Although it is not strictly speaking corona, a similar effect can be caused by screening cans. Instead of being screwed to the chassis some of these are secured and earthed by spring clips. Though this is better from the point of view of service accessibility, the connection is likely to be less positive and a high-resistance joint can result in minute arcing. Earthing the line output transformer screening can be means of a screwdriver or flying lead should establish whether or not this is the cause.

Not all causes of corona interference are within the set itself.

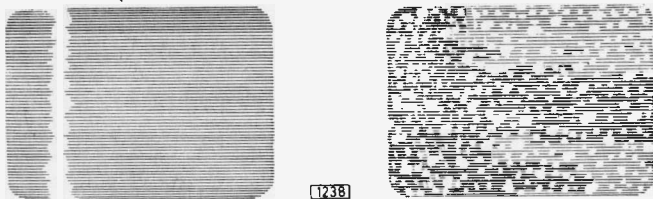

Fig. 1 (left): Appearance of corona discharge on the screen. The interference is normally on the left-hand side of the raster.

Fig. 2 (right): Snowstorm effect caused by a discharge from the d.c. side of the e.h.t. rectifier.

Cases are not unknown of the interference line drifting slowly across the picture from one side to the other, and on one channel only. The cause is another receiver operating nearby – e.g. on the other side of a party wall – and on another channel. The movement of the line is the result of the phase difference between the line sync pulses in the two transmissions. Since the discharge is occurring during the interfering receiver's flyback it may not be noticeable on the screen of this set. But as the discharge occurs during varying parts of the forward line scan of the neighbouring set the result is visible interference. The remedy of course lies in repairing the offending receiver – or, if the neighbours are uncooperative, in moving the set to another wall.

There is no point in looking for the source of the trouble at the c.r.t. e.h.t. cap, the e.h.t. lead, or the d.c. side of the rectifier. Being d.c., any discharge from these parts of the circuit will not be at line frequency or in sync with the line scanning. The symptom when discharges occur here is not a vertical line but random spots over the whole of the screen, the "snow-storm" effect (see Fig. 2). In the case of interference of this type there is, conversely, little point in looking for the cause in the pulse circuits.

Actual arcing is more severe in its effects and since current at e.h.t. is flowing there is dissipation which generates heat. There is usually little difficulty in tracing the source of this trouble since there will be tell-tale signs – burnt insulation, molten wax or pitch or discolouration around the affected area when the set is cold, or the arc itself when the set is operating. When tracing this the set should be left on no longer than is necessary to locate the source – a couple of seconds should be sufficient.

Arcing does not take place through insulation unless this is pierced or cracked. The e.h.t. overwinding is a common culprit, as also is the e.h.t. rectifier anode lead. Especially in the case of older sets, the insulation tends to harden and crack, exposing the wire. Another frequent cause is where the connection between the overwinding and the rectifier anode lead has broken. The joint is made to a metal contact embedded in the overwinding's insulating material. Mechanical stress as a result of changing the rectifier a number of times can loosen the binding material and the lead-out wire breaking. Because the broken end lies close to the original connection point however the voltage jumps the gap and the e.h.t. is maintained, though with poor regulation. The arcing which produces the interference seen on the screen may not be visible if it is well buried in the overwinding insulation. The poor regulation (picture size increasing as the brightness control is advanced) is a

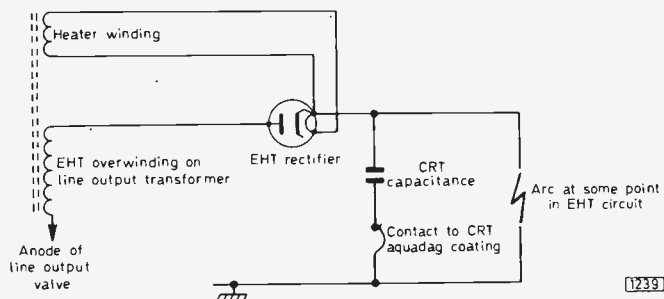

Fig. 3: An arc in the e.h.t. circuit may result in sparking at the c.r.t. aquadag earthing contact due to the discharging and charging of the c.r.t. capacitance.

clue, but positive diagnosis can be made by checking the resistance between the e.h.t. rectifier anode and the line output valve anode.

As already mentioned a discharge on the d.c. side gives the snow-storm effect. A common cause is leakage between the c.r.t. final anode connector and the aquadag coating which surrounds it. There is normally a large gap around the connector, but this can become covered with a conductive layer of dirt through which the discharge takes place. The remedy is not to plaster grease all round but to thoroughly clean off all the dirt so that just clean glass remains between the connector and the aquadag.

Another common source is the e.h.t. rectifier heater winding on the line output transformer. This is at the full e.h.t. potential, and any crack or pinhole in the insulation will result in immediate arcing to the transformer core or to part of the other windings. The remedy depends entirely on how long the arcing has been allowed to continue. If it has damaged the other windings the only answer is a new transformer: if not, the heater winding can easily be replaced since it consists of a couple of turns of e.h.t. cable wound over the other windings. Note the exact number of turns of the original winding before removing it.

Ineffective earthing of the tube's aquadag coating is another possible cause of this trouble. The earthing is usually accomplished by means of a phosphor-bronze contact or a spiral spring around part of the c.r.t. bowl. Poor contact will give rise to discharge interference and may also produce other effects such as poor e.h.t. regulation. One can be easily misled here however. Sparking may be noticed at the aquadag contact point and it may be assumed that the contact is poor, but attempts to improve it make little difference. This is because the cause of the trouble is elsewhere – if the sparking is at all violent the cause is certainly elsewhere.

The external and internal coatings on the c.r.t. bowl form the plates of the e.h.t. reservoir capacitor, which of course is charged to the full e.h.t. potential. If arcing occurs elsewhere in the e.h.t. supply circuit power will be drawn not only from the rectifier but also from the capacitor. Thus violent discharging will take place and, during the intervals between discharges, equally violent charging will occur. So the capacitor will be heavily charging and discharging and as the contact spring is the capacitor's earth connection the currents will flow through it, resulting in the sparking observed (see Fig. 3).

Sometimes an arc will jump intermittently from inside the e.h.t. rectifier's insulated base to some nearby object. For this to happen an air gap is necessary, so the cure is to make sure that all gaps are sealed and that any base cover is well fitted. If the cables are thin, leaving an appreciable gap between them and the leadout bush, the arc may jump through this gap. Molten wax run down inside the bush should provide a cure. Check too that there are no sharp points on any of the soldered joints to the pins in the base.

If arcing is experienced over a longer than normal distance the e.h.t. and/or boost voltage should first be measured. These may be excessively high, due to a misadjusted set-boost (width) control or a fault.

Though seldom seen today, an effect frequently encountered on certain sets at one time was BK (Barkhausen-Kurz) oscillation. It may still be experienced with some older models. In appearance it can be mistaken for corona discharge. The vertical line is not so ragged however: in fact it looks more like a twisted rope. The cause is a form of electron oscillation within the line output valve, and replacing this will in most cases provide the cure. If the problem persists however other measures must be taken.

Since the oscillation is affected by a magnetic field it can be eliminated by placing a small magnet near the valve. In fact some manufacturers did just this, mounting a magnet on a clamp fitted around the valve envelope. For optimum effect it was necessary to adjust the position of the clamp, a rather tricky operation in view of the pulse voltages present. A small choke fitted in the boost diode's cathode lead and/or an anode stopper resistor in the line output valve's anode lead will also suppress this type of oscillation. Such measures are now adopted by manufacturers as standard practice, which is why the effect is not often seen nowadays. ■

CCTV

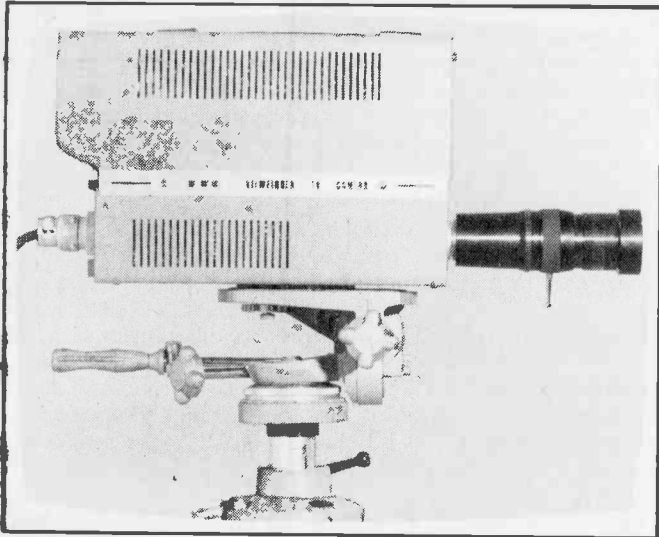

PART 16

Peter GRAVES

SO far we have considered in detail only the commonest type of camera pickup tube, the vidicon, but there are several types of tube now available each with various advantages and disadvantages. The principle rival to the vidicon (at the moment) is the lead oxide tube. Trade names for this are the Plumbicon and Leddicon. Except for the target layer the construction and operation of the lead oxide tube is almost identical to that of the vidicon.

The lead oxide tube

The target, unlike the vidicon's single layer of antimony trisulphide, is of lead monoxide which is split into three sublayers (Fig. 1). The signal connection to the target layer is a thin,

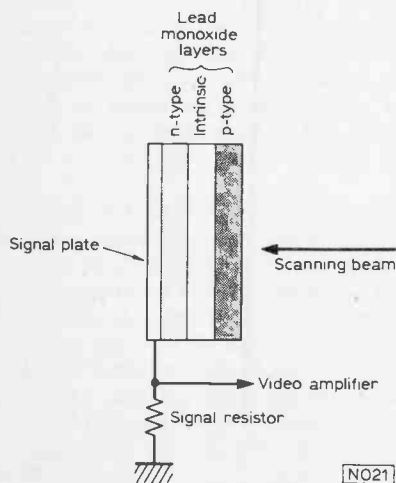

Fig. 1: Target layer construction in the lead oxide tube.

transparent, conductive layer of tin oxide. The first layer, next to the signal connection, is doped (in the same way as a semiconductor is doped) to be n-type material. The central layer is undoped, that is, left as intrinsic material in which very few free charge-carriers exist, and the layer on the scanning-beam side is doped to be p-type material. The overall effect (and, it must be stressed, this is a simplified explanation) is of a large number of diodes (known as p-i-n diodes from their construction) in parallel, with one end connected to a common terminal – the signal connection. Their opposite ends are connected in turn to the cathode by the scanning beam moving in a pattern predetermined by the currents flowing in the scan coils. The target is held at a positive potential with respect to the cathode (typically of the order of 25 volts) and the diodes are, therefore, reverse biased.

When the target is in darkness, only a very tiny reverse leakage current flows – the dark current – which is typically $0.004\mu\text{A}$ and is virtually independent of temperature. Compare this with the dark current of a vidicon under average operating conditions – $0.2\mu\text{A}$.

Suppose now that light falls on some of the diodes; the material is sufficiently thin for the light to penetrate and photoelectric action will generate electron-hole pairs. If the diode is connected to an external circuit and voltage supply a current, proportional to the amount of light falling on the diode, will flow. If it is not connected, recombination of the electrons and holes will take place until an equilibrium condition is reached where the number combining is equal to the number being generated. Thus, currents will flow through the signal resistor as the target is scanned, the output signal from any given point being proportional to the amount of light falling on that point.

Advantages and disadvantages

The advantages of the lead oxide tube are its low and constant dark current, low lag (image retention at low light levels) and uniform shading characteristic – unlike the vidicon where a uniformly illuminated target layer may not produce a uniform output signal level and correction circuits are needed. The sensitivity of a lead oxide tube is greater than that of a vidicon, meaning that it can work at lower light levels.

The principal drawback, apart from a higher initial cost, is the necessity of running the tube at a constant target voltage. Unlike the vidicon, the sensitivity of the lead oxide tube cannot be varied by varying the target voltage. The vidicon is a photo-resistive device and increasing the target voltage increases the output current for a given illumination. Increasing the target voltage of a lead oxide tube merely increases the leakage currents under dark conditions and has very little effect on the output current when it is illuminated.

Thus, the advantages and simplicity of the vidicon's auto target are lost. If automatic sensitivity is required a lens with an auto iris is used. This has a photocell mounted above the front of the lens and looking at approximately the same field of view as the lens. The cell feeds a servo motor, via a suitable amplifier, which drives the lens iris open or closed as the scene brightness changes. As a result, the illumination falling on the tube target stays constant rather than allowing the illumination to vary and adjusting the tube's sensitivity to maintain a constant output. Lenses like this are bulky, expensive and do not have the range of an auto target circuit.

Tube sizes

The smallest lead oxide tube is 32mm (1.25in) in diameter and about 200mm (8in) long compared to the 25mm (1in) diameter and 150mm (6in) length of a comparable vidicon. Many vidicon cameras will take a lead oxide tube with the minimum of modification since the scanning, focus, heater and gun voltage requirements are similar. Before the tube is inserted the camera must be set to the manual target mode and the target voltage set as recommended by the tube manufacturers. It is best to seal the control afterwards to prevent accidental misadjustment. The

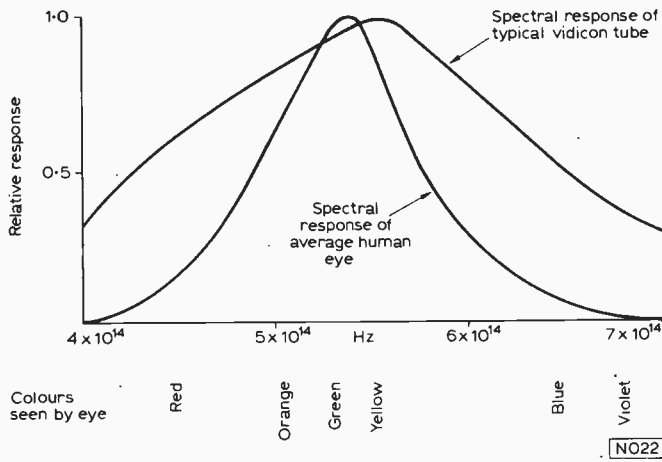

Fig. 2: The spectral responses of a vidicon and a human eye.

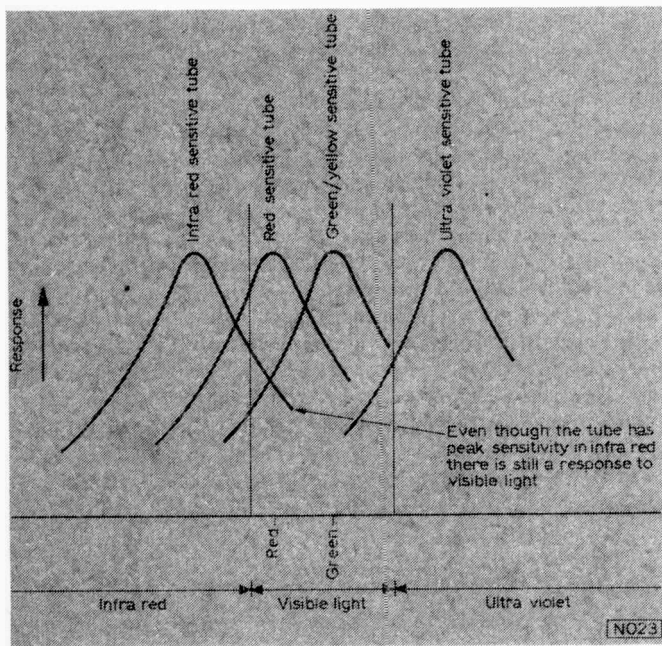

Fig. 3: The spectral responses of various camera tubes.

scanned area of a lead oxide tube is larger than a vidicon's – 16 x 12mm (0.63 x 0.47in) compared to 12.7 x 9.5mm (0.5 x 0.375in) – and the lenses used for a vidicon may not be big enough, causing loss of definition at the edges and corners of the picture. Larger and hence more expensive lenses may therefore be needed.

Spectral response

All pickup tubes have a varying response to light of different colours – the spectral response. If a camera is viewing different coloured objects, even though the same amount of illumination falls on the target from each object, the output signal level will depend on the colour. Normally the response approximately matches that of the human eye, Fig. 2, and is most sensitive to green/yellow light. By choice of target material for a pickup tube and by altering the method of manufacture the spectral response can be changed (Fig. 3) so that its peak of maximum sensitivity is higher or lower or even outside the visible spectrum.

To appreciate the significance of this let's look briefly at the main application of lead oxide tubes – in multitube colour cameras. The incoming light from the viewed scene is split up by filters and prisms into the three primary colours, red, green and blue and fed to the appropriate camera tube for each colour. The sensitivity of each channel can be enhanced by using a tube for the red channel which is most sensitive in the red part of the spectrum and so on.

It also follows from Fig. 3 that a camera tube of the vidicon type can be made sensitive to electromagnetic radiation (to use the general term) outside the visible spectrum. Since the output from a camera as viewed on the monitor is in the visible range, we can see otherwise invisible objects.

Infra-red

A typical application is night surveillance. An infra-red sensitive tube is used in a camera and an infra-red spotlight is mounted on top of the camera, moving with it to illuminate the field of view. The spotlight is usually a normal lamp with a suitable filter over the front; only a dull red glow can be seen from it and then only when looking straight into it. To the naked eye and to an intruder the scene is in darkness, but it can be clearly seen on the camera's monitor.

The type of infra-red tube normally encountered has some sensitivity in the visible range and can be set up with a light box in the usual way. The camera is normally adjusted first with an ordinary tube to check out its circuits and performance. When viewing a general scene (say the inside of the workshop) with an infra-red tube a rather dull picture is seen until the camera looks at a working soldering iron or a lighted cigarette end. Such rich sources of infra-red radiation give the impression that a torch is being shone at the camera – an unusual experience when first seen!

Lens materials

Normally we are concerned only with the near infra-red, that is infra-red frequencies close to the visible spectrum. Ordinary lenses, designed for visible light, can then be used. It should be borne in mind that materials transparent to visible light may not be transparent to other frequencies of radiation. Transparent is a relative term and strictly speaking the frequencies concerned must be specified for it to have any meaning. A comparison between some common lens materials is shown in Fig. 4. The selection of lens materials is a specialised job and the advice of the tube or lens manufacturer should be sought when operating in the infra-red or ultra-violet regions.

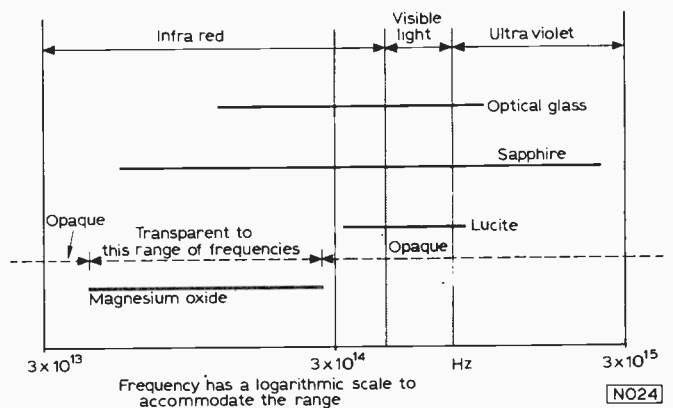

Fig. 4: Selection of materials for use in lenses. In each case the line indicates the approximate range of frequencies for which the material is transparent.

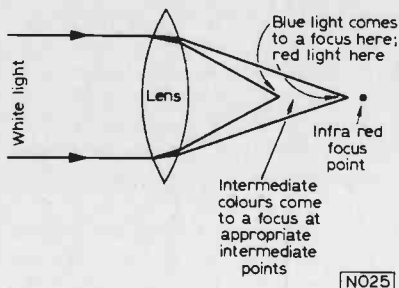

Fig. 5: Chromatic aberration (or chromatism) in a simple lens.

Chromatic aberration

Light of different colours (i.e. frequencies) passed through a simple lens (Fig. 5) comes to a focus at different points because the refractive index of the lens material varies with colour – a defect of a simple lens known as chromatic aberration. Lenses used for CCTV work are more sophisticated and are corrected for the visible range so that light of all colours is brought to a focus at the same point. However, this correction may not be so accurate outside the visible range.

In practical terms, this means that the focusing scale marked on the lens, while satisfactory for objects viewed by visible light, will not be so accurate if radiation of a different frequency is used to illuminate the object. If a camera tube is sensitive to (say) infra-red radiation and visible radiation, as is often the case, two distinct points of sharpest focus will be found corresponding to the focusing of the two types of radiation. For frequencies just outside the visible range the correction will be small, in many cases negligible unless the lens is used at a wide aperture. When the lens is stopped down the depth of field of the lens will automatically take care of the correction.

Lenses for use in the ultra-violet and infra-red parts of the spectrum often have two scales, one for visible light and one for the other specified frequency or, alternatively a mark (a red dot is common) to indicate where the lens should be set to. In many cases all this can be ignored as focusing is carried out by trial and error on the actual scene to be viewed and the actual reading on the focus scale is unimportant.

X-ray inspection

An even more exotic tube is the X-ray sensitive tube which has a beryllium faceplate which is transparent to X-rays. These can be used for the internal inspection of small electronic components – a typical application – by laying the components on the tube face and illuminating them with X-rays, rather like making a contact print from a photographic negative. The tube cannot be used for viewing bigger objects as it is not possible to focus X-radiation with lenses in the same way as light and radiation of similar frequencies. The chief advantage is the speed with which such inspections can be carried out. The cost and processing delay inherent with X-ray films is eliminated.

The silicon diode tube

A modern rival of the vidicon is the silicon diode tube, a development of modern semiconductor fabrication techniques. The target layer consists of an array of individual semiconductor diodes made by methods similar to those used to manufacture integrated circuits. The operation is akin to that of the lead oxide tube with one side of the diodes commoned to a transparent signal plate. There are considerable problems in fabricating the large number of diodes needed to produce the required image definition. Most of the diodes must be satisfactory, particularly in the centre of the picture which is the area of maximum interest, as a faulty diode will show up as a blemish on the final picture. The resolution performance is comparable to that of a vidicon but a silicon diode tube has an exceptionally low dark current – typically 8 to 10nA, much smaller than that of a lead oxide tube.

This choice of target material overcomes a major bugbear of the vidicon – image sticking after the target has been exposed to a bright image. It is even possible to point the tube at the sun for short periods without damage. Again, using diodes in the target layer means that the tube sensitivity cannot be altered by changing the target voltage and the control must be carried out in the optical system as for the lead oxide tube.

Much work has been carried out on low-light television tubes, primarily for military applications. Instead of flooding the scene with light from a spotlight (working in the visible or invisible radiation spectrum) the available light is used. Even on a moonless, overcast night it is not completely dark. Some light is still present from starlight filtering through the clouds and light scattered from sources on the ground. Light also comes from fluorescence in the atmosphere due to collisions of air molecules and high energy sub-atomic particles from cosmic rays originating outside the atmosphere.

The SEC tube

Perhaps the commonest type of tube for low light level work is the Secondary Electron Conductance tube known, for short, as a SEC tube (pronounced as one word). Fig. 6 shows a cross section through one version of this tube, though several variations are available. Light from the scene being viewed is focused onto a photocathode at the front of the tube. This is a thin sheet of glass coated on its rear with a thin layer of (typically) caesium silver oxide which, when illuminated, emits electrons; the higher the illumination the more electrons. Thus, behind the photocathode, there is an electron image corresponding to the original optical image with a large number of electrons in bright areas and a low number in dark areas. The electrons are focused onto the SEC target by the combined action of the external focusing coils and the internal focusing electrodes.

The target is not the same as a vidicon's although it is scanned at the rear in the same way with a conventional vidicon electron gun, focusing and scan coil assembly. The signal plate (Fig. 7) is a very thin layer of aluminium (typically 0.7 microns thick, where a micron is a millionth of a metre) supported by an equally thin layer of aluminium oxide. The main target material is a low-density layer of potassium chloride (facing the electron gun). The

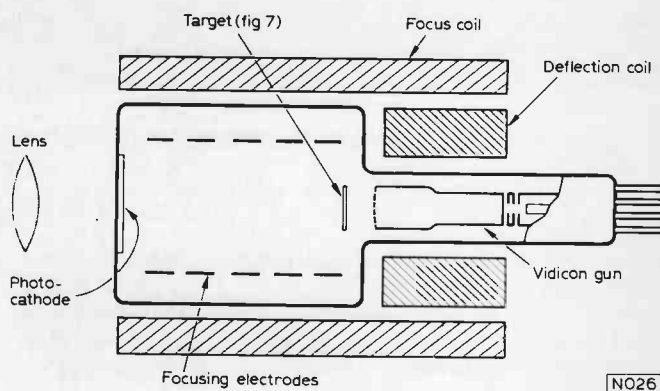

Fig. 6: Arrangement of one type of SEC tube.

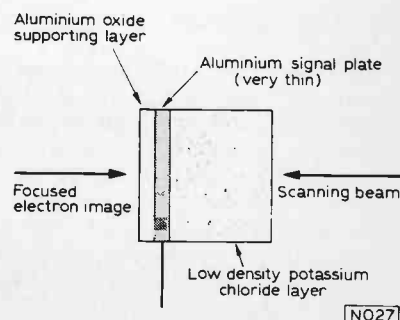

Fig. 7: Construction of the target in a SEC tube.

electrons from the photocathode pass right through the signal plate and its support and into the potassium chloride where they knock off secondary electrons from the atoms of potassium chloride, typically 200 secondaries for each incoming primary electron.

As the potassium chloride is not a solid mass the electrons that have been dislodged pass through it to the signal plate leaving behind a pattern of positive charges (due to the fixed atoms in the material which have lost electrons). When the rear of the layer is scanned these charges are neutralised by electrons flowing from the scanning beam, the changes in beam current being detected as a voltage drop across an external signal resistor in the usual way. Thus, a few primary electrons from a low level of light have produced a comparatively large output signal.

Image intensifier

The front end of the tube (up to the target) is sometimes used as a separate device, known as an image intensifier. The SEC target is replaced by a screen which fluoresces under the impact of electrons. The resulting visual image can be viewed from the rear of the tube by the eye or with a conventional camera. The secondary electrons emitted from the photocathode at low energy have been accelerated (so gaining energy) and strike the fluorescent screen violently giving a brighter image than that of the original scene being viewed. There has thus been an effective amplification in the system.

Sometimes the fluorescent screen is replaced by a second photocathode which will also emit secondary electrons, again large numbers from areas of the image that were brightly illuminated and less from duller areas. The secondaries from the second photocathode are focused by a further set of coils and electrodes to form another electron image either on a third photocathode or on a fluorescent screen. Three-stage intensifiers (that is with three photocathodes and sets of focusing coils) are about the limit, as the image quality deteriorates due to noise as the number of stages increases. The disadvantages are the weight and size of the intensifier and the need for bulky, heavy power supplies.

All-solid-state devices (which we will look at briefly in a later article) show much promise for use as low level light detectors and could well supersede the devices mentioned above in a few years.

Image dissector

To go to the other extreme, for scenes that are always under high levels of illumination such as the interior of furnaces, the image dissector tube may be used. It is relatively insensitive to light (hence the high illumination requirement) but is rugged, tolerant of temperature changes, and long-lived as there is no heater/cathode assembly to deteriorate. An added advantage is

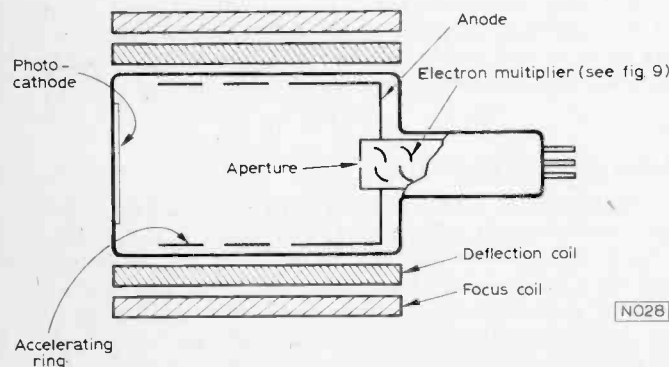

Fig. 8: Construction of the image dissector tube.

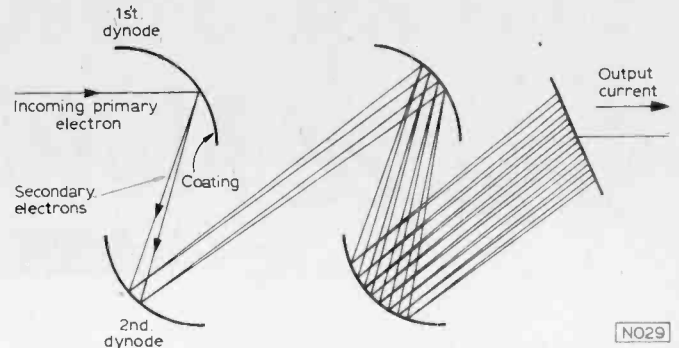

Fig. 9: Principle of operation of the electron multiplier. In practice, many more secondary electrons than are shown on this diagram are dislodged by each incoming electron.

that the output signal is high-level which simplifies the video circuitry. As in the SEC tube the image is focused onto a photocathode and the emitted electrons then focused into an electron image at the rear of the tube by external coils and internal electrodes (Fig. 8). Electrons from all parts of the image except for those falling on a tiny aperture at the centre are lost, in the sense that they do not contribute to the output signal at that instant but just form a small current flowing in the anode circuit.

Electron multiplier

The image is scanned by deflecting the entire electron image over the aperture by means of the external deflection coils. In other words, instead of moving the beam over the image as in a normal vidicon tube the image is moved over the detector. Thus, electrons from each part of the image in turn pass through the aperture to an electron multiplier shown in detail in Fig. 9. The electron multiplier gives an output signal proportional to the number of electrons entering which is itself proportional to the illumination level of the original light image focused onto the tube. Each element of the picture is thus analysed in turn as the image is scanned across the electron multiplier.

Incoming electrons strike the first electrode (or dynode) which is coated with a material that will emit secondary electrons. These secondaries are attracted to the next dynode, which is at a more positive potential than the first, and which is also coated with a secondary electron emitter. Typically, there are eleven dynodes in an image dissector tube (instead of the four shown in Fig. 9). Suppose each electron incident on the first dynode dislodges two secondary electrons. These two, on striking the second dynode will knock off two secondaries each – a total of four. By the time we get to the fourth dynode there will be sixteen electrons for each input electron (to the first dynode). With eleven dynodes, for the same emission per electron, there is an amplification of over a thousand.

The number of secondary electrons dislodged by one electron may well be more than just two (obviously designers will try to make it much higher) and amplifications up to about a thousand million are possible with this type of assembly – not bad for a single valve! Because of this high amplification the output signal level is much higher than that of a vidicon, 0.5V peak to peak being typical.

Other tube types

This is not an exhaustive list of pickup tube types but rather a round-up of the principal ones. Perhaps the main omission is the image orthicon, which is very common in broadcast applications but rarely finds its way into CCTV because of its cost and bulk.

It is probable that all the devices described here will be rendered obsolete by the solid-state pickups arriving on the market, but more of this in a later article.

Service Notebook

1



G.R. WILDING

Experiences with EHT Triplers

No picture but severe sparking noises and a slight smell of burning were the complaints with a 20in. set fitted with the Thorn 1500 chassis. On swinging back the hinged chassis we discovered that the e.h.t. tripler had been arcing from an internal point to the adjacent multiple electrolytic capacitor can, producing a small round hole in the tripler. We fitted a new tripler only to discover a gap of almost an inch at each side of the raster. When this was reduced by advancing the width control the replacement tripler began to spark through to the electrolytic capacitor can in the same way as the original. This caused us some surprise until we remembered that two non-interchangeable triplers are used in the 1500 chassis, one giving 15kV (smaller screen sizes) and the other 20kV. Both the transformer and tripler for 15kV receivers are identified by either pink or green stick-on discs while the components for 20kV sets have white stick-on discs. It became apparent that a 20kV tripler had been supplied by mistake, the additional e.h.t. voltage causing the reduced picture size ("stiffer" c.r.t. beam) and the occasional sparking. On fitting the correct tripler a normal size picture was obtained with the width control at its original setting. A point worth remembering!

A few days later we were called to a remote farmhouse to look at a colour receiver fitted with the Philips G8 chassis. On arrival we discovered that there was severe sparking at the tripler due to the insulation of the e.h.t. lead having become hard and cracked, revealing the inner conductor, just where it entered the tripler unit – which in these models is screwed to the focus control unit. Since a replacement was not immediately available and only the e.h.t. lead was at fault we decided to see whether we could satisfactorily replace the defective lead. It was useless snipping the faulty lead just outside the casing and soldering a new length of cable to it since there was no means of effectively insulating the joint – corona discharge would occur unless the insulation of the new lead went right into the tripler.

The only chance of an effective remedy was to dig out the insulating material filling the reverse side of the tripler, connect a new lead to the 25kV output point or to a section of the output lead well within the casing, and seal the unit up again. The only "sealant" available was ordinary sealing wax, but as the tripler was no use as it was there was nothing to lose by making the attempt. An electric drill with a round-end rotary file was found to be the best way of breaking through the extremely hard insulating material, and once the output lead was contacted about half an inch in from the edge of the unit we found that by careful scraping with a sharp file there was enough copper to form a soldering point for the new lead.

The solder joint was naturally kept as small and rounded as possible. Next the sealing wax was melted to fill in the entry hole for the new lead. We then applied the soldering iron to the wax to ensure that it flowed easily to fill any air spaces, and as its insulating properties certainly weren't going to be on a par with the original material we built up the wax until it was a third of an inch above the original level.

On test the repair was found to be completely successful, with no suggestion of corona or arcing. We were undoubtedly lucky in breaking through the insulating material and contacting the old lead at a suitable point, and though the heavy coating of sealing wax proved adequate there are doubtless more suitable materials available. Where a tripler is a write off due to a faulty lead it might however be worth having a go at this repair.

No Sound or Vision

There was neither sound nor vision on a colour set fitted with the Thorn 3000 chassis, just a blank raster, the absence of speaker hiss and screen noise clearly indicating that the fault wasn't lack of aerial input. The four stage i.f. strip handles both sound and vision, with separate luminance and sound/chrominance detectors. Thus the fault was in either the tuner unit or the i.f. strip. Signal injection at the i.f. panel input produced no output, clearing the tuner, but on working backwards from the bases (fourth) i.f. stage outputs were obtained by injection at the bases of the fourth and the third i.f. stages. There was negligible response however when the base of the second i.f. amplifier was tried.

Voltage checks then revealed that both the second and the first i.f. amplifier transistors were drawing excessive current – instead of being 15V and 14.5V respectively both collector voltages were well below 12V, with a proportional increase in their emitter voltages. In this chassis the a.g.c. is applied to the base of the first i.f. amplifier while the base of the second i.f. amplifier receives its forward bias from the emitter of the first i.f. amplifier. Thus the excessive current in the second stage was clearly due to the excessive current in the first stage. On checking back to the a.g.c. circuit we discovered a virtual short-circuit between the collector and emitter of the a.g.c. amplifier transistor. As a result, the forward a.g.c. applied to the controlled i.f. stage was excessive and both it and the second i.f. stage were in a condition approaching saturation point, preventing them responding to the small amplitude input signal. Normal operation was restored on replacing the a.g.c. amplifier transistor.

Distorted Sound

The complaint with a single-standard Murphy Model V2016S monochrome receiver (A774 chassis) was distorted sound at high volume levels. A new PCL86 audio valve produced no improvement whatsoever and as the distortion suggested excessive bias the pentode section cathode resistor 2R53 was checked. This was found to be of correct value however (120Ω). An equivalent was then shunted across the 10μF electrolytic which decouples the pentode screen grid and the triode anode h.t. feed. Again there was no improvement. We next checked voltages, which proved to be near normal, but on contacting the triode grid with the test prod normal sound was immediately restored. The triode is self biased by its 10MΩ grid leak resistor but this was found to have risen in value to nearer 30MΩ. Thus until the triode grid was shunted by the resistance of the meter the triode was almost biased off on strong signal inputs.

Mains Cut-out Operating

The mains cut-out of a colour set fitted with the Thorn 3500 chassis would operate a few seconds after switch on. Although so short, the delay at least ruled out the possibility that the chopper transistor VT604, which provides the 58-65V supply, was short-circuit for in that event the crowbar overvoltage thyristor would have immediately fired and operated the cut-out. Tests showed that the voltage from the chopper transistor increased steadily after switch on, to in excess of 70V. The crowbar thyristor then fired. It was also discovered that the 30V rail, which is stabilised

by VT601, was high at just over 35V. The immediate suspect was the zener diode W605 in the base circuit of the 30V stabiliser transistor VT601, and on replacing this the l.t. rail voltage returned to normal and the cut-out didn't operate.

The increased 30V rail voltage, which powers the line oscillator and chopper drive monostable stages as well as other circuits, had resulted in the mark-space ratio of the switching waveform applied to the chopper transistor changing, thus increasing the 58-65V line voltage until, when it rose above 70V, the overvoltage crowbar thyristor fired.

Pulse Polarities

If asked to draw the line sync pulse obtained from the anode of a sync separator many people would without thinking draw a positive-going pulse. The output pulse obtained from the anode of a pentode sync separator, also from the collector of an npn transistor sync separator powered from a positive supply line, is negative-going however – see Fig. 1(a). This is because the anode of the valve or the collector of the transistor will be at rail voltage when the device is cut-off during picture information: the voltage will then fall drastically – especially in the case of transistors – when the device is driven into saturation by the sync pulse.

The line sync pulses are generally applied to a flywheel sync discriminator or to a phase-splitter stage driving a discriminator. The field sync pulses are fed to an RC integrating circuit whose time-constant is such that the relatively very brief line pulses – 4.7 μ S on 625 lines, 10 μ S on 405 – have no appreciable effect on the voltage across the capacitor. The field sync pulse train however, consisting on 625 lines of five pulses of 27.3 μ S

duration, results in the capacitor *discharging* – in the usual serrated-edge manner. Since the resultant waveform is far from ideal for triggering the field oscillator at precisely the correct point the field sync pulse is often fed to the field oscillator via a biased diode which conducts only when the field sync pulse waveform falls to a certain predetermined level. As all this implies, the integrated field sync pulse is negative-going, and to confirm this you will notice that where a biased diode is used in the manner just described the field sync pulse is applied to its cathode.

Getting the pulse waveform and polarity right is important when following through circuit action. For instance, whilst the burst gate transistor in a colour receiver decoder is generally gated on by applying a positive-going pulse to its base it is equally possible to gate the transistor on by means of a negative-going pulse applied to its emitter. This in fact is done in one or two decoder designs. The effect is the same in each case – a forward biased base-emitter junction.

When an npn transistor is used as the video output stage in a monochrome set it is common practice to carry out line and/or field flyback blanking by applying positive-going pulses to the emitter – see Fig. 1(b). These momentarily raise the emitter voltage above the base voltage, reverse biasing the transistor so that its collector voltage rises to the supply rail voltage. This positive-going voltage pulse is fed to the c.r.t. cathode, cutting off the beam current.

In one or two imported colour sets employing solid-state colour-difference tube drive circuitry, field flyback blanking is achieved by feeding negative-going pulses to the emitters of the npn colour-difference output transistors – see Fig. 1(c). As a result the transistors are driven hard on, and the negative-going pulses developed at their collectors reverse bias the c.r.t. grids to cut off the beam currents.

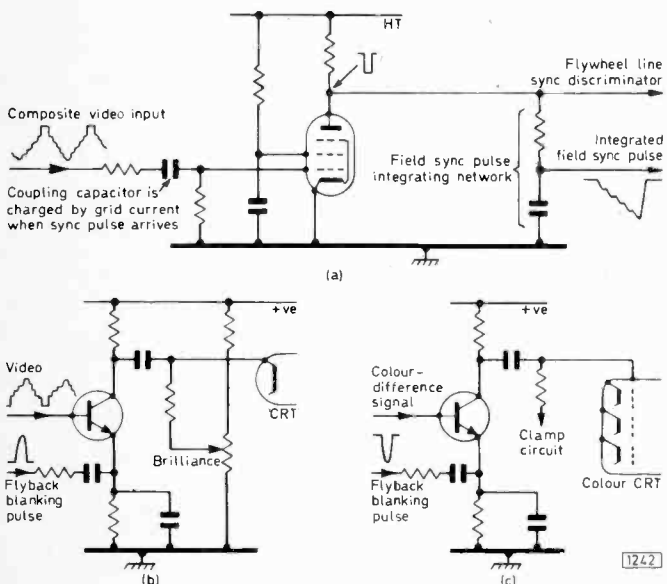

Fig. 1: Pulse polarities: getting to know the polarities of the pulses present at various points is important for understanding circuit operation. (a) The output pulses obtained from a pentode sync separator are negative-going. The serrated edge of the integrated field sync pulse is due to the presence of line sync pulses during the field sync period. (b) To carry out flyback blanking in a video output stage driving the c.r.t. cathode positive-going pulses are applied to the transistor's emitter. (c) Where the c.r.t. grid is driven, as when colour-difference tube drive is used, negative-going blanking pulses are required at the emitter of the output transistor.

Subnormal Line Frequency

A set with the ITT/STC VC51 chassis was suffering from subnormal line frequency on both systems as a result of which a black vertical band appeared near the centre of the screen. Adjusting the line hold controls to obtain a normal picture resulted in the line oscillator packing up. A new PCF802 line oscillator valve made no improvement, and the OA81 flywheel sync discriminator diodes were found to have good forward and reverse resistances. The voltages in the stage were near enough to normal, suggesting that the fault was not due to change of value in an h.t. feed resistor.

Reduced line frequency can be caused by loss of value in a time-constant network capacitor or resistor or reduction in the inductance of an oscillator transformer. When shorted turns reduce the inductance of a transformer however the resultant loading can often produce conflicting symptoms. The oscillator transformer used in these chassis seldom gives trouble, and as the primary and secondary windings had resistance readings very close to the correct figures (280 Ω and 55 Ω) we decided to assume that the transformer was o.k. until all other possibilities had been checked.

Following our normal practice we next decided, before delving into time-consuming component checks and replacements, to make sure that any electrolytic capacitors in the stage were in order. This once again paid off, for on shunting a near equivalent across the 16 μ F electrolytic (C110) which decouples the h.t. feed to both sections of the PCF802 (and also to the triode of the PCL86 audio valve) there was a substantial increase in line frequency. On readjusting the main line hold control a perfect picture was obtained.

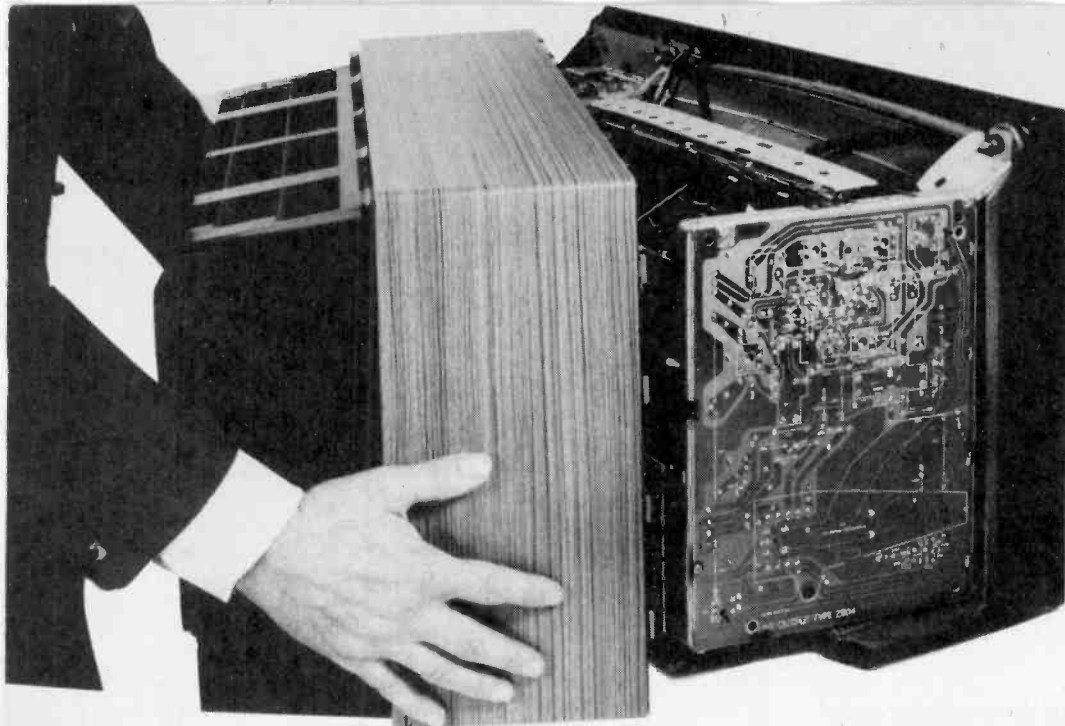

INSIDE RANK'S NEW 18" COLOUR SETS

NOWADAYS a new TV chassis has to be designed with the international market firmly in mind. For many years the Japanese dominated the smaller sizes of colour receiver – even the discount houses had a job to compete with the low Japanese prices. In this section of the market there have been from UK setmakers the various Thorn models fitted with the 8000 and 8500 chassis, the Pye Model CT200 and its successors, and now Rank have come up with the 18in. Bush Models BC6100 and BC6111. These are fitted with a new chassis, the Z718, which features a lot of new and interesting circuitry. The BC6111 differs from the BC6100 in using a varicap tuner unit and incorporating the remote control system described last month.

Technical Features

The new chassis has been designed around the Toshiba 470ERB22 c.r.t. This is an in-line gun, slotted shadowmask, vertical phosphor striped screen tube with 110° deflection – one of the Toshiba RIS range. The unusual feature of this range is the rectangular shaped cone which reduces the deflection power required. The tube has inherently good convergence, with a simplified adjustment procedure. The 470ERB22 is slightly different from the other tubes in the Toshiba RIS range since for this chassis Rank required a tube that could be mounted with the final anode connection at the bottom of the cabinet. You may think that it doesn't matter which way up an in-line tube is mounted, but if the final anode connection is to be at the bottom the getter should be on the same side.

Other features of the chassis are the 21kV e.h.t. which removes the necessity for an e.h.t. multiplier, grey-scale compensated beam current limiting which allows full c.r.t. drive with average brightness pictures, a Mullard three i.c. (TBA560C, TBA540, TCA800) type decoder, and an i.c. line generator which has facilities for VCR operation. Unlike the Thorn 8000 series which use third harmonic line output stage tuning, fifth harmonic tuning is employed.

The most unexpected feature however is that the power supply circuit consists of a simple full-wave bridge rectifier with choke input filter. Since this is a 110° set an east-west (EW) modulator is required in the line output stage to provide EW pincushion distortion correction: the EW modulator also provides width

stabilisation and compensates for fluctuations in the h.t. and e.h.t. voltages.

Servicing is made easy by a quick release back which when removed makes all the printed panels accessible. The i.c.s on the decoder and timebase panels have plug-in sockets while, for obvious reasons, the i.c.s on the i.f. panel are directly soldered to the board.

The i.f. panel and decoder use familiar Mullard circuitry. It is in the timebases and the c.r.t. drive circuitry that novel techniques are used and in consequence it is to these that we will now turn.

Field Timebase

The field timebase circuit is shown in Fig. 1. The field oscillator consists of transistors 4VT1 and 4VT2 which act in the same way as a silicon controlled switch. 4C2 is the field timing capacitor, which at the beginning of the forward field scan is discharged. Since 4VT2 is a pnp transistor its base-emitter junction will under these conditions be reverse biased, and since there is in consequence no current flow through 4R4, 4D1 and 4R5 4VT1 will also be cut off. During the field scan 4C2 charges exponentially via 4RV1, 4R3 and 4R7, and eventually a point is reached when the emitter voltage of 4VT2 is greater than its base voltage, causing it to conduct. The flow of collector current raises the base voltage of 4VT1 and in consequence it too conducts, the two transistors locking on. The resultant low-impedance path across 4C2 results in it discharging rapidly, and once this has occurred 4VT2 and 4VT1 switch off. 4C2 then recharges. The circuit is synchronised by feeding positive-going field sync pulses to 4VT1 base. These are obtained from pin 7 of the TBA950 sync separator/line oscillator i.c. Diode 4D1 rectifies the sync pulses, producing a negative bias to ensure that 4VT1 remains cut-off until the next field sync pulse arrives.

The field charging capacitor is 4C3. This charges via 4RV2, 4R8, 4R9 and 4R10, at a slower rate than 4C2. This ensures that 4VT2 is always cut off during the field scan. During the flyback, when 4C2 discharges, 4VT2 conducts because its base voltage falls rapidly below its emitter voltage. When 4VT2 conducts a low-impedance path is present across 4C3 which thus discharges.

The linear field scan waveform produced in this way is coupled to the common-emitter stage 4VT3 by 4C4. The network 4C7,

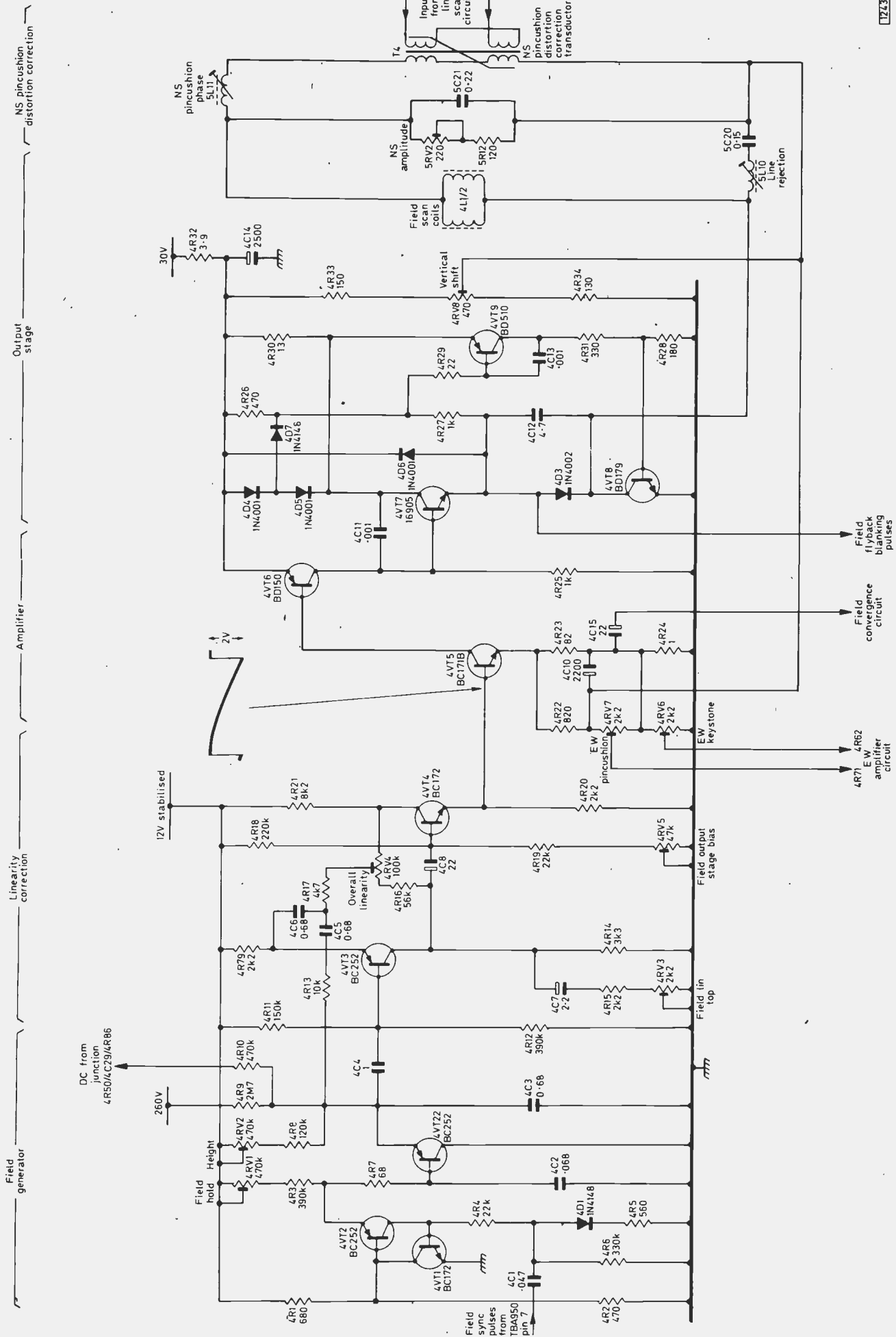

Fig. 1: Circuit diagram of the field timebase.

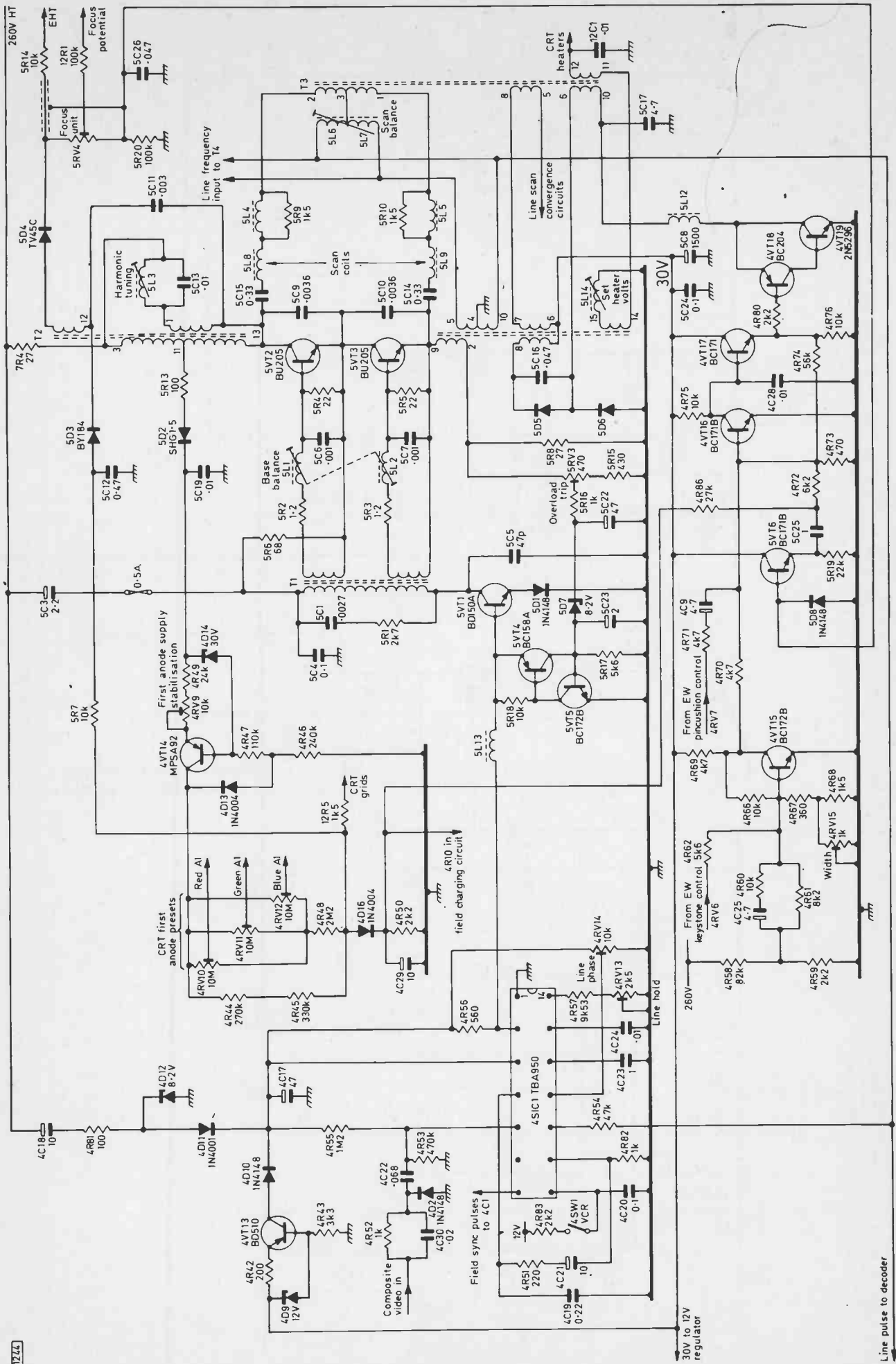

Fig. 2: Circuit diagram of the line base, sync separator, c.r.t. supply arrangements including the beam limiter, and the sync separator/line generator i.c.

4R15 and 4RV3 provides top linearity correction. The following transistor 4VT4 acts as an emitter-follower driving the amplifier/output stages and as a common-emitter feedback amplifier for 4VT3. The amplified signal at 4VT4 collector is fed back via 4RV4 and 4R16 to its base – negative feedback – and is also applied as a positive feedback signal via 4C5, integrated by 4C6, to add to 4C3's charging current. This parabolic feedback waveform provides the scan correction necessary because of the wide c.r.t. deflection angle.

The scan waveform thus produced is d.c. coupled from 4VT4 base through to the scan coils. Consequently 4VT4 base is a convenient point at which to introduce a d.c. component to bias the output stage. Adjustment of the bias voltage is provided by 4RV5.

Field Output Stage

The field amplifier/output section – 4VT5-4VT9 – is certainly an unusual configuration. The aim has been to avoid the crossover effect associated with a class B transistor field output stage.

The negative-going scan waveform at 4VT4 emitter is coupled to the base of the common-emitter amplifier 4VT5 which in turn drives 4VT6 and 4VT7. The waveform at 4VT7 base is negative-going, i.e. a positive voltage at the beginning of the scan. Since 4VT7 is an npn transistor it is conducting at the start of the scan, current flowing from chassis via 4R24, 4C10, the NS pincushion distortion correction transductor (T4) circuit, the field scan coils, 4D3, 4VT7, 4D5 and 4D4 to the 30V positive rail. 4VT8 is not conducting at this time (see below). The voltage drop across 4D5 and 4D4 is 1.4V, holding 4VT9 emitter at the same potential as 4VT7 collector (28.6V). Diode 4D7 is also conducting at this stage, the current through it flowing from chassis via 4R24, 4C10, T4, the field scan coils, 4D3 and 4R27. As a result 4VT9's base voltage is the same as its emitter voltage, holding it cut off, and as there is no 4VT9 collector current the base of 4VT8 is without forward bias and it too is cut off.

As the scanning waveform at 4VT7 base falls towards zero (scan centre) its collector voltage rises and the voltage across 4D5 decreases – note that 4R30 also forms part of 4VT7's collector load. In consequence 4VT9's emitter voltage rises. Its base is still held at 28.6V however since current is still flowing from 4D3 anode via 4R27, 4D7 and 4D4 to the 30V line. As the field scan nears the centre of the screen 4VT9 begins to conduct. Its collector current, flowing via 4R28 and 4R31, biases 4VT8 into conduction, bleeding 4VT7 emitter current. This action causes the current in the field scan coils to fall to zero, and the deflected spot reaches the centre of the screen.

As 4VT8 is driven further towards saturation 4C10 will begin to discharge through the scan coils and 4VT8, reversing the current in the coils. The speed of the discharge is governed by the conduction of 4VT8, 4VT9 and 4VT7. As 4VT7's conduction is governed by the waveform from the generator section of the timebase the scan coil current will follow the waveform at its base.

Field Flyback

When the flyback occurs the base of 4VT5 is driven positive. This in turn drives 4VT7 to saturation, forcing current through the scan coils in the opposite direction. The series current negative feedback applied to 4VT5 – its emitter is not decoupled – is not affected by the flyback because the scan coil inductance prevents the scan current following the very quick voltage transition at the base of 4VT5. The scan coil inductance also causes a voltage overshoot at 4D3 cathode, reverse biasing it. 4C12 charges, its bottom plate reaching approximately 55V positive. As the overshoot falls away 4C12 discharges through the scan coils, 4C10, 4R24, the power supply and 4VT7 which is still saturated. The next field scan can then start.

Vertical Shift

Vertical shift is effected by tapping a proportion of the 30V rail

via 4R33, 4RV8 and 4R34 and adding it to the junction of 4VT8, 4D3 via the NS pincushion distortion correction transductor circuit and the field scan coils.

Field Output Summary

Just to summarise which of the three output transistors is on and which off during the various phases of the scanning cycle, at the start of the field scan 4VT7 is conducting while 4VT8 and 4VT9 are cut off, towards the centre of the scan 4VT8 and 4VT9 begin to conduct as well and all three transistors conduct during the second half of the scan. There is a carefully controlled transition point at the scan centre. At the end of the scan 4VT7 is at minimum conduction: the flyback drives it rapidly to saturation point, 4VT8 and 4VT9 switching off.

Line Timebase

The TBA950 integrated circuit 4SIC1 (see Fig. 2) performs the following functions: sync separator, field sync pulse integrator, flywheel line sync phase control loop, line oscillator and amplifier, and automatic phase control loop time-constant switch. It is fed with a constant-current supply via the series regulator transistor 4VT13 – this compensates for voltage fluctuations on the 30V rail, which is derived from an overwinding on the line output transformer. Because the 30V rail is obtained in this way a start circuit is required to supply power to the i.c. before the line output stage comes into operation. This is achieved by feeding h.t. (260V) to 4C18: as 4C18 charges current is drawn from 4C17 via 4D11 and the current limiter 4R81. Thus supply pin 3 of the i.c. receives a voltage, whose maximum value is set by the 8.2V zener diode 4D12. As 4C18 charges, the current flow falls and the voltage applied to pin 3 of the i.c. drops. By this time however the 30V rail voltage has been established and the i.c. is supplied via 4VT13. A similar start arrangement is used in the line driver stage (5C3).

With the advent of VCRs on the UK market Rank have decided to include a means whereby the time-constant of the a.p.c. loop controlling the line oscillator can be switched so that it follows the line sync frequency variations of a signal from a VCR – a long time-constant is required for this. Under normal, i.e. off-air, conditions the time-constant automatically switches from long to short once the line oscillator has locked to the transmitted signal, thereby making the oscillator immune to noise present on the incoming video signal.

The line frequency output from the i.c. is taken from pin 2 via 5L13 to the base of the high-voltage line driver transistor 5VT1. A protection circuit is incorporated in 5VT1's base circuit to bias it off should the line output stage draw excessive current. Diode 5D1 is included in the emitter circuit to slightly raise the emitter voltage, enabling the protection circuit to operate. 5C1 and 5R1 damp out the positive overshoot at 5VT1 collector so that the output waveform is substantially square, 5C5 smoothing the switching edges of the waveform. Once the line output stage has come into operation 5VT1 is powered via 5R6.

Over-voltage Protection Circuit

The current drawn by the line output transistors 5VT2 and 5VT3 flows through the network 5R8, 5R15 and 5RV3. This current is approximately 380mA, producing a voltage of 10V across the network. Should the current be excessive the voltage at 5RV3 slider will rise and when it exceeds the zener voltage of 5D7 plus the base-emitter voltage of 5VT5 the zener will conduct, causing 5VT4 and 5VT5 to switch on. This action effectively short-circuits the base of 5VT1 to chassis, cutting the line driver stage off. The line output stage ceases to operate, the 30V supply dies and the receiver shuts down. To restart, the set has to be switched off long enough to allow the start capacitors 4C18 and 5C3 to discharge. If there is a fault the trip will operate again at switch on of course. The circuit protects the line output stage in the event of faults affecting the 30V supply as well as faults in the line output stage itself. Resistor 5R16 and capacitor 5C22

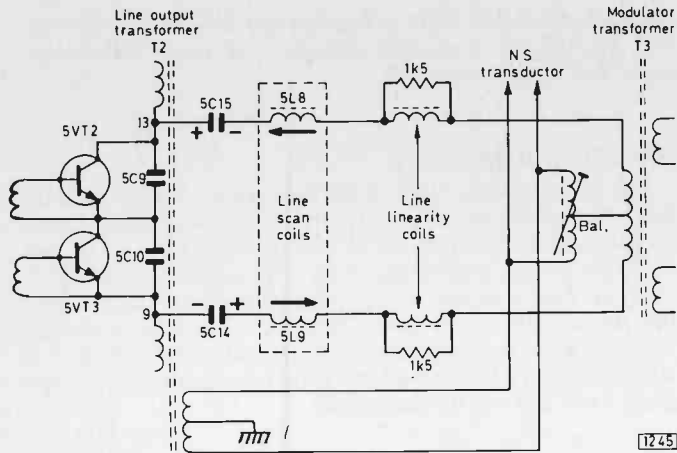

Fig. 3: Basic action of the line output stage. The two output transistors are connected in series between the split primary winding (tags 2-9 and 13-3) of the line output transformer. The flyback pulses charge the scan correction capacitors 5C15 and 5C14 in the polarity indicated. Following the flyback, current flows in the scan coils in the direction shown by the thick arrows, reversing when the transistors are switched on by the base drive waveform halfway through the scan.

provide a time-constant to prevent the trip operating on switch-on surges.

Line Output Stage

The line output transistors 5VT2 and 5VT3 operate in unison and are in series with the split primary (pins 3-13, 9-2) of the line output transformer. At the end of the scan both transistors are conducting, current is flowing in the transformer primary winding and a magnetic flux has built up. The pulse waveform from 5VT1 collector then turns the two transistors off. Since the primary winding of the transformer is split between the output transistors the polarity of the flyback pulse at 5VT2 collector will be positive while the pulse at 5VT3 emitter will be negative. These two pulses charge the scan-correction capacitors 5C15 and 5C14 in the direction indicated in Fig. 3. The flyback occurs, deflecting the c.r.t. beam to the left-hand side of the screen. Then the efficiency diode (5VT2/3 c-b junctions) action occurs, electron current flowing in the direction shown by the thick arrows in Fig. 3. The decay of this current provides the first half of the forward scan. Towards the middle of the scan the two line output transistors are driven into conduction, effectively short-circuiting pins 9 and 13 of the line output transformer. The current in the scan coils then reverses, providing the second half of the line scan. Current is also flowing in the transformer primary winding, building up the magnetic flux in preparation for the next line flyback period.

Width Modulator

As a result of the 110° deflection, any scanning errors will be more pronounced on the face of the c.r.t. Consequently a width modulator is used. This performs several functions as follows: (1) width correction; (2) east-west (EW) pincushion distortion correction; (3) keystone distortion correction; (4) correction for fluctuations in the h.t. and e.h.t. voltages. The basic operation of the circuit is as follows.

Transistors 4VT15-4VT19 comprise the width modulator amplifier. It will be seen that these transistors are all d.c. coupled. Thus if the base bias at 4VT15 is altered so will the biasing points of all the other transistors in the train. Adjusting the width control 4RV15 in fact swings the collector of 4VT19 from chassis potential to +30V. The output from this transistor is fed directly to the secondary winding of the modulator transformer T3 (pin 10), 5L12 and 5C17 preventing the line flyback pulse present on this winding reaching 4VT19 collector. The other end of this winding (pin 6) is connected to 5D6 cathode, and because this diode conducts during the line scan pin 6 is effectively at chassis

potential. The primary winding (pins 1 and 2) of this transformer induces a line flyback pulse into the secondary winding, but because the secondary winding is being fed with a d.c. control voltage from 4VT19 the mean level of the induced flyback pulse cannot exceed the control voltage. By adjusting the control voltage the mean level of the induced flyback pulse will also be varied therefore. In practice it varies between 0V and 250V peak-to-peak. Transformer action between T3 secondary and primary windings reflects the secondary voltage back to the primary winding, changing its inductance, and since the primary is in series with the line scan coils the width of the picture is controlled.

Any change in the scanning circuit inductance will alter the flyback time and thus the e.h.t. voltage. In consequence the change in T3 primary's inductance has to be compensated for. For this purpose, every time the picture width is increased extra capacitance is added to the line output transformer primary circuit. Consider the situation where +30V is being fed to pin 10 of T3 and a 250V pulse is present across this winding and therefore at 5D6 cathode. At the same time a 250V pulse is present at 5D5 cathode due to the secondary winding (pins 6, 8) of T2. In consequence there is identical voltage on both plates of 5C16 which thus has no effect on the circuit. As the control voltage applied to T3 secondary is reduced so the voltage at 5D6 cathode falls and 5C16 can charge. Its capacitance is reflected back across the transformer primary, in parallel with the primary winding tuning capacitors 5C9, 5C10, thus compensating for the changed inductance.

EW Distortion Correction

Keystone distortion correction is effected by feeding a field frequency sawtooth waveform from 4RV6 slider to 4VT15, via 4R62. With the slider of 4RV7 at the lower end of its travel the same sawtooth waveform is also fed to 4VT16, via 4R71 and 4C9. 4VT15 inverts the sawtooth at its base and adds it to the sawtooth at 4VT16 base. It can be seen from Fig. 4 that the waveform thus produced can be made to tilt in either direction. As 4RV7 slider travels towards 4C10 the output waveform from the potentiometer becomes bowed due to the integrating action of 4C10. This gives the pincushion EW distortion correction effect.

EHT Stabilisation

E.h.t. current fluctuations are corrected as follows. The d.c. voltage across 4R50 and 4C29 is inversely proportional to the e.h.t. current (see account of beam current limiting later). Thus any increase in c.r.t. beam current will produce a voltage change across 4R50. This voltage is coupled to 4VT16 base via 4R72 and 4R86 where it is added to the pincushion and keystone correction waveforms. The field scanning tracks because of the link via 4R10.

E.h.t. voltage a.c. fluctuations on a line-by-line basis are capacitively coupled from the centre core to the screen of the e.h.t. lead and then to 5VT6 base. This emitter-follower couples

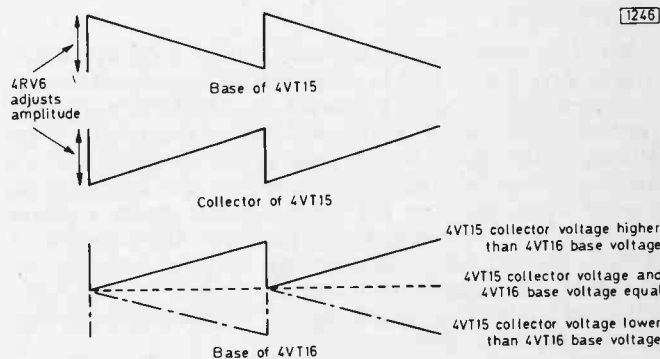
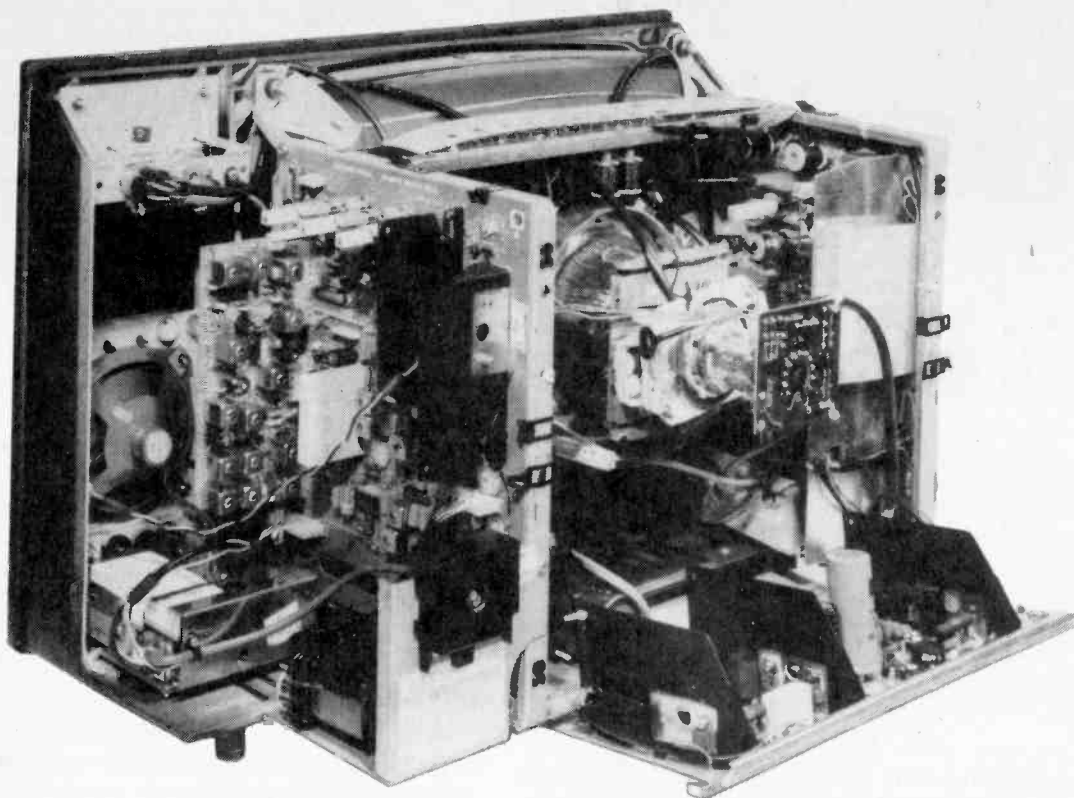

Fig. 4: Keystone distortion correction. The basic waveform at 4VT16 base is a sawtooth which can be tilted in either direction depending on the setting of 4RV6.



The Rank Z718 chassis assembly. Eight part modular construction is used.

the signal via 5C25 to 4VT16 base where it is added to the other correction waveforms.

LT Supplies

The diodes in the width modulator circuit, 5D5 and 5D6, also provide the 30V rail which is used to power most sections of the receiver: 5C8 and 5C24 smooth the ripple. Producing the main supply for the receiver in this way could lead to many frustrating hours for a service engineer confronted with a dead set if he was not familiar with the system. After some experimentation I found that the quickest way to isolate this type of fault is to use a separate 30V supply to power the l.t. side of the receiver. Drive to the line output stage can then be checked and the fault located to the nearest stage. Care must be taken however when connecting any equipment to this receiver as the chassis is at half mains potential – an isolating transformer should be used at all times when the receiver is being worked on.

CRT First Anode Supplies

The c.r.t. first anode potentials are derived from a constant-current source, 4VT14. This transistor receives its h.t. supply from pin 11 of the line output transformer, the pulse waveform at this point being rectified by 5D2 and smoothed by 5C19. 4RV9 sets the current passed to this transistor to 1mA. The current flows via 4R50, 4D16, 4R48, the first anode potentiometers 4RV10-12 and parallel resistors 4R44-5, 4VT14, 4RV9 and 4R49. The voltage range of the first anode potentiometers is 250-530V – the anodes draw virtually no current. The three c.r.t. grids are returned to the anode of 4D16. Thus the first anodes are held at a constant positive potential with respect to the grids at all times.

Beam Limiting

The d.c. path for the e.h.t. current is from the c.r.t. cathodes through the tube, 5R14, the e.h.t. lead, the e.h.t. rectifier 5D4, the overwinding on T2 and then via 5D3, 5R7, 4R48, 4VT14 and its associated circuitry to the positive d.c. supply derived from pin 11 of the line output transformer. As 4VT14's collector current is

limited to 1mA it can be seen that the e.h.t. current is also limited to this value. When there is 1mA e.h.t. current no current will be flowing through 4D16 which will be reverse biased. The c.r.t. grids are then negative with respect to chassis and the tube is driven towards cut off, reducing the beam current.

Convergence

For a 110° chassis, the convergence circuitry is very simple. This is the result of using the Toshiba RIS in-line gun tube. The green gun is at the centre and thus requires no convergence at all. The correction currents required for the other two guns are identical, thus greatly reducing the cost of the convergence circuitry. The field convergence waveform is tapped from the emitter circuit of 4VT5 and amplified by a simple circuit consisting of a driver and single-ended push-pull output stage. The line convergence waveform is tapped from pin 7 of the line output transformer and fed to the line convergence circuitry via a winding on T3 to provide correction for width variations.

Conclusion

Having lived with one of these sets for some weeks, in the home as well as in the workshop, I have come to the following conclusions. The receiver is extremely well built, and as far as component layout and accessibility are concerned can only be described as a serviceman's dream. The panels are easy to remove and replace, everything is labelled on both sides of the boards and the convergence is very simple. The quick-release back takes about fifteen seconds to remove and leaves the face and base of the receiver on the stand – the sides, top and back are one piece of plastic which is very strong. There were one or two points I didn't care for: the half mains potential on the chassis (unless the serviceman carries an isolating transformer around with him), the mechanical tuner fitted on some versions, the close proximity of the line output transistor heatsinks to the static convergence controls, and the idea of a 21kV e.h.t. overwinding and rectifier. On reflection however I can say that I like the set very much indeed and feel that it is going to be a very strong challenger in the 18in. section of the market. The appearance of the receiver is quite neat, but the stand is not as stable as it could be. ■

QUICK-HEAT

CRTs

Harold PETERS

IT was mentioned recently in *Teletopics* (April, page 248) that Mullard "Quick-vision" c.r.t.s would soon be on the market. Now that they are, a few more details should be given, starting with a possible snag.

HEATER CURRENT

If it is intended to replace a conventional Mullard 110° c.r.t., it is quite likely that the replacement tube supplied will be of the Quick-vision type. The physical and electrical properties of the Quick-heat replacement will be identical to those of the original tube *except for the heater current*, which is less. You must allow for this if the heater of the new tube is not to be over-run.

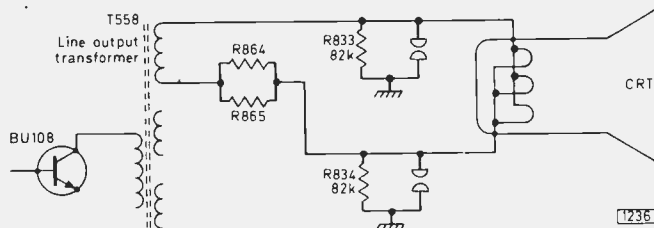

Fig. 1: The c.r.t. heater supply circuit in the Pye 731 110° chassis. With conventional tubes — the A56-140X or A66-140X — R864 and R865 are 1.2Ω each and the c.r.t. heaters dissipate 5-7W. With a Quick-vision tube, such as the A56-410X or A66-410X, R864 and R865 become 2.2Ω each and the c.r.t. heater dissipation drops to 4.65W.

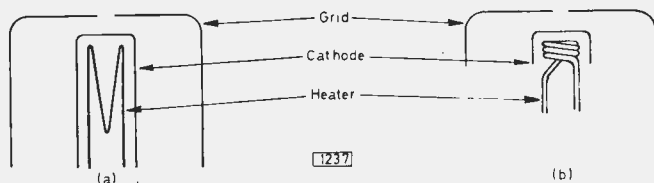

Fig. 2: The conventional form of c.r.t. heater-cathode assembly construction is shown on the left. On the right, the Quick-vision heater-cathode assembly: a small spirally-wound heater enables the size of the cathode to be considerably reduced.

If the supply to the c.r.t. heater is obtained from a winding on the line output transformer, it is normal to find a limiting resistor fitted in series. The value of this should be adjusted accordingly (see Fig. 1 for a typical example). If the heater is fed from a mains transformer, with no series resistor, no change is needed provided the transformer source impedance is less than 0.6Ω. Service manuals and group house magazines carry this information, as well as the Mullard applications notes which also have full information.

TUBE TYPES

The tubes affected are all 110° types currently fitted in solid-state television chassis. Details:

The A31-410W 12in. monochrome Quick-vision c.r.t. supersedes the conventional A31-120W tube.

The A56-410W 22in. colour Quick-vision c.r.t. supersedes the conventional A56-140X tube.

The A66-410W 26in. colour Quick-vision c.r.t. supersedes the conventional A66-140X tube.

WHY THE CHANGE?

Why this change to Quick-vision types of tube? The latest chassis are mostly all solid-state designs with the h.t. taken directly from the mains supply and the c.r.t. heater fed from a winding on the line output transformer. Having arranged things so that the mains transformer is dispensed with it is annoying to have to put it back in order to give an "instant-on" facility. The Quick-vision c.r.t. overcomes this problem by displaying a picture within five seconds of receiving its heater supply. This is at switch on when the tube is supplied from a mains transformer, and from the start of the line scan in the case of solid-state sets in which the tube's heater is supplied from the line output transformer. So, to the relief of dealers, sets no longer have to be permanently plugged in and drawing current to enable them to produce a picture quicker than the one next door.

THE QUICK-VISION TECHNIQUE

Conventional c.r.t. heater-cathode assemblies, based on the experience of valve manufacture, are rather bulky, with a long, folded heater in a tubular cathode (see Fig. 2). Since the business end is the little bit at the top, inside the grid, most of the rest can be pruned away without affecting performance.

In the Quick-vision tube this is done by using a small, rugged, spirally wound heater mounted inside a truncated cathode which, being much less bulky, attains its working temperature up to five times more rapidly than in the case of the conventional design. Two bonuses are obtained: less heater current is required, and there is less chance of microphony.

SET WARM-UP PERIOD

The only headache is for the setmakers. Accustomed to having a leisurely minute or so for the line and field timebases to settle, for the colour reference oscillator to lock and for the varicap tuning voltage to stabilise, they now have only five seconds. But that's their problem, unless it's yours also by virtue of having just been given a Quick-vision replacement c.r.t. Experience shows that the worst offender is the 33V varicap tuning voltage zener stabilising i.c. (TAA550), and an isolated heatsink should fix that. ■

Your PROBLEMS solved

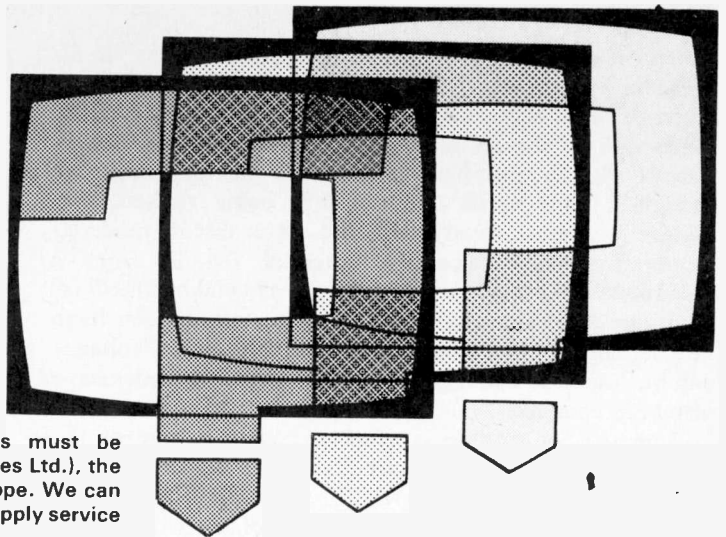

Requests for advice in dealing with servicing problems must be accompanied by an 11p postal order (made out to IPC Magazines Ltd.), the query coupon from page 435 and a stamped addressed envelope. We can deal with only one query at a time. We regret that we cannot supply service sheets nor answer queries over the telephone.

DECCA CS2630

When the set is first switched on the colours are faded – there is excessive white – and all detail is lost. After about five minutes normal, near perfect colours appear instantaneously. This lasts for about two hours. Then the colours momentarily weaken for one-two seconds, this sequence repeating at fifteen minute intervals. I suspect a faulty valve in the line output stage.

The PL509 and PY500 valves are not the cause of the fault. Basically the trouble is increased brightness which results in the colours fading. We have known this to be due to the field flyback blanking pulse coupling capacitor C451 (0.022 μ F) on the convergence board being leaky, thus putting excessive voltage on the c.r.t. grids. Another possibility is a beam limiter/brightness circuit fault: check the 8.2V zener diode D208. The MC1327P demodulator/RGB matrix i.c. on the decoder panel could also cause the trouble. (Decca 30 series chassis.)

EKCO T433

I'd like to know what equivalents could be used to replace the following diodes in this set: V7 CG64H, V8 Z35PC1, V16 M3.

The CG64H can be replaced by an OA90, the other two by any modern silicon diode such as the BA155. (Pye 11U series.)

ULTRA 6710

The fault to start with was that for about ten minutes after the picture appeared there was a green hue on white areas. The period during which the hue persisted gradually increased until it lasted for about two hours. Normal colour was then lost altogether. When the set was switched on there was a green and black picture. This condition persisted for about ten hours over three days. A normal picture then returned without any servicing action having been taken! The green cast is still present for a short warm-up period but everything is normal otherwise.

This sort of thing can be caused by dry-joints on the video board but is more often due to faulty electrolytic capacitors on this panel. The following are suspect: decouplers C221 and C222 (both 1 μ F, 300V), and the electrolytics in the clamp circuits, C215, C227, C231 (all 2 μ F, 40 or 63V). We generally replace the lot. (Thorn 3500 chassis.)

PHILIPS 554

The set works very well when first switched on but after a time, perhaps an hour or so, the picture shakes. It will be normal for a minute or so and will then shake up and down for a few seconds or minutes. This situation will continue intermittently for the rest of the time the set is left on. The shake consists of a vertical judder which is very rapid but clearly noticeable, producing multiple images on the screen. The judder seems to be about $\frac{1}{2}$ in. and stops if the field hold control is set to a position so that the picture falls down from the locked setting. On rarer occasions the picture shakes horizontally, on the right-hand side only, instead of vertically.

This symptom is not uncommon on this chassis and is due to jitter in the breakover point of the diac (D1377) in the thyristor stabilised power supply circuit (power board). D1377 should be replaced therefore (type BR100). In the unlikely event of the fault persisting the thyristor (SCR 1379, type BT106) is suspect. (Philips G8 chassis.)

DECCA CTV25

A picture of poor quality can be obtained when the brightness and contrast controls are fully advanced. If either control is moved in the opposite direction even slightly the picture disappears. Mostly affected are the light parts of the picture, with people's faces almost disappearing. The focus control has no effect.

The c.r.t. could well be of low emission by now. First however check the PL802 luminance output valve and its associated components. Crushing or limiting in the luminance output stage often gives rise to these symptoms in this model.

EKCO T541

There is intermittent jitter of the whole picture from left to right. Sometimes the fault is there when the set is switched on and may last for fifteen to twenty minutes before clearing for up to two hours, at other times it does not occur until the set has been on for several hours. All relevant valves have been replaced.

Suspect a faulty capacitor in the line oscillator stage – C65 which tunes the coil, or the triode cathode decoupling electrolytic C66. Other possibilities are the oscillator coil L14 or the TAA700 jungle i.c. (Pye 169 chassis.)

FERGUSON 3800

When the set is first switched on the picture "winks" in an irregular manner, the fault being worst at initial switch on when it can momentarily affect the sync. The fault diminishes as the set warms up but the contrast level is always slightly unstable. At its worst the fault looks as though a poor aerial connection is being shaken. The picture is almost steady with the a.g.c. circuit rendered inoperative and a control potential fed in from a potentiometer, though small variations can still be noted. All i.f. transistors, also the video and a.g.c. transistors, have been changed. No variation in the supply or h.t. voltages can be detected. The a.g.c. and vision detector diodes have also been changed.

This sort of trouble is often traceable to one of the electrolytics in the base circuit of the a.g.c. amplifier transistor, i.e. C3 (50 μ F) or C6 (25 μ F). C32 (50 μ F) which decouples the bias applied to the base of the video driver stage and C37 (64 μ F) which couples the signal to the video output transistor occasionally cause intermittent vision problems, and we have had one or two cases of leakage in the small disc ceramic capacitors used for decoupling in the i.f. strip. The latter seems unlikely to be the trouble in your case however. (Thorn 1500 chassis.)

BAIRD 660

There is compression at the top and bottom of the raster, more noticeable at the bottom where there is also what I take to be foldover. Adjustment of the field timebase controls makes no difference. I have changed the PCL85 field timebase valve and the 100 μ F pentode cathode decoupler (C164).

The fact that the bottom of the raster is folded up indicates that the PCL85 is drawing too much current. This could be due to leakage through C172 (0.033 μ F) which couples the triode anode to the pentode control grid, or to a change in the value of one of the cathode bias resistors R131 (100 Ω) and R132 (390 Ω) which should be checked. These two resistors are decoupled by separate electrolytics: C169 (2.5 μ F) should also be checked.

Note: R132 is incorrectly shown as 330 Ω instead of 390 Ω on the circuit diagram given in the December 1974 issue (pages 72-3). The value of 330 Ω applies to the earlier 620/640 series which employs a single cathode bias resistor.

KB CK602

This colour set has stopped working, following a small amount of smoke from the chassis. The PY500 and PL509 valves in the line output stage seem to be lighting up rather brightly.

The distress in the line output department is due to lack of drive from the line oscillator. Try a new PCF802 line oscillator valve first. If the valve's 5.6k Ω cathode resistor R406f is burnt, replace it as well as the valve. If the tuning capacitors C294f (0.0022 μ F) and C295f (0.01 μ F) and the quadrature feedback capacitor C291f (0.001 μ F) are of the polystyrene (see-through) type they are suspect. Other possibilities are the oscillator feedback capacitor C293f (330pF) and the oscillator coil L96f. To prevent damage to the PL509 line output valve while investigating the line oscillator, disconnect its 2.7k Ω screen grid feed resistor R421h. When drive to the line output valve has been restored a negative voltage will be present at its control grid (pin 1). (ITT CVC5 chassis.)

BUSH 1122

There is a good picture, with perfectly satisfactory contrast and brightness, on this set. After a period of operation which varies in length of time however the picture collapses to a narrow, bright horizontal line across the screen. If the cabinet is tapped the picture returns and sometimes remains for a long period.

The trouble is due to a poor connection or dry-joint on the field timebase panel which is on the extreme right-hand side as you look into the back of the set. Check the plug and socket connections to this board, and probe around looking for loose components, cracks or bad joints. (Rank A823AV chassis.)

SOBELL 1048

The problem with this set is that a buzzing noise appears after it has been on for approximately one and a half hours.

It may be necessary to make a slight adjustment to the intercarrier sound i.c. quadrature coil L117 and its input coil L116. Before doing this however check that the l.t. supply line is 20V. This supply is obtained from the line output stage and is dependent on the boost voltage being correct. Check therefore that there is 890V at SC6 after switching on, and that this has not varied after one and a half hours. (GEC Series 1 chassis.)

DECCA CTV19

On very bright or peak white picture content there is field jitter.

The luminance panel should be modified as follows: change R203 to 2.2k Ω (5%) – it may be a 5.6k Ω variable resistor – and remove R213 if fitted. Then modify the video emitter-follower stage as shown in Fig. 1.

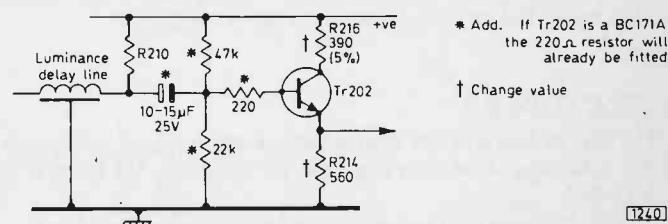

Fig. 1: Suggested luminance emitter-follower modifications, Decca Model CTV19.

PYE CT205

On switching on the picture failed to appear and a burning smell was noticed. On examination the PL509 line output valve's glass had melted and cracked, its cathode bypass capacitor C221 had bulged and split whilst its cathode resistor R226 had melted out of the printed board at its top end. These components, also the PY500 efficiency diode, were replaced. But since then the set still does not always produce a picture after switching on, and when this happens the PY500 anode glows red after about a minute. Quickly switching off and on again produces a picture immediately.

The line oscillator stage seems to be reluctant to operate. First suspect is the valve itself (PCF802), then the polystyrene capacitors C209 which tunes the oscillator coil and C211 which provides the feedback to the pentode control grid. The line oscillator coil could also be responsible. (Pye 697 chassis.)

ULTRA 6703

The screen has gone blue, with only very faint picture content discernible when the screen is examined at close range. Checking at the c.r.t. base reveals that the blue cathode voltage is well down, at 20V. Before changing the blue output transistor, are there other components that could be at fault?

The fault could lie anywhere in the blue channel, i.e. any of the three transistors VT213, VT214 or VT215 or the electrolytic C231 (2 μ F) or diode W208 (BA145) in the feedback clamp circuit could all equally well be responsible. We suggest you check each of these components individually, replacing as necessary. (Thorn 3000 chassis.)

STELLA ST2049A

There is no e.h.t. and very little spark at the top caps of the PL500 line output valve and PY800 efficiency diode. The boost voltage is only about 220V. There is almost normal line whistle, which gets much louder when the PY800 top cap is removed. The boost capacitor has been checked and is not short-circuit. After checking and changing one or two

other components I now suspect the line output transformer, but would like your views before replacing this.

The line output transformer is very vulnerable on this chassis and often fails giving the symptoms you describe. After replacement make sure that the width is not excessive. This will prevent premature failure of the new transformer. (Philips Style 70 series chassis.)

QUERIES COUPON

This coupon is available until July 21 1975 and must accompany all Queries sent in accordance with the notice on page 433. Don't forget the 11p (inc. VAT) postal order!

TELEVISION JULY 1975



Each month we provide an interesting case of television servicing to exercise your ingenuity. These are not trick questions but are based on actual practical faults.

An elderly Sobell Model 1012 arrived in the workshop with the symptom intermittent line timebase failure. It was placed on soak test and for several hours operated normally. Attention was then drawn to the set by intermittent sound crackling and on investigation it turned out that the picture had also disappeared and that screen illumination could not be obtained by advancing the brightness control.

The receiver was switched off for a few minutes and when switched on again both sound and vision were normal. While

various basic tests were being made the symptom again occurred, but this time it was noticed that the picture dissolved into a vertical line before finally fading away. While examining the receiver under the fault condition it was discovered that the PL504 line output valve was operating much below normal temperature.

Further tests proved that the valve itself was in order and that it was receiving anode voltage via the transformer and the boost diode. But there was no flyback pulse potential while the voltage on the screen grid of the valve was significantly higher than it should have been, the hall-mark of either a reduced value screen grid feed resistor or lack of screen grid current. The resistor was found to be of correct value.

A test was next made at the cathode of the valve, and much to the technician's surprise a substantial voltage was indicated.

Why was the technician surprised by this, and what was the most likely cause of the symptom? See next month's Television for the solution and for a further item in the Test Case series.

SOLUTION TO TEST CASE 150

(Page 379 last month)

In order to stabilise the bias applied to the tuning diodes in a varicap tuner either a zener diode or a zener integrated circuit is employed. Tuning is achieved by applying a reverse bias to the varicap diodes in the tuner from a bank of potentiometers one of which is switched into circuit by means of a selector button, etc. in order to tune to a particular channel. As the reverse bias applied to the varicap diodes is increased so the capacitance of the diodes decreases (hopefully in step!).

The symptom described in Test Case 150 had nothing to do with the tuner itself, the tuning drift being the result of the tuning potential to the diodes varying slightly. The trouble was traced to the stabilising zener diode D11. This was not completely open-circuit but had developed an intermittent fault. If the diode goes completely open-circuit the tuning voltage will rise, thereby pulling the tuning to a higher frequency channel.

The lesson then in the event of apparent u.h.f. tuner drift is first to check that the tuning control voltage remains stable. If not, replace the zener or i.c.!

Published on approximately the 22nd of each month by IPC Magazines Limited, Fleetway House, Farringdon Street, London EC4A 4AD. Filmsetting by Pacesetters, London SE1. Printed in England by Carlisle Web Offset, Newtown Trading Estate, Carlisle. Sole Agents for Australia and New Zealand - Gordon and Gotch (A/sia) Ltd.; South Africa - Central News Agency Ltd. Publisher's subscription rate (including postage): for one year, £5.80 inland rate, £5.65 overseas rate, \$15.50 USA/Canada. International Giro facilities Account No. 5122007. Please state reason for payment "message to payee". "Television" is sold subject to the following conditions, namely that it shall not, without the written consent of the Publishers first having been given, be lent, resold, hired out or otherwise disposed of by way of Trade at more than the recommended selling price shown on the cover, excluding Eire where the selling price is subject to VAT, and that it shall not be lent, resold, hired out or otherwise disposed of in a mutilated condition or in any unauthorised cover by way of Trade or affixed to or as part of any publication or advertising, literary or pictorial matter whatsoever.

TELEVISION CLASSIFIED ADVERTISEMENTS

The pre-paid rate for classified advertisements is 8p a word (minimum 12 words), box number 30p extra. Semi-display setting £4.50 per single column inch. All cheques, postal orders, etc., to be made payable to TELEVISION and crossed "Lloyds Bank Ltd." Treasury notes should always be sent *registered post*. Advertisements, together with remittance, should be sent to the Classified Advertisement Manager, TELEVISION IPC Magazines Ltd., Fleetway House, Farringdon Street, London, EC4A 4AD, for insertion in the next available issue.

SETS & COMPONENTS

Electronically Tested TV Valves

DY86/7	15p	PC97	15p
ECC82	15p	PCL86	15p
EF183	15p	PCF802	15p
EF184	15p	PCL82	10p
PFL200	18p	PCL84	10p
EY86	15p	PCL805/85	18p
PC86	15p	PL504	18p
PC88	15p	30PL1	15p

PL508	30p	PL509	40p	PY500/A	35p
-------	-----	-------	-----	---------	-----

Many others available, please send list of types required with s.a.e. for quotation. All valves subject to availability.

P. & P. 6p per valve, over 10 3p per valve.
Orders over £5 post free.

Mail order only

L. & D. COMPONENTS LTD.,
71 Westbury Ave., London N22 6SA.

MAINS DROPPERS

37-31-97-26-168Ω	50p.
25-35-97-59-30Ω	50p.
14-26-97-160Ω	50p.
14-26-97-173Ω	50p.
15-19-20-70-63-28-63Ω	50p.

Post free. C.W.O.

Durham Supplies
367 Kensington Street, Bradford, 8, Yorkshire

VALVES, Radio, TV, Transmitting, Industrial 1930 to 1975. 2,000 types stocked. Many obsolete. X78, TH41, 2P, N78, EBL1, EBL21, ECC31, EL37, EN31, T41, MKT4, PENDD 4020, PX4, X81M, W61, X101, X109, X145, X147, Z21, Z319, Z359, 6F33, 61BT, etc. List 20p. We wish to purchase new 2 Boxed Valves. Cox Radio (Sussex) Ltd., The Parade, East Wittering, Sussex. West Wittering 2023.

EX RENTAL TV'S BARGAIN

23" & 19" 3 Channel with U.H.F. Tuner £3.50
19" & 25" Colour from £50.00
19" & 23" tubes guaranteed from £2.00

All sets complete.

EDWARDS & SONS
103 Goldhawk Road, London, W.12.
Telephone: 743 6996.

CALLERS ONLY

TURN YOUR SURPLUS capacitors, transistors, etc., into cash. Contact Coles-Harding & Co., P.O. Box 5, Frome, Somerset. Immediate cash settlement.

VALVE LIST

ALL VALVES FULLY TESTED

Five valves or over postage paid
Under five valves postage 6p each

DY86/87	15p	PC900	8p	PCL85/805	20p
EB91	12p	PCC84	8p	PL36	20p
ECC82	10p	PCC85	20p	PL504	25p
ECL80	8p	PCC89	8p	PY32/33	15p
EF80	8p	PCC189	8p	PY81/800	15p
EP85	8p	PCC805	15p	PY801	20p
EF183	10p	PCF80	8p	U191	15p
EF184	10p	PCF86	15p	6F23	15p
EH90	13p	PCF805	20p	6/30L2	15p
EY86/87	13p	PCL82	15p	30F5	10p
PC86	15p	PCL83	15p	30FL1	20p
PC88	15p	PCL84	15p	30PL14	15p

AND MANY MORE AVAILABLE

S. W. ELECTRONICS

114 Burnley Road, Rawtenstall, Rossendale, Lancs.

250 New Resistors, well assorted, 1/2-2 Watts, Carbon-Hi-Stab Oxide, etc. £1.50 post free. Whitsam Electrical, 33 Drayton Green Road, London, W13.

T.E.S.T.

PO BOX 1, KIRKHAM, PRESTON, PR4 2RS
Tel. 077-48-2796.

Part exchange, ex-rental and repossessed colour televisions.

Most makes including:
Decca, Bush/Murphy, Philips, etc.
25 in. Non-workers £60
Workers £85.

Fully serviced fitted reconditioned tube guaranteed 12 months £110.

All with nice cabinets, plus V.A.T. Other makes and sizes. S.A.E. details please.

Colour TV spares for most makes including tubes and cabinets.

Australian readers please contact our agent in N.S.W.

Phil. Diggerman, East Bank Road, Coramba, N.S.W. 2466.

BRC 2000, 3000, 3500, 8000, 8500

Panel Repairs/Exchange—Singles or Bulk

All Details:

MODULAR ELECTRONICS
160 Brabazon Road, Hounslow TW5 9LP
Tel. 01-897 0976

MAKE 1975

A BETTER VIEWING YEAR

Improve your colour and monochrome T.V. reception with a U.H.F. pre-amplifier of the type supplied to the trade.

We manufacture amplifiers of the following types:

Group	Channel	Typical Gain
A	21-34	18dB
B	39-51	16dB
C/D	49-68	14dB
Wide Band	21-68	10dB

All the above units are supplied complete with an attractive mains power unit at the competitive price of £9.75 (U.K. only), V.A.T., post and packing inc.

Trade enquiries welcome. For details of aerials and aerial accessories send S.A.E.

Order direct from:

IMPACT ELECTRONICS,
Unit 16, Storforth Lane Trading Estate,
Chesterfield, Derbyshire S41 0QQ.

VALVE BARGAINS

ANY 1-12p, 5-50p, 10-90p, 50-£3.30

ECC82, ECH84, EH90, DY86/7, EF80, EF183, EF184, PC86, PC88, PCF80, PCF802, PCL82, PCL84, PCL85/805, PCL86, PY81, PY800, PY88, PL36, PL504, 6F28, 30PL14.

COLOUR VALVES 25p EACH

PY500/A, PL508, PL509.

Postage & Packing 15p, no VAT.

VELCO ELECTRONICS

9 Mandeville Terrace, Hawshaw, Via Bury, Lancs.

WANTED

TELEVISION. August 1973 to June 1974 inc. S. G. Smith, 4 Fairfield Court, Stafford. Tel: Stafford 44413.

NEW VALVES (pref. BVA) of popular types, PCL805, PFL200, PL504, etc. Cash waiting, Bearman, 6 Potters Road, New Barnet, Herts. Tel: 449 1934-5.

TOP PRICES PAID for NEW VALVES and TRANSISTORS

Popular T.V. and Radio types
KENSINGTON SUPPLIES (A)
367 Kensington Street, Bradford 8, Yorkshire.

POWER SUPPLY and Line Timebase Panels for BRC 300. Tel: 0608 3340.

PARTS WANTED for Phillips D/S G6 Colour Chassis, also Manual. Jones, 24 Darren Road, Coleford, Glos.

SERVICE SHEETS

SERVICE SHEETS for Radio, TV, etc., 50p and SAE. Catalogue 20p and SAE Hamilton Radio, 47 Bohemia Road, St. Leonards, Sussex.

SERVICE SHEETS, Radio, TV, etc., 10,000 models. Catalogue 24p plus SAE with orders - enquiries, Telray, 154 Brook Street, Preston PR1 7HP.

LARGE SUPPLIER OF SERVICE SHEETS

All at 50p each

(T.V., RADIO, TAPE RECORDERS, RECORD PLAYERS, TRANSISTORS, STEREOGRAMS, RADIOGRAMS, CAR RADIOS)

"PLEASE ENCLOSE LARGE S.A.E. WITH ALL ENQUIRIES & ORDERS" Otherwise cannot be attended to

(Uncrossed P.O.'s please, original returned if service sheets not available.)

PLEASE NOTE

We operate a "by return of post" service. Any claims for non-delivery should be made within 7-days of posting your order.

C. CARANNA
71 BEAUFORT PARK
LONDON, NW11 6BX

We have the largest supplies of Service Sheets (strictly by return of post). Please state make and model number alternative.

Free T.V. fault tracing chart or T.V. list on request with order.

Mail order or phone 01-458 4882

No Overseas Mail Please

'CAUSE & CURE' TV Manuals. Invaluable for professional and amateur. SAE details: Colis, 33 Maple Avenue, Morecambe, Lancs. LA3 1HZ.

50 assorted Service Sheets £1.55 P. & P. 60p Hamilton, 47 Bohemia Road, St. Leonards, Sussex.

FOR SALE

VIDEO TAPE RECORDER FOR SALE

Sony Type 2000B with 9" Monitor/TV new Camera and 8 hrs. of Tapes.

Offers to: **W. COUGHLAN**
50 DAVITT STREET,
TIPPERARY,
IRELAND.

Carriage by arrangement with Buyer

AERIALS

GENUINE FULL SIZE 18 element TV aerial

as used by leading TV companies

FOR ONLY
£2.55
incl. VAT
+ 59p cart

ITV BBC1 & 2B/W & Colour Guaranteed Perfect Pictures. Save ££s. We supply this genuine U.H.F. aerial for only £2.55, can be fitted outside or inside. Quality made technically advanced design. Precision grid reflector eliminates ghosting. Complete with clamp, instructions, advice. Money Back Refund. Wall/Caravan Bracket 25p. Best Cable 12p per yard. Plug 10P & FREE with order maps & channel reference of Radio & TV Transmitters. Send direct to Dept. PT10 219 Mansfield Rd., Nottingham

IMPERIAL TRADING (AERIALS) LTD.
the quality Aerial Specialists

WRIGHT'S AERIALS

UHF aerials: all Jaybeam and Antiference products. Antiference Tricolour TC10 £4.63, TC18 £6.14. Jaybeam High Gain MBM30 £5.96, MBM48 £8.91, MBM70 £13.34, MBM88 £17.36. Antiference Extra Gain XG8 £9.14, XG14 £16.20, XG21 £21.99. State transmitter/channel group if known. Labgear UHF masthead amps. with mains power unit: CM6000 (grouped) or CM6019 (wideband) £14.59. Prices incl. 25% VAT. Coax. semi air-spaced low-loss 12p/yard. All prices incl. mainland P/P. Band III high Gain: Large SAE for full lists.

Please state particular interest.

3 Cheltenham Rise, Scawsby, Doncaster, S. Yorks.

FANTASTIC BARGAINS

J BEAM CARAVAN AERIAL KIT

Rec. Retail £12.65
OUR PRICE £10.89

Complete with Mast Coaxial Cable Plug, and fixing bracket.

TELEVISION SET TOP AERIALS

Star Beam 4 element for 625 reception
£2.40

Top Log Periodic for 625 reception
£3.40

MULTIBEAM UHF AERIALS

MBM 28 £5.00 MBM 48 £7.98
MBM 88 £16.48

PARABEAM UHF AERIALS

PBM 10 £3.45 PBM 18 £5.00

VHF/FM STEREO AERIALS

SBM 2 £3.60 SBM 3 £5.30
SBM 4 £5.80 SBM 6 £8.60

Mast Head UHF Amplifiers with mains power supply
£9.95

Low Loss Coaxial Cable 12p per metre
Aerial Plugs 12p each

SEND CWO TO:

HEATEX ELECTRONICS
94 ROCKINGHAM ROAD, CORBY
NORTHANTS

Please add 50p p & p.

Carriage and VAT paid. We keep a good range of Jaybeam Aerials in stock.

Multibeam High Gain Aerials: MBM 28 £4.80, MBM 48 £7.20, JBM 10 £3.00, JBM 18 £4.00.
Stereobeam: SBM 2 £3.80, SBM 3 £4.90, SBM 4 £5.35, SBM 6 £7.58. **Logperiodic:** LBM 2 £6.00.

Low Loss Co-ax 12p/m. Aerial Rotator AR30 £27.00, AR40 £32.00. Rotor cable 20 p/m.

J. & A. TWEEDY (Electronic Supplies) LTD.
79 Chatsworth Rd., Chesterfield, S40 2AP
Tel. Chesterfield 34982

NEW RADIO AERIAL

Stereo or mono!

Increase volume, quality and sensitivity of any VHF/FM Radio or Hi-Fi, stereo or mono, with this genuine aerial. It's a necessity if you want the best out of your equipment, whether a small radio or expensive stereo. Don't put up with poor reception any longer. Send now, hear for yourself. Ideal for the do-it-yourself enthusiasts. Supplied with clamp, instructions and advice. Use inside or out. FREE with order maps and channel reference of Radio and TV Transmitters!

Money back refund, send to Dept. TVR 219 Mansfield Rd., Nottingham. Best cable 12p yd.

IMPERIAL TRADING (AERIALS) LTD.
the quality Aerial Specialists

EDUCATIONAL

TELEVISION TRAINING

16 MONTHS' full-time practical and theoretical training course in Radio & TV Servicing (Mono & Colour) for beginners.

13 WEEKS' full-time Colour TV Servicing course. Includes 100 hours practical training. Mono revision if necessary. Good electronics background essential.

NEXT SESSION commences on September 15th.

PROSPECTUS FROM:

London Electronics College, Dept. TT7,
20 Penywern Road, London SW5 9SU.
Tel. 01-373 8721.

CITY & GUILDS EXAMS

Study for success with ICS. An ICS home study course will ensure that you pass your C. & G. exams. Special courses for: Telecoms. Technicians, Electrical Installations, Radio, TV and Electronics Technicians, Radio Amateurs.

Full details from:

ICS SCHOOL OF ELECTRONICS

Dept. 330, Intertext House, London, SW8 4UJ.
Tel: 01-622 9911 (all hours).

TECHNICAL TRAINING

Get the training you need to move up into a higher paid job. Take the first step now - write or phone ICS for details of ICS specialist home study courses on Radio, TV, Audio Eng. and Servicing, Electronics, Computers; also self-build kits.

Full details from:

ICS SCHOOL OF ELECTRONICS

Dept. 331, Intertext House, London, SW8 4UJ.
Tel: 01-622 9911 (all hours).

COLOUR TV SERVICING

Learn the techniques of servicing Colour TV sets through new home study course approved by leading manufacturer. Covers principles, practice and alignment with numerous illustrations and diagrams. Other courses for radio and audio servicing.

Full details from:

ICS SCHOOL OF ELECTRONICS

Dept. 332, Intertext House, London, SW8 4UJ.
Tel: 01-622 9911 (all hours).

MISCELLANEOUS

THYRISTORS gold bonded BT119 95p P. & P. 8p. Numerical read out tubes type GN4A 95p P. & P. 7p. B7G bases 3p P. & P. 7p. 8 pin octal bases 9p P. & P. 7p. General purpose diodes GEX 54 6p P. & P. 7p. Neons W/ended 6p P. & P. 7p. 1000 mf 16v 10p P. & P. 7p. Lead with two female bnc plugs 32p P. & P. 7p. P/CB B9A ceramic bases 4p P. & P. 7p. 24v ac plug in relay octal base dp/co 75p P. & P. 27p. 6v miniature relay dp/co EX Equip new 75p P. & P. 27p. Foot operated switch 3 1/2" x 2 1/2" 95p P. & P. 35p. 10 damaged TV panels some colour delay lines, etc., and B/W fantastic value at £1.65 P. & P. 60p. One Panel containing 7 common electrolytic capacitors ex 250mf 50v, etc. and 11 amp bridge rectifier 8 IA diodes and 7 other devices 75p P. & P. 35p. Giant switch cleaner in aerosol can 80p P. & P. 35p. Orders over £10 P. & P. free. Orders for 7p P. & P. over 10 items 27p. To: Industrial RF Services, 51 Deptford Broadway, London, SE8 4PH. Tel: 01-692 4284.

Build the Mullard C.C.T.V. Camera

Kits are now available with comprehensive construction manual (also available separately at 80p).

Send 5" x 7" S.A.E. for details to:

CROFTON ELECTRONICS

124 Colne Road, Twickenham, Middlesex TW2 6QS.

LOWEST COST IC SOCKETS. Use Soldercon IC socket pins for 8 to 40 pin DIL's, 50p for strip of 100 pins, £1.50 for 3 x 100, £4 for 1,000, 10p P. & P. for orders under £2. Add 8% VAT. Instructions supplied - send SAE for sample. SINTEL, 53d Aston Street, Oxford. Tel: 0865 43203.

BOOKS & PUBLICATIONS

G. T. TECHNICAL INFORMATION SERVICE

10 DRYDEN CHAMBERS, 119 OXFORD ST., LONDON W1R 1PA

MAIL ORDER ONLY

BOOKS

We are pleased to be able to offer the following books.

"TV FAULT FINDING" by J. R. Davis
Price £1.05 post paid

GETTING THE BEST FROM YOUR COLOUR TV by R. Maude
Price 80p post paid

A GUIDE TO TELEVISION ALIGNMENT by B. R. Epton, B.Sc.
Price 40p post paid

HOW TO MAKE 2 METRE AND 4 METRE CONVERTERS FOR AMATEUR USE
Price 70p post paid

HOW TO MAKE WALKIE-TALKIES FOR LICENSED OPERATION by T. D. Zedd
Price 50p post paid

***RADIO CONTROL FOR MODELS** by F. C. Jodd
Price 90p post paid

***RADIO CONTROL MANUAL No. 4**
Price £1.10 post paid

***SAVE 50p**
If both Radio Control Books bought together £1.50 the pair

COLOUR TV MANUALS

WE CAN SUPPLY
MANUALS FOR MOST
MAKES OF COLOUR
TELEVISION RECEIVERS

**B.R.C. PYE ECKO PHILIPS
ITT/KB SONY G.E.C. HITACHI
BAIRD ULTRA INVICTA etc.**

Please send a Stamped Addressed Envelope for a prompt reply.

SERVICE SHEETS SERVICE for Black and White TV, Radios, Record Players and Tape Recorders **45p**

Please send Stamped Addressed Envelope.

Books by J. McCOURT

Build yourself "THE COLOUR TV SIGNAL INJECTOR" Manual **£1.30**

Manual with Printed Circuit **£2.05** post paid

THE COMPREHENSIVE BLACK AND WHITE TV REPAIR MANUAL

Volumes 1, 2, 3 and 4 **£3.20** each post paid

THE COMPREHENSIVE COLOUR TV REPAIR MANUAL

Send for Details of New Editions

SOUTHERN VALVE COMPANY

P.O. Box 144, BARNET, Herts.
Telephone: 01-440 8641. Mail order only. Most leading makes.
(subject to availability)
VAT INCREASE - ADD 16% FROM 1st MAY 1975.

AZ31	62p	EM84	42p	PCL83	48p	UCL82	40p	30L1	38p
DY86/7	35p	EY51	45p	PCL84	45p	UCL83	55p	30L15	75p
DY802	40p	EY86/7	35p	PCL85	55p	UF41	65p	30L17	70p
EB91	18p	EZ40/1	48p	PCL805	55p	UF89	40p	30P12	75p
ECC81	34p	EZ80	33p	PCL86	48p	UL41	70p	30P19	70p
ECC82	32p	EZ81	28p	PDS00	£1.60	UL84	42p	30PL1	80p
ECC83	32p	GY501	75p	PFL200	70p	UY41	44p	30PL13	75p
ECC85	38p	GZ30	44p	PL36	58p	UY85	32p	30PL14	80p
ECC88	45p	PC86	61p	PL81	48p	U25	70p	30PL15	80p
ECH42	70p	PC88	61p	PL81A	52p	U26	66p	30P4MR	90p
ECH81	34p	PC97	38p	PL82	37p	U191	70p		
ECH84	50p	PC900	47p	PL83	44p	6/30L2	70p		
ECL80	50p	PCC84	38p	PL84	45p	6BW7	65p		
ECL82	44p	PCC85	42p	PL500	72p	6F23	70p		
ECL83	65p	PCC88	60p	PL504	72p	6F28	65p		
ECL86	40p	PCC89	48p	PL508	80p	6V6	45p		
EF80	28p	PCC189	50p	PL509	£1.45	6X4	38p		
EF85	30p	PCF80	38p	PL802	90p	6XS	44p		
EF86	50p	PCF82	48p	PY13	50p	10F1	65p		
EF89	30p	PCF86	55p	PY81/3	33p	20L1	80p		
EF183	35p	PCF200	85p	PY88	39p	20P4	85p		
EF184	35p	PCF801	48p	PY800	39p	30C1	38p		
EH90	53p	PCF802	50p	PY801	39p	30C15	75p		
EL34	65p	PCF805	75p	PY300A	90p	30C17	77p		
EL41	55p	PCF806	52p	UBF89	38p	30C18	75p		
EL84	33p	PCF808	75p	UCC85	44p	30F5	75p		
EL90/1	45p	PCH200	75p	UCH42	70p	30FL1	68p		
EM80	45p	PCL82	36p	UCH81	40p	30FL2	68p		

One valve post 6p, each extra valve 5p. (maximum 35p) LISTS s.a.e. please.

PLEASE MENTION TELEVISION

WHEN REPLYING TO ADVERTISEMENTS

COLOUR TV's

Bush 25" tube } Always in stock.
GEC 19" tube } Many other makes.
Baird 25" tube } Working sets from £45.
Plenty of non-workers.

Large variety of B/W TV's in stock, working and non-working at competitive prices. Untested sets from 50p to callers.

Trade welcome, open all week except Wednesday p.m. and Sunday.

COLORCARE TV

1532 Pershore Road, Stirchley
BIRMINGHAM B30 2NW
(Main A441 road from City centre)

PHILIP H. BEARMAN

6 POTTERS ROAD, NEW BARNET, HERTS.

We offer one of the finest range of new or rebuilt tubes in the country; tubes tested before despatch and usually ex stock and despatched daily securely packed. Deliveries arranged World Wide, prices on application.

Colour tubes, 4 year g'tee		MONO Tubes, usually 2 year g'tee.	
17"/20" 90° types		TSD217/282 (1 year)	£13.50+54p cge
A49/11X, A49/120X and A49/191X	£54.00+cge	Cathodeon MW31/74	£3.24+54p cge
A51/110X and 20" 510CKB22	£55.00+cge	TSD290/CME1201	£10.80+54p cge
22" A55/14X, A56/120X-140X	£58.00+cge	CME1202	£10.80+54p cge
25" A63/11X, A63/120X and A63/200X	£66.00+cge	CME1220/A31-120W	£11.34+54p cge
26" A66/120X & A67/120X	£66.00+cge	CME1402/AW36-80	£5.13+59p cge
Note, 1 year g'tee 20" colour	£50.00+cge	MW36/24-44	£5.13+59p cge
22" Mullard A56/120X	£53.00+cge	CME1601	£10.26+59p cge
26" Mullard A66/120X & 140X	£60.00 to £70.00+cge	CME1602	£11.34+59p cge
25" Mullard A63/11-120X when available	£54.00+cge	CME1713 (A44/120W)	£14.00+59p cge
		Other 17" tubes	£6.35+59p cge
		A47/11-26W (CME1913)	£13.65+64p cge
		A47/14W-CME1908	£10.80+64p cge
		A47/13W (CME1906)	£13.50+64p cge
		A50/120 (CME2013)	£12.28+64p cge
		A50/120 rebuilds	£10.45+64p cge
		A59/15W (CME2308)	£10.80+70p cge
		Rebuilds on application.	
		A59/11W-A59/23W	New £15.22+70p cge
		A59/13W (CME2306)	£15.20+70p cge
		A61/120 (CME2413)	£16.20+70p cge

We often have Mullard 22"/26" electrically perfect with fractional marks from £42.00 upwards, availability etc. on application, also 20" 2nds. Excellent value, g'teed.

Colour cge £2.00 (sea journeys 99p extra).

NOTE: VAT alteration, ADD 16% to prices quoted.

TEL. 449-1934/5

NOTE. All prices subject to fluctuations when due to circumstances beyond our control.

STOP PRESS. Philips A28/14W £12.50+75p cge.

REBUILT TUBES!

YOU'RE SAFE WHEN YOU BUY FROM RE-VIEW!

HERE IS WHAT YOU PAY:

MONO	
9", 11", 13", 14", 16"	£6.50
19"	£5.50
21"	£6.50
23"	£7.50

We offer return of post service.

Items in stock at time of going to press but subject to possible market fluctuations if unavoidable.

Post free over £10.

RIMBAND & TWIN PANEL

19"	£7.50
20"	£8.50
23"	£9.50
24"	£10.50
Carriage	£1.00

COLOUR

19"	£26.00
22"	£29.00
25"	£32.00
26"	£35.00

Exchange Basis (carriage-ins. £2.00)

Guarantee 1 year

Cash or cheque with order, or cash on delivery

Add V.A.T. to all orders

RE-VIEW ELECTRONIC TUBES
237 LONDON ROAD,
WEST CROYDON, SURREY
Tel. 01-689 7735

COLOUR TUBES

STANDARD TUBES

METAL BAND TUBES

TWIN PANEL TUBES

Rebuilt with new Electron Guns to British Standard 415/1/1967.

SUFFOLK TUBES LIMITED

261 CHURCH ROAD
MITCHAM, SURREY CR4 3BH
01-640 3133/4/5

Britain's Largest Independent TV Tube Rebuilder

A. & S. T.V. COMPONENTS

Stockists of semi-conductor devices for television & audio equipment.

BRIAN ARDEL
8 CAVENDISH CRESCENT,
DEACONS HILL ROAD,
ELSTREE, HERTS.

Telephone:
01-953 9724 (Elstree)
Northwood 26571
(Middx.)

TRANSISTORS

AC188	10p
AD161	35p
AD162	35p
AF139	30p
BC147	7p
BC148	7p
BC187	18p
BD124	62p
BD131	40p
BD132	40p
BDX32	£2.00

TRANSISTORS

BF180	29p
BF196	10p
BT106	95p
BU108	£1.75
BU208	£1.75
BY126	11p
BY238	11p
0A90	7p
2N1711	20p
R2010B	£1.80

INTEGRATED CIRCUITS

TAA550	40p
TBA120AS	£1.00
TBA4800	£1.10
TBA5200	£2.30
TBA5300	£1.70
TBA5400	£1.70
TBA560Q	£2.30
TBA800	95p
TBA9200	£2.80
TBA9900	£2.80
TCA2700	£2.80
SN76013ND	£1.00
ETTR6016	£2.00

(Colour Triplers from £3.00)
(Many other transistor devices available)

WHOLESALE & RENTAL COMPANIES & TELEVISION DEALERS SUPPLIED

Enquiries invited on 100 lots upwards. **SPECIAL** quotations given plus a **FANTASTIC** bonus for certain stock available.

Please add 25% for VAT. Minimum order £1.00. Under £5.00 please add 20p P. & P. UK only. Terms of Business C.W.O.

PHILIP H. BEARMAN

(VALVE SPECIALISTS) SUPPLIERS TO H.M. GOVT. Etc.

NEW valves by Mullard, Mazda, Telefunken, Tungram

IMMEDIATE POSTAL DESPATCH. LISTS S.A.E. DISCOUNT PRICES

VAT ALTERATION. ADD 16% TO PRICES QUOTED.

PRICES FROM MARCH 1975 (INCL. V.A.T. @ CURRENT RATE)

DY86/7	40p	PCC84	45p	PDS00	£1.60	6F23	95p	ENQUIRIES WELCOMED ON OUR VAST RANGE BY 100/127 etc. all 17p each with 10W resistor.
DY802	42p	PCC89	52p	PFL200	74p	6F28	80p	
ECC81	38p	PCC189	58p	PL36	80p	2DP4	88p	
ECC82	42p	PCF80	50p	PL84	60p	30C1	50p	
ECL80	60p	PCF86	62p	PL504	85p	30C17	95p	
EF80	36p	PCF200	84p	PL509	£1.45	30FL1	82p	
EF183	57p	PCF801	52p	PL802	£1.20	30FL2	82p	
EF184	57p	PCF802	64p	PY81	40p	30L15	98p	
EH90	56p	PCF805	95p	PY800	45p	30L17	90p	
EY51	66p	PCF808	95p	PY801	45p	30P12	95p	
EY86/7	34p	PCH200	96p	PY500(A)	98p	30PL1	98p	
GY501	70p	PCL82	47p	U25	80p	30PL13	£1.10	
PC86	72p	PCL83	52p	U26	90p	30PL14	£1.25	
PC88	72p	PCL84	46p	6/30L2	95p	30PL15	£1.10	
PC97	42p	PCL805/85	60p	6BW7	74p	ETC., ETC.		
		PCL86	58p					

See separate Component, CRT and Transistor Lists. Many obsolete types available. SAE with enquiries please. Please verify current prices

Overseas Post @ Cost. U.K. Post 5p per valve under £8.00. (max. 40p)

(Adjacent to Post Office) **6 POTTERS RD., NEW BARNET**

HERTS. Tel: 499/1934-5 any time.

STOP PRESS. PL95, PL519 PC92/96 available!

IF YOU HAVE DIFFICULTY
IN OBTAINING

TELEVISION

PLEASE PLACE A REGULAR ORDER WITH
YOUR NEWSAGENT OR SEND 1 YEAR'S
SUBSCRIPTION (£5.80) TO:

**SUBSCRIPTION DEPARTMENT,
TELEVISION,
TOWER HOUSE, SOUTHAMPTON STREET,
LONDON, WC2E 3QX.**

Registration London 53626

TELEVISION TUBE SHOP

NEW TUBES AT CUT PRICES

A28-14W Equivalent	£17.00
A47-11W/A47-18W	£11.00
A47-26W	£13.50
AW47-91/CME1903	£9.50
AW59-91/CME2303	£12.00
CME1201/A31-18W	£13.50
CME1202/A31-181W	£13.50
CME1220/A31-120W	£14.95
CME1420/A34-100W	£13.50
CME1520/A38-160W	£16.50
CME1601/A40-11W	£12.50
CME1602/A40-12W	£13.50
CME1713/A44-120	£17.50
CME1906/A47-13W	£12.50*
CME1905/CME1907	£9.50*
CME1908/A47-14W	£9.50
CME2013/A50-120	£12.95
CME2306/A59-13W	£13.50*
CME2308/A59-15W	£12.00
CME2313/A59-23W	£14.50
CME2413/A61-120W	£16.50
TSD217/TSD282	£7.50

JAPANESE/USA TUBES

190AB4	7"	£14.00
240AB4A	9"	£9.50
230DB4/CT468	9"	£15.00
280TB4	11"	£9.95
CT507	11"	£16.50
310DMB4	12½"	£11.50
310DGB4	21½"	£11.50
340AB4	14"	£15.50
340RB4	14"	£15.50

*Types marked thus are fully rebuilt.

NEW COLOUR TUBES

A49-191X/120X	£45.00
A56-120X	£60.00
A63-120X	£68.00
A66-120X	£75.00

NEW SCRATCHED COLOUR TUBES

20", 22", 26" from £35.

All tubes guaranteed for 12 months.

Carriage/insurance £1 mono,
£1.50 colour.

Add 25% VAT to all prices.

TELEVISION TUBE SHOP

46/48 BATTERSEA BRIDGE RD.,
LONDON, SW11. Tel. 228 6859.

WE GIVE GREEN SHIELD STAMPS

The Theory and Practice of PAL Colour Television in three important Sound Colour Films

- Part 1. The Colour Signal**
Running time 30 mins.
- Part 2. The Receiver Decoder**
Running time 25 mins.
- Part 3. Receiver Installation**
Running time 25 mins.

For purchase or hire in 16mm. and Philips VCR.

Send SAE for Precis details.

ZAAR COLOUR VIDEO LTD.

339, CLIFTON DRIVE SOUTH,
ST. ANNES-ON-SEA, LANCS. FY8 1LP
TEL. (0253) 721053

Film-to-Video tape transfers specialists

BENTLEY ACOUSTIC CORPORATION LTD.

The Old Police Station, Gloucester Road, LITTLEHAMPTON, Sussex

PHONE 6743

ALL PRICES INCLUSIVE OF V.A.T. AT 25%.

OB2	.46	6S17	.63	50C5	.69	ECF86	.86	GZ32	.58	PL509	1.67
3V4	.81	6V6G	.20	50L6GT	.75	ECH35	1.44	GZ34	.69	PY33/2	.52
5R4GY	.92	6V6GT	.52	85A2	.69	EC442	.81	HVR2A	1.15	PY81	.40
5U4G	.46	6X4	.46	5763	1.73	ECH81	.38	KTW61	1.73	PY82	.35
5V4G	.58	6X5GT	.52	ATP4	.58	ECH83	.51	KTW62	1.73	PY83	.44
5Y3GT	.52	7B6	.86	AZ31	.69	ECH84	.51	KTW63	1.15	PY88	.46
5Z4G	.52	7Y4	.86	AZ41	.29	ECL80	.46	KT66	2.88	PY500	1.09
6/30L2	.69	9D7	.75	DAF91	.35	ECL82	.39	PABC80	.44	PY800	.46
6AH6	.69	10F1	.86	DAF96	.58	ECL83	.81	PC86	.69	PY801	.46
6AQ5	.52	10F18	.63	DF91	.35	ECL86	.46	PC88	.69	QQV03/	
6AT6	.52	10P13	.86	DF96	.58	EF22	1.73	PC97	.40	10 2.01	
6AU6	.35	10P14	2.30	DK91	.52	EF40	.86	PC900	.46	R19	.69
6AV6	.52	12A6	1.15	DK92	.81	EF41	.81	PCC84	.35	U25	.69
6BA6	.40	12AC6	.81	DK96	.69	EF80	.25	PCC85	.51	U26	.76
6BE6	.40	12AD6	.75	DL92	.46	EF83	1.15	PCC88	.69	U191	.58
6BH6	.69	12AE6	.75	DL96	.63	EF85	.35	PCC89	.52	U801	.75
6BJ6	.63	12AT6	.46	DY87/6	.40	EF86	.52	PCC189	.55	UABC80	.46
6BQ7A	.63	12AU6	.52	DY802	.40	EF89	.35	PCF80	.46	UAF42	.69
6BK7	1.15	12AV6	.58	E88CC	.86	EF91	.43	PCF82	.46	UBC41	.69
6BR8	1.73	12BA6	.75	E180F	1.15	EF92	.58	PCF84	.68	UBC81	.52
6BW6	.92	12BE6	.58	EAB80	.31	EF98	.92	PCF86	.55	UBF80	.46
6BW7	.81	12BH7	.58	EABC80	.44	EF183	.35	PCF200	1.15	UBF89	.46
6BZ6	.56	12BY7	.86	EAF42	.86	EF184	.40	PCF201	1.15	UC92	.52
6C4	.46	12K5	1.15	EAF801	.86	EF184	.40	PCF801	.58	UCC84	.86
6C6	.46	14S7	.92	EB91	.23	EL32	.58	PCF802	.58	UCC85	.52
6C9	1.15	19AQ5	.58	EB94	.86	EL34	1.15	PCF805	.81	UCF80	.81
6CL6	.75	30C15	.81	EB8C1	.40	EL41	.58	PCF806	.58	UCF42	.86
6CU5	.86	30C17	.92	EBF80	.45	EL84	.36	PCH200	.98	UCH81	.46
6E5	1.15	30F5	.86	EBF83	.40	EL506	1.04	PCL82	.44	UCL82	.44
6F1	.86	30FL1	.77	EBF89	.37	EM80	.52	PCL83	.52	UCL83	.63
6F6G	.58	30FL2	.77	EC92	.52	EM81	.75	PCL84	.46	UF41	.81
6F18	.63	30FL14	.81	ECC33	1.73	EM83	.63	PCL805	.63	UF80	.40
6F23	.81	30L15	.81	ECC35	1.09	EM84	.46	PCL86	.54	UF85	.51
6F28	.77	30L17	.75	ECC40	1.15	EM87	.81	PEN45	.92	UF89	.46
6H6GT	.29	30P12	.75	ECC81	.39	EY51	.46	PEN46	.58	UL41	.69
6J5GT	.52	30P19	.86	ECC82	.38	EY83	.62	PL36	.69	UL84	.48
6J6	.35	30PL1	.98	ECC83	.38	EY87/6	.38	PL81	.52	UM80	.51
6K7G	.35	30PL13	1.09	ECC84	.40	EY88	.46	PL81A	.52	UY41	.52
6K8G	.52	30PL14	1.27	ECC85	.46	EZ40	.58	PL82	.43	UY85	.40
6L6GC	.67	35L6GT	.86	ECC88	.51	EZ41	.63	PL83	.46	X41	1.15
6Q7G	.58	35W4	.58	ECC8071.38	EZ80	.32	PL84	.46	X66	1.44	
6Q7GT	.58	35Z4GT	.81	ECF80	.52	EZ81	.33	PL504	.81	X759	5.75
6SG7	.51	50B5	.98	ECF82	.52	GY501	.81	PL508	1.04		

All goods are unused and boxed, and subject to the standard 90-day guarantee. Terms of business: Cash or cheque with order only. Despatch charges—Orders below £10. add 25p extra per order. Orders over £10 post free. Same day despatch. Terms of business available on request. Any parcel insured against damage in transit for only 5p extra per parcel. Please enclose S.A.E. with any enquiries.

LINE IT UP WITH A BI-PRE-PAK MARK 2

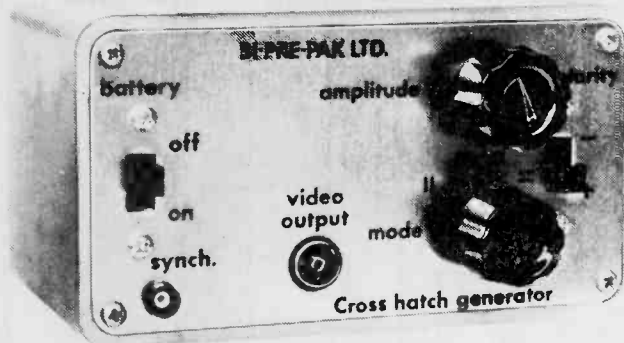

- ★ 4-PATTERN SELECTOR SWITCH
- ★ SIZE 3" x 5 1/4" x 3" (76 x 133 x 76mm)
- ★ OPERATES FROM 3 SELF-CONTAINED U.2 TYPE BATTERIES
- ★ FUNCTIONS TO PROFESSIONAL STANDARDS

TV SIGNAL STRENGTH METER

As described in this journal. A finely designed instrument of enormous value to the TV engineer, etc. Complete kit of guaranteed

parts, and as specified **£19.50** + 40p postage & packing + V.A.T. at 8%.



These TV instruments are two examples of the many attractive items sold by Bi-Pre-Pak. For catalogue of these and audio modules, semi-conductor bargains, books, etc., send large S.A.E. envelope with 6p stamp.

BI-PRE-PAK LTD

(Reg. No. 820919)

Dept. X, 222-224 WEST ROAD
WESTCLIFF-ON-SEA, ESSEX SSO 9DF
Telephone: Southend (0702) 46344

CROSS HATCH GENERATOR

IN KIT FORM OR READY-BUILT

Based on the design originally published in "TELEVISION" this unit is invaluable to industrial and home users alike. Improved circuitry assures reliability and still better accuracy. Generates four different line patterns to facilitate lining-up, etc., at the turn of the pattern selector switch. Very compact; self-contained. Robustly built. Widely used by TV rental and other engineers. In strong reinforced fibre-glass case, instructions, but less batteries. INDISPENSABLE FOR COLOUR.

In Kit form **£7.93**

Ready built and tested **£9.93**

add 8% for V.A.T. to total value of order plus 30p for postage and packing (in U.K.)

BI-PRE-PAK LTD. 222 West Rd., Westcliff, Essex SSO 9DF

Please send X-Hatch Generator Kit Built
TV Signal Strength Meter
for which I enclose £.....inc. V.A.T. & post & packing.

NAME

ADDRESS

.....