

TELEVISION

SERVICING · CONSTRUCTION · COLOUR · DEVELOPMENTS

25p

MARCH
1975

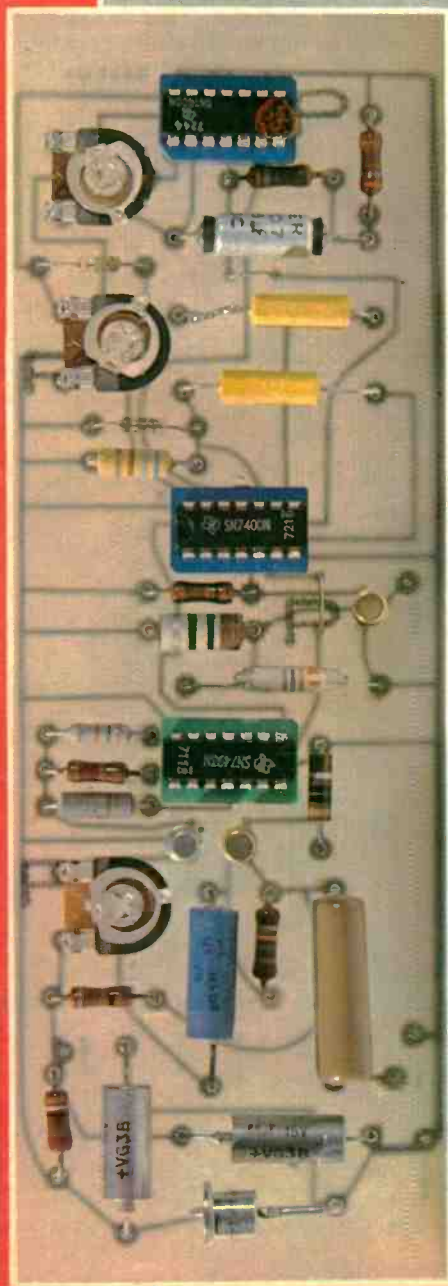

GREY-SCALE GENERATOR

ALSO:

COLOUR SET PRE-INSTALLATION CHECKS
USING TUNERS AS PREAMPLIFIERS
HEATHKIT PORTABLE TV REVIEWED

COLOUR 25 KV TRIPLERS

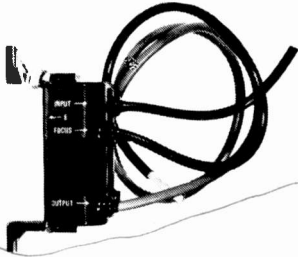

£1.70 + 13p V.A.T.

REPLACEMENT TRIPLERS

TS25, 11TAZ	£3.00 + 24p V.A.T.
G8 TRIPLERS	£3.00 + 24p V.A.T.
COLOUR SCAN COIL	£3.00 + 24p V.A.T.
I.C. SN76544N	£1.00 + 8p V.A.T.
BU105 Transistors	50p + 4p V.A.T.
DECCA CS1730	£1.00 + 8p V.A.T.
E.H.T. RECTIFIER STICKS	
X80/150D	10p + 1p V.A.T.
PYE TRANSISTOR TUNER UNITS	
VHF, UHF. No push button assembly	
	£1.50 + 12p V.A.T.
PHILIPS UHF UNIT	£1.50 + 12p V.A.T.
6 OR 4 PUSH-BUTTON UHF TUNER UNIT	
PYE	£3.00 + 24p V.A.T.
UHF AERIAL ISOLATING CO-AX SOCKETS & LEAD	30p + 2p V.A.T.
22 MFD, 315V/W Condensers	
25 MFD, 300V/W, 470MFD 35 V/W	
10 MFD, 250 V/W	
1000 PF 8Kv	10p + 1p V.A.T.
120 PF 8Kv	10p + 1p V.A.T.
200 + 100 MFD, 325 V/W	30p + 2p V.A.T.
200 + 200 + 100, 325 V/W	40p + 3p V.A.T.
200 + 100 + 50 + 100	40p + 3p V.A.T.
300 + 200 + 100 MFD, 350 V/W	50p + 4p V.A.T.
200 + 200 + 100 MFD, 350 V/W	50p + 4p V.A.T.
100 W/W Resistor	£1.00 + 8p V.A.T.
300 Mixed Condensers	£1.00 + 8p V.A.T.
350 Mixed Resistors	£1.00 + 8p V.A.T.
40 Mixed Pots	£1.00 + 8p V.A.T.

COLOUR T/V COMPONENTS

MANUFACTURERS DISCARDED MATERIALS	
VHF or UHF Varicap Tuners	£1.20 + 9p V.A.T.
Line o.p. Panels	£1.20 + 9p V.A.T.
Decoder Panels	£1.00 + 8p V.A.T.
G8 Type Yoke	50p + 4p V.A.T.
Frame Panels	75p + 6p V.A.T.
IF Panels	£1.20 + 9p V.A.T.

Money returned if not completely satisfied

SENDZ COMPONENTS

2 WOODGRANGE CLOSE
THORPE BAY, ESSEX

P.P. PAID U.K. ONLY

Reg Office Only—No Personal Callers Please

VALVE BARGAINS

Any 5 50p, 10 75p, 50 £3.30, 100 £6.40. Your choice from the following list:

ECC82, ECL80, EB91, EF80, EF183, EF184, PC86, PC88, PC97, PC900, PCC84, PCC89, PCC189, PCF80, PCF802, PCF805, PCL82, PCL84, PCL85, PCL805, PCL86, PFL200, PL36, PL504, PY33, PY81, PY800, PY88, EH90, 30FL1, 30FL2, 30PL14.

Colour Valves 25p each
PL508, PL509, PY500/A

Press 4 Button UHF
Tuners £2.50.

AERIAL BOOSTERS

We make three types of Aerial Boosters all for set top fitting, with Co-ax Plugs and Sockets.

B11—For Stereo and Standard VHF Radio

B12—For the older VHF Television, please state BBC1 and ITV Channels.

B45—For mon. or colour this covers the complete UHF band. All Boosters are complete with Battery and take only minutes to fit.

Price £3.40 each

BARGAIN PACKS

All Components in the Bargain Packs are unused and marked.

Pack 1—Polyester (C280) Axial Leads Capacitors
—250V/W & 400V/W, very good mixed selection from 0.01 UF to 2.2 UF. Price 100 £1, 1000 £8 (our choice).

Pack 2.—Electrolytic Capacitors—good mix selection from 1 UF to 1000 UF, and from 10V/W to 63V/W. Price 100 £1.50, 500 £6 (our choice).

Pack 3.—Transistors—any 10 80p, any 100 £7 (your choice). AC128 - AC176 - BC113 - BC115 - BC135 - BC153 - BC171 - BC172.

Pack 4.—15 Mixed Plugs, mixed selection of co-ax, din 2-3-5 pins, jack standard—3.5mm - 2.5mm. £1.

Prices include V.A.T. P. & P. under £1/10p, £1 to £3/15p, over 20p. Overseas at cost. Money back refund on all orders.

ELECTRONIC MAILORDER LTD., 62 BRIDGE STREET, RAMSBOTTOM, BURY, LANCs. Tel. Ramsbottom 3036.

TRAIN for SUCCESS

Start training *today* and make sure you are qualified to take advantage of the many opportunities open to the trained man. ICS can further your technical knowledge and provide the specialist training so essential to success.

ICS, the world's most experienced home study college, has helped thousands of ambitious men to move up into higher paid jobs—they can do the same for *you*.

Fill in the coupon below and find out how!

There is a wide range of courses to choose from, including:

CITY & GUILDS CERTIFICATES

Telecommunications Technicians'
Radio TV Electronics Technicians'
Electrical Installations Technicians'
Electrical Installation Work
Radio Amateurs'
MPT Radio Communications Cert.

**EXAMINATION STUDENTS—
GUARANTEED COACHING
UNTIL SUCCESSFUL**

TECHNICAL TRAINING

ICS offer a wide choice of non-exam courses designed to equip you for a better job in your particular branch of electronics, including:
Electronic Engineering & Maintenance
Computer Engineering/Programming
Radio, TV & Audio Engineering
& Servicing
Electrical Engineering, Installations
& Contracting

COLOUR TV SERVICING

Technicians trained in TV Servicing are in constant demand. Learn all the techniques you need to service Colour and Mono TV sets through new home study course approved by leading manufacturer.

POST THIS COUPON OR TELEPHONE FOR FREE PROSPECTUS

I am interested in

Name Age

Address

Occupation

ICS Accredited by CACC To: International Correspondence Schools, Dept 250D, Intertext House, LONDON Member of ABCC SW8 4UJ or 'phone 01-622 9911 (all hours)

T.V.'s & SPARES TO THE TRADE

BBC2 TVs from **£2.50** each
(BRC, KB, Baird, Pye, Philips, Bush)

GEC 2000, BRC 950 (Mk II & III), Bush 141,
Philips Style 70, Baird (600 & 700 Series)
All at **£7.00** each

Thorn 1400, Bush 170 Series, Philips 210,
Pye Ecko Series, Baird 673 Push Button
All at **£12.50** each

PLEASE NOTE:

- ALL TUBES GUARANTEED
- ALL SETS GUARANTEED COMPLETE
INSIDE AND OUT
- ALL CABINETS VERY GOOD
- ALL SETS "WALK AND TALK"
- ALL SPARES GUARANTEED FREE

COLOUR TVs—19" and 25"

Rank-Bush, Murphy, GEC, Decca, Philips,
Baird, BRC
All sets with guaranteed tubes and
guaranteed complete from **£65.00**

Alberice 10p Slot Meters—**£1.50** each

PLEASE NOTE:

1. WE STAND BY OUR GUARANTEES
2. WE DO NOT SELL RUBBISH
3. DELIVER ANYWHERE
4. ALL ORDERS WITH 1/3rd DEPOSIT
PLEASE
5. ANY QUANTITY SUPPLIED
6. ALL PRICES SUBJECT TO V.A.T. and
DELIVERY
7. NO CONNECTION WITH ANY OTHER
COMPANY

WE SINCERELY AIM TO PLEASE

(Stamped addressed envelope for enquiries please)

MAIL ORDER SERVICE**TELEVISIONS***Working**Untested but
guaranteed complete*19"—**£9.50**19"—**£4.00**23"—**£12.50**23"—**£5.00**All plus p. & p., V.A.T.—**£1.50****All tubes guaranteed****TUBES**19"—**£3.00**20"—**£4.50**23"—**£4.00**24"—**£5.50**} Postage and packing,
} V.A.T. **£1.50**

LOPTs **£2.50**; VHF Tuners **£2.00**;
UHF Tuners—Rotary **£2.50**, Push Button
£4.50, plus 50p p. & p.
Complete Panels, I.F., etc.

**Spares available for GEC, Philips, Baird,
BRC, Bush, Baird, Pye, etc.**

Valves **12p** each plus 5p p. & p. (no p. & p.
on 10 valves or more)

COLOUR SPARES

Including Tubes, Panels, Tuners, LOPTs,
Cabinets, etc., etc.

Available for GEC, Baird, Philips, Decca, Bush,
BRC, prices on request.

Colour Tubes 19"—**£15.00**, 25"—**£18.00**
plus **£2.50** postage and packing

ALL SPARES EX-EQUIPMENT

Speakers 6"x4", 5" Round, 8"x2" **30p** each
plus 20p postage and packing

COLOUR & MONOCHROME CABINETS
available—prices on request

**"VEGA" BRAND NEW TRANSISTOR
RADIOS**

(in makers' cartons—fully guaranteed—less batteries)

Model No. 206 6SW Bands MW-LW **£15.80**

Model No. 201 Meridian LW-MW

2SW Bands **£12.70**

Model No. 302 LW-MW-VHF **£9.62**

Sapphire LW-MW-SW1 SW2 **£8.50**

Jade Alarm Radio LW-MW **£6.60**

Vega Selga 404 LW-MW **£4.70**

All radios plus **£1.00** postage and packing

ALL ORDERS WITH FULL CASH PLEASE

TRADE DISTRIBUTORS (I.M.O.S.)

5 COMMERCIAL STREET · HARROGATE
YORKSHIRE Tel. No. (STD 0423) 3498

BENTLEY ACOUSTIC CORPORATION LTD.

7a GLOUCESTER ROAD, LITTLEHAMPTON, SUSSEX
All prices inclusive of V.A.T. Telephone: 6743

0B2	0-40	6AM8A	0-55	6F13	0-70	6V6G	0-80	12SQ7GT	0-85	38C5	0-75	AZ1	0-25	EAC91	0-75	EF41	0-70	FW4/500	£1	PCF82	0-40	PY500	0-95	UM80	0-44
0Z4	0-47	6AN8	0-70	6F14	0-75	6V7G	0-80	12SR7	0-75	35D5	0-75	AZ21	0-60	EAF42	0-75	EF42	0-70	FW4/800	£1	PCF84	0-59	PY500A	0-95	UR1C	1-00
1A3	0-45	6AQ5	0-45	6F15	0-85	7A7	1-00	14H7	0-55	35L6GT	0-75	AZ41	0-25	EAF80	0-75	EF80	0-26	GY501	0-70	PCF86	0-59	PY800	0-40	UC1	1-00
1ASGT	0-50	6AR5	0-60	6F18	0-55	7B6	0-75	1487	0-50	35W4	0-50	B163	2-00	EBC34	0-25	EF83	1-00	GZ30	0-45	PCF80	0-50	PY801	0-40	UU12	0-29
1ATGT	0-65	6AR6	1-00	6F23	0-80	7B7	0-70	19AQ5	0-50	35Z3	0-75	CL33	1-60	EBC41	0-75	EF86	0-45	GZ32	0-50	PCF80	0-50	PZ30	0-48	UY41	0-45
1B3GT	0-50	6AT6	0-45	6F24	0-85	7C7	1-00	19G6	0-60	35Z4GT	0-70	CV6	0-53	EBC90	0-45	EF91	0-37	GZ37	1-00	PCF80	0-50	PY800	0-40	UV33	0-58
1D5	0-60	6AU6	0-30	6F25	1-00	7F8	1-50	19H1	2-00	35Z5GT	0-75	CV63	0-75	EBC91	0-45	EF92	0-50	HABC80	0-60	PCB200	0-80	Q895/101-00	U16	1-00	0-75
1D6	0-80	6AV6	0-45	6F28	0-87	7H7	0-75	20D1	0-60	42	0-50	CV10	1-00	EBC92	0-45	EF93	0-80	HL23D	0-60	PCB200	0-80	Q895/101-00	U17	1-00	0-75
1G6	1-00	6AW8A	0-95	6F32	0-50	7I7	0-80	20D4	2-00	50B5	0-85	CV31	0-50	EBC93	0-45	EF94	0-80	HL23D	0-60	PCB200	0-80	Q895/101-00	U18	1-00	0-75
1H5GT	0-60	6AX4	0-75	6G0G	0-50	7V7	1-50	20F2	0-75	50C5	0-60	D63	0-25	EBC94	0-45	EF95	0-80	HL23D	0-60	PCB200	0-80	Q895/101-00	U19	1-00	0-75
1L4	0-28	6B8G	0-30	6G8A	0-75	7Y4	0-75	20L1	1-10	50CD6G	0-60	DAF96	0-50	EBC95	0-45	EF96	0-80	HL23D	0-60	PCB200	0-80	Q895/101-00	U20	1-00	0-75
1LD5	0-60	6BA6	0-28	6GK6	0-65	7Z4	0-80	20P1	0-55	1-25	DC90	0-60	ECC32	1-50	EL41	0-90	KT2	0-75	0-80	PCB200	0-80	Q895/101-00	U21	1-00	0-75
1LN5	0-60	6BC9	0-60	6G7U	0-75	9BW6	0-75	20P3	0-80	50EH5	0-75	DD4	1-00	ECC33	1-50	EL42	2-00	KT8	2-50	PCB200	0-80	Q895/101-00	U22	1-00	0-75
1NSGT	0-65	6BE6	0-35	6H6GT	0-25	9D7	0-65	20P4	1-00	50L6GT	0-65	DP91	0-30	ECC34	1-00	EL43	0-80	KT4	1-00	PCB200	0-80	Q895/101-00	U23	1-00	0-75
1R5	0-45	6BG6G	1-05	6J5GT	0-65	10C2	0-65	20P3	1-30	72	0-60	DP96	0-50	ECC35	1-00	EL44	0-80	KT4	1-00	PCB200	0-80	Q895/101-00	U24	1-00	0-75
1S4	0-43	6BH6	0-60	6J6	0-30	10DE7	0-75	25A6G	0-60	77	0-53	DH63	0-50	ECC36	1-00	EL44	0-80	KT4	1-00	PCB200	0-80	Q895/101-00	U25	1-00	0-75
1S5	0-30	6BJ6	0-55	6J7G	0-40	10F1	0-75	25A6GT	0-60	85A2	0-60	DH77	0-45	ECC37	1-00	EL45	0-44	KT6	2-50	PCB200	0-80	Q895/101-00	U26	1-00	0-75
1U4	0-60	6BK7A	0-60	6J7(M)	0-45	10F9	0-65	25V5	0-80	85A3	0-60	DH81	0-75	ECC38	1-00	EL46	0-38	KT8	2-00	PCB200	0-80	Q895/101-00	U27	1-00	0-75
1U5	0-75	6BQ5	0-31	6J8UA	0-75	10F18	0-55	25Y5G	0-70	90AG	2-50	DK40	0-70	ECC39	1-00	EL46	0-38	KT8	2-00	PCB200	0-80	Q895/101-00	U28	1-00	0-75
2D21	0-45	6DQ7A	0-58	6K7G	0-70	10LD11	0-70	25Z6	0-80	90CG	2-40	DK92	0-70	ECC40	1-00	EL47	0-38	KT8	2-00	PCB200	0-80	Q895/101-00	U29	1-00	0-75
2X2	0-60	6RR7	1-00	6K8G	0-45	10P13	0-70	25Z6GT	0-70	90CV	2-40	DK96	0-80	ECC41	1-00	EL48	0-38	KT8	2-00	PCB200	0-80	Q895/101-00	U30	1-00	0-75
2GK5	0-55	6BR8	1-50	6L1	2-00	10P14	2-00	28D7	1-00	90C1	0-75	DL96	0-55	ECC42	1-00	EL49	0-38	KT8	2-00	PCB200	0-80	Q895/101-00	U31	1-00	0-75

VALVES ALSO REQUIRED FOR CASH. LOOSE OR BOXED, BUT MUST BE NEW. OFFERS MADE BY RETURN.

344	0-50	6BS7	1-40	6L6GT	0-58	12A6	0-40	30A5	0-65	150B2	0-75	DM70	0-60	ECC80	0-45	EM81	0-65	MHL4	0-75	PL81A	0-55	UBF89	0-40	U404	0-55
3B7	0-45	6BW6	0-80	6L7	0-50	12A09	0-70	30C1	0-40	807	1-00	DM71	1-50	ECC80	0-45	EM83	0-55	MHL6	£1	PL82	0-37	UB121	0-77	U801	0-85
3D8	0-40	6BW7	0-70	6L18	0-55	12A19	0-65	30C13	0-80	4033X	0-50	DW4/500	1-00	ECC81	0-45	EM84	0-40	N39	1-10	PL83	0-45	UC92	0-45	VP13C	0-60
3Q4	0-60	6BZ8	0-49	6L19	2-00	12A26	0-85	30C17	0-80	5792	1-00	ECC82	0-45	EM85	1-00	P61	0-50	0-50	0-50	PL84	0-40	UC84	0-75	VP23	0-75
3Q3GT	0-55	6C4	0-35	6LD20	0-75	12A76	0-40	30C18	0-80	6057	1-00	DY87/6	0-35	ECC82	0-45	EM87	0-70	PABC80	0-38	PL84/500	0-40	UC85	0-45	VP41	0-75
384	0-40	6C5G	0-50	6N7GT	0-60	12A77	0-34	30P3	0-50	5060	1-00	DX802	0-35	ECC83	1-25	EMM803	0-60	0-60	0-60	PL85	0-45	UC82	2-00	VT6A	1-85
3V4	0-70	6C6	0-40	6P15	0-31	12A16	0-45	30PL2	0-67	5067	1-00	EBOCC	2-20	ECC84	0-70	0-70	0-70	0-70	0-70	PL505	1-45	UC81	0-40	U120	£1
4C86	0-55	6C8	1-00	6Q7G	0-50	12A17	0-33	30PL1	0-67	7193	0-53	EBOF	1-40	ECC81	0-33	EY31	0-40	PC95	0-60	PL508	0-90	UC82	0-38	U111	0-80
5C88	0-55	6C12	0-33	6Q7(M)	0-55	12A16	0-50	30PL12	0-60	7475	1-00	E83F	1-30	ECC83	0-44	EY83	0-54	PC97	0-38	PL509	1-45	UC81	0-40	U120	£1
5R4G	0-90	6C17	2-00	6Q7GT	0-50	12A17	0-38	30PL13	0-55	9002	1-00	ECC80	0-75	ECC84	0-44	EY84	0-70	PC90	0-48	PL509	1-45	UC81	0-40	U120	£1
5T4	0-40	6C8A	0-40	6R7	0-75	12BA6	0-45	30PL14	0-78	9008	0-30	E92CC	0-60	ECC85	0-40	EY87	0-33	PC94	0-40	PL509	1-45	UC81	0-40	U120	£1
5U4G	0-40	6D0GA	1-25	6R7G	0-60	12BE6	0-50	30L1	0-40	A1834	1-00	E180CC	1-70	ECC86	0-40	EY88	0-40	PC98	0-44	PL509	1-45	UC81	0-40	U120	£1
5V4G	0-50	6C8A	0-75	6SA7	0-44	12BH7	0-50	30L15	0-75	A2134	1-00	E180F	1-00	ECC87	0-40	EY91	0-58	PC98	0-60	PL509	1-45	UC81	0-40	U120	£1
5Y3GT	0-45	6C1A	0-65	6S6GT	0-33	12E1	1-30	30L17	0-70	A3042	1-00	E182CC	1-25	ECC88	0-40	EY40	0-55	PC98	0-50	PL509	1-45	UC81	0-40	U120	£1
323	0-75	6C1A	0-80	6T7	0-44	12F3GT	0-33	30P4M	0-80	AC2/PEN	1-00	E1148	0-53	ECC89	0-40	EY41	0-55	PC98	0-57	PL509	1-45	UC81	0-40	U120	£1
324G	0-45	6C1A	0-75	6R7	0-44	12F7GT	0-60	AC2/PEN	0-80	AC2/PEN	0-80	EAS0	0-27	ECC90	0-40	EY42	0-55	PC98	0-57	PL509	1-45	UC81	0-40	U120	£1
524GT	0-45	6C1A	0-75	6R7	0-44	12F7GT	0-60	AC2/PEN	0-80	AC2/PEN	0-80	EAS0	0-27	ECC91	0-40	EY43	0-55	PC98	0-57	PL509	1-45	UC81	0-40	U120	£1
6/3012	0-60	6CWA	1-00	6K7GT	0-44	12K7GT	0-50	30P19/	1-00	AC2/PEN	0-80	EAS0	0-27	ECC92	0-40	EY44	0-55	PC98	0-57	PL509	1-45	UC81	0-40	U120	£1
6A8G	1-25	6D3	0-60	6R7GT	0-45	12Q7GT	0-45	30P4	0-75	DD	1-00	EABCS0	0-38	ECC93	0-40	EY45	0-55	PC98	0-57	PL509	1-45	UC81	0-40	U120	£1
6AC7	0-49	6DE7	0-75	6U4GT	0-70	12SA7GT	0-55	30PL1	0-85	AC2/PEN	0-80	EABCS0	0-38	ECC94	0-40	EY46	0-55	PC98	0-57	PL509	1-45	UC81	0-40	U120	£1
6AG5	0-27	6DT6A	0-75	6U7G	0-45	12SC7	0-50	30PL13	0-8	AC/TH11-00	1-00	EABCS0	0-38	ECC95	0-40	EY47	0-55	PC98	0-57	PL509	1-45	UC81	0-40	U120	£1
6AR6	0-60	6E6W	0-75	6V6G	0-17	12SG7	0-40	30PL13	0-85	AL60	1-00	EABCS0	0-38	ECC96	0-40	EY48	0-55	PC98	0-57	PL509	1-45	UC81	0-40	U120	£1
6AJ5	0-65	6E3	1-00	6V6GT	0-45	12SH7	0-35	30PL14	1-10	ARP3	0-60	EABCS0	0-38	ECC97	0-40	EY49	0-55	PC98	0-57	PL509	1-45	UC81	0-40	U120	£1
6AK5	0-40	6F1	0-75	6X4	0-40	12SJ7	0-44	30PL15	0-90	ATP4	0-50	EABCS0	0-38	ECC98	0-40	EY50	0-55	PC98	0-57	PL509	1-45	UC81	0-40	U120	£1
6AK6	0-60	6F0G	0-50	6X3GT	0-45	12SN7	0-60	35A3	0-85			EABCS0	0-38	ECC99	0-40	EY51	0-55	PC98	0-57	PL509	1-45	UC81	0-40	U120	£1

All goods are unused, boxed, and subject to the standard 90-day guarantee. Cash or cheque with order. Despatch charges—All orders below £10 in value, add 25p for post and packing. Orders over £10 post and packing free of charge. Same day despatch. Any parcel insured against damage in transit or only 3p extra per parcel. Terms of business free on request. Please enclose S.A.E. for a reply to any correspondence. Many other types in stock too numerous to list.

ENGINEERS

FREE

YOURSELF FOR A BETTER JOB WITH MORE PAY!

Do you want promotion, a better job, higher pay? "New Opportunities" shows you how to get them through a low-cost home study course. There are no books to buy and you can pay-as-you-learn.

This helpful guide to success should be read by every ambitious engineer. Send for this helpful 76 page FREE book now. No obligation and nobody will call on you. It could be the best thing you ever did.



CUT OUT THIS COUPON

CHOOSE A BRAND NEW FUTURE HERE!
Tick or state subject of interest. Post to the address below.

<input type="checkbox"/> Electrical Engineering <input type="checkbox"/> Electrical Installations and wiring <input type="checkbox"/> Electrical Draughtsman-ship <input type="checkbox"/> Electrical Mathematics <input type="checkbox"/> Electronic Engineering <input type="checkbox"/> Computer Electronics <input type="checkbox"/> Computer Programming <input type="checkbox"/> General Radio and TV Engineering	<input type="checkbox"/> Radio Servicing, Maintenance and Repairs <input type="checkbox"/> Transistor Technology <input type="checkbox"/> CITY AND GUILDS Installations and Wiring <input type="checkbox"/> CITY AND GUILDS Electrical Technicians <input type="checkbox"/> CITY AND GUILDS Telecommunications <input type="checkbox"/> Radio Amateurs' Exam. etc. etc.
--	--

To ALDERMASTON COLLEGE Dept EY03 Reading RG7 4PE

NAME (Block Capitals Please) _____

ADDRESS _____

POST CODE _____

Other subjects _____ Age _____

Acredited by C.A.C.C. Member of A.B.C.C.

HOME OF BRITISH INSTITUTE OF ENGINEERING TECHNOLOGY

WITWORTH TRANSFORMERS

MONOCHROME TV Line out-put transformers
(Discounts to Trade)

ALL ONE PRICE £5.72 EACH V.A.T. & CARRIAGE PAID
(£5.45 PERSONAL SHOPPERS)

BUSH	
TUG versions	TV125
TV75 or C	TV125U
TV76 or C	TV128
TV77	TV134
TV78	TV135
TV79	TV135R
TV83	TV138
TV84	TV138R
TV85	TV139
TV86	TV141
	TV145
TV91	TV148
TV92	TV161
TV93	TV165
TV94	TV166
TV95 or C	TV171
TV96 or C	TV175
TV97	TV176
TV98C	TV178
TV99 or C	181S
TV100C	183
TV101C	183D
TV102C	183S
TV103 or D	183SS
TV105 or Dor R	185
TV106	186
TV107	186D
TV108	186S
TV109	186SS
TV112C	1915
TV113	191D
TV115 or Cor R	1935
TV118	193D
TV123	
TV124	

BAIRD				
600	628	662	674	
602	630	663	675	
604	632	664	676	
606	640	665	677	
608	642	666	681	
610	644	667	682	
612	646	668	683	
622	648	669	685	
624	652	671	687	
625	653	672	688	
626	661	673		

Please quote part No. normally found on tx. base plate; 4121, 4123, 4140 or 4142.

DECCA				
DR20	DR34	DR71	DR505	
DR21	DM35	DR95	DR606	
DR23	DM36	DR100	666TV-SRG	
DR24	DM39C	DR101	777TV-SRG	
DR29	DR41	DR121		
DR30	DM45	DR122	MS1700	
DR31	DM55	DR123	MS2000	
DR32	DM56	DR303	MS2400	
DR33	DR61	DR404	MS2401	

SOBELL				
T24	ST284 or ds	1010dst	1033	
SC24	ST285 or ds	1012	1038	
TPS173	ST286 or ds	1013	1039	
TPS180	ST287 or ds	1014	1047	
ST195 or ds	ST288 ds	1018	1048	
ST196 or ds	ST290ds	1019	1057	
ST197ds	ST291ds	1020	1058	
SC270	ST297ds	1021	1063	
T278	1000ds	1022	1064	
ST282	1002ds	1023	1065	
ST283	1005ds	1032	1066	

MURPHY					
V310	V430	V520	V879 or C*	V789	V20155S
V310A	V430C	V530	V923*	V163	V2016S
V310AD	V430D	V530C	V929 or L*	V159	V2017S
V310AL	V430K	V530D	V973C*	V173	V2310
V310CA	V440	V539	V979*	V179	V2311C
V320	V440D	V540	V653X	V1910	V2414D
V330 or D	V440K	V540D	V659	V1913	V2415D
V330F or L	V470	V649D	V683	V1914	V2415S
V410	V480	TM2 Chassis	V739	V2014	V24155S
V410C	V490	V843*	V735	V2014S	V2416D
V410K	V500	V849*	V783	V2015D	V2316S
V420	V510	V873*	V787	V2015S	V2417S
V420K	V519				

PHILIPS				
23TG111a	G19T210	G23T210		
23TG113a	G19T211	G23T211		
23TG121a	G19T212	G23T212		
23TG122a	G19T213	G24T230		
23TG131a	G19T214	G24T232		
23TG142a	G19T215	G24T236		
23TG152a	G20T230	G24T238		
23TG153a	G20T232	G24T300		
23TG156a	G20T236	G24T301		
23TG164a	G20T238	G24T302		
23TG170a	G20T300	G24T306		
23TG171a	G20T301	G24T307		
23TG173a	G20T302	G24T308		
23TG175a	G20T306	G24T324		
23TG176a	G20T307			
23FG632	G20T308			

GEN				
2000	2015	2022	2043	2064
2001	2017	2023	2044	2065
2010	2018	2032	2047	2066
2012	2019	2033	2048	2082
2013	2020	2038	2063	2083
2014	2021	2039		

PYE				
11u Series				
12u				
13u	State Pt. No.			
14u	required			
15u	AL21003 or			
20u	772494			
V700 or A or D				
V710 or A or D	State Pt. No.			
V720	required—			
V830A or D or	772444 or			
LBA	771935			

FERGUSON, ULTRA, MARCONI, H.M.V. (BRC, Jellypots). ALL MODELS IN STOCK.

ALBA, COSSOR, EKCO, FERRANTI, K.B., PYE. ALL MODELS IN STOCK.

E.H.T. RECTIFIER TRAYS (MONOCHROME)

THORN B.R.C. MONOCHROME	ORDER Ref.	
980, 981, 982	RT1	£3.30
911, 950/1, 960	RT2	£3.60
950/2, 1400-5 stick	RT3	£3.90
1400 Portable-3 stick	RT3A	£3.60
1500 20" 3 stick	RT4	£3.60
1500 24" 5 stick	RT5	£3.90
1580 Portable-2 stick	RT16	£3.50
1590, 1591	RT17	£3.30

E.H.T. RECTIFIER TRAYS (COLOUR)

MAKE	CHASSIS COLOUR	
DECCA	CTV19, CTV25	£8.00
DECCA	CS1910, CS2213	£8.00
DECCA	CS1730	£5.80
GEN	Dual & Single std. Valve Type	£6.70
ITT-KB	CVC-1, 2, 3	£7.20
PHILIPS	G8 510-550 Series	£7.20
PYE	691, 692, 693, 697	£6.70
PYE	713 CT200	£6.40
BUSH MURPHY	Single std plug-in	£8.00
BUSH MURPHY	Dual standard	£9.80
THORN BRC	2000	£8.00
THORN BRC	3000	£7.10
THORN BRC	8000	£4.10
THORN BRC	8500	£7.00
GEN	Solid State 90°	£8.50
PYE	CT262 & 266 731 Chassis	£7.40

COLOUR TV Line out-put transformers

THORN (BRC)	BUSH	EKCO	
2000 Chassis	CTV25 Mk. 1 & 2	CT102	
Scan O/P T.x.	£12.00 ea.	CT104	£13.00 ea.
EHT O/P T.x.		CT103	
3000 Chassis	CTV25 Mk.3	CT105	
Scan O/P T.x.	CTV162	CT106	
EHT O/P T.x.	£7.90 ea.	CT107	
8000 Chassis	CTV167 Mk.1 & 2	CT108	
£12.00 ea.	£12.00 ea.	CT109	
8500 Chassis	CTV174D	CT111	
All £6.80 ea.	CTV182S	CT120	
	CTV184S	CT121	&/T
	CTV187CS	CT122	£9.90 ea.
	CTV194S		
	CTV197C		
	CTV199S		
	£7.90 ea.		
ITT-KB	DECCA	PYE	
CVC1 Chassis	CTV19 Valve Rec.	CT70	
CVC2 " "	CTV25 " "	CT71	£13.00 ea.
CVC5 Chassis	Primary Coil	CT72	
£7.10 ea.	£3.70 ea.	CT73	
		CT78	
		CT79	
		CT152	
		CT153	
		CT154	£9.90 ea.
PHILIPS	DECCA	MURPHY	
G6 Chassis D/S	CTV19 D/S Tripler	CV1912	CV2510 Mk.3
G6 " S/S	CTV25 S/S Tripler	CV1916S	CV2511 Mk.3
£9.40 ea.	CS1730	CV2210	CV2516S
	CS1910	CV2212	CV2610
	CS2030	CV2213	CV2611
	CS2213	CV2214	CV2614
G8 Chassis	CS2220		£7.90 ea.
£8.32 ea.	CS2225	CV2510 Mk. 1 & 2	
	£7.24 ea.	CV2511 Mk. 1 & 2	£12.00 ea

Most items listed stocked. Most newer and older models in stock. S.A.E. for quotation
For by-return service contact your nearest depot. Callers welcome.

Tidman Mail Order Ltd., Dept. NA.
236 Sandycombe Road,
Richmond, Surrey.
London: 01-948 3702
MON - FRI 9 am to 12.30 pm 1.30 pm to 4.30 pm
SAT 10 am to 12 noon

Hamond Components (Midland) Ltd., Dept. NA.
89 Meriden Street,
Birmingham 5.
Birmingham: 021-643 2148

NO HIDDEN EXTRAS - PRICES INCLUDE V.A.T. and CARRIAGE

The Sinclair DM2 Multimeter.

Comprehensive. Accurate. Portable.

And really rugged.

Yet only £59. (PLUS VAT)



State-of-the-art circuit design, incorporating high-quality components, has resulted in a professional, 3½ digit instrument of outstanding performance and reliability at a realistic price.

A custom-designed MOS LSI digital processing IC controls the auto-polarity dual-slope-integration A to D converter. The circuit built around this IC uses a MOSFET op-amp input buffer with 0.1% metal-film resistors. The result is excellent accuracy and stability with a very high basic input impedance.

The instrument reads to ± 1999 and has a basic accuracy on the 1 V DC range of $0.3\% \pm 1$ digit. Four 8 mm LED displays provide excellent legibility and angle of view.

Battery operation allows complete independence of mains supply.

The Sinclair DM2 has all the capability you need. Just take a look at its features and compare them with higher-priced multimeters. You'll find the DM2 is their equal in virtually everything – except price!

Features of the Sinclair DM2

5 functions giving 22 ranges

DC volts – 1 mV to 1000 V
AC volts – 1 mV to 500 V
DC current – 0.1 μ A to 1 A
AC current – 1 μ A to 1 A
Resistance – 1 Ω to 20 M Ω

Easy to use

Automatic polarity, bush-button selection for all ranges and modes from a single input terminal pair.

Easy to read

Big, bright 8 mm LED display gives a quick, clear reading.

3½ digit display

Display reads from 000 to 1999.

Overload indicator.

Protected

Separate fuses for current and resistance circuits.

Accurate

Dual slope integration. High stability.

Rugged construction

Tough metal casing takes the roughest treatment – try standing on it!

Two power sources

Supplied with a 9 V battery, giving 60-hour typical life. Mains adaptor also available.

Portable

Weights only 2½ lb approx, including battery.

Measures only 2 in x 9 in x 6 in approx.

Optional extras

Mains adaptor – £2.43 inc VAT.
Carrying case – £5.40 inc VAT.

12-month no-quibble guarantee

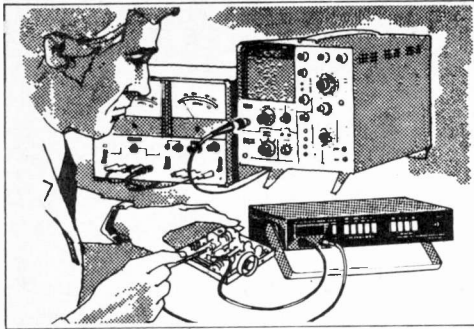

Use it in your laboratory. The DM2 sits rigidly on its combined carrying handle/stand.

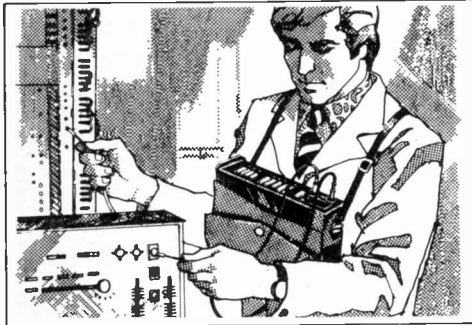

Use it on the move. Keep the DM2 in its carrying case – it's always ready for use.

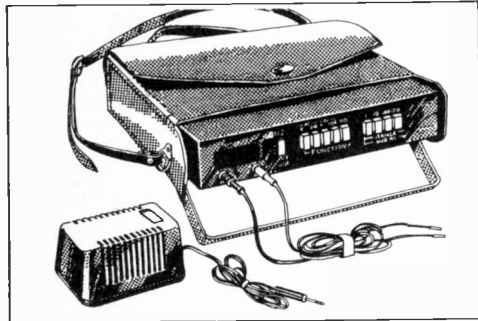

All you need to use the DM2... anywhere. Mains adaptor... carrying case... multimeter... you're ready for quick, efficient metering – whatever the situation.

Take advantage of this money-back, no-risk offer today

Test the Sinclair DM2 for yourself. Simply send us a cheque, your Access/Barclaycard number, or an official company order, with the coupon below. And in the unlikely event you find it's not what you need, return it to us within 10 days and we'll refund your money in full.

Interested in a quantity discount?

Use the coupon to arrange a demonstration and get details of prices on 5 or more instruments.

Sinclair Radionics Ltd,
London Road, St Ives, Huntingdon,
Cams., PE17 4HJ.

Tel: St Ives (0480) 64646.

VAT Registration No: 213 8170 88.

The Sinclair DM2 Multimeter: full technical story

DC Volts Range	Accuracy	Input Impedance	Resolution
1 V	0.3% ± 1 Digit	> 100 MΩ	1 mV
10 V	0.5% ± 1 "	10 MΩ	10 mV
100 V	0.5% ± 1 "	10 MΩ	100 mV
1000 V	0.5% ± 1 "	10 MΩ	1 V

Maximum overload – 350 V on 1 V range
1000 V on all other ranges.

AC Volts Range	Accuracy	Input Impedance	Frequency Range
1 V	1.0% ± 2 Digits	10 MΩ/40 pF	20 Hz–3 KHz
10 V	1.0% ± 2 "	10 MΩ/40 pF	20 Hz–3 KHz
100 V	2.0% ± 2 "	10 MΩ/40 pF	20 Hz–3 KHz
1000 V	2.0% ± 2 "	10 MΩ/40 pF	20 Hz–1 KHz

Maximum overload – 300 V on 1 V range
500 V on all other ranges.

DC Current Range	Accuracy	Input Impedance	Resolution
100 μA	2.0% ± 1 Digit	10 KΩ	100 nA
1 mA	0.8% ± 1 "	1 KΩ	1 μA
10 mA	0.8% ± 1 "	100 Ω	10 μA
100 mA	0.8% ± 1 "	10 Ω	100 μA
1000 mA	2.0% ± 1 "	1 Ω	1 mA

Maximum overload – 1 A (fused).

AC Current Range	Accuracy	Frequency Range
1 mA	1.5% ± 2 Digits	20 Hz–1 KHz
10 mA	1.5% ± 2 "	20 Hz–1 KHz
100 mA	1.5% ± 2 "	20 Hz–1 KHz
1000 mA	2.0% ± 2 "	20 Hz–1 KHz

Maximum overload – 1 A (fused).

Resistance Range	Accuracy	Measuring Current
1 KΩ	1.0% ± 1 Digit	1 mA
10 KΩ	1.0% ± 1 "	100 μA
100 KΩ	1.0% ± 1 "	10 μA
1000 KΩ	1.0% ± 1 "	1 μA
10 MΩ	2.0% ± 1 "	100 nA

Overload protection – 50 mA (fused).

To: Sinclair Radionics Ltd, FREEPOST, St Ives, Huntingdon, Cams., PE17 4BR.

Please send me:

..... Multimeters @ £63.72
inc VAT.

..... Mains adaptors @ £2.43
inc VAT.

..... Carrying cases @ £5.40
inc VAT.

I am interested in 5 or more multimeters.

..... Please arrange a demonstration.

..... Please send details of quantity discounts.

*I enclose a cheque for £

*My Access/Barclaycard number:

*I enclose an official company order – signed and dated.

*Please complete or delete as applicable.

Name

Address

Please print

FREEPOST – no stamp needed with address above.

T/3/75

sinclair

Marshall's

A. Marshall & Son (London) Limited Dept. T
42 Cricklewood Broadway London NW2 3HD Tel: 01-452 0161
& 85 West Regent Street Glasgow G2 2QD Tel: 041-332 4133

Everything you need is in our new 1975 catalogue. Available now price 25p

Trade and export enquiries welcome

PW TELE TENNIS KIT

As featured on B.B.C. Nationwide and in the Daily Mail Oct 2nd 1974

This exciting new game is now available in kit form. Due to popular demand we are now able to offer a fantastic saving on list prices. Ideal game for whole family. No need to modify your TV set, just plugs in to aerial socket.

Parts list as follows . . .

A Resistor Pack	£1.00 p.p. 20p
B Potentiometer Pack	£1.25 p.p. 20p
C Capacitor Pack	£3.10 p.p. 20p
D Semiconductor Pack	£14.50 p.p. 20p
E IC Sockets	£4.00 p.p. 20p
F Transformer	£1.15 p.p. 25p
G PCB's	£7.50 p.p. 20p
H Switches	£4.50 p.p. 20p
I UHF Modulator Kit	£7.30 p.p. 20p

Special Prices—complete kit excluding case £42.00 p.p. 50p. Sections A-F incl. £23.50 p.p. 30p. Assembly instructions with complete kit or 75p on request.

SN7400	16p	SN7420	16p	SN7453	16p	SN7491	£1.10
SN7401	16p	SN7423	37p	SN7454	16p	SN7492	75p
SN7401AN	38p	SN7425	37p	SN7460	16p	SN7493	65p
SN7402	16p	SN7427	45p	SN7470	30p	SN7494	85p
SN7403	16p	SN7430	16p	SN7472	38p	SN7495	80p
SN7404	24p	SN7432	45p	SN7473	44p	SN7496	£1.00
SN7405	24p	SN7437	35p	SN7474	48p	SN74100	£2.16
SN7406	45p	SN7438	35p	SN7475	59p	SN74107	43p
SN7407	45p	SN7440	16p	SN7476	45p	SN74118	£1.00
SN7408	25p	SN7441	85p	SN7480	75p	SN74119	£1.92
SN7409	33p	SN7442	85p	SN7481	£1.25	SN74121	57p
SN7410	16p	SN7445	£1.59	SN7482	87p	SN74122	80p
SN7411	25p	SN7446	£2.00	SN7483	£1.20	SN74125	72p
SN7412	28p	SN7447	£1.30	SN7484	95p	SN74141	£1.00
SN7413	50p	SN7448	£1.50	SN7485	£1.58	SN74150	£1.44
SN7416	45p	SN7450	16p	SN7486	45p	SN74190	£1.95
SN7417	30p	SN7451	16p	SN7490	65p		

TRY OUR NEW GLASGOW SHOP

Prices correct at February 1975, but exclusive of VAT.
Post and Package 20p postage and package charges.

Popular Semiconductors

2N696	0-22	2N3707	0-13	AD142	0-50	BC309	0-10	LM709T099	
2N697	0-16	2N3708	0-70	AD143	0-60	BC327	0-21		0-48
2N698	0-40	2N3715	1-50	AD161	0-45	BC328	0-19	BD1L	0-38
2N699	0-45	2N3716	1-80	AD162	0-45	BCY70	0-17	I4D1L	0-40
2N1302	0-19	2N3771	2-20	AD161	0-45	BCY71	0-22	LM723C	0-90
2N1303	0-19	2N3772	1-80	AD162	1-05	BCY72	0-13	LM74IT099	
2N1304	0-24	2N3773	2-65	AF109R	0-40	BD123	0-82		0-40
2N1305	0-24	2N3819	0-37	AF115	0-24	BD131	0-40	BD1L	0-40
2N1306	0-31	2N3820	0-38	AF124	0-30	BD132	0-50	I4D1L	0-38
2N1307	0-22	2N3823	1-42	AF125	0-30	BD135	0-42	LM747	1-00
2N1308	0-25	2N3904	0-27	AF126	0-28	BD136	0-49	LM7805	2-00
2N1309	0-36	2N3905	0-24	AF127	0-28	BD137	0-55	MC1310	2-92
2N1671	1-44	2N4036	0-63	AF139	0-39	BD138	0-63	MJ480	0-90
2N1671A	1-54	2N4037	0-42	AF178	0-55	BD139	0-71	MJ481	1-14
2N1671B	1-72	2N4126	0-20	AF179	0-65	BD140	0-87	MJ490	0-98
2N1671C	4-32	2N4289	0-34	AF180	0-58	BF115	0-25	MJ491	1-38
2N2102	0-50	2N4921	0-73	AF239	0-51	BF116	0-23	MJE340	0-45
2N2147	0-78	2N4922	0-84	AF240	0-72	BF117	0-43	MJE355	1-12
2N2148	0-94	2N4923	0-83	AF279	0-54	BF154	0-16	MJE3055	0-68
2N2160	0-60	2N5190	0-92	AF280	0-54	BF163	0-32	MFC4000B	40
2N2218A	0-23	2N5191	0-95	BC107	0-16	BF180	0-35	MFC4010A	49
2N2219	0-26	2N5192	1-24	BC108	0-15	BF181	0-34	MFC40600-0-51	
2N2219A	0-60	2N5195	1-46	BC109	0-19	BF184	0-30	MFC60400-0-91	
2N2221	0-18	2N5245	0-47	BC147	0-12	BF194	0-12	NE555A	0-70
2N2221A	0-21	2N5457	0-49	BC148	0-13	BF195	0-12	NE560D	4-48
2N2222	0-20	2N5458	0-45	BC149	0-12	BF196	0-13	NE561	4-48
2N2222A	0-25	2N5459	0-49	BC167B	0-13	BF197	0-15	NE565A	4-48
2N2646	0-55	40361	0-48	BC168B	0-13	BF198	0-18	OC28	0-76
2N2904	0-22	40362	0-80	BC168C	0-11	BF200	0-40	OC42	0-50
2N2904A	0-24	40363	0-88	BC169B	0-13	BF237	0-22	OC71	0-17
2N2905	0-24	40406	0-44	BC169C	0-13	BF238	0-22	OC72	0-25
2N2905A	0-26	40407	0-33	BC182	0-12	BF239	0-30	SL414A	1-80
2N2906	0-19	40408	0-50	BC182L	0-12	BFX30	0-27	TAA263	1-00
2N2906A	0-21	40409	0-52	BC183	0-12	BFX84	0-24	TBA800	1-50
2N2907	0-22	40410	0-52	BC183L	0-12	BFX85	0-30	TBB10	1-50
2N2907A	0-24	40411	2-25	BC184	0-13	BFX87	0-28	TIP29A	0-49
2N2928	0-11	40502	0-46	BC184L	0-13	BFY89	0-25	TIP30A	0-58
2N3053	0-32	40604	0-56	BC212K	0-16	BFY98	0-90	TIP31A	0-62
2N3054	0-60	40669	1-00	BC212L	0-16	BFY19	0-62	TIP328	0-74
2N3055	0-75	AC117	0-20	BC214L	0-17	BFY51	0-23	TIP33A	1-01
2N3441	0-97	AC126	0-20	BC237	0-13	BFY52	0-21	TIP34A	1-51
2N3442	1-69	AC127	0-20	BC238	0-13	BFY90	0-60	TIP35A	2-90
2N3415	0-10	AC129	0-20	BC239	0-13	BRV39	0-48	TIP36A	3-70
2N3416	0-15	AC151V	0-26	BC257	0-13	C1060	0-65	TIP41A	0-79
2N3417	0-21	AC152V	0-17	BC258	0-13	CA3020A	1-80	TIP42A	1-80
2N3702	0-11	AC153K	0-25	BC259	0-14	CA3046	0-70	TIP2955	0-93
2N3703	0-12	AC176	0-18	BC300	0-26	CA3048	2-11	TIP3055	0-60
2N3704	0-14	AC176K	0-25	BC301	0-34	CA3089E	1-96	ZTX 300	0.13
2N3705	0-12	AC187K	0-23	BC307	0-11	CA3090	4-23	ZTX 302	0.20
2N3706	0-09	AC188K	0-34	BC308	0-12	LM301A	0-46	ZTX 500	0.15

when you want spares yesterday...



YOU NEED A FRIEND!

same-day despatch is as near as your telephone - try it!

Stockists of genuine manufacturers spares for Rank Bush Murphy . . .
 CES . . . Pye . . . Philips . . . Invicta . . . Pam . . . Ekco . . . Ferranti
 BRC . . . Ferguson . . . Ultra . . . Marconi . . . HMV . . . Stockists of
 TELEPART SPARES for Decca . . . KB . . . GEC . . . Sobell
 Masteradio . . . RGD etc. Line output transformers . . . EHT rectifier trays
 Scan coil assemblies . . . Frame and sound outputs . . . Dropper sections
 Entertainment valves . . . Transistors and integrated circuits . . .
 Components . . . Cathode ray tubes . . . Meters . . . Test equipment . . .



4-5 THE BROADWAY - HANWELL LONDON W7 01-567 5400
 74 MAXWELTON RD - PAISLEY RENFREW 041-887 4949
 42 WEST END - STREET SOMERSET 045-84 2597

Ask for your free copy of our 68-page catalogue.

TELEVISION

SERVICING · CONSTRUCTION · COLOUR · DEVELOPMENTS

VOL 25 No 5
ISSUE 293

MARCH 1975

CIRCUIT SYMBOLS

Standardisation of the symbols used in electronic circuits is of course an excellent aim. It would not help the service engineer, or anyone else for that matter, if each setmaker adopted his own set of symbols. There has always been a degree of standardisation, but in recent years our standard setter, the British Standards Institution, has been making a great effort to decide what everyone should do and to make its decisions known. With what results?

It sometimes seems, as modification follows modification, that the BSI is wasting its time—and everyone else's—in its endeavours. Why is it necessary to keep chopping and changing the recommendations for even such simple matters as how to show a diode? BSI might bear in mind that we did at one time have a fairly basic set of circuit symbols that everyone knew and understood: what could be clearer and more to the point than the traditional capacitor, resistor and diode symbols? They could be readily recognised and anything unusual in the circuit stood out.

Confusion probably reached a peak with the rapid introduction of new semiconductor devices. But a large degree of standardisation occurred long before the standardisers decided to lay down the law. The more common devices—transistors, zeners, thyristors—were soon given a readily recognisable circuit presentation, though the various forms of f.e.t. caused problems. What those responsible for circuit drafting instinctively achieved was not good enough for the standardisers however.

The BSI has already persuaded most drawing offices to replace the gloriously apposite traditional resistor zigzag with those horribly undistinguished little boxes (which become a total mess in the case of thermistors, v.d.r.s etc.). More recently it has been having another go at the diode symbol: the solid black arrowhead is to be left open, but with a line through it. Perhaps BSI decided to unleash this latest horror on us by way of reprimand since no one would follow their earlier recommendation that all diodes should have a circle round them like transistors. No one, thinking farther back, would follow the fatuous suggestion to drop the term transmitter in favour of sender. At least we should perhaps be thankful that they haven't so far had a go at the capacitor, though probably right now some committee is busy trying to decide on "something completely different". One point that seems to have escaped the notice of the BSI is that circuits are used by the servicing trade for

many years: thus the opposite of standardisation is achieved as the BSI's fancies change year by year, with the result that a batch of manuals issued by a single manufacturer over a period of years will (if BSI fashions are religiously followed) show circuit diagrams in a wild conglomeration of styles.

The traditional circuit symbols have two great merits. They do symbolise component function in the circuit, and they stand out. Those resistor boxes just don't stand out in the way that the traditional resistor symbol does, neither do they seem to indicate in any way what the component is there for. It seems to be some kind of law of nature unfortunately that whatever the standardisers come up with will be inferior to what was previously in common use. Standardisation is a good intention: the current approach to it however has failed to achieve anything much that one can honestly say is of positive value.

L. E. HOWES—*Editor*.

THIS MONTH

Teletopics	200
Colour Receiver Pre-Installation Checks	
<i>by Vivian Capel</i>	202
Using Tuners as Preamplifiers	<i>by Hugh Cocks</i> 206
Servicing Television Receivers—Decca	
MS1700/MS2001/MS2401, continued	
<i>by L. Lawry-Johns</i>	208
Review of the Heathkit GR9900 Monochrome	
Portable	<i>by R. A. Philby</i> 210
Closed Circuit Television, Part 12	<i>by Peter Graves</i> 213
Grey-Scale Generator	<i>by L. Cook, B.Sc.(Hons.)</i> 216
Service Notebook	<i>by G. R. Wilding</i> 222
Jelly Pot LOPTs and Stick EHT Rectifiers	
<i>by John Law</i>	225
A Watery TV Fault	<i>by Steven Knowles</i> 227
Long-Distance Television	<i>by Roger Bunney</i> 228
Your Problems Solved	231
Test Case 147	233

THE NEXT ISSUE DATED APRIL
WILL BE PUBLISHED ON MARCH 17

Held-over: Due to shortage of space in this issue Part 3 of the series on Video Circuits and Faults, covering colour receiver luminance and colour-difference stages, has been held over till next month.

TELETOPICS

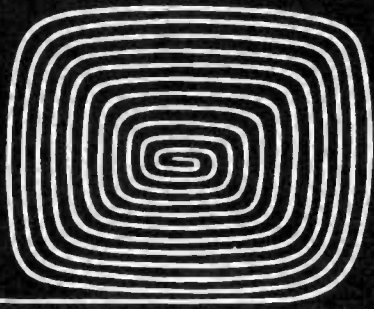

TELEFUSION SELL COLOUR TV PLANT

Telefusion, who went into the business of making TV sets because they were unable to get sufficient supplies during the boom period back in 1973, are selling their Kearsley (Lancashire) plant to ITT Consumer Products. The plant is capable of turning out some 2,500 sets a week though it has never operated at full capacity. Telefusion have been making and selling sets under the brand name Telpro: the chassis is electrically very similar to the Decca series 30 chassis. Unfortunately the plant came into operation just as the boom ended following the reimposition of credit restrictions in December 1973. Telefusion say that the factory had been profitable but not giving them the return on investment they achieve from their traditional activities. ITT on the other hand had been considering setting up new plant.

AERIAL ISOLATION PANELS

From the safety point of view one of the most important sections of a live-chassis TV receiver is the network of components on the aerial isolation panel. These components are made to special standards but can nevertheless be damaged by electrostatic charges. In a recent issue of the Thorn technical bulletin *Scope* it is recommended that the isolation panel should always be tested before a receiver is returned after servicing—especially if the receiver has seen long service. The following two procedures are suggested. First, testing with a 500V Megger connected between the chassis and the aerial socket—check both the inner and outer coaxial connections: the reading obtained should correspond with the value of the leak resistor (if fitted) across the isolating capacitor. If a Megger is not available the following procedure can be used. Connect the set to the mains so that its chassis is live (but don't return it connected in this manner!). Then check the current reading, using an Avo or similar meter, between the neutral mains terminal and the aerial socket. If a leak resistor is fitted the current reading will depend on its value: it should not normally exceed 500 μ A. Thorn point out that a neon tester can give misleading results as the normal current through a leak resistor will cause it to light.

LOCAL TV IN TROUBLE?

Whilst the idea of community TV—local-interest programmes distributed via a cable TV network—is very commendable it has always been difficult to see that there would be any great demand for it. Now, the first such experimental service to be started, run by

Greenwich Cablevision, has announced that it has had to severely curtail its operations. The permanent staff have been made redundant and the number of hours weekly reduced to three, at the weekend, with a further two hours' repeats. The service was costing £30,000 a year to run: the reduced service will cost about £3,000 a year and be run by local people who have become involved in the experiment. Greenwich Cablevision say they were unable to continue the operation on the original scale until the Annan committee reports—during the present experimental period cable TV companies are not allowed to charge extra for including in their service a community TV channel. It had been hoped that an increase in the number of subscribers would have met the cost of the local interest programmes.

RELIABILITY

The subject of set reliability continues to haunt us. Some time ago we reported a representative of one of the largest setmakers pointing out that a very precise equation could be worked out to assess whether or not increased production costs would be worthwhile. How this went was that if the use of improved assembly methods, more testing, or components with more generous ratings or tighter specifications resulted in a saving of service calls so that a certain "market dissatisfaction" level was not exceeded they would be worth adopting. If on the other hand the added production costs had little effect on service calls—during the guarantee period presumably, when most faults do show up—they would not be worthwhile. Now we appreciate that the engineering of goods for the mass domestic consumer market is a matter of compromise: little would be sold if all goods were produced to Rolls Royce standards. Nevertheless it seems to us that the costings have been rather too much towards production savings—a case of the accountants having the final say perhaps?—and that the importance of that vital ingredient for long-term growth and success, a reputation for reliability, has not been given sufficient consideration. In this connection we were appalled to learn that the RCA service division, which was set up early last year to provide a centralised repair service to the trade, covering all brands, and is at present operating from some half dozen centres, spends sixty per cent of its time on "broken wires and badly soldered joints made at the factory".

Clearly things are far from good enough, though they are said to be improving. Exactly what is wrong is not so easy to say, but components tend to be to international specifications nowadays and test procedures seem much the same from country to country,

leaving the feeling that it's something to do with what goes on in between, i.e. the actual assembly methods. Perhaps it's relevant to recall that a senior executive of a major UK concern commented a while ago after being shown around a Japanese competitor's plant that what he ran was "a cottage industry". Maybe so, but small-scale production doesn't have to be inefficient. It would surely be worthwhile spending a little more on improved production techniques in order to achieve the reputation for reliability that in recent years seems to have gone to imported goods by default.

A final thought. Why were so many dealers unable to locate broken wires and dry-joints?

RELAY STATION OPENINGS

The following relay stations are now in operation:

Bala (North Wales) ITV channel 23 carrying HTV Wales programmes. Receiving aerial group A.

Ferndale (South Wales) BBC-Wales channel 57, ITV channel 60 carrying HTV Wales programmes, BBC-2 channel 63. Receiving aerial group C/D.

Oxenhope (West Yorkshire) BBC-1 channel 22, BBC-2 channel 28. Receiving aerial group A.

Porth (South Wales) ITV channel 43 carrying HTV Wales programmes. Receiving aerial group B.

All these transmissions are vertically polarised.

NEW TV ICs

Texas Instruments (Bedford) are now producing in volume a group of three i.c.s which together form a complete PAL decoder. The aim has been to maintain or enhance performance whilst reducing to the minimum the number of associated peripheral components required and the number of preset adjustments necessary. The type numbers of the i.c.s are SN76226N, SN76227N and SN76228N. The SN76227N has been in production for a while and appears to interchange with the Motorola MC1327P. It carries out the processes of chrominance signal demodulation, RGB matrixing and the PAL switch, with emitter-follower outputs. The SN76226N "luminance processor" contains the luminance channel, with tracking contrast amplifiers, gated black-level clamp, beam limiter, line flyback pulse processor for a.g.c. gating and the sync separator. It directly drives both the luminance and the chrominance delay lines from buffered amplifiers. The SN76228N "chrominance processor" contains the chrominance amplifier with a.c.c., the reference oscillator with its control loop, the PAL ident circuit and colour killer. That's a lot to get into just three i.c.s, and our accompanying photograph compares the

new three-i.c. decoder with the previous Texas PAL decoder design. The use of d.c. contrast, brightness and saturation controls eliminates the need for expensive screening.

Direct coupled RGB output stages are suggested but it is recommended that to reduce drift and the loading on the SN76227N a two-stage circuit is used. There are two recommendations for this. Either a npn emitter-follower driving an npn output transistor so that the base-emitter voltage drifts cancel (the two transistors should ideally be mounted on the same heatsink); or alternatively a cascode output circuit (since the output transistor in this arrangement is current driven and operates in the common-base mode, drift is unimportant).

What with that and a complete TV sound channel i.c. from SGS-ATES, colour receivers will soon look inside rather like the monochrome portables of not so long since (especially with the use of self-converging colour c.r.t.s). SGS-ATES's TV sound i.c. is the TDA1190 which was previewed by J. Matthews in our May 1974 issue and has now been released. It contains the intercarrier sound channel, demodulator, a.f. preamplifier and output stage, with provision for d.c. volume control. The high input impedance of the TDA1190 enables it to be used conveniently with a 6MHz ceramic input filter. 4.2W of audio output into 16 Ω with a supply of 24V can be obtained, or 1.5W into 8 Ω at 12V. No shielding is required.

ITT Semiconductors have announced a range of 15 and 30 channel i.c.s for use in TV set remote control systems.

NEW CHASSIS

Grundig's latest colour receiver, Model 2210, is fitted with a new chassis featuring thirteen plug-in modules. A 22in., 110° in-line gun/slotted shadowmask tube is used. To aid servicing Grundig have designed a diagnostic adaptor which fits into a socket at the rear of the chassis and gives a visual indication—by means of l.e.d.s.—of any faulty circuit sections.

Last month we mentioned the new Bush Model BC6100 colour receiver which is fitted with an 18in. 110° in-line gun c.r.t. We have now had a chance to look over the circuit and find that the set uses a completely new RRI chassis. The decoder is of the Mullard three-i.c. variety (TBA560C/TBA540/TCA800). This is the first time we have come across the use of a TCA800 chrominance demodulator/RGB matrix i.c. in a production chassis. The RGB output stages consist of npn/npn transistor pairs (see note on Texas i.c.s above). Amongst a number of other integrated circuits used in this chassis another to appear for the first time in a UK produced set is the TBA950 sync separator/line oscillator i.c. Like the TBA920, this includes provision for switching to VCR operation. The most unusual feature for a solid-state chassis however is that the h.t. rail is not stabilised: instead, separate stabilisation is applied to the c.r.t. first anode supplies, the line and field timebases, the l.t. supplies and elsewhere in the circuit. The field timebase is one of the most unusual we have come across, with the raster correction tap-off points to the E-W amplifier/modulator in the field driver circuit. The field convergence circuits are also fed from the same point, via a class B single-ended push-pull amplifier of the type one is used to seeing in audio equipment. We are planning to publish a separate article on the novel techniques used in this chassis.

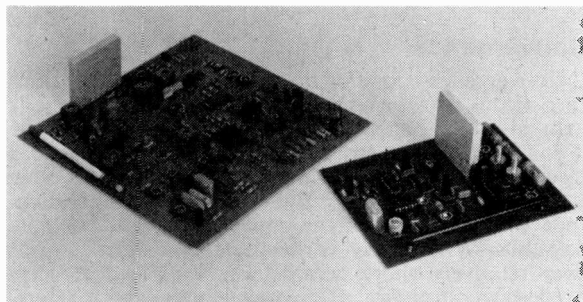

The Texas Instruments three-i.c. decoder, right, compared to its four-i.c. predecessor.

COLOUR RECEIVER PRE-INSTALLATION CHECKS

VIVIAN CAPEL

"I've never seen such natural colour as that!" The speaker was a customer who had come into the workshop to discuss a repair to his monochrome set and happened to notice a new colour set running on a pre-delivery test. The set, a Philips 520, had been checked and set up according to the maker's service instructions and was now producing a very good picture on the afternoon live transmission.

As many non-colour television set owners' experience of colour reception is limited, the remark could have been dismissed as coming from someone who had seen only one or two sets that were badly adjusted or receiving a poor quality early colour film. This was by no means an isolated remark however and in fact comments of this type from workshop visitors who see new sets on test are so common that we have come to take them for granted.

Could it be the make of set? Not in itself. One lady who had gone elsewhere where the discounts were higher had turned down one of the very models she later came in and enthused about. Enquiries farther afield suggest a similar state of affairs elsewhere. After watching an appalling picture last year in the TV lounge of a south-coast hotel I found that the general consensus of opinion among the guests was that colour still had a long way to go. Some said they had been put off buying a set by the poor results they had seen so far. Yours truly kept very quiet and later made a few surreptitious internal adjustments after everyone else had gone to bed. Subsequent events make quite a story in themselves but are beyond the scope of this article.

Now it's true that many owners, especially new ones, tend to like the colour control to be too far advanced. This could be partly responsible for the unnatural colour complained about by others. The evidence suggests however that this is only part of the trouble and that the main problem is that many dealers do not adequately check and set-up receivers before sale.

The problem is aggravated by the discount houses. As a rule they sell sets in the carton or make only a cursory check to see that a set is working. By law they now have to give proper service in the event of a fault under guarantee, but substandard performance due to poor initial setting-up can and does pass. The customer may not be aware that better results could be obtained or, if he is, may be unable to describe the shortcomings to the discount salesman. There must in fact be many thousands of colour sets giving less than their best simply because of inadequate pre-installation adjustment.

Most receivers are adjusted by the makers before dispatch. The amount of adjustment needed is usually only slight therefore and some of the settings do not need altering at all. It is also a fact that dealer's workshops must be run on an economic basis and that a lengthy period spent by a qualified colour engineer going through every adjustment and virtually realigning the decoder would be expensive and impossible to justify, especially when most of the work would be unnecessary.

The maker's installation instructions usually set out the adjustments in detail. It is not necessary to go through every one, as long as the end result of each adjustment is checked. It is perhaps because so little adjustment is in most cases required that the pre-installation check is frequently ignored altogether, leading to the situation we have described.

Purity

Take for example the purity adjustment. If done strictly according to the book this involves removing the pattern or noise from the raster by disconnecting the i.f. signal, switching off the blue and green guns, cancelling the purity magnets by setting them in line with each other, moving the deflection coils forward on the tube neck to produce a small area of red, then centring the red ball with the magnets and finally sliding the coils back until the whole screen is filled with a pure red area. A check must then be made on the purity of the green and blue rasters, with their respective guns turned on and the others off.

Rarely is all this necessary. An initial check can be made by tuning in a black-and-white picture, either from a broadcast transmission or from a pattern generator, and then turning the contrast and colour controls to the minimum. The picture can then be examined all over to see whether the white is of the same tone in all parts, ignoring any colour fringing effects due to misconvergence. If it is there is little wrong with the purity, but if there is a slight tint of colour in one part of the picture adjustment must be made.

Even then it is not usually necessary to go through the whole procedure. The deflection coils are held in place by wing nuts on the yoke and rarely move in transit unless the nuts are loose. All that is needed in most cases is to switch off the blue and green guns after which the colour patch can be cleared by slight adjustment of the magnets. If a blank raster can be obtained easily by pulling a plug this will facilitate the adjustment; if not, adjustment can be done on a weak stationary picture or pattern.

Convergence

Convergence is one of the most common operations carried out by the engineer. According to the maker's manual it is a long and laborious job, and so it can be if you have to start from scratch. The newly unpacked receiver will have been converged by the makers however and will not need the whole works therefore. Indeed in many cases the convergence will be quite passable. With many earlier sets convergence drift over relatively short periods was experienced. They needed reconverging at frequent intervals therefore. The stability of more recent models is much better however, due not only to improved circuitry and stabilising but also to built-in compensatory character-

Heathkit televisions begin as they mean to go on.

At Heathkit we go to great lengths to make sure that the kits we produce represent the ultimate in quality and reliability.

And, in order to achieve that end, every kit has to be right. Right from the beginning.

Our GR-9900 black and white television is no exception. It has a factory pre-assembled and aligned UHF tuning unit which gives you low cross modulation, no overload on strong signals and sensitivity which is much higher than most.

It also has exceptionally good frequency stability. And the use of four highly advanced integrated circuits ensure performance and reliability second to none.

We haven't forsaken looks either. The GR-9900 comes in a beautifully finished white cabinet that would look good anywhere.

At home, or in the caravan or boat. (The GR-9900 can be operated

from the mains or a 12V battery.)

For more details and a free Heathkit catalogue showing the rest of our wide range of kits, just post the coupon.

Or call into the London Heathkit Centre, 233 Tottenham Court Road, or our showroom in Bristol Road, Gloucester.

And we'll show you exactly what the end result of a Heathkit television kit looks like.

Heath (Gloucester) Limited,
Dept. TV-35, Bristol Road,
Gloucester, GL2 6EE. Telephone:
Gloucester (0452) 29451.



To: Heath (Gloucester) Limited, Dept. TV-35, Gloucester, GL2 6EE.
Please send me my free Heathkit catalogue.

Name _____

Address _____

Remember easy terms are available with the Heathkit Monthly Budget Plan

HEATH

Schlumberger

istics in the shadowmask tube. It is nevertheless often found that adjustments are needed following a short settling-down spell from new, usually after no more than a few hours.

After checking the purity and adjusting if necessary the convergence should be examined therefore. This can be done with a crosshatch pattern or even a test card. Setmakers usually recommend converging the different colours separately: many engineers however find it quicker and less of a strain on the eyes to carry out convergence with all guns on and a white pattern displayed. As some adjustments are interdependent the effect on other parts of the display can immediately be seen.

Static

If you use the test card the convergence of the noughts and crosses game in the centre can be observed and any colour that is displaced can be corrected by altering the setting of the appropriate static convergence magnet. These are set at 120° angles around the deflection yoke, the bottom left being green, bottom right red and top blue, looking in at the back of the set. The rotatable magnet fitted to a small clamp on the tube neck is the blue lateral shift magnet.

Dynamic

The dynamic convergence controls differ from one chassis to another, but their function will be indicated either in the maker's instructions or by little diagrams alongside each one. By examining the displayed pattern it should be easy to determine which control needs adjustment: usually it is only one or two out of about a dozen. On the Philips G8 series chassis for example it is often found that the vertical red/green lines on either the left or the right need a slight touch, sometimes together with the red/green tilt.

Minor convergence errors can usually be corrected quite quickly unless there is a fault, but it is largely a matter of experience. Most engineers will remember their first couple of convergences when they followed every item religiously in the prescribed sequence whether each step was required or not—and took a couple of hours to do it. Having to do the whole thing at least twice with the dual-standard models once current didn't help of course.

Grey-scale Tracking

Having tiddled up the convergence, the next step is the grey-scale tracking.

Errors here are rather more common than may be thought, and are probably the cause of many of the unnatural colour complaints. Although convergence may get more attention minor convergence errors are less noticeable, especially at a distance, because they affect only the outlines, and then only those in the part of the picture where the convergence error is present. Grey-scale tracking errors on the other hand affect the whole picture area.

Here again a monochrome picture or pattern is required. A careful check on all parts of the picture should be made to ensure that the rendering of all light levels from white through light, medium and dark grey are of a neutral hue with no colour cast. If the grey-scale seems right tune in a good colour picture and observe the flesh tones on the faces. This is where even minor

errors show up. Some tones may tend towards brownish green, others may be too pink. Be careful not to be misled by a poor colour film (try to find a live broadcast) or in summer by characters with sunburn!

If there is a colour cast in the dark parts of the picture the controls supplying the tube first anodes need adjustment. The recommended way of doing this is to obtain a blank raster and switch off two of the guns. Then adjust the appropriate first anode control to give a barely visible raster. Repeat this for the other two guns. The manual will specify some means of setting the correct brightness level for this process.

Assuming that the adjustment is only slightly out—as it should be with a new set—it is quicker to adjust with all guns on however, using a stepped grey pattern. The one on the test card will do. It can also be assumed that only one control needs altering—this is so in nine cases out of ten.

Dark Greys

If the dark greys have a primary colour cast—red, green or blue—the appropriate first anode control needs easing back until the grey becomes neutral. If the cast is of a complementary colour the opposite colour control needs to be slightly increased: a cyan cast calls for more red, magenta more green and yellow more blue. These first anode controls are usually of high value and are thus quite critical: just a touch is generally all that is necessary and it is easy to go too far.

Drive Controls

Coming to the lighter parts of the picture, light greys and whites, any colour tints here after the dark areas have been dealt with are corrected by the controls in the c.r.t. drive stages. It is these controls that have the greatest effect on the flesh tones: if skin colours are unnatural (assuming an impeccable programme source) adjustment of these controls will generally effect an improvement.

The drive controls should be adjusted for neutral white. It is difficult to determine just what is neutral however, far more so than with the dark greys. Much of what we take for "white" has a strong bias toward one of the constituent colours. Sunlight and light from incandescent lamps for example has predominant yellow and red components, while the light from a monochrome receiver's tube has a strong bias to blue. Curiously, we are not greatly aware of this when actually watching the screen, but if reflected light from the c.r.t. is observed in an otherwise darkened room the blue content becomes very noticeable.

Ideally a comparison should be made with a standard white light generator, but adjustment using both flesh tone and white should give a good result. We have this in the test card where the girl's face provides the flesh tone and there are large areas of light grey with some white. If the flesh is pink, the green and blue controls need to be advanced slightly; if it is a bluish pink, just the green control should be increased. A sallow rather jaundiced look indicates that a little more blue is required, while either a green or bluish tint obviously means a little less of the appropriate colour. When the flesh tone seems about right (one can use the back of the hand as a comparison) check that the white and light grey are as pure as you can judge them to be.

With colour-difference drive, less common nowadays, matters are more complicated. The luminance highlight controls—there are usually only two, green and blue—are set for pure white (with the colour turned off) and the colour-difference drive controls then set for best flesh tones.

Voltage Checks

Apart from checking the picture on these points and adjusting as necessary there are often various voltages which should be checked. In the Philips G8 chassis for example there are h.t. and overvoltage protection adjustments. These are usually correct, but occasionally one needs resetting. It takes but a moment to check that the h.t. voltage is at 205V and thereby verify that the settings are in order. There is also a field output bias adjustment which needs to be set for 23.5V. This is more often found to need adjustment. Attention to such matters will minimise the risk of subsequent premature breakdowns.

Visual Examination

In addition to all this the engineer should run a practised eye over the panels and wiring, looking for obvious potential sources of trouble. Such things as wire-ended components misplaced so as to be dangerously close to other bare wires or metalwork; leads touching hot power resistors; plugs, valves or tube bases being only partly engaged in their respective sockets; incorrect value fuses and any other of the many defects which may be found by visual examination of a new set.

Soak Test

The back should then be replaced to achieve normal operating temperature and the set soak tested for a number of hours. Just how long will depend on the space available but it should not be less than four hours. A large proportion of faults due to defective components or assembly and soldering will appear in the first few hours of operation: it is better that they occur in the workshop than in the customer's home! Finally, a check can be made on the convergence in case this has drifted, and any slight readjustment needed can be made. The receiver is then ready for delivery.

Conclusion

Many dealers do of course carry out such pre-installation tests. But as mentioned at the beginning of this article there is evidence that many do not. This can result in expensive recalls, lost sales and be damaging to the trade as a whole. It takes time of course, and an engineer's time costs money, but it makes good economic sense.

In the highly competitive state of the trade today the smaller dealer can and should make a feature of his pre-installation tests. Both verbally and in his advertising matter he should make it known that all new sets are carefully checked and adjusted by a qualified engineer to give the best possible results and then tested for so many hours. Prospective clients can be invited to call in and see for themselves the improvement over the sets sold elsewhere, and no doubt many will do so. ■

NEXT MONTH IN

TELEVISION

UHF MODULATOR

The simplest way of displaying a video signal is to modulate it on to a u.h.f. carrier and feed it into the aerial socket of a domestic TV receiver. The author tried various modulators but found that simple types had a number of disadvantages. An economic solution was found in modifying a standard varicap tuner to act as a modulator, applying the video signal to the a.g.c. input. The result is a high-quality modulator which is equally happy with colour or monochrome signals, is simple to set up and has negligible harmonic output.

COLOUR RECEIVER FAULTS

Two features next month on faults in well known colour chassis. Paul Soanes deals with the Thorn 3000/3500 chassis, probably the most widely used in UK produced colour sets, while Les Lawry-Johns in his servicing series turns his attention to the Pye CT70 and its successors.

THE TBA120 AND TBA120S

The TBA120 and TBA120S have become almost industry standard i.c.s for the intercarrier sound section of modern TV sets. Phosphor describes their circuitry, mode of operation and how to use them.

LUMINANCE CIRCUITS AND FAULTS

Taking up again his series on video circuit techniques and fault conditions S. George investigates the luminance and colour-difference channels used in sets featuring colour-difference tube drive. Both hybrid and all solid-state circuits are covered.

PLUS ALL THE REGULAR FEATURES

ORDER YOUR COPY ON THE FORM BELOW

TO.....
(Name of Newsagent)

Please reserve/deliver the APRIL issue of TELEVISION (25p), on sale March 17th, and continue every month until further notice.

NAME

ADDRESS.....

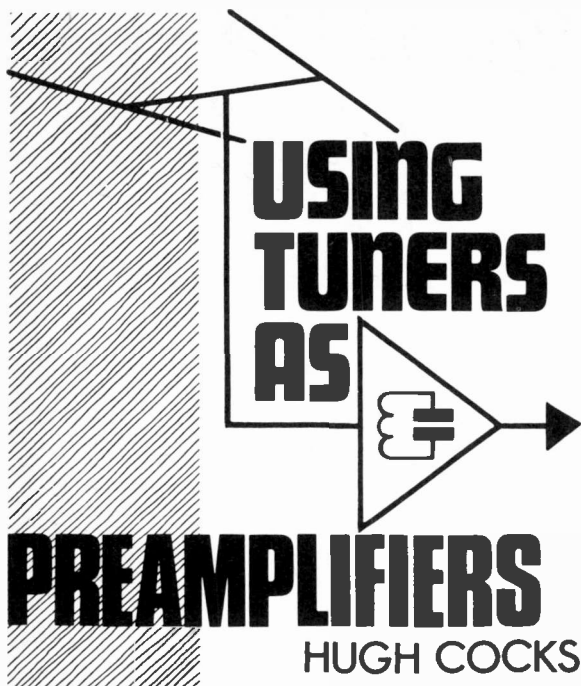

USING TUNERS AS PREAMPLIFIERS

HUGH COCKS

THOSE DX-TV enthusiasts unfortunate enough to live close to a u.h.f. or v.h.f. transmitting site know only too well the problems involved. The local station will appear on a supposedly vacant channel or even cover a large part of the band. The writer is in such a position, living just three miles southwest of the Stockland Hill transmitter in Devon which operates on u.h.f. channels 23, 26 and 33 and v.h.f. channel 9.

On first moving to this otherwise excellent location for DX-TV, tests were made using a conventional wideband u.h.f. preamplifier. These served only to confirm the worst. The local station came in from channels 21-69 irrespective of aerial direction, with channel 9 appearing in places as well.

The next approach was to try a commercial narrow-band (single channel) preamplifier. This gave some improvement except on channels adjacent to the local station where the lack of any aerial input tuning caused problems. A conventional u.h.f. varicap tuner modified to act as a preamplifier gave similar results for just the same reason.

This need for high selectivity at the aerial input led to the use of a 4-gang rotary transistorised tuner, giving excellent results at minimum cost. The particular tuner used was the u.h.f. section of the A633, as fitted to the Bush TV125, see Fig. 1.

The BF180 r.f. stage was left untouched and the output taken from the collector of the BF181 mixer/oscillator transistor. The latter then provided isolation between the tuned circuits and the output coaxial cable which would otherwise have damped the high Q of the r.f. stage. Capacitor 4C14 was removed to stop the BF181 oscillating and the output was taken from the junction of 4VT2 and 4L3 via a 470pF capacitor.

As the output lead is connected directly to the transistor, the lid of the tuner unit must be discarded. This seems to have very little effect on the tuning, but it is worth repeaking the three trimmers which remain active.

This preamplifier has proved highly successful in operation with good gain and selectivity. Weak signals have been well received on either side of the local channels.

Operation of the unit is simple. First tune to the required channel on the TV receiver which must, of course, have accurate frequency calibration. Then tune the preamplifier for an increase in noise on the screen—retune the receiver accurately and finally peak the preamplifier. The maximum gain is obtained over about one channel and falls to unity approximately one channel either side of resonance. Beyond this severe attenuation occurs, so tuning is quite critical.

It must be admitted that some cross-modulation takes place either side of the local channels when the writer's Jaybeam MBM70 aerial is pointing directly at the Stockland Hill mast. However, as this lies NNE, reception of France and the low countries on adjacent channels proved no problem and no 405-line channel 9 signals were received on u.h.f.

Band III

Reception problems on Band III proved even worse, with channel 9 received all over the band when using a two-stage AF239 preamplifier. Notch filters were tried but their Q was too low, so that half of Band III disappeared as well.

Rather than devote time to devising a suitable circuit based on f.e.t.s, it was decided instead to go back to valves, using a PC900/PCF801 v.h.f. tuner (Bush TV141) which was to hand. This, in common with all Bush designs, tunes continuously through Bands I and III. Using a similar approach to that adopted in the u.h.f. unit, the output was taken from the anode of the mixer, 1V2a, this valve acting as a straight pentode amplifier. The h.t. feed to the local oscillator, 1V2b, was broken by removing 1R12.

As shown in Fig. 2, 1R8 and 1C22 are removed and 1L11 is replaced by a 5 μ H r.f. choke. The output is taken from the anode end of this choke via a 470pF capacitor. It is also necessary to remove 1C27, 1L16 and 1C29. The r.f. amplifier a.g.c. line is disabled by shorting it to chassis.

The heater arrangements require a little experimentation. The PC900 and PCF801 are both rated at 300mA and their working voltages are quoted as 3.9V and 8.5V respectively. In theory these should run in series from a 12V or 12.6V transformer winding without problems. In fact it was found that the heaters in the prototype were overrun, the current being too high, and a 10 Ω dropper section had to be inserted to restore normal conditions. You should therefore check the running current and add series resistance as and if necessary to bring it to 300mA.

The r.f. output socket was fitted on a bracket on the side of the tuner and the control knobs secured by glue, rather than by the springs and bracket originally used.

Operation

This unit also has proved to be most successful. The gain is about 15-16dB and is flat over a bandwidth of some 5 to 6MHz. Noise is very low.

It is just possible to receive ch. B10 vision and ch. F8 vision (5MHz below the B9 sound channel) without interference from the local channel 9 transmitter.

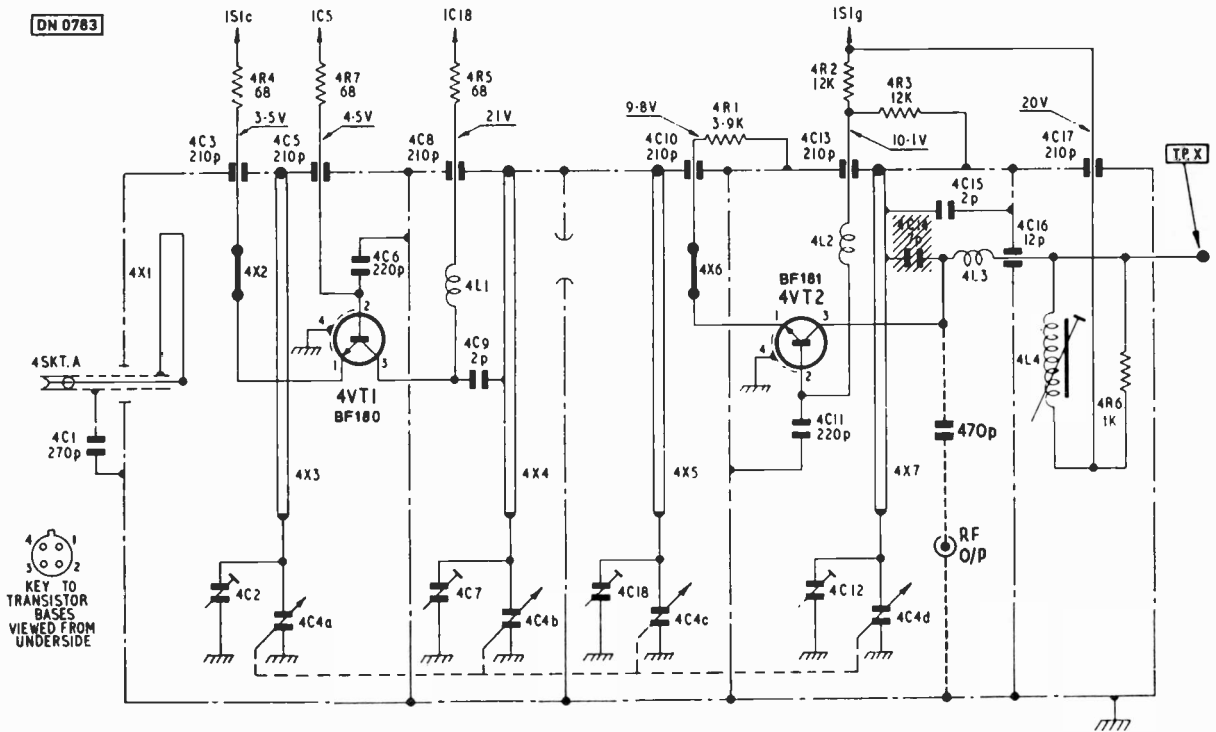

Fig. 1: Bush u.h.f. tuner type A633, modified for use as a narrow-band preamplifier. The local oscillator is disabled by removing 4C14, and the signal output taken from 4VT2 collector via a blocking capacitor.

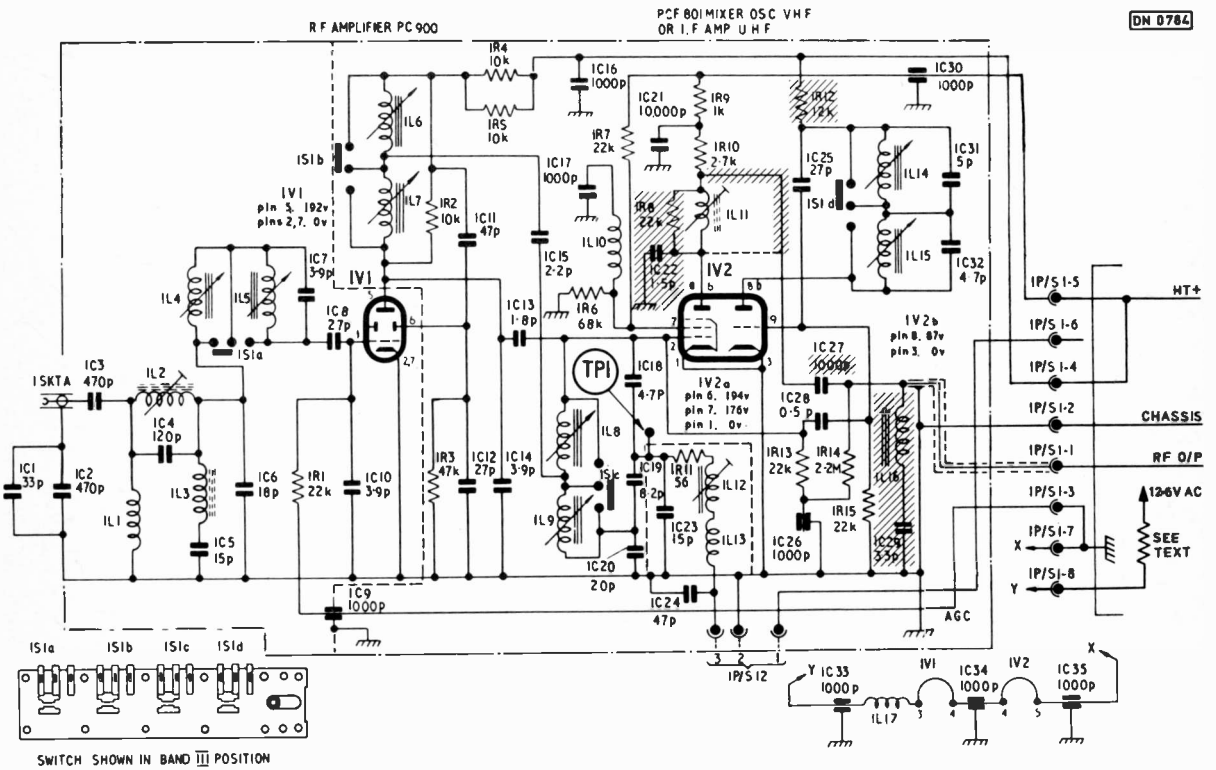
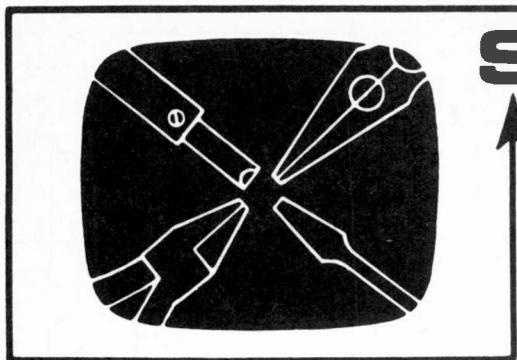

Fig. 2: The v.h.f. tuner from a Bush TV141 converted to a selective preamplifier. Components and wiring shown shaded are removed, and the dashed link added. 1L11 is replaced by an r.f. choke and 1C27 is changed to 470pF.

—continued on page 221



SERVICING television receivers

L. LAWRY-JOHNS

DECCA MODELS MS1700, MS2001
AND MS2401—continued

Line Timebase

Several faults which can have misleading symptoms can develop in the line timebase. The most common of these symptoms is overheating in the PL504 and PY88. This is usually due to lack of line drive of course, so if a meter check at pins 1 and 2 of the PL504 proves that the line drive is absent the first suspect is the ECC82 line oscillator. If this valve refuses to oscillate the voltages at pins 1 and 6 (the anodes) will be low.

If a new valve still refuses to perform and the voltages are low a check at pin 7 may well show the same reading as that at pin 1. As pin 7 is the oscillator grid, it should show a negative reading or no reading at all (if the stage is not oscillating). If the reading is positive capacitor C81 will be found shorted. The failure of this capacitor in this chassis as well as in many chassis of other makes is one of those faults which were once rare but which are now becoming more common (they don't seem to make capacitors like they used to). The value of 820pF is not terribly critical within a few pFs since the line hold control has the final say on the frequency. The control should not be too far from its mid point of course.

It is often the case however that line drive to the PL504 is present despite the overheating. In this case the fault is most likely to be in the output stage and the regular fault-finding routine should be observed, bearing in mind the fact that the boost reservoir capacitor C88 is not returned to h.t. but via the coils to chassis. First remove the top cap of the DY802 e.h.t. rectifier. If things then start to happen the DY802 should be replaced. If there is no difference there could be shorted turns in the line output transformer.

Bearing this in mind however first change the PL504 and PY88 valves. This could well clear the fault. A low-emission PY88 will often cause the PL504 to overheat while a PL504 which is drawing grid current will result in a similar effect. This latter condition should be proved when the line drive is checked as the grid current will to a large extent be cancelled.

Dry-Joints

If the line output stage is functioning but at reduced efficiency, and there is a vertical white line down the centre of the screen, one tends to condemn the line scan coils. A moments thought however will bring home the fact that there are several other possibilities. It will also be observed that R112 is overheating, and that the vertical line is not as bright as one would

expect while the screen is not being fully scanned vertically. A quick check on the continuity of the scan coils will almost certainly prove these to be intact but a similar check back to the line output transformer will almost as certainly show a higher reading than expected. This is usually due to a tag from the transformer not contacting the print, or to one of the other soldering posts not making contact. Each lead out and short length of track should be measured and if the resistance reading is higher than zero the relevant soldered connections should be remade, including those on the transformer itself. Many a lead is only wrapped in manufacture and makes contact for a limited period until disturbed. A careful check on these points will clear up many a mystery.

Why the overheating of R112? Well, if the circuit through the scan coils is open the only path for the boost line is through this resistor to chassis. Hence the reduced efficiency all round.

Note that the line linearity coil L18 is not fitted in all sets, its place in some being taken by a closed-loop sleeve on the tube neck. The appearance of vertical rulings (striations) down the left side of the screen will normally indicate that L18 is fitted and that R113 (1.5k Ω) has gone high.

Reduced Width

Lack of width can be due to reduced valve efficiency but the value of resistor R111 (3.9M Ω) should be checked as this tends to increase in value.

Red Hot PY88

We have mentioned the fact that the boost line capacitor C88 is returned to chassis and not to the h.t. line. This means that when C88 goes short-circuit the PY88 is placed across the h.t. line and suffers accordingly. Suffers that is until F2 fails. If the correct 500mA fuse is fitted this won't take long. We have found higher value fuses fitted in this position however and in this case the PY88 is subjected to treatment which is limited only by R121 and R122. This may prove too much for the valve.

Line Hold Troubles

In cases of weak line hold check the ECC82 line oscillator valve and the flywheel sync discriminator diodes D4 and D5 of course: the reference pulse

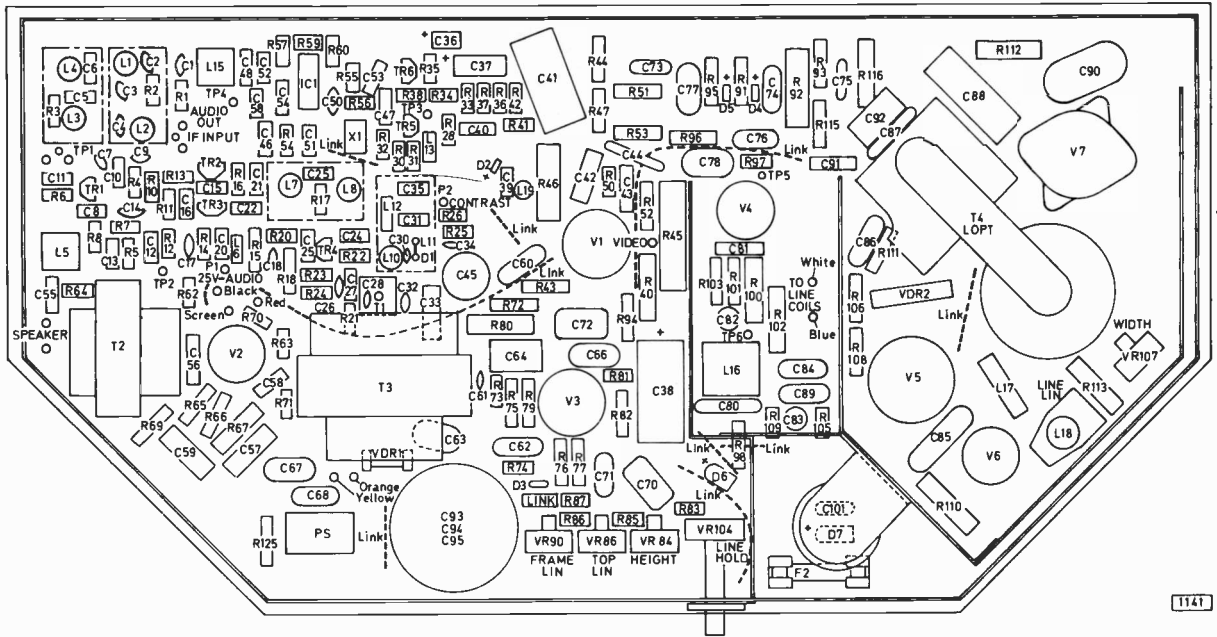

Fig. 2: Printed panel component layout.

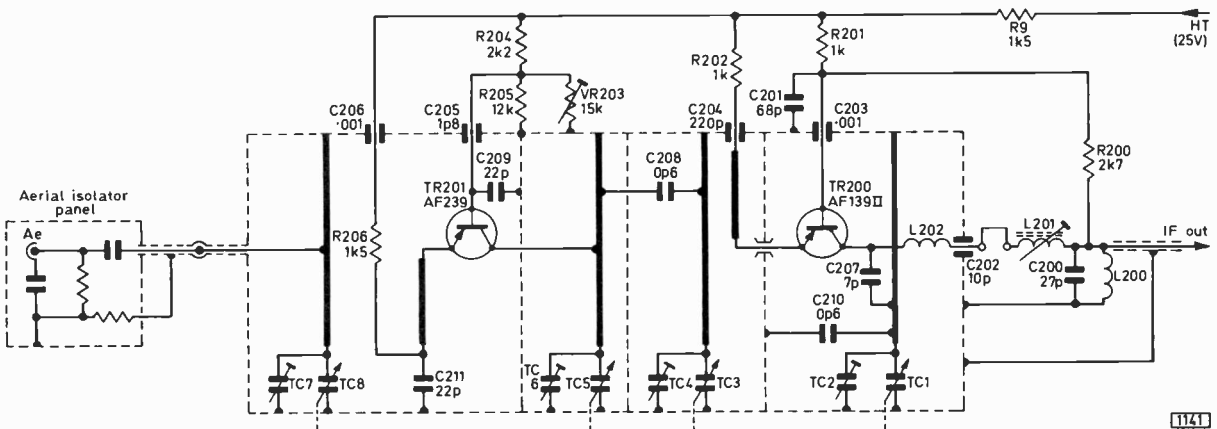

Fig. 3: Circuit of the Hopt tuner unit.

feedback capacitor C75 has also been known to cause this trouble however. In later production C74 was changed from 0.0033uF to 0.0022uF in order to improve the horizontal stability.

Field Timebase

The field timebase uses a single oscillator-output valve (PCL805) in a circuit which can present some problems from a fault diagnosis point of view. The circuit is well nigh identical to that used in the Baird 660, 670 and 680 chassis which were covered in the last article in this series however. There is little point therefore in going over the same ground. The important things to remember are as follows.

The supply to pin 1 of the PCL805 is from the boost h.t. line via a single fixed resistor (R94, 820k Ω). The height control is not in this feed. If the PCL805 is in order lack of height could well be due to R94 going high, but the height control VR84 has been known to

put on a few ohms on its own account although it is not in any d.c. path.

Severe bottom compression is usually caused by C64 drying up.

Most other troubles if not due to the PCL805 should lead to a general check first on resistor values and then on capacitors (mainly for leakage).

Tuner Unit

The Hopt tuner unit follows conventional lines but has an external preset control (VR203) which varies the gain of the r.f. amplifier. This control is normally set for maximum gain but if the receiver is used in an area of high signal strength which results in overloading the control setting should be reduced to clear the symptoms of cross-modulation. An aerial attenuator is only required in exceptional situations but the necessity for this would be well known in the area.

—continued on page 212

REVIEW OF THE HEATHKIT 12" MONO PORTABLE MODEL GR9900

R. A. Philby

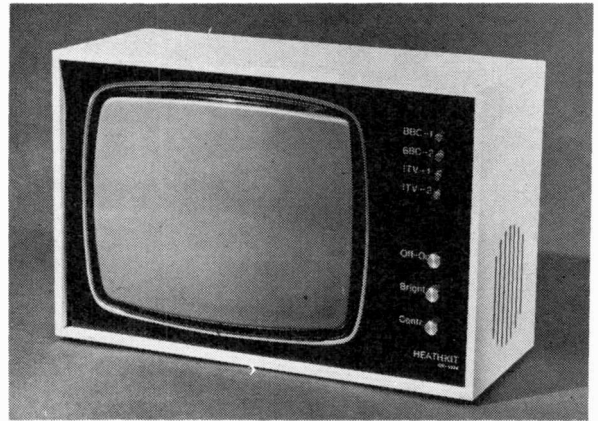

THE Heathkit 12in. monochrome portable television receiver kit is thoroughly up to date, making use of an ELC1043/05 varicap tuner and packing most of the circuitry into four integrated circuits. A Plessey SL437D i.c. comprises the complete i.f. section—vision i.f. strip, intercarrier sound channel, demodulators and a.g.c. system. There are two Texas SN76001ND i.c.s, one for audio output and the other for field output, while a Texas SN76544 takes care of the sync separator, flywheel line sync and both timebase generators. The only discrete component stages are the line driver and output stages, video emitter-follower and output stages, the power supply regulator, an inverter to interface with one of the i.c.s and a flyback blanking pulse (field) amplifier. With things thus neatly arranged there is not a great deal to go wrong and nothing daunting about the construction.

Sensitivity

A simple aerial is supplied for fitting to the back of the set but it is better to use a proper directional aerial mounted in the loft or on the rooftop. Exact requirements depend on the particular location of course. The sensitivity of the set itself is very good, comparing well with most alternative ready-made receivers.

Handbook

Heathkit have a reputation for providing detailed instruction manuals with their kits and this kit is no exception. There is a full parts list for checking and identifying every item in the kit, with line drawings of all the components. In fact the handbook is superb, including full setting-up instructions, waveforms, troubleshooting charts, sample fault illustrations, detailed layouts and a circuit description. One feels that constructors cannot possibly go wrong if they follow the instructions properly. Nevertheless if problems are encountered there are a Technical Consultancy and Service Department ready to help.

Assessing the Project

One crucial factor with a kit of this kind is that the constructor should not be faced with difficult setting-up problems. In this case all the tuning coils are supplied prealigned, only two requiring a final adjustment for

optimum sound/vision signal balance. This latter operation can be done quite simply without the need for alignment equipment, and a non-magnetic trimming tool is provided in the kit for this purpose.

Heathkit have gone a long way to overcome the types of problems likely to arise in a project of this type. First, most of the circuitry is low-voltage, being operated from a regulated 12V supply, the only exceptions being a 100V line for the video output transistor (obtained by rectifying line flyback pulses) and the e.h.t. (12kV) for the c.r.t. Secondly, by making the construction and mechanics as simple as possible, as the accompanying photograph shows. And thirdly by providing an after sales service to help anyone having problems with the completed set. When built and working the set makes an excellent second set for the bedroom or elsewhere. It can be operated from the mains or a 12V battery and its compact size makes it easy to take around. For an experienced constructor the set is very easy to build. Less experienced constructors, possibly even beginners, should be able to achieve satisfactory results if they follow the instructions to the letter, marking off each step as recommended. The handbook emphasises repeatedly the need for care and the use of a clean soldering iron, which should not exceed 25W.

Results

After completing the construction we connected the set to an 18-element aerial in the loft and switched on. A picture was present on the screen. By following the setting-up instructions we improved the picture and brought in the sound. After careful and repeated adjustment of the two coil cores previously mentioned, a slight adjustment of the tuner module and the tuning button knobs, we obtained first class BBC-1 and ITV. The BBC-2 signal was a little weaker, with more noise, so we switched to this channel to find the optimum results that could be obtained from the adjustments provided. Repeated cross checks between stations lead to excellent results—some patience in doing this is well rewarded.

Having obtained optimum setting up we studied the set and used it for a period of about three months. The picture quality in the London area (Crystal Palace transmitters) was first class with adequate gain in hand. The contrast control sets the degree of negative feedback in, and hence the gain of, the video output

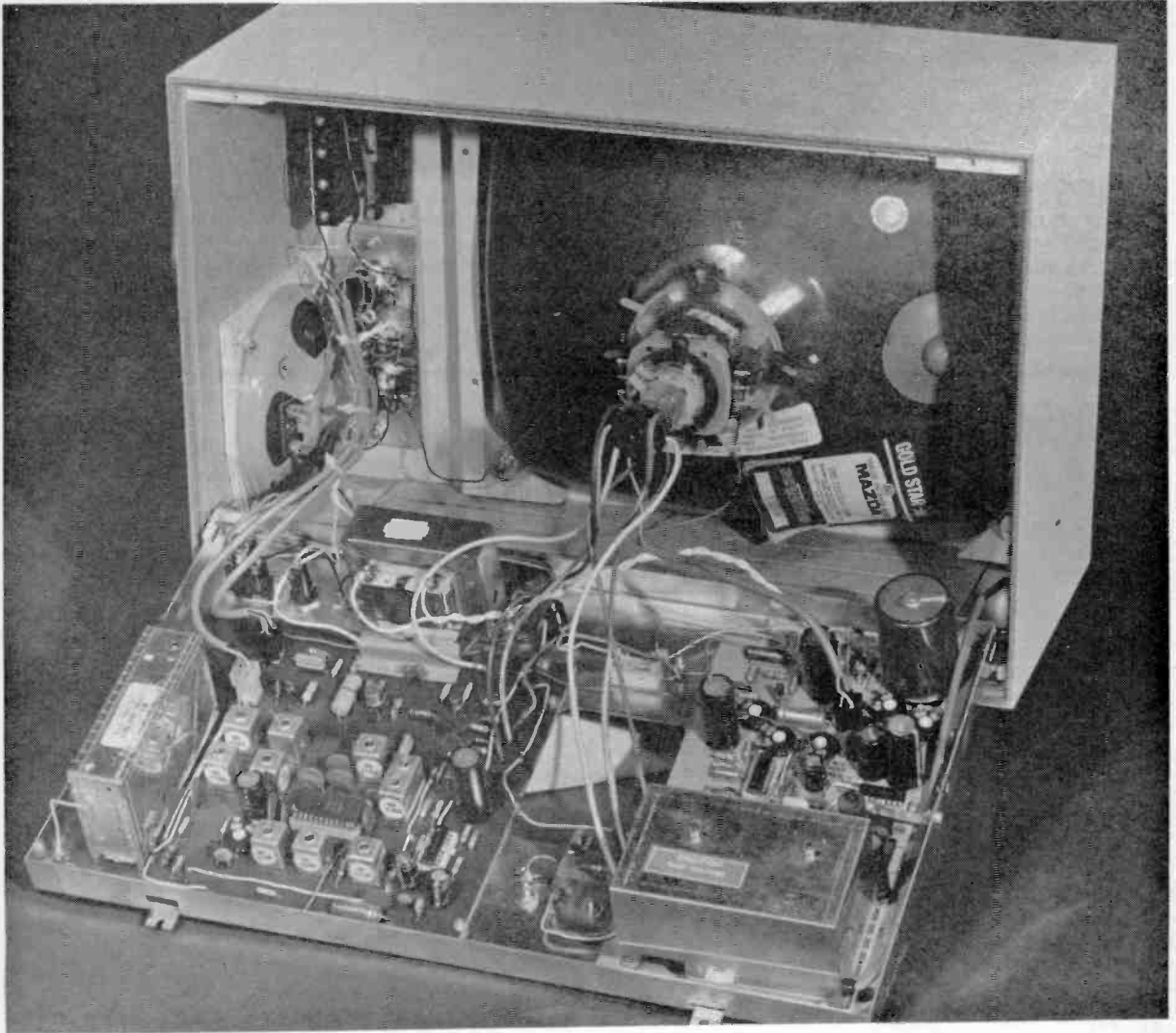

Interior of the completed set, showing the neat layout and mechanical arrangements. The signal circuits are on the left, the timebase circuits on the right. The SL437D i.c., which forms the complete i.f. system, can be seen in the foreground on the left.

stage: we found that the range of adjustment was more than adequate to get a balanced range of tones under both good and poor signal conditions.

Two aerials were tried, a four-element indoor type and an 18-element loft array. The indoor aerial gave reasonable results in a bedroom at about 18ft. above ground level. The large array gave clean results with negligible visible noise, and one can assume that an outdoor aerial would result in even better reception. The distance from the transmitters averaged 25 to 30 miles, at about 300ft. above sea level and with higher ground (about 450ft.) in between.

One problem we had was an irritating buzz from the mains transformer. Heathkit's replacement parts service for missing, damaged or faulty components was called upon and the replacement solved the problem.

Modifications

There have been a few minor modifications since the

early versions. First, there is a small modification to the timebase board to remove from the picture some ripple induced on to the d.c. return foil. Secondly there is a resistor value change in the field linearity circuit (R132 changed to 100k Ω) to enable Ceefax/Oracle lines to be moved up away from the top of the picture. Thirdly the rating of the silicon rectifier which provides the 100V video output stage supply is changed to 1A, 600V. Fourthly a field flyback blanking pulse amplifier stage has been added—it was found that on occasions field flyback lines were visible at high brightness levels due to blanking pulses of insufficient amplitude. And fifthly vertical striations on the left-hand side of the screen have been overcome by adding a 1k Ω damping resistor across the line linearity coil and using tighter specification components. Details of these modifications are supplied with the instruction manual.

The only fault we had on our set concerned the mains supply bridge rectifier which ran rather warm. After about two months operation there was evidence

of scorching on the printed board and, after warning symptoms, the bridge finally broke down from a surge at switch on. On taking the matter up with Heathkit we were recommended to advise readers to mount the diodes clear of the board and told that this is now a standard instruction in the manual.

Constructional Points

Points we noticed during construction are as follows. The polarity of C127 was not indicated on the board, though it's easy to check up on what to do. For some reason the circuit and assembly instructions refer to IC101 and IC102 while the board layouts refer to IC3 and IC4 respectively. We found that in assembling

the cabinet components it is easier to mount the push-button tuning unit before mounting the loudspeaker.

Conclusion

By comparison with the ready-made small portable monochrome sets available the GR9900 may seem on the expensive side at £68.00 including VAT and a table top aerial. This however includes the detailed manual with its photos, fault-finding charts etc., after sales service, top-grade components, ready-made mounting frame, printed boards and cabinet. There is also at present a special offer—the standard kit with table top aerial at £54.00 including VAT. This applies to the white version only. ■

SERVICING TV RECEIVERS

—continued from page 209

Poor reception with a grainy picture which has hitherto been good should lead to a check on the aerial input socket and plug and then the AF239 r.f. transistor.

Buzz on Sound & Picture Shading

Buzzing on sound and shading of the picture should direct attention to smoothing electrolytics, particularly C37 (a.g.c.) and as a second check C36. If these are not at fault check C45 which smooths the l.t. supply.

Wavering Picture

If the picture is wavering, denoting timebase ripple, the main electrolytics (C93-C95) will have to be checked. Adding capacitance is not always the answer as the trouble could be due to leakage through the sections of the multiblock, shorting out the smoothing resistors. Thus replacement of the complete can is the only sure check.

Vertical Striations Across Screen

Vertical striations at 1½ in. intervals right across the screen are due to velocity modulation of the c.r.t.

beam: failure of C68 in the field flyback blanking circuit is the usual cause

Modifications & Later 20 Series

To eliminate picture shift with beam current variations R105 was changed to 100kΩ in later production.

The same basic chassis is used in the later 20 series (Models MS2020 and MS2420) which feature a varicap tuner unit. The other main difference is that certain component, circuit and fuse changes were made to meet BEAB requirements.

In these models the video output valve anode load resistor R45 is a fusible type. To prevent premature operation of this the cathode bias resistor R44 has been increased to 82Ω and to compensate for the higher c.r.t. cathode voltage the brilliance control feed resistor R125 is reduced to 120kΩ.

Voltage Conditions

Voltage readings, taken with an Avo Model 8, were given on the circuit diagram last month. The valve and h.t. voltages were measured with a normal picture and a total h.t. current (through F2) of 400mA. The transistor and i.c. voltages were measured with no signal, the contrast control at maximum, the i.f. input lead disconnected and a 10kΩ resistor in series with the meter lead.

BLACK-LEVEL CLAMP (NOV.): AMENDMENTS

We regret that due to a misunderstanding on our part certain features shown in Fig. 3 of this article could cause problems. The c.r.t. grid (pin 6) circuit shown is as in the Thorn/BRC 950 Mk. I chassis, not the Mk. II. The difference between these two chassis so far as the c.r.t. circuitry is concerned is that in the Mk. I version the brightness control is in the c.r.t. grid circuit while in the Mk. II version it is in the cathode circuit. With the clamp circuit added, the brightness control must be in the grid circuit, as shown, and the flyback blanking pulses must be capacitively coupled (C94) to the c.r.t. grid. In the case of the Mk. I chassis the grid circuit can be left as it is therefore whilst in the case of the

Mk. II chassis it must be modified to correspond with the Mk. I version as shown in Fig. 3. Note that the correct value of R117 is 100kΩ as in Fig. 6.

There are several other points which should be noted: use a 47μF, 63V electrolytic in position C1; R16 and R19 should be rated at 1W; C8 is shown incorrectly in the components list as 5000μF—its correct value is 5000pF as on the circuit.

If a receiver in which the brightness control is in the c.r.t. cathode circuit is being adapted the connections to its tracks should be reversed when moving it to the grid circuit—otherwise the control will operate the wrong way round.

CCTV

PART 12

Peter Graves

MODERN lenses are corrected, as far as is possible, for all the aberrations and defects that lenses are prone to. This article therefore deals with the more practical aspects of selecting and using lenses rather than delving into their theoretical side. Details of this aspect can be found in any good photographic manual or optics textbook.

Image Size

The lens forms a focused image of an external scene on the vidicon target layer. The size of the image produced is determined by the distance of the object from the lens and the focal length of the lens, which is fixed by its design. The camera sees only that part of the scene whose image falls on the scanned area of the vidicon, and this is known as the field of view of the camera. Since the size of the scanned area is fixed for a given diameter tube we can easily work out the size of the field of view of a given lens at a known distance from the camera.

For a 1in. vidicon, the scanned area is 0.500 × 0.375in. or, in metric measurements, 12.7 × 9.52mm. In normal use the longest side is horizontal and this is assumed to be so throughout the article. Note, too, that this corresponds to an aspect ratio (ratio of width to height) of 4:3. Calculating the length of one side of the field of view automatically fixes the length of the other.

Let's look at a simplified aerial view of a camera looking at some scene at distance D from the camera (we will gloss over the units of measurement used for the time being)—Fig. 2. By simple geometry (similar triangles) we can say:

$$\frac{f}{w} = \frac{D}{W}$$

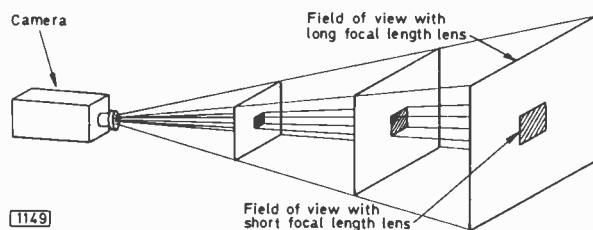

Fig. 1: Relationship between field view size, distance from camera and lens focal length.

where f is the focal length of the lens, w the width of the scanned area of the tube and W the width of the field of view at distance D from the camera. Strictly, D is the distance from the centre of the lens to the object but in practice D is usually measured in feet and f in inches so there is not much error involved if the front of the camera is taken as the point of measurement.

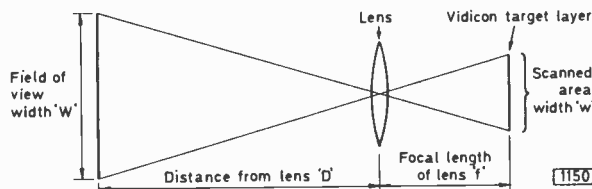

Fig. 2: Simplified aerial view of lens, camera and distant object.

A little manipulation of this equation gives the focal length in terms of the other factors:

$$f = \frac{D \times w}{W}$$

Units

Strictly, all the measurements (f , w , W , and D) should be in the same units (all in feet, all in inches, all in metres, etc.). Actually, from the way the equation is arranged we can cheat a little and say that the equation will give the right results, that is f will come out in the right units, provided that both D and W are in the same units, usually feet or metres, and that f is measured in the same units as w . That is, if w is measured in inches, f will be in inches; if w is in mm, f will be in mm. For a 1in. vidicon, w is fixed so we get:

$$f = \frac{D}{W} \times 0.5 \quad f \text{ will work out in inches}$$

$$\text{and } f = \frac{D}{W} \times 12.7 \quad f \text{ will work out in mm}$$

Let's look at some examples; for instance, what focal length lens must be used on a 1in. vidicon camera to give a field of view 10ft. wide at a distance of 40ft.?

$$\text{For the focal length in inches: } f = \frac{D}{W} \times 0.5 \text{ where } D=40\text{ft.}, W=10\text{ft.}$$

$$\text{Substituting: } f = \frac{40}{10} \times 0.5 = 2\text{in.}, \text{ i.e. the lens focal length is 2in.}$$

$$\text{For the focal length in mm: } f = \frac{40}{10} \times 12.7 = 50.8\text{mm} \text{— a 50mm lens would be used.}$$

By further manipulation of the basic equation we can also ask the question in reverse: What is the field of view of a 2in. lens at a distance of 40ft. from a 1in. vidicon camera?

$$W = \frac{D \times w}{f}$$

Again, D and W , w and f must be in the same units, in this case feet and inches respectively. Substituting:

$$W = \frac{40 \times 0.5}{2} = 10\text{ft.}, \text{ as before.}$$

If the width of the field is 10ft. then the height (from the aspect ratio) must be $\frac{2}{3}$ of 10ft. or 7.5ft. So, at 40ft. the field of view measures 10ft. wide by 7.5ft. high. Fig. 3 gives a rough guide to the fields of view of various size lenses at different distances. Remember, for the same distance from the camera, the smaller the focal length the bigger the field of view.

These calculations assume that D is much larger than f —which is usually the case. However, when D is small (i.e. for objects close to the lens) light rays from the object do not come into focus at a distance from the lens equal to the focal length (the assumption in the calculations) but at some distance beyond it. So the lens-vidicon distance must be varied by a focus mechanism (of which more later).

Close-up Work

For objects very close to the lens (within a few feet usually, but it depends on the lens) the range of adjustment of the focus mechanism is inadequate and other techniques must be employed. Two methods are in common use. In the first a supplementary lens screws on the front of the main lens and, by bending the light rays from the object, "kicks" the main lens that the object is further away than it actually is. The other way is to use extension tubes.

These are tubes threaded at one end to take the lens and at the other to screw into the camera. They come in various sizes and physically move the lens (and hence the point where the light rays come into focus) forward so that adjustment is once again within the range of the focus control. The plane containing the points where the light rays come into focus is known as the focal plane and, when the lens has been focused, it coincides with the vidicon target layer.

Focus Mechanisms

The camera may be focused (exactly as a film camera is) by using a lens fitted with a focus ring that, when rotated, moves the lens in and out from the vidicon faceplate. This method is found in cheaper cameras but more sophisticated ones keep the lens focus fixed (for normal use the lens ring, where fitted, is set to the infinity position) and focus by moving the entire vidicon and its yoke backwards and forwards by a carriage mechanism. This gives a greater range of focusing and means that the manual focus control can be brought out to the rear of the camera, a very much more convenient point for the operator. Remote control of focus is also made easier.

Note that, in this article, focusing only refers to optical focusing—the formation of an optical image on the target layer—not to electronic focusing which is concerned with the electron beam inside the tube.

Up to now it has been implied that only fixed focal length lenses are used, such as are found on film cameras. For many purposes involving fixed fields of

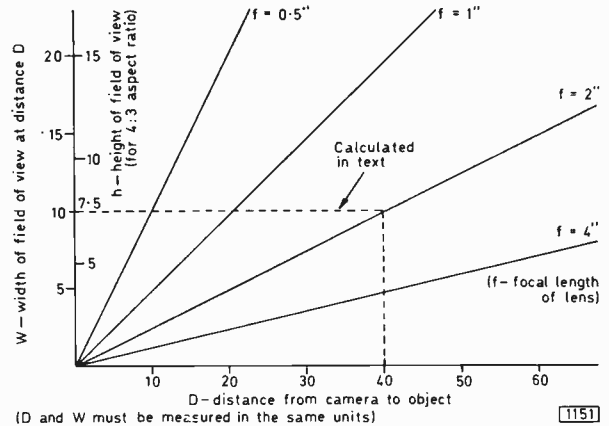

Fig.3: Field of view sizes for a 1in. vidicon camera.

view, or in studios where the camera can be wheeled around until the field of view is correct, these are perfectly satisfactory. For other purposes, such as outside security surveillance, there are many disadvantages.

Take a camera looking at the outside of a factory and feeding a monitor watched by a guard. Normally, he would want a general view but at times a close up of some suspicious activity may be required. Two or more fixed focal length lenses would need to be mounted on a rotating lens turret, driven by a motor with an indexing system to stop the lens accurately in front of the vidicon. The advantage of a focusing mechanism independent of the lens is immediately apparent, but trouble can arise over setting the aperture of the different lenses if a wide range of lighting conditions must be allowed for.

Zoom Lenses

The zoom lens overcomes many of these disadvantages. Basically it is a fixed focus lens with a variable magnification telescope mounted in front of it. The net result is a lens with a field of view which can be varied continuously over a certain range whilst maintaining an in-focus image. The effective focal length is changed while maintaining a fixed distance between the rear of the lens and the vidicon faceplate. Typically the control that varies this—the zoom control—rotates a cylinder in which are cut slots of appropriate shape. Engaging in these slots are pegs attached to the individual lenses inside the zoom lens, known as lens elements. The pegs drive the elements along precalculated paths to achieve the desired effect.

A zoom lens is loosely referred to by the ratio of its effective focal lengths. Suppose a zoom lens can be varied so that, at its limits, its effective focal lengths (in terms of the field of view) are respectively 20mm and 100mm, then the lens would be a 5:1. Ratios of 3:1, 5:1, and 10:1 are common, special types of a much greater ratio (and much more expensive) are occasionally encountered.

Practical lenses of this type have three controls—zoom focus, for initial setting up, aperture (or iris), and zoom. These may be operated either by flexible wire drives to the operator's controls at the rear of

the camera, or remotely by small motors mounted inside the zoom lens cover. Drive is applied via toothed rings (nylon for quietness) clamped round the operating rings of the basic lens. A very common fault—loss of control of one or more lens functions—is caused by these rings working loose.

There are disadvantages to the zoom lens. It is expensive and comparatively delicate because of the great deal of precision engineering that must go into its construction. To achieve the zoom function a number of lens elements are needed and light is lost by absorption and reflection at each element's surface. The amount of light leaving the lens is therefore less than that leaving a fixed focus lens of equivalent focal length. Size and cost put a limit to the maximum aperture that can be obtained compared with fixed focus lenses.

Modern advances are overcoming some of these defects, notably the practice of lens blooming, of which more later, and the use of concave mirrors instead of lenses for part of the optical system thus making the lens more compact.

Whatever kind of lens is used it could equally well be used on a film camera (in fact, use of the lenses is sometimes one of the perks of a CCTV engineer who is also an amateur film enthusiast). The main difference between the two fields is the threads used for mounting the lens which means that thread adapters may sometimes have to be used. The thread commonly used on CCTV cameras is known as a C-mounting.

Aperture Marking Systems

The same system of aperture marking (the f-stop system) is used for most types of lens. The f-number is defined as the ratio of the focal length of the lens to its diameter, so that the smaller the f-number, the bigger the aperture, i.e. the more light allowed to pass through the lens giving a brighter image on the vidicon target layer. For a change from one f-stop to the next (say from $f/4$ to $f/5.6$) the amount of light going through the lens is halved when going from the smaller number to the larger or doubled when going from the larger f-number to the smaller. This happens each time the f-stop is increased so that a change from $f/8$ to $f/4$ (two stops) will result in a four-fold increase in the light passing through the lens.

While f-numbers like $f/3.769$ have a meaning there is a standard set of f-stops which is used throughout the photographic and television industry and the lens is only marked with these, frequently positive click stops are provided at each f-stop. The standard system is: $f/1.4$, $f/2.8$, $f/4$, $f/5.6$, $f/8$, $f/11$, $f/16$ over the most used operating range. Lenses are referred to by their maximum f-stop, i.e. the maximum aperture that can be achieved with that particular lens.

Another system that may be encountered is the T— or Transmission numbered lens (referred to as T-stops). This system takes into account the amount of light lost in the glass lens elements through reflection and absorption. The actual amount of light that passes through a lens at a particular f-stop (as opposed to the relative amount that passes as we change from one stop to another) will depend on how the lens is constructed, basically how much glass is in the way. The T-number of a lens (at a given aperture) is defined as the f-number divided by the square root of the transmittance value of that lens. The transmittance value is the ratio of the amount of light that passes through the lens at that aperture to the amount of light that

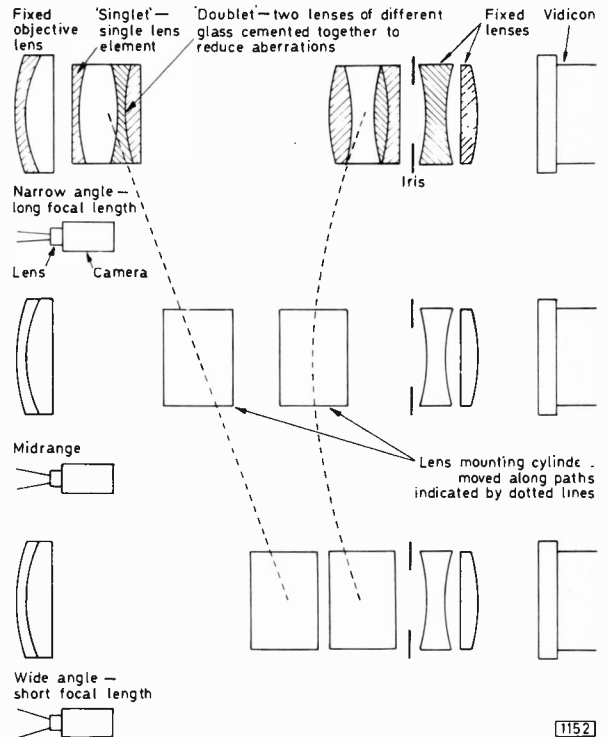

Fig. 4: Principle of action of one type of zoom lens.

passes through a clear hole of the same aperture. In practice, the systems are similar.

Because of the tremendous range of sensitivity adjustment available on a modern vidicon camera the aperture or iris setting is not as critical as it is on a film camera. Under good lighting conditions the aperture may be changed by one or two stops without much change in the monitor picture quality.

Depth of Field

Sometimes a remote aperture control is fitted, otherwise the aperture is adjusted experimentally to prevent what in film terms amounts to under or over exposure, recognised by lack of contrast and loss of detail in bright areas respectively. But the amount of light falling on the vidicon is not the only thing affected by the aperture. Because of the way a lens works the aperture also sets the depth of field. Suppose the lens is focused on an object 20ft. away from the camera; a certain distance in front of and behind the object will be in sharp focus as well. The total distance is known as the depth of field, see Fig. 5. Its length depends on how far from the camera the object is, and also on the aperture setting; the smaller the aperture the greater the depth of field.

While it is nice to be able to vary the depth of field as desired, to cover a long field of interesting objects or to bring into prominence some object against an out-of-focus, and hence less distracting, background, the amount of light reaching the vidicon must also be

continued on page 221

GREY-SCALE

L. COOK B. SC. (HONS)

It has been said that the most certain way of ensuring fine weather is to carry an umbrella. Certainly the surest way of being denied a broadcast test-card or colour bars is to start adjusting a colour television! The complete answer to the problem is, of course, a 'box of tricks' to generate these elusive picture signals as and when required but, unfortunately, such desirable items of test gear are beyond the financial capabilities of all but professional establishments.

On the other hand there is no doubt that relatively simple and cheap items of test gear can be well worthwhile for the amateur and professional engineer alike, and can significantly save time and effort in the basic setting-up of receivers. The unit to be described is just such an item and will enable as near perfect grey-scale tracking as possible to be obtained.

It may seem paradoxical to worry about obtaining a good black and white picture on a colour set. Correct grey-scale adjustment is essential, however, if we are to avoid the 'magenta soot and green whitewash' pictures so often displayed, not to mention the hideous flesh tints.

The Colour Guns

The ideal state of affairs for the three guns would be for each one to behave just like the others. That is to say if a signal were applied to all of them simultaneously, the picture obtained would be a monochrome (i.e. 'black and white') one.

In practice the sensitivity of the screen phosphors varies, as do the electrical characteristics of the guns.

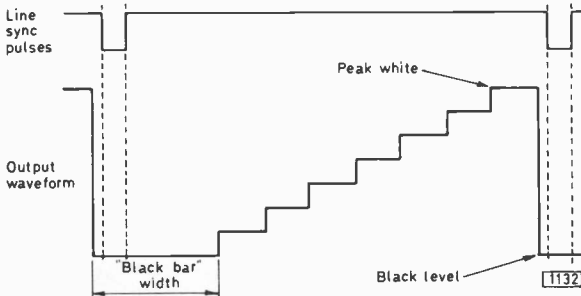

Fig. 1: The output waveform of the generator and its relationship with the incoming sync pulses.

Thus the grid to cathode voltage for raster extinction varies between the red, green and blue guns, as does the voltage corresponding to full brightness. This means that the d.c. bias applied to the guns must be adjusted to equalize their cut-off point, and the amount of video drive to each gun adjusted to equalize their maximum brightness point.

In order to facilitate these adjustments a video signal consisting of several discrete amplitude levels ranging from black to white is invaluable. Its use will be described in detail later, but in essence it enables the background and video drive presets to be set for best compromise between the aforementioned requirements and performance on half tones.

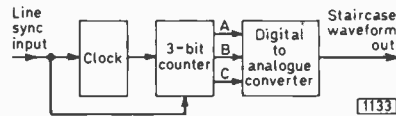

Fig. 2: Basic principle of the generator.

Design Objectives

In order to display a stable pattern on the screen the video waveform injected into the receiver must be synchronised with the line scan. For equipment of this type the circuit complexity necessary to generate composite video (including line and field sync pulses and interlace of the field scans) cannot be justified. Instead we synchronise the receiver from any off-air transmission and in turn synchronise the generator to receiver line scan using a loose 'pick-up' wire.

It was decided to display eight brightness levels—black then six lightening shades of grey and finally peak white. The black level would also have to be present during black level clamping, just after the line sync pulse. You will see from Fig. 1 that the black bar duration extends through flyback as well as occupying one-eighth of active line time to meet this latter requirement. The remaining seven levels occupy approximately one-eighth of active line period each. Such a display is equivalent to the broadcast colour bars minus chrominance information.

The incorporation of variable video level was considered essential to cater for various receiver circuits, both valve and transistor. A maximum output level of the order of 6V is available. A final requirement was to make the generator battery powered yet not unduly susceptible to ageing of the battery. All these requirements have been met in the present design.

GENERATOR

Staircase Generation

The signal corresponding to a grey scale is, as has already been seen, a staircase waveform comprising eight steps. This is a convenient number since any level from 0 to 7 (i.e. any one of eight) may be represented as a 3-bit binary code. This enables an accurate staircase to be produced by clocking a 3-bit binary counter at the correct rate and feeding the output to a digital to analogue converter (DAC), see Fig. 2.

In practice it is necessary to incorporate additional features, namely a monostable to define the black bar width, a sync pickup circuit and an output amplifier stage. The final arrangement is shown in Fig. 3. Logic functions, including the clock oscillator and the monostable, are accomplished by means of TTL integrated circuits. The sync amplifier, DAC and output amplifier use readily available npn silicon transistors. Both types of component are operated well within their ratings for reliability.

Clock Oscillator

The requirement here is to design a circuit which is a guaranteed starter. Many oscillators using TTL gates are unduly sensitive as regards frequency, and even whether they 'go' or not, to the particular sample of i.c. used. Also it should be possible to hold the oscillator off with a logic signal so that it will always start at a known point in its cycle of oscillation and, furthermore, start cleanly without a few bursts of spurious oscillation. It is not permissible to leave the clock running and merely gate its output since this will not necessarily produce an integral number of half-cycles. The circuit employed is shown in Fig. 4.

The feedback capacitor C3 is taken from a potential divider across the output. This small modification to conventional circuits is well worthwhile, it prevents the input of G1 being driven hard negative, a practice which would eventually render the circuit prone to drift or even premature failure. It also presents a more

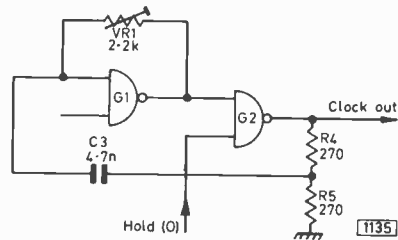

Fig. 4: The clock oscillator circuit.

resistive load to the output of G2 thereby excusing G2 from delivering large current surges, albeit short, into a capacitor.

The variable resistor VR1 sets the operating frequency, the timing capacitor being chosen to allow the correct frequency to be obtained with any gates within specification. A logic 0 on the 'hold' input forces the output to logic 1. On removal of the hold command the output falls to logic 0 and thereby begins oscillating on the falling edge of its cycle.

★ Components list

Resistors:

R1	1M Ω	R5	270 Ω	R9	3k Ω
R2	1k Ω	R6	39 Ω	R10	15k Ω
R3	680 Ω	R7	750 Ω	R11	100 Ω
R4	270 Ω	R8	1.5k Ω	R12	10 Ω

All $\frac{1}{4}$ W \pm 5% except R6 $\frac{1}{2}$ W.

Potentiometers:

VR1, VR2 2.2k Ω VR3 100 Ω

All linear carbon track horizontal presets

Capacitors:

C1	300pF	C5	47 μ F 25V
C2	10nF	C6	47 μ F 25V
C3	4.7nF	C7	10 μ F 25V
C4	33nF	C8	1 μ F 250V paper

Semiconductors:

IC1, IC2 SN7400 IC3 SN7493
Tr1 — Tr3 2N706
D1, D2 1N4148 (1N914) D3 BZY88 C5V1

Miscellaneous:

S1 ,SPST; 9V battery; materials for pcb, 2 $\frac{1}{2}$ x 7 in.; 3 i.c. sockets, 14-pin DIL (if required—see text)

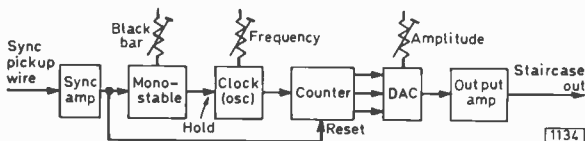

Fig. 3: Block diagram of the complete generator.

Black Bar Monostable

This part of the circuit must be negative-edge triggered and produce a good clean negative pulse of pre-settable width at the output. Like the oscillator it must be stable and tolerate a spread of i.c. characteristics. The circuit finally adopted is shown in Fig. 5.

The input capacitor/resistor combination C2, R3 differentiate the input signal to give a narrow trigger spike for the monostable. The diode D1 protects the input to G3 from damage due to being driven too positive. Similarly D2 protects G4 from negative voltages. Capacitor C4 and VR2 set the output pulse width. Operation is as follows.

Assume G4 output is high, the input to G4 being held low by its input resistor to ground, and assume G3 output to be low, its inputs being held high by R3 and G4 output respectively. A negative-going pulse arriving at the monostable input drives G3 output, and hence G4 input, momentarily high; G4 output therefore goes low. This holds G3 input low and output high, and G4 input is held high also, via the timing capacitor. As this charges, the input to G4 eventually falls below the threshold for the gate, so the output reverts to its quiescent high state.

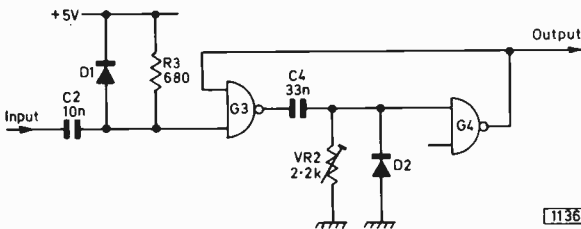

Fig. 5: Circuit of the black bar monostable.

Meanwhile the trigger to G3 input has gone so both its inputs are now high. G3 output goes low and the timing capacitor discharges into G3 output via D2 ready for the next trigger. The variable resistor on G4 input affects the charge rate and so the output pulse width may be set to the correct value.

Digital to Analogue Converter

The count sequence of the 3-bit counter is shown in the table. Logic 0 can be considered as earth and logic 1 as +5V. Bit A is the least significant bit having a weight of 1. Bit B has a weight of 2 and C of 4. Thus each combination represents a number from 0 to 7.

3-bit count sequence			
Clock	C	B	A
t_n	0	0	0
t_{n+1}	0	0	1
t_{n+2}	0	1	0
t_{n+3}	0	1	1
t_{n+4}	1	0	0
t_{n+5}	1	0	1
t_{n+6}	1	1	0
t_{n+7}	1	1	1

There are many ways of converting these logic signals to a corresponding analogue voltage. One well known approach involves a chain of resistors in a

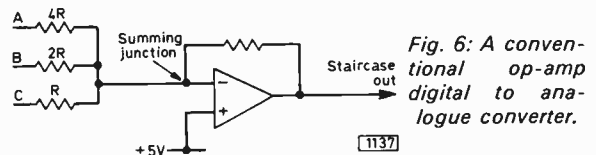

Fig. 6: A conventional op-amp digital to analogue converter.

ladder network but this uses too many components and is somewhat inelegant. A better method is to have three resistors of weight 1, 2 and 4 driven from the counter and feeding a current summing junction.

It is usual to use an operational amplifier to give a summing junction as shown in Fig. 6. Negative feedback endeavours to maintain +5V at the inverting input of the amplifier by developing an output voltage proportional to the binary input, thereby generating a staircase. However, operational amplifiers are costly and require voltage supplies greater than those available for this equipment.

The circuit used here (Fig. 7) is, as far as the author knows, a novel one. It consists of a single transistor with the base held at +5V and the three resistors connected to the emitter, which acts as a summing junction. By emitter follower action the emitter voltage remains fixed and the collector current therefore varies in sympathy with the binary input. A proportion of the voltage developed across the collector load is fed to the output amplifier to define the output voltage.

The complete circuit is shown in Fig. 8. Capacitor C1 removes unwanted high frequency pickup at the input to the sync amplifier, Tr1, and gives a more reliable synchronisation pulse.

The extra gate G5 is required because the counter, type SN7493, requires a positive-going pulse to reset it to zero. It may seem unfortunate that the inclusion of this gate necessitates incorporating a second i.c. of four gates, but the small additional cost is offset by the relaxed demands on layout of the printed circuit board.

The 9V supply is derived from a battery and need not be stabilised. The 5V supply is obtained via a dropper resistor and zener shunt stabiliser. Both rails are decoupled by capacitors.

Construction

It is a fact that by far the greatest number of 'electrical failures' are due to bad mechanical design. The printed circuit board goes a long way towards eliminating wiring errors and provides a high degree of robustness, yet many people negate these advantages

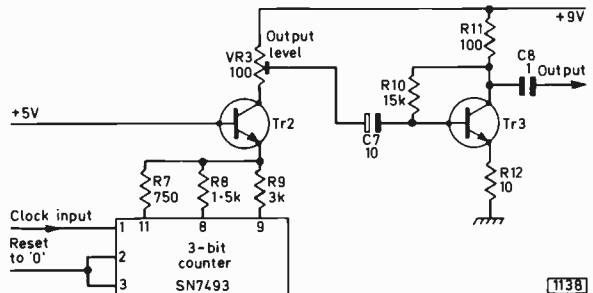

Fig. 7: The novel DAC circuit and its output amplifier.

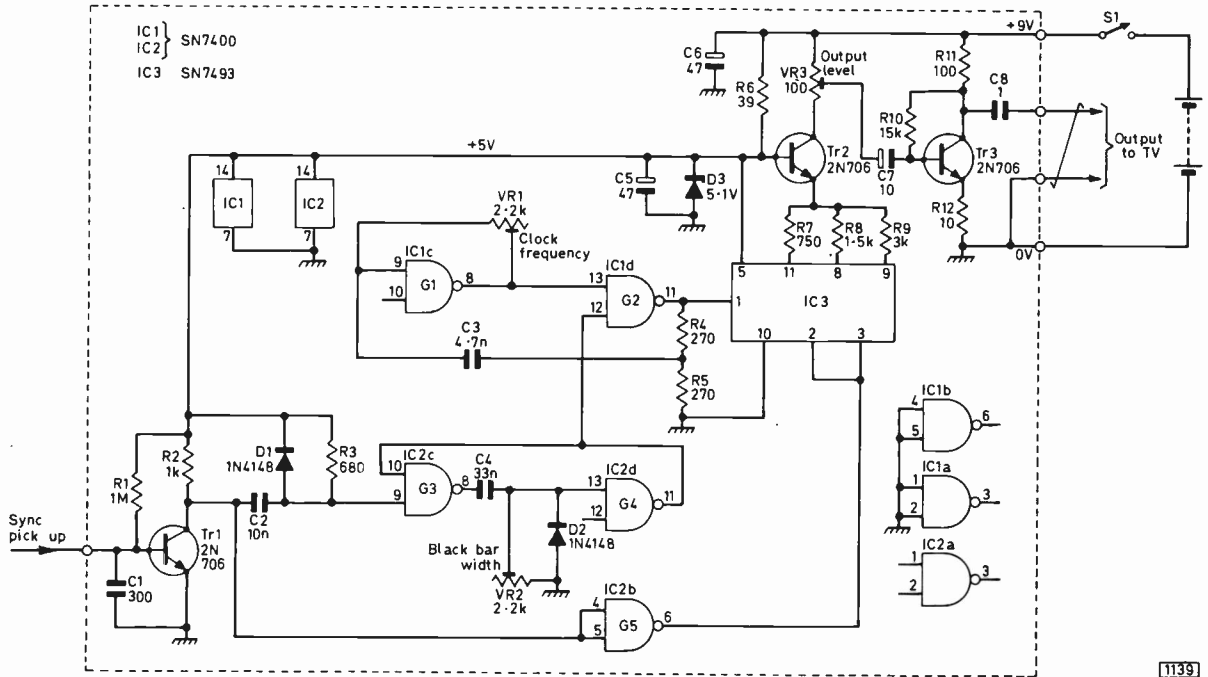

Fig. 8: Circuit diagram of the complete grey-scale generator.

by adopting practices such as routing tracks between adjacent pins on an integrated circuit, in an effort to avoid the dreaded link. Of course, a two layer or multiple layer board would be very pleasing, until the price is considered!

A better solution for the home constructor is a single layer board even if one or two links are inevitable. A link is far better than inadequate clearance between pads, and possible poorly soldered i.c. pins. The board layout is shown in Fig. 9. It should be noted that the preset potentiometers require larger holes to be drilled than do the other components. This is to be preferred to filing the legs on the pots, which can weaken the bond between them and the track as well as being a fiddly job.

Sockets were used for the i.c.s in the prototype in order to verify the ability of the circuit to operate satisfactorily with different samples of i.c. Their use is at the discretion of the constructor but ensure slim-type sockets are used, if any, to clear other components.

Enough has been written elsewhere on the subject of soldering components on a circuit board. Everybody seems to have their own preferred method; all that remains to be said is to note the orientation of the integrated circuits, unless you have a de-soldering tool and are slow to anger!

Connect a couple of feet of well insulated wire to the sync input and a length of twisted pair to the output (black) and 0V (red). Connect a length of twisted pair to 0V (blue) and +9V (brown) to go to the 9V battery (e.g. PP9 or two 4½V pocket lamp batteries), via the ON/OFF switch S1.

Testing and Setting Up

Connect the blue and brown pair to the battery, observing polarity. Check for the 5V supply across the

zener diode. A reading of 0.6V means the battery is reversed or the zener has been inserted backwards. Turn all pots approximately to mid-position and feed the video into the set.

Exactly where you feed the video depends on the set. If possible disconnect the set's own video source temporarily at the point where the staircase is injected. It is necessary to choose a point after sync extraction so the set can still lock to an off-air transmission e.g. on the TELEVISION colour receiver the luminance input to the RGB board is an ideal location. Crocodile clips may be connected to the colour coded output pair already described, to make this easier. Red is positive-going with respect to black (usually black goes to receiver chassis).

Place the sync pickup wire near the LOPT. **Do Not** make any direct connection, nor bare the end of the wire. Sync is picked up by stray coupling. Some form of stable display should be visible, dark at the left of the picture and brighter towards the right. Set the black bar width potentiometer to give a black bar one-eighth of the screen width. Set the clock frequency potentiometer to give another seven bars between the black bar and the right-hand side of the picture. Set the receiver brightness control so that the black bar is truly black (raster just disappearing) and set the video level potentiometer on the generator so that the peak white bar (furthest right) is of suitable brilliance.

Using the Grey Scale Generator

The 'background pots' on the receiver must be adjusted to give true black. Usually this involves varying the first anode potentials (**warning**—lots of nasty volts!) by means of preset potentiometers. This in turn alters the grid-cathode voltage for raster extinction, by altering the behaviour of the tube. Note

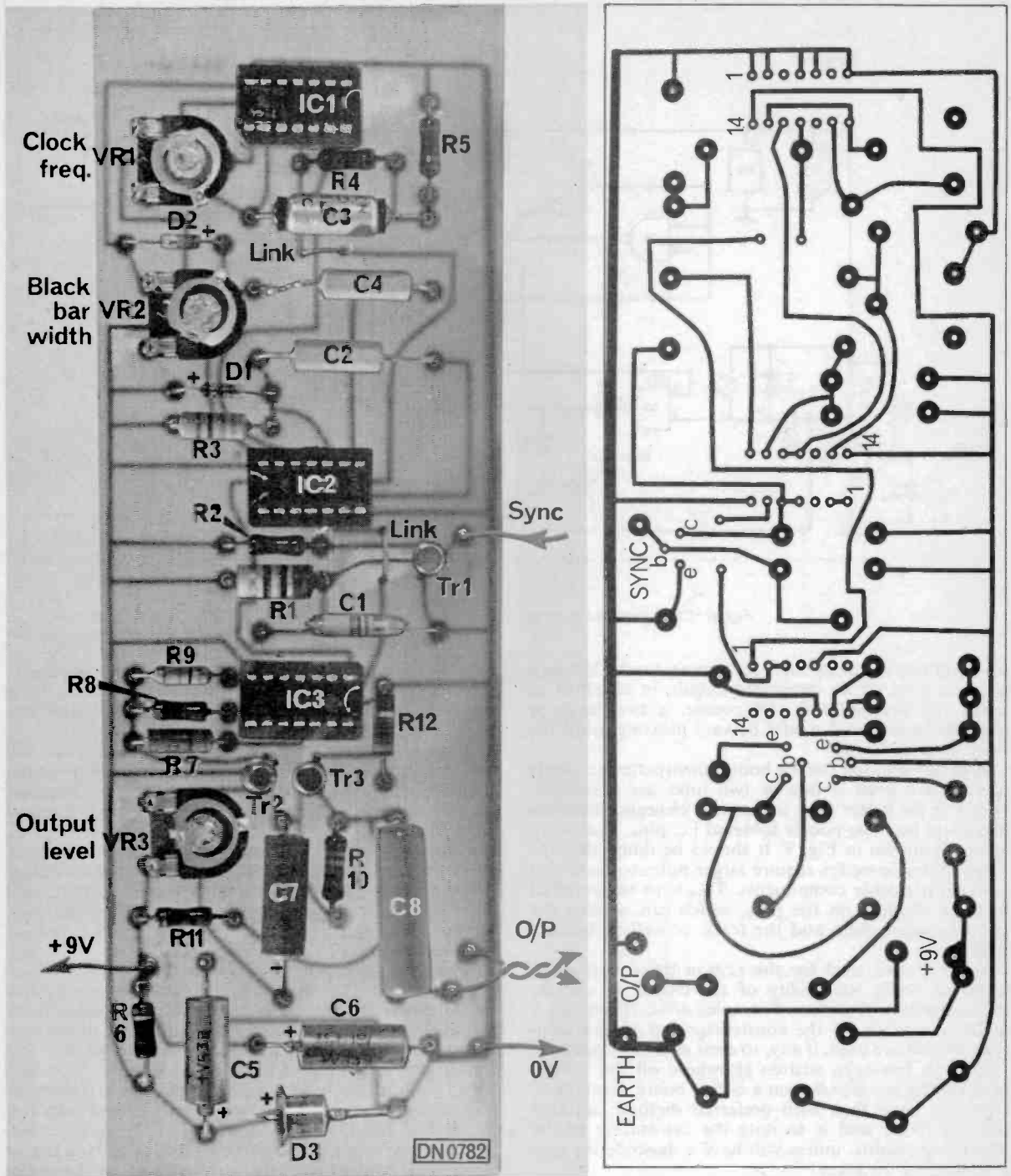

Fig. 9: Component layout and printed circuit board, both shown full size.

that all these adjustments should be carried out in a darkened room.

If, for example, black has a greenish cast, back off the green background pot. This establishes correct operation in low-lights. To achieve correct operation in the high-lights the separate video drives require adjustment. The object is to display illuminant D

(a warmer white than that on monochrome receivers) on peak white and also at reduced intensity throughout the grey scale.

Some interaction between high-light and low-light adjustments is inevitable so run through the receiver adjustments again. More specific instructions are usually provided by the manufacturer of the particular receiver

being adjusted. If proper grey scale cannot be obtained check tube potentials, etc.

With an old tube it is possible that one gun has low emission. On a set with colour difference drive, maximum signal is sometimes applied to the red gun and the other two drive levels varied. If for example, blue is weak the red and blue luminance drives may be swapped over to give that bit extra to the ailing gun.

Note that inadequate emission symptoms can arise if heater voltage is low. On commercial sets a transformer is often used but some sets employ thermistors, resistors, diodes and all sorts of things in series with the heater. Any of these can go high resistance and make you think a new tube is required but this is seldom necessary. Also beware of using a meter to read the voltage unless it is a true r.m.s. one (not an Avo etc.).

Other faults are incorrect clamp pulse amplitude, faulty luminance drives, etc., but the most frequent cause of poor grey scale is simply maladjustment.

Conclusion

Apart from its primary function, the grey scale generator can also be used to check the frequency response of the video output stages with the aid of an oscilloscope. However, the benefits to be obtained from correct grey scale tracking are reward enough for the small amount of time and money expended on its construction. ■

USING TUNERS AS PREAMPLIFIERS

—continued from page 207

Sound splatter affecting channels F8/F8A was overcome by turning back the gain of the receiver tuner. The only DX channel on which reception has proved completely impossible is E7. Operation is similar to that described for the u.h.f. preamplifier though the tuning is less sharp.

Reception on Band I presents little problem using the f.e.t. circuit from TELEVISION, January 1974. A separate 2-stage bipolar preamplifier is used for the TV section of Band II (77–93MHz), and this requires a filter to keep out the local transmitter on Band III or u.h.f.

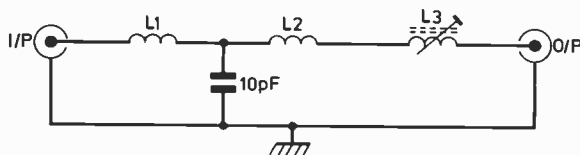

- L1/L2 Band IV: 2 turns coaxial cable inner over $\frac{1}{4}$ in.
Band V: 1 turn coaxial cable inner.
- L3 6 turns coaxial cable inner wound over $\frac{1}{2}$ in. on a $\frac{1}{4}$ in. dia. dust iron core.

DN 0785

Fig. 3: A low-loss Band III/u.h.f. absorption filter.

A suitable design having very low insertion loss at Band I/Band II frequencies is shown in Fig. 3. The only setting-up required is to adjust L3 for minimum Band III signal, the response being quite flat. If the reader has a local signal on Band I then one of Roger Bunney's excellent notch filters can be used. ■

CCTV Part 12

—continued from page 215

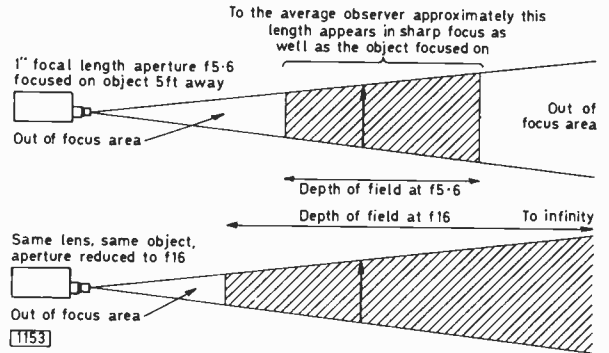

Fig. 5: Variation of depth of field with lens aperture.

considered. For many applications, particularly outdoors, a compromise must be made between depth of field and picture contrast. In a studio the lighting can be adjusted for the desired effect.

The edges of a lens tend to be more defect prone than the centre and opening the aperture means that more and more of the lens is in use, so it is advisable not to operate the lens at maximum aperture if it can be helped. Under low light conditions, there is little choice.

Lens Care

Whatever kind of lens is used a little care will ensure that it has an almost indefinite life. Cleanliness of the external lens surfaces is the first essential and they should be cleaned with a soft brush or a very soft cloth. Lens tissue—available from vidicon suppliers or opticians—may be used. Care must be taken to avoid scratching or damaging the surface, particularly if the lens is bloomed. Blooming may be recognised by a purplish tint on the lens surface when it is held against the light. It is a very thin coating of a high refractive index material (e.g. magnesium fluoride) which cuts down losses due to reflection from the lens surface.

Any temptation to dismantle the lens should be firmly resisted as any misalignment on reassembling will result in degraded pictures. Stripping and checking, particularly if the lens has been dropped, should be referred to the manufacturer. The moving parts of the lens must not be oiled as the oil can get inside the lens and cause clouding of the elements.

Condensation on lens surfaces can be a problem with cameras that are taken from warm rooms to cold areas. There is not much you can do except keep mopping the lens surface with soft tissue until the lens has cooled off. Cameras that are used a lot outdoors should be protected with a heated, weatherproof housing. The lens looks through a window in the end of the housing which may also be provided with remotely controlled windscreen wipers and washers.

For the best pictures the lens quality should be at least equal to the camera quality, it is a false economy to skimp on lenses. Buying the best will amply repay the extra expense.

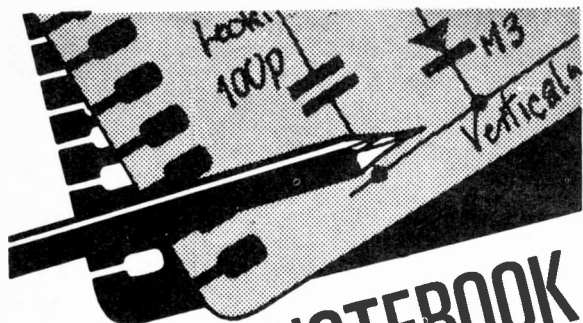

SERVICE NOTEBOOK

G. R. WILDING

Printed Board Burn-ups

Every now and then we come across small burn-ups on printed circuit boards—generally due to breakdown of a high voltage carrying capacitor. If the panel is large and expensive, which is generally the case, it pays to make a repair, though no matter how carefully the work is done the end result rarely looks neat.

The first thing to do is to snip or break away even suspect sections of the panel around the actual burn-up. This is essential because carbonisation or near carbonisation of a panel results in it becoming to some extent conductive, particularly to high voltages which can track across. Remember also that while temperature rise increases to a small extent the resistance of a conductor it enormously decreases the resistance of insulating materials: thus suspect insulation must not be left where the working temperature may be high.

After snipping away all faulty and suspect sections, but leaving the well soldered ends of damaged components untouched—to help later component identification—the next step is to clean up any smoke blackened but sound areas. This can be done with a clean rag moistened with turps or some other cleaning fluid.

In addition to the circuit diagram you will need the panel's print layout. The next step is to identify positively an easily recognisable print shape or cluster of soldering points, then annotate your print pattern. It cannot be emphasised too much that all subsequent work depends on getting the actual panel and diagram layout accurately co-related. Recently we had to repair a section of the timebase panel in a colour receiver fitted with the ITT/KB CVC5 chassis. Just above the burnt out section was a line of five soldering points. Only three were indicated on the print chart however, so having checked and rechecked what should go where we marked both the panel and the diagram with coloured identifying marks.

The next stage is to replace the broken printed wiring tracks across the section of the board snipped out, using flexible, thin insulated wire. For soldering points use the middle of large print areas wherever possible. It is best to peel tracks which terminate at the hole made in the board right back to a perfect area to eliminate risk of leakage across the panel being picked up. Where several components were connected to a track which has had to be removed link them with thin gauge bare wire insulated where advisable with

pieces of Systoflex. Watch out for components mounted between the panel and some other point.

If any high-wattage resistors are mounted near the damaged area it is often best to disconnect the end nearest the damage and connect it into circuit with stiff, bare wire—otherwise the heat dissipated could well result in breakdown of an already overheated section. Always check the soldering of such components. The high working temperature leads to defects that result in minute sparking, burning away the surrounding panel insulation.

After completing a repair always check before switching on that no h.t. shorts are present.

Weak Field Sync

Weak field sync with normal line lock is one of the most common TV set faults. The more common causes of the trouble are a faulty field generator valve or hold control circuit, a sub-standard sync separator or video amplifier, a high forward resistance interlace diode or inadequate bandwidth. To preserve the shape of the field sync pulses the overall bandwidth must be in excess of 2.5MHz: when the c.r.t. is old and has lost the normal degree of focus it is quite easy to overlook this point unless a test card is being received.

On 625-line reception in particular unusual causes of weak field sync crop up—mainly due to the fact that on this system the sync pulses comprise 77 to 100% of the modulation amplitude. Thus a slightly soft vision i.f. pentode or an over-biased transistor can result in the sync pulses being clipped or limited—an over-advanced sensitivity control being a common cause of limiting, particularly in some Bush/Murphy dual-standard models. Other possibilities to bear in mind when investigating this trouble are sub-standard power supply smoothing, impaired video amplifier decoupling (particularly at the screen grid), incorrect working voltages due to resistor values changing, and a defective field sync pulse integrating capacitor.

In a Rank-Bush-Murphy colour receiver that came our way recently with the complaint sub-standard field but normal line sync, replacing the scan output and e.h.t. unit which contains the sync separator, integrating components, interlace diode and thyristor field generator made no difference whatsoever. The trouble was cured however when the i.f. and sound output panel (type A809) which also contains the luminance amplifier and a.g.c. circuitry was replaced. Attention was directed to the circuitry around the luminance amplifier stage 2VT5 and as a first move the 4 μ F electrolytic 2C34 which decouples the forward bias applied to the base of this stage was replaced. This made no difference however and all working voltages were found to be correct and all diodes had excellent forward/reverse resistance ratios. Although there wasn't the slightest suggestion of instability the various 0.01 μ F and electrolytic l.t. supply decouplers were next checked but all appeared to be in order. As it seemed that the weak field lock was rather worse on strong signals attention was then turned to the a.g.c. amplifier circuit. Replacing the electrolytic 2C37 which decouples the collector of the a.g.c. amplifier transistor to chassis restored normal field lock.

Loss of Line Sync after an Hour

A colour set fitted with the TCE 3000 chassis would work perfectly for an hour or so after which it would tend to lose line sync. This could usually be remedied by resetting the line hold control (see Fig. 1) but this had to be carefully set in order to do so. The first suspects of course were the flywheel sync discriminator diodes W501 and W502, followed by the diode (W503) in the feedback loop between the collector and base of the line oscillator transistor VT502. The forward resistances of all these diodes were found to be above normal and after replacing them some improvement was noted. The fault continued to develop after long periods of operation however. There are no really high-value resistors—these most often tend to change value when warm—in the circuit so we went for the electrolytics. Increased ambient temperature can greatly increase the normal small leakage current in these. The supply decoupling electrolytic C508 was first replaced, again with no real improvement, but after replacing C506 (25 μ F) in the flywheel sync filter anti-hunt network (C506/R510) greatly improved line lock which did not deteriorate was obtained.

Top Foldover

Foldover at the bottom of the raster is quite a common fault, generally caused by the combined effect of a soft field output valve and a reduced value cathode bias resistor. Recently however we came for the first time across a raster of diminished height with a pronounced foldover at the top. This was in a single-standard Bush model fitted with the RBM A774 chassis (for full circuit see pages 264-5, April 1973). The field timebase consists of a conventional cross-coupled PCL805 and needless to say trying a new valve made no difference—though this must always be the first check. The voltages in the stage were about normal and there were no discoloured resistors. It seemed therefore that the fault must be due to an open-circuit, changed value or leaky capacitor. Those concerned with sync pulse integration and coupling could be ruled out, as could the pentode cathode decoupler, and attention was first turned to 3C11 and 3C12 in the grid circuit of the triode section of the valve. These proved to be in order in every respect so we directed attention to the capacitors providing the cross-coupling between the

triode anode and pentode grid. We eventually found that by shunting a near equivalent across 3C15 (2,200pF) in this network a full-sized raster without foldover was obtained.

Faulty Scan Coils

The fault on a set fitted with the Thorn 950 chassis was normal sound but no picture. This was found to be due to there being negligible e.h.t.—there was only the slightest suggestion of a spark at the anode of the PL504 line output valve. Removing the top cap of the boost rectifier failed to increase the spark available, new valves did not improve matters and disconnecting the e.h.t. tripler also failed to result in increased spark size. All components in the width circuit seemed to be in order and there was the normal negative voltage at the line output valve control grid. It seemed therefore that either the line output transformer or the scan coils were at fault. The latter was the easiest check to make and on disconnecting the coils we were able to get a good spark at the anode of the PL504. As is the usual practice the line scan coils are connected in parallel so it is a simple matter to determine by disconnecting one of them which is faulty. With the faulty winding disconnected and the e.h.t. tripler back in position quite a good though wedge-shaped picture was obtained. We examined the faulty winding hopefully to see whether there was any visual evidence of shorted turns but it became clear that the only remedy was a new yoke.

When the e.h.t. is low always check the scan coils before condemning the line output transformer. For sure indication note the effect of disconnecting one of the windings.

No Raster and No Sound

The fault in a KB receiver fitted with the ITT VC200 chassis was no raster or sound, the latter because in this as in many other recent chassis the l.t. supply for the signal stages is obtained from the line output stage. Removing the back showed that all the valve heaters were glowing and although there was h.t. at the anode of the PL504 line output valve no suggestion of a spark could be obtained and the valve was running very cool. This suggested that the

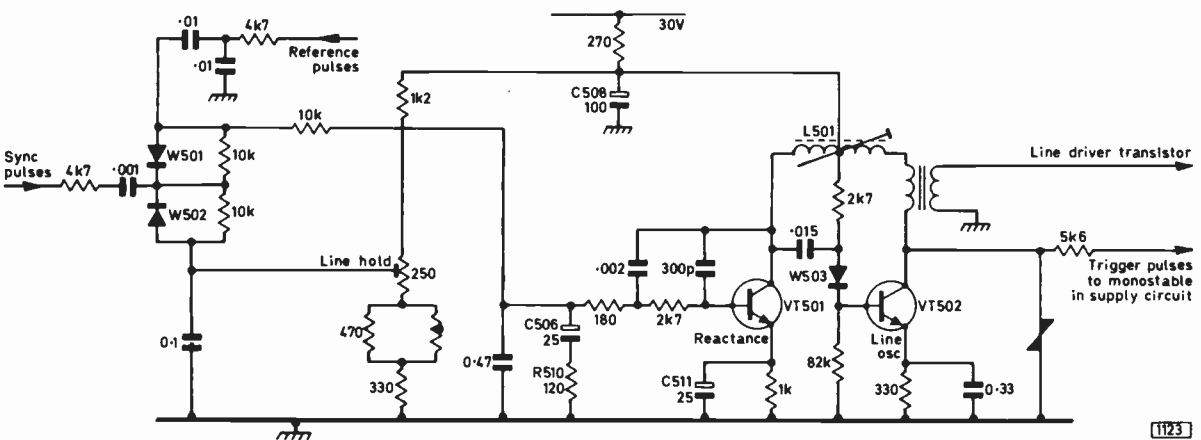

Fig. 1: Line generator circuit used in the Thorn 3000 and 3500 chassis: VT502 oscillator, VT501 reactance stage.

cause of the fault was absence of voltage at the PL504 screen grid due to an open-circuit feed resistor. The feed resistor was found to be intact however, placing about 200V on the screen grid pin, but on checking at the control grid a considerable positive reading was obtained instead of the usual -50V or so grid bias. This would normally suggest absence of line drive but as both the screen grid and anode voltages were present this would have resulted in the valve running excessively hot.

The main possibilities were a break in the printed wiring in the control grid or cathode circuits of the PL504 or an internal disconnection to either of these electrodes. The negative grid bias developed at the control grid of a line output valve on application of the drive waveform occurs as a result of grid current charging the coupling capacitor—the control grid and cathode of the valve acting as a diode. In modern receivers this negative bias is offset to some extent by the positive potential from the width stabilising circuit—this was the positive grid voltage detected. Fitting a new PL504 immediately restored the picture and sound, indicating that as suspected the original valve had an internal disconnection. If the disconnection had been to the anode there would have been very heavy screen grid current, enough to make the winding glow, while if the disconnection had been to the screen grid the valve would have passed some anode current and the normal negative voltage would have been developed at the control grid.

No Picture, TCE 8000 Chassis

The complaint with a colour receiver fitted with the TCE 8000 chassis was absence of picture. On test it was discovered that following switch off the line output transistor was completely cold. There was virtually full h.t. potential (HT1, 180V) at its collector so L406 and R727 (see Fig. 2) in series with the supply to it were clearly o.k. It seemed therefore that VT401 had an internal open-circuit or that there was no line drive. Voltage checks soon showed that the latter was the

case since there was almost the full h.t. potential at the collector of the driver transistor VT402 instead of the correct 96V. There is no emitter resistor in this stage so a check was made between the base and emitter of VT402, a complete short-circuit being found in both directions. This meant that either the base-emitter junction of the transistor or the shunt diode W417 was short-circuit. One end of the diode was disconnected, proving that this component was responsible for the fault, and on fitting a replacement a normal picture was obtained.

Brightness Changes and Field Jitter

The owner of a set fitted with the Philips G8 chassis complained that the brightness level sometimes jumped up and down spasmodically, though the set would on many occasions work perfectly for hours. During a bench test the set worked without fault for about half an hour: mild but annoying field jitter, which could be alleviated but not cured by adjusting the field hold control, then developed. This gave a clear indication as to where the fault could be. A thyristor stabilised h.t. supply circuit is employed, a diac being used to trigger the gate of the thyristor. The diac is type BR100 but for a time when these were in short supply ST2 diacs were fitted instead. These have been known to cause intermittent field jitter as a result of providing an erratic trigger pulse feed to the thyristor. This set was found to be fitted with an ST2 and on fitting a new BR100 and resetting the set h.t. and overvoltage protection controls no further field jitter was experienced while the brightness level remained constant.

The diac is a bidirectional device which passes only a small leakage current until the voltage across it reaches a certain level—32V in the case of the BR100. This voltage is called the breakover potential and when it is reached the device very rapidly switches fully on. Diacs are ideal therefore for generating the trigger pulses required for the gate of a thyristor.

Thyristors can develop leaks and break down only when the h.t. voltage is applied: more commonly however they break down completely, a fault which is revealed by making an ohmmeter check. Indication that a thyristor is operational is also possible using an ohmmeter. Use the lowest resistance range and connect up so that the test prods supply a positive potential from the meter's internal battery to the anode of the thyristor and a negative potential to its cathode (with Avos and similar meters this means applying the "positive" test prod to the cathode). No reading should be obtained, but on momentarily connecting the gate and anode of the thyristor—thus in effect applying a triggering pulse—the meter reading should move to and stay at 15-50 Ω . On then removing either the cathode or anode test prod and reapplying it the reading should again be infinity.

Mains Fuse Blowing

The mains fuse in a colour set fitted with the Philips G6 chassis repeatedly blew, though no short existed across the valve heater chain or in the h.t. circuits. As is usually the case in such instances, the fault was a short-circuit in one of the h.t. rectifiers—this set uses two BA148 rectifiers in a full-wave circuit. The short effectively put the reservoir capacitor directly across the mains supply!

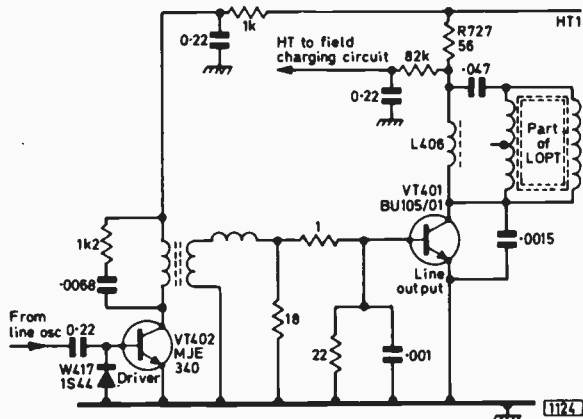

Fig. 2: Line driver and output stage circuit (simplified) used on the Thorn 8000 chassis. Note that a BU105 cannot be used to replace the BU105/02 (shown incorrectly above as BU105/01) line output transistor. An alternative which may be used is the 2SC643A.

JELLY-POT LOPTs & EHT STICK RECTIFIER TRAYS

JOHN LAW

WITH the introduction of the Thorn 900 chassis in 1964 came a new line output transformer design known as the jelly pot which is used with a selenium stick e.h.t. rectifier tray. Jelly pot transformers are so called because they are filled with a silicone jelly insulating material and because of their squat shape and plastic cases. The stick e.h.t. rectifiers consist of a paxolin tube of $\frac{1}{2}$ in. diameter packed with miniature selenium disc rectifiers. Two to five such tubes are mounted along with one or more capacitors in a plastic tray which clips on to the jelly pot line output transformer. E.H.T. outputs of from 10kV to 25kV are provided and there are no heat producing filament supplies. This helps to keep the heat dissipation within the cabinet down.

Jelly pot line output transformers and selenium stick rectifier trays are found in a large number of Ferguson, HMV, Ultra, DER and Marconiphone models amongst others. The line output transformers have proved to be very reliable but as with other components breakdowns do from time to time occur. The silicone jelly gives a high degree of insulation between the windings and any insulation breakdown is usually between adjacent turns of a particular winding. When this occurs it imposes a load on the inductance of the transformer, damping its efficiency. The only answer to this fault is transformer replacement.

Correct Transformer Soldering

One often comes across the problem of a replacement transformer failing to operate. This is normally due to careless soldering however. The makers advise the use of a small, low-consumption iron when making connections to a jelly pot transformer and the application of the iron to each tag just long enough to ensure a firm joint. There are two reasons for this: first the plastic case has a low melting point, while secondly sustained application of a very hot soldering iron may loosen the internal connection to the winding. Because of the low melting point the tag can become displaced in its socket. Dabbing the iron on to the connection can on the other hand result in a dry-joint which may not show immediately but cause breakdown later. Placing a single turn of the connecting wire around the solder tag will prevent the wire subsequently falling off should a dry-joint develop, causing possible extra damage if the lead is live.

Tuning Capacitors

In some chassis tuning capacitors are wired across tags on the line output transformer, one of the tags being

at chassis potential. These capacitors are suspect when diagnosing line timebase failure. Examples are C131 in the 950 Mk 11 chassis, C114 in the 1400 chassis and C95 or C113 in the 1500 chassis. These capacitors are rated at 8kV working and can break down with a spectacular display of arcing—there is no difficulty in tracing this fault! It is best to use replacement capacitors rated at 12kV to avoid a repeat breakdown, which is not unknown.

Selenium Rectifier Faults

Perhaps the most common and certainly the easiest fault to find in a set using selenium stick rectifiers is a short resulting in overheating inside one of the sticks. A pungent odour which fills the room is given off—it is reminiscent of school time stink bombs. The affected stick turns black in the centre. Individual sticks can be replaced but the makers do not recommend this—other components in the tray may have suffered from the extra stress. One cause of breakdown is drawing arcs from the tray when fault finding in the line output stage: the excessive current quickly leads to breakdown in the tray, so spark tests should on no account be made. The simplest way of checking an e.h.t. tray is by substituting a known good one. If you decide to replace an individual stick take great care to ensure that the soldering is smooth: the slightest suggestion of an edge or point will result in arcing in the tray.

Other symptoms can result from rectifier breakdown. A common one is a narrow picture with or without erratic variations in width, the latter symptom sometimes being accompanied by sizzling on the sound. An overall shimmering effect on the picture with varying focus, or snow effects on the screen increasing as the brightness is turned up, are other indications of rectifier stick failure. It is an unfortunate fact that e.h.t. trays can fail for no apparent reason. This is just as likely to happen with a replacement only a few days or weeks old. In this case one must throw oneself on the mercy of the suppliers and beg a replacement under guarantee!

Replacements

With some ten types of jelly pot line output transformer used in various Thorn monochrome chassis and eight varieties of e.h.t. rectifier trays identification of the correct combination for any particular set is essential. With few exceptions the transformers used in different chassis are not interchangeable. Equally the correct e.h.t. tray must be used in any chassis—some are half-wave rectifiers, some doublers and others

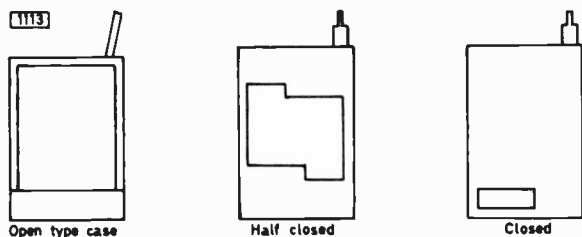

Fig. 1: Thorn e.h.t. tray designs.

triplers. Identification is not always easy but the following notes should help. When ordering, the chassis and circuit reference number should be specified.

Transformer Identification

900 and 950 chassis: There are two versions of the 950 chassis, one operating with an e.h.t. of 16.5kV and the other with an e.h.t. of 20kV (Mk 11 chassis). The transformer (T4) used in the 900 and earlier (16.5kV) 950 chassis originally had a red case but this has been changed to grey with a red identification spot. The transformer (T4) used in the 950 Mk 11 chassis (20kV) is white with no identification mark. A variation on this is the all white transformer with a red spot for the 950 Mk 11 chassis.

An 11in. version of the 950 chassis uses a clear plastic transformer with a blue spot.

960 chassis: This 16in. portable version of the 950 chassis sometimes has the red transformer (T4) as in the 950 chassis or in later sets a grey transformer.

970 chassis: A version of the 950 chassis with integrated silicon transistor push-button tuner unit. Uses the same line output transformer (T4) as the 950 Mk 11 chassis.

980 and 981 chassis: These single-standard (v.h.f.) mains portable chassis use an all black transformer (T3).

1400 chassis: This chassis marked a complete departure in design, with an upright panel mounted on hinges to facilitate servicing. The line output transformer (T4) is white.

1500 chassis: Small-screen versions operate at 15kV: the grey transformer (T4) is coded with a pink or green spot. Larger-screen versions operate at 20kV: the transformer (T5) coding spot on this is white.

1580 chassis: A grey line output transformer (T3) with blue spot is used in this hybrid mains portable chassis.

Types of EHT Trays

Thorn e.h.t. trays are produced in three styles of case, open, half-closed and closed (see Fig. 1). The case clips on to the line output transformer and is secured by a perforated plastic strap. The position of the clip determines whether the tray is mounted vertically, horizontally or even, in some sets, sideways. This means that trays are not interchangeable, quite apart from the different internal arrangements. Identification is mainly by type of case, the length and colour of the e.h.t. lead and the colour of the e.h.t. connector. This has led to some confusion in the past. The features of each tray are listed below to help identify the unit required.

The earliest chassis (900 and 950 16.5kV) use an open tray (W11) containing three stick rectifiers (half-wave

rectifier circuit); the 16in. e.h.t. lead is white and the connector black.

The 950 Mk 11 (20kV) and 970 chassis use a half-closed tray (W11 and W9 respectively) with five rectifier sticks (tripler); the 18in. e.h.t. lead is orange and the connector black.

The 950/960 mains portables use an open-case, three-stick (half-wave rectifier) tray (W11) with 18in. lead and red e.h.t. connector.

The 980, 981 and 1580 chassis use the same half-closed, two-stick e.h.t. tray with 11in. white lead and black e.h.t. connector. Circuit reference for the 980 and 981 is W6/7, for the 1580 W10/11.

The e.h.t. tray (W12) used in the standard 1400 chassis is a half-open, five-stick type with 24in. long orange lead and grey e.h.t. connector. A 15kV version of the 1400 chassis used a three-stick, closed tray with 22in. long white lead and red e.h.t. connector.

Both e.h.t. trays used in the 1500 chassis are of the closed type. The 15kV version (W9-11) has a 16in. yellow lead and black e.h.t. connector. It contains three stick rectifiers (voltage doubler). The 20kV tray (W12-16) has a 22in. yellow lead and white e.h.t. connector. This one contains five stick rectifiers.

Thorn Colour Chassis

Jelly pot transformers are also used in Thorn colour receivers.

In the first (2000) chassis there are two output transformers (T3 and T4) on the line timebase panel, mounted on heatsinks. They are identical and are wired in parallel. The outer case is white with eight solder tags.

Above the timebase panel in the 2000 chassis is the e.h.t. generator board. A third jelly pot transformer (T1) is mounted on this. The case is again white but as there are only three solder tags there is little danger of confusing this transformer with the line output transformers. The circuit reference of the e.h.t. tripler tray,

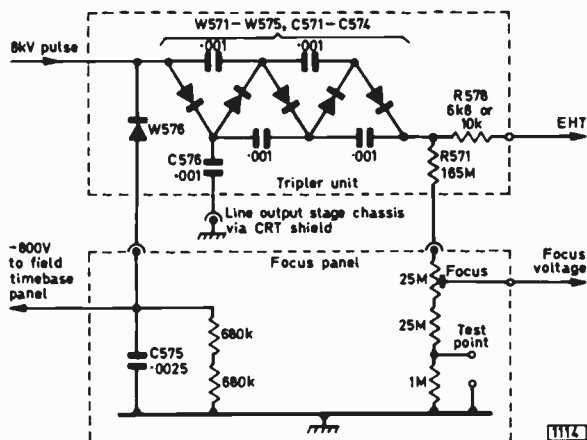

Fig. 2: The e.h.t. tripler and focus circuit used in the Thorn 3000 chassis. The e.h.t. can be checked by connecting a meter switched to a $250\mu\text{A}$ range between the focus panel test point and chassis: the reading should be $100\text{--}120\mu\text{A}$. In later versions R571 is reduced in value and fed from the first stage of the tripler. R578 is $6.8\text{k}\Omega$ in the 3000 chassis. The same circuit is used in the 3500 chassis but R578 is then $10\text{k}\Omega$, the focus control $33\text{M}\Omega$ and its adjoining series resistor on the focus panel $30\text{M}\Omega$.

which is of the sealed variety, is W500-4.

A more substantial design means that only a single line output transformer is required in the 3000 chassis. A glance at the circuit shows two transformers side by side, T503 and T504. These are not wired in parallel however. T503 is a separate transformer used to supply an 8kV pulse to the e.h.t. tripler (W571-5). This transformer was originally white but in later sets it is grey with a black spot. It has five terminals. The line output transformer T504 is in a grey case with a yellow spot and has nine terminals.

The 3500 (26in. c.r.t.) chassis uses the same transformers and e.h.t. tripler unit as the 3000 chassis. The wiring between the two transformers differs however in order to obtain 25.5kV instead of 24kV e.h.t.

A grey foam sleeve is fitted over the red lead which feeds the 8kV pulses from T503 to the tripler. Arcing can occur if this sleeve is not fitted, leading to extensive damage.

Fig. 2 shows the circuit of the tripler unit and the focus panel used in the 3000 and 3500 chassis. Two common external causes of e.h.t. tripler unit breakdown are as follows. If C575 on the focus panel becomes leaky W576 in the tripler will be overloaded. Some triplers use a silicon diode in this position, with a

series limiter resistor (not shown in Fig. 2). This resistor will overheat if C575 is leaky, resulting in early failure of a replacement tray. The other trouble is when C576 becomes open-circuit, which will automatically occur if the tripler unit's earth return lead is not effectively connected to the lug on the magnetic c.r.t. shield. In this event R578 overheats and eventually fails. Picture quality is not affected if C576 is not effectively earthed, thus the fault condition will not be noticed but the e.h.t. unit will quickly fail.

Another common fault with this tripler is the tendency of R571 to increase in value so that the focus control has to be reset. In the latest trays R571 is reduced in value and connected to the first stage of the multiplier. Note that there is then no d.c. return path at the output of the tripler.

Different Encapsulations

Do not be confused if the e.h.t. tray found in a Thorn model has a different appearance to that given above—replacement units are also made by other manufacturers. The purpose of the information in this article is to enable the correct Thorn unit to be obtained. Note that Thorn no longer use part numbers. ■

A WATERY TV FAULT

Steven Knowles

EVERY engineer receives from time to time a complaint that a piece of domestic electrical equipment, be it a radio, television set or record player, is doing something that his logical mind tells him cannot be. Such was the case recently when I received a frantic telephone call from a lady who informed me that water was coming out of the back of her television set. She went on to say that there was a big pool of water on the floor behind the set. The logical mind telling me that water cannot come from a television set, I advised her to look around for other possible sources, to mop up the pool and forget about it. I thought that would be the end of the matter, but on the following day another phone call informed me that water was still coming out of the back of the set. At this point I considered it prudent to make a service call.

The customer lived on the ground floor of a ten-storey block of flats and on arrival I found that the trouble was exactly as reported—a pool of water on the floor directly below the set. There were no leaky flower vases on the top of the set—I had confidently expected this—nor any leaks from surrounding window frames, all of which were dry. Feeling round the back of the set and underneath revealed no clues.

By this time I was rather bewildered and decided to forget about the water and concentrate on the set itself since the owner mentioned that its performance had deteriorated recently. Upon switching on it was immediately apparent that something was badly amiss with the aerial since the picture was a mass of waves, shadows and ghosts. The aerial was the owner's property and was fixed on the roof of the block. Rocking the aerial plug at the back of the set failed to make any improvement, indicating that there was no fracture or break at this end, so I decided to go up to the roof to inspect the aerial itself—two days of heavy rain and gale-force winds might, I thought, have blown the aerial off course.

Preliminary inspection showed that the aerial had not moved. Closer inspection however revealed that the cover cap which clips over the terminal housing box was missing and that the well itself was full of water. Understanding dawned! And on returning downstairs to the set my suspicions were confirmed when after removing the plug from the set's aerial socket a lively amount of water came from the plug and the socket itself.

Aerial Downlead

How was this possible? The cable used as the downlead was ordinary u.h.f. cable of the air-spaced variety. This does not have solid insulation around the centre conductor as most types do, the insulation consisting of small air pockets which travel the length of the cable. Water that had settled in the terminal box at the aerial had penetrated the air pockets and following two days of incessant rain had eventually travelled the length of the downlead, finding an outlet at the co-axial plug and socket at the back of the set. The reason for the poor picture of course was the water at both end terminals of the cable, providing a low-resistance path from the centre conductor to earth at each end. The obvious answer for those using this type of cable is to make sure that no water can enter the aerial's terminal box and that the cap is a good seal fit. Having said that I should also stress that these precautions should be taken whatever the type of cable being used. Note that if the set had been incorrectly connected to the mains so that its chassis was live, and the aerial isolation had been defective—a set of circumstances I have come across—it would have been a lethal object indeed.

I still find this sequence of events hard to believe, but if anyone in future tells me they've got water coming out of the tele . . . ! ■

LONG-DISTANCE TELEVISION

ROGER BUNNEY

LIKE the past few months, December has been rather quiet so far as TV signals from afar are concerned. The usual December Sporadic E activity didn't seem to happen while the tropospherics were very far from their former glories. Fortunately the two predicted meteor shows, the Geminids and Ursids, gave a lift to the conditions. There was meteor shower activity from the 9th through to the 15th from the Geminids: this was fruitful indeed and included Band III signals. The later Ursids similarly gave a considerable number of short-burst signals. Apart from these and a lift in the tropospherics on the 7th—including CLT (Luxembourg) ch. E21—the period was depressing indeed!

Spain Received via Trops

Fortunately there are those better situated than I. Hugh Cocks (Colyton, Devon) has again succeeded in receiving TVE (Spain) via the tropospherics—chs. E9 and E11 on the 8th, plus a possible ch. E3 signal as well via the same mode. The signals were up to "fair" strength and present throughout the period 1345–1800. It seems that Hugh is well placed: earlier, on November 24th, he similarly received the Bilbao ch. E4 outlet. While on the subject of TVE reception important (though not unexpected!) news has come from both Hugh and Clive Athowe (Norwich): TVE is now using a version of the PM5544 test card. This may be seen from 1245–1300 and 1730–1745GMT. There is an identification "tve" at the top and "cadena" at the bottom. Apparently there is an additional identification above "cadena" and I feel that this is probably an indication of the first or second chain programme. Another feature of the card is a digital clock: this is superimposed in the lower right-hand corner. Clive has promised us a good shot of the card and we hope to feature this once his film has been developed.

Band III MS

The subject of Band III MS is worth further airing I feel since quite remarkable distances can be achieved during periods when this band would be otherwise dead. From my own limited successes and those of others (Clive and Hugh in particular) it can be said that time spent on the lower channels in Band III will give signals at distances similar to those obtained in Band I via MS and SpE. Certainly the only chances for North African reception are via this mode since all the stations there are operating in Band III. It's likely that any test cards seen from this area would be to the Marconi No. 1 pattern. This is a most distinctive card and easily recognised.

Monthly Log

One final item before my log: the Fubk card has been seen on ch. E2 with the identification "Sarri. Rundfunk". This is from the Gottelborner Hohe transmitter of the Saarlandischer Rundfunk.

My log for the period is as follows:

- 2/12/74 DFF (East Germany) chs. E3, 4 (MS); NOS (Holland) E4, E32 (trops).
- 3/12/74 DFF E4; DR (Denmark) E3; TVP (Poland) R1—all MS.
- 4/12/74 CST (Czechoslovakia) R1—MS.
- 5/12/74 ORF (Austria) E2a; SR (Sweden) E2; RAI (Italy) IB—all MS.
- 6/12/74 WG (West Germany) E2; DFF E4; ORF E2a—all MS.
- 7/12/74 DFF E4; WG E2, 3; SR E2, 3—all MS; also improved trops into ORTF (France).
- 9/12/74 SR E2; DFF E4; WG E2, 3; RAI IB; NRK (Norway) E4; CST R1—all MS.
- 10/12/74 SR E2; TVP R1—both MS.
- 11/12/74 DFF E4; WG E4; ORF E2a—all MS.
- 12/12/74 SR E2, 3; DFF E4; WG E4; DR E3; CST R1—all MS.
- 13/12/74 TVE E2; ORF E5; RAI ID; unidentified E7 programme—all MS.
- 14/12/74 WG E4; NRK E2, 3, 4, 5; TVP R1, 2—all MS.
- 15/12/74 SR E3; WG E4; DFF E4—all MS.
- 16/12/74 DFF E4—MS.
- 17/12/74 SR E2; DR E3; DFF E4—all MS.
- 18/12/74 WG E2—MS.
- 19/12/74 SR E2, 3—MS.
- 20/12/74 Swiss E3; DFF E4; SR E2—all MS.
- 21/12/74 RAI IB; SR E2—both MS.
- 22/12/74 DFF E4—MS. Also considerable MS activity, mainly programmes, during p.m.
- 24/12/74 WG E2, 4; RAI IB—both MS.
- 27/12/74 RAI IB; ORF E2a; DFF E4; SR E2; TVP R2—all MS; TVE (Spain) E2, 3—SpE.
- 28/12/74 RAI IB; ORF E2a; WG E2—all MS.

Miscellany

Important news from Ryn Muntjewerff (Holland). It seems that JRT (Yugoslavia) is operating on ch. E2! Ryn received the PM5544 card with the identification "JRT Beograd" on November 19th at 1625CET. This is an unlisted transmitter at present so we must assume that there is a new unit operating on this channel. The T05 (Telefunken) card has also been seen used by JRT on ch. E2. This ties in with a report in the November Benelux DX Club bulletin in which a photograph of the T05 card carrying the identifications "RTV" and "SKOPJE" respectively above and below the centre circle was shown. The T05 card was also received on ch. E4 in Holland. I shall be keeping a careful watch on ch. E2 for signs of the new transmitter, but with the great number of PM5544 users now there will probably be some problem of identification unless a very strong burst is received. Incidentally, the CS U 01 CST (Czechoslovakia) pattern often carries the identification "RS-KH" which is an abbreviation for "Retransla Stanice Kavci Hory": perhaps one of our language experts can translate for us?

Clive has been very active recently and has been re-equipping his installation using varicap tuner units. In this connection he has sent us a circuit (Fig. 1, from *Wireless*

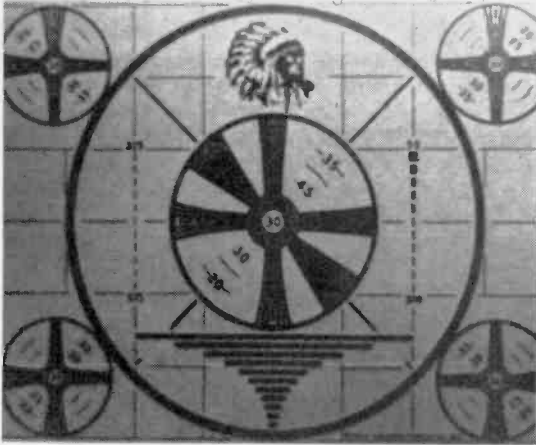

Indian head test card. Photograph courtesy Keith Hamer.



VPRO interval caption, Holland. The budgies are live! Courtesy Peter Vaarkamp.



Calendar caption for May 26th, TSS (USSR). Photograph courtesy Dieter Scheiba.

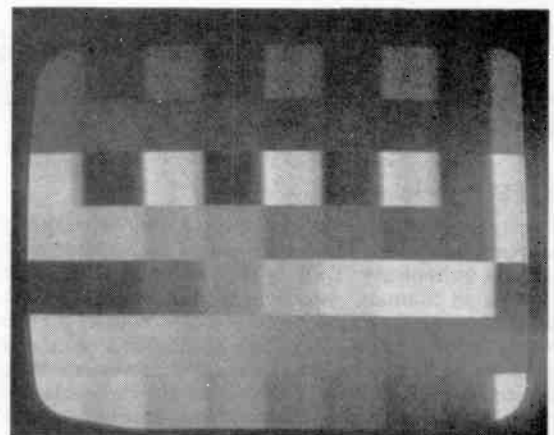

New blockboard pattern used by TSS (USSR). Photograph courtesy Clive Athowe.

World, May 1974) that gives a linear meter tuning scale (in my version—see October 1973 TELEVISION—scale cramping occurs at the I.f. end).

We are showing the service area map and polar diagram for the Grunten transmitter (SWF service on ch. E43 at 500kW e.r.p.) this month—Fig. 2—since the beam is effectively aimed at the UK and should and indeed has provided signals during appropriate tropospheric conditions.

News Items

Italy: The Turin ch. IC transmitter has been replaced—the Torino transmitter was first brought into service in 1949.

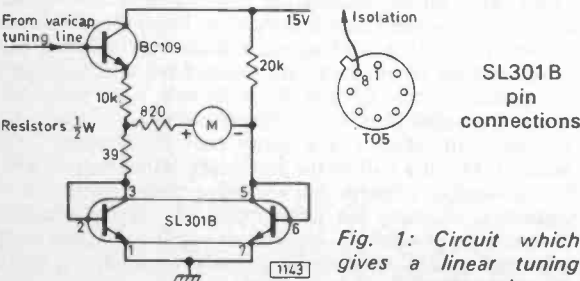

Fig. 1: Circuit which gives a linear tuning meter scale.

It is assumed that the e.r.p. will be somewhat higher although no further information is at present available.

France: The French broadcasting arrangements have undergone considerable and fundamental change. As from January 1st, 1975 a new system has come into being, the ORTF (Office de Radiodiffusion-Télévision Française) having been disbanded on January 6th. The broadcasting system now consists of a number of autonomous organisations. A state controlled authority "of an industrial and commercial nature" is concerned with the operation, servicing and development of the transmission system from the studios through to the transmitters. Four national programme companies—one for radio services, the other three for the TV chains—are concerned with programme origination. A production company—its shares are held by the State, public bodies and mixed economy companies—will produce programmes for the programme companies. Finances for the new system will come mainly from licence fees which will be collected by the State and divided between the authority and the programme companies. The other source of finance will be from advertising—this revenue will not exceed 25% of the total however.

Middle East: The Siemens company has received an order for a colour TV transmitter for the Sultanate of Oman. Pye TVT has received an order for the first u.h.f. TV transmitter in the Middle East. The order, for a 40kW transmitter

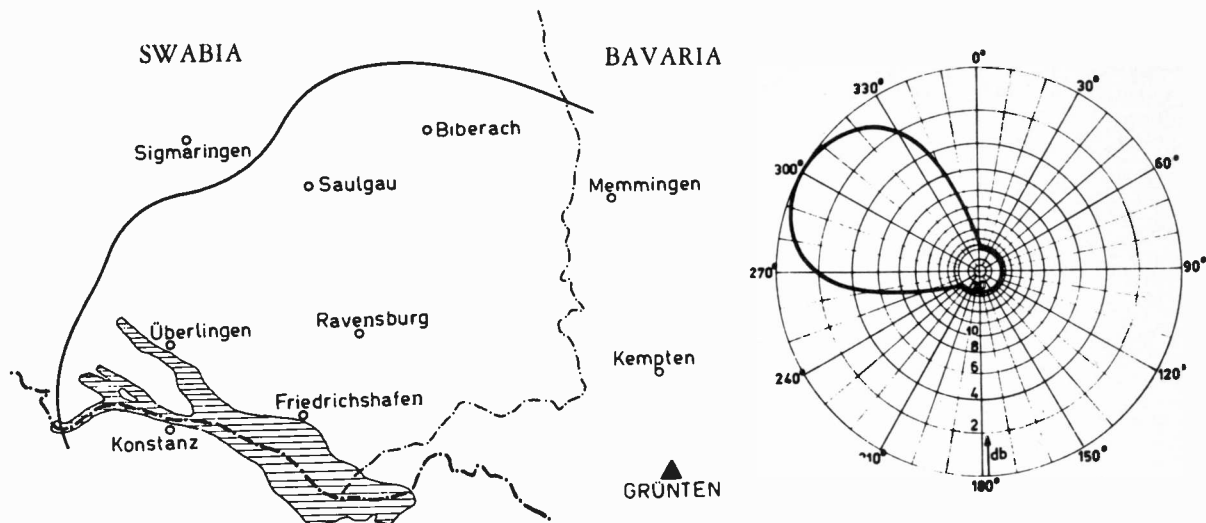

Fig. 2: Polar diagram and service area (solid black line) of the Grünten transmitter.

with associated equipment, was placed by Dubai and will augment the existing Dubai TV service.

DX-TV Publications

One of the most important items for the TV DXer is a reference work for the identification of programmes, test cards and transmitters. There is the invaluable EBU "List of Television Stations" which in fact is essential. More recently the EBU has published a test card booklet for the Western European area. This costs 80 Belgian Francs and is available from the Technical Centre, 32 Avenue Albert Lancaster, Bruxelles 18, Belgium. It is an extremely valuable work but omissions unfortunately include most of the OIRT countries. Now Keith Hamer and Garry Smith are busy compiling a booklet full of test cards from all over the world. This will contain well over 200 test cards including the standard patterns, the transmission standards and the abbreviations used by the various services. Publication is expected to be early in February at a cost of under £1.00. It will be a valuable tool for the long-distance television enthusiast and as soon as we have more news this will be passed on.

From our Correspondents . . .

George Ridgwell (Harold Wood) became interested in TV DX recently and wrote in for advice. Subsequently he installed a wideband Band I array (two-element version) and a Wolsey Colour King wideband u.h.f. array. These arrays are mounted on a short mast and rotated by a Stolle rotator unit. He is also using a Wolsey Orbit wideband low-noise preamplifier and we await news as to how this performs with particular interest since not many enthusiasts use this preamplifier. George has already received Belgium (v.h.f./u.h.f.), Holland (u.h.f.) and many UK u.h.f. transmitters and when his Thorn 900 chassis has been modified to give variable selectivity and video detector polarity switching we anticipate greatly improved results.

Wallace Roone (Pietersburg, South Africa) has written to tell us that F2 conditions have again been present, with signals from TVE Madrid ch. E2 and RAI ch. IA on November 7th and 20th. The Madrid signals were particularly strong, the RAI ones somewhat weaker. Wally is now receiving signals

from a new ch. E41 transmitter on test in South Africa; previously he was able to receive signals from the ch. E5 Pretoria transmitter. Wally also forwarded a newspaper cutting describing progress on the new 32 storey block at Auckland Park, Johannesburg for the SABC TV service.

Hetesi Laszlo (Bocskai, Hungary) has sent us another informative letter. It seems that Test Card G is radiated by Hungarian TV only during periods when a new transmitter is being tested. At one time it was used throughout the network, with "Budapest" identification. Hetesi has had some successes with reception of middle eastern transmissions. Apart from Jordan he has received mystery signals on chs. E2, 3. I suspect these may be Iran and Egypt respectively. CLT (Lebanon) ch. E4 was also noted on test grid with music.

Reducing B2 Interference

Since I last mentioned the subject of reducing interference on channels E2 and R1 from local ch. B2 transmissions Hugh Cocks has come up with an alternative method which he uses to good effect. Basically, he uses one main DX aerial array plus a number of aeriels which provide anti-phase ch. B2 signals. With his main array aimed towards Belgium ch. E2, for example, Hugh receives considerable splatter from North Hessary Tor on ch. B2. To reduce this he connects into the feeder from his main array to his receiver/amplifier the output from another aerial, usually a single horizontal dipole, mounted on a small pole. This aerial is sited so that the phasing of its output cancels the ch. B2 signals from the main array. By using a number of "antiphase" aeriels cancellation is obtained in the various directions in which Hugh is interested. Hugh mentions that the input matching is of course considerably affected, but in practice no undue losses are experienced and he is able to operate on chs. E2 and R1 with ease. This technique makes it possible to obtain complete cancellation of ch. B2. To the south Hugh's null array provides freedom over some 25-35°, the null to the east being rather more sharp. In wet weather a nearby hill and some trees provide signal scattering, reducing the effectiveness of the cancellation. It should be possible to experiment with this system even in a small garden: if you have access to the roof of a block of flats the method would be ideal.

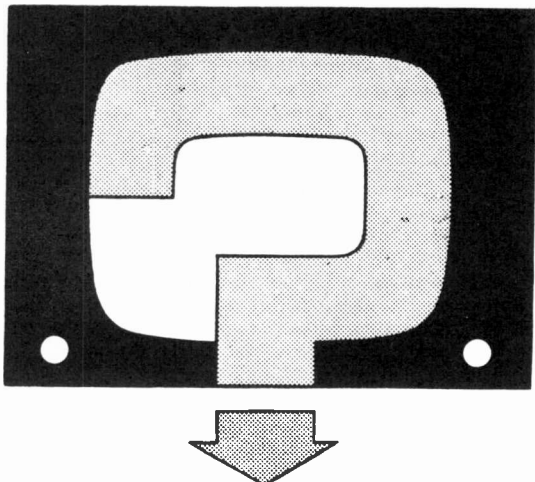

YOUR PROBLEMS SOLVED

★ Requests for advice in dealing with servicing problems must be accompanied by an 11p postal order (made out to IPC Magazines Ltd.), the query coupon from page 233 and a stamped addressed envelope. We can deal with only one query at a time. We regret that we cannot supply service sheets or answer queries over the telephone. We cannot provide modifications to circuits published nor comment on alternative ways of using them.

FERGUSON 3816

The fault on this set is sound-on-vision, even though the fine tuning has been set as closely as possible to the vision signal. Also the top half of the screen is darker than the bottom half.—J. Swain (Pontypridd).

There are two 100 μ F electrolytics (C15 and C35) which smooth the supply to the video driver and i.f. amplifier stages. We suggest you check these by shunting each with a known good one. Failure of these capacitors is quite common and would explain the darker area at the top of the screen as well as the sound-on-vision. (Thorn 1590 chassis.)

PHILIPS T-Vette

The sound obtained from this set became very fuzzy and on examination I found that the two 1 Ω audio output transistor emitter resistors were in very poor condition while the printed circuit beneath them was burnt. Voltage readings taken in the audio output stage all appear to be correct and on replacing these two resistors the set functions perfectly with no signs of overheating. Is there anything else I should check?—T. Barrow (Ipswich).

There is a bias preset (R2031) in the audio output stage and this should be set up so that the current in the stage is not excessive. There should be 6.7V at the AC128 emitter and 6.8V at the AC127 emitter, i.e. a total of 0.1V across the two emitter resistors. The AC128 could be causing overheating if the supply voltage has risen above the correct figure of 11V (HT1). This is set by means of R4035.

MURPHY V2015S

There is bad linearity on the left-hand side of the screen. On test card the squares on the left are only two-thirds the width of those on the right-hand side. Altering the controls does not improve matters and new valves have been tried. There are also three or four dark vertical striations on the extreme left-hand side. The vertical linearity is good and the picture otherwise without fault.—S. Jenkins (Benfleet).

First replace the 4.7k Ω damping resistor 3R28 across the line linearity coil. If the linearity control is not effective replace the scan-correction capacitor 3C24 (0.1 μ F) then suspect the coil itself. (RBM A794 time-base chassis.)

BERRY VISION 510

There is an intermittent whistle which seems to come from the line output transformer. The frequency is lower than the line timebase frequency however, about 10kHz. The whistle can be stopped by tapping the base of the transformer or by rotating the line hold control so the line sync is lost then locking the picture again. I have tried altering the line output transformer mounting bracket, also loading the base to try to prevent or reduce the noise, but this has had very little effect.—G. Mills (Crewe).

This annoying fault crops up from time to time and is due to magnetostriction in the line output transformer core. First ensure that the core is tightly clamped therefore. If the fault is still present the only sure cure we know of is to change the line output transformer.

KB CVC5

During something like 40 per cent of monochrome transmissions the colour killer does not seem to work since there is colour confetti on the screen.—F. Woods (Croydon).

The colour-killer potential is applied to the base of the chrominance delay line driver transistor and comes from the PAL bistable. This in turn is driven from the burst channel via the ident stage. Unfortunately the burst signal is not completely suppressed on all monochrome transmissions and the colour-killer may in these circumstances not be entirely effective. The operation of the circuit can be made less sensitive by swapping over R196 and R197, the two resistors which damp L67 in the chrominance channel and provide a tap-off point for the feed to the burst channel. Another possibility is that the trouble is due to the burst blanking operation which is also carried out at the base of chrominance delay line driver stage and continues whether the transmission is colour or monochrome. The blanking pulses are fed via diode D41 whose cathode is biased by R309 from the 20V rail. Try reducing the value of R309 from 47k Ω to 22k Ω .

DECCA DR24

After fitting a new line output transformer we find that the line speed is wrong. A double check has been made to ensure that the transformer is of the correct type. The line hold control alters the width but will not resolve the lines.—A. Gracechurch (Hornsey).

It is unlikely that the line output transformer is causing the incorrect speed. Ensure first that nothing else was disturbed when the new transformer was fitted, then concentrate on the line generator stage. Make sure that the system switch is operating correctly. There are two valves in the line generator stage, the ECC82 line oscillator and ECL80 flywheel line sync discriminator. Check the valves and the two electrolytics in the flywheel sync stage, C113 and C109, both 2.2 μ F.

GRUNDIG 5010GB

The fault on this 110° colour set is north-south pin-cushion distortion which lasts for about half an hour after switch on. The set works normally after half an hour.—K. Allsop (Burton).

The first suspects are the two BA157 diodes Di481 and Di482 which provide the supply to the vertical shift control. They are mounted towards the top right-hand side of the main chassis. If these are o.k. check the associated electrolytics C481 and C482, also C478. Careful use of freezing compound and gentle heat from a hair dryer should help you pinpoint the responsible component.

KB WV90

The fault with this set is complete absence of raster, with the PL36 line output valve overheating severely. The sound is o.k. The PL36 and the PCF802 line oscillator valve have been replaced. This restored the picture for about an hour after which it suddenly collapsed again. The PY801 boost diode has also been replaced.—T. Gordon (Chatham).

Check for a negative voltage at the PL36 control grid (pin 5). If this is absent the line oscillator is faulty: check the load resistor R135 (47k Ω) and feedback capacitor C121 (800pF). If however line drive is present at the PL36 control grid disconnect the PY801 top cap. If this restores some life to the stage (the PL36 top cap live) the boost reservoir capacitor C134 (0.1 μ F, 1kV) should be replaced. If there are still no results disconnect the lead to the scan coils. If the stage then comes to life the scan coils are faulty. Otherwise suspect short-circuit turns in the line output transformer. (STC VC2 chassis.)

MARCONIPHONE 4615

When the set is switched to 625-line operation there is insufficient width to fill the screen. Any attempt to increase the width produces black lines on 625 and flashes of white on 405. 405-line reception is without fault however. Incidentally two width controls have burnt out!—G. Rogers (Aldershot).

Your final comment provides a likely clue. First replace C106 (100pF) the pulse feedback capacitor to the width control circuit—it could be intermittent. Then check the resistors in the width control circuit—R133 (330k Ω), R131 (1.8M Ω) and R130 (2.2M Ω). If the 625-line scan-correction capacitor C98 (0.1 μ F) goes short-circuit the symptom will be lack of width. (Thorn 950 chassis.)

BUSH TV141

The fault is in the sound section. After the set has been on for about ten to fifteen minutes there is a whistle when the volume control is turned up to two-thirds rotation. The whistle turns to a screeching as the volume control is farther advanced but the screeching ceases when the control is at almost full rotation. As time progresses the volume control has to be turned down progressively to avoid the screech. A pair of isolated headphones connected to the 405-line sound interference limiter diode just prior to the volume control shows no sign of the fault. All the components in the sound output stage, including the valve, have been changed or checked without success. The fault is present with the aerials in or out, and on both systems. The volume control has also been changed. The picture is unaffected.—R. Greene (Folkestone).

There could be an earth loop on the screening of the leads connected to the volume control plug PS3 (pins 2 and 3 connect to chassis). Try connecting a separate lead to chassis. If this makes no difference, insert a 100k Ω stopper resistor in the feed to the triode grid (pin 1) of the valve—you will have to cut the track to add this. Finally, disconnect the pentode electrolytic decoupler 2C62 (50 μ F) from the cathode (pin 2) and connect it instead to the junction of the two series connected cathode bias resistors 2R54 and 2R55.

PHILIPS 23TG171A

The picture on this set is not very bright while when the brilliance control is turned up a little the picture expands and disappears, reappearing after a few moments after which the same thing happens again. The line output stage valves, also the video amplifier, have been changed without success.—H. Field (Dorking).

The fault could be caused by a faulty heater series resistor (R503) in the base cup of the DY87 e.h.t. rectifier. Check this. The fault could also be due to lack of drive to the PL500 line output valve: there should be -50V on pins 1 and 2. Check the values of the two 8.2M Ω resistors (R427 and R457) in the width circuit. Also check that the boost voltage at pin 3 (first anode) of the c.r.t. is about 580V. The trouble could be due to faulty line output transformer. (Philips Style 70 series.)

DYNATRON CTV9

Reception on this colour set is perfect except for the appearance of Ceefax/Oracle lines at the top of the picture—these are visible at least an inch below the top of the screen. The lines and the picture can be moved by altering the height control setting. Operation of the field shift control moves the picture but leaves the interference in the same position. The lines are not present when the set is switched on: they appear at the top of the picture after about twenty minutes and then creep down progressively until they are about an inch from the top. There is also slight sound-on-vision.—T. Lawrence (Chatham).

The symptom appears to be slight top foldover. Concentrate on ensuring that all transistor voltages in the field timebase are correct, particularly those around the BD124 output pair. Suspect all electrolytics in the circuit and the diodes, checking the forward and reverse resistances of these. The sound-on-vision suggests that the input signal is too strong: try a plug-in aerial attenuator of around 6dB. (Pye group 697 chassis.)

PHILIPS G19T210

When the brightness or contrast controls are set to normal positions the line timebase goes out of synchronisation. With the brightness control at either end of its travel the lines move out to become "double superimposed", though there is no flicker. There is also some tearing on the right-hand side of the picture once the set has warmed up. The contrast and brightness controls operate normally otherwise and the sync separator and line timebase valves have been replaced.—R. Taylor (Doncaster).

Troubles of this sort in this chassis can be caused by the drive waveform shaping network between the line oscillator and the line output valve. The components concerned are R2172 (82k Ω) and C2062 (220pF) which are connected in series between the PL500 control grid and chassis. Make sure that the resistor is of the correct value, then experiment with different capacitor values—add extra capacitance in parallel with C2062, not more than another 220pF. (Philips 210 chassis.)

DECCA CS2219

The trouble with this set is that the pulse and bar test pattern can be seen about two inches down from the top of the screen.—K. Roberts (Gillingham).

The problem is slow field flyback. Try adjusting the field linearity controls, then check the field timebase valves (PCF80 and PL508) and the PL508's screen grid feed resistor R415 (3.9k Ω). The fault can also be caused by a faulty field output transformer. (Decca series 10 chassis.)

QUERIES COUPON

This coupon is available until March 17 1975 and must accompany all Queries in accordance with the notice on page 231. Don't forget the 11p (inc. VAT) postal order!

TELEVISION MARCH 1975

TEST CASE

147

Each month we provide an interesting case of television servicing to exercise your ingenuity. These are not trick questions but are based on actual practical faults.

? A Philips receiver fitted with the G8 colour chassis exhibited the symptoms of severe lack of line lock. The field appeared to be locking normally, and there was no trouble with the sound. This model employs a sinewave line oscillator with an inductor core that can be adjusted to set the line frequency for correct lock.

The line frequency was found to be so far removed from the correct frequency that several turns of the core were required to regain line lock. A picture was obtained by this readjustment however, but was lacking in definition and devoid of good, sharp contrast. The picture was also weak in body and rather "watery".

It was decided to check first why the line frequency had drifted so much, and on questioning the owner it was discovered that the fault suddenly appeared—the lock and picture being perfect one day and the faults present the next time the receiver was switched on.

It was concluded therefore that a component in the frequency-determining circuitry had suddenly failed rather than drifting gradually with time. Tests were made of the components which could be critical in this respect. One or two capacitors and resistors in the line oscillator and flywheel sync circuits were found to be a trifle low or

high in value and these were replaced. The faults persisted however. Following these tests it seemed that a shorting turn in the line oscillator inductor L4501 must be responsible, but before changing this component the circuit diagram was examined in greater detail.

In the G8 chassis a TBA550Q or TAA700 integrated circuit is associated with both line generation and video signal control. It was decided therefore to explore the circuit around this in detail. After a few measurements the trouble was located and one replacement (not the i.c.) cleared both the incorrect line lock and the poor picture.

What was the most likely component responsible for these two symptoms? See next month's TELEVISION for the solution and for a further item in the Test Case series.

SOLUTION TO TEST CASE 146

Page 185 (last month)

In chassis where the intercarrier sound is extracted at the anode of the video output valve background buzz, rather like intercarrier buzz, can arise from incorrect operating conditions in this stage. The problem is often experienced in sets fitted with the Thorn 1400 chassis and it was to this section of the circuit that the technician turned his attention.

He noticed that R36 which feeds the screen grid of the 6F28 video output valve was running rather too warm for comfort. The resistor was discoloured but appeared to have been an 8.2k Ω type. It measured significantly less than this. After fitting a replacement 8.2k Ω resistor the fault was completely cleared.

An abnormally low-value screen grid feed resistor tends to lower the anode operating point of the valve, thereby precipitating too early saturation and hence the buzz.

Some early 1400 chassis used a 3k Ω screen grid feed resistor. If buzz is present with these the resistor should be increased in value to 8.2k Ω .

TELEVISION CLASSIFIED ADVERTISEMENTS

The pre-paid rate for classified advertisements is 8p a word (minimum 12 words), box number 30p extra. Semi-display setting £4.50 per single column inch. All cheques, postal orders, etc., to be made payable to TELEVISION and crossed "Lloyds Bank Ltd." Treasury notes should always be sent *registered post*. Advertisements, together with remittance, should be sent to the Classified Advertisement Manager, TELEVISION IPC Magazines Ltd., Fleetway House, Farringdon Street, London, EC4A 4AD, for insertion in the next available issue.

BOOKS & PUBLICATIONS

YOU NEED

COMPREHENSIVE TV REPAIR MANUALS

by J. McCourt.

- COLOUR TV VOL 1. British models to end 1973, except ITT/KB.
 COLOUR TV VOL 2. ITT/KB to 1973 plus Foreign: includes Sony, Nordmende, etc.
 COLOUR TV VOL 3. Expansion of Vol 1 plus British models to end 1974.
 COLOUR TV VOL 4. Expansion of Vol 1 plus remaining British models to end 1974.
 MONO TV VOL 1. British sets to end 1973, covering from Alba to Ultra.
 MONO TV VOL 2. All Philips, Pye, Ekco and RBM models to end 1973.
 MONO TV VOL 3. Main British and Foreign portables in UK.
 MONO TV VOL 4. British models released during 1973/74.

Full money back assurance. Thousands of faults—hundreds of models. All written in a practical, easy to follow symptom, cause and cure style. Invaluable to amateurs and students as well as to practising engineers. Written for minimum use of instrumentation. £3.00 each (p. & p. 35p under 4 copies).

BELL'S TELEVISION SERVICES

100, KINGS ROAD, HARROGATE, YORKSHIRE. Telephone: 0422-5080

SETS & COMPONENTS

VALVE LIST

ALL VALVES FULLY TESTED

One valve postage 4p. Over 5 valves postage paid.

DY86/87	13p	PC900	8p	PCL85	20p
DY802	20p	PCC84	8p	PFL200	25p
EB91	15p	PCC89	8p	PL36	20p
EC882	10p	PCC189	8p	PL504	25p
ECL80	8p	PC8005	15p	PY81/800	15p
EF90	8p	PC885	20p	PY801	20p
EF183	10p	PCF80	8p	U191	18p
EF184	10p	PCF86	13p	6P23	15p
EH90	13p	PCF805	20p	630L2	15p
EY86/87	13p	PCL82	13p	30F5	10p
PC86	15p	PCL83	13p	30FL1	20p
PC89	15p	PCL84	13p	30PL1	20p

AND MANY MORE AVAILABLE

S. W. ELECTRONICS

114 Burnley Road, Rawtenstall
Rossendale, Lancs.

MAINS DROPPERS.

37-31-97-26-168 Ω 50p.
 25-35-97-59-30 Ω 50p.
 14-26-97-160 Ω 50p.
 14-26-97-173 Ω 50p.
 15-19-20-70-63-28-63 Ω 50p.
 Post free. C.W.O.

Durham Supplies, 367 Kensington Street,
Bradford, 8, Yorkshire.

250—New Resistors well assorted ½—2 watts.
 Carbon—Hi-Stab Oxide etc. £1.00 Post Free.
 Whitsam Electrical, 33 Drayton Green Road,
London W.13.

MULLARD CAPACITORS

Polyester (280) 250V/W—.01, .022, .047, 3p (25p), .1, .15, 4p (36p), .22, .33, 47, 7p (55p), .68, 2.2, 12p (£1.00). Electrolytic—UF. 1/63v, 10/25v, 40/10v, 80/25v, 100/6.4v, 220/10v, 400/25v, 400/4v, 470/10v, 8p (60p)—220/63v, 220/40v, 470/40v, 680/25v, 1000/25v, 11p (90p)
 Prices in brackets for ten, price includes VAT, P & P 10p.

ELECTRONIC MAILORDER LTD.
 62 Bridge Street, Ramsbottom, Bury, Lancs.

MAKE 1975 A BETTER VIEWING YEAR

Improve your colour and monochrome T.V. reception with a U.H.F. pre-amplifier of the type supplied to the trade.

We manufacture amplifiers of the following types:

Group	Channel	Typical Gain
A	21-34	18dB
B	39-51	16dB
C/D	49-68	14dB
Wide Band	21-68	10dB

All the above units are supplied complete with an attractive mains power unit at the competitive price of £8.40 (U.K. only), VAT, post and packing inc.

Trade enquiries welcome. For details of aerials and aerial accessories send S.A.E. Order direct from:

IMPACT ELECTRONICS,
 Unit 16, Stortforth Lane Trading Estate,
 Chesterfield, Derbyshire S41 0QQ

BRC 2000, 3000, 3500, 8000, 8500

Panel Repairs—Singles or Bulk

All Details:

MODULAR ELECTRONICS

160 Brabazon Road, Hounslow TW5 9LP
 Tel. 01-897 0976

Top 20 Plus Electronically Tested TV Valves

PL504	18p	30FL1/2	15p
PCF801	15p	PCL84	10p
DY86/7	15p	PCL82	10p
PL36	15p	PD500/A	50p
PC88	15p	ECC82	10p
PC86	15p	EH90	10p
PC97	15p	EY86	15p
PCL805/85	15p		

Colour Valves Fully Tested

PL509	40p	PY500/A	30p
PL508	30p	GY501	50p
PL802	40p	PCF802	15p

Many others available including Mazda Types.

P. & P. 4p per valve, over 12 2½p per valve, orders over £4 post free.

Prompt service. S.A.E. for New free list
 Mail order only.

L. & D. COMPONENTS LTD.,
 71 Westbury Ave., London N22 6SA.
 Tel. 01-888 2701.

EX RENTAL TV's BARGAIN

23" & 19" 3 Channel with U.H.F. Tuner £3.50
 19" & 25" Colour from £50.00
 19" & 23" tubes guaranteed from £2

All sets complete.

EDWARDS & SONS

103 Goldhawk Road, London W.12

Telephone 743-6996

CALLERS ONLY

AERIALS

J. & A. Tweedy, (Electronic Supplies) Ltd.

Full range of Jaybeam Aerials available
 We supply High Gain Multibeam aerials.

Carriage and VAT included in the quoted price.

Multibeam UHF TV Aerials MBM 28 £5.00.

MBM 48 £8.00, MBM 70 £11.00. Parabeam

UHF TV Aerials PBM 12 £4.00, PBM 18 £5.00.

Stereobeam FM Aerials SBM 2 £3.00, SBM 3

£4.00, SBM 4 £5.00, SBM 6 £8.00. SAE for full list

of accessories available. Low Loss Co-ax 12p/m.

79 Chatsworth Road, Chesterfield, Derbyshire Tel. 34982

DX/TV aerials, Band 1—£5. Band III—£3.
 Details. Cook, 90 Ewhurst Road, Crawley
 23885, Sussex.

GENUINE FULL SIZE
 18 element TV aerial
 as used by leading TV companies

FOR ONLY £2.20
 + 35p cart

Quality made technically advanced design. Precision grid reflector eliminates ghosting. Complete with clamp, instructions advice. Money Back Refund. Wall/Caravan Bracket 25p. Low Loss Cable 10p per yard. Plug 8p & FREE with order maps & channel reference of all Radio & TV Transmitters. SEND DIRECT TO DEPT. PT 10
 219 Mansfield Rd. Nottingham.

IMPERIAL TRADING (AERIALS) LTD.
 the quality Aerial Specialists

WRIGHT'S AERIALS

Full range of J Beam and Antiference aerials and accessories. Antiference Tricolour: TC10

£4.00, TC18 £5.30. J Beam High Gain: MBM

30 £5.15, MBM 46 £7.70, MBM 70 £13.25.

New Antiference Extra Gain: XG8 £7.90,

XG14 £14.00, XG21 £19.00. Please state

transmitter or channel group if known.

Labgear UHF masthead amplifiers: CM6000

(grouped) £11.05, CM6019 (wideband) £9.75.

Both with mains power supply. Coax: semi

air-spaced low-loss 12 p / yd. Prices include

VAT and UK mainland postage. Comprehensive

stocks of high gain aerials and accessories—

VHF - DX aerials.

Large SAE for list. Information sheets and individual

advice supplied with order if requested.

Dept. 1, 3 Cheltenham Rise, Scawby, Don-

caster, S. Yorks.

SERVICE SHEETS

**BELL'S
TELEVISION
SERVICES**

SERVICE SHEETS • MANUALS • BOOKS

SERVICE SHEETS 50p plus S.A.E. * SERVICE SHEET CATALOGUE 25p
OVER 12,000 SERVICE SHEETS & MANUALS IN STOCK ON COLOUR/MONO TELEVISIONS
RADIOS, RADIOGRAMS, T/RECORDERS, R/PLAYERS, ETC. S.A.E. WITH ENQUIRIES

Send large S.A.E. for FREE booklists.

NEW BOOKS & PUBLICATIONS post paid UK only

TV FAULT FINDING BOOK by Data Publications Ltd. 5th Edn. £1.04
RECEIVING PAL COLOUR TELEVISION by A.G.Priestley £5.25
COLOUR TV With Particular Reference to the PAL System by G.N.Patchett. 3rd Edn. £5.15
MAZDA BOOK OF PAL RECEIVER SERVICING by D.J.Seal £5.10
COLOUR TELEVISION PICTURE FAULTS by K.J.Bohlman £2.70
COLOUR TELEVISION THEORY by G.H.Hutson £4.40
COLOUR TELEVISION SERVICING by G.J.King. 2nd Edn. £4.70
NEWNES COLOUR TV SERVICING MANUAL. VOLUME ONE by G.J.King £5.25
NEWNES COLOUR TV SERVICING MANUAL. VOLUME TWO by G.J.King £5.25
TELEVISION SERVICING HANDBOOK 3rd Edn. by G.J.King £4.10
SERVICING WITH THE OSCILLOSCOPE by G.J.King £2.05
BEGINNER'S GUIDE TO COLOUR TELEVISION 2nd Edn. by G.J.King £2.10
BEGINNER'S GUIDE TO TELEVISION 5th Edn. by G.J.King £1.75
BEGINNER'S GUIDE TO ELECTRONICS by Squires & Deason. 3rd Edn. £2.07
TRANSISTOR AUDIO & RADIO CIRCUITS by Mullard Ltd. 2nd Edn. £2.05
TV TECHNICIANS BENCH MANUAL by G.R.Wilding £2.75
RADIO TECHNICIANS BENCH MANUAL by H.W.Hellier £3.20
AUDIO TECHNICIANS BENCH MANUAL by John Earl £3.20
Mechanics Course in Radio TV & Electronics 222 (433) by B.Fozard & G.N.Patchett
PRINCIPLES & CALCULATIONS (FIRST YEAR) B.Fozard £0.65
PRINCIPLES & CALCULATIONS (SECOND & THIRD YEARS) B.Fozard £1.35
ELECTRONIC SYSTEMS (PART 1. FIRST YEAR) G.N.Patchett £1.05
ELECTRONIC SYSTEMS (PART 2. SECOND YEAR) G.N.Patchett £1.15
ELECTRONIC SYSTEMS (PART 2. THIRD YEAR) G.N.Patchett £2.25
TELEVISION (COLOUR & MONOCHROME PART 3.) G.N.Patchett £2.70

"RADIO & TELEVISION SERVICING" books bought and sold, from Volume 1 up to 1973-1974 edition.
Back issues of PW. PE. EE. TV. E-Today & Constructor available, cover price plus 7p postage per copy.
OPEN UNTIL 6pm DAILY & 8pm SATURDAY. CALLERS WELCOME TO COME AND BROWSE.

B.T.S (Mail Order Dept.) 190, KINGS ROAD, HARROGATE, YORKS. Tel. 55885

SERVICE Sheets for over 6,000 models of Televisions, Radios, Transistors, Stereo, Tape Recorders, Record Players etc., at only 30p plus S.A.E. with free Fault-Finding Guide. Over 50,000 sheets in stock for 10,000 models. S.A.E. enquiries. Catalogue 20p plus S.A.E. Hamilton Radio, 47 Bohemia Road, St. Leonards, Sussex. Telephone Hastings 429066.

**LARGE SUPPLIER
OF
SERVICE SHEETS**

All at 50p each

(T.V., RADIO, TAPE RECORDERS, RECORD PLAYERS, TRANSISTORS, STEREOGRAMS, RADIOGRAMS, CAR RADIOS)

"PLEASE ENCLOSE LARGE S.A.E. WITH ALL ENQUIRIES & ORDERS"

Otherwise cannot be attended to

(Uncrossed P.O.'s please, original returned if service sheets not available.)

PLEASE NOTE

We operate a "by return of post" service. Any claims for non-delivery should be made within 7-days of posting your order.

**C. CARANNA
71 BEAUFORT PARK
LONDON, NW11 6BX**

We have the largest supplies of Service Sheets (strictly by return of post). Please state make and model number alternative. Free T.V. fault tracing chart or T.V. list on request with order.

Mail order or phone 01-458 4882

'CAUSE & CURE' T.V. Manuals. Invaluable for professional and amateur. SAE details: Colis, 33 Maple Avenue, Morecambe, LA3 1HZ, Lancs.

SERVICE SHEETS, Radio, TV etc. 8,000 models. Catalogue 20p. S.A.E. enquiries. Telray, 11 Maudland Bank, Preston.

MISCELLANEOUS

LOWEST COST IC SOCKETS. Use Solder-on IC socket pins for 8 to 40 pin DIL's. 70p for strip of 100 pins, £1.50 for 3 x 100, £4 for 1,000. 10p p & p for orders under £2. Add 8% VAT. Instructions supplied—send SAE for sample. SINTEL, 53d Aston Street, Oxford. Tel: 0865 43203.

Build the Mullard C.C.T.V. Camera

Kits are now available with comprehensive construction manual (also available separately at 80p)

Send 5" x 7" S.A.E. for details to

**CROFTON ELECTRONICS
124 Colne Road, Twickenham,
Middlesex TW2 6QS**

BRC 950/1400/1500. E.H.T. rectifier 3 sticks £3.50, 5 sticks £3.75. Philips 210/310 mains dropper £1.00. Post free c.w.o., Devi, 44 Sandells Avenue, Ashford, Middx. 58335.

NEWNES RADIO and TV Servicing. Buying 1963-74 £2.50 each. Selling most years. Television Magazine buying/selling, S.A.E. lists. Derwent Radio, 5 Columbus Ravine, Scarborough.

WANTED

"RADIO & TV SERVICING" Books wanted from 1962 edition onwards. £2 paid per copy by return post—Bell's Television Services, 190 Kings Road, Harrogate, Yorks. Tel. (0423) 55885.

NEW VALVES (pref BVA) of popular types, PCL805, PFL200, PL504 etc. Cash waiting. Bearman, 6 Potters Road, New Barnet, Herts. Tel: 449/1934-5.

**TOP PRICES PAID for NEW
VALVES and TRANSISTORS**

popular T.V. and Radio types
**KENSINGTON SUPPLIES (A)
367 Kensington Street, Bradford 8,
Yorkshire.**

SERVICE SHEETS purchased, HAMILTON RADIO, 47 Bohemia Road, St. Leonards, Sussex.

TELEVISION. Any issues before June 1972. D. Symons, Anatomy Department, Birmingham University.

WANTED Colour TV, also M/B mono portable. Holmes, 86 Abbots Road, Colchester.

LADDERS

ALUMINIUM Cat Ladders 12 ft-24 ft. Tel: Telford 586644. for Brochure.

FOR SALE

TELEVISION Colour Project. Complete built panels. 1F aligned by Television. Cabinet. 26" Mullard (second) tube. Requires some trouble shooting. £80 o.n.o. Ring Iver 653 239.

TELEVISION Colour Receiver. Complete set of PCBs etc. mounted in frame with new 24" tube ready for inter-connections. 1F aligned. Offers: Marlow 3186.

NEWNES Radio & Television Servicing. Volumes 1 to 6 (1956). Offers. Hooper, 3 Grange Park, West Bridgford, Nottingham.

EDUCATIONAL

TELEVISION TRAINING

16 MONTHS' full-time practical and theoretical training course in Radio & TV Servicing (Mono & Colour) for beginners.

13 WEEKS' full-time Colour TV Servicing course. Includes 100 hours practical training. Mono revision if necessary. Good electronics background essential.

NEXT SESSION commences on April 21st.

PROSPECTUS FROM:
London Electronics College, Dept. TT3
20 Penywern Road, London SW5 9SU.
Tel. 01-373 8721.

T.V. SCOOP!!!

First 100 customers only, 'Brand new' and 'as new' condition 110° Slim-line T.V. sets by famous British Manufacturers. Many in manufacturers packing. These were specially made for a national company, and consist of a normal T.V. (625 line, attractive wood finish cabinets) without i.f. strip and tuner. Can be converted to normal U.H.F. operation by adding these items, or used as a **Monitor for Table-Tennis Game** or C.C.T.V. (405/625). These will be Rasta-tested to callers at our Warehouse, or checked as complete but sent 'pot-luck' by BRS £2.50 extra. Spares available from usual sources.

19" £12; 20" £14; 23" £13; 24" £15.
(Give second choice if possible)
ADD V.A.T. to total order price.
Other items on sale as per Jan. advt.

SUMIKS

1532 Parshore Rd., Stirchley, (Main A441 from City)
Birmingham, B30 2NW

SOUTHERN VALVE COMPANY

P.O. Box 144, BARNET, Herts.

Telephone: 01-440 8641. Mail order only. Most leading makes.

AZ31 62p	EM84 42p	PCL83 48p	UCL82 40p	30L1 38p
DY86/7 35p	EY51 45p	PCL84 45p	UCL83 55p	30L15 75p
DY802 40p	EY86/7 35p	PCL85 55p	UF41 65p	30L17 70p
EB91 18p	EZ40/1 48p	PCL805 55p	UF89 40p	30P12 75p
ECC81 34p	EZ80 33p	PCL86 48p	UL41 70p	30P19 70p
ECC82 32p	EZ81 28p	PD500 £1.60	UL84 42p	30PL1 80p
ECC83 32p	EY501 75p	PFL200 70p	UY41 44p	30PL13 75p
ECC85 38p	GZ30 44p	PL36 58p	UY85 32p	30PL14 80p
ECC88 45p	PC86 61p	PL81 48p	U25 70p	30PL15 80p
ECH42 70p	PC88 61p	PL81A 52p	U26 66p	30P4MR 90p
ECH81 34p	PC97 38p	PL82 37p	U191 70p	
ECH84 50p	PC900 47p	PL83 44p	6/30L2 70p	
ECL80 50p	PC884 38p	PL84 45p	6BV7 65p	
ECL82 44p	PC85 42p	PL500 38p	6F23 70p	
ECL83 65p	PC88 60p	PL504 72p	6F28 65p	
ECL86 40p	PCC89 48p	PL508 80p	6V6 45p	
EF80 28p	PCC189 50p	PL509 £1.45	6X4 38p	
EF85 36p	PCF80 38p	PL802 90p	6X5 44p	
EF86 50p	PCF82 48p	PY33 50p	10E1 65p	
EF89 30p	PCF86 55p	PY81/3 33p	20L1 80p	
EF183 35p	PCF200 85p	PY88 38p	20P4 85p	
EF184 35p	PCF801 48p	PY800 39p	30C1 38p	
EH90 53p	PCF802 50p	PY801 39p	30C15 75p	
EL34 65p	PCF805 75p	PY500A 90p	30C17 77p	
EL41 55p	PCF806 52p	UBF89 38p	30C18 75p	
EL84 33p	PCF808 75p	UCC85 44p	30F5 75p	
EL90/1 45p	PCH200 75p	UCH42 70p	30FL1 68p	
EM80 45p	PCL82 36p	UCH81 40p	30FL2 68p	

One valve post 6p, each extra valve 5p. LISTS s.a.e. please.

We offer return of post service.

Items in stock at time of going to press but subject to possible market fluctuations if unavoidable.

Post free over £10.

VHF MODULATOR

Which enables the use of a standard TV as a monitor for CCTV and Video games (TV Tennis).

Operates from 8V-12V DC. Tuneable over VHF Channels 27-40. Input—Standard IV poss Video.

Output—7.5mV into 75ohm at 600MHZ.

Dimensions: 2½" x 2" x ½"—6' coax.

Price—Fully Assembled and Tested £6.50 inc. VAT and postage.

Please send cheque or P.O. with order to:

STRONG ELECTRONICS LIMITED
Bourne Works, Whyteleafe, Surrey CR3 0YD

PHILIP H. BEARMAN

(VALVE SPECIALISTS) SUPPLIERS TO H.M. GOVT. Etc.

NEW valves by Mullard, Mazda, Telefunken, Tungram

IMMEDIATE POSTAL DESPATCH, LISTS S.A.E., DISCOUNT PRICES

ALL PRICES SUBJECT TO ALTERATION WITHOUT NOTICE.

PRICES FROM NOV. 1974 (INCL. V.A.T. @ CURRENT RATE)

DY86/7 38p	PCC84 40p	PD500 £1.60	6F23 80p	ENQUIRIES
DY802 42p	PCC89 52p	PFL200 74p	6F28 67p	WELCOMED
ECC81 38p	PCC189 58p	PL36 80p	20P4 88p	ON
ECC82 40p	PCF80 47p	PL84 60p	30C1 47p	OUR
ECL80 60p	PCF86 62p	PL504 77p	30C17 84p	VAST
EF80 37p	PCF200 84p	PL509 £1.45	30FL1 67p	RANGE
EF183 54p	PCF801 52p	PL802 £1.20	30FL2 67p	
EF184 54p	PCF802 64p	PY81 40p	30L15 86p	
EH90 56p	PCF805 83p	PY800 45p	30L17 86p	
EY51 66p	PCF808 78p	PY801 45p	30P12 87p	
DY86/7 34p	PCH200 98p	PY500(A) 98p	30PL1 87p	
GY501 70p	PCL82 47p	U25 80p	30PL13 95p	
PC86 72p	PCL83 52p	U26 80p	30PL14 £1.10	
PC88 72p	PCL84 46p	6/30L2 80p	30PL15 94p	
PC97 38p	PCL805/85 58p	6BV7 74p	ETC., ETC.	
	PCL86 58p			

See separate Component, CRT and Transistor Lists. Many obsolete types available. SAE with enquiries please. Please verify current prices. Overseas Post @ Cost. U.K. Post 4p per valve under £5.00.

(Adjacent to Post Office) **6 POTTERS RD., NEW BARNET**
STOP PRESS. PC92/96, HERTS. Tel: 449/1934-5 any time.
PL95, PL519 available!

COLOUR, UHF AND TELEVISION SPARES

"TELEVISION" CONSTRUCTOR'S SIGNAL STRENGTH METER, PHILIPS G8 SURPLUS VISION SELECTIVITY PANEL 25p, VISION GAIN PANEL 25p, MULLARD ELC1043 NEW VARICAP TUNER £4.50, pp 25p (OTHER PARTS ALSO AVAILABLE).

"TELEVISION" CONSTRUCTOR'S COLOUR SET PROJECT. NEW MARK II DEMONSTRATION MODEL WITH LATEST IMPROVEMENTS. TWO SETS WORKING AND ON VIEW AT 172 WEST END LANE, N.W.6. TREMENDOUS RELIABILITY SUCCESS OVER A YEAR. CALL, PHONE OR WRITE FOR UP-TO-DATE COLOUR LISTS.

SPECIAL OFFER I.F. Panel, leading British maker, similar design to "Television" panel. Now in use as alternative incl. circuit, and connection data, checked and tested on colour £13.80 p.p. 40p. Also DECODER panel checked and tested on colour, full details. £15.00 p.p. 45p.

CROSS HATCH unit kit, new design £3.85 p.p. 15p. MAINS TRANSFORMER 280W, for Colour Set. Guaranteed to give correct outputs under actual load conditions. Designed for original power board. Includes C.R.T. 6-3V Htr. supply. In successful use for over a year in completed sets £10.00 p.p. 70p.

PRINTED CIRCUIT BOARDS. Convergence 3 for £2.75 p.p. 35p. Decoder I.F. amp. Time Base £1.25, Power £1.50 p.p. 30p. R.G.B. Varicap. C.R.T. Base 75p p.p. 15p. Audio 60p p.p. 15p.

PACKS (incl. p.p.), No. 2 £4.90, No. 5 £1.05, No. 9 45p, No. 12 31p, No. 13 35p, No. 14 £10.85, No. 15 £2.48, No. 16 £10.95, No. 17 £2.95, No. 19 £2.30, No. 21 £10.40, No. 22 £2.20, C.R.T. Shields £2.25 p.p. 65p, Pack No. 23 £2.95, Pack No. 24 £1.25. ELC1043 £4.50, p.p. 25p. A.E. Isolpanel 30p, TAA550 54p p.p. 10p.

PACK No. 18, Components £8.50 p.p. 35p, also "add-on" Stabiliser Unit Kit for either 40V or 20V £3.00 p.p. 25p.

Field & Line Blanking Mod. Kit 30p, Beam Limiter Mod. Kit £1.30. CABLE 7 x 0.2 mm Screened 10 yds for 65p. Colours, 15p p.p. 10p. Line Osc. Coil 50p, 500 ohm Contrast 25p, 100 ohm W.W. 25p, 250 ohm 25W 30p, A1 Slide Switches (Break before make) 3 for 48p. Ident Coil 50p. p.p. 12p. 100+200+200UF 350V £1.00 p.p. 25p.

G.E.C. 2040 decoder panels suitable for "Television" decoder parts incl. DL20, crystal, ident coil, etc., £3.50 p.p. 35p. CRT HEATER TRANSFORMERS 6-3V 1A £1.35 p.p. 25p. PYE 697 Line T.B. for "Television" set parts £1.50 p.p. 35p. GEC 2040 Field/Line T.B. panels for "Television" parts £1 p.p. 35p. MULLARD AT1023/05 convergence yoke. New £2.50 p.p. 35p.

PHILIPS G6 single standard convergence panel, incl. 16 controls, switches etc., and circuits £3.75 p.p. 35p, or incl. Yoke £5.00. PHILIPS G8 decoder panel part complete £2.50.

Field and Line Osc. Panels for spares 75p p.p. 30p. KB CVCI convergence control panels. New, complete £2.75 p.p. 35p. VARICAP/VARACTOR ELC 1043 UHF tuner £4.50 p.p. 25p.

Varicap tuners salvaged, VHF or UHF £1.50 p.p. 25p. Control units. 3PSN £1.25, 4PSN £1.80, 5PSN £2.30 p.p. 20p.

UHF/625 Tuners, many different types in stock. Lists available. UHF tuners transist. £2.85, incl. s/m drive, indicator £3.85; 6 position, or 4 position pushbutton £4.50 p.p. 30p.

MURPHY 600/700 series UHF conversion kits in cabinet plinth assembly, can be used as separate UHF receiver £5.50 p.p. 50p.

PHILIPS 625 I.F. panel incl. cct 50p. p.p. 35p. FIREBALL TUNERS Ferg. HMV, Marconi. New £1.25 p.p. 25p.

TURRET TUNERS. KB "Featherlight" VC11, Philips 170 series, GEC 2010 £2.50. AB Dual Stand, suitable Ferguson, Baird, KB, etc. 75p. Pye 110/510-Pam, Invicta, Miniature, increm. £1.00 p.p. 35p.

MULLARD TBA series I.C.S. now in stock also R.B.M. LINE OUTPUT TRANSFORMERS. Popular types available, brand new replacements, fully guar. A selection which can be supplied p.p. 35p, C.O.D. 28p.

BUSH TV92, 93, 105 to 186SS £5.40

DECCA DR95, 101/606, DRI 2, 3, 121/123, 20/24, 2000 £5.40

EKCO, FERR. 418, 1093 series £5.40

FERG, HMV, MARCONI, PHILCO, ULTRA, THORN 850, 900, 950, 1400, 1500 series £4.90

GEC 302 to 456, 2000 series £5.40

KB VC2/9, 51, 52, 53, 100, 200 £5.40

MURPHY 849, 939, 153 2417S £5.40

P/SCOTT 960, COSSOR 1964 £4.70

PHILIPS 19TG121 to 19TG156 £5.40

PHILIPS 19TG170, 210, 300 £5.40

PYE 110/510, 700, 830 series £4.40

11U, 20, 30, 40, 67, 368 series £5.40

PYE 169, 569, 769 series £4.90

PAM, INVICTA, EKCO, FERRANTI. equivalents £5.40

SOBELL 1000 series £5.40

STELLA 1043/2149 £5.40

THORN 850 Time Base Panel, Dual Standard 50p. p.p. 35p.

MULLARD Scan Coils Type AT1030 for all standard mono 110° models, Philips, Stella, Pye, Ekco, Ferranti, Invicta £2.00 p.p. 35p.

CALLERS WELCOME AT SHOP PREMISES

MANOR SUPPLIES

172 WEST END LANE, LONDON, N.W.6
(Near W. Hampstead tube stn: 28, 59, 159 Bus Routes) 01-794 8751
Mail Order: 64 GOLDERS MANOR DRIVE, LONDON, N.W.11



"I MADE IT MYSELF"

Imagine the thrill you'll feel! Imagine how impressed people will be when they're hearing a programme on a modern radio you made yourself.

Now! Learn the secrets of radio and electronics by building your own modern transistor radio!

Practical lessons teach you sooner than you would dream possible.

What a wonderful way to learn—and pave the way to a new, better-paid career! No dreary ploughing through page after page of dull facts and figures. With this fascinating Technatron Course, you learn by building!

You build a modern Transistor Radio... a Burglar Alarm. You learn Radio and Electronics by doing actual projects you enjoy—making things with your own hands that you'll be proud to own! No wonder it's so fast and easy to learn this way. Because learning becomes a hobby! And what a profitable hobby. Because opportunities in the field of Radio and Electronics are growing faster than they can find people to fill the jobs!

No soldering—yet you learn faster than you ever dreamed possible.

Yes! Faster than you can imagine, you pick up the technical know how you need. Specially prepared step-by-step lessons show you how to: read circuits—assemble components—build things—experiment. You enjoy every minute of it!

You get everything you need. Tools. Components. Even a versatile Multimeter that we teach you how to use. All included in the course AT NO EXTRA CHARGE! And this is a course anyone can afford.

So fast, so easy, this personalised course will teach you even if you don't know a thing today!

No matter how little you know now, no matter what your background or education, we'll teach you. Step by step, in simple easy-to-understand language, you pick up the secrets of radio and electronics.

You become a man who makes things, not just another of the millions who don't understand. And you could pave the way to a great new career, to add to the thrill and pride you receive when you look at what you have achieved. Within weeks you could hold in your hand your own transistor radio. And after the course you can go on to acquire high-powered technical qualifications, because our famous courses go right up to City & Guilds levels.

Send now for FREE 76 page book—see how easy it is—read what others say!

Find out more now! This is the gateway to a thrilling new career, or a wonderful hobby you'll enjoy for years. Send the coupon now. There's no obligation.

POST TODAY FOR FREE BOOK

To: ALDERMASTON COLLEGE
DEPT. CTV03
READING RG7 4PF

CTV03

Yes, I'd like to know more about your course. Please send me free details—plus your big, 76-page book that tells about all your courses.

NAME

ADDRESS

POST CODE



HOME OF BRITISH INSTITUTE OF ENGINEERING TECHNOLOGY

COLOUR TUBES STANDARD TUBES

METAL BAND TUBES

TWIN PANEL TUBES

Rebuilt with new Electron
Guns to British Standard
415/1/1967.

SUFFOLK TUBES LIMITED

261 CHURCH ROAD
MITCHAM, SURREY CR4 3BH
01-640 3133/4/5

Britain's Largest Independent
TV Tube Rebuilder

REBUILT TUBES!

YOU'RE SAFE WHEN YOU
BUY FROM RE-VIEW!

HERE IS WHAT YOU PAY:

MONO

15-17"	£5.00
19"	£5.50
21"	£6.50
23"	£7.50

RIMBAND & TWIN PANEL

19"	£7.50
20"	£8.50
23"	£9.50
24"	£10.50

Carriage £1.00

COLOUR

19"	£26.00
22"	£29.00
25"	£32.00
26"	£35.00

Exchange Basis
(carriage-ins. £2.00)

Guarantee 1 year

Cash or cheque with order, or cash on delivery

RE-VIEW ELECTRONIC TUBES

237 LONDON ROAD,
WEST CROYDON, SURREY
Tel. 01-689 7735

TELEVISION TUBE SHOP

BRAND NEW TUBES AT
REDUCED PRICES

A31-18W	£12.50
A47-11W	£9.95
A47-13W	£12.50
A47-14W	£8.25
A47-26W	£10.75
A50-120WR	£12.50
A59-11W	£12.95
A-59-13W	£13.50*
A59-15W	£9.95
A59-23W	£14.75
A61-120WR	£16.50
AW43-80	£6.95
AW43-88, 43-89	£6.75
AW47-90, 47-91	£7.50
AW53-80	£7.50*
AW53-88, 53-89	£8.25
AW59-90, 59-91	£9.00
CME1201	£12.50
CME1601	£10.50
CME1602	£12.00
CME1705	£7.75
CME1713/A44-120	£14.50
CME1901, 1903	£7.50
CME1906	£12.50
CME1908	£7.75
CME2013	£12.50
CME2101, 2104	£8.25
CME2301, 2302, 2303	£9.00
CME2305	£14.75
CME2306	£13.50*
CME2308	£9.95
CME2413R	£16.50
MW43-80	£6.75
MW53-20, 53-80	£7.50
TSD217, TSD282	£14.00†
13BP4 (Crystal 13)	£14.00†
190AB4	£9.25
230DB4	£11.25

* These types are fully rebuilt.

† Rebuilt tubes also, at £7.00 plus
carriage and old bulb.

COLOUR TUBES NEW R/B

	£	£
19" Unprotected	25	-
A49-120X	45	-
A56-120X	72	48
A61-15X	78	52
A63-11X	-	52
A66-120X	82	55
A67-120X	85	-

SHOP-SOILED COLOUR TUBES

19", 22" & 26" NOW AVAILABLE
Brand new, with slight scratches.
Prices from £20. Callers only.
Add Carriage and Insurance! Mono-
chrome 75p, Colour £1.50.

ALL PRICES SUBJECT TO V.A.T.

TELEVISION TUBE SHOP

48 BATTERSEA BRIDGE ROAD,
LONDON, S.W.11. BAT 6859

WE GIVE GREEN SHIELD STAMPS

TV'S! TV'S! TV'S!

High Quality Ex-Rental mono and colour
THOUSANDS TO CHOOSE FROM

19"/23" MONO

With valve UHF tuner from £2
(Thorn 850, GEC 1000, Bush 135, KB QV)
with transistorised UHF tuner from £5
(GEC 2018, Philips 70, Bush 141, Thorn 950)
with integrated UHF tuner from £9
(Pye Olympic, Philips 210, Bush 181)

20"/24" MONO

Single and dual standard from £12

19" Colour from £40

25" Colour from £50

22" Colour from £70



Northern 1043 Leeds Road, Bradford 3.
Tel. Bradford (0274) 665670.

Southern Watling Street, Hockliffe
3 miles N. of Dunstable A5.
Tel. Hockliffe 768.

Scotland Peacock Cross Industrial Estate
Burnbank Road, Hamilton.
Tel. (06982) 29511/2

BINDERS AND INDEXES

Binders which hold a year's
copies of TELEVISION
are available from IPC
Magazines Ltd., Binders
Department, Carlton House,
68 Great Queen Street,
London WC2 5DD. They
cost £1.34 each including
postage and are supplied
with either a blank spine
or with the volume number
printed on it (please state
requirements when order-
ing). Indexes are available
at 30p each (up to and
including Volume 22, 1971-
72).

LINE IT UP WITH A B-P-P MARK-2 CROSS-HATCH GENERATOR

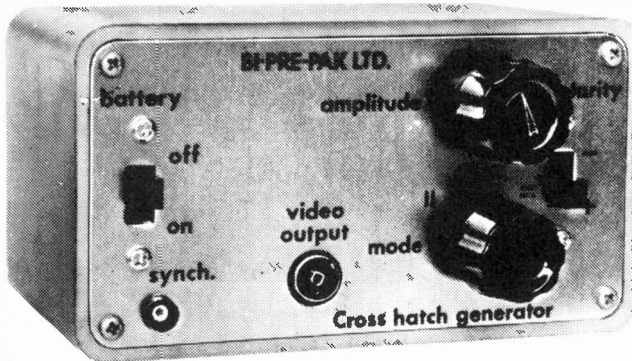

- ★ 4-PATTERN SELECTOR SWITCH
- ★ SIZE 3" x 5¼" x 3" (76 x 133 x 76mm)
- ★ OPERATES FROM 3 SELF-CONTAINED U.2 TYPE BATTERIES
- ★ FUNCTIONS TO PROFESSIONAL STANDARDS



This is one of the many attractive items sold by Bi-Pre-Pak. For catalogue of these and audio modules, semi-conductor bargains, books, etc., send large S.A.E. envelope with 6p stamp.

BI-PRE-PAK LTD

(Reg. No. 820919)

Dept. X, 222-224, WEST ROAD
WESTCLIFF-ON-SEA, ESSEX S50 9DF

Telephone: Southend (0702) 46344

in kit form or ready-built

Based on the design originally published in "TELEVISION" this unit is invaluable to industrial and home users alike. Improved circuitry assures reliability and still better accuracy. Very compact; self-contained. Robustly built. Widely used by TV rental and other engineers. With strong metal case, instructions, but less batteries. **INDISPENSABLE FOR COLOUR.**

In Kit form **£7.93**

Ready built and tested **£9.93**

add 8% for V.A.T. to total value of order and inc. 15p postage and packing (in U.K.)

★ TV Signal Strength Meter as described in this journal. Complete kit as specified £19.50+40p. postage & packing+£1.59 VAT.

BI-PRE-PAK LTD, 222 West Rd., Westcliff, Essex S50 9DF

Please send X-Hatch Generator Kit Built

TV Signal Strength Meter

for which I enclose, £..... inc. V.A.T. & post & packing.

NAME

ADDRESS

THE UM4 "COLOURBOOSTER" UHF/625 LINE

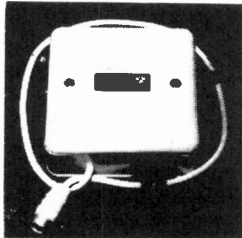

CAN PRODUCE REMARKABLE IMPROVEMENTS IN COLOUR AND PICTURE QUALITY IN FRINGE OR DIFFICULT AREAS WITH SIGNIFICANT REDUCTION IN NOISE (SNOW).

HIGH GAIN—VERY LOW NOISE
FITTED FLY LEAD—INSTALLED IN SECONDS
HIGHEST QUALITY COMPONENTS
IVORY PLASTIC CASE 3½ x 3½ x 1½ CORK BASE
CHANNELS: Group A, Red code 21-33
Group B, Yellow code 39-51
Group C-D, Green code 52-68

EQUALLY SUITABLE FOR BLACK AND WHITE

Also the M4 DUAL BAND VHF UNIT

BOOSTS ALL BAND III and ANY SPECIFIED BAND I CHANNEL SIMULTANEOUSLY
NOMINAL GAIN 16-18 DB BOTH BANDS

PRICES BOTH TYPES:

Battery model £4.17 Mains version £6.50

Including VAT p/p 27p

TRANSISTOR DEVICES LIMITED
6 ORCHARD GDNS., TEIGNMOUTH, DEVON
Telephone: Teignmouth 4757

Learn to understand electronics for your hobbies

1. Lerna-Kit course

Step by step, we take you through all the fundamentals of electronics and show you how easily the subject can be mastered.

- (1) BUILD AN OSCILLOSCOPE.
- (2) READ, DRAW AND UNDERSTAND CIRCUIT DIAGRAMS.
- (3) CARRY OUT OVER 40 EXPERIMENTS ON BASIC ELECTRONIC CIRCUITS AND SEE HOW THEY WORK.

2. Become a Radio-Amateur

Learn how to become a radio-amateur in contact with the wide world. We give skilled preparation for the G.P.O. licence.

FREE!

Brochure, without obligation to:

BRITISH NATIONAL RADIO & ELECTRONICS SCHOOL, Dept TX35
P.O. BOX 156, JERSEY, CHANNEL ISLANDS.

NAME

ADDRESS

**BLOCK CAPS
PLEASE TX35**

TV LINE OUTPUT TRANSFORMERS

ALL MAKES SUPPLIED PROMPTLY by our
RETURN OF POST MAIL ORDER SERVICE

All Lopts at the one price

£4.86 TRADE £5.40 RETAIL (INCLUDING V.A.T.)

Except

BUSH MODELS TV53 to TV101.

EKCO MODELS TC208 to TC335, TV407 to TV417.

FERGUSON MODELS 305 to 438, 506 to 546.

FERRANTI MODELS 1084 to 1092.

Post and Packing 30p COD 33p

HMV MODELS 1876 to 1878, 1890 to 1896, FR 20.

MURPHY MODELS V280 to V330, V420, V440, 653X to 789 OIL-FILLED.

REGENTONE MODELS 10-4 to 10-21, 1718, R2, R3, 191, 192.

RGD 519-621, 710, 711.

ALL AT £2.70 + 30p P&P

EHT TRAYS SUPPLIED—MONO & COL.

All Lopts NEW and GUARANTEED for SIX MONTHS

E. J. PAPWORTH AND SON Ltd.,
80 MERTON HIGH ST., LONDON, S.W.19

01-540 3955

01-540 3513

PHILIP H. BEARMAN

6 POTTERS ROAD, NEW BARNET, HERTS.

We offer one of the finest range of new or rebuilt tubes in the country; tubes tested before despatch and usually ex stock and despatched daily securely packed. Deliveries arranged World Wide, prices on application.

Colour tubes, 4 year g'tee.

17"/20" 90° types	
A49/11X, A49/120X and A49/191X	£54.00 + cge
A51/110X and 20" 510CKB22	£58.00 + cge
22" A55/14X, A56/120X-140X	£58.00 + cge
25" A63/11X, A63/120X and A63/200X	£66.00 + cge
26" A66/120X & A67/120X	£66.00 + cge
Note. 1 year g'tee	
20" colour	£60.00 to £70.00 + cge
22" Mullard A56/120X	£53.00 + cge
26" Mullard A66/120X & 140X	£60.00 to £70.00 + cge
25" Mullard A63/11-120X (when available)	£54.00 + cge

We often have Mullard 22"/26" electrically perfect with fractional marks from £42.00 upwards, availability etc. on application, also 20" 2nds. Excellent value, g'teed.

Colour cge £2.00 (sea journeys 99p extra).

TEL. 449-1934/5

NOTE. All prices subject to fluctuations when due to circumstances beyond our control.

STOP PRESS. Philips A28/14W £11.50 + 50p cge.

MONO Tubes, usually 2 year g'tee.

TSD217/282 (1 year) ...	£13.50 + 54p cge
Cathodeon MW31/74 ...	£3.24 + 54p cge
TSD290/CME1201 ...	£10.80 + 54p cge
CME1202 ...	£10.80 + 54p cge
CME1220/A31-120W ...	£11.34 + 54p cge
CME1402/AW36-80 ...	£5.13 + 59p cge
MW36/24-44 ...	£5.13 + 59p cge
CME1601 ...	£10.26 + 59p cge
CME1602 ...	£11.34 + 59p cge
CME1713 (A44/120W) ...	£14.00 + 59p cge
Other 17" tubes ...	£6.35 + 59p cge
A47/11 (CME1907) rebuilt ...	£10.80 + 64p cge
A47/11, 26W (CME1913) ...	£13.65 + 64p cge
A47/14W-CME1908 ...	£10.80 + 64p cge
A47/14W-AW47/91 rebuilds when available ...	£6.05 + 64p cge
A47/13W (CME1906) ...	£13.50 + 64p cge
A50/120 (CME2013) ...	£12.28 + 64p cge
A50/120 rebuilds ...	£10.45 + 64p cge
A59/15W (CME2308) ...	£10.80 + 70p cge
Rebuilds on application.	
A59/11W-A59/23W rebuilds	On application
A59/11W-A59/23W New	£15.22 + 70p cge
A59/13W (CME2306) "	£15.20 + 70p cge
A61/120 (CME2413) "	£16.20 + 70p cge
24" rebuilds ...	£12.65 + 70p cge

PLEASE MENTION
TELEVISION
WHEN REPLYING
TO ADVERTISEMENTS

REBUILT COLOUR TUBES

ALL SIZES AVAILABLE

Full range of rebuilt mono tubes available, Standard, Rimband and Twin Panel.

- ★ Complete new gun fitted to every tube.
- ★ 12 months' guarantee
- ★ 17 years' experience in tube rebuilding.
- ★ Trade enquiries welcomed.

N.G.T. ELECTRONICS LTD.

20, Southbridge Road,
Croydon, Surrey

Telephone: 01-681 7848/9

FREE!

Over 150 ways to engineer a better future



HIGHER PAY **A BETTER JOB**

SECURITY

find out how in just 2 minutes

That's how long it will take you to fill in the coupon. Mail it today and we'll send you full details and a free book. We have successfully trained thousands of men at home—equipped them for higher pay and better, more interesting jobs. We can do as much for YOU. A low-cost home study course gets results fast—makes learning easier and something to look forward to. There are no books to buy and you can pay-as-you-learn.

Why not do the thing that really interests you? Without losing a day's pay, you could quietly turn yourself into something of an expert. Complete the coupon (or write if you prefer not to cut the page). No obligation and nobody will call in on you . . . but it could be the best thing you ever did.

Others have done it, so can you

"Yesterday I received a letter from the Institution informing that my application for Associate Membership had been approved. I can honestly say that this has been the best value for money I have ever obtained, a view echoed by two colleagues who recently commenced the course". Student D.I.B., Yorks.

"Completing your course, meant going from a job I detested to a job that I love, with unlimited prospects"—Student J.A.O. Dublin.

"My training quickly changed my earning capacity and, in the next few years, my earnings increased fourfold". Student C.C.P., Bucks.

FIND OUT FOR YOURSELF

These letters and there are many more on file at Aldermaston College, speak of the rewards that come to the man who has given himself the specialised know-how employers seek. There's no surer way of getting ahead or of opening up new opportunities for yourself. It will cost you a stamp to find out how we can help you. Write to:

Aldermaston College

Dept. TTV03, Reading RG7 4PF

HOME OF BRITISH INSTITUTE OF ENGINEERING TECHNOLOGY

Practical Radio & Electronics Certificate course includes a learn while you build **3 transistor radio kit.**

Everything you need to know about **Radio & Electronics** maintenance and repairs for a **spare time income** and a **career** for a better future.



CUT OUT THIS COUPON
Tick or state subject of interest. Post to address below.

<input type="checkbox"/> MECHANICAL Society of Engineers— A.M.S.E. (Mech) Institute of Engineer & Technicians (A.M.I.E.) <input type="checkbox"/> CITY & GUILDS Gen. Mech. Eng. Maintenance Eng. Welding Gen. Diesel Eng. Sheet Metal Work Eng. Inspection Eng. Metallurgy	<input type="checkbox"/> DRAUGHTSMANSHIP Institute of Engineering Designers (A.M.I.E.D.) General Draughtsmanship Elec. Draughtsmanship Architectural Draughtsmanship Technical Drawing	<input type="checkbox"/> Construction Surveyors Institute L.C.S.I. City & Guilds General Building (all branches) Heating & Vent. Inst. Clerk of Works Site Surveying Health Engineering Road Construction Quantities Estimates Hydraulics Structural Eng.
<input type="checkbox"/> ELECTRICAL & ELECTRONIC CITY & GUILDS Gen. Electrical Engineering Electrical Installations Electrical Maths Computer Electronics Electronic Eng. Practical Radio & Electronics (with kit)	<input type="checkbox"/> RADIO & TELECOMMUNICATIONS City & Guilds Telecoms. Gen. Radio & TV Eng. Radio Amateurs Exam Radio Servicing	<input type="checkbox"/> GENERAL Agricultural Eng. Council of Eng. Institutions Farm Science Plastics <input type="checkbox"/> Supplementary courses for Nat. Certificates.
<input type="checkbox"/> MANAGEMENT & PRODUCTION Institute of Cost & Management Acctnts. Computer Programming Works M'tment Work Study Gen. Production Eng. Estimating & Planning Storekeeping Management Skills Quality Contro	<input type="checkbox"/> AUTOMOBILE & AERONAUTICAL Institute of the Motor Industry A.M.I.I. M.A.A./I.M.T. City & Guilds Auto Eng. Gen. Auto Eng. Motor Mechanics Auto Diesel Eng. Garage M'tment AEC Aero Engineering Exams Gen. Aero Eng.	<input type="checkbox"/> G.C.E. —choose from 58 'O' & 'A' level subjects
	<input type="checkbox"/> CONSTRUCTIONAL Institute of Building L.I.O.B. A.B.T. Clerk of Works	<input type="checkbox"/> Coaching for many exams, including C & G

POST TODAY FOR A BETTER TOMORROW

To Aldermaston College,
Dept. TTV03, Reading RG7 4PF

NAME.....
Block capitals please
ADDRESS.....
.....
POST CODE.....
OTHER SUBJECTS.....
.....
AGE.....
Accredited by C.A.C.C. Member of A.B.C.C.

