

# TELEVISION

SERVICING · CONSTRUCTION · COLOUR · DEVELOPMENTS

20p

MARCH  
1973

## Renovating the BRC 2000 CHASSIS

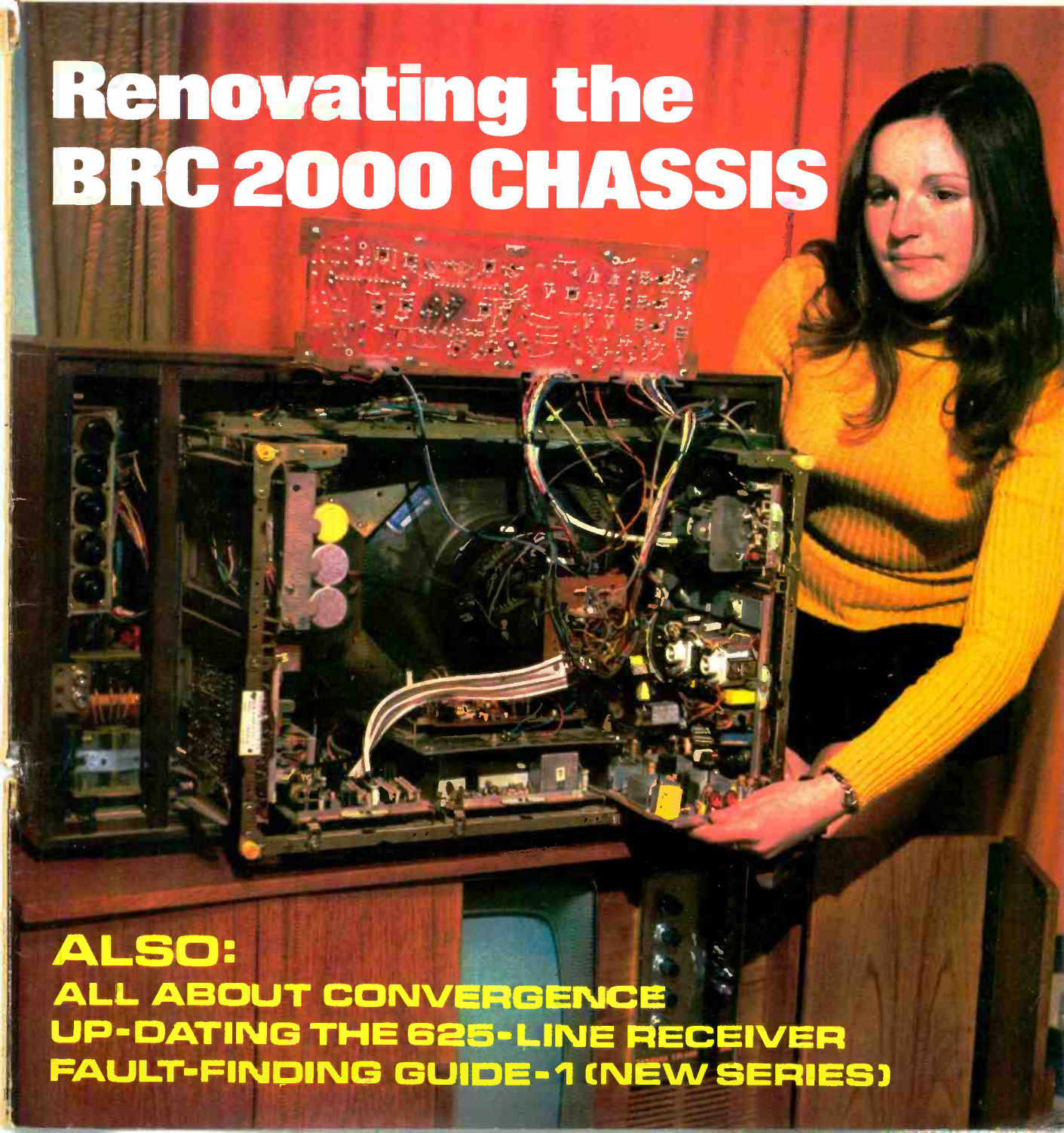

**ALSO:**  
**ALL ABOUT CONVERGENCE**  
**UP-DATING THE 625-LINE RECEIVER**  
**FAULT-FINDING GUIDE - 1 (NEW SERIES)**

## COLOUR, UHF AND TELEVISION SPARES

"TELEVISION" Colour set parts, available from us. Save £££. Call, phone, or write for up to date information, colour lists.

**SCAN PACK**, Philips/Mullard or Plessey Scan Coils, Convergence Yoke, Blue Lateral, complete set for £10.00 p.p. 35p.  
**PRINTED CIRCUIT BOARDS**, Convergence, 3 for £2.50 p.p. 25p. T.B., £1.25, Decoder £1.25, I.F. amp £1.25 p.p. 25p. R.G.B. 65p. p.p. 15p, Power Supply £1.50 p.p. 25p. E.H.T. Tripler (ITT.TS25) £4.75, Focus Control Erie £1.30, Mullard AT2055 LOPT £3.25 p.p. 25p, DL1 £1.50, DL20 £3.50 p.p. 25p. Crystal 75p. FX2249, 5 for 40p, Luminance Delay Line 75p p.p. 15p. Two B9D, one B9A Bases 25p, Varicap ELC1043 £4.50, TAA550 62p, AE. Isolpanel 30p.

**SPECIAL OFFER** IF panel, leading British maker, similar design to "Television" panel, includes TAA350, lum. delay line AFC generator, etc., incl. circuit, £8.50 p.p. 30p Convergence Panel Pots, Coils, etc. available, CRT Base 25p. C.R.T. Shields £1.85 p.p. 50p. Degaussing Coil Pack No. 19 (state size) £2.30, G.E.C. Colour decoder panels (for parts) panel components (for parts), G.E.C. Colour decoder panels incl. DL20, crystal & approx. 50% of resistors, Conds., diodes, transist., etc. for "Television" decoder £3.50 p.p. 30p.

**PHILIPS** G6 decoder panel incl. DL1E crystal, etc. £6.50 p.p. 30p.  
**PHILIPS** G6 single standard convergence control panel, incl. 16 controls, switches etc. & circuits £5.00 p.p. 25p.

**PHILIPS** G8 decoder panel part complete incl. 1/C £2.50 p.p. 25p.

**BUSH** CTV25 timebase units, line frame, E.H.T. surplus £3.95 p.p. 50p.

**VARICAP/VARACTOR** ELC 1043 UHF tuner (for "Television" colour receiver) £4.50, VHF Varicap tuners for band 1 & 3 £2.85, Varicap tuners salvaged £1.50 p.p. 25p.

**UHF** 625 kits and tuners. Lists available at reduced prices. UHF tuners, transistd. £2.85; incl. s/m drive, indicator £3.85; 6 position pushbutton £4.95, UHF/VHF transistd. tuner, latest type, incl. circuit £3.25, Cyldon valve type £1.50 p.p. 25p.

**MURPHY** 600/700 series UHF conversion kits in cabinet plinth assembly, can be used as separate UHF receiver £7.50 p.p. 50p.

**SOBELL/GEC** Dual 405/625 IF amp and o/p chassis incl. circuit £1.50 p.p. 30p. **PHILIPS** 625 IF panel incl. cct £1 p.p. 25p.

**FIREBALL TUNERS** Ferg., HMV, Marconi. New £1.90 p.p. 25p.

**TURRET TUNERS**, KB "Featherlight" VC11, Philips 170 series, GEC 2010 £2.50, AB Dual Stand, Suit, Ferguson, Baird, KB, etc. 75p, Cyldon C 75p, Pye 110/510-Pam, Invicta, Miniature, increm. £1.95, Peto Scott 960, Decca 95/606 £1.50 p.p. 25p.

**LINE OUTPUT TRANSFORMERS**, Popular types available, brand new replacements, fully guar. A selection which can be supplied p.p. 25p. C.O.D. 25p

		SPECIAL OFFERS	
<b>MURPHY</b> 849, 939, 153 2417S	£4.50	<b>BUSH</b> TV53/86...	£1.75
<b>PHILIPS</b> 1768/2168, 1796/2196	£4.50	<b>BUSH</b> TV95/99...	£2.50
<b>PHILIPS</b> 17TG/100 Range	£3.90	<b>EKCO</b> 407/417	£2.50
<b>STELLA</b> 1011/1029	£4.00	<b>FERR</b> 1084/1092	£2.50
<b>PHILIPS</b> 19TG111/112	£4.50	<b>FERG</b> 506 to 546	£1.50
<b>PHILIPS</b> 19TG121 to 156	£4.50	<b>HMV</b> 1890 to 1896	£1.50
<b>PHILIPS</b> 19TG170, 210 series	£4.50	<b>P/SCOTT</b> 1419 to	£1.75
<b>BUSH</b> TV92, 93, 105 to 186SS	£4.50	1725,733 to 738	£2.50
<b>EKCO</b> 221 to 394, <b>FERRANTI</b>	£3.90	<b>REG.</b> 10-6, 10-17	£2.50
1001 to 1065	£3.90	<b>REG.</b> 191, 192,	£2.50
<b>EKCO, FERR</b> 418, 1093 etc.	£4.25	17-18	£2.50
<b>DECCA</b> DR95, 101/606, DR1,	£3.90	<b>RGD</b> 519 606,	£2.50
2, 3, 121/123, 20/24, 2000	£3.90	610, 612, 619,	£2.50
<b>FERG</b> 305 to 436, 606 to 727	£4.25	620, 711	£2.50
<b>FERG, HMV, MARCONI,</b>	£4.25	<b>PHILCO</b> 1010/21	£2.25
<b>ULTRA, PHILCO</b> 3600, 2600,	£4.00	<b>LOPT</b> Inserts p.p.	15p
4600, 6600, 1100 series, Jellypot	£3.90	<b>KB</b> NF70, OV30,	£1.75
<b>KB</b> VC1 to VC11	£4.00	<b>PV40, PVP20,</b>	£1.75
<b>MARCONI</b> VT157 to 172	£4.50	<b>QV10, 20, 30</b>	£1.75
<b>GEC</b> 302 to 456, 2000 series	£3.90	<b>KB/RGD</b> VCII	£2.50
<b>HMV</b> 1865/9, 1870/6, 1910/1924	£3.90	Featherlight	£1.75
<b>PYE</b> 17/21, 17/S, 110 to 510	£3.90	<b>KB/RGD</b> VCI-9	£1.75
700, 830, 1, 2, 3, 11U to 64	£3.90	<b>PHILCO</b> 1030/50	£1.75
<b>PAM, INVICTA</b> equiv. LOPTS	£4.50	<b>PHILIPS</b> 17TG100	£1.75
to above <b>PYE</b>	£3.90	range	£1.75
<b>SOBELL</b> 195/282/1000 series	£4.50		
<b>ULTRA</b> 1770 to 2834	£3.90		

**PRACTICAL TV 625 RECEIVER**  
 Integrated push button transistorised tuner ... £4.90 p.p. 25p  
 Transistorised IF panel ... £4.75 p.p. 25p  
 850 line output transformer ... £3.90 p.p. 25p  
 850 field output transformer ... £1.62 p.p. 15p  
 850 scan coils ... £3.90 p.p. 25p

(p.p. on complete set of 5 items 50p)  
**THORN** 850 Time Base Panel, Dual Standard £1 p.p. 30p.  
**THORN** 850 Mains Droppers 25p, p.p. 10p (state approx. values).

CALLERS WELCOME AT SHOP PREMISES

## MANOR SUPPLIES

172 WEST END LANE, LONDON, N.W.6

(Near W. Hampstead tube stn; 28, 59, 159 Bus Routes) 01-794 8751

Mail Order: 64 GOLDERS MANOR DRIVE,  
 LONDON, N.W.11

## SOUTHEND ELECTRONICS

### DELAY LINES



30p Each P.P. Paid

### COLOUR 25 KV TRIPLERS

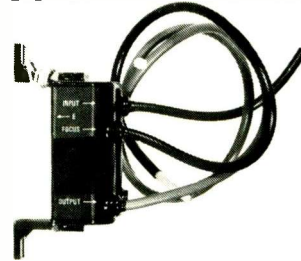

£1.65 P.P. Paid

### CONVERGENCE PANEL & YOKE

£5.00 P.P. Paid

### TRANSISTOR U.H.F. SIX PUSH BUTTON TUNER UNITS

£4.50 P.P. Paid

V.H.F., U.H.F. £3.50 Each P.P. Paid  
 No Push Button

200 + 200 + 100 +  
 32 MFD 275V

£1.00 P.P. Paid

### 100 W/W MIXED RESISTORS

£1.00 P.P. Paid

### 250 MIXED RESISTORS

£1.00 P.P. Paid

### 200 MIXED CONDENSERS

£1.00 P.P. Paid

### 40 MIXED POTS

£1.00 P.P. Paid

## SOUTHEND ELECTRONICS

240 Rayleigh Road,  
 Eastwood,  
 Leigh-on-Sea,  
 Essex.

Phone: Southend 521363

<p><b>Branded TTL I.C.'s</b></p> <table border="0"> <tr><td>7400 28p</td><td>7475 55p</td><td>UA 709 34p</td></tr> <tr><td>7413 30p</td><td>7476 45p</td><td>UA 710 45p</td></tr> <tr><td>7418 20p</td><td>7480 75p</td><td>UA 723 95p</td></tr> <tr><td>7473 40p</td><td>7482 75p</td><td>UA 741 55p</td></tr> <tr><td>7474 40p</td><td>7483 75p</td><td>UA 748 80p</td></tr> </table> <p><b>I.C. Sockets</b></p> <p>Dual in-line for 2ig 2ag 14 and 16 pin Our Price 1p per pin.</p>	7400 28p	7475 55p	UA 709 34p	7413 30p	7476 45p	UA 710 45p	7418 20p	7480 75p	UA 723 95p	7473 40p	7482 75p	UA 741 55p	7474 40p	7483 75p	UA 748 80p	<p><b>VDR's &amp; Thermistors</b></p> <table border="0"> <tr><td>A15B 75p</td><td>GL23 £1.00</td><td>VA1005 15p</td></tr> <tr><td>C21 15p</td><td>R53 £1.32</td><td>VA1026 13p</td></tr> <tr><td>C24 15p</td><td>R54 £1.46</td><td>VA1033 13p</td></tr> <tr><td>C213A 13p</td><td></td><td>VA1040 10p</td></tr> <tr><td>E298 ED/A258 10p</td><td></td><td>VA1063 10p</td></tr> <tr><td>E298 ZZ/06 10p</td><td></td><td>VA1055S 10p</td></tr> <tr><td>GL16 £1</td><td></td><td>VA1034 10p</td></tr> </table>	A15B 75p	GL23 £1.00	VA1005 15p	C21 15p	R53 £1.32	VA1026 13p	C24 15p	R54 £1.46	VA1033 13p	C213A 13p		VA1040 10p	E298 ED/A258 10p		VA1063 10p	E298 ZZ/06 10p		VA1055S 10p	GL16 £1		VA1034 10p	<p><b>Potentiometers</b></p> <table border="0"> <tr><td>5KΩ</td><td>50KΩ</td><td>500KΩ</td></tr> <tr><td>10KΩ</td><td>100KΩ</td><td>1MΩ</td></tr> <tr><td>25KΩ</td><td>250KΩ</td><td>2MΩ</td></tr> <tr><td>log or lin less switch (&amp; 1KΩ lin)</td><td></td><td>12p</td></tr> <tr><td>log or lin wth switch</td><td></td><td>24p</td></tr> <tr><td>dual less switch</td><td></td><td>40p</td></tr> <tr><td>dual with switch 10K, 100K &amp; 1M log only</td><td></td><td>52p</td></tr> <tr><td>10K log - 10K antilog less switch</td><td></td><td>40p</td></tr> </table>	5KΩ	50KΩ	500KΩ	10KΩ	100KΩ	1MΩ	25KΩ	250KΩ	2MΩ	log or lin less switch (& 1KΩ lin)		12p	log or lin wth switch		24p	dual less switch		40p	dual with switch 10K, 100K & 1M log only		52p	10K log - 10K antilog less switch		40p	<p><b>Capacitors</b></p> <table border="0"> <tr><td colspan="2">Ceramic - plate</td><td>63V (C333)</td></tr> <tr><td>1 8pf</td><td>8 2pf</td><td>33pf 120pf</td></tr> <tr><td>2 2pf</td><td>10pf</td><td>39pf 150pf</td></tr> <tr><td>3 3pf</td><td>12pf</td><td>47pf 180pf</td></tr> <tr><td>3 9pf</td><td>15pf</td><td>56pf 220pf</td></tr> <tr><td>4 7pf</td><td>18pf</td><td>68pf 270pf</td></tr> <tr><td>5 6pf</td><td>22pf</td><td>82pf 330pf</td></tr> <tr><td>6 8pf</td><td>27pf</td><td>100pf</td></tr> <tr><td colspan="3">all 5p. each</td></tr> <tr><td colspan="2">mylar film</td><td>100V</td></tr> <tr><td>1000pf 3p</td><td>0.01μF</td><td>3p -0.68μF 4p</td></tr> <tr><td>2000pf 2p</td><td>0.02μF</td><td>3p -1μF 4p</td></tr> <tr><td>5000pf 2p</td><td>0.04μF</td><td>3p -2μF 5p</td></tr> <tr><td></td><td>0.05μF</td><td>3p</td></tr> <tr><td colspan="2">metallised polyester</td><td>250V (C280)</td></tr> <tr><td>0.01μF 3p</td><td>0.068μF</td><td>3p -47μF 8p</td></tr> <tr><td>0.015μF 3p</td><td>1μF</td><td>4p -68μF 11p</td></tr> <tr><td>0.022μF 3p</td><td>1.5μF</td><td>4p 1μF 13p</td></tr> <tr><td>0.033μF 3p</td><td>2.2μF</td><td>5p 1.5μF 20p</td></tr> <tr><td>0.047μF 3p</td><td>3.3μF</td><td>6.3p 2.2μF 24p</td></tr> <tr><td colspan="2">metallised polyester</td><td>400V (C281)</td></tr> <tr><td>0.01μF 4.3p</td><td>0.068μF</td><td>6p -22μF 10p</td></tr> <tr><td>0.015μF 4.3p</td><td>0.068μF</td><td>6p -33μF 14p</td></tr> <tr><td>0.022μF 4.3p</td><td>1μF</td><td>7p -47μF 15p</td></tr> <tr><td>0.033μF 5.3p</td><td>1.5μF</td><td>8p</td></tr> <tr><td colspan="2">mixed dielectric</td><td>600V</td></tr> <tr><td>0.01μF 7p</td><td>0.047μF</td><td>7p -22μF 16p</td></tr> <tr><td>0.022μF 7p</td><td>0.068μF</td><td>8p -47μF 24p</td></tr> <tr><td>0.033μF 7p</td><td>1μF</td><td>8p 1μF 33p</td></tr> <tr><td colspan="2">mixed dielectric</td><td>1000V</td></tr> <tr><td>1000pf 6p</td><td>6800pf</td><td>9p -1μF 12p</td></tr> <tr><td>2200pf 6p</td><td>0.01μF</td><td>9p -22μF 22p</td></tr> <tr><td>3300pf 6p</td><td>0.022μF</td><td>9p -47μF 30p</td></tr> <tr><td>4700pf 6p</td><td>0.047μF</td><td>12p</td></tr> <tr><td colspan="2">Ceramic</td><td>12KV.d.c.</td></tr> <tr><td>15pf 9p</td><td>200pf 9p</td><td>1000pf 5p</td></tr> <tr><td>22pf 9p</td><td>220pf 9p</td><td>1500pf 5p</td></tr> <tr><td>22pf 9p</td><td>250pf 9p</td><td>2000pf 5p</td></tr> <tr><td>68pf 9p</td><td>270pf 9p</td><td>3000pf 5p</td></tr> <tr><td>82pf 9p</td><td>300pf 9p</td><td>5000pf 5p</td></tr> <tr><td>100pf 9p</td><td>750V DISC</td><td>10,000pf 5p</td></tr> <tr><td>120pf 9p</td><td>470pf 5p</td><td>feed-</td></tr> <tr><td>140pf 9p</td><td>1000pf 5p</td><td>through</td></tr> <tr><td>150pf 9p</td><td>5000pf 5p</td><td></td></tr> <tr><td>180pf 9p</td><td>10,000pf 5p</td><td>1000pf 5p</td></tr> </table>	Ceramic - plate		63V (C333)	1 8pf	8 2pf	33pf 120pf	2 2pf	10pf	39pf 150pf	3 3pf	12pf	47pf 180pf	3 9pf	15pf	56pf 220pf	4 7pf	18pf	68pf 270pf	5 6pf	22pf	82pf 330pf	6 8pf	27pf	100pf	all 5p. each			mylar film		100V	1000pf 3p	0.01μF	3p -0.68μF 4p	2000pf 2p	0.02μF	3p -1μF 4p	5000pf 2p	0.04μF	3p -2μF 5p		0.05μF	3p	metallised polyester		250V (C280)	0.01μF 3p	0.068μF	3p -47μF 8p	0.015μF 3p	1μF	4p -68μF 11p	0.022μF 3p	1.5μF	4p 1μF 13p	0.033μF 3p	2.2μF	5p 1.5μF 20p	0.047μF 3p	3.3μF	6.3p 2.2μF 24p	metallised polyester		400V (C281)	0.01μF 4.3p	0.068μF	6p -22μF 10p	0.015μF 4.3p	0.068μF	6p -33μF 14p	0.022μF 4.3p	1μF	7p -47μF 15p	0.033μF 5.3p	1.5μF	8p	mixed dielectric		600V	0.01μF 7p	0.047μF	7p -22μF 16p	0.022μF 7p	0.068μF	8p -47μF 24p	0.033μF 7p	1μF	8p 1μF 33p	mixed dielectric		1000V	1000pf 6p	6800pf	9p -1μF 12p	2200pf 6p	0.01μF	9p -22μF 22p	3300pf 6p	0.022μF	9p -47μF 30p	4700pf 6p	0.047μF	12p	Ceramic		12KV.d.c.	15pf 9p	200pf 9p	1000pf 5p	22pf 9p	220pf 9p	1500pf 5p	22pf 9p	250pf 9p	2000pf 5p	68pf 9p	270pf 9p	3000pf 5p	82pf 9p	300pf 9p	5000pf 5p	100pf 9p	750V DISC	10,000pf 5p	120pf 9p	470pf 5p	feed-	140pf 9p	1000pf 5p	through	150pf 9p	5000pf 5p		180pf 9p	10,000pf 5p	1000pf 5p
7400 28p	7475 55p	UA 709 34p																																																																																																																																																																																																				
7413 30p	7476 45p	UA 710 45p																																																																																																																																																																																																				
7418 20p	7480 75p	UA 723 95p																																																																																																																																																																																																				
7473 40p	7482 75p	UA 741 55p																																																																																																																																																																																																				
7474 40p	7483 75p	UA 748 80p																																																																																																																																																																																																				
A15B 75p	GL23 £1.00	VA1005 15p																																																																																																																																																																																																				
C21 15p	R53 £1.32	VA1026 13p																																																																																																																																																																																																				
C24 15p	R54 £1.46	VA1033 13p																																																																																																																																																																																																				
C213A 13p		VA1040 10p																																																																																																																																																																																																				
E298 ED/A258 10p		VA1063 10p																																																																																																																																																																																																				
E298 ZZ/06 10p		VA1055S 10p																																																																																																																																																																																																				
GL16 £1		VA1034 10p																																																																																																																																																																																																				
5KΩ	50KΩ	500KΩ																																																																																																																																																																																																				
10KΩ	100KΩ	1MΩ																																																																																																																																																																																																				
25KΩ	250KΩ	2MΩ																																																																																																																																																																																																				
log or lin less switch (& 1KΩ lin)		12p																																																																																																																																																																																																				
log or lin wth switch		24p																																																																																																																																																																																																				
dual less switch		40p																																																																																																																																																																																																				
dual with switch 10K, 100K & 1M log only		52p																																																																																																																																																																																																				
10K log - 10K antilog less switch		40p																																																																																																																																																																																																				
Ceramic - plate		63V (C333)																																																																																																																																																																																																				
1 8pf	8 2pf	33pf 120pf																																																																																																																																																																																																				
2 2pf	10pf	39pf 150pf																																																																																																																																																																																																				
3 3pf	12pf	47pf 180pf																																																																																																																																																																																																				
3 9pf	15pf	56pf 220pf																																																																																																																																																																																																				
4 7pf	18pf	68pf 270pf																																																																																																																																																																																																				
5 6pf	22pf	82pf 330pf																																																																																																																																																																																																				
6 8pf	27pf	100pf																																																																																																																																																																																																				
all 5p. each																																																																																																																																																																																																						
mylar film		100V																																																																																																																																																																																																				
1000pf 3p	0.01μF	3p -0.68μF 4p																																																																																																																																																																																																				
2000pf 2p	0.02μF	3p -1μF 4p																																																																																																																																																																																																				
5000pf 2p	0.04μF	3p -2μF 5p																																																																																																																																																																																																				
	0.05μF	3p																																																																																																																																																																																																				
metallised polyester		250V (C280)																																																																																																																																																																																																				
0.01μF 3p	0.068μF	3p -47μF 8p																																																																																																																																																																																																				
0.015μF 3p	1μF	4p -68μF 11p																																																																																																																																																																																																				
0.022μF 3p	1.5μF	4p 1μF 13p																																																																																																																																																																																																				
0.033μF 3p	2.2μF	5p 1.5μF 20p																																																																																																																																																																																																				
0.047μF 3p	3.3μF	6.3p 2.2μF 24p																																																																																																																																																																																																				
metallised polyester		400V (C281)																																																																																																																																																																																																				
0.01μF 4.3p	0.068μF	6p -22μF 10p																																																																																																																																																																																																				
0.015μF 4.3p	0.068μF	6p -33μF 14p																																																																																																																																																																																																				
0.022μF 4.3p	1μF	7p -47μF 15p																																																																																																																																																																																																				
0.033μF 5.3p	1.5μF	8p																																																																																																																																																																																																				
mixed dielectric		600V																																																																																																																																																																																																				
0.01μF 7p	0.047μF	7p -22μF 16p																																																																																																																																																																																																				
0.022μF 7p	0.068μF	8p -47μF 24p																																																																																																																																																																																																				
0.033μF 7p	1μF	8p 1μF 33p																																																																																																																																																																																																				
mixed dielectric		1000V																																																																																																																																																																																																				
1000pf 6p	6800pf	9p -1μF 12p																																																																																																																																																																																																				
2200pf 6p	0.01μF	9p -22μF 22p																																																																																																																																																																																																				
3300pf 6p	0.022μF	9p -47μF 30p																																																																																																																																																																																																				
4700pf 6p	0.047μF	12p																																																																																																																																																																																																				
Ceramic		12KV.d.c.																																																																																																																																																																																																				
15pf 9p	200pf 9p	1000pf 5p																																																																																																																																																																																																				
22pf 9p	220pf 9p	1500pf 5p																																																																																																																																																																																																				
22pf 9p	250pf 9p	2000pf 5p																																																																																																																																																																																																				
68pf 9p	270pf 9p	3000pf 5p																																																																																																																																																																																																				
82pf 9p	300pf 9p	5000pf 5p																																																																																																																																																																																																				
100pf 9p	750V DISC	10,000pf 5p																																																																																																																																																																																																				
120pf 9p	470pf 5p	feed-																																																																																																																																																																																																				
140pf 9p	1000pf 5p	through																																																																																																																																																																																																				
150pf 9p	5000pf 5p																																																																																																																																																																																																					
180pf 9p	10,000pf 5p	1000pf 5p																																																																																																																																																																																																				
<p><b>Transistors</b></p> <table border="0"> <tr><td>AC128 15p</td><td>BC172 18p</td><td>BF184 25p</td></tr> <tr><td>AC176 15p</td><td>BD115 6.7p</td><td>BF185 25p</td></tr> <tr><td>AF139 28p</td><td>BD124 £1.01</td><td>BF194 15p</td></tr> <tr><td>AF239 30p</td><td>BD131 7.0p</td><td>BF195 15p</td></tr> <tr><td>BC107 10p</td><td>BD132 7.0p</td><td>BF196 15p</td></tr> <tr><td>BC108 10p</td><td>BD131/2M.P. £1.49</td><td>BF197 15p</td></tr> <tr><td>BC109 10p</td><td>BF115 25p</td><td>BF272 53p</td></tr> <tr><td>BC147 10p</td><td>BF167 20p</td><td>BFV50 24p</td></tr> <tr><td>BC148 10p</td><td>BF173 20p</td><td>BRV39 36p</td></tr> <tr><td>BC149 10p</td><td>BF180 25p</td><td>BSX21 26p</td></tr> <tr><td>BC171 21p</td><td>BF181 30p</td><td>BU105 £2</td></tr> </table>	AC128 15p	BC172 18p	BF184 25p	AC176 15p	BD115 6.7p	BF185 25p	AF139 28p	BD124 £1.01	BF194 15p	AF239 30p	BD131 7.0p	BF195 15p	BC107 10p	BD132 7.0p	BF196 15p	BC108 10p	BD131/2M.P. £1.49	BF197 15p	BC109 10p	BF115 25p	BF272 53p	BC147 10p	BF167 20p	BFV50 24p	BC148 10p	BF173 20p	BRV39 36p	BC149 10p	BF180 25p	BSX21 26p	BC171 21p	BF181 30p	BU105 £2	<p><b>Resistors</b></p> <p>1/2 watt 5% Carbon Film - low noise</p> <p>Hi-Stabs</p> <p>All E24 values 1p each plus p. &amp; p. 7p for up to 50 Resistors and a further 2p for each additional 50. Deduct 33% for 100 of one type or 25% for mixed orders over £1 in value.</p> <table border="0"> <tr><td>1W 10% Carbon Composition</td><td>3p each</td></tr> <tr><td>2W 10% Carbon Composition</td><td>6p each</td></tr> <tr><td>21W 5% Wire wound</td><td>9p each</td></tr> <tr><td>5W Wire wound</td><td>9p each</td></tr> <tr><td>10W Wire wound</td><td>10p each</td></tr> </table> <p>plus p. &amp; p. 7p for up to 25 resistors plus 1p for each additional 25.</p>	1W 10% Carbon Composition	3p each	2W 10% Carbon Composition	6p each	21W 5% Wire wound	9p each	5W Wire wound	9p each	10W Wire wound	10p each	<p><b>TV Electrolytics</b></p> <table border="0"> <tr><td>1-2: 4: 8μF 450V</td><td>14p 32μF</td><td>450V 20p</td></tr> <tr><td>16μF</td><td>450V 15p</td><td>50μF 350V 20p</td></tr> <tr><td>8-8μF: 450 V.W</td><td>18p</td><td>32-32μF: 350 V.W 25p</td></tr> <tr><td>8-16μF: 450 V.W</td><td>20p</td><td>32-32μF: 450 V.W 43p</td></tr> <tr><td>16-16μF: 450 V.W</td><td>25p</td><td>50-50μF: 350 V.W 39p</td></tr> <tr><td>16-100-100-300μF: 275 V.W</td><td></td><td>£1.23</td></tr> <tr><td>32-100-125-200μF: 275 V.W</td><td></td><td>£1.23</td></tr> <tr><td>32-100-200-200μF: 300 V.W</td><td></td><td>£1.23</td></tr> <tr><td>100-100-100-150-150μF: 320 V.W</td><td></td><td>£1.66</td></tr> <tr><td>175 (400V)-100-100μF: 350 V.W</td><td></td><td>£1.66</td></tr> <tr><td>60-100-200μF: 300 V.W</td><td></td><td>£1</td></tr> <tr><td>100-200μF: 275 V.W</td><td></td><td>£1</td></tr> <tr><td>100-200-200μF: 300 V.W</td><td></td><td>75p</td></tr> <tr><td>100-400μF: 275 V.W</td><td></td><td>£1.15</td></tr> <tr><td>200μF: 275 V.W. 50p</td><td>300+300μF: 300 V.W. £1.90</td><td></td></tr> </table>	1-2: 4: 8μF 450V	14p 32μF	450V 20p	16μF	450V 15p	50μF 350V 20p	8-8μF: 450 V.W	18p	32-32μF: 350 V.W 25p	8-16μF: 450 V.W	20p	32-32μF: 450 V.W 43p	16-16μF: 450 V.W	25p	50-50μF: 350 V.W 39p	16-100-100-300μF: 275 V.W		£1.23	32-100-125-200μF: 275 V.W		£1.23	32-100-200-200μF: 300 V.W		£1.23	100-100-100-150-150μF: 320 V.W		£1.66	175 (400V)-100-100μF: 350 V.W		£1.66	60-100-200μF: 300 V.W		£1	100-200μF: 275 V.W		£1	100-200-200μF: 300 V.W		75p	100-400μF: 275 V.W		£1.15	200μF: 275 V.W. 50p	300+300μF: 300 V.W. £1.90		<p><b>Eliminators</b></p> <table border="0"> <tr><td>9 volt (a 20mA (PP3))</td><td>£1.25</td></tr> <tr><td>9 volt (a 50mA)</td><td>£1.50</td></tr> <tr><td>9 volt (a 50mA)</td><td>£1.50</td></tr> <tr><td>6-6 volt 50mA</td><td>£2.50</td></tr> <tr><td>9-9 volt 50mA</td><td>£2.50</td></tr> <tr><td>7 1/2 volt for cassette recorders</td><td>£2.00</td></tr> <tr><td>6, 7 1/2 or 9 volt</td><td>£3.00</td></tr> <tr><td>3, 4 1/2, 6, 7 1/2, 9, 12 or 500mA</td><td>£3.99</td></tr> </table> <p>Car Battery Converter fully stabilised to provide 6, 7 1/2 or 9 volts £4.99</p> <p>(p &amp; p. 15p on all types)</p>	9 volt (a 20mA (PP3))	£1.25	9 volt (a 50mA)	£1.50	9 volt (a 50mA)	£1.50	6-6 volt 50mA	£2.50	9-9 volt 50mA	£2.50	7 1/2 volt for cassette recorders	£2.00	6, 7 1/2 or 9 volt	£3.00	3, 4 1/2, 6, 7 1/2, 9, 12 or 500mA	£3.99																																																																																											
AC128 15p	BC172 18p	BF184 25p																																																																																																																																																																																																				
AC176 15p	BD115 6.7p	BF185 25p																																																																																																																																																																																																				
AF139 28p	BD124 £1.01	BF194 15p																																																																																																																																																																																																				
AF239 30p	BD131 7.0p	BF195 15p																																																																																																																																																																																																				
BC107 10p	BD132 7.0p	BF196 15p																																																																																																																																																																																																				
BC108 10p	BD131/2M.P. £1.49	BF197 15p																																																																																																																																																																																																				
BC109 10p	BF115 25p	BF272 53p																																																																																																																																																																																																				
BC147 10p	BF167 20p	BFV50 24p																																																																																																																																																																																																				
BC148 10p	BF173 20p	BRV39 36p																																																																																																																																																																																																				
BC149 10p	BF180 25p	BSX21 26p																																																																																																																																																																																																				
BC171 21p	BF181 30p	BU105 £2																																																																																																																																																																																																				
1W 10% Carbon Composition	3p each																																																																																																																																																																																																					
2W 10% Carbon Composition	6p each																																																																																																																																																																																																					
21W 5% Wire wound	9p each																																																																																																																																																																																																					
5W Wire wound	9p each																																																																																																																																																																																																					
10W Wire wound	10p each																																																																																																																																																																																																					
1-2: 4: 8μF 450V	14p 32μF	450V 20p																																																																																																																																																																																																				
16μF	450V 15p	50μF 350V 20p																																																																																																																																																																																																				
8-8μF: 450 V.W	18p	32-32μF: 350 V.W 25p																																																																																																																																																																																																				
8-16μF: 450 V.W	20p	32-32μF: 450 V.W 43p																																																																																																																																																																																																				
16-16μF: 450 V.W	25p	50-50μF: 350 V.W 39p																																																																																																																																																																																																				
16-100-100-300μF: 275 V.W		£1.23																																																																																																																																																																																																				
32-100-125-200μF: 275 V.W		£1.23																																																																																																																																																																																																				
32-100-200-200μF: 300 V.W		£1.23																																																																																																																																																																																																				
100-100-100-150-150μF: 320 V.W		£1.66																																																																																																																																																																																																				
175 (400V)-100-100μF: 350 V.W		£1.66																																																																																																																																																																																																				
60-100-200μF: 300 V.W		£1																																																																																																																																																																																																				
100-200μF: 275 V.W		£1																																																																																																																																																																																																				
100-200-200μF: 300 V.W		75p																																																																																																																																																																																																				
100-400μF: 275 V.W		£1.15																																																																																																																																																																																																				
200μF: 275 V.W. 50p	300+300μF: 300 V.W. £1.90																																																																																																																																																																																																					
9 volt (a 20mA (PP3))	£1.25																																																																																																																																																																																																					
9 volt (a 50mA)	£1.50																																																																																																																																																																																																					
9 volt (a 50mA)	£1.50																																																																																																																																																																																																					
6-6 volt 50mA	£2.50																																																																																																																																																																																																					
9-9 volt 50mA	£2.50																																																																																																																																																																																																					
7 1/2 volt for cassette recorders	£2.00																																																																																																																																																																																																					
6, 7 1/2 or 9 volt	£3.00																																																																																																																																																																																																					
3, 4 1/2, 6, 7 1/2, 9, 12 or 500mA	£3.99																																																																																																																																																																																																					
<p><b>Diodes &amp; Rectifiers</b></p> <table border="0"> <tr><td>AA119 9p</td><td>BA156 15p</td><td>BY176 £1 50</td></tr> <tr><td>AA120 9p</td><td>BA243 56p</td><td>BY182 £1 50</td></tr> <tr><td>AA129 9p</td><td>OA47 10p</td><td>BY200 23p</td></tr> <tr><td>BA102 25p</td><td>OA79 9p</td><td>IN4001 6p</td></tr> <tr><td>BA115 17p</td><td>OA90 7p</td><td>IN4002 7p</td></tr> <tr><td>BA130 10p</td><td>OA101 7p</td><td>IN4003 8p</td></tr> <tr><td>BA145 20p</td><td>OA200 10p</td><td>IN4004 8p</td></tr> <tr><td>BA148 20p</td><td>BY100 15p</td><td>IN4005 10p</td></tr> <tr><td>BA154 13p</td><td>BY126 15p</td><td>IN4006 12p</td></tr> <tr><td>BA155 14p</td><td>BY127 15p</td><td>IN4007 15p</td></tr> </table>	AA119 9p	BA156 15p	BY176 £1 50	AA120 9p	BA243 56p	BY182 £1 50	AA129 9p	OA47 10p	BY200 23p	BA102 25p	OA79 9p	IN4001 6p	BA115 17p	OA90 7p	IN4002 7p	BA130 10p	OA101 7p	IN4003 8p	BA145 20p	OA200 10p	IN4004 8p	BA148 20p	BY100 15p	IN4005 10p	BA154 13p	BY126 15p	IN4006 12p	BA155 14p	BY127 15p	IN4007 15p	<p><b>Power Sections</b></p> <p>ohms</p> <table border="0"> <tr><td>7, 9, 10, 12, 14, 17.5, 20</td><td>(a 700mA 20p</td></tr> <tr><td>22, 25, 28, 30, 33, 36</td><td>(a 700mA 25p</td></tr> <tr><td>40, 47, 52, 56, 60, 63, 66</td><td>(a 300mA 20p</td></tr> <tr><td>75, 87, 100, 120, 140, 160</td><td>(a 300mA 25p</td></tr> <tr><td>180, 200, 220, 250, 270</td><td>(a 300mA 25p</td></tr> <tr><td>300, 350, 400, 470, 560</td><td>(a 120mA 20p</td></tr> <tr><td></td><td>(a 150mA 25p</td></tr> <tr><td></td><td>(a 100mA 20p</td></tr> <tr><td></td><td>(a 70mA 25p</td></tr> </table> <p>726 1KΩ 2KΩ</p> <p>plus p. &amp; p. 7p per section.</p>	7, 9, 10, 12, 14, 17.5, 20	(a 700mA 20p	22, 25, 28, 30, 33, 36	(a 700mA 25p	40, 47, 52, 56, 60, 63, 66	(a 300mA 20p	75, 87, 100, 120, 140, 160	(a 300mA 25p	180, 200, 220, 250, 270	(a 300mA 25p	300, 350, 400, 470, 560	(a 120mA 20p		(a 150mA 25p		(a 100mA 20p		(a 70mA 25p	<p><b>Presets</b></p> <p>Vertical or Horizontal</p> <table border="0"> <tr><td>0-1 watt 5p</td><td>0-25 watt 7p</td></tr> <tr><td>100 1K</td><td>10K 100K</td></tr> <tr><td>250 2.5K</td><td>25K 250K</td></tr> <tr><td>500 5K</td><td>50K 500K</td></tr> </table>	0-1 watt 5p	0-25 watt 7p	100 1K	10K 100K	250 2.5K	25K 250K	500 5K	50K 500K	<p><b>Presets</b></p> <table border="0"> <tr><td>1M</td><td>1M</td></tr> <tr><td>2-5M</td><td>2-5M</td></tr> <tr><td>5M</td><td>5M</td></tr> </table>	1M	1M	2-5M	2-5M	5M	5M																																																																																																																																					
AA119 9p	BA156 15p	BY176 £1 50																																																																																																																																																																																																				
AA120 9p	BA243 56p	BY182 £1 50																																																																																																																																																																																																				
AA129 9p	OA47 10p	BY200 23p																																																																																																																																																																																																				
BA102 25p	OA79 9p	IN4001 6p																																																																																																																																																																																																				
BA115 17p	OA90 7p	IN4002 7p																																																																																																																																																																																																				
BA130 10p	OA101 7p	IN4003 8p																																																																																																																																																																																																				
BA145 20p	OA200 10p	IN4004 8p																																																																																																																																																																																																				
BA148 20p	BY100 15p	IN4005 10p																																																																																																																																																																																																				
BA154 13p	BY126 15p	IN4006 12p																																																																																																																																																																																																				
BA155 14p	BY127 15p	IN4007 15p																																																																																																																																																																																																				
7, 9, 10, 12, 14, 17.5, 20	(a 700mA 20p																																																																																																																																																																																																					
22, 25, 28, 30, 33, 36	(a 700mA 25p																																																																																																																																																																																																					
40, 47, 52, 56, 60, 63, 66	(a 300mA 20p																																																																																																																																																																																																					
75, 87, 100, 120, 140, 160	(a 300mA 25p																																																																																																																																																																																																					
180, 200, 220, 250, 270	(a 300mA 25p																																																																																																																																																																																																					
300, 350, 400, 470, 560	(a 120mA 20p																																																																																																																																																																																																					
	(a 150mA 25p																																																																																																																																																																																																					
	(a 100mA 20p																																																																																																																																																																																																					
	(a 70mA 25p																																																																																																																																																																																																					
0-1 watt 5p	0-25 watt 7p																																																																																																																																																																																																					
100 1K	10K 100K																																																																																																																																																																																																					
250 2.5K	25K 250K																																																																																																																																																																																																					
500 5K	50K 500K																																																																																																																																																																																																					
1M	1M																																																																																																																																																																																																					
2-5M	2-5M																																																																																																																																																																																																					
5M	5M																																																																																																																																																																																																					
<p><b>EHT Rectifier Trays</b></p> <p>(5 stick version) for BRC Chassis i.e. Ferguson, Ultra, Marconiphone &amp; HMV - 950 Mk.II, 960, 970 &amp; 1400 chassis Our Price £3.50 plus p. &amp; p. 20p</p>	<p><b>Mains Droppers</b></p> <table border="0"> <tr><td>(1) 37Ω + 31Ω + 97Ω - 26Ω + 168Ω</td><td>50p</td></tr> <tr><td>(2) 14Ω + 26Ω - 97Ω + 173Ω</td><td>50p</td></tr> <tr><td>(3) 30Ω + 125Ω + 2.85KΩ</td><td>50p</td></tr> </table> <p>plus p. &amp; p. 7p per dropper.</p>	(1) 37Ω + 31Ω + 97Ω - 26Ω + 168Ω	50p	(2) 14Ω + 26Ω - 97Ω + 173Ω	50p	(3) 30Ω + 125Ω + 2.85KΩ	50p	<p><b>Presets</b></p> <p>Vertical or Horizontal</p> <table border="0"> <tr><td>0-1 watt 5p</td><td>0-25 watt 7p</td></tr> <tr><td>100 1K</td><td>10K 100K</td></tr> <tr><td>250 2.5K</td><td>25K 250K</td></tr> <tr><td>500 5K</td><td>50K 500K</td></tr> </table>	0-1 watt 5p	0-25 watt 7p	100 1K	10K 100K	250 2.5K	25K 250K	500 5K	50K 500K	<p><b>Presets</b></p> <table border="0"> <tr><td>1M</td><td>1M</td></tr> <tr><td>2-5M</td><td>2-5M</td></tr> <tr><td>5M</td><td>5M</td></tr> </table>	1M	1M	2-5M	2-5M	5M	5M																																																																																																																																																																															
(1) 37Ω + 31Ω + 97Ω - 26Ω + 168Ω	50p																																																																																																																																																																																																					
(2) 14Ω + 26Ω - 97Ω + 173Ω	50p																																																																																																																																																																																																					
(3) 30Ω + 125Ω + 2.85KΩ	50p																																																																																																																																																																																																					
0-1 watt 5p	0-25 watt 7p																																																																																																																																																																																																					
100 1K	10K 100K																																																																																																																																																																																																					
250 2.5K	25K 250K																																																																																																																																																																																																					
500 5K	50K 500K																																																																																																																																																																																																					
1M	1M																																																																																																																																																																																																					
2-5M	2-5M																																																																																																																																																																																																					
5M	5M																																																																																																																																																																																																					

**CHROMASONIC electronics**

MAIL ORDERS: Where no p. & p. charge is shown, a minimum of 7p applies. p. & p. on overseas orders is charged at cost.  
ADDRESS TO: TV Component Dept. 56, Fortis Green Road, London, N10 3HN.  
Telephone: 01-883 3705

**COLOUR TUBES**

**STANDARD TUBES**

**METAL BAND TUBES**

**TWIN PANEL TUBES**

Rebuilt with new Electron Guns to British Standard 415/1/1967.

**SUFFOLK TUBES LIMITED**

261 CHURCH ROAD  
MITCHAM, SURREY CR4 3BH  
01-640 3133/4/5

Britain's Largest Independent TV Tube Rebuilder

**U.H.F. TV AERIALS**

Suitable for Colour and Monochrome Reception

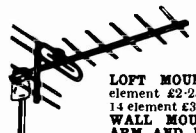

All U.H.F. aerials now fitted with tilting bracket and 4 element reflector.

**LOFT MOUNTING ARRAYS.** 7 element £2-25. 11 element £2-75. 14 element £3-25. 18 element £3-75.

**WALL MOUNTING e/w WALL ARM AND BRACKET.** 7 element £3-25. 11 element £4-75. 14 element £4-25. 18 element £4-75.

**CHIMNEY MOUNTING ARRAYS e/w MAST AND LASHING KIT.** 7 element £4. 11 element £4-50. 14 element £4-75. 18 element £5-25.

**MAST MOUNTING arrays only** 7 element £2-25. 11 element £2-75. 14 element £3-25. 18 element £3-75. Complete assembly instructions with every aerial. LOW LOSS coaxial cable 9p yd. KING TELE-BOOSTERS from £3-75. LABGEAR all band V.H.F.-U.H.F.-F.M. radio mains operated pre-amps £7-50. State clearly channel number required on all orders. P.p. on all aerials 50p. Accs. 15p. C.W.O. Min. C.O.D. charge 25p.

**BBC-TV-FM AERIALS**  
BBC (band 1) Wall S/D £2. LOFT inverted 'T' £1-25. EXTERNAL 'H' array only £4. ITV (band 3) 5 element loft array £2-50. 7 element £3. COMBINED BBC-TV loft 1+5 £2-75. 1+7 £3-50. WALL AND CHIMNEY UNITS ALSO AVAILABLE. Pre-amps from £3-75. COMBINED U.H.F.-V.H.F. aerials 1+5+9 £4. 1+5+14 £4-50. 1+7+14 £3. FM RADIO loft S/D £1. 3 element £3-25. 4 element £3-50. Standard coaxial plugs 9p. Coaxial cable 5p yd. Outlet box 30p. P.p. all aerials 50p. Accs. 30p. C.W.O. Min. C.O.D. charge 25p. Send 5p for fully illustrated lists.

**CALLERS WELCOMED**  
OPEN ALL DAY SATURDAY

**K.V.A. ELECTRONICS**  
40-41 Monarch Parade  
London Road, Mitcham, Surrey  
01-648 4884

**REBUILT COLOUR TUBES**

19"	£22.50	22"	£25.00
25"	£27.00	26"	£28.00

Exchange prices: Tubes supplied without exchange glass at extra cost, subject to availability.

Colour Tubes demonstrated to callers.  
Carriage extra all types.

New RCA Type A49-15X: £30.00  
Full range of rebuilt mono tubes available, Standard, Rimband and Twin Panel

- \* Complete new gun fitted to every tube.
- \* 2 years' guarantee monochrome, 1 year colour.
- \* 15 years' experience in tube rebuilding.
- \* Trade enquiries welcomed.

**N.G.T. ELECTRONICS LTD.**  
(Nu Gun Teletubes)  
22-24, Anerley Station Road,  
London S.E.20.  
Telephone: 01-778 9178.



## The J & P Switchgear Book

7th Edition

R. T. Lythall

Edited by C. A. Worth

1972 816 pp illustrated  
0 408 00069 4 £9.90

## The J & P Transformer Book

10th Edition

S. Austen Stigant and  
A. C. Franklin

Edited by C. A. Worth

1973 784 pp illustrated  
0 408 00044 5

## Newnes Colour Television Servicing Manual

Volume I

Gordon J. King

1973 240 pp illustrated  
0 408 00089 9 £4.90

## Telecommunication by Speech

*The Transmission Performance  
of Telephone Networks*

D. L. Richards

1973 604 pp illustrated  
0 408 70344 X £12.00

Available through any bookseller, or  
from the publisher.

From  
**The Butterworth Group**  
88 Kingsway, London WC2B 6AB  
Trade counter:  
4-5 Bell Yard, WC2



## COLOUR T.V.

19" £125 25" £160

Completely overhauled. Variety  
of makes and models available.

### MONOCHROME

**UHF** — Single Standard —  
Push Button T.V. — Reduced  
price to 'PT' readers, see  
previous adverts.

20" Tube £34.95  
24" Tube £44.95

Carriage — Ins. £2.50

Stamped, self-addressed envelope for  
leaflet and copy. 12 Month Guarantee  
**UHF**—working and overhauled  
BBC 2 TV's (Ferguson 900 and  
similar sets) £20 carr. £2. State  
if VHF operation required.

**VHF** — working and over-  
hauled, state channels reqd.  
£12 carr. £2

**UHF** — Untested Ferg. 900  
and similar sets supplied  
together with a UHF Tuner:  
£10 carr. £1.50

**VHF** — 405/625 TB Sets, com-  
plete £4 carr. £1.50

**VHF** — 405 sets — 2 for £4.  
carr. £1.50 per set.

**UHF TUNERS** (ex-equip) suits  
PHILIPS 19TG152-8 etc., £2  
inc. valves. **PUSH-BUTTON**  
type UHF transistorised tuners  
**BRAND-NEW** — untested, £5  
inc. carr.

**SUMIKS T.V.**, 7 High St.,  
Langley, Warley, Worcs.

Vary the strength  
of your lighting with a

## DIMMASWITCH

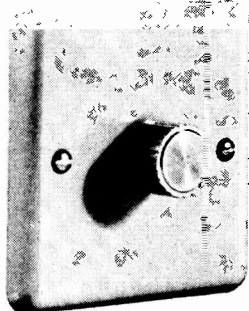

The DIMMASWITCH is an attractive and  
efficient dimmer unit which fits in place of  
the normal light switch and is connected up  
in exactly the same way. The white mounting  
plate of the DIMMASWITCH matches modern  
electric fittings. Two models are available,  
with the bright chrome knob controlling up to  
300 w or 600 w of all lights except fluores-  
cents at mains voltages from 200-250v, 50Hz.  
The DIMMASWITCH has built-in radio inter-  
ference suppression.

600—£3.20 Kit Form £2.70  
300—£2.70 Kit Form £2.20

All plus 10p post and packing.  
Please send C.W.O. to:—

**DEXTER & COMPANY**  
3 ULVER HOUSE, 19 KING STREET,  
CHESTER CH1 2AH. Tel: 0244-25883

As supplied to H.M. Government Departments,  
Hospitals, Local Authorities, etc.

## TELEVISION TUBE SHOP

BRAND NEW TUBES AT  
REDUCED PRICES

A28-14W (A28-13W) ...	£12.75
A31-18W .....	£12.50
A47-11W .....	£9.95
A47-13W .....	£12.50
A47-14W .....	£8.25
A47-26W .....	£10.75
A5J-120WR .....	£12.50
A59-11W .....	£12.95
A59-13W .....	£13.50*
A59-15W .....	£9.95
A59-16W .....	£13.50*
A59-23W .....	£14.75
A61-120WR .....	£16.50
AW36-21, 36-80 .....	£5.75
AW43-80 .....	£6.95
AW43-88, 43-89 .....	£6.75
AW47-90, 47-91 .....	£7.50
AW53-80 .....	£7.50*
AW53-88, 53-89 .....	£8.25
AW59-90, 59-91 .....	£9.00
C17LM, 17PM, 175M ...	£6.50
CME1201 .....	£12.50
CME1601 .....	£10.50
CME1602 .....	£12.00
CME1702, 1703 .....	£6.75
CME1705 .....	£7.75
CME1713/A44-120 .....	£14.50
CME1901, 1903 .....	£7.50
CME1906 .....	£12.50
CME1908 .....	£7.75
CME2013 .....	£12.50
CME2101, 2104 .....	£8.25
CME2301, 2302, 2303 ...	£9.00
CME2305 .....	£14.75
CME2306 .....	£13.50*
CME2308 .....	£9.95
CME2413R .....	£16.50
CRM171, CRM172 .....	£6.50
CRM211, CRM212 .....	£7.50*
MW36-24, 36-44 .....	£5.50
MW43-69 .....	£6.75
MW43-80 .....	£6.75
MW53-20, 53-80 .....	£7.50
TSD217, TSD282 .....	£14.00†
13BP4 (Crystal 13) .....	£14.00†
190AB4 .....	£9.25
230DB4 .....	£11.25

\* These types are fully rebuilt.

† Rebuilt tubes also, at £7.00 plus  
carriage and old bulb.

COLOUR TUBES	NEW R/B	
	£	£
A49-15X	35	-
A49-120X	45	-
A56-120X	72	48
A61-15X	78	52
A63-11X	-	52
A66-120X	82	55
A67-120X	85	-

### SPECIAL OFFER TO EXPERIMENTERS

New 90° Colour Tubes 19", Suitable  
for "Television" T.V., Unprotected  
£25.

Add Carriage and Insurance: Mono-  
chrome 75p, Colour £1.50.

## TELEVISION TUBE SHOP

48 BATTERSEA BRIDGE ROAD,  
LONDON, S.W.11. BAT 6859

WE GIVE GREEN SHIELD  
STAMPS

# Service Engineers



WHEREVER YOU ARE FOR BY  
RETURN DESPATCH. WILLOW  
VALE IS AS NEAR AS YOUR  
PHONE. . . .



## STOCKISTS OF GENUINE MANUFACTURERS SPARES FOR:-

RANK BUSH MURPHY LTD. C.E.S. LTD. PYE.  
PHILIPS INVICTA. PAM. EKCO. FERRANTI.  
BRITISH RADIO CORPORATION. FERGUSON.  
ULTRA. MARCONI. HIS MASTERS VOICE.

STOCKISTS OF "TELEPART" SPARES FOR:-  
DECCA. K.B. GEC. SOBELL. MASTERADIO.  
R.G.D. etc.

*LINE OUTPUT TRANSFORMERS  
EHT RECTIFIER TRAYS  
SCAN COIL ASSEMBLIES  
FRAME AND SOUND OUTPUTS  
DROPPER SECTIONS*

**MONOCHROME & COLOUR**



HUGH RANGE OF:-

**ENTERTAINMENT VALVES** up to 48% DISCOUNT  
**TRANSISTORS AND INTEGRATED CIRCUITS**  
**COMPONENTS.** CAPS. RESISTORS. V/CONTROLS. PRESETS.  
VALVE BASES. SLIDERS. A/E PANELS. BIAS and SMOOTHING  
ELECTROLYTICS. etc.  
**CATHODE RAY TUBES.** NEW and REBUILT. MONO and  
COLOUR FROM TVETTE TO 26" COLOUR. ALL TYPES.  
**METERS AND TEST EQUIPMENT.** Servisol, Electrolube,  
Multicore, Service Tools.

FOR "BY RETURN" SERVICE CONTACT  
THE SPECIALIST WHOLESALERS:-

## willow vale electronics ltd

4&5 THE BROADWAY, HANWELL, LONDON W7  
or  
74 MAXWELLTON RD, PAISLEY, RENFREW  
or  
42 WEST END, STREET, SOMERSET

I would like a free copy of your catalogue

NAME .....

ADDRESS .....

P.T.

HOT LINES: LONDON 01 -567 5400  
GLASGOW 041-887 4949  
SOMERSET 045-84 2597

NO RETAIL ENQUIRIES  
SEND FOR FREE COPY OF OUR 64-PAGE CATALOGUE  
STRICTLY WHOLESALE ONLY

# TELEVISION

SERVICING · CONSTRUCTION · COLOUR · DEVELOPMENTS

VOL 23 No 5  
ISSUE 269

MARCH 1973

## FORESIGHT SAGA !

The attempts to fanfare the UK's entry into the EEC have by now been greeted with the quiet apathy they deserve. What might the results be so far as the television engineer is concerned however? There was first the necessity to float the pound, leading inevitably to the wages and prices freeze. The float resulted in increased costs of components and materials and once the freeze thaws and labour costs catch up higher TV service charges seem inevitable. Secondly the introduction of VAT in April will increase the prices of components and other at present untaxed goods by at least 10%—in some cases this may be made part of a package increase taking into account other cost increases as well. Thirdly with the removal of tariff barriers there will be greater competition in the field of lucrative specialised products.

What can the UK television industry offer in return to balance these disadvantages? Though some setmakers are taking a tentative (rather belated we'd say) look at the European market they are still almost wholly preoccupied with the needs of the home market.

If the UK television industry is to participate in Europe in a big way it must first find the resources to be able to operate in what is by nature a fluctuating market. It must also keep ahead technically: the Continental market has always been far more conscious of technical advances than our more staid home market. And it must persuade the government that support for technical research is necessary and that economic planning should look farther ahead than the day after tomorrow.

The industry has suffered from lack of and often non-existent foresight, especially with regard to the problems of component supply. As a report overpage shows the industry has been truly caught with its trousers down (if you will pardon the expression!) by the shortage of the components needed to meet the present demand for colour receivers.

We too with our colour receiver project are victims of this situation. The popularity of the project surpassed even our most optimistic expectations and we very much regret the shortages that have hampered the efforts of many constructors. We can only ask for the understanding of readers about the inevitable delays.

M. A. COLWELL—*Editor*

## THIS MONTH

Teletopics	198
IBC-72	by J. I. Sim 200
Renovating the Rentals—Part 11—BRC 2000 Chassis—Part 1	by Caleb Bradley, B.Sc. 203
New Products	207
Up-Dating the 625-line Receiver	by Keith Cummins 208
Assessing Receiver Performance—Part 2	by E. J. Hoare 210
Servicing Television Receivers—Philips T-Vette/Stella Companion—continued	by L. Lawry-Johns 215
Long-Distance Television	by Roger Bunney 219
Colour Receiver Circuits—Convergence Techniques	by Gordon J. King 222
Fault-Finding Guide—1: BRC 900/950 Chassis Field Timebase Circuit	by John Law 226
Letter: Tuner Drift, BRC 1500 Chassis	227
The TELEVISION Colour Receiver—Part 12—Tuner/I.F. Pre-amplifier Panel	228
Your Problems Solved	233
Test Case 123	235

**THE NEXT ISSUE DATED APRIL  
WILL BE PUBLISHED MARCH 19**

**Cover:** You can see quite clearly in our cover photograph the innards of the BRC 2000 dual-standard colour chassis, which Caleb Bradley, B.Sc. starts to deal with this month.

# TELETOPICS



## LARGE-SCREEN PROJECTION TV

The intention has been announced by the US General Electric Company to build large-screen monochrome video projectors. The light-source is to be a sealed-beam xenon lamp, a sealed light valve being used to modulate the beam. The projectors will operate at various scanning rates up to 1,023 lines, giving very high resolution pictures for closed-circuit TV applications. As the light beam is modulated in this way it would appear that the scanning will be by mechanical means. Regular readers will recall our covering this topic in some detail in November 1972.

## THIN-PANEL TV DISPLAY DEVICE

Research scientists from Zenith Radio (USA) have demonstrated a newly developed thin-panel (the panel is 0.63in. thick) TV display device which consists of an assembly of gas-discharge cells. The experimental version has 80 columns and 212 rows of cells giving a picture 2.4in. wide and 6.3in. high. The resolution appears to be comparable to that provided by a standard c.r.t., but the present version gives a red display. Presumably the cells can be modulated to determine the light given off by each, adjusting the modulation of each one in sequence giving a "scanned" display. There would be saving in space and in avoiding the need for power-consuming deflection circuitry.

## UHF SERVICE EXTENSIONS

There has been a spurt in the commencement of further u.h.f. transmissions recently. The IBA's high-power transmitters at **Darvel** (Ayrshire) and **Midhurst** (Sussex) are now in operation. The former carries Scottish Television programmes on channel 23 (receiving aerial group A, horizontal polarisation), the latter Southern Television programmes on channel 58 (receiving aerial group D, horizontal polarisation). The following relay services have come into operation:

**Perth** BBC-1 channel 39, BBC-2 channel 45. Aerial group B.

**Roseheart** (Aberdeenshire) BBC-1 channel 51, BBC-2 channel 44. Aerial group B.

**Cop Hill** (Yorkshire) BBC-1 channel 22, BBC-2 channel 28, ITV (Yorkshire Television programmes) channel 25. Aerial group A.

**Rhymney** (Mon.) BBC Wales channel 57, BBC-2 channel 63. Aerial group C.

**Bristol** (Ilchester Crescent) BBC-1 channel 40, ITV

(HTV West programmes) channel 43. Aerial group B.

**Idle** (Yorkshire) ITV (Yorkshire Television Programmes) channel 24. Aerial group A.

**Merthyr Tydfil** ITV (HTV Wales programmes) channel 25. Aerial group A.

**Aberdare** (Glamorgan) ITV (HTV Wales programmes) channel 24. Aerial group A.

All these relay transmissions are vertically polarised.

## NEW PURITY ADJUSTMENT TECHNIQUE

Details are given in the latest issue of *Mullard Technical Communications* of a new method of adjusting the purity of colour c.r.t. displays. The article is by J. Gerritsen of the Picture Tube Development Department, Philips, Eindhoven. The new technique is more accurate than the traditional red ball method and simpler than the microscope method. It enables the positions of the colour purity magnets to be set to give a beam landing accuracy within  $\pm 10\mu\text{m}$ . With the usual red ball method the deflection coils are first withdrawn rearwards along the tube neck and the purity magnets then set, with the red gun only operating, for a pure red ball at the centre of the screen: the deflection coils are then returned to their normal position to give an overall red screen display. Since the initial adjustment is carried out with the coils not in their normal operational position a systematic error, which increases in proportion to the magnitude of the purity correction needed, is introduced: although this error is generally small it can in some cases reach significant proportions. Purity adjustment with the microscope method is done with the coils in place and all beams operating, the microscope (which is usually in the form of a periscope so that the tube face can be observed from the rear) being used to observe directly the landing positions of the three beams relative to the phosphor dot triads.

The new method is based on obtaining a pure red ball towards the centre of the screen but enables this to be done with the deflection coils in their normal operating position. The red ball is obtained by placing a specially-made thin, circular (diameter 200mm.) coil in front of the screen on which a pure red raster is displayed. The coil is in contact with the tube face and is positioned so that its axis coincides with the tube axis. When d.c. is passed through the coil the magnetic field produced rotates the beam landing, giving a clearly defined ball with other colours off-centre. The purity magnets are then set



to give the correct red ball position. A template with cut-out is used to establish this position, which depends on whether or not the tube has centre beam landing precompression. The diameter of the red ball depends on the magnitude of the current in the coil: if the diameter is too large (small coil current) the ball is blurred and difficult to adjust; if too small the setting accuracy at the centre decreases.

## DEVELOPMENTS

For the first time an i.c. which combines the functions of the line and field timebase generators has been introduced. This is the SGS-ATES type TCA511 for use in monochrome, particularly small-screen, TV receivers. The circuitry within the i.c. performs the following operations: line oscillator, line a.p.c. and a.f.c. circuitry, pull-in range/noise bandwidth adjustment, field oscillator and sawtooth generator. The i.c. operates without the need for any coils or transformers and will drive different types of output stages.

Teleng held an open day recently to display the latest techniques in cable TV distribution. Along with normal equipment a demonstration was given of two-way vision transmission over a single coaxial cable—said to be the first time this has been done in Europe. Videophones for visual telephone conversations were also shown.

RCA have now developed a colour videodisc. This is said to be a low-cost system capable of giving 20 minutes playing time per side. We are awaiting further information. There are now three groups—Philips, Telefunken/Decca and RCA—working on videodiscs: as if the confusion in the videocassette field wasn't enough!

Pre-production versions of a colour videocassette recorder which can also replay ordinary  $\frac{1}{2}$ in. tapes from any EIAJ-1 standard reel-to-reel videotape recorder have been shown by Shibaden who reckon that this ability will give it a decided advantage over other videocassette machines. Provided the tape has been made on an EIAJ-1 compatible machine it can be rethreaded on a split Shibaden cartridge. Playing time is 20 minutes with standard tape or half an hour if special thin tape is used. The inputs and outputs are at video frequency in the present versions. Shibaden have also introduced a colour camera at £7,000 which they claim gives many of the functions of broadcast cameras at a CCTV price. The camera uses three Plumbicon tubes.

A portable single-tube colour camera has also been shown by Shibaden: it is understood that the camera incorporates colour-encoding stripes inside the tube.

## IMPORTS AND THE CONTINUING BOOM

The comments made in our leader last month are highlighted by some further figures that have since been released. UK overseas trade in electronic equipment and components went deeply into the red during the first nine months of 1972, imports exceeding exports by £26.5 million—compared to a trade surplus of £32.4 million during the same period of 1971. And by now you should know the main culprit—colour television! Imports of colour sets

reached £22.6 million during the period, compared to only £6.3 million during the same period of 1971. But this is only part of the story: imports of colour c.r.t.s rose from £6.8 million to £13.9 million, and of course many other imported components and assemblies are used in colour sets made in the UK. It is sobering to think that but for the colour TV boom (set imports at £22.6 million plus c.r.t.s at £13.9 million alone coming to £36.5 million) the UK electronics industry would be in surplus.

Year-end reports in *Electronics Weekly* give further insight into the problems facing the industry at present. Prices of all semiconductor devices are rising, with delivery times for most widely used devices now three months or more, small-signal transistors being particularly hard to get in quantity (the entire European semiconductor industry is said to have a capacity 25% beneath current demand!). In addition to semiconductor devices there are said to be shortages of carbon film resistors (nearly all of these are imported), polystyrene and ceramic capacitors, loudspeakers, wound devices and even chassis metal-working capacity.

Predictions as to how long the current TV boom will last vary from nine months to two years. No slump following this is anticipated, rather a flattening of demand at around two and a half million sets a year in the UK after 1974. This seems on the high side to us, since the market will by then be getting round to being mainly a replacement one.

## NEW MULLARD COLOUR CRT PLANT OPENED

Considering the above points it is welcome news that Mullard's new 310,000 sq. ft. plant devoted to the production of shadowmask tubes has now been officially opened. The plant is expected to produce some half million tubes this year and to be operating at a production rate of 900,000 tubes a year by the end of the 1970s. Production is at present concentrated on 90° 22in. tubes but during the year the intention is to phase in production of 110° tubes. It is expected that production of 110° types will exceed that of 90° types by 1975. Mullard believe that by then 90° tubes will be required for replacement purposes only.

## TRADE NEWS

A monochrome set fitted with 24in. tube and featuring touch tuning, high sensitivity, 2 $\frac{1}{2}$ W audio output and optional remote control has been introduced by Grundig: this, Model R810UE/GB, has a recommended retail price of £95.80. A new mains-battery portable, Model T9, has been introduced in the Elizabethan range from Lee Products (GB) Ltd. Fitted with a 9in. tube this model is housed in an all-white cabinet and has a recommended retail price of £66.39.

A recent report suggests that nearly all major UK setmakers have been contemplating introducing all-in (i.e. labour and replacement parts) guarantees but that the government's "freeze" resulted in such plans, which would necessitate a revised price policy, being shelved for the time being. As we reported last October Pye was the first setmaker to introduce such a guarantee in the UK with their model CT200.



### J. I. SIM

THAT it was two years since the last IBC was in itself surprising; that the manufacturers and broadcasters had any spare equipment and staff available in the second week of the Olympics gives some insight into the present size of the UK television broadcasting industry.

Colour is here to stay of course: it is no longer a debating point or a novel thing to the broadcaster and we now look for new generations of equipment that accept that fact without fuss and to developments in processing quality and general reliability and servicing assistance. Broadcasting now means commercial local radio as well and as more and more of the details of frequency allocations, sites and aerial types become available a larger proportion of the industry becomes involved with sound.

Lord Hill of Luton, Chairman of the BBC, opened IBC-72. He talked of the income from colour television licences. It is unfortunate that when members of the BBC administration talk of money in public they sound like the vicar who will never mention it from the pulpit!

As usual IBC was really two things: a technical exhibition and a programme of technical papers. The technical sessions opened with surveys from both the BBC and Independent Television. James Redmond, Director of Engineering of the BBC, talked on the reasonably well known structure of the Engineering Division of the BBC and the methods of capital financing. Delegates' questions centred around that never ending region of doubt the proportion of financing that should be given to research.

### Independent TV Research

Gerry Kaye, Chief Engineer of the ATV network, spoke in his role as Chairman of the Technical Committee of the Independent Television Companies Association (ITCA). Although the general purpose of his paper was undoubtedly to present the general image of the Independent Network, particularly its structure, to overseas delegates he also took the opportunity to lay an old ghost—that the television programme companies never produce any novel engineering work of their own. In fact Mr. Kaye pointed to some 70 major and minor projects in progress while a number of earlier projects are now in commercial production. We hope that the appointment of an ITCA coordinating engineer will help maintain this effort.

### Training Broadcast Engineers

Bernard Webster of Plymouth Polytechnic and Harry Henderson of the BBC presented rather dif-

ferent views of the training and education of the broadcast engineer. Mr. Henderson's approach was more that of the aged tutor who presented himself as a willing drain for technical training suggestions and problems. We would have expected the BBC and Mr. Henderson in particular to have presented a more coherent picture of the situation—their own after all—rather than appearing to be mainly prepared to listen to and foster the worries of others. It was rather disappointing and some of his senior staff present were quite obviously of the same opinion. Mr. Webster presented a rather different picture of engineering education and training, mainly in relation to training for the IBA and the programme contractors. One gains the impression from the BBC, Plymouth Polytechnic and the IBA that it is probably about time the whole matter was brought up for discussion as a general matter of policy for the British industry. This can only be done by those who have individual experience of the management of this training.

### Technical Papers

Other sections of the technical programme covered origination and recording, distribution and satellites, sound broadcasting and transmitters, educational broadcasting, propagation and receivers. We do not have the space even to mention the majority of these papers but a couple were of particular interest to readers.

The Chief Engineer of BRC (Bradford)—Mr. A. Martinez—described some of the development thoughts that went into the BRC 8000 series colour chassis. This is of course the prime UK example of the low-cost colour receiver. Mr. Martinez emphasised his company's wish that the performance and reliability should nevertheless be high. The design was based around the 170V needed for the line output stage which uses a transistor with a collector rating of 1700V. To reduce costs the use of an e.h.t. tripler was avoided. Instead, third harmonic tuning and a full e.h.t. overwinding is employed, with the overwind and coupling being on a separate secondary limb of the line output transformer. As a result of using accurate manufacturing methods no preset adjustment of the third harmonic tuning is necessary. The e.h.t. winding is terminated in an anti-corona connector which is coupled to a silicon half-wave rectifier. The arrangement gives a low-beam e.h.t. of 22kV. Avoidance of a tripler and use of silicone jelly techniques is claimed to give high reliability. We would question this latter point however: a transformer operating at 22kV overwind voltage just cannot be more reliable than a similarly made transformer operating at 8.5kV!

The other "domestic" paper was a Mullard one describing some of their work on surface-wave filters for i.f. strips. This is an important subject for the future but is taking a time to reach the stage of being a practical design proposition. We expect it to be the subject of an article in the magazine shortly. As an interim summary we can do no better than quote Mullard: "The acoustic surface-wave filter is an attractive complement to integrated circuits for television receiver i.f. amplifiers. It requires no alignment and has an inherently linear phase response. Development has reached the point

—continued on page 214.

# LAWSON BRAND NEW TELEVISION TUBES



**SPECIFICATION:** The Lawson range of new television tubes are designed to give superb performance, coupled with maximum reliability and very long life. All tubes are the products of Britain's major C.R.T. manufacturers, and each tube is an exact replacement. Tubes are produced to the original specifications but incorporate the very latest design improvements such as: High Brightness Maximum Contrast Silver Activated Screens, Micro-Fine Aluminising, Precision Aligned Gun Jigging, together with Ultra Hard R.F. High Vacuum Techniques.

## DIRECT REPLACEMENTS FOR MULLARD-MAZDA BRIMAR GEC, ETC.

A47-11W	MW43-69	C19/AK	CME1903	172K
A47-13W	MW43-80	C21/1A	CME1905	173K
A47-14W	MW52/20	C21/7A	CME1906	212K
A47-17W	MW53/80	C21/AA	CME1908	7205A
A47-18W	AW47-97	C21/AF	CME2101	7405A
A47-26W	AW53-80	C21/KM	CME2104	7406A
A59-11W	AW53-88	C21/SM	CME2301	7502A
A59-12W	AW53-89	C23/7A	CME2302	7503A
A59-13W	AW59-90	C23/10	CME2303	7504A
A59-14W	AW59-91	C23/AK	CME2305	7601A
A59-15W	C17/1A	CME1601	CME2306	7701A
A59-14W	C17/5A	CME1602	CME2308	A50-120W/R
AW43-80	C17/7A	CME1702	CRM172	MW36/24
AW43-88	C17/AA	CME1703	CRM173	MW36/44
AW43-89	C17/AF	CME1705	CRM212	CRM141
AW47-90	C17/FM	CME1706	CRM211	
AW47-91	C17/5M	CME1901	23SP4	
MW43-64	C19/10AP	CME1902	171K	

## LAWSON TUBES

18 CHURCHDOWN ROAD,  
MALVERN, WORCS.

Malvern 2100

## 2 YEARS' GUARANTEE FULL TUBE FITTING INSTRUCTIONS

Tubes are despatched day of order by passenger train, road or goods taking far too long for customers satisfaction.

## REBUILT TUBES

**LAWSON "RED LABEL" CRTS** are particularly useful where cost is a vital factor, such as in older sets or rental use. Lawson "Red Label" CRTS are completely rebuilt from selected glass, direct replacements and guaranteed for two years.

	New Tubes £	Red Label £	Colour Tubes old glass not required
14"	3-50	—	
17"	6-25	4-97	19" £39-50
19"	7-25	5-25	
21"	8-50	6-95	22" £43-50
23"	9-75	7-25	
19" Twin Panel	10-25	8-25	25" £47-50
23" Twin Panel	15-50	9-75	
16" Panorama	8-50	—	26" £49-50
19" Panorama	9-38	6-95	
20" Panorama	10-50	7-50	carr. £1-50
23" Panorama	11-95	8-75	

Carriage/Insurance: 12"-19" 62p. 20"-25" 75p  
Plus V.A.T. Rate from April 1st.

# 1/2 MILLION MUST GO!

## NEW - Guaranteed & boxed TV VALVES -

!PRICE BARRIER SMASHED!

**Cheapest  
Available  
Anywhere**

SEND PD, CHEQUE or MO to:

QOV03/10

PCF 80  
PCC 84  
EBF 80  
ECC 40  
PCF 808  
PCF 805  
PCF 802

**25p**  
EACH  
PLUS  
5p p. & p.  
OVER 2  
POST  
FREE

PY 82

PL 84  
EBF 89  
ECL 80  
6F 23  
6AK5  
ECC 91  
EF 85

**25p**  
EACH  
plus  
5p p. & p.  
OVER 2  
POST  
FREE

EF 92

PCF 80  
PC 97  
PCF 201  
PC 95

**25p**  
EACH  
plus  
5p p. & p.  
OVER 2  
POST  
FREE

\* LOTS OF 100 APPROX. 10 OF EACH OF ABOVE  
ONLY £15.50

**SOUTHERN MACHINE SERVICES**

DEPT PT 285 MORLAND ROAD  
CROYDON, SURREY, CRO 6HE

Telephone 01-653 4863  
or 01-656 0374



# RENOVATING the RENTALS

## 11 BRC 2000 CHASSIS

CALEB BRADLEY B Sc

PART 1

THE BRC 2000 chassis represented an important milestone in television receiver development, being the first ever all-transistor colour chassis. It is found in dual-standard colour models by Ferguson ("Colourstar"), Ultra ("Bermuda"—a long-used name), HMV ("Colourmaster"), Marconiphone and DER and is probably the most complex domestic device ever sold, since it came before such simplifications as single-standard (u.h.f. only) operation and the use of integrated circuits. It has nevertheless proved itself over about 7 years to be a most reliable design. If you know the stock faults it is easy to recondition an ex-rental 2000 set—if you can get one!

### General Features

The chassis is a rectangular girder frame carrying eight detachable printed boards which are labelled with component references. If you happen to have spare boards servicing is easy: exchange boards are not too readily available now however. The general layout of a 25in. tube model is shown in Fig. 1. The 19in. chassis is similar except that the power supply regulator board is mounted piggyback fashion over the chrominance board, obstructing access to it. To overcome this, loosen four Phillips screws to allow the heatsink sheet to be detached from the supporting brackets: the assembly can then be parked vertically in slots provided in the left-hand bracket.

For general access loosen four large nuts on the outside corners of the frame to allow it to be slid out on rails. Retighten the nuts in this position. Access to the convergence board is obtained by sliding it out and propping it upright rather crudely on two metal tabs screwed to the top rear of the cabinet. Wires tend to tangle when this is done and for safety the set should be switched off while handling the board.

### Board Removal

Before attempting to remove a board check that the set is switched off and that any flying leads are disconnected from the board. Remove or loosen the retaining pieces screwed to the frame. The board can then be pulled out of its socket. If necessary pass a screwdriver through the extractor tab and lever gently against the frame. Similar forceful means may be needed to return the board to its socket but be sure the board does not jam against one edge of the socket and avoid shear force which can crack the board. It is permissible to switch on the set with a board unplugged but switch off before replacing the board.

The board sockets themselves are a source of intermittent faults. Note that any individual pin of the

socket can be driven out by means of a narrow screwdriver inserted at the far side from the connecting wire—never pull it out by the wire. If necessary retension the arms of the pin or remake the wire connection. This must be neatly crimped and soldered so that the pin slides back into the socket body.

### Tuner

The tuner is an integrated u.h.f./v.h.f. six-button unit. Most of its troubles are minor mechanical ones although occasionally the BF180 r.f. amplifier or the BF115 (VT4, mixer on v.h.f., i.f. preamp on u.h.f.) transistor fails. Either will still let a snowy 625 picture through; the BF180 is definitely at fault if the 625 picture improves vastly when the aerial centre conductor is brought near the second tuned line. The circuit was published in our October 1970 issue (page 34).

Sometimes the tuning capacitor vanes touch: to avoid upsetting the alignment make the readjustment minimal. Often a pushbutton breaks internally so that it cannot be tuned by the user (although the channel can be tuned from behind with a screwdriver): it can be re-welded with a soldering iron. When pulling off a button grip the spindle with pliers to avoid straining a nylon part in the tuner mechanism.

### System Switch

There is a spring-loaded strip visible inside the tuner. This operates the u.h.f./v.h.f. Band III/v.h.f. Band I switch. A screw associated with each button allows a 'pip' to be located in one of three holes in the bar for one of these three bands, reading from top to bottom. Intermittent tuner action or poor station reset accuracy can be due to the return spring weakening or the gang rotator bar coming adrift. It is possible to remove turns from the return spring to increase its tension. It is only rarely necessary to remove the band switch slider itself for contact cleaning.

In most areas every button should be set for u.h.f.-625 operation. Thus the 'pip' for each button should be set to the top hole in the bandswitch strip for u.h.f. There should be a spring (0085-084) and washer (00L6-014/131) behind the circlip on each pushbutton spindle for 625 use; ordering numbers are given in brackets in case you need to convert buttons from 405.

### Single-Standard Use

It is tempting to cut off the wires to the system

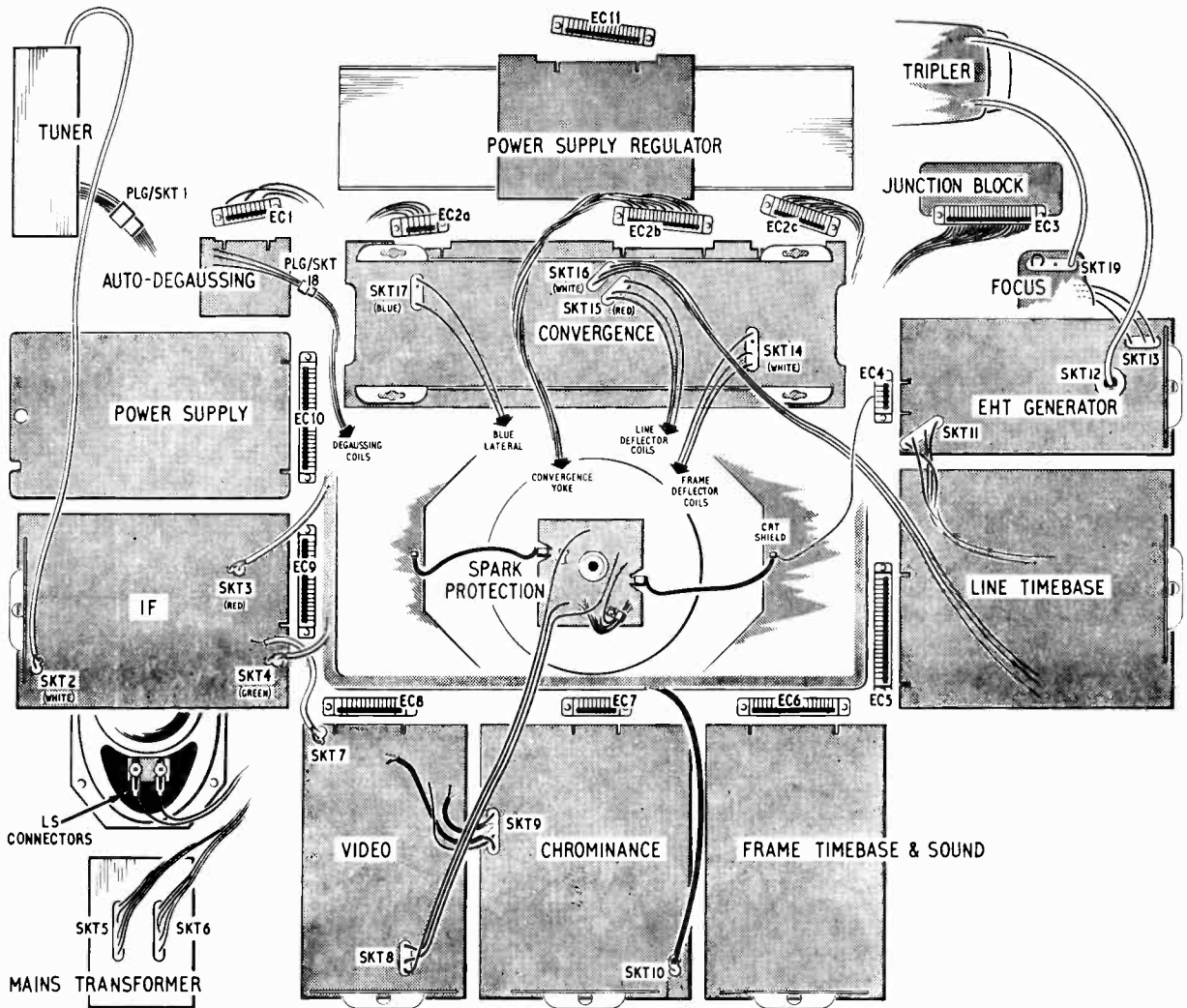

Fig. 1: Arrangement of the eight detachable printed boards. In 19in. models the power supply regulator board is mounted above the chrominance board on two brackets.

microswitch on top of the tuner for single-standard (u.h.f.-625) use and one often finds this done. It will cause viewer complaints about colour purity 'after weeks or months however' because doing this also disables the automatic degaussing. The best way of disconnecting the system solenoids on the i.f., line timebase and convergence boards is by opening the fusible resistors R16, R17 and R18 on the power supply board. For utmost reliability the system switch contacts can be soldered in the 625 position: when servicing however it is helpful to be able to operate a switch by hand to check whether a fault exists on the 405 side as well.

### Misleading Fault Condition

A misleading situation can arise if the line timebase system solenoid is "chopped" and the set transported much. The system switch delights in settling into an intermediate position: this causes one of the two 30V rails to be pulled down (see line timebase later)—a deliberate arrangement to prevent the c.r.t. being damaged by video drive with no line scan—

presenting a misleadingly "dead" set with the symptoms of a 30V rail short. Shove the offending switch and everything comes alive.

### Video Board

The circuit of the video board marked "235" is shown in Fig. 3; this is a slightly modified version of the earlier board type 135. In particular type 135 has the following component differences: R38, R58 and R75 are 50Ω presets; R39, R59 and R76 are 82Ω; R40, R60 and R77 are 33kΩ; R42, R61 and R79 are 25kΩ presets; R46, R47, R65, R66, R83 and R84 are 68kΩ; R48, R67 and R85 are 6kΩ 9W wirewound. In addition the following were omitted on the earlier board: clamp diode shunt resistors R86, R87, R88; optional bias reducer resistors R89, R90, R91; luminance delay line terminating resistor R93 and pre-delay-line choke L10. Instead of the latter a choke L5 was fitted immediately after the delay line.

A niggling incompatibility arises if a 235 video board is operated with a line timebase below serial

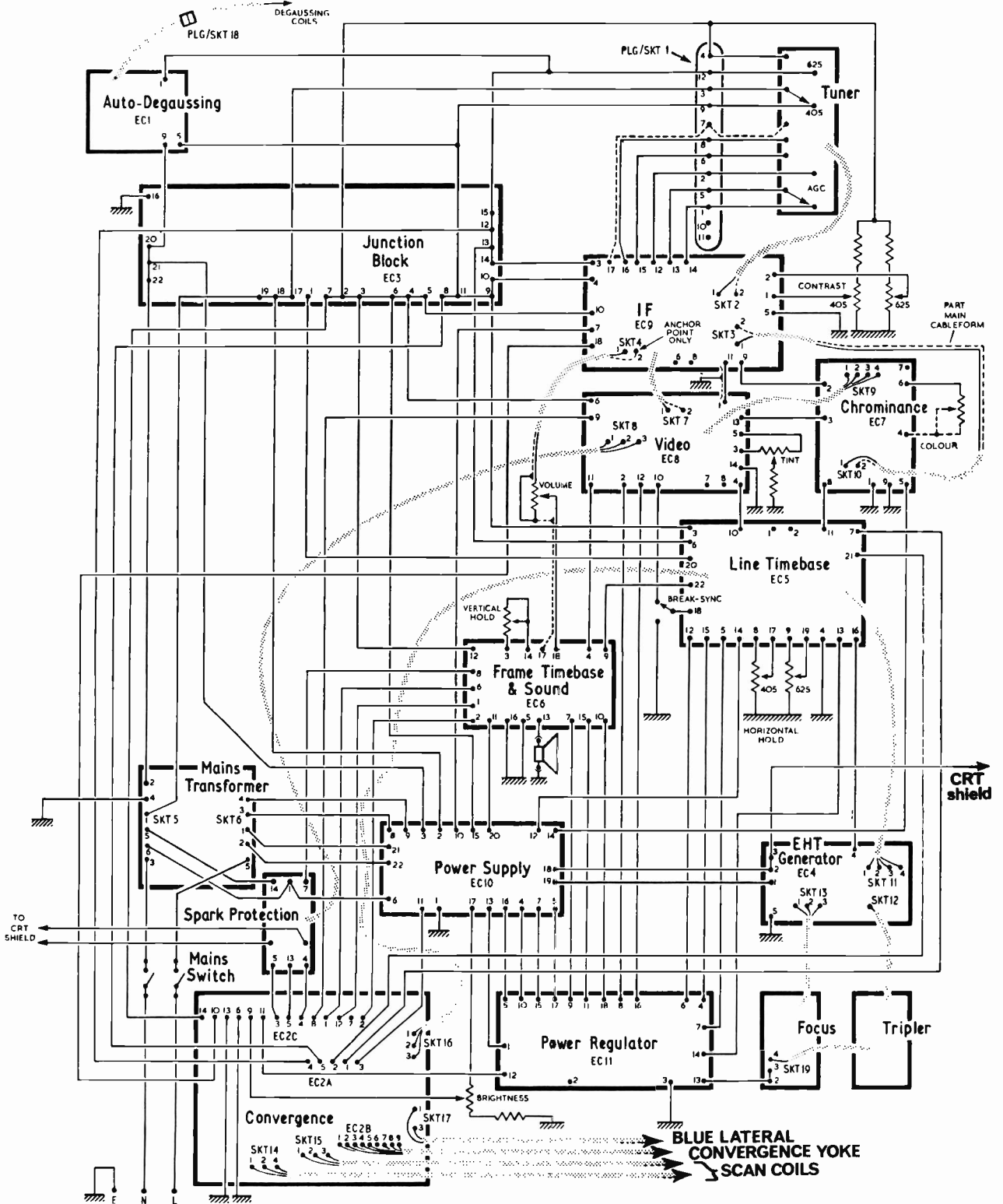

Fig. 2 : Cableform and wiring interconnections.

number 12,000. It takes the form of loss of colour on the extreme right of the picture. The cure is to

change components in the line timebase as described later.

**Corrections :** R42 and R89 are transposed on the printed board. The collector voltage of VT11, VT16 and VT21 should be shown as typically 190V, not 180V.

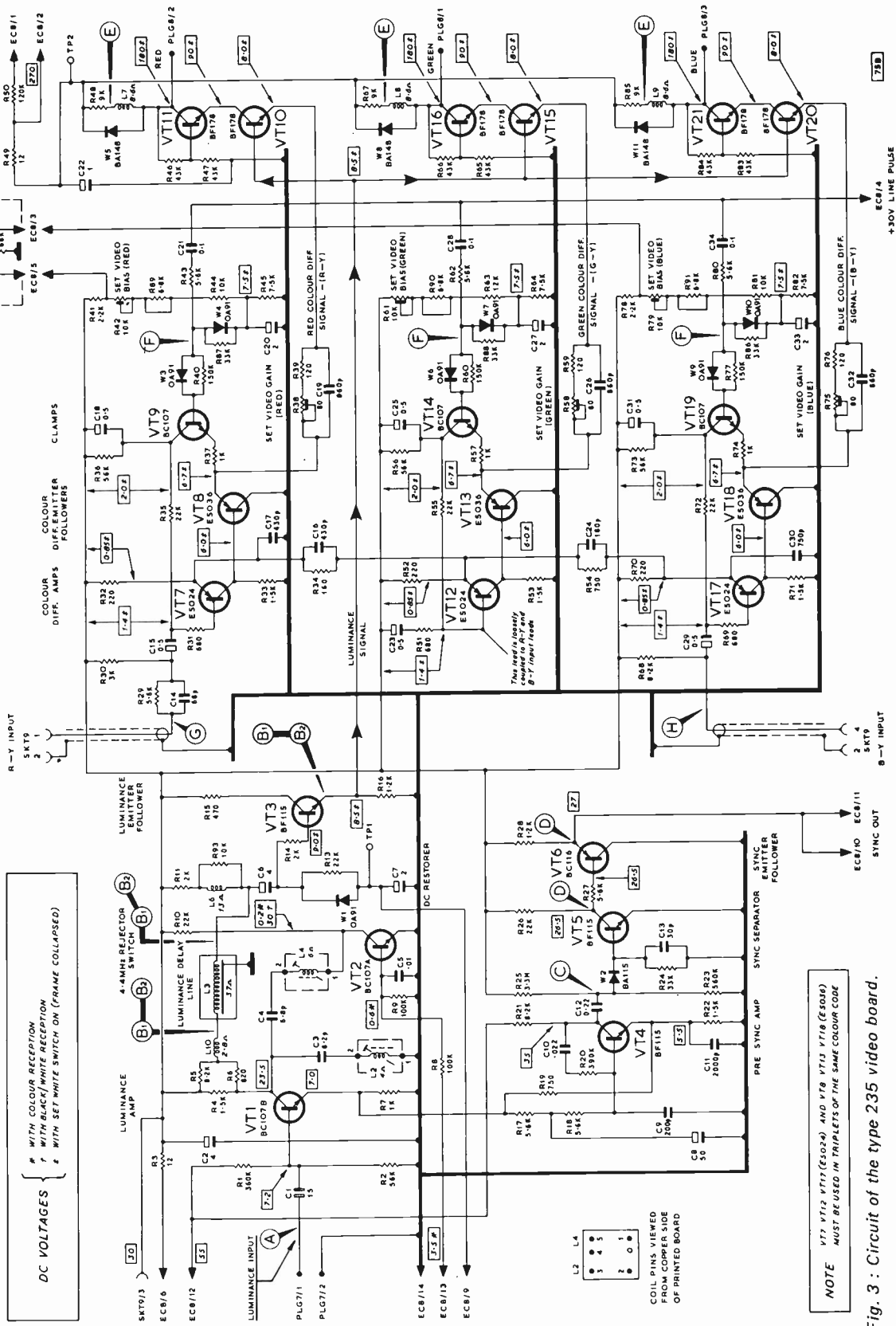

Fig. 3 : Circuit of the type 235 video board.



The most noteworthy feature of this circuit is that it provides primary-colour drives (R, G and B) to the c.r.t. cathodes instead of using the colour-difference principle (luminance "Y" to all three cathodes with R-Y, G-Y and B-Y to the respective grids) generally used in early colour sets. High-voltage transistors were then less readily available so pairs in cascade were used to work from the 270V rail and give the required signal voltage swing. Needless to say these output pairs usually fail together, causing one gun of the c.r.t. to switch permanently on or off. But note that a turned-on gun may simply be due to L7, L8 or L9 going open-circuit.

Circuit operation is as follows. Luminance from the i.f. board is fed via VT1 to the usual delay line L3 which compensates for the different delay times experienced by the luminance and chrominance signals. Intermittent luminance troubles can be the result of L3 breaking away from the printed track. Note also that it is convenient to connect our video crosshatch generator (TELEVISION September 1972) output across one end of L3. On colour reception only, VT2 is turned on by the chrominance board colour killer circuit, making the subcarrier rejector C4/L4 operative to prevent fine patterning in areas of saturated colour. The luminance d.c. level lost by the a.c. couplings C1 and C6 is restored by W1 which sets the sync tip level at a voltage set by the brightness control (see power supply). Emitter-follower VT3 (sometimes responsible for smeary luminance) supplies luminance to the bases of the lower cascode output transistors. The red and blue drives are obtained in VT10 and VT20 by means of base-emitter addition of Y to R-Y and B-Y respectively. The green drive is similarly obtained in VT15 using G-Y obtained by summing R-Y and B-Y by R34 and R54.

One of the 0.5 $\mu$ F electrolytics C15, C23, C29 in a colour channel can fail, causing a permanent colour cast. The same result occurs if one of the 0.5 $\mu$ F electrolytics C18, C25, C31 fails since this will upset the bias on one of the colour-difference amplifiers VT7, VT12 or VT17: because of the d.c. coupling used all voltages in the affected channel will be incorrect. The manufacturer's insistence that VT7/VT12/VT17 (E5024) and VT8/VT13/VT18 (E5036) be used only in triplets of matching colour code can be flouted without any very terrible consequences.

The video gain presets R38, R58 and R75 often get noisy which shows as an intermittent tint change while viewing. Treatment with switch cleaner is usually only partially successful.

There are two components which fail with nasty repercussions elsewhere. C22 shorts, opening fusible resistor R20 (it may also destroy VT2-BFY50) in the power supply. Also R50 changes value causing an a.g.c. circuit burnup (see i.f. board).

The sync separator is VT5; a component to watch here is C8 which fails causing no field lock and only weak line lock.

### Grey-Scale Adjustment

Grey-scale adjustment, which ensures a neutral monochrome picture and is essential for good colour reproduction, is more critical with RGB than with colour-difference drive sets. First set controls as follows: Viewer tint control midway; CRT first anode (A1) presets (convergence board) clockwise; R video gain (video board) 45° clockwise; G and B video gains (video board) midway; Set white (convergence board) switch to field collapsed position; Video reference (convergence board) for 9.5V at video board TP1.

Connect the positive lead of the meter (on its 250V d.c. range) to TP2 on the video board. Set the video bias presets R42, R61, R79 for 80V (board 235) or 90V (board 135) across R48, R67 and R85 respectively. On board 235 the shorting links across R89, R90 or R91 may be removed or replaced as necessary. Now set the c.r.t. grid bias preset (R30 on frame and sound board) for 40V (board 235) or 30V (board 135) at c.r.t. pin 12. Advance each A1 preset slowly in turn until a line of the relevant colour just appears, making use of the beam switches. With worn tubes it may be necessary to advance the c.r.t. grid bias preset for a maximum grid bias of 60V.

Return the set white switch to normal and with all beams switched on set up a normal monochrome picture, ideally of colour bars (i.e. a grey-scale staircase). Trim the video gain presets for neutral white and the video bias presets for neutral dark grey. The viewer tint control merely varies the relative bias in the red and blue channels, giving quite a pleasing effect.

**TO BE CONTINUED**

## NEW PRODUCTS

A useful nylon-tipped printed-circuit board marking pen (Model 33PL) is now available from Decon Laboratories Ltd., Ellen Street, Portslade, Brighton. The pen applies etch-resistant ink to the copper laminated board in line thicknesses down to 1/32in. —a spare nylon tip in the body of the pen can be trimmed down for finer work if required. Price is £1 including postage for single orders and £3.85 for boxes of six—separate quotes will be given for larger orders.

R. W. Dixon and Co. (Winton, Beacon Road, Crowborough, Sussex) have introduced a TV listening aid, the Soundmaster, for the hard of hearing. The device operates on the loop induction principle and is not connected to the set therefore: a loop from the set's loudspeaker is taken round the room

so that units can be used in any position. A volume control is incorporated.

J Beam have introduced a massive new array intended for use in areas where u.h.f. reception has been difficult or impossible. The MBM70 has 17 multiple director assemblies and for absolute rigidity an extra long trombone support is provided. The recommended price is £11.50. Stacked (Model 2MBM70) and quad (Model 4MBM70) arrays will also be available at £27 and £54 respectively. Enquiries to J Beam Aerials Ltd., Rothersthorpe Crescent, Northampton.

A new low-cost colour-bar generator has been announced by Labgear. The aim is to enable service engineers to do a greater percentage of colour service work in the field. The generator has been jointly developed by Labgear and Granada TV Rentals and is to sell at £80 trade.

# up-dating the

# 625-LINE RECEIVER

**KEITH CUMMINS**

REGULAR readers will have noticed articles on a fast-acting line-gated a.g.c. system (January 1972) and a sinewave line oscillator (August 1972) for the single-standard 625-line receiver originally featured in the March-July 1970 issues of Practical Television. These articles described part of an up-dating programme on the receiver and the information given in this present article concludes the programme for the time being in giving details of a transistorised smoothing circuit for the h.t. supply, a modified brilliance control circuit which discharges the c.r.t.'s e.h.t. supply when switching off and a 6MHz dot-pattern trap for the video amplifier.

## Power Supply Circuit

We will deal with the power supply modification first. Some readers experienced trouble with the picture "weaving" or "breathing" because of asynchronous mains working. Increasing the value of the main smoothing resistor R2 cured this but resulted in a lower h.t. rail voltage and higher dissipation overall on account of the increased current taken by the line timebase with the lower h.t. supply.

The method now adopted to overcome this problem is simple: it uses the basic circuit shown in Fig. 1. A d.c. supply containing a.c. ripple is introduced at the input. The ripple is smoothed by R and C so that a virtually ripple-free d.c. potential is applied to the base of the transistor Tr. The transistor is connected as an emitter-follower and a smooth d.c. supply is taken from its emitter. The point about this circuit is that the transistor has a current amplification factor of at least 10 so that R, which supplies the base current only, can be much larger than it would have to be had it been passing the full output current. As a result the smoothing effect of C is proportionately greater. Provided the ripple content in the supply is not so great that on the downward voltage swings the collector-to-emitter voltage of Tr becomes too low for linear operation the circuit will provide a consistently smooth output. The voltage drop across the transistor is much smaller than that which would occur using resistance smoothing and the h.t. rail voltage is thus increased. As a result the h.t. current consumption is less and the overall dissipation is reduced.

The practical circuit as used in the 625-line receiver is shown in Fig. 2. R2 is changed to 3.3k $\Omega$  and becomes the base feed resistor for the transistor Tr3. The main smoothing capacitor is still C1c, connected to the base of the transistor via diode D14. R48 forms the lower part of the base divider network and feeds C1d, providing a very well smoothed supply for the line oscillator etc.

The smoothing transistor is type 2N3055 and is mounted on the side plate of the receiver, just below the i.f. strip. A mounting kit is necessary to fit this transistor, which is in a TO3 casing. The transistor is isolated from the chassis by a mica washer and care should be taken when fitting the transistor that no short-circuits occur. The standard TO3 mica washer can be used as a template for drilling the chassis. Radiospares supply both the transistor and the mounting kit.

Now a word about the other components in the base circuit. Because the time-constant of R2 and C1c is so long it is possible for Tr3 collector to rise to the h.t. voltage much more quickly than its base: during this time the collector-base voltage could exceed the rating for the transistor, thus destroying it. The 33k $\Omega$  base feed resistor and D14 are incorporated to prevent this. On switching on sufficient current flows from the supply into Tr3 base to lift the voltage to a level at which the collector-base voltage is not excessive. This level is still below the normal operating point however and as soon as C1c charges to its normal voltage D14 is forward biased and conducts to connect C1c to Tr3 base. The 4700pF capacitor is included to prevent spurious oscillations.

The original circuit diagram shows R48 in the area of the line timebase: in fact however it is physically situated across the tags of C1, so the amount of rearrangement is minimal. The components associated with Tr3 (including R2) are mounted on a tagstrip secured by one of the transistor fixing bolts—see Fig. 3. Note that Tr3 collector is over 200V positive with respect to chassis—so be careful if you are tempted to feel if it is warming up! Actually it runs quite cool because of the large heatsink area formed by the chassis side plate and it is well within its rating.

## Switch-off Spot Suppression

Next the new brilliance control circuit, shown in Fig. 4. You will see that there are some additional components: first however the original spot suppressor transistor Tr3 (BSX21 or equivalent) in the cathode circuit of the video cathode-follower V1B is removed—the end of R9 which was connected to the BSX21 collector is connected directly to chassis instead. The BSX21 base feed resistor R6 is removed, and this component number is now allocated to one of the new resistors in the modified brightness circuit.

The brilliance control potentiometer VR8 is fed from the h.t. rail via D15, R33 and R6. Blanking pulses from the field output stage are introduced via

Fig. 1 (right): Principle of the transistorised smoothing circuit: the smoothing components RC drive the smoothing transistor Tr.

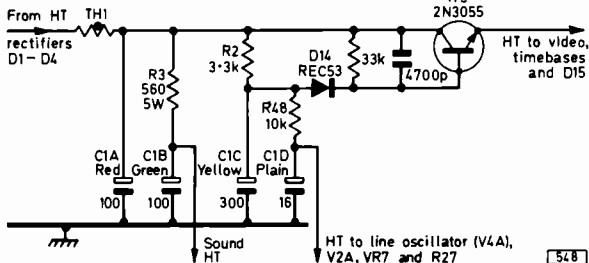
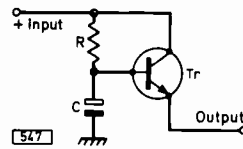

Fig. 2: Modified power supply circuit with transistor smoothed h.t. line.

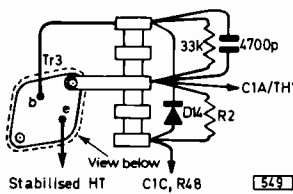

Fig. 3 (left): Layout of the modified power supply circuit: the components associated with Tr3 are mounted on a tagstrip which is secured by one of the transistor's securing bolts.

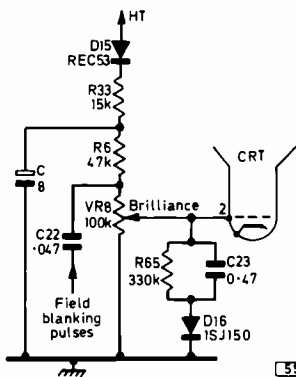

Fig. 4 (left): Modified brilliance control circuit with switch-off spot suppression.

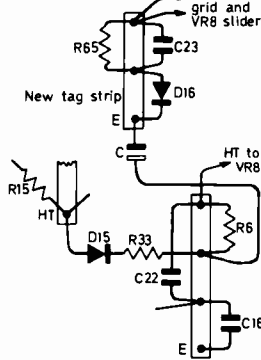

Fig. 5 (right): Layout of the modified brilliance control circuit.

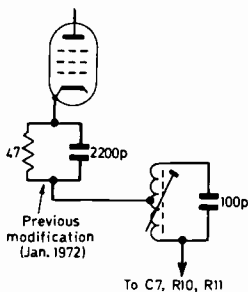

Fig. 6 (left): Incorporation of a 6MHz trap in the cathode circuit of the video amplifier.

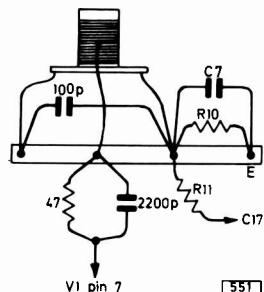

Fig. 7 (right): Layout of the modified video amplifier cathode circuit.

C22 which is now  $0.047\mu\text{F}$ . The junction of R33 and R6 is decoupled to earth via C ( $8\mu\text{F}$ ). When the receiver is switched off this capacitor can only discharge via R6 and VR8 since when the h.t. rail collapses diodes D15 is non-conductive. The c.r.t. cathode voltage also falls and as its grid voltage is held positive by the charge in C a heavy current flows in the tube, completely discharging the e.h.t. besides leaving no residual spot at the centre of the screen. On switching off the field timebase will be seen to collapse first, then the line, producing a horizontal collapsing trace on the tube screen which is finally left blank.

Now to the function of R65, C23 and D16. The slider of the brilliance control is connected directly to the c.r.t. grid in the new circuit, with these new components forming a network between the c.r.t. grid and chassis. To prevent streaking at high brilliance it is necessary for the c.r.t. grid to be adequately decoupled by a long time-constant circuit. C23, now  $0.47\mu\text{F}$ , would do this adequately on its own but would also short-circuit the field blanking pulses, R65 passes a current through D16 so that D16 is forward biased and the lower end of C23 is effectively connected to chassis. When the negative-going field blanking pulse arrives however D16 anode is driven negative so that it becomes non-conductive: C23 is thereby disconnected from chassis and the blanking pulse reaches the c.r.t. grid unimpaird. The circuit layout is shown in Fig. 5.

### Pattern Elimination

The final modification involves fitting a 6MHz tuned circuit in the cathode circuit of V1A: this serves to reject any residual 6MHz patterning which cannot be cleared by adjustment of the i.f. amplifier. The tuned circuit provides negative feedback at 6MHz, thus reducing the gain of the video amplifier at this frequency. The coil consists of 40 turns of 32 s.w.g. enamelled copper wire wound on a  $\frac{1}{4}$ in. coil former fitted with a standard core: the coil is centre-tapped. The circuit is shown in Fig. 6—the  $47\Omega$  and  $2200\text{pF}$  video sharpening components were mentioned in the January 1972 article on the modified a.g.c. circuit.

The easiest way to adjust the coil is to deliberately off-tune the receiver so that the 6MHz pattern is visible. This is easier with a black and white transmission with which of course there will be no 1.57MHz sound-chrominance beat. Simply adjust the coil for minimum patterning which will show up more in the dark parts of the picture. The layout of the new arrangement is shown in Fig. 7.

### Conclusion

This series of modifications brings the 625-line receiver specification to as high a level as can at present be practically constructed. If any further improvements can be usefully incorporated however details of these will be published. Since surplus i.f. strips are now difficult to get (the original receiver used a surplus tuner and i.f. strip) thought is being given to a new approach to this side of the receiver. Finally a correction to the August 1972 article: if a Siemens N22/250A pot core is used for the sine-wave oscillator coil the wire gauge should be 38 s.w.g., not 34 s.w.g. ■

# Assessing

# RECEIVER PERFORMANCE

## PART 2

E.J. HOARE

LAST month we investigated receiver scanning and synchronising performance. It is now time to take a critical look at the quality of the picture itself. What we are primarily concerned with in this group of tests is the way in which the receiver handles picture transitions, i.e. the quality of reproduction of fine picture detail. It is no good having good time-base performance if the signal circuits are incapable of driving the c.r.t. with an accurate copy of the original scene being televised.

A stationary pattern is essential for carrying out a proper assessment, a transmitted test card probably being best of all. Beware of test pattern generators—even if you are lucky enough to have one available—because the quality of a small piece of portable equipment can hardly be expected to equal that of a proper broadcasting system. Once again we emphasise the importance of a good aerial.

### HF Performance

Tune your receiver very carefully for best resolution and picture clarity and adjust the brightness and contrast for correct black level and good highlight brightness. Assuming that you have a test card displayed look closely at the frequency gratings—see Fig. 1. If the i.f. and video bandwidths are correctly chosen you may see a trace of the 5.25MHz gratings: the 4.5MHz ones should certainly be clearly visible. If they are not try retuning for better resolution. If you retune too far you will probably be able to see the gratings but the line sync will become unsteady and patterning will appear on the picture. Tune back again for best compromise. If the 4.5MHz gratings are still not reasonably clear then either the i.f. or the video bandwidth is inadequate. If you cannot see them even when overtuned the chances are that the video channel—as distinct from the i.f. strip—is at fault. Jot down the results on your test sheet. At the end of our testing we will summarise the procedure with a complete check list.

### Smearing

Now look at the plain black rectangle at the top centre of the picture. It is surrounded by a white area. Turn the brightness up and down slowly and steadily, keeping your eyes fixed on the right-hand

end of the black block (see Fig. 2). Does the edge of this black area extend and spread across towards the right as you turn the brightness down, and retreat towards the left as you turn the brightness up? If the edge spreads and retreats by more than about one eighth of an inch depending upon picture size you have a smear problem. This is one of the most common signal path defects; its name makes it largely self explanatory. In a bad case the black area—indeed any black area—may spread by an inch or more. Smearing is strikingly obvious then and the picture looks dreadful. The cause is usually a badly shaped i.f. response in the region of the vision carrier (39.5MHz) but it is often enhanced by a poor video response.

### Ghosts

Readjust the brightness control and inspect the vertical lines of the picture. Are they clearly defined? Look first for a faint separate image of the line spaced more than about an eighth of an inch away to the right-hand side—see Fig. 3. If you see one try moving your aerial (not usually a very simple job!) and see if this spurious image moves in

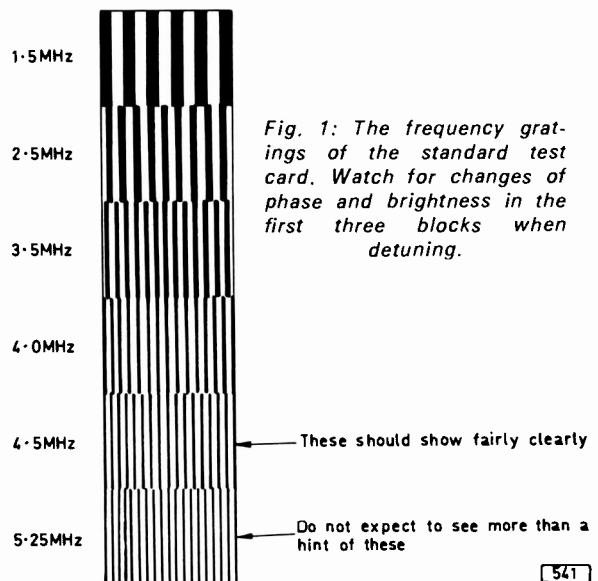

Fig. 1: The frequency gratings of the standard test card. Watch for changes of phase and brightness in the first three blocks when detuning.

sympathy. It usually will as it is a "ghost" produced by a reflected signal which arrives at the aerial a little later than the wanted signal because it has farther to travel. Adjust the aerial for minimum ghosting and the clearest picture. Sometimes ghost



Fig. 2: Smearing. A black area such as the rectangle at the top of the test card is followed by a dark smudge as shown above right.

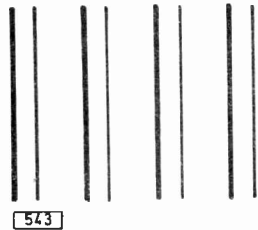

Fig. 3 (left): Ghosts. A faint duplicate image occurs to the right of the wanted one.

images are caused by damaged coaxial aerial feeders, bad connections at either end of the aerial, or signal pick-up on the coaxial outer in areas of high signal strength.

### Overshoots and Ringing

Having disposed of this very common bogey look again at the vertical lines. Is there a second image immediately after or partially superimposed upon the first as illustrated in Fig. 4(a)? If in doubt check the right-hand edge of the black block and adjust the brightness control a little if necessary. Look for the other effects also shown in Fig. 4. If you see a narrow strip of whiter than white followed by a thin dark line after the edge of the black rectangle then you have "overshoots". What happens is that when the signal in the i.f. or video channel has to go from black to white as quickly as possible it overshoots, i.e. goes a bit too far. Then in returning to its proper level it goes too far again and overshoots towards black. Hence the black/white/black effect.

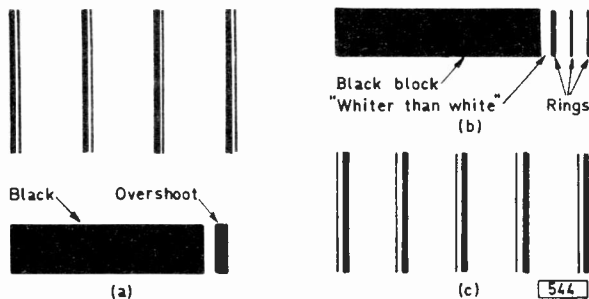

Fig. 4: (a) Overshoots. A faint duplicate image occurs very close to the wanted one. It shows up clearly after a black area with a well-defined edge. (b) Ringing. Two or more overshoots with diminishing intensity occur. The "whiter than white" ring also shows. (c) Preshoots. A duplicate image occurs before the wanted one: usually as a dark line before the verticals on a test card.

A very similar defect is one in which the overshoot is taken a stage further, see Fig. 4(b). Instead of merely overshooting once, say to white, or twice to white and black as previously described, the process continues and in severe cases you see three or four thin black lines of progressively less intensity evenly spaced from the edge of the black rectangle. This is called ringing and is caused by the same kind of mechanism that causes ringing or a damped oscillation in other electronic circuits. It tends to occur if very deep traps with steep response flanks are used in the i.f. circuits, combined with other sharply tuned circuits immediately adjacent to the trap.

### Preshoots

The next part of the picture to inspect is the area immediately *before* the vertical lines. Is there a spurious partial image there? See Fig. 4(c). You may wonder how any defect can occur before the picture has arrived: the chicken seems to be arriving before the egg (or is it the other way round?)! Anyway the fact is that a small amount of unwanted picture information is often present in advance, although it is usually fairly unobtrusive. This is "preshoot" (why not preview?). An explanation is given later.

### Overall Response

The results of the tests you have just carried out may have shown the i.f. and video response of your receiver to be very satisfactory. But there is another factor to bear in mind. All tuners have some degree of frequency drift and in any case not everybody tunes in to the same point, or in other words to the same i.f. It is important therefore to test the effects of detuning to see if anything untoward occurs to the quality of picture reproduction. With a perfect i.f. response all that happens as you detune is that the high-frequency gratings disappear, followed progressively by the others until only the 1.5MHz gratings remain. Picture detail becomes blurred or course due to the fall-off in picture resolution but no overshoots, rings, etc., should appear.

In practice virtually all receivers have defects in their i.f. or video responses and as you detune there will be a change in the response amplitude and phase characteristics. For example overshoots will appear to move, usually becoming more pronounced. If you can look at a picture, as distinct from a test card, and notice nothing much more than a general fall-off in resolution—unless you look very critically—you can feel reasonably satisfied.

### Interference Patterns

Nearly all receivers show traces of interference patterns when receiving colour transmissions. The 4.43MHz colour subcarrier lies inside the video (i.e. picture) passband and if no precautions are taken it will produce an obtrusive 4.43MHz pattern on the picture—see Fig. 5(a). Look for it on your receiver. It is normal practice for sets to have an i.f. response with about 6dB of attenuation at the i.f. corresponding to the colour subcarrier, i.e. 35.07MHz, and some receivers have a narrow rejector circuit in the video channel tuned to 4.43MHz to reject it still further. In spite of these



(a)



(b)

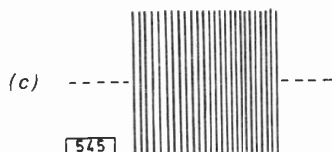

(c)

Fig. 5: (a) 4.43MHz patterning (shows up in this photograph on the colour bars) caused by the presence of colour signal components at the subcarrier frequency. (b) 1.57MHz patterning caused by the beat between the 6MHz sound intercarrier and 4.43MHz colour signal components. (c) Impression of 6MHz patterning caused by the presence of the intercarrier sound in the luminance channel: the lines are usually very faint and evenly spaced, looking like noise at a quick glance.

efforts the pattern will still be visible to some extent but it is not normally disturbing.

Another kind of patterning, shown in Fig. 5(b) and also on the February cover (lower left-hand photograph), is caused by the beat between the 6.0MHz sound intercarrier and the 4.43MHz colour subcarrier, giving a resultant of 1.57MHz. This is a coarse pattern and in some cases is very obtrusive. If you cannot see it on your receiver tune towards the high-resolution end of the range and it will show quite clearly. The point to check is whether it is annoying when the receiver is correctly tuned.

Now examine the picture very carefully and see if there are any other interference patterns. Try the

effect of tuning to opposite ends of the band, using a high contrast setting. Adjust the brightness control so that you have some medium to darkish grey tones, because these will show interference patterns more clearly. The sort of patterns you are looking for range from the stationary 6.0MHz beat between the sound and vision carriers—see Fig. 5(c)—to a flickering effect of perhaps 100kHz caused by instability in the i.f. channel. Spurious frequencies can also be generated in certain cases in the video output circuits, in the a.g.c. loop, in high-gain loops associated with some integrated circuits, by beats between the harmonics (generated in the detector) of the i.f. and the incoming r.f. signal, and by various other peculiar effects. The most important factors to note down on your test sheet are these: the approximate frequency of the pattern (compared with say the 4.43MHz and 1.57MHz patterns you already have) and does the frequency change as you vary the tuning?

### Cross Modulation

When looking for interference patterns you may be misled by an effect caused by cross modulation. Cross modulation is the result of an input signal which is too large for the tuner to handle: the frequency changer circuit then acts as a detector as well, the sound and vision carriers getting modulated on to each other to cause a buzz on sound and a disturbance on the picture. Sometimes the effect on the picture is merely an uncertainty of the line synchronisation so that vertical lines quiver: on other occasions the whole picture looks smudged in a way that is difficult to describe.

To check whether cross modulation is present turn up the volume and listen for a rasping hum or buzz. Then plug a coaxial attenuator of about 20dB into the aerial socket so that the incoming signal is reduced by about ten times. If the picture and/or sound disturbance disappear then the trouble was cross modulation. If they do not try a larger attenuator—if your signal is very strong indeed—just as a precaution: the chances are however that your troubles are caused by some other effect.

### Noise

Noise is a very important aspect of a receiver's performance. It is normally only associated with fringe area operation where the signal is very weak. The fact is often overlooked that noise can occur also even with strong signals when it is least expected. It is difficult to assess on a single receiver in isolation if you do not know the strength of the signal coming down your aerial. A pattern generator usually produces a signal which is virtually noise free and of strength such that an insignificant amount of noise will appear on a receiver with a good noise performance. An off-air signal of at least 5-10mV will behave in the same way. Alternatively you can compare your receiver against a known good one.

Whatever method is used the noise on your picture should be only just visible and no more. When comparing or assessing noise performance take care to adjust the contrast and brightness to a normal level, and exactly equal to the contrast and brightness settings of any comparison receiver. Make sure that the a.g.c. is correctly set also. Even small

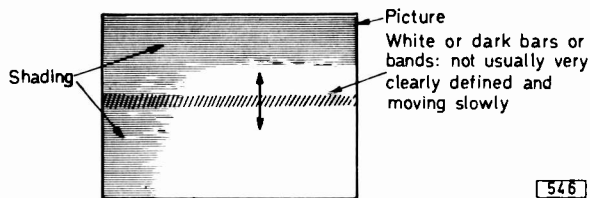

Fig. 6: Turn the brightness down gradually and look for picture shading and bars or bands.

differences of picture content, ambient lighting or tonal gradation will tend to make comparisons invalid. Noise really is a highly subjective and difficult parameter to assess.

### AGC

The a.g.c. circuits of a receiver are intended simply to maintain a picture of constant contrast regardless of the strength of the signal input to the receiver. The test is a quick one. With the full signal input adjust the controls for a normal picture. Now remove the aerial plug and hold it very close to the socket so that a noisy picture typical of edge of service area reception is obtained. Is the picture contrast nearly the same as before?

If you live in an area with a lot of aircraft flying close overhead observe also how much the picture is affected by unwanted signals reflected from the metal surfaces of the aircraft. On some older receivers operating at v.h.f. the disturbances can be quite severe, with large changes of contrast, ghost reflections and picture "breathing". On modern receivers operating at u.h.f. and fitted with integrated circuits to carry out the sync separation function the effects are usually very small.

### Tonal Gradation

One of the essential features of good picture quality is that the tonal gradation is correct. In other words the brightness differences in the parts of the original scene must be reproduced faithfully on the screen of the c.r.t. The reason why many old films fail to look pleasing when transmitted on television is that the dark areas tend to get compressed by the film scanner, the tonal gradation being in this way distorted—the picture looks all black and white with not much in between.

To check this you need a test card again. Adjust the controls to give a fairly contrasty picture with the lighter spot in the bright square of the grey scale and the lighter spot in the black square both just and only just visible. Then inspect the grey scale and see if the changes of brightness from square to square are approximately equal. Do you get an impression of good tonal gradation? If not there may be distortion of the signal in the vision detector or elsewhere in the video channel.

### Picture Shading

Picture shading is more commonly raster shading out it can be either. Set up the receiver in a darkened room and turn the contrast well down. Use a fairly low brightness level and then look closely at the screen. Ignore the picture as such and try to find

any areas of the screen that are brighter or darker than the rest—see Fig. 6. The three things to look for are stationary areas at the top or left-hand side of the screen and horizontal bars or bands moving either up or down at a very slow rate. The first two are usually caused by ill-shaped flyback blanking pulses and the moving bars by interference from the mains, i.e. hum on the h.t. or l.t. lines. Repeat the test at normal and high contrast levels.

### Black Level

Our next item concerns the black level of the picture. In an ideal receiver the black parts of the picture remain exactly at black level regardless of time, picture content, changes of mains voltage, choice of channel or changes in room temperature, provided the brightness control has been properly adjusted in the first place. This condition is generally achieved in colour receivers by means of black-level clamping circuits but these are seldom provided in monochrome receivers.

There are three different effects to look for. The first item to check is this: does the black level (i.e. the areas which should be exactly black) change with picture content? It will usually be found that when the picture changes to a predominantly light one the black areas will go below black, while when the picture goes dark the black areas turn grey. This is due to a.c. coupling of one kind or another.

The next check is to see whether the black level changes with mains voltage or when changing programmes or channels. Adjust the black areas until they are just a shade above black, or so that you can just see the lines when you look closely. Then change channels and the mains voltage too if you have the equipment and see what happens. A small change is inevitable when changing channels because the transmission standards permit a small deviation.

Now set up a test card (for preference), switch on from cold and leave the receiver working for about half an hour. Has the black level changed due to warming up effects, or random drift?

Unless black-level clamping circuits are used a certain amount of drift is more or less inevitable under all three conditions. With pure a.c. coupling, still used by one or two setmakers, large changes of black level occur. This is undesirable because the gradation of the picture is constantly changing, only one transitory condition being correct. Small changes pass unnoticed and are therefore unimportant. On colour receivers however an accurately controlled black level is essential if good colour fidelity is to be achieved.

### Switch-off Spot Suppression

Next we come to switch-off spot suppression. With the brightness control set normally switch off the receiver. Does a small bright spot appear in the centre of the screen after the picture has collapsed? If it does do not repeat this test. If it does not turn the brightness down and try again. Continue until you get a faint spot or have an all black screen. It is possible to get a single very intense spot which is caused by some e.h.t. voltage remaining on the c.r.t. anode after the scanning currents in the deflection coils have run down to zero but the c.r.t. heater is still hot and the cathode emitting

electrons. This spot can contain so much energy that it burns a scar on the screen and leaves a permanent mark caused by phosphor that cannot glow.

This can be a serious problem for the amateur constructor who cannot afford to damage a c.r.t., so *be careful* in carrying out this test. If you find evidence of such a spot stop testing and always turn up the brightness control before switching off. This will discharge the e.h.t. and prevent damage.

Note that a spot about one inch in diameter is normal and harmless.

### **Breathing**

Does your receiver "breathe" badly? Turn up the brightness and contrast so that you have the brightest usable picture and note by how much the picture changes in size, in both height and width. If you have a stationary scene or test card you can stick some tape on the screen near the four edges: mark it opposite some well-defined detail at a very low brightness setting, then do the same again under full drive conditions, i.e. a high c.r.t. beam current.

Usually the picture increases in size. This is acceptable provided the distance between your two marks in each of the field and line directions does not change by more than about five per cent. The field and line scans should change by equal proportions (not equal amounts) because otherwise the overall linearity of the picture will be distorted, circles appearing squashed. Try turning the brightness control up and down quickly. Does the picture bounce or do anything peculiar? Some do.

### **Sound Channel**

There is rather more to be listened for in the sound channel than some people realise, particularly in all solid-state designs. Begin by checking the maximum output. Turn up the volume control gradually and note the point at which distortion becomes obtrusive. Carry on until you are going full blast and the neighbours are expected to bang on the wall at any minute. Are you getting enough sound output: is it as much as the output stage *ought* to give and the neighbours to bear? Does it

begin to distort too early, or is it all in order? Hold your head near the speaker and try to distinguish between electronic distortion in the amplifier and distortion in the speaker due to cone break-up etc. Does the grille buzz?

Turn the volume to minimum, put your ear to the speaker and listen for hum. Is it a smooth low-pitched hum or a rasping type of hum? Can you hear it from across the room if you listen carefully? If so there is obviously too much. A very smooth hum is usually due to some mains ripple getting into the sound output stage. A rough hum is caused by coupling from the field output stage and if you turn the field hold out of synchronisation so that the picture slips you will hear a corresponding change of tone from the speaker.

Now try the tuning. Tune slowly through the whole range that gives a usable picture and note whether you get adequate sound, free of hiss, the whole way. Do this again several times very slowly and listen carefully for any buzz, whistles or plops. If you get a buzz watch the picture and see whether the buzz changes with picture content. Listen particularly for buzz when the picture contains a lot of bright detail—especially captions. This is vision-on-sound. Caption buzz can be difficult to design out but you should be free of any disturbances caused by ordinary picture information.

Try tuning yet again and this time make sure that you have the correct sound programme all the way through the range. Yes, it may seem an odd thing to do, but there are several mechanisms by which you can get BBC-1 or f.m. sound when you don't want them!

With a fairly high volume setting switch off the receiver and listen for any strange noise at the instant when the sound should peacefully die away. Do the same again at the instant of switching on. Some receivers give a sudden spurt of noise.

Next month we shall be discussing fringe-area performance and colour. Meanwhile look through the notes on your test sheet and make sure that you have recorded all your observations. These notes will be very useful when you want to assess the performance as a whole or to start curing some of the defects.

**TO BE CONTINUED**

## **IBC-72**

—continued from page 200

at which suitable devices have been made and used in TV i.f. systems, giving satisfactory performance. More work is needed to choose an optimum filter material and to decide on the best method of packaging with its associated amplifiers."

### **The Exhibition**

With the majority of broadcast installations in the UK already colour capable the sales emphasis at this year's exhibition was directed towards second generation colour equipment, the overseas buyer and of course sound broadcasting.

EMI for example were placing maximum emphasis on their 900 series fully automated radio station equipment. The system is controlled by a memory

store which calls up programme material on reel-to-reel and cartridge players. Material is cued up to six hours in advance.

Marconi showed little technical development this year but the Marconi Mk VIII colour camera was again in evidence and its operational quality has obviously improved since its appearance at IBC 70.

The Philips LDK5 colour camera which we first saw at Montreux in 1971 was on show on the Pye stand and again time has enabled its performance to be considerably improved. Timing of the various signals coded on to the triaxial camera cable is much better though it was noticeable that Pye had a little difficulty timing the signal overall into their programme vision mixer. This mixer is of a new breed and its performance—particularly in colour effects and chroma-key—bodes well for the future.

As always a good convention in civilised surroundings and with an extremely pleasant atmosphere: I look forward to 1974. ■



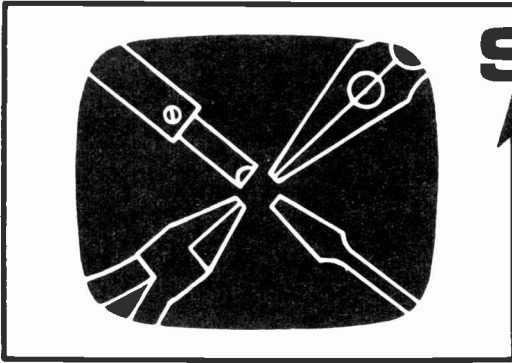

# SERVICING television receivers

L. LAWRY-JOHNS

PHILIPS T-VETTE/STELLA COMPANION—Cont.

## Cracks in Tracks

As in most sets with printed panels faults are often caused by a break in one or more of the tracks. Such faults can usually be traced by taking voltage readings and then confirmed through continuity checks with the set switched off, using either an ohmmeter or a buzzer (this saves watching the meter whilst making the tests). Solder a wire across the break when you locate it: putting a blob of solder across the crack is very bad practice as this will not stand up to any stress and will probably break open as the set is being reassembled.

## Field Timebase

One very common and irritating fault occurs in the field timebase. Usually this shows as jittering up and down mainly at the lower part of the picture—similar to the effect caused by a faulty linearity preset control. In these sets however the cause usually turns out to be poor contact between the body of the field output transistor T4028 and the print. The cure is to tighten up the screws and resolder on to the print.

The makers offer several suggestions of probable causes of field timebase faults as a result of their experience and we list these below.

*Intermittent field collapse at maximum signal:* X4019 short-circuit.

*Excessive height at minimum control setting:* T4027 open-circuit.

*Intermittent field output:* C4113 open-circuit or dry joint.

*No field oscillation:* T4026 short-circuit.

*Short field amplitude, cramping at bottom:* R4134 high-resistance.

*Intermittent field with signal:* X4019 leaking or short-circuit.

*Incorrect speed:* Field oscillator transformer L4086-8.

*Field jitter or intermittent field amplitude:* See our remarks concerning T4028 and check C4113.

*Intermittent field collapse with wavy line:* C4113, dry joint (check field coils).

*False lock:* C4104 open-circuit.

*Jitter or poor interlace:* C4109 or C4110 faulty.

*No field:* C4108 open-circuit.

## Vision and Sound Faults

Assuming that the picture is the correct size the other likely picture faults are insufficient contrast, excessive contrast, picture too dark, poor definition

and fluctuating contrast. Depending upon whether the sound is also affected and upon the system in use a fair guess can be made as to the source of the trouble. For example when the set is switched to 405 the v.h.f. signals are handled by the v.h.f. tuner, are then passed via a screened lead to the system switch, amplified by the first two transistors T2015 and T2016 where at the output of the latter the sound signals are filtered to T2006, T2007 etc. while the vision signals pass on to T2017, are detected and fed to T2019 and thence to the video amplifier T1220. Note that the video amplifier is type BF177, not type BF117 as marked on the manufacturer's circuit. It is reasonable to assume therefore that if the sound is in order but the vision signals are faulty the source of the trouble must be in the circuitry around T2017, T2019 or T1220: this includes the contents of can A which can hold a few juicy dry joints. If on the other hand the vision is nice but the sound is not one would immediately apply an audio check at the volume control and take it from there. If the sound is faulty when a signal is injected at this control voltages should be taken from T2008 on (if a nasty smell of overheating has not already issued from the output stage).

Thus by using one's ears and eyes (and perhaps nose) the fault can be narrowed down when the 405 system is used. When 625 is used the problem is a little more involved as the intercarrier sound is tapped off at the detector stage in can A.

Weak sound and vision signals or no signals at all on 405 would involve the i.f. stages T2015 and T2016 as well as the v.h.f. tuner: signal injection should locate the faulty stage where voltage readings should reveal the cause.

If loss of signals is confined to v.h.f. it should be remembered that the v.h.f. tuner uses the fine tuning plastic wand with the small metal sleeve. As most readers will know by now this small item can fracture and put the v.h.f. tuning way out. The point is that there will still be something coming through even though it may be a confused load of mush. Thus the diagnosis is not too difficult. The inside of the v.h.f. tuner will look quite familiar although the top may look a bit bare.

The u.h.f. signals are handled by the u.h.f. tuner, then passed to the v.h.f. tuner for further amplification before being piped to the i.f. panel. If the u.h.f. signals are weak and noisy the usual checks on switching should be made but the probable cause will be the first stage transistor in the u.h.f. tuner. This is an AF186 (T6001): an AF139 can be used in this position. The second AF186 (T6002) should

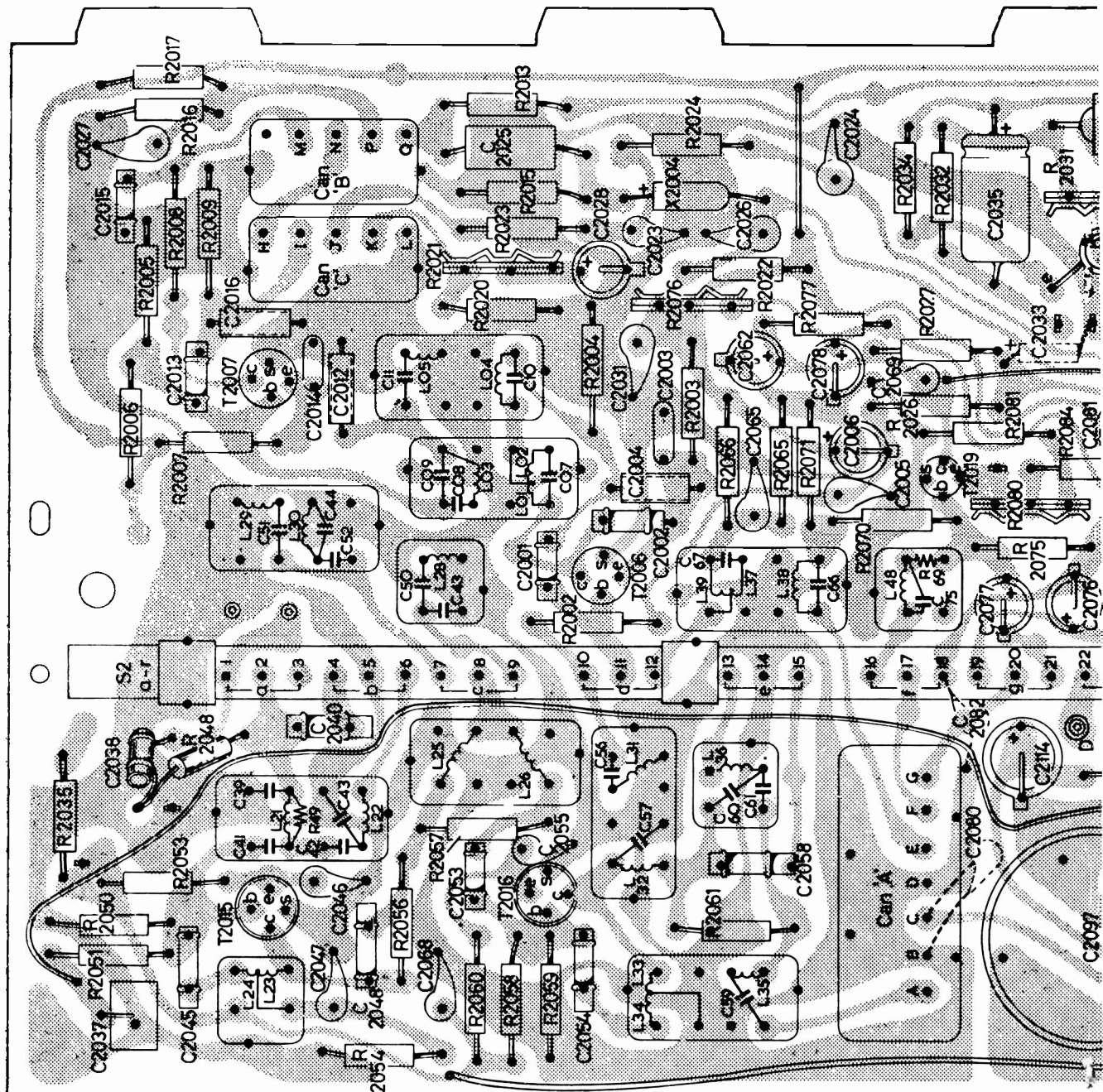

Fig. 2: Layout of the i.f. printed board, viewed from the component side.

be suspected when the irritating habit of oscillating at one frequency but not at others develops: this means that one u.h.f. transmission may be received perfectly well but another may not or may be received for a few minutes or so only. First check the gang to make sure that the plates are clearing at the suspect point, then accuse the oscillator-mixer of not performing the first of these functions. Replacement is not too difficult but does require a delicate touch, a small soldering iron and a dear little pair of wire cutters which may also serve as tweezers if a fine pair of these is not at hand.

Now let us have a look at some of the maker's suggestions of probable faults in the vision and sound stages.

*No vision:* Contrast control R4087 open-circuit; T2019 (BF115) faulty; T2018 collector voltage low; T1220 (BF109 or BF177) faulty; faulty vision detector diode (X2010).

*405-line picture OK, 625-line picture negative:* Faulty video detector diode X2010.

*Insufficient brightness:* Dry joint on c.r.t. panel or X2014 faulty.

*405-line picture smeary, 625-line picture very weak:*

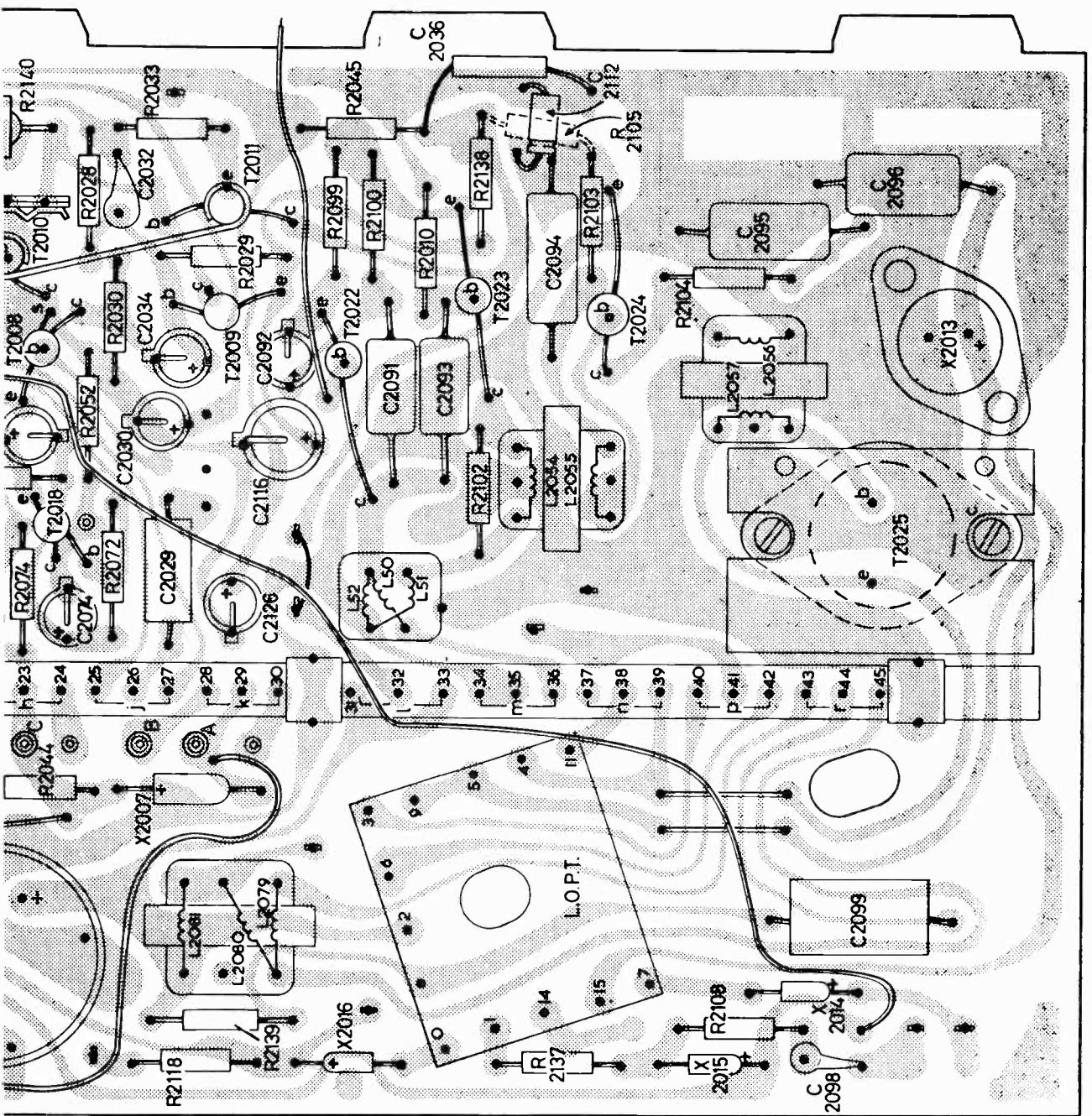

side. The capacitor in the can with L28/C50 is C49, not C43.

X2010 faulty or L1285 open-circuit.

No sound or vision: T2018 open-circuit; T3001 short-circuit; X2007 short-circuit; R2076 and R2080 incorrectly adjusted. (T3001 is v.h.f. r.f. stage.)

No sound and/or small picture: Thermal runaway in output transistors.

Sound present with volume at minimum: Volume control high-resistance.

Distorted sound: R2033 or R2034 high-resistance or open-circuit.

Very weak and distorted sound: R2031 open-circuit.

No 405-line sound, a.g.c. low, 625-line sound in

order: 405 sound take-off coupling capacitor C2056 leaking or short-circuit.

### General Hints

When the complaint is no results check the mains input (if this is being used) and the fuses. Remove the 2A fuse and check the current passing. If this is over 1.5A check the voltage on the body of the AD149 regulator which is on the right side metal panel. This will almost certainly be low. With the set on its face feel under the front centre for signs

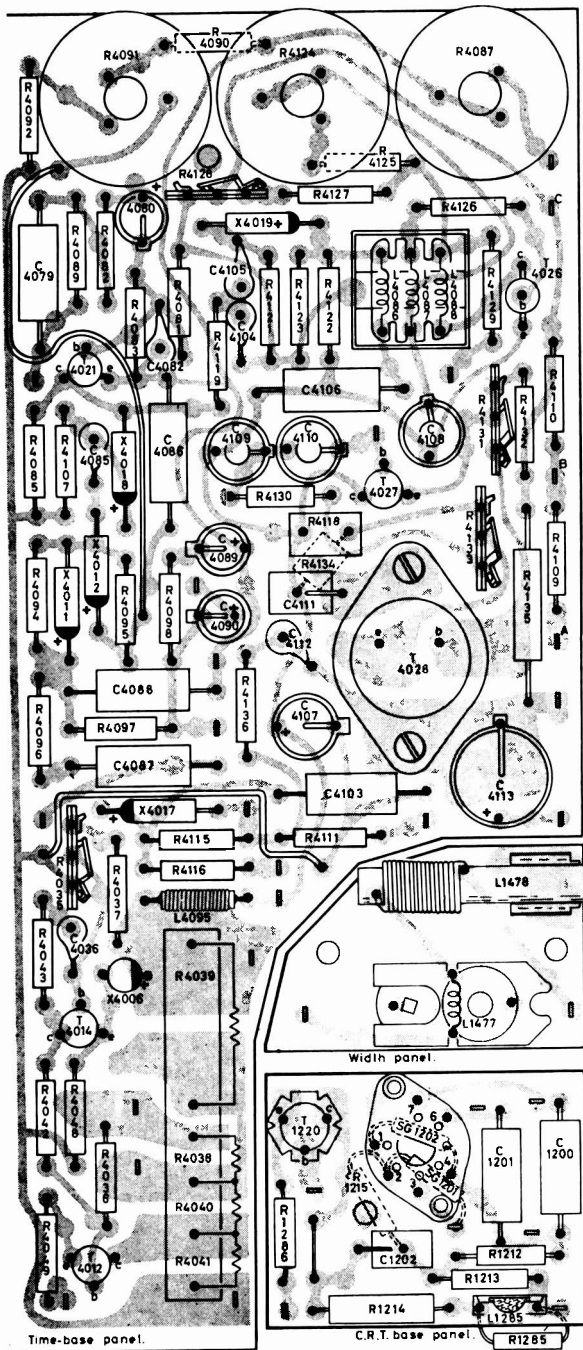

Fig. 3: Layout of the timebase panel, viewed from the component side.

of overheating. If there aren't any, suspect the AU103 line output transistor (part no. 13047 043) and cut the track to its base (this is the lower pin). If this restores some sound and field buzz, also a fine whistle on 405, it is reasonable to assume that the AU103 is at fault. This is soldered to the panel on the right side (under) from the base and emitter point of view and bolted at each end of its body (collector). It has its own little house in the screened section which comes into view when the panels are

parted: the assembly should be observed when the new transistor is fitted.

Note the six-tag resistor on the right side (R4038-39-40-41). The left end of this is the supply line point and it is a matter of moments to disconnect the red lead which goes down to the i.f. panel and line timebase if the current of this line has to be read.

The right-hand section (100Ω) of this wirewound resistor assembly tends to become open-circuit and as this is in the collector circuit of the AC128 (T4012 feedback amplifier in the regulator circuit) the result is a supply line which is not anchored at 11V but which is high on low load and low on high load.

## COLOUR RECEIVER CIRCUITS

—continued from page 225

When the red, green and blue pictures have been pulled into a common shape residual pincushion distortion remains. This can be removed by using a special line/field "intercoupling" transformer called a transductor. It differs from a conventional transformer in having three windings which are arranged on the limbs of an E-shaped Ferroxcube core. The two outside windings are in series and are connected in shunt with the line scan coils; the middle winding is connected in series with the field scan coils.

Correction is achieved since the transductor causes a form of "modulation" of the vertical scan current by line scan signal and of the horizontal scan current by field scan signal. This makes the horizontal deflection slightly greater towards the middle of the vertical scan, thereby pulling out the sides of the "pincushion". The top and bottom edges of the "pincushion" are straightened by correction current applied to the vertical scan coils at line frequency.

When a line is being traced the correction applied is zero at the start, gradually rising to maximum at the middle, then decreasing for the next half of the line so that it is zero again at the end. The diminishing correction required on the lines from the top and bottom to the middle of the screen is achieved by a parabolic current component which results from the progressive saturation of the E-shaped core over each half of the field cycle.

Some idea of the line and field correction waveforms, both at field frequency, is given respectively at (a) and (b) in Fig. 8.

The amount of correction is adjustable, often by means of a potentiometer across the control winding and a variable inductor in series. For more information on this see the article on the TELEVISION colour receiver in the November 1972 issue.

The wider scanning angle of 110° picture tubes presents additional problems with both pincushion distortion correction and convergence correction, particularly in the corners of the screen. Various circuits, some extremely complicated, have been devised to satisfy the requirements. At the time of writing however there is no basically "standard" circuitry. Involved circuits have been produced but these to date are rather specialised and are used only in imported receivers. UK setmakers are at present working on minimising the circuit problems without detracting from the pureness of display.

# LONG-DISTANCE TELEVISION

## ROGER BUNNEY

DECEMBER has produced a few surprises this year! Sporadic E has certainly had its moments, with several openings throughout the month. This is an encouraging sign since a mid-winter opening was often noted in the early '60s when conditions were quite fantastic during the May-September "season". Along with the improved conditions during 1972 I feel these are indications of an excellent 1973 season to come—I hope so! Sporadic E openings were noted on the 6th, 7th, 23rd and 25th. In addition a slow-moving high-pressure system (anti-cyclone) with extensive fog during the morning periods produced enhanced Tropospheric conditions in Band III and at u.h.f. The best period seems to have been December 15th-21st.

My own log for the period is listed below—I am still using the temporary array incidentally—but the section 10th-17th inclusive is from our old friend Garry Smith (Derby). Work on the new lattice mast and arrays is now at an advanced stage: I hope—weather permitting—to bring them into operation in early February.

- 1/12/72 SR (Sweden) ch.E2; WG (West Germany) E2; CST (Czechoslovakia) R1; TVP (Poland) R1—all MS (meteor shower/scatter); BRT (Belgium) E2—trops.
- 2/12/72 SR E3—MS; BRT E2—trops.
- 4/12/72 SR E2—MS.
- 6/12/72 BRT E2—trops.
- 7/12/72 NRK (Norway) E2, 4; WG E2—all MS.
- 8/12/72 BRT E2—trops.
- 9/12/72 SR E2—MS.

### From Garry Smith:

- 10/12/72 Various MS and SpE ch.R1/E2a; E3.
- 11/12/72 CST R1; NRK E2—MS.
- 12/12/72 SR E2, 3; NRK E2; TVP R1; CST R1; unidentified SpE signal at 1950 on E2/R1; BRT E2—trops.
- 13/12/72 SR E2, 3; NRK E2, 3; WG E2; also unidentified signals.
- 14/12/72 Switzerland E2—MS.
- 15/12/72 SR E2; ORF (Austria) E2a; CST R1; MT (Hungary) R1—MS.
- 16/12/72 ORF E2a; MT R1—both SpE.
- 17/12/72 Various MS on E2, E2a, R1, E3.

### Back to my own log:

- 19/12/72 DFF (East Germany) E4—MS—using new identification slide—see Data Panel!
- 21/12/72 NOS (Holland) E4—trops.
- 22/12/72 SR E2, 3—MS.
- 23/12/72 ORF E2a; WG E2; unidentified signals on ch. E2 twice; R1; R2; E4—all SpE.
- 25/12/72 NRK E2—SpE; BRT E2—trops.
- 27/12/72 NRK E4—MS.
- 29/12/72 SR E2—MS.

It is interesting that during the improved tropospherics here on the 19th ORTF (France) was noted using 819 lines during the morning at a time when they would normally be testing on 625 lines. The Sporadic E opening on the 23rd allowed a close examination of the "new" ORF PM5544 card carrying the identification ORF FS1—indeed this is very prominent. We have been fortunate in obtaining from Dieter Scheiba an excellent shot of the ORF second chain card and this is featured in our Data Panel this month. Generally the Sporadic E conditions gave medium to long skip signals from typically ORF, JRT (Yugoslavia), TSS (USSR) etc.

An important reception occurred on December 7th when Graham Deaves (Norwich) received TVE (Spain) on ch.E2 in colour. The EBU colour bars were received,

followed by the normal TVE monochrome card. I feel that in the not too distant future TVE's PM5544 pattern generators will be in service for further extended colour tests. At present we have no idea if and when TVE will be going on to colour programming—any information on this point would be appreciated.

The improved tropospherics at long last gave reception within the UK of CLT-Luxembourg on ch.E21. The ZDF card is used with the identification CLT inserted on the left-hand side of the grey scale (second row of information) in large white letters. Signals on both ch.E7 and E21 were reported by Paul Gardiner as far distant as Aldershot.

I have kept one of the important news items until last, though this is rather like a goodly blast on my own trumpet! I mentioned in the August column my reception of a caption "BAKY" on ch.R3 and have at last received a letter from the authorities which when translated (from the Russian!) confirms that the caption did in fact originate from the Baku Television Centre, Azerbaydhan (on the Caspian Sea). More important was the fact that on May 21st this caption was not networked to any other area. Consequently the signal came from a transmitter in or around Baku. This is my farthest definite reception, some 2,600 miles. We have endeavoured to reproduce the photograph—complete with blurring etc. It shows reasonably clearly the all important word "BAKY".

### From our Correspondents

A. Papaeftychiou writes from Cyprus to say that the mysterious ch.E9 Greek transmitter he has received is operating from the Island of Rhodes. Because of the excellent propagation possibilities it is understood that an increase in power is under consideration so as to cover parts of Cyprus.

Alan Reekie of Brussels has been on his travels. Apparently test card C is in use in Jordan with super-imposed black lettering indicating transmission on ch.E3 or E6. Between 2030-2330 local time channels E3 and E6 carry separate programmes.

A new correspondent—Alan Pemberton of Sheffield—has written us a long letter telling of Autumn conditions in his area. Alan uses the recently featured

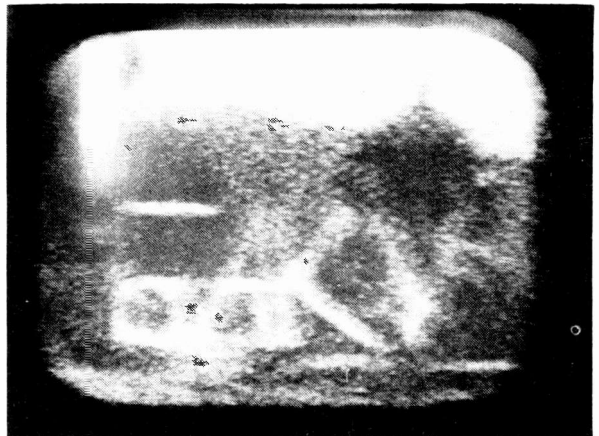

Multiple-hop Sporadic E signal from Baku, USSR.

**DATA PANEL 20—2nd series**

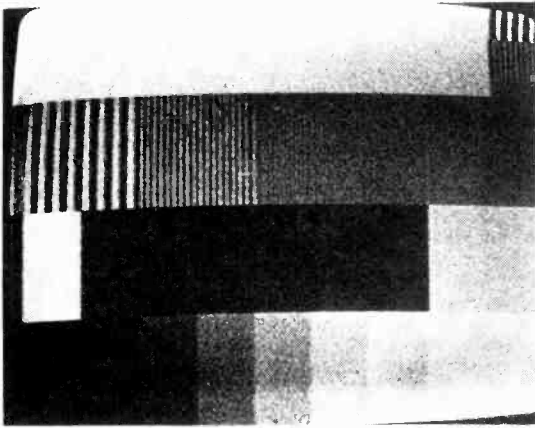

*ORF (France) test pattern.*

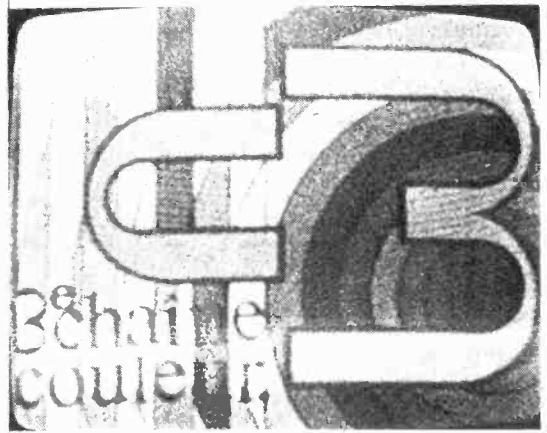

*ORTF-3 identification slide.*

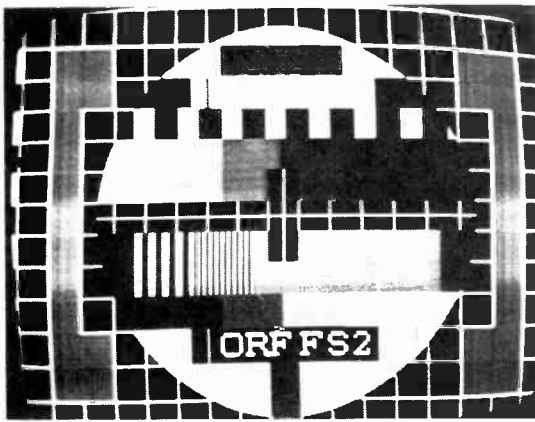

*New ORF test card—with identification ORF FS1 or ORF FS2 for the first and second chains.*



*New East German (DFF) transmitter identification slide.*

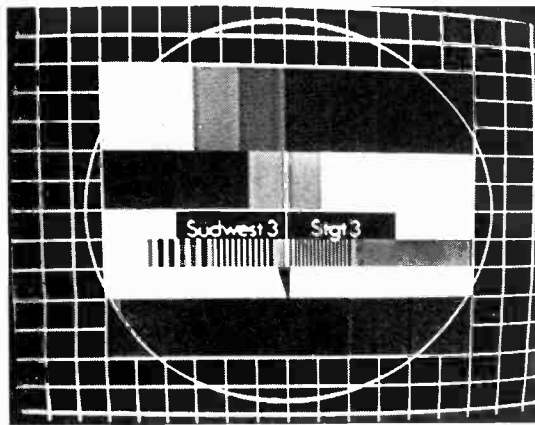

*Südwestfunk (West Germany) test card.*

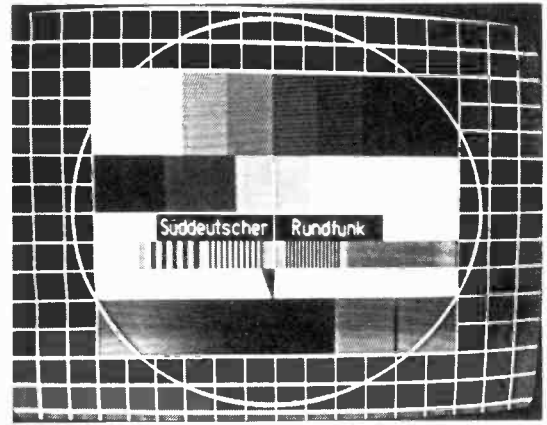

*Süddeutscher Rundfunk test card.*

*Photographs courtesy of Dieter Scheiba and Ralf Erler.*

TELEVISION monochrome TV receiver for his DXing. He finds the wide bandwidth most useful for observing

small detail but a disadvantage in giving poor selectivity during good openings. A system of high-pass filters is

being considered to give improved selectivity working. The *Wireless World* 15 element log periodic aerial is in use at u.h.f. An interesting point about his method of taking off-screen photographs. The use of a half-frame 127 camera (16 shots per roll) with a ground glass screen at the rear of the camera allows accurate camera focus and alignment. By using the brief exposure setting (approximately  $\frac{1}{2}$  second) an improvement in quality is obtained as the snow/noise on the exposure is evened out.

## News Items

**West Germany:** The German electronics firm AEG-Telefunken is to build replacement transmitters for Grunten ch.E2, Kreuzberg ch.E3 and Ochsenkopf ch.E4. The interesting point is that they will have two sound channels. We await further news on this development with interest—can it be the start of stereo TV sound?

**Austria:** Test transmission times—first and second networks, 0900-1300 CET; 1400 30 minutes before programmes. The exception is Tuesday—unfortunately we are not advised what happens on Tuesdays at ORF!

## Data Up-Date

This month we are taking a pause in our series through Europe in order to catch up with a few new items. The cards shown in Data Panel 20 are as follows: (1) ORTF test pattern, compare with June 1972 column. (2) ORTF-3 identification slide. (3) ORF—the identification ORF-FS1 or ORF FS2 is now included on the PM5544 card for the first and second chains (v.h.f. and u.h.f.) respectively. (4) DFF (German Democratic Republic, East Germany). New identification slide. Each main transmitter radiates its own slide. Our example shows a second chain slide; the first chain slide is similar but the II in the centre of the lower horizontal line is replaced with I. (5) West Germany, Südwestfunk. Note the studio origination identification Stgt 3. An alternative shows Badn 3. This depends on whether the Stuttgart or Baden-Baden feed is being taken. (6) West Germany, Süddeutscher Rundfunk test card. Our thanks to Dieter Scheiba, Brussels and to Ralf Erler, Parchim, GDR for these excellent shots.

## Varicap Tuned UHF Aerial Amplifier

Information has recently come in about a u.h.f. amplifier at present being marketed in Holland. This is of particular interest to "weak signal enthusiasts". It is basically a two transistor masthead amplifier but unlike conventional types it is fitted with varicap diodes. The latter are tuned from a control box marked ch.20-70: Fig. 1 shows the gain and bandwidth. The advantage of course is the selectivity which enables it to be used on channels adjacent to very strong transmissions. Rym Muntjewerff in Holland has used one of these for some months and comments favourably on its performance—"I can tune all channels on u.h.f. and that's why I never have cross-modulation. It is possible to receive very clear RTB and BRT Wavre on channels 25 and 28 in the direction of Lopik which has an e.r.p. of 1000kW" Note that the Lopik transmissions referred to are on

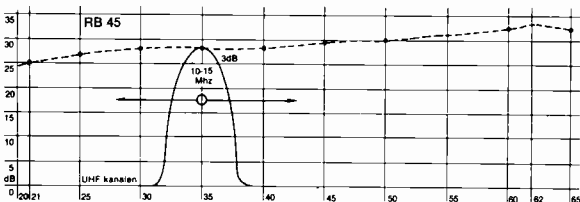
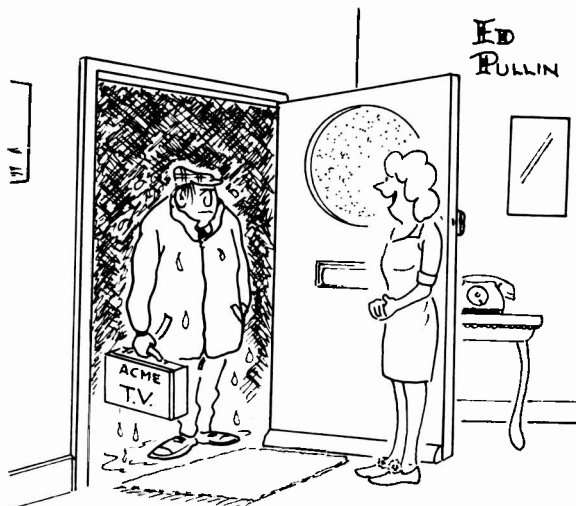

Fig. 1: Varicap diode u.h.f. aerial preamplifier frequency response and tuning characteristics.



"Could you pop up on the roof first, we think it might be the aerial!"

channel E27. More information can be obtained from Schrader Electronics, Lippynstraat 4B, Amsterdam-W, Holland. The cost is approximately F1 145.

## West Germany

Following our recent attempts at detailing the West German test card situation we have received up-dated information which at the time of writing is correct! This should be read in conjunction with the notes in the November 1972 column.

**ZDF:** In a modified version the colour bars/grey scale are replaced with a grey rectangle including the transmitter location and channel, e.g. Buderich Kanal 35. The former type is still in extensive use.

**WDR:** WDR-3 also use the ZDF type card, with no identification and omitting the circle.

**SWF:** SWF-1 also use the circular electronic card with no identification—as the SFB-3 type in Panel 17. SWF-3 use the ZDF card with identifications as noted above.

**HR:** HR-1 use the Telefunken T05 card as already noted but with a horizontal colour bar superimposed—similar to WDR-1.

**BR:** BR-1 also use the EBU bar pattern with circle: a network of fine white dots is superimposed over the whole pattern. BR-3 also use the electronic card as in Data Panel 16 (NDR-3).

**Radio Bremen:** The RB-1 card carries the identification "radio bremen K22, K5".

**SFB:** SFB-1 also use the SFB-3 card.

**SR:** The ZDF card is used with circle and identification, Saarland Rundfunk.

**SDR:** Both the ZDF type card and the circular electronic card—as SFB-1—are used, carrying the identification Sueddeutscher Rundfunk—as noted above.

**Notes:** The modified EBU bar pattern (i.e. EBU bar superimposed over the EBU colour bars) has been noted on various networks carrying the identification "Schul-TV" (schools) for approximately 30 minutes before transmissions. WDR radiate schools programmes on both the first and third networks, SWF, SR, SDR have been noted with a common programme until 2015 CET when they change to separate programmes. We have noticed that the ZDF/SWF/YLE card is often referred to on the Continent as the Fubk card. We will investigate to establish the correct title!

**For the Beginner:** We regret that due to shortage of space we have had to hold this feature of the column until next month.

# COLOUR RECEIVER CIRCUITS

## CONVERGENCE TECHNIQUES

GORDON J. KING

PRETTY well every department of the colour receiver has now been investigated with the exception of the convergence circuits: it is now intended to round off the series by looking in this concluding article at some of these circuits.

### Why Convergence?

First let us briefly recapitulate on why convergence correction is necessary. The electron beam from the red gun must strike only the red phosphor dots on the c.r.t. screen, the electron beam from the green gun only the green dots and the electron beam from the blue gun only the blue dots. These requirements, essential for the correct registration of the red, green and blue pictures, necessitate *separate control of each electron beam*.

The effect of the controls must be such that the three beams intersect each other at one point in the plane of the shadowmask, and this condition must be maintained over the entire scanning area. The necessary beam control actions are effected by magnetic fields which are produced by the convergence units on the neck of the picture tube.

The three guns in the picture tube neck are positioned as shown in Fig. 1(a). The idea is that each electron beam strikes the appropriate phosphor dots on the screen through the holes in the shadowmask—see Fig. 1(b) and (c).

### Static Convergence

The conditions depicted in Fig. 1(b) and (c) represent perfect convergence at the centre of the screen: that is, with the beams in the "neutral" scanning position. The control applied to achieve correct convergence at the centre of the screen is called *static convergence* control. The same conditions must be maintained as the beams are deflected vertically by the field timebase and horizontally by the line timebase towards the edges of the picture: this is where *dynamic convergence* comes in.

All that is required for static convergence is to subject each electron beam to a magnetic field of non-alternating polarity but of adjustable intensity: each beam can then be deflected by the required amount to provide correct centre convergence. The three static convergence fields are produced by magnets in the main convergence unit: Fig. 2 shows the arrangement for one of the beams. The pole pieces extend inside the tube neck in such a manner that each beam passes through its appropriate pair of pole pieces. Each beam is thus mildly deflected by an amount depending on the intensity of the field applied to it, each beam being in this way aligned for optimum static convergence. The beams exhibit

a circular magnetic field in their direction of travel of course: thus when they pass through the homogeneous static convergence field the lines of force are reinforced on one side of the beam and reduced on the other. This means that the beams are deflected at right angles to the lines of force across the pole pieces—as shown in Fig. 2.

This diagram shows that each beam can be moved radially—by regulating the intensity of the magnetic field in the polarity required for the direction of movement. While this neatly converges the red and green beams the blue beam, whose gun is generally at the top of the tube neck, could fail to converge with the others owing to lateral displacement—see Fig. 3.

What is also required therefore is a means of displacing the blue beam in the direction shown so that it will converge at the shadowmask with the red and green beams. This displacement is provided by a further assembly which is mounted on the neck of the tube behind the other assemblies. The magnetic field from this further assembly shifts only the blue beam, laterally.

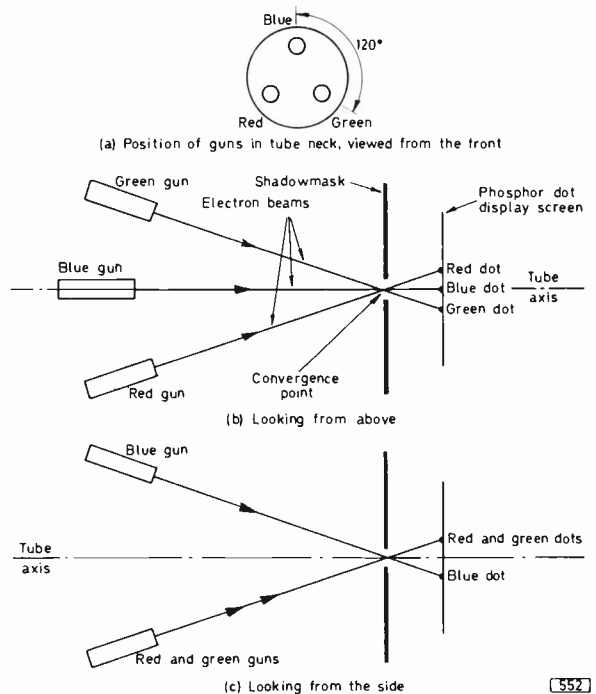

Fig. 1: The beams from the three guns must converge at the shadowmask. Static convergence ensures that this condition is met at the centre of the screen.



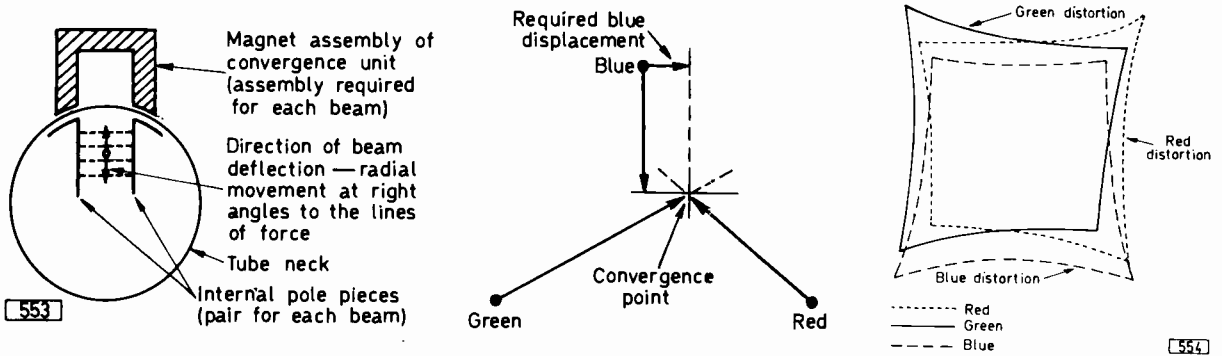

Fig. 2 (left): One limb of the radial convergence assembly: note how the pole pieces extend within the tube neck.

Fig. 3 (centre): It is generally necessary to shift the blue beam laterally as well as radially in order to get it to converge with the red and green beams. For this reason the blue lateral convergence assembly is fitted at the rear of the tube neck.

Fig. 4 (right): As the three guns are not mounted on the tube axis and the length of the beam paths alter over the screen area the basic rasters produced are subject to trapezoidal distortion as shown here. Dynamic convergence produces a common raster shape, residual pincushion distortion being removed by the transducer which intercouple the line and field scan circuits (see later).

Four different directions of movement are thus necessary to get accurate convergence at the centre of the screen. In most receivers these movements are provided by permanent magnets mounted on the convergence units and designed so that the field of each one can be adjusted separately.

In some models however—mostly those of European manufacture—electromagnets are used instead of permanent magnets. With this arrangement each field is produced separately by passing d.c. through the appropriate coil assembly. A potentiometer or variable resistor is provided so that the intensity of each field can be adjusted. The dynamic convergence coils are generally employed for the d.c.: they thus provide static convergence in addition to providing a path for the changing current required to obtain the dynamic convergence fields:

### Dynamic Convergence

Convergence problems are relatively easily solved at the centre of the screen: it is a different matter however to retain uniform convergence over the whole screen area. This is partly because the screen and the shadowmask do not form a sphere whose centre is on the deflection axis—if they did the curvature of the screen would be very far removed from the essentially “flat” screen required for convenient viewing.

Distortions occur therefore at the sides and corners of the screen. In other words we get trapezoidal distortion of each raster or picture, and because the three guns are not on a common axis each raster has a different trapezoidal shape—see Fig. 4. The three rasters fail therefore to register accurately over the screen area. There will be good registration in the middle of the picture—as a result of the static convergence applied—but at the outsides and corners the registration will fail, the red, green and blue components of picture elements being displaced. This gives an effect rather like a badly processed colour print. The problem is effectively a function of the different lengths of the beam paths as the

beams are deflected away from the centre of the screen. It is the job of the dynamic convergence system to compensate for this.

Fig. 4 shows the basic distortion of the red, green and blue rasters or pictures. To correct these distortions, magnetic fields changing at line and field frequency are required, adjusted so that the three displays are pulled into a common shape. Correct convergence is then obtained over the entire screen area (though the corners will not be 100%).

The pole pieces inside the neck of the tube (Fig. 2) produce the dynamic convergence fields as well as the static fields already discussed. Static correction is provided by a steady field for each beam while dynamic correction is provided by magnetic fields which change at both line and field frequency. Each beam must be subjected to both line and field correction then, so for the three beams there are three sets of coils in the main convergence assembly, one in each set providing the field for horizontal correction while the other in each set provides the field for vertical correction.

Each trapezoidal distortion shown in Fig. 4 is composed of two components. One component is pincushion distortion pure and simple. This results from the lack of coincidence of the scanning and screen radii. The other is asymmetry, resulting from the displacement of each gun from the tube axis.

Now because the pincushion component results from an increase in the length of the beams towards the sides of the screen, this increase following an essentially parabolic law, correction of this distortion is possible by energising the coils with a changing current having the same law. Thus correction in the vertical sense is provided by a parabolic current at field frequency while correction in the horizontal sense is provided by a parabolic current at line frequency.

The asymmetry on the other hand is countered by sawtooth currents, again at both line and field frequencies.

The convergence circuits are fed therefore with line and field timebase currents or pulses and process

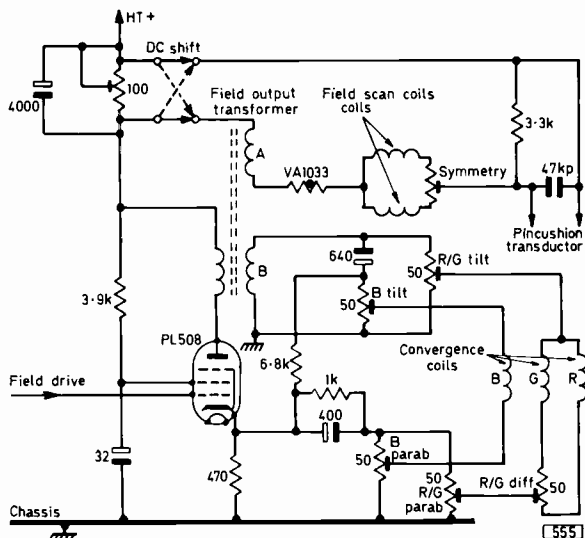

Fig. 5: Typical field (vertical) dynamic convergence circuit for use with a valve field timebase.

these in a manner to yield the required parabolic and sawtooth correction components. Controls are provided so that the mixture (tilt) and amplitude of the currents fed into the convergence coils can be preset.

The blue lateral assembly usually also incorporates a coil: this as would be expected is energised by current at line frequency.

The convergence coils may be series or shunt fed from the timebases. The former would be low impedance and the latter high impedance. The two correction components are obtained by integration and/or differentiation, depending on the exact design. A sawtooth waveform is produced by integrating a pulse waveform or differentiating a parabolic waveform, a parabolic waveform is produced by integrating a sawtooth waveform while a pulse waveform is produced by differentiating a sawtooth waveform. Quite a few alternative approaches to obtaining the various currents required are thus open to the designer.

## Field Convergence

Dynamic convergence circuits can be resolved into two main sections. One provides the current for the vertical convergence coils while the other provides the current for the horizontal convergence coils. A representative example (Mullard) of a field convergence circuit is shown in Fig. 5.

At the 50Hz field frequency this circuit represents an essentially resistive load to the field output stage. A sawtooth correction current is obtained from a separate secondary winding (B) on the output transformer—winding A supplies the scanning current to the field scanning coils via a thermistor in the usual manner.

The parabolic correction current is derived from the cathode circuit of the field output pentode (PL508). The cathode resistor of this valve passes a sawtooth current which is integrated by this resistor and the associated 400 $\mu$ F electrolytic so that the voltage at the cathode is parabolic.

The red and green coils thus have a sawtooth at

one side, via the R/G tilt preset, and a parabola at the other side, via the R/G differential preset. The amplitude of the parabola is adjustable by the R/G parabola preset. The blue coil is energised similarly but with a sawtooth from the blue tilt preset and a parabola from the blue parabola preset.

The R/G tilt preset adjusts the phasing of the sawtooth and thus provides the required left or right tilt to the waveform, zero tilt occurring at the centre setting. The blue coil needs current of opposite tilt (see Fig. 4) and this is provided by the blue tilt preset.

Owing to the low impedance at its earthy side the 400 $\mu$ F capacitor not only couples the parabolic current to the coils but also decouples the valve cathode. Some circuits of this type employ a centre-tapped output transformer secondary for the sawtooth current supply, the tap easing the function of phasing and hence tilt. However in Fig. 5 the circuit parameters automatically provide the tilt difference between the blue and red/green feeds over the range of the presets. The tilt in the blue circuit is provided by the 640 $\mu$ F capacitor.

Although this is not shown each convergence coil actually consists of two windings, one on each limb of the convergence yoke. The two are in each case connected in parallel to minimise the net impedance.

In transistor receivers it is common practice to obtain the convergence waveforms from the scanning current itself. Resistance is wired in series with the scan coils and it is the voltage developed across this that feeds the convergence coils. The voltage is roughly sawtooth, which is one requirement to start with, and since the resistive path is of low value compared to the shunt impedance of the convergence circuit the source is of essentially constant-voltage characteristics.

A circuit of this type is shown in Fig. 6. Current from the field output stage passes through the scanning coils, the 400 $\mu$ F d.c. blocking capacitor, the three arms of the convergence circuit and then back to source again: from the values of the resistors it will be appreciated that the net resistance in series with the scanning current path is very small.

The impedance of the convergence coils is such that the sawtooth voltage is integrated—which as we have seen means that each one passes a parabolic current. Owing to the somewhat distorted sawtooth waveform to start with however and the d.c. resistance of the convergence coils a sawtooth current component is also present in the coils. This tilts the waveforms.

The amplitude of the blue voltage is adjustable by the blue amplitude preset: it is across the effective resistance of this preset that the voltage for the blue coil is developed. Part of the voltage for the red and green coils is developed across the R/G amplitude preset: equal currents flow through the two coils when the R/G differential preset is balanced with respect to the R/G tilt preset. Current is also supplied via the 150 $\mu$ F capacitor: this current is roughly a sawtooth and appears across the R/G tilt preset. The net voltage across the red and green coils therefore is the vector sum of the voltages from the R/G amplitude and the R/G tilt presets, the latter varying the sawtooth component and hence the tilt of the parabolic current waveform.

The current is adjustable differentially between the red and green coils by the R/G differential pre-

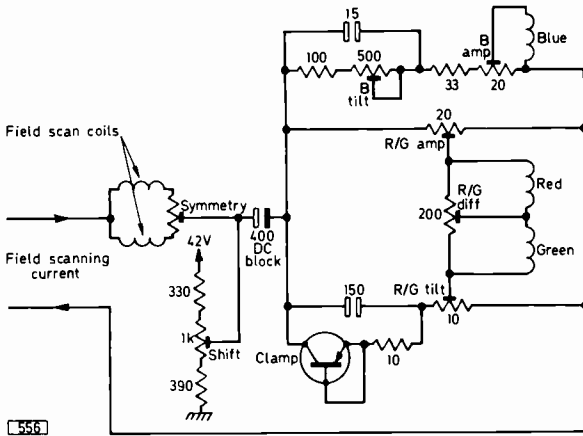

Fig. 6: Field convergence circuit for use with a transistor field timebase (circuit used in the BRC 2000 chassis). This low-impedance circuit uses the field scanning current for convergence purposes.

set. The converse tilt required for the parabolic current flowing in the blue coil is provided by the  $15\mu\text{F}$  capacitor working in conjunction with the blue tilt preset at the top of the circuit.

Diodes are often found in convergence circuits and as in Fig. 6 may consist of a transistor with its emitter and base strapped. This rectifies the red and green components so that direct current flows through the  $10\Omega$  resistor which develops a d.c. voltage. The purpose of this is to clamp the convergence waveforms to a steady value so that static convergence changes do not occur when the dynamic convergence presets are adjusted.

## Line Convergence

A common method of obtaining currents for the horizontal convergence coils is by dual integration. Line flyback pulses are first integrated to produce a sawtooth waveform and this is then integrated to produce a parabolic waveform. A circuit of this type is shown in Fig. 7. Line flyback pulses are applied simultaneously to the blue amplitude control and the R/G amplitude control via the  $1\mu\text{F}$  capacitor.

Starting with the blue circuit at the left, line pulses applied to the blue amplitude control inductance are integrated so that quasi-sawtooth current flows through the inductor and the blue tilt resistive preset. The voltage across this preset is also essentially sawtooth and is integrated by the inductance of the blue convergence coil so that parabolic current flows through it.

Current must also flow into the coil from the control inductor of course. The net current in the convergence coil is partly sawtooth and partly parabolic therefore, the parabolic current waveform in the coil being tilted by an amount determined by the relative impedance of the two inductances. The total series impedance of the blue coil network is adjustable by the blue tilt preset since this varies the impedance of the capacitive arm.

In many blue horizontal convergence circuits an inductive element resonated at line frequency by a capacitor is used to obtain a quasi-sinewave which modifies the net parabolic current waveform in the manner required for optimum correction: the induct-

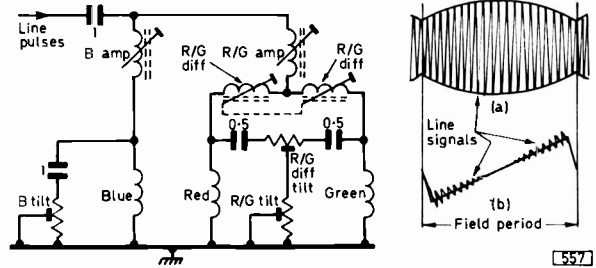

Fig. 7 (left): Line dynamic convergence circuit based on integrating line flyback pulses to produce the horizontal correction waveforms required. The Philips G6 chassis used this approach.

Fig. 8 (right): The basic idea of pincushion distortion correction, (a) line and (b) field, using a transductor to intercouple the field and line scan circuits.

ance is adjustable and is often labelled "blue parabola shape".

The red and green branches in Fig. 7 are arranged differentially by the split R/G differential control which is fed from the R/G amplitude control inductance. The ratio of currents in the red and green coils can thus be altered by the R/G differential control. There are two tilt presets in this circuit: one works differentially while the other works similarly to the tilt control in the blue circuit—in conjunction with the two  $0.5\mu\text{F}$  capacitors. These capacitors resonate the red and green coils to provide correction in the manner just explained.

## Controls and Additional Correction

Convergence correction currents can be obtained from a wide variety of circuit configurations and it would need a whole book to detail and explain them all. Often the correction currents are obtained from the line scan current, the convergence circuit then being effectively in series with the scanning coils as in the field circuit discussed earlier. Diodes or transistors strapped as diodes are commonly used in this type of circuit for clamping, and in dual-standard arrangements the diode circuits are often switched to maintain the correct static fields from the coils on the two line standards—one circuit may include a variable resistor for establishing the correct d.c. level.

While most of the controls in field circuits are resistive many of those used in the line circuits are inductive. Also in most sets dynamic blue lateral correction is used. This is usually based on the line flyback pulse drive technique, the inductive elements in the circuit integrating the pulses to provide sawtooth current for the blue lateral convergence coil. A variable inductor regulates the current rate-of-change at the start and conclusion of the correction waveform.

Symmetry controls are connected between the two halves of the scanning coils—generally a resistive control in the field circuit and an inductive one in the line circuit. These allow the currents in the two halves to be balanced, another requirement for correct overall convergence (otherwise the vertical or horizontal red and green lines in a crosshatch pattern cross over).

—continued on page 218

# FAULT FINDING GUIDE

1

John Law

## FIELD TIMEBASE BRC 900/950 CHASSIS

MOST field timebase circuits in general use today have been devised around the PCL85 valve or its later near-equivalent the PCL805. The Thorn/BRC group have used it exclusively for some ten years now. This article deals with the circuit employed in the widely used Thorn 900 and 950 chassis which are found in many dual-standard models in the Ferguson, Marconiphone, HMV and Ultra ranges and also in DER rental sets. In common with the sets produced by other manufacturers Thorn TV receivers have their share of field faults.

### Circuit Description

The circuit is shown in Fig. 1: we will outline its operation briefly and then go on to faults which have been traced and repaired in our workshops. The triode and pentode sections of the valve are cross-coupled in a multivibrator configuration, the pentode section also acting as the output stage driving the deflection coils via the field output transformer T3. During the scan period C81 charges from the boost rail via R127, R101 and R102. V8a is cut off during this period and the waveform generated across C81 is fed to V8b grid via C82, R104, R107/C87 and R109. The negative-going sync pulse cuts V8b off and by multivibrator action V8a is driven hard on, discharging C81 to chassis. As the multivibrator is stable V8a cuts off again and V8b starts to conduct. The process goes on repeating.

The voltage-dependent resistor Z2 across the primary of the field output transformer limits the field flyback pulse amplitude. Height stabilisation is provided by Z1 which stabilises the supply to C81 and

by the thermistor X2 which compensates for the increase in resistance of the field scan coils as they warm up. X2 is mounted on the scan assembly to sense the temperature change in the coils. C92 across the secondary of the field output transformer bypasses line-frequency harmonics induced in the scan coils. R139 and R140 across the coils provide damping to reduce ringing resulting from the line flyback.

The field linearity network is via C90 etc. from the anode to the grid circuit of the PCL85 pentode section. A second feedback circuit consisting of C83, R105 and C84 minimises the effect on interlacing of line pulses fed back from the scan coils.

The sync pulses are shaped by C86/R108 and C87/R107.

### Valve Faults

When servicing a field fault in the early days of the PCL85 changing the valve more often than not cured the trouble. With the introduction of the PCL805 reliability increased but the valve is still the first suspect when tackling field faults. The most common symptom it produces is height shrinkage with time. An internal electrode fault can cause the more serious troubles of a single white line across the screen or loss of field hold. An internal inter-electrode short usually shows other exterior symptoms such as a burnt pentode cathode resistor (indicating excessive current flow).

### Faulty Resistors

There is a tendency for small low-wattage current-carrying resistors to increase in value, increasing the voltage that develops across them. An example of this is R102 in the anode lead of V8a. In its early stages the fault is not evident as the gradual increase in value can be offset by adjusting R101 which is in series with it. Eventually however R101 will be set at minimum resistance: further increase in the value of R102 thereafter will mean that the scan height will no longer fill the screen and a gap will show.

It seems to be a general rule that the higher the resistance value of a small resistor the more prone it is to go high-resistance when carrying current within its wattage rating. Excessive current in any resistor tends to change its value.

### VDRs and Thermistors

A complaint we had of crackling and intermittent height variation caused much concentration over the circuit until it was found that the width was excessive and could not be controlled by the width potentiometer. This led us to concentrate on the boost line and eventually Z1 was found to be intermittent: replacement cured the fault.

Another unusual fault was cured by replacing the thermistor X2. As it is tucked away on the scan assembly this component tends to get overlooked. The symptoms were poor linearity and loss of height. Changing the PCL85 gave no improvement, and the pentode cathode bias components R112 and C89 were checked and found to be in order. Adjustment of the height and linearity controls to fill the screen made the picture roll. The triode anode voltage was high, the field output transformer primary winding d.c. resistance was correct but the d.c.

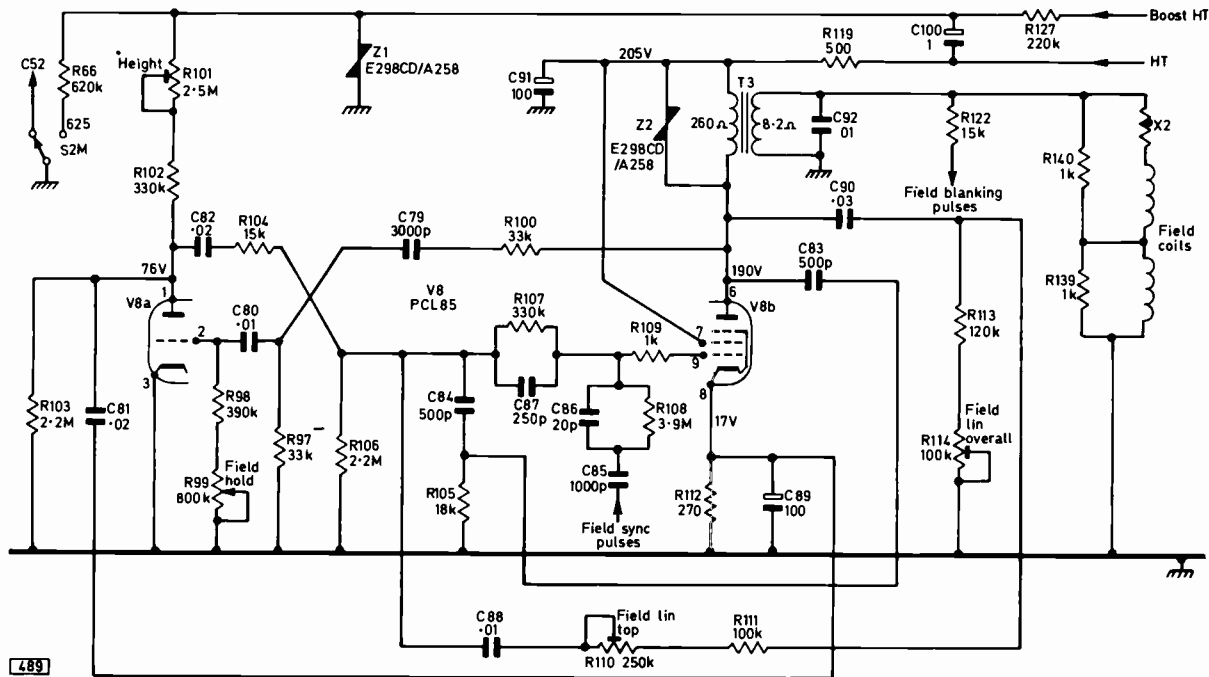

resistance of the scan coils read over  $100\Omega$  instead of  $22.5\Omega$ .

Thermistors and v.d.r.s are most easily tested by direct replacement: they are usually accessible and easy enough to change.

### Capacitor Troubles

Similarly the simplest way of checking capacitors subject to high-voltage pulses is by direct replacement: they are not expensive and this can save time and money. C79 in this circuit is a case in point. Although it is rated at 1,250V working it can fail and produces differing symptoms when it does. In one case the complaint was low field scan; in another the field hold was inoperative; in another the timebase was locking solidly at half speed; and in another there was very bad field linearity. In other instances two or more of these symptoms have been present. In all these cases replacement of C79 gave a complete cure.

Another fault which gave us trouble was described as occasional picture blinking. When it occurred it seldom gave time for decisive tests to be made. Meters left across the pentode anode, screen and cathode however eventually revealed spasmodic cathode voltage variations. Resistance checks then showed that the resistance from pin 8 to chassis varied between 100 and  $360\Omega$ . The fault was in the cathode bypass capacitor C89 and replacement effected a complete cure.

### Quick Tests

Working from common symptoms however, here is a list of quick tests:

*No field lock:* Check R98 and R108. Change C85, C86.

*Small picture:* R112, R127 C81, C89, C100.

*Bottom compression:* C89, C88, R114.

*Poor linearity top and bottom:* C82 and C81.

*Single white line across screen:* C100, C79-C83, output transformer winding open-circuit.

Field faults can of course originate in the PFL200 circuitry. Field hold faults for example can be due to weak sync as a result of a defective video valve or associated components.

Another fault due to a component not mounted on the timebase section of the panel shows as a half-size picture doubled over on itself: this has been found to be due to an open-circuit h.t. decoupler C91 which is in the main smoothing can.

The aim in presenting this information has been to help speed up fault location: it by no means covers all field fault possibilities. Common sense in diagnosis and a methodical approach works wonders in even the most obstinate cases.

**NEXT: ITT/STC-KB LINE TIMEBASES**

## LETTER: TUNER DRIFT

I have read your articles on servicing the BRC 1500 chassis with interest. The problem of tuner drift is as you say quite common but does not usually require return of the tuner to BRC. I service these chassis nearly every day and the following information may be of help to other readers.

The drift is usually caused by bad rotor shaft earthing. The remedy is as follows. With a fairly heavy soldering iron remove the earthing springs. Then clean off any grease and/or dirt from the rotor shaft and springs. Retension the springs by slightly bending them to a more acute angle and replace making sure that the soldering is good. This cure has never failed me yet.—A. B. Smith (Bletchley).

# THE 'TELEVISION' COLOUR RECEIVER

## PART 12

# TUNER/IF PREAMPLIFIER PANEL

FOLLOWERS of the colour receiver project will be aware from comments in the last couple of articles that we have had some problems in driving a number of constructors' i.f. strips using the Mullard type ELC1043 varactor tuner. The problems are greater with the earlier version of the tuner. Although a very large proportion of constructors would probably have enough u.h.f. signal to drive the tuner/i.f. strip combination we decided that things should be improved. An intermediate preamplifier has therefore been designed and fitted between the tuner and the i.f. strip. The operation of this amplifier is discussed later.

### The Tuner Panel

The printed circuit panel has to provide mounting for the tuner unit itself, the supply feeds required—power, delayed a.g.c. and automatic frequency control (d.c.)—the i.f. preamplifier and the various connections to the varactor control unit.

The decision to use the control unit specified—a different one which is no longer available was used in the original prototype—has led to one modification which involves additional connections to the a.f.c. section of the i.f. module.

### Types of Tuner

Three different tuners can be used with the given circuit and the pin connections provided on the p.c. board. Two of these tuners are for normal u.h.f. reception in the UK, the third is for v.h.f. reception—either from a wired relay system in the UK or in another country: Ireland, Germany and parts of the Commonwealth seem to be the popular places for construction outside the UK. All three tuners are Mullard ones, the u.h.f. units being the earlier and later ELC1043 and ELC1043/05 varactor tuners and the v.h.f. one the ELC1042. All other tuners—varactor or not—would unfortunately require the production of a completely separate printed circuit board. This is clearly not an economic proposition.

The external differences between the three recommended tuners are as follows. The ELC1043/05 has one pin less than the ELC1043. The additional pin on the latter—pin 9—is an i.f. injection point. On the ELC1043/05 this point is reached through an aperture close to the "pin 9" position. A pin 9 connection point is provided on the p.c. board (this need not be drilled if the /05 tuner is being used) but it is vitally important that no permanent connection is

made to this point. If the /05 tuner is used the i.f. injection point must be drilled in the printed circuit board in the position indicated for it on the layout diagram.

The ELC1042 tuner has an additional pin again: this is pin 3 which must be provided with a +12V supply in order to switch from Band I to Band III. We suggest that those constructors who will be operating their sets at v.h.f. use the switch on the left-hand end of the varactor control panel to switch this +12V supply rather than using it as the a.f.c. switch.

The aerial input to all three varactor tuners is the pin connection on the body of the tuner adjacent to pin 2. A screening connection must also be made at this point (see Fig. 5).

### Tuner Performance

There have been some misunderstandings about the use and performance of the two versions of the ELC1043 tuner. We would like to make it quite clear therefore that either version of the ELC1043 tuner can be used in the colour receiver. There are certain differences in performance but in the vast majority of cases these are immaterial. This does of course assume that the products supplied are band new and up to specification: it is up to the constructor to assure himself on this point.

On the straightforward performance specifications the /05 tuner has the edge on gain and noise. The relevant figures are these:

	ELC1043	ELC1043/05
Power gain on any channel	15dB min.	17dB min.
Noise factor		
channel 21	6.5dB	6.0dB
channel 68/69	9.0dB	7.0dB

Particularly in a deep fringe location where the higher channel groupings are used an /05 tuner is very certainly to be preferred and in the extreme case of having a signal just sufficient to give a display of entertainment value with all gains flat out the /05 tuner would be expected to give pictures of 4.5 dB better signal-to-noise ratio on channel 68 but only about 2dB better on channel 21.

### Frequency Stability

The frequency stability of the oscillator in the varactor tuner is vital for colour and must be within the control range of the a.f.c. from the i.f. module. It is also desirable to use the a.f.c. output direct

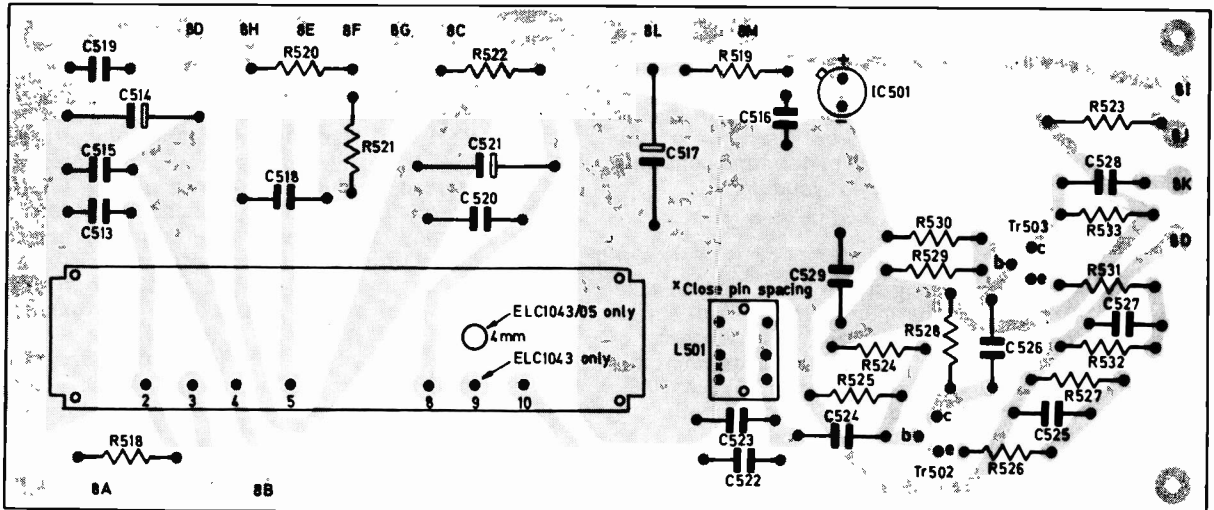

Fig. 1: Layout of the tuner unit/i.f. preamplifier panel, viewed from the copper side. The pin 3 connection is only required when using the ELC1042 v.h.f. varicap tuner—see text. Board size  $7\frac{1}{8}$  in. x  $3\frac{1}{8}$  in. Bend transistor leads as shown.

rather than to employ a form of d.c. amplifier as this introduces its own stability problems because of d.c. drift. Before considering this in more detail it is as well to comment on another point about differences between the ELC1043 and /05 tuners: this concerns the oscillator frequency drift with temperature for each type. The specifications quote a maximum drift of 600kHz on *any* channel for the ELC1043 and a maximum drift on *any* channel of 1MHz for the ELC1043/05. What seems to be overlooked in reading the specifications however is the range of temperature for each set of quoted figures. The drift for the ELC1043 is given for a temperature range of 25-40 deg. C; this is 40kHz/deg. C. The temperature range in the specification for the ELC1043/05 is given as 25-50 deg. C (an additional 10 deg. C)—40kHz/deg. C again! In fact one would also expect the drift at the higher temperatures (i.e. 40-50 deg. C) to be greater in proportion to that for every ten degrees below 40 deg. C; it is possible, indeed probable, therefore that the frequency drift with temperature over a working temperature range of 25-35 deg. C in a reasonably well ventilated cabinet would be less using the /05 tuner! The same may not be true in an all-valved receiver where the working temperature range may be rather higher.

Assuming a working temperature inside the cabinet of 25-40 deg. C the drift on either tuner can be assumed to be approximately 600kHz, i.e.  $\pm 300$ kHz. Warm-up accounts for another 200kHz maximum drift, making a total possible drift from switch-on of 800kHz, i.e.  $\pm 400$ kHz. These figures assume that the supply rails are constant which they should be for at least a -15% change in mains potential.

### Application of AFC

Because of the nonlinearity of the varactor diodes a tuning voltage change of 1V on these tuners has rather different effects at different ends of the u.h.f. spectrum. At the top end a 1V change gives about 10MHz tuning change; at the bottom end a 1V change gives about 16MHz tuning change. An

increasing potential increases the tuning frequency, a decreasing potential reduces the tuning frequency.

The worst a.f.c. output that is being accepted with the i.f. modules that pass through the alignment service is a peak-to-peak amplitude of 0.1V. Generally the average output is between 0.13 and 0.2V. With just 0.1V range there would be a frequency change capability of 1MHz at the top end of the spectrum and 1.6MHz at the lower end—both more than enough to cope with the absolute maximum drift that has already been evaluated. In practice these figures are bettered all round.

There is also of course the necessity for the a.f.c. system to have sufficient capture range. If we are expecting an absolute maximum drift of 800kHz the capture range—the bandwidth of the a.f.c. discriminator characteristic really—must be better than this. The minimum bandwidth of modules leaving the alignment service is 1MHz. The minimum specification for the a.f.c. output is shown in Fig. 2. It will be noticed that the output is positive below the vision carrier and negative above the vision carrier.

An example will show most clearly how the a.f.c. loop operates to correct any frequency drift. Imagine that the tuner is being used on a channel where the vision carrier is 800MHz and the sound centre frequency therefore is 806MHz. The oscillator in the tuner should then be operating at 839.5MHz, giving (by subtractive mixing) a vision carrier i.f. of  $839.5 - 800 = 39.5$ MHz and a sound centre i.f. of  $839.5 - 806 = 33.5$ MHz. If the oscillator in the tuner drifts upwards by 500kHz to 840MHz then

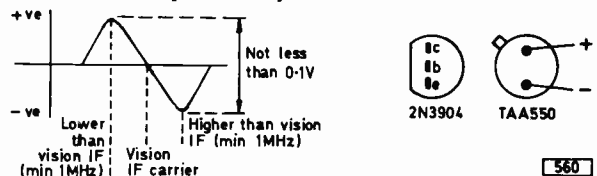

Fig. 2 (left): Minimum a.f.c. output specification.

Fig. 3 (right): Connection data, viewed from below.

the 800MHz vision carrier would become an i.f. of  $840 - 800 = 40\text{MHz}$ . The 500kHz increase in vision i.f. produces a *negative* a.f.c. voltage which reduces the tuning voltage fed to the tuner, so reducing the oscillator frequency again to bring the channel into tune. The servo characteristics of the loop will be determined mainly by the time-constants of the a.f.c. output from the i.f. module.

### Circuit Description

As we have been talking about a.f.c. we will take a look at this part of the circuit first. Fig. 4 shows the complete tuner panel circuit. The main a.f.c. output from 2F on the i.f. module feeds point 8F on the tuner panel. The "earthy" side (2G) feeds 8G. So the minimum 0.1V which will occur with any carrier drift in the tuner appears across R521. The time-constant of the output has already been determined by C163 on the i.f. module. Too slow a time-constant will result in a tendency to lose colour during receiver warm-up and the possibility of a tuning "lag". With too fast a time-constant it is possible that the tuning will oscillate around the correct point, in the worst cases producing an effect not unlike Hanover bars.

### Changing Channels

The a.f.c. must be removed when changing channel so that the control does not lock on to the first carrier that it sees when moving in frequency—usually the colour subcarrier because the sound is at too low a level in the i.f. strip. On the specified varactor control panel this requirement is provided by a small wire-lever switch which momentarily moves across as a new push-button is selected (a further note about this is given later). Unfortunately this switch connects to the chassis of the control unit: it has been found necessary therefore to isolate the control panel chassis and the main receiver chassis in order to use this switch. The connections to this switch at 8L and to the chassis at 8M are returned to the i.f. module where they short-circuit the secondary (L124/5) of the a.f.c. output transformer. This has been found to be the only satisfactory way of removing the a.f.c. completely: it is not sufficient just to short-circuit the "hot" side of the a.f.c. output because the "earthy" side then appears far less earthy than the really short-circuited side and an output (in reverse phase) appears at the "earthy" side.

It is important to note that if the time the a.f.c. switch takes to close is shorter than the time-constant of the a.f.c. output then the a.f.c. will in effect not be removed and the tuning will probably lock out.

A screened lead must be used for the connections from 8L and 8M back to the i.f. module otherwise hum may be present on the a.f.c. output—this would play havoc with the tuning!

### Tuning Voltage

The tuning voltage for the varactor tuner (pin 5) is derived from the +33V output from the power supply unit. It is fed in at point 8I and is shunt stabilised by the TAA550 (IC501). Note that for

a colour receiver a zener diode is *not* sufficient to hold tuning stability; as previously pointed out we are talking in terms of tenths of a volt causing MHz of tuning change.

The output across IC501 is smoothed by the filter circuit R519/C517 and the resultant voltage passed to the tuner control unit. It should be noted that a 3-4V spread in the performance of the TAA550 can be expected with different batches and the value of R519 may require changing from its nominal  $1\text{k}\Omega$  value in order to set the input voltage at 8C to 30V. The minimum value that would be required for R519 would be about  $390\Omega$  and the maximum value might be  $3\text{k}\Omega$ .

The varactor control unit consists of five preset potentiometers each with a series switch on the slider output, a switch being closed when a button is depressed. The selected voltage is decoupled by C518. The voltage level at 8F therefore is identical to that set up by the particular switched potentiometer selected, and this voltage adds to the a.f.c. voltage which is also fed to this point. R520 in the feed to the tuner itself acts as a current limiter.

### AFC Muting

For initial tuning purposes it is desirable to be able to mute the a.f.c. This could be done by keeping the selected tuning button fully depressed, so that the small lever switch already mentioned makes. This is unsatisfactory however because of the mechanical difficulty of both depressing and turning a button (↓), and also because we have found from forwarded samples that very few of the small lever switches operate fully when the buttons are depressed farther than their normal lock position even though they operate correctly—momentarily—when the channel is initially selected. The tension of these switches cannot be reset effectively. For these reasons the separate switch on the control panel (at the left-hand end) is used for killing the a.f.c. during initial tuning. When this switch is operated the control potential is fed direct to the tuner instead of through R521/R520, the a.f.c. voltage across R521 being ineffective of course.

### VHF Operation

Constructors who intend to operate at v.h.f. may be using this switch for Band I/III changeover: in this case another switch will be needed for a.f.c. on/off. Alternatively but not perhaps so neatly the separate switch could be the band-changing switch. The +12V supply needed for switching may be taken from the +33V rail via a suitable dropper.

### LT and AGC Feeds

As noted in a previous article (Part 10) the d.c. supplies for the tuner are derived from different sources because of the wide variation in current drain by the r.f. amplifiers in the tuner with changing gain control. The +12V r.f. amplifier supply is from 6M on the power supply unit and is applied to 8B on the tuner panel. It is decoupled to both l.f. and h.f. by C514 and C515. The feed from the power supply is already series stabilised.

The +12V supply for the oscillator/mixer stage



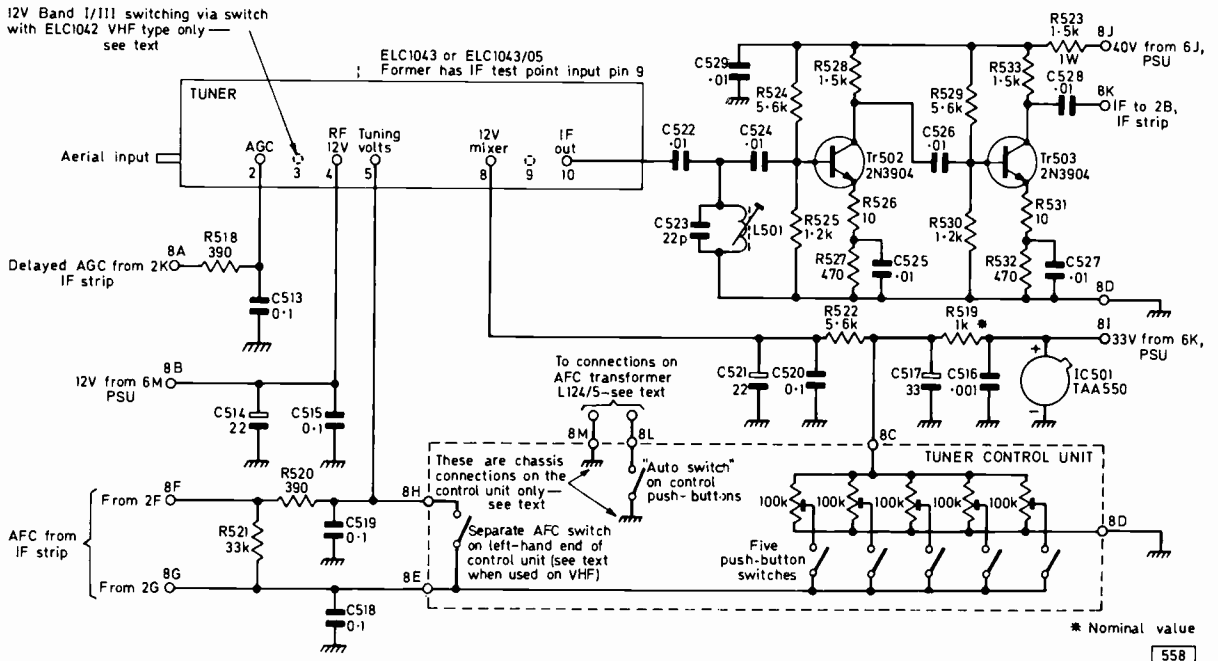

Fig. 4 : Circuit of the i.f. preamplifier and tuner connections.

of the tuner is derived from the regulated tuning voltage supply: for the 3.6mA current taken by this stage R522 must be 5.6kΩ. This feed is again i.f. and h.f. decoupled, by C521 and C520.

The delayed forward a.g.c. feed to the tuner is passed from 2K on the i.f. panel to 8A on the tuner panel. A current limiting resistor (R518) is included in the feed and the line is decoupled by C513. The potential divider circuitry is included on the i.f. panel and has been described previously (Part 3).

**IF Preamplifier**

The preamplifier is a little unusual. It is basically wideband (the upper -3dB point with the layout used for the prototype was in fact about 95MHz) but one tuned circuit is necessary at the input in order to complete the bandpass tuner output circuit. The feed from the i.f. output point on the tuner (pin 10) to the input point of the preamplifier is only about 1 1/4 in. and no further matching capacitance is needed. Using a low-Q coil for L501 gives tuning which is not very critical and does not affect the i.f. passband.

Any amplifier which is going to be placed in a wideband feed must have an extremely tight linearity characteristic. If not intermodulation distortion will be produced between the various carriers present. Tests on the preamplifier show that the non-linearity is rather less than 1%. The basic voltage gain of the two-stage circuit is about 60—using a nominal 16V rail—while the noise addition to the detected video signal was found to be immeasurable.

C522 acts as an additional precautionary d.c. block at the tuner output, C523/L501 form the required bandpass tuned circuit secondary while C524 provides a d.c. block between the transistor base bias (R524/R525) and the coil L501. Both transistor stages are identical. The base bias is about 2.8V and

has a high stability ratio. The value of the collector load resistors (1.5kΩ) is optimised for the application and the signal levels involved. Broadband coupling is used between stages.

The preamplifier is operated from the 40V field timebase power rail (i.e. from 6J on the p.s.u.), the input to the tuner panel being at 8J. The 16mA current required by the two stages necessitates a dropper (R523) of 1.5kΩ with a 1W rating. The use of the unregulated 40V supply is quite in order as the amplifier gain is relatively insensitive to supply voltage variations.

It is emphasised that the transistors (type 2N3904) used in this preamplifier cannot be changed to any other type without a re-optimisation of the component values, while the layout of the printed circuit board must be either very close or identical to the one produced for the project.

**Constructing the Module**

One mechanical part has to be made for the module. This is the small earthing plate for the input coaxial lead from the aerial socket. The dimensions are shown in Fig. 5 and although this is best made of aluminium (say 18 or 20 gauge) many constructors may find it easier to use a small piece of brass.

Drill the component mounting holes then insert the tuner. Although the tuners are well packed by

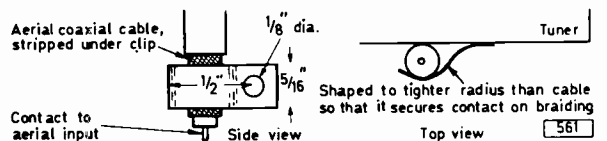

Fig. 5 : Fixing clip for the input lead shielding.

559

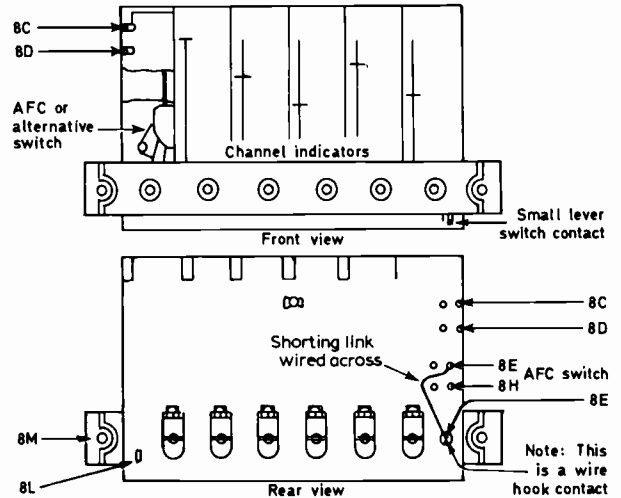
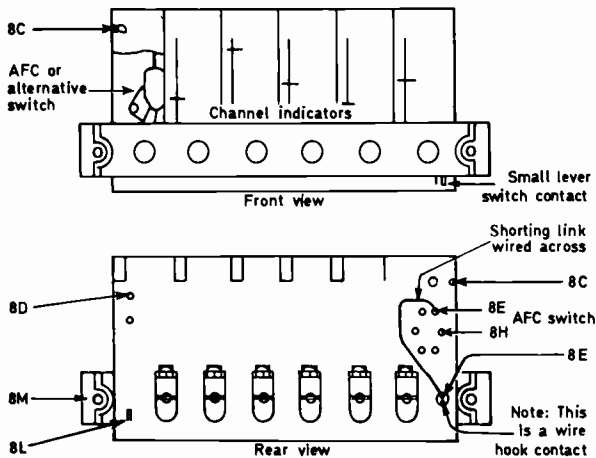

Fig. 6: Either of these two varactor tuner control units may be supplied in Pack 15 (Manor Supplies). Each has five 100k $\Omega$  potentiometers in parallel plus switch. Version 1 (left) has black pushbuttons and is of lower height; version 2 (right) has grey pushbuttons and is taller.

**Table 1: Components List**

**Component—Pack 20**

R518 390 $\Omega$	R526 10 $\Omega$
R519 1k $\Omega$ *	R527 470 $\Omega$
R520 390 $\Omega$	R528 1.5k $\Omega$
R521 33k $\Omega$	R529 5.6k $\Omega$
R522 5.6k $\Omega$	R530 1.2k $\Omega$
R523 1.5k $\Omega$ , 1W	R531 10 $\Omega$
R524 5.6k $\Omega$	R532 470 $\Omega$
R525 1.2k $\Omega$	R533 1.5k $\Omega$

All  $\frac{1}{2}$ W, 5% carbon film except R523.

\* This is a nominal value and is the one that will be supplied with the pack. It may need to be altered in some circumstances—see text.

C513 0.1 $\mu$ F	C522 10nF
C514 22 $\mu$ F, 25V	C523 22pF
C515 0.1 $\mu$ F	C524 10nF
C516 1nF	C525 10nF
C517 33 $\mu$ F, 40V	C526 10nF
C518 0.1 $\mu$ F	C527 10nF
C519 0.1 $\mu$ F	C528 10nF
C520 0.1 $\mu$ F	C529 10nF
C521 22 $\mu$ F, 25V	

Minimum voltage ratings of the electrolytics are indicated; the values of the electrolytics need not be exact. C523 is a mica or polystyrene 5% type, all others may be polystyrene, polyester or ceramic with a minimum voltage rating of 40V.

L501 9 turns of 38 s.w.g. en cu or t.n.a. wound on a Neosid 722/1 former with 6/900 core and 5027/6PLD base and can.

Tr502 2N3904 Tr503 2N3904  
Coaxial cable with aerial socket (u.h.f.); cable length 9in.

**Suppliers**

Pack 20 Electrokit, 12 Lauderdale Road, London W9.

Cost: £2.10 including postage.

Printed Circuit Board ( $\frac{3}{16}$ in.):

E. J. Papworth & Son Ltd., 80 Merton High Street, London, SW19.

Cost: £1.00 including postage.

Note: IC501 supplied in Pack 17.

the suppliers you will almost certainly find that the pins need a little straightening before insertion in the board. Press the tuner through until it rides on the ledges of the four mounting pins at its corners. The tuner should then be soldered down, including these four corner mounts (these may be twisted slightly before soldering to improve the job mechanically).

All the other components should now be mounted, starting with the coil (L501) and then the capacitors, the resistors and finally the i.c. and two transistors. The usual heat precautions must be taken with the transistors, the i.c. and the tuner connections to the board. The i.c. should be mounted about  $\frac{1}{4}$ in. above the board but the two transistors should be mounted virtually on the board.

For reference purposes the connections to the two sorts of varactor control unit are shown in Fig. 6: the interconnections will be described later.

Blank boards ( $\frac{3}{16}$ in. thick) cut to size are available at 50p each including post and packing from Servitronix Ltd., 26 Killarney Road, London SW18.

**Matters Arising**

Mention of the supply to the low-voltage stages on the RGB board was omitted in Part 10. The feed should be taken from point 6N on the power supply unit, the current requirement being calculated along with the decoder supply. The -8V supply required by the decoder will be described when we come to the c.r.t. base panel. Several readers have written about the value and rating of R501: we shall be commenting on this next month.

Mr. Papworth has asked us to convey apologies to readers for the delay that occurred in supplying the power supply printed panels: production of these was held up by the Christmas holidays.

A 20in. Toshiba shadowmask tube is available from RB Television, 82 North Lane, East Preston, Sussex, at the attractive price of £42.50 plus £1 carriage (delivery 21 days), including insurance and a 1 $\frac{1}{2}$  year replacement guarantee. It is a standard 90° push-through type. —continued on page 234

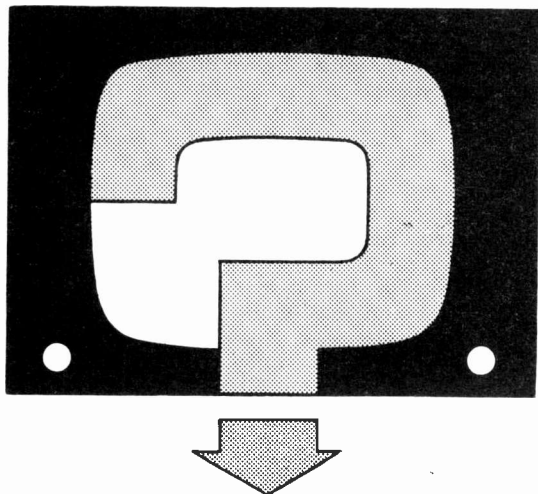

# YOUR PROBLEMS SOLVED

★ Requests for advice in dealing with servicing problems must be accompanied by a 10p postal order (made out to IPC Magazines Ltd.), the query coupon from page 235 and a stamped, addressed envelope. We can deal with only one query at a time. We regret that we cannot supply service sheets or answer queries over the telephone.

## PETO SCOTT 236

When the set is first switched on there is a loud buzz and hum and pulling to the right over the top two inches of the picture. The sound becomes normal after about ten minutes. The main electrolytics have been changed but the faults remain. There is also pulling on whites and the picture creeps up at the bottom even though the PCL85 bias decoupler has been replaced. When the picture first appears it comes and goes with accompanying clicks on sound. This clears when the sound becomes normal: the pulling also clears though it does occasionally occur with normal sound.—J. Atkins (Barnsley).

We are not at all sure that the hum and pulling to the right are due to the same cause. There are two h.t. lines in addition to the main one: C36 decouples the h.t. line to the audio output stage and should be checked, as should the PCL82 audio valve; C15 decouples the other h.t. line and should also be checked. Check the PCL84 V6, noting that the pentode video stage section has a bias stabiliser resistor: this (R16 12k $\Omega$ ) and its cathode resistor R19 (180 $\Omega$ ) should be checked. The contraction at the bottom of the picture should lead to suspicion of the PCL85 field timebase valve and its cathode bias resistor R63 (330 $\Omega$ ).

## GEC BT302

There is on all channels a series of white flickering lines on the left-hand side of the screen. The lines vary in width but are usually over a 5-6in. vertical band from top to bottom. The stronger the picture the weaker these lines appear but they can only be tuned out at the expense of the sound. The picture is otherwise good for a set of this age and a new set of valves has been fitted to bring it up to scratch.—T. Livingstone (Harlow).

Check the following capacitors: C107 (0.01 $\mu$ F) which decouples the line output valve screen grid, C126 (0.1 $\mu$ F) which decouples the slider of the brightness control and C149 (0.5 $\mu$ F) which decouples the c.r.t. first anode. It is possible that the cause of the trouble is intermittent ringing or brushing in the line output circuit.

## MARCONIPHONE VT170

Resistors R53 and R54 on the i.f. board were found to be burnt out. They were replaced and the i.f. valves checked for shorts but on switching on these two resistors started to heat up and smoke.—B. Smith (Crewe).

The fact that these two resistors, which actually feed the mixer pentode in the tuner, burn up means that there is a short-circuit somewhere. First check C52 on the i.f. panel. If this is OK turn attention to the tuner, checking the i.f. output feedthrough capacitor C20 (the ceramic may be discoloured or cracked where the lead connects) and the PCF86 mixer/oscillator valve which may have an internal short.

## DECCA MS2000

The picture is weak with a foldover which takes the form of a thin vertical line just left of centre. On increasing the brightness the picture balloons and disappears: the contrast control gives a similar effect. All line timebase valves have been tested and either found to be OK or replaced as necessary.—R. Horton (Ruislip).

Replacement of the boost reservoir capacitor C134 (0.1 $\mu$ F) should clear the fault. If not you will have to check the set boost control VR107 and the associated resistors, first R170 (1M $\Omega$ ) then R169 (1M $\Omega$ ), R146 (2.2M $\Omega$ ) and the v.d.r.

## EKCO T433

The problem with this set is a rolling picture. The PCL85 field timebase valve has been changed, also the PCL84 video/sync separator. The picture can be held, but only with two pictures and a  $\frac{3}{4}$ in. black band between.—A. Rowan (Stoke).

One half of the field multivibrator consists of the triode section of the PCF80 V11. Try changing this. Then check the interlace diode V16 (M3) by shorting it out. Another suspect is the field sync pulse integrating capacitor C83 (220pF) which may have lost capacitance.

**NEXT MONTH IN**

# TELEVISION

## TOUCH TUNING

The latest development in television receiver design is touch-sensitive tuning, using touch-button units which provide a completely non-mechanical means of channel changing. A very high-impedance electronic switching circuit selects the required channel when a finger is placed across a pair of contacts to complete the appropriate circuit. Several models featuring touch tuning are now on the market and next month we shall be investigating the technique and the circuitry involved. The change from mechanical to all-electronic channel selection should improve the stability and reliability of TV tuning.

## BAND III PREAMPLIFIER

Another Bunney wideband aerial amplifier intended for DX work. The two-transistor (BF272) design on test lifted a weak signal from mere traces of line sync pulses to a solidly locked noisy image. Part of Roger's present programme of improving his DX receiving equipment.

## SERVICING

Plenty on the servicing front next month. John Law in his new fault-finding series investigates the line timebase used in most KB-STC models. Vivian Capel completes his guide to power supply circuit servicing. Les Lawry-Johns starts on the single-standard **Bush-Murphy TV181S/V2016** series. And Caleb Bradley takes us further with the BRC 2000 colour chassis.

## PLUS ALL THE REGULAR FEATURES

**ORDER YOUR COPY ON THE FORM BELOW**

TO.....  
(Name of Newsagent)

**Please reserve/deliver the APRIL issue of TELEVISION (20p), on sale March 19, and continue every month until further notice.**

NAME.....

ADDRESS.....

.....

## GEC 2019

It is impossible to lock the picture on 405 lines. On 625 lines the picture is OK until a car passes when lock is lost until the car has gone. I have changed the PFL200 and the components feeding the video signal to the sync separator section of this valve. The flywheel line sync discriminator diodes would be replaced but I am having difficulty obtaining the correct type.—G. Packmire (Southport).

You would do well to change the diodes mentioned: a pair of OA91s can be used. Then if necessary check and replace the diode load resistors R113 and R116, the sync pulse couplers C160 and C162 and, in the sinewave line oscillator circuit, the common cathode resistor R122 and the tuning capacitors C168 and C169.

## PHILIPS 19TG171A

The sound is good and the vision reasonable. However in crowd scenes the people at the back have bright negative faces. The brightness and contrast controls both operate normally. With a raster only displayed there are alternate light and dark vertical bands down the screen, approximately  $\frac{1}{4}$  to  $1\frac{1}{2}$  in. in width. The PFL200 and the a.g.c. clamp diode X206 have been replaced without any improvement being obtained.—J. Ranger (Greenwich).

Unfortunately the first effect you describe suggests that the c.r.t. is getting slightly soft and may therefore need replacement in the near future. The vertical striations are generally due to the line linearity control damping resistor R501 being open-circuit. It is mounted on the line output transformer.

## COLOUR RECEIVER PROJECT

—continued from page 232

Aerial sockets with 9in. length of coaxial cable can be obtained separately from Forgestone Components or Manor Supplies at 30p each including post and packing.

### Component Pack 21

Scan coil yoke, radial convergence yoke and blue lateral assembly. Either Plessey, Mullard or Philips units will be supplied—full details of connections will be given next month. Note that it is essential to state tube size when ordering. (This applies also to Pack 19, the automatic degaussing components—a number of readers have omitted to do this, resulting in extra correspondence and delays.)

**Supplier:** Manor Supplies, 172 West End Lane, London NW6. Price £10 plus 35p post and packing.

Note that the price given above applies up to the introduction of VAT on April 1st: it may be necessary for suppliers to revise prices after that date.

Either of two blue lateral assemblies, the AT1025/05 or AT1025/06 may be supplied: the former should be used with the coils connected in parallel—details next month.

The scan coils and convergence assemblies are also available at £10.35 (including post and packing) from Forgestone Components, Ketteringham, Wymondham, Norfolk.

## GEC 2041

The screen flickers to green about ten minutes after switching on. Sometimes the green disappears after a few seconds; sometimes, if the trouble is more persistent, pressure on the channel selector button or a quick switch off and on again returns things to normal, after which the picture remains normal. Sometimes however no amount of tapping or switching makes any difference and the set has to be turned off. If it is turned on say an hour later the picture is normal again. With the fault present and the colour control backed off to minimum the raster is green instead of black and white. If the contrast control is turned to maximum with the colour control similarly set the excess green is almost overcome—but at the expense of picture quality.—F. Maddox (Beeston).

Since the colour control has no influence on the fault the trouble is due to incorrect tube biasing or a faulty green colour-difference output stage clamp. The following components are suspect and should be checked: the G-Y output clamp V408b (PCL84) and the G-Y output coupling components C417 (0.002 $\mu$ F) and R425 (8.2M $\Omega$ ) on the output panel; and the 22M $\Omega$  resistor R611 from the green first anode to chassis and plug 20-2 on the convergence panel.

## PHILIPS 23TG175A

The set operates perfectly on 405 lines but on 625 there is an effect similar to hum in the line timebase. This creeps slowly down the picture. If the contrast or sensitivity controls are turned down the fault disappears. The components around the video amplifier PFL200 have been checked and all valves tested in case of heater-cathode leakage.—I. Muldoon (London W6).

We think the most likely offenders are the main electrolytics even if only through a poor earth connection. You should however try the effect of shunting a 1M $\Omega$  resistor across R258, the PFL200 video amplifier grid leak resistor on 625 lines. Further points to check if necessary are the a.g.c. clamp diode X206 (BA115) and the PFL200 screen decoupler C255 (20 $\mu$ F).

**QUERIES COUPON**

This coupon is available until March 19 1973 and must accompany all Queries sent in accordance with the notice on page 233. Don't forget the 10p postal order!

**TELEVISION MARCH 1973**

# TEST CASE

## 123

Each month we provide an interesting case of television servicing to exercise your ingenuity. These are not trick questions but are based on actual practical faults.

**?** A very recent colour receiver came in with the symptom of horizontal brightening across the middle of the screen, with a slight colour tint along the bright section. The receiver was operating perfectly normally prior to this and the symptom appeared to have no effect at all on the luminance or chrominance sections of the receiver or on the locking of the field timebase.

Since the bright line was horizontal it was concluded that the fault was in the field timebase, but as this was transistorised it was not easily possible to test—as in valve receivers—by changing the active components. It was noticed that two power transistors were used in the field output stage but changing these failed to cure the fault. In fact the replacement pair tended to worsen the symptom slightly.

Closer examination revealed that the brightening

effect was caused by line compression, rather like a sudden change to non-linear operation half way through the field scan. The linearity over the rest of the field scan was excellent and adjustment of the two preset linearity controls merely impaired the overall linearity without unduly changing the middle compression. The other presets in the circuit were not adjusted.

What should this symptom have immediately indicated to the service technician and why were the power transistors changed unnecessarily? See next month's TELEVISION for the solution to this problem and for a further item in the Test Case series.

### SOLUTION TO TEST CASE 122

Page 187 (last month)

The clues which should have led the service technician to the source of the fault were (1) the collapse of the line scan and the gradual fade out of the vertical line and (2) the overheating of the line output valve: (1) indicates a collapse of e.h.t. as well as line scan energy while (2) indicates lack of line drive and hence collapse of grid bias (which is derived from the drive signal) with a consequent heavy rise in line output valve anode current.

It was eventually found that the lack of line drive was the result of intermittent breakdown of a capacitor coupling line flyback pulses to one of the phase discriminator diodes in the flywheel-controlled line oscillator circuit. Replacement solved the problem.

# TELEVISION CLASSIFIED ADVERTISEMENTS

The pre-paid rate for classified advertisements is 6p a word (minimum 12 words), box number 20p extra. Semi-display setting £3.50 per single column inch. All cheques, postal orders, etc., to be made payable to TELEVISION and crossed "Lloyds Bank Ltd." Treasury notes should always be sent *registered post*. Advertisements, together with remittance, should be sent to the Classified Advertisement Manager, TELEVISION IPC Magazines Ltd., Fleetway House, Farringdon Street, London, EC4A 4AD, for insertion in the next available issue.

## AERIALS

### U.H.F. (625) 18 ELEMENT T.V. AERIALS

As used by Leading Companies  
Receives BBC1, BBC2, ITV  
black and white or  
colour. Can be used  
inside or outside.  
Complete with  
mounting  
bracket.

**£1.90** plus  
34p p.p.

Please state your  
nearest transmitting  
station.  
Low Loss VHF Coaxial ... 10p yard  
Coaxial Plugs ..... 10p each  
Callers Welcome. C.W.O.  
**DAMON ELECTRONICS**  
118/120 Arkwright St., Nottingham  
Tel. 0602-865688

Direct from the  
Manufacturers

### U.H.F. AERIALS

EASY ASSEMBLY KITS

10 Element **SAVE**

**£1.25** **40%**

14 Element 18 Element  
**£1.50** **£1.75**

Mast clamp optional extra.  
Ready assembled add 20p,  
allow 35p carriage and packing.  
Please state which channels or group.

**TRADE SUPPLIED, SEND FOR LIST**

### APEX AERIALS (T.V.)

ALBAN WORKS, MARY ST  
JOHNSTONE RENFREWSHIRE

### CUT PRICE UHF AERIALS

10 element UHF Ae. with grid reflector  
and tilt clamp, completely assembled,  
state Ch. group, £1.15. Chimney lash  
kits for 1"-1 1/2" poles, 75p, 6' 1" masts,  
60p. Aerialite low-loss coax, 8p/yard.  
Aerialite std. coax 4p/yard. Coax plugs  
(all metal), 5p each. P. & P. on aerials  
40p, accessories, 20p. All items complete  
with instructions. Please send s.a.e. for  
complete list of aerials, accessories, all  
at drastically reduced prices. **HANDLEY  
AERIALS**, 65 Alkincoats Road, Colne,  
Lancs.

**BAINES** for High Frequency Aerials.  
UHF Multibeams by J. Beam

MBM 10, £2.20; MBM 18, £2.90;  
MBM 30, £3.90; MBM 46, £6.00;  
MBM 70, £11.00.

VHF FM Aerials  
Dipole, £1.40; FM/H, £2.00; FM3,  
£3.00; FM4S, £5.55; FM6S, £7.80.

Masthead Pre-amps  
Single Stage, £6.00; Two Stage, £8.00;  
Wideband, £7.00.

Accessories: SAE for full list.

Co-ax, 5p; low loss, 9p.

11 Dale Cres., Tupton,  
Chesterfield S42 6DR.

### GENUINE FULL SIZE 18 element TV aerial

as used by leading  
TV companies

FOR ONLY  
**£1.99**  
+35p p.p.



ITV BBC 1/2  
Black/White  
and Colour  
Guaranteed  
Perfect Pic-  
tures. Save  
££. We supply  
this genuine  
U.H.F. aerial for  
only £1.99, can be  
fitted inside or in-  
side. Quality made,  
technically advanced  
design. Precision grid  
reflector eliminates ghost-  
ing. Complete with clamp,  
instructions, advice.

Money Back Refund. Wall/  
Caravan Bracket 25p. Low Loss  
Cable 10p per yard. Plug 8p &  
FREE with order maps & channel  
reference of all Radio and TV  
Transmitters.

Send Direct to Dept P.T.10, 219  
Mansfield Road, Nottingham

**IMPERIAL TRADING (AERIALS) LTD.**  
the quality Aerial Specialists

**UHF AERIALS.** High Gain 10  
Element, only £1.50. Post and  
Packing Free. Please state channels  
or transmitter.

### TRU VISION

9 Fleet Street, Stepany Lane,  
Hull, Yorkshire.

## FOR SALE

UHF and VHF televisions for sale to  
the trade, UHF from £6, VHF from  
£1, over 1,000 televisions in stock  
including at least 500 tested workers,  
we can deliver to any part of the  
country. Tel: Kidderminster 61907,  
Bewdley 2796 or call at Midland TV  
Trade & Retail Services, 115 Mill  
Street, Kidderminster and pick your  
own sets.

### BBC 2 TVS **£7.50** Including Delivery

Thorn 850 Chassis with UHF  
Tuner. Ex-rental sets sold com-  
plete but unserviced, with re-  
polished cabinets. Rush £7.50. Cash  
with Order.

### U.H.F. TUNERS

For Ferguson 850, 900 Chassis,  
but adaptable for most D/STD  
Chassis, £2.50 each, C.W.O., post-  
age included.  
Send S.A.E. for list of TVs, Tubes,  
Valves, etc. Allow 10-14 days  
delivery.

### TRADE DISPOSALS

Midlands & North: 1043 Leeds  
Road, Bradford 3.  
Scotland: Unit 5, Peacock Cross  
Industrial Estate, Burnbank Road,  
Hamilton.  
Cornwall: Pencoys, Four Lanes,  
Redruth.

**OSCILLOSCOPE** Heathkit 10-12 U 5",  
new condition £45, Carriage extra.  
"TELE-SERVICE", 50a, Higher Bore  
Street, Bodmin. Tel. 2011.

**BUSH** CTV167 similar to CTV25.  
Decoder fault. Bargain at £100. 34  
Dagnall Crescent, Cowley, Uxbridge,  
Middlesex.

## BOOKS AND PUBLICATIONS

### DX-TV

The illustrated booklet, "Long  
Distance Television" by Roger W.  
Bunney is again available, covering  
all aspects of the DX-TV hobby.  
Contents include: World-wide chan-  
nel allocation charts, signal propa-  
gation, receiver requirements with  
basic modification details, aerials and  
preamplifiers, "off-screen" photo-  
graphy, station identification, test  
cards, etc.

The publication, costing 50p (in-  
cluding surface postage world-wide)  
is available from:

### WESTON PUBLISHING

33 Cherville Street, Romsey,  
Hants SO5 8FB

**WORLD RADIO TV HANDBOOK**  
1973, authoritative source of informa-  
tion about broadcast stations, used by  
listeners, viewers, stations and en-  
gineers, £2.80, postage (first class) 10p.  
Fortnightly World Radio Bulletin, £3.13  
(ask for sample copy), David McGarva,  
Box 114M, Edinburgh EH1 1HP, Giro  
17 412 0001.

## SERVICE SHEETS

## LARGE SUPPLIER of SERVICE SHEETS

(TV, RADIO, TAPE RECORDERS,  
RECORD PLAYERS, TRANSIS-  
TORS, STEREOGRAMS, RADIO-  
GRAMS, CAR RADIOS)

Only 40p each.

**PLEASE ENCLOSE LARGE S.A.E. WITH  
ALL ENQUIRIES AND ORDERS.**

Otherwise cannot be attended to.

(Uncrossed P.O.'s please, original  
returned if service sheets not available)

### C. CARANNA

**71 BEAUFORT PARK,  
LONDON, N.W.11**

We have the largest supplies of Service  
Sheets (strictly by return of post).  
Please state make and model number  
alternative.

Free TV fault tracing chart or TV list on  
request with order.

**MAIL ORDER ONLY**  
or Phone 01-458 4882.

## ★ SERVICE SHEETS • MANUALS • BOOKS ★

**SERVICE SHEETS** OVER 12,000 SERVICE SHEETS AND MANUALS IN STOCK ON RADIOS, TV's, R.PLAYERS AND T.RECORDERS, ETC... **SERVICE SHEET** 30p + Postage PLEASE ENCLOSE S.A.E. WITH ENQUIRIES... **Catalogue 20p.**

NEW BOOKS & PUBLICATIONS	PRICE	P. & P.
1. COLOUR TELEVISION SERVICING by G.J. King. 332 pages.	£4.40	30p
2. COLOUR TELEVISION PICTURE FAULTS by K.J. Bohlan. Illustrated in Colour . . . . .	£2.50	15p
3. MAZDA BOOK OF PAL RECEIVER SERVICING by D.J. Seal. FS.E.R.T.M.R.T.S. 288 pages . . . . .	£3.80	30p
6. T.V. TECHNICIAN'S BENCH MANUAL by G.R. Wilding. 187 pages. 127 illustrations . . . . .	£2.25	15p
9. BEGINNERS GUIDE TO TELEVISION 5th Edition by G.J. King. 212 pages. Illustrated . . . . .	£1.60	15p
30. RADIO TECHNICIANS BENCH MANUAL by H.W. Hellyer. 215 pages. 131 illustrations . . . . .	£3.00	15p
36. TRANSISTOR AUDIO AND RADIO CIRCUITS by Mullah Ltd. 230 pages. New Edition . . . . .	£1.80	15p
38. SERVICING WITH THE OSCILLOSCOPE by G.J. King. 176 pages. . . . .	£1.80	15p
44. TAPE RECORDERS by H.W. Hellyer. Guide to Purchase & Operating. 239 pages. . . . .	£2.25	15p
57. THE HI-FI AND TAPE RECORDER HANDBOOK by G.J. King. 304 pages. . . . .	£2.00	20p
62. GUIDE TO PRINTED CIRCUITS by G.J. King. 140 pages. 95 illustrations . . . . .	£2.50	15p
76. RADIO, TV & AUDIO TEST INSTRUMENTS. 2nd Edition by Gordon J. King . . . . .	£3.80	30p
85. MANUAL OF SOUND RECORDING. 2nd Edition by J. Aldred. 269 pages. . . . .	£3.50	15p
87. PICKUPS & LOUDSPEAKERS by John Earl. 203 pages. 156 illustrations . . . . .	£3.00	15p
88. PUBLIC ADDRESS HANDBOOK. A Manual of Sound Reinforcement by V. Capel . . . . .	£3.00	15p
123. AUDIO TECHNICIANS BENCH MANUAL by John Earl. 182 pages. 114 illustrations. . . . .	£3.00	15p
124. TUNERS & AMPLIFIERS by John Earl. 187 pages. 127 illustrations . . . . .	£2.10	15p
125. WORD RADIO-TV HANDBOOK 1972. Immense amount of tabulated matter . . . . .	£2.80	25p
126. VIDEO-RECORDING RECORD & REPLAY SYSTEMS by G. White. 216 pages . . . . .	£3.25	20p

Send S.A.E. for Free Lists of Practical and Technical Books on Radio & Television now available to

### BELL'S TELEVISION SERVICES

Albert Place, Harrogate, Yorks. Tel. 0423-86844

### A.L.S. SERVICE SHEET SERVICE

OUR STOCKS NOW COVER OVER 10,000 MAKES AND MODELS  
1973 list covering mono and colour—TV,  
Radio, Tape, Record Players, etc. List price 25p, plus SAE.

**Service Sheets**—Service price 30p plus LARGE SAE.

Manuals for many makes. Enquiries welcome but please—a SAE.  
Always state make, model number and whether TV, radio, tape, etc.

**NEW SERVICE SHEETS**, Magazines and Newsletter. SAE brings details and free sample.

#### BARGAIN CORNER

Metal box containing Heavy Duty 12V 2PCO Relay OC35 (type) transistor and other components (originally fluid level control unit) price 50p.

MAIL ORDER ONLY

A.L.S.

21c Dryden Chambers, 119 Oxford Street, London W1R 1PB

### SERVICE SHEETS

(1925-1972) for Radios, Televisions, Transistors, Radiograms, Car Radios, Tape Recorders, Record Players, etc.  
By return post with

FREE FAULT FINDING GUIDE

PRICES FROM 5p

Over 8,000 models available.  
Catalogue 15p

Please send stamped addressed envelope with all orders and enquiries.

### Hamilton Radio

47 Bohemia Road, St. Leonards, Sussex. Telephone Hastings 29066.

**SERVICE SHEETS**, Radio, TV etc. 8,000 models, Catalogue 15p. S.A.E. enquiries. Telray, 11 Maudland Bank, Preston.

### SETS & COMPONENTS

#### EX RENTAL TV's BARGAIN

23" 3 Channel with U.H.F. Tuner	£7.50
23" 2 Channel	£4.00
19" 3 Channel with U.H.F. Tuner	£5.50
19" 2 Channel	£1.50
All sets complete. Callers only.	

EDWARDS & SONS

103 Goldhawk Road, London W.12.

INCREASE YOUR PROFITS!

## TELEBAR

London's Cut-Price  
Wholesalers

S/H UHF Transistor Tuners	£1.75
S/H UHF Valve Tuners	£1.25
VHF Indoor Aerials	75p
UHF Indoor Aerials	75p
Ex-Rental 3 Station TV's	£2.25
Single Wave Radios	£1.45
Jumbo Radios	£4.35
Teleton 12" Colour	£123.00
Elizabethan Bat./Mains 12"	£49.50
Full range of Eagle, Sinclair, Teleton, Elizabethan, Indesit, Koyo, etc. All at Trade Prices.	

TELEBAR 01-743 2502

87 Gayford Rd, Shepherds Bush W12  
Callers Welcome S.A.E. for free lists

TVs TVs TVs TVs

All Sets Complete but untested  
No Scrap!

19" Thorn 850 with UHF Tuner

19" Bush or Murphy with UHF  
Tuner—Push Button Models

£10.50 each + £1.50 carriage  
S.A.E. FOR LISTS

LINAVALLE RADIO LTD.

48 HOE ST., LONDON, E.17

01-520 7546

### BUILDING A COLOUR TV?

Already got a TV? Then fit our 4 channel TOUCH TUNING UNIT. Drives Mullard etc. varicap tuner. At last, no moving parts! Kit including drilled PC board, instructions, and all electronic components for £4.75 (post free). Add the final touch to Your Television!

L. COOK,

7 Plumtree Close, Prescott, Lancs.

BRAND NEW

A61-120W / R 24" TUBES

£10 + £1 carriage

State Mullard or Mazda

NVR, 38 Front Street West,  
Bedlington, Northumberland  
Tel. 822790

Television's Colour Receiver Epoxy Glass P.C.B.'s, drilled and tinned. Decoder, I.F. Strip, Timebase, Power Supply £2.00 each. R.G.B. Module £1.25 each. Convergence Boards £3.25 per set.

Cash with Order.

Electronic Design Services Ltd.,  
Bolholt Works, Walshaw Road, Bury,  
Lancs.

specialist components for colour  
sales & consultants s.a.e. for catalogue

# forgetstone

## components

KETTERINGHAM

WYMONDHAM NORFOLK TEL 0603 810453

**NEW TV VALVES  
TOP QUALITY—  
DIRECT FROM FACTORY**

DY 86 .23	PCF 801 .30
ECC 82 .19	PCL 82 .29
EF 80 .21	PCL 84 .32
EF 183 .25	PCL 86 .36
EF 184 .25	PCL 805 .37
EY 86 .27	PL 36 .46
PC 86 .44	PL 81A .43
PCC 84 .28	PL 504 .60
PCF 80 .30	PY 81 .23

post & packing 3p per valve  
**ACORDELECTRONICS Ltd,**  
5 High St., Guildford, Surrey.

**Top 20 Plus Tested T.V. Valves.**

PL504 18p	PCL84 10p
PC86 15p	PCL82 10p
PC88 15p	PFL200 10p
PL36 15p	ECC82 10p
PCL805/85 15p	EH90 10p

**Colour Valves Fully Tested.**

PL509 30p	PD500 30p
PL508 30p	GY501 30p
PY500/A 30p	PL802 30p

Many others available including Mazda types.  
P. & P. 4p per valve, over 12 2½p per valve, orders over £3 post free.  
Prompt service.  
S.A.E. for free list.  
**L. & D. Components Ltd.,**  
71 Westbury Ave, London N22 6SA.  
Tel. 01-888 2701.

### BARGAIN T.V.'s

Slim Line

23" 3 channel with UHF tuner	£9.00
19" 3 channel with UHF tuner	£8.00
23" 2 channel	£5.00
19" 2 channel	£3.50

All sets working. Personal callers welcome.

Carriage can be arranged.

Open Fridays - Mondays inclusive.

### PLASGWYN WAREHOUSE,

Caernarvon Road, Fourcrosses,  
Pwllheli, Caernarvonshire.  
Tel.: Pwllheli 2800.

For quality Hi-Fi Equipment, records and Colour Television, Visit  
**HANSPAL'S AUDIONICS**  
488 Lady Margaret, Southall, 01-578 2258; 54 St. Anns Road, Harrow, 01-863 3400. 24 hours Autophone Service. Marantz, Pioneer, Sansui, Akai, Rotel, Nikko, Lux, Telefunken, Sony, Sanyo, Lux, Tandberg, Hitachi, Grundig, Scandyna, KEF, TEAC, National, Quad. Telefunken, Hitachi, Sony and Grundig Colour T.V. Always in stock.  
Up to 5 years Colour Tube guaranteed and 1 year Free Servicing and Labour. Late evening: Friday until 7.00 p.m.  
**EXCELLENT CREDIT FACILITIES**

**TOP PRICES PAID**  
for new valves, popular  
TV & Radio Types

**KENSINGTON SUPPLIES**  
(A), 367 Kensington Street  
Bradford 8, Yorks

## T.V. SPARES

Ex-equipment valves 10p each + P. & P. 2½p each. U.H.F. Transistor Tuners Complete with slow motion drive £2.95 + 25p P. & P.

**EX RENTAL.** 3 Programme 19" T.V.s. Tested Working £10. + P. & P. £2.

### CALLERS WELCOME

By appointment.

3 Programme T.V. chassis. No tuners, but complete with L.O.P.T. etc. £1.25. CALLERS ONLY.

**D. G. REEVES (T.V.) LTD.,**  
26A Standish Street, Burnley.  
Telephone Burnley (0282) 21230.

**150 NEW Capacitors/Resistors/Silicon Diodes. Electrolytic. Mica. - Ceramic. Carbon. Oxide etc. £1 Post Free.**  
Whitsam Electrical, 33 Drayton Green Road, London. W.13.

**TRANSISTORISED U.H.F. Tuners £1 inc. P. & P. V.H.F. with valves, rotary or P.B. 75p inc. P. & P. C.P. Trading,**  
15 Cavour Road, Sheerness, Kent.

## EDUCATIONAL

### TRAIN FOR SUCCESS WITH ICS

Study at home for a progressive post in Radio, TV and Electronics. Expert tuition for City & Guilds (Telecoms Techn's Cert. and Radio Amateurs') R.T.E.B., etc. Many non-exam courses incl. Colour TV Servicing, Numerical control & Computers. Also self-build kit courses—valve and transistor.  
*Write for FREE prospectus and find out how ICS can help you in your career.*

**ICS, DEPT. YA 100, INTERTEXT  
HOUSE, STEWARTS ROAD,  
LONDON SW8 4UJ.**

## COLOUR T.V. SERVICING

Be ready for the coming Colour TV boom. Learn the techniques of servicing colour TV sets through new home-study courses specially prepared for the practical TV technician, and approved by leading manufacturer.

Full details from ICS, (D.750E1),  
Intertext House, London SW8.

**ENGINEERS**—get a technical certificate. Postal courses in Engineering, Electronics, Radio, T.V., Computers, Draughtsmanship, Building, etc. **FREE** book from: BIET (Dept ZC BTV 13), Aldermaston Court, Reading, RG7 4PF. Accredited by CACC.

## SITUATIONS VACANT

**MEN!  
£50 p.w.  
can be yours**

**Jobs galore!** 144,000 new computer personnel needed by 1977. With our revolutionary, direct-from-America, course, you train as a Computer Operator in only 4 weeks! Pay prospects? £2500 + p.a. After training, our exclusive appointments bureau—one of the world's leaders of its kind—introduces you **FREE** to world-wide opportunities. Write or 'phone **TODAY**, without obligation.

**London Computer Operators**

Training Centre

P7, Oxford House

9-15, Oxford Street, W.1.

Telephone: 01-734 2874

127, The Piazza, Dept. P7,  
Piccadilly Plaza, Manchester 1.  
Telephone: 061-236 2935

## MISCELLANEOUS

**Build the Mullard C.C.T.V. Camera**  
Kits are now available with comprehensive construction manual (also available separately at 65p.)

SEND 5 X7 S A E FOR DETAILS TO

**CROFTON ELECTRONICS**  
15/17 Cambridge Road, Kingston-on-Thames, Surrey KT1 3NG

### COLOUR—COLOUR—COLOUR

**Big Price Reductions**  
19" and 25" Colour Televisions.  
Decca-Bush-Murphy-Philips, etc.  
19" Working £105  
25" Working £135  
All Good Tubes, Tested before despatch. Delivery can be arranged. Also non-worker from £80.  
S.A.E. Details.

T.E.S.T.  
P.O. Box 1, Kirkham, Preston  
PR4 2RS.

### T.V. CABINET PROBLEM?

Give your set the professional finish it deserves, with a **BRAND-NEW** cabinet—specially made for us from selected woods. Ready cut-out for latest 24" tube, but no other holes drilled—i.e. ready to take your choice of tuner and chassis.

**WALNUT, TEAK or MAHOGANY VENEERED FINISH**  
£4.80, or 'in the white' £3.50, plus carr. 70p.  
Matching stand only £2.95 + 50p carr.  
**SUMKES, 7 High Street, Langley, Warley, Worcs.**



## COLOUR TELEVISION TRAINING

**11 WEEKS' COURSE** for men with Mono experience. Hours 10 a.m. to 1 p.m. Monday to Friday. Next course commences April. Prospectus from: London Electronics College, Dept. T/3, 20 Penywern Road, London, SW5 9SU. Tel. 01-373 8721.





# PHILIP H. BEARMAN,

**A LEADING NAME IN  
NEW  
VALVES AND TUBES  
(★ONE YEAR GUARANTEE)**

Suppliers to H.M. Government **QUANTITY TERMS B/WHITE TUBES**  
LARGE STOCKS BY LEADING BRITISH AND FOREIGN MANUFACTURERS  
TUBES GUARANTEED 2 YEARS, COLOUR 4 YEARS! ALL EX STOCK

<i>FOR EXAMPLE :</i>		* Rebuilds		Open Saturday mornings	
CME1702, AW43-80, CRM173, MW43-80, MW43-69* CRM172, AW43-88, AW43-89, CME1705, CME1703 C17AF	17"	<b>£5.87p</b>	<i>Cge.</i> <b>55p</b>	*TSD282	11" <b>£12.50</b>
CME1903, CME1902, CME1901, AW47-90, AW47-91, A47-14W, C19AH	19"	<b>£6.87p</b>	<b>60p</b>	A28-14W(Mullard)	11" <b>£11.00</b>
CME2101, AW53-88, AW53-89, CRM211, CRM212, MW53-20, MW53-80, CME2104	21"	<b>£7.87p</b>	<b>65p</b>	MW31-74	12" <b>£3.00</b>
CME2303, CME2301, AW59-90, AW59-91 A59-15W, CME2308	23"	<b>£9.50p</b>	<b>65p</b>	TSD290/CM1201	12" <b>£9.80</b>
				*13BP4	13" <b>£14.00</b>
				MW36/24 & 44	14" <b>£4.75</b>
				CME1601	16" <b>£7.50</b>
				CME1602	16" <b>£10.00</b>
				CME1906}	19" <b>£11.00</b>
				A47-13W}	19" <b>£11.00</b>
				A47-11W & 26W	19" <b>£8.50</b>
				A50-120W/	
				CME2013	20" <b>£10.50</b>
				CME2306}	23" <b>£15.00</b>
				A59-13W }	23" <b>£15.00</b>
				A59-11W & 25/23W	23" <b>£11.50</b>
				CME2413	24" <b>£13.00</b>
				CME2501	24" <b>£17.00</b>
				Rebuilt CME1908}	1903} <b>£5.50,</b>
				Rebuilt CME2308}	.. 2303} <b>£7.50</b>

OPTIONAL BREAKAGE INSURANCE, ETC. 50p per tube.

## COLOUR TUBES

4 YEAR GUARANTEE

19" A49.11X,	A49.120X	<b>£49.00</b>	plus £1	carriage
22" A55.141X,	A56.120X	<b>£53.00</b>	plus £1	carriage
25" A63.11X,	A63.200X	<b>£57.00</b>	plus £1	carriage
26" A67.120X	A66.120X	<b>£59.00</b>	plus £1	carriage
	(as available)			

*All prices net trade, old glass not required.*

*We endeavour to maintain prices but all are subject to alteration without notice. Enquiries s.a.e.*

**NOTE** From 1st April 1973, a tax of probably 10% will be added for all tube prices.

**6 POTTERS ROAD, NEW BARNET, HERTS. TEL: 01-449/1934 (Robophone) and 449/1935**

All enquiries welcomed. All prices NET trade to all!

For the  
amateur and  
craftsman alike

PRACTICAL

# WOODWORKING

the magazine for  
detailed how-to-do-it  
features covering  
every aspect of  
working with wood

**PLACE A REGULAR ORDER  
TODAY Out monthly 25p**

## THE NEW UM4 "COLOURBOOSTER" UHF/625 LINE

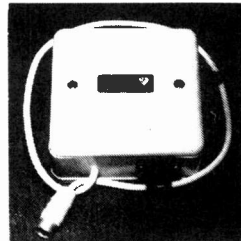

**CAN PRODUCE  
REMARKABLE  
IMPROVEMENTS IN  
COLOUR AND  
PICTURE QUALITY  
IN FRINGE OR  
DIFFICULT AREAS  
WITH SIGNIFICANT  
REDUCTION IN  
NOISE (SNOW).**

HIGH GAIN—VERY LOW NOISE  
FITTED FLY LEAD—INSTALLED IN SECONDS  
HIGHEST QUALITY COMPONENTS  
IVORY PLASTIC CASE 3½ x 3½ x 1½ CORK BASE  
CHANNELS: Group A, Red code 21-33  
Group B, Yellow code 39-51  
Group C-D, Green code 52-68

*EQUALLY SUITABLE FOR BLACK AND WHITE*  
**Also the M4 DUAL BAND VHF UNIT**

BOOSTS ALL BAND III and ANY SPECIFIED  
BAND I CHANNEL SIMULTANEOUSLY  
NOMINAL GAIN 16-18 DB BOTH BANDS

*PRICES BOTH TYPES:*

**£3.75** Battery model or **£5.87** Self-contained mains version  
Postage and Packing 13p

**TRANSISTOR DEVICES LIMITED**  
6 ORCHARD GARDENS, TEIGNMOUTH, DEVON  
Telephone: Teignmouth 4757



# FREE!

## Over 150 ways to engineer a better future

HIGHER PAY

A BETTER JOB

SECURITY

### find out how in just 2 minutes

That's how long it will take you to fill in the coupon below. Mail it to B.I.E.T. and we'll send you full details and a free book. B.I.E.T. has successfully trained *thousands* of men at home - equipped them for higher pay and better, more interesting jobs. We can do as much for YOU. A low-cost B.I.E.T. home study course gets results fast - makes learning easier and something to look forward to. There are no books to buy and you can pay-as-you-learn.

Why not do the thing that really interests you? Without losing a day's pay, you could quietly turn yourself into something of an expert. Complete the coupon (or write if you prefer not to cut the page). No obligation and nobody will call on you . . . but it could be the best thing you ever did.

#### Others have done it, so can you

"Yesterday I received a letter from the Institution informing that my application for Associate Membership had been approved. I can honestly say that this has been the best value for money I have ever obtained - a view echoed by two colleagues who recently commenced the course".—Student D.I.B., Yorks.

"Completing your course, meant going from a job I detested to a job that I love, with unlimited prospects".—Student J.A.O. Dublin.

"My training with B.I.E.T. quickly changed my earning capacity and, in the next few years, my earnings increased fourfold".—Student C.C.P., Bucks.

#### FIND OUT FOR YOURSELF

These letters - and there are many more on file at Aldermaston Court - speak of the rewards that come to the man who has given himself the specialised know-how employers seek. There's no surer way of getting ahead or of opening up new opportunities for yourself. It will cost you a stamp to find out how we can help you. Write to B.I.E.T. Dept, BTV2 Aldermaston Court, Reading RG7 4PF



<b>MECHANICAL</b> A.M.S.E. (Mech.) Boiler Inspection & Operation C & G Eng. Crafts C & G Fabrication Diesel Eng. Eng. Inspection Eng. Metallurgy Inst. Eng. & Tech. Inst. Motor Ind. Maintenance Eng. Mechanical Eng. Sheet Metal Work Welding	<b>Man. Prod.—cont.</b> Salesmanship Storekeeping Work Study Works Management <b>DRAUGHTSMANSHIP</b> A.M.I.E.D. Design of Elec. Machines Die & Press Tool Design Electrical Draughtsmanship Gen. Draughtsmanship Jig & Tool Design Technical Drawing	<b>Constructional-cont.</b> Building Drawing Building Foreman Carpentry & Join. Civil & Municipal Engineering Constructional Construction Surveyors Institute Clerk of Works Council Eng. Geology Health Eng. Heat & Vent. Hydraulics Inst. of Builders Inst. Clerk of Works Inst. Works & Highway Supers. Painting & Dec. Public Hygiene Road Engineering Structural Eng. Surveying
<b>ELECTRICAL &amp; ELECTRONIC</b> A.M.S.E. (Elec.) C & G Elec. Eng. C & G Elec. Inst. C & G Elec. Tech. Computer Elect. Elec. Maths Elec. Science Electronic Eng. Electrical Eng. Install. & Wiring Meters & Measuring Instruments	<b>COMMUNICATIONS</b> Colour TV C & G Radio/TV/ Electronics C & G Telecomm. Tech. Prac. Radio & Elec. (with kit) Radio Amateurs Exam. Radio Servicing & Repairs Radio & TV Eng. Transistor Course TV Main. & Serv.	<b>GENERAL</b> Agricultural Eng. Council of Eng. Inst. Farm Science General Education Gen. Plastics Pract. Maths Pract. Slide Rule Pure & Applied Maths Refrigeration Rubber Technology Sales Engineers Tech. Report Writing Timber Trade University Ent.
<b>MANAGEMENT &amp; PRODUCTION</b> Automatic Control Computer Prog. Electronic Data Processing Estimating Foremanship Inst. Cost & Works Accountants Inst. Marketing Management Production Motor Trade Man. Network Planning Numerical Control Operational Research Personnel Man. Planning Eng. Production Eng. Quality Control	<b>AUTO &amp; AERO</b> Aero Eng. A.M.I.M.I. A.R.B. Cert. Auto Engineering Auto Repair C & G Auto. Eng. Garage Management MAA/IMI Diploma Motor Vehicle Mechanics <b>CONSTRUCTIONAL</b> A.M.S.E. (Civil) Architecture Building	<b>G.C.E.</b> 58 'O' & 'A' LEVELS SUBJECTS Over 10,000 group passes

Coaching for many major exams, including HNC, ONC, C & G, etc.

## POST TODAY FOR A BETTER TOMORROW

To B.I.E.T., Dept. BTV2, Aldermaston Court, CV BTV2  
Reading RG7 4PF



NAME.....  
Block Capitals Please  
ADDRESS.....

SUBJECT OF INTEREST..... AGE.....

Accredited by the Council for the Accreditation of Correspondence Colleges.

### BRITISH INSTITUTE OF ENGINEERING TECHNOLOGY