

PRACTICAL TELEVISION

3/6

JUNE
1970

TV in the DARK

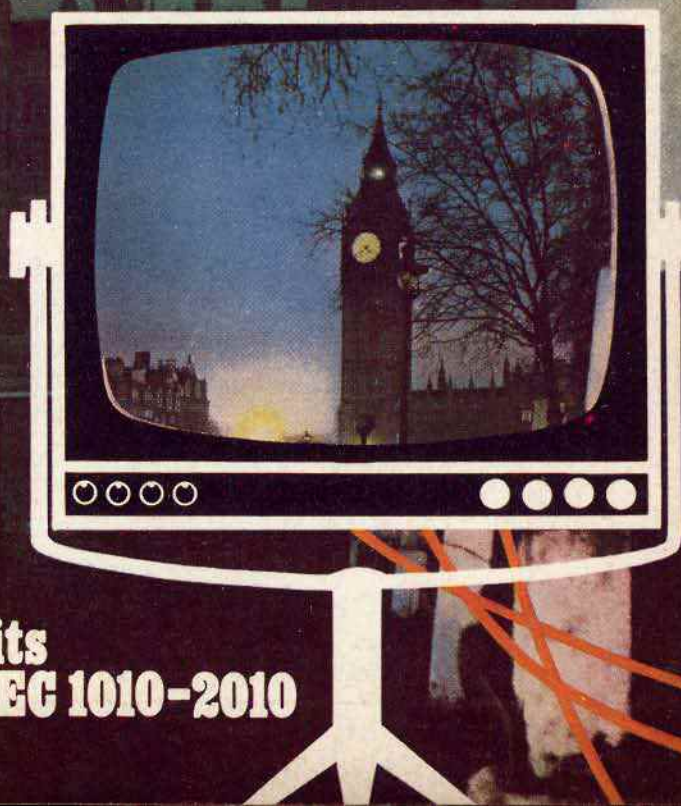

also:

R-Y Phase Alternation

TV Power Supply Circuits

Servicing the Sobell-GEC 1010-2010

BENTLEY ACOUSTIC CORPORATION LTD.

38 CHALCOT ROAD, CHALK FARM, LONDON, N.W. 1
THE VALVE SPECIALISTS Telephone 01-722 9090
SAVE POSTAL COSTS! CASH AND CARRY BY CALLERS WELCOME

| | | | | | | | | | | | | | |
|-------|------|-------|------|--------|------|--------|------|--------|------|--------|---------|-------|------|
| 0A2 | 5/9 | 6B8G | 2/6 | 6P25 | 12/- | 12AT6 | 4/6 | 30PL14 | 14/6 | A2134 | 10/6 | D133 | 6/- |
| 0B2 | 6/- | 6B1A6 | 4/6 | 6P26 | 12/- | 12AT7 | 3/6 | 30L1 | 6/2 | A3012 | 15/- | D135 | 4/9 |
| 0Z4 | 4/6 | 6B2E | 4/9 | 6P28 | 25/- | 12A16 | 4/9 | 30L15 | 13/9 | AC2PEN | 12/- | D192 | 5/9 |
| 1A3 | 4/6 | 6B8H | 7/6 | 6Q7 | 8/6 | 12A17 | 4/6 | 30L17 | 15/6 | 19/6 | D194 | 5/9 | |
| 1A5 | 5/- | 5B36 | 8/6 | 6Q7G | 6/- | 12A18 | 5/6 | 30P4 | 12/- | AC2PEN | DL96 | 7/- | |
| 1A7GT | 7/6 | 6BQ5 | 4/9 | 6R7 | 11/- | 12A1X | 4/6 | 30P4MR | 12/- | BD | 19/6 | D1410 | 9/9 |
| 1C5 | 4/9 | 6BQ7A | 7/- | 6R7G | 7/- | 12A1Y | 7/9 | 30P4 | 12/- | AC2PEN | 7/6 | D170 | 6/- |
| 1D5 | 7/6 | 6B8T | 10/9 | 6R7GT | 7/- | 12A1Z | 6/- | 30P19 | 12/- | AC/PEN | 5/9 | DM71 | 7/6 |
| 1D6 | 9/6 | 6B8R | 12/6 | 6SA7M | 7/6 | 12B2E | 5/9 | 30P19 | 12/- | 19/6 | DW43508 | 6/- | |
| 1FD1 | 6/6 | 6B8T | 25/- | 6SC7GT | 6/6 | 12B17 | 6/- | 30PL1 | 13/9 | AC/PEN | 7/6 | DY86 | 5/9 |
| 1FD9 | 4/6 | 6B8W | 13/- | 6SG7 | 6/- | 12E1 | 17/- | 30PL15 | 15/6 | 19/6 | DY87 | 5/9 | |
| 1G6 | 6/- | 6B26 | 6/- | 6SH7 | 3/6 | 12K5 | 10/9 | 30PL14 | 15/- | AC/TH1 | 10/- | E50F | 24/- |
| 1H5GT | 7/- | 6C6 | 3/9 | 6S7 | 6/6 | 12K7 | 10/9 | 30PL15 | 15/- | 10/- | E50F | 24/- | |
| 1L4 | 2/6 | 6C9 | 14/6 | 6S7GT | 6/6 | 12K7GT | 6/9 | 35A3 | 10/- | AC/TP | 10/6 | E83F | 24/- |
| 1LD5 | 6/- | 6CD6G | 23/- | 6SN7GT | 4/6 | 12Q7GT | 6/9 | 35A3 | 15/- | AC/VP | 10/6 | E83C | 12/- |
| 1LN5 | 9/- | 6C6H | 6/- | 6SN7GT | 4/6 | 12S7 | 8/- | 35D5 | 12/6 | AL60 | 15/6 | E180F | 19/- |
| 1N3GT | 7/6 | 6C6L | 8/6 | 6SQ7GT | 7/6 | 12S7G | 8/- | 35L16 | 8/6 | AR73 | 7/- | E180C | 22/6 |
| 1B5 | 5/6 | 6C9W | 12/- | 6T4 | 4/3 | 12S7GT | 8/6 | 35W4 | 4/6 | ATP4 | 2/9 | E1148 | 10/6 |
| 1B4 | 4/9 | 6D3 | 7/6 | 6U7G | 7/- | 12S7G | 4/6 | 35Z10T | 4/9 | AZ1 | 8/- | E180 | 11/- |
| 1B5 | 4/9 | 6D6 | 3/6 | 6V4G | 6/6 | 12S7H | 3/6 | 35Z10T | 4/9 | AZ1 | 9/6 | E186 | 8/- |
| 1U4 | 5/9 | 6F1 | 12/6 | 6V6GT | 6/6 | 12S7J | 4/6 | 35Z10T | 4/9 | AZ1 | 10/6 | E186 | 8/- |
| 2P21 | 6/6 | 6F1G | 12/6 | 6X4 | 4/3 | 12S7K | 4/9 | 35Z10T | 4/9 | AZ1 | 10/6 | E186 | 8/- |
| 3A5 | 10/- | 6F6G | 5/- | 6X4GT | 5/- | 12S7GT | 8/6 | 35Z10T | 4/9 | AZ1 | 10/6 | E186 | 8/- |
| 3B7 | 5/- | 6F12 | 3/6 | 6Y7G | 12/6 | 14H7 | 9/9 | 50C26G | 4/3 | CY10 | 10/6 | E834 | 4/6 |
| 3D6 | 3/9 | 6F13 | 3/6 | 6Y7G | 12/6 | 14H7 | 9/9 | 50C26G | 4/3 | CY10 | 10/6 | E834 | 4/6 |
| 3Q4 | 7/6 | 6F15 | 10/9 | 7B0 | 10/9 | 19A05 | 4/9 | 72 | 6/6 | CY21 | 7/6 | E891 | 2/3 |
| 3Q5GT | 6/- | 6F18 | 7/6 | 7B7 | 7/- | 19H1 | 10/9 | 85A2 | 8/6 | D68 | 5/- | E8C41 | 9/6 |
| 3S1 | 5/9 | 6F23 | 14/3 | 7C6 | 6/- | 20D1 | 13/9 | 85A3 | 8/6 | D77 | 2/3 | E8C81 | 6/6 |
| 3V4 | 6/6 | 6F24 | 13/6 | 7F8 | 12/6 | 20D4 | 20/9 | 90A4 | 6/6 | DAC32 | 7/- | E8C90 | 4/- |
| 5R46Y | 10/6 | 6F25 | 13/6 | 7H7 | 5/6 | 20F2 | 14/9 | 90A4 | 6/6 | DAP91 | 4/3 | E8C91 | 5/6 |
| 5U4G | 5/6 | 6F28 | 14/3 | 7R7 | 13/- | 20L1 | 20/- | 99C6 | 34/- | DAP96 | 6/6 | E8F80 | 6/9 |
| 5V4G | 7/6 | 6F32 | 3/- | 7T7 | 3/- | 20P1 | 17/6 | 96V9 | 33/6 | DCC90 | 10/- | D8F83 | 8/- |
| 5Y3GT | 5/6 | 6H6GT | 3/9 | 8R7 | 10/9 | 20P3 | 18/- | 96C1 | 16/- | D14 | 10/6 | E8F89 | 6/9 |
| 6Z3 | 7/- | 6J6 | 3/9 | 9D7 | 15/6 | 20P4 | 18/6 | 96C2 | 14/6 | D8F33 | 7/9 | E8L21 | 12/- |
| 6Z4G | 7/- | 6J6 | 3/9 | 10C1 | 25/- | 20P5 | 20/- | 150C2 | 5/9 | DF91 | 2/9 | EC53 | 12/6 |
| 630L2 | 10/- | 6J7G | 4/9 | 10C2 | 10/- | 25L6GT | 6/6 | 301 | 20/- | DF96 | 6/6 | EC54 | 10/- |
| 6A8G | 6/6 | 6J7GT | 6/6 | 10D1 | 8/- | 25Y5 | 6/- | 302 | 16/6 | DF97 | 10/- | EC70 | 4/9 |
| 6AK7 | 3/- | 6K7G | 2/- | 10D2 | 14/7 | 25Y6G | 8/6 | 303 | 15/- | DH63 | 6/- | EC86 | 12/6 |
| 6AG5 | 4/- | 6K7GT | 4/6 | 10F1 | 15/- | 25Z4G | 8/6 | 305 | 16/6 | DH76 | 5/- | EC88 | 12/- |
| 6AK5 | 5/- | 6K8G | 4/6 | 10F9 | 9/- | 25Z5 | 8/- | 306 | 16/6 | DH77 | 5/- | EC92 | 6/6 |
| 6AL6 | 6/- | 6L1 | 19/4 | 10F18 | 7/- | 25Z6G | 8/6 | 807 | 11/9 | DH81 | 10/9 | EC93 | 15/6 |
| 6AK5 | 2/3 | 6L6GT | 7/9 | 10LD11 | 10/9 | 30C1 | 6/6 | 956 | 2/- | DH101 | 25/- | KTS | 34/6 |
| 6AM6 | 2/3 | 6L7GT | 12/6 | 10P13 | 13/- | 30C15 | 13/- | 1821 | 10/6 | DH107 | 11/11 | PC183 | 10/- |
| 6AQ5 | 5/6 | 6L18 | 6/- | 10P14 | 20/- | 30C17 | 16/- | 6763 | 10/- | DK32 | 7/8 | R10 | 15/- |
| 6AR6 | 2/9 | 6L19 | 27/6 | 12A6 | 12/6 | 30C18 | 14/- | 9099 | 8/6 | DK40 | 10/- | R15 | 15/6 |
| 6AT6 | 4/- | 6LD29 | 9/6 | 12AC6 | 7/6 | 30F5 | 16/- | 7193 | 10/6 | DK91 | 5/6 | R16 | 15/6 |
| 6AV6 | 5/- | 6N7GT | 8/6 | 12AD6 | 7/6 | 30FL1 | 13/9 | 7475 | 14/- | DK92 | 9/- | R16 | 15/6 |
| 6AV6 | 5/6 | 6P1 | 12/- | 12AE6 | 12/6 | 30FL12 | 16/- | A1834 | 20/- | DK96 | 7/- | R16 | 15/6 |

| | | | | | | | | | | | |
|----------|------|-------|------|--------|------|---------|--------|-------|------|-------|------|
| EC92 | 4/6 | EF184 | 6/- | KT41 | 19/6 | PC184 | 7/6 | R17 | 17/6 | U19 | 34/6 |
| EC93 | 31/6 | EF190 | 10/- | KT44 | 20/- | PC185 | 9/- | R18 | 10/9 | U92 | 7/9 |
| EC93A | 29/6 | EH90 | 7/6 | KT61 | 12/- | PC186 | 8/6 | R19 | 7/6 | U25 | 13/- |
| EC94 | 11/- | EL32 | 3/6 | KT63 | 5/- | PC188 | 15/- | R20 | 11/9 | U26 | 11/9 |
| EC98 | 3/9 | EL33 | 12/- | KT66 | 17/3 | PEN36C | R52 | 7/6 | U31 | 6/- | |
| EC982 | 4/6 | EL34 | 10/6 | KT71 | 12/6 | RK54 | 15/- | SP12 | 7/6 | U33 | 29/6 |
| EC983 | 4/8 | EL37 | 17/3 | KT72 | 12/6 | PEN45 | 7/- | SP12 | 12/6 | U39 | 16/6 |
| EC984 | 6/3 | EL41 | 11/- | KT88 | 34/- | PEN43DD | SP61 | 3/3 | U37 | 34/11 | |
| EC985 | 5/6 | EL42 | 10/6 | KTW61 | 12/6 | 15/- | TH4B | 10/- | U45 | 15/6 | |
| EC986 | 8/- | EL81 | 10/- | KTW62 | 12/6 | PEN46 | 4/- | TH233 | 7/- | U47 | 13/- |
| EC987 | 7/- | EL83 | 7/6 | KTW63 | 8/6 | PEN43DD | TP6290 | 8/9 | U49 | 11/9 | |
| EC989 | 9/6 | EL84 | 4/9 | L83 | 2/9 | 18/6 | UABC80 | 6/6 | U30 | 5/9 | |
| EC989A12 | 12/- | EL85 | 8/- | LX192 | 7/- | PEN4A19 | 6/6 | UAF42 | 10/3 | U52 | 5/6 |
| EC989B27 | 12/- | EL86 | 8/- | LX309 | 10/- | PEN/DD | UB41 | 6/6 | U70 | 4/9 | |
| EC989C | 6/6 | EL85 | 5/3 | LX319 | 13/9 | 4092 | 17/6 | UBC41 | 9/- | U78 | 4/3 |
| EC989D | 6/6 | EM80 | 7/6 | LX389 | 13/9 | PFL200 | 11/9 | UBC81 | 7/6 | U107 | 18/3 |
| EC989E | 9/- | EM81 | 7/6 | LZ39 | 5/3 | PL38 | 19/6 | UBC85 | 5/9 | U191 | 12/6 |
| EC989F | 4/6 | EM84 | 6/6 | M5192 | 12/6 | PL39 | 9/6 | UBF89 | 6/9 | U251 | 14/6 |
| EC989G | 4/6 | EM85 | 11/- | ME1400 | 14/9 | PL81 | 9/6 | UBL21 | 9/- | U281 | 8/- |
| EC989H | 7/- | EL83 | 7/6 | M1L4 | 12/6 | PL81A | 10/6 | UC92 | 5/6 | U282 | 8/- |
| EC989I | 7/6 | EL83 | 7/6 | M1L4 | 12/6 | PL82 | 6/6 | UC94 | 8/6 | U301 | 11/- |
| EC989J | 7/6 | EL83 | 7/6 | M1L4 | 12/6 | PL83 | 6/6 | UC95 | 7/6 | U329 | 14/6 |
| EC989K | 7/6 | EL83 | 7/6 | M1L4 | 12/6 | PL84 | 6/6 | UCF80 | 8/6 | U403 | 6/6 |
| EC989L | 7/6 | EL83 | 7/6 | M1L4 | 12/6 | PL85 | 6/6 | UCF81 | 9/- | U404 | 7/6 |
| EC989M | 7/6 | EL83 | 7/6 | M1L4 | 12/6 | PL86 | 6/6 | UCF82 | 10/6 | U405 | 7/6 |
| EC989N | 7/6 | EL83 | 7/6 | M1L4 | 12/6 | PL87 | 6/6 | UCF83 | 11/6 | U406 | 7/6 |
| EC989O | 7/6 | EL83 | 7/6 | M1L4 | 12/6 | PL88 | 6/6 | UCF84 | 12/6 | U407 | 7/6 |
| EC989P | 7/6 | EL83 | 7/6 | M1L4 | 12/6 | PL89 | 6/6 | UCF85 | 13/6 | U408 | 7/6 |
| EC989Q | 7/6 | EL83 | 7/6 | M1L4 | 12/6 | PL90 | 6/6 | UCF86 | 14/6 | U409 | 7/6 |
| EC989R | 7/6 | EL83 | 7/6 | M1L4 | 12/6 | PL91 | 6/6 | UCF87 | 15/6 | U410 | 7/6 |
| EC989S | 7/6 | EL83 | 7/6 | M1L4 | 12/6 | PL92 | 6/6 | UCF88 | 16/6 | U411 | 7/6 |
| EC989T | 7/6 | EL83 | 7/6 | M1L4 | 12/6 | PL93 | 6/6 | UCF89 | 17/6 | U412 | 7/6 |
| EC989U | 7/6 | EL83 | 7/6 | M1L4 | 12/6 | PL94 | 6/6 | UCF90 | 18/6 | U413 | 7/6 |
| EC989V | 7/6 | EL83 | 7/6 | M1L4 | 12/6 | PL95 | 6/6 | UCF91 | 19/6 | U414 | 7/6 |
| EC989W | 7/6 | EL83 | 7/6 | M1L4 | 12/6 | PL96 | 6/6 | UCF92 | 20/6 | U415 | 7/6 |
| EC989X | 7/6 | EL83 | 7/6 | M1L4 | 12/6 | PL97 | 6/6 | UCF93 | 21/6 | U416 | 7/6 |
| EC989Y | 7/6 | EL83 | 7/6 | M1L4 | 12/6 | PL98 | 6/6 | UCF94 | 22/6 | U417 | 7/6 |
| EC989Z | 7/6 | EL83 | 7/6 | M1L4 | 12/6 | PL99 | 6/6 | UCF95 | 23/6 | U418 | 7/6 |

All goods are new and subject to the makers guarantee. We do not handle manufacturers' seconds, nor relets, which are often described as "new and tested" but have a limited and unreliable life. Business hours Mon-Fri, 9.30 a.m. - 5.15 p.m. Sat, 9.15 a.m. - 4.30 p.m. Terms of business, Cash with order only. Post packing 6d. per item. Orders over £5 post packing free. Same day despatch by first class mail. Any parcel insured against damage in transit for only 6d. extra. Complete catalogue of valves, transistors and components with conditions of sale, price 10d. post free. No enquiries answered unless S.A.E. enclosed for reply.

T.V. TUBES "VIDEOCHROME" T.V. TUBES

FOR BRILLIANCE & DEFINITION



CASH OR CHEQUE WITH ORDER

COMPARE OUR PRICES

| | |
|-----|---------|
| 17" | £4-15-0 |
| 19" | £5-5-0 |
| 21" | £6-10-0 |
| 23" | £7-10-0 |

TRADE SUPPLIED

ALL TUBES PRECISION REBUILT AT OUR OWN FACTORY BY SKILLED CRAFTSMEN WHO HAVE BEEN REBUILDING TUBES FOR OVER 10 YEARS ● EACH TUBE BENCH AND SET TESTED TO A VERY HIGH STANDARD BEFORE DISPATCH

PRICES FOR TWIN PANEL TUBES AVAILABLE ON REQUEST
2 YEARS GUARANTEE ● FREE DELIVERY ANYWHERE IN THE U.K.

VIDEOCHROME TUBES LTD.
25 BELLEVUE AVENUE,
RAMSGATE, KENT. Tel. THANET 52914

EX-RENTAL TELEVISIONS

TWO-YEAR GUARANTEE

FREE ILLUSTRATED LIST OF TELEVISIONS
17" SLIMLINE 405 only £11 10 0
19" SLIMLINE 405/625 39 gns.
17"-19"-21"-23"
WIDE RANGE OF MODELS, SIZES AND PRICES
DEMONSTRATIONS DAILY
Carriage and Insurance 30/-

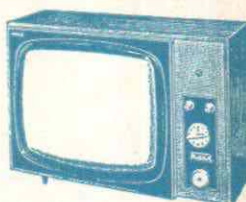

TWO-YEAR GUARANTEED TUBES 100% REGUNNED

Slim Line Tubes 110" 17" and 19" 109/6, 21" and 23" 129/6.
Normal Tubes 70" and 90" 17" 99/6, 21" 119/6, 14" and other sizes 79/6.

SPEAKERS 10", 2 1/2" 8Ω, 3 1/2" 25Ω, 4" 10Ω, 3" x 5" 8Ω, 7" x 4" 3Ω, 8" x 3" 3Ω. BRAND NEW. P. & P. 2/-.
Transistors: Mullard matched output kit 7/6, OC81D-2 OC81's. P. & P. FREE. AF 117, AF114, OC44, OC45, OC71; 2/6 each
Ferrite Rods 3/6: 6" and 8" complete with LW/MW Coils. P. & P. FREE.
Transistor Cases 4 for £1.
SIZE 9 1/2 x 6 1/2 x 3 1/2 P & P 9/6.
STRIP LIGHT TUBES 3/9 each. 11" (284 mm.) 230/240 volts, 30 watts. Ideal for cocktail cabinets, illuminating pictures, diffused lighting, etc.

RECORD PLAYER CABINET



Cloth covered. Size 16 1/2" x 14 1/2" x 7 1/2". Takes any modern auto-changer. P. & P. 7/6.

DUKE & CO. (LONDON) LTD.
621/3 Romford Road, London, E12 Tel. 01-478 6001/2/3

REBUILT TUBES!

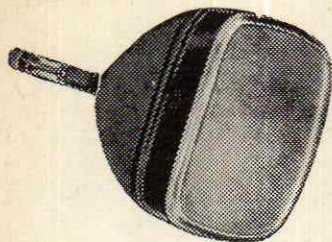

YOU'RE
SAFE
WHEN YOU
BUY FROM
RE-VIEW!

HERE IS WHAT YOU PAY:

| | | | |
|-------------|---------|------------------|---------|
| 12in. | £4.15.0 | 19in. | £5.15.0 |
| 14in. | £5. 0.0 | 21in. | £7. 5.0 |
| 15in. | £5. 5.0 | 23in. | £8.10.0 |
| 17in. | £5. 5.0 | 19in. Twin Panel | £7.10.0 |

23in. Twin Panel £10. 0.0

Cash or cheque with order, or cash on delivery

Discount for Trade

- ★ Each tube is rebuilt with a completely new gun assembly and the correct voltage heater.
- ★ Each tube comes to you with a guarantee card covering it for two years against all but breakage.
- ★ Each tube is delivered free anywhere in the U.K. and insured on the journey.
- ★ Each tube is rebuilt with experience and know-how. We were amongst the very first to pioneer the technique of rebuilding television tubes.

RE-VIEW ELECTRONIC TUBES

237 London Road, West Croydon, Surrey.
Tel. 01-689/7735

DON'T BE CAUGHT OUT!

Colour Television is already here, but 1970 is a big year for colour television with a number of single standard colour sets coming on to the market, engineers with a knowledge of colour television will obviously be in great demand.

SO DON'T DELAY

We have developed a colour television course geared for the service engineer which will enable him to tackle any problem in colour television

The course consists of 10 lessons on colour mixing, Pal colour system, colour receivers, decoders, IF circuits, time-bases, convergence, waveforms, set-up procedures, test equipment, fault finding, typical circuits. Fee for complete course 10 gns. Write for details without obligation to:

DAYLIN ELECTRONICS
(Dept. A) 32 Parkstone Drive
SOUTHEND · ESSEX

Learn at home... First Class Radio and TV Courses

get a
certificate

After brief, intensely interesting study—undertaken at home in your spare time—YOU can secure a recognised qualification or extend your knowledge of Radio and TV. Let us show you how.

FREE GUIDE

The New Free Guide contains 120 pages of information of the greatest importance to both the amateur and the man employed in the radio industry. Chambers College provides first rate postal courses for Radio Amateurs' Exam., R.T.E.B. Servicing Cert., C. & C. Telecoms., A.M.I.E.R.E. Guide also gives details of range of certificate courses in Radio/TV Servicing. Electronics and other branches of engineering, together with particulars of our remarkable terms of

Satisfaction or refund of fee

Write now for your copy of this valuable publication. It may well prove to be the turning point in your career.

Founded 1885 Over 150,000 successes

CHAMBERS COLLEGE

(Incorp. National Inst. of Engineering)
(Dept. 844V) 148 Holborn, London, E.C.1.

NEW RANGE U.H.F. - TV - AERIALS

All U.H.F. aerials now fitted with tilting bracket and 4 element grid reflectors.

Loft Mounting Arrays, 7 element, 40/-; 11 element, 47/6; 14 element, 55/-; 18 element, 62/6. Wall Mounting with Cranked Arm, 7 element, 60/-; 11 element, 67/6; 14 element, 75/-; 18 element, 82/6. Mast Mounting with 2in. clamp, 7 element, 42/6; 11 element, 55/-; 14 element, 62/-; 18 element, 70/-. Chimney Mounting Arrays, Complete 7 element, 72/6; 11 element, 80/-; 14 element, 87/6; 18 element, 95/-. Complete assembly instructions with every unit. Low Loss Cable, 1/6 yd. U.H.F. Pre-amps from 75/-. State clearly channel number required on all orders.

BBC - ITV AERIALS

BBC (Band 1), Loft 25/-, External S D, 30/-, "H", £2.15.0.
ITV (Band 3), 3 element loft array, 30/-, 5 element, 40/-, 7 element, 50/-, Wall mounting, 3 element, 50/-, 5 element, 55/-. Combined BBC/ITV. Loft 1+3, 40/-; 1+5, 50/-; 1+7, 60/-; Wall mounting, 1+3, 60/-; 1+5, 70/-; Chimney 1+3, 70/-; 1+5, 80/-; VHF transistor pre-amps, 75/-.

COMBINED BBC 1-ITV-BBC2 AERIALS 1+3+9, 70/-, 1+5+9, 80/-, 1+5+14, 90/-, 1+7+14, 100/-. Loft mounting only. F.M. (Band 2), Loft S D, 17/6. "H", 35/-. 3 element, 57/6. External units available. Co-ax. cable, 8d. yd. Co-ax. plugs, 1/6. Outlet boxes, 5/-. Diplexer Crossover Boxes, 17/6. C.W.O. or C.O.D. P. & P. 6/6. Send 6d. stamps for illustrated lists.

CALLERS WELCOME
OPEN ALL DAY SATURDAY
K.V.A. ELECTRONICS (Dept.P.T.)
40-41 Monarch Parade
London Road, Mitcham, Surrey
01-648 4884

DIMMASWITCH



The DIMMASWITCH is an electronic dimmer capable of controlling from 40-600 watts of incandescent lighting at mains voltages from 200/250 V at 50 Hz. The DIMMASWITCH has the same dimensions (3 3/4" x 3 3/4") as a standard switch and is intended as an alternative fitting, finished in ivory, with a contrasting control knob.

Two models of the DIMMASWITCH are now available, each incorporating an on/off switch, and at 10/- less in each case a kit is produced to enable a competent constructor to self build the DIMMASWITCH. Both models are available with either clockwise or anticlockwise dimming and internal fusing may be provided at an additional cost of 3/- in each case, or 2/6d. for the kit.

MODEL DS500/2—utilises an advanced design of triggering circuit to enable smooth fade up from zero—£3 12s. 6d. Similar to competitive products at £5 5s.

MODEL DS500/2/P—a DIMMASWITCH incorporating a newly patented on/off control enabling the lamp to be switched on and off at any brilliance setting by push/pull action of the knob—£3 18s.

All models give control from zero to maximum and use RCA and Mullard components and semiconductors, and comply generally with the recommendations of B.S. 800. Ideal for T.V. viewing and for children's night lights, etc.

Please send C.W.O. to:-

DEXTER & COMPANY
ULVER HOUSE, 19 KING STREET,
CHESTER, CHI 2AH. Tel. Chester 25883
As supplied to H.M. Government Departments, Hospitals, etc.

NEW LINE OUTPUT TRANSFORMERS

ALBA 655, 656, 717, 721 75/-.
 BUSH TV53 to TUG69 40/-
 DECCA DM1, DM3C, DM4C (70°) 78/- DR1, DR2, DR121, DR122, DR123 90/-
 DYNATRON TV30, TV35 55/6, TV36 70/-
 EKCO T231, T284, TC267, T283, T293, T311, T326, T327, T330 55/6. TMB272 68/6. T344, T344F, T345, TP347, T348, T348F, TC347, TC349, TC356, T368, T370, TC369, T371, T372, TP373, TC374, T377A, T393, T394, 433, 434, 435, 436, 437 all at 70/-.
 503, 504, 505, 506 95/-
 FERGUSON 306T, 308T 55/6 each. 406T, 408T, 416, 436, 438, 506, 508, 516, 518, 536, 546, 604, 606, 608, 616, 619, 636, 646, 648, 725, 726, 727, 3600, 3601, 3602, 3604, 3611, 3612, 3614, 3617, 3618, 3619, 3620, 3621, 3622, 3623, 3624, 3625, 3626, 3627, 3629 80/-
 FERRANTI T1001, T1002, T1002/1, T1004, T1005 55/- T1023, T1024, T1027, T1027F, TP1026, T1071, T1072, T1121, TC1122, TC1124, T1125, TC1126 70/- 1154, 1155 95/-
 G.E.C. BT302, BT304 62/6. BT454DST-456DST, 2010, 2013, 2014, 2012, 2000DS, 2001DS, 2002DS 85/-
 H.M.V. 1865, 1869 55/6. 1870, 1872, 1874, 1876, 1890, 1892, 1894, 1896 80/-
 KB OV30, NF70, NV40, PV40, QV10, PVP20 90/- Featherlight 90/-
 PILOT PT450, 452, 455, 650, PT651, P60A, P61 70/-
 PHILCO 1019, 1020, 2021 82/6. 1029, 1030, 1035, 1036, 1040, 1050, 1060 82/6.
 PYE V200, V400, 200LB, 210, 220, 300F, 300S, 310, 210S, 410 70/- PYE 11U-P/No. AL21003 70/-
 REGENTONE TV403 90/-
 R.G.D. RV203 90/-
 ULTRA 1770, 2170, 1772, 1782, 2172, 1771, 2171, 1775, 2175, 1774, 2174, 1773, 2137, 1980c, 1984c, 100c, 200c, 2380, 2384, 1984, 1985, 1986, 1980, 1980a, 1780, 2180, 2181, 2183, 2182, 1871, 1783 80/-

LINE OUTPUT TRANSFORMER INSERTS

BUSH TV92-TV93, TV94-TV95-TV96-TV97, TV98, TV99, TV100, TV101, TV103, TV104, TV105, TV106, TV108, TV109, TV110, TV113, TV115, TV115R, TV115c, 123, 125, 128, TV75, TV85, 55/- Complete with heater windings.
 DECCA DR95, DR100, DR101, DR202, DR303, DR404, DR505, DR606, 55/-
 EMERSON E700, E701, E704, E707, E708, E709, E710, E711, Portarama 32/6.
 FERGUSON 204T, 205T, 206T, 214T, 235T, 236T, 244T, 245T, 246T 30/-
 FERRANTI 14T2, 14TC, 14T3F, 14T4, 14T4F, 14T5, 14T6, 17K3, 17K3F, 17T3, 17T3F, 17K4F, 17K6, 17SK6, 17T4, 17T4F, 17T5, 17T6, 21K6, 21K6V 32/6.
 INVICTA T118, T119, T120 40/-
 KB PV40, MV100, OF100, PV100, NV40, NF70, OV30, QV10, QV30 32/6 pair.
 PETO SCOTT 1416, 1418, 1419, 1422, 1423, 1716, 1719, 1720, 1922, 1723, 1724, 1725 29/6.
 PYE V4, VT7, CTM4, TCM7 40/-
 REGENTONE 10-4, 10-6, 1021, 17-18, 10-12 30/- T176, TT7, 191, 192 32/6.
 R.G.D. Deep 17, The 17, 590, 600, 606, 611, 710, 723 32/6.
 Guarantee. Post and Package 4/6. C.O.D. 6/-

PRESET CONTROLS

Wirewound, 3 W rating 5/- Each. P.P. 6d.
 Ohms 10, 25, 50, 100, 250, 500.
 K Ohms 1, 2, 3, 5, 10, 25, 30.
 Carbon, 1/2 W rating 4/2 Each. P.P. 6d.
 K Ohms 50, 100, 250, 500.
 M Ohms 1, 2.

OPEN (SKELETON) PRESETS

Open type controls with mounting lugs to suit printed circuit boards.
 Vertical Mounting 2/6 Each. P.P. 6d.
 K Ohms 5, 10, 25, 100, 150, 250, 500, 680.
 M Ohms 1, 2, 2.5.
 Horizontal Mounting 2/6 Each. P.P. 6d.
 K Ohms 100, 250, 500, 680.
 M Ohms 1, 2.2, 3.3.
 Miniature Horizontal Mounting 2/6 Each. P.P. 6d.
 Ohms 100, 220, 470.
 K Ohms 1, 2.2, 4.7, 10, 22, 47, 100, 220, 470.
 M Ohms 1.

"SLIDER" PRESET CONTROLS

Wirewound, 1/2 W rating 3/- Each. P.P. 6d.
 Ohms 10, 25, 100, 250, 500.
 K Ohms 1, 5.
 Carbon, 1/2 W rating 2/6 Each. P.P. 6d.
 K Ohms 10, 100, 250, 500.
 M Ohms 1, 2.2.

IRON DUST CORES

Dimensions: L.5" dia. 6mm (normal thread), hexagon centre hole.
 Trimming Tool for adjusting 6mm. cores as above 1/- Each. P.P. 4d.
 10-oz. tin Switch Cleaner 9/-, Aerosol Switch Cleaner 17/6.

REPLACEMENT DROPPERS

Ferguson, H.M.V., Marconi, Ultra 800 & 850 Series (Convertible)
 37 + 31 + 97 + 26 + 168. 12/6 P.P. 11d.
 As above 850 Series (Dual Standard) 14 + 26 + 97 + 173 12/6 Each.
 P.P. 1/-

E.H.T. CAPACITORS

Single O.B.A. Stud Mounting. 001 uf 20kV . . 10/6 each. P.P. 2/6.
 High Voltage Pulse Ceramics.
 10, 15, 22, 33, 68, 82, 100, 120, 140, 155, 180, 220, 250pf 1/6 P.P. 6d.

CALLERS WELCOME.

All new components inserts are guaranteed for three months from the date of invoice subject to the breakdown being due to faulty manufacture or materials.
 S.A.E. all enquiries.

T.V. CANNED ELECTROLYTICS

| | |
|-------------------------------------|---|
| 64-100. 450v. 22/6 each. P.P. 2/6. | 100-400-16. |
| 100-200. 275v. 18/- each. P.P. 2/6. | 275v. 26/- each. P.P. 2/6. |
| 100-200. 350v. 22/6 each. P.P. 2/6. | 150-100-100-100-150. |
| 100-200-60. | 320v. 39/9 each. P.P. 2/6. |
| 300v. | 200. 350v. 15/- each. P.P. 2/6. |
| 100-300-100-16. | 200-200-100. |
| 275v. | 350v. 31/6 each. P.P. 2/6. |
| 100-400. 275v. 19/- each. P.P. 2/6. | 300-300. 300v. 37/9 each. P.P. 2/6. |
| | 150 + 100 + 100 + 100 + 150. 320v. 39/6 P.P. 2/6. |

POWER RESISTOR SECTIONS

These wirewound sections enable you to build up any Mains Dropper to your requirements. A central 2B.A. hole is provided for mounting.
 Ohms 7, 9, 10, 12, 14, 17-5, 20. All at 7A. 3/10d. each
 Ohms 22, 25, 28, 30, 33, 36. All at 7A. 4/9d. each
 Ohms 40, 47, 52, 56, 60, 63, 66, 75, 87, 100 at 3A. 3/10d. each
 Ohms 120, 140, 160, 180, 200, 250, 270 at 3A. 4/9d. each
 Ohms 300, 350, 400, 470, 560, all at 12A. 3/10d. each
 Ohms 726 at 15A. 4/9d. each
 K Ohms, 1 K ohm at 1A. 3/10d. each
 K Ohms, 2 (-07A.) 4/9d. each

Postage each section 6d.

PARTS FOR THE CONSTRUCTOR 625 RECEIVER

| | | |
|-----------------------------------|------------|---------------------|
| T.2 | 35/- | P.P. 4/6. |
| L.3 Scan Coils | 90/- | P.P. 4/6. |
| T.3 Line Output TX | 80/- | P.P. 4/6. |
| T.4 Audio Output | 21/- | P.P. 2/6. |
| Electrolytic 100 + 100 + 300 + 16 | 27/- | P.P. 1/- |
| D1 to D4 | 6/- | each. P.P. 6d. |
| D5, D8, D10, D11, D13 | 2/6 | each. P.P. 6d. |
| D9, D12 | 2/7 | each. P.P. 6d. |
| C35, Pulse Ceramic | 1/6 | each. P.P. 6d. |
| BSX 21 | 9/- | P.P. 6d. |
| AC 127 | 6/6d. | P.P. 6d. |
| 27 Way Tag Strip | 5/6 | for 3. P.P. 1/- |
| VA1015 Thermistor | 3/6 | each. P.P. 6d. |
| Fuse Carriers 20mm. | 5/9 | each. P.P. 6d. |
| S.W.1 switch | 6/3 | each. P.P. 6d. |
| Ceramic valveholders B9A | 1/6 | each. P.P. 6d. |
| Ceramic valveholders Octal | 1/7 | each. P.P. 6d. |
| 3 Ohm Elliptical speaker | 34/10 inc. | 6/10 tax. P.P. 3/6. |

Capacitors prices on request.

Complete set of 9 Potentiometers 43/8. P.P. 4/6.

Dept. "R" D. & B. TELEVISION (Wimbledon) LTD.

80 MERTON HIGH STREET, S.W.19
 01-540 3513 01-540 3955

PRACTICAL TELEVISION

VOL 20 No 9
ISSUE 237

JUNE 1970

THEN AND NOW!

ALTHOUGH the very first issue of Practical Television appeared in September 1934 it subsequently suffered the indignity of becoming a supplementary section in Practical Wireless. After the war when it became clear that the re-establishment of the television service was stimulating sufficient interest however Practical Television emerged from its temporary hiatus and regular monthly publication as a separate magazine began again.

That was twenty years ago. In the first issue of the reborn P.T. there were articles on television theory and servicing, aerials, projection systems, broadcasting and constructing a home-brew TV receiver. Familiar ingredients, but with that indefinable tang of the printed word two decades old. The major difference between then and now is the enormous strides which have been taken. Then there were only two BBC stations on the air, but planning for a nationwide chain was well under way. Yet there were signs of the troubles to come in the announcement by the BBC that it was not proposed to "change the present system for at least five years."

Little did the contemporary writer realise how near the mark he was when he suggested that although the standards of the television service were "as good as any home cinematograph" nevertheless "finality has not been reached." Two ideals to be aimed for were given as colour and stereoscopy, developments which "may not reach fruition for many years." Well, we now have colour but the interest in stereoscopy seems to have quietly faded away.

In the intervening twenty years much water has flown under the bridge. Today's world of u.h.f. colour on 625 lines, satellite reception which has become commonplace, I.C.s and videotape recording is a world apart from those early post-war days. One thing however has not changed.

The first editorial page carried the statement that "Our policy will be technical without being high-brow." This is still our basic aim, though adjusted upwards to cater for the more sophisticated readership of the 1970s.

W. N. STEVENS, *Editor*

THIS MONTH

| | |
|---|---|
| Teletopics | 388 |
| TV in the Dark | <i>by I. R. Sinclair</i> 390 |
| R-Y Phase Alternation | <i>by G. R. Wilding</i> 395 |
| DX-TV | <i>by Charles Rafarel</i> 398 |
| Servicing Television Receivers — GEC-Sobell 2010-1010 series | <i>by L. Lawry-Johns</i> 399 |
| Power Supply Circuits | <i>by S. George</i> 402 |
| Single-Standard 625-Line Receiver for the Constructor—Part 4 | <i>by Keith Cummins</i> 406 |
| Underneath the Dipole | <i>by Iconos</i> 412 |
| Waveforms in Colour Receivers— Part II | <i>by Gordon J. King</i> 414 |
| Workshop Hints | <i>by Vivian Capel</i> 417 |
| Strobe-Trigger Timebase Unit— Part 3 | <i>by Martin L. Michaelis, M.A.</i> 418 |
| Letters to the Editor | 423 |
| Your Problems Solved | 425 |
| Test Case 91 | 426 |

THE NEXT ISSUE DATED JULY WILL
BE PUBLISHED JUNE 19

TELETOPICS

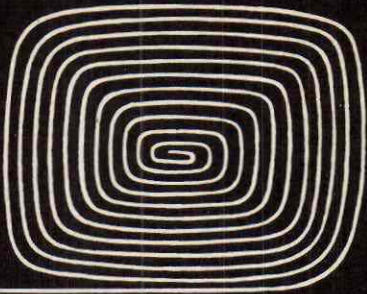

CONTINENTAL COLOUR SETS IN UK

With the present shortage of home-produced colour sets comes news of further Continental entries into the UK market. B & O sets have of course been available for some time and now German 22in. and 25in. colour receivers from the **Telefunken** Pal-colour range are available through AEG (Great Britain) Ltd., Lonsdale Chambers, 27, Chancery Lane, London WC2. Recommended price of the 22in. model is £355 12s. and of the 25in. model £381 12s. 7d. The sets have the same basic specification which includes electronic tuning, socket for remote control and external loudspeaker socket.

On top of this **Granada** have placed a large order with a Finnish electronics company for sets for Granada TV Rental. Deliveries of the "Finlandia" 22in. model have already begun. The sets have been adapted by the manufacturers Salora to meet the UK standards and include electronic tuning.

Philips expect European colour set sales to grow from 850,000 last year (154,000 in the UK) to 1,800,000 this year and 4,400,000 by 1973. With the forecast that the UK colour set market will reach 1,300,000 in 1975, Philips are planning an extension to their Dunfermline component factory and are negotiating with Washington Corporation, Co. Durham, for a site for further extensions with a view to this becoming the company's main television component production centre. The idea is to move component manufacture from Croydon to enable television set assembly there to be expanded.

RANK-BUSH-MURPHY EXTEND PLANT

Rank-Bush-Murphy expect to double their weekly output of colour television sets this year as a result of the recent opening of a £750,000 extension to their Plymouth factory. The output of colour sets is at present running at 1,000 a week and is expected to rise to 1,500 a week over the next few months. Over 5,000 black-and-white sets a week are being produced.

R & D ON DISPLAY SYSTEMS

Marconi and Mullard have both revealed the results of research on new display techniques. From Marconi come multi-coloured displays using a material called "liquid crystal", a class of liquids with a regular crystal-like structure some of which change their appearance on the application of a voltage. A see-through display panel is made by sandwiching a layer of liquid crystal only a thousandth of an inch thick between two sheets of

conductive glass across which the voltage is applied. The voltage and power requirements are low and the displays equally legible in poor light and brilliant sunshine. A new liquid crystal material which changes colour from green to blue when a voltage is applied has been developed at Marconi and present work is expected to yield materials for other colours. The immediate practical uses of the display panels are for control panel readouts, see-through map displays etc. but it is thought they might one day be used in TV screens thin enough to hang on a wall.

The Mullard work is on a transparent solid crystal material known as KTM whose optical characteristics change on the application of a voltage. This electro-optic effect can be used for deflecting or modulating a light beam, e.g. from a laser, and the low voltages needed with KTN are such that the power and voltage requirements can be derived from portable transistorised sources. KTN optical modulators can be used for laser-beam communications systems and are of potential use for flat-screen TV displays.

J-BEAM EXTEND AERIAL RANGE

Two new aeriels—the Metrobeam and Logbeam—and a modified version of an existing model have been introduced by J-Beam Aerials Ltd., Rothers-thorpe Crescent, Northampton. The Metrobeam is a six-element u.h.f. aerial which has been specifically designed for internal or external use.

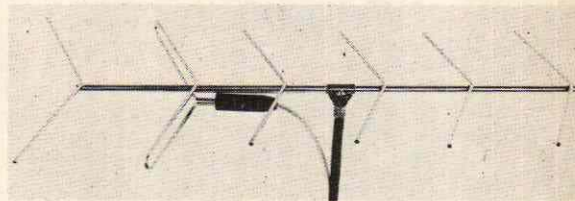

The Metrobeam indoor/outdoor u.h.f. aerial.

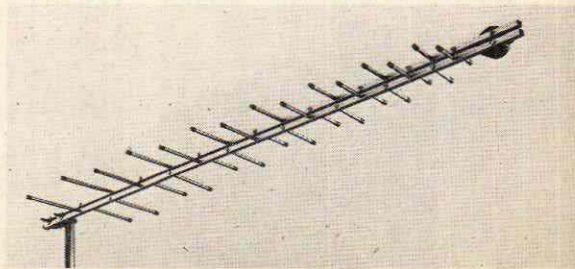

The Logbeam wideband u.h.f. aerial.

It is capacitance-coupled and supplied with 18ft. coaxial cable and plug at the list price of £2 5s. The Logbeam is a log-periodic aerial providing almost constant gain over Bands IV and V while maintaining good matching throughout (voltage standing wave ratio less than 1.5:1). The list price is £4 10s. The modification is to the Parabeam which is now a 10-element model with unchanged list price of £2 8s. 6d.

MORE AERIAL EQUIPMENT

Two new TV distribution amplifiers—the Castle range—have been introduced by Belling & Lee Ltd., Great Cambridge Road, Enfield, Middx. The Conway is a sophisticated channelised distribution head-end amplifier for large blocks of flats and estates and the Stirling an ultra broadband amplifier and power unit for smaller installations. Also available is a small, self-contained and economically priced distribution amplifier designed for workshops and showrooms, together with a new range of sockets, diplexers, triplexers and a new non-solder coaxial plug all designed for v.h.f./u.h.f. working.

We have often been asked about u.h.f./v.h.f. diplexers. Labgear Ltd. (Cromwell Road, Cambridge CB1 3EL) have available an indoor diplexer type CM6009/DP which can be used for separating u.h.f. and v.h.f. signals fed via a common download or for combining u.h.f. and v.h.f. signals on to a common download. They also have an indoor two-way splitter type CM6008/TS, an ultra wideband inductive splitter-combiner for combining or splitting any two signal sources covering all TV and f.m. sound transmissions.

LATEST STATIONS

The BBC-Wales u.h.f. colour service from **Wenvoe** started on April 4th on channel 44 with horizontal polarisation (group B aerial). BBC-2 from **Limavady** (Co. Londonderry) started on the same date on channel 62 (horizontal polarisation, group C aerial). The BBC has also ordered a 500ft. mast for a u.h.f. station at **Carmel** (S. Wales). BBC-2 on channel 63 is expected to commence in Spring 1971. Polarisation will be horizontal and a group C aerial will be needed.

The ITA has started transmitting the Harlech Welsh service from **Brecon**. This v.h.f. relay station transmits on channel 8 with horizontal polarisation and a maximum e.r.p. of 100W.

CLE-SOL SPECIALISED CLEANSER

A new premium solvent cleaner called CLE-SOL has been introduced by Spectra Chemicals Ltd., Haywards Heath, Sussex. The 18oz. aerosol costs 18/-. Intended for use on electronic equipment, it is inert to acetate and polyester film and magnetic oxide coatings, cleaning and removing greases, common soils and oils without attacking plastics, resins, coatings, sealants, varnishes, etc.

DIY PRINTED CIRCUITS IN MINUTES

One-off printed circuits can be produced in only a few minutes by a process developed by Cirkitrite Ltd. (c/o 32 Haven Green, London W5). In this process electrically conductive patterns are pro-

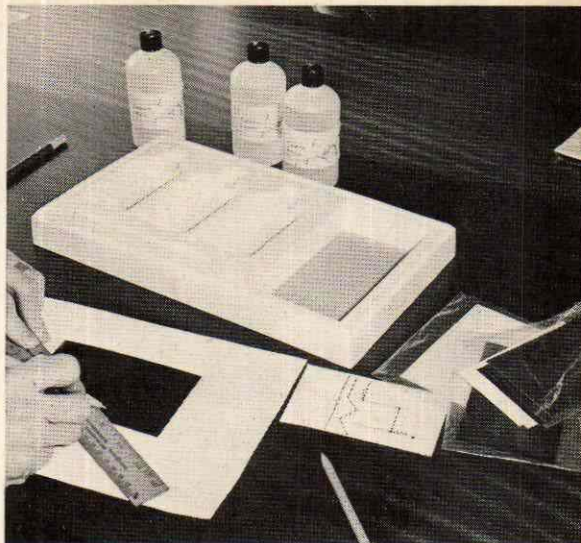

The Cirkitrite printed circuit kit. The required pattern is drawn with the pen on specially prepared plastic panels and developed by immersion in a chemical solution.

duced by direct application of a special pen to selected areas of the base material. A Cirkitrite kit has been produced (see photo) to demonstrate the principle and includes sufficient chemicals and materials for experimental sample products to be produced. A chemical contained in the Cirkitrite pen is applied directly to a specially prepared material which is then immersed in a metal reducing solution. The chemical provides a catalytical surface to the selected areas only so that metal deposition is confined to these areas. Due to the thickness of the copper pattern its current carrying capacity is limited but this can be increased by electroplating or further deposition. Due to oxidation the initial deposit has a limited lifetime. It can however be preserved by further treatment or electroplating.

NEW MULTIMETERS

Bach-Simpson Ltd. (19 Nortoft Road, Chalfont St. Peter, Bucks) have introduced two new multimeters. The 635 is a 20,000 Ω /V instrument with a basic accuracy of ± 1.35 per cent and the following ranges: voltage five each for a.c. and d.c. from 3V to 600V f.s.d. with an additional 0.0-3V range on d.c.; current three a.c. ranges from 0.12A to 12A and seven d.c. from 60 μ A to 12A f.s.d.; resistance four ranges from 0.2M Ω . List price is £28. The 635HV is a high-voltage version incorporating an isolated high-voltage multiplier for measurements up to 6kV a.c. or d.c. with a list price of £33.

SIMPLE FET VOM

Mullard have released details of a simple f.e.t. voltmeter with input resistance on all ranges of at least 10M Ω intended as an educational project. Details can be obtained from Mullard Educational Service, Mullard Ltd., Mullard House, Torrington Place, London WC1. Kits of components are available from sources listed in the booklet.

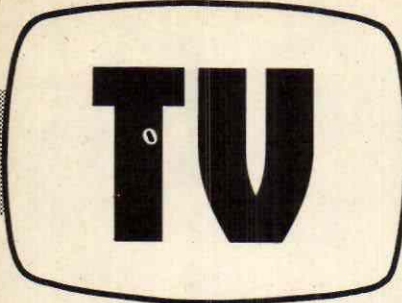
 TV

IN THE DARK

I. R. SINCLAIR

If there was one feature which struck the visitor to a TV studio in the early days of television it must have been the intensity of the lighting. The Emitron camera tubes used in those days were extremely insensitive, lenses were of comparatively small aperture and consequently the lighting had to be brilliant enough to compensate for these failings. Much of the work on TV camera development has been devoted to improving the sensitivity of the camera without sacrificing the picture quality in terms of resolution, grey scale or signal-to-noise ratio. There is a limit to what can be done by improving lenses, though the improved sensitivity of modern cameras certainly owes a lot to modern lens techniques; the major part of the improvement in the sensitivity of cameras however comes from the development of camera tubes.

The development of camera tubes from the early Emitrons through Super Emitrons and CPS Emitrons to today's image orthicons has satisfied the sensitivity needs of television for all normal purposes. TV however has military and security applications and, at the other extreme of use, nuclear and astronomical research applications. These other uses of TV often demand sensitivity levels capable of televising scenes whose illumination is no more than that provided by starlight, levels of illumination millions of times less than those used in studios for broadcasting.

For these special purposes three methods can be used to increase the sensitivity of camera tubes. One is to develop the ordinary image orthicon so as to increase its sensitivity without any drastic change in its method of working. Another method, now in production, is to use a variation of the image orthicon design called the image isocon. This is capable of giving better signal-to-noise ratios than the image orthicon at all light levels. The third method is to use a conventional camera tube along with an image amplifier mounted as part of the optical system to increase the illumination of the image applied to the camera tube.

THE IMAGE ORTHICON

As the first two techniques for the improvement of sensitivity are based on the image orthicon we had better be sure that we understand the operation of the normal image orthicon tube. Referring to Fig. 1, an optical image on the faceplate of the image orthicon causes electrons to be released from each portion of the *photocathode*, the layer of light-sensitive material deposited on the rear surface of the faceplate. The number of electrons per second—the quantity which we call *current*—released from each portion of the photocathode depends on the light strength at that point. The speed at which they leave

the photocathode depends on the colour of the light, red light giving slow electrons and violet light fast electrons; this is because the energy of light depends on its frequency. Incidentally it was this discovery which won Einstein the Nobel prize for his work on it in 1905. Infra-red light, being of lower frequency than red, can release electrons only from a very few specially-prepared surfaces.

The released electrons are accelerated along straight parallel paths to a glass target which they strike. Because the target is at a fairly high voltage (about 800V) positive to the photocathode, the electrons strike the target at a high velocity—about 20 million metres per second. The effect of this high velocity is that the electrons hitting the target—the *primary electrons*—knock some of the electrons from the glass. These latter electrons, called *secondary electrons*, have much lower velocities—in the region of a few hundred thousand metres per second—and are collected by the *target mesh* which is usually slightly positive to target. Few primary electrons are collected on the target mesh because their speed makes it impossible for them to change course to strike the metal portions, so most of them pass through. Since in this process more electrons are knocked off the target than land on it, the target becomes positively charged (losing negative is equivalent to gaining positive). The amount of the positive charge varies from place to place, being greatest where the greatest number of electrons have struck. This in turn depends on the light level at the part of the photocathode which emitted these electrons. In this way a "charge image" is built up at the target, controlled by the light image at the photocathode.

The distance between the target and its target mesh is important, for these two elements act as the plates of a capacitor. If the spacing between them is wide, around 0.1mm. (0.004in.) or more, then few electrons are needed to raise the voltage of the target by one volt because of the low capacitance; and the tube is sensitive to low light levels. If the spacing is close, 0.025mm. (0.001in.) or less, the capacitance is higher, more electrons are needed to charge the target and the sensitivity is lower. The latter case has the advantage however that the charge on the target is large compared to that on a wide-spaced target and is also large compared to the clumps of charge in the discharging beam, about which we shall talk later. This gives a superior signal-to-noise ratio and accounts for the fact that close-spaced target tubes are greatly preferred for broadcast use.

On the other side of the target an electron beam is directed so that it focuses on and is scanned across the target. Because the voltage between the

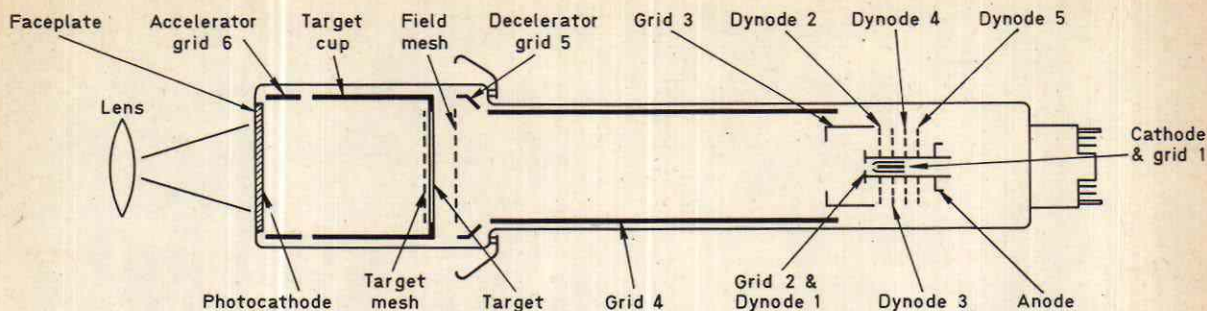

Fig. 1: Structure of the image orthicon camera tube.

cathode of the electron gun and the target is deliberately made very small the electrons of the beam move fairly slowly as electrons go, at about 500,000 metres per second. Though the target is made of glass or a glass-like material it is very thin (about 0.025mm.) and thus conducts appreciably from front to back so that the rear side is at the same voltage as the front.

When the electrons from the scanning beam reach the target three things can happen to them. Some electrons land on the target, neutralising its positive charge and taking no further part in the action. Others, usually the slower electrons in the beam, are reflected back just as light is reflected by a mirror. This process, illustrated in Fig. 2(a), is called *specular reflection*, so we call these electrons the *specular electrons*. The remainder of the electrons are scattered in all directions, as is light when it strikes a sheet of white paper; we refer to these as the *scattered electrons* (see Fig. 2(b)).

The fraction of the total electrons approaching the target that ends up in each of these three categories depends on the charge on the target. When an area of the target has a large charge, because it corresponds with a well-illuminated portion of the photocathode, most of the electrons land and neutralise the charge. Some are scattered and a few are specularly reflected to return in the direction of the gun. When the charge on a portion of the target is low, because of low illumination of the corresponding part of the photocathode, few electrons land, fewer are scattered than in the previous case, and many more are specularly reflected. These differences in the behaviour of electrons at the target are important, because they are the root cause of the limitations of the image orthicon and of the advantages of the image isocon.

The electrons which return towards the gun, a

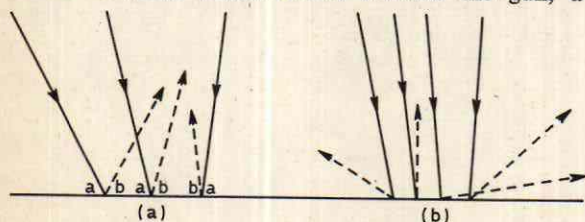

Fig. 2: (a) *Specular reflection*: for each electron path the angle a equals the angle b . A beam of electrons arriving from a fixed direction is reflected as a beam leaving in a fixed direction. (b) *Scattering*: the paths of electrons leaving the surface cannot be predicted. A beam of electrons causes scattering in all directions.

mixture of specular and scattered electrons, land on the first dynode, which is the first of a number of amplifier stages built into the tube itself. Once again the high velocity of the returning electrons, because of the fairly high positive voltage on the dynode, causes more electrons to be knocked from the first dynode surface than land on it. The stream of secondary electrons from the first dynode is then accelerated to the second dynode where the process is repeated. At each dynode the beam current is increased about sixfold, thereby amplifying the beam to an extent sufficient to be presented to an external amplifier.

The overall amplification in this process is about 500,000 and contributes no noise to the beam. Despite this however the signal-to-noise ratio of the image orthicon is limited by the noise in the beam from the cathode, as this noise is amplified along with the signal. This is made worse by the fact that the maximum return beam is in the regions where the target voltage is lowest, corresponding to poorly illuminated areas of the photocathode. This means that the maximum beam and the maximum noise exist in the black parts of the picture, just where noise is most noticeable.

LOW-LIGHT ORTHICONS

The standard version of the image orthicon is itself remarkably sensitive compared with earlier camera tubes but quite a lot can be done to improve sensitivity without any change in basic design. For broadcasting use the colour response of the photocathode is rather more important than the maximum sensitivity, because each colour must be rendered as a different shade of grey on the monitor. Where this is of less importance photocathodes can be made whose sensitivity is up to three times greater than normal, giving a useful overall gain with no loss of signal-to-noise ratio at the expense of greater processing difficulty and a higher rejection rate.

The most favoured high-sensitivity photocathode is the *trialkali*, made by evaporating films of sodium, potassium and caesium alternately with films of antimony on to the glass faceplate. The problems of controlling the process, each stage of which must be carried out with the faceplate at a different temperature, are enormous. So far it has been impossible to form the photocathode outside the tube, test it and transfer it, so that each photocathode is made in place after the rest of the tube processing is complete. Thus a slip up in the photocathode processing means the scrapping of a complete tube.

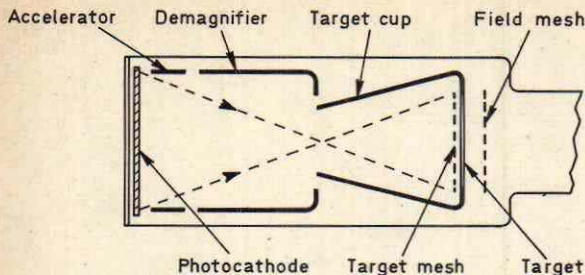

Fig. 3: Extended orthicon image section.

Another possibility is to use a wide target to target mesh spacing. As explained earlier this means that fewer electrons are required from the photocathode to charge the target to any given voltage, so that less light gives more signal. In broadcast use this has the disadvantage that the beam current from the gun must be enough to discharge the most positive areas of the target, and in this condition the noise of the beam is large compared to the charge on the target. At low light levels the beam current can be reduced, with some reduction in noise, and the wider spacing can give a sensitivity advantage up to ten times that of a close-spaced target tube.

To increase the sensitivity of the image orthicon much more than this requires some redesign. One method which has been extensively used is to retain the normal structure of gun, target and mesh but to substitute an extended image section of the type shown in Fig. 3. A photocathode of about double the normal area is used; in practice this is done by using the whole diameter of a $4\frac{1}{2}$ in. tube rather than the smaller portion used on broadcast tubes whose photocathode size is equal to that of the target.

With a normal image section the extra area would not contribute to the sensitivity as the electrons from it would not strike the target anyway. However if the image section is modified so that the electrons converge towards the target, all the electrons from a large photocathode can be focused on to a small target. This act of reducing the image size increases the sensitivity and can be combined with a wide target-to-mesh spacing and a trialkali photocathode to give image orthicons of very high sensitivity. An early application of such tubes was in televising the image on X-ray fluoroscope screens. In this way the dosage of X-rays could be cut down to less than could ever be used if the image were to be visible to the eye yet the monitor image could be comfortably viewed.

THE IMAGE ISOCON

The image isocon has great advantages over the image orthicon not through any increase in sensitivity (its sensitivity is rather less) but because of the great reduction in the beam noise which accompanies the signal at the final anode. In many ways the design is identical to that of the image orthicon but to understand fully how the reduction in noise level is achieved we must be clear about what we mean by beam noise.

In any beam of electrons there are differences in the energies of individual electrons. We can illustrate this by measuring the characteristics of a diode valve at low positive and negative values of anode voltage. As Fig. 4 shows, the current through the

diode does not cut off abruptly as the voltage on the anode drops and is finally made negative. The reason is that the electrons have different values of energy; some, having low energies, are prevented from reaching the anode when the anode voltage is a fraction of a volt positive. Others, with more energy, continue to reach the anode until the voltage is slightly negative, while the most energetic electrons continue to reach the anode even when the anode voltage is more than one volt negative.

In a vacuum—as distinct from the different conditions of the solid state—the differences between electrons of different energy result in the electrons having different velocities, and this means that a number of electrons leaving the cathode at a given time do not arrive together at the anode since some are travelling faster than others. When electrons are leaving the cathode continually, these different velocities mean that the electrons arriving at the anode will arrive in groups as fast electrons catch up with slow electrons which started out earlier. The longer the electrons take to travel from cathode to anode, the more likely it is that they will bunch up in this way, and we must add to this the fact that no cathode emits electrons continually and evenly but only in bursts.

We measure this irregular arrival of electrons at the anode as small variations of current which we call noise for the simple reason that it sounds like noise of no definite frequency when amplified and fed to a loudspeaker. Incidentally, diodes are still used in this way as noise generators so that signal-to-noise ratios can be measured. The hotter a cathode is, the more noisy the beam of electrons, and even materials which are physically cold can generate noise because of some random interference with the flow of electrons through them. In some cases we talk of these materials as having a *noise temperature*, meaning that they produce the noise which we would expect a source of that temperature to produce. The lower the temperature, the lower the noise, down to a limit of -273°C (absolute zero) where noise ceases. We cannot reach this temperature in any working electron beam but we can and do run high-gain maser and parametric amplifiers at very low temperatures to reduce their noise level.

BEAM NOISE IN THE ORTHICON

The beam of an image orthicon carries a noise signal which is normally inescapable. It arises due to the temperature of the cathode which must be kept hot so as to emit electrons. Our only hope of reducing the noise is to make the beam forget somehow that it came from a hot cathode! This we cannot do, but we can select a part of the returning beam to form the signal current which appears to have "forgotten" that it came from a hot cathode.

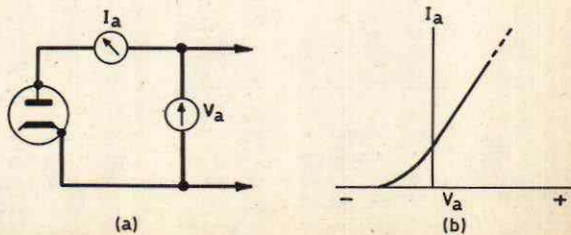
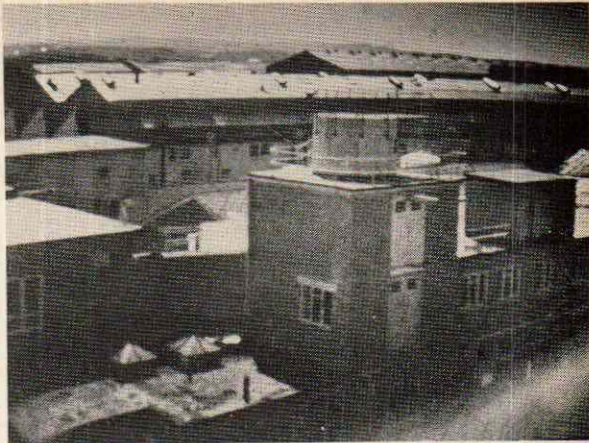
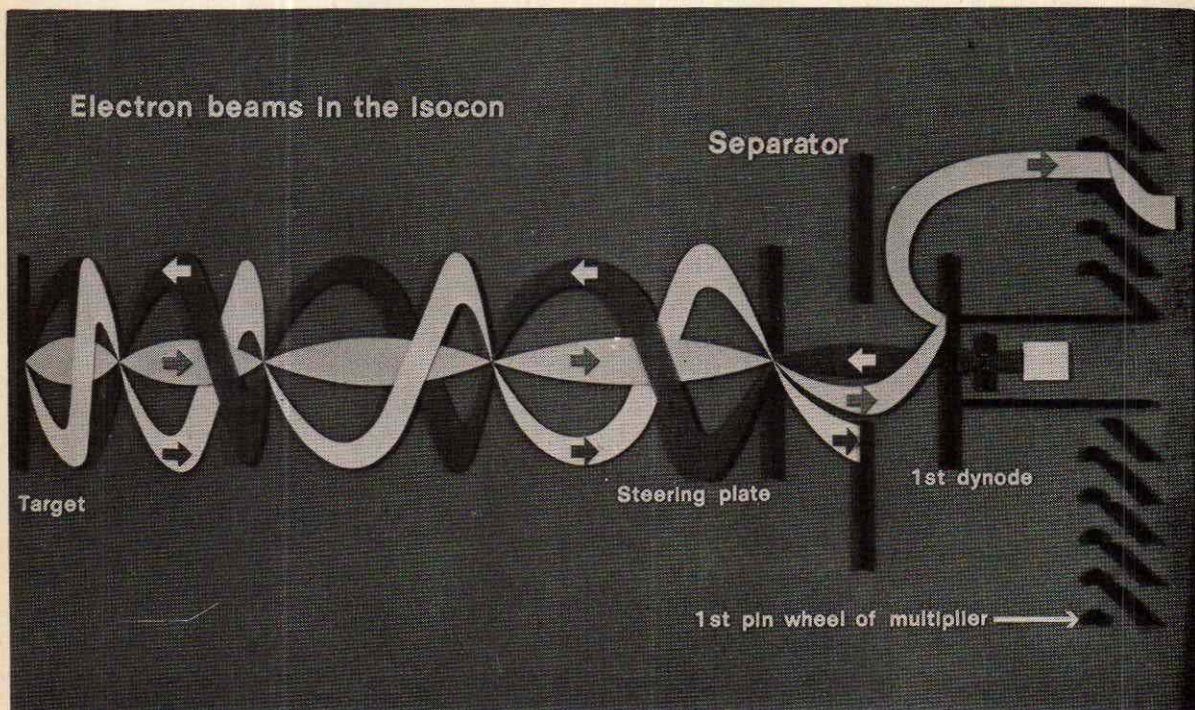

Fig. 4: Noise characteristics of a thermionic diode.



Photographs of pictures taken using an image isocon camera tube. Left, picture taken on a cloudless, moonless night. Right, scene illuminated by full moon.



Electron beams in the image isocon tube. (Illustrations by courtesy of the English Electric Valve Co. Ltd.)

The two types of returning electrons are those which are *specularly reflected* and those which are *scattered*, as we saw earlier. Now if we compare this with the case of light beams, we see that the beam of light reflected from a mirror carries information about where it came from—in everyday language, we see an image in a mirror. A scattered beam of light however does not carry this information, that is we do not see reflected images in a sheet of white paper. In the same way, the specularly reflected electrons from the target make up a beam which has the same noise as the beam from the cathode, but the scattered electrons behave as if they had come from a “cathode” at the temperature of the target.

In an image orthicon these two types of electrons

are not distinguished. Both land on the first dynode and are multiplied to form the signal current. If however we could separate the scattered electrons from the specularly reflected ones we would have two advantages: first the noise of our return beam would be low because the “noise temperature” of the scattered electrons is the temperature of the target; and secondly as the number of scattered electrons is greatest in the regions of large target charge (white on photocathode) and least in the low-charge (black) areas what noise there is occurs mainly in the white parts of the picture where it is least noticeable. This is the principle on which the image isocon tube is based. There is one slight drawback: the number of scattered electrons which can end up back at the first dynode is small, because

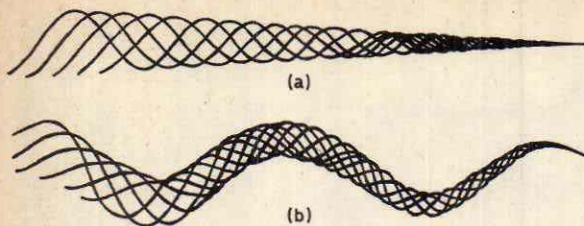

Fig. 5: (a) In the image orthicon each electron follows a spiral path but the outline of the electrons (i.e. the beam) is straight and focused. (b) In the image isocon the beam as a whole follows a spiral path. The number of spirals has been exaggerated in each case. For further details see illustration on previous page.

electrons are scattered in all directions and many end up on other positively charged surfaces. For this reason we might expect the sensitivity in terms of electrons collected per unit of light on the photocathode to be rather less than for an image orthicon, and this is indeed the case. However, the usefulness of a tube at low light levels depends more on its signal-to-noise ratio than its absolute sensitivity, since the image on the monitor must be visible through the noise, and in this respect the image isocon is greatly superior to the image orthicon.

The scattered beam is separated from the specular beam in the image isocon by an ingenious method. This involves "labelling" the beam from the cathode in such a way that the specularly reflected beam still carries the "label" but the scattered beam does not, having lost its "label" along with the noise of the cathode beam.

If the beam from the gun is passed between deflector plates with a voltage of about 50V between them this, combined with the magnetic field used for focusing the beam, will make the beam move in a spiral path. This type of path must be distinguished from the spiral paths which individual electrons in the image orthicon take. In the image orthicon the spirals are small and the beam as a whole is straight. In the image isocon however the whole beam of electrons spirals its way to the target (see Fig. 5). This spiralling is the "label" we need, because the specularly reflected beam keeps up this spiral motion as it returns towards the first dynode while the scattered electrons do not spiral but return in straight lines.

PRACTICAL OPERATION

All we need now is a method of separating the spiralling from the straight beams. This is achieved by the deflector plates (usually called *steering plates*) again. When the spiralling beam of specular electrons passes back through the steering plates the radius of its spiral is increased to such an extent that the beam can be intercepted on a plate set at just the right diameter out from the first dynode. The beam of scattered electrons however is given only a slight spiral motion by the steering plates as it returns and the radius of the beam is not large enough to result in interception by the plate (the *separator*) which catches the specularly reflected electrons. Thus the scattered electrons end up on the first dynode to be multiplied in the usual way.

Isocons at present in production feature three steering plates so that the steering field can be applied in any direction. The tube is first set up as an image orthicon with the steering plates and separator at the fourth grid voltage. When a good picture is obtained the tube is changed over to isocon operation by adjusting the separator voltage to about 80V and adjusting one or more of the steering electrodes until the picture turns negative. The video amplifier is then switched to reverse polarity and the picture adjusted for minimum noise, uniform shading and best resolution by alterations to the steering plates, separator and grid two voltages along with the usual image orthicon controls.

The isocon principle can be and is combined with the features of extended-image section and wide target spacing mentioned earlier to produce acceptable pictures at levels of illumination little greater than that of starlight. The limit of performance is set not by the noise level, as was always the case with earlier low-light level tubes, but by the loss in resolution as the available light level drops.

USING IMAGE AMPLIFIERS

If the light level on the photocathode of an image orthicon can be increased by any means this increases the sensitivity of the system. One method of doing this is to use electronic amplification of the image. Image intensifiers were dealt with in an article in *PRACTICAL TELEVISION*, May 1968, but a summary of the facts may be useful.

When light strikes a photocathode the number of electrons emitted depends on the light level. When electrons strike a phosphor the light emitted depends on the number of electrons striking the phosphor and also on the potential between the phosphor and the photocathode. This forms the basis of one type of image intensifier in which image diode cells consisting of phosphor and photocathode in each unit are stacked together. A light gain of 50 times in each cell gives a total gain for a stack of three of 125,000 if we disregard losses due to the coupling of cells. In stacks of this type made so far the coupling is improved by making the endplates of each cell from aligned glass fibres, the so-called "fibre-optic" technique.

The other important type of image amplifier uses thin aluminium oxide films as electron multipliers either in a straightforward way, by secondary emission, or in the S.E.C. (Secondary Electron Conduction) method of use. The S.E.C. principle was described in an article in *PRACTICAL TELEVISION*, January 1967. In this type of tube the electron stream from the photocathode is multiplied at each dynode. The stream is kept in focus by a strong magnetic field from a solenoid, which may be an electromagnet or a permanent magnet. The final electron stream at the phosphor is of higher current and also at a higher energy due to the high potential between phosphor and photocathode, so that very high gain can be achieved.

The most recent development in very low-light level working is that of coupling an image amplifier of the first type mentioned to an image isocon by means of fibre optics to ensure maximum gain with minimum coupling loss. There will undoubtedly be further progress in this field. ■

G. R. WILDING

R-Y Phase Alternation

The phase reversal of the R-Y component of the chroma signal on alternate lines in the PAL system serves two purposes: it enables spurious phase changes in the transmission path to be automatically cancelled at the receiver and also enables the R-Y and B-Y components of the chroma signal to be separated prior to detection so that the design of the detector circuits is less critical. In the PAL-D type of receiver these two actions are carried out in the circuits associated with the line-duration delay line in the decoder.

THE major difference between PAL and the original US NTSC colour system is the line-by-line reversal of the R-Y information in the PAL system to cancel out the phase errors that can develop anywhere in the transmission path from studio to receiver and which would otherwise cause the display of incorrect colours on the screen. In all PAL-D receivers this continuous reversal of the R-Y signal from line to line is changed back to a constant phase signal by electronic means involving the use of a delay line. But what precisely does R-Y reversal infer?

To answer this question fully it is necessary to consider the input to the delay line. This consists of an amplified version of the received colour subcarrier sidebands minus the blanked out colour bursts. Up to the delay line the chroma subcarrier sidebands vary in both amplitude and phase, the value of the former establishing saturation and angle of the latter indicating hue. After the delay line circuitry—or from pins 2 and 3 in the more recent DL1E type of delay line—what was previously the phase and amplitude modulated subcarrier becomes two separate signals, R-Y and B-Y, amplitude modulated to $\pm 1\text{MHz}$. Subsequent circuitry then detects the instantaneous R-Y and B-Y values by reference to a locally generated 4.43MHz signal which is kept in synchronism with the transmitter by the colour burst signal. After demodulation by means of a special type of detector called a synchronous detector the third colour-difference signal required, G-Y, is obtained by matrixing circuitry which in effect adds an inverted 0.51 of R-Y to 0.19 of B-Y.

Concentrating however on the R-Y delay line output, Fig. 1 illustrates the principle of line-by-line

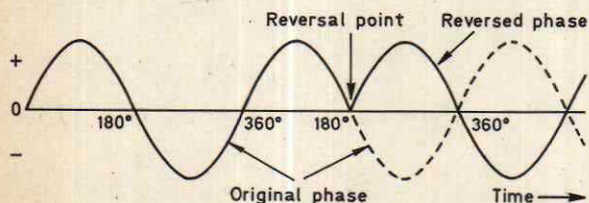

Fig. 1: Effect of phase reversal on a sine wave. The 180° phase displacement means that the instantaneous positive and negative values become interchanged. Reversal of the R-Y signal phase in the PAL colour system occurs during each line blanking period.

phase reversal, showing the effect on a sine wave of changing its phase by 180°. This is the change which is imposed on the R-Y signal at the transmitter during each line blanking period. It will be seen that reversing the signal phase amounts to reversing the instantaneous rising or falling polarity values. If the original signal is at peak positive, reversing its phase will place it at peak negative. And if two such signals are added the net output is zero.

Equally obvious and vitally important, if a signal constantly subject to phase reversal is applied to a conventional diode detector it will produce the usual positive or negative rectified output according to the manner of diode connection. The fact that the signal is repeatedly reversed does not make any noticeable difference to output.

To abstract the encoded information from the R-Y and B-Y signals it is necessary to detect or measure their instantaneous values with reference to a standard, using a special form of detector. The standard is of course the locally generated 4.43MHz reference signal, the special detectors being synchronous types to which when the reference signal is applied together with the R-Y or B-Y signal the diodes will be switched on to give an output of amplitude and polarity directly related to the instantaneous R-Y and B-Y values.

It will be apparent that whereas the output from the B-Y detector will be a facsimile of the original encoded B-Y information, that from the R-Y detector will be correct on one line but out of phase on the next, so that unless steps are taken to avoid this there will be correct hues on one line and complementary hues on the next. To obtain a constant-phase output, i.e. an R-Y signal as obtained from the camera, one of two courses can be used: (a) line-by-line phase reversal of the R-Y signal in step with the transmitted reversals or (b) line-by-line phase reversal of the reference signal applied to the R-Y detector. Both methods will have precisely the same end effect, the production of a constant-phase R-Y signal, and both methods are in use, the latter being more popular on the grounds that it is generally preferable to route the unmodulated 4.43MHz reference signal through the phase-reversing circuitry rather than the 2MHz wide modulated signal.

The same techniques can be used in either case,

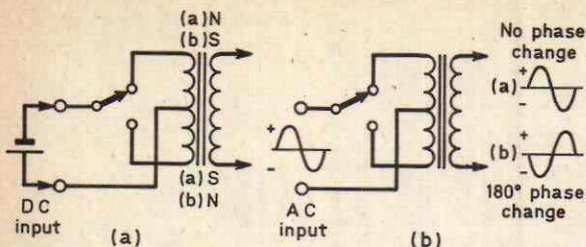

Fig. 2: (a) Effect of reversing d.c. input polarity. (b) Output phase reversal obtained by switching an a.c. transformer input to opposite ends of a centre-tapped primary. Such transformers, with signal feed or take-off via switched diodes, form the basis of most R-Y phase reversing circuits.

so how then is this phase reversal or 180° phase shift continuously achieved on consecutive lines? It is generally done by routing the signal through, or arranging for it to be tapped from, identical but oppositely wound transformer windings or from a single centre-tapped winding.

The basic principle is demonstrated in Fig. 2 where at (a) the application of a d.c. supply between the transformer primary centre-tap and a free end results in a core magnetic polarity dependent on the winding direction selected by the switch. On then changing over the switch position so that the d.c. supply is connected between the centre-tap and the other free end the core polarity is reversed and a secondary voltage of opposite polarity to that induced by the first application is produced.

If an a.c. signal is applied—see (b)—from the centre-tap to a free end the secondary induced voltage will be either in phase with or completely out of phase with the primary a.c. voltage depending on the winding direction. If it is in phase, applying the a.c. signal to the centre-tap and the other free end will result in an out of phase secondary voltage, and vice versa.

The steering of the local reference signal or the R-Y signal through a similar type of transformer is achieved by diodes—in place of the switches so far shown—rendered conductive by (usually) a bistable oscillator triggered by line pulses tapped from the line output circuit and with correct switching “sense” maintained by the over-riding ident signal.

To turn now to a practical example—used in many GEC/Sobell colour models—illustrated in Technichart No. 1. It will be seen that the delay line driver transistor, which is fed with the amplified chrominance information, is arranged to give two equal-amplitude outputs (a) one developed across its 390Ω collector load resistor and fed to the DL1E delay line pins 4 and 5, and (b) one from a tapping point in its emitter circuit and fed to pin 1 (direct feed) of the delay line. (Pin 1 is the one between pins 2 and 3.)

The function of the delay line is to separate the R-Y and B-Y constituents of the chroma signal by a process of addition and subtraction. The earlier type DL1 delay line required an external auto-transformer but the necessary windings are incorporated in the type DL1E delay line shown. Delay line action has been covered in these pages before but can be summarised as follows. The signal delay

provided by the DL1E delay line is equal to one line period, i.e. 64μsecs. The addition of information from two successive lines, i.e. one direct and one delayed feed, doubles the B-Y component since its phase is constant but cancels out the R-Y signal since the addition of (R-Y) and -(R-Y) is zero. This output is obtained at pin 2. On the other hand by rearranging the phase relationships of the signal to give signal subtraction instead of addition the B-Y signal is cancelled and the R-Y signal doubled, but on one line we shall get +2(R-Y) and on the next -2(R-Y). This output is obtained at pin 3. Thus terminals 2 and 3 provide pure B-Y and R-Y signals respectively. And in the processes of signal addition and subtraction spurious phase shifts are cancelled.

The precise manufacturing tolerance of the delay line ensures coincident timing of the direct and delayed line information, while a 100Ω rheostat in the driver stage emitter lead enables exact amplitude matching to be achieved.

Turning next to the locally generated reference signal, this is taken from the emitter of a buffer stage following the crystal oscillator and fed to transformer T1 which then induces equal amplitude but opposite phase signals in the two identical secondary windings. The anodes of the two diodes D1 and D2 are connected to opposite ends of these windings while the cathodes are commoned and taken via a parallel RC combination through T2 primary to chassis. The other ends of both secondaries are directly linked to the collectors of the bistable oscillator, the induced reference signals being earthed by the 1.5 kF capacitors.

Rectification of the reference signal produces a positive voltage across the 10μF capacitor but as the bistable transistors are alternately cut-off and fully conductive during successive line periods to a collector voltage of 14V when cut-off the anodes of the diodes are alternately raised above and below cathode potential to fully bias them on or off. When either bistable transistor is cut-off its collector potential approaches the positive rail voltage since

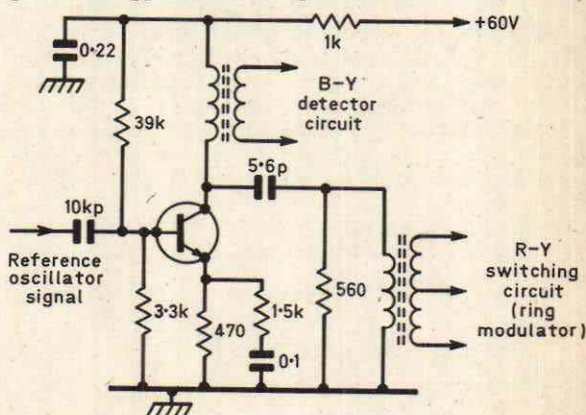

Fig. 3: Reference oscillator feed used in the Beovision 3000 colour receiver. Instead of routing the local 4.43 MHz signal via a 90° phase shifter to the B-Y detector and via the 0°/180° inverter to the R-Y detector, the output from the reference signal amplifier is fed direct to the B-Y detector and via both phase shifters to the R-Y detector. This still preserves the essential 90° phase disparity between the R-Y and B-Y signals.

DX-TV

A MONTHLY FEATURE FOR DX ENTHUSIASTS CHARLES RAFAREL

THERE is still no change in the very poor conditions that we have been suffering from for the past two months. If anything both SpE and Trop reception during March dropped to an even lower level than in February. However it cannot be long now until there is a marked improvement in SpE reception. As I write at the end of March it will soon be April when SpE can really open up. It has done so many times before and even if April is not too good May has always been really open for SpE reception so patience for only just a little longer! I can only suppose that the continuing very cold weather has been the cause of the trouble: this winter is the worst that I have known in over ten years of DXing here.

As last month, there has been some evidence of F2 activity once again but this too has been on a somewhat reduced scale and limited to the USSR forward-scatter network. It would seem that the recent peak is now passing and the skip shortening as no USA paging stations were heard.

Now to the SpE log for the period 1/3/70 to 31/3/70—and once again I really was trying:

- 2/3/70 Poland R1, Czechoslovakia R1, W. Germany E2 and "new" card E2 see below.
- 5/3/70 Poland R1, Czechoslovakia R1.
- 10/3/70 Czechoslovakia R1.
- 15/3/70 Poland R1, Czechoslovakia R1.
- 18/3/70 Poland R1, Sweden E2.
- 21/3/70 Czechoslovakia R1, Sweden E2.
- 29/3/70 Poland R1.
- 30/3/70 Czechoslovakia R1.

There was F2 reception from the USSR on the 3rd, 6th, 14th and 20th but with weaker signals than last month. The less said about the Trop's during this period the better! There was only the odd day or so when things temporarily improved.

Thanks to G. J. Deaves of Norwich we are able to publish an official list of Norwegian TV stations as follows (all Band I and horizontally polarised):
Ch. E2: Melhus 100kW, Steigen 60kW, Greipstad 60kW, Varanger 30kW.

Ch. E3: Gamlemsveten 60kW, Bagn 30kW, Hemnes 60kW, Kautokeino 8kW.

Ch. E2: Melhus 100kW, Steigen 60kW, Greipstad
His Scandinavian source of information also gives the following times for test card transmissions in Norway, Sweden and Denmark:

Norway: Daily except Tuesday 09.30 to 17.00.

Sweden: Monday and Wednesday 09.30 to 11.00,

12.00 to 16.00 and 17.30 until start of programme.

Tuesday and Friday 09.30 to 11.00, 12.00 to 15.00 and 16.00 until start of programme.

Thursday 09.30 to 11.00, 12.00 to 13.30 and 16.00 until start of programme.

Saturday 09.30 to 11.00 and 12.00 to 15.00.

Colour tests Tuesday and Friday 15.00 to 16.00 and Monday and Wednesday 16.00 to 17.30.

Denmark: Monday, Tuesday, Thursday and Friday 09.00 to 10.00 and 13.30 to 17.30.

Wednesday 09.00 to 10.00 and 13.00 to 16.00.

Saturday 09.00 to 15.00.

I presume that the above times are in GMT but it is not indicated in the Norwegian publication. The rest of the information I assure you is correct even if it was translated from the Norwegian by "yours truly" based on what knowledge of the language he picked up during his holiday there last year!

Roger Bunney has also received an official list of Finnish TV stations as follows:

Finland: 1st programme Taivalkoski E2 15kW vertical polarisation, Tervola E3 80 kW horizontal, Kajaani E4 15kW horizontal (TV1 on card).

2nd programme Tampere E2 10kW vertical (TV2 on card).

His contact in Finland says two new u.h.f. stations are expected to be on air shortly. These are located at Sippola and Jyväskylä, both in Southern Finland, so could be possible here if conditions are "excellent". The channels are not yet known but he hopes to have more news soon which we will pass on.

There is one Finnish u.h.f. station listed at present. Lahti Ch. 40 (horizontal) but it seems to be low-power at present—only 1kW. I would suggest that this is due for upgrading. Finland is a long way for u.h.f. but it could happen here.

We have already had our first 1970 mystery received by Roger Bunney and myself in the form of a new test card on E2 on 2/3/70 at 11.52. Unfortunately it was a short duration signal with no follow-up at 12.00 in the form of captions etc. This test card consisted of two concentric narrow black circles enclosing a single horizontal contrast wedge in the lower half of the circle and a white square inside towards the top left-hand side. With the weak signal there did not appear to be any corner circles on the card. We have no idea as yet as to the origin of this card. From the aerial direction it seems to lie to the North-East and we would be very grateful for any news of other DXers' reception of it.

Now for a very preliminary report on high-band Meteor DX, the subject of our recent articles. The results to date by Roger Bunney and myself have been encouraging if not exactly spectacular. We chose Band III Chs. E5/R6 and there has certainly been some evidence of very short duration activity in the form of snatches of programme and sawtooth patterns. No positive station identifications to date but if we can get some bursts of test card we will know the source of the signals. We are continuing our vigil and hope to have more news before long. We feel sure that this new project is well worth further investigation.

May I ask you all once again for your co-operation. Your reports on this type of reception would be most welcome as we are anxious to assess as far as possible the potentialities of this new method of propagation and reception.

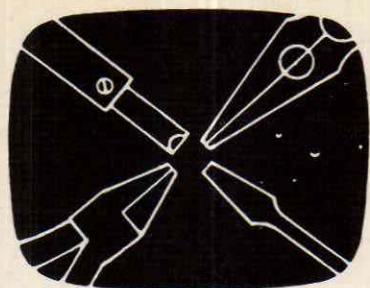

SERVICING television receivers

L. LAWRY-JOHN'S
GEC-SOBELL 2010-1010 SERIES

We dealt with the Sobell 1000 series in the June-July 1968 issues. This later group of models was developed from the earlier chassis and many of our notes will be found applicable to a very large number of models produced from 1964 up to very recent months. There have been many minor circuit changes and the layout differs considerably but the fault symptoms and their location remain sensibly the same. For example, the dropper sections still go open-circuit although the dropper is no longer at the top but at the left-hand side of the chassis. The horrible disc-type thermistor (TH2) used in earlier models from the dropper to the rectifier, and which was a real drop-out, has been replaced by a more sensible tubular type which doesn't give any trouble.

We cannot wax lyrical about the v.h.f. tuner changes however. The original rather bulky semi-incremental type with the two large discs was superseded by a more conventional biscuit turret type

which was a reasonable change and all our heads nodded in agreement. A couple of years ago our heads stopped nodding. The small turret was replaced by a strange contraption of springs, iron dust slugs on wires, sliding contacts which are almost inaccessible, tiny screws of differing lengths which have to go in their own tiny holes, pieces of sticky tape over resistors which change value and a kinky disc which wanders out of position to make channel changing a chancy affair.

Despite this however the range of receivers is among the most reliable and, perhaps more important, the most predictable available in recent years.

The system of numbering the various models under the different brand names is logical enough. For example the Sobell 1020, GEC 2020, McMichael 3020 and Masteradio 4020 are all fitted with the same chassis. With certain reservations these notes can be extended to the 1010, 1012, 1017, 1018, 1022

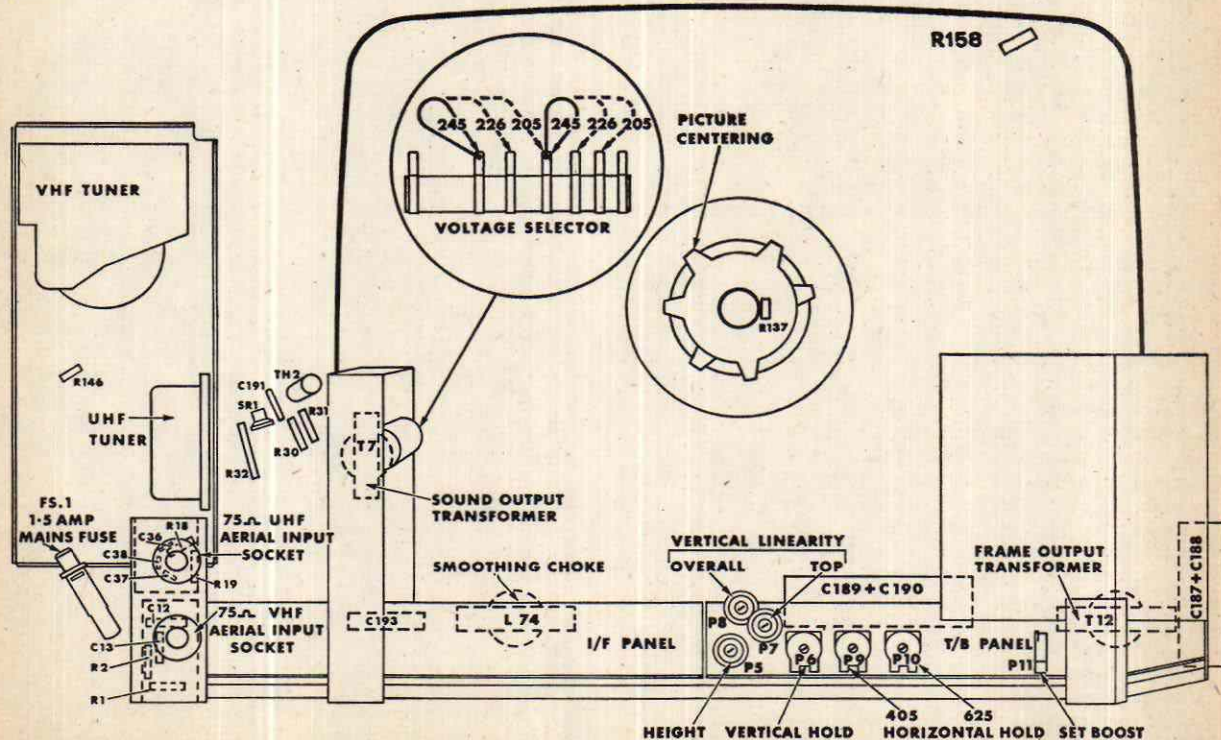

Fig. 1: Rear chassis view. In earlier models the focus adjustment (R137-R139) is on the tube base.

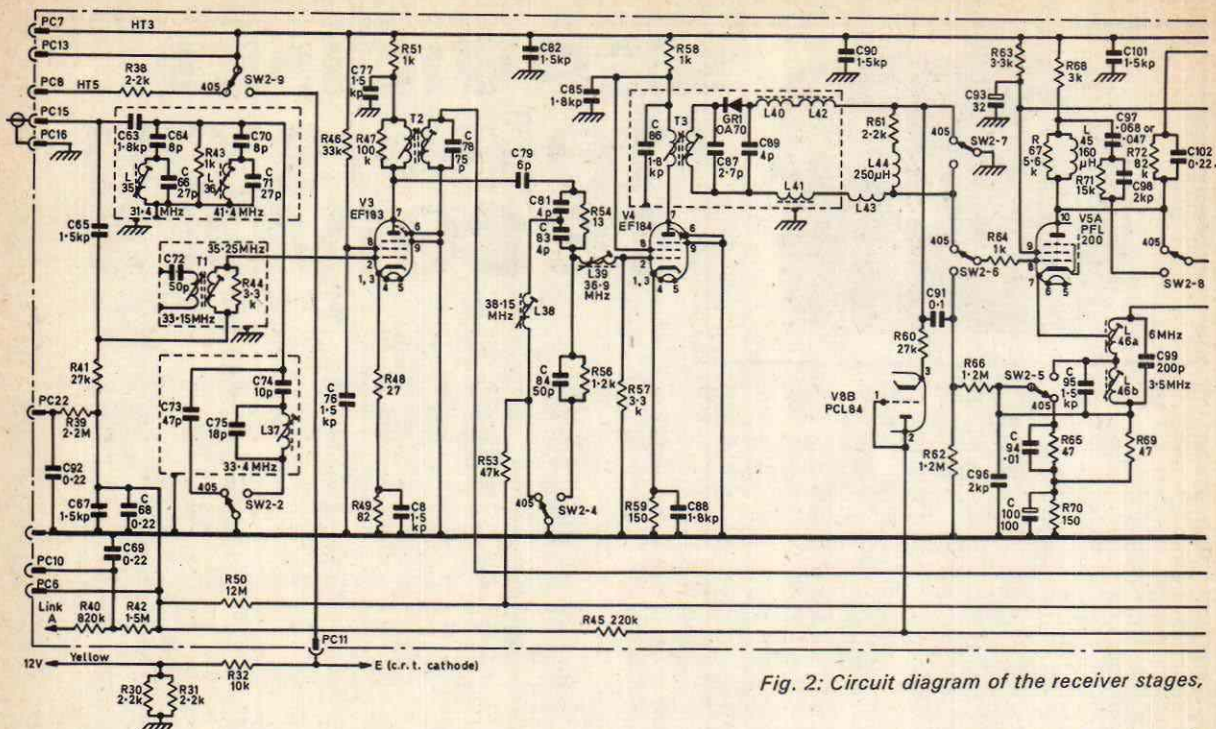

Fig. 2: Circuit diagram of the receiver stages,

and 1038 series, bearing in mind the fact however that the 1012 group feature completely transistorised tuner units and i.f. stages with a heater circuit diode to supply current to the six valves and tube. The 1017 features v.h.f. radio facilities and a ratio detector circuit as opposed to the quadrature EH90 detector used in the other valved models.

Common Faults

The most common fault which will be encountered is a failure of one section of the dropper. This is usually towards the front end and is most often the 15Ω section. The symptom is that although the valve heaters are glowing normally the set is otherwise dead. The faulty section can be located immediately with a neon screwdriver, a healthy glow at all sections indicating that the dropper is not at fault so that one moves on to the thermistor TH2. However it is the dropper which will almost certainly be at fault and one has the alternative of fitting a complete new dropper or bridging the faulty sections with a resistor of the correct or near value and an adequate wattage rating. The writer's own favourite is a Radiospares 14Ω section which can be fitted in minutes with two small nuts and bolts to make a neat and strong job. If a wire-ended resistor is used the wires should be wrapped securely around the tags before soldering and it should be of 10W rating or higher. It is not clever merely to short out the faulty section by means of the flying leads and tags as this raises the h.t. voltage and causes further trouble.

If the symptom is valve heaters not glowing check the rear sections of the dropper, remembering that these have a much higher value, and if all these show a strong indication move on to check the PY800 heater.

Neon checks are only useful if done properly (however simple this may be). The first check must always be to the receiver chassis to ensure that it is not "live". If all points are live check the on-off switch and the mains supply as the neutral is likely to be open-circuit.

Distorted Sound

Low and distorted sound is most often due to the resistors associated with the EH90 valve changing value. The cause of the trouble is mainly the 18kΩ 2W resistor R92 on the left side of the panel. This gradually falls in value causing an increase in current which cooks it further until the value falls rapidly causing the 5.6kΩ resistor R93 to overheat and change also. The smaller 180Ω resistor R90 in series with these two seems to escape damage due to its already low value.

The distortion usually calls attention to the situation before the current flow becomes excessive so that the danger of a complete h.t. short and burn-out is averted. The values are not too critical and a 22kΩ resistor can be used in place of R92 if a large 18kΩ resistor is not available. It is essential that this is rated at 2W or more. The rating of R93 is not so important as less voltage is dropped across this. A 4.7kΩ 1W type can be used if the correct value is not available.

Distortion can also be caused by the limiter (GR3 OA81) clipping but this is not usual even if the 4.7MΩ resistor R84 goes high because of the 1.8MΩ resistor R87 from the EH90 anode. This resistor serves to "lift" the OA81 away from its limiting condition on 625 since the voltage at V7 anode rises to 125V on this standard.

We do not imply by these remarks that R92 and R93 are always responsible for distorted sound,

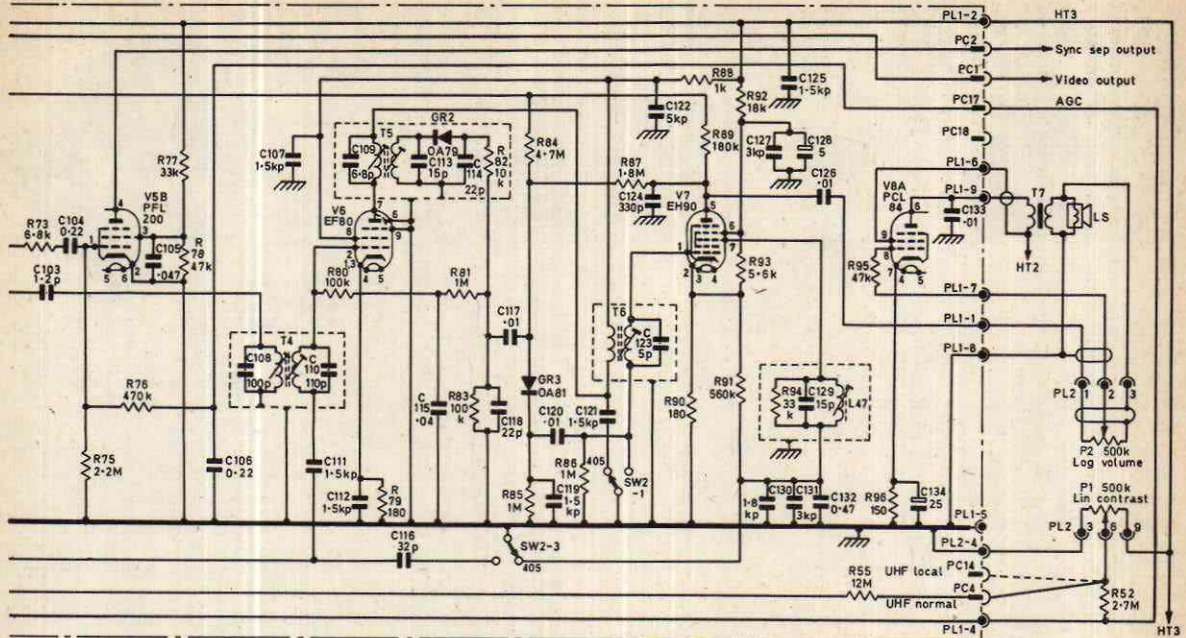

GEC-Sobell 2010-1010 series. There are a number of component value changes in later models. These will be listed next month.

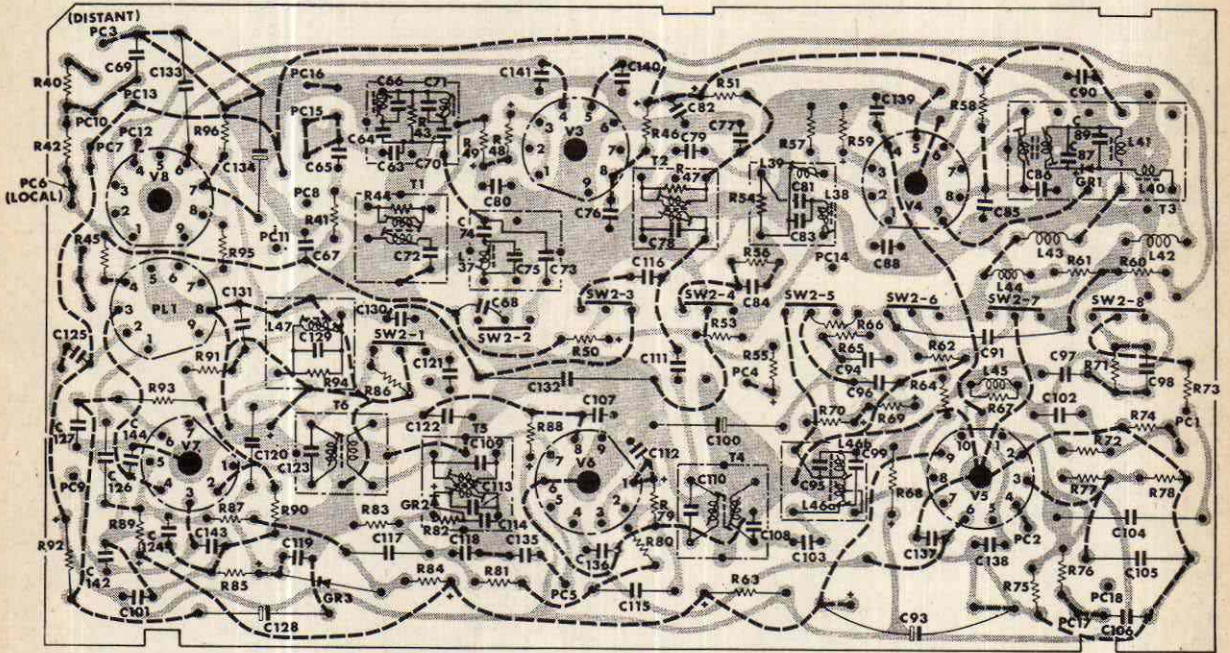

Fig. 3: Layout of the i.f. board viewed from the print side. Wiring on component side shown in broken lines.

Indeed it could be said that the PCL84 valve is just as often responsible for the condition. Quite a few things can happen to this stage but before discussing these let us be quite clear on one or two points. The output valve used on the 1012 series is a PCL86 while the 1017 uses both sections of a PCL84, triode as a.f. amplifier as there is no EH90 in this model. All other models use the pentode section as the sound output and the triode section as a.g.c. clamp diode (grid and anode strapped).

The usual troubles in the output stage are low

emission, making the sound weak or non-existent, leakage between electrodes which causes low and distorted sound (R92 being quite innocent despite its discolouration), and shorts between electrodes which cause the bias resistor (R96, 150Ω on some models, 120Ω on others) to burn out. In the event of the latter resistor being found charred replace the PCL84 and check the 25μF electrolytic C134 which may have suffered during the fault condition. As far as the replacement of the resistor is concerned the follow-

—continued on page 424

POWER SUPPLY CIRCUITS

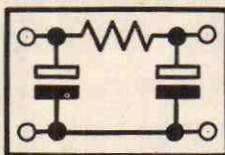
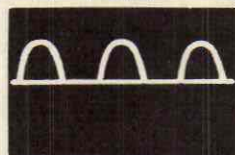
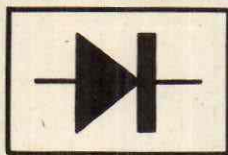
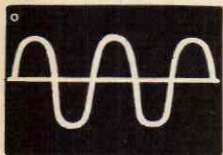

DC

S. GEORGE

TELEVISION h.t. supplies are almost universally provided by means of a half-wave rectifier, either directly fed from the mains or from a tapping on an autotransformer. The size and cost of a fully-wound transformer usually outweighs their advantages in standard monochrome receivers, but in colour models a transformer is generally employed in order to conveniently obtain the transistor i.t. supplies and the heater feed for the shadowmask tube. Whether or not a transformer is used for the h.t., shadowmask tube heaters are always transformer fed to eliminate the risk of switch-on surges that inevitably occur in a series heater chain.

H.T. circuits can be of two types, (a) single-rail versions, usually employing an iron-cored choke for smoothing to minimise the voltage drop, and (b) arrangements providing multiple h.t. rails each individually fed by low-value wire-wound resistors. This latter arrangement reduces the risk of unwanted coupling between different sections of the receiver and has the advantage of providing supplies at differing smoothing and voltage levels to suit the requirements of different stages. For instance the line output stage, which requires maximum voltage, can be fed via a lower-value resistor from the reservoir capacitor than the signal amplifying stages for which the smoothing level is the most important

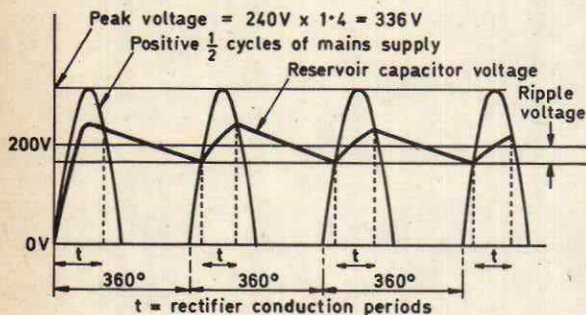

Fig. 1: Half-wave rectifier output. As diode conduction occurs for only about 100° of each full input cycle the reservoir charging current is on average three-four times the constant receiver current.

factor. When a single h.t. rail is used the smoothing level must of course be adequate for all stage requirements.

With either system the total h.t. consumption will be in the region of 275-300mA with the output voltage ranging from just over 200V to a maximum of about 265V. The reservoir capacitor associated with the rectifier must be large enough to sustain the stipulated voltage with only a slight voltage drop between the succeeding positive half-cycles or the

smoothing filter will be unable to maintain a constant output voltage.

A rectifier can only conduct when a positive voltage at its anode exceeds the cathode voltage. If the latter is assumed to be 225V, then as the peak 240V mains input equals 336V (240×1.4) diode conduction will only commence at approximately $\sin^{-1} 225/336$, or closely 41° from the commencement of a positive half-cycle, and will finish slightly earlier than this angle from the termination of each positive half-cycle since the charge will have raised the reservoir capacitor potential during this time. Therefore, assuming that non-conduction occupies 80° of the positive half-cycle, conduction will only be for 100° of each complete cycle and the charge current must thus average three-four times that of the constant current drain with peak values rising to a still higher figure. The reservoir charging current thus consists of a train of comparatively short-term, high-amplitude, rounded pulses: Fig. 1 illustrates these points.

Throughout a one-cycle period the total charge drawn from the reservoir capacitor will be $Q=It$, and assuming a current demand of 300mA this equals 0.3×0.02 or 0.006 coulomb. With a typical reservoir capacitor of $200\mu F$ charged to 225V the voltage drop at the end of a one-cycle period equals Q/C . As this basic formula relates to capacitance in farads it is convenient to convert C to microcoulombs. Thus the voltage drop is $V=6,000(\mu C)/200\mu F=30V$.

This variation or a.c. ripple must of course be reduced to a fraction of this figure by the RC or LC filters. Such filters can be considered as series RC or LC combinations with the capacitance offering a low reactance to the ripple or a.c. component and the resistor or choke offering a much higher impedance so that most of the a.c. content is developed across the inductive or resistive component.

Chokes are much more effective than resistors since the resistance of the latter represents its sole impedance to a.c. or d.c. while the reactance of a choke to a.c. can reach a very high value, with the added advantage that the d.c. voltage drop across the winding resistance is small. While chokes are often used with a single h.t. rail system, resistors are generally used in multi-rail circuits mainly because of cost and size considerations.

At this point it is appropriate to see how the smoothing effect of these filters can be calculated. For LC filters the main point to be made is that the individual reactances of the two components X_L and X_C are electrically opposite, so the formula to

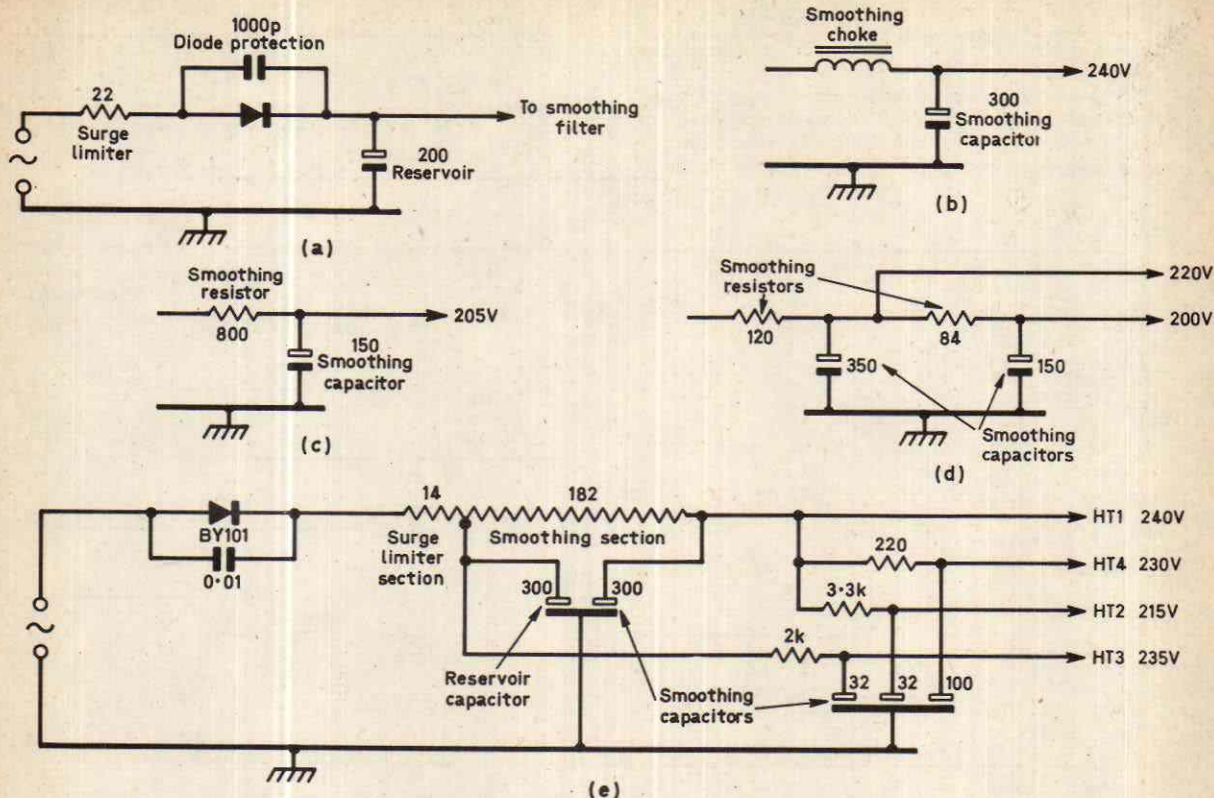

Fig. 2: (a) Basic diode rectifier circuit. (b)-(d) Three common types of smoothing filter. (e) Bush-Murphy h.t. supply circuit with four separate h.t. lines and surge limiter in cathode lead of rectifier. HT1 feeds the tuner, i.f. stages, video and line output stage; HT2 feeds the line oscillator; HT3 feeds the audio output stage and HT4 the field output stage.

determine by what percentage they reduce input ripple is as follows:

$$\frac{\text{Output}}{\text{Input}} \% \text{ ripple} = \frac{X_c}{X_L - X_c} \times 100$$

When the reservoir ripple is known therefore it becomes a simple matter to calculate the ripple voltage across the smoothing capacitor.

As on the other hand resistance and reactance are electrically at right angles, the formula for an RC filter is:

$$\frac{\text{Output}}{\text{Input}} \% \text{ ripple} = \frac{X_c}{\sqrt{R^2 + X_c^2}} \times 100$$

An idea of the effectiveness of simple two-component smoothing filters can be gauged from the figure relating to the h.t. supply system used in many GEC models: the potential of 267V across the reservoir capacitor has a peak-to-peak ripple of 30V while on the receiver side of the choke the ripple is reduced to only 1.7V peak-to-peak. A further RC filter comprising a 300Ω resistor and 50μF electrolytic capacitor feeding the vision and sound receiver section then reduces this ripple to only 0.3V peak-to-peak or 1% of the original figure.

Due to the high value of electrolytic reservoir capacitors used and the extremely low forward resistance of modern diodes, surge limiters are absolutely essential to prevent damaging current surges at switch-on when there is zero charge on the

capacitor and the initial charging current is solely limited by series resistance in the circuit. Their value is largely dependent on reservoir capacitor value and what other resistance may be present in the circuit. Where the h.t. feed is from an auto- or fully-wound transformer the surge limiter value can be greatly reduced or it may even be dispensed with altogether if the d.c. resistance of the transformer winding is of sufficient value.

Although surge limiters are usually connected in the a.c. feed to the diode anode (see Fig. 2 (a)), this is not universal practice. In many Bush-Murphy models the surge limiter is connected between the diode cathode and the reservoir capacitor (see Fig. 2(e)). With both arrangements their action is of course the same.

In a valved receiver employing a semiconductor rectifier the reservoir capacitor voltage will rise rapidly to the peak applied voltage until the valves start to pass current. Thus the rectifier must have a working voltage well in excess of this value. Furthermore when the diode anode voltage swings to the maximum negative value the reverse potential across the rectifier will be twice the peak voltage, or about 672V, so the rectifier must be able to withstand this considerable voltage plus a safety margin.

Hybrid and Colour Receivers

Most monochrome receivers now employ transistors to some extent, either in an integrated tuner

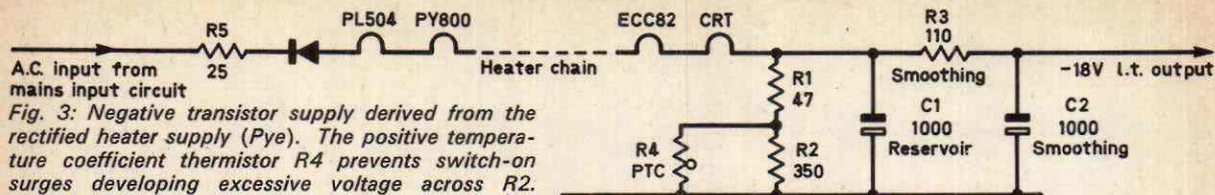

Fig. 3: Negative transistor supply derived from the rectified heater supply (Pye). The positive temperature coefficient thermistor R4 prevents switch-on surges developing excessive voltage across R2.

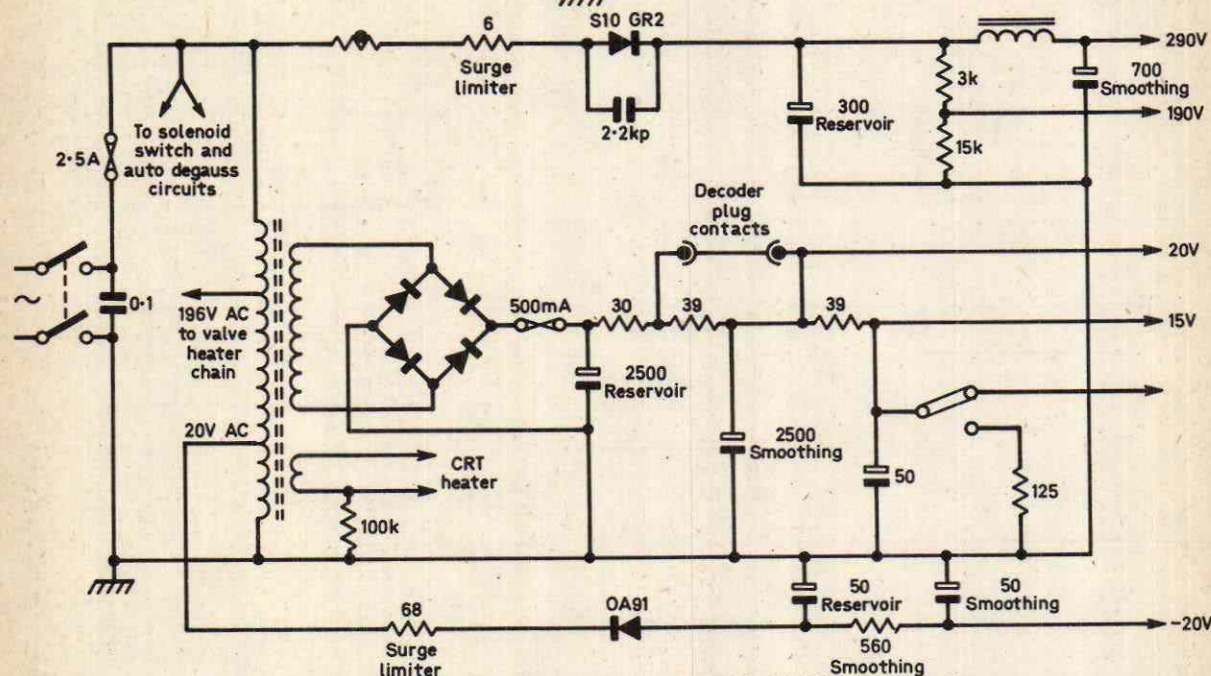

Fig. 4. Power supply circuits of the KB-ITT Model CK400 colour receiver.

or throughout the vision and sound i.f. stages. When the current demand is small, as when only the tuner is transistorised, the l.t. is usually provided from a potential divider between the h.t. line and chassis. When the complete receiver section is solid-state, however, many designs derive the l.t. supply from the rectified heater current by including at the end of the chain a low-value resistor or resistors across which the desired l.t. is developed. This rectified heater current consists of a train of positive or negative half-cycles depending on the heater rectifier polarity, and must be well smoothed before it can be used as transistor power. As the circuit impedance is low this implies high capacitance shunting electrolytics and a small-value series smoothing resistor as shown in the typical example in Fig. 3, used in many Pye hybrid models.

R1, R2 and R4 constitute the heater chain termination with R3 in conjunction with C1 and C2 forming a pi smoothing filter. R4 is a positive-temperature coefficient thermistor so that when it is cold at switch-on and the heater current is high its value remains low to reduce the voltage developed across R2 and thus prevent excessive voltage being applied to the transistors during this initial period. When the valve heaters are fully warmed up and the heater current falls to the normal value the resistance of R4 increases to permit the correct voltage to be developed across R2. This action is of course the

opposite of that given by a negative-temperature coefficient thermistor in series with a heater chain.

Due to the hybrid nature of most colour receivers and the fact that both npn and pnp transistors may be used in one model, both positive and negative l.t. rails may be required and at differing voltages.

Fig. 4 shows a typical colour receiver power supply system giving h.t. at 290V and 190V directly from the mains input, l.t. at +15V and +20V from a bridge-type transformer-fed rectifier and -20V derived from a tapping on the transformer primary. The bridge rectifier in conjunction with the large-value reservoir and smoothing capacitors gives an extremely high smoothing level, while the secondary winding resistance obviates the need for surge limiters.

A miniature thermistor is included in series with the 6Ω h.t. circuit surge limiter. This enables a slightly higher d.c. output to be obtained than if only a resistor is used, since of course the thermistor's value reduces when warm to marginally increase the applied a.c. potential.

FAULT SUMMARY

Reduced h.t. with increased hum level

This may be caused by (a) a reduced-value reservoir capacitor or (b) excessive current consumption.

The two most common causes of (b) are complete lack of drive to the line output pentode or a valve with an internal electrode short-circuit. To check for the latter—if no overheating resistor indicates the faulty valve—connect an ohmmeter from the h.t. rail to chassis and remove or replace each valve in turn till the short-circuit meter reading drops significantly.

Care must be taken when making resistance tests from h.t. to chassis in modern receivers with low-resistance rectifiers, for if the ohmmeter current is of appropriate polarity it can flow through the rectifier and then via the heater chain to chassis to give the erroneous impression that a short-circuit exists when none is in fact present. Furthermore if a partial short-circuit does exist it will mask the effect of removing valves and disconnecting any circuit feeds to trace it. An essential precaution therefore is always to reverse the meter leads to obtain the minimum reading across h.t. and chassis or to remove any one valve or the c.r.t. base connector to break the heater chain.

Normal h.t. with increased hum level

In receivers with a single h.t. rail increased hum level is often the first sign of a deteriorating smoothing electrolytic but on occasions weak field sync may be the most noticeable symptom.

Where there are multiple h.t. feeds the symptoms produced will depend on the type of circuit decoupled by the faulty electrolytic and may be loss of sync, instability or impaired picture quality, etc. In all cases the quickest and most positive way of identifying a faulty electrolytic is to temporarily connect a known good one across it. This test capacitor does not need to be of equivalent value, in fact a truer test is made with one of smaller capacitance since only very rarely does an electrolytic go completely open-circuit.

It is important not to stab a large-value uncharged electrolytic across a suspect in a working receiver as the initial heavy spark and surge current could damage the rectifier and possibly a circuit transistor as well. The safest procedure is to connect the electrolytic across the h.t. rail and chassis before switching on so that it can charge up slowly. It can then be subsequently applied to any high-voltage point with minimum voltage disturbance.

On rare occasions increased hum level can be caused by short-circuited turns in the smoothing choke which reduces the inductance and therefore the reactance of this component to the supply a.c. ripple. This usually results in the choke running much warmer than usual due to the short-circuited turns acting as the shorted secondary of a step-down transformer. As the d.c. resistance reduction may be only a few ohms, check replacement is the only sure test.

Reduced h.t. with normal hum level

The cause of this is a low-emission valve rectifier or a high-resistance metal rectifier. Modern silicon power diodes are practically immune from high forward resistance. When any sections on the mains dropper resistor have been changed check that surge limiter replacements are not of excessive value. ■

NEXT MONTH IN

Practical TELEVISION

COLOUR FAULT-FINDING

—MAKING A START

Specially prepared for those who have not so far made a start on fault-tracing in colour receivers this article also provides many tips to help those who have already plunged into the complexities of colour sets, with a view to saving the hours that can otherwise be wasted following wrong trails. A great deal can be learnt about a colour set's operation from careful examination of the colour-bar test pattern it displays: full details of what to look for are given.

UHF AERIAL PREAMP

Full details of a simple, self-powered u.h.f. preamplifier for the constructor, using a readily available silicon transistor. Alternative Band IV and V tuning line dimensions are included.

CIRCUIT DEVELOPMENTS

In a further series of *Circuit Notes* H. K. Hills takes a look at some of the new circuit techniques that have been introduced with the new breed of single-standard chassis.

CONVERGENCE WAVEFORMS

In the final instalment of *Waveforms in Colour Receivers* Gordon J. King describes and illustrates the waveforms required for dynamic convergence, where they are obtained and how used and adjusted, and also looks at pincushion distortion in colour sets.

PLUS ALL THE REGULAR FEATURES

ORDER YOUR COPY ON THE FORM BELOW

TO.....
(Name of Newsagent)

Please reserve/deliver the JULY issue of PRACTICAL TELEVISION (3/6), on sale JUNE 19th, and continue every month until further notice.

NAME

ADDRESS.....

.....

SINGLE-STANDARD PART 4 625-LINE RECEIVER FOR THE CONSTRUCTOR KEITH CUMMINS

THIS month we shall deal with the r.f. and i.f. sections of the receiver. The tuner and i.f. strip used were originally intended for dual-standard operation and this includes components which are not necessary for single-standard operation. Both tuner and i.f. strip contain system switches. These should be permanently set to the correct positions as will be described later. The tuner is modified by removal of all the band and system switching mechanics as well as three of the six tuning buttons so that it is mechanically greatly simplified. The i.f. strip is modified to allow the use of sync-tip a.g.c.

Sync-tip a.g.c. can only be used where negative vision modulation is employed and since not all readers will be familiar with the technique we shall describe it in detail. Fig. 9 shows the video waveform present at the output of the detector circuit when negative modulation is employed. Black level corresponds to 77% modulation while the sync pulses extend to 100%. The important point to note is that the sync pulses will always be reaching the 100% level irrespective of the video content of the picture.

If, therefore, we can devise a circuit capable of measuring the peak amplitude of the sync pulses—as opposed to the mean-level of the video signal as is generally used on dual-standard sets—the a.g.c. voltage will be constant for any given signal strength, and since the a.g.c. voltage then no longer depends on the video content of the signal the black level will be stable. Thus the circuit will meet the specification requirement laid down, namely that the receiver should provide black level stability. Note that d.c. restoration in the video amplifier stage—previously described—is useless unless the video output from the detector is stable. The converse of course also applies.

If the video output from the detector has an unstable black level—for example when mean-level

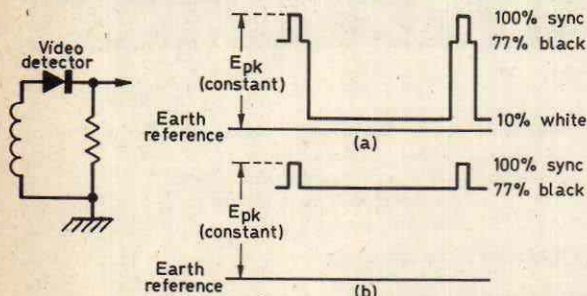

Fig. 9: Illustrating how measurement of sync tip amplitude can produce a stable a.g.c. reference level independent of picture content—(a) peak white line, (b) black line.

a.g.c. is employed—the only way to obtain a stable black level is by the use of a keyed black level clamp. Unfortunately while this provides an improvement in presentation the picture is still not accurately displayed, for although the black level as viewed is constant the ratio of the differing video levels is not. Captions for example, which have a low mean level, are displayed at accentuated contrast against a black background.

The sync-tip a.g.c. system has the advantage that keyed black level clamping is not required. The simpler process of d.c. restoration is sufficient to enable a completely accurate video presentation to be achieved.

The i.f. strip as supplied contains two video detector circuits using two diodes fed from the same end of the final i.f. transformer secondary winding. The diodes are connected in opposite polarity so that both positive- and negative-going outputs are available. The negative-going signal from D2 (Fig. 13) is filtered and taken directly to the video amplifier. The signal lead cannot be screened since the capacitance introduced would attenuate the higher video frequencies. To ensure that stray signals are not induced in the lead and that the capacitance is kept to a minimum the lead is taken individually from the i.f. strip to the video amplifier and kept away from chassis and other conductors as far as possible.

The positive-going output diode (D1, Fig. 13) serves two purposes. It provides both the intercarrier sound signal (which is taken off via a 6MHz tuned circuit) and the input to the sync-tip a.g.c. circuit. It is important that the loading of the a.g.c. circuit should be kept not only low but linear so that excessive downward modulation of the intercarrier signal does not occur.

Figure 10 shows the basic vision detector system. For the benefit of readers not familiar with the technique of intercarrier sound it should be explained that the sound and vision carriers are made to beat together in the intercarrier detector (which need not always be a separate diode from the video detector one) to form the 6MHz signal. The frequency of 6MHz is determined by the frequency difference between the sound and vision carriers set at the transmitter and is not affected by the frequency of the receiver's local oscillator. Thus the frequency of the signal applied to the discriminator or ratio detector used for sound demodulation is constant.

The 6MHz signal for the intercarrier diode is filtered out by the tuned circuit L, C shown. The output from the winding coupled to the tuned circuit is a 6MHz signal modulated in amplitude by the vision signal and in frequency by the sound

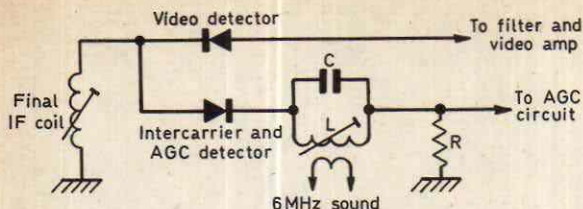

Fig. 10: Vision detector arrangements for video, a.g.c. and intercarrier sound.

signal. A limiter stage removes the amplitude modulation to leave the f.m. sound signal. This is fed to a discriminator stage which provides the audio drive to the a.f. amplifier stages. The use of intercarrier sound is particularly advantageous when receiving u.h.f. transmissions since otherwise oscillator drift—which has negligible effect on vision—could adversely affect sound reception.

AGC Action

The tuned circuit shown in Fig. 10 is connected to the resistor R which increases the impedance placed across L , C and also provides a d.c. load resistor across which the a.g.c. sample voltage is developed. It will be seen that the input impedance of the a.g.c. circuit should be high by comparison with R so that both maximum a.g.c. sample voltage is developed and the parallel impedance across L , C kept high.

Figure 11 shows in detail the sync-tip a.g.c. circuit. The positive-going video signal is applied via the intercarrier sound take-off circuit to the base of Tr1. Under no-signal conditions Tr1—an emitter-follower—is turned fully on so that its emitter is near earth. The video signal as it increases progressively turns Tr1 off so that its emitter voltage rises positively with respect to earth. The greater the signal the more Tr1 is turned off. This arrangement is ideal since the loading on the detector circuit is greatly reduced. As Tr1 emitter moves positively so does the base of Tr2 to which it is connected. Base current flows in Tr2, supplied from the 12V rail and not the detector circuit. Tr2 is connected as an npn emitter-follower. The emitter load R31 is shunted by capacitor C20. The pulses of current flowing in Tr2—which correspond to the sync pulses—charge C20 to a level slightly below that of the sync pulse tips.

Because of the long time-constant of C20 and R31 the level is maintained constant during the period between pulses. Thus it will be seen that the voltage developed across C20 is directly proportional to the sync-tip amplitude and hence is a measure of signal

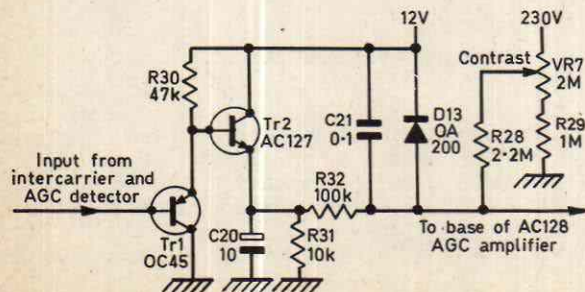

Fig. 11: Sync-tip a.g.c. circuit.

strength irrespective of picture content. This sync-tip voltage is used to control the remainder of the a.g.c. circuit.

The sync-tip voltage is fed via R32 to the base of the a.g.c. amplifier transistor Tr4 (Fig. 13) type AC128 situated on the i.f. panel. Also fed to this base is a positive bias from VR7, the contrast control (Fig. 11), via R28. It will be seen that R31 is much less in value than R32. Therefore any change in voltage at the junction of R28 and R32 will have little effect on the voltage present at the emitter of Tr2. Similarly R32 is much less in value than R28 so that small changes in voltage applied through R32 will have much greater effect than a similar voltage change applied through R28. The choice of values has been made so that the setting of the contrast control can set the working point of the a.g.c. amplifier while changes in the sync-tip voltage can be communicated to the amplifier with minimum attenuation.

Two other components need mentioning, D13 and C21. D13 is a catching diode which prevents the base of the AC128 a.g.c. amplifier transistor being driven positive with respect to its emitter which is fed from the 12V rail. C21 provides base-to-emitter a.c. decoupling for the AC128 to enable an unscreened lead to be used to connect the circuit of Fig. 11—which is built on the main chassis—to the i.f. panel.

In order to connect the circuit of Fig. 11, it is necessary to modify the i.f. panel as shown in Fig. 15 which also gives details of other connections and the functions of relevant tuned circuits.

Figure 13 shows the circuit diagram of the i.f. strip in its modified form. Note that the system switch is in the 625 position. All connections to and from the i.f. panel are clearly shown including those to the sync-tip a.g.c. circuit. It will be seen that the AC128 transistor Tr4 referred to earlier acts as an a.g.c. amplifier which is turned off progressively as the signal strength increases. The collector of the AC128 is connected via R18 750 Ω to the emitter of the first vision i.f. amplifier Tr1. R18 with the 150 Ω emitter resistor R4 forms a voltage divider. Under no-signal conditions the BF164 transistor Tr1 is passing optimum current (i.e. low current) for maximum gain. As the signal increases the a.g.c. system reduces the current in the AC128 amplifier stage so that the emitter to earth potential of the BF164 is reduced. Since the base network tends to hold the base potential constant this is effectively equivalent to increased drive to the BF164 and the current through the BF164 increases. The transistor is designed so that this forward a.g.c. action reduces the gain. Forward a.g.c. has the advantage that cross-modulation of signals is far less than in conventional reverse a.g.c. controlled amplifiers. This becomes obvious when one considers a reverse a.g.c. biased transistor nearly cut off and presented with a large signal: since the transistor is under these conditions biased towards the non-linear part of its characteristic intermodulation of signals becomes very likely.

The a.g.c. amplifier also provides a control bias for the r.f. amplifier in the tuner. This AF186 npn transistor is also forward controlled but the action is delayed so that no reduction of signal occurs in the r.f. stage for weak to medium-strength signals. This precaution ensures that the signal-to-noise ratio is maintained at its best.

The basic circuit of the r.f. amplifier a.g.c. arrange-

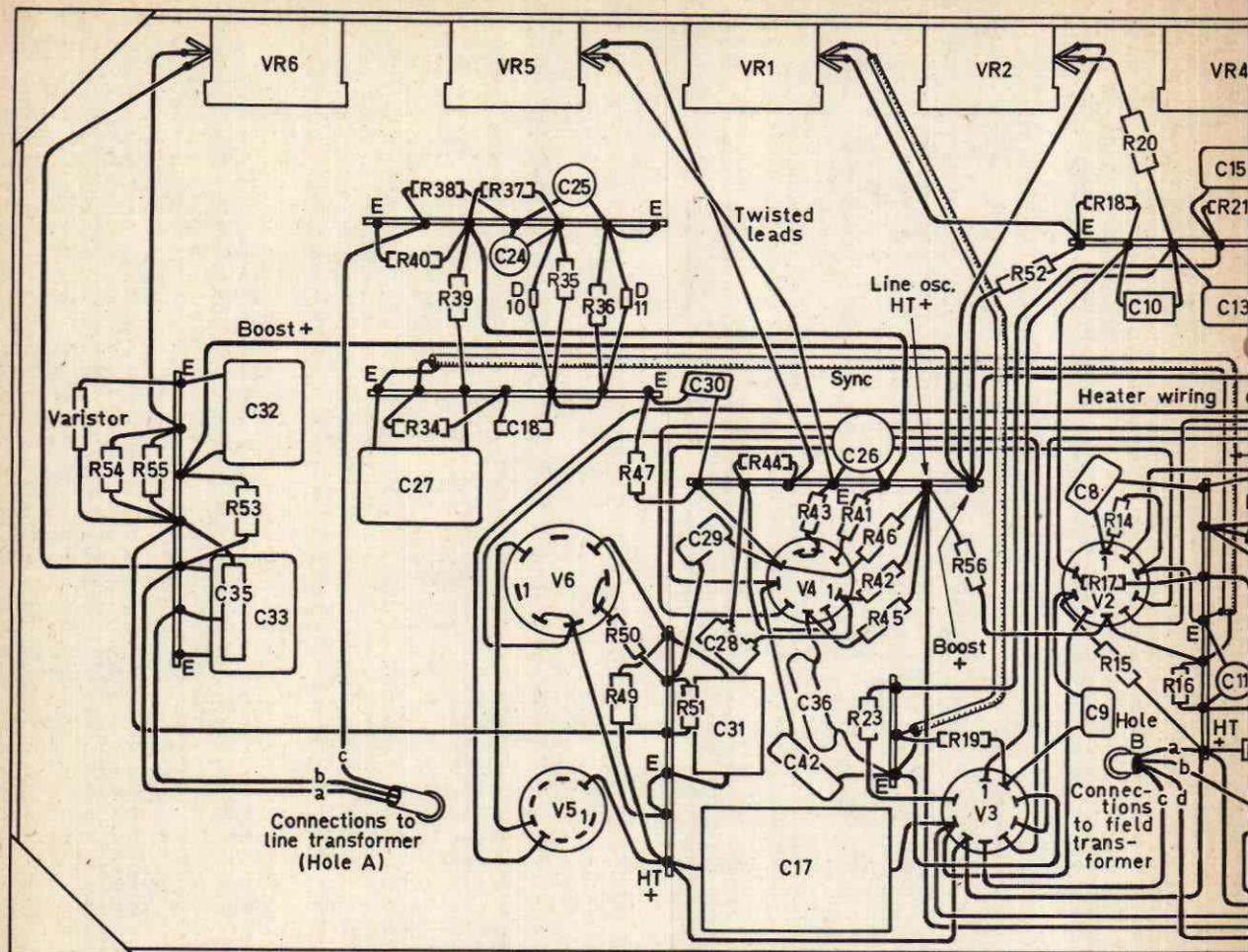

E = tag earthed to chassis

Valve bases: pin 1 only indicated. Numbering is clockwise

CONNECTIONS ABOVE CHASSIS (VIA HOLES A-F)

Hole A

- a Boost voltage from T3 tag 1
- b To T3 tag 3
- c Pulse feed from T3 tag 7 to R38

Hole B

- a H.T. to T2 primary
- b To T2 secondary from junction C16, C22
- c To T2 primary from V3 pin 6
- d T2 secondary earth return

ment is shown in Fig. 16. Under no-signal conditions the base—which is fed from the a.g.c. line—is positive by about 10V. The collector to earth resistance is negligible. The emitter is fed from the h.t.+ rail via a 100kΩ resistor (R27 in the main circuit diagram Fig. 4). Being of such a high value this resistor produces heavy d.c. feedback in the emitter circuit of the r.f. amplifier so that changes in the a.g.c. rail voltage initially have very little effect on the current through this transistor. Thus these changes—which control the first i.f. amplifier—do not

Hole C

- a H.T. line to R2 and R3 (mounted on top of chassis)
- b From R3
- c From R2
- d Feed to c.r.t. first anode (pin 3)
- e, f C.R.T. heater feed (pins 1, 8)
- g Earth return from C23 wired on tube base socket

Hole D

- a To c.r.t. pin 2 (grid)
- b To c.r.t. pin 7 (cathode)

affect the r.f. amplification. This situation continues until the a.g.c. rail falls from its initial level to around +5V. The emitter of the AF186 follows without significant change in current until the catching diode (D12 on the main circuit), whose anode is tied to a supply of approximately +5V, conducts. The emitter is now "caught" at +5V and cannot easily fall farther.

If the a.g.c. line now moves towards earth the AF186 passes more current which reduces its gain. Thus the catching voltage sets the point at which

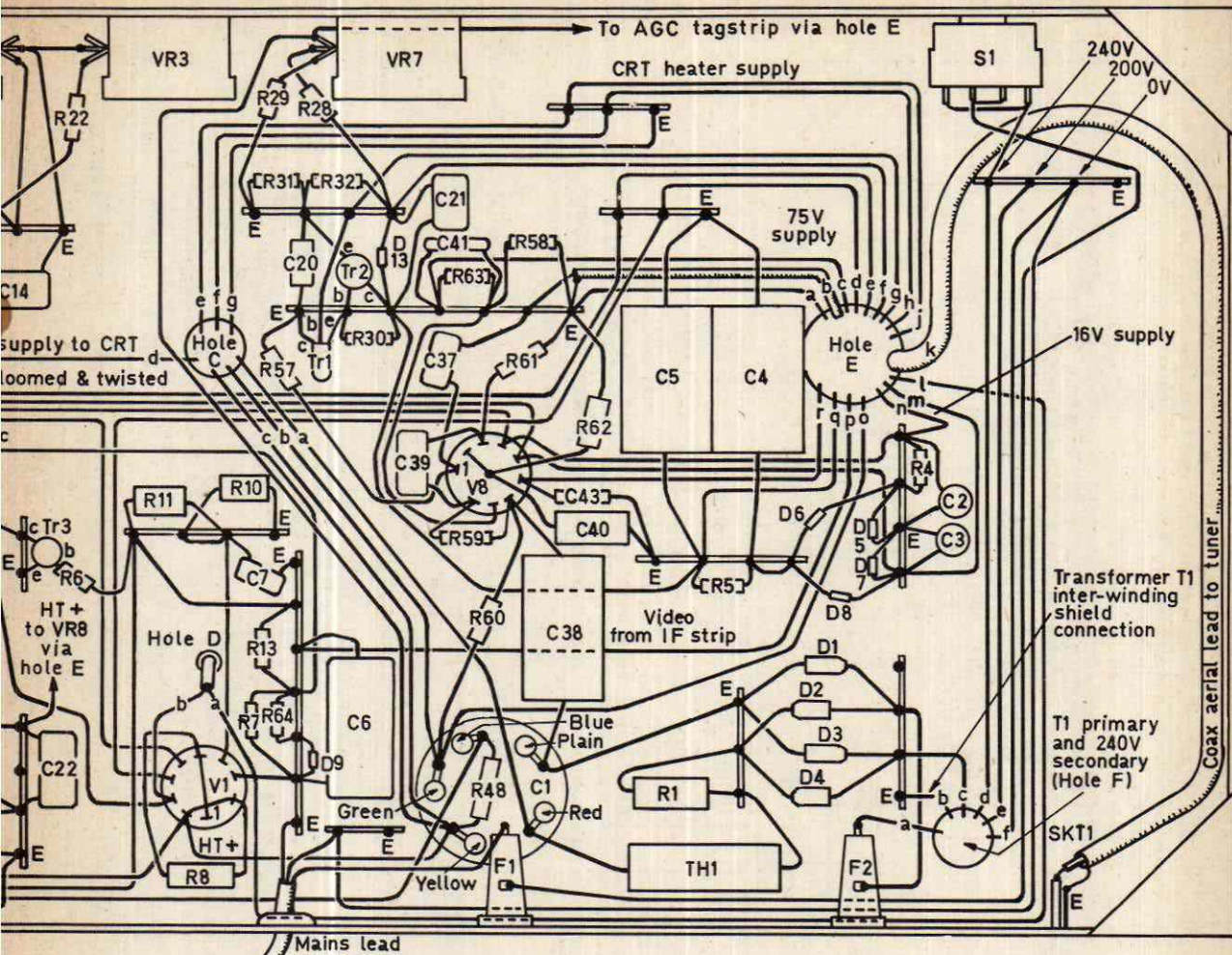

2: Complete underchassis wiring details for the 625-line single-standard receiver. See below for interconnections to top of deck.

Hole E

- a To T4C and loudspeaker
- b To VR9 (volume control) slider (screened lead)
- c To T4D and loudspeaker
- d 75V feed from T1 (mauve lead) to PCL84 heater (pin 4)
- e 75V feed from T1 (mauve lead) to PY800 heater (pin 5)
- f To i.f. panel, AC128 base
- g To i.f. panel, junction R12, T4/C28
- h, j 6.3V feed from T1 (white leads) to c.r.t. heater via hole C
- k Input to tuner unit

the a.g.c. action commences in the r.f. amplifier. In the main circuit diagram Fig. 4 (published in the April issue) R24 and R25 divide the +12V supply down to approximately 5V which is applied to the anode of D12 the catching diode.

Tuner Modifications

We shall next consider the tuner. This is a basic unit capable of tuning over Bands I, III, IV and V. Our use is only for Bands IV and V so the switching

- l To VR8 slider (brilliance control)
- m, n Green leads from T1, 16V supply
- o H.T. feed to T4 (1)
- p Input from i.f. panel to C6
- q 12V feed to tagstrip under tuner, R24 etc.
- r To T4 (3) from V8 pin 6

Hole F

- a Grey lead from T1 to F2
- b Red lead from T1 to chassis (intershield connection)
- c Grey lead from T1 to junction D3, D4
- d Brown lead from T1 (240V tap)
- e Yellow lead from T1 (200V tap)
- f Orange lead from T1 to mains neutral

mechanism concerned with the other Bands can be removed leaving the bandswitch in the u.h.f. position. Similarly the mechanism associated with system switching can also be removed.

To start with the carrier for the system switch slider mechanism can be removed. Only two screws are employed for this purpose. When the mechanism is removed the push-bar for the tuner is revealed. The following sequence should now be followed:

- (1) Remove slide-switch operating mechanism. This is assisted by removing the band-setting screws.

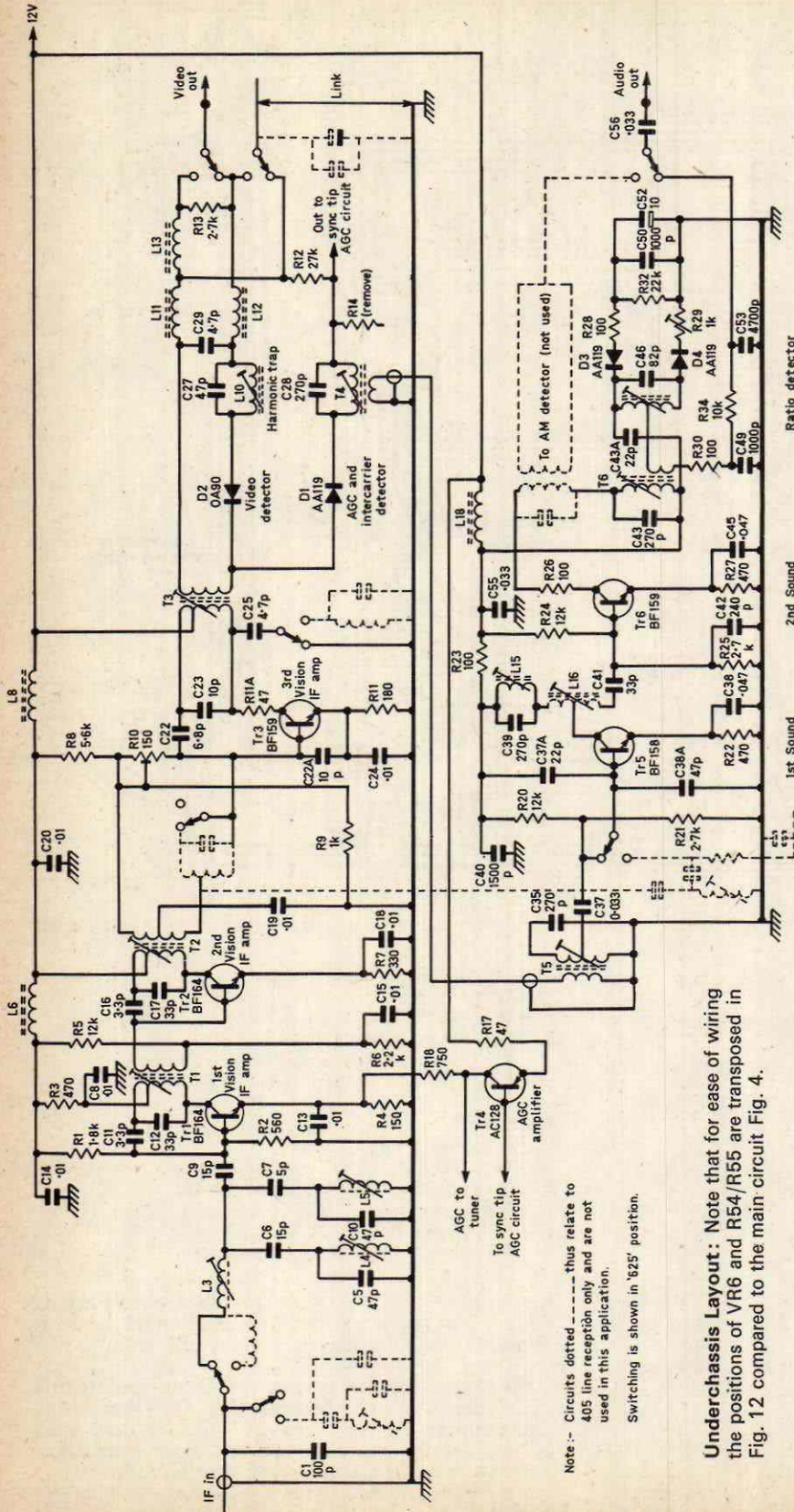

Fig. 13: Circuit diagram (625-line sections only) of the printed-circuit i.f. strip used on the prototype, with modifications incorporated as described in the text of this instalment. Component reference numbers above as printed on board.

IMPORTANT : The component value list (March issue) contained two errors: VR9 is 500 kΩ and C43 0.0047 μF (circuit Fig. 4 shows the correct values). V9 (c.r.t) grid is pin 2. C1D in Fig. 4 should be shown coded blue, not plain (the plain tag on the specified component is the earth connection). **Supplies:** Fresh i.f. strip supplies are being sought. For those who cannot obtain a surplus strip, a design for the constructor is being built by the author and will be published shortly. Willow Vale Electronics Ltd. can supply a set of valves for £4 4s. 4d., the c.r.t. at £11 19s. 6d. carriage, the line output transformer and scan coil assembly at £8 10s. 10d. and a kit of resistors, potentiometers, capacitors, semiconductors and the miscellaneous parts (except for the Varistor) plus T4 at £15 14s. 4d. BF178, a suitable substitute for the BSX21, is supplied for Tr3.

Underchassis Layout: Note that for ease of wiring the positions of VR6 and R54/R55 are transposed in Fig. 12 compared to the main circuit Fig. 4.

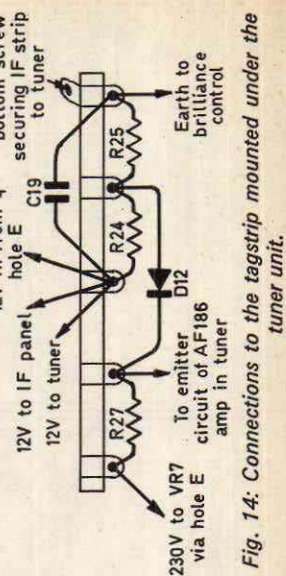

Fig. 14: Connections to the tagstrip mounted under the tuner unit.

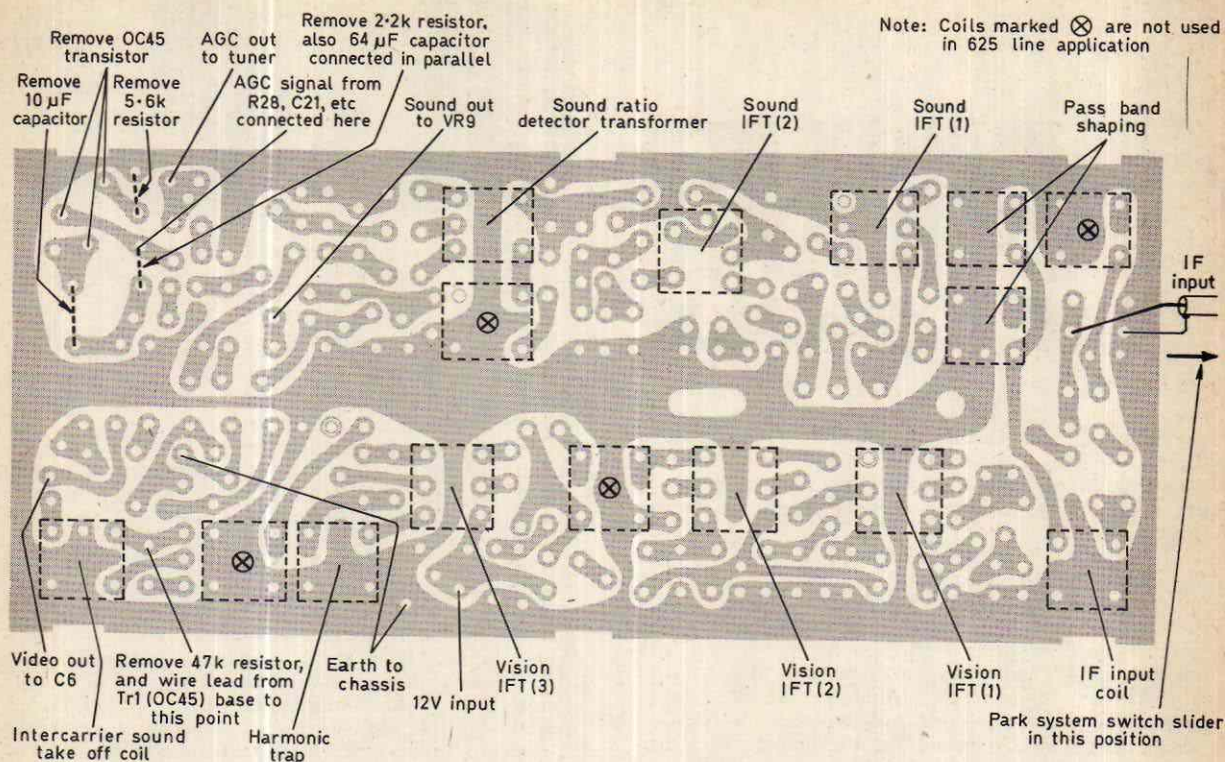

Fig. 15: The i.f. panel viewed from the foil side, indicating modifications required. Coils marked with a cross in a circle are not used on 625 lines.

(2) Remove stop-bar (with pointed ends) situated under the turned-up ends of the push-button rods.

(3) Remove the tuner from the push-button assembly by removing three securing screws, two at rear of unit and one under the tagstrip adjacent to the buttons. Hold the gang rotor drive against the spring action and mark the gearwheel and rack with a pencil so that they can be correctly phased when reassembling later.

(4) Remove screw in the centre of the mechanism plate, revealed by removal of the tuner unit.

(5) Remove the guide plate at the rear of the buttons, adjacent to the push-rod. Pull plastic covers free of buttons.

(6) With the buttons at the right-hand side and with the mechanism facing you remove the top and bottom two buttons after taking off the circlips holding the plastic centre fine-tuning knobs. Note that the straight tabs may need to be bent slightly to facilitate the final removal.

(7) Reassemble the mechanism and tuner so that a simple three-button mechanism remains—without band or system switching facilities.

(8) Park the bandswitch slider so that it is fully pushed into the tuner.

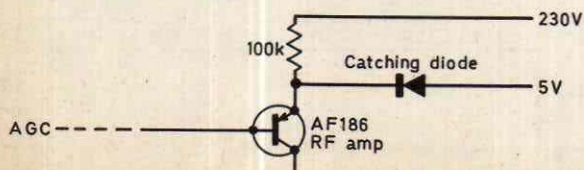

Fig. 16: A.G.C. delay system for r.f. stage.

The tuner and i.f. strip can now be fitted together. It will be found that the i.f. strip will bolt conveniently to the back of the tuner. Wiring between the two units should be completed according to the main receiver circuit diagram (Fig. 4) with reference also to the printed panel diagram (Fig. 15) and Fig. 14 which shows the layout of the components mounted on a tagstrip attached to the lower side of the tuner.

Assembly Above Chassis

The tuner is finally bolted on to the front panel above the loudspeaker using 2BA nuts, bolts and large washers. The securing bolts pass through two holes originally occupied by push-buttons. The large washers fit on the tuner side to cover these holes.

The brilliance and volume controls are fitted below the tuner, the brilliance on the left and the volume control to the right as viewed from the front of the receiver. Screened audio cable links the audio output from the i.f. strip to the volume control and then from the volume control to the audio amplifier section of the main chassis. The brightness control is earthed to the tagstrip attached to the tuner unit.

All the interconnections can be completed including the aerial coaxial lead which runs from SKT1 to the input point on the tuner halfway along its edge. The other input point is for v.h.f. reception and is not used. The video lead from the i.f. strip to the video stage on the main chassis should be kept away from other leads as far as possible,

—continued on page 424

UNDERNEATH THE DIPOLE

ASPECT ratio is the ratio of width to height of a picture projected on to the screen of a cinema, printed on film or reproduced on a television receiver screen. (It also concerns the shape of the proscenium opening of a live theatre, the frame of an oil painting and the dimensions of a picture postcard.)

So far as television is concerned we are interested in obtaining the maximum information within an acceptable shape. J. L. Baird opted for a square picture with his first crude mechanical contrivance. Later when competing with EMI in Britain and with various other companies in America the ratio of 5 width to 4 height (1.25 to 1) was adopted for a time. But the ready-made programme material that had been originally filmed for the cinema then had an aspect ratio of 4:3 or 1.33 to 1 and this was a world standard for both 35mm. and 16mm. film. It stayed that way for years, from the earliest films of Edison, Robert Paul and Lumiere.

Thirty years or so later in 1928 sound-tracks used up about 100 mil of the picture width and this resulted in an almost square-looking, ugly picture. The American Academy of Motion Picture Arts and Sciences promptly restored the shape to an aspect ratio of 1.33:1 by reducing the height of the picture and thickening up the frame line. So it remained for many years—until the great gimmick of CinemaScope was introduced by the Fox Film Corporation in America whose technical scouts discovered the anamorphic lens in France.

This squeezed the width of the picture within the 35mm. film dimensions and projected it in expanded form to an aspect ratio of 2.55 to 1. This large wide picture made a big impression in cinemas, especially when stereo sound was added with four magnetic sound tracks. It still pleases audiences, but the magnetic sound on release prints has gone—and the ratio has been reduced to 2.35 to 1.

WIDE SCREENS

Large pictures on large cinema screens were now demanded and non-CinemaScope pictures were projected the top of which could not be seen by the last few (favourite) rows of the cinema stalls because the front of the circle obstructed the top line-of-sight. So pictures were composed in the camera to aspect ratios of anything from 1.66 to 1.75 to 1.85 and even to 2 to 1. Sometimes this ratio was shot using a hard-mask in the camera to limit the picture area to that unyielding shape. Films photographed in this way appear on television (and in many cinemas too) with a black bar above and below the picture (see Fig. 1).



Fig. 1: Aspect ratios for cinema and television. The effect of using a hard-mask in the camera when the film is shown on television is illustrated on the left.

In cinemas the black frame-shape is mechanically adjusted to fit the picture but on television the black topping and tailing bar is very noticeable and most unimpressive to say the least.

It has been said by film people that the public is reticent to enter a cinema not presenting a CinemaScope or Todd A-O picture in the correct manner. It has also been said that TV viewers will probably turn over to another channel when a castrated letter-box shaped picture appears on their sets. The ITV do not like to present CinemaScope-shaped pictures in which the characters at the extreme left and extreme right of picture are heard *but not seen*. When remedied by some magical electronic "panning" device the viewpoint lurches from side to side. Apart from this subterfuge being crude and mechanical the atmosphere of a scene is probably lost on TV even if it was excellent in a cinema.

What is the answer to it all? The Film Production Association put forward recommendations which have been used for years by most British producers without complaint (see Fig. 2).

The association found that the most commonly used screen aspect ratios in UK cinemas for non-anamorphic wide-screen films are between 1 to 1.60 and 1 to 1.75 and that from a sample survey of 32 films the majority of feature film producers in the UK shoot films with camera apertures masked to a ratio of either 1 to 1.62 or 1 to 1.52 and compose the picture thereon to a ratio of 1 to 1.85. Television stations however both in the UK and abroad require a picture image area of 0.868 × 0.631 in. (1 to 1.376) for the satisfactory presentation of films on domestic television receivers, while reduction printing of 35mm. film to 16mm. and

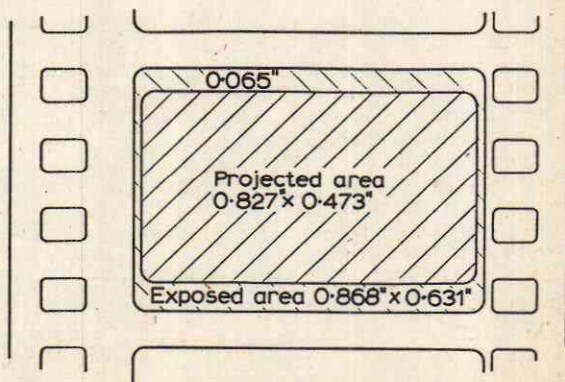

Fig. 2: Wide-screen photography for cinema and TV. Above, 35mm. film frame. Inner area for cinema projection, outer area for TV telecine play-off.

8mm. also requires a picture-frame ratio of approximately 1 to 1.376.

They also found that the existence of frame-lines wider than normal—due to the introduction of masks in camera apertures—can increase the possibility of sound interference in prints with optical sound-tracks.

Thus the Association while appreciating that producers wish to compose their films at any aspect ratio which they feel artistically necessary recommended adherence to British Standard 2784:1956 as being in the industry's best interests. This was to enable film-makers to obtain the largest possible revenue from their films from all fields of exhibition and to improve the confused situation arising from the varying aspect ratios in use.

TECHNISCOPE

Technicolor are usually well to the fore in meeting the technological problems of Cinerama, CinemaScope, wide-screen and 16mm. film in colour and have adapted their "Techniscope" system for television use. Techniscope is an ingenious use of 35mm. film in which the film is pulled down in the camera only two perforations instead of the normal four. This gives a wide-aspect picture from which Technicolor CinemaScope anamorphic prints can be made for the cinema on the one hand and on the other hand straightforward 35mm. or 16mm. prints for television. An important fact is that the cost of colour negative and film stock is *exactly half* that for normal 35mm. processing.

VIDEOPRINTING

Several film-processing companies are tackling the problem of transferring colour videotape TV features on to 16mm. film, necessary for the telecine machines which are the mainstay of thousands of television stations in every part of the world. Most of them have 16mm. black-and-white telecines but a growing number are turning over to colour. The London firm Colour Video Services Ltd. has made enormous progress with a special transfer system which was described by R. J. Venis at the International Film '69 event in London and later at the Royal Television Society.

This system—called Videoprinting—uses three

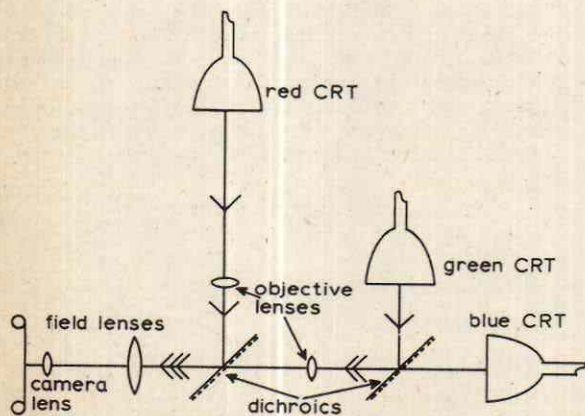

Fig. 3: Tubes and optics of the Videoprinting system. Diagram reproduced by courtesy of the Royal Television Society.

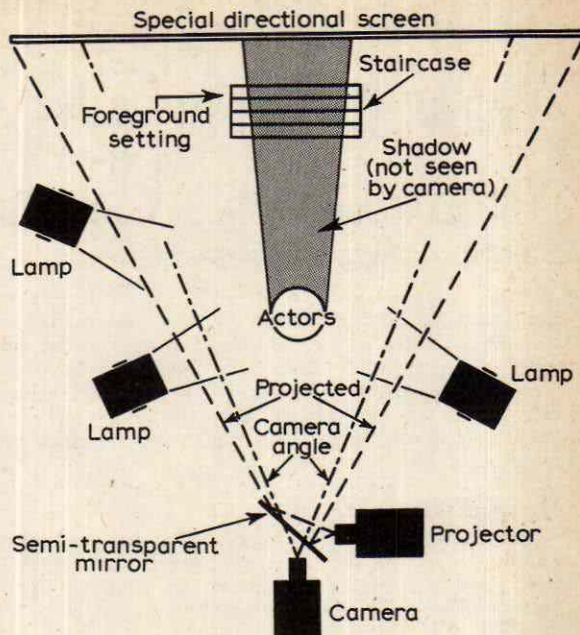

Fig. 4: Pinewood's front-projection system.

high-resolution display tubes mounted in special cradles to display the separated red, green and blue components of the picture (see Fig. 3) to an optical system which uses dichroic filters (these reflect light of certain frequencies and pass light at other frequencies) to combine the outputs of the display tubes for photographing direct on to Eastman-colour negative (the output from a shadowmask tube is unsuitable for being recorded direct). The problem is to obtain accurate registration of the red, green and blue display tube outputs at the input to the camera—hence the use of special tubes and mountings.

The results are very good: I had always anticipated that this development would happen but never expected it to be so good so soon! The original colour tape quality has to be really good because every kind of dupe or transfer magnifies small blemishes in the original videotape, camera or rack work.

THREE-TUBE COLOUR CAMERAS

The Philips-Peto-Scott three-tube colour camera—without the additional luminance tube—gives magnificent results. This was tested out recently by Television Recordings Ltd. at Pinewood Studios where it was used with the front-projection system for which Charles Staffell received a technical Oscar in Los Angeles last year. For this Pinewood test a simple setting comprising four large pillars and a section of staircase was erected in front of a special front-projection screen. Two film artists appropriately dressed walked down the steps while a colour slide of an interior of Buckingham Palace was projected on to the screen via a dichroic mirror. This enabled the TV camera to pick up the composite picture from the optical centre of the projected beam. The shadows of the actors were therefore not seen. The illusion as displayed on TVR's high-quality colour monitors was perfect.

waveforms in COLOUR receivers

PART 11

GORDON J. KING

AREAS of the colour set that we have not yet looked into include the sound channel, synchronising and a.g.c., field and line timebases, field and line convergence and power supplies. It is proposed to deal with these in this article and the final one next month. Let us start with the a.g.c. circuits and systems.

Sound AGC

The simplest is the a.g.c. used in the sound channel, and an arrangement sometimes found in dual-standard models is shown in block diagram form in Fig. 1. Here the channel feeding the sound

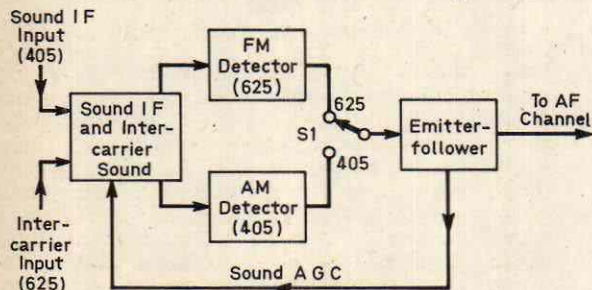

Fig. 1: Sound channel a.g.c. system.

detectors is designed to respond to both the 405-line sound i.f. and the 6MHz 625-line intercarrier signal. The two sets of tuned circuits are connected in series with each other throughout the channel (this being possible because of the significant difference between the i.f. and intercarrier-frequency signals), the transformer feeding the 625-line detector being tuned to 6MHz and that feeding the 405-line detector to the sound i.f. at 38.15MHz.

The active detector output is coupled to the input of an emitter-follower via the standard-change switch and the emitter-follower feeds audio to the a.f. channel and a d.c. potential to the controlled stage

in the i.f./intercarrier channel. The input of the emitter-follower is d.c.-coupled from the a.m. detector so the d.c. level across the detector load upon which the demodulated audio rides appears also at the output (emitter) of the emitter-follower and it is this which is applied to the base of the controlled transistor as an a.g.c. bias. The audio is effectively deleted by filtering and the remaining d.c. potential assumes a value dependent on the amplitude of the carrier wave at the a.m. detector input. Thus if the signal amplitude falls the a.g.c. bias automatically turns up the gain of the controlled transistor to compensate and vice versa.

Such a.g.c. is not required on 625-lines because the signal is frequency modulated and the amplitude at the f.m. detector input can be held constant by limiting in the intercarrier channel. When S1 is switched to the 625-line detector therefore a standing d.c. potential from the h.t. line is fed to the emitter-follower input, along with the 625-line audio coupled in via a capacitor, and this d.c. is reflected back to the controlled transistor via the emitter circuit of the emitter-follower so as to set the gain of the controlled transistor at maximum.

Sound channel a.g.c. in fact differs very little in colour sets from the techniques used in monochrome receivers.

Vision AGC

The vision a.g.c. circuits are somewhat more involved but again the basic monochrome principles apply, with the scheme for single-standard models being somewhat less complicated than that adopted for dual-standard models. Forward a.g.c. is commonly applied to the vision i.f. and sometimes to the tuners. With this technique the controlling bias pushes the controlled transistors into increased collector current when signal strength rises, resulting in an increased voltage drop across a resistive element in the collector circuit and thus a drop in collector voltage and consequent reduction in gain. Reverse a.g.c. implies that the controlling potential

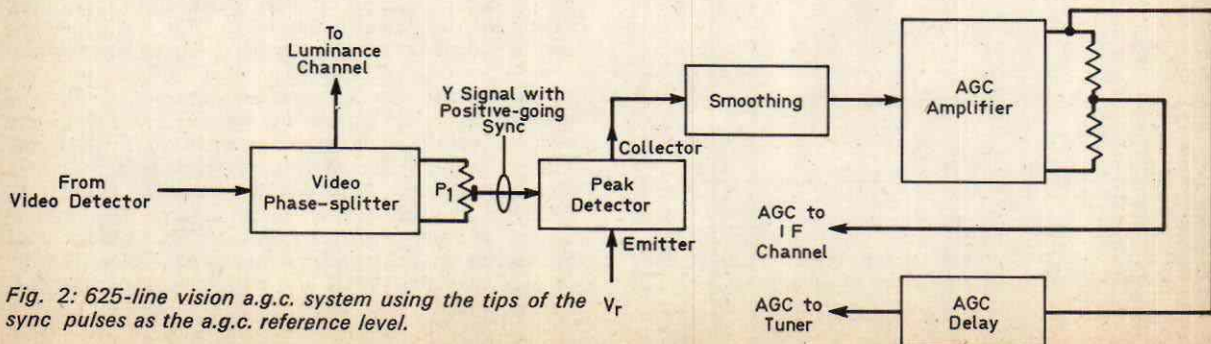

Fig. 2: 625-line vision a.g.c. system using the tips of the sync pulses as the a.g.c. reference level.

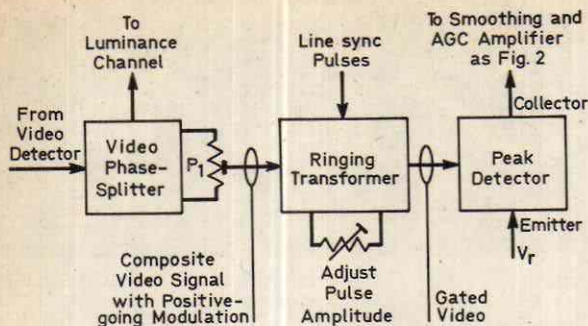

Fig. 3: Use of a ringing transformer to obtain a black-level reference for the 405-line a.g.c. system in a dual-standard colour receiver.

turns down the collector current and in this way directly reduces the gain of the stage. Forward a.g.c. is less inclined towards transistor overload and cross-modulation effects than reverse a.g.c. and v.h.f. and i.f. transistors are now made to exploit forward a.g.c. characteristics.

In some models the tuner r.f. gain is controlled on u.h.f. by a manually adjustable preset, the idea being to set this to match the level of signal fed to the set from the aerial under the prevailing signal conditions.

Sync-tip AGC: 625 Lines

It is common in dual-standard sets for the vision a.g.c. potential to be derived on 405 lines from the vision signal black level and on 625 lines from the tips of the sync pulses. Fig. 2 shows the general set-up on 625 lines. Here the video phase-splitter

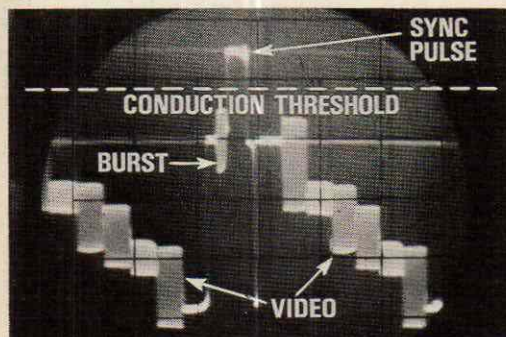

Fig. 4: Video signal at the input to the peak detector shown in Fig. 2. Note that due to a studio slip this waveform is actually a mirror image of the one present at this point in the circuit, i.e. the burst is on the back porch of the sync pulse, not the front porch as above.

feeds the Y signal to a transistor peak detector via the preset potentiometer P1. The peak detector is fed with a reference potential V_r at its emitter, and since the phase of the Y signal is such that the sync pulses are positive-going it follows that the peak detector will draw current only when the tips of the sync pulses exceed the reference potential. The output at the collector therefore consists of signal peaks corresponding to the tips of the sync pulses. These are passed through a smoothing network to the a.g.c. amplifier whose output constitutes the a.g.c. bias. There are often two a.g.c. feeds, one from the collector of the a.g.c. amplifier to the tuner

via a delay system and the other tapped down a resistive divider and then fed to the i.f. channel.

The idea of the delay in the tuner feed is to maintain the best signal-to-noise ratio. This is achieved by the gain being first reduced—when the signal is not excessively strong—by biasing in the i.f. channel, followed then by further gain reduction—when the aerial signal is very strong—by biasing in the tuner r.f. amplifier as well. Should the tuner biasing occur at medium signal levels the noise performance of the front-end will be impaired more than is necessary and the picture will be rather grainy even on medium-strength inputs. There are various techniques used to provide the delay in the tuner feed. In most a diode is biased by a reference potential so that it conducts only when the a.g.c. bias reaches the reference level. The arrangement in this area is again not much different from that in monochrome sets.

Black-level AGC: 405 Lines

Black-level 405-line a.g.c. circuits may follow closely the techniques of monochrome sets. However one variation found in several chassis, for example the Decca CTV25, is shown in block diagram form in Fig. 3. Here the video phase-splitter feeds the peak detector via a ringing transformer. The peak detector acts in the manner just described for the sync-tip type of 625-line a.g.c.

The transformer is made to ring by the application on each line of a low-level sync pulse. The pulses are derived from the sync separator and their timing is such that the positive-going excursion of each ring coincides with the black-level porch to the sync pulse. The rings thus provide a gating action so that the a.g.c. peak detector operates only during the black-

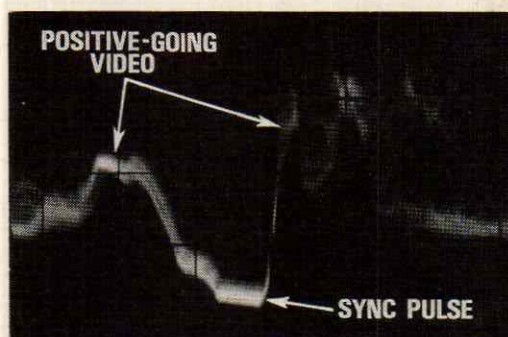

Fig. 5: The video signal fed to the ringing transformer shown in Fig. 3. In this system a constant-amplitude pulse coincident with the back porch is added to the waveform.

level portion of the video waveform to ensure that the output to the a.g.c. amplifier is proportional to the black-level of the signal.

Vision AGC Waveforms

Figure 4 shows the nature of the video signal fed to the input of the peak detector and the conduction threshold established by the reference potential V_r . This is colour-encoded signal, the line sync pulse appearing positive-going between two lines of video. Fig. 5 shows the 405-line video at the input of the ringing transformer in Fig. 3. Here the video is positive-going. Fig. 6 gives some idea of the nature of the pulses at the ringing transformer—their

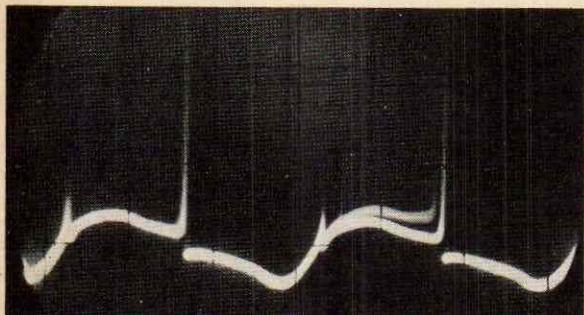

Fig. 6: The nature of the pulses at the ringing transformer shown in Fig. 3. The amplitude of the pulses can be adjusted by means of the preset control across the circuit.

amplitude can be controlled by the preset shown in Fig. 3 which provides variable damping across the transformer.

Synchronisation

The sync separator can be either a valve or transistor and there is little difference between the working of this in a colour or monochrome set. The Y signal at the final luminance amplifier—sometimes an emitter-follower when transistorised—is fed to the input of the sync separator in the usual manner and the pulse output is filtered to the field and line timebases. The field sync input invariably passes via an integrator which removes all but the field sync while the line sync is passed through a differentiator and thence to a discriminator to provide flywheel synchronisation to yield optimum line lock under a diversity of reception conditions. The discriminator compares the phase of a signal fed back from the oscillator or output stage with that of the sync pulses and lack of coincidence results in a d.c. control potential which varies the effective reactance (L or C simulation) of a reactance stage. This is in shunt with the line oscillator and the frequency of the oscillator is thus automatically "steered" so that it coincides with that of the sync pulses. The control potential, shown in Fig. 7, is fed to the reactance stage through a longish time-constant so that noise and interference on the composite video signal have minimal effect on the line synchronising. The line generator stage is generally a sinewave oscillator with an LC circuit adjusted to provide the correct nominal frequency. Absolute control is achieved by the reactance stage appearing across the LC circuit.

Audio Circuits

I shall be having more to say about the signals in the timebases next month, but to conclude this article a word or two about the audio channel would not be amiss. Colour sets are now being made with transistorised audio sections and viewers spending several hundreds of pounds on such sets should rightly expect better sound quality than yielded by relatively inexpensive monochrome models. To this end some makers are fitting two loudspeakers with basic acoustic loading. The net result is quite acceptable provided the transistor audio section is correctly adjusted. There are commonly one or two presets, one to set the push-pull quiescent current of the class B output stage and the other (when fitted) to adjust the balance

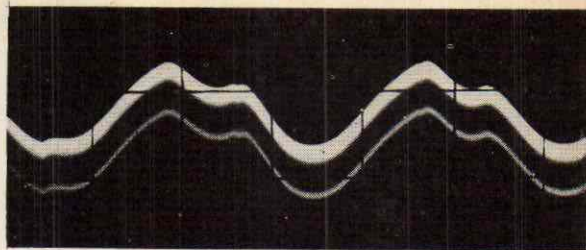

Fig. 7: Flywheel discriminator output. The residual signal on this basically d.c. control potential is from the line timebase.

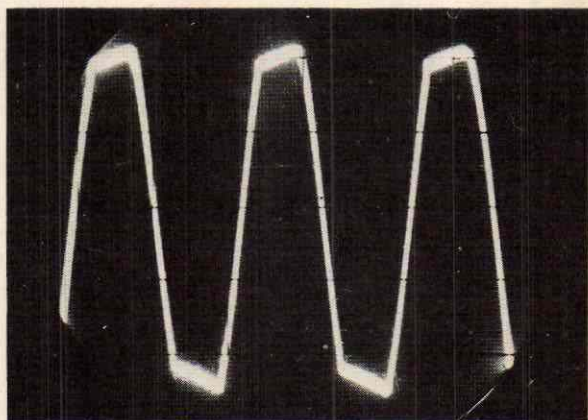

Fig. 8: Symmetrical clipping indicates good a.c. balance in a push-pull audio output stage.

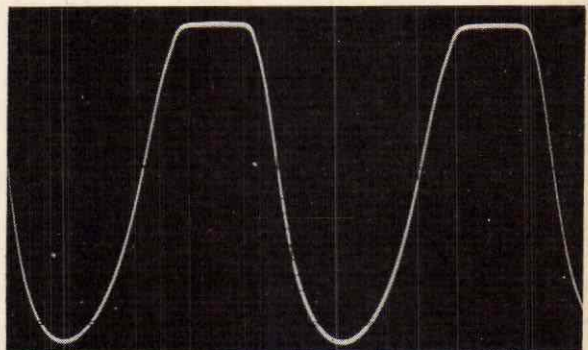

Fig. 9: Clipping on one half-cycle indicates a.c. unbalance.

between the two sections in terms of conduction. The quiescent current preset should be adjusted in accordance with the maker's instructions or—sometimes better—for the least total harmonic distortion on a 1kHz sinewave (provided by a low-distortion generator at the input) at a power of around 100mW r.m.s. across a resistive output load (connected in place of the speaker).

The balance preset is best adjusted by increasing the amplitude of the input signal until the output waveform clips on its peaks, as indicated on an oscilloscope connected across the load. Correct balance is achieved when both half cycles clip simultaneously, as shown in Fig. 8. If clipping occurs only on one half cycle, as shown in Fig. 9, then the balance preset (or circuit constants) requires resetting.

TO BE CONTINUED

Workshop

HINTS

by VIVIAN CAPEL

MUCH time is wasted in the workshop in trying to get things apart or to fit them together again, or to gain access to some awkward position. This time we will take a look at methods to minimise the difficulties involved.

Hinged Panels

Over the past few years many (though not all) manufacturers have tried to make life easier for the service engineer by providing reasonably quick access to both sides of the main printed circuit panels. This has been done by making vertically mounted panels hinged in some way. There are a variety of methods of doing this. One set has a long narrow panel running along the top of the set and mounted at an angle. This has a simple hinge arrangement on the edge nearest the back of the cabinet so that the panel will swing backwards and can be operated in the upside-down position.

Another has twin panels mounted vertically on either side of the c.r.t. neck both of which are hinged at one side and so can be swung sideways like a door. A further model has a wired chassis which is hinged on the left side and the complete chassis can be swung out.

With most of these the construction is obvious and also the manner of releasing (in some cases instructions are stamped on the framework). This is, however, not always the case. One model has a pair of panels mounted on a frame with the tuner. The whole thing looks as though it is all part of the c.r.t. cradle and that the only way to obtain access is to remove it from the cabinet. Actually the frame is hinged at the bottom and secured at the top by a single concealed snap-fastening. A firm pull will cause it to swing downward, the only preliminary being the removal of the tuner knobs. There are several other models where it is not at all obvious that easy access can be obtained so that one could go to the trouble of dismantling unnecessarily.

When servicing any set of recent vintage where access is required behind the panel, give a close examination around the edges of the panel or supporting framework for any sign of hinges, latches or other fastenings. It may prove well worth the few seconds spent.

Small Plastic Cases

Another dismantling problem sometimes presents itself in the form of transistor radio cases. Some of these seem to defy all attempts to get inside and

appear to have been moulded around the works without thought for future service!

The construction is usually in two halves that interlock in the manner shown in Fig. 1, by what could be termed a lip and groove arrangement. The

Fig. 1: Lip and groove arrangement used in some plastic cabinets.

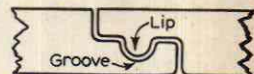

fit is often so close that it is difficult to tell where the join is, so this is the first exercise. Examine the case for a joint running completely around it. Having located it we must next find the interlocking sections and determine which half forms the lip and which the groove. Parting is accomplished by depressing the groove section so that it disengages with the lip. If the lip section is depressed the parts will interlock all the more!

The only way this can be ascertained is by gently pressing around the edge of each side in turn while watching what happens to the other side. When the lip is depressed the opposite edge will give as well under the pressure, but when the groove side is pressed the lip edge will be unaffected. Having identified the groove edge, it can be firmly depressed and the opposite side then pulled away. The two halves should thus separate but if they do not try the opposite side of the case. One lip and groove is often made deeper than those on the opposite side to hold the case together firmly at that point, the shallow ones being designed to spring the case apart.

Having got access to the inside it is often as difficult to remove the panel as it is with a TV set. Sometimes the panel is slotted in a groove in the case and can be sprung out. More usually it is secured by means of screws. Difficulties arise when after removing the obvious ones around the edge the panel still refuses to come away. The trouble is often one or two remaining screws that have been overlooked in the middle of the panel. With the dense concentration of components on these panels screwheads can be easily missed. If the panel is gently lifted it can usually be seen at which point it remains fixed, leading to quick location of the offending screw.

Another means of fixing that can be baffling is where the panel is screwed to a loudspeaker magnet the frame of which is fixed to the front of the case. It can easily be assumed that the speaker is mounted to the panel by these screws and should come away from the case with the panel. In other instances case-mounted loudspeakers have their leads passing up through slots in the print and soldered. It is by no means clear that these must be unsoldered before the panel can be removed, but unsoldered they must be.

Another nasty trick is to fix the gang capacitor to the case by means of a couple of screws the heads of which are concealed behind the scale plate which is glued in place. Panel removal usually involves removing the tuning knob. In most cases this can be done by merely pulling it off, but some are fitted by means of a screw through the centre of the tuning spindle. The head of this screw is hidden by the decorative boss in the centre of the knob so this must first be removed. In others the boss is itself the screw that secures the knob. If

—continued on page 424

STROBE-TRIGGER TIMEBASE UNIT

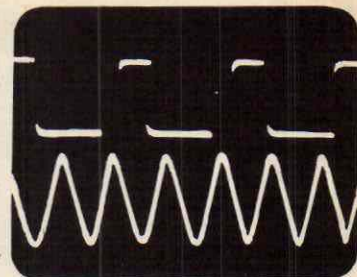

PART 3

THE full circuit of the master multivibrator was shown in Fig. 2. The basic arrangement is a conventional grounded-emitter multivibrator with cross-couplings between the collectors and bases of the respective transistors (Tr1 and Tr4). C1 and C2 are banks of switch-selected capacitors which establish the feedback and thus determine the duration of the pulses at each collector. The master pulse (shown in the oscillograms) is produced by cut-off of Tr1 for the interval determined by the time-constant of C1 and R1. During this master pulse Tr1 collector rests at the positive rail voltage of about 13V and the charging current of C1 is producing a ramp across R1. This ramp commences at about -13V and aims at +13V. As soon as the threshold of D1 and Tr1 base is exceeded (about +1.2V) Tr1 cuts on again by abrupt multivibrator trip action, which now cuts off Tr4. This terminates the master pulse and is the starting point of the corresponding ramp at Tr4 base. This ramp, which always exactly fills the intervals between successive master pulses, is used to derive the strobe trigger delay.

The delay ramp runs from about -13V to +1.2V at the anode of D3. R15, VR2 and R12 form a d.c. bias bridge on which this ramp is superimposed. The strobe gate is always triggered off at the moment the potential at VR2 slider has risen to the threshold level (+0.6V) of Tr5 in Fig. 3. If VR2 slider is close to the R12 end of the track this threshold level is not reached until close to the end of the ramp, just before Tr4 cuts on again at the end of the delay ramp and the start of the next master pulse. This represents maximum strobe gate delay. If VR2 slider is at the R15 end of the track the potential is already close to the strobe trigger threshold at the start of the delay ramp and the strobe gate commences almost at once after the master pulse has finished, representing minimum strobe delay. R14 is an isolating resistor to prevent muting of the multivibrator when the strobe trigger fires with VR2 slider close to Tr4 base.

S1 is the coarse repetition frequency control, S1A determining the master pulse duration and S1B selecting a corresponding delay ramp duration. VR1 is the fine control for the repetition frequency, varying the duration of the delay ramp between one and three times the duration of the master pulse without affecting the master pulse itself.

MASTER PULSE OUTPUT AMPLIFIER

A positive-polarity master pulse appears at Tr1 collector. Now it is well known that the positive-

Martin L. Michaelis M.A.

going flank of the pulse at this point of the basic circuit with a simple collector load resistor is severely rounded because C2 must recharge through R3 and the conducting base-emitter path of Tr4 before the pulse roof is reached. A pulse with such a slow leading edge is not acceptable for the transient response tests for which the output at Sk1 is used as described earlier. The hold-off diode and additional resistor R2 remove this defect. As soon as Tr1 is cut off at its base by virtue of feedback via C1 at the start of the master pulse, D2 cuts off because the collector potential of Tr1 can rise sharply but the anode potential of D2 lags behind on account of the recharging time of C2. Thus the master pulse at Tr1 collector is isolated from C2 and possesses a much sharper leading flank. R5 and R6 form a simple voltage divider feeding the Darlington pair emitter-follower Tr2 and Tr3 which in turn delivers the output pulse to Sk1. Any load impedance may be connected externally provided it has a value of at least 300Ω.

SYNCHRONISATION

The diodes D1 and D3 prevent application of the full negative ramp voltage of -13V directly to the bases of Tr1 and Tr4 because this would exceed the reverse breakdown limit of about -5V. This is the sole function of D3, but D1 also performs the vital sync gating function which makes the multivibrator responsive to sync only during the master pulse.

When a master pulse is present Tr1 is cut off because the base ramp is holding D1 cut off. Thus in fact Tr1 is not conducting because its base is resting at emitter potential (chassis) via R4 and VR3 (Fig. 4). Since D1 is cut off nothing apart from the sync input via R4 and VR3 is effectively connected to Tr1 base at this time. Consequently the sync signal from VR3 provides normal amplifier control (class B) of Tr1. If at any time before the master pulse terminates of its own accord by D1 cutting on again the sync signal from VR3 rises above the threshold level of +0.6V for a silicon transistor—quite regardless of how fast or slow this excursion above +0.6V takes place or with what waveform—Tr1 must cut on and the multivibrator retrip terminating the master pulse follows at once.

This leads to extremely efficient sync action which is substantially independent of the sync waveform and extremely smooth and rigid. The circuit in fact behaves as a Schmitt trigger during the master pulse but as an ordinary multivibrator at all other

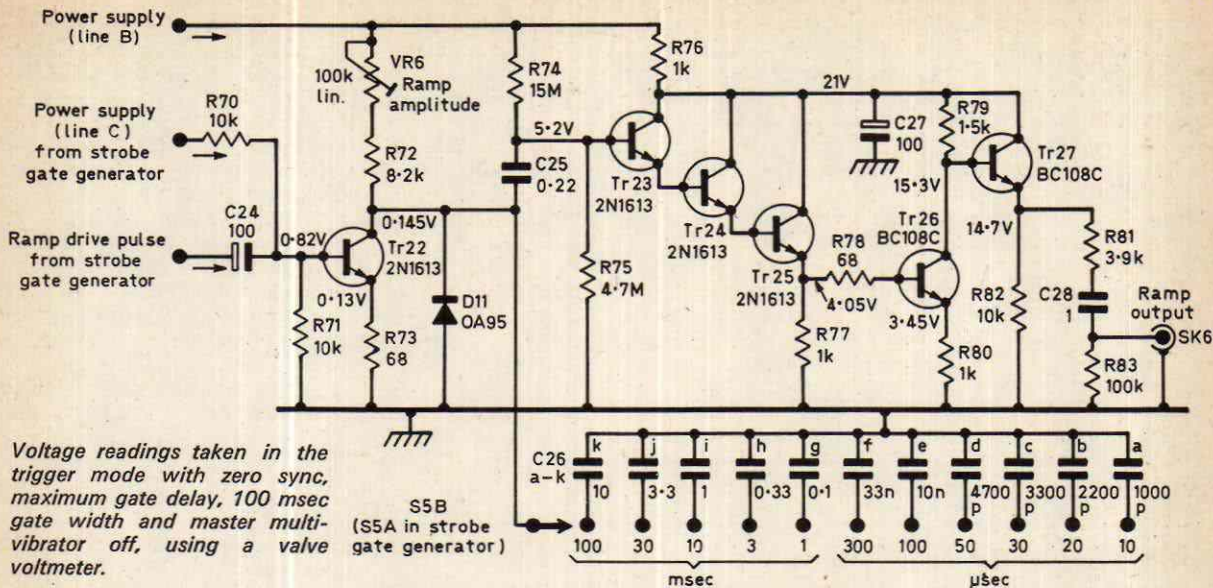

Fig. 6: Circuit diagram of the ramp generator.

times. However, if it is a type of Schmitt trigger with a thyristor characteristic, i.e. it cannot be quenched again by the drive signal (sync signal) returning to below the firing threshold level. Once fired the complete strobe delay ramp must run before reset is possible by multivibrator trip at the end.

As soon as the sync signal has fired Tr1 by rising above the threshold level of +0.6V during the master pulse, the strobe delay ramp at Tr4 base diode commences and the master pulse is terminated. Tr1 is now insensitive to sync because D1 has cut on and is drawing current through the base-emitter path of Tr1 which consequently shorts out R4 to chassis so that no sync signal can get through until D1 is once again cut off by the leading flank of the next master pulse.

SYNC EXPERIMENTS

The author is not aware of any previous publication of this interesting method of synchronising a multivibrator, but the hold-off diode D2 at the collector to improve the leading flank of the pulse is a circuit artifice commonly mentioned. There are serious problems in synchronising a transistorised multivibrator by the conventional method familiar and successful with analogous valve circuits. This would have amounted in this circuit to feeding a differentiated pulsed sync signal to the anode of D1 or D3, producing a succession of positive pips sitting on the ascending ramp with the first pip to briefly rise above the threshold near the end of the ramp terminating the latter prematurely. A small coupling capacitor would be used to inject this sync signal since otherwise the sync circuits would mute the multivibrator through shunting effects. Now during the ramp at the base of one transistor the other one is conducting to saturation and thus connecting the feedback capacitor to chassis for a.c. signals. Thus the base circuit is effectively loaded with the feedback capacitor, forming a capacitive divider with the sync injection capacitor. Adequate sync amplitude can then be impressed on the base ramp

only if the sync injection capacitor is given a value which is a reasonable fraction of the feedback capacitance. This condition can be satisfied over a wide frequency range only by using a third switch wafers to select sync injection capacitors. The trouble is virtually absent in such a circuit using valve techniques because a conducting valve is far from being a dead short between anode and cathode, so that it suffices to select a single suitable sync injection capacitance value and to make the source impedance of the sync circuit equal to or small in relation to the anode resistance of the valve.

Another undesirable aspect of the classical pip synchronisation used with valve multivibrators is that it can operate only with sharp flanks in the sync amplifier. Thus either such flanks must be generated from an arbitrary input waveform in the sync amplifier or we are restricted to using only pulsed sync input signals. The great advantage of the sync method finally adopted is that it is a genuine threshold level response system which is inherently independent of sync waveform. The practical performance limits are set solely by the top and bottom cut-off frequencies of the sync amplifier, i.e. whether an input signal can get through the amplifier at all to produce an output of at least 0.6V. The waveform of this output, and whether or not it is an undistorted replica of the input, is immaterial.

THE SYNC AMPLIFIER

Another welcome feature of the sync system adopted is that it possesses a well-defined response amplitude level which is substantially independent of other parameters. The synchronisation will lock in as soon as an output signal of +0.6V is produced. D8 across VR3 (Fig. 4) clamps the negative peaks of an arbitrary sync output waveform to chassis potential so that the sync condition is given as soon as the peak-to-peak value of the output signal reaches +0.6V. This enables us to make optimum use of the amplitude of an arbitrary sync waveform.

The design considerations for the sync amplifier

are now straightforward. If we decide that we want to obtain sync with a minimum peak-to-peak input amplitude of $1/N$ of 0.6V we must provide a sync amplifier with a gain factor of N and give it a bandwidth sufficient to handle all sync signal frequencies which will be encountered. Particular attention must be given to adequate bass response if efficient synchronisation is desired on low-frequency sinusoidal signals too. In this respect the circuit shown in Fig. 4 cuts off quite rapidly below 50Hz whilst of course sync persists undiminished for pulse signals of very much lower frequency. If for any reason strong sync is required with sinusoidal sync signals much lower than 50Hz then the coupling capacitor values C7, C10, C13, C14, C15, C17 and C18 will have to be increased correspondingly to lower the bass cut-off frequency. The low collector load resistors used in the sync amplifier place the high-frequency cut-off point in the MHz range as is essential for obtaining good sync with Y-signals having a repetition frequency in this region.

SYNC SENSITIVITY

It was decided to design for a sync sensitivity (with VR3 turned to maximum) of some 25 to 50mV peak-to-peak Y-signal being looped through Sk2 and Sk4 or external sync signal applied to Sk3. The maximum vertical deflection sensitivity of the Videoscope MV3 is 100mV/cm, so that this design figure gives rigid internal sync for all oscillogram heights greater than 2.5 to 5mm, which is the smallest height properly observable. The ratio of this sync input level to the required output level of 0.6V is 12:24, so that this is the required gain between S3 wiper and the track of VR3.

Y-SIGNAL LOOP-THROUGH

It is not possible to lash-up sync extraction from a broadband Y-signal input circuit in any haphazard manner because this would unbalance the frequency compensation of the input attenuator system described in the Videoscope MV3 article. To establish a properly balanced system the coaxial signal lead from the probe to the Y-input of the oscilloscope must be looped through the strobe trigger unit via proper coaxial fittings. It should be possible to use the same probe connected directly to the oscilloscope (when the strobe unit is not being used, or when it is being operated with a separate external sync signal and thus the Y-signal does not need to be looped through it) or transferred to Sk2 on the strobe unit without readjustment.

For this purpose a definite length of cable is prepared for use between Sk4 and the Y-input of the oscilloscope, and the self-capacitance of this cable is trimmed with C8 and C9 to be exactly equal to the total effective capacitance with a direct connection of the probe to the oscilloscope, i.e. the capacitance at the oscilloscope input has now been doubled. If we halve the resistance, by shunting a total resistance of $1M\Omega$ across the Y-signal line inside the strobe unit, input attenuator balance is restored. The price paid is that the input sensitivity has been halved (only when the probe is used at Sk2; the input sensitivity is unchanged for a signal fed directly to Sk2 but the resistive and capacitive load imposed on the signal source is then doubled).

The internal $1M\Omega$ shunt resistance is split into the effectively parallel paths R30-R31 and R29 to provide a discharge path for C7 even when the plugs are disconnected from Sk2 and Sk4. Otherwise there is a danger of electric shock or damage to subsequently connected equipment since C7 blocks and thus charges up to the d.c. component of any input signal fed to Sk2. The path R30-R31 is at the same time a 100:1 voltage divider. This is essential to limit maximum possible sync distortion thrown back on to the Y-signal to not more than the trace width for a full screen amplitude oscillogram. Without this attenuator the sync limiter diodes D4 and D5 would produce heavy distortion of large Y-signals. But these limiter diodes are essential to prevent destruction of Tr11 on large Y-signals and to make the sync action even smoother by rendering the setting of VR3 less dependent on signal amplitude at the amplifier input.

SYNC PREAMPLIFIER

The attenuation factor of 100 introduced by R30 and R31 must be made good in order to obtain the same overall sync sensitivity with respect to the Y-input Sk2 and the external sync input Sk3. The sync preamplifier Tr11, Tr12 provides the required gain. Two stages are necessary to preserve the same polarity relations at S4 for internal and external sync. Thus even though Tr12 is redundant on gain considerations it is necessary to restore correct polarity.

The sync amplifier from Tr11 through to Tr16 is a rather high-gain system with an input sensitivity in the region of $250\mu V$. Thus it is necessary to keep spurious injected signals down to a level well below the sync threshold. This is not possible if the initial stages are placed on the common printed circuit board together with all the other circuit modules. The preamplifier Tr11 and Tr12 must therefore be bunched tightly round Sk2 and kept well away from Sk1. The output from Tr12 is a point already much less susceptible to interference and is looped over to the internal-external sync switch with a short piece of coaxial cable (do not use screened audio cable as its high capacitance unnecessarily restricts the high-frequency response).

The emitter-follower Tr13 forms the link from S3 on the panel to Tr14 on the printed board. It effectively places a short-circuit at the base of Tr14 for all signals arriving on other routes except via Tr13 base which can be kept well clear of sources of interference. Tr14 provides nearly all the gain of the main sync amplifier, so that from its collector susceptibility to spurious interference is negligible. Thus even though the stages Tr14 to Tr16 are on the printed board in close proximity to the master multivibrator—an arrangement dictated by the need to maintain short wiring with respect to the synoptical layout of the panel controls—there is no danger of interference. Tr16 is a conventional phase-splitter to provide positive and negative sync polarity selectable with S4.

OVERDRIVE

D4 and D5 in conjunction with the attenuator R30, R31 give full protection of the sync amplifier with respect to large Y-signals. D6 and D7 serve the same function for large sync signals applied to Sk3,

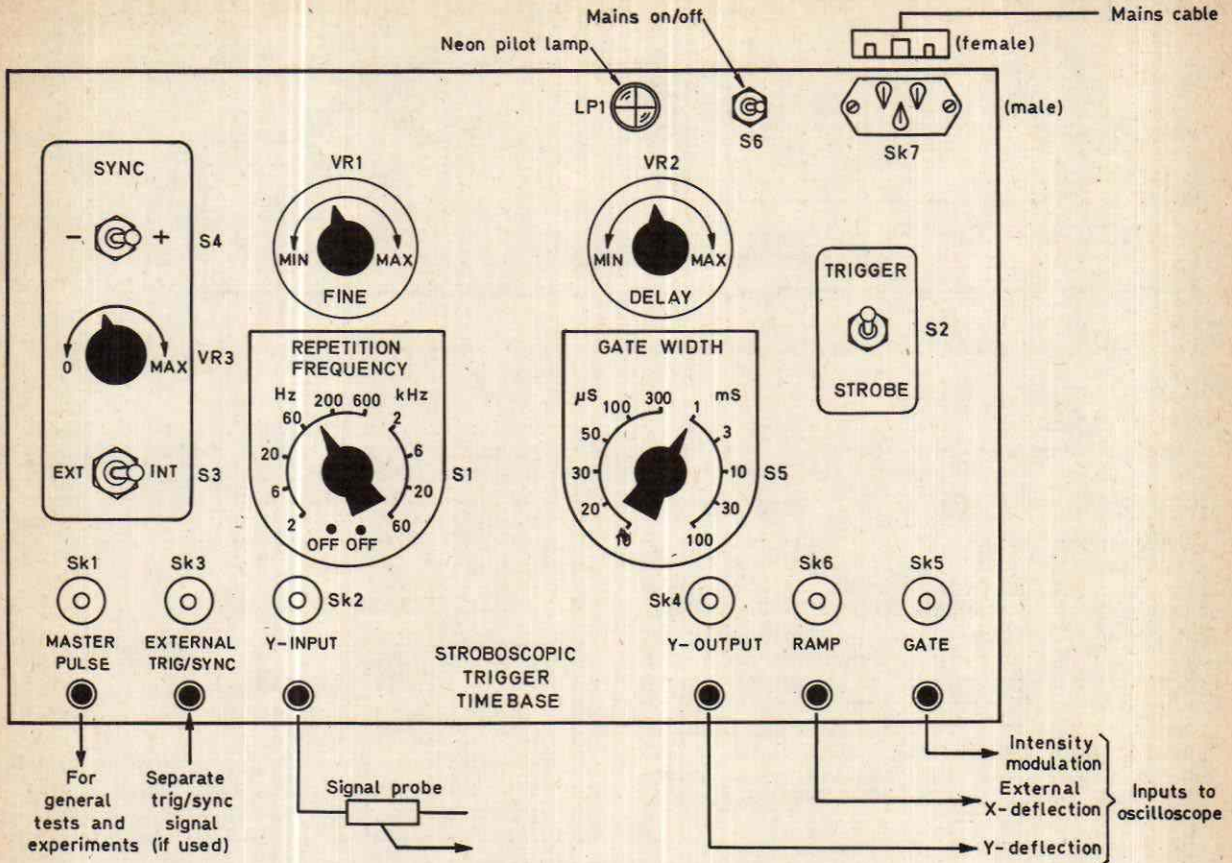

Fig. 7: Front panel layout and connections.

especially while C13 is charging, to block any large d.c. voltage component such sync signals may possess. R38 is the safety discharge resistor for C13. An attenuator is not necessary behind Sk3 because distortion is here immaterial. R35 limits surge currents through D6 and D7 and restricts loading imposed on the sources of the external sync signals.

Overdrive at the output is uncritical. Normally VR3 should be turned up from zero only to the point where the trace just locks securely, indicating that the sync amplifier is then delivering about 0.6V p-p at the slider of VR3. Performance is not much changed if VR3 is turned up some considerable way beyond this point, but if very large amplitudes are present across the track of VR3 and this control is turned up to maximum there may be some sync breakthrough into the strobe delay ramp, causing instability. Thus in common with nearly all oscilloscope timebases the general rule holds here too: do not apply excessive sync. This point is nevertheless much less critical here than for many conventional synchronised timebases, including the internal one in the Videoscope MV3.

INITIAL SYNC ADJUSTMENT

To effect initial sync of the Y-signal to the master multivibrator, first switch the latter to the appropriate repetition frequency range and then switch the strobe gate width to progressively higher values until the length of the timebase trace on the screen just

begins to reduce. This indicates that the gate width is now trying to be longer than a full cycle of the master multivibrator, which is impossible, so that it is reduced by amplitude clipping to be just one period of the multivibrator. It is now easy to adjust the fine frequency and sync controls to give two cycles of the Y-signal synchronised on the trace. The strobe gate delay and strobe gate width controls can then be operated quite independently to give the desired phase position and phase angle display. For the initial synchronisation operation the strobe delay control must be set to minimum delay, otherwise it may be difficult to get a gate much longer than from the actual delay point to the end of the next master pulse.

The condition when the strobe gate is unable to excure much beyond the end of the next master pulse imposes a certain logical restriction on the otherwise independent action of the repetition frequency and strobe gate width controls. This is no hindrance in operation, however, because a false setting which would imply an illogically long strobe gate is evident at once by severe shortening of the timebase trace. This is a very clear indication to the operator to switch down to a permissible gate width.

This completes the lengthy description of measures taken to provide very good sync action in this strobe timebase unit. *The operating convenience of a strobe timebase unit stands or falls with the*

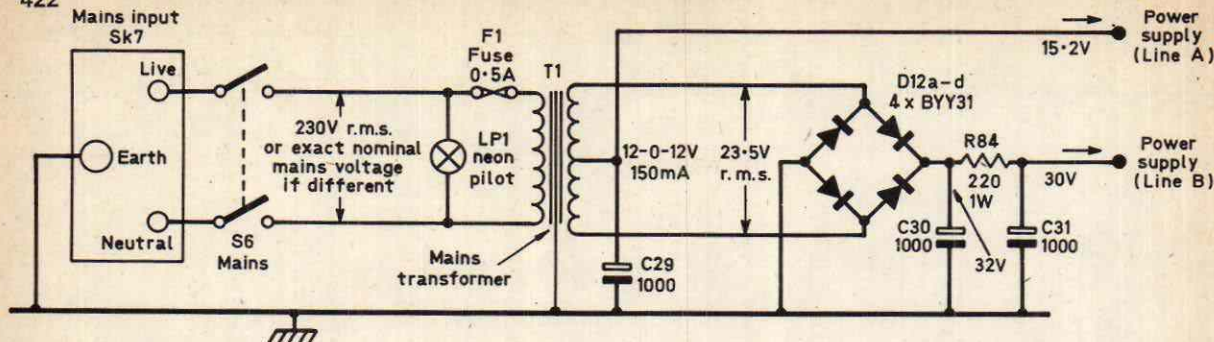

Fig. 8: Power supply circuit. Voltage readings taken in trigger mode with zero sync, maximum gate delay, 100 msec gate width and master multivibrator off, using a valve voltmeter.

efficiency of the sync circuits adopted, so that the considerable emphasis on this point is fully justified.

STROBE THRESHOLD DISCRIMINATOR

This section of the circuit is shown in Fig. 3. Tr5 is the threshold transistor which cuts on as soon as the strobe delay ramp of the master multivibrator has risen above 0.6V at VR2 slider. Tr6 performs essentially the same function for the signal fed direct from the sync amplifier for normal trigger-mode operation, i.e. Tr6 is cut on as long as the sync output signal is more than 0.6V above its negative peak (negative peak clamping to chassis potential with D8 in the sync amplifier). Tr5 remains cut on from the threshold point on the gate delay ramp until the end of the next master pulse.

Regardless of whether it is Tr5 or Tr6 that is cut on—according to the selected mode—the effect is always to bring the base of Tr7 close to chassis potential as long as one of these transistors remains cut on. Tr7 and Tr8 form a Darlington input to the conventional Schmitt trigger stage Tr9, Tr10. The latter is another threshold trip circuit which possesses only two stable states, with Tr9 conducting and Tr10 cut off, or vice versa. The changeover between the two states takes place abruptly and reversibly when the input voltage at Tr7 crosses the threshold level. Thus however slow or fast this transition across the threshold takes place the result at Tr10 emitter is always a very sharp pulse flank.

If neither Tr5 nor Tr6 is conducting Tr7 base rests at a high potential above the threshold so that Tr9 is conducting and Tr10 cut off. The moment Tr5 or Tr6 starts to conduct Tr7 base goes below the threshold so that Tr9 cuts off abruptly and Tr10 conducts to saturation, placing a short-circuit from R25 to the positive collector supply rail. This sharp positive flank across R25 and R26 is differentiated by C5 and R27 to produce the brief trigger pulse which fires the strobe gate at once.

The purpose of this composite strobe threshold discriminator is to generate from the smooth transition of the delay ramp a sharp pulse capable of firing the strobe gate circuit. In the trigger mode the threshold discriminator fulfils the same function as Tr1 and D1 in the multivibrator sync system, i.e. it produces an abrupt response flank as soon as the sync signal rises at least 0.6V above chassis potential, how fast or slowly this rise takes place being immaterial. It follows that the strobe sync sensitivity and trigger response sensitivity are

exactly the same in the respective modes because the manner of firing the gate is essentially the same in either case. Thus trigger action is equally effective on sinewave input signals and does not demand pulses any more than the strobe sync mode does. There is little difference in pulse and sinewave sync response in both modes.

TO BE CONTINUED

EVR IN COLOUR

EVR have now demonstrated the ability of their audio-visual recording system to play film or television programmes in full colour through a normal domestic colour receiver. Previous demonstrations have been confined to monochrome. The programmes are contained in small telecartridges for replay via an EVR teleplayer through a standard set. Work on monochrome EVR teleplayers is already advanced and it is claimed that these will be easily converted to accept colour programmes.

NEW VALVES

Guaranteed and Tested
24 HOUR SERVICE

| | | | | | | | |
|--------|------|--------|-----|--------|------|--------|------|
| IR5 | 5/6 | DL35 | 4/9 | EH90 | 6/- | PL500 | 12/9 |
| IS5 | 4/3 | DL92 | 5/9 | EL33 | 9/3 | PL504 | 13/3 |
| IT4 | 2/9 | DL94 | 5/9 | EL84 | 4/9 | PY32 | 10/- |
| 3S4 | 5/9 | DL96 | 7/- | EY51 | 7/- | PY33 | 10/- |
| 3V4 | 5/9 | DY86 | 5/3 | EY86 | 6/3 | PY81 | 5/- |
| 6/30L2 | 11/6 | DY87 | 5/3 | EZ80 | 4/3 | PY82 | 5/- |
| 6AQ5 | 4/3 | EABC80 | 5/9 | EZ81 | 4/6 | PY83 | 5/6 |
| 6AT6 | 3/10 | EBC33 | 7/9 | KT61 | 9/3 | PY88 | 6/6 |
| 6SN7GT | 4/- | EBC41 | 9/3 | KT66 | 16/6 | PY800 | 7/- |
| 6V6G | 3/- | EBF80 | 6/3 | N78 | 17/- | PY801 | 6/9 |
| 25L6GT | 4/6 | EBF89 | 5/9 | PC86 | 10/3 | R19 | 6/3 |
| 30FL1 | 13/9 | ECC81 | 3/6 | PC88 | 10/3 | U25 | 12/9 |
| 30FL12 | 14/3 | ECC82 | 4/- | PC900 | 7/- | U26 | 11/6 |
| 30P4 | 11/6 | ECC83 | 4/9 | PCC84 | 6/3 | U191 | 12/- |
| 30P19 | 11/6 | ECC85 | 5/- | PCC89 | 8/11 | U251 | 14/- |
| 30PL1 | 14/6 | ECH35 | 5/6 | PCF80 | 5/11 | U301 | 10/- |
| 30PL13 | 16/9 | ECH81 | 5/9 | PCF801 | 6/6 | U329 | 14/- |
| CCH35 | 13/- | ECL80 | 6/6 | PCF802 | 8/9 | UABC80 | 6/- |
| CL33 | 17/6 | ECL82 | 6/3 | PL82 | 6/9 | UBC41 | 8/3 |
| DAC32 | 6/9 | ECL83 | 8/- | PCL83 | 11/9 | UBF89 | 6/3 |
| DAF91 | 4/3 | ECL86 | 7/6 | PCL84 | 7/- | UCC85 | 7/3 |
| DAF96 | 6/9 | EF37A | 6/- | PCL85 | 8/6 | UCH81 | 6/6 |
| DF33 | 7/6 | EF39 | 4/6 | PCL86 | 8/- | UCL82 | 6/9 |
| DF91 | 2/9 | EF80 | 4/6 | PFL200 | 11/- | UF41 | 10/6 |
| DF96 | 6/9 | EF85 | 5/9 | PL36 | 9/3 | UF89 | 6/- |
| DH77 | 3/10 | EF86 | 6/3 | PL81 | 8/6 | UL41 | 11/9 |
| DK32 | 6/9 | EF89 | 4/9 | PL82 | 5/9 | UL84 | 6/3 |
| DK91 | 5/6 | EF183 | 5/6 | PL83 | 6/3 | UY41 | 7/- |
| DK92 | 8/3 | EF184 | 5/3 | PL84 | 6/- | UY85 | 5/3 |
| DK96 | 7/3 | | | | | | |

Postage on 1 valve 9d. extra. On 2 valves or more postage 6d. per valve extra. Any parcel insured against damage in transit 6d. extra. Office address, no callers.

GERALD BERNARD

83 OSBALDESTON ROAD, STOKE NEWINGTON,
LONDON, N.16

letters

REPLACEMENT FOR THE 50CD6G

Readers with the KB OV30 New Queen Special and similar models may have found the 50CD6G line output valve expensive to replace. A cheaper replacement which gives better results is the PL36. The use of this necessitates rewiring the valvebase because of the different pin connections. It is also necessary to disconnect the heater line between this valve and the PY81 and insert an 82Ω 5W resistor to correct for the lower heater voltage of the PL36. It is important that no connections remain on pins 1 and 3 of the valvebase.

With the above KB set it was only necessary to adjust the line width and linearity controls for best results after conversion. Other models modified in this manner may require adjustment of the screen feed resistor and/or line drive. The latter may be accomplished by altering the value of the small capacitor from the grid to earth of the valve.—**E. A. Crathorne (Walsall).**

SOBELL TPS180 FIELD CRAMP

I noticed that the problem of field cramp in the Sobell Model TPS180 came up in *Your Problems Solved* for March. No mention was made however of C98 and C99, both $0.01\mu\text{F}$ capacitors, in the linearity feedback circuit. In my experience these capacitors are the most common cause of this symptom. They are situated at the top and towards the left-hand side of the timebase panel, mounted horizontally and parallel to each other.—**M. Thomas (Bristol).**

625-LINE CONVERSION

I have just converted a receiver to 625-line operation in a similar fashion to D. Robinson (January 1970) but using a transistorised i.f. strip and found that the

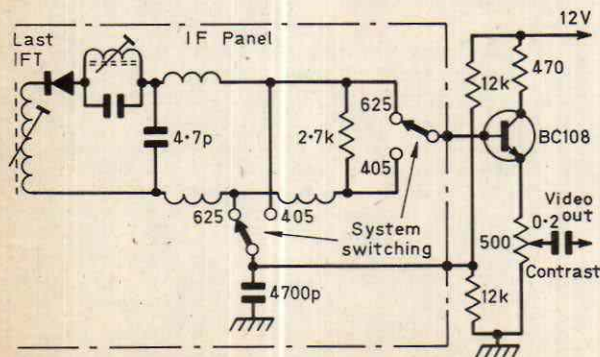

Mr. Reynault's buffer stage with contrast control.

video output of the strip was designed for use with a transistor buffer stage. It was therefore necessary to build such a stage, and the circuit details are enclosed. As the i.f. strip did not have provision for a contrast control a 500Ω potentiometer was placed in the emitter circuit of the transistor and was found to give good control over the picture. I hope these details will be of interest to other readers.—**J. Reynault (Bookham, Surrey).**

REGULAR LONG-DISTANCE RECEPTION

In connection with your recent feature on regular long-distance TV reception you may be interested to know that here in Leeds I can receive something on all channels except 3 and 11. Starting with Band I:

- Ch. 1 BBC London (Sheffield relay) poor picture.
- Ch. 2 BBC North (Local).
- Ch. 4 BBC Midlands (Sutton Coldfield) good.
- Ch. 5 BBC North East (Pontop Pike) poor.

The Band III results are much better. The aerial is a 10-element array cut to ch. 9 (the design comes from PRACTICAL TV around 1959).

- Ch. 6 YTV relay (Scarborough) patterned.
- Ch. 7 Anglia TV (Belmont) good.
- Ch. 8 Midlands ATV (Lichfield) fairly weak.
- Ch. 9 Granada (Winter Hill) patterned (interference from YTV).
- Ch. 10 YTV (Local).
- Ch. 12 BBC North West (Winter Hill) good.
- Ch. 13 BBC Anglia (Belmont) quite good.

The channels which are of programme value are chs. 2, 4, 6, 7, 9, 10, 12, 13.

I have even had London Weekend TV on ch. 9 after Granada and YTV closed down although it was very weak.—**C. Morton (Leeds).**

FEATHERLIGHT BRIGHTNESS FAULT

I see you suggest that the symptom of failing brightness (*Your Problems Solved*) with a KB Model KV003 could be due to an ageing tube. This is reasonable but I would like to point out the stock fault on this chassis that very often causes the brightness to deteriorate. This is the first anode feed resistor R167 ($4.7\text{M}\Omega$) to pin 3 of the c.r.t. which tends to go high-resistance. R176 ($3.9\text{M}\Omega$) which feeds the brightness control from the boost rail can also (and often does) cause the same trouble. Both resistors are located on the rear part of the chassis close to the width and focus controls and should be replaced with 1W types.—**J. Elsworthy (Dovercourt, Essex).**

BACK ISSUES

I have available as new the March 1968-December 1969 issues inclusive. If any readers are interested I would be pleased to hear from them.—**C. W. Henry (14, Lodge Hill Road, Lower Bourne, Farnham, Surrey).**

I have the following PRACTICAL TELEVISION issues for disposal free to anyone interested: 1954 July-December, 1955 January to October, 1956-1967 complete, 1968 January-October.—**J. Somers (7, St. Andrew's Road, Farlington, Portsmouth, Hants, PO6 1AD).**

WORKSHOP HINTS

—continued from page 417

the tuning knob seems stubborn and refuses to pull off, then try unscrewing the centre boss.

Make Use of Gravity

When trying to fit parts together one often has to battle against the force of gravity. A vertically mounted transformer for example must be held in its correct position while at the same time a fixing screw is introduced one-handed through its fixing hole into the chassis. More often than not it does not bite first time and promptly falls out into the bowels of the set. It must then be retrieved before we start all over again, probably with the same result.

Difficulties arise with all manner of fixing jobs. Nuts, screws and clips tend to want to go somewhere other than where they should. Attempting to fit a heavy component such as a field output transformer in an upside-down position can be particularly trying. Not only must its weight be supported but the screws prevented from falling out.

One sees struggles of this sort in most workshops, yet they could be so easily prevented. Instead of trying to combat the force of gravity make it work for you. If you can't beat it, use it. Turning the cabinet on its side to gain access to the underneath of the chassis is a common practice. Why not turn the cabinet in any other plane so that gravity assists the operation?

Thus the cabinet could be turned on either side, upside down or on its face, although in the latter case a duster free from grit should always be spread out on the bench first to avoid scratching or rubbing the tube face or implosion shield. This may seem an obvious trick, yet strangely it is one that is rarely employed.

Hints on refitting awkward screws were given in a previous part in this series (see January 1970).

SERIES TO BE CONTINUED

625-LINE RECEIVER

—continued from page 411

though it has to pass through the same cable hole in the chassis as many other leads.

The completed receiver has good sensitivity since the tuner contains a transistor employed as an additional i.f. amplifier on u.h.f. So we have an r.f. amplifier stage, mixer-oscillator and i.f. amplifier stage in the tuner followed by three vision i.f. amplifiers in the i.f. strip. Intercarrier sound i.f. as described earlier is detected and taken to two 6MHz i.f. amplifiers followed by a ratio detector.

Note that a stopper resistor is included in the i.f. lead from the tuner to the i.f. strip (see R26, April circuit diagram—Fig. 4). The value of this proved to be optimum at 68Ω in the prototype but can be reduced to 15Ω consistent with stability.

We shall continue next month. Although the set is now virtually finished please do not "jump the gun" by switching on until you have read the next article which deals with the order of setting up as well as some final touches which must be completed.

CONTINUED NEXT MONTH

SERVICING TV RECEIVERS

—continued from page 401

ing tip can be borrowed from Philips: solder two wires to the panel and solder the replacement to these so that in the event of subsequent overheating the resistor will drop off and prevent damage to the panel. The wattage rating should be kept low and should not exceed $\frac{1}{2}$ W.

Line Output Troubles

Some misleading symptoms occur in the line output stage and it is easy to jump to the wrong conclusion. Lack of width and poor e.h.t. regulation for example is most often due to a faulty PL500 (PL504) valve. The symptom may be a dark, narrow picture which quickly expands and fades completely as the brilliance or contrast controls are advanced. Before dashing out to the van for a new PL504 however it is well worth while to check the effect of adjusting the "set boost" control P11. This often develops a faulty point of high resistance on the track which causes the conditions described above. It may or may not be necessary to replace the control (1MΩ). A similar condition can arise if the 470kΩ resistor R133 which feeds the control goes high-resistance. Most often a replacement PL504 will right matters but the PY800 is not above suspicion.

No Picture, No EHT

Listen for the line whistle (better heard on 405). If this is clearly heard it is most likely that the DY86-87 e.h.t. rectifier is at fault. If this is clearly heard however the e.h.t. is almost certainly in order and the fault elsewhere (check tube base voltages).

If the line whistle is low or inaudible remove the e.h.t. connector from the tube or the top cap of the DY86. If this restores normal line whistle and the valve lights up replace the DY86 as it has an internal short. If there is no difference and the valves are not at fault remove the PY800 top cap. If this restores some degree of working replace the 0.1μF boost capacitor (C176—use a type with 1kV rating) as this is shorted. If again there is no difference check the 0.47μF capacitor C175 associated with the top cap of the PL500 (actually mounted on the transformer panel) as well as the more obvious points such as the PL500 screen feed resistor R127. As far as this is concerned the resistor may be open-circuit or the system switch may not be making properly.

These faults concern the output stage. Defects in the line oscillator stage can cause similar effects with overheating. The PCF802 valve can stop oscillating on its own account or it can be caused to stop oscillating. If the valve is not at fault check the h.t. supply to pins 1 and 6 and the oscillator stage components as necessary. Remember that the line oscillator h.t. supply is separate from the output stage, being common to the vision and sound stages (HT3) and not, as shown on some circuit diagrams, common to HT4. To clarify this point some circuits show PL3-7 connecting to HT4 (C187 50μF decoupler) whereas it should jump across and connect to HT3 (C188 150μF decoupler).

TO BE CONTINUED

YOUR PROBLEMS SOLVED

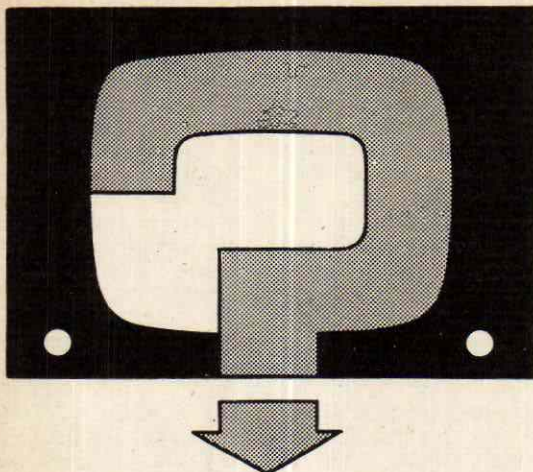

Whilst we are always pleased to assist readers with their technical difficulties, we regret that we are unable to supply service data or provide instructions for modifying equipment. We cannot supply alternative details for constructional articles which appear in these pages. WE CANNOT UNDERTAKE TO ANSWER QUERIES OVER THE TELEPHONE. The coupon from page 426 must be attached to all Queries, and a stamped and addressed envelope must be enclosed

HMV 1890

The picture has two interrupted bright lines about $\frac{1}{2}$ in. from the top of the screen. It is otherwise OK.—E. Mandle (Epsom).

If the lines are the pulse-and-bar test signals inserted in the waveform, change the 22k Ω resistor behind the ECC82 on the lower deck. If the trouble is top foldover, check the linearity control and associated resistors and also the 0.1 μ F feedback capacitor (C98).

BUSH TV85

The LW15 metal rectifier is giving only 180V and needs replacing. The sound comes on first and it is a minute before the picture follows with cramped height and lack of width. I am having difficulty getting a replacement rectifier as the type seems to be obsolete.—W. T. Ryall (Brentford).

Wire a silicon diode type BY100 or similar with a 15 Ω wire-wound resistor in series across the existing rectifier. The only precaution necessary is to observe correct polarity of the diode.

ALBA T766

I have a reasonable picture but there is only 100V at the anode of the video amplifier V5 and R23 gets warm although I have fitted a 5W type. The h.t. is normal and I have checked the valve and associated components. If I short the grid to earth the anode voltage is 140V as it should be.—H. Hardwick (Colne, Lancs).

Shorting the video amplifier grid to earth and thereby removing the fault suggests that the drive is exceedingly high or that the d.c. conditions of the valve are incorrect. Either could cause high anode current and thus an overheated anode load resistor. To check the d.c. conditions, check that the grid-cathode resistance is 6.8k Ω , the cathode-earth resistance 330 Ω , its parallel capacitance 1550pF and the screen-cathode resistance 47k Ω . If these are OK disconnect one end of the demodulator diode and see whether the anode goes back to 140V. If it does there is some d.c. leakage through the diode or the video level at that point is excessive. If it is excessive this could be due to incorrect a.g.c. circuit operation or the bias on a previous stage being incorrect thus causing excess gain.

PYE V630A

There is sound but no picture. The ECC82 and associated components appear to be OK. I noticed that the lower part of the mains dropper was glowing and replaced this but it still glows.—K. Bennett (Swindon).

The fault appears to be in the line output stage. Check the h.t. line at this point for shorts. The prime suspect is C72 (0.5 μ F).

PHILIPS 19TG155A

I cannot control the brilliance and have renewed the control and the resistors and capacitors associated with it. A bright spot remains on the screen after the set is switched off—H. J. Scott (Tottenham).

We suspect the v.d.r. (type E299DC/P348), R106, in the brilliance control circuit. Check the effect of shorting it out.

BUSH T57

There is good picture and sound when the set is switched on but after about a minute both go.—A. Hodson (Barnsley).

Replace both the tuner unit valves—PCF80 and PCC84—and remove the left-side chassis and the 6BA nuts holding the cover of the tuner unit to clean the sliding contacts.

BAIRD M640

The sound output on BBC-2 is very low even with the volume control at maximum. There is also break-through of channel 8 sound on BBC-2.—J. E. Hood (Sunderland).

It is often found that v.h.f. sound breaks through on u.h.f. on Baird models in this series, but this is not usually at the maximum tuning point for the channel. It is rarely troublesome when sufficient u.h.f. sound signal is present. Assuming that the signal strength from the aerial is sufficient loss of sound could occur anywhere in the sound channel. The intercarrier sound take-off capacitor (C84) could be faulty or one of the sound channel valves may not be giving sufficient gain at 6MHz. The f.m. discriminator diodes should be checked and the contact resistance of the system changeover switch at the detectors measured. If these are all OK the fault is probably poor alignment.

BUSH TV105

We are experiencing r.f. interference on the BBC picture in the form of wavy lines just like Continental interference. Sometimes you can see the ITA picture behind BBC one, moving across the screen horizontally.—G. R. Smith (Peterborough).

You will have to check the tuner unit thoroughly. Especially check the switch contacts which are of the sliding type. Clean all contact surfaces and ensure that the slider has the correct amount of travel.

PHILIPS 19TG172A

The set gives a perfect picture for about half-an-hour then goes very bright or very dark and constant adjustment of the brightness control is required.—B. M. Sutherland (Truro).

The trouble could be in one of two circuits and this can be determined by taking voltage readings at the c.r.t. base. The brilliance circuit should be suspected (check the v.d.r.) if the grid voltage at pins 2 or 6 varies. The video amplifier is suspect if the variation is at pin 7.

FERGUSON 3634

All verticals have very severe ragged edges although occasionally for a few seconds only the set is perfect. The line timebase valves have been replaced and the voltages are normal. The fault is the same on both standards.—R. Dunbar (Darlington).

The fault would appear to be one of the pencil type rectifiers in the e.h.t. multiplier circuit breaking down. Change the e.h.t. rectifier tray.

EKCO T371

The picture and sound were very good when the set was switched off but on switching on the following day only a faint raster and picture were present, with flyback lines well in evidence. Sound was good. I fitted a new U26 and everything went well for an evening. Next day only faint results again. A few days later after checking the seating of all the valves I switched on and after the set had warmed up there was a flash across the screen and perfect pictures for the rest of the evening. However since then only the faint picture again.—E. Plowman (South Woodford).

The e.h.t. flash you had suggests a wiring rather than a component fault. Check the base of the e.h.t. rectifier to ensure that all connections are properly made, and clean the valve base contacts. If this does not cure the fault check the metrosil between the c.r.t. final anode cap and chassis, and the efficiency diode (U193). Check the line output transformer for any signs of burn marks and test the boost reservoir capacitor.

QUERIES COUPON

This coupon is available until June 19, 1970, and must accompany all Queries sent in accordance with the notice on page 425.

PRACTICAL TELEVISION, JUNE 1970

TEST CASE**91**

Each month we provide an interesting case of television servicing to exercise your ingenuity. These are not trick questions but are based on actual practical faults.

?

A Ferranti Model T1086 was brought in with the complaint "wavy line at the top of picture". Switching on in the workshop certainly revealed the effect of a ripple (like 50Hz waves) not only at the top edge but also all the way down the picture. The ripple at the top was discernible because the top edge was slightly folded down, but by reducing the height exactly the same effect was present at the bottom edge. It was just as though a spurious signal—like mains hum or field signal—was modulating the line scan.

Although the hum on sound was normal, a check was made of the main smoothing and electrolytic capacitors. These were found to be well up in value. The control grid circuit of the line output valve was also examined, for sometimes field fre-

quency or hum signals can be injected here due for example to an increase (or almost open-circuit) of the grid return resistor. All was found well in this area.

What section of the set was overlooked? See the next issue of PRACTICAL TELEVISION for the solution to this problem and for a further item in the Test Case series.

SOLUTION TO TEST CASE 90
Page 379 (last month)

An oscilloscope can speed-up diagnosis of the kind of line timebase fault which was the subject of this Test Case. Using such an instrument revealed that while the frequency of the signal and the shape were correct on the grid (pin 2) of the 30L2 oscillator and on the control grid (also pin 2) of the PL81A, the amplitude was abnormally low and could not be increased.

The line oscillator produces a suitable line drive waveform across a capacitor connected from the anode of the oscillator valve to chassis, and the amplitude of the drive is governed by the time-constant of this capacitor in conjunction with the anode load charging resistor. The resistor's value was correct, but checks subsequently proved that the capacitor had dropped from its correct value of 200pF to about 5pF. Replacing this completely cured the fault.

LAWSON BRAND NEW TELEVISION TUBES

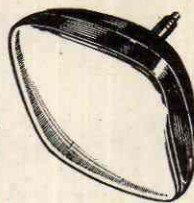

SPECIFICATION: The Lawson range of new television tubes are designed to give superb performance, coupled with maximum reliability and very long life. All tubes are the products of Britain's major C.R.T. manufacturers, and each tube is an exact replacement. Tubes are produced to the original specifications but incorporate the very latest design improvements such as: High Brightness Maximum Contrast Silver Activated Screens, Micro-Fine Aluminising, Precision Aligned Gun Jigging, together with Ultra Hard R.F. High Vacuum Techniques.

DIRECT REPLACEMENTS FOR MULLARD-MAZDA BRIMAR GEC, ETC.

| | | | | |
|-------------|----------|--------------|-------------|--------|
| A47-11W (P) | MW53/20 | T914 | CME1901 | 21C2P4 |
| A47-13W (T) | MW53/80 | C19/10A | CME1902 | 21DKP4 |
| A47-14W | AW-47-97 | C19/10AP (T) | CME1903 | 23SP4 |
| A47-17W (P) | AW-53-80 | C19/AK | CME1905 | 171K |
| A47/18W (P) | AW53-88 | C21/1A | CME1906 (T) | 172K |
| A59-11W (P) | AW53-89 | C21/7A | CME1908 | 112K |
| A59-12W (P) | AW59-90 | C21/AF | CME2101 | 7205A |
| A59-13W (T) | AW59-91 | C21/KM | CME2301 | 7405A |
| A59-14W (T) | C17/1A | C21/SM | CME2302 | 7406A |
| A59-15W | C17/4A | C21/TM | CME2303 | 7502A |
| A59-16W (T) | C17/5A | C23/7A | CME2305 (P) | 7503A |
| AW36-80 | C17/7A | C23/10A | CME2306 (T) | 7504A |
| AW43/80 | C17/AA | C23/AK | CME2308 | 7601A |
| AW43-88 | C17/AF | C23/AKT (T) | CRM173 | 7701A |
| AW43-89 | C17/AM | CME1402 | CRM212 | CRM121 |
| AW47-90 | C17/SM | CME1702 | CRM211 | CRM211 |
| AW47-91 | MW/53-80 | CME1703 | I7ARP4 | I7ARP4 |
| MW43-69 | T908 | CME1705 | I7ASP4 | I7ASP4 |
| MW43-64 | T911 | CME1706 | I7AYP4 | I7AYP4 |
| MW43-80 | | | | |

FOR YOUR INFORMATION

Experience of supplying CRTs over many years has shown us that when a customer requires a new CRT he means **Immediately**. We at Lawson's are geared to give a by-return service. Tubes are sent fully insured by passenger train. Goods or Road Services are not used, delivery taking far too long for customer satisfaction.

| | | Carr. Insur. |
|--------------------|----------|--------------|
| 12-14" Types | £4.10.0 | 10/- |
| 16-17" " | £5.19.0 | 12/6 |
| 19" " | £6.19.0 | 12/6 |
| 21" " | £7.19.0 | 12/6 |
| 19" Panorama (P) | £8.10.0 | 12/6 |
| 23" Mono | £9.10.0 | 15/- |
| 23" Panorama (P) | £11.10.0 | 15/- |
| 19" Twin panel (T) | £9.17.6 | 15/- |
| 23" Twin panel (T) | £12.10.0 | 15/- |

LAWSON TUBES

STATION ESTATE, MALVERN

Offices

18 CHURCHDOWN ROAD,
MALVERN, WORCS. MALVERN 2100

2 YEARS' FULL REPLACEMENT GUARANTEE

Complete tube fitting instructions are supplied with each tube.

VALVES SAME DAY SERVICE

NEW! TESTED! GUARANTEED!

SETS

1R5, 1R5, 1T4, 3R4, 3V4, DAF91, DF91, DK91, DL92, DL94.

Set of 4 for 18/6. DAF90, DF90, DK90, DL90, 4 for 27/-.

| | | | | | | | | | | | |
|--------|------|-------------|------|--------|------|--------|-------|-------------|-------|-------------|------|
| OZ4 | 4/6 | 19B6G6/17/6 | DK92 | 8/6 | EH90 | 6/3 | PCL83 | 12/- | URF89 | 6/9 | |
| 1A70T | 7/6 | 20F2 | 13/6 | DK96 | 7/3 | EL33 | 9/9 | PCL84 | 7/6 | UCR84 | 7/9 |
| 1R5GT | 7/3 | 20P3 | 11/9 | DL35 | 5/- | EL34 | 9/6 | PCL85 | 9/- | UCR85 | 7/3 |
| 1N6GT | 7/9 | 20P4 | 18/6 | DL92 | 5/9 | EL41 | 11/- | PCL86 | 8/3 | UCF80 | 7/8 |
| 1R5 | 6/9 | 25L6GT | 5/- | DL64 | 6/3 | EL34 | 4/9 | PENA4 | 12/6 | UCH42 | 12/6 |
| 1R5 | 4/3 | 25U4GT/11/8 | | DL96 | 7/3 | EL90 | 4/6 | PFL200/11/9 | | UCH81 | 6/8 |
| 1T4 | 2/9 | 30C1 | 6/6 | DY86 | 5/9 | EL500 | 12/6 | PL36 | 9/9 | UCL82 | 7/- |
| 1R4 | 6/9 | 30C15 | 13/- | DY87 | 5/9 | EM80 | 7/6 | PL81 | 8/9 | UCL83 | 11/9 |
| 3V4 | 6/3 | 30C17 | 18/- | EABC08 | 6/6 | EM81 | 7/6 | PL81A | 10/6 | UP41 | 10/6 |
| 5Y3GT | 9/9 | 30C18 | 18/- | EAF42 | 10/- | EM84 | 6/9 | PL82 | 6/6 | UF80 | 7/- |
| 5Z4G | 7/8 | 30F5 | 5/- | EB91 | 2/3 | EM87 | 7/6 | PL83 | 6/6 | UF85 | 6/9 |
| 6/30L2 | 12/- | 30FL1 | 14/- | EBC33 | 3/- | EY61 | 6/3 | PL84 | 6/6 | UF89 | 6/9 |
| 6AL5 | 2/3 | 30FL12 | 14/6 | EBC41 | 9/6 | EY86 | 6/6 | PL600 | 13/- | UL41 | 12/- |
| 6AM6 | 2/9 | 30FL14 | 14/9 | EBF80 | 6/9 | EZ40 | 8/- | PL504 | 13/6 | UL44 | 20/- |
| 6AQ5 | 4/6 | 30L1 | 6/6 | EBF89 | 8/3 | EZ41 | 3/- | PL508 | 23/6 | UL84 | 7/- |
| 6AT6 | 4/- | 30L15 | 14/9 | ECC81 | 3/9 | EZ80 | 4/6 | PM84 | 7/6 | UM84 | 6/6 |
| 6AU6 | 4/6 | 30L17 | 15/6 | ECC82 | 4/9 | EZ81 | 4/9 | PX35 | 12/- | UY41 | 7/6 |
| 6BA6 | 4/6 | 30P4 | 12/- | ECC83 | 7/- | GZ32 | 8/9 | PY32 | 10/- | UY85 | 5/9 |
| 6BE6 | 4/9 | 30P12 | 13/9 | ECC85 | 5/- | GZ34 | 9/9 | PY33 | 10/- | VP4B | 10/- |
| 6B36 | 8/6 | 30P19 | 12/- | ECC91 | 3/- | KT61 | 3/9 | PY81 | 5/3 | W77 | 3/6 |
| 6BW6 | 13/- | 30PL1 | 14/9 | ECC94 | 12/- | KT66 | 10/9 | PY82 | 5/3 | W119 | 7/9 |
| 6C5G | 4/9 | 30PL13 | 17/6 | ECP80 | 6/6 | N78 | 17/6 | PY83 | 5/9 | Z77 | 2/9 |
| 6F12 | 3/6 | 30PL14 | 16/6 | ECP82 | 6/6 | PABC80 | 7/- | PY88 | 6/6 | | |
| 6F14 | 9/- | 35L6GT | 8/6 | ECH35 | 6/- | PC86 | 10/3 | PY800 | 7/6 | Transistors | |
| 6P23 | 14/3 | 35W4 | 4/6 | ECH42 | 13/6 | PC88 | 10/3 | PY801 | 7/6 | AC107 | 3/6 |
| 6P25 | 13/- | 35Z4GT | 5/- | ECH51 | 5/9 | PC86 | 8/6 | R19 | 8/6 | AC127 | 2/6 |
| 6J5G | 4/9 | 507 | 15/- | ECH33 | 8/3 | PC97 | 7/6 | R20 | 12/6 | AD140 | 7/6 |
| 6K7G | 2/6 | 6063 | 12/6 | ECH84 | 7/6 | PC90A | 7/6 | U25 | 12/- | AP115 | 3/- |
| 6K8G | 2/9 | AC/VP2 | 10/- | ECL60 | 7/- | PC84 | 6/6 | U26 | 12/- | AP116 | 3/- |
| 6L18 | 6/- | AZ31 | 9/6 | ECL82 | 6/9 | PC85 | 6/- | U47 | 13/6 | AP117 | 3/6 |
| 6SN7GT | 4/3 | B729 | 12/6 | ECL83 | 8/6 | PC88 | 9/- | U49 | 13/6 | AP125 | 3/6 |
| 6V6G | 5/3 | CCX85 | 13/6 | ECL86 | 8/3 | PC89 | 10/6 | U78 | 4/3 | AP127 | 3/6 |
| 6V6GT | 6/6 | CL33 | 18/6 | EF37A | 6/6 | PCF80 | 6/9 | U81 | 12/6 | OC26 | 5/- |
| 8X4 | 4/3 | CY31 | 6/9 | EF39 | 4/9 | PCF80 | 6/6 | U193 | 8/6 | OC44 | 2/6 |
| 6X5GT | 5/9 | DAC32 | 7/3 | EF41 | 10/9 | PCF82 | 6/6 | U251 | 14/6 | OC45 | 2/6 |
| 10F1 | 14/- | DAF91 | 4/3 | EF80 | 4/6 | PCF86 | 10/6 | U301 | 10/6 | OC71 | 2/6 |
| 10F18 | 7/- | DAF96 | 7/3 | EF85 | 6/3 | PCF80 | 13/6 | U329 | 14/6 | OC72 | 2/6 |
| 10P13 | 12/- | DF33 | 7/3 | EF86 | 6/3 | PCF81 | 6/9 | U301 | 13/6 | OC75 | 2/6 |
| 12A77 | 3/9 | DF91 | 2/9 | EF89 | 5/3 | PCF80 | 6/6 | UABC80 | 6/6 | OC81 | 2/6 |
| 12A06 | 4/9 | DF96 | 7/3 | EF91 | 2/9 | PCF805 | 14/6 | UAF42 | 10/3 | OC81D | 2/6 |
| 12A07 | 4/9 | DH77 | 4/- | EF94 | 4/6 | PCF806 | 12/9 | UB41 | 6/6 | OC82 | 2/6 |
| 12A37 | 4/9 | DK32 | 7/6 | EF183 | 5/9 | PCF808 | 14/9 | UBC41 | 9/- | OC82D | 2/6 |
| 12K9GT | 7/3 | DK91 | 6/9 | EF184 | 5/6 | PCL82 | 7/3 | UBF80 | 6/9 | OC170 | 4/6 |

READERS RADIO

85 TORQUAY GARDENS, REDBRIDGE, ILFORD, ESSEX. Tel. 01-550 7441

Postage on 1 valve 9d. extra. On 2 valves or more, postage 6d. per valve extra. Any Parcel Insured against Damage in Transit 6d. extra.

PADGETTS RADIO STORE

OLD TOWN HALL, LIVERSEDGE, YORKS

Tel. Heckmondwike 4285

AW48-80 TV Tubes good picture—no guarantee £1 plus 12/- carriage.

Aircraft Sighting Head with Gyro Unit. Condition Fair 18/6, carriage B.R.S. 12/-.

Small 24-volt blower motor. Complete with fan Ex units. 10/- post paid.

Panel of 19 mixed pots, 5/- post paid. Ex unit.

Panels of Resistors and Condensers 8/- per doz., post paid. Ex unit.

Complete untested 17 inch TV Sets 12 channel 50/-, 15/- carriage. Small Sub Chassis containing small 12-way Plug and Socket. Few Resistors and Condensers, 5/-, p.p. 1/6.

Speakers removed from T.V. Sets. All PM and 3 ohm. 6in. round 3/-, p. & p. 3/-; 6 for 24/-, post paid 6 x 4in. 3in. p. & p. 3/-; 6 for 24/-, post paid. 7-4in. 5/-, p. & p. 3/-; 6 for 34/-, post paid. Slot Speakers 8 x 2 1/2in. 5/-, p. & p. 3/-; 6 for 30/-, post paid.

Reclaimed T.V. Tubes, with 6 months' guarantee 17in. Type AW43/80, AW43/88 40/-, MW43/69 30/-, 14in. Type 17/-, All Tubes 12/- carriage.

Silicon Rectifier 500mA 800 PIV, 2/6 post paid 24/- per dozen, post paid.

Jap Earpiece. Magnetic 8 ohm. Small and Large Plug 1/11 post paid.

G.P. Diodes 3/6 per dozen, post paid.

Top Grade Mylar Tapes, 7in. Standard 11/6, 7in. Long Play 14/-, 5in. Standard 7/9, 5in. Long Play 10/-, plus post on any tape 1/9.

VALVE LIST—Ex Equipment, 3 months' guarantee. Single Valves Post 7d., over 3 Valves p. & p. paid.

| | | | | | |
|-------|-----|-------|-----|--------|-----|
| ARP12 | 1/6 | PCL82 | 4/- | 6B8 | 1/8 |
| EB91 | 9d | PCL83 | 5/- | 6B7 | 2/6 |
| EF88 | 3/- | PL36 | 5/- | 6K7 | 1/9 |
| EBF50 | 3/- | PL38 | 6/- | 6T4 | 5/- |
| ECC81 | 3/- | PL81 | 4/- | 6P28 | 5/- |
| ECC82 | 3/- | PY33 | 5/- | 10P13 | 2/6 |
| ECC83 | 3/- | PY81 | 1/6 | 180BT | 8/6 |
| ECL80 | 1/6 | PY82 | 1/6 | 20D1 | 3/- |
| EF50 | 1/6 | PZ30 | 5/- | 20P1 | 5/- |
| EF80 | 1/6 | U191 | 5/- | 20P3 | 2/6 |
| EF91 | 9d | U281 | 5/- | 30P11 | 5/- |
| EF86 | 5/- | U282 | 5/- | 30P12 | 5/- |
| PCC84 | 2/- | U301 | 5/- | 30F5 | 2/6 |
| PCF80 | 2/- | U329 | 5/- | 30FL1 | 5/- |
| | | U261 | 5/- | 6/30L2 | 5/- |

RECORD PLAYER CARTRIDGES

ACOS: GP67/2g. High gain general purpose Mono
 GP91/3C. Stereo-compatible replacement
 GP91/3SC. High gain version of above
 GP94/1SS. Stereo cartridge

GENERAL PURPOSE REPLACEMENT FOR TC8 s etc.
 High gain, plenty of output (Jap.)
 Stereo version

16/8d.
 22/0d.
 22/0d.
 37/9d.

19/10d.
 37/9d.

SERVISOL AND ELECTROLUBE PRODUCTS (Nett trade)

Servisol aerosol can
 Electrolube 2AX aerosol
 Servisol Freezit
 Electrolube No. 1 Snorkel
 Electrolube 2GX Grease
 Servisol Aero-Clene for tape heads
 Servisol Aero-Duster

12/6d. nett
 14/0d. nett
 9/6d. nett
 18/0d. nett
 8/4d. nett
 10/6d. nett
 10/6d. nett

REPLACEMENT STYLI

TC8 4/6d.
 GC8 4/6d.

REBUILT AND NEW TUBES—TWO YEARS GUARANTEE

| RE-BUILT | BRAND NEW | A FEW SAMPLE TYPES, REMEMBER WE STOCK EVERY TUBE |
|-----------------------------------|-----------|---|
| 17" @ £4 14 6 | £5 10 0 | CME1702, AW43-80, CRM173, MW43-80, MW43-69*, CRM172*, AW43-88, AW43-89, CME1705, CME1703, C17AF, C17SM etc. |
| 19" @ £4 17 6 | £5 19 0 | CME1903, CME1902, CME1901, AW47-90, AW47-91, A47-14W, C19AH, C19AF, C19A. |
| 21" @ £7 5 0 | £8 10 0 | CME2101, AW53-88, AW53-89, CRM211*, CRM212*, MW53-20*, MW53-80*. |
| 23" @ £7 5 0 | £8 19 0 | CME2303, CME2301, AW59-90, AW59-91. |
| ALL PRICES ARE NETT. | | * NEW ONLY. NO REBUILDS |
| TWIN PANELS 19" CME1906 } £10 1 0 | | 23" CME2306 } £14 1 0 |
| | A47-13W } | A59/13W } |

EVERY TUBE IN STOCK INCLUDING 11", 12", 16" PORTABLES, PANORAMA & RM GUARDS + Philips Tvette and KB Featherlight etc. TERMS: CASH WITH ORDER. CARRIAGE ANYWHERE IN GT. BRITAIN 10/6 per Tube

HOT-LINE ORDERS
TRADE ONLY
Tel: 01-567 5400/2971

e.g. New VALVES . . . 33½ plus 13% plus quantity discounts 6%

RADIO AND TELEVISION VALVES SMALL SELECTION

British made valves normally supplied. EVERY TYPE IN STOCK

| | | | | | |
|---------|-------|--------|-------|--------|-------|
| DY86/7 | 10/- | EY86/7 | 10/- | PCL86 | 11/4 |
| DY802 | 9/1 | EZ80 | 10/10 | PD500 | 31/7 |
| EAB8C80 | 12/8 | EZ81 | 8/2 | PFL200 | 15/9 |
| EB91 | 8/2 | EZ90 | 9/3 | PL36 | 16/4 |
| EBC90 | 10/10 | GZ34 | 13/7 | PL81 | 13/7 |
| EBF80 | 10/10 | GY501 | 15/9 | PL81A | 14/6 |
| EBF89 | 10/10 | PC86 | 14/6 | PL82 | 10/10 |
| ECC81 | 10/0 | PC88 | 14/6 | PL83 | 13/8 |
| ECC82 | 10/0 | PC97 | 10/10 | PL84 | 12/8 |
| ECC83 | 10/0 | PC900 | 12/8 | PL302 | 13/7 |
| ECC804 | 15/4 | PCC84 | 10/0 | PL504 | 20/- |
| ECH81 | 14/6 | PCC88 | 16/8 | PL508 | 20/4 |
| ECH84 | 12/8 | PCC89 | 13/7 | PL509 | 31/7 |
| ECL80 | 9/6 | PCC189 | 13/7 | PY33 | 12/2 |
| ECL82 | 12/8 | PCC806 | 15/9 | PY81 | 10/10 |
| ECL83 | 13/4 | PCF80 | 11/4 | PY800 | 10/10 |
| ECL84 | 11/4 | PCF86 | 13/7 | PY801 | 10/10 |
| ECL86 | 12/8 | PCF87 | 18/1 | PY82 | 8/4 |
| EF80 | 9/6 | PCF801 | 13/7 | PY83 | 13/7 |
| EF85 | 12/8 | PCF802 | 13/7 | PY500 | 20/4 |
| EF86 | 16/4 | PCF805 | 14/11 | UABC80 | 13/7 |
| EF89 | 10/10 | PCF806 | 13/7 | UACH81 | 13/7 |
| EF183 | 12/8 | PCF808 | 14/11 | UCL82 | 12/8 |
| EF184 | 12/8 | PCL82 | 11/4 | UCL83 | 14/6 |
| EH90 | 13/7 | PCL83 | 13/4 | UL41 | 14/6 |
| EL34 | 10/0 | PCL84 | 13/7 | UL84 | 12/8 |
| EY51 | 13/7 | PCL85 | 13/7 | UY85 | 9/0 |

ALL MAZDA/BRIMAR TYPES IN STOCK.

TRADE & SERVICE ENGINEERS ONLY SUPPLIED

Cash with order. 10% MAY BE DEDUCTED FROM THE ADVERTISED PRICES EXCEPT FOR NETT ITEMS, C.O.D., OR TUBES

All orders must exceed 50/0d. in value otherwise postage and packing will be charged at 5/0d. per invoice. Components must be ordered in multiples as packed.

SEE WHAT YOU SAVE AT WILLOW VALE, THE SERVICE DEPT. WHOLESALE, 4 THE BROADWAY, HANWELL, LONDON, W.7. 01-567/5400-2971, 01-579 3582.

Send 2/6d in loose stamps for our comprehensive catalogues listing valves, components, tubes, transistors, mikes, aerials, Line output transformers. BY RETURN SERVICE ANYWHERE.

L.O.P.T.'s

LINE OUTPUT TRANSFORMERS

ALL MAKES SUPPLIED

EXCHANGE UNITS AND NEW REPLACEMENTS

EVERY MAKE SUPPLIED (EXCEPT MURPHY OIL-FILLED)

REWIND SERVICE FOR OBSOLETE MODELS

FRAME OUTPUT, SOUND OUTPUT AND MAINS TRANSFORMERS REWOUND

REMEMBER . . . We are the Service department Wholesalers and supply only the Service Engineers requirements and can therefore carry large stocks, and also we know and understand your problems regarding getting the right spares QUICKLY and the RIGHT PRICE. HOT-LINE Orders: 01/567 5400-2971. 01/579-3582.

Practical Television Classified Advertisements

The pre-paid rate for classified advertisements is 4/- per line (minimum order 12/-), box number 1/- extra. Semi-display setting £2 10s. 0d. per single column inch. All cheques, postal orders, etc., to be made payable to PRACTICAL TELEVISION and crossed "Lloyds Bank Ltd." Treasury notes should always be sent *registered post*. Advertisements, together with remittance, should be sent to the Classified Advertisement Manager, PRACTICAL TELEVISION IPC Magazines Ltd., Fleetway House, Farringdon Street, London, EC4, for insertion in the next available issue.

EDUCATIONAL

BECOME "Technically Qualified" in your spare time guaranteed diploma and exam. Home-study courses in radio TV servicing and maintenance. T.T.E.B. City and Guilds, etc., highly informative 120-page Guide—FREE. CHAMBERS COLLEGE (Dept. 858K), 148 Holborn, London, E.C.1.

TV and RADIO, A.M.I.E.R.E., City & Guilds, R.T.E.B., Certs., etc. on "Satisfaction or Refund of Fee" terms. Thousands of passes. For full details of exams and home training courses (including practical equipment) in all branches of Radio, TV, Electronics, etc., write for 132-page Handbook—FREE. Please state subject. BRITISH INSTITUTE OF ENGINEERING TECHNOLOGY (Dept. 172K), Aldermaston Court, Aldermaston, Berks.

TRAIN FOR SUCCESS WITH ICS

Study at home for a progressive post in Radio, TV and Electronics. Expert tuition for City & Guilds (Telecoms Techn's Cert. and Radio Amateurs') R.T.E.B., etc. Many non-exam courses incl. Closed circuit TV, Numerical control & Computers. Also self-build kit courses—valve and transistor.

Write for FREE prospectus and find out how ICS can help you in your career.

ICS, DEPT. 560, INTERTEXT HOUSE, STEWARTS ROAD, LONDON S.W.8.

TECHNICAL TRAINING

CITY & GUILDS (electrical, etc.) on "Satisfaction or Refund of Fee" terms. Thousands of passes. For details of modern courses in all branches of electrical engineering, electronics, radio, TV, automation, etc., send for 132-page handbook—FREE. B.I.E.T. (Dept. 173K), Aldermaston Court, Aldermaston, Berks.

SITUATIONS VACANT

ENGINEERS. A TECHNICAL CERTIFICATE or qualification will bring you security and much better pay. Elem. and adv. private postal courses for C. Eng., A.M.I.E.R.E., A.M.S.E. (Mech. & Elec.), City & Guilds, A.M.I.M.I., A.I.O.B., and G.C.E. Exams. Diploma courses in all branches of Engineering—Mech., Elec., Auto., Electronics, Radio, Computers, Draughts, Buildings, etc. For full details write for FREE 132 page guide: BRITISH INSTITUTE OF ENGINEERING TECHNOLOGY, (Dept. 171K), Aldermaston Court, Aldermaston, Berks.

RADIO AND TV Exams and Courses by Britain's finest home study School, Coaching for Brit.I.R.E., City and Guilds Amateur's Licence, R.T.E.B., P.M.G. Certificate etc. Free brochure from British National Radio School, Russel Street, Reading.

SITUATIONS VACANT

(continued)

CCTV ENGINEER

required to take complete charge of service department of well known company, London, W.1 area engaged in wholesale and retail distribution of TV cameras, monitors, video tape recorders and ancillary equipment.

Salary envisaged not less than £1,500 per annum with opportunity for overtime if required.

Ring Mr. Biddle at 01-437 8811 for early interview.

APPOINTMENTS

CAREERS in SCIENCE and ENGINEERING

Exciting and rewarding opportunities in these fields are almost unlimited.

Write now for details of the following courses offered by:

BOURNEMOUTH COLLEGE OF TECHNOLOGY

UNIVERSITY OF LONDON EXTERNAL DEGREES

B.Sc. General (Hons.)—*Mathematics, Physics, Chemistry, Botany, Zoology, Statistics.*

B.Sc. (Eng.) (Hons.)—*Electrical (including Electronics).*

These courses are suitable for both men and women.

Study by the sea in Britain's foremost international and cultural resort.

For prospectus apply to: The Principal, Room 70, College of Technology, Lansdowne, Bournemouth, BH1 3JJ. Tel. B.20844.

WANTED

SERVICE SHEETS AND MANUALS PURCHASED. Highest prices paid. Sultan Radio, 29 Church Road, Tunbridge Wells, Kent. Phone: T.W. 22093.

WANTED! New valves especially TV types. Cash waiting. Bearman, 6 Potters Road, New Barnet, Herts. Tel. 449/1934.

WANTED Tuner Coils Channels 3-8-10. For Murphy V310-V519. Box 83.

WANTED (continued)

TRAINEE requires odd vols. Newnes R. and T. Servicing, any condition. Cheap. Cash. 394 Victoria Road, Aston, Birmingham.

LINE LINEARITY Choke and Magnet/ Knob Assy. and Knobs for a Murphy V310A Television. W. Milne, 7 Healey Street, London, N.W.1.

CASH PAID for New Valves. Payment by return. WILLOW VALE ELECTRONICS, 4 The Broadway, Hanwell, London, W.7. 01-567 5400/2971.

SERVICE SHEETS purchased, HAMILTON RADIO 54 London Road, Bexhill.

VALVES and cheap components required by small television retail company. Ring ACE TV, Derby 53006.

AERIALS

TELEVISION AERIALS BBC 2 LOFT AERIALS including fittings, 7-element 33/6, 11-element 39/6, 18-element 49/6. Chimney Lashing Kit, BBC 2 Array and Mast 7-element 65/6, 11-element 72/6, 18-element 82/6. BBC 1 EXTERNAL H 42/6, ITV 4-element 45/6. Combined BBC/ITV 1+3 61/6, 1+5 69/6, H+5 79/6, including Mast and Lashing, Low Loss Coax Cable 1/5 yd. Coax Plugs 1/4, 6 ft. 1 in. Masts 12/6, 12 ft. 2 in. masts 47/6. Chimney Mounting Brackets 14/6 and 22/6 Heavy Duty. Mark channels required. C.W.O. P. & P. 4/-. C. K. Aerial Erections, 1A Brook Street, Drifford, E. Yorks.

BAKER AND BAINES

BBC dipole 30/-. H 42/-. 3 ele 89/-. ITA 3 ele 26/-. 5 ele 34/-. 8 ele 47/5. 11 ele 57/6. ITA doubles 8 ele 112/-. 11 ele 140/-. 13 ele 159/-. Combined BBC/ITA D+5 45/-. D+8 52/-. H+5 69/-. X+5 75/-. Combined Loft Special D+5 with loft pole and fixings 37/-. UHF Aerials BBC-ITA 14 ele 37/-. 18 ele 54/-. 22 ele 63/-. Double 22 ele 142/-. CO-AX low loss at 1/3 and 2/3. Co-Ax plugs 1/4.

Diplexers—Triplexers—Patched UHF/VHF Diplexers. VHF/UHF Pre Amps 75/-. Poles, Lashings, Clamps, Couplers, etc. Postage paid inland on aerials. Extra on accessories.

Please state channels when ordering. 11 Dale Cres., Tupton, Chesterfield.

SERVICE SHEETS

SERVICE SHEETS (1925-1970) for Televisions, Radios, Transistors, Tape Recorders, Record Players etc., by return post, with free Fault-finding Guide. Prices from 1/-. Over 8,000 models available. Catalogue 2/6. Please send S.A.E. with all orders/enquiries. Hamilton Radio, 54 London Road, Bexhill, Sussex.

SERVICE SHEETS. Radio, TV etc. 8,000 models. List 2/-. S.A.E. enquiries. TELRAY, 11 Maudland Bank, Preston.

SERVICE SHEETS with Free Fault Finding Chart, 4/6. S.A.E. Lesmar, 15 Conholt Rd., Andover, Hants. (Mail only). No business from May 23rd-Mar 30th, and also June 27th-July 11th.

SERVICE SHEETS (continued)

RADIO, TELEVISION over 3,000 models.
JOHN GILBERT TELEVISION, 1b
Shepherds Bush Road, London, W.6.
SHE 8441.

LARGE SUPPLIER OF SERVICE SHEETS

(T.V., RADIO,
TAPE RECORDERS,
RECORD PLAYERS,
TRANSISTORS,
STEREOGRAMS,
RADIOGRAMS,
CAR RADIOS)

FREE. Fault Tracing Guide or
TV list on request with order.

5/- each; Manuals from 10/-
plus large S.A.E.

(Uncrossed P.O.s please, original
returned if service sheets not
available.)

C. CARANNA
71 BEAUFORT PARK
LONDON, N.W.11

We have the largest supplies of
Service Sheets (strictly by return
of post). Please state make and
model number/alternative.

Mail order only.

TRADER SERVICE SHEETS

5/- each plus postage

We can supply Trader Service Sheets for
most makes and types of Radios, Tape
Recorders and Televisions—Manuals for some.

Cheques and open P.O.s returned if sheets not
available.

OAKFIELD ENTERPRISES

LIMITED

30 CRAVEN STREET, STRAND
LONDON WC2

| Make | Model | Radio/TV |
|------|-------|----------|
| | | |
| | | |
| | | |

1970 List now
available at 2/-
plus postage

If list is required
indicate with X

From

Address

enclose remittance of

(and a stamped addressed envelope)
s.a.e. with enquiries please

MAIL ORDER ONLY (June PT)

FOR SALE

VALVE CARTONS at keen prices. Send
1/- for sample and list. J. & A. BOX-
MAKERS, 75a Godwin Street, Bradford 1.

FOR SALE

 (continued)

NEW COLOUR GOODIES—25in. CRT
with scan coils and base £85. Bush Line/
Frame O/P stage £18, also valves and
Testgear. Osment, 7 Coppice Hatch,
Harlow.

NEWNES RADIO and Television Servicing.
8 Volumes 1952 to 1959. £10 o.n.o.
Leigh, 78 Woodhouse Lane, Beighton,
Sheffield.

SETS & COMPONENTS

150 NEW ASSORTED Capacitors, Resistors,
Silvered Mica, Ceramic, etc. Carbon,
Hystab, Vitreous ½-20 watt, 15/-
Post Free. WHITSAM ELECTRICAL, 33
Drayton Green Road, West Ealing,
London, W.13.

Free and illustrated lists of all types of
Hi-Fi equipment; Tuners, Amps, etc.
Electronic equipment, components and
Gadgets at lowest prices

from:
ALBION ELECTRONICS SUPPLIES
D/5,
16 Albion Road, Birchington, Kent.

EX N.E.V. C.C.T.V. Camera and Monitor
Circuits, S.A.E. for list. LOWE, 35 Hensley
Point, Hackney, London, E.9.

VALVES, VALVES, VALVES

Any ten of your choice 14/6d., post 1/-.
100 £5 10s. Od., post paid.

EF85, EF80, EB91, EBF89, ECL80,
EF183, EY86, PCF80, PCC84, PL36,
PY81, PCL82, PCL83, PCC89, PY33,
PY82, PY800, PY801, PY88, PCL84,
30F5, 6BW7, PY801.

BOB'S,

2 St. James Street, Rawtenstall
Rossendale, Lancs.
Mail order ONLY.

WITWORTH

TRANSFORMERS LTD.

Dept. P.T., 26 All Saints Road,
North Kensington, W.11

Telephone: 01-229 9071. 9 a.m. till 5 p.m.

TELEVISION LINE

OUTPUT

TRANSFORMERS

PRACTICALLY ANY MAKE OR MODEL
SUPPLIED OR REWOUND

EKCO, FERRANTI, DYNATRON
Replacement cases 16/- each, please state
model.

S.A.E. for return of post quotation.
TERMS: Cash with order or C.O.D., please
add 4s. for postage.

C.O.D. orders will be charged 6s.
Transformers fully guaranteed. (98)

NEW! Continuous range high-gain pre-
amplifier, 40-900 MHz! Television, Radio,
Stereo, all Bands, all Channels, VHF, UHF,
Colour! Precision made, built-in power
unit, totally enclosed, neat case. Fixed in
seconds back of set, no mods, aerial
connection only. Superb value at £7.12.6d.
post paid to any address in U.K. Send
S.A.E. for leaflet: Johnsons (Radio), St.
Martins Gate, Worcester, WR1 2DT.

CONSISTENT LARGE QUANTITIES OF EX-RENTAL T/V's

Ideal for Slot or Re-sale
DELIVERY CAN BE ARRANGED
Ring: 061-872 3709 and 061-445 9091

SETS & COMPONENTS

(continued)

TELEVISION TUBE SHOP

BRAND NEW TUBES AT
REDUCED PRICES

| | |
|-----------------|-----------|
| A28-14W | £11. 0.0 |
| A31-18W | £12. 10.0 |
| A47-11W | £9. 19.6 |
| A47-13W | £11. 15.0 |
| A47-14W | £7. 12.6 |
| A47-26W | £10. 15.0 |
| A50-120WR | £12. 10.0 |
| A59-11W | £12. 19.6 |
| A59-13W | £15. 10.0 |
| A59-15W | £9. 19.6 |
| A59-16W | £14. 15.0 |
| A59-23W | £14. 15.0 |
| AW21-11 | £10. 15.0 |
| AW36-20, 21 | £5. 12.6 |
| AW36-80 | £5. 7.6 |
| AW43-80 | £6. 17.6 |
| AW43-88, 43-89 | £6. 12.6 |
| AW47-90, 91 | £7. 10.0 |
| AW53-80 | £8. 17.6 |
| AW53-88, 53-89 | £8. 5.0 |
| AW59-90, 59-91 | £9. 10.0 |
| C17LM, PM, SM | £6. 12.6 |
| CME1201 | £12. 10.0 |
| CME1101 | £11. 19.6 |
| CME1601 | £10. 5.0 |
| CME1602 | £12. 0.0 |
| CME1702, 1703 | £6. 12.6 |
| CME1705 | £7. 12.6 |
| CME1901, 1903 | £7. 10.0 |
| CME2013 | £12. 10.0 |
| CME2101, 2104 | £8. 5.0 |
| CME2301, 2302 | £8. 15.0 |
| CME2306 | £15. 10.0 |
| CRM93 | £5. 10.0 |
| CRM124 | £5. 10.0 |
| CRM141, 2, 3, 4 | £5. 12.6 |
| CRM171, 2, 3 | £6. 7.6 |
| CRM211, 212 | £8. 17.6 |
| MW36-24, 44 | £5. 2.6 |
| MW43-64, 69 | £6. 7.6 |
| MW43-80 | £6. 17.6 |
| MW53-20 | £8. 17.6 |
| MW53-80 | £8. 17.6 |
| 7405A | £6. 12.6 |
| TSD217, 282 | £14. 0.0 |

All tubes tested before despatch and
guaranteed for 12 months.

Fully rebuilt tubes available—prices on
request.

CARRIAGE 10/-, via B.R.S. or 15/- via
Passenger train. Add 2/6 for Compre-
hensive insurance.

COLOUR TUBES

(Carriage & Insurance 40/-)

| | |
|----------|----------|
| A49-11X | £66. 0.0 |
| A56-120X | £72. 0.0 |
| A63-11X | £77. 0.0 |

TELEVISION TUBE SHOP

48 BATTERSEA BRIDGE ROAD
LONDON, S.W.11. BAT 6859

WE GIVE GREEN SHIELD
STAMPS

AERIAL BOOSTERS 59/- EACH

Three types of high gain transistorized pre-amplifiers to work off PP3 battery or 210-250 D.C.

1. **U.H.F. 625 Type L45** this will tune the complete U.H.F. band.
2. **V.H.F. 405 Type L12** with separate tuning for band I and III. Please state band I Channel No. required.
3. **F.M. V.H.F. Radio Type L11** with bandwidth for the complete band. All pre-amplifiers are complete and ready to use. Size $3\frac{1}{2} \times 3\frac{1}{2}$ colour Ivory. The 210-240 DC unit is 7/- extra.

VELCO ELECTRONICS

62 Bridge Street, Ramsbottom, Bury, Lancs. Tel. 3036

VALVE BARGAINS

Any 1-2/-, 5-9/-, 10-14/-, 100-£5.10.0.

EB91, EBF80, EBF89, ECC82, EY86, EF80, EF85, EF183, EF184, PCC84, PCC89, PCF80, PCF86, PCL82, PCL83, PCL84, PL36, PL81, PY32, PY33, PY800, PY801, 30PL1, 30FL1, 30F5, 6F23, 6-30L2, 10F1.

Many other types in stock. BY100 Type Rectifiers 2/6 each

Guaranteed valves 4/- each. Any from the list above (except valves in bold type) selected, tested, boxed and with three month written guarantee. S.a.e. for leaflets.

P. & P. on all goods 1/6.
Money refunded if not satisfied, if returned within 7 days.

TOWERBY LTD

For Line Outputs and Deflector Coils

We have the Country's largest stock of Manufacturer's Original (or Authorised Replacement) Line Output Transformers for many "difficult" makes, including Ambassador, Baird, Cossor, Decca, Dynatron, Ekco, Ferguson, G.E.C., H.M.V., K.B., Masteradio, Peto-Scott, Philips, Regentone, RGD, Sobell, Ultra, etc. Also deflector coils output and oscillator transformers inc. Alba, Bush, Murphy, Examples, L.O.P.T. Murphy 350/410/540/655/759, 147/-; Bush TV80, TV95, TV96, 147/-; Cossor 950, 77/6; Ferguson 306/308, 79/6; Philips 1768U L.O.P.T. assembly, 135/-; Ultra 1984-200c, 101/3.

Rewind most L.O.P.T.s, 90/-.

SPECIAL OFFER

Ekco improved type for Models T221, 231, 310, all at 45/-; Ferranti 14T4 series inserts, 25/-; Philco 1019/1021, 52/6. Terms: C.W.O. or C.O.D. (3/6) post/packing; 6/- 2 or more L.O.P.T.s post/packing free.

All enquiries answered but regret no lists available. Same day delivery on most types.

TOWERBY LTD

MAIL ORDER DIVISION OF T.C.S. LTD.
70 STREATHAM HILL, LONDON, SW2.
Tel: 01-674 2185.

TOP PRICES PAID

for new valves and components

Write:

KENSINGTON SUPPLIES,

(A), 367 Kensington Street,
Bradford 8, Yorks.

NEW BVA VALVES! Huge range by return postal service well known to the trade. Brief list of television types herewith, full list S.A.E. All types ex stock!

| | | | | | | | |
|---------|------|----------|------|---------|------|--------|-------------------|
| DY86/7 | 8/- | PCF86 | 12/3 | PY82 | 7/- | 20L1 | 19/6 |
| EB91 | 5/- | PCF801/2 | 12/3 | PY800/1 | 8/3 | 20P4 | 20/- |
| ECC82 | 8/6 | PCF805 | 13/- | R19 | 13/- | 30C15 | 13/9 |
| ECL80 | 8/- | PCF808 | 13/6 | U25 | 15/- | 30C17 | 15/9 |
| EF80 | 8/- | PCL82 | 10/3 | U26 | 15/- | 30F5 | 16/6 |
| EF85 | 8/3 | PCL83 | 12/3 | U37 | 15/- | 30FL1 | 12/9 |
| EF183/4 | 11/3 | PCL84 | 10/3 | U191 | 14/6 | 30L15 | 15/3. |
| EH90 | 10/3 | PCL85 | 10/6 | U193 | 8/3 | 30L17 | 14/6 |
| EY51 | 7/6 | PCL86 | 10/3 | U251 | 17/3 | 30P12 | 15/6 |
| EY86/7 | 7/9 | PL36/8 | 12/9 | U301 | 17/- | 30PL1 | 12/9 |
| PC86/8 | 10/3 | PL81 | 10/3 | U801 | 24/- | 30P4MR | 20/- |
| PC97 | 8/3 | PL83 | 10/3 | 6/30L2 | 15/6 | 30P19 | 12/9 |
| PC900 | 10/3 | PL84 | 8/3 | 6AT6 | 9/9 | 30PL13 | 18/6 |
| PCC84 | 9/3 | PL500 | 16/6 | 6BW7 | 13/9 | 30PL14 | 18/6 |
| PCC89 | 12/3 | PL504 | 17/- | 6CD6G | 28/- | | |
| PCF80 | 10/3 | PY81 | 8/3 | 6F23 | 15/6 | | etc. Trade prices |

POST FREE OVER £3—LATEST ENCAPSULATED BY 100 & 33 ohm res, 4/-!

Note. Ask for separate components lists.

LOOK! Nearly every type in stock now !!

NEW TELEVISION TUBES!

TWO YEAR FULL REPLACEMENT GUARANTEE

SEE THE DIFFERENCE A NEW TUBE CAN MAKE TO YOUR VIEWING—LATEST SCREENING TECHNIQUES INCLUDING TINTED SCREENS ON MOST 19" & 23" TYPES

Large stocks by Cathodeon & other leading manufacturers so why buy ordinary rebuilds? Colour 25" £60!

Special offer! 19" rebuilds, 2 year guarantee £5 10s.! 23" £7 10 0.

12" £3 0 0 (not 110°) 20" Mullard. 14" to 16" (not 110°) £4 15 0
17" £5 17 6 A50/120W £10 17 0 19" 1901 & 19AH £7 10 0

Other 19" mono tubes—all £6 17 6. Carriage all 12/- All 21" mono tubes—£7 17 6, 23" mono tubes £9 10 0. Carriage 15/-

RIMBANDS, 19" £8 10 0; 23" £11 10 0

TWIN PANELS, 19" £9 17 6; 23" £14 0 0

Carriage
20/-

Bulk enquiries welcomed, special terms.

PAY BY GIRO. Our No. 34.361.4006.

PHILIP H. BEARMAN

(Suppliers to H.M. Govt. etc.)

6 POTTERS ROAD, NEW BARNET, HERTS.

Closed Thurs & Sat afternoons TEL. 449/1934 (Robophone) & 7873

TELEVISION SALES, 77-79 Victoria Road, Warminster, Wilts., Phone Warminster 8156. Valves, boxed, tested and guaranteed. PCF80, PCC84, PL81, PY81, EY86, EF80, 30F5, EB91, ECC82, PCL83, 30FL1, ECL80, PCL82, PY82, PCL84, 6-30-L2, you select 8 for 20/-, p. & p. 2/- S.A.E., other types, several CRTs cheap, tested, for calls only.

R & R RADIO

51 Burnley Road, Rawtenstall
Rossendale, Lancs.

Tel.: Rossendale 3152

VALVES BOXED, TESTED & GUARANTEED

| | | | | | |
|-------|-----|-------|-----|-------|-----|
| EF80 | 3/- | PCC84 | 3/- | PY81 | 3/6 |
| EBF89 | 3/6 | PCF80 | 3/- | PY82 | 3/- |
| ECC82 | 3/- | PCF82 | 3/6 | U191 | 4/6 |
| ECL80 | 3/- | PCL82 | 4/- | 30F5 | 2/6 |
| EF80 | 1/6 | PCL83 | 4/- | 30L15 | 5/- |
| EF85 | 3/- | PL36 | 5/- | 30P12 | 4/6 |
| EY86 | 4/- | PL81 | 4/- | 30C15 | 5/- |
| EZ40 | 4/6 | PL83 | 4/- | | |
| EBC41 | 4/6 | PY33 | 5/- | | |

POST: ONE VALVE 9d. TWO TO SIX 6d.
OVER SIX POST PAID.

Please mention

**PRACTICAL
TELEVISION**

when replying to

ADVERTISEMENTS

A NEW "KING TELEBOOSTER"



THE M4 DUAL BAND V.H.F. UNIT KING . . .

the name you
can depend on.

- * Boosts all Band III and any specified Band I Channel simultaneously.
 - * Still higher gain . . . nominally 17-18 d.B. both Bands.
 - * Very low noise third generation passivated transistor.
 - * Fitted fly lead . . . installed in seconds.
 - * Quality Case 3½" × 3½" × 1½" Cork base.
- Specify Band I channel when ordering.

THE NEW UMF "COLOURBOOSTER"
Channels:-Group "A" Red Spot. "B" Yellow Spot, "C" Green Spot. Prices: Both types:—75/- Battery Model OR £5.17.6 Self Contained Mains Model. P/P 2/6d.

TRANSISTOR DEVICES LIMITED
Bridge House, Newton Abbot, South Devon
Literature on request.

UHF, COLOUR AND TELEVISION SPARES

COLOUR Leading Brit. makers surplus time base units incl. frame o/p, line o/p and EHT trans. £5.0.0, p.p. 10/- Scan coils £3.10., p.p. 6/-
UHF/625 conversion kits and tuners at reduced prices. Lists available.
UHF integrated transist. 6 position push button tuners, leading Brit. maker surplus, £4.10.0, p.p. 1/9.
MURPHY 600/700 series UHF conversion kits in cabinet plinth assy. can be used as separate UHF receiver £8.10.0, p.p. 10/- 625 IF amplifier incl. 5 valves and circuit 58/6, p.p. 6/-
SOBELL/GEC dual 405/625 IF amp. and o/p chassis incl. circuit 32-6 **ULTRA** 19800 to 2384 625 IF amp. chassis and switch incl. circuits 30/-, p.p. 4/6
UHF TUNERS transist. incl. s/m drive £5.5.0, valve type 58/6, p.p. 4/6
TV SIGNAL BOOSTER UNITS Sens. gain all stations. **PYE/LADGEAR** trans'd. **BB1/ITA** or UHF Battery "plug in", 75/- UHF Masthead £5.5.0
FIREBALL TUNERS, Ferg. HMV, Marconi new 37/6, other types salvaged 18/6, p.p. 4/6. **PUSH BUTTON**, Plessey, Ekco incl. valves 58/6, p.p. 4/6
TURRET TUNERS **PETO SCOTT** 968, **COSSOR** 1964, **DECCA** DR 05, 101/606 50/- **CYLDON** C 20/- **EKCO** 283/830 25/- **KB Featherlight**, Philips 19TG170 Series, Sobell 1010 35/-, p.p. 4/6. Large selection ch. coils.
LINE OUTPUT TRANSFS. Popular types available, brand new replacements fully guar. A selection which can be supplied, p.p. 4/6, C.O.D. 3/6.

| | | | |
|--|----------------------------|-----------------------------------|------|
| PHILIPS 17TG100 range, STELLA 1011/1029 | 70/- | LOPT Inserts p.p. 2/- | 35/- |
| BUSH TV33 to 49 | 32/6 | Alba 655, 656 | 35/- |
| EKCO 221 to 331 (U25 or U26 types) | 42/6 | Bush TV32, 48, 49 | 45/- |
| FERRANTI 1001 to 1019 (U25 or U26 types) | 42/6 | Coscor 933 to 950 | 35/- |
| EKCO 342 to 394, FERRANTI 1021 to 1065 | 75/- | Ekco TP308 | 38/6 |
| EKCO/FERRANTI 415, 1093, etc. | 82/6 | Emerson 700 range | 35/- |
| DECCA DM17, 3, 4 (700) DR95, 101/606 | 78/6 | Ferguson 203 to 246 | 35/- |
| FERG 305 to 426, 426/6 506 to 727 | 58/- | Ferranti 1475 to 21K6 | 25/- |
| FERG HMV MARCONI ULTRA PHILCO | | KB NP70, OV80, PV40 | |
| 3600, 2600, 4600, 6600, 1100 ranges, Jellypot | 75/- | PVP20 , QV10, 20, 30 35/- | |
| KB QVP20, QV20/1 to SV20 | 55/- | KB RGD Featherlight 50/- | |
| KB VCI to VCI1 | 78/6 | KB RGD VCI, 2, 3, 4 | 38/- |
| MARCONI VT157 to 172 | 55/- | PETO SCOTT 733/738 | 35/- |
| GEC 802 to 340, 451-1448, 2000 series | 89/6 | Philco 1961 series | 35/- |
| HMV 1863/9, 1870, 42/6; 1890 to 1924 | 58/- | Philips 17TG100 range 35/- | |
| PYE VT17, CS, CTM, CW17, 17/21, 17/8, 110 to 510, 790, 830, 111U to 40P | 62/6 | Pye VT4, VT7 | 42/6 |
| PAN INVICIA equiv. LOPTS to above Pye | 62/6 | RGD D17, 590 to 619 | 35/- |
| PETO SCOTT 1419 to 1735, 35/-; 733 to 738 | 78/6 | REG 10-4, 10-17 to 192 | 35/- |
| SOBELL/McMICH TFS173, 180, T23, 24, 178 | | Ultra 1770 1780 range | 35/- |
| 378, SC24, 270, MP17, 18, MT2, 74 | 40/- | | |
| TP8781 , T279, SC34, 370, MP27, M75, 76, 93 | 98/6 | | |
| 195, 282, 1000, 782, 300 series | 39/6 | | |
| PHILCO 1010 to 1021, 451-1029 to 1060 | 55/- | | |
| ULTRA 1770 to 2384, PILOT PT450 to 650 | 72/6 | | |
| SCAN COILS, Frame O/P, mains droppers, etc. | C.O.D. despatch available. | | |

MANOR SUPPLIES

172 WEST END LANE, LONDON, N.W.6.

(Near W. Hampstead tube stn. or No. 23 Bus)

MAIL ORDER: 64 GOLDERS MANOR DRIVE, LONDON, N.W.11

Available now! The new Mullard data book for 1970

Quick! get up-to-date with the latest information about Mullard semiconductors, valves, television picture tubes and components.

For easy flick-through location, each section of this pocket-sized data book is colour-coded.

just 4/-
(20p)



Get your copy from your local TV retailer, Bookshop or cash with order, including p.p. 4/9 (24p), direct from Mullard Limited.

Mullard

Mullard Limited, Mullard House,
Torrington Place, London, WC1

VALUABLE NEW HANDBOOK FREE TO AMBITIOUS ENGINEERS

Have you had your copy of "Engineering Opportunities"?

The new edition of "ENGINEERING OPPORTUNITIES" is now available—without charge—to all who are anxious for a worthwhile post in Engineering. Frank, informative and completely up to date, the new "ENGINEERING OPPORTUNITIES" should be in the hands of every person engaged in any branch of the Engineering industry, irrespective of age, experience or training.

On 'SATISFACTION or REFUND of FEE' terms

This remarkable book gives details of examinations and courses in every branch of Engineering, Building, etc., outlines the openings available and describes our Special Appointments Department.

WHICH OF THESE IS YOUR PET SUBJECT ?

TELEVISION ENG.

Advanced Television Eng.—
Gen. Television Eng.—Tele-
vision Servicing and Main-
tenance.

ELECTRONIC ENG.

Advanced Electronic Eng.—
Gen. Electronic Eng.—
Applied Electronics—
Practical Electronics—
Radar Tech.—Frequency
Modulation—Transistors.

MECHANICAL ENG.

Advanced Mechanical Eng.—
Gen. Mechanical Eng.—
Maintenance Eng.—Diesel
Eng.—Press Tool Design—
Sheet Metal Work—
Welding—Eng. Pattern
Making—Inspection—
Draughtsmanship—
Metallurgy—
Production Eng.

RADIO ENG.

Advanced Radio—Gen.
Radio—Radio Servicing—
Telecommunications—
Sound Recording—Auto-
mation—Practical Radio—
Radio Amateurs' Exam.

ELECTRICAL ENG.

Advanced Electrical Eng.—
Gen. Electrical Eng.—
Installations—Draughts-
manship—Illuminating
Eng.—Refrigeration—
Elem. Electrical Science—
Electrical Supply—Mining
Electrical Eng.

CIVIL ENG.

Advanced Civil Eng.—
Municipal Eng.—Structural
Eng.—Sanitary Eng.—
Road Eng.—Hydraulics—
Mining—Water Supply—
Petrol Tech.

WE HAVE A WIDE RANGE OF COURSES IN OTHER SUBJECTS INCLUDING CHEMICAL ENG., AERO ENG., MANAGEMENT, INSTRUMENT TECHNOLOGY, WORKS STUDY, MATHEMATICS, ETC.

Which qualification would increase your earning power?
B.Sc. (Eng.), A.M.S.E., C.Eng., A.M.I.E.R.E., R.T.E.B., A.M.I.P.E.,
A.M.I.M.I., A.M.I.E.D., A.R.I.B.A., A.I.O.B., P.M.G., A.R.I.C.S., M.R.S.H.,
A.M.I.Mun.E., CITY & GUILDS, GEN. CERT. OF EDUCATION, ETC.

British Institute of Engineering Technology
445A ALDERMASTON COURT, ALDERMASTON, BERKSHIRE

THIS BOOK TELLS YOU

- ★ HOW to get a better paid, more interesting job.
- ★ HOW to qualify for rapid promotion.
- ★ HOW to put some letters after your name and become a key man . . . quickly and easily.
- ★ HOW to benefit from our free Advisory and Appointment Dept.
- ★ HOW you can take advantage of the chances you are now missing.
- ★ HOW, irrespective of your age, education or experience, YOU can succeed in any branch of Engineering.

164 PAGES OF EXPERT
CAREER-GUIDANCE

PRACTICAL EQUIPMENT

Basic Practical and Theoretic Course for beginners in TV, Radio, Electronics etc. A.M.I.E.R.E. City & Guilds Radio Amateurs' Exam. R.T.E.B. Certificate P.M.G. Certificate Practical Radio Television & Radio Servicing Practical Electronics Electronics Engineering Automation

INCLUDING TOOLS

The specialist Electronics Division of B.I.E.T. NOW offers you a real laboratory training at home with practical equipment. Ask for details.

B.I.E.T.

You are bound to benefit from reading "ENGINEERING OPPORTUNITIES", and you should send for your copy now—FREE and without obligation.



POST COUPON

TO B.I.E.T., 445A ALDERMASTON COURT,
ALDERMASTON, BERKSHIRE

Please send me a FREE copy of "ENGINEERING OPPORTUNITIES." I am interested in (state subject, exam., or career).

NAME

ADDRESS

WRITE IF YOU PREFER NOT TO CUT THIS PAGE

THE B.I.E.T. IS THE LEADING INSTITUTE OF ITS KIND IN THE WORLD