

WILEY

Practical TELEVISION

AUGUST 1967

2/-

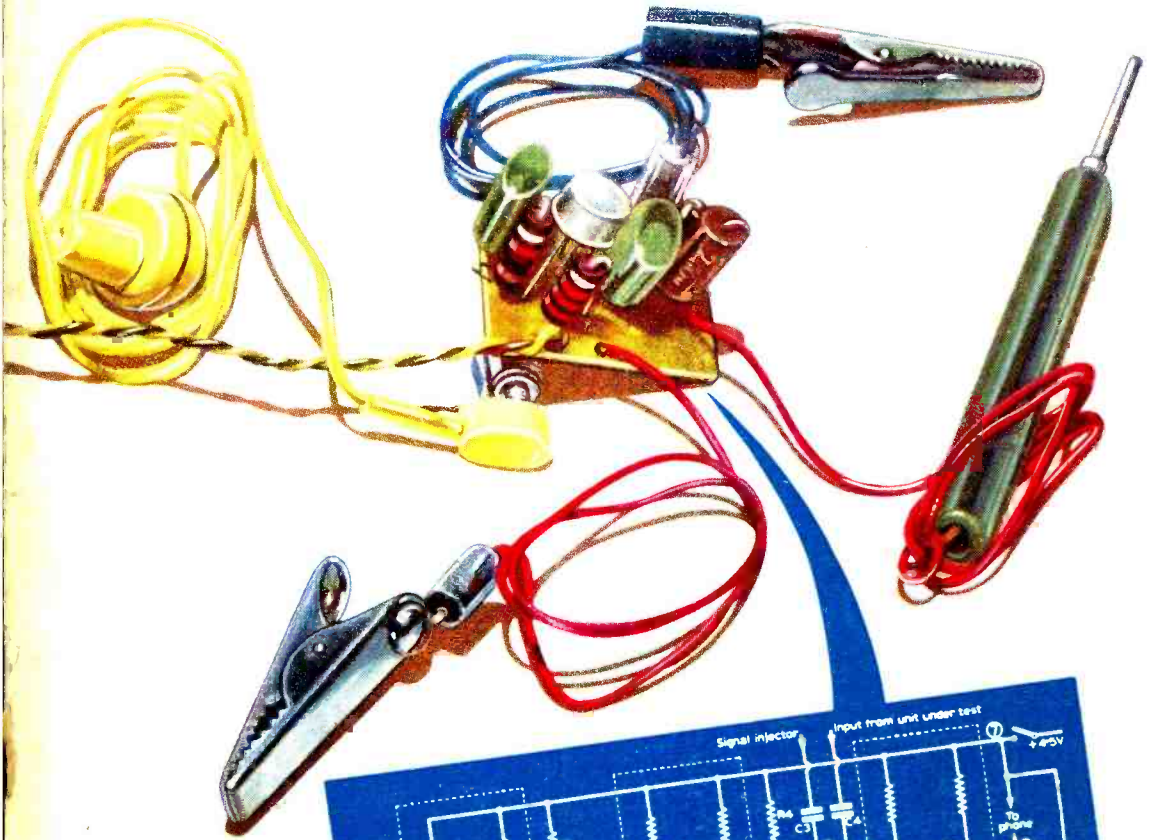

**INTEGRATED
CIRCUIT**

TU TEST OSCILLATOR

This is the latest list of Line Output Transformers and Inserts from D & B Television

NOW UNDER NEW MANAGEMENT

ALBA Prices on request.
BUSH TV53, TV56, TV57, TUG58, TUG59, M59, TV63, TV66, TV67. Inserts 27/6. Other types rewind at 70/-.
DECCA DM3, Exchange unit 70/-.
EKCO TC208, TC209, TC209/1, T221 to 331. Complete L.O.P.T. 40/-, TMB272 48/6, T344, T344F, T348, T348F, T356, TC312, T313, T313F, T335 58/6.
EMERSON E700, E701, E704, E707, E708, E709, E710, E711, Portarama, Inserts 35/-.
FERGUSON 306, 308 40/-, 204 to 246, Inserts 30/-.
FERRANTI 14T2 to 14T5, 17K3 to 17Sk4, Inserts 35/-, T1001, T1002, T1002/1, T1004, T1005, T1021, T1011 40/-, T1012, T1023, T1034, T1022 58/6.
K.B. PV40, MV100/1, OF100, PV100, NV40, NF70, OV30, QV10, QV30, Inserts only 45/- pair. All other types rewind 70/-.
PETO SCOTT TV1416, TV1419, TV1716, TV1719, TV1720, TV1722, TV1725, TV1418, TV1726, Inserts only 32/6.
PYE V4, V7, VT4, VT7, CTM4, CTM7. Insert only 40/-, V200, V400, V210 55/-, Other types prices on request.
PILOT V110, 117U, Inserts only 30/-.
REGENTONE T14, 10-6, 10-4, 10-17, 10-21, Inserts only 30/-, T176, 191, 192, T21FM, Inserts only 45/-, Deep 17, THE17, T21, 600, 590, Inserts only 35/-, T25, T280, 193, SC24, SC34, SC370, T279, TPS186, Rewinds only 70/-.
SOBELL All the above L.O.P.T. can be rewound at 70/-.

ULTRA 1984, 1984C, 200C, Rewind only 70/-.

1967 REVISED VALVE LIST

CBL31	14/-	EF184	6/3	PL83	6/6
DAF91	4/3	EL84	4/2	PL84	6/6
DAF96	6/3	EM81	6/9	PL500	13/6
DF91	3/-	EY51	6/10	PY33	8/6
DF92	3/-	EY86	6/3	PY81	6/-
DF96	6/11	EZ81	4/11	PY82	5/6
DK92	7/9	PC86	10/9	PY800	6/-
DK96	6/9	PC88	10/9	PY801	6/-
DL94	5/9	PC97	7/3	UABC80	5/3
DY87	6/3	PCC84	5/6	UCH81	6/3
EABC80	6/3	PCC89	10/-	UCL82	7/-
EB91	3/-	PCF89	10/10	U25	12/3
EBC90	4/3	PCC180	6/2	U26	12/3
EBF89	6/6	PCF82	7/7	30C15	11/3
ECC82	4/9	PCF86	7/9	30F5	9/9
ECH42	9/3	PCL82	7/-	30FL1	13/9
ECH81	5/-	PCL83	8/6	30L15	14/9
ECL80	6/9	PCL84	7/6	30P12	8/11
ECL82	6/3	PCL85	8/11	30P19	12/9
EF80	4/9	PFL200	13/6	30PL1	14/9
EF85	6/3	PL36	10/6	30PL13	14/9
EF183	6/-	PL81	7/6	30C18	10/-

All Line Output Transformers, Inserts and Valves are new and are fully guaranteed for 3 months. C.O.D. 5/- extra. Return of Post service. S.A.E. all enquiries. Post and packing 4/6.

D. & B. TELEVISION (Wimbledon) LTD

131 KINGSTON ROAD, WIMBLEDON,
 01 540 3513 S.W.19 01 540 3955



(Regd. Trade Mark)

SOLDERING EQUIPMENT

DESIGNED FOR ALL RADIO ENGINEERS

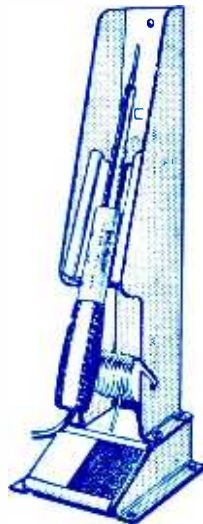

APPLY CATALOGUES:—
ADCOLA PRODUCTS LTD.
 ADCOLA HOUSE,
 GAUDEN ROAD,
 LONDON, S.W.4.

TELEPHONE: 01 622 0291
 TELEGRAMS: SOLJOINT. LONDON, S.W.4.



"SABRINA"

STILL WELL IN FRONT

COMPLETELY REBUILT C.R. TUBES ALL TYPES

12" now	£5. 0.0	} For Single Tubes
14" to 17" now	£5.10.0	
19" now	£6.15.0	
21" now	£8. 0.0	

ALL C.W.O.—TRADE SUPPLIED

Special Bonus Scheme for Service Engineers—Reducing to:

12"—87/6; 14"/17"—97/6; 21"—147/6

FREE Pass. transit & Ins. anywhere in British Isles or N. Ireland (12 months' guarantee).

ALSO FULL RANGE OF VALVES
 (Guaranteed 12 months)

SABRINA C.R. TUBE CO.

Electron Works, 50 North Bar
 BANBURY, OXON
 Telephone 2390

Practical Television

MEET THE IC

AUGUST
VOL. 17

1967
No. 11
issue 203

RADIO sets to carry in the palm of the hand. Quite a novelty once, but now a commonplace due to the progress of semiconductor development and miniaturisation techniques. Nowadays the general public are more attuned to radio sets in small matchboxes and stories of *TV sets* to carry in the palm of the hand.

It must be very disconcerting to writers of science fiction literature to find that not only are the figments of their fertile imaginations failing to keep up with all the progress of the backroom boys but are in danger of looking positively pre-Marconi in comparison.

Circuitry itself is not largely responsible for the momentum of miniaturisation. The first major breakthrough was, of course, the simple transistor, followed by the resultant proliferation of other more sophisticated semiconductor devices, and culminating in the module and integrated circuit.

The emergence of the integrated circuit was obviously of major importance in applications such as computers and space communications and for some time such fields were the natural niche for the integrated circuit. From the commercial point-of-view, the IC was a fascinating development but of little practical use, due mainly to the considerable expense of setting up the initial equipment.

However, intensive research and the restless activities of the development laboratories are now bearing interesting results and there is little doubt that with the cost factor becoming much more attractive the IC will begin to edge into more domestic fields.

In the USA, at least one major TV manufacturer is introducing an IC as part of the circuitry. At the recent RECMF Exhibition in London we saw quite clearly the inevitable trend in silicon chips containing, for example, circuitry to function as mixer/oscillator, i.f. amplifier, demodulator and audio amplifier. In fact we have reached the stage when a single IC can carry practically all the components for a radio receiver.

As a result of all this activity, we foresee that integrated circuit units will one day begin to appear on the amateur component market—possibly outside manufacturers tolerances (like “surplus” transistors) but at a sufficiently attractive price for the amateur.

We regard the article by A. J. McEvoy, starting on page 504 of this issue, as an important milestone for the TV experimenter. So far as we know this is the first article describing the building of an IC test unit to be published in this country. That there will be more in the future, you can be sure!

W. N. STEVENS—*Editor.*

THIS MONTH

Teletopics	482
Colour is Coming!—Part III <i>by A. G. Priestley</i>	484
Rapid Fault Diagnosis— Part II <i>by G. R. Wilding</i>	489
DX-TV <i>by Charles Rafarel</i>	492
Making Permanent Repairs <i>by V. D. Capel</i>	494
BBC-1 and BBC Wales Television Stations	496
Letters to the Editor	498
Timebase Traces—Part II <i>by K. Royal</i>	499
Integrated Test Oscillator <i>by A. J. McEvoy</i>	504
Learning the Trade <i>by S. George</i>	507
Servicing Television Receivers —Pye V210 Series <i>by L. Lawry-Johns</i>	509
Underneath the Dipole <i>by Iconos</i>	512
Servicing Notebook <i>by G. R. Wilding</i>	514
The Royal Television Society <i>by John D. Benson</i>	516
Trade News	518
Your Problems Solved	519
Test Case—57	524

OUR NEXT ISSUE DATED SEPTEMBER
WILL BE PUBLISHED ON AUGUST 18

TELETOPICS

INFRA-RED TELEVISION

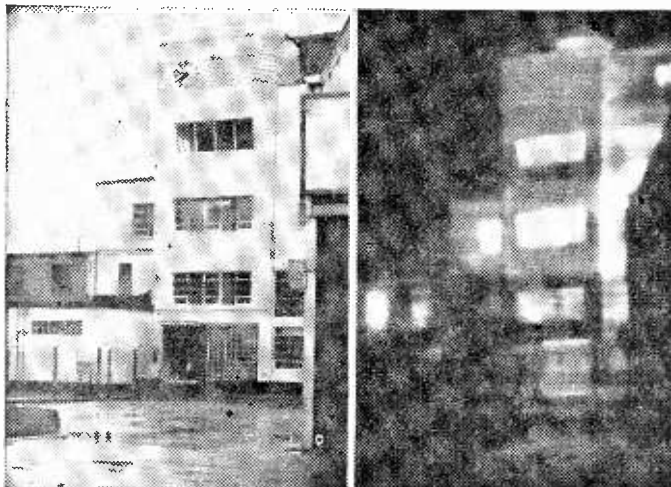

WHERE a normal television system utilises the reflection of light, infra-red television uses the heat or infra-red radiation emitted by an object. With the system that EMI is currently engaged in developing, temperature variation of a few hundredths of a degree C can be detected and pictures of acceptable quality can be obtained in complete darkness.

The photographs show some results obtained with the EMI system. The infra-red picture (right) was taken at night with

an overcast sky and no visible light; a light level of approximately 10^{-4} Lux. An ordinary photograph of the same subject taken in daylight is shown on the left. It can be noticed that the hotter the object, the whiter it shows on the TV screen, the loss of heat through the windows of the building being clearly shown.

Infra-red TV systems have many uses, an example being in the field of medicine where they can detect cancerous growths and areas of poor circulation.

FLORIDA INSTRUCTIONAL TV COVERAGE

MIAAMI, Fla., May 24 — The Dade County Board of Public Instruction has awarded a contract for the installation of the first phase of a complete television network which will ultimately broadcast four channels of instruction to more than 200 schools.

When the first phase of the construction is completed this autumn, the district will be able to originate and broadcast instructional programmes to 41 junior high schools throughout the county. In its final stage, the network will have the four-channel capability to transmit programming for elementary schools, senior high schools, and for administrative purposes and for in-service teacher training. This will cover from a learning resource centre more than 200 schools.

Broadcasts will be transmitted from the Lindsey-Hopkins Building in Miami and relayed via a repeater station at Cutler Ridge Junior High School 16 miles to the south. The repeater station will utilise a 145-foot tall tower being erected at the school.

The broadcast signal is at a frequency of 2.5-billion cycles per second — 10 times higher than commercial v.h.f. television. At this high frequency, special receiving antennas are necessary. Thus, while using the airwaves these systems are essentially tailor-made "closed circuit" systems leaving full programming control in the hands of the local educator.

Brierley Hill BBC-2 relay station

THE BBC has placed a contract for the erection of the building for the BBC-2 relay station at Brierley Hill, Staffordshire.

This station is being built at Amblecote Bank, about one mile south of Brierley Hill. It will transmit BBC-2 on Channel 63, with vertical polarization and will serve an area including Brierley Hill, Stourbridge, Amblecote and parts of Rowley Regis.

MULLARD GUARANTEE

MULLARD LTD. have announced details of the guarantee of their "Colour-Screen" colour TV picture tubes.

The initial formal guarantee, subject to the same conditions as those applicable to Mullard monochrome tube guarantees, will be for one year.

At the time of purchasing his receiver, however, the customer will also have the option of extending the tube guarantee for a further three years, under exactly the same conditions, for a recommended premium of £8.

The above applies to 25in. Mullard "ColourScreen" tubes. The premium for 19in. tubes will be announced at a later date.

LLANGOLLEN TELEVISION RELAY STATION

THE BBC has placed a contract with A. E. Davies and Sons (Builders) Limited, of Wrexham, for the erection of the building for the television relay station which is being built at Barber's Hill near Llangollen. This new relay station is of a number being built by the BBC to extend and improve the coverage of its services in Wales. It will transmit BBC Wales on Channel 1, with horizontal polarization and will serve some 3,000 people in Llangollen. It is expected that the Llangollen relay station will be brought into service in the late summer of this year.

ANTIFERRECE POLICY ON COLOUR AERIALS

ANTIFERRECE LTD. fully supports the recommendations of the various authorities concerned with the provision of a colour TV service, that to give the introduction of colour television the maximum chance of success, a good outdoor aerial should be provided for every installation.

They state, however, that a well designed set-top aerial gives perfectly adequate results for black and white u.h.f. reception under favourable conditions.

They recognise the need and will continue to meet the demand for u.h.f. indoor aerials because there are viewers who are unable (or do not wish) to install outdoor aerials and there are viewers who may not be colour-minded.

Antiferrence Ltd. do not think that the Aerial Industry can or should dictate to Trade or Consumer what standard of reception is acceptable since this is a matter of personal choice and experience and varies from one individual

to another. Experience alone will show the extent to which indoor aerials will be suitable for colour and this will vary in different parts of the country.

The reception demands for colour TV are much more critical than for black and white. There is no doubt that the best results will be obtained with a well-designed, well sighted and rigidly mounted outdoor aerial. Average reception conditions will be satisfied with the use of a 10-element aerial but 6, 13, 18 element and stacked arrays are available for areas closer or further from the transmitter. The cost difference will be very small when compared to the price of a colour set, but the difference in viewing standard can be enormous. Antiferrence therefore strongly recommends viewers to install the best aerials they can afford in order to obtain the very best out of what it confidently expects to be the finest colour TV service in the world.

BBC-2 TRADE TRANSMISSIONS

MONDAYS to Saturdays inclusive: 0900-0945 monochrome test card, 0945-0950 colour bars, 0950-1000 colour slide, 1000-1100 as 0900-1000, 1100-1125 programme — "Play School" (monochrome test card on Saturdays), 1125-1145 monochrome test card, 1145-1150 colour bars, 1150-1200 colour slide.

Tuesdays to Saturdays inclusive: 1200-1300 as 0900-1000.

Mondays to Saturdays inclusive: 1400-1415 monochrome test card, 1415-1425 colour bars, 1425-1500 colour slide, 1500-1600 as 1400-1500, 1600-1625 colour film, 1625-1630 colour slide, 1630-1645 monochrome test card, 1645-1700 colour slide, 1700-1800 as 1400-1500.

Mondays to Saturdays inclusive: 1800-1830 black level and syncs, 1830-1835 colour bars, 1835-1915 colour slide followed (approx.) by colour film.

The vision transmissions will be accompanied by sound as follows: 0900-0904 440-c/s tone, 0904-0905 no sound, 0905-0930 recorded music. This sequence will be repeated throughout the trade tests except during the colour films.

25th GREAT GERMAN RADIO EXHIBITION

FOR the 25th time, the public will see a show of technical progress in the field of radio and television at the Great German Radio Exhibition in Berlin. The great attraction this year will be colour television, the official commencement of which is to be got under way with the televising of the opening celebration on August 25. The programme will be simultaneously telecast on both stations (ARD and ZDF).

During the Exhibition a joint coloured TV programme will be produced by both television stations, which will be receivable on channel 39 in Berlin from 10 a.m. till 7 p.m. daily. The Exhibition's black and white television programmes of the ARD and ZDF stations will also be telecast over channels 7 (ARD) and 33 (ZDF) from 10 a.m. till 7 p.m.

In addition, the visitors to the Radio and Television Exhibition will be offered an extensive all-round programme. In the summer garden of the fair grounds athletic events, variety shows and concerts will be held daily.

COLOUR TV COMMISSION

A SOVIET delegation, headed by Deputy Minister of the Radio Industry, Ivan Lobov, were in Paris recently to take part in the fifth session of the Soviet-French commission for co-operation in colour television. Discussions included the progress of work in the U.S.S.R. and France in preparation for the introduction of the Secam-3 joint system of colour television next autumn.

NEW EMI CAMERA AT NAVEX '67

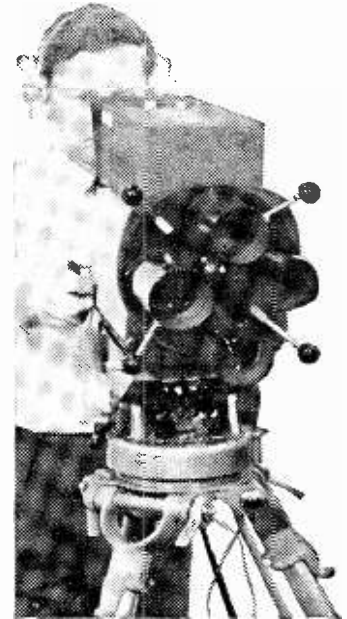

MAKING its debut at the National Audio-visual Aids Conference and Exhibition held at the Royal Festival Hall, July 5/7 was a new semi-professional turret camera, Type BC.920 from EMI which has been specially designed to meet the requirements of educational television and similar small studio installations. This camera is a high resolution, low noise, transistorised camera channel suitable for 625, 525 or 405-line operation on standard broadcast, industrial standard or random interlace systems. Compact and lightweight, the camera head incorporates a 4in. electronic viewfinder, side focusing adjustment, cue light and full communications facilities.

COLOUR IS COMING!

A SHORT BASIC COURSE ON COLOUR TV FOR
THE TECHNICIAN AND AMATEUR ENTHUSIAST

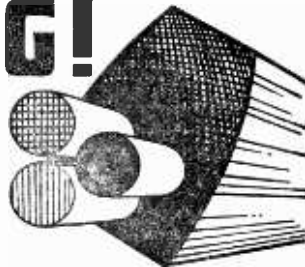

by A. G. PRIESTLEY

PART 3 — TRANSMITTING COLOUR

In this series of articles we are primarily concerned with the PAL system of colour television because this is the one which has been chosen for use in this country. The choice was made on the basis of European standardisation and because PAL is basically a good system. Not only is it capable of giving very good colour pictures, but it also has a high degree of immunity to defects in transmission, propagation and reception, it fits neatly into our existing pattern of broadcasting, and it provides considerable scope for future developments. We shall be discussing all these aspects later on, but first let us start with the basic requirements that the system has to meet.

In view of the fact that nearly every home in the country has a monochrome receiver it is unthinkable that all these people should be unable to receive colour programmes (displayed in black and white). Similarly owners of colour receivers must be able to display black and white programmes as well because at first only a proportion of transmission hours will be in colour. So our first requirement is that monochrome receivers must be able to display colour transmissions with an acceptable standard of performance, and colour receivers must be able to display monochrome transmissions. This is called "compatibility" and "reverse compatibility".

This means that a colour transmission must have the same basic characteristics as a monochrome one and be capable of being transmitted on the same channel. It has been decided that colour will be confined to 625 line operation, and so straightaway our basic limitations are established. The colour information has to be added as a separate component to the monochrome vision and sound signal of the standard 8.0Mc/s 625 line channel at u.h.f. In passing it should be noted that the colour receiver should be capable of dual standard 405/625 line operation so that it can be used on all channels.

THE COLOUR COMPONENT

Whatever else it contains our complete colour signal must have a normal vision carrier modulated in the same way, and carrying the same picture information and sync pulses, as in the case of an ordinary monochrome transmission. This is in order to meet the requirements of compatibility discussed above. Somewhere inside the channel passband we must add a colour component which, when used in conjunction with the ordinary vision carrier carrying the monochrome information, can be processed in a colour receiver to give a full colour signal at the c.r.t. This colour component is called a "colour difference" signal. If our monochrome (or brightness) information is called M, and the full colour

information from the same scene is C, then our colour difference component is C—M. If we now apply the monochrome information M to the cathodes of a colour c.r.t. and the colour difference signal C—M in the correct polarity to the grids, the c.r.t. will add these together to give $M + (C - M) = C$ —the full colour signal. This is an over simplification but we will see how the technique is actually applied a little later on.

Note that if an ordinary monochrome signal is supplied to the colour receiver it will be fed to the cathodes of the c.r.t., and since there is nothing on the grids except a d.c. potential, a normal monochrome picture will be produced in the same way as on a monochrome receiver. Our requirement of reverse compatibility has therefore been met.

This is the basis on which all the highly controversial colour TV systems of the last few years have been designed. The main differences between

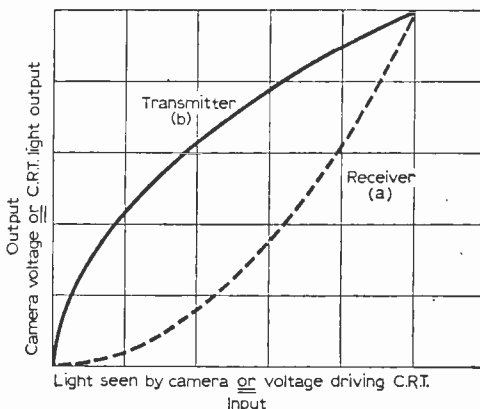

Fig 5: Gamma correction. The camera signals are pre-corrected to compensate for the receiver characteristics.

the various systems is the way in which the colour difference component has been added to the signal.

THE COLOUR TV CAMERA

The colour difference signal must contain enough information to enable the original scene to be reproduced accurately in the receiver. Last month we concluded that if we could transmit suitable proportions of red, green and blue information we could reproduce nearly all colours occurring in nature. Signal voltages corresponding to these three primary colours are obtained from a TV camera

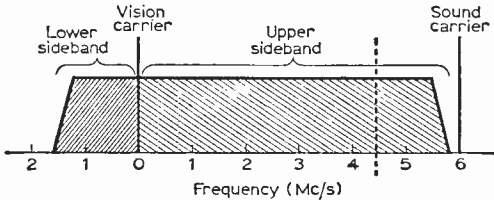

Fig. 6: A normal monochrome signal in an 8Mc/s 625 line channel.

which provides three separate outlets proportional to the red, green and blue content of the scene.

The simpler types of camera have three pick-up tubes and light from the scene being televised is fed to each one through a system of lenses and mirrors. A coloured filter is placed in front of each tube so that one tube sees only the red light coming from the scene, the second sees only the green light, and the third sees only the blue.

These filters are carefully matched to the primary colours specified in the overall TV system, and these colours are again matched by the phosphors on the screen of the colour c.r.t. Thus a colour seen by any camera can be reproduced accurately on any receiver providing that the signal processing in between is properly carried out.

Each tube in the camera produces a voltage proportional to the amount of light of the appropriate primary colour falling on it. Before these signals leave the camera, however, they have to be amplified and processed to a standard form suitable for encoding and subsequent modulation on the transmitted carrier.

GAMMA CORRECTION

The need for this arises from the fact that the input/output characteristics of a c.r.t. are non-linear. In other words equal increments of input voltage do not cause equal increases of light output. This is illustrated in Fig. 5. The light output is proportional to $V\gamma$ where V is the input voltage and the power 'gamma' varies between 2.2 and 2.7. So the output of each camera pick-up tube has to be processed in the amplifiers to give an inverse

characteristic by way of compensation. See Fig. 5. If this were not done the colour and brightness gradation of the scene would not be reproduced accurately on the c.r.t. in the receiver unless complicated non-linear circuits were added.

A camera must be adjusted to a standard condition so that the outputs from the three tubes are in the correct proportions, otherwise different cameras would give different outputs when viewing the same scene. The adjustment consists of making the three voltage outputs equal when the camera is pointed at a white card. The white light seen by the camera is known as the "reference white". Strictly speaking this should be "illuminant C" which is the sort of light obtained from a north sky and supposedly much beloved by artists. If the receiver is also adjusted to have a blank raster of the same colour, an accurate match will be achieved on colour programmes.

In practice studio lighting is somewhat different and the camera outputs are adjusted accordingly. Any error in setting either the camera or the picture will produce a corresponding bias in the colours displayed on the c.r.t.

The next thing is to decide what information we have to transmit in order to achieve our object of getting a colour picture on the screen of a c.r.t.

We have seen that it is necessary to provide a completely normal monochrome signal plus colour difference information. The monochrome signal is obtained by mixing the red, green and blue outputs from the camera in the right proportions to give an output from the c.r.t. proportional to the brightness of the original scene, just as in a monochrome receiver. The colour information must contain the

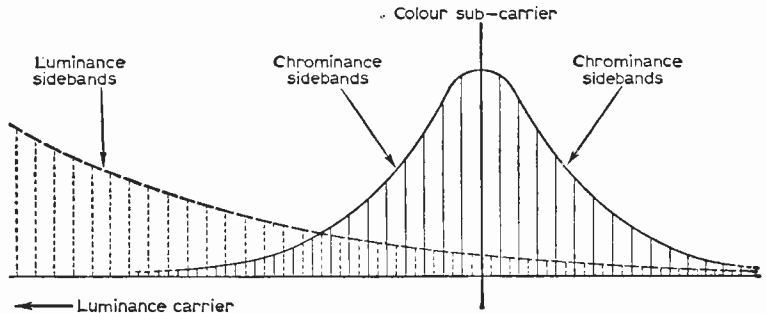

Fig. 7: Diagrammatic representation of frequency interleaving showing how interaction between chrominance and luminance sidebands is reduced.

right amounts of the red, green and blue camera outputs to provide a colour picture when added to the brightness (or monochrome) information. The camera outputs we will call R, G and B. Now if we transmit the correct monochrome signal (which we will now call 'Y') to the cathode of each gun in a shadow mask tube, and R-Y, G-Y and B-Y to the three grids, the c.r.t. will add these to give R, G and B effective drive voltages. If the colour difference signals (R-Y etc.) are correct then the colours seen on the c.r.t. will be correct too, assuming a properly designed and adjusted receiver. If the form of a colour difference signal seems a bit strange at first sight, note that there is no reason why we should not subtract one voltage from another whatever their amplitudes, polarities and waveforms.

However, if we transmit all three colour difference signals we are sending some redundant information. Most of us who studied algebra at school learned that if you have three unknowns, $x-y-z$, you need three equations relating them in order to find out what x , y and z are. Similarly, since Y contains R , G and B , we only need to send two of the three colour difference signals in addition to Y to enable the receiver to extract all the information it needs. $R-Y$ and $B-Y$ are in fact transmitted in the PAL system, and the receiver calculates $G-Y$.

CODING THE CAMERA OUTPUT

The gamma corrected camera outputs R , G and B have to be processed in order to get them into the form Y , $R-Y$, and $B-Y$. The three tubes in the camera record all the red, green, and blue content of the scene, and so these have to be added in the right proportions in order to give a

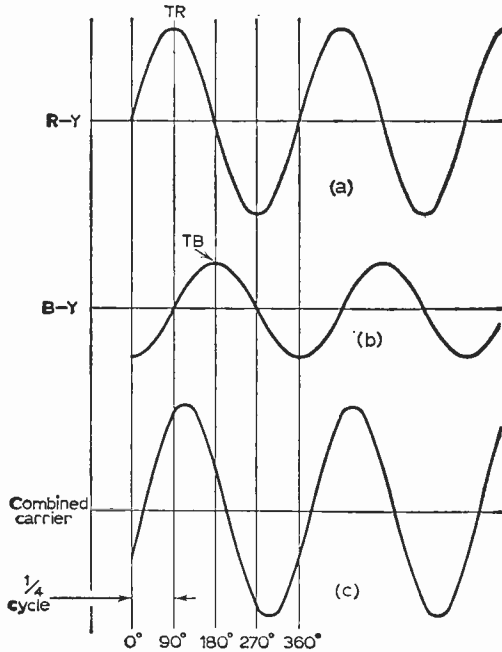

Fig. 8: Showing individual $R-Y$ and $B-Y$ carriers and how they add to give a resultant combined carrier.

monochrome signal which represents only the brightness. This signal must be capable of producing a black and white picture on a receiver duplicating as near as possible the original scene. In deciding the correct ratios of R , G and B the characteristics of the human eye must be taken into account because light sources of equal energy but different colour do not appear to have the same brightness. The Y (or brightness) signal is therefore made up as follows:

$$Y = 0.3R + 0.59G + 0.11B$$

Having obtained Y we can now derive the colour difference signals:

$$R-Y = R - (0.3R + 0.59G + 0.11B) = 0.7R - 0.59G - 0.11B$$

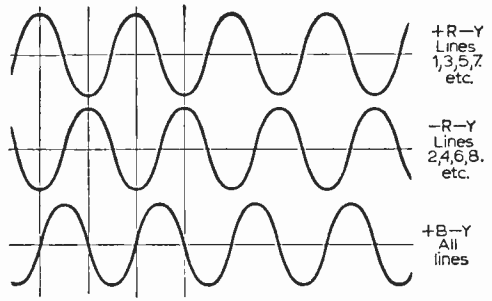

Fig. 9: The $R-Y$ signal is switched in phase by 180° on alternate lines.

Similarly $B-Y = B - (0.3R + 0.59G + 0.11B)$

$$= 0.89B - 0.3R - 0.59G$$

And $G-Y = G - (0.3R + 0.59G + 0.11B)$

$$= 0.41G - 0.3R - 0.11B$$

It can also be shown that

$$G-Y = -0.51(R-Y) - 0.19(B-Y)$$

So if the receiver mixes $R-Y$ and $B-Y$ signals in these proportions it can obtain the third colour difference signal $G-Y$ without it having to be transmitted as a separate piece of information.

It is not necessary to delve very deeply into the mathematics of signal coding in order to get a general understanding of how a colour TV system works. In any case it is a rather specialised art. The relationships listed above have been included to show the sort of process that has to be carried out in order to convert the camera outputs into signals ready for modulation on to the transmitted carrier.

THE COLOUR SUB-CARRIER

A normal monochrome transmission has the form shown in Fig. 6, where the hatched areas indicate the sidebands carrying the picture and sound information. At first sight there is not enough space to add a completely separate colour difference component, complete with sidebands carrying information about the colour detail in the picture. However, there are two helpful circumstances. In the first place the higher sidebands of the monochrome, or luminance (meaning brightness) carrier do not contain much energy. Secondly, most of what energy there is happens to be grouped in discrete chunks at harmonics of line and field frequency as shown in Fig. 7. If therefore we add an extra carrier carrying colour difference information about $4Mc/s$ above the luminance carrier, and choose the frequency so that its groups of sideband energy fall between those of the luminance carrier,

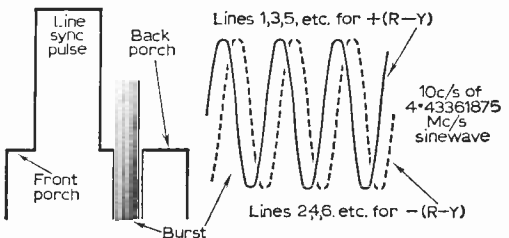

Fig. 10: The alternating burst signal.

we shall have a viable system. See Fig. 7. This extra carrier is commonly called the "colour sub-carrier" and is modulated on to the *luminance carrier* in just the same way as any other information. Fortunately, though, the bandwidth of the *colour sub-carrier* can be limited to -1.6 and $+1.0$ Mc/s about the centre frequency in the PAL system because the eye is not capable of recognising fine colour detail corresponding to higher sideband frequencies.

The actual frequency of the PAL colour sub-carrier has been chosen as 4.43361875 Mc/s. This rather precise figure is dictated by the relationship between field and line scanning rates: the need to interleave the *luminance* and *chrominance* sideband energy; and the general placing of the sub-carrier so that its sidebands do not impinge unduly upon either the *luminance* or sound carriers. A further factor to be taken into account is that the frequency must be chosen so that the dot pattern caused by the sub-carrier does not add up on adjacent fields, but instead forms a pattern with minimum visibility.

QUADRATURE MODULATION

The luminance signal is modulated on to the vision carrier in exactly the same way as in a monochrome transmission. This leaves us with the problem of how to modulate our two colour difference signals R-Y and B-Y on to the colour sub-carrier and here we come to the technique of "quadrature modulation".

The colour sub-carrier is derived from two separate carriers in quadrature: i.e. with a phase difference of 90° . In other words one carrier leads the other by a quarter of a cycle. See Fig. 8a and b.

One carrier is amplitude modulated with the R-Y signal so that the height of the carrier is proportional to the amplitude of the R-Y signal. Similarly the other carrier is amplitude modulated with B-Y. If a colour difference signal falls to zero the carrier is at zero amplitude also, and this system of modulation is called "suppressed carrier" working. The carrier itself is not transmitted, but only

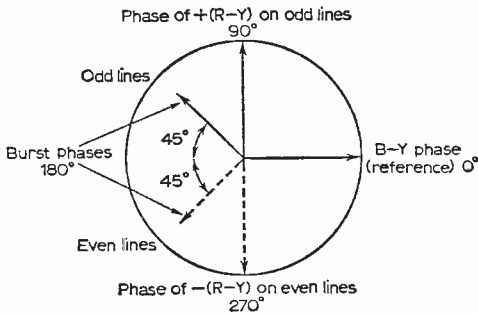

Fig. 11: A colour circle diagram showing the times (or phase angles) at which each carrier is at maximum amplitude.

its sidebands. This technique differs from normal amplitude modulation in which the carrier is maintained even when no information is present.

The first thing to note is that when one carrier is at a maximum the other is zero. At an instant in time shown as TR we can measure (or detect) the

R-Y carrier and obtain the R-Y signal without any contribution at all from the B-Y carrier. Similarly at time TB we can detect the B-Y carrier without getting any R-Y signal. Rather neat isn't it?

So far we have considered these carriers as being separate, but in practice they are added together. The same argument still holds though. Fig. 8c shows the combined carrier obtained by adding the two together, with the same relationships at times TR and TB. This single carrier has the same frequency, but contains both *amplitude* and *phase* modulation.

The phase of the combined carrier can vary between that of the R-Y carrier and that of the B-Y carrier, and so it tells us the relative amounts of the two colour difference signals being transmitted. The amplitude of the carrier is a measure of

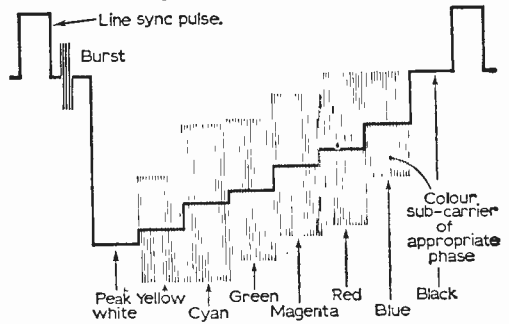

Fig. 12: The colour bar test pattern. The heavy line shows a monochrome staircase. but the addition of the sub-carrier converts this to a colour bar pattern.

the amount of colour being transmitted. So the *phase* of the carrier tells you the relative amounts of R-Y and B-Y which define the *hue*, and the *amplitude* gives the *saturation*..

If a particular colour in a scene becomes more saturated but the hue remains the same (for example pink changes to red) the amplitude of the carrier will increase. If however the saturation stays the same but the hue changes (red becomes purple) the phase of the carrier will change, but not its amplitude.

As an alternative to measuring the phase and amplitude of the carrier as separate quantities we can measure its amplitude alone at two different instants in time. Harking back to Fig. 8c if we inspect the carrier at time TR the amplitude gives us the R-Y colour difference signal, and at time TB we get B-Y. This inspection process is known as "synchronous detection", and we shall consider it in more detail when we discuss the colour receiver.

The G-Y colour difference signal is obtained in the receiver by adding the R-Y and B-Y signals in the right proportion. We then have the *luminance signal* applied to each cathode and the *colour difference signals* applied to the grids. As we saw earlier this gives R.G.B. effective drive voltage on the three guns, and so a full colour picture.

PAL SWITCHING

So far the technique of modulation that we have been describing has been nearly identical to the

NTSC system used in the USA and Japan. The only difference has been that whereas PAL uses R—Y and B—Y colour difference signals NTSC uses I and Q, which are close derivatives. The important difference however between NTSC and PAL is that in the latter the R—Y signal is reversed in phase on alternate lines. Hence the name *Phase Alternation Line*. This is shown in Fig. 9. On line one we get + (R—Y) and + B—Y. Line two —(R—Y) and + (B—Y). Line three + (R—Y) and + (B—Y) again and so on.

The transmission technique is not changed fundamentally but it opens up all sorts of possibilities in the receiver which enable us to get better colour pictures. In the more common type of PAL receiver using a delay line the alternating R—Y signal enables an averaging process to be carried out from line to line which results in the cancellation of hue errors. Propagation errors and other defects which cause phase changes in the colour sub-carrier will produce changes in hue on the NTSC system. Hence the old saw about never twice the same colour. On PAL however you merely get slight changes of saturation. We shall discuss this in more detail when we consider the design of the receiver itself.

THE REFERENCE BURST

The hue being transmitted at any given instant is denoted by the phase of the combined sub-carrier, and so if we are to inspect the amplitude of the carrier at the correct times we need a carrier in the receiver with constant phase to use as a reference. Ten cycles of a sine wave are therefore transmitted during the back porch of the line sync pulse, and these are used in the receiver to lock a local crystal oscillator.

However a further item of information is needed insofar as we have no means of knowing whether + (R—Y) or —(R—Y) is being transmitted on a particular line. Accordingly the phase of the *burst* (sine wave) signal is altered by 90° on alternate lines and this can be recognised in the receiver to indicate the polarity of the R—Y signal. The burst signal is shown in Fig. 10. The phase of the burst has been chosen to give minimum visibility on the picture, but since it occurs during line flyback it will in any case be blanked by the normal line flyback suppression pulse.

A COLOUR CIRCLE DIAGRAM

We saw earlier in Fig. 8 that the individual R—Y sub-carrier starts a quarter of a cycle before the B—Y carrier: i.e. it leads B—Y by 90° . The phase of the transmitted burst is different again.

If we draw a circle and mark the circumference from 0 to 360° using the B—Y carrier as a reference we can draw lines indicating the positions of the R—Y, B—Y and burst signals. See Fig. 11. The length of the lines tell us the amplitude of these signals. The positions of the lines represent the instants in time when we must inspect the combined sub-carrier and the burst signal in order to extract these three components at their maximum (i.e. correct) amplitude.

The dotted line at 6 o'clock shows that on alternate lines the R—Y signal is being reversed in polarity. The phase of the burst is alternating in sympathy with R—Y but by 90° only, as shown by the dotted line at 7.30.

We have now established a simple vector diagram which shows the timing and amplitude of the three individual carriers relative to each other. It is a form of shorthand which saves pages of explanation once one has grasped the basic idea. All the *chrominance* part of the transmitted signal is contained on this diagram.

THE COMPLETE COLOUR SIGNAL

To sum up, a PAL colour transmission consists of a complete monochrome signal with normal vision and sound carriers. An extra carrier at a frequency of 4.43361875Mc/s carrying the colour information is modulated on to the vision carrier in addition to the monochrome information. The sync pulses are exactly the same, but a burst of reference carrier is added to the back porch after the line sync pulse. The combination of these elements forms the complete colour signal, and this is illustrated in Fig. 12 for the standard vertical colour bar test pattern.

This completes our survey of the transmitted signal and once the basic characteristics are understood it becomes much easier to understand the workings of a receiver.

To be continued

PRACTICAL WIRELESS — SEPTEMBER

MINIATURE STABILISED POWER SUPPLY UNIT

Build this tiny power unit giving 9 volts at up to 100mA. Incorporates a series stabiliser network using a power transistor and a Zener diode. Suitable for transistor radios etc.

FOUR WAVEBAND SET for the NOVICE

A constructional article describing a simple three-valve receiver covering 10–600 metres. Covers short waves and medium waves plus amateur bands.

BULB TUNING INDICATOR

In this article the author describes a novel method for obtaining tuning indication in transistor receivers with a simple old-fashioned bulb.

on sale August 4th — 2s. 6d.

RAPID FAULT Diagnosis G.R. Wilding

Part 2 — Low gain

(continued from the June issue)

ONE of the most common faults is low gain. Points to watch, and which immediately help to localise the cause, are as follows: Is the picture grainy?; is sound also weak and accompanied with hiss?; it is worse on one Band than another?; is the picture definition up to standard?; does the contrast control have any effect?; is background patterning present?

Low gain with grain implies a faulty aerial, aerial connection or defective tuner r.f. stage while weak sound with hiss will reconfirm the probability. Low gain without grain shows that the input signal must be strong enough to overcome front-end noise so the defect must be in the i.f. stages.

Mis-alignment seldom produces symptoms solely of low gain; more likely pronounced ringing, S on V, V on S, smearing or impaired high frequency resolution. If the Test Card gratings are well reproduced without ringing, if fine tuner adjustment peaks sound volume with optimum picture definition and free of cross modulation effects, it will be safe to assume that alignment is within acceptable limits. Background patterning would strongly suggest the possibility that an i.f. decoupling capacitor is open circuit and simultaneously causing low gain by introducing negative feedback and/or mis-tuning of the associated circuit.

CHECK AERIAL SYSTEM

With all cases of low gain, even before removing the set back, first check the connections to the coaxial aerial plug and test aerial input by contacting only the inner coaxial conductor to the centre of the aerial socket. Improved results using only half the aerial in this manner indicate the possibility of a short circuit somewhere in the aerial installation, and if results deteriorate on contacting the outer metallising to the outer ring of the aerial socket, it's almost certain to be aerial trouble. Very often it will be found that a strand of inner conductor will cause a s/c inside the plug or that no electrical contact exists between the coaxial metallising and the plug body. Be particularly suspicious of coaxial outlet sockets where fitted, since being mounted near floor level, they get kicked, damaged and often painted over with disastrous results to good electrical contact.

Assuming that the aerial is in order and the graininess still persists, especially on Band III, the

prime suspect must be the r.f. amplifier valve. Often replacement will produce a dramatic improvement. Further improvement, though not so spectacular, usually occurs when the frequency-changer is replaced.

Once tuner valves have been eliminated and if "grain" is more evident on Band I than Band III, the odds are that an indoor aerial is being used. While indoor aerials are suitable in many reception areas, it must be remembered that they cannot compete with outdoor types. Where reception is present on one Band only and weak on the other, the frequency-changer is often at fault by completely failing to oscillate on the non-operative band. Furthermore, if car or other interference is present it is almost a certainty that this is so since most interference covers such a wide frequency band that it can get through most i.f. tuned circuits. A further cause of low gain can be incorrectly adjusted preset sensitivity controls. In many modern printed circuit receivers, these miniature controls are not always apparent, often being behind the main printed-circuit panel and accessible through a very small hole.

CHECK THE CORRECT VALVES ARE IN THE TUNER

Occasionally you may find a PCC89 type of r.f. amplifier where a PCC84 should be or vice versa, so that the actual valve fitted cannot always be assumed to be the maker's original specification.

Usually replacement of the earlier PCC84 type by the higher slope frame-grid PCC89 results in a reduction in performance unless the associated circuitry is altered, but sometimes it can result in a freak increase of gain in one band at the

Fig. 3: Typical front end of a 405-line receiver. Common causes of low sensitivity may be eliminated by checking (A) when the symptoms are grain and usually worse on Band I; (B) grain and usually worse on Band III; and (C) with no gain but weak on both Bands.

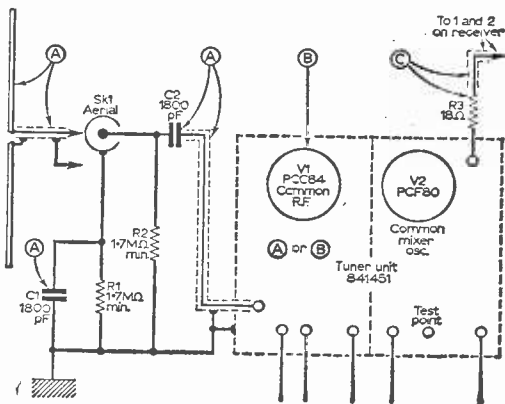

expense of the other. When the r.f. amplifier and frequency-changer valves get transposed in the tuner, almost always a resistor burn-up occurs, so when in any doubt about which valve goes where, note where the fine tuner is placed and where the coaxial lead enters the tuner from the receiver aerial socket. These factors always positively identify the respective f.c. and r.f. valve positions.

THE CONTRAST CONTROLS

A further but fairly rare cause of low gain is failure of the contrast control in the now almost universal mean-level a.g.c. circuits to reduce the negative voltage obtained from the sync separator grid before feeding it to the controlled r.f. and i.f. valves. In such circuits, the contrast control is a high value potentiometer shunted across the h.t. rail whose slider backs off the negative a.g.c. voltage via a high value decoupling resistor. Failure of this resistor, or more likely a disconnection in the contrast control between the h.t. tag and control track will leave gain unalterable. When checking that the contrast control is operative, remember that when the receiver is giving weak results that its range of operation will be limited anyway, since deriving its negative bias from the sync separator, a low signal amplitude at the end of the receiver strip will also produce a low sync separator grid voltage. If any doubt exists about the a.g.c. line being constantly at peak negative value, simply short it to chassis and note if any improvement in gain occurs. It is possible to check this voltage with a meter, but due to the extremely high values of feed resistor employed, any value shown must be taken as an indication and not as an actual measurement.

TRY CHANGING THE I.F. AND VIDEO VALVES

Having tried tuner valves and checked the aerial and plug connections, the next step must be to check (by substitution) all valves in the i.f. and video stages. In most receivers such valves are readily identified by their positioning and type. EF85's and EF80's in older models, EF183's and EF184's in more modern receivers, but not over-

looking that the pentode section of PCF80's are also used in certain models as i.f. amplifiers. Usually instances of poor gain arising in the i.f. stages will be found due to a general decline in each valve's performance rather than by one valve failing. Thus the gain of 3 successive valves whose individual performance rating is 80% results in an overall gain of only 51.2%.

When the video amplifier has low emission, the symptoms could possibly be misinterpreted as an ageing tube since on increasing contrast setting, the picture seems to merge or disappear into the background raster. This effect is produced because grid inputs of only quite small value drive anode current to saturation point irrespective of picture modulation.

DON'T FORGET THE VIDEO DIODE

Assuming that valve replacements all round fail to bring up sensitivity to the desired standard, remembering that the sensitivity of different models varies widely, the next step must be component checking. Some years ago the prime suspect would have been the miniature germanium diode used as the video detector, but in recent years their reliability has increased enormously. This diode, which is usually mounted inside the last vision i.f.t., can eliminate patterning, there is seldom any need to physically "get at it" for testing since in the older 405-only models and in most dual-standard receivers on 405, there is direct coupling between video detector and video amplifier grid. This enables one to measure the forward and reverse resistance existing between the video grid and chassis to show up any rectifier inefficiency. One way, depending on ohmmeter battery polarity, the meter current will pass through the grid resistor and any grid stopper or choke present (total resistance 5-6k Ω). In the reverse direction the meter current will also pass through the diode in its conductive direction to give an almost short-circuit reading. When making this test, always check that the high reading is at least 5k Ω , since a marked reduction would severely reduce gain. Any reduction in resistor value is usually caused by a prior temporary short-circuit in the video valve producing a heavy grid current to burn it up.

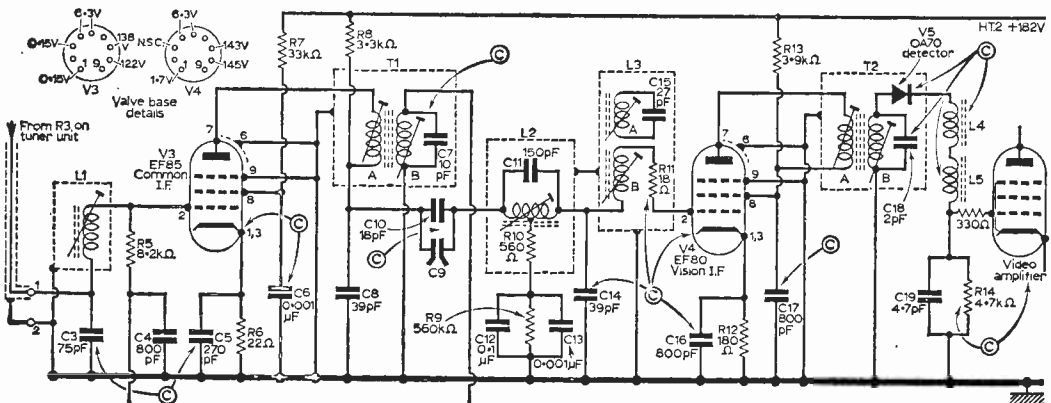

Fig. 4: Common causes of low sensitivity. To eliminate system switching, a 405-line only receiver section is shown terminating at the video amplifier grid. Symptoms A, B and C as Fig. 3.

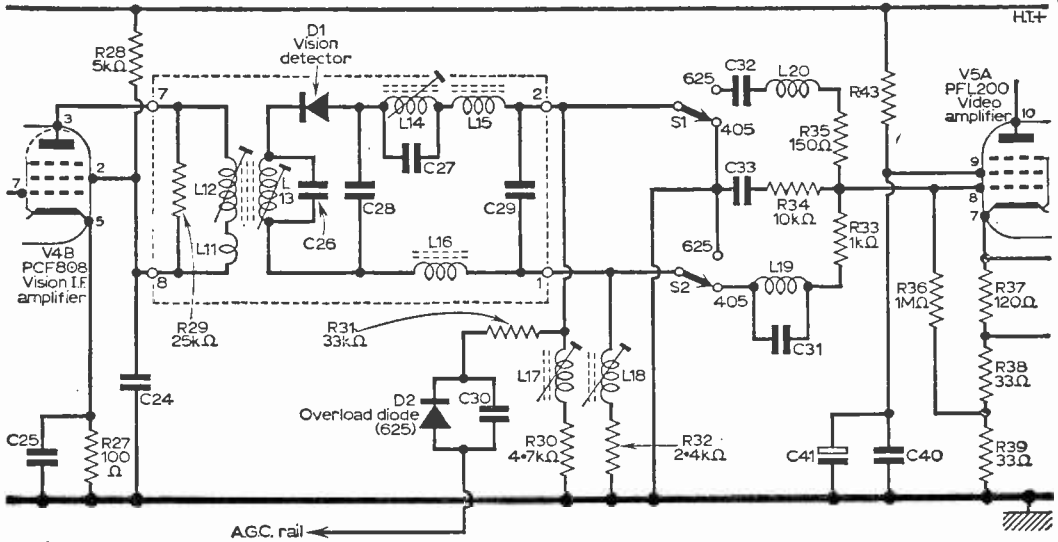

Fig. 5: It is possible to check the video diode without removing the final i.f.t. can, in which most are housed, with the aid of an ohmmeter. On this particular chassis (Thorn 900) a reading should first be taken (on 405-lines) from the grid of the video amplifier to chassis: the path being through R33, L19, L18 and R32. A total resistance of approximately 3-4kΩ will be found in one direction. Reversing the meter and ignoring the coils, the diode short circuits R32 (assuming the polarity of the meter is the right way round) to leave R33 (1kΩ) in circuit. If there is less than 5kΩ difference in the two readings, the diode should be changed.

CHECK FOR DRY JOINTS

In at least 80% of cases, checking aerial and aerial connections, tuner valves, i.f. valves and the vision detector will have eliminated the fault. The most likely cause of low gain must now be an o/c or dry jointed screen or cathode decoupling capacitor in the i.f. strip.

The best way of checking for o/c decouplers is simply to "stab" a good replacement across each suspect in turn, although often merely touching the component with a meter test-prod will indicate

inadequate decoupling by the addition of hand capacity.

Finally, the following rarer causes of low gain must never be overlooked: open-circuited aerial isolating capacitors mounted on the aerial socket panel; dry-jointed or disconnected coaxial leads from aerial panel to tuner or from tuner to i.f. strip; o/c or dry jointed i.f. fixed trimmers.

Causes of excessive gain or an inability to control contrast are intimately bound up with the sync separator and both will be dealt with together in a later article.

MULLARD COLOUR COMPONENTS

There follows a description of the remainder of the colour TV components shown by Mullard Ltd. at the RECMF Exhibition (see page 449 in the July 1967 issue of PRACTICAL TELEVISION).

A range of five valves designed expressly for colour timebases and e.h.t. circuits was featured. All have a magnoval (B9D) base which reduces the seated height and thus simplifies screening. They are: Line output pentode PL509—the highest rated single-structure line output valve yet produced. It has smooth knee characteristic and low anode-grid leakage current to eliminate spurious line displacement, and a "cavitrap" anode to prevent Barkhausen oscillation. Its peak anode rating is 1.4A coupled with a maximum anode dissipation of 30W.

Booster diode PY500 for use with PL509 has peak voltage and current ratings of 5.6kV and 800mA.

Shunt stabiliser PD500 for line output stages has design-centre ratings of 25kV anode voltage and 30W anode dissipation. (40W for short-term operation.)

E.H.T. rectifier GY501 has special components

to prevent internal flashover, and a rigid anode construction that improves reliability and life expectancy. Peak inverse voltage rating is 31kV and the maximum output current is 1.7mA.

Field deflection valve PL508 is a 12W pentode rated for operation at a continuous peak anode current of 230mA. Special constructional features reduce hum and microphony.

There was also a delay line for the decoder circuits of PAL receivers, the ultrasonic delay line type DL1 is of glass with ceramic transducers. It is simpler to use than other lines designed for this purpose as it gives the required delay of 63.943 micro-seconds at 4.433Mc/s without recourse to adjustment *in situ* by means of additional, extraneous circuitry. This pre-adjustment is achieved by means of inbuilt compensating inductors which are accurately set during manufacture. The DL1 has an insertion loss of only 10dB (into a 150Ω load) and a bandwidth of 2Mc/s.

The display is completed by a selection of scanning and convergence units together with ancillary components such as line-linearity coils, blue lateral shift units and raster correction transducers.

DX

A MONTHLY FEATURE
FOR DX ENTHUSIASTS

by Charles Rafarel

AT last we are really back in business again for Sporadic E DX, and all the frustration and waiting during the past months seem to be over. The end came on 17/5/67, which seems to have been the opening date for the 1967 season.

This first opening came quite suddenly, and it was a good one. The 18th was good as well, and hopes ran high, but the next 10 days were somewhat mediocre again, although there was at least some activity almost every day.

By the end of the month conditions really did start to improve again, and most of June has shown more than good results on a number of days. Readers reports show that the openings were widespread throughout the country, so if you have any queries on the identification of your stations in this period, please write and I will try to answer them by reference to my log.

There have been some good tropospheric openings as well, particularly on u.h.f. on 31/5/67, 2/6/67, and 12-14/6/67 inclusive as the best days, and there was some evidence of Dutch, and West German stations being received here. I am not well placed here on the south coast for their reception, so I suspect that reception further east must have been very good indeed.

Faithful as ever to French TV, and after all that is my best area, reception has been excellent at times. My "local" Caen Ch. 25 has been so good that I have had to forget DX at times and allow the two French girl students who live with us to follow the ORTF2 programmes! However, when I did get near the set. I noted that apart from the usual ones even Paris Eiffel Tower was in, plus two new ones, Rennes Ch. 45, and Reims Ch. 46. The latter was a bit of a surprise, reception very good, and at least three other DXers in this area succeeded in getting it after I "tipped them off" so south coast DXers please note!

I am only going to give the dates on which there was really good reception. As noted, there were reasonable results on other days but these were the best:

17/5/67. Austria E2a, Czech R1, USSR R1, and R2, Poland R1, Spain E2, and E4.

18/5/67. Sweden E2, Czech R1, Norway E2, E3, and E4, very good.

30/5/67. Czech R1, and R2, Yugoslavia E3, and E4, W. Germany E2, and E3.

31/5/67. Austria E2a, Spain E2, and E3.

1/6/67. Italy IA, Austria E2a, and Hungary R1 (caption seen).

2/6/67. Yugoslavia E3, and E4, W. Germany, Grönten E2, also Biedenkopf E2, Kreuzberg E3,

and Raichberg E4, Spain E2, E3, and E4, Czech R1, Austria E2a.

3/6/67. USSR R1, and R2, Poland R1, and R2.

7/6/67. Czech R1, Poland R1, and R2 (on weather maps).

9/6/67. Austria E2a, Italy IA, and IB, Swiss E2, W. Germany E2, E3 and E4.

10/6/67. USSR R1, and R2, Poland R1, and R2.

11/6/67. Spain E2, E3, and E4, very good.

15/6/67. Spain E2, E3, and E4, Portugal E2, Muro (at last!), and E3.

17/6/67. USSR R1, and R2, Czech R1, Switzerland E2, E3, and E4, Italy IA, and IB (2 stations), Yugoslavia E4, Spain E2, and E4, Poland R1, and R2, W. Germany E2 (2 stations), Austria E2a.

NEWS

We still have some mysteries and problems carried over from 1966, as shown during reception of the above:

(1) Poland and Hungary are still both using the "Retma" test card, confusion as before, the only certain proof on weak signals would seem to be written captions. Poland is the more likely one if the USSR is coming in at the same time.

(2) Yugoslavia, still using the N.T.S. type check-board patterns on E4, whilst on E3 I have seen both the Pol/Hun. Retma card and Marconi Resolution Chart No. 1 (like Televis Eirrean). This could mean two stations on E3, Kapaonik and Kum. This card has also been about on E2, and this could be another Yugoslavian station.

(3) W. Germany, Grönten E2 is using the "round" type Electronic test card, whilst Biedenkopf is using the "square" one.

(4) USA "Paging" stations. We understand from R. Bunney, and one of his USA contacts that these are used to call US business people to ask them to 'phone their offices, etc. These stations in the 30 to 40Mc/s band can indicate possible USA TV reception here if they are received.

READERS' REPORTS

B. Williamson of Shetland is back for the new season with Denmark Vestjaelland E10, Norway Bergen E9. He says that after our Aurora notes, he is watching out for this type of reception; we wish him good luck, he is certainly in a favourable northern area.

C. R. Dykes of Bexleyheath reports Spain E2, E3, and E4, and says that two stations were received on E3. If these were different programmes

DATA PANEL-23

"RIKISUTVARPIC SJONVARP" ICELAND

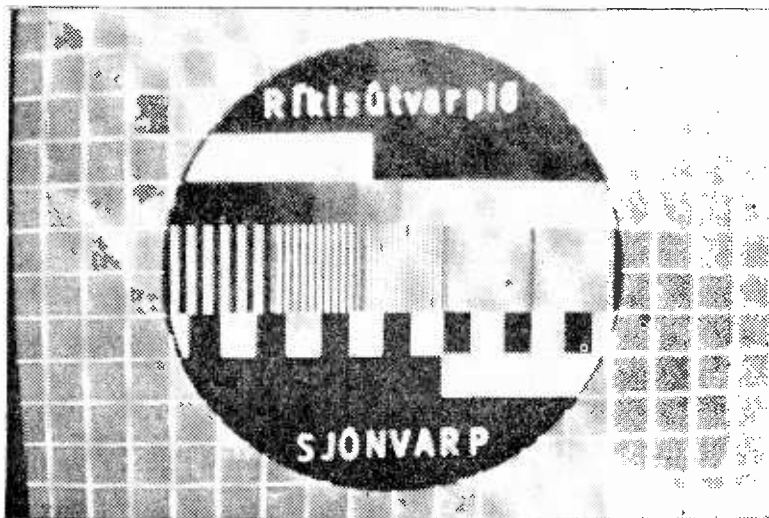

Test Card: The test card is usually that shown in the photograph above. Note, however, that a second type of test card is also in use, and this is similar to that used by BBC-2 in the early days.

Channel: Only one is in use. E10 Reykjavik (Vatnsendi). Power is 4kW, horizontal polarisation. Station opened on 30/9/66.

Reception: This station must, of course, rate as "exotic" but it is worth noting that the distance from some parts of Scotland is only the same as that from the North of England to Norway, Bergen, which has been received at times by several DXers. Reykjavik is of lower power than Bergen but the aerial direction is very different from that required for the rest of Europe, so co-channel interference should not be serious.

in Spanish then one of them must have been Canary Islands. He also had Italy IA, and Portugal E3, plus unidentified East Europeans on R1.

W. "Dusty" Miller of Catterick says that he now has over 100 stations logged, his current log includes Yugoslavia E3, and E4, Austria E2a, and (?) E4, Hungary R1, and R2, Czech R1, USSR R1, and R2.

G. J. Deaves of Hitchen (our F2 to E, Nigeria expert), has done very well lately with Czech R1, and R2, USSR R1, and R2, Hungary R1, and R2, Poland R1, and R2, Sweden E2, Yugoslavia E3, and E4, Italy IA, and IB, W. Germany E2, E3, and E4, and Austria E2a.

He has his "mysteries" too. On one occasion he says the RAI test card on IA carried the figure "2"; this does not tally with the known IA transmitters, and he queries whether this is in fact a new station. Has anyone any comments please?

He also received a check pattern consisting of five rows of small black squares six per row on a white background. This was received (wait for it!) on Ch. R4, he wonders if this could be Hungary Tokaj R4. I think so, but am making further inquiries.

PRACTICAL ELECTRONICS

TRANSISTORISED
BITE INDICATOR

A compact self-contained unit for attachment to a fishing rod. Particularly valuable for night fishing.

THE CHEMOSTAT

An electronic thermostat with remote temperature feeler for accurate thermostatic control of chemical liquids. Temperature range (17°C-40°C) suitable for colour and monochrome photo-processing.

special feature
MICROELECTRONICS

Beginning a special survey of a rapidly developing field of electronic technology. Describes various integrated circuit devices and how these may be applied to amateur use.

AUGUST ISSUE ON SALE NOW — 2/6

Making PERMANENT REPAIRS

by V.D. CAPEL

FEW things hurt a repair man more than a job that goes wrong soon after it has been repaired. If it is his own equipment that is involved it is just a nuisance and perhaps involves some loss of face with his family. If it is a job for an outsider for which a charge has been made, then in most cases a quick repair must be carried out without charge. This can involve the repairer in an actual financial loss and will have a damaging effect on his service reputation. If amateur readers have had this experience, they may take heart from the fact that it frequently happens to the professional serviceman. Often the defect for which the receiver is returned has no relationship with the previous fault.

WATCH SMALL POINTS

There are many things that can contribute to the second service, and most of them are quite simple. Small components may have been fitted without sleeving over the whole of the lead out wires, or positioned so that they short-circuit against adjacent components or tags. All soldered joints should be well made, and should be tested by moving the wire or lead to and fro to see whether the joint is in fact sound. Do not use a lot of solder as there is a danger of contact with adjacent components or metal work. Blobs of solder that have run down from a soldering tag and are touching the chassis, or are nearly touching it, are frequent causes of future trouble. Fragments of solder liberated from an unsoldering operation, or wire ends that have been cut off from replacement components should not be dropped in the chassis; if they are accidentally dropped they must be removed. Similarly if screws, nuts or washers are dropped inside the set, they must be removed.

Any fresh wiring that may have been fitted must be carefully routed. It must not be strained across tags or around sharp edges of the chassis. While the insulation on the wire may prevent any trouble at the moment, it may take only a short time for the sharp edge to penetrate and cause a short circuit. Also the effect of heat must not be overlooked, particularly with wiring near mains-droppers or other high current carrying resistors. Also make sure wiring is not routed near to sources of pulse voltage. A wire that is too near an e.h.t. over-wind on the line-output transformer, will soon produce corona discharge and probably insulation breakdown.

Most servicemen will automatically observe these details, but may slip up if there is an outside interruption. In the service department a technical query may come from the shop right in the middle of an alignment or soldering operation. When returning to the job it is very easy to miss a vital step. Soldering in particular can suffer from this type of interruption. The golden rule is never

to leave a mechanically made joint unsoldered. This applies equally to the non-professional repairer and the home constructor. Never start joining up wires to a tag unless you are going to solder them immediately.

DIRTY PINS

One common cause of repairs that come back is badly-seated valves. With so many valves on the normal TV chassis, it is easy for one that is partly out of its holder to go unnoticed. A similar fault is noisy valve holders. Deposits of oxide or dirt can give rise to noise or intermittent operation, especially if the valve moves in its holder. It is possible with this fault that the set will work correctly on the work bench but when the receiver is being transported back to the customer the vibration can cause trouble. It may not be apparent when the set is first switched on in the customer's home, but all sorts of faults can arise after the set has thoroughly warmed up. Not knowing the simple cause of the trouble the owner will feel that the repair on his set has not been properly executed.

This sort of fault is quite easy to prevent by gently rocking each valve in its holder before pushing it well home. Any noisy contacts will be shown up by a disturbance on sound, vision, or time-base operation, according to where the valve is in the circuit. Generally the pins or their contacts can be cleaned by continuing the rocking motion until the disturbance ceases. A circular motion is best as all pins are thus equally affected. One must be careful not to overdo the rocking action as pins can be bent, the glass envelope cracked, or the contacts in the holder forced open resulting in insufficient grip. Very noisy valves may not respond to the rocking treatment, and their pins should be smeared with silicone grease or other cleaning preparation and then rocked as before. In almost every case this will cure the trouble. It should be obvious that line output and boost valves cannot be rocked by hand while the set is switched on.

EXUDING ELECTROLYTICS

Component failures are not possible to anticipate, except perhaps electrolytic capacitors which begin to exude electrolyte. Capacitors in this condition may continue for some period, but in most cases this is a sign of impending failure.

When the repair has involved replacing the h.t. rectifier then the condition of the electrolytic capacitors is particularly important.

Usually the h.t. rectifier has been failing over a period of time giving less and less output. The capacitors become accustomed to this low voltage

and when a new rectifier is fitted, the electrolytics which may be reaching the end of their life, are suddenly subjected to a greatly increased potential. Generally a few hours' running is all that is needed to cause them to break down. Apart from those that are exuding electrolyte, it is not possible to tell which, if any of the capacitors are going to give trouble. The only thing to do is soak test the set after replacing the rectifier.

Usually the final test on a receiver is carried out with the back off. This enables last minute adjustment to be made if necessary. It sometimes happens though, that when the back is ultimately replaced flying leads such as those to the tube base can be disturbed. A bad contact can thus be caused which may give rise to further trouble later. The obvious answer to this one is that after the final adjustments and setting up are finished the back should then be replaced and the set switched on again to make sure that everything is still working properly.

VOLTAGE SETTINGS

It often happens that when a repairer gets a set into his workshop he finds that the mains voltage adjustment is set to a different voltage to that of the supply to his own premises. Naturally he alters it so that the repair can be carried out. It is easy to forget about this later, especially if the job has been a long one. The result is that the set is taken back to the owner adjusted to the wrong voltage. If the set is returned when there is no test card being transmitted the difference in a performance may not be noticed. The set may be over-run with the result of premature failure of a valve or a component in the near future. Alternatively it may be under-run with the height and the width of the picture just about filling the mask. Cases are not unknown where the mains-dropper has been open-circuit between the voltage tappings. The fault did not affect the lower workshop setting, but would cause an open-circuit when adjusted to the customer's supply.

The best answer to this problem is to equip the workshop with an auto-transformer. By using one of these the voltage adjustment on the receiver need not be altered at all and both the repair and final testing can be carried out at the same setting as the set will be used. Thus hidden faults in the mains-dropper or associated circuitry will not be overlooked and also there is no chance of sets going back on the wrong voltages. The home constructor will find one of these auto-transformers useful when experimenting and constructing equipment.

WATCH THE VOLTAGE

If an auto-transformer is not available, make sure that if the mains voltage tapping is altered that it is returned to the original setting. Also, a resistance test does not hurt. It may help to write the voltage on a tie-on label fitted to the mains lead. Also some test should be made after the voltage tappings have been replaced to their original settings, even if it is just a simple check

across the mains plug for continuity. Another simple thing which can be a cause of trouble is the mains plug.

CHECK THE CONTROLS

If the non-permanent repair is to be avoided, then it is important to check the action of all controls and pre-sets; some of these may be noisy, or even open-circuit in places. Satisfactory results may be obtained with them in their present position but when valves start to age and adjustments have to be made, then these faults will show up. For example it may be almost impossible to achieve good frame linearity by adjusting the linearity control. These frequently give trouble and need to be cleaned or replaced. All the pre-sets then should be checked and if any are noisy they should be treated to a dose of switch cleaner. It may be found that the hold controls are hard over to one end of their travel. This often indicates a fault in the associated circuit, most probably a series high-value resistor going high. Alternatively the generator valve itself may need replacement. If these points are neglected even though the picture may be locking at the correct speed, sooner or later the picture will go out of lock, either frame or line, and it will not be possible to bring it back in.

The channel selector control is particularly prone to trouble. In most cases this takes the form of a turret tuner and dirt or oxide forms upon the stud contacts of the coil biscuits. Cleaning off with spirit and an application of oil or switch cleaner will in most cases effect a cure. Whatever the repair, always check whether the tuner needs cleaning. This can be done by gently rocking the selector from side to side. Any disturbance on sound or vision will indicate that cleaning is needed.

TUNING

The optimum tuning point should be at about the centre position of the fine tuner. If it is too near one end then tuning drift may occur after the set has been on for some little time and it may not be possible to correct it with the fine tuner. In such cases the oscillator cores should be adjusted on both the channels to bring the tuning point to the required position.

The coaxial aerial socket must not be overlooked as the centre contacts frequently become enlarged. A failure to contact with the inner conductor of the aerial plug will not result in a loss of picture and sound as there will be some capacity coupling between the two. The actual result will be grain and noise on the picture and all the symptoms of low sensitivity. Because of this other causes may be suspected. On the final test in the workshop then, move the aerial plug from side to side in the socket and note if there is any disturbance of picture. If there is it is usually possible to squeeze together the enlarged contact in the aerial socket.

In spite of all the efforts in the workshop to check and double check, faults can still be put on by careless transportation. ■

BBC-1 and BBC WALES TELEVISION STATIONS

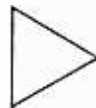

	Channel and Polarisation	Maximum Vision ERP		Channel and Polarisation	Maximum Vision ERP
1 †	Abergavenny (BBC—Wales)		60 †	Llangollen (BBC—Wales)	11H
2 †	Aldeburgh	5V	61	Llanidloes (BBC—Wales)	3H
3 †	Ambleside		62 †	Lochgilphhead	
4 †	Ammanford (BBC—Wales)		63	Londonderry	2H
5	Ashkirk	1V	64	Machynlleth (BBC—Wales)	5H
6 †	Ayr	2H	65	Maddybenny More (Portrush)	5H
7 †	Ballachulish	2V	66	Manningtree	4H
8 †	Ballater		67 †	Marlborough	
9	Ballycastle	4H	68	Mel drum	4H
10	Barnstaple	3H	69	Melvaig	4V
11 †	Bath	16H	70	Moel-y-Parc (BBC—Wales)	6V
12 †	Bedford	10H	71	Morecambe Bay	3H
13	Belmont	3V	72 †	Neath (BBC—Wales)	
14 †	Betws-y-Coed (BBC—Wales)		73	Newry	4V
15	Bexhill	3H	74	Northampton	3V
16	Blaen-Plwyf (BBC—Wales)	3H	75	North Hessary Tor	2V
17	Bodmin	5H	76	Oban	4V
18	Bressay	3V	77	Okehampton	4V
19 †	Bridlington		78	Orkney	5V
20	Brighton	2V	79	Oxford	2H
21	Brougher Mountain	5V	80	Penifiler	1H
22	Bude	4V	81	Perth	4V
23	Cambridge	2H	82	Peterborough	5H
24 †	Campbeltown		83	Pitlochry	1H
25	Canterbury	5V	84	Pontop Pike	5H
26	Cardigan (BBC—Wales)	2H	85 †	Port Ellen	
27	Carmarthen (BBC—Wales)	1V	86	Redruth	1H
28	Churchdown Hill	1H	87 †	Richmond (Yorkshire)	
29	Crystal Palace	1V	88	Rosemarkie	2H
30	Divis	1H	89	Rowridge	3V
31 †	Dolgellau (BBC—Wales)	5V	90 †	Rye	
32	Douglas	5V	91	Sandale (North)	4H
33	Dundee Law	2V		(Scotland)	6H
34	Eastbourne	5V	92	Scarborough	1H
35 †	Ffestiniog (BBC—Wales)		93 †	Scilly Isles	
36	Folkestone	4H	94 †	Seaford	
37	Forfar	5V	95	Sheffield	1H
38	Fort William	5H	96 †	Sidmouth	
39	Girvan	4V	97	Skegness	1H
40	Grantown	1H	98	Skraig	3H
41	Hastings	4H	99	Sutton Coldfield	4V
42	Haverfordwest (BBC—Wales)	4H	100 †	Swaledale	
43 †	Helensburgh		101	Swindon	3H
44	Hereford	2H	102	Swingate	2V
45	Holme Moss	2V	103	Tacolneston	3H
46	Holyhead (BBC—Wales)	4H	104	Thrumster	1V
47 †	Hungerford		105	Toward	5V
48 †	Jamestown		106	Ventnor	5H
49	Kendal	1H	107	Weardale	1H
50	Kilkeel	3H	108 †	Wensleydale	
51	Kingussie	5H	109	Wenvoe (BBC—1)	5V
52	Kinlochleven	1V		(BBC—Wales)	13V
53	Kirk O'Shotts	3V	110 †	Weymouth	
54	Larne	3H	111 †	Whitby	4V
55	Les Platons	4H	112	Winter Hill	12V
56 †	Limpley Stoke				
57	Llanddona (BBC—Wales)	1V			
58	Llandrindod Wells (BBC—Wales)	1H			
59 †	Llanelli (BBC—Wales)				

* Directional aerial.

† Station not in service at date of preparation; where channel and ERP are not shown, these are not finalised.

BBC-1 & BBC WALES TELEVISION STATIONS

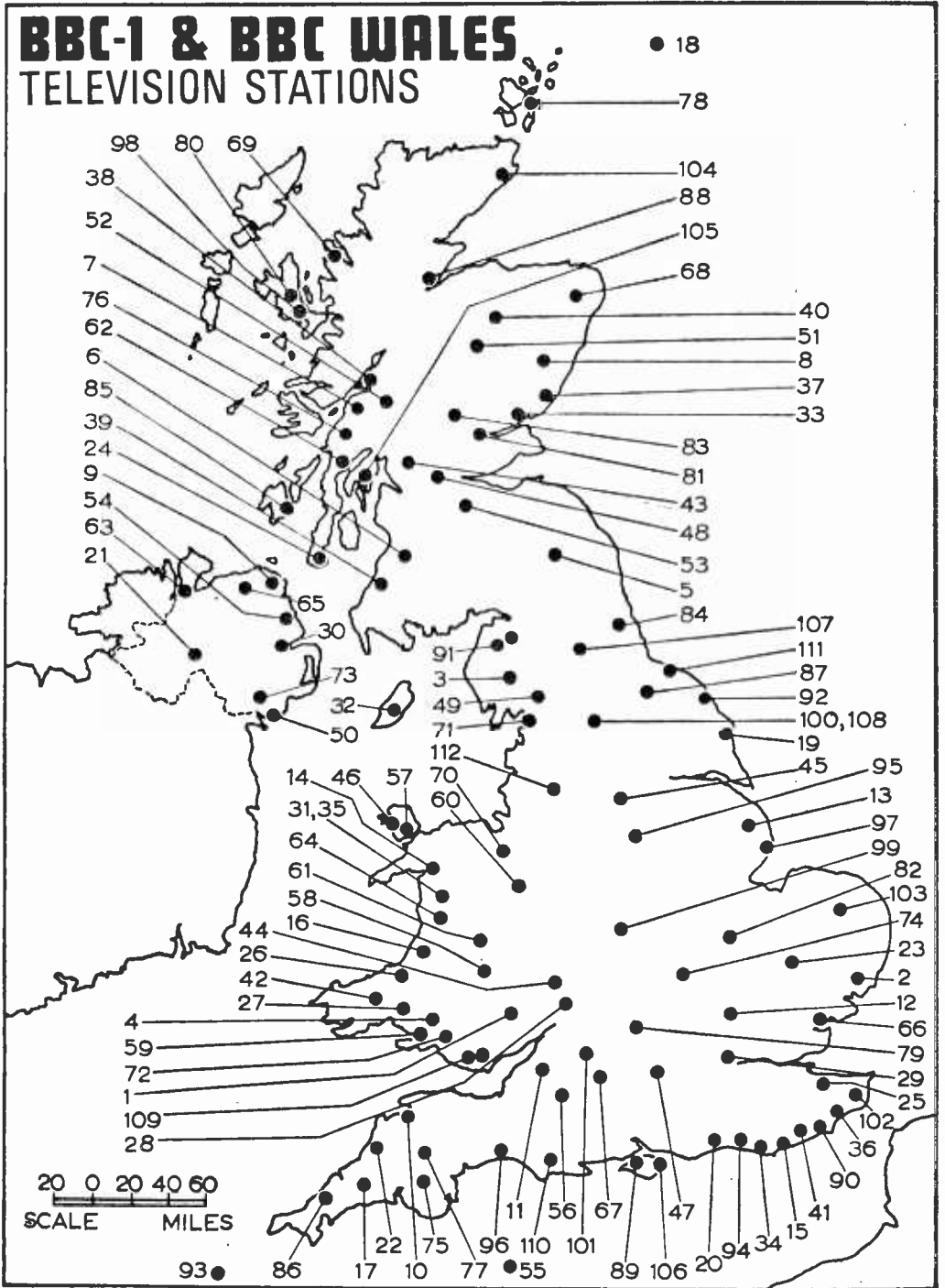



LETTERS TO THE EDITOR

SPECIAL NOTE: Will readers please note that we are unable to supply Service Sheets or Circuits of ex-Government apparatus, or of proprietary makes of commercial receivers. We regret that we are also unable to publish letters from readers seeking a source of supply of such apparatus.

The Editor does not necessarily agree with the opinions expressed by his correspondents.

ANYONE A "BACON SAVER"?

SIR,—I am in a spot over the Henlow Oscilloscope as I am unable to obtain the two issues of PRACTICAL TELEVISION which concluded this article. If any readers could lend me the August and September 1963 issues of PRACTICAL TELEVISION just 15 minutes with these copies would save my bacon.—D. J. DULBOROUGH ("Quantock", Adie Road North, Greatstone, New Romney, Kent).

PHILIPS 23TG170A

SIR,—In your advice to Messrs. Halliwell and Wallace re the Philips 23TG170A you advise them to replace the PFL200 video output, for excessive brightness on 625 only. This is not a complete cure, they will find the fault recurs fairly soon, as it is caused by a circuit fault which allows the PFL200 to run into grid current. On the left of the PFL200 they will find a 1 meg. resistor (R258), beside it a 22,000pF (C249). The resistor must be changed to 150k Ω , the cap. to 0.15 μ F. In my experience this is a complete cure. It is also advisable to change the PFL200 as it has probably been damaged if run for any length of time under the fault condition.—D. W. DUBY (Beckenham, Kent).

ANYONE WANT?

SIR,—Any reader requiring a particular copy or copies of PRACTICAL TELEVISION, January 1960—July 1967, can have them by sending postage to cover their requests. Also for disposal *Record Changer Troubles in 5 Minutes*, *Pin Point TV Troubles in 10 Minutes*. A few P.W. Blueprints covering Testmeters, Amplifiers, S.W. etc, if any reader is interested.—EDWARD LAND (11 Duntaryie Crescent, Easterhouse, Glasgow E.4).

[All readers are advised that all enquiries should be accompanied by a stamped addressed envelope. —Editor]

SOUND-ONLY TV TUNER

SIR,—Reference your reader's request "A sound only TV Tuner"—I have used one of the BBC-2 tuners "Philips type" sold at around £3 and find that very good sound can be obtained direct from this unit with no noticeable drift. All this unit requires is 175V h.t. and 24V a.c. for the heaters. The output from the tuner is ready for direct insertion into an audio amplifier provided an isolation condenser is added.

This unit comprises v.h.f. tuner, i.f. sound and vision, i.f. sound at 6Mc/s and demodulation diodes, no further items are required except a power pack. If the writer requires further information, circuit, etc., I will be pleased to help.—J. F. CANNELL (Mudeford, Hants).

625 LINES IN 405 CHANNELS

SIR,—Last month, after reading Part 1 of Mr. Hopkins's article "625 lines in 405 channels", I wrote a letter to you outlining what, from logical reasoning, the system he would propose in Part 2 would be, and what objections there were to such a system. I thought Mr. Hopkins would suggest a quadruple-interlace (i.e. 4 fields per picture) system. I had not seriously thought that he would propose a triple-interlace system (3 fields per picture) because of faults inherent in such a system that seemed too obvious to mention, but obviously my deep interest in this subject has blinded me to what is "obvious" and what is not.

The overriding fault of Mr. Hopkins's triple-interlace system of TV is that it would be subject to severe and intolerable line crawl effects, with the lines crawling down the screen about 50 lines/second. In writing his article Mr. Hopkins has assumed, in outlining the working of the eye, that the eye is capable of staring fixedly at one point for a length of time. In fact the eye moves about in small motions continuously, and so is liable to start "scanning" slowly down the TV screen, thus seeing a severe line crawl effect, with the lines spaced only one two-hundredth of the height of the screen apart. Such line crawl effects occurred in early line-sequential colour TV systems also.

Because of the severe line crawl effect, triple interlace is not suitable for ordinary TV, and quadruple interlace (with a special scanning sequence that I described in my letter last month) is necessary to avoid line crawl while increasing the number of fields per second. If a system on the lines suggested by Mr. Hopkins is to work, quadruple interlace *must* be used, but I have my doubts about whether such a system would be satisfactory from other points of view.—M. A. GERZON (Oxford).

'BEYOND THE FRINGE'

It is regretted that errors appeared in this article and the following corrections should be observed. In the components list, for C4 read 1000pF. In table 1, for C3 read Tc1 and for C4 read C3. In Fig. 4, for C6 read C5. The details for the coils refer to the inside diameter and a suitable gauge would be 18 s.w.g. The r.f. choke L2 is included when line-powering is used.

timebase traces

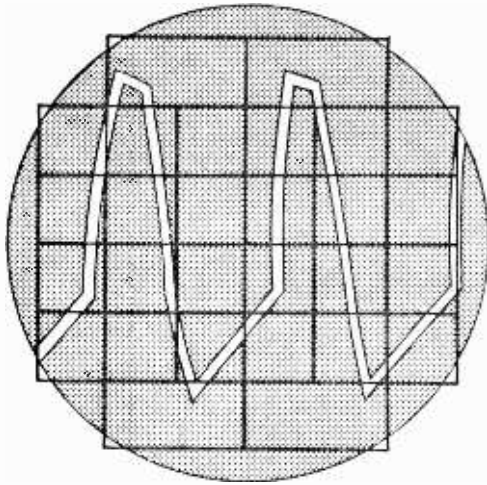

PART 2

K. ROYAL

THE resolution of a television picture is governed by the speed at which the scanning spot can change from peak white to black and from black to peak white as it traces out lines on the screen of the picture tube. For a given definition, the brightness change rate must be stepped up as the scanning velocity of the spot is increased. This means that the brightness change rate must be greater on the 625 standard than on the 405 standard to secure full advantage of the increased number of lines; that is, to get the 625 standard horizontal definition to match the improved vertical definition given by the greater number of lines.

On the 405 standard the scanning spot takes about $80\mu\text{s}$ to trace out an active line, while on the 625 standard the time is cut to about $53\mu\text{s}$. This gives some idea of the greater scanning speed of the 625 standard. The vision amplifiers and the video circuits govern the speed at which the scanning spot can change in brightness, and if these circuits are unaltered while the timebase is altered to get a greater number of lines on the 50c/s field frequency, the horizontal definition of the 625 line picture will be poorer than that of the 405 line picture. This factor is not generally fully understood. However, it does highlight the extra importance of the 625 standard video circuits.

The brightness of the scanning spot is under the complete control of the video signal applied between grid and cathode of the picture tube. The spot brightness is said to be modulated by the video signal. Now, picture tubes are designed so that very little suppression is given to the rate of video signal change. For instance, their capacitive and inductive losses between grid and cathode are very low. And since we are dealing with electronics, the change in spot brightness due to signal change is virtually instantaneous.

The same basic philosophy can be applied at the camera and transmitting end of the chain up to the full definition standards of the system, but the fly in the ointment is often at the receiver end, from the aerial to the picture tube. A signal applied at the aerial, for instance, will fail to appear instantaneously at the picture tube. There is a progressive reduction in rate of change of signal as it travels through the vision channel as a whole, and this reflects at the screen as a slowing down of the rate of change of the spot brightness, and a consequent drop in picture definition.

Indeed, it is possible for a video signal to rise and then fall over such a small period of time at the input, that it fails to register at the output at all. This "transient" signal might well represent very fine picture detail, which is thus wholly or partly lost in the vision channel before it arrives at the picture tube.

To illustrate this, Fig. 11 shows at (a) a $1\mu\text{s}$ pulse of video signal, such as produced by the 1Mc/s bars on a 405 standard Test Card. If it arrives at that form at the picture tube, then it will modulate the scanning spot and the tube will show this detail. However, if the vision circuits are slow to operate, the pulse may appear at the tube as shown in (b), with a substantial fall in definition; or it may show as in (c), giving virtually no detail on the screen at all.

RISE-TIME

How picture detail pulses appear at the picture tube, therefore, depends on the rise and fall characteristics of the vision channel as a whole, the main factor being the *rise-time* of the channel. Fig. 12 (a) shows an impossible condition where the input

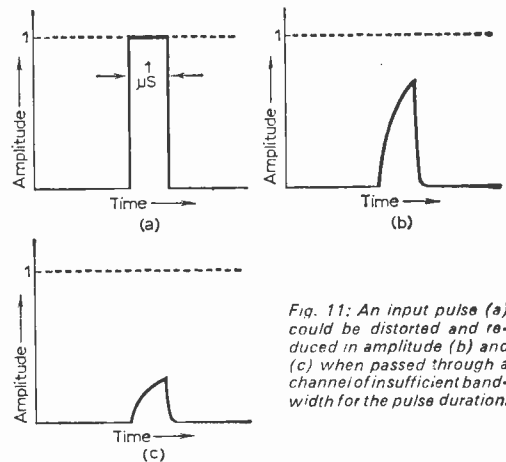

Fig. 11: An input pulse (a) could be distorted and reduced in amplitude (b) and (c) when passed through a channel of insufficient bandwidth for the pulse duration.

signal rises in zero time from level A to level B. Even in the very best systems there must be some delay from A to B. This, in fact, is the *rise-time*.

But let us assume that the input signal is created with zero rise-time so that this does not complicate the rise-time of the output signal. (b) shows how in practice the signal will build up at the output to level B during time a-b. Now, if the input signal falls, say, to level A again before time b, say, at time a+, then the maximum signal level will only be A+, as shown in Fig. 12(c). This explains why the amplitudes at (b) and (c) in Fig. 11 are below the signal amplitude at (a).

There is no need for us to get too technical over rise-times to understand this article, but it is worth remembering that the rise-time is taken as that time between 10% and 90% signal build-up at the output of an amplifier or channel.

What then, determines the rise-time in an amplifier or channel? This is a good question, but the answer is fundamentally *bandwidth*. The greater the bandwidth relative to the input signal, the smaller the rise-time, and rise-time is related to bandwidth by the following expression.

$$\text{Bandwidth (Mc/s)} = \frac{0.4}{\text{rise time } (\mu\text{S})}$$

This means that to reproduce accurately at the output of an amplifier an input transient signal with a

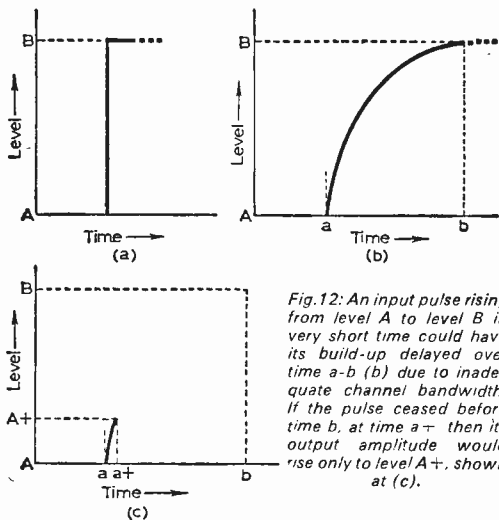

rise-time of, say, $0.25 \mu\text{S}$, the amplifier will need a bandwidth of $0.4/0.25$, or 1.6 Mc/s . Conversely, an amplifier with a bandwidth of, say 3 Mc/s would have a rise-time of $0.4/3$, or about $0.13 \mu\text{S}$. With television, however, we do not have to go to absolute extremes, for quite reasonable definition is obtained with a vision/video channel bandwidth yielding a rise-time somewhat below the theoretical absolute. We need, in fact, something approaching 3 Mc/s on the 405 standard and 5 Mc/s on the 625 standard.

If bandwidths of these orders are not available, then the set just cannot give full advantage to the rise-time characteristics of the transmitted signals. In other words, the horizontal definition is then below that which is possible in the transmitted signal.

COLOUR BANDWIDTH

In colour television the *hue* (light wavelength) of the effective scanning spot, comprising a cluster of red, green and blue light elements, also changes along with its brightness, called *luminance* in colour television parlance, and because the eye is less critical of colour detail than black-and-white or monochrome detail, the rate of hue change need not be as great as luminance change. The colour bandwidth, or *chrominance* in colour television, is thus less than the luminance bandwidth by a factor of about 5-to-1.

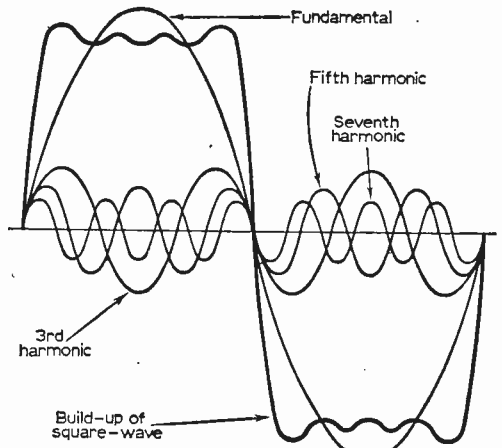

Fig. 13: Illustrating the make-up of a square-wave. Note the odd-numbered harmonic component sine-waves.

Video signal can be analysed into a series of pulse waveforms between each line sync pulse, and the shape of these can be anything between square or rectangular to triangular or transient, depending upon the nature of the picture detail. Colour encoded video signals also contain extra, lower detail pulse information dealing with the colours alone. These aspects of colour television are very interesting and it is hoped to highlight them in future articles in these pages.

We have seen, then, that if the video channel has insufficient bandwidth to cater adequately for the detail of the transmitted information the picture definition will suffer due to rounding of the leading edges of the video pulses and in some cases their attenuation. However, picture detail is not all that suffers; a restricted video bandwidth also distorts the sync pulses to some extent.

Sync pulses, of course, are more or less rectangular waves, and this shape has to be preserved through the video channel and sync separator to produce sharply-defined pulses for triggering the line and field timebases. Thus, if the bandwidth is down, the sync performance of the set, as well as the picture definition performance, will be impaired, and the line and field hold controls may be critical and difficulty may be experienced in securing a good picture lock.

Another way of looking at this sync pulse distur-

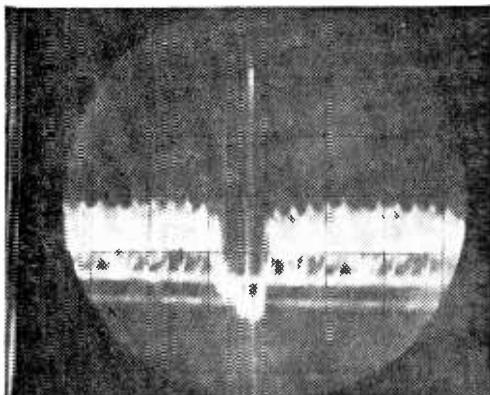

Fig. 14: Video signal display with line sync pulse in the middle of two half lines of picture signal. The pulse rising from the sync pulse is explained in the text.

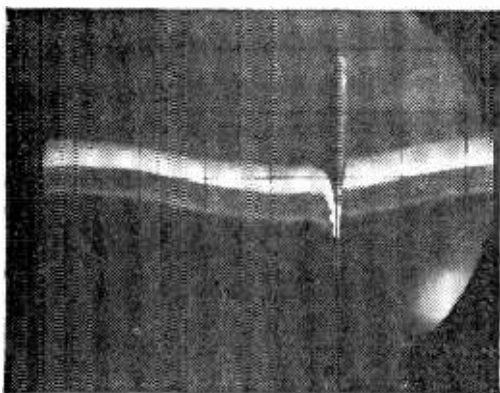

Fig. 15: The field period in a display of video signal. The pulse here is caused by the field blanking (see text)

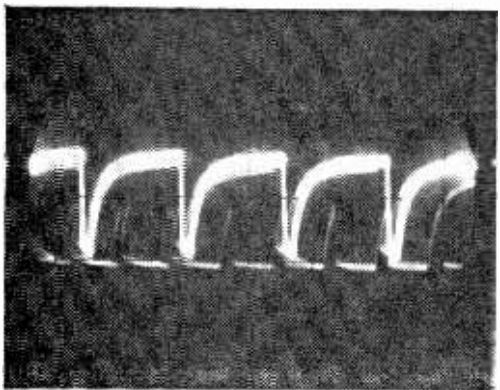

Fig. 16: Line sync pulses (negative-going) as obtained from the output of the sync separator.

tion is to consider that a square-wave has this characteristic shape because it is composed of a whole series of odd-numbered harmonics of the fundamental frequency. A fair square- or rectangular-wave is produced when the signal contains not less than the tenth odd-numbered harmonic. This corresponds to the twenty-first harmonic of the fundamental frequency, over 210 kc/s on the 405 standard 10,125c/s line sync pulses and almost 340kc/s on the 625 standard 15,625c/s pulses, and bandwidths in excess of these frequencies are required for optimum reproduction of the pulses at the output of the sync separator.

COMPOSITION OF SQUARE-WAVE

Figure 13 shows the development of a square-wave by the addition of odd-numbered harmonics, and it is important to note that the required square-wave is developed only when the harmonic components (which are sine waves, incidentally) are added to the fundamental signal in *correct amplitude and phase*. Thus, amplitude and phase distortion in the channel can distort the shape of the pulses. Sawtooth waves are created in a similar manner, but here the added sine-wave components comprise both even-numbered and odd-numbered harmonics.

Having this knowledge, we can now consider the video signal components themselves as waves or pulses containing a large number of harmonically-related sine waves.

Of course, if the channel attenuates or deletes some of the harmonic components, the original wave-shape will be distorted. The same applies, as just mentioned, if the phase of the harmonic components is altered. That is, if all the component sine-wave signals fail to arrive at the output of the amplifier or channel simultaneously. This, in fact, is just what phase distortion is—a slowing down of some component frequencies relative to others.

In colour television a delay line has to be introduced in the luminance channel (not to be confused with the PAL delay line, which we are hearing a lot about just recently) to slow down the signals in this wider frequency channel, so they arrive at the picture tube at the same time as the slower-travelling signals in the chrominance channel of a smaller bandwidth.

Thus, we can consider pulse signals in television in terms of both rise-time and harmonic component make-up. It is handy to have both of these conceptions in mind when exploring video circuits and channels.

PULSE TRANSIENTS

In passing, it is also of interest to note that sound channels in television sets are made wider in bandwidth than required for the audio sidebands alone to help with the suppression of impulsive interference. This is the kind of interference produced by motor cars, electric motors and so forth, and it superimposes spikes of transient signal on the sound modulation envelope. These transient characteristics are retained through the sound i.f. channel only if the channel is relatively wide band. If incorrect alignment reduces the bandwidth the

transient pulses are distorted and their duration is increased, and it then becomes impossible for the sound interference limiter to suppress them efficiently. The result, of course, is more interference on sound than there need be, although the quality of sound itself is not affected. Too narrow a sound bandwidth also aggravates the effects of tuner local oscillator drift on the 405 standard. Pulse duration in μS at the output of a channel is equal to the reciprocal of its bandwidth in Mc/s .

If we have an oscilloscope we can "look-in" at the demodulated video signal, at the sync pulses and at transient signals. In Part I of this series, we gave full details about connecting oscilloscopes to television sets and also information about the types of oscilloscopes most suitable for this work. It may be a good idea to refer back to last month's article before connecting a 'scope to obtain video and sync traces.

Composite video signal, that is, picture signal complete with sync pulses, can be picked up best at the cathode of the picture tube. The signal level here is pretty high so very little—if any—Y gain will be needed. It is best to take the signal to the Y terminal through unscreened cable of the shortest possible length to minimise shunt capacitance effect which would otherwise reduce the video bandwidth and distort the waveform displays. If the 'scope's timebase is set to about $30\mu\text{S/cm}$, a display of one or two complete lines of signal will result by adjusting the fine sweep control, the display often locking on the line sync pulse rather than the picture signal.

It is sometimes possible to lock the display on the screen so that the line sync pulse appears between two half lines of picture signal, as shown in Fig. 14. Note here the complex nature of the component waveforms of the picture signal. These, of course, change in character and wriggle about as the transmitted picture changes.

LINE INTERFERENCE

A very interesting feature of this particular display is the large amplitude, positive-going pulse rising from the middle of the line sync pulse. This is not normal, but was caused by a discharge within the line output transformer of the set from which the display was taken due to bad winding insulation. On the actual picture this trouble shows as vertical columns of short, irregular-length, horizontal lines, usually on the left-hand side, viewing the tube face on. The discharge pulses are radiated by the line output stage and are picked up at the front of the set, or via the aerial, as impulsive interference synchronised to the line timebase frequency. The discharge pulses thus occur at the time of the line sync pulses on the video signal, and the only cure for this trouble is line output transformer replacement, unless the discharge happens to be external to the line output transformer.

With the main sweep control altered to about $3\mu\text{S/cm}$, the fine sweep control should lock a field sync period on the 'scope. Such a display is shown in Fig. 15, with the video signal still obtained from the picture tube cathode. The bright band at the top of the waveform represents multiple lines of picture signal, while the darker band below represents the line sync pulses.

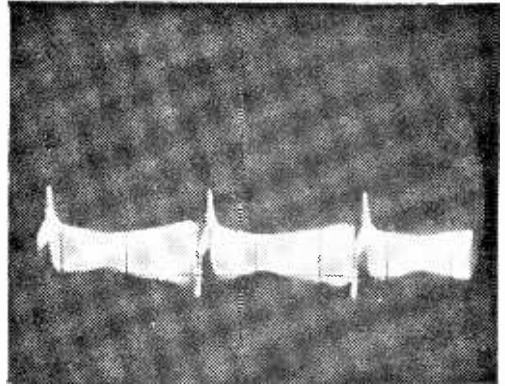

Fig. 17: Field sync pulses rising a little above the line pulses (represented by the bright band). These were obtained from the output of the sync separator.

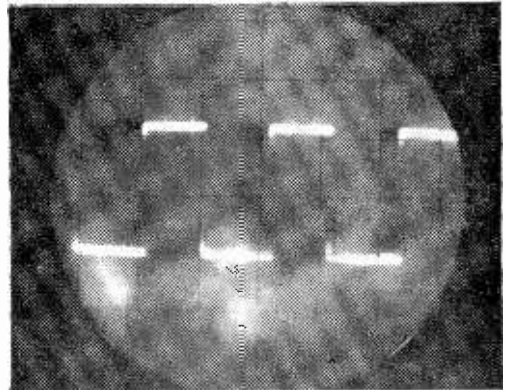

Fig. 18: Square-wave input for testing in the video amplifier.

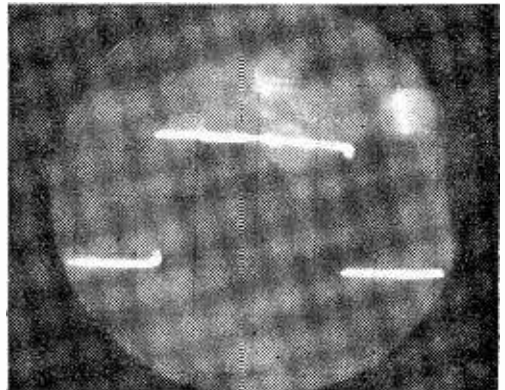

Fig. 19: The slightly declined top of this square-wave indicates a fall in l.f. response of the amplifier.

The large amplitude positive-going pulse rising from the field sync period of the waveform, represents a pulse signal from the field timebase for blanking the picture tube during the field retrace, thereby suppressing the display of flyback lines. This is reflected as negative-going at the tube grid.

Now, if we remove the Y input from the tube cathode and take it to the anode of the output of the sync separator we can get displays of the line and field sync pulses, and see how effective the sync separator stage is in removing picture signal.

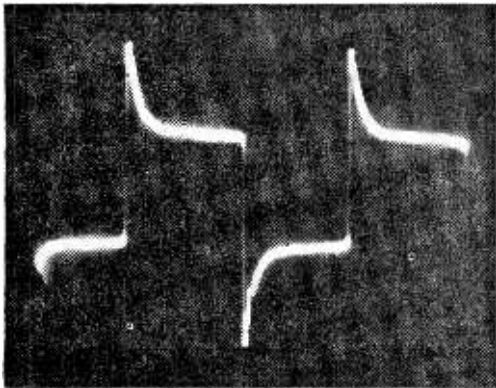

Fig. 20: Low-frequency square-wave distortion. See text.

A note of warning here, however. If the line and field timebase are running while it is attempted to obtain sync pulse displays, the timebases themselves may produce sufficient signal at the sync separator output to mask or distort the real sync pulses. Indeed, one may be looking at timebase waveforms thinking they are real sync pulses. The solution is to mute the timebases. This is best done by plugging in dummy valve bases to the line and field timebase generator valve holders in place of the valves. The heater pins should be shunted (in a.c./d.c. sets) with resistors to match the resistance of a hot valve heater so as to maintain heater line continuity. Moreover, the screen grid feed to the line output valve should also be disconnected to prevent this valve from destroying itself when there is no line drive applied to its control grid.

SYNC PULSE DISPLAYS

Figure 6 shows a series of line sync pulses taken from the anode of the sync separator. Note the almost complete absence of picture signal. A little picture signal is shown by the thick, horizontal parts of the display. Note also the rounding of the waveform from sync pulse back to signal. This is caused by a little loss in bandwidth somewhere in the channel, but the line pulses themselves (negative-going) are sharp and solid and should produce a good line lock.

Changing the 'scope's sweep to suit the field frequency, the field pulses can be defined, as shown in Fig. 17. The white bands between these pulses are the closely spaced line sync pulses, as both line

and field pulses are present at the output of the main sync separator stage. The wriggle on the waveform is due to the presence of a little mains hum.

The line pulses are fed to the line generator through a differentiating network and the field pulses to the field generator through an integrating network, and often through a diode circuit (i.e., interlace filter) as well. The differentiator gets rid of field sync pulses and the integrator of line sync pulses, while the diode circuit builds the field pulses up to a large pulse (something like those individually in Fig. 16) for a steady vertical lock, essential for accurate interlacing. These separated line and field pulses can also be viewed by careful connection of the oscilloscope, but correct display triggering is often difficult to obtain in the field integrator/diode output circuit. The process is that the series of field sync pulses transmitted at the end of each field of picture signal is caused to charge a capacitor, and when the charge build-up is sufficient the field generator is "fired". The diode shapes the build-up pulse and eliminates residual line signal.

SQUARE-WAVE TESTING

Square waves are useful for checking the performance of the video amplifier stage without having to bother about off-the-air television signals, as necessary for the displays so far outlined. The square-wave generator should deliver signals up to about 1Mc/s, if possible, and should be applied to the control grid of the sync separator. They are then displayed on the 'scope from the cathode of the picture tube, as for the video signal tests.

Figure 18 shows the nature of the signal at the amplifier input, and if this shape is retained without rounding up to about 300kc/s at the output, the video amplifier has a very good high frequency performance (in excess of 3Mc/s). Rounding of the waves will occur as the square-wave frequency is increased, the effect then being like that pictured in Fig. 16; but there should be no drastic rounding below about 200kc/s. If there is, the possibility of the video amplifier anode load resistor having increased in value should be investigated. This trouble would increase the fundamental gain of the amplifier while reducing its top-frequency bandwidth.

Reducing the generator frequency right down to about 25c/s will reveal low-frequency shortcomings in the amplifier. A sloping top to the displayed wave, as in Fig. 19, indicates falling off of the l.f. response. This is not abnormal in some receivers due to l.f. response having been purposely reduced in design to overcome aircraft flutter and other l.f. shortcomings in the video circuits.

Sometimes the display at low frequencies will appear as in Fig. 20 due to excessive h.f. response relative to the l.f. response. The display is changed from a pure square-wave because of phase changes in some of its harmonic sine-wave components. This kind of display could indicate a change in value of a resistor or capacitor in the cathode circuit of the video amplifier or in the r.c. compensation in the anode circuit or even in the coupling from the anode circuit to the cathode of the picture tube.

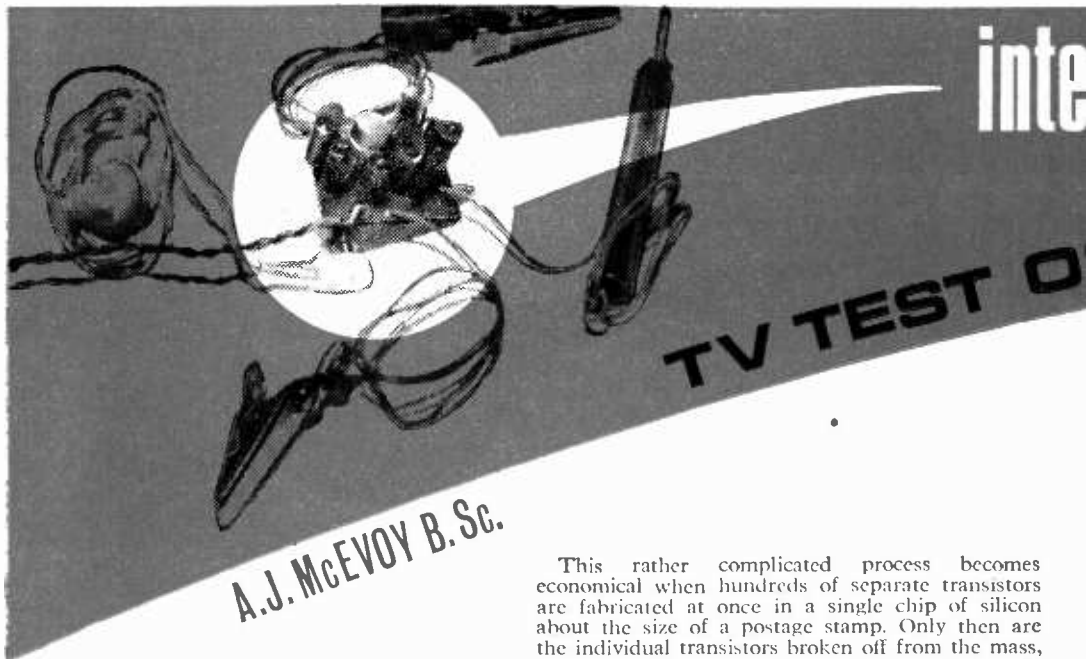

AT intervals over the past few years the "PRACTICAL" group of magazines have carried hints, both in editorials and in news features, of progress in the miniaturisation of transistor circuitry, and even the ordinary daily newspapers have, at times, published tantalising glimpses of the latest from the labs.—hand-sized television sets, or computers with 20,000 transistors in a brief case.

Until recently, the writer's personal reaction was to dismiss these reports as interesting, but of merely curiosity value to the average amateur, due to the high prices quoted for the devices shown. Such developments, however, tend to emerge from the laboratory, and enter the market place ever more rapidly, with the result that their application as a matter of course to amateur projects is no longer a distant prospect, but rather an immediate challenge.

The first point to be remembered is that the integrated circuit does not employ any new principle, as the transistor did when it appeared to supplement and replace the valve practically throughout the field of electronics. It is rather the result of increasing sophistication in the technology of fabricating silicon, so that closer manufacturing tolerances can be achieved. With more precise control over the properties of a semiconductor, it becomes feasible to mass-produce high quality transistors by the planar process, forming the layers of P and N type material by deposition of vapour of the doping elements on to the silicon base at high temperature in a vacuum, controlling the areas where the vapour may diffuse into the silicon to modify its electrical properties by resists, accurately deposited by a photographic process, just as, on a much larger scale, resists are applied in the etching of printed circuit boards.

This rather complicated process becomes economical when hundreds of separate transistors are fabricated at once in a single chip of silicon about the size of a postage stamp. Only then are the individual transistors broken off from the mass, and each mounted in its own can. Now, not only transistors can be fabricated in this fashion. A diode, which requires only one p-n junction, is even simpler to make, and of course a reverse-biased diode is the equivalent of a capacitor of up to 15pf. As for resistors, no junctions at all are needed, since the conductivity of the silicon wafer on which the device is being formed is greatly dependant on the proportion of the doping element permitted to diffuse into its crystal structure. It is obviously not a practical proposition to make separate resistors and capacitors by processes like these, but if it were a question instead of forming all the components of a sub-assembly such as a multivibrator or an amplifier stage, simultaneously within a single silicon chip, or perhaps to make them in quantities of several dozen at a time on an inch-square wafer, it might be a different matter. This step was taken by several firms in the U.S.A. several years ago, as a result of the requirement of the military and space research efforts for ever smaller and more complicated electronics. It was then found that these new devices were not only smaller, but much more reliable than conventional transistor circuits, and due to their size, could work at higher speeds in computer applications. Finally it was noted that if a particular circuit were required in sufficient quantities, it could become cheaper to produce it as an integrated circuit than to wire it up from discrete components.

Triple inverter

This is the point behind the current competition throughout the electronics industry to bring these devices into use, but at the same time it is the source of the delay in finding amateur applications. Circuits must be produced by the hundred thousand before they become economically com-

Integrated circuit OSCILLATOR

petitive in integrated form, and although there is this sort of demand for large numbers of identical circuits in the computer industry, a firm would be a long time selling the same number of, say, 2-watt audio amplifiers to amateurs. Therefore the amateur must approach the integrated circuit and be prepared to adapt himself to what is economically available.

The notes which follow outline a useful amateur application of a typical IC, the "triple inverter" type ZSS54A from the Ferranti "Micronor 11" range of logic circuits. The explanation is intended to serve as a guide to experimenter in dealing with any projects involving IC's, and not merely comment on the present simple unit.

Circuit description

The reader will recognise that the first section of the circuit is simply a multivibrator, though it incorporates four transistors rather than the two normally found in these circuits. This brings out one feature of IC work—that often there is no point in trying to economise on components: the manufacturer has incorporated three two transistor

amplifiers in the unit, so two transistors must be accepted in each arm of the multivibrator. The operation of the circuit is unchanged, however, since Tr2 and Tr4 give phase reversals to the signals passing through them (hence the manufacturer's term of "triple inverter" for the IC), just as the single transistor in common emitter mode in each arm of a normal multivibrator, does. The first four transistors therefore produce the familiar multivibrator square wave, and with the quality silicon transistors of the IC, and the fast rise and fall of the wave due to the gain of the paired inverters, the fundamental frequency will have harmonics up at least to the television i.f. frequency. It can therefore be used as a signal injector throughout the circuitry of a television set in the same way as a simple multivibrator is used by many amateurs as a radio and amplifier checker. There will be no difficulty about the sound channel of the TV under test, as the signal from the oscillator can be heard through the loudspeaker as the user proceeds stage-by-stage through the set. The situation differs for the video circuits, though. A pattern should emerge on the screen when the square wave is fed into an early stage in the video amplifier chain, but due to tube faults or insufficient gain this may not always be visible.

This then is the application of the third inverter in the IC—to detect and amplify the signal from the multivibrator so that, after it has passed through the video amplifier, it may be heard in the magnetic earphone of the tester.

The video amplifier may then be checked as rapidly and easily as the audio circuits, simply by clipping the detector connection into the video output of the television, and injecting the oscillations at the grid of each valve in the video chain until one fails to respond, or more likely, responds at a low level. Then the circuit of only this valve needs to be examined in detail to find the fault.

There is one point in the inverter circuit which requires some thought and attention, and that is

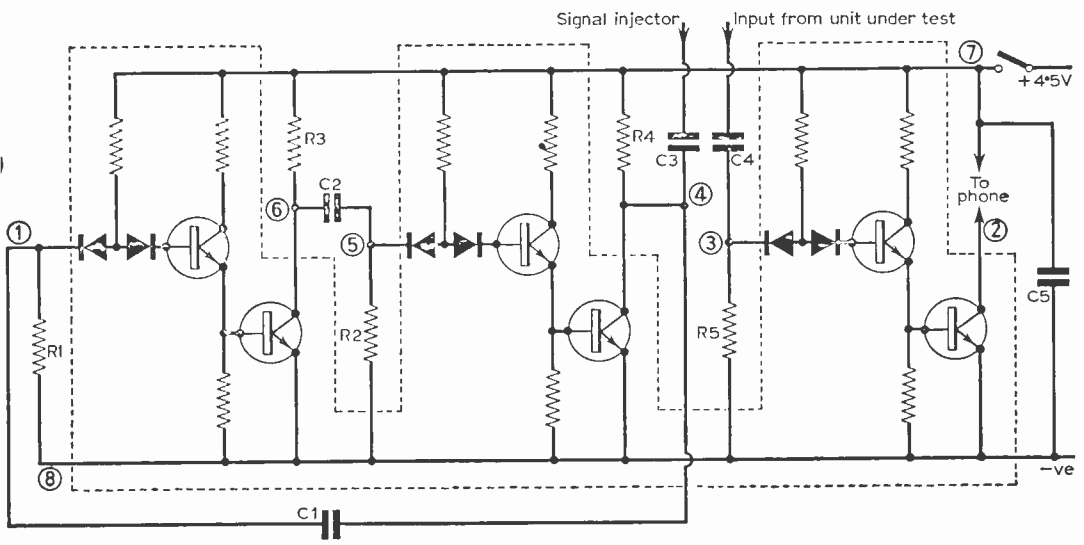

Fig. 1: Complete circuit of the integrated circuit TV test oscillator.

the pair of diodes in the input circuit. (Fig. 2). These bring out the fact that a manufacturer may have to incorporate into an IC a component or feature which the constructor will find a hinder-

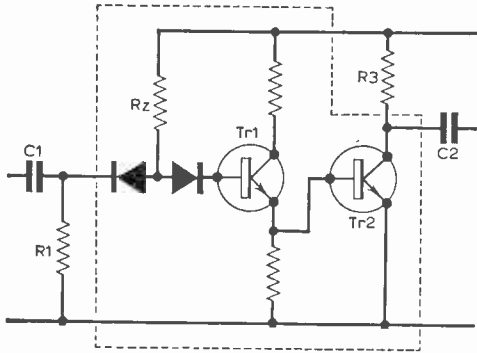
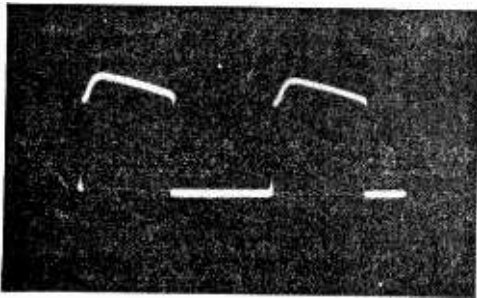

Fig. 2: Circuit of the first two stages of the IC—note that D1 is on the left—D2 to the right.

ance, and he may have to take steps to frustrate or avoid a function introduced by the circuit designer. These diodes perform a useful function in the logic circuits for which this unit was designed, but for our purposes we may at times require a linear performance from the ZSS54A, so that all clipping or limiting action, at least on small signals, will be avoided. D2 presents little difficulty;



Photograph shows oscilloscope trace of output waveform from the IC.

in the logic application it prevents any damage to the IC if the input should be driven too far negative. In our circuit it will always be forward biased, and present a low resistance as it conducts, carrying the base current of Tr1. The diode D1 is slightly more difficult. As it stands it will act as a clipper on any signals reaching it. It must instead be biased to conduct, so that small signals will cause merely a fluctuation in a standing current, and the diode will have no more effect on the signal than a small resistor. (If the diode were to be reverse biased it would act as a very small capacitor, and the input signal would suffer extreme attenuation). This result can be achieved by a resistor (R1) from the diode to the negative line. However, it must also be remembered that the current in R1 also flows in RZ, inside the IC, and therefore controls the base cur-

rent to Tr1, and through it the operating conditions of the whole circuit.

In the computer the manufacturer intends the transistor Tr2 to rest in one of two states—saturated or cut off. In a linear amplifier, on the other hand, the transistor must sit at a point mid-way between these limits. The value of R1 was chosen to achieve these conditions.

Construction

Assembly of the unit is simplicity itself. The prototype was made up on a printed circuit board only 1 x 1.3in., and that without using sub-miniature components or overcrowding. There is no need to repeat the familiar procedure of painting a resist pattern corresponding to the figure on the copper-paxolin laminate, etching in FeCl₃ solution, cleaning, and mounting the components. In any event the layout is not critical, and the circuit may even be built on a tagboard. If this sort of short-cut is tried, however, care must be taken with the eight leads on the IC—it is much easier to have an accidental short circuit or breakage than with a transistor with a mere three leads! The constructor can also decide for himself the type of container to use for the tester; round most houses a small box to take the circuit board and battery can usually be found. Notes that a 4.5 volt battery is recommended; the manufacturer quotes 6 volts as the maximum tolerable with this IC.

The use in TV servicing has been clearly indicated already, but no doubt the ingenuity of constructors will find other applications, such as the world's smallest Morse practice outfit. Incidentally,

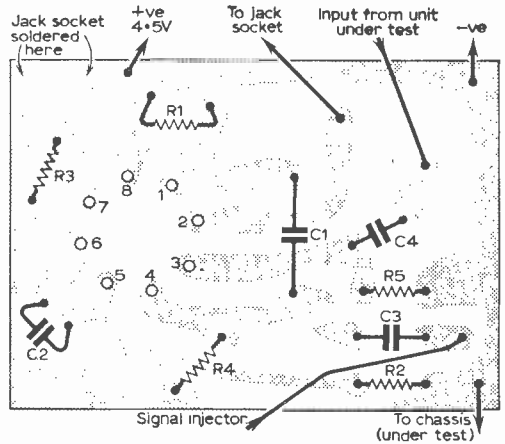

Fig. 3: Layout details of the complete test oscillator.

due to the proximity of the oscillator and amplifier components—not just in the same can, but actually part of the same silicon crystal—one would expect some breakthrough, so that the oscillator

—continued on page 508

LEARNING THE TRADE

by S. GEORGE

WITH the increasing complexity of modern radio and television receivers, a sound knowledge of basic theory and logical fault finding techniques is essential for the Service Engineer. To this end, it is becoming increasingly the custom for employers to give junior staff and entrants to the trade time off for specialised instruction at a recognised Technical College once or twice a week, where the very necessary theoretical knowledge and service expertise can be learned to augment the mainly practical experience gained during working hours.

Alternatively such servicing staff and apprentices can take Evening Classes instead, and which cover the same syllabus as that for day-release students. The complete course for both, from intake to sitting for the RTEB final certificate in Radio and Television Servicing, usually takes about 5 years. Most Technical Colleges in the larger towns offer such complete part-time Radio, Television or Electronic Servicing courses, and we felt that a visit to one of these establishments might well prove of interest to PRACTICAL TELEVISION readers who always evince great interest in the servicing aspect of the subject.

One of the newest and best equipped is the Riversdale Technical College at Liverpool, where a modern 4-storey building houses a comprehensive Radio Department catering for students wishing to obtain the PMG Certificate in Marine Radiotelegraphy and Radiotelephony, the B of T Radar Maintenance Certificate or C and G Certificates in Telecommunications as well as the RTEB Servicing Certificates. Additionally, for Service Engineers who have the final Servicing Certificate, there is a course of 30 Lectures on Colour Television on either one afternoon or one evening per week during the session.

While appreciating that the entire building with its content of Marine Transmitters, Receivers, Direction-Finders, Radar Equipment, Pulse Generators and Electronic apparatus would prove to be a fascinating venue to everyone with the slightest inclination in that direction, during this short article we must confine ourselves to the first floor which houses the servicing laboratories and instruction rooms.

Mr. A. G. Brown Grad.I.E.E. A.M.Inst.E. is head of the Radio Department and kindly conducted the writer around the Radio and Television Servicing section, explaining most fully the operation of the courses. Typically, day-release students, who must be actively engaged in the radio or electrical field and exceeding 16 years of age, attend for one full working day per week, and after 3 years' tuition can sit for the RTEB intermediate certificate. Students who attend for evening instruction, do so for a total of 6½ hours spread over 3 evenings per week, and

similar to the day-release students, may sit for the intermediate certificate after 3 years' attendance. After 2 years' further study, students who successfully passed the intermediate Radio and Television Servicing examination or have the Final Radio Servicing Certificate issued under the earlier scheme prior to 1960 may then sit for the final examination.

E. A. W. Spreadbury M.I.E.R.E., Chairman of the Society of Electronic and Radio Technicians (SERT) pointed out in an earlier article in this journal (Mar. 66), possession of the final certificate then permits the Service Engineer to join the above society and establish professional recognition.

At this College, all students provide small hand tools, testing leads and connecting links, but electric soldering iron, stand and multi-range meter are provided for each student at his own laboratory position, each of which is provided with a.c. mains outlet, TV aerial socket, f.m. aerial socket and speaker connections. Equipment is both up-to-date and generous, so that in each laboratory there are Signal Generators, Valve Voltmeters, Tape Recorders, Oscilloscopes of various patterns, including outsize types for class demonstration purposes, plus the usual assortment of ammeters, voltmeters and circuit constructional items associated with well fitted radio and electrical laboratories. Possibly in no field of instruction has the use of modern demonstration aids been so obvious as in basic electronics, and at this particular College there were comprehensive sets of Unilab and Lan-elec "boxed" circuits and circuit panels plus two "Philco Trainers".

Instructional Aids

For those unaccustomed to these comparatively recently introduced instructional aids, let me commence with the "Philco Trainers" since these were probably the most widely used in the servicing class-rooms. Basically they comprise a large metal rack into which standard circuit panels may be fitted—each performing a different function. A theoretical drawing of the circuit is boldly printed on each with the actual components mounted close to each, so that automatically the student associates the schematic with the actual. Furthermore, each resistor or capacity is mounted on a small plug-in fitting so that the effect of their removal or replacement by different valves can be noted by change in circuit function and voltages.

There are Power Supply Panels, A.F. Amplifier Panels, Power Output Stages, I.F. Amplifiers, Frequency Changers, A.M. Detectors, F.M. Detectors and indeed every stage necessary to the making up of a complete a.m. or f.m. receiver or

transmitter. Naturally, as Mr. Brown pointed out, it was both easy and often advantageous to plug in defective or wrongly coded components wherever required to simulate fault conditions. Lan-ec panels were somewhat similar but on a much smaller physical scale and mainly intended to enable students, particularly full-time telecommunication students, to make up "bench top" constructional projects.

Unilab items were neat black bakelite cases which could contain anything from individual components or valves to complete circuits and with a schematic diagram boldly etched in white on top. For instance, one small Unilab case contained only a pentode valve internally connected to small sockets aligned on the respective electrodes of the pentode symbol etched on the case top. Thus the student could apply the appropriate voltages and inputs to the respective electrodes and note the effect of varying their values on exterior meters. In this way the pentode symbol was graphically associated with the actual valve. Other Unilab items seen were various types of oscillator, a.f. amplifier, half-wave rectifier and transistor circuits—again all with the appropriate circuit etched on top and with sockets permitting electrical access to all points in the unit. However, as so much ground must be covered during the 5-years' tuition, both the Day-release and Evening Courses are dominantly practical as the following syllabus for the 7-hour Day Course shows.

First Year	Elec. and Radio Principles.	2 hrs.
	Calculations and Practice.	2 hrs.
	Practical Work.	3 hrs.
Second Year	Radio and TV Principles.	3 hrs.
	Calculations and Circuits.	1 hr.
	Practical Work.	3 hrs.
Third, Fourth and Fifth Years.	Radio and TV Principles.	3 hrs.
	Circuits.	1 hr.
	Practical Servicing.	3 hrs.

The emphasis on practical servicing work is continued throughout the course and ordinary domestic receivers were well in evidence for students to work on. However, as it is or should be the aim of every student to sit for the RTEB examinations, and as the practical part of these tests require the entrant not only to diagnose and rectify faults but also show on paper the steps leading up to the ultimate diagnosis, this type of systematic thinking is constantly encouraged. Haphazard valve changing and spontaneous check replacements, though sometimes "making the set go", are no substitute for sound basic theory and logical servicing action.

There is a marked shortage of Television Service Engineers at the present time and when Colour gets firmly established, the shortage of competent Technicians will be all the more apparent. At this particular College, there are between 2 and 3 hundred part-time Radio and Television Servicing students, and undoubtedly there is no better way of learning this highly technical vocation than by attending such course complementary with practical service in a commercial company.

TV TEST OSCILLATOR

—continued from page 506

would be continuously audible; it is a tribute to the skill of the manufacturer in forming an insulation round each inverter that only the faintest sound is audible, and even this may be due to stray capacitance in the rest of the unit rather than an intrinsic break through inside the IC. If a low-capacity battery is used, there may be some signal carried into the amplifier along the positive line, and C5, a large capacity decoupling capacitor, may be helpful in limiting this. Finally, it was found convenient to use the earphone socket as the on/off switch: it was modified as shown in Fig. 4, so that the plug closed the contacts and so

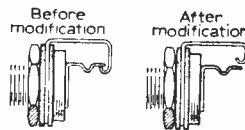

Fig. 4: Jack socket modifications—note that the insertion of the earpiece plug will cause the modified contact to touch the fixed contact, and so complete the d.c. supply to the oscillator.

COMPONENTS LIST

Resistors:

R1	2.2k Ω	R4	1k Ω
R2	2.2k Ω	R5	2.2k Ω
R3	1k Ω		

All 10% miniature $\frac{1}{4}$ W.

Capacitors:

C1	0.1 μ F	C4	0.02 μ F
C2	0.1 μ F	C5	250 μ F 6V
C3	0.02 μ F		electrolytic

All miniature ceramics or polyester, unless otherwise stated.

Miscellaneous:

Ferranti integrated circuit type ZSS54A (Micron 11 "triple inverter"). — Ferranti Ltd., Gem Hill Chadderton, Oldham, Lancs.
150 Ω magnetic earpiece, with socket.

switched on the unit, rather than opening the circuit, as happens in the ordinary phone circuit of a transistor radio. The signal to the magnetic earpiece, which forms the load of the transistor appearing at pin 2 of the IC, will come from what is normally the earth side of the jack socket, that is through the barrel of the plug; here the tip is the earth return. The writer's apologies are extended to all amateurs who hereby lose the excuse that their testgear is too large to bring anywhere!

URGENTLY REQUIRED

Clean copies of the October 1965 issue of Practical Television.

Please write to the editor.

Servicing TELEVISION Receivers

No. 137 - PYE V210 series

by L. Lawry-Johns

ALL the following receivers used a similar chassis with minor divergencies. Pye 210, 210LB and 220, 410 and 430. Pam 800, 802, 804, 808 and 821. Invicta 538, 539, 939 and 146. The 17in. models used an AW43-88 c.r.t. and the 21in. an AW53-88. To avoid too many "ifs and buts", these notes will deal with the V210, 220 and 410 in particular.

General servicing

Removal of V410 chassis. Unplug loudspeaker leads. Take off the two wing nuts and washers from chassis to tube fixing plate and release plate from the two securing screws attached to top of tube strap support. Remove rear chassis fixing screw. Unplug deflection coils leads, e.h.t. clip from side of tube and the tube base connector. Withdraw chassis.

Remove both screws securing side panel in position and ease panel from inside outward and

upward at the same time turning panel to the right. Remove bottom first through cut out in side of cabinet.

V220

Pull off front knobs, lay receiver face down. Unplug l.s. leads, tube base socket, the four deflection coils leads, the two screws securing control panel to cabinet and the ten screws securing chassis to cabinet. Unclip e.h.t. lead and withdraw.

There is an extension plate on the chassis which takes the aerial bracket when it has to be removed from its original position for servicing in the hinged position.

V210

Using a long screwdriver, unscrew the two top tube fixing screws. Remove the hexagon screws from the rear of the chassis and withdraw com-

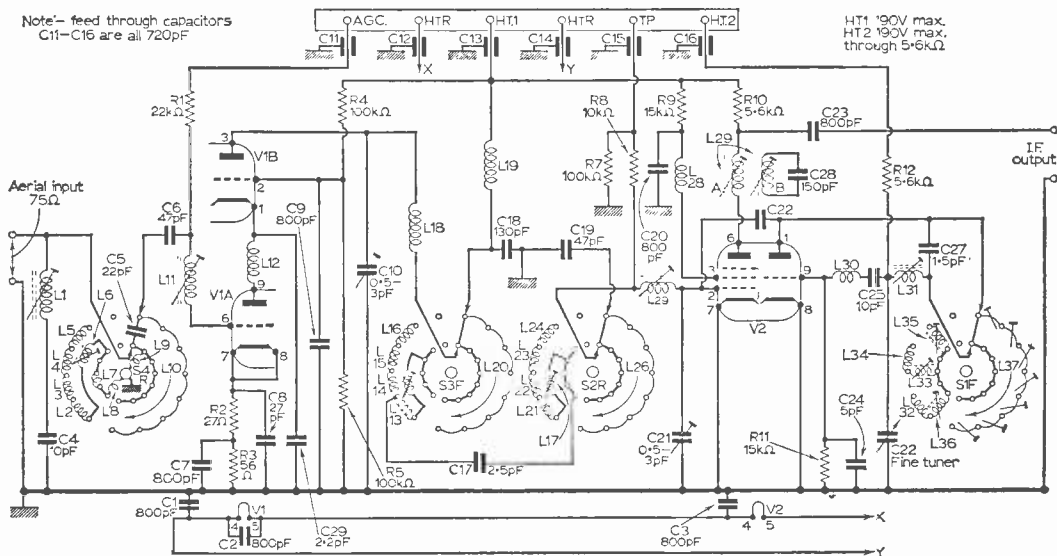

Fig. 1: The tuner section of the receiver.

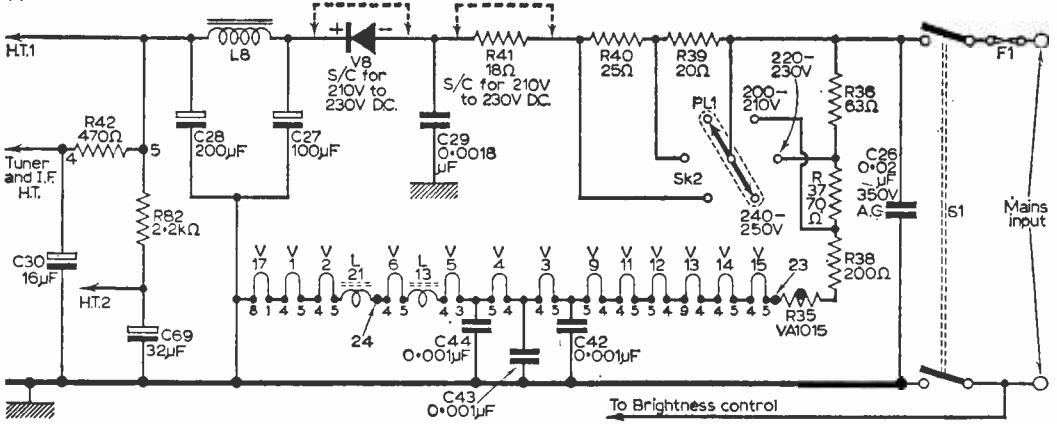
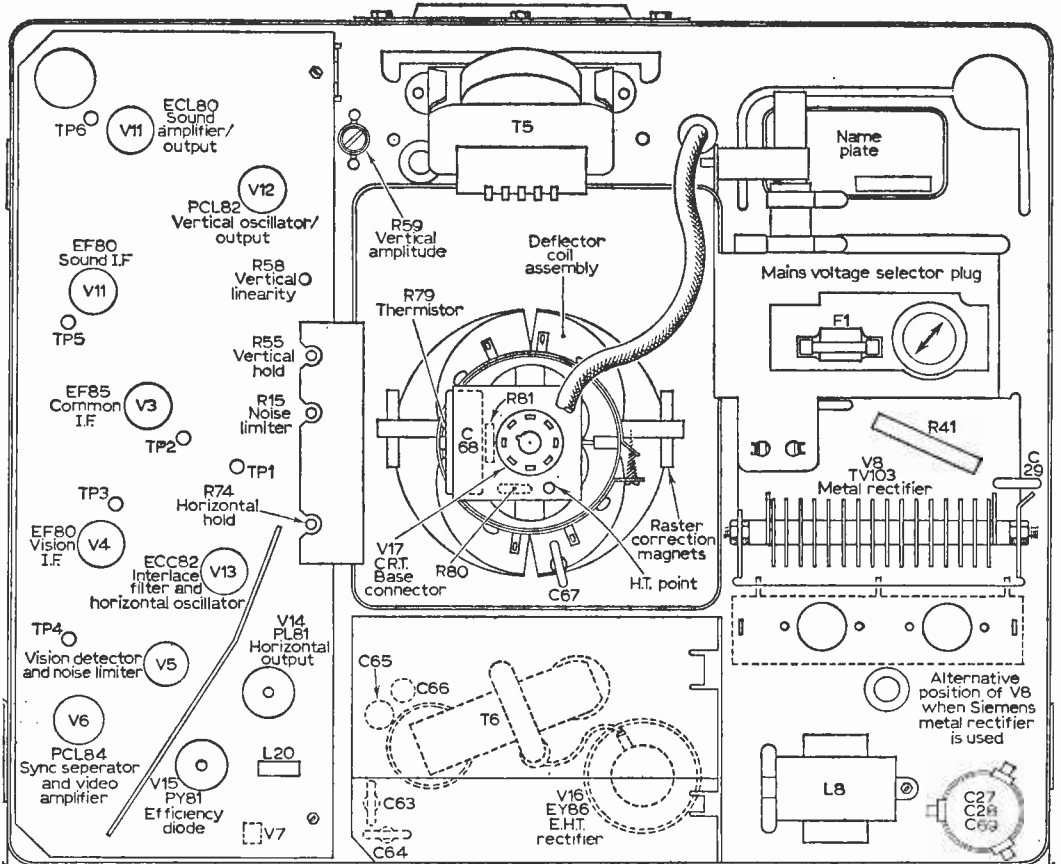

Fig. 2 (above): The power supply and heater chain.

Fig. 3 (below): Chassis rear view of receiver showing the location of the main components.



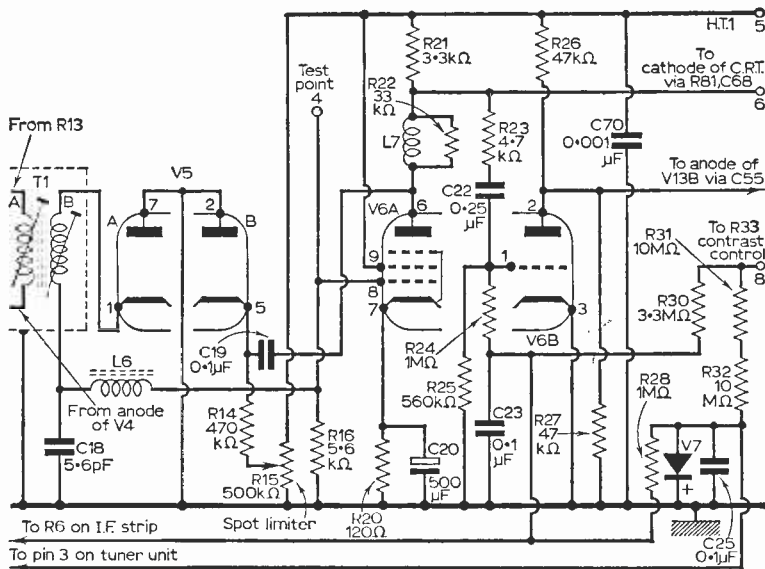

Fig. 4: The video circuitry.

not so. Also it's not much good looking for a bias resistor or electrolytic capacitor in the cathode circuit because there isn't one. Nearly always the fault is due to C47 or C48 (perhaps both) becoming leaky. Both have a value of 0.1μF. It is also worth while checking the grid resistor(s). The timebase circuit shows two resistors R60 and R61 both having a value of 10MΩ. These may not be found as all later models used a single resistor of 2.2MΩ connected from the grid pin 3 back to triode grid pin 1 instead of to chassis. The purpose of this was to avoid intermittent loss of field scan which occurred under some transient conditions.

plete panel. The control panel is held by two 4BA nuts at the front and one (or a wing nut) at the rear centre.

Common faults

These receivers are prone to produce one or two faults almost without fail. Poor or no BBC reception is one. Bottom compression is another. To this may be added reduced width and total inoperation.

Poor Band 1 reception

If the ITV is coming in well and the aerial is in order it can be assumed that the fault is in the tuner. Remove the screw and panel support bracket and take off the tuner cover. Look inside the rear of the tuner as one of the coils may have dropped off completely. If not, examine the rear wafer where one coil is probably away at one end.

Very light probing of the coils will probably reveal which is not soldered and also where it wants to go. If there is any doubt try it to each position with the set on. Properly tin the end and solder into position with a small iron. Finally dress the coils so that they will not foul against anything when the assembly is completely rotated. If reception is still not up to standard check or recheck the PCC84.

Bottom compression

While a gap at the bottom with the lower part of the picture compressed could well indicate a low emission PCL82, more often than not this is

Lack of width

While a replacement PL81 may produce a temporary or even complete cure, it is essential to check the 2.2kΩ 1 watt screen feed resistor R75. A replacement should be rated at 2 watt or more for reliable service. Also check the h.t. voltage which if low could cause lack of width due to a failing metal rectifier. This however is not often the case in these receivers.

No results at all

When the set appears to be completely dead with no heaters operating, first check the fuse. This is on the upper right hand side. Mains should reach this point. If it doesn't, check mains supply, lead, etc.

Assuming mains is present at the fuse but not at any point on the dropper (vertical wire wound behind fuse) check the on/off switch and wiring. If the on/off is not at fault, mains should be present at R36 and R39. Check through these sections—R36, R37 and R38 to find which is open circuit. It is very common for one of these sections to become so defective.

The thermistor VA1015 leads directly from the dropper and itself could be at fault, which would generally be obvious just by looking at it.

Assuming however in the unlikely event of mains being present at all these points, it can be assumed that a valve is at fault with an o.c. heater (or even the tube—check across pins 1 and 8 and breathe a sigh of relief).

to be continued

WHEN is sport news? Or when is sport just sport? So far as television is concerned, sporting events have always been an attractive part of the programmes; especially those on the BBC channels. Sheer professionalism in this field has been built up over many years, even before ITA existed.

Properly handled, TV can give more of a topical news flavour to sporting items. This applies to historical and ceremonial events, too, for which the BBC are well ahead, largely thanks to the influence of the late Richard Dimbleby. But for sport, there is now beginning to be competition in a field which is newsworthy as well as "sporting" I refer especially, to the epic arrival of Gipsy Moth IV at Plymouth and the return of Sir Francis Chichester from his solo trip around the world. Competitive television came into its own on that historic night which resulted in the excellent versions both organisations put out.

The scenes at Plymouth were superb, and this must be the TV sporting news actuality of the year. What a tragedy that ITN had earlier lost one of their technicians, who had died after a lifeboat had answered their distress signals. Newsreel, TV cameramen and journalists are constantly risking their lives to bring the news, in peace and war.

Combined operation

The Price of a Record was a telling documentary on Donald Campbell's fighting attempts to raise the world's water speed record, and his final fatal attempt on the waters of Lake Coniston. Four ITV regional companies, Grampian, Border, Ulster and Westward had planned to film Campbell's bids in Eastman Colour for world-wide distribution. The whole project was set up as a co-production. Transmitted within such a few days of one another, these two TV features helped to underline the enormous courage and the single-mindedness of Chichester and Campbell—two men determined to keep Britain great.

From a production point of view, let us recall that the Chichester coverage was live television, whilst the Campbell documentary was filmed and edited. What was surprising was the similarity in the finished

UNDER NEATH



THE DIPOLE

article—TV expertise at its best. The refreshing thing, is that via such consortiums as Four Companies Productions, the smallest ITV companies have a contribution that is as valuable as that of the big brothers with their vast resources of technicians and equipment.

War correspondents

The Middle East War started and ended before I reached this far in this month's notes. Details of how the coverage was achieved by BBC, ITN and the American companies will follow next month.

There is nothing very funny for journalists and cameramen sent out to cover war operations and to obtain material under fire. BBC, ITN and the cinema newsreels obtained large footages of the fighting in Sinai, much of it being obtained with hand-held 16mm cameras with the cameramen tied to an armoured vehicle or a jeep travelling at high

speeds. The "combat" cameras of today are small instruments usually with a zoom lens and held in the operator's hands. The most-used camera for this purpose is the Arnold and Richter "Arriflex", the mechanism of which will stand up to a lot of knocking about without requiring frequent skilled servicing.

In the Second World War, 35mm film cameras were used, the "combat" types being mainly clockwork-driven Newman-Sinclair with the British and Commonwealth cameramen; and Bell and Howell 35mm cameras with the Americans. The Germans used 35mm Arriflex cameras, which became a highly-prized capture by British cameramen. I used German Contax (Still) cameras—but on reconnaissance in a British Wellington!

In the First World War, from 1914 to 1918, the few motion picture cameras under fire were all large hand-turning instruments, British photographers using the large, cumbersome (but rugged) Moy camera, mounted on a heavy tripod. I am told that it was not easy for the cameraman to crank the camera handle steadily under fire, yet some of them with iron nerves did just this! They also fitted armour plating on the camera fronts as additional protection for the camera—and for themselves.

Uproarious relics

The consistent viewer tends to have an almost blasé attitude to the mass of drama poured out on television today—on all three channels. One might say the same for the light entertainment programmes, but they are certainly going through the doldrums at the moment.

In fact, more often than not, it is something like a re-showing of the vintage comedy, *Hells-a-poppin* that is the brightest laugh on the cathode ray tube! I have seen that film at least four times—but find it funnier each time I see it. Perhaps this old cinema film can be shown regularly on the closed-circuit screens of A-TV — ABC — Granada — YTN — LTC — and Uncle Redifusion and all for the education of their comedy directors.

When, recently, in New York I noticed that there was rarely a day (or night's) television programme on one or other of the New York stations which didn't

show a Laurel and Hardy comedy. There — the Buster Keatons, the Chaplins and the Harold Lloyds are continuously popular. What about the old *Carry On* series, made in England and still going strongly, even in USA?

"The Fellows" and others

The Fellows is ahead of the proverbial boat, whilst *Those Two Fellers* misses it—at least it did even when Frankie Howerd was there. Perhaps Dimmock and Oldenshaw are to be the Oxbridge answer to Steptoe and Son. Theirs is a comedy thriller with a brain, and the off-beat manner in which a case is solved (or is it?) is as credible as those of Gideon etc. seem incredible. The Hills and Green show is static by contrast.

Other boat missers have been the Hugh Lloyd missers show *Hughie* and the Leslie Crowther vehicle, which is so wrong for him. Crowther is a raconteur and a marvellous "ad libber". *Likely Lads* having a re-run is well worth it—amazing how similar all these series are named—James Bolam and Rodney Bewes are perfect as the "likely lads".

Drama has had its ups and downs too — Charles Wood's *Drums along the Avon* was sub-titled "a fable", and it could indeed exercise one's imagination if one cared. Leonard Rossiter played Mr. Marcus who stained his face brown, wore a turban and sold ties from a suitcase as his contribution to racial integration—whilst much of the rest of the play appeared to be concocted from the loose ends of film and tape from the cutting room floors of several styles of pictures. At least one of the critics on *Late Night Line Up* dubbed it simply as "rubbish"!

An adaption of the socialist tract — like *Ragged Trousered Philanthropists* was also the reason for another *Late Night Line Up* of Left Wingers. Perhaps BBC-2 should rename that programme *Left Wing Line Up*. The decrying of the British heritage will continue unchallenged, that is the parrot cry of the Leftist tub thumpers. Viewers can draw their own conclusions as to how much of this "anti-everything" talk would have been



A Westward Television film unit shooting the arrival of Sir Francis Chichester at Plymouth.

transmitted by Moscow or Peking! Iconos would welcome Liberals, and Sch—you know who—Tories on "LNLU"—they can talk too!

BBC makes Yorkshire region bid

"They don't want me at t'mill anymore . . ." with such fruity dialogue redolent of regional qualities, and with the homely title of *Champion House*, the BBC must be bidding for that Yorkshire regional station on offer from Lord Hill! This new series is melodrama in the robust style of Arnold Bennett at his best—with overtones of Edward Knobloch perhaps? Needless to say, Edward Chapman is in it, and very good he is too, but some of his confrères have still to play themselves in. The BBC series and serials are certainly making use of the regions of the United Kingdom; astute use is made of the locations so no wonder we must conjecture with Gerald Cock, the first Director of Television, who in a moving interview with Tony Billbow spoke of that first O.B.—12th May 1937, Coronation Day. I can recall that transmission so well, and viewing it at the local radio retailer in Richmond together with my seven-year-old son and about twenty others cramped in a small back room. The BBC must repeat this Gerald Cock vintage interview at a peak

viewing time—his comments on today's TV were pungent and individual, and above all, self-effacing. At 82 he returned to give us a shot in the arm — or was it a kick in the well-pressed pants?

Expo '67

Taken for granted now are the "Early Bird" hook-ups — "live from . . ." The relay of British Day from Montreal's Expo '67 a high spot in the recent 24 Hours programme. The anchor-men are well established and any snags are soon glossed over — they are a special breed of their own, the Robin Days, Cliff Michelmores, Kenneth Allsops, Iconos awards them all ties with the emblem of an anchor entwined with co-axial lines!

I wonder what the position will be when NTSC system via "Early Bird" via PAL system via co-axial links and repeaters via SECAM ends up in Moscow on yet another system? Who will pay the patent royalties and who will get them? RCA? Telefunken? Hazeltine? EMI? Marconi? Edison? Brunel? Scott-Taggart? Only one thing is certain. It won't be Iconos. There will be little left when the lawyers have taken their rightful slice!

Iconos

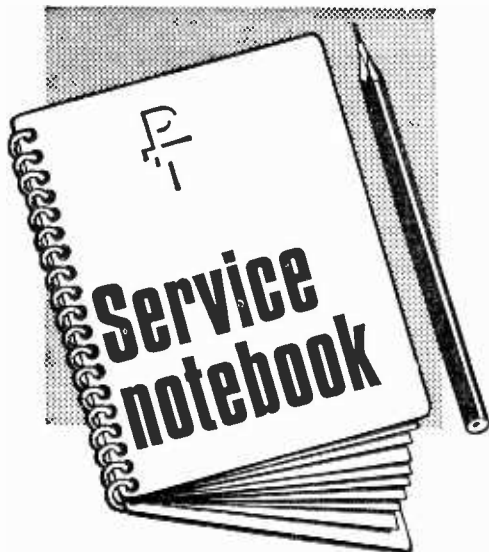

by G. R. WILDING

IT is now becoming general practice to use a silicon rectifier in place of the breakdown resistor to limit valve heater current to the correct value, with the advantages of reducing both power consumption and heat dissipation. However, should a s/c develop in the rectifier, and the fuse fail to "blow", the whole heater chain would be grossly over-run and apart from a general increase in brightness and sensitivity, the set owner could be unaware of a major fault being present and continue to use the receiver. Although such rectifier failures are rare, it is of course wise to show such a fault condition, and to this end, in the latest series of Bush/Murphy receivers, this defect would "show up" as uncontrollable frame slip.

The way in which this effect is brought about, so that the owner is compelled to get service attention, is most ingenious and centres on the sync separator valve. A quite conventional PFL200 is used, but its screen h.t. supply is obtained from a tapping on the heater chain, smoothed and filtered by a 22k Ω resistor and an 8 μ F capacitor. While the rectifier functions normally, the screen supply is uni-directional, but should it go s/c the heater chain current will be pure a.c. so that the sync separator screen voltage will also be a.c. and thus cause constant field slip (Fig. 1).

Old hands will recall that some years ago when tubes frequently developed heater/cathode "leaks", in some Plessey chassis where the tube heater was transformer fed, such a tube failure would only result in a loss of h.f. definition with some "pulling on whites". To ensure that any c.r.t. heater/cathode leak would produce symptoms demanding immediate attention, a large capacitor was connected from the tube heater to chassis. Thus the c.r.t. heater was "earth" to video signals so that the slightest leak was immediately noticed as an almost complete loss of vision. Apart from these inbuilt "automatic fault indicators", there are many natural fault indicators if you care to think about them.

Introducing a new feature for the service technician and amateur. "Service Notebook" will comprise short individual items on various subjects relating to repair work. The frequency with which it appears, and the space taken, will depend on the response from readers. May we hear your comments or suggestions please?

For instance, a visibly glowing pentode screen is a sure sign that the anode is minus h.t., for when this occurs, screen current increases enormously. With line output pentodes, absence of anode voltage is generally due to a defective boost rectifier. A visibly glowing anode and screen in a line output pentode indicates lack of grid drive, since these valves are only biased by input application.

Lack of sound and vision but with ignition interference present can safely be assumed to be failure of the mixer valve to oscillate, since ignition interference covers such a wide frequency band that it does not need conversion to the intermediate frequency to pass through the receiver.

Sparking and brushing at the c.r.t. aquadag earthing clips is a sure sign that the e.h.t. is wholly or partly a.c. in content, due of course to a failure of the e.h.t. rectifier. There are many more, some widely known, some not, but as opportunity arises, we shall endeavour to cover them all.

Mains tappings

Undoubtedly, the easiest way of getting the last ounce from an ageing tube or indeed an ageing receiver, is to lower the mains tapping adjustment. However, it is nothing less than folly to do so with anything resembling a modern receiver, for while this simple action certainly "boosts" the tube, it also "boosts" every valve, and when the tube is subsequently changed and the mains tapping returned to its correct position, it will be necessary to change many valves if performance is to be up to standard. With a decent set, it is far better as a short term measure, to just boost

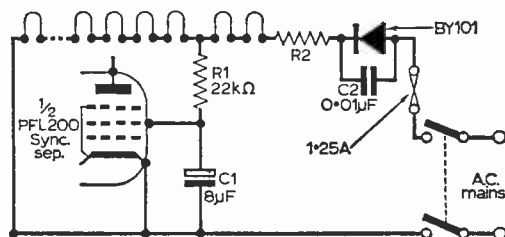

Fig. 1: Should a s/c develop in the heater circuit supply rectifier, although the set would still operate, the c.r.t. and valve heaters would be grossly over-run. To prevent its use in this condition the sync separator screen is fed from a tapping on the uni-directional heater supply and smoothed by R1/C1. If the rectifier develops a s/c, the heater supply current would then be pure a.c. to cause incurable field slip and necessitate service attention.

the tube only by connecting a 5 or 10k Ω high wattage resistor from the "live" a.c. mains input to the unearthed pin of the c.r.t. heater, when, as is usual, the c.r.t. is last in the heater chain. The low price and high quality of reconditioned tubes makes it uneconomic to go to the trouble and expense of fitting "boost transformers", which have only a limited value anyway, but I can visualise their return in a few years time when colour tubes start losing emission! However, we seem to be getting far too many receivers in the Service Department with good tubes, that are working on the wrong tapping.

The reasons may prove to be insufficient width, not apparently curable by other means, low gain, or because it was necessary to lower the tapping to accommodate the reduced mains voltage last winter,—or the winter before.

Whenever possible, within economic limits, we try to get the set back on the right tapping, for apart from over-running the valves and c.r.t., it can lead to poor sync locking, performance deterioration after an hour or so of use and excessive drift in the tuner due to valve and component thermal changes.

Screen blanking

In many Pye/Ekco dual standard models there is an s.p.d.t. section on the 405/625 switch that at first glance seems to serve no useful purpose, inasmuch as it switches h.t. to the same points on both systems (Fig. 2). However, its primary function is a very important one, for it prevents surges developing in the output stage during system change

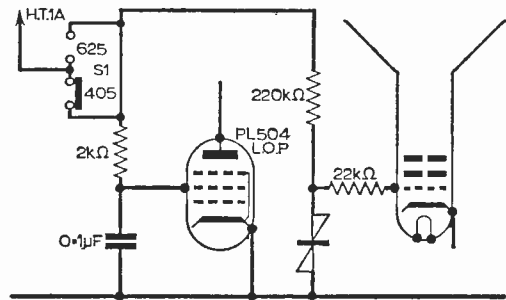

Fig. 2: Switch S1 which at first sight appears to fulfil no useful purpose since it supplies h.t. to the same point in both positions, prevents surges during system change by momentarily removing l.o.p.t. screen voltage during its operation, and blanks out the c.r.t. (Pye/Ekco).

by momentarily removing the l.o.p. screen supply during switch operation. Secondly, as this action prevents line scan, the switch simultaneously blacks out the screen by removing the c.r.t. grid voltage.

Intermittent vision

We had an Ekco 23in. dual-standard model in for service recently which was stated to give normal vision for only 20 minutes after switch-on. After that, although sound continued, the picture disappeared.

Our first move was to let down the bottom hinged chassis, switch on and await results. It

worked perfectly for a couple of hours. However, on screwing the chassis back to its vertical position, vision cut out within minutes and a 4.7k Ω resistor mounted above the PCL84 video amplifier started to "cook". Inspection showed that the cooking resistor was the anode load of the video amplifier and that it was overheating purely because the valve was passing excessive current.

Further tests then showed a complete absence of cathode bias to this valve due to a s/c between the valve holder cathode connection and chassis. The only capacitor that could possibly cause this s/c was an 820 pF ceramic shunting the 220 Ω cathode resistor, and as it had a working voltage of 400V. while the valves cathode potential was about 7V, it was difficult to envisage it breaking down, still more difficult to understand the thermal delay. Anyway, to be quite sure, we unsoldered one lead of this capacitor and tested the set again. Results were again normal for about 20 minutes.

After considerable further testing we ultimately found that the cause of the trouble was a solder "blob" on the cathode circuit printed wiring was just clearing an earthed point, and when the chassis warmed up in its normal vertical position, thermal expansion enabled the "blob" to short the valves cathode resistor. This kind of fault, so simply caused, can take more time to rectify than many seemingly major defects.

Clearing H.T. shorts

What's your way of clearing h.t. shorts? Much depends on the severity of the short, but if a cooking resistor fails to give a clue, almost certainly the best first move is to put an ohm-meter across h.t. rail and chassis and then withdraw and replace each valve in turn, commencing first with those of the PCL83, PL81, PY81 and video amplifier types. In many instances this procedure will show up a valve with an internal s/c, but if the fault persists and the Service Manual is to hand, it always pays to measure the ohmmage of the "short" and then see if any decoupling capacitor is fed from the h.t. rail by a resistor or inductor of that value. However, if the "short" is really very low, suggesting a pinched lead entering a can, a shorting "blob" on a PC panel, or a defective main electrolytic, with a wired circuit, snip off, don't unsolder each h.t. feed till you find the culprit.

On the other hand, with a printed circuit panel, where several h.t. feed strips or leads run from a central point,—cut across each feed in turn till the culprit is identified. Having identified and cleared up the s/c, it is then only a moments work to put a solder blob across each knife cut on the PC panel. H.t. short circuits in new or nearly new printed circuit receivers are almost always due to shorting solder "blobs" and it often pays to brush the panel with a clean, fairly stiff brush to dislodge any possible sources of this trouble.

Following these simple rules will be found to save much time and trouble. If you are ever faced with a heavy drain on a receivers h.t. supply and yet there appears to be no short circuit in the receiver when measured with an ohm-meter "cold"—never overlook the possibility of wrongly fitted or transposed valves.

—to be continued

THE ROYAL TELEVISION SOCIETY

by John D. Benson

ON September 7th, 1927, at a meeting of the British Association in Leeds, several television pioneers, including John Logie Baird, decided to form a Society for the furtherance of study and research in television and allied subjects. Since those early days the Society has progressed to a membership of over 1,500, most of whom are engaged in the television and radio industry.

The original prospectus laid down under Objects "to afford a common meeting ground for professional and other workers interested in current research relating to television and allied subjects". Thus was the Television Society born and the amateur welcomed to its folds.

John Logie Baird was the first Honorary Fellow. The first President was Lord Haldane of Cloan. In fact among the members of the first council were the names of scientists and engineers who have since become nationally and internationally recognised for their work in the wide field of television engineering.

The Television Society was the first of its kind in the world, antedating the start of the first public television service by some nine years, and today most countries are represented within its membership. Last year came recognition of its past services and status—royal patronage—and by

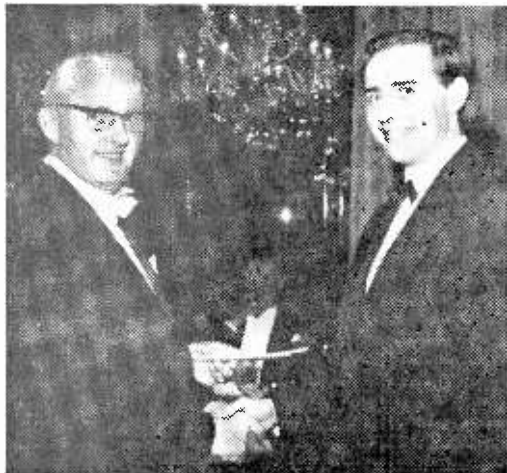

Mr. J. D. Penney, B.Sc. (right), receives the 1966 John Logie Baird Travelling Scholarship.



The Geoffrey Parr award, presented annually to either an individual or a team in recognition of a notable contribution to television engineering or an associated science.

command of Her Majesty the Queen, the Society became The Royal Television Society.

The Society accepts membership from all branches of the profession—engineering, education, programme production, servicing or retailing. Grades of membership are Fellow and Member, Associate Member, Associate and Student. The grade of Associate is open to all interested in television from a non-professional standpoint. Although the Society is not an examining or qualifying body, its certificate of Corporate Membership is only awarded to those who give evidence of their training and proficiency in television engineering or production.

During the session from September to March, fortnightly meetings are arranged at which original or review papers are read and demonstrations given of new equipment. Many of these lectures are given by established engineers and other notables in the television world and cover a wide range of subjects—engineering, production, studio techniques, lighting, administration, etc. Each lecture is followed by ample question time, which gives everyone an opportunity to voice opinions and seek information. One of the most valuable assets of these meetings is the chance to meet and talk to fellow enthusiasts, both amateur and professional.

In 1949, the Author suggested to the Council that a Centre should be established outside the London area to cater for engineers and experimenters who found it both costly and time-consuming to attend London lectures. Now there are seven established provincial centres. Many of the London lectures are repeated in the provinces but, more important from the experimenter's point of view, local problems can be discussed on the spot.

Colour television is, naturally, a much discussed subject and it is in this field that the Royal Television Society can offer the experimenter access to information through lectures and demonstrations that is not readily available unless one is

prepared to attend courses at the various technical institutions.

An excellently produced Journal is published quarterly in which outstanding lectures are reproduced and reports of new developments and equipment given. The Journal is circulated free to members and is available to non-members at a subscription of 30s. 0d. per annum. A monthly bulletin is also distributed to all members.

The Society's library and reading room is open to members during normal office hours and provincial members are invited to make use of the head-quarter's facilities when visiting London.

Bearing in mind that "All work and no play . . ." etc., the Society has introduced several social events which again provide opportunities for amateur and professional to meet and exchange views. The Annual Dinner is an increasingly popular occasion at which a number of well known television personalities are invited to meet members and their guests. This is held at the Dorchester Hotel in the Spring.

It is at the Annual Dinner that the Society's Silver Medals for Artistic Achievement in Television are presented. There are two awards—one for work *behind* the camera and one for work *in front* of the camera. Other awards made by the Society each year include the John Logie Baird Travelling Scholarship (financed by Baird Television Ltd.). The Geoffrey Parr award (to an individual or a team in recognition of a notable contribution to television engineering or an associated science), The Wireless World Premium, and the Mullard Premium.

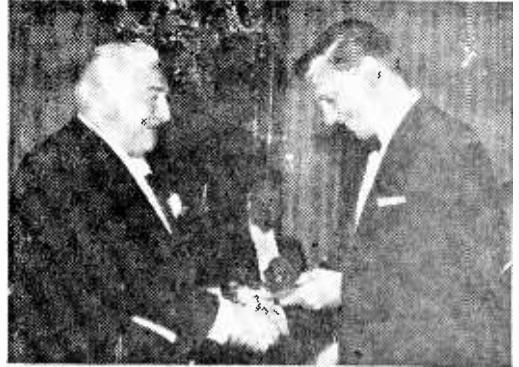

Mr. David Attenborough (right) receiving the Society's Silver Medal for work behind the camera.

All these awards are, of course, highly prized but the Baird Travelling Scholarship is, perhaps, one of the most imaginative. Valued up to £200, this is open to post-grade students (in UK educational establishments) who are concerned with television engineering or an allied technology. It is intended to assist the successful applicant in undertaking a period of investigation abroad of approximately 6 to 8 weeks.

Particulars of membership may be obtained from The Secretary, The Royal Television Society, 166 Shaftesbury Avenue, London, W.C.2 (Telephone 01-836 3330).

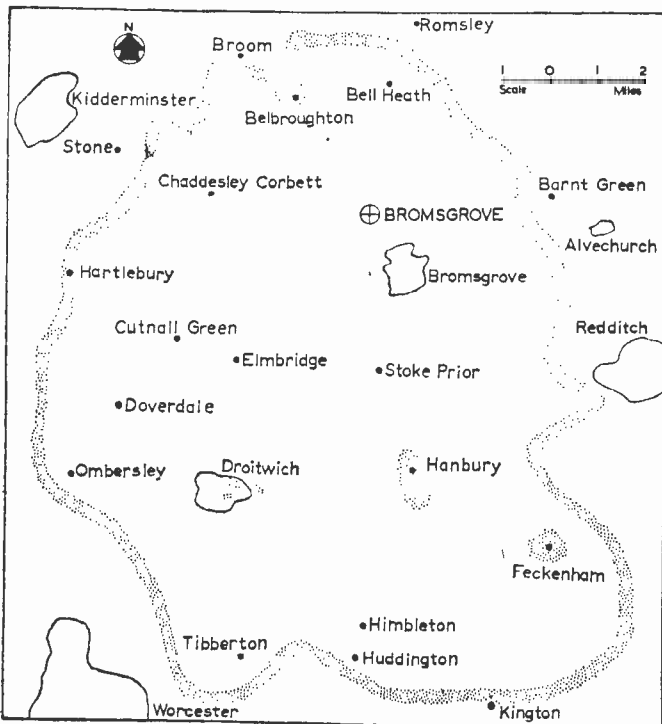

BROMSGROVE BBC-2 TELEVISION SERVICE

Transmissions are vertically polarised on Channel 27. Vision frequency is 519.25Mc/s and sound 525.25Mc/s. Maximum vision, e.r.p. is 4kW (directional aerial).

The limit of the service area is roughly indicated by the dotted band on the map; this must not be interpreted as a rigid boundary and reception may be possible at many places outside it. Also, because the quality of reception on u.h.f. can vary at places only short distances apart, there are, inevitably, small pockets of poor reception within the service area which cannot be shown.

TRADE NEWS • TRADE NEWS NEWS • TRADE NEWS

U.S. SWEEP GENERATOR NOW BRITISH MADE

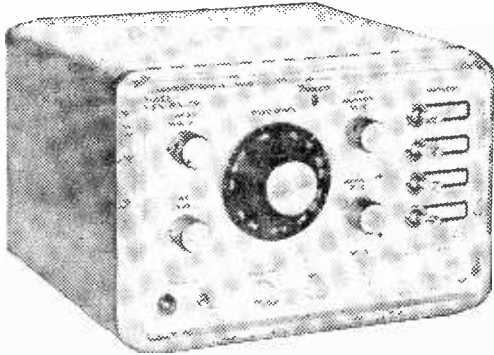

THE compact model CS 76 u.h.f. Sweep Generator developed by Texscan, leading American specialists, is now being manufactured in the U.K.—enabling Livingston Laboratories Limited to offer quick delivery without any duty restrictions.

The CS 76 has a centre frequency variable from 460Mc/s to 920Mc/s and will sweep anywhere within that range, making it ideal for production line testing of u.h.f. TV tuners and other similar u.h.f. applications.

Further details may be obtained from Instrument Division, Livingston Laboratories Limited, Livingston House, Greycaine Road, North Watford, Herts.

WORKSHOP FIRST-AID KIT

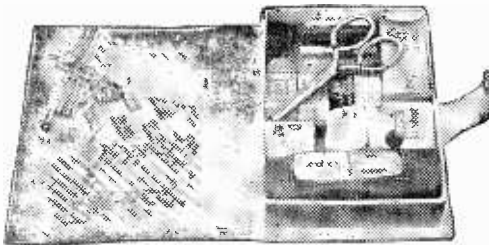

EVER burned yourself on the soldering iron or jabbed the screwdriver into your hand? Even if you are lucky and have not, it doesn't hurt to have a first-aid kit in the workshop or shack.

Illustrated above is a compact kit measuring $6\frac{1}{2} \times 4\frac{1}{2} \times 1\frac{1}{2}$ in. It contains $\frac{1}{2}$ oz. cotton wool, burn dressings, lint dressings adhesive plaster, bandages, antiseptic cream, Elastoplast and a pair of scissors.

It's a good idea to slip it into your pocket if you're going mobile too, so that it doubles up as a car first-aid kit!

Price is £1, postage is free and kits are obtainable from George Bros. & Mott, Gothic Works, 1 Hainault Road, London, E.11.

TRADE NEWS • TRADE NEWS NEWS • TRADE NEWS

WORLD'S SMALLEST TV CAMERA

THE world's smallest TV camera was on display at the Plannair stand at the Radio, Electronic Components Manufacturers' Federation Exhibition (Grand Hall annexe, Olympia, May 23 to May 26, 1967).

The sub-miniature camera, a mere one and a half inches in diameter designed for exploring pipes, tubes and inaccessible parts of machinery is controlled by equipment which owes much of its operational efficiency to Plannair Limited, the international specialists in air movement and temperature control.

The camera is already being widely used in the aircraft and ship-building industries, in power stations and oil refineries.

NEW MAZDA CRT's

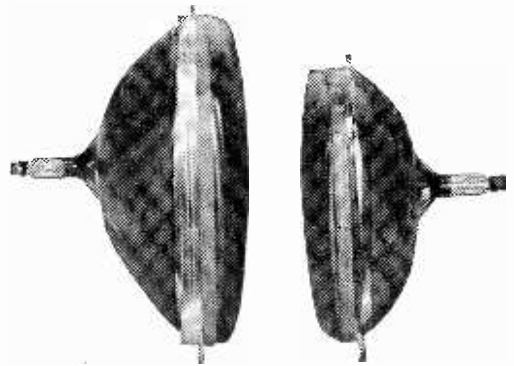

MAZDA have recently introduced two new self-protected television picture tubes using the new Rimguard III system of reinforcement which permits push-through mounting without special mouldings to insulate the metal frame. They are: CME1913 (A47-28W) 19in. Rimguard III, CME2313 (A59-23W) 23in. Rimguard III (see picture). Both tubes are fitted with the MAZDA B8H Sparkguard base for circuit protection, and offer all the normal advantages of self-protected tubes such as reduced reflections and dust elimination.

It may be realised from the name that Rimguard III tubes have many features in common with the earlier Rimguard I and II. All three types achieve protection by the reinforcement of the critical rim region where the face meets the conical back of the bulb.

It is intended that Rimguard III tubes should be mounted, by means of the mounting brackets, on bolts held in supports on the rear surface of the front panel of the receiver. These supports, against which the brackets are held, should be so dimensioned that the face of the tube protrudes through a cut-out aperture in the front panel in the usual manner of the "push-through" presentation. This will normally be satisfactorily achieved if the forward edge of the reinforcing metal shell is in the plane of the rear surface of the front panel.

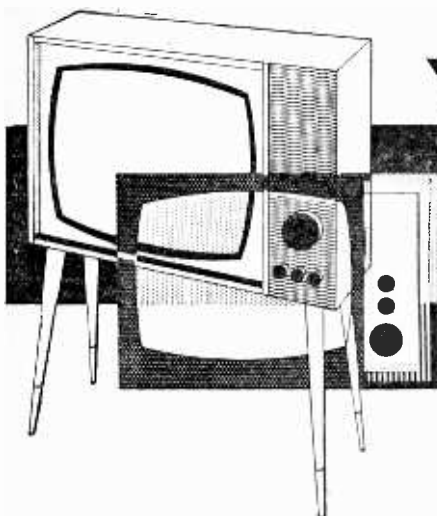

Your Problems Solved

Whilst we are always pleased to assist readers with their technical difficulties, we regret that we are unable to supply diagrams or provide instructions for modifying surplus equipment. We cannot supply alternative details for constructional articles which appear in these pages. WE CANNOT UNDERTAKE TO ANSWER QUERIES OVER THE TELEPHONE. The coupon from page 524 must be attached to all queries, and a stamped and addressed envelope must be enclosed.

SOBELL 1014

On the back there are three controls: vertical hold, horizontal hold for 405 and horizontal hold hold for 625 lines.

I have tried these controls, the horizontal control breaks or locks the picture, but the vertical control has no effect on the picture when turned to the extent of its travel.—F. Martin (Dunoon, Argyll).

The vertical hold control adjusts the field timebase frequency over a small range, and on strong signals this is insufficient to cause the picture to "roll" or break-up vertically. If you could reduce the signal to the set, the effect of the control would become apparent. You are fortunate to be in such a good signal area. Clearly the fact that the control has no marked effect on the picture is not necessarily indicative of a fault condition.

PYE V210

With the field linearity control at the limit of its travel, I am still unable to eliminate cramping at the bottom of the picture and elongation at the top (short legs and long heads). I have replaced V12 (PCL82) without success. The field hold (R55) is also at the limit of its travel.

The highlights of the picture tend to be "burnt out" and shimmery. The contrast pattern on the test card shows the two top tones as white and the bottom three as equally black. I believe this indicates a soft tube and have fitted a booster transformer (20% overrun) to the heater but this does not seem to make any improvement.—K. Cowell (Sevenoaks, Kent).

We advise you to try replacing the $2 \times 0.1 \mu\text{F}$ capacitors associated with the grid circuit of the PCL82 pentode. These are C47 and C48 on the printed panel and should be replaced by first quality components.

Your second symptoms do suggest a low emission c.r.t. and if this is the original, it is doubtful if boosting will help matters much.

BUSH TV80

The trouble is apparently in the line control. There is much snow-storming, ghosting and feathering on vertical lines. The line control seems to be critical.—S. Lown (Buxton, Denbighshire).

The trouble seems to be due to the use of an aerial which is less than efficient. You should aim to achieve a ghost-free picture (as near as possible). The line sync should then be vastly improved. Check the timebase PCF80 and the $2.2\text{M}\Omega$ resistor to pin 3.

MARCONIPHONE VT150

On this receiver, I get two complete pictures side by side. I have adjusted the line hold and changed the line oscillator valve without effect.—C. Harris (Wimborne, Dorset).

You should change the $330\text{k}\Omega$ resistor from the hold control to pin 2 of the line oscillator valve Z152. If this does not effect a cure, check the capacitors in this stage—preferably by replacement.

K-B 5V7C

The sound is perfect but there is no raster or picture and no line whistle. I am also having trouble in obtaining a 50CD6G valve for another television of the same model. Can you tell me if there is a direct equivalent?—W. Jones (Tredegar, Monmouthshire).

There is no direct equivalent of the 50CD6G, but this is a current valve and should be available. Try a London firm if you have trouble locally.

The set fault indicates complete failure of the line timebase. If there is no line drive to the output valve, then the oscillator section is at fault, but listen carefully for a trace of the line whistle when the line hold control is turned with the aerial removed. If it is only very weak, the trouble lies in the output stage. Check the valve (and booster diode) and associated components. Shorting turns in the line output transformer is a possibility.

NEXT MONTH IN

Practical TELEVISION

Inside TV Today

The average viewer, and even some technicians and experimenters, have only a limited idea of what goes on behind the scenes to bring us the pictures on the screens. This bright new series takes us on a conducted tour to describe equipment, techniques and other aspects of providing a TV service.

Transistor TV Circuits

Transistor u.h.f. and v.h.f. tuners, hybrid receivers and even fully transistorised TV sets are now on the market. The author takes a look at the circuitry and techniques involved in the change from valves to solid state.

Phones for the Hard-of-Hearing

People with impaired hearing often reduce their viewing to avoid annoying others by a high setting of the volume control, or because the continuous use of a hearing aid is not wanted. This article shows how to fit headphones safely to TV sets.

Colour is Coming!

Part four of this established series deals with the vital shadowmask tube. Don't miss it!

ORDER YOUR COPY ON THE FORM BELOW

TO _____
(Name of Newsagent)

Please reserve/deliver the SEPTEMBER issue of PRACTICAL TELEVISION (2/-), on sale August 18th and continue every month until further notice.

NAME _____

ADDRESS _____

BUSH TV53

This set is giving scan trouble. Until it has warmed up, the picture is broken up horizontally. Adjustment of the line hold corrects this. If the line output pentode is replaced while the boost diode is still warm, the picture comes on correctly. This leads me to suspect the booster diode or the line drive. Could the booster diode be replaced by a metal rectifier if this is at fault? Adjusting the setting of the line drive causes a broken line on the left of the picture using a PL81. This is not so with an N339, but this valve takes about five minutes to warm up from cold.

There is also considerable noise on bands 1 and 3 with and without the aerial plug inserted. In addition, as the set warms up, the picture loses both width and height.—A. Debham (Mansfield, Nottinghamshire).

Replace the ECC82 next to the PY81. Check tuner unit valves and the aerial efficiency. Check both PY82 valves.

ALBA T656

The picture is losing height top and bottom. I have adjusted the appropriate control but this has made no difference.—J. Ashley (Bordon, Hampshire).

Check both 0.02 μ F capacitors C43 and C44. Also C42 0.1 μ F if necessary. The 0.1 μ F C37 could be leaky. Generally check these items and the PCL82 (V11).

DECCA DM45

The sound is OK but there is a wicker-work pattern on the screen and no picture.—T. Patterson (Southampton).

Check C42 (0.005 μ F). If the i.f. coil cores have been disturbed, realign L15 (top) for maximum rejection at 38.15Mc/s.

FERRANTI T1137

When first switched on, the sound and vision are normal, but after the set has warmed up, the raster disappears when the channels are changed.

When the set is in normal working order, the c.h.t. valve (DY87) heater lights up. The voltage readings at the top caps of PL36 and PY801 are normal, but when the fault occurs, these voltage readings are lower than normal and the DY87 heater does not light up.

Next to the line output transformer there is a burnt-out resistor in series with a 12pF capacitor. Can you please state the value of this resistor?

Last but not least, there is a fault on BBC-2. The picture appears with a black dotted bar about 3in. wide down the centre of the screen.—P. Lee (London, S.W.11).

Replace the 12pF (6kV) capacitor and the series 270k Ω resistor. Check PL36 and PY801 valves by replacement. Check standards switch contacts.

HMV 1893

The picture and sound are OK on both channels, but the picture rolls in a vertical direction. On BBC this can be corrected by turning the vertical hold control fully clockwise and advancing the contrast control. On the weaker ITV channels, however, the picture will not lock at all. The PCL82 valve has been changed but the vertical hold is still at the extreme of its travel.—I. Brooks (Martock, Somerset).

Change the $2.2M\Omega$ resistor R119 and check C93 ($0.05\mu F$) if necessary.

PHILIPS 19TG111A

There was a kind of "phut" and the picture disappeared and left a thin bright horizontal line across the middle of the screen. The sound remained perfect.—C. Taylor (Ravenshead, Nottinghamshire).

Check ECL80 and PCL85 valves which are near the contrast control. Check the voltages to the valve pins—particularly to pin 6 of the PCL85.

MARCONIPHONE 4614

On switching on the set, the sound and picture come on normally on all channels including BBC-2. After about five minutes, the sound gradually fades away. This only happens on ITV and BBC-1. If the channel selector is rotated to the next position and then brought back to ITV (9) or BBC (12) the sound returns to normal. Also, if the aerial is pulled out and pushed back again, the sound comes on.

The sound output and i.f. valves have been changed. On testing the final sound i.f. valve, a short in the screen grid was discovered, so this valve (EF184) was replaced. The sound remained normal for about three weeks after replacement but then reverted to its former state.

During all this time, BBC-2 has remained quite unaffected and the picture on all channels is excellent.—M. Fawkes (St. Annes-on-Sea, Lancashire).

The trouble almost certainly lies in the v.h.f. tuner. Since the set is still well under guarantee (within the period anyway), we would strongly suggest that you have it corrected by the supplier, as a replacement tuner may be required. On the other hand, the second valve (nearest the output) of the tuner could be faulty.

PHILIPS 170A

Upon switching on there is a loud hum which continues until the set warms up. As the picture comes on, the hum gradually fades till it is only very faint. I have changed the valves AZ31 and EM34.—F. Thompson (Sheffield, 7).

Check the output valve for heater/cathode leakage. If this is alright, check the main electrolytic smoothing capacitors. Since the trouble almost clears when the set is hot, however, we feel that a valve may be responsible.

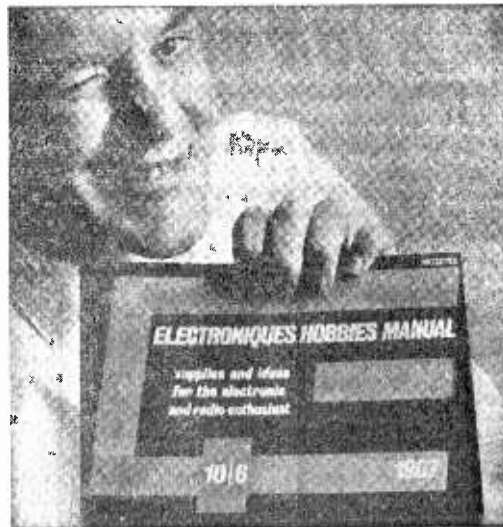

I should like a copy of the Electronics Hobbies Manual. Enclosed is a cheque/P.O. for 10/6.

NAME _____

ADDRESS _____

P.T.1.

Available now! The enthusiasts' greatest-ever components guide!

Over 600 pages packed full of tips, kits and details of over 11,350 different parts from 85 leading manufacturers!

Electroniques Hobbies Manual is huge and a first-class investment.

It saves you time. No searching around for the parts you need. Every type of equipment — from stock components to sophisticated professional items — is *all* available by mail order on fast despatch.

It aids your projects. Complete designs and details of kits available for beginners and experts alike.

It costs just 10/6 post free. And it puts the whole electronics industry at your service, including the specialised knowledge of Electroniques.

Be sure of your Electroniques Hobbies Manual. Clip the coupon, and send today — while stocks last!

Electroniques (Prop. STC Ltd.) Edinburgh Way, Harlow, Essex. Telephone: Harlow 26777.



High-grade components for amateur communications

67/10MG

LAWSON BRAND NEW CATHODE RAY TUBES

The rapidly increasing demand for a complete range of new tubes of the very highest quality is now being met by the new Lawson "CENTURY 99" range of television tubes.



SPECIFICATION:

The new "Century 99" range of C.R.T.s are the products of Britain's premier C.R.T. manufacturers. All types are exact replacements, manufactured to the original specification but incorporating the very latest design improvements to give superb performance, coupled with maximum reliability and very long life.

"Century 99" C.R.T.s, available as direct replacements for the following makes and types

MULLARD		MAZDA		BRIMAR		EMISCOPE & EMITRON		GEC & COSSOR also ENGLISH ELECTRIC	
MW43/69	AW36-80	CRM121	CME1901	C12FM	C17SM				
MW43/64	AW36-21	CRM123	CME1902	C14M	C197A	4/14		141K	
MW36/24		CRM122	CME1903	C14GM	C1915A	4/15		171K	
MW31/74		CRM124	CME2101	C14HM	C1910AD	4/15G		172K	
MW31/16	Twin Panel Types	CRM141	CME2104	C14JM	C19AH	5/2		173K	
MW43/80		CRM142	CME2301	C14LM	C19AK	5/2T		212K	
MW36/44	A47-13W	CRM143	CME2302	C14PM	C211A	5/3		7102A	
MW53/80	A59-16W	CRM144	CME2303	C171A	C217A	5/3T		7201A	
MW53/20	A59-13W	CRM153		C174A	C21AA	14KP4		7203A	
MW43/43		CRM171	Twin Panel Types	C175A	C21HM	17ARP4		7204A	
AW59-91		CRM172		C177A	C21KM	17ASP4		7205A	
AW59-90		CRM173		C17AA	C21NM	17AYP4		7401A	
AW53-89		CRM211	CME1906	C17AF	C21SM	21CJP4		7405A	
AW53-28		CRM212	CME2306	C17BM	C21YM	SE14/70		7406A	
AW53-80		CME141		C17FM	C23-7A	SE17/70		7501A	
AW47-91		CME1402		C17GM	C23-TA			7502A	
AW47-90		CME1702		C17HM	C23AG			7503A	
AW43-89		CME1703		C17JM	C23AK			7504A	
AW43-88		CME1705		C17LM				7601A	
AW43-80		CME1706		C17PM				7701A	

- 12" .. £4.10.0
- 14" .. £5.10.0
- 17" .. £5.19.0
- 19" .. £6.19.0
- 21" .. £7.15.0

Terms:
C.W.O.
Carr. and
Ins. 10/-

2 YEARS' FULL REPLACEMENT GUARANTEE
Complete fitting instructions supplied

LAWSON TUBES
STATION ESTATE, MALVERN. Offices
18 CHURCHDOWN ROAD
MALVERN WORCS. MALVERN 2100

COLOUR TELEVISION SCHOOL

DAYLIN ELECTRONICS ANNOUNCE A CORRESPONDENCE COURSE IN THE THEORY AND PRACTICE OF COLOUR TELEVISION

A series of 10 lessons dealing in detail with:-

Colour mixing, the PAL colour system, colour receivers, decoders, IF circuits, time-bases, convergence, waveforms, set-up procedures, test equipment, fault finding, typical circuits. This course is designed for engineers who will be called upon to service colour television receivers within the next four months. Expert guidance throughout the course. Test questions with each lesson. Model answers supplied. Terms available. Certificates awarded.

Fee for the complete course 10 guineas.

To: DAYLIN ELECTRONICS LIMITED
32 PARKSTONE DRIVE
SOUTHEND-ON-SEA, ESSEX

Please send, without obligation, details of your colour television course.

NAME _____
ADDRESS _____

PRE-PAK SEMICONDUCTORS

DAVIS & WHITWORTH LTD.
BY 222-224 WEST ROAD, WESTLIFE-ON-SEA, ESSEX
PHONE: SOUTHEND (0502) 46344

FANTASTIC! BARGAINS OF THE YEAR

OC45	1" transistor	1/9
OC44	Osc. transistor	1/11
OA9	Equal to OA5	2/-
OC36	Power transistor (better than DC35)	7/6

GENUINE TRANSISTORS NOT REMARKS

No.	Description	PRICE
A1	6-Silicon rectifiers BY100 type	20/-
A2	10-Relays mixed types and voltages	20/-
A3	20-Mixed marked and tested trans.	20/-
A4	1-2N 174 rect. power trans. 50V 150W	20/-
A10	2-Power Comp. Pair. AD112	20/-
A11	50-Unmarked untested, trans., new	10/-
A12	1-Solar cells, inc. Book of Instructions	10/-
B1	4-OA3 gold bonded, diodes Mullard	10/-
B2	1-Matched set, OC44, 40/51D/81+diode	10/-
B3	15-Red spot AF trans. or white spot RF	10/-
B4	9-Power trans. OC26/35 type	10/-
B5	1-Light sensitive cell, ORP12 type	9/-
B10	10-50V trans. genu. P.N.P. latest type	10/-
B44	1-Tunnel diode. AEU11, 1050 Mc/s	10/-
B41	8-Sil. recs. 10 amp., 50-100PIV	10/-
B52	30-Trans. new tested, but unmarked	10/-
B42	8-Switching trans. TK22C 8TC	10/-
C1	1-Uni junction, 2N2160 or 2N2646	15/-
C4	3-RF power trans. OC22 and BU11	15/-
D18	1-ORP60 type light sensitive cell	9/-

Transistors	Price
AF114	4/-
AF115	4/-
AF116	4/-
AF117	4/-
AF118	4/6
AF119	4/6
AF175	4/6
BSY95A	4/-
OC21	4/-
OC23	4/-
OC25	4/-
OC26	4/-
OC28	4/-
OC35	4/-
OC41	4/6
OC42	4/6
OC71	4/6
OC72	4/6
OC73	4/-
OC81	4/6
OC81D	4/6
OC83	4/-
OC139	4/6
OC140	4/-
OC141	4/6
OC17	4/6
OC20	4/-
OC201	4/-
2N394	4/-
2N49	4/-
1N 05	5/-
2N 1302	4/6
2N 1304 or 4	4/-
2N 1306 or 7	4/-
2N 308 or 8	4/-

★ ALL OUR SEMICONDUCTORS HAVE A WRITTEN GUARANTEE ★
Send for our FREE lists and catalogue of all our products. Check your own equivalents with our free substitution chart.

FIRST EVER LOGIC KITS. Learn for yourself how computers work, even make one for yourself. Full instructions for a noughts and crosses machine, binary counters, timers, etc. L.1 5 gns. L.2 10 gns. No need to purchase both kits. you can start with L.2, which incorporates L.1. DETAILS FREE.

NO CONNECTION WITH ANY OTHER FIRM. MINIMUM ORDER 10/- CASH WITH ORDER PLEASE add 1/- post and packing. OVERSEAS ADD EXTRA FOR AIRMAIL.

PHILIPS 1768

The field scan is reduced to about 1in. and the reduced raster is in the form of a sine wave.

The picture is fully locked and all voltages appear to be correct around the field output valve.

If the set is left switched on, the raster resorts to its proper size after about an hour and the sine wave effect disappears.—W. Wilby (Knottingley, Yorkshire).

If the sine wave effect is disposed horizontally on the screen, suspect trouble in the field amplifier valve. It would, in fact be a good idea to have the timebase valves checked for emission and inter-electrode insulation. If the effect is vertically on the screen, suspect failure of an electrolytic smoothing capacitor and examine the coupling from the boosted h.t. supply to the field timebase oscillator, via the height control.

BUSH TV125

The picture is elongated at the top and bottom and bright lines appear across that part of the screen when the height control and general linearity are turned to the end of their travel.

There is also a mechanical fault in the controls of the 405 tuner, ITV section. One knob of this unit is inoperable. Looking at the tuner without moving it from the cabinet, there appears to be a thick greyish composition washer missing from that spindle.—W. Johnson (Smethwick, Warley).

Check the PCL85 by substitution. Check 3C37 and 3R42 (270 Ω) if necessary.

The fact that the ITV section of the tuner has one button inoperative probably means that the keyway in the knob has worn away. Check and change as necessary.

RGD T14

After about half an hour of viewing, the sound went low and the picture dropped from the top, giving people on the screen compressed heads.

I replaced a 3.3 Ω resistor (R68) which restored the sound to its original level but the picture fault remains.—H. Venturis (Erith, Kent).

Check the field timebase valves and the setting of the field (vertical) linearity controls. Trouble at the top of the picture usually indicates a fault in the negative feedback linearising components, working in conjunction with the linearity controls (presets) mentioned.

BUSH TV53

I wish to replace the tube in this set with a 17in. tube. Can I fit an MW43-64 in its place and if so, are there any adjustments to make?—A. Neal (Burnley, Lancashire).

If the existing tube is an MW36-24 or 36-44 there is no reason why an MW43-64 or 69 should not be used. If the TV53 is a late model with an AW36-21, this cannot be done without a focus magnet.

HMV 2620

On adjustment of the field hold control, I get half the picture above and half the picture below. I have changed the PCL85 but this has made no improvement.—R. Heever (Fulwell, Sunderland).

This fault would appear to be caused by change in value of a resistor (or capacitor) associated with the field timebase generator stage. The resistor connected to the top end of the vertical hold control sometimes increases in value and puts the correct vertically locking point outside the range of the control, the picture then tending to lock on half-frames, as described. Check all resistors in the vertical hold circuit.

FERRANTI T1046

The trouble is intermittent and appears to originate in the field timebase (the trouble is apparent with the aerial disconnected).

The picture exhibits vertical jittering and bars which are caused by the line spacing widening momentarily—the bars appearing to bounce up and down, mainly in two distinct parts of the screen about 2in. from the upper and lower edges.—R. Neave (Chelmsford, Essex).

Check the height and linearity controls and clean them. Also, check oscillator and output stages for dry joints and other improper connections. Check the output cathode bias electrolytic.

PAM A7T

The picture collapsed to a horizontal line. I have replaced the PCL83 and all other associated valves but the fault remains.—W. Hardman (Radcliffe, Lancashire).

We do not recognise the A7T as a model No. of any Pam receiver. If you would examine the serial-model plate more carefully, you will probably find the correct model No. is 501C or similar.

With regard to the fault, the trouble could be in the scancoils if the valve base voltages are correct. Check the continuity of the coils and if the PCL83 is the field oscillator—output, check h.t. to pins 1 and 6.

REGENTONE 10-8

The picture is very good but the sound has gone down to a distorted whisper. There is no flash on the screen when changing stations. I have changed all the valves but this has made no difference.—J. Green (Wednesbury, Staffordshire).

The cause of this trouble could lie anywhere in the sound section of the set, and since you have not given many details, there is little that we can do to help materially. However, since the valves are in order, have the sound i.f. channel checked for alignment, especially if there is vision-buzz tendency on sound. Then go on to the audio stages, making sure that the detector is working. Check h.t. voltages on the audio and sound i.f. valves. Suspect trouble in the speaker transformer.

DECCA DM45

Once in a while, the field expands and contracts in a non-linear fashion. This happens occasionally on picture but more often on test card.—B. Beckett (Birmingham 13).

The expansion and contraction observed is due to the phase difference between the transmitter and the receiver and is very common. No steps need be taken in this direction.

BUSH TV56

The screen is completely blank, but the sound is perfect.—A. Mitchell (Warminster, Wiltshire)

Check the right side valves PL81, PY81 and ECC 82. If there is a timebase whistle fully audible, check EY51 (or EY86) on top of the line output transformer. If the e.h.t. is correct at the side of the tube, check the setting of the ion trap magnet on the end of the tube neck.

BAIRD 630

The fault takes the form of a vertical flutter—not loss of vertical hold, but looks like another picture over the top of the same picture. This only happens on 625.—R. Grindley (Oswestry, Shropshire).

This seems like some kind of field amplifier instability at a frequency below that of the field and at much smaller amplitude, of course. Firstly, check the field timebase valves by substitution. If the trouble persists, check the components on the control grid of the field pentode.

QUERIES COUPON

This coupon is available until AUGUST 18th, 1967, and must accompany all Queries sent in accordance with the notice on page 519.

PRACTICAL TELEVISION AUGUST 1967

TEST CASE -57

Each month we provide an interesting case of television servicing to exercise your ingenuity. These are not trick questions, but are based on actual practical faults.

? The sound on a Thorn 850 chassis had a tendency towards intermittent fading. Although the symptom was present on both BBC and ITV channels, it seemed to be aggravated on the Band III channel. At all times the vision remained without fault or variation in quality even when the sound fault was occurring.

Past experience has shown that trouble in the tuner can be responsible for this kind of fault, in spite of the tuner carrying both the sound and vision signals, and as a consequence various tests were made in the tuner, including valve replacement and applying mechanical pressure to the vulnerable components and circuits within the tuner, but all to no avail.

Although it was not considered very likely that the sound channel was responsible, it was decided to make several tests here to prove or disprove the possibility.

What tests should be made to isolate the vision from the sound in terms of a fault of this nature, and where would be the most likely fault area?

See next month's PRACTICAL TELEVISION for the solution to this problem and for a further item in the Test Case series.

SOLUTION TO TEST CASE 56

Page 476 (last month)

Coupling actually between the circuits and/or components of the field timebase and the audio stages is very often responsible for rough buzz on sound, present with the aerial removed (i.e., no

vision signal) and variable in tone by operating the field hold control.

Indeed, the fact that the buzz could be altered by adjusting the field hold control signified without doubt that the signal getting into the sound channel was that generated by the field timebase.

A clue was given by the effect that pressure had on the volume control knob. This control operates in a fairly sensitive part of the audio circuits, where pick-up of spurious signals or mains ripple is likely, thus attention should have been directed immediately to the earthing of the metal cover of the volume control and the signal leads feeding it.

Subsequent investigating into this part of the set revealed poor "earths", but the trouble was not totally cleared since the sound-on-vision symptom remained. Attention was then directed to the field timebase printed-circuit panel, and pressure was applied to various parts of this by the insulated handle of a screwdriver. Pressure towards the edge of the panel not only cleared the sound-on-vision symptom but also eliminated the final traces of the buzz from sound. Concentrated attention in this area soon indicated that although the panel retaining screws appeared to be fully screwed home, they were not, in fact, and a poor "earth" resulted. This was soon cleared by fully tightening the P-K (self-threading) screws.

It is worth noting that a large number of faults in recent equipment employing printed circuit boards, with no absolute chassis, are traced to poor "earths" between the panels and to the main metalwork.

FREE TO AMBITIOUS ENGINEERS

— THE LATEST EDITION OF ENGINEERING OPPORTUNITIES

Have you sent for your copy?

ENGINEERING OPPORTUNITIES is a highly informative 132-page guide to the best paid engineering posts. It tells you how you can quickly prepare at home for a recognised engineering qualification and outlines a wonderful range of modern Home Study Courses in all branches of Engineering. This unique book also gives full details of the Practical Radio & Electronic Courses administered by our Specialist Electronics Training Division—explains the benefits of our Appointments Dept. and shows you how to qualify for five years promotion in one year.

SATISFACTION OR REFUND OF FEE

Whatever your age or experience you cannot afford to miss reading this famous book. If you are guaranteed less than £30 a week send us your copy of "ENGINEERING OPPORTUNITIES" today—FREE.

BRITISH INSTITUTE OF ENGINEERING TECHNOLOGY
(Dept. 301B), Aldermaston Court, Aldermaston, Berkshire

WHICH IS YOUR PET SUBJECT

- Mechanical Eng.
- Electrical Eng.
- Civil Engineering
- Radio Engineering
- Automobile Eng.
- Aeronautical Eng.
- Production Eng.
- Building, Plastics
- Draughtsmanship
- Television, etc.
- B.Sc.
- City & Guilds
- Gen. Cert. of Education
- etc., etc.

PRACTICAL EQUIPMENT INCLUDING TOOLS!

Basic Practice and Theoretical Courses for beginners in Radio, T.V., Electronics Etc. A.M.I.E.R.E. City & Guilds
Radio Amateur's Exam. R.T.E.B. Certificate
P.M.G. Certificate
Practical Radio
Radio & Television Servicing
Practical Electronics
Electronics Engineering
Automation

The Specialist Electronics Division of B.I.E.T.

Now offers you a real laboratory training at home with practical equipment. Ask for details.



POST COUPON NOW!

■ Please send me your FREE 132-page "ENGINEERING OPPORTUNITIES" (Write if you prefer not to cut page)

■ NAME.....

■ ADDRESS.....

■.....

■.....

■.....

■ SUBJECT OR EXAM.....

■ THAT INTERESTS ME..... **301B**

THE B.I.E.T. IS THE LEADING INSTITUTE OF ITS KIND IN THE WORLD

VALVES SAME DAY SERVICE

NEW! TESTED! GUARANTEED!

SETS 1R5, 1R5, 174, 384, 3V4, DAF91, DF91, DK91, DL92, DL94, Set of 4 for 16/8, DA96, DF96, DK96, DL96, 4 for 24/8.

1A7GT	7/8705	0/8	DA322	7/8	ECL80	0/	PC889	3/8	TR10	1/8
1H5GT	7/8709	0/8	DA981	0/8	ECL82	7/8	PC899	3/8	U25	9/8
1N5GT	7/8717	0/8	DA986	0/	ECL86	7/8	PC980	0/8	U26	9/8
1R3	5/874	0/8	DCC90	7/	EF30	5/8	PC982	0/	U47	9/8
1R4	4/810F1	9/8	DF33	7/8	EF41	0/3	PC986	0/3	U49	9/8
1R5	3/810P13	3/8	DF91	2/8	EF50	4/8	PC980	1/8	U52	4/8
1R4	2/811AT	3/8	DF96	0/4	EF83	0/	PC981	0/8	U75	3/8
1A1	7/12AU1	4/8	DF177	4/	EF86	0/3	PC982	0/8	U91	10/
3Q1	7/812AU7	4/8	DF181	12/6	EF91	5/	PC985	0/8	U90	11/8
8E1	4/812AX7	4/8	DK2	7/8	EP91	3/8	PC986	11/8	U80	10/3
3V1	5/813K9GT	7/8	DK91	5/8	EP92	3/8	PC986	11/8	U80	5/8
5U4	4/810P2	10/8	DK92	4/	EP97	7/8	PC986	11/8	U82	7/8
5V4G	7/820L1	14/	DK96	0/8	EL143	0/8	PC882	0/8	UB41	0/8
5Y3GT	5/820P1	9/	DL33	0/8	EL184	0/3	PC883	0/8	UB41	0/8
3Z4G	7/820P3	12/	DL35	5/	EL33	6/8	PC883	0/8	UB80	0/
6J50L2	3/830P4	13/8	DL92	4/8	EL41	8/8	PC886	0/8	UB89	5/8
6AL5	2/835U	11/8	DL94	5/8	EL42	7/8	PC884	7/	UB21	9/
5AM6	7/839C15	10/8	DL96	0/	EL81	4/8	PEN4A	0/9	UC92	5/8
6A2	4/840C17	11/8	DL96	5/8	EL93	5/	PEN36A	15/	UC84	7/8
1A9	4/840C18	10/8	DL97	5/	EL95	5/	PC890	13/8	UC85	6/8
6BA5	4/830F3	9/8	EAC80	0/	EM80	5/8	PL81	0/9	UC80	8/8
6B4	3/830F11	10/8	EAC82	0/	EM81	5/8	PL82	0/8	UC81	9/8
6B9G	15/830FL14	11/8	EB91	2/8	EM84	0/8	PL82	0/8	UC82	9/8
6B9E	0/830FL15	11/8	EB93	7/	EM87	0/8	PL83	0/	UC81	0/
6B9W	7/830L17	12/	EB41	8/	EY31	0/8	PL84	0/8	UC82	9/8
6F1	7/830P4	11/8	EB80	0/	EY86	0/	PL300	13/8	UC83	5/8
6F13	3/830P12	9/8	EB89	5/8	EZ40	6/8	PL25	7/8	UC81	8/
6F14	3/830P19	11/8	EC081	3/8	EZ41	6/8	PL31	0/8	UC80	7/
6F23	3/830P11	12/8	EC082	4/8	EZ50	4/8	PL32	0/8	UC89	5/8
6K70	1/830PL13	13/8	EC83	7/	EZ81	4/8	PL33	0/8	UC41	8/8
6K80	4/830PL14	13/8	EC84	0/8	EZ92	3/	PL30	5/8	UC41	20/
6K8GT	7/835LGT	12/8	EC86	5/8	KP91	7/8	PL31	5/8	UC84	0/
6L18	0/835W1	4/8	EC89	7/8	N1	4/8	PL32	5/	UC21	9/8
6V8G	3/835ZGT	4/8	EC82	0/8	N78	14/8	PL33	5/8	UC41	5/8
6V8GT	0/835A2	5/8	EC96	9/	PC86	8/8	PL38	7/8	UC85	4/8
6X4	3/830B3	12/8	EC135	0/	PC88	8/8	PL80	0/8	UC4B	11/
6X5GT	5/84231	0/4	EC142	9/	PC87	5/8	PL81	0/	UC21	21/
7B8	10/8606	9/8	EC181	5/3	PC900	8/8	R19	7/8	W77	3/8
7B7	7/8B79	10/	EC184	8/8	PC884	5/8	R20	12/8	Z77	3/8

STEREO RADIOGRAM CABINETS £15

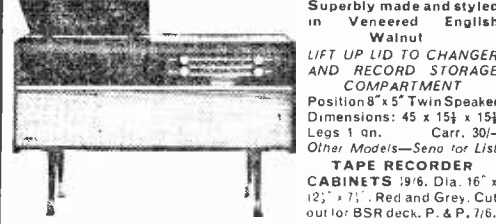

Superbly made and styled in Veneered English Walnut
LIFT UP LID TO CHANGER AND RECORD STORAGE COMPARTMENT
Position 8" x 5" Twin Speaker
Dimensions: 45 x 15 1/2 x 15 1/2
Legs 1 in. Carr. 30/-
Other Models—Send for List
TAPE RECORDER CABINETS 19/6. Dia. 16" x 12" x 7 1/2. Red and Grey. Cut out for BSR deck. P. & P. 7/6.

TRANSISTOR CASES 19/6. Cloth covered, many colours. Size 9 1/2" x 6 1/2" x 3 1/2". P. & P. 4/6. Similar cases in plastic 7/6.

SINGLE PLAYER CABINETS 19/6. P. & P. 7/6.

TV TURRET TUNERS, 2/6. New, less valves. Slim models 5/-. Press button models 19/6. P. & P. 4/6.

17in.—£11.10.0 TWO-YEAR GUARANTEE
3 Star Guarantee
★ Tube ★ Valves
★ Component's Carr. 30/-
FREE ILLUSTRATED LIST OF TELEVISIONS
17" —19" —21" —23"
WIDE RANGE OF MODELS SIZES AND PRICES
DEMONSTRATIONS DAILY

TWO-YEAR GUARANTEED TUBES 100% REGUNNED
14in.—69/6 17in.—89/6
21in. and all SLIMLINE TUBES 99/6
Exchanged Bows Carr. 10/6
EX MAINTENANCE TESTED TUBES
17in.—35/- 14in.—15/-
Carr. 5/- (not slimline)

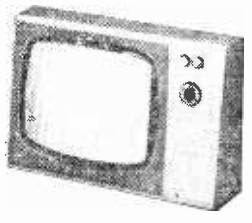

DUKE & CO. (LONDON) LTD.
621/3 Romford Road, E.12 01-478 6001-2-3

READERS RADIO
85 TORQUAY GARDENS, REDBRIDGE, ILFORD, ESSEX. 01-550 7441
Postage on 1 valve set, extra. On 2 valves or more 6d. per valve extra. Any Parcel insured against damage in transit 6d. extra.

SETS & COMPONENTS

TV SPARES fully guaranteed Makers' Parts. Telephone orders sent same day C.O.D. Line O.P. Trans: Murphy V270/280 99/6, Ekco T311, 330, 221, 231, 327 series and Pye VT4 etc.. all 62/6. Most types stocked. Send S.A.E. for quote. Add 4/- p.p. Ekco/Ferr. Plastic Hsgs.. 15/- KING'S (ORPINGTON) LTD., 8 Cray Parade, Main Road, St. Paul's Cray, Kent. Orpington 30566.

BARGAIN PRICES

Any 10 Valves 15/-. Any 100 Valves £6 from list below:

PCF80	PY81	EF184
PCC84	PY800	39F11
PCL83	PY82	6-30L2
PCL82	ECL80	EF85
PL81	EY86	30L15
PL36	ECC82	EB91
PL82	EF80	30C15

3 BY100 Type Rectifiers 10/-, 100 Mixed Small Capacitors 5/-, 50 Mixed Television Fuses 5/-. All Valves and Components Tested. P. & P. 1/-

VELCO ELECTRONICS. 49 Bridge St. Ramsbottom, via Bury, Lancs.

NEW MANUFACTURERS BBC-2 CONVERSION KITS, including tuner, IF panel, 405/625 switch, etc. List 12s. our price 65/- p/ins. 9/- 60 Wellesley Ave. Norwich. NOR 49S.

STOP

FULLY GUARANTEED L.O.P.T. REWINDING SERVICE

A few of the types are listed below:-
BUSH TV 53-66.
K.B.P.V.P.20, etc.
PHILIPS 1768U, 17TG100U, etc. **All at 50/-**

NEW FROM STOCK

U25 Type EKCO, stator model. PYE 200-400.
FERGUSON 306-308 305-307 **All at 45/-**
FERGUSON 406, 408, 416, 436, 438
S.A.E. Enquiries P. & P. 4/-. C.O.D. 6/-

WITWORTH TRANSFORMERS Ltd.
26 All Saints Road, North Kensington
W.11 Telephone: 01-229 9071

OLYMPIC II TV. S.A.E. for itemised price list. **AJAX ELECTRONICS**, 18a Rumbold Road, Fulham, S.W.6.

RATES: 4/- per line or part thereof, average five words to line, minimum 2 lines. Box No. 1/- extra. Advertisements must be prepaid and addressed to Advertisement Manager, "Practical Television", 15/17, Long Acre, London W.C.2.

SETS & COMPONENTS (continued)

THIS MONTH'S SCOOP!

**HUGE PURCHASE
NEW BRIMAR C17AF BOXED**
17", 110", 0.3A Short neck
Can replace AW43-88, CME1705 etc.
£3-19-6
TELEVISION TUBE SHOP
48 BATTERSEA BRIDGE ROAD, SW11

EX N.E.V. C.C.T.V. Camera and Monitor Circuits. S.A.E. for list. **LOWE**, 62 Brownswood Road, London, N.4.

GUARANTEED IDEAL FOR ANY RECORDER TAPE

World Famous make. **PRICES SLASHED. APPROX. HALF PRICE!**
By enormous purchase we can offer you fully tensilised Polyester/Mylar and P.V.C. tapes of identical Hi-Fi wave range recording characteristics as top grade tapes. Quality control manufacture. Not standard in any way. **TRY ONE for YOURSELF. They are TRULY WORTH A FEW MORE COPPERS.**

STANDARD PLAY		DOUBLE PLAY	
3"	150' 2/3	3"	300' 4/-
4"	300' 4/6	4"	600' 8/-
5"	600' 7/6	5"	1200' 15/-
5½"	900' 10/6	5½"	1800' 19/6
7"	1200' 13/6	7"	2400' 27/-
LONG PLAY		TRIPLE PLAY	
3"	225' 2/9	4"	900' 13/-
4"	450' 5/6	5"	1800' 25/-
5"	900' 10/6	5½"	2400' 34/-
5½"	1200' 13/-	7"	3600' 44/-
7"	1800' 18/6	QUADRUPEL PLAY	
		3"	600' 8/-

Postage 1/- per reel.
Post free and less 5% on three.
Trade and quantity enquiries welcomed.

TECHNICAL TRADING CO.
All Mail Orders to Brighton please.
**Devonian Court, Park Crescent
Place, Brighton, 689722 67606**
350/352 Fratton Road, Portsmouth 22034
72 East Street, Southampton 25851
132 Montague Street, Worthing 2639

SETS & COMPONENTS (continued)

R. & R. RADIO & T.V. SERVICE

Salvage Valves		Good Emission Guaranteed.	
EL50	1/5	30P4	6/-
EF184	5/-	EB91	1/-
EL50	4/6	EF85	5/-
30L15	5/-	6B W7	4/-
PCF80	4/-	LY80	4/-
U191	5/-	30P12	5/-
		PCL84	6/6
		PL82	4/6
		PL36	5/-
		PCC54	4/-
		PY81	3/6
		PY33	6/6

Speakers Ex T.V. 5 inch Rnd 3/6, 6 x 4 3/6. Post 2/6. 8 inch Rnd 6/- Post 1/6 for one or two. BY100 and equiv. with Inwall res 5/6 post paid. Ekco line O/P Tubes. 1.26 type 85/-, 1.25 type 27/6. Push Button tuners, req valves type 30L15 and 30C15 rectangular buttons. 27/6 post paid.

Postage on valves 6d. Three and over post paid. S.A.E. with all enquiries.

**51 Burnley Road,
Rawtensall, Rossendale,
Lancs.**

MANSTONE LTD.

FOR LINE OUTPUTS AND DEFLECTOR COILS

We have the Country's largest stock of Manufacturers' Original (or Authorised Replacement) Line Output Transformers for many "difficult" makes, including Ambassador, Baird, Cosmor, Ekco, GEC, HMV, KB, Masteradio, Petobell, Philips, Regentone, RGD, Sobell, Ultra, etc. Also deflector coils, output and oscillator transformers, Inc. Alba, Bush, Murphy. Examples. L.O.P.T.s: Murphy 280, 89/5; 310/350/410/540/659/759, 85/-; Bush TV53, 79/6; 80, 95/-.

SPECIAL OFFER:

Ekco improved type for Model T221 at 42/6, T231 at 45/-; T310 at 47/6d.

Terms: C.W.O. or C.O.D. (3/6). Post/packing 5/-, 2 or more L.O.P.T.s Post/packing Free.

All enquiries answered but regret no lists available. Same day delivery on most types.

MANSTONE LTD.

28 BROCKLEY CROSS, LONDON SE4
Tel. TIDeway 5394 (Day) or 01-589 0439 (S.T.D.) (Night).

(continued on next page)

BRAND NEW TELEVISION TUBES — 2 YEAR GUARANTEE!

(CATHODEON AND OTHER LEADING MANUFACTURERS)

We hold large stocks of top quality tubes, why buy ordinary rebuilds? Some rebuilds available, 19in. upwards at 21/- off quoted prices, 12 months warranty. Colour, rimbands, etc. available. Lists: Rimband types, 19in. **£8.10.0**; 23in. **£11.0.0**.

CRM121, 2, 3 & 4; MW31-16. MW31-74; C12FM; 121K. C12/1, etc.	£3 0 0
AW36-20, 36-21; AW36-80; MW36-24, 36-44; CRM143, 4; CME1402; C14BM; C14FM, MW41/1, etc.	£4 0 0
CRM143, CRM144; £4.0.0. CRM141, 2; CRM151, 2, 3; 15EP4, etc. C17BM, SE14/70.	£4 15 0
AW43-80, 43-88, 43-89; MW43-64, 43-69; MW43-80; CRM171, 2, 3, 4; C17FM; CME1703, 5; C17AF; C17SM	£5 15 6
AW47-90; AW47-91; CME1902; CME1903, etc.	£6 17 6
C19AH; CME1901; AW53-88, 9; CME2101, 4; AW53-80; MW53-20. MW53-80; CRM211, 2, etc.	£7 10 0
19in. Twin Panels A47-13V; CME1906, £9.17.6	23in. Twin Panels A59-13V, CME2306
(Carriage 15/-)	(Carriage 25/-)

CARRIAGE AND INSURANCE. Up to 19in. 12/-, 21in. upwards 15/-. Twin Panels (see above). Lists, s.a.e. please.

SOME OLD TUBES WANTED 17" UPWARDS

PHILIP H. BEARMAN, 6 Potters Road, New Barnet, Herts. Tel: BAR 1934/7873 (Robophone)

LISTS BRITISH VALVES!

SETS & COMPONENTS
(continued)

TELEVISION TUBE SHOP

THE

NEW TUBE Specialists

A47-13W	£12.10.0
A59-13W	£15.10.0
AW36-20, 21	£5.12.6
AW36-80	£5. 7.6
AW43-80	£6. 7.6
AW43-88, 43-89	£6.12.6
AW47-90, 91	£7.10.0
AW53-80	£7.12.6
AW53-88, 53-89	£7.17.6
AW59-90, 59-91	£9.10.0
C148M, FM	£5.15.0
C178M, FM, HM	£6. 7.6
C171M, PM, SM	£6.12.6
C21HM, SM, TM	£7.17.6
CME1402	£5.17.6
CME1702, 1703	£6.12.6
CME1705	£7. 7.0
CME1901, 1903	£7.10.0
CME2101, 2104	£7.17.0
CME2306	£15.10.0
CRM93	£5.10.0
CRM124	£5.10.0
CRM141, 2, 3, 4	£5.17.6
CRM152	£5.10.0
CRM153	£3.19.6
CRM171, 2, 3	£6. 7.6
CRM211, 212	£8.17.6
MW31-16, 74	£5. 0.0
MW36-24, 44	£5. 2.6
MW43-64, 69	£6. 7.6
MW43-80	£6. 7.6
MW53-20	£8.17.6
MW53-80	£8.17.6
14KP4A, 141K	£5.12.6
171K, 172K, 173K	£6. 7.6
7201A, 7203A	£5.12.6
7204A	£5.10.0
7401A	£6. 7.6
7405A	£6.12.6

Manufacturers' Reprocessed Tubes available at £1 each less than the above prices.

All tubes tested before despatch and guaranteed for 12 months.

CARRIAGE 10/-, via B.R.S. or 15/- via passenger train. Add 2/6 for Comprehensive Insurance.

* Reprocessed tubes only of this type at present.

Midland Stockists:—

Amateur Electronics Co.,
240 Lichfield Road, Aston,
Birmingham.

TELEVISION TUBE SHOP

48 BATTERSEA BRIDGE ROAD
LONDON S.W.11. BAT 6859

JUST SOUTH OF THE BRIDGE
OPEN SATURDAY UNTIL 4 p.m.

SETS & COMPONENTS
(continued)

150 NEW ASSORTED Capacitors, Resistors, Silvered Mica, Ceramic, etc. Carbon Hystab, Vitreous, 1-20 watt, 12/6. Post Free. WHITSAM ELECTRICAL, 18 Woodrow Close, Perivale, Middlesex.

TUBES, AERIALS, VALVES

U.H.F. aerials. Bands I, II & III aerials. U.H.F. transistorised boosters. I.T.V. boosters. Regunned T.V. tubes, Valves, etc. New and second-hand T.V. sets. Transistor Radios and all types of Electrical Appliances. Quotations without obligation. Coaxial cable, fluorescent light fittings, all at special prices to the trade and Home Engineers. S.A.E. for list.

G. A. STRANGE

BROADFIELD, NORTH WRANHALL,
nr. Chippenham, Wilt. Tel. Marchfield 236

AERIALS

TV AERIALS

Band I, H. Mast Fitting	£1 15 0
Band III, 5 Ele Mast Fitting	£1 10 0
Band III, S/D and 4-Array	£1 15 0
Band IV, 9 Ele Array	£1 10 0
Band IV, 18 Ele Array	£2 18 6
Landing Kits from 10/-; Poles, Co-ax Bd., Grade "A" 1/4, Plugs 6d.	

C.W.O., S.A.E. for list.

TELEINDUSTRIES LTD.
BREAKSPEAR ROAD, RUISLIP, Middlesex

FOR SALE

VALVE CARTONS at keen prices. Send 1/- for sample and list. J. & A. BOX-MAKERS, 75a Godwin Street, Bradford 1.

RECTIFIERS

SILICON TV 6j- or complete with matn. resistor-condenser 7/6.

Rectifiers—Contact Cooled
14RA1282/FC101 13/6; 18R02281/FC124FW 13/6; EC1 12/6; EC2 12/6; FC116 7/6; 14RA1283 (FC31) see Silicon.

Rectifiers—Fin Types
Eppis. for RM1 9/6; RM5 17/6; 14A97 13/6; 14A86 10/6; PK2 17/6; EK6 17/6; 14A919 19/-; LW15 19/-; LW1 19/-; 14A100 19/-; 14A989 10/-; LW12V-1A 5/-; 2A 7/-; 4A 10/6.

MULTIMETERS from 32/-
Stamped envelope for full latest selection and bargain offers in cheap meters, Radios, Baby Alarms, Intercoms and Walkie-Talkies.

Line O.P. Trans: all 30/- each
Murphy V35 and V291, Cosmo 948, Philips 1446U/45 and 1740 45 with PV51.

DURHAM SUPPLIES
175 DURHAM ROAD, BRADFORD 8, YORKS.

WANTED

WANTED: Turret Tuner for Philips TV. Model 1768u, in working order. Martin, 7 The Cottages Glen Striven Road, Toward, by Dunoon, Argyll.

NEW VALVES WANTED. Popular T.V. and Radio Types. Best cash price by return. DURHAM SUPPLIES, 175 Durham Road, Bradford 8, Yorkshire.

WANTED—Popular Brand New Valves—R.H.S. Stamford House, 538 Great Horton Road, Bradford 7.

WANTED
(continued)

SERVICE SHEETS purchased. HAMILTON RADIO, Western Road, St. Leonards, Sussex.

DAMAGED AVO METERS WANTED. Models 7 and 8. Any condition. Any quantity. HUGGETTS LTD., 2-4 Pawsen's Road, West Croydon. Send for packing instructions.

WANTED—Willing to pay for Sent., Oct. 1961 Practical Television Magazines. Mr. R. Mills, 49 Deepfield Road, Bracknell, Berks.

EDUCATIONAL

TV and Radio, City & Guilds, R.T.E.B. Certs., etc. on "Satisfaction or Refund of Fee" terms. Thousands of passes. For full details of exams and home training Courses (including practical equipment) in all branches of Radio, T.V., Electronics, etc. write for 132-page Handbook—FREE. Please state subject. BRITISH INSTITUTE OF ENGINEERING TECHNOLOGY (Dept. 172K), Aldermaston Court, Aldermaston, Berks.

BECOME "Technically Qualified" in your spare time, guaranteed diploma and exam. home-study courses in radio, T.V. servicing and maintenance. T.T.E.B., City and Guilds, etc.; highly informative 120-page Guide—FREE, CHAMBERS COLLEGE (Dept. 858K), 148 Holborn, London, E.C.1.

TECHNICAL TRAINING

CITY & GUILDS (electrical, etc.) on "Satisfaction or Refund of Fee" terms. Thousands of passes. For details of modern courses in all branches of electrical engineering, electronics, radio, T.V., automation, etc., send for 132-page handbook—FREE, B.I.E.T. (Dept. 173K) Aldermaston Court, Aldermaston, Berks.

SITUATIONS VACANT

RADIO AND TV Exams and Courses by Britain's finest home study School. Coaching from Brit.I.R.E., City and Guilds Amateur's Licence, R.T.E.B., P.M.G. Certificate etc. Free brochure from British National Radio School, Russell Street, Reading.

ALDERMASTON COURT POSTAL TRAINING for B.Sc. (Eng.) Part I, A.M.I.E.R.E. A.M.S.E., City and Guilds, pay and security as Technician or Technologist. Thousands of Passes. For details of Exams and Courses in all branches of Engineering, Buildings, Electronics, etc. (including latest information on C.Eng.), write for 132-page Handbook—FREE. Please state interest. BRITISH INSTITUTE OF ENGINEERING TECHNOLOGY (Dept. 171K), Aldermaston Court, Aldermaston, Berks.

SERVICE SHEETS

SERVICE SHEETS (75.000) 4/- each; Please add loose 4d stamp; callers welcome; always open; THOMAS BOWER, 5 South Street, Oakenshaw, Bradford.

SERVICE SHEETS, Radio TV, 5,000 models. List 1/6. S.A.E. enquiries. TEL-RAY, 11 Maudland Bank, Preston.

SERVICE SHEETS (continued)

SERVICE SHEETS

4/- each, plus postage

We have the largest supply of Service Sheets for all makes and types of Radios and Televisions, etc. in the country (speedy service).

To obtain the Service Sheet you require please complete the attached coupon:

Name:

Address:

To: S.P. DISTRIBUTORS

35/36 Great Marlborough Street, London, W.1

Please supply Service Sheets for the following:

Make:

Model No. Radio/TV

Make:

Model No. Radio/TV

Make:

Model No. Radio/TV

I also require new 1967 List of Service Sheets at 1/6 plus postage.

(please delete items not applicable)

I enclose remittance of (which includes postage)

MAIL ORDERS ONLY (Aug Pt.)

NEW VALVES

Guaranteed Set Tested 24 HOUR SERVICE

Table listing various valve types and their prices, including models like 1R5, 1S5, 1T4, etc.

Postage on 1 valve 1d, extra. On 2 valves or more, postage 6d, per valve extra. Any parcel insured against damage in transit 6d, extra.

Office address, no callers.

GERALD BERNARD 83 OSBALDESTON ROAD STOKES NEWINGTON LONDON N.16

SERVICE SHEETS (continued)

SERVICE SHEETS

For all makes of Radio, Television, Tape Recorders, 1925-1967. Prices from 1/-.

Catalogue of 6,000 models, 2/6. Free fault-finding guide with all Service Sheets.

Please send Stamped Addressed Envelope with all orders and enquiries.

HAMILTON RADIO

Western Road, St. Leonards, Sussex

RADIO 2/-, TV 3/-. Manuals 5/-. C.W.O. S.A.E. Model No., HOPKINS, 44 Dale Valley, Poole.

SERVICE SHEETS with free fault finding chart 3/-. S.A.E. LESMAR, 17 New Street, Andover, Hants.

PADGETTS RADIO STORE

OLD TOWN HALL, LIVERSEDGE, YORKS.

Telephone: Cleckheaton 2866

Speakers Removed from TV Sets. All 3 ohm PM and perfect 6 x 4in. and 6in. round 3/-, post 2/6. Six for 22/-, post paid. 7 x 4in. 5/-, post 2/9. Six for 34/-, post paid. 8in. round 6/6, post 3/6.

New 10W Speakers with Built-in Tweeter, 28/6, post paid. 3 or 15 ohm Coil.

VALVE LIST

Ex. Equipment, 3 months' guarantee. 10P1, EF80, EB91, ECL80, EF50, PY32, PZ30, 20P3. All at 10/- per doz. Post paid, Single valves post 7d.

Table listing various valve types and their prices, including models like AKP12, EB91, EF80, etc.

NEW VALVES EX UNITS

1T4, 2/-; 1L4 2/-; 1A3, 2/6; 1S5, 2/6; 12AT7, 3/-; 6A4, 2/6; EF91, 2/-; EB91, 1/3; EL91, 2/-; U19, 4/-; 6SN7, 2/6; 10P13, 4/-; box of 50 A1P 12 Valves, 22/-, post paid.

New Boxed TV Tubes 14in. MW36/44, 40/- Carriage 10/- 12 months' guarantee. 90 degree Tubes, Twelve months' guarantee. Slight glass fault, 30/- and 50/- Carriage 10/-.

Special Offer, 19 Sets, Mark 3, in good clean condition. Parts removed. B section, 90/- valve, and TX section made US. Receiver Bench Tested all you would need is a Power Pack. Price 35/-, Carriage 10/-.

19 Sets in fair condition as above and also removed is the meter and relay. 10/- Carriage 10/-, Not tested.

Reclaimed Tubes, Six months' guarantee. AW43/80, 40/-; MW43/80, 30/-; MW33/69, 30/-; CRM12, 30/-; CRM12, 17/-, 12in Tubes, 10/-; 17in. Tubes, perfect but without guarantee, 17/-, Carriage on any Tube in G.B. 10/-.

Ex Washing Machine Motors. Fully guaranteed. Single phase 1 h.p., 26/-, Sixth h.p., 15/- Plus carriage, 10/-.

Our new Walk Round Room is now open. Full of Surplus Bargains. Also our Special Department, nothing over 6 pence.

NEW RANGE U.H.F. AERIALS for BBC2 (625) line transmissions

All U.H.F. aerials now fitted with tilting bracket and 4 element grid reflectors. Loft Mounting Arrays, 7 element 35/-, 11 element 42/6, 14 element 50/-, 18 element 57/6. Wall Mounting with Cranked Arm, 7 element 60/-, 11 element 87/-, 14 element 75/-, 18 element 82/6. Mast Mounting with 2in. clamp, 7 element 42/6, 11 element 55/-, 14 element 62/-, 18 element 70/-, Chimney Mounting Arrays, Complete, 7 element 72/6, 11 element 80/-, 14 element 87/6, 18 element 95/-. Complete assembly instructions with every unit. Low Loss Cable, 1/6 s.d. U.H.F. Preamps, from 75/-. State clearly channel number required on all orders.

BBC · ITV · FM · AERIALS

BBC (Band D), Telescopic 5ft. 21/-, External S/D, 30ft. plus, 22-10/0. ITV Band 3, 3 element loft away, 25/-, 5 element, 35/-, Wall mounting, 2 element, 35/-, 5 element 50/-, combined BBC/ITV. Loft 1+3, 41/3; 1+5, 48/9; Wall mounting 1+3, 56/3; 1+5, 63/9; Chimney 1+3, 63/9; 1+5, 71/3. VIII transistor preamps, 75/-.

F.M. (Band 2), Loft S/D, 12/6, "H", 30/-, 3 element, 52/6. External units available. Co-ax cable, 8d, yd. Co-ax plus, 1/3. Outlet boxes, 4/6. Diplexer Crossover Boxes, 12/6. C.W.O. or C.O.D. P. & P. 5/-, Send 6d. stamps for illustrated lists.

Quotations for special arrays available on request.

K.V.A. ELECTRONICS (Dept. P/T)

27 Central Parade, New Addington Surrey (CR0-0JH) LODGE HILL 2266

FIRST-CLASS RADIO AND T/V COURSES... GET A CERTIFICATE!

After brief, intensely interesting study - undertaken at home in your spare time - YOU can secure a recognised qualification or extend your knowledge of Radio and TV. Let us show you how.

FREE GUIDE

The New Free Guide contains 120 pages of information of the greatest importance to both the amateur and the man employed in the radio industry. Chambers College provides first rate postal courses for Radio Amateurs' Exam., P.T.E. Servicing Cert. C. & C. Telecoms., A.M.I.E.R.E. Guide also gives details of range of diploma courses in Radio/TV Servicing, Electronics and other branches of engineering, together with particulars of our remarkable terms of

Satisfaction or refund of fee

Write now for your copy of this invaluable publication. It may well prove to be the turning point in your career.

FOUNDED 1885 - OVER 150,000 SUCCESSES

CHAMBERS COLLEGE

(Incorp. National Inst. of Engineering) (Dept. 884V), 148 HOLBORN LONDON, E.C.1

REBUILT TUBES!

You're safe when you buy from RE-VIEW!



- ★ Each tube is rebuilt with a completely new gun assembly and the correct voltage heater.
- ★ Each tube comes to you with a guarantee card covering it for two years against all but breakage.
- ★ Each tube is delivered **free** anywhere in the U.K. and insured on the journey.
- ★ Each tube is rebuilt with experience and know-how. We were amongst the very first to pioneer the technique of rebuilding television tubes.

HERE IS WHAT YOU PAY:

12in. . . .	£4.15.0
14in. . . .	£5. 0.0
15in. . . .	£5. 5.0
17in. . . .	£5. 5.0
19in. . . .	£5.15.0
21in. . . .	£7. 5.0

Cash or cheque with order, or cash on delivery

Discount for Trade
Old Tubes Purchased

RE-VIEW ELECTRONIC TUBES

237 LONDON ROAD, WEST CROYDON, SURREY. Tel. THOrnton Heath 7735

BBC2, TV, RADIO & TAPE REC. SPARES

UHF/625. Modify your set to BBC2. 1955 to 1965 models covered. Selection of new manufacturers' converter kits and tuners at reduced prices. List available. **SPECIAL OFFERS:** FERGUSON 625 1F amp. chassis NEW incl. 6 valves 39/6 (less valves, 19/6). Circuit and Instr. 3/6. p/p 4/6. PHILIPS 625 conversion kit, incl. tuner, 1F amp., valves, circuits etc. £3.10.0, p/p 6/6. GEC/SOBELL dual 405/925 1F amp. and output chassis, NEW 45/6, p/p 4/6. **UHF TUNERS.** NEW, with valves, 30/6. PHILIPS transistorised 70/6, p/p 4/6. **TV SIGNAL BOOSTER UNITS.** Steady gain all stations. PYLE/LAB/FAIR trans'd. BBC1/ITA or UHF Battery "plug in", 75/6. UHF Mains "plug in", 87/6. UHF Masthead 105/6. Post free. **FIREBALL TUNERS.** New or Man. tested, Ferguson, H.M.V., Marconi 92/6. Philips, Ultra, Emerson, etc. 75/6. Quantity used/good condition 30/6. P/P 4/6. **PUSH BUTTON TUNERS.** 1st class/good condition for Sobell 250, RGD 612, 619, REG 17/18, 192 30/6. P/P 4/6. **TURRET TUNERS.** New, Cyclon C. 38 Mc/s 20/6, KB 16 Mc/s, KB MV/P 38 Mc/s 10/6, P/P 4/6. Many others available. Tech. repl. service for Pyle, Perk., Sobell, Philips, Stella, IBC, McMich, etc. Large selection channel coils. **CRTs.** Rebuilt, guar. 15in. 70/6, 30" 85/6; 17, 19in. 110/6, 105/6. Callers only. **LINE OUTPUT TRANSFS.** Popular types available, brand new exact replacements fully guar. A selection which can be supplied:—

PHILIPS 1768/1774, STELLA 8617/1017	98/6
EKCO 221 to 331 (U25 types)	42/6
FERRANTI 1001 to 1011 (U25 types)	42/6
EKO/FERRANTI U25 types 70" 90"	58/6
EKCO 344, FERRANTI 1023 range,	78/6
DECCA DM1, 2, 17; DM3C DM4C (70")	78/6
FERG 305, 306, 308, 42/6; 406, 500 range.	58/6
FERG. HMV, MARCONI, ULTRA 3600,	50/6
2600, 4600, 5000 range	30/6
KB H160 to MV60, 20" - 44" 20", RV20 range	30/6
MARCONI, VT157, 159, 160, 164,	58/6
GEC 1252, 1748, 2745 range 58/6 later models	72/6
HMV 1865, 1866, 42/6; 1870/6, 1890/6	58/6
PYE V14, V17, CFM17, 1721, 110 to 510	62/6
P.A.M. INVICTA equiv. LOPT's to above Pye	82/6
SOBELL TP8180, SC24, SC270 range	72/6

Also ALBA, BUSH, COSSOR, McMICHAEL, MURPHY, ULTRA, etc. Postage and Packing for L.O.T.S 4/6, C.O.D. 3/6 extra. **SCAN COILS.** Frame o/p frame osc. transf., width/linearity coils, sound o/p transf., mains droppers, control knobs, dual vol., controls, line osc., transf. resistors, condensers, etc. **TAPE REC/CHANGER.** Drive Belts, Heads Pinch Wheels, Idlers, Motors for most British (incl. WALTER) and Continental. **SALVAGED COMPONENTS.** Large selection for popular models, clean, serviceable condition, turrets, transformers, etc. ENQUIRIES invited, quotations given. C.O.D. despatch available.

MANOR SUPPLIES

64 GOLDERS MANOR DRIVE, LONDON, N.W.11

Callers: 589b, HIGH ROAD (nr. Granville Road), N. Finchley, N.12
(10.30am-5.30pm, Sun. 11.30am-5.30pm, Aug. 14 to 23), HIL 9118.



THE ORIGINAL VHF DUAL BAND TUNABLE PRE-AMPLIFIER

Still the best of its kind available. Latest low-noise transistor and printed circuit. Boosts Band I and III simultaneously without switching. Two amplifiers in one. Can produce good viewing out of almost nothing in fringe areas. Ideal for DX work. Guaranteed gain: Minimum 18 dB Band I, 14 dB Band III. Channels: Red spot, Band I, 1, 2 and 3, all Band III. Yellow spot, Band I, 3, 4 and 5, all Band III. Power: Self-contained 9V PP4 battery. 11mA. Plastic case 3 1/2 x 3 1/2 x 2 1/2 in., brown, with cork base. Retail price, £3.15.6, complete with battery. OR self-contained mains version, retail price £5.17.6. Specify channels, one Band I, one Band III.

THE KING UHF TELEBOOSTER FOR BBC2

Unique design, employing quarter-wave cavity resonator for 100% stability, printed circuit for reliability, with the very latest second generation low-noise transistor. Channels: Blue spot 25-45, White spot 45-65, tunable. Plastic case 3 1/2 x 3 1/2 x 2 1/2 in., brown, with cork base. Retail price, £4.17.6, complete with battery. OR self-contained mains model, £6.15.0.

Sole manufacturers:

TRANSISTOR DEVICES LTD.

BRIDGE HOUSE, NEWTON ABBOT, Devon
Tel. 2457 *Send for literature*

RADIO AND TELEVISION SERVICING

1966-1967
MODELS

For the
first time
Colour
TV (PAL
System)



NEW—1967 Edition of RADIO & TV SERVICING

Up-to-the-minute repair data for 1966-67 popular Televisions, Radios, Radiograms, Car Radios and Record reproducers

You can't afford to be without this goldmine of money-spinning data for Radio and TV Repair. It's packed with the Circuits, Diagrams, Alignment data and Repair hints you must have for the 1966-67 popular TVs and Radios. PLUS the very latest facts on COLOUR TV. All this in one essential 496-page volume that will more than repay its low cost on one repair job alone. Prove this for yourself. Send no money now—simply post the coupon below and this time-saving volume is yours to use for seven days WITHOUT OBLIGATION TO BUY. It's a great money-maker!

Vital Repair hints, Circuits and Data for all these makes

Alba - Baird - Bush - Cossor - Dansette - Decca - Defiant - Dynatron - Ekco - Ferguson Ferranti - Fidelity - G.E.C. - Grundig - H.M.V. - Kolster-Brandes - Marconiphone Masteradio - Murphy - National - Pam - Perdio - Philips - Pye - R.G.D. - Regentone Roberts' Radio - Sanyo - Sharp - Standard - S.T.C. - Stella - Thorn - Ultra.



**Big 32-page section of advance data on
COLOUR TELEVISION (PAL SYSTEM)**

Compiled by W. A. Montgomery, B.Sc. Head of Advanced Development Group, Consumer Products Division, S.T.C. This new, illustrated feature explains the basic encoding and decoding processes which will be in use shortly.

**496 PAGES
Nearly 270 Circuits**

Over 290 printed panel diagrams, layout diagrams and waveform graphs. Strong maroon binding with gold lettering to match volumes previously published in this famous series.

It's yours on 7 days Free Trial

Buckingham Press Ltd., Headington Hill Hall, Oxford
Without obligation to buy, please send—

RADIO & TV SERVICING 1966/67 Models
5/- dep. 10/- monthly for 8 months, paying subscription price of 85/-, Cash price in 8 days 80/-

RADIO & TV SERVICING 1965/66 Models
5/- deposit, 10/- monthly for 8 months, paying subscription price of 85/-, Cash price in 8 days 80/-

Tick (✓) your choice above.

If both titles kept 10/- deposit, then 10/- monthly for 16 months paying £8 10s. in all, Cash price in 8 days £8.

If you accept this application I will either send deposit in 8 days, then monthly payments—or cash price(s) in 8 days—or return the books.

If under 21 your father must fill up coupon

Full Name (BLOCK LETTERS) (Mr., Mrs., Miss)
Tick ✓ where applicable

Address

The address on left is —

My Property

Rented unfurnished

Parents' Home

Furnished Accom.

Temporary Address

Occupation

Signature

R67 R66 3021

You can also see on Free Trial
RADIO & TV SERVICING
(1965-66 Models)

If you missed seeing the 1966 edition of Radio & TV Servicing take advantage of this offer. There is only a limited number of these big 496-page volumes available. When stocks are exhausted there can be no reprint.

Full Servicing Data for nearly 390 POPULAR MODELS—over 600 Circuits, Layout Diagrams, Drawings and Tables. Hard wearing rich maroon Binding with gold lettering. To see this volume on Free Examination tick (✓) coupon on left.

