

TRENDS IN TV DESIGN

# Practical Television <sup>16</sup>

NOVEMBER 1959

AND TELEVISION TIMES



## CONTENTS

SIMPLE LOFT AERIAL  
EHT SUPPLIES  
BAND V SIGNAL GENERATOR  
SERVICING TV RECEIVERS  
YOUR PROBLEMS SOLVED  
ETC. ETC. ETC.



This splendid AVO instrument has been developed to meet a definite demand for a sturdy pocket-size multi-range test meter at a modest price, suitable for use on modern electronic apparatus as well as for radio and television receivers, motor vehicles, and all kinds of domestic appliances and workshop equipment.

Readings are obtainable quickly and easily on a very open scale, and range selection is by means of a robust, clearly marked rotary switch of the characteristic AvoMeter type. Measurements of A.C. and D.C. Voltage, D.C. Current and Resistance are made by means of only two connection sockets.

Designed and Manufactured by

**AVO LTD** AVOCET HOUSE • 92-96 VAUXHALL BRIDGE RD. • LONDON • S.W.1  
MM.11

# Just Right for your pocket !

## THE MULTIMINOR

### 19 Ranges

**D.C. Voltage:** 0-1,000V in 7 ranges

**A.C. Voltage:** 0-1,000V in 5 ranges

**D.C. Current:** 0-1A in 5 ranges

**Resistance:** 0-20,000  $\Omega$ , 0-2M  $\Omega$ .

**Pocket Size:** 5½ x 3½ x 1½ inches.

**Weight:** 1 lb. approx.

List Price **£9 : 10s.**

Complete with Test Leads and Clips.  
Leather Case if required 32/6.

**Sensitivity:**  
10,000 ohms per volt on D.C. voltage ranges.  
1,000 ohms per volt on A.C. voltage ranges.

**Accuracy:**  
On D.C. 3% of full scale value.

On A.C. 4% of full scale value.

To meet special requirements, instruments can be supplied to a higher degree of accuracy for a small additional charge.

Telephone: VICTORIA 3404 (12 lines)

**TAKE THE PROBLEMS  
OUT OF SOLDERING**



**HENLEY  
SOLON**  
TRADE MARK

**FOR 25 YEARS THE BEST  
ELECTRIC SOLDERING IRON**

*Leaflets on request from:*  
**W. T. HENLEY'S  
TELEGRAPH  
WORKS CO. LTD.**

Engineering  
Sales Department,  
59-62 High Holborn,  
London, W.C.1  
Telephone: CHANCERY 4361

*25 watt instrument  
model (Illustrated)*

# TELEVISION TUBES REBUILT

**BUY DIRECT FROM THE FACTORY!  
12 MONTHS' GUARANTEE**

12"	-	-	-	-	£5. 0.0
14"	-	-	-	-	£5.10.0
17"	-	-	-	-	£6.10.0

Carriage and insurance 12/6 extra.

**MARSHALLS for TELEVISION**  
131 St. Ann's Road, Tottenham,  
London, N.15.

Telephone: STAMFORD HILL 3267



# Out in the blue

## 2 radio men on 4 wheels

Take one wireless truck, one wireless operator, one wireless mechanic. Drive 300 miles on rough tracks, find a spot that's just a map reference. Set up a radio station and link strike aircraft with base. Keep it going . . . stay fit. . . .

These R.A.F. men are no mere tradesmen. Nobody's mere anything in the R.A.F. Every man has skilled training, and a job he's counted on to do supremely well.

But the R.A.F. gives a man far more than "know-how." It gives him a career that's both secure and exciting. It gives him a standard of living that's hard to better in civilian life. It takes him—with his family—all over the world.

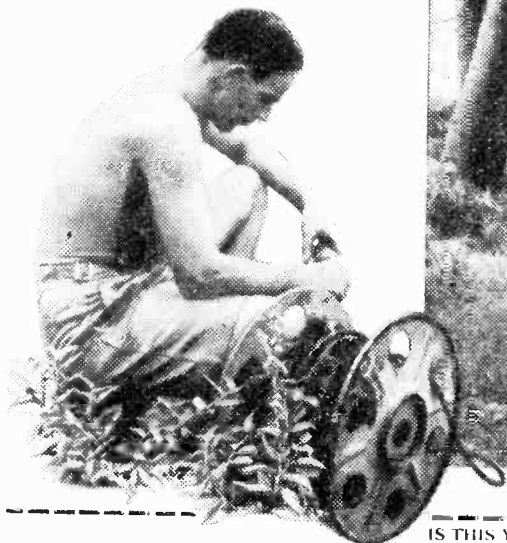

A full life in the  
**R.A.F.**

IS THIS YOUR LIFE? The R.A.F. wants men who make the most of life's chances. There are vacancies now in these key jobs. Full pay while you train, specialist pay when you qualify. Tick your particular interests, and post the coupon for free booklets about R.A.F.

Wireless Mechanic  Electrical Mechanic  Nursing Attendant  R.A.F. Regiment  Operations Clerk  Radar Mechanic  R.A.F. Police  Progress Clerk  Teleprinter Operator  Typist  Wireless Operator  Tape Relay Operator

NAME ..... DATE OF BIRTH .....

ADDRESS .....

Post to: Royal Air Force Central Recruiting Office. (PTN 19a.)  
Victory House, Kingsway, London, W.C.2.

# BENTLEY ACUSTIC CORPORATION LTD.

THE VALVE SPECIALISTS. 38 CHALCOT ROAD, LONDON, N.W.1. Telephone: PRIMROSE 9090

EXPRESS POSTAL SERVICE I ALL ORDERS DESPATCHED SAME DAY AS RECEIVED. C.O.D. ORDERS BY PHONE OR WIRE ACCEPTED UP TO 3.30 P.M. FOR IMMEDIATE DESPATCH.

ANY ORDER		INSURED	AGAINST	DAMAGE IN	TRANSIT	FOR ONLY	6d.	EXTRA.											
0B2	17/6	6C8	12/6	6X4	4/6	19H1	10/-	AC/PEN	DL94	7/6	EL33	12/6	KTZ63	10/6	QP25	15/-	UCH81	9/6	
0Z4	6/-	6C9	12/6	6X5GT	6/-	20D1	15/3	5-pin 23/3	DL96	9/-	EL34	15/-	L63	6/-	QS150/15	10/6	UCL82	11/6	
1A3	3/-	6C10	10/6	6/30L2	10/-	20F2	26/6	7-pin 15/-	DL10	10/6	EL38	26/6	LN152	10/6		10/6	UCL83	19/3	
1A5	6/-	6CD6G	7/6	12/6	20L1	26/6	AC2PEN	DM70	7/6	EL41	9/-	MH4(C)	7/-	R12	9/6	UF41	9/-		
1A7GT	29/10	7B6	19/3	20P1	26/6	23/3	AC2PEN	EA50	2/-	EL42	13/11	MHL4	7/6	R18	14/-	UF42	12/6		
21/11	6CH6	12/6	7B7	8/6	20P3	23/3	AC2PEN	EABC80	9/-	EL81	12/6	MHLD6	12/6	R19	19/11	UF80	10/6		
1C5	12/6	6D3	19/11	7C5	8/-	20P5	23/3	DD 26/6	EAC91	7/6	EL84	8/6	ML4	12/6	SD6	12/6	UF85	10/6	
1D6	10/6	6D6	6/6	7C6	8/-	25A6G	11/-	AC4PEN	EAF42	7/6	EL85	13/11	MU14	9/-	SP4(7)	15/-	UF86	17/11	
1H5GT	11/-	6E5	12/6	7D8	23/3	25L6GT	10/-		EB34	2/6	EL91	5/-	MX40	15/-	SP41	3/6	UF89	9/-	
1L4	6/-	6F1	26/6	7H7	8/-	25U4	16/7	AC5PEN	EB41	8/6	EL95	10/6	N37	19/11	SP42	12/6	UL41	9/-	
1LD5	5/-	6F6G	7/-	7R7	12/6	25Y5	10/6		EB91	5/6	EM34	10/6	N78	19/11	SP61	3/6	UL44	26/6	
1LN5	5/-	6F6GTM	8/-	7S7	10/6	25Y5G	10/-	AC6PEN 7/6	EB83	23/3	EM71	23/3	N108	19/11	SU25	26/6	UL46	14/6	
1NSGT	11/-	6F8	12/6	7V7	8/6	25Z4G	9/6	AC/P4	8/-	EB83	7/-	EM80	9/6	N308	20/7	SU61	9/6	UL84	8/6
1R5	7/6	6F11	17/3	7Y4	8/-	25Z5	10/6	AC/SG 23/3	EB81	8/6	EM81	9/6	N39	23/10	T41	23/3	UM4	17/3	
1S4	9/-	6F12	5/6	7Z4	18/7	25Z6G	10/-	AC/TP	8/6	EM84	10/6	OA70	4/-	TD44	24/7	UR1C	9/-		
1S5	7/6	6F13	11/6	8D2	3/6	25Z6GT	10/-	AC/VP1	16/7	7 pin 15/-	EBF80	10/-	EN31	37/-	OA71/81	4/-	TH48	15/6	
1T4	6/-	6F14	26/6	8D3	5/6				EBF83	13/11	EY51	9/6	OCT7	17/-	TH41	26/6	UJ7	16/7	
1U5	10/-	6F15	15/3	9B2W	15/3	27S4	19/11	AC/VP2 23/3	EBF89	9/6	EY83	16/7	P61	3/6	TH233	33/2	UJ9	7/6	
2A7	10/6	6F16	9/6	9D4	4/-	28D7	7/-	ATP4	5/-	EBL21	23/3	EY84	14/-	PABC80	TH2321	20/-	UY1N	18/7	
2P	26/6	6F17	12/6	10C1	12/-	30C1	8/-	AZ1	18/7	EBL31	23/3	EY86	10/-		13/11		UY21	16/6	
2X2	4/6	6F32	10/6	10C2	26/6	30F5	7/-	AZ31	10/6	EC52	5/6	EZ35	6/-	PCC84	8/-	TP25	19/6	UY41	7/6
3A4	7/-	6F33	7/6	10D2	12/-	30FL1	10/-	AZ41	13/11	EC54	6/-	EZ40	7/6	PCC88	23/11	TY86F	13/3	UY85	7/-
3A5	10/6	6G6	6/6	10F1	17/6	30L1	8/-	B36	24/7	EC70	12/6	EZ41	7/6	PCC89	14/-	UY12/14	12/-	VMS4B	23/3
3B7	12/6	6H4GTG	3/6	10F9	10/6	30P12	8/-	BL63	7/6	EC92	13/3	EZ80	7/6	PCF80	8/-	U16	12/-	VP2(7)	12/6
3D6	5/-	6H6GTM	3/6	10D3	8/6	30P16	8/-	C1C	12/6	EC332	10/6	EZ81	7/6	PCF82	11/6	U18/20	9/-	VP4(7)	15/-
3O4	7/6	6J5G	5/6	10D11	11/6	30P11	7/6	C8L1	26/6	EC334	24/7	FC4	15/-	PCL82	11/6	U22	8/-	VP2B	24/6
3Q5GT	9/6	6J5GTG	5/6		15/11	31	11/6	CBL31	23/3	EC335	8/6	FC13	26/6	PCL83	11/6	U24	29/10	VP4B	13/3
3S4	7/6	6J5GTM	6/6	10P13	15/6	33A/158M	10/6	CCH35	23/3	EC420	23/3	FC13C	26/6	PCL84	12/6	U25	12/6	VP13C	7/-
3V4	7/6	6J6	5/6	10P14	19/3			CK506	6/6	EC83	8/-	FW4/500	9/-	PEN4DD	26/6	U26	10/6	VP23	6/6
5R4GY	17/6	6J7G	6/6	11D3	24/7	35S1	12/6	CK506	6/6	EC83	8/-	FW4/500	9/-	PEN25	19/11	U33	26/6	VP41	6/6
5U4G	8/6	6J7GT	10/6	12A6	6/6	35A5	21/3	CL33	19/3	EC82	7/6			PEN36C	10/6	U35	26/6	VR105/30	17/6
5V4G	11/-	6K6GT	8/-	12A6	15/3	35L6GT	9/6	CV63	10/6	EC83	8/-	FW4/800	9/-	PEN40DD	10/6	U37	26/6		
5X4G	12/6	6K7G	5/-	12AD6	17/3	35W4	7/6	CV271	10/6	EC84	9/6			PEN45	19/6	U43	9/6		
5Y3G	8/-	6K7GT	6/-	12AE6	13/11	35Z3	10/6	CV429	30/-	EC85	8/6			PEN45	19/6	U45	9/6		
5Y3GT	7/6	6K8G	8/-	12AH7	8/-	35Z4	6/6	CY1	18/7	ECF80	11/6			PEN45DD	10/6	U49	16/7		
5Y4	12/6	6K8GTG	12/6	12AH8	12/6	35Z5GT	9/-	CY31	18/7	ECF80	11/6			PEN45DD	10/6	U54	19/11		
5Z3	12/6		12/6	12AT6	7/6	41MTL	8/-	D1	3/-	ECF82	10/6	H30	5/-	PEN46	7/6	U78	6/6		
5Z4G	10/6	6K25	19/11	12AT7	8/-	42	23/3	D15	10/6	ECH3	26/6	H63	12/6	PEN46	7/6	U81	10/7		
5Z4GT	12/6	6L1	23/3	12AU6	23/3	43	12/6	D63	5/-	ECH21	23/3	HABC80		PEN45DD	10/6	U84	19/11		
6A7	26/6	6L6G	9/6	12AU7	7/6	50C5	12/6	D77	5/6	ECH35	9/6			PEN46	7/6	U76	6/6		
6A8	10/-	6L6M	12/6	12AV6	12/7	50CD6G		DAC32	11/-	ECH42	10/6	HL23	10/6	PEN383	23/3	U107	16/7		
6AB7	8/-	6L7GT	12/6	12AX7	8/-	29/10		DAF91	7/6	ECH81	9/-	HL23DD		PEN45DD	10/6	U191	16/7		
6AC8	10/6	6L18	13/-	12BA6	8/-	50L6GT	9/6	DAF96	9/-	ECH83	13/11			PEN45DD	10/6	U201	16/7		
6AC7	6/6	6L19	23/3	12BE6	10/-	53KU	19/11	DC90	13/11	ECL80	10/6	HL41	17/6	PEN/DD	33/2	U251	14/6		
6AG5	6/6	6LD3	8/6	12BH7	21/3	72	4/6	DD41	13/11	ECL82	10/6	HL41DD		4020	33/2	U281	19/11		
6AK5	8/-	6LD20	15/11	12E1	30/3	75	24/7	DDT4	24/7	ECL83	19/3			PL33	19/3	U282	23/3		
6AL5	5/6	6N7	8/-	12J5GT	4/6	77	8/6	DF33	11/-	EF9	23/3	HL42DD		PL36	14/-	U301	22/7		
6AM6	5/6	6P1	19/3	12J7GT	10/6	78	8/6	DF66	15/-	EF22	14/-	HN309	24/7	PL81	12/6	U329	14/6		
6AQ5	8/6	6P25	12/6	12K5	17/11	80	9/-	DF70	15/-	EF36	6/-	HVR2A	6/6	PL82	8/6	U403	16/7		
6AT6	8/6	6P28	26/6	12K7GT	6/6	83	15/-	DF91	6/-	EF37A	8/-	PL84	12/8	PL84	12/8	U801	29/10		
6AU6	10/6	6Q7G	8/-	12K8GT	14/-	83V	12/6	DF96	9/-	EF39	5/6	PL84	12/8	PL82	18/7	U4020	16/7		
6AV6	12/6	6Q7GT	11/-	12Q7GT	6/6	85A2	15/-	DF97	9/-	EF40	15/-	KF35	8/6	PL84	12/8	U801	29/10		
6B7	10/6	6R7G	10/6	12SA7	8/6	150B2	15/-	DF97	9/-	EF41	9/6	KL35	8/6	PL82	18/7	U4020	16/7		
6B8G	4/6	6SA7GT	8/6	12SC7	8/6	185B2	33/2	DH63(Me)	17/6	EF50(A)	7/6	KL32	24/7	PM28	12/6	UABC80	X78M		
6B8GT	5/-	6SC7	10/6	12SC7	8/6	185BTA	33/2			EF50(E)	5/-	KT2	5/-	PM12	6/6		X79		
6BA6	7/6	6SG7GT	8/-	12SH7	8/6	304	10/6	DH76	6/6	EF50(E)	5/-	KT33C	10/6	PM12M	6/6	UFAF2	X101		
6BE6	7/6	6SH/GT	8/-	12S17	8/6	305	10/6	DH77	8/6	EF54	5/6	KT36	29/10	PM24M	21/3	U841	X109		
6BG6G	23/3	6S1GT	8/-	12SK7	8/6	402Pen(A)		DH101	28/6	EF73	10/6	KT41	26/6	PM4	26/6	UBC41	X109		
6BH6	9/-	6S1GT	8/-	12SD7	12/6			DH107	13/11	EF80	7/-	KT41	26/6	PM4	26/6	UBC41	X109		
6B16	7/6	6SL7GT	8/-	12SR7	8/6	807	7/6	DK32	21/11	EF85	7/-	KT44	15/6	PM25	19/8	UBC81	X109		
6BQ7A	15/-	6NS1GT	6/6	12Y4	10/6	956	3/6	DK40	21/11	EF86	12/6	KT61	12/6	PY31	5/6	UF80	X109		
6BR7	23/3	6S7GT	9/-	14H7	23/3	1821	16/7	DK91	7/6	EF89	9/-	KT63	7/-	PY32	11/6	UF89	X109		
6BW6	10/6	6S5GT	8/-	14S7	27/10	5763	12/6	DK92	10/6	EF91	5/6	KT66	15/-	PY80	7/6	UBL21	X109		
6BW7	7/-	6U4GT	12/6	15D1	26/6	7193	5/6	DK96	9/-	EF92	5/6	KT88	22/6	PY81	9/-	UCC84	X109		
6BX6	7/-	6U5G	7/6	18	23/3	7193	5/6	DL33	9/6	EF97	13/3	KTW61	8/-	PY82	7/-	UCC85	X109		
6C4	7/-	6U7G	8/6	19A5G	10/6	7475	7/6	DL66	15/-	EF98	13/3	KTW62	8/-	PY83	9/6	UCH80	X109		
6C5G	6/6	6V6G	7/6	19B6G	6/6	9002	5/6	DL68	15/-	EK32	8/6	KTW63	8/-	PZ30	19/11	UCH21	X109		
6C6	6/6	6V6GTG	8/-		23/3	9006	6/-	DL92	7/6	EL32	5/6	KTZ41	8/-	QP21	7/-	UCH42	X109		

## NEW METAL RECTIFIERS—FULLY GUARANTEED

DRM-1B	15/4	RM-2	9/-	WX3	3/6	14A100	27/-	14RA 1-2-8-2	19/-	16RE 2-1-8-1	8/6
DRM-2B	16/2	RM-3	9/6	WX4	3/6	14A124	28/-	14RA 1-2-8-3	23/6	1BRA 1-1-8-1	4/6
DRM-3B	23/3	RM-4	18/-	WX6	3/6	14A163	38/-	14RA 2-1-16-1	21/6	1BRA 1-1-16-1	6/6
LW7	22/6	RM-5	24/-	14A86	18/-	14B130	35/-	16RC 1-1-16-1	8/6	1BRA 1-2-8-1	11/-
RM-0	7/11	W4	3/6	14A97	25/-						

# Are you looking

- ★ for sound quality, rebuilt C.R.T.s with new gun units...
- ★ with immediate free delivery of one or one hundred covered by a full 12 months' guarantee...
- ★ at a price which you can afford and which is constant regardless of the type of tube?

Then please contact :

## SUFFOLK TUBES LTD

London's Largest Independent Tube Rebuilders

Suffolk Hall,  
1-3, Upper Richmond Road, Putney,  
S.W.15. Tel: VAN. 5267, 4304.



with local area distribution almost everywhere.

# A television course for you to study at home

*Entirely new! Practical!  
Bang up to date!*

## THE FAMOUS BENNETT COLLEGE OFFERS YOU THIS

An entirely new course of study based upon up-to-date techniques has now been prepared by The Bennett College.

The course is non-mathematical, and contains numerous clear diagrams, starting from the very beginning (even including the basic principles of sound radio receivers, if desired) and covering all the relevant knowledge that you need to know!

This is what you've been looking for! You can now gain thorough knowledge of this vast subject in your spare time at home. The course includes: production of the signal,

scanning and reproduction of picture from signal. Aerials, types and purpose. The cathode ray tube. Time-base oscillators, and output circuits. Synchronisation. Video frequency amplifiers. The TV tuner, turret, incremental, etc. Television test gear. Television faults.

*For more details, fill in the coupon below. Your studies cost you very little, the book you need is included in the cost.*

To THE BENNETT COLLEGE  
(DEPARTMENT L55TV) SHEFFIELD  
*Please send me details of the new  
Television Servicing Course*

NAME \_\_\_\_\_

ADDRESS \_\_\_\_\_

AGE \_\_\_\_\_

# R.S.C. (BRADFORD, LEEDS) (and MANCHESTER)

(Leeds) Ltd.

Post Terms C.W.O. or C.O.D. NO C.O.D. under £1. Postage 1/9 extra under £2. 2/9 under £5. Open to callers 9 a.m. to 6 p.m. Wednesdays until 1 p.m. S.A.E. with enquiries, please. Trade supplied.

## R.S.C. TRANSFORMERS Fully Guaranteed

Interleaved and Impregnated  
**Primaries 200-250-250 v 50 c/s screened**  
**TWO SHROUDED DROP THROUGH**  
 280-0-260 v 70 ma. 6.3 v 2 a, 5 v 2 a ... 16/9  
 350-0-350 v 80 ma. 6.3 v 2 a, 5 v 2 a ... 18/9  
 250-0-250 v 100 ma. 6.3 v 4 a, 5 v 3 a ... 23/9  
 350-0-350 v 100 ma. 6.3 v 4 a, 5 v 3 a ... 23/9  
 350-0-350 v 150 ma. 6.3 v 4 a, 5 v 3 a ... 29/9  
**FULLY SHROUDED UPRIGHT**  
 250-0-250 v 60 ma. 6.3 v 2 a, 5 v 2 a  
 Midget type 21-3-3 in. ... 17/9  
 250-0-250 v 100 ma. 6.3 v 4 a, 5 v 3 a ... 25/9  
 300-0-300 v 100 ma. 6.3 v 4 a, 5 v 3 a ... 25/9  
 350-0-350 v 100 ma. 6.3 v 4 a, 5 v 3 a ... 25/9  
 350-0-350 v 150 ma. 6.3 v 4 a, 5 v 3 a ... 33/9  
 425-0-425 v 200 ma. 6.3 v 4 a, C.T. 6.3 v  
 4 a C.T. 5 v 3 a ... 49/9

**FILAMENT TRANSFORMERS**  
 All with 200-250 v 50 c/s Primaries: 6.3 v  
 1.5 a, 5/9; 6.3 v 2 a, 7/6; 3 v 2 a, 7/9;  
 12 v 1 a, 7/11; 6.3 v 3 a, 8/11; 6.3 v 6 a, 17/9.

**CHARGER TRANSFORMERS**  
 200-250 v 0-9-15 v 11 a, 11/9; 0-9-15 v 3 a, 16/9  
 0-9-15 v 5 a, 19/9; 0-9-15 v 6 a, 23/9.

**OUTPUT TRANSFORMERS**  
 Standard Pentode 5,000 to 3 ohms ... 5/9  
 Small Pentode 5,000 to 3 ohms ... 3/9  
 Standard Pentode 7,000 to 3 ohms ... 5/9  
 Push-Pull EL to 3 or 15 ohms ... 16/9  
 Push-Pull 10-12 watts 6V6 to 3 or 15  
 ohms ... 16/9  
 Push-Pull 10-12 watts 6V6 to 3, 5, 8 or  
 15 ohms ... 18/9

**SMOOTHING CHOKES**  
 100 ma 10 h 250 ohms ... 8/9  
 60 ma 10 h 350 ohms ... 5/6  
 60 ma 10 h 400 ohms ... 4/11

**SELENIUM METAL RECTIFIERS**  
 Special quotes for quantities of 50 to 5,000.  
**I.L.T. (H.W.) F.W. (Bridge)**  
 250 v 50 ma ... 3/11 6/12 v 1 a ... 3/11  
 250 v 80 ma ... 5/11 6/12 v 2 a ... 6/11  
 250 v 100 ma ... 6/11 6/12 v 3 a ... 9/9  
 Contact Cooled 6/12 v 4 a ... 12/3  
 250 v 80 ma ... 6/11 6/12 v 5 a ... 14/6  
 250 v 75 ma ... 6/12 v 6 a ... 15/6  
 F.W. (Bridge) 8/11 6/12 v 15 a ... 27/9

**CO-AXIAL CABLE** 1in.  
 75 ohms 14/36  
 Twin-screened Feeder ... 11ft. yd.  
**STANDARD JACK PLUGS**, with  
 4ft. screened lead. 1/11.  
**STANDARD JACK SOCKETS**  
 (moulded). 2/9.

**ACCUMULATORS**, 2 v 16 A.H. New  
 Ex-Gov., 5/6 ea.; 3 for 15/.

**BATTERY SET CONVERTER KIT**  
 All parts for converting any normal type  
 of Battery Receiver to A.C. mains 200-250v  
 50 c/s. Supplies 120 v, 90 v or 60 v at 40 ma.  
 fully smoothed and fully smoothed L.T.  
 of 2 v at 0.4 to 1 a. Price including cir-  
 cuit, 49/9. Or ready for use, 9/9 extra.

**ALL DRY RECEIVER BATTERY  
 ELIMINATOR KIT**—All parts for the  
 construction of a unit (metal-cased  
 5 1/4-2 1/4 in.) to supply Battery Portable  
 receivers requiring 90 v and 1.5 v. Fully  
 smoothed. From 200-250 v 50 c/s mains.  
 Price, inc. point-to-point wiring dia-  
 grams, 39/9. Or ready for use, 46/9.

**D.C. SUPPLY KIT**—Suitable for Elec-  
 trical Trainers. Consists of mains trans-  
 former, 200-250 v 50 c.p.s., A.C. 12 v 1 Selenium  
 F.W. Bridge Rectifier, 2 Fuseholders, 2  
 Fuses, Change Direction Switch, Variable  
 Speed Regulator. Partially  
 drilled Steel Case, and Circuit. 29/9

**EX-GOV'T. CASES**, Well ventilated,  
 black crackle finished, undrilled covers.  
 Size 14 x 10 x 2 1/2 in. high. IDEAL FOR  
 BATTERY CHARGER OR INSTRUMENT  
 CASE, OR COVER COULD BE USED FOR  
 AMPLIFIER. Only 9/9, plus 2/9 postage.

**TELEVISION RECTIFIERS**  
 250 v 200 ma. Size 3 x 1 1/2 in. Brand  
 New, 6/9.

**11-F1 8-WATT AMPLIFIER**, Special  
 purchase due to cancelled export orders.  
 24/19/9. Carr. 7/6. For 200-250 v. A.C.  
 A limited number is available of these  
 highly sensitive push/pull units guaran-  
 teed brand new and in working order and  
 with separately controlled inputs for  
 1" mike and gram. etc. at least  
 B.V.A. valves. Excellent performance.

54-56 MORLEY STREET, BRADFORD.  
 5/7 COUNTY ARCADE, BRIGGATE, LEEDS, 1.  
 8/10 BROWN ST., (Market St.) MANCHESTER.  
 Mail orders to Dept. N., 29-31 Moorfield Rd., Leeds, 12.

**EX-GOV'T. MAINS TRANSFORMERS**  
 All 200-250 v 50 c/s input.

Removed from New-Ex-Gov't. units. 22/9  
 275-0-275 v 100 ma. 6.3 v 7 a, 5 v 3 a ...  
 300-0-300 v 60 ma. 6.3 v 2 a ... 11/9  
 265-0-265 v 150 ma. 6.3 v 11 a, 5 v 3 a, 5 v  
 3 a ... 29/11  
 350-0-350 v 100 ma. 6.3 v 2 a, 5 v 2 a ... 18/9  
 360-0-350 v 160 ma. 6.3 v 5 a, 5 v 3 a ... 27/9  
 400-0-400 v 250 ma. 5 v 2 a, 5 v 2 a ... 18/9  
 450-0-450 v 250 ma. 6.3 v 3 a, 6.3 v 1 a,  
 5 v 6 a ... 49/9

0-24-26-28 v 15 a ... C.C.T. (marked with D.C.  
 rating after rectification.) 69 6 Carr. 15/9.

**AUTO 0-110/120-220/240 v. 50 watts ... 8/11**

**EX-GOV'T. SMOOTHING CHOKES**—  
 60 ma 5-10 h 250 ohms ... 2/11  
 80 ma 10 h 450 ohms ... 6/9  
 100 ma 5 h 100 ohms Tropicalised ... 3/11  
 100 ma 8-10 h 100 ohms Parmeko ... 6/9  
 120 ma 10 h 100 ohms ... 8/9  
 150 ma 6-10 h 150 ohms Trop. ... 6/9  
 150 ma 10 h 150 ohms ... 9/9  
 200 ma 3-5 h 100 ohms Parmeko ... 7/9  
 0-10-25 v 24 a, 79/6, Carr. 15/9.

**R3683 UNITS**, Comprising chassis with  
 strong cover 17 x 10 x 8 ins. Over 60 res-  
 istors (many high stability) and con-  
 densers, wholders, F.T. 2's, co-ax. sects.,  
 controls, fuse-holders, tagboards, etc., etc.  
 Except, value at only 7/9 for callers only.  
**TRANSISTORS**—Audio types T51 (Brim-  
 mar), 5/8; Green/Yellow, 6/8; XB102,  
 XB104, OCT71, 10-, OCT2, 16/9; OC45, OC44,  
 17/6; V1810P Goltpo 2 watts output, 17/9.

## BATTERY CHARGERS

For 200-250 v 50 c/s A.C.  
 mains. 12 months guaran-  
 teed. Extractable well  
 ventilated hammer  
 finished cases. 6 v or 12 v  
 4 amp. with meter  
 and variable charge  
 rate selector, as illus-  
 trated. 69/9



Or Deposit 13/3 and 5  
 monthly payments of  
 13/3. Few only as above  
 but rated 6 amps. to be  
 cleared at only 4 GNS. Carr. 5/9, as cases  
 have become store soiled. Fully guaran-  
 teed. 6 v or 12 v 1 amp type. Also  
 suitable for electric train power supply.  
 Only 27/9, post 2/9.

## NEW STOCK 24 HOUR SERVICE

# VALVES

## ALL GUARANTEED

Postage:—Up to 3 6d.; 4-6 9d. Upwards of 6 see our normal terms.

1AB6 6/9	639 11/9	6V6G 6/9	20P1 12/9	DD41 8/9	EF50 4/9	KT33C 9/9	R2 9/9	UCC85 10/6
1AH5 6/9	6D1 1/9	6X2 6/9	20P2 8/9	DD42 8/9	EF54 5/11	KTW63 4/9	R3 9/9	UCH42 10/9
1AJ4 6/9	6D2 6/9	6X4 6/9	21A6 8/9	DH77 7/9	EF90 7/9	KTZ41 7/9	R12 11/9	UCL82 14/9
1CIEM 6/9	6D6 5/9	6X5 5/11	25L6 10/6	DH109 10/6	EF85 7/3	1.63 4/9	SDG1 1/9	UF42 8/9
1C3 6/9	6F1 11/9	7B7 9/9	30L1 8/9	DH142 8/9	EF86 16/9	LN152 9/9	SP6 8/6	UF89 9/9
1F1 6/9	6F42 6/9	7C5 7/9	30P16 9/9	DH147 8/9	EF89 9/9	MH4 6/9	SP35 9/9	UL41 9/9
1F2 6/9	6F13 11/9	7C8 7/9	35Z4 7/9	DH150 8/9	EF91 5/9	MU12 9/9	SP42 11/9	UL46 14/9
1F3 5/9	6F14 11/9	7AN7 7/9	41MHL 6/9	DH719 8/9	EF93 9/9	MU14 9/9	SP81 2/9	UL84 9/9
1FD1 6/9	6F15 11/9	7B7 9/9	58KU 10/9	DK91 7/9	FK90 9/9	N1 7/3	SP64 8/9	U03 9/9
1FD9 6/9	6H6 2/3	7Y4 4/9	54KU 11/9	DK96 9/9	EL32 4/9	N19 9/9	SCU1 9/9	U04 9/9
1L4 5/11	6HX6 6/6	8D2 3/3	62DDT 8/9	DL82 7/3	EL33 11/9	N37 19/9	T41 16/9	U05 9/9
1P1 6/9	6J5 4/9	8D3 6/9	62VP 7/9	DL93 7/9	EL34 16/9	N77 4/9	U18 20/9	UY41 7/9
1P10 6/9	6J6 4/9	8D4 6/9	63ME 8/9	DL96 9/9	EL38 10/9	N142 9/9	U22 7/9	UY08 10/6
1P11 8/9	6J6 4/9	9D2 3/3	65ME 8/9	DL96 9/9	EN144 10/9	N144 9/9	U24 7/9	VF32 9/9
1R5 7/9	6J7G 5/9	908 6/9	141TH 8/9	EAS0 1/9	EL84 9/9	N148 9/9	U25 14/9	V8110 3/9
1R5 7/9	6K7G 4/9	854 1/9	171DDP 8/9	EABC80 9/9	EL90 9/9	N152 9/9	U31 9/9	VU120A 3/9
174 5/11	6K7M 5/9	10C1 13/9	311SU 8/9	EAF42 8/9	EL91 4/9	N154 9/9	U35 9/9	W17 5/11
344 6/9	6K8G 8/9	6X4 6/9	451PT 7/9	EB34 2/9	EM80 9/9	N142 9/9	U42 7/9	W187 10/6
3C4 6/9	6L1 10/9	10LD3 9/9	441U 7/9	EB41 7/9	EN134 10/9	N703 9/9	U46 8/9	W150 9/9
354 7/3	6L12 8/9	10LD12 15/9	AC/EN 5/9	EB91 5/9	EY51 11/9	N727 9/9	U50 8/9	W179 9/9
3V4 8/9	6L18 11/9	10LD14 15/9	AC/HL 5/9	EY96 6/9	EY96 13/9	OM4 6/9	U52 6/9	W272 9/9
4D1 5/9	6L19 11/9	10P13 9/9	B36 8/9	EBC41 9/9	EZ35 9/9	P61 2/9	U54 10/9	WD142 9/9
5U4G 6/9	6L6G 8/11	10P14 9/9	B152 8/9	EB32 12/9	EZ80 9/9	PCF80 12/3	U78 9/9	WD709 9/9
5Y3G 7/9	6P28 8/9	10P18 9/9	B152 8/9	EBF90 9/9	EZ81 8/9	PCF82 9/9	U81 6/9	W177 9/9
5Z4G 9/9	6LD12 9/9	12A6 5/9	B309 8/9	EBF89 9/9	EZ90 6/9	PCL82 12/6	U142 9/9	X78 10/6
6AB8 12/9	6LD20 8/9	12AT7 7/9	B319 8/9	EBF85 7/9	FW4/500 9/9	PCL84 8/9	U151 9/9	X142 9/9
6AG6G 11/9	6M1 6/9	12AU6 7/9	B329 8/9	ECC81 7/9	GZ30 9/9	PEN46 8/9	U152 9/9	X719 9/9
6AJB 8/9	6N8 8/9	12AU7 6/9	B339 8/9	ECC82 7/3	GZ32 11/9	PEN3683 8/9	U153 9/9	X727 9/9
6AK8 8/9	6P25 11/9	12AX7 9/9	B719 8/9	ECC83 9/9	GZ33 10/9	PL36 18/9	U154 9/9	Y63 5/9
6AL5 5/9	6P28 9/9	12S8TP 6/9	CCH35 7/9	ECC84 9/9	GZ34 13/9	PL36 18/9	U281 9/9	Z63 8/9
6AM5 4/9	6Q7G 9/9	13S7GA 3/3	D1 2/3	ECC85 9/6	GZ37 9/9	PL81 13/9	UY22 9/9	Z66 8/9
6AM6 6/9	6S7G 6/9	13VPA 3/3	D3 2/3	ECC91 4/9	HL41DD 9/9	PL82 9/9	U319 8/9	Z77 7/6
6A95 7/9	6S8K 6/9	15A6 7/9	777 5/11	ECF83 12/9	IWA/350 11/9	PL83 10/9	U381 8/9	Z142 9/9
6A95 7/9	6S8K 6/9	15A6 7/9	777 5/11	ECF83 12/9	IWA/350 11/9	PL83 10/9	U381 8/9	Z142 9/9
6AT6 7/9	6SL7GT 7/9	16A5 6/9	849 8/9	D152 8/9	ECH81 8/9	PY31 11/9	U403 9/9	Z145 9/9
6B83 3/11	6U5G 6/9	17Z3 9/9	DAF91 7/9	DAF91 7/9	ECL80 10/9	PY80 7/9	U403 9/9	Z145 9/9
6B96 9/9	6U4GT 12/9	19X3 9/9	DAF91 7/9	DAF91 7/9	ECL82 11/9	PY81 8/9	UAF42 10/6	Z719 5/9
6BE9C 9/9	6U8 6/9	19Y3 9/9	DF92 9/9	DF92 9/9	EF39 5/9	PY82 8/9	UB41 11/9	Z729 16/9
6BG9C 16/9	6V4 8/9	20D1 14/9	DF96 9/9	DF96 9/9	EF41 8/11	PY83 8/9	UBC41 9/9	ZD17 9/9
6BY5 7/9	6V6GT 7/9	20L1 8/9	DD6 11/9	DD6 11/9	EF42 8/9	PZ30 16/9	UBF90 9/9	ZD152 5/9

**DEFERRED TERMS TO SUIT ALL POCKETS**  
**MONTHLY CREDIT TERMS OR WEEKLY EASY PAYMENTS—Details on request**

**17" T.V. 19 GNS.**

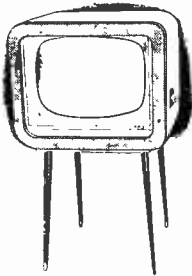

Due to overwhelming demand, some delay may occur. Please enquire when ordering.

**FEATURES :**

- ★ Beautiful latest finish cabinet in contemporary style covered and washable.
- ★ Polished legs 18in. optional extra for 25/-.
- ★ 17in. Rectangular Tube. Guaranteed fully for 12 months.
- ★ 13 channels. "Turret Tuned"—ITV/BBC. Extra coils at only 7/6 a pair (with order).
- ★ Chassis. 14 B.V.A. Valves. Salvaged but re-conditioned and guaranteed 3 months.  
Carr. & Ins. 30/-.

**REPLACEMENT RE-BUILT T/V TUBES**



**12 months' full guarantee**  
 All sizes except 10in. Completely rebuilt gun assembly, new cathode, heaters, etc., giving the high standard required for long picture life, quality and value. Carr. & Ins. 15/6.

**CASH PRICE £8/10/0**

**OR :**

Yours for 8/6 initial payment (plus Carr. & Ins.) and 19 weekly payments of 8/6.

**EXPRESS DESPATCH SERVICE**

Please phone to confirm Tube in stock. Send Telegraph Money Order. Tube despatched Passenger Train same day. This service only available with remittance by a Telegraph Money Order and cash sales, not terms.

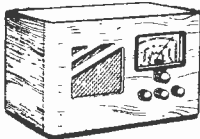

**HOME RADIO 79/6**

AC/DC. Universal mains 5 valve octal superhet 3 waveband receiver, can be adapted to gram. p.u. In attractive wooden cabinet. 9 1/4 x 18 1/2 x 11 1/2in. Ins. carr. 4/6.

**SOLO SOLDERING TOOL**  
 12/6

110 v., 6 v. or 12 v. (special adaptor for 200/250 v. 10/- extra). Automatic solder feed including a 20ft. reel of Ersin 60/40 solder and spare parts. It is a tool for electronic soldering or car wiring. Revolutionary in design. Instantly ready for use and cannot burn. In light metal case with full instructions for use. Post 3/6.



**THE LATEST ADDITION TO OUR CHASSIS RANGE**

**A complete and working 17in. T.V. chassis 24 GNS.**

Latest chassis including 17in. tube, permanent magnet speaker, 13 channel Turret Tuner (any two selected channels fitted). Other channels supplied on request at 7/6 each. 13 valves.  
 Chassis and valves guaranteed for three months. CRT. for 12 months' full guarantee.  
 Sound I.F. 19.5 Mc/s. Vision 16 Mc/s. A.C. only. Ready and working to fit into your own cabinet.  
 Carr. & Ins. 25/-.  
 As above with 14in. tube, complete and working. £19.19.0.

**RECORD PLAYER CABINET**  
 69/6

A beautifully styled cabinet. Made by a famous manufacturer. In polka dot cloth with clipped lid and carrying handle. Size 16 x 14 1/2 x 8 1/2in. deep. Will take B.S.R. Monarch 4-speed Autochanger and 7 x 4in. elliptical speaker and most of the modern portable amplifiers. Carr. & Ins. 4/6.



R.P.2.

**PORTABLE AMPLIFIER MK. D.2. 79/6**  
 12 months' guarantee.

Printed circuit. Latest design. Dimensions 7 x 2 1/2 x 5in. A.C. only. Mains isolated 3-4 watts output. Incorporating the latest ECL82 triode pentode output valve giving higher undistorted output. Volume and tone controls. Knobs 2/6 extra. P. & P. 3/6.

**PORTABLE AMPLIFIER MK. D.3 89 6**  
 De luxe model. Printed circuit. Latest design. Dimensions 7 x 2 1/2 x 5in. A.C. only. Mains isolated 3-4 watts output. Incorporating the latest ECL82 triode pentode output valve giving higher undistorted output. Volume, treble and bass control. Knobs 3/6 extra. P. & P. 3/6.

**IDEAL FOR STEREOPHONIC SOUND**

8in. P.M. Speakers, 8 9. | 7 x 4in. Elliptical Speakers, 19 6.  
 6 1/2in. P.M. Speakers, 12 6. | 9 1/2 x 4 1/2in. Elliptical Speakers, 22 6.  
 Post 2 6 | Post 2/9.

**EXTENSION SPEAKERS 19/9**

Polished oak cabinet of attractive appearance. Fitted with 8in. P.M. speaker. W.B. or Goodmans of the highest quality. Standard matching to any receiver (2-5 ohms). Switch and flex included. Ins. carr. 3/9



**AUTOCHANGERS**

**U.A.8. B.S.R. MONARCH 4-SPEED AUTO-CHANGER, £6.19.6.**

**U.A.12. LATEST B.S.R. MONARCH 4-SPEED MIXER, £8.9.6.**

**COLLARO CONQUEST 4-SPEED AUTO-CHANGER, £6.19.6.**

**COLLARO CONQUEST STEREO AUTO-CHANGER, 11 GNS.**

**T.U.9. B.S.R. 4-SPEED SINGLE PLAYER, 89/6.**  
 Carr. & Ins. 5/6.

**DUKE & CO.**

(Dept. E.II.)

**621/3, Romford Road, Manor Park, E.12.**

Tel. ILF. 6001/3.

Catalogue FREE upon request.



# 'CATHODRAY' VISCONOL CONDENSERS

for the most stringent conditions

The 'Visconol' Process — exclusive to T.C.C. — means greater dependability and a longer useful life than ever before. It is the answer by T.C.C. research engineers to the insistent demand for condensers which will stand up to higher and still higher voltages. A selection from the range is given below. Features include: low power factor; complete dielectric stability; resistant to voltage surges; ample rating at higher temperatures; proof against breakdown or flash-over. Full details on request.

Cap. in $\mu$ F.	Max. Wkg. at 60°C.	Dimens. (Overall)		T.C.C. Type No.	Price
		Length	Dia.		
.0005	25000	5 $\frac{1}{2}$	1 $\frac{1}{2}$	CP57HOO	18/-
.001	6000	2 $\frac{1}{2}$	2 $\frac{7}{32}$	CP55QO	6/-
.001	12500	3	1 $\frac{1}{2}$	CP56VO	10/-
.001	20000	2 $\frac{1}{2}$	1 $\frac{1}{8}$	CP56GOO	10/-
.002	18000	5 $\frac{1}{2}$	1 $\frac{1}{2}$	CP57XO	18/-
.01	6000	3	1 $\frac{1}{2}$	CP56QO	10/-
.02	12500	6 $\frac{1}{2}$	2	CP58VO	20/-
.05	6000	5 $\frac{1}{2}$	1 $\frac{1}{2}$	CP57QO	13/-
.1	7000	6	2	CP58QO	20/-
.25	1000	3	1 $\frac{1}{8}$	CP56V	10/-



**THE TELEGRAPH CONDENSER CO. LTD**

RADIO DIVISION: NORTH ACTON LONDON W.3 Tel: ACORN 0061

## LASKY'S RADIO



### C.R. TUBES

NEW, UNUSED & GUARANTEED

16in. Metal Cone, famous make, Type T901/B. 6 volt .3 amp. heater, ion trap, 12-14 kV. E.H.T., wide angle, standard 38 mm. neck. LIST £16.  
**LASKY'S PRICE £6.9.6.**  
Carr. & Insur., 21/-.  
Masks, Anti-Corona, Bases and Ion Traps available.

FERRANTI 9in., T9/3, 4 v. heater, triode, octal base, standard deflection. LIST £9.  
**LASKY'S PRICE 50/-**

FERRANTI 12in., T12/44 and T12/54. LIST £12.  
**LASKY'S PRICE 84/-**  
Carr. & Insur., 12/6.

**REGUNNED C.R. TUBES**  
14 in. £6.10.0. Carr. 12/6.  
17 in. £6.19.6. Carr. 21/-.  
21 in. £7.19.6. Carr. 25/-.

## TV CHASSIS SNIP

BRAND NEW, BY WELL-KNOWN MAKERS

For 200/250 v. A.C. mains. 90° deflection, 12 channel turret tuning covering all BBC and ITV channels. Complete with brand new Mullard valves and C.R. tube. Strictly limited number only, factory soiled. Write at once for full details, circuit diagram, etc.

LASKY'S PRICE

21in. 39 GNS. 17in. 29 GNS.

Other types in stock. 21 in. from 35 Gns. 17 in. from 25 Gns.

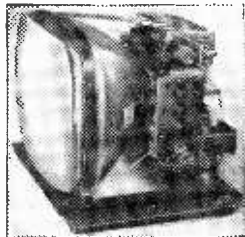

### ★ LASKY'S COMPONENTS CATALOGUE

Over 100 pages, size 8  $\frac{1}{2}$  x 5  $\frac{1}{2}$  in., copiously illustrated. The most comprehensive catalogue for the constructor. Send for your copy! Price 2/-, post 6d.

### ANOTHER SCOOP!

## 12-channel TURRET TUNER

Leading make, new and unused. Complete with PCC84 and PCF80 valves and 8 sets of coils for five Band I channels and channels I, 2, 3 Band III. I.F. 33-38 Mc/s. Limited number only, secure now! Today's value £7.

**LASKY'S PRICE 49/6**

Post 3/6.

### "STIRLING" BAND III CONVERTER

Very efficient, tunable over all 13 channels, incorporates own power supply for 200-250 v. A.C. Brown metal case, 4in. wide, 7in. deep, 2in. high.  
Cash Price **6 GNS.**  
Post 2/6.

Easy Terms: 21/- deposit and 5 monthly payments of 21/-.

### METER BARGAIN

AN/20. Pocket size 18-range Test Meter, 5,000 ohms per volt A.C. and D.C., in black leatherette-covered case, 3  $\frac{1}{2}$  x 3  $\frac{1}{2}$  x 1  $\frac{1}{2}$  in. deep. LIST 9 Gns.  
**LASKY'S PRICE £5.19.6.**  
Post 3/6.  
Leads, 3/9 extra.

### LASKY'S (HARROW ROAD) LTD.

Open All Day Saturday. Early Closing, Thurs. Mail Orders to Harrow Rd.  
42, TOTENHAM COURT ROAD, W.1. 207, EDGWARE ROAD, LONDON, W.2.  
Telephone: MUSEUM 2605. PADDINGTON 3271.2 and CUNNINGHAM 1979.





# Practical Television

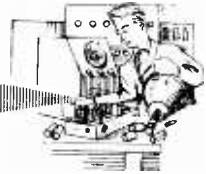

## & TELEVISION TIMES

Vol. 10 No. 110

EVERY MONTH

NOVEMBER, 1959

### TELEVIEWS

Editorial and Advertisement Offices :  
**PRACTICAL TELEVISION**  
George Newnes, Ltd., Tower House,  
Southampton Street, Strand, W.C.2.  
© George Newnes Ltd., 1959.

Phone : Temple Bar 4363.  
Telegrams : Newnes, Rand, London.  
Registered at the G.P.O. for trans-  
mission by Canadian Magazine Post.

**SUBSCRIPTION RATES**  
including postage for one year  
Inland - - £12.0 per annum  
Abroad - - £10.6 per annum  
Canada - - 19s. per annum

#### CONTENTS :

	Page
Editorial ... ..	59
Band V Signal Generator ... ..	60
Servicing TV Receivers ... ..	63
TV Without Mains ... ..	65
Simple Loft Aerial ... ..	67
EHT Supplies ... ..	68
Telenews ... ..	72
Switched Aerial Filter ... ..	74
Replacing C.R. Tubes ... ..	77
Trends in TV Design ... ..	80
Granada and the President ... ..	82
Analysing and Servicing TV Receivers ... ..	84
Correspondence ... ..	91
Faults with Focus ... ..	92
Underneath the Dipole ... ..	95
Your Problems Solved ... ..	99

The Editor will be pleased to consider articles of a practical nature suitable for publication in "Practical Television." Such articles should be written on one side of the paper only, and should contain the name and address of the sender. Whilst the Editor does not hold himself responsible for manuscripts, every effort will be made to return them if a stamped and addressed envelope is enclosed. All correspondence intended for the Editor should be addressed to: The Editor, "Practical Television," George Newnes, Ltd., Tower House, Southampton Street, Strand, W.C.2.

Owing to the rapid progress in the design of radio and television apparatus and to our efforts to keep our readers in touch with the latest developments, we give no warranty that apparatus described in our columns is not the subject of letters patent.

Copyright in all drawings, photographs and articles published in "Practical Television" is specifically reserved throughout the countries signatory to the Berne Convention and the U.S.A. Reproductions or imitations of any of these are therefore expressly forbidden.

#### SERVICE AREAS

**B**EFORE new TV stations are brought into service, an estimate is usually made of the service area. However, a special boundary survey carried out in July and August by Television Audience Measurements Ltd. revealed that satisfactory reception of programmes from Chillerton Down ITA transmitter is being obtained in several districts outside the provisional boundary. According to the survey, the southern ITV area now stretches unbroken from Lyme Regis to Beachy Head. Bexhill-on-Sea to the east of Eastbourne also qualifies for inclusion and in the Channel Islands Jersey is now part of the area. Therefore it is worth while remembering that estimates made of the service areas of projected TV stations may not be accurate particularly in the fringe areas and good reception may in fact be possible.

#### A MESSAGE TO READERS

**T**HIS magazine has always endeavoured to serve its readers in every possible way. We try to present articles which have a bearing on the latest developments in television and electronics and which can be readily understood by the "practical" man. This is a practical magazine and our policy is to cater for the amateur constructor rather than the theoretician—a policy which we are sure carries your full approval.

Many readers own television receivers and accordingly we devote a large amount of space to details of fault finding and servicing. The information given in our pages enables many amateurs to keep their sets in working order themselves without having to call in a professional TV repair man. However, we not only assist in servicing through articles in our pages but also operate a free advisory service which, as a great many of you are aware, is unrivalled; we receive hundreds of letters each week giving details of television receiver faults which are analysed by our experts and are given prompt informative postal replies. Our technicians, knowing the various kinds of "usual faults," are often able to pinpoint faulty components or valves thus enabling the repairs to be made quickly. Each month we print a selection of readers' queries under the heading "Your Problems Solved."

Unfortunately, the steadily increasing costs of both paper and production make it necessary for us to increase the price of the magazine or reduce its size. We know from views expressed by many of you in the thousands of letters which reach our offices, that the latter course would not be approved, and accordingly we have decided to make a slight increase in price. With this, and subsequent issues, PRACTICAL TELEVISION will cost 1s. 6d.

We are sure you will agree that at the new price, this magazine represents very good value and you may be sure that we shall strive to keep the editorial content at its present high value.

*Our next issue, dated December, will be published on November 20th*

# BAND V SIGNAL GENERATOR

By R. B. Archer

(Continued from page 29 of the October issue)

**A**FTER the containing and screening box has been constructed as described, in the previous article, the acorn valve can be attached to the Lecher lines.

The anode and grid pins are carefully bent so as to lie more nearly parallel, and are pushed as far as they will go into the clips attached to the Lecher lines. If construction has been carried out reasonably well, the clips should go right up to the glass seal of the valve. This is really necessary, since every millimetre counts in the tuned circuit, and extra length means lower frequency.

The L.T. supplies and cathode connections to the valve are made *via* chokes, as shown in the circuit diagram. All chokes used in the apparatus consist of 14 cm. of 22 s.w.g. bare wire, wound on a  $\frac{1}{4}$  in. drill as a temporary former—sub-

## Leads

Power and grid supplies are next fixed to the soldering tags already mounted on the mid-points of the Lecher lines. The grid lead is brought out with the heater leads, through a hole in the screening, into a small aluminium can where all three are decoupled by further chokes and condensers L5, C6, L9, C7, C10. The H.T. lead is decoupled inside the oscillator compartment by its own choke L3 and condenser C5, and brought out through a hole drilled in the Perspex baseplate.

It is stressed that extremely good lead filtering is needed if the signal generator is to have a controllable output. Self-tapping screws are used to secure the two halves of the screen together, and when the whole apparatus is completed it is enclosed in a further well-screwed-up metal container. The mains leads themselves are decoupled by similar chokes and condensers (not shown in the diagram) and a screened earthed lead to the mains plug is also specified.

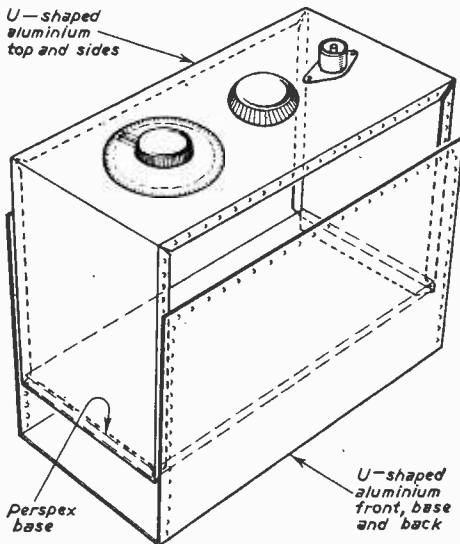

Fig. 5.—The construction of the case.

sequently the turns are spaced out by the diameter of the wire. Tag strips bolted to the baseplate are used to hold the wiring, and the valve will be found to be quite well supported in this way. If a firmer mounting is wanted for the valve, it can be secured to a Perspex projection from the baseplate with a touch of adhesive.

## The Coupling Loop

Output is taken from the oscillator by means of a small loop. This consists of 16 gauge tinned copper wire, and is fashioned so that it is of rectangular shape, sides 3.8 cm. in length and 1.6 cm. wide. The free ends are brought together and crimped individually round a piece of  $\frac{1}{4}$  in. Tufnol rod. This is used as a rotor, and can be operated by a knob on the outside of the oscillator compartment. Thin flexible wire twisted together is led from the ends of the loop to the coaxial output socket. The loop should be arranged so that it lies 2.2 cm. above the Lecher lines and parallel to them, and can be rotated so as to be at 90 deg. to them as required. The centre of the acorn is chosen as the centre of rotation of the loop. The arrangement is perhaps a little rudimentary, but it is simple and works well. The dimension specified allows for a small but sufficient coupling, and gives a correct match to an 80 ohm feeder. The match is important because it is possible that with poor matching, reflections from the feeder may result in the oscillator ceasing to operate at certain frequencies.

It is also important that the oscillator compartment has the following dimensions, as it acts as a resonant cavity and is critical at certain frequencies:—length, 20 cm.; width, 8.5 cm.; depth, 13 cm.

### The Modulator

The conventional Wien-bridge oscillator needs no special layout, any logical arrangement working well. R9 controls the pitch of the modulation tone, and by means of R5 the amplitude can be varied; near the minimum setting (maximum resistance) the stage ceases to oscillate and so allows unmodulated R.F. to be generated.

### Power Supplies

Minimum H.T. required is 200V for good operation at all frequencies, and 220V is recommended. Smoothing is by two 4.7k resistors in parallel, and two 32 $\mu$ F condensers. The L.T. supply is 6.3V at 1 amp. or less.

### Calibration

Two possible methods are open to the experimenter. Both are capable of high accuracy, but the better will be described first.

For this, a V.H.F. receiver is required, the I.F. of which is known. If the dial is calibrated, so much the better; but if not there is still no difficulty as long as the BBC station frequencies are known. The method is as follows, and the constructor will only need to modify the arithmetic slightly for any given frequencies. If it is necessary to use an uncalibrated V.H.F. receiver, the aerial should be removed after tuning exactly to the BBC station (preferably a distant one) replacing it by 6in. to 8in. of wire to prevent appreciable pick-up from the BBC.

Switch on the oscillator and modulate with a suitable tone at fairly high level. Allow to warm for five minutes at least. Switch on the V.H.F. receiver at the same time and set to 90Mc/s. At this setting the V.H.F. set oscillator is working at (90+I.F.)Mc/s. Assuming the I.F. is 10.7Mc/s.

the oscillator is running at 100.77Mc/s and is generating harmonics at 604.2Mc/s and 704.9Mc/s (among others). These will beat with frequencies of 593.5, 614.9, 694.2 and 715.6Mc/s to give a small audible response. Use a 10in. length of wire in the coaxial output socket of the signal generator as an aerial. Swing the slow-motion drive round ensuring that all four frequencies are found (maximum volume from the V.H.F. set may be needed) noting their position in degrees on the S.M. drive.

Next reset the V.H.F. set to 95Mc/s. Similarly, oscillator harmonics will beat with frequencies of 539.2, 623.5, 644.9, 739.9 and 761.3Mc/s. These should all be heard, but the top or bottom ones may be missing. Note their position—degrees also. Finally, retune the V.H.F. set to 100 Mc/s and find the response points of the signal generator at 542.8, 564.2, 653.9 and 674.9 Mc/s.

### Calibration Graph

A graph is now drawn to relate the rotation of the signal generator tuning drive to frequency, and from it a very accurately calibrated dial can be marked out. It is quite essential to plot it properly, because only in this way can one be quite certain of identifying the various harmonics correctly. However, success is certain with a little care.

It must be realised that the action of the tuning condenser is quite different from that obtaining in ordinary "lumped" circuits. With the tuning capacitor at minimum, the frequency is governed almost completely by the physical (half-wave) dimensions of the Lecher lines. However great the maximum tuning capacitance, all one can do is to short-circuit the Lecher lines to R.F.,

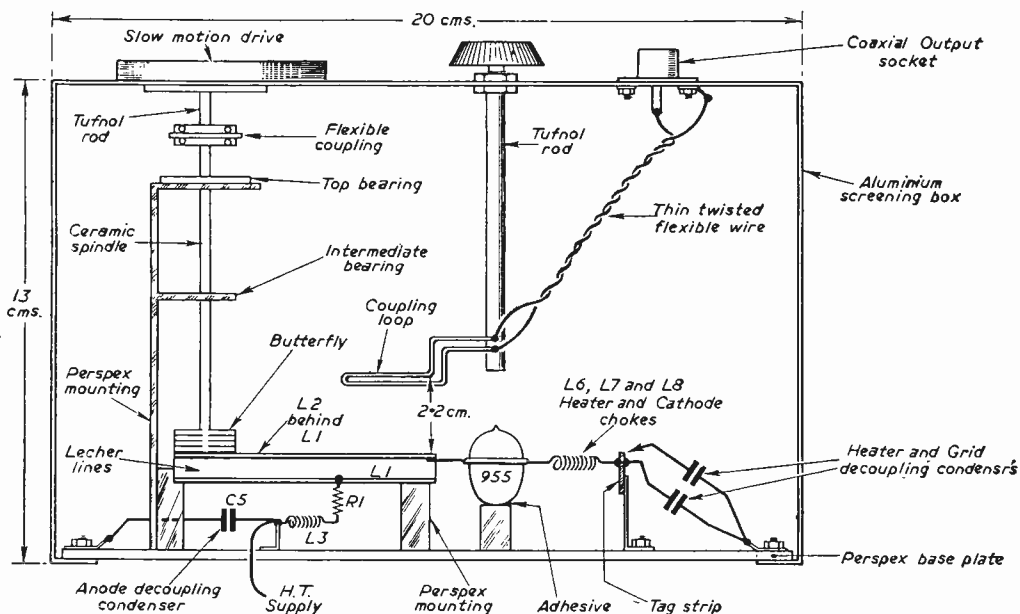

Fig. 6.—The internal layout.

in which case the frequency is governed by the same Lecher lines operating as quarter-wavelength lines. For this reason a 2:1 frequency coverage is the maximum. In the writer's apparatus the frequency goes from 540 to 765 Mc/s—the restricted coverage being due entirely to valve and other stray capacitances. Fig. 7 reproduces the writer's own calibration graph.

#### Transmission Line Method

The second method of calibration is the use of long transmission lines, which has been described previously in this journal. Briefly, the

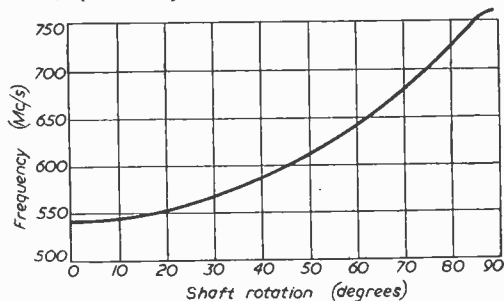

Fig. 7.—A typical calibration graph.

method is as follows:—Across the room stretch two wires, say, 20 gauge bare wire,  $\frac{1}{4}$  in. apart and dead parallel. At one end (the "near" end) short-circuit the wires. Connect the signal generator by means of a piece of coaxial cable to the lines, tapping in about 1  $\frac{1}{2}$  in. from the "near" end. Improvise a V.H.F. voltmeter from a microammeter and a silicon crystal, and, starting from the "far" end, move it along the transmission lines counting "minima" all the way along up to say 2 ft. from the "near" end. Measure the total distance and divide by the number of minima, so getting the half-wave length at that particular generator setting. Convert to frequency. Repeat for a number of signal generator settings, about 10 in all, and plot a graph as before.

This method is not so accurate. If it can be done out of doors in a field or open space better accuracy can be had. With this method 5 per cent. accuracy is hard to obtain: the accuracy by the first method is governed by the accuracy with which the I.F. of the V.H.F. receiver is known, and 1 per cent. is not too difficult to achieve. It may not be possible to work the dial with this accuracy however!

#### Conclusion

If constructed with reasonable care and to specification, a highly accurate and reliable signal generator can be made very cheaply. It has good and controllable output, and is free from "holes"—settings of which oscillation ceases. The resetting accuracy is good also. The writer's instrument has proved capable of at least 50 milliwatts output—far more than is normally needed, but useful for preliminary lining-up of circuits. The stray field is small also, but it may be necessary to fit an attenuator in the coaxial lead when finally aligning a

sensitive receiver. The frequency stability is also remarkable after a few minutes warming up; random drift of 50kc/s is the most that has been observed. Normally it will keep on the same frequency within a few kc/s for half an hour on end.

The writer is well aware that the instrument described here does not cover the whole of Band V, which extends from 610 to 960 Mc/s. Certain selected acorns may be made to operate at higher frequencies than the 750 Mc/s or so which is here regarded as the upper limit, by using shorter Lecher lines or—for the highest frequencies—a coaxial assembly. This, however, results in over-running the valves: their life tends to be short and their performance erratic. It is thought that little better can be done with conventional valves than is represented by this circuit.

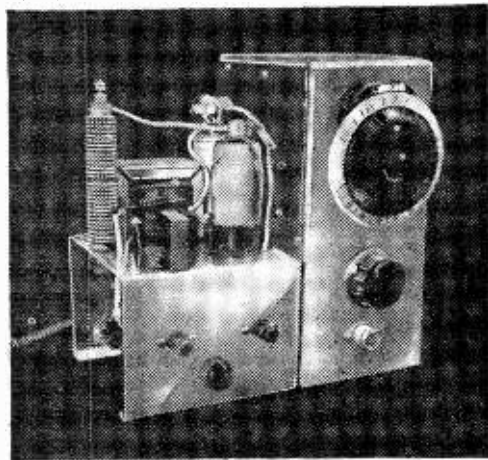

The completed generator with external power-pack.

However, the likelihood exists that the coverage is sufficient for present purposes. The circuit is moreover adaptable with ease to cover Band IV—merely by using longer Lecher lines—and the possibility of using harmonic operation might be investigated. It might result in a much larger piece of equipment, but the device of bending the Lecher lines into a semi-circle would probably reduce this difficulty.

When special V.H.F. triodes become generally available, the circuit will doubtless be usable as it stands to cover the whole of Band V.

## PRACTICAL WIRELESS CIRCUITS

17th Edition

By F. J. CAMM

17/6, by post 18/7

From

GEORGE NEWNES, LTD., Tower House,  
Southampton Street, Strand, W.C.2.



# Servicing Television Receivers

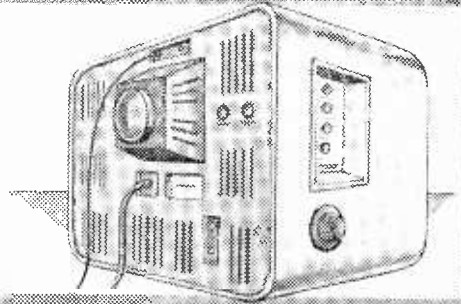

No. 50.—RAYMOND AND BEETHOVEN 14 AND 17

By L. Lawry-Johns

**T**HIS article deals with further faults in the above receivers and includes the circuit of the video and sync separator stages.

could be due to the .001 $\mu$ F decoupling capacitor shorting to chassis (pin 8 of V8) or to V8 itself shorting internally.

### No Picture

Raster shows when brilliance is increased, and sound is in order. Check V8, V9 and V10 and continuity of L4. If there are signs of overheating, check V8 valve base where the 1k $\Omega$  H.T. feed resistor may be burned out. This

### Raster Very Bright, Brilliance Control Has No Effect

Check H.T. to V10 anode (pin 7). If *absent* check L6; and if *low* check tube base pin 11 (cathode). If there is no reading suspect heater-to-cathode short in tube and use 6.3V isolating transformer as described in previous articles.

If there is a reading at pin 11 and V10 anode voltage is normal, check the brilliance control which may be o.c. at one end.

If there is no raster at all but increasing the contrast causes a poor "sooty" picture to appear and picture height is excessive, again check the brilliance control. If the symptoms are similar but with reduced height, check the height control VR4.

### No Sound, No Picture

Raster appears when VR5 advanced. Check valves 1, 2 and 3 and the H.T. supply to pin 7 and 8 in each case. If H.T. is absent at either pin on each valve base, check the associated decoupling resistor and .001 $\mu$ F capacitor.

### No Sound, Picture O.K.

Check valves V4, 5 and 6. If in order, check voltage to V4 base pins 7 and 8. If absent check the 1k $\Omega$  feed resistor and again the .001 $\mu$ F decoupling capacitor.

Low sound, distorted when contrast is advanced, should direct attention to the 1:5M $\Omega$  resistor which connects to pin 2 of V5 (EB91). If the distortion is worse as the volume control is advanced, check the .02 $\mu$ F capacitor connected to the volume control. Low volume with no distortion at

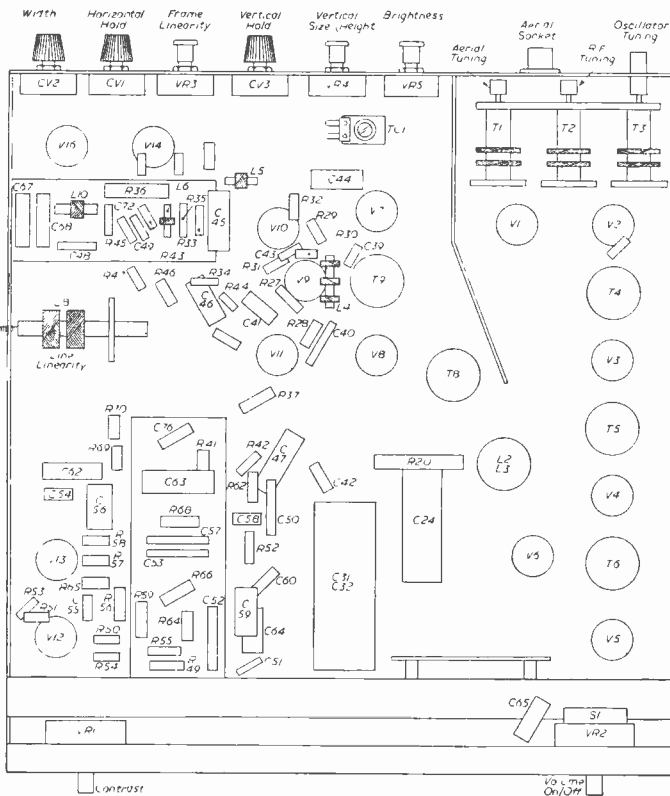

Fig. 6.—Underchassis layout.

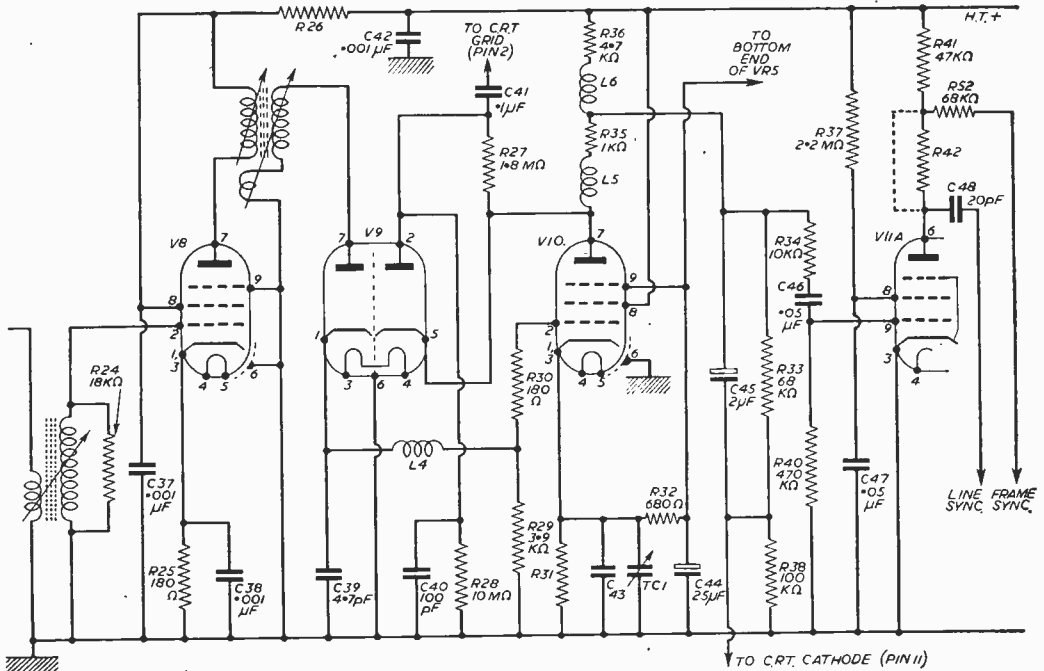

Fig. 7.—Video and sync separator stages.

all should direct attention to the 25 $\mu$ F electrolytic capacitor, pin 3 of the PL83 to chassis.

#### No Results

Valve heaters alight. Check R23, 47 $\Omega$  6 watt resistor to pin 9 of the PY82. Before replacing check V7 for shorts and the H.T. line generally. Quite often R23 will become o.c. with no defect causing it.

#### Valve Heaters Out

Check fuses. If one has gone, check V7, V14 and V16, then H.T. If fuses are in order check valve heater chain and ballast resistors R21-22. Valve heaters barely glowing, check thermistor (CZ1).

#### Voltages

EF80 valves base pins 7 and 8. 140-170V.

ECL80 (V11) Pentode Anode 110V, screen 12.5V, Triode Anode 110V.

ECL80 (V13) Pentode Anode 170V, screen 175V, Triode Anode 10V.

ECH42 (V12) Hexode Anode 170V, screen 53V, Triode Anode 11-17V.

PL81 (V14) Screen only 155V.

PY82 (V7) Anode 208V A.C. Cathode 180V D.C.

EHT 12.5kV Boosted H.T. line 360V.

#### Low H.T. Voltages

Check C31-32 main electrolytic capacitor, C32 is likely to be o.c.

## "P.T." and "P.W." FILM SHOW

ANOTHER film show, sponsored by this journal and our companion journal *Practical Wireless*, is to be held at Caxton Hall, Westminster, on Friday, January 22nd, 1960, at 7.30 p.m. when the Editor will take the chair. Admission will be by ticket only. The event, which has proved so popular in previous years, is being arranged in conjunction with Mullard Ltd.

The films are entitled "Photo Emission", "From us to View" and "Mirror in the Sky". The latter film deals with events leading up to the experiments by Sir Edward Appleton to confirm the existence of the Heaviside layer, and continues with the discovery of the Appleton layer and the developments of the pulse techniques which became the basis of radar. The film concludes with one of the latest scientific achievements—the radio telescope.

Applications for tickets should be made now. Please mark your envelopes "Caxton Hall" in the top left-hand corner and send a stamped, addressed envelope for the tickets. All applications will be dealt with in strict rotation.

### WIRELESS COILS, CHOKES AND TRANSFORMERS

8th Edition

Price 6/-, by post 6/11.

# TV WITHOUT MAINS

METHODS OF OPERATING TV RECEIVERS IN REMOTE DISTRICTS

(Concluded from page 25 of the October issue)

By F. G. Rayer

THE rotary convertor to be used must have a wattage rating at least equal to that of the receiver. The receiver consumption will be indicated in the operating instructions or elsewhere and should be known when buying the convertor. If the convertor output is given in terms of current, this may be changed to wattage by multiplying the voltage by the current. The current must be expressed in fractions of an amp., and 1,000mA equal 1A. A 200V, 500mA convertor would thus have an output of  $200 \times 0.5$ , or 100 watts. It will be noted that the current required is fairly large, and very small convertors are thus unsuitable.

## A.C. Output

Convertors are occasionally seen with an A.C. output. For example, 230V, 50 cycles A.C. output, with 110V input. With these, A.C. or A.C./D.C. receivers can be used, provided the frequency is kept reasonably near 50 cycles. Fluctuations of

Interference from the engine or convertor may easily be carried to the receiver by the wiring, and suppressors will probably be needed to minimise this, as shown in Fig. 3. The type of receiver and its location will effect interference troubles, but condensers of about  $0.05\mu\text{F}$  from each lead to convertor frame and earth may suffice. In the output circuit, small value mica condensers can be tried. Electrolytic condensers are unsuitable, despite their large capacity. Suppressor chokes may also be added in series with the leads to the receiver, with further condensers, or a boxed suppressor unit. Chokes can be wound as in Fig. 4.

The better type of plant with diesel engine will not cause trouble, but with small petrol plants a suppressor should be fitted to the spark plug, as in Fig. 5. If the generating plant is well removed from the receiver and aerial, this may be sufficient. If not, an improvement can be obtained by using a screened H.T. lead, or additional suppressor condenser. Small plants have flywheel magneto ignition and a plug suppressor should suffice.

## Locating Interference

If interference is troublesome, a few tests will help to show how it reaches the receiver. If the interference continues with the engine stopped, and the convertor running from the accumulators, then the convertor is responsible. Worn brushes or commutator can cause bad sparking, or the commutators and brushes may need cleaning with a cloth moistened with petrol. Abrasives should not be used.

If interference ceases with the engine stopped, its ignition system is most probably responsible, but the dynamo or generator must also be suspected. Here, a

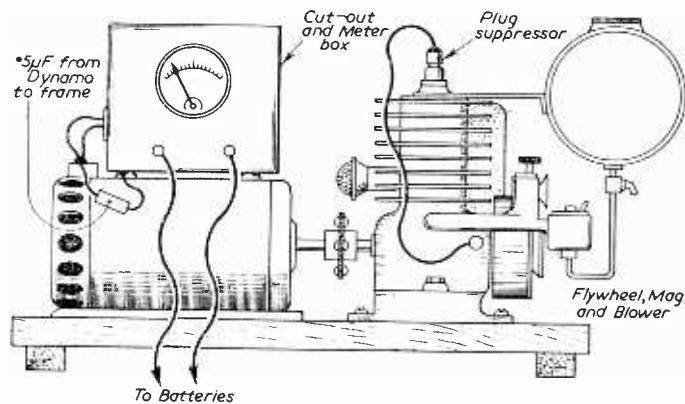

Fig. 5.—Dynamo and plug suppressors on small plant.

frequency owing to uneven running of the convertor can be troublesome with some receivers.

Convertors providing a D.C. output are suitable for A.C./D.C. receivers. An A.C. receiver cannot be operated from D.C., and the conversion of an A.C. receiver to run from a D.C. supply is usually very difficult or quite impracticable. Convertors changing D.C. to A.C., with or without a change of voltage, are sometimes obtainable, but in all except unusual circumstances (as when a D.C. supply is soon to be replaced by A.C. mains) they are scarcely justified.

## Cables

Twin mains cable of 5A or so rating will do well for wiring between convertor and receiver. The convertor is, of course, only run when the TV receiver is switched on.

dirty commutator or brushes could be responsible and suppressor condensers may be wired from brushes to frame, or output terminals to frame, as in Fig. 5.

Should interference almost cease when the aerial is disconnected, the aerial or down-lead must be suspected. If possible, these should be clear of the plant and convertor, and wiring to these items, or trouble may be caused unnecessarily. Orienting the aerial for minimum pick-up from the direction of the plant may be worth while, when this can be done without reducing signal strength too much.

A check of operating voltage is wise when first using the receiver, because some valves may be run at maximum ratings, and a low heater voltage can then be serious, while over-running is also to be avoided.

### Portable 12V TV

Receivers designed to run from a 12V accumulator supply have been available. Regular long periods of running are only possible when some means of keeping the 12V accumulator well charged is available, and a 24V or other D.C. house plant can easily be used for charging, as shown in Fig. 6 taking accumulator negative to house negative.

With a 24V supply, a 12V lamp can be used, and a 36W lamp would give a charging rate of about 3A. This lamp may be put to some useful purpose, such as illuminating a passage. With a house supply of higher voltage, the lamp voltage should be increased. With a 50V or 100V D.C. plant, a 50V or 100V lamp can be used, though it will not light at full brilliance. With these higher voltages, it will be necessary to use a lamp of greater wattage, or to leave the charging circuit operating longer each day. For example, a 50V, 48W lamp will pass just under 1A, so that longer charging periods are necessary.

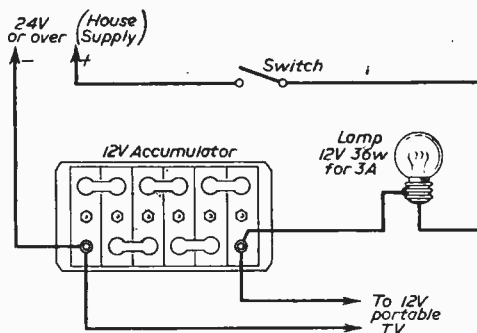

Fig. 6.—Circuit for charging a 12V battery.

Receivers of this type are more economical to run than are conventional mains receivers with converter supply, but the mains set can be run in the ordinary way from mains, if—mains should eventually become available.

## Remotely-controlled TV Camera

THE BBC Television Service has taken over for experimental trial a remotely controlled television camera developed by the engineering division.

The camera is located in the All Souls television interview studio, near Broadcasting House, but all its functions—pan, tilt, focus, zoom and iris—can be controlled from the news studio at Alexandra Palace, about six miles away.

### Servo Motors

The camera proper is of the vidicon type and can be switched on from Alexandra Palace; it is then ready to operate within one minute. The camera tripod carries a special head in which the panning and tilting movements are operated by servo motors. Additional servo motors, mounted on a plate fitted to the camera body, are arranged to drive the focus, iris and zoom controls. The operation of the motors and their associated servo amplifiers is controlled, over cable circuits, from a special console at Alexandra Palace or, alternatively, by the interviewer in the studio who is provided with push-buttons for the purpose.

Apart from the console, all the control equipment is at All Souls and is combined in a metal cabinet some 22in. square and about 5ft. high. In addition to the power supply equipment this cabinet houses the transistorised servo amplifiers, control relays and four additional sets of potentiometers for controlling the camera functions when under local control.

### Studio Control

Local control is effected by using a set of four push-buttons in a small box at the end of a trailing lead which, in conjunction with change-over controls, allow the camera to be operated locally, for example, by an interviewer, to any one of four pre-set shots.

The interviewer, by pressing the appropriate buttons, can cause the camera to show himself and perhaps two other people in a long-shot and then bring any one of the three people into close-up as required. The camera will pan and tilt as necessary, and for each shot the degree of pan, tilt, focus and zoom will be automatically adjusted to suit the particular situation. The "shot-box" as it is called is small enough for the interviewer to hold comfortably in his hand; the trailing lead is sufficiently long to give him wide freedom of movement within the area which the camera has been set to cover.

The four shots which the shot-box will produce are pre-set by controls in the control equipment cabinet and these are arranged to provide an almost unlimited range of camera angles.

The whole equipment is mains-operated and can derive its power from any convenient power point. The servo motors are A.C. driven from a 50V transformer and the transistors take their operating power from a 24V metal rectifier.

It is intended that this new technique be used for news and interview studios; an extension of the plan would enable the control to be extended over long lines if required.

### JOIN THE PRACTICAL GROUP

**PRACTICAL WIRELESS** ... .. 1/6  
Every Month.

**PRACTICAL MECHANICS** ... .. 1/3  
Every Month.  
Devoted to Mechanics, Science and Invention.

**PRACTICAL MOTORIST** ... .. 1/6  
Every Month.

**PRACTICAL HOUSEHOLDER** ... .. 1/3  
Every Month.



# Simple Loft Aerial

SUITABLE FOR ANY BBC CHANNEL

By D. Jacobs, B.Sc.

**I**N regions of high signal strength a simple indoor aerial of the pattern described below will give excellent results on both Bands I and III. The X-shaped combination of director and dipole gives a great improvement in signal

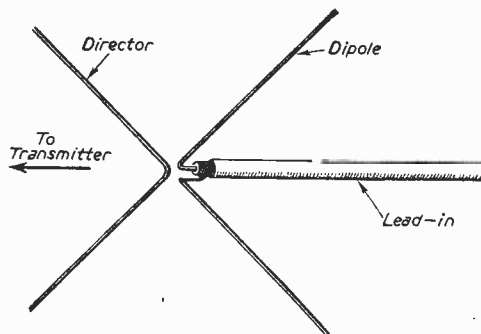

Fig. 1.—The "X" aerial.

most, 3½ yards of heavy two- or three-core electric cable; a similar length of wood (in two equal pieces), about 1in. X ½in. or so, and two dozen insulated staples. Coaxial cable to carry the signal from the aerial to the receiver is also required.

The arrangement is shown schematically in Fig. 1, where it will be seen that the aerial consists of a director between the dipole and the transmitter, both elements being bent through 90deg. This bending both increases the gain and reduces the physical size of an "H" combination of the two elements.

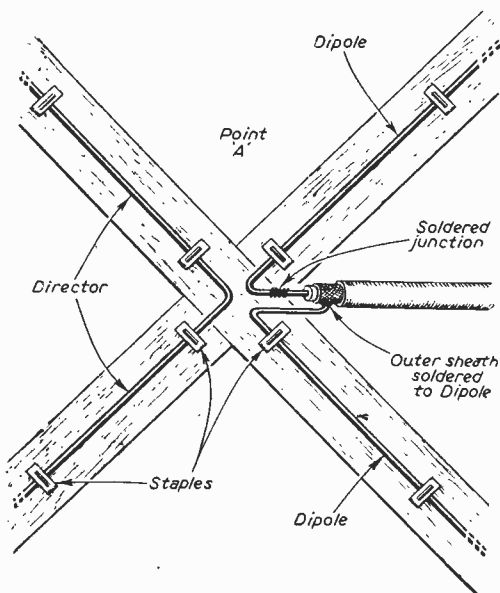

Fig. 2.—Connections to the dipole. No connections are made to the director, nor is it broken in the middle.

strength over a simple dipole. The author's aerial cost nothing to make, all the materials coming out of the spares box. All that is required is, at

Channel	Director	Dipole (2 pieces each)
1	10ft. 5in.	5ft. 5in.
2	9ft. 0in.	4ft. 8in.
3	8ft. 2in.	4ft. 3in.
4	7ft. 5½in.	3ft. 10½in.
5	6ft. 11in.	3ft. 7½in.

The appropriate lengths of the elements for the different channels are given in Table I. These are cut from the single cores removed from the cable mentioned before. This wire is fixed to the wooden X-shaped frame using insulated staples every 1ft. or so. Table II shows the sizes of the wood frame pieces required for the different channels. A single rail is used to hold both pieces together at the point A. The director is fixed on the shorter pair of limbs of this frame. This can be done best by finding the centre of the director, fixing it to the point A and working out towards the ends of the wire with staples. The dipole halves are fixed on the other two limbs of the frame. The ends of the dipole nearest the cross-over are bared and are soldered to the centre wire and outer sheath of a length of coaxial cable long enough to reach from the TV set to the loft, as shown in Fig. 2.

(Continued on page 103)

Lengths of wood required—2 of each length.			
Channel	Length	Position of Point A from one end	NOTE :
1	10ft. 7½in.	5ft. 5in.	It is permissible to use lengths up to a foot or so less than those stated, since the wire used should be rigid enough to project a few inches from the end of the frame without bending.
2	9ft. 2in.	4ft. 8in.	
3	8ft. 4in.	4ft. 3in.	
4	7ft. 7½in.	3ft. 10½in.	
5	7ft. 1in.	3ft. 7½in.	

# EHT Supplies

No. 1.—A NEW SERIES ON OBTAINING HIGH VOLTAGES FOR TV SETS AND OSCILLOSCOPES  
By W. Cleland

ON modern television receivers post-deflection acceleration demands between 10 and 16kV with the majority of picture tubes. These low-power supplies are obtained with compactness and economy in a system working at line frequency (10,125c/s) or at a low radio frequency.

### Power Output

EHT power outputs are in general less than 2W, because at the higher voltages the additional current drain of a potential divider is avoided. Sometimes, however, a chain of resistors totalling 150MΩ or more is incorporated to discharge the condensers on switching off. The potential divider required to supply the electrodes of an oscilloscope tube may draw a current of as much as 1mA, corresponding to 1W for a kilovolt of EHT

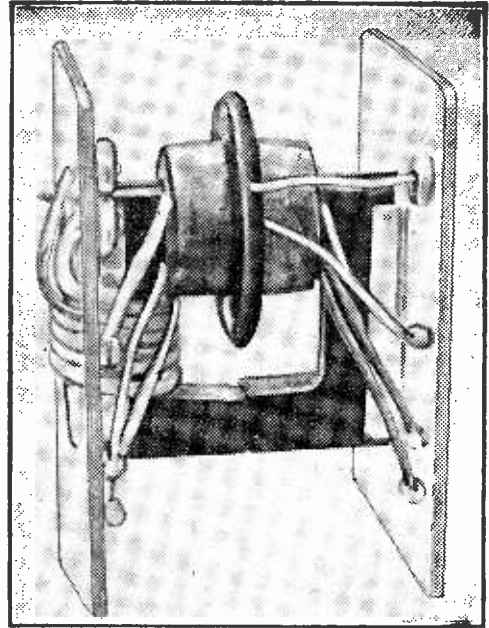

A home constructed line-output transformer.

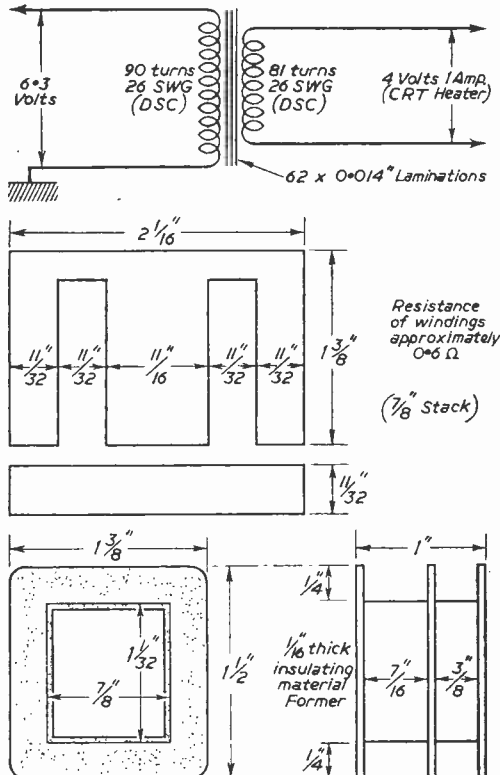

Fig. 1.—Isolating transformer to heat a C.R. tube. With a thicker gauge of wire less turns would be needed owing to the reduced resistive voltage drop.

potential. This makes the load nearly constant, especially as brightness modulation is only occasionally used in an oscilloscope. A constant load is a very desirable feature when the regulation of the EHT supply is not very good.

The voltage regulation should be sufficiently small (not more than 10 per cent., if possible, for the maximum current change) to avoid defocusing with variations in the average brightness of a picture. The average beam current of a picture tube (as compared with peaks on highlights) is normally quite small, but may rise towards 100μA on a brightly lit scene. Such an increase of current should not, if it can be prevented, cause an excessive fall in EHT voltage, as this would not only affect the sharpness of focus, but might cause the picture to expand by half an inch or more.

### Source Resistance

The effective source resistance or internal resistance of an EHT supply varies with the load, but can be specified approximately at the normal current drain, and enables comparisons to be made. When multiplied by the maximum current, it gives the maximum voltage drop that will occur, and this voltage drop expressed as a percentage of the no-load EHT voltage is the voltage regulation for that current change. An internal resistance of 1MΩ per kilovolt (10MΩ for 10kV) may be considered satisfactory, corresponding to a regulation of 5 per cent. for 50μA change of beam current.

By introducing various kinds of voltage regulators, it is possible to obtain a low internal resistance over a limited range of outputs. The voltage regulator prevents the voltage from rising so high on light loading, but is unable to prevent a

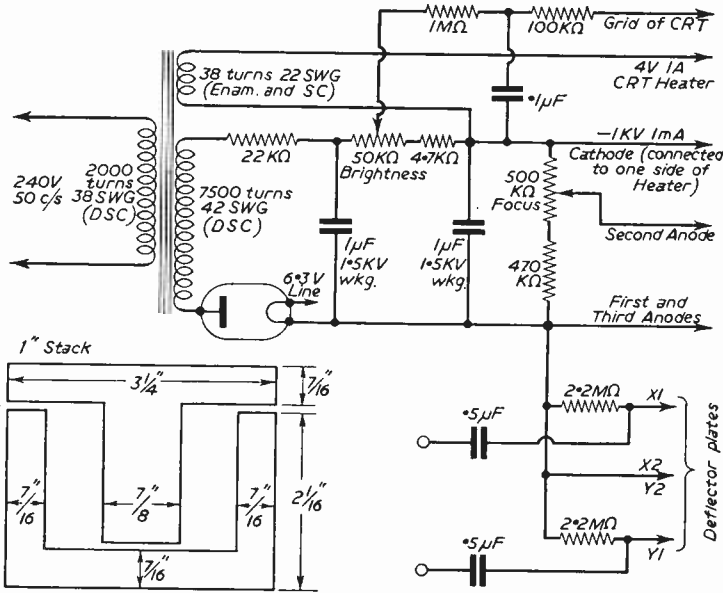

Fig. 2.—Simple C.R. tube supply, omitting the shift controls.

large voltage drop should an excessive current be drawn, since this would imply an increase of power.

**Stabilisation**

Some of the simpler types of regulator which employ special non-linear devices such as gas-filled tubes and zener diodes are used for low voltages, although at high voltages corona-type regulators and Metrosils are applicable. For closer control, direct-coupled negative feedback circuits are used, often with one of the simple types of regulator as a "voltage reference" against which a portion of the EHT output can be "compared" by subtraction, the difference voltage being fed back as a control voltage so that variations in the output are reduced. The use of a fixed reference voltage increases the degree of stabilisation and enables a standard output to be maintained even if mains variations occur.

The EHT potential should not appear before the scanning action has begun, and precautions may also be taken to prevent an intense spot on the screen after the scanning action has ceased, upon switching off, due to the residual charge in the EHT capacitor, which would in time damage the screen. This can be counteracted by deriving the cathode potential from the boosted H.T. line, and with a tetrode tube, the voltage for the second anode can also be derived from this line.

It is also desirable to arrange for the EHT voltage to disappear if the horizontal scan should fail. This usually happens automatically with the flyback type of EHT system, but it can also be arranged with other types of supply, or the spot can be blacked out by a bias voltage which is cancelled out only when both the frame and line scanning circuits are functioning. This is

particularly important in projection television, where a very bright picture is needed to overcome the low optical efficiency, and 25kV or more is required for post-deflection acceleration.

**Mains Frequency Supplies**

Moderate EHT voltages were provided in some of the earlier receivers by oscilloscope technique using a mains transformer and a half-wave rectifier. An oscilloscope, however, employs electrostatic deflection, and a negative EHT supply is convenient because it allows the voltages of the final anode and deflector plates to be brought near to chassis potential. The grid and cathode are then at a high negative voltage to the chassis, making it necessary to use a special well-insulated heater winding for the cathode-ray tube, but a small isolating transformer will

serve the purpose, fed from the ordinary 6.3V supply. Details of such a transformer are given in Fig. 1. The secondary requires to be well insulated from the primary and from the side limbs of the core.

When post-deflection acceleration is included in an oscilloscope to make rapid transients visible,

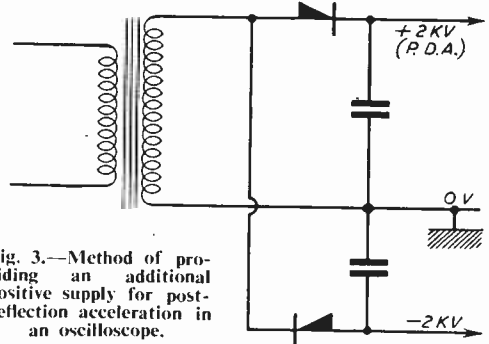

Fig. 3.—Method of providing an additional positive supply for post-deflection acceleration in an oscilloscope.

an additional positive EHT supply is provided for the graphite coating inside the flare of the tube.

In television, the EHT line is positive, with the grid and cathode of the tube at low voltages to the chassis, so making it easy to heat the tube and to apply the grid modulation giving the detail of the picture.

**Heater Supply**

The EHT rectifier of the negative supply for an oscilloscope can be heated from the same 6.3V supply as the other valves, except when a series stabiliser valve is included. However, the peak

voltage between the transformer and chassis can be halved by heating the rectifier from a separate winding, thus permitting one end of the EHT secondary to be connected to the chassis.

Since one or two watts of EHT power is all that is required, a small transformer would suffice except for the requirement that the core must have a cross-section large enough to keep the number of turns from being excessive. A 1kV supply for a small oscilloscope tube (Fig. 2) required a secondary winding of 7,500 turns.

Higher voltages would make it necessary to use a more massive transformer to keep down the number of turns, and except in fixed installations, one probably would not wish to develop more than 7kV in this way.

### Regulation

The regulation of these simple 50c/s supplies is very satisfactory. The circuit of Fig. 2 has an equivalent internal resistance of about  $60k\Omega$ , dropping only 60 volts at a current of 1mA. This, however, has its risks when the possibility of an electric shock is considered. One manufacturer recommends that the short-circuit current be limited to 5mA to protect the cathode-ray tube in the event of internal arcing. This requirement is met more conveniently by supplies of the limited energy (high frequency) type. Adding a  $200k\Omega$  limiting resistance to the preceding 50c/s supply would considerably worsen the regulation over the normal range of currents, but a filter resistance will, however, be necessary.

At mains frequency, capacitors of values up to  $1\mu F$  are necessary, depending upon the current taken by a potential dividing network, and upon the series filter resistance. The charge stored by such a capacitor can be dangerous if the energy exceeds one joule, which is the amount stored in a  $2\mu F$  capacitor at 1kV. The amount of energy stored is proportional to the capacitance, but increases as the square of the voltage, so that at 10kV it is a hundred times as large as at 1kV and to discharge a large capacitor at such a voltage would yield not a mere spark, but a flash accompanied by a loud bang.

### Charge Stored

The charge stored by a  $1\mu F$  capacitor at 1kV is 1millicoulomb (proportional to capacitance and also to voltage). The instantaneous current which a capacitor can deliver may be very large, and if the charge exceeds 250 microcoulombs it is recommended that a resistance of  $16k\Omega$  should be inserted between the EHT capacitor and the cathode-ray tube, as a protection should internal arcing occur. This is not, of course, possible when the EHT capacitor consists of the inner and outer graphite coatings of the picture tube itself.

An auxiliary or alternative method of stepping up the voltage is to use a multiplier chain of rectifiers and capacitors. The simplest example is the provision of positive and negative EHT lines as in Fig. 3, in what amounts to a voltage-doubling system. Extended chains can be employed as in the circuits of Fig. 4 which produce an output of 2.5kV at about 1mA from an input of 380V r.m.s. Pencil rectifiers of 5mA

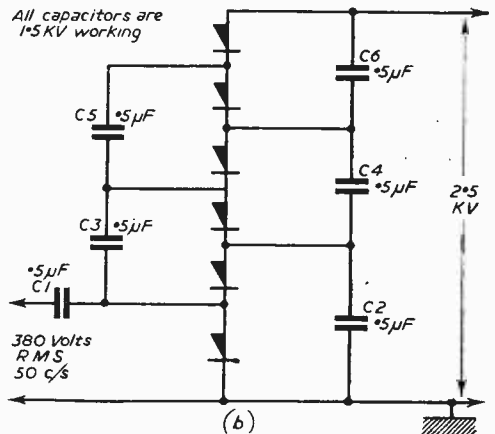
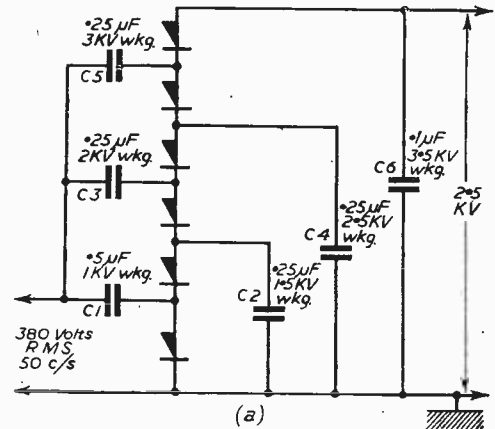

Fig. 4.—Voltage multiplying rectifier system.

rating are used in this circuit, but for an output current in the region of  $100\mu A$ , it would be possible to use 1mA rectifiers.

### Source Resistance

The effective internal resistance of the supply is decided by the load rather than the input voltage, and decreases when a larger current is drawn. In the circuits of Fig. 4, the internal resistance is about  $0.8M\Omega$ . Connected as in (a), the capacitors require to be of increased working voltage towards the top end of the chain. This can be avoided with series connection as in (b), but larger values of capacitance are required.

One advantage of multiplier systems is that short-circuiting the output will not damage the rectifier as it will in simple half-wave rectifier systems.

### Operation

The working of multiplier chains is easily understood. Referring to Fig. 4 (a), current flows through the bottom rectifier into C1, on one half-cycle, and on the next this rectifier ceases to conduct. The voltage on C1 then adds to the input voltage of the second half-cycle and C2 is charged



through the second rectifier to this combined voltage. When the first half-cycle resumes, not only is C1 recharged, but C3 is charged by the voltage on C2 added to the input voltage. Thus every second rectifier conducts on one half-cycle, and the rest on the other half-cycle. Each rectifier has to withstand a peak inverse voltage (p.i.v.) of twice the input peak voltage, but the currents carried by the rectifiers are greater towards the input end of the chain, and these must therefore be of adequate rating. Since the voltage is spread over a series of components, systems of this type should prove very reliable.

Although originally used in 1932 to produce up to 700kV for accelerating protons to bombard lithium nuclei, multiplier systems are not considered the most economical for the 10-16kV now used in television receivers. This is because of the number of rectifiers and condensers which would be required, making a bulky unit, with the added risk associated with the large values of capacitance required at mains frequency.

**Radio-frequency EHT**

The special considerations of safety, compactness, and lightness which apply in a domestic television receiver, have led to the adoption of methods other than the foregoing ones of generating the EHT voltages now required.

An oscillator working at 1kc/s can be used to develop the final anode voltage for an oscilloscope. At this frequency it is still possible to use an iron-cored step-up transformer with thin laminations. The majority of oscillators for EHT generation, however, work at frequencies between 25kc/s and 300kc/s. Towards the upper of these frequencies, there is an increased risk of producing radio interference, although even at the lower frequency, the frequency should be selected to avoid causing whistles with medium and long wave stations, since strong harmonics due to the non-linearity and limiting action of the valve may coincide with broadcast frequencies.

**Radiation**

It should be remembered that the oscillator employed is much more powerful than that used in a frequency-changer, and capable not merely of causing interference, but of overloading a nearby receiver. Thus careful screening and filtering is necessary. Unfortunately this means that the supply cannot be made so compact because a small screening container would reduce the output, and for the same reason it should be of copper or aluminium rather than of steel.

An air-cored coil is usual and flux leakage difficulties can be overcome by employing resonance, i.e., the EHT secondary is tuned by its self-capacitance to the frequency of the primary

circuit: the latter being tuned by a pre-set capacitance.

When two circuits, each tuned to the same frequency, are brought together, they react upon each other to give a double resonance. The closer the coupling, the stronger this effect, and the more widely separated are the two new frequencies, which are one above and one below the original frequency of each circuit in isolation. This occurs because the net series reactance of either circuit, which varies according to frequency and is zero at the original resonance, is coupled into the other circuit, so making it come into resonance at the two new frequencies.

The two peaks of resonance only begin to separate when the coupling between the two circuits is closer than a certain value which is determined by the Q values of the two circuits.

**Close Coupling**

In an R.F. EHT unit, much closer than critical coupling is employed to make it less affected by changes in loading. To avoid having to bring the primary and secondary close together, critical coupling must be obtained at a low value of coupling, i.e., the loaded Q's must be large.

Often it is found that oscillation can be obtained when the connections to the grid winding are reversed. This implies that a phase shift of 180 deg. has occurred to overcome the reversal, and to produce this, the frequency must have altered. The amplitude of oscillation will also be very different, although it may increase to

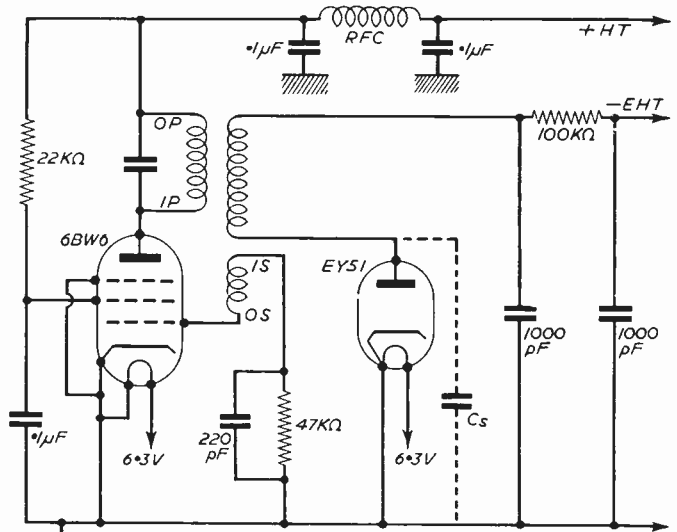

Fig. 5.—Negative R.F. EHT supply for an oscilloscope.

some extent on readjustment of the value of the tuning capacitance. Normal oscillator connections are as shown in Fig. 5. Each coil is wound in the same direction around the former, and the inner and outer leads of the anode primary and grid secondary are marked I.P., I.S., and O.P., O.S. respectively.

(To be continued)

# TELENEWS



## Television Receiving Licences

THE following statement shows the approximate number of Television Receiving Licences in force at the end of August, 1959, in respect of television receiving stations situated within the various Postal Regions of England, Wales, Scotland and Northern Ireland.

Region	Total
London Postal ... ..	1,735,415
Home Counties ... ..	1,255,527
Midland ... ..	1,485,979
North Eastern ... ..	1,571,451
North Western ... ..	1,310,758
South Western ... ..	786,514
Wales and Border Counties ...	571,797
<b>Total England and Wales ...</b>	<b>8,717,441</b>
Scotland ... ..	792,526
Northern Ireland ... ..	117,690
<b>Grand Total ... ..</b>	<b>9,627,657</b>

## BBC at Peterborough

THE BBC's new Peterborough television and V.H.F. sound broadcasting station is now nearing completion.

The new station is situated at Morborne Hill, six miles south of Peterborough and the equipment is housed in a single-storey building which provides accommodation for the vision and sound transmitters for the television service, the F.M. transmitters for the sound broadcasting service, and the Post Office vision link equipment. A 560ft. lattice steel mast carries two aerial systems, one for the television service and one for the V.H.F. sound service.

## Electron Gun Mounts

ELECTRODE WELDING CO., LTD., Cobbold Road, Willesden, London, N.W.10. have been appointed sole representative in the United Kingdom for Electron Gun Mounts manufactured by Superior Electronics Corporation, Clifton, New Jersey, U.S.A.

## Lead for Safety

EACH year the public is being introduced to bigger and better TV sets. Some concern has been expressed that the greater power needed to operate these sets will generate soft X-rays which may escape, and so add to the general background of radiation to which we are all now exposed. However this is now a groundless fear because a very simple technique is available to ensure complete safety from hazards of this nature. X-rays emanating at this intensity can be effectively absorbed by thin lead foil which is readily available in this country. It can be pasted, after the fashion of paper, on the inside of a cabinet before the electronic components are assembled or, alternatively, incorporated into the body of the cabinet which is often of plywood construction. Finally, the sheet of armoured glass placed in front of most television tubes

can be made of lead glass following the principle adopted by atomic scientists when dealing with this problem. In this way manufacturers can ensure that the whole set is completely encased in lead and so achieve absolute security.

## Extended Guarantee

THREE well-known firms, Suffolk Tubes Ltd., Midland Tubes Ltd., and Video Replacement Co., who specialise in rebuilding cathode ray tubes, announce that they have extended their full cover guarantee from seven to 12 months.

## I.T.A. in Northern Ireland

THE I.T.A.'s programmes in Northern Ireland will begin on October 31st, and will be transmitted from the new station at Black Mountain near Belfast. More than one million people will be within its service area and when this station comes on the air less than 9 per cent. of the population of the United Kingdom will be outside one or

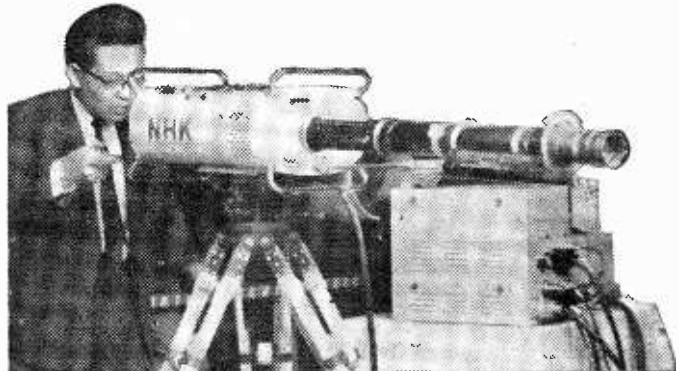

A technician of the NHK Technical Research Laboratory, Tokyo, aims what looks like a futuristic space gun, but which is a newly developed fully transistorised lightweight TV camera. It is called a television Zoomar.

other of the areas served by the Independent Television Authority. Black Mountain will operate on Channel 9 and it will transmit horizontally polarised signals.

### New Marconi Monitors for BBC

THE BBC has ordered 75 of a new type of 21in. picture monitor designed and manufactured by Marconi's Wireless Telegraph Company. These are for the BBC's new Television Centre, near Shepherd's Bush, where they will be used in Studio Production Control Rooms. The new monitor has been designed to provide studios with a larger picture than those in current use. It is considered essential for studio control room and studio floor monitors to provide a picture as large as that seen by viewers on domestic receivers and the order reflects the growing popularity of the 21in. screen in the home. The new Marconi Type BD850, while basically simple, is a high performance equipment. To ensure maximum reliability and ease of maintenance extensive use has been made of printed circuits and long-life valves. It has been specially designed for monitoring and is not a modified domestic receiver. The BD850 is suitable for use on 405, 525 or 625 lines. Normally a monitor will be supplied to operate on one standard only but change-over from one to any of the other standards can be effected by four simple wiring modifications and changing one condenser. Alternatively a change-over switch can be fitted which enables the monitor to operate on any of the three standards without modification. A remotely operated brightness control is also available.

### Atom TV

THE first part of a large order for closed circuit television equipment to be supplied to the Hunterston Nuclear Power Station (Scotland) has been placed with Pye Ltd. Television is to be used for observation inside the reactor and for the monitoring of various other services. The contract, which involves the supply of about 30 special-purpose TV cameras of various designs, is worth about £50,000.

### TV in the Bank

THE City office of Barclays Bank has recently installed closed circuit television for the purpose of document-viewing. The public business of the bank is transacted on the ground floor and, owing to the demand for space, the book-keeping department was moved to the third floor. With the closed-circuit

installed in key positions and when an executive wants details of a customer's account he rings the console operator giving the nature of the information required. The latter selects the appropriate ledger, places it in one of the consoles and a push button "punches up" the image of the half-page on to the executive's screen on the ground

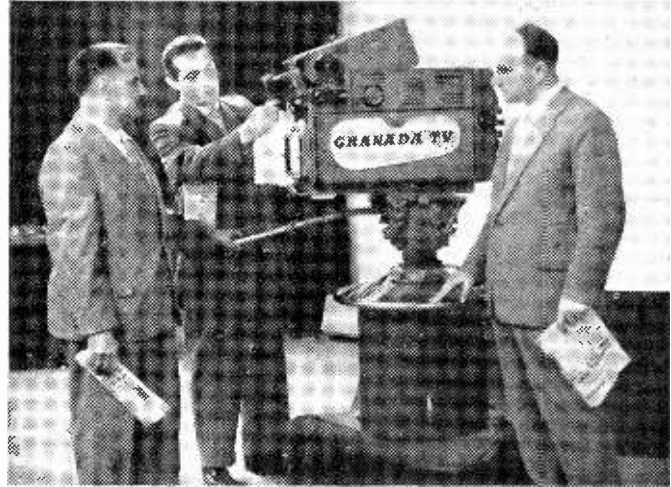

A television camera at the Granada TV Centre, Manchester, intrigues three TV men from the Soviet Union, who recently made a ten-day visit to Britain as guests of Granada TV. The visitors are representatives of the Soviet Radio and Television Commission, which controls all TV in the USSR. They are (left to right) Vladimir Parkhomenko, a television engineer; Alexander Suskij, chief telerecording engineer at the Kiev studio and George Ivanov, Director of the Moscow television studio.

TV it is possible for the book-keeping department to supply information to managers and cashiers on the ground floor quickly and efficiently. In the book-keeping department on the upper floor three document viewing consoles are installed. Each console, is, in essentials, a light-box with a lid at the top which gives access to a glass screen upon which the document to be viewed is placed. Inside the console a television camera is housed, together with its control unit; the camera is arranged to view, via a solenoid-operated rotatable mirror, one-half of the document area. The illumination is provided by two 75W spot lamps. Above the consoles, three 14in. monitors are installed, each connected to one console to enable the operator to obtain a picture of maximum quality by adjustment of the simple controls. On the ground floor, eight viewing monitors are

installed in key positions and when an executive wants details of a customer's account he rings the console operator giving the nature of the information required. The latter selects the appropriate ledger, places it in one of the consoles and a push button "punches up" the image of the half-page on to the executive's screen on the ground

### TV in the West

THE number of homes in the South Wales and West ITV area able to receive independent television is more than 500,000 according to the latest report from Television Audience Measurement Ltd. (TAM). This means that more than 300,000 new ITV homes have been added to the opening night total of 191,000. Programmes from the St. Hilary transmitter began on January 14th, 1958. Forty-three per cent. of all homes in the area are now able to receive ITV. The total audience that can now be reached is 1,695,000—49 per cent. of the population of the area.

# Switched Aerial Filter

A VERSATILE UNIT FOR USE AS A DIPLEXER OR SPLITTER

By M. A. Hammond

THERE are probably hundreds of television receivers, originally for BBC reception only, that are functioning quite satisfactorily with the addition of a converter for present-day alternative programmes. There are also many viewers who still change over aerials when the second programme is desired, to the eventual detriment of the aerial plugs and sockets. It was with a view to "tidying up" this operation that this filter was designed.

## Diplexer

For the modern receiver with single aerial input, it provides a useful function at the aerial end in order that a single downlead can be used. For this purpose, the switch would have to be left

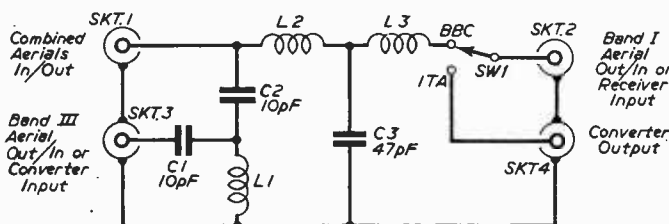

Fig. 1.—Circuit diagram.

in the "BBC" position and socket 4 ignored (see Fig. 6). Indeed, filters made for this function only could have the switch and socket 4 omitted in the construction, the connection between socket 2 and L3 being direct.

Referring to the circuit diagram, Fig. 1, it will be seen that it comprises a simple high-pass/low-pass filter network with switching facilities for converter use. The coils are made quite simply from 18 s.w.g. tinned copper wire (see Figs. 2 and 3), and were found to perform satisfactorily. The 3/8 in. loop (Fig. 3) is not of great significance, but merely a suitable anchorage for C3 (see Fig. 4).

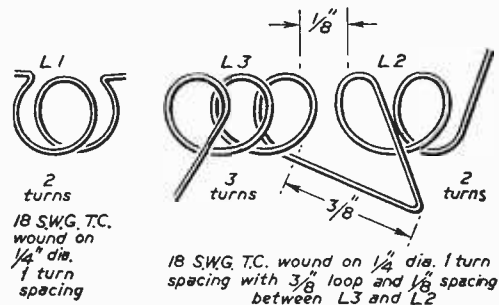

Fig. 2 (left).—L1 winding. Fig. 3 (right).—L2, L3 winding.

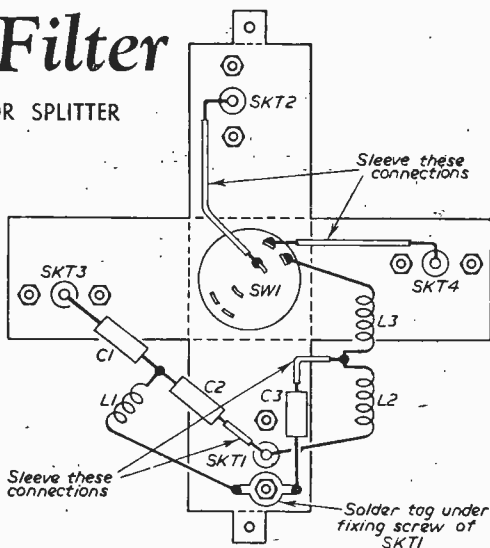
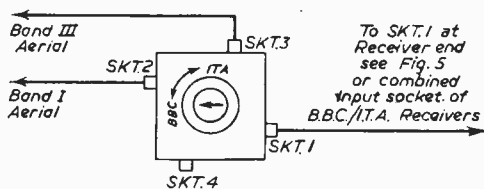

Fig. 4.—Exploded view showing wiring of components.

## Housing

In the author's case, the filter was constructed in a cut-down 1 1/2 in. square screening can, for the sake of compactness, but it could be equally well housed in any small metal box, bearing in mind to keep the wiring as short as possible and "earthy" side of L1 and C3 taken to the solder

tag under fixing screw of socket 1 (see Fig. 4). Tubular ceramic capacitors were used, but any good quality components would suffice. The switch used was a 1-pole, 2-way type.



Leave switch at 'BBC' position

Fig. 5 (above).—Use of filter at Band I only receiver end with converter for Band III.

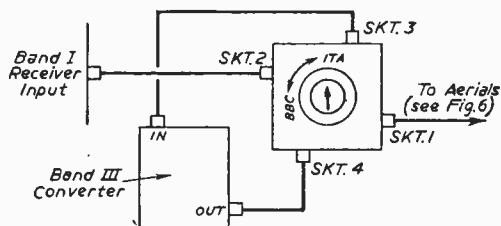
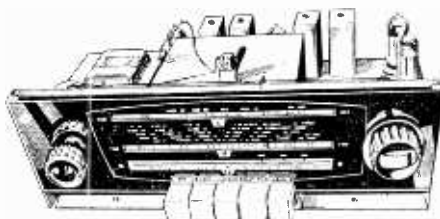

Fig. 6.—Use of filter at aerial end to facilitate single down-lead feeder to receiver (in this case SKT.4 is ignored and switch left at BBC position).

# BRAND NEW A.M.-F.M. (V.H.F.) CHASSIS AT £13.6.8. (P. & P. 10/-)



Why buy a F.M. Tuner at the same price ?  
Tapped input 200-225 v. and 226-250 v. A.C. ONLY.  
Chassis size 15" x 6 1/2" x 5 1/2" high. New manufacture.  
Die! 14" x 4" in gold, red and deep brown.  
Pick-up, Extension speaker, Ae., E. and Dipole sockets.  
Five "piano" push buttons—OFF, L.W., M.W., F.M. and Gram. Aligned and tested. With valves, Tone control.  
Cover 1,000-1,900 Mc.; 200-500 Mc.; 88-99 Mc. s.  
Valves E780 rect. ECH81, EF89, EABC30, EL84, ECC85.  
Speaker & Cabinet to fit, polished with back. 67/6.  
8" x 5" ELLIPTICAL SPEAKER. 20/-.

TERMS :—(Chassis) £4.16.8 dep. + 10/- carr. and 6 Mthly. Payments of 30/-, or with Cabinet and Speaker, £5.9.2. dep + 10/- carr. and 7 Mthly. Payments of 35/-. Interior or outside F.M. dipole, 12/6 (2 - post). Co-axial cable pr. flat twin (300 ohm), 8d. yd.

We are specialists in I.T.A. Converters. Our converters give direct switching I.T.A. to B.B.C., metal rectifier, co-axial plug, can be fitted in 5-10 mins., and need no alteration to your set. ALL ARRAS. ALL SETS. ALL CHANNELS. 12 months guarantee (3 months on valves).

## "READY TO USE" I.T.A. CONVERTER

Separate gain controls. Valves PCF80 and PCC84. Switch positions I.T.A. (1)—I.T.A. (2)—B.B.C. Bakelite moulded cabinet 8 1/2" x 4" x 6". £5.5.0. P. & P. 3/-.



For the last 200 I.T.A. Converters of this type (Brand New and Fully Guaranteed) we will accept the "Below Cost" figure of ONLY 60/- (3-P. & P.). Reduced from £47.6.

Two valves ECH81—grey hammer finish—switch positions OFF, I.T.A., B.B.C. Own Power supply. BUY IT NOW.

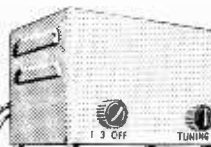

60/- (3 - P. & P.)

## THE BRAYHEAD TURRET TUNER.

£7.0 post free. Complete with booklet and fitting instructions. State set and model no. when ordering. Converts your 5-channel B.B.C. only set to receive 13 channels.

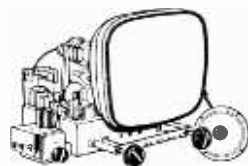
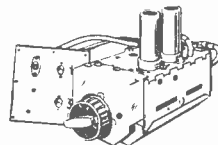

## UNUSED 14" TV CHASSIS WITH RECTANGULAR TUBE

TV chassis in working order. 16-19 Mc/s Tuning Channels 1-5 B.B.C. and I.T.A. 8-11. When tuned for local reception only switching is necessary for I.T.A. £28 with tuner + £1 carr. 17in. £32 with tuner + £1 carr.

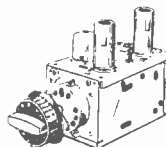

**INCREMENTAL TURRET TUNER** by famous manufacturer for 35 to 38 Mc/s : with knobs. Valves PCC84 and PCF80. ONLY 77.6. post free. or valves UCC84 and UCF80.



17/6

**13-CHANNEL TUNER.** I.F. 34-38 Mc/s complete with valves PCF80 and PCC84. Removed from chassis but in working order. Knobs included. (2/6 P. & P.)

**50 SILVERED MICA AND CERAMIC CONDENSERS.** 10 - 50 RESISTORS. 5/-.

## I.T.A. TABLE TOP AERIAL

An I.T.A. table top aerial with amazing performance. The Wolsey Hi-Q at 19 6 (2/6 post). Gives good reception up to 20 miles, and has cross-over unit in base with socket for B.B.C. aerial. Same model but very slightly tarnished for ONLY 12 6 (2/6 post).

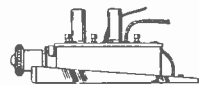
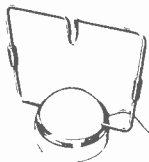

## CHASSIS CONVERTER INTERNAL MOUNTING

Specification as 5 gn. model above ; with leads for power supply, etc. Size 9 x 2" x 5" high. PRICE £2.17.6 (2/6 post). Power pack, fully wired with connection instructions. 25/- extra.

## AUTOMATIC RECORD CHANGERS. COLLARO

CONQUEST with manual play also Turnover crystal pick-up. 4-speed, A.C. mains 200-250 v., see illus

B.S.R. 4-SPEED AUTO-CHANGER UA8 only £6.12.6 (5 - carr.).

£7.10.0 (5/- P. & P.)



**PERSPEX UNSCRATCHED.** (Post 2/- each or 6 post free.) 12" x 9" x 1" clear, 4/6 ; 14" x 11" x 1" clear, 5/- ; 15" x 12" x 1" tinted, 6/- ; 17" x 13" x 3/16" clear, 7/- . (Also 15" x 12" slightly scratched at 3/-)

**NEW PRE-SET WIREWOUND POTENTIOMETERS.**—6 different values as used in modern sets. 10/-, post paid.

**NEW WAXED TUBULARS.** 350 v. or above. 3 of each. .001 .002 .005 .01 .02 .05 .1 .5 mF. Total 24 for 5 6. post paid.

## NEW CAN TYPE ELECTROLYTICS

40—40 mF. 300 v. (1" dia.)	...	...	...	...	2/6
40—40 mF. 300 v. (1" dia.)	...	...	...	...	2/9
100—200 mF. 275 v. (1 1/2" dia.)	...	...	...	...	5/6
100—200 mF. 350 v. (2" dia.)	...	...	...	...	7/6
100—200 mF. 25 v. (1" dia.)	...	...	...	...	1/3
1 mF. 500 v. (Tubular)	...	...	...	...	1/-
100—400 mF. 275 v. (2" dia.)	...	...	...	...	7/8
400 mF. 250 v. (1 1/2" dia.)	...	...	...	...	3/6

Post 6d. on one. Two or more Post Free.

Delivery by return. C.O.D. 2/- extra. Terms : Cash with order or one-third down and balance plus 7/6 (up to £7.10.0) in four equal monthly payments. Balance over £7.10.0, add 1/- in £1 and pay in not more than 6 monthly payments. See special terms for A.M.-F.M. chassis. All new goods unless stated. Send 6d. for 16-page catalogue.

## GLADSTONE RADIO

or callers to 3 Church Road, Bristol, 5. Tel. 51207

58A HIGH STREET, CAMBERLEY, SURREY.

Tel. 22791

(Camberley closed Sats.)

# D.C. OSCILLOSCOPE

A.C. MAINS 200-250 VOLTS

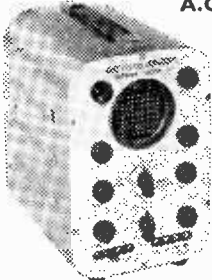

**SIMPLIFIED SERVICING PROBLEMS WHEN USING THE 'TESTGEAR' SCOPE 3in. D.C. OSCILLOSCOPE**

Engineered to precision standards, this high-grade instrument is made available at the lowest possible price, incorporating the essential features usually associated with luxury instruments.

This "SCOPE" will appeal particularly to Service Engineers and Amateurs. A high gain, extremely stable differential amplifier suitable for measurement of transistor operating conditions where maintenance of D.C. levels is of paramount importance. Push-pull X amplifier; Fly-back suppression; Internal Time-base Scan Waveform available for external use; pulse output available for checking T.V. Line O/P Transformers, etc.; Provision for external X I/P and CRT. Brightness Modulation. Size 10in. high, 6 1/2in. wide, 9in. deep. Wgt. 1 1/2 lbs. £15.15.0. plus P. & P. 7/6, or 30/- deposit, plus P. & P. 7/6 and 12 monthly payments of 28/6.

**FULL 12 MONTHS' GUARANTEE INCLUDING VALVES AND TUBE.**

## WOLSEY 3-ELEMENT FOLDED DIPOLE

I.T.V. Aerial less mounting bracket, complete with 12 yds. of coaxial cable. 15/-; 4 element. 17/6; 5 element. 25/- P. & P. on above 3/6.

**E.H.T. Smoothing Condenser 500 p.f. 18 KV. D.C. 1/6.**

## LINE E.H.T. TRANSFORMER

By famous manufacturer. 14 Kv. Complete with built-in line and width controls. Winding for EY51 Rectifier. 19/6 Plus P. & P. 2/6.

## 13 CHANNEL TUNER

34 to 38 Mc/s complete with PCF80 and FCC84. These have been removed from chassis.

**23/-** complete with knobs. P. & P. 3/6 extra.

18-19 Mc/s complete with knobs less valves. 13/- Plus P. & P. 2/6.

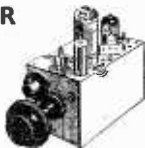

## SIGNAL GENERATOR

£6.19.6 or 25/- deposit and 6 monthly payments of 21/6. P. & P. 5/- extra. Coverage 100 Kc/s-100 Mc/s on fundamentals and 100 Mc/s to 200 Mc/s on harmonics. Metal case 10in. x 6 1/2in. x 5 1/2in. grey hammer finish. Incorporating three miniature valves and Metal Rectifier. A.C. Mains 200/250. Internal Modulation of 400 c.p.s. to a depth of 30%; modulated or unmodulated R.F. output continuously variable 100 milli-volts.

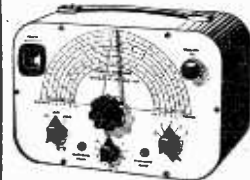

C.W. and mod. switch, variable magic-eye as output indicator. Accuracy plus or minus 2%.

## F.M. TUNER UNIT

Permeability tuned, by famous German manufacturer. Coverage 88-100 Kc/s. Complete with ECC86, size 4in. x 2in. x 2in.

**25/-** P. & P. 1/6. Circuit Diagram 1/- FREE with Unit.

## SIGNAL & PATTERN GENERATOR

25/- deposit plus P. & P. 5/- and 6 monthly payments of 21/6. Cash £6.19.6 plus P. & P. 5/- Coverage 7.6 Mc/s-210 Mc/s in five bands, all on fundamentals, slow-motion tuning, audio output, 8 vertical and horizontal bars, jogging scale. In grey hammer finished case with carrying handle. Accuracy ± 1% A.C. mains 200-250 v.

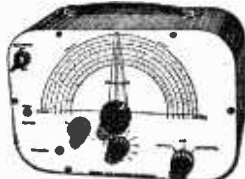

## RADIO & T.V. COMPONENTS (Acton) LTD.

23, HIGH STREET, ACTON, LONDON, W.3.

All enquiries S.A.E. GOODS NOT DESPATCHED OUTSIDE U.K.

# TECHNICAL TRAINING

*in Radio, Television & Electronics Engineering*

**WITH ICS**

The decision is YOURS. To be a success in your chosen career; to qualify for the highest paid job . . . to control a profitable business of your own. ICS home-study courses put your plans on a practical basis; teach you theory and practice; give you the knowledge and experience to take you, at your own pace, to the top.

**These are the Courses ICS offer :**

Radio and Television Engineering—Radio and TV Servicing—Radio Service and Sales—Electronics—VHF/FM Engineering—

. . . and the Examinations

A.M.BRIT.I.R.E., City and Guilds Telecommunication, Radio Servicing; P.M.G. Radio Amateurs Cert.

**plus Learn-as-you-Build Practical Radio Course**

A basic course in radio, electronic and electrical theory backed by thorough practical training. You build a 4-valve T.R.F. and a 5-valve superhet radio receiver, signal generator and multi-tester. Other Learn-as-you-Build radio courses are also available.

**Other ICS Courses include :**

MECHANICAL ENGINEERING—MOTOR ENGINEERING—FIRE ENGINEERING—CHEMICAL ENGINEERING—WOODWORKING—SALESMANSHIP AND SALES MANAGEMENT—PHOTOGRAPHY—ARCHITECTURE—ART—AGRICULTURE—HORTICULTURE, etc. etc.

*If subject not shown state on coupon.*

**Post this Coupon TODAY**

For FREE book on Careers in Radio & Television, etc., and giving details of other ICS Courses.

**International Correspondence Schools**  
(Dept. 164A), Intertext House, Parxgate Road, London, S.W.11.

Please send book on .....

Name and Address ..... Age .....

Occupation.....II.59

**INTERNATIONAL CORRESPONDENCE SCHOOLS**

# Replacing C.R. Tubes—8

PROJECTION RECEIVERS

By H. Peters

**T**HIS article covers the Philips/Mullard projection units, which are used in almost every manufacturer's projection models. The sketches and diagrams are reproduced by permission of Messrs. Mullard Ltd.

At first sight the replacement of a tube in one of these units looks difficult, but it is in fact

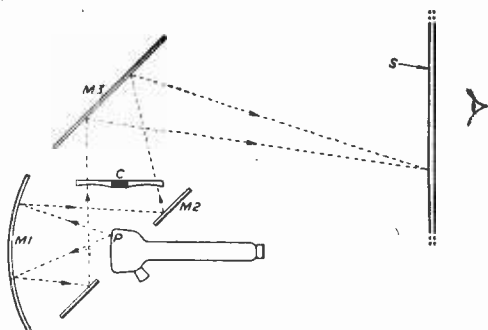

Fig. 1.—How the system works. The small bright picture (P) on the tube face is focused by concave mirror (M1), reflected up by mirror (M2) through corrector lens (C) to the cabinet mirror (M3), being finally focused, on the fluted Perspex screen (S).

much simpler than the average direct viewed tube. The EHT of 25kV is well screened from the user, although a nasty burn may be had from the anode of the EHT generator valve (usually an EL38 or PL38) should the body pass too close. Much has been said about the danger from doses of soft X-rays, but the effects are negligible unless the small picture is viewed direct at full brightness.

## Dismantling

Switch off the receiver and remove the back of the cabinet. If the optical unit is mounted sideways with a hatch in the side of the cabinet, remove this as well.

Slacken off the three screws which secure the tube mounting to the crescent-shaped yoke and turn the whole tube mounting assembly clockwise until the stop is reached. The three screws will coincide with three recesses in the tube mounting plate and the entire tube assembly can now be drawn out of the optical unit. Note the angle at which the EHT lead comes away from the tube assembly and remove the plastic EHT

cap. In winter, or if the cap is stiff with age, it is easy to break the tube by attempting removal, and the plastic cap should be heated by holding it in the hand for about ten minutes, or if it is possible, run the set for about half an hour before starting the tube change. The EHT lead may be discharged by touching the spring on some convenient chassis point, although the charge it holds is not so offensive as some of the direct viewed 17in. EHT systems. It may be noticed here that the EHT lead is a screened one which is grounded at the point where it leaves the EHT box, and is thus safe to handle. This screened lead forms part of the reservoir capacitor of the final EHT smoothing circuit, the remainder being provided by graphite coating on the tube itself and a small resistor (usually 1M $\Omega$ ) in the anode cap of the lead itself. This resistor can sometimes cause variations in picture size and simulate the symptoms of a faulty C.R. tube or EHT unit. It is a simple matter to check it, since it may be extracted with a pair of tweezers (if the anode cap is pliant) together with the spring which contacts the anode pip of the tube.

## Removing Tube

Having removed the EHT cap, remove the 5-pin side contact C.R. tube holder and slacken the clamp which grips the tube neck just above the base. The tube will now slide out forward from the scanning unit.

A rough guide to the state of the old tube may be obtained by a careful inspection of its face. First note how much dust you have been able to remove from it as this will be similar to the layer

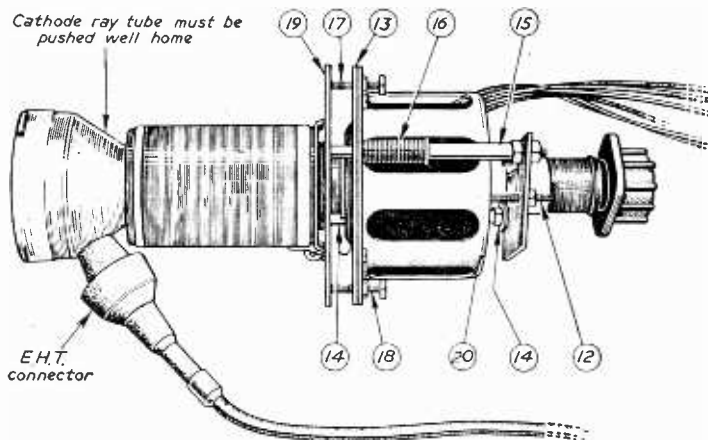

Fig. 2.—The tube and focus unit removed from the optical box.



of dust on the inside of the optical box and will tell you if the latter needs to be cleaned out or not. Then note the colour of the rectangular portion of the tube face which has had the most usage. This will be a darker shade than the rest of the tube face, and on well used tubes will be rust coloured.

### Reassembly

Before reassembling you should decide if it is going to be necessary to clean the optical unit, for now is the time to do it, although it is dealt with on a later paragraph. If the unit is clean, fit the new tube, pressing it well down into the scan coils so that the graphite coating makes good contact with the spring leaf inside the top of the scan coils. Dress off the anode connection with silicone grease such as DC4 or MS4 (a little "Vaseline" will do in an emergency) and refit the anode cap and base. Check that the tube is still pressed well down into the coils and that the anode cap is at the correct angle, and tighten up the clamp which holds it at the back. Lightly score around the tube neck on either side of this clamp with a soft crayon so that it is possible to see if the tube has crept forward in reassembling. If it has, focus will be difficult to obtain.

### Focusing

Before refitting the assembly to the optical box, switch the set on, and adjust the receiver controls to give a picture on the face of the tube which is bright enough to be examined but not bright enough to dazzle the naked eye. Check that the picture is central on the tube face and that the focus control is substantially in the centre of its range for good electrical focus. If focus is difficult to obtain it will probably mean that some of the valves in the set have lost emission, for the focus current is usually taken from the smoothed H.T. supply to a group of receiver valves whose operation is not affected by signal variations. It may be more expedient to add an extra current drain in the form of a high wattage resistor of suitable value or, alternatively, to add a resistor in series with the focus control, which is usually a shunt across the focus coil. It is seldom found that the coil passes too much current.

Some receivers have a special "focus" valve, the current of which is controlled by variations of grid potential. After some use this valve becomes slow heating and it is usually necessary to run the set about ten minutes before attempting to focus electrically.

### Centring the Picture

To adjust the picture to be central on the screen of the new tube, unlock the screw 12 (Fig. 2) and unscrew a few turns. Position the picture by means of screws 17 and 18 (identified by their red fibre washers) and re-lock the focus unit with screw 12.

It may be found that the C.R. tube assembly is awkwardly placed when out of its optical box to enable these adjustments to be carried out. If this is the case a sheet of corrugated cardboard placed over the chassis is normally sufficient to enable the C.R. tube assembly to be laid in a serviceable position.

### Refitting

With the picture central in the tube and in focus switch off and refit the tube assembly to the optical box, screwing up the three fastening screws finger tight. Switch on and obtain a picture on the screen and turn the whole assembly to correct tilt. The three fixing screws may then be tightened up. Try to avoid handling the tube face in this operation, and when the unit has been

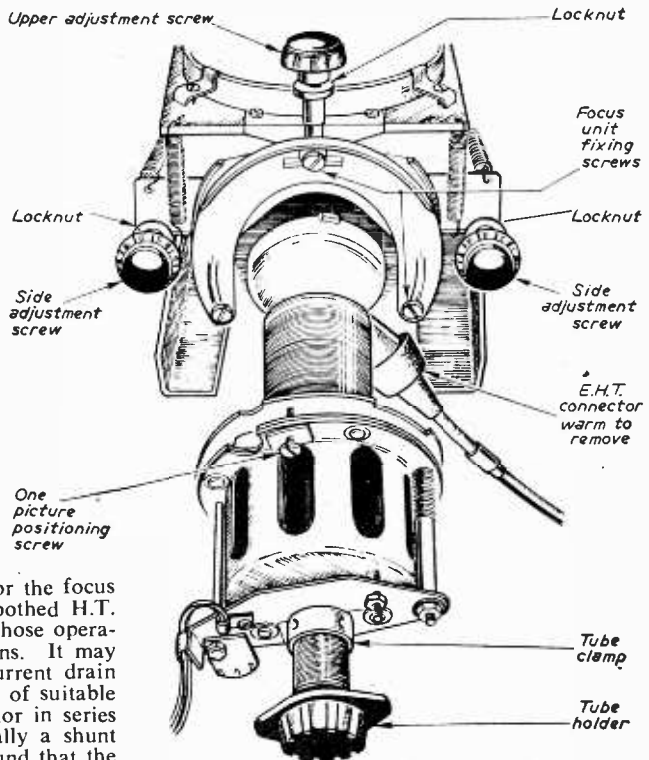

Fig. 3.—Details of the tube and focus unit.

refitted, check that the tube has not crept forward in its clamping. This may be ascertained by observing the crayon mark around the clamp. If this has moved forward, slacken the clamp and pull the tube back to its fullest extent before tightening the clamp again.

It is advisable to discharge the graphite coating before doing this, as it may have disconnected from the spring inside the deflector coils and can then assume a potential of a few kV. This is not sufficient to give a severe shock, but the involuntary movement imparted to the elbow is more

than ample to cause mechanical faults in other parts of the chassis.

### Optical Focusing

First obtain the best picture you can on the screen by operating the controls. Check that the electrical focus is still good. This may be difficult with the optical focus out of adjustment, but can be done by observing the change in picture colour.

If the electrical focus is out of adjustment, the picture will have a purple tint, which will change to a brown-green as electrical focus is reached. This effect is seen to better advantage in a mirror.

Unlock the three large black knobs around the optical box by unscrewing the milled, threaded washers until they touch the knobs. Finally unscrew the top black knob. You will notice that it lifts the back of the tube. This should present you with a narrow strip of focused picture, which is probably neither central nor upright, and which has now to be positioned in the centre of the screen. If the tube is mounted sideways to the viewer (i.e., parallel to the screen) as in Fig. 4 this strip will have to be upright. If the tube is mounted in line with the viewer (i.e., at right angles to the screen) this strip will be horizontal. Referring to Fig. 4, where the tube is mounted parallel to the screen, the two black side knobs should be rotated together until this band of focused picture (A) passes through the axis of the tube as at (B).

### Adjustment

If the two tubes are similar, a few turns in either direction should suffice. If the two tubes are physically different in length or the mechanical arrangements have been disturbed it will be necessary to start from scratch by fully unscrewing the two side screws and then screwing them in together until the focused strip passes across the screen. Once the focused strip rests across the axis (B) it can be tilted upright by adjusting the knobs equally in opposite directions (C). The narrow band of focused picture may then be spread by screwing down the top black knob until the raster lines are visible all across the screen. If the focus reaches one side of the screen before the other, a slight readjustment of the side screws may be needed to put this right. Having obtained correct focus, lock the three adjusting screws by the milled, threaded washers.

At this juncture it is only fair to explain that the writer finds that it is almost impossible to perform the optical focusing on a moving picture. The ideal waveform to use is a synchronised raster at either black or white level, such as may be produced by a pattern generator, but test card "C" can be utilised if contrast is reduced to the threshold of synchronisation.

Unreliable results have been experienced when attempting to focus using the unmodulated raster available when the aerial is removed. This raster is usually in relative motion and as the timebases are unlocked the focus current can vary.

### Boosting

It is extremely unlikely that a filament boost

transformer will be very successful, as the emission on the MW6/2 tube usually outlives the screen phosphor.

### Cleaning the Optical Unit

The three parts of the optical unit which are likely to need cleaning the most frequently, are the upper surface of the corrector lens, the mirror in the top of the cabinet, and the translucent screen. They all present individual problems as follows:

*Upper surface of the corrector lens.* This may be cleaned by wiping with a small pad of cotton wool, and if the dirt is "sticky," the pad may be moistened with methylated spirits. Do not use any proprietary window cleaning fluids as these are usually slightly abrasive.

*The cabinet mirror.* This mirror is silvered on its surface to prevent a double image being formed on the screen and is therefore very easily scratched. Never touch the surface with the hand or any greasy or gritty material. Brush off the dust with a large camel hair brush. If the mirror surface is finger-marked or covered with a film of grease a small pad of cotton wool moistened slightly (not soaked) in a dilute solution of detergent should be very gently rubbed across the surface. As even the gentlest of such treatment will introduce small scratches on the surface and reduce the efficiency of the mirror, it should only be used in an emergency.

*The translucent screen* is just about as delicate; it is normally made from thin plastic and is etched with upright lines on one side and circular lines on the other, the combination of which allows the most light to be projected towards the circle of viewers, as can readily be seen by standing beside a working set in a darkened room. Its treatment is the same as for the mirror, i.e., dilute detergent on cotton wool. Never scrub it or fingermark it, as permanent scratches will result. Rub the cotton wool in the direction of the etching, not across it.

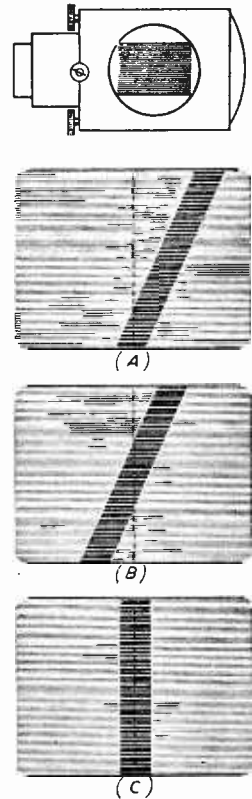

Fig. 4.—Successive stages in optical focusing. The focused strip (A) is centralised (B) by turning the two side knobs in the same direction. It is then straightened (C) by turning these knobs in opposite directions before finally spreading it across the screen with the top knob.

(Continued on page 91)

# Trends in

NEW DEVELOPMENTS AND EASIER  
SERVICING

By "Engineer"

At each year's Radio Show the products of practically all the trade are gathered together and one is able to see them all and make comparisons more readily. It then becomes obvious that all the designers are more or less treading the same ground, almost as though they all attended the same school of design, or perhaps they are following the well-worn paths laid by the American market. Each year there is some definite trend in design which all adopt in one form or another, and this year it was without doubt the "slim" line—fostered by the production by the tube makers of the 110deg. picture tubes. This has led to a number of interesting points in design, of which, obviously, the shallower cabinet is the most important.

## Shorter Tubes

The 110deg. tube is approximately 3in. or 4in. shorter than its predecessor, but one or two manufacturers had produced a receiver in a cabinet which was several inches shallower, although the majority had used the artifice of making an extended back to give an impression of a very much reduced cabinet length. Of course, the chief among these was the Philco, where the main part of the cabinet was only 5in. or 6in. deep and the remainder was extended to the rear and the entire cabinet made to hang on the wall in a corner so that the only visible part was the narrow cabinet. This was, in our opinion, the most important development in the shallow cabinet idea, as it not only put the receiver in a position which is most productive of high quality sound reproduction, but it also

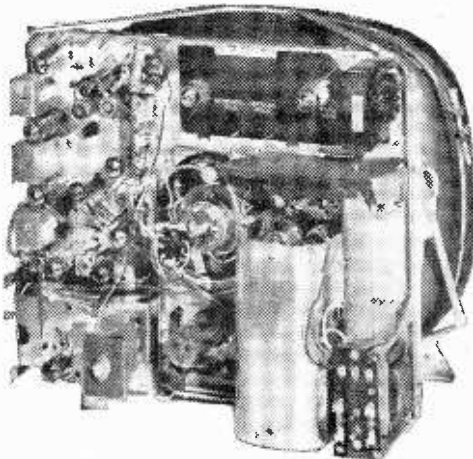

This is an Ekco model which is accessible for servicing by a "Three-stage Plan."

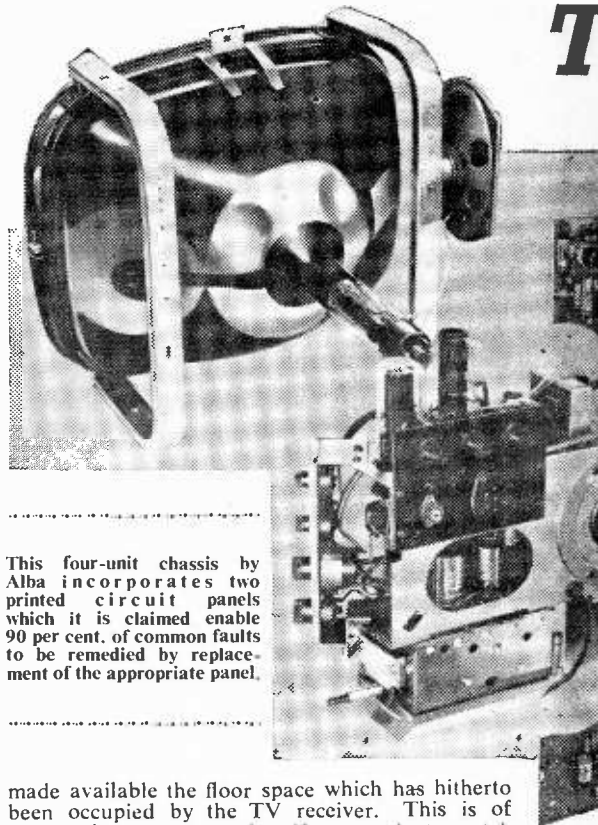

This four-unit chassis by Alba incorporates two printed circuit panels which it is claimed enable 90 per cent. of common faults to be remedied by replacement of the appropriate panel.

made available the floor space which has hitherto been occupied by the TV receiver. This is of greater importance to-day if stereo is to catch on—otherwise the floor will become littered with cabinets and tables and there will be little room to sit in a modern small flat.

## Housing the Set

So much for the tube and the cabinet, but there is one very important point which arises from this decrease in overall size. Whilst printed circuit techniques permit of smaller receivers, the reductions in tube length and cabinet size result in there being very much less room to house the receiver proper, and it was suggested to us by one well-known manufacturer-designer that a small "tray" beneath the cabinet may be the next step, otherwise it will not be possible to house the receiver itself. Another point in this connection is, of course, the dispersal of the heat which is generated. The large number of valves, the tube and the mains "power pack" all give off a fairly large amount of heat, and if this is too enclosed there will be not only a risk of damaging certain components and printed circuit panels, but the use of transistors may be difficult in future designs. This drive for smaller cabinets must, therefore, be apparently halted at this stage.

Not one manufacturer had adopted the idea which was seen last year in Paris, and which was repeated at this year's Paris show, of removing the tube from the cabinet—the tube in its own housing being placed on top of the cabinet or

# V Design

any other suitable convenient place in the room. (See the cover of the July, 1958, issue.)

## Single Chassis

One scheme, which we believe was first adopted by the designer of the "Viewmaster" during experiments to produce a new version of this popular receiver, was to place the entire receiver circuit on a single chassis, and to mount the scanning yoke in the centre of the chassis. The latter could then be placed over the neck of the tube and give the designer the largest dimension in the cabinet for housing the essential parts, as well as making for greater accessibility for servicing. It will be noted that in the Alba receiver shown in our heading illustration this idea has been developed, although this receiver also includes separate chassis for certain parts.

## Separate Chassis

This is one important point in design which, whilst not by any means new, has received a new lease of life from the printed circuit technique. Several manufacturers have made the separate parts of the receiver—the tuner, video strip, sound strip, timebases, etc., in the form of separate chassis and in more than one instance inter-connections have been provided by plugs and sockets. In the Alba receiver the chassis is made up of four units and there are two printed circuit panels. It is stated that these two panels contain the components which are usually the cause of 90 per cent. of breakdowns, and consequently the faults are cured simply by plugging in a replacement panel. For this, it is not necessary to remove the chassis from the cabinet or unsolder any wiring.

## Unused Space

The principal advantage of this form of assembly is that it makes full use of the cabinet space, whilst the orthodox arrangement leaves a large unused space as shown in our cover illustration. To offset this, however, there is the question of heat

dissipation, or the effect of heat on components situated above valves. Hot air rises (for the purist, hot air is displaced by colder air), and with the vertical arrangement everything above a valve will be in the stream of warm or hot air rising from the valve, and whilst this may not be of immediate importance, over a period it may have an effect.

In a Decca receiver (DM45/C) the chassis is on a hinge and it may be swung out and upward so that it is above the top of the cabinet. This idea and others are primarily for the aid of servicemen—a side of design which must be considered by the manufacturer. In the receiver shown below, for instance (Ferguson model 546T), the left-hand side unit and the top printed circuit board are hinged so that they may be swung out and over to facilitate servicing.

In the Ekco receiver shown on the opposite page, a "Three-stage Plan" is adopted for servicing. In stage one a quarter turn of two screws releases the back exposing all valves and adjustments, including a plug-in EHT rectifier in a quickly detachable screen. In the second stage, removal of push-on speaker connections, tube, knob, etc., and three screws allows withdrawal of chassis and tube assembly, whilst stage three is the removal of the tube or other major items.

In the RGD Model 605, the release of only two screws situated in the back cover allows complete removal of the chassis including mask and fascia from the body of the receiver.

Against the principle of separate panels, etc., the makers of the Spencer-West receiver shown on the cover, stress that all components are in one place and fully accessible from above or through the base on removal of a panel. In this particular receiver the printed circuit is not dip-soldered. Some groups of joints, e.g., valveholders, are made with special jig soldering tools, the makers claiming that this gives greater reliability and gives the equivalent of manually soldered joints.

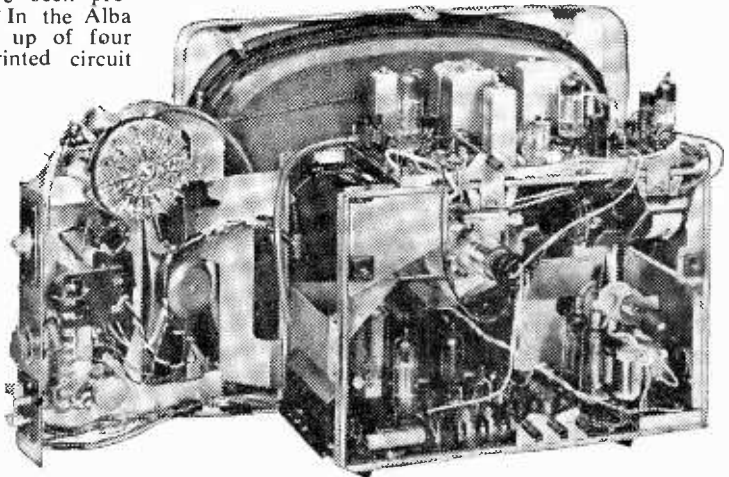

In this Ferguson model the left-hand chassis hinges out as shown. The upper panel also hinges outward and may then be removed if desired without disconnecting any wires.

# Granada and the President

SPECIAL TECHNIQUES WITH VIDEOTAPE RECORDINGS ENABLED AMERICAN VIEWERS TO SEE PICTURES OF PRESIDENT EISENHOWER'S VISIT TO EUROPE A FEW HOURS AFTER THE EVENTS HAD TAKEN PLACE

By Our  
Special  
Correspondent



(Above) CBS commentator Alex Kendrick describes the arrival of President Eisenhower at London Airport. This was one of the programmes covered by Granada's cameras for CBS.



(Left) A Videotape machine in action during the conversion operation.

**W**HEN President Eisenhower visited Europe recently, the Columbia Broadcasting System of America asked Granada if they would prepare Videotape recordings of the President's arrival and activities and send them by plane to the USA for immediate playback. The technical difficulties involved in meeting such a request were enormous; it was necessary to receive at London Airport the television coverage of the day-to-day engagements of President Eisenhower and convert it before recording so that it was suitable for American television standards. The Videotape records then had to be sent across the Atlantic with the utmost speed.

## Different Standards

American television, working with a mains frequency of 60c/s, shows 30 complete, interlaced pictures per second with 525 lines per picture as opposed to the British standard of 25 pictures per second with 405 lines. Thus, before the programmes could be recorded, they had to be

passed through a "Standards Converter" so that the pictures would be technically suitable for the USA. When Videotape recording was first employed at Granada, attention naturally turned to the possibility of exchanging recorded programmes with other television services, particularly those in the USA. Before such exchanges could take place, a Standards Converter had to be made. This consists of a high grade monitor, with a long-persistence screen, set up in front of a normal TV camera operating on American standards. The output from this camera is used to feed the Ampex recorder.

The advantages of tape made it the ideal medium for recordings of this nature when speed is the essential. Tape is easy to edit, pack and despatch. It is only 2in. wide and programme material which takes an hour to play back weighs only 20lb on the reel and, of course, no developing and printing is required as with film. Both sound and vision is recorded on the same tape and the quality of reproduction is better than with film recordings.

## Location

Until the visit of President Eisenhower, the Standards Converter had always been used in the Granada TV Centre in Manchester, but it was obviously necessary, on this occasion, to operate

the unit close to the Transatlantic airlines. Accordingly, a convertor was installed in one of the travelling eye vans and sent south together with an eagle tower, a links van, and a mobile Videotape recording van. One of the most difficult items of equipment to move was the 60c/s generator which was needed to produce the American Standard. This weighed three-quarters of a ton!

Another difficulty arose regarding the choice of a suitable site at London Airport; the various requirements left few areas available. It was necessary to have access to Post Office lines, to have a suitable radio-link path into London, to have sufficient three-phase and single-phase power to run equipment, and enough space to park all the vehicles involved. The final site chosen had to be a compromise and there were several disadvantages, the chief of which was that a three-mile drive round the airport was required to deliver the reels of tape to the take-off point of the Comet and Boeing airliners.

### Timing

Normally, freight for aircraft is expected to be at the airport at least two hours before take-off to allow time for passage through the Customs and for forms to be completed. However, on some occasions, the reels of tape arrived so late

that in the hurry to take them on board stewardesses sometimes had to take them into the cabin instead of having them stowed in the hold.

For a safety precaution, in case of late arrival of a plane, each reel of tape was duplicated and the second reel sent by the next plane. Thus in the event of any unforeseen delay the pictures would arrive in the USA only a few hours late.

### Trial Run

Before the President's visit commenced, the system was given a dummy run. The tape was despatched on the 11 a.m. plane, reaching New York just after 3 p.m. Within an hour, a cable was received from CBS "Tops as regards audio, video and geometry."

Not only the activities in this country were recorded, but also, by way of the Eurovision link, the President's visit to Germany. Some excellent pictures of his departure from Germany, though not specifically requested by CBS, were flown to the USA.

The arrival of the President in Great Britain, like his arrival at Balmoral, was covered in two different ways as a precaution against failure. On one tape, the BBC coverage was taken, which consisted of vision and sound effects without a commentary. The unit made its own coverage on another tape which included the official speeches.

An old control tower in the airport grounds and a special platform were used for the camera positions. The commentary on this tape was given by Alexander Kendrick of CBS.

When the tapes reached the USA special arrangements were also needed so that they could be played back over the American networks as soon as possible.



As soon as the recording was ready for despatch it was rushed from the mobile Videotape recording van to the aircraft. The small size of the reels of tape is clearly illustrated.

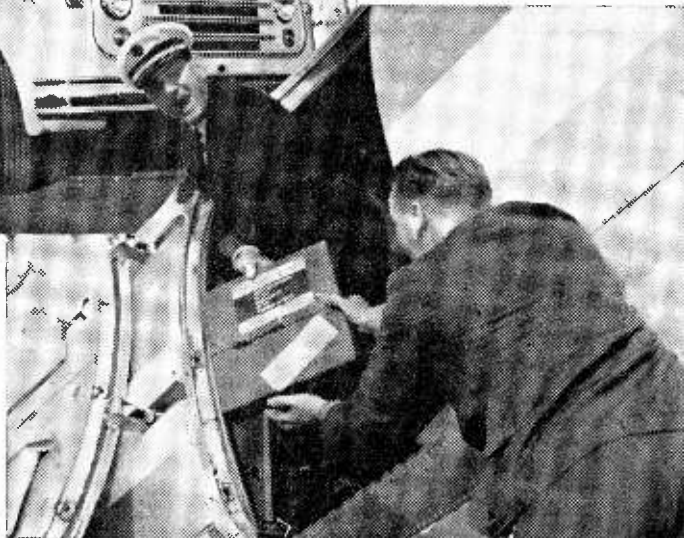



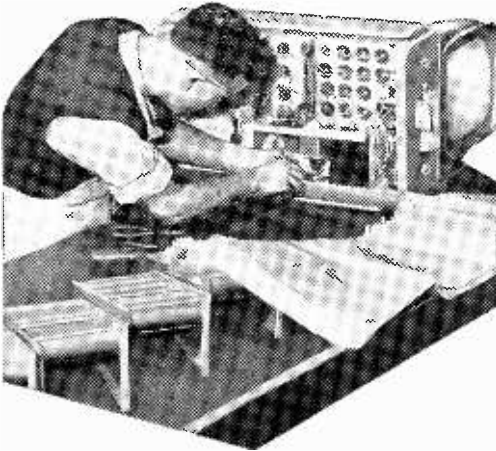

# Analysing and Servicing TV Receivers

No. 10.—FOCUSING SYSTEMS

By "Diadem"

but the focus coil is this time wired in the H.T. negative lead.

The high resistance focus coil in Fig. 46 is energised by feeding it direct from the H.T. supply. The variable resistor in series with it alters the current passing through the coil and gives control of focus.

### Permanent Magnet Focusing

Many receivers use a permanent magnet to focus the electron beam. The operation is essentially the same as for the electro-magnetic type of

**F**OLLOWING the previous article on the C.R. tube, we now deal with the various circuits employed to focus the electron beam on the screen of the tube.

The two main methods adopted for focusing the picture on the screen of the C.R. tube use an electro-magnet or a permanent magnet. Various forms of electro-magnetic focus commonly encountered are shown in Figs. 42-46. Of course, individual applications of these methods may result in slightly different circuitry. In Fig. 42 the focus coil forms part of the anode circuit of the sound output valve of the receiver. Control of focus is achieved by altering the value of a variable system in the valve cathode circuit. A similar arrangement is employed in Fig. 43. The coil is tapped as shown and thus the focus coil is energised partly by the main H.T. current and partly by the current flowing in the cathode circuit of the output valve. Control of focus is again achieved with the variable resistance which alters the bias on the valve.

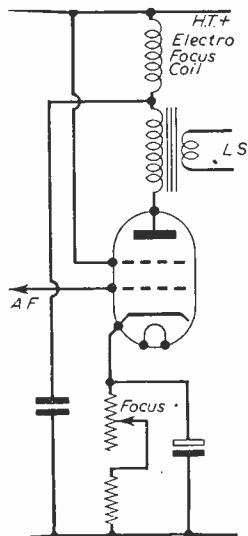

Fig. 42.—Wiring the focus coil in series with the sound output valve.

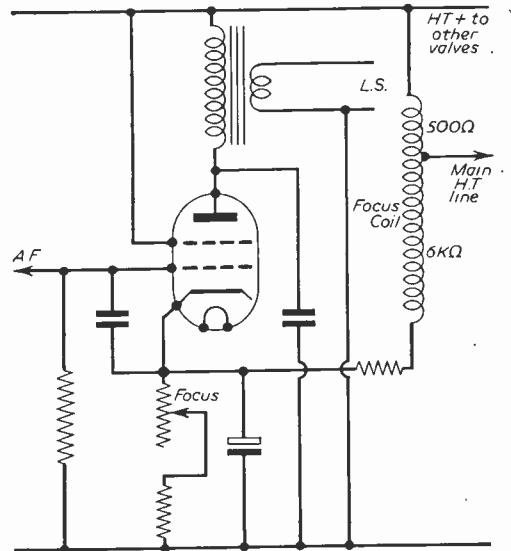

Fig. 43.—The focus coil is energised partly by the main H.T. current and partly by the sound output valve bias current.

focus unit, but the degree of control may be less. Tetrode tubes need a weaker focusing field than triode tubes and when substituting a tetrode for a triode and a permanent magnet is being used it will be necessary to weaken its magnetic field. This is achieved by placing around the magnet three or four mild steel strips about 1/4 in. wide and 1/16 in. thick and long enough to bridge the pole pieces. The number of strips depends on the reduction the magnetic field requires. Ordinary steel washers can sometimes be used. On no account try to de-magnetise the magnet by removing the pole pieces or it may become unstable.

### Ion-trap Magnets

Sometimes it is required to change from a tube with a straight gun to a more modern one with



*The Biggest Money-Maker in the Business!*

**NEWNES  
RADIO & TELEVISION SERVICING**

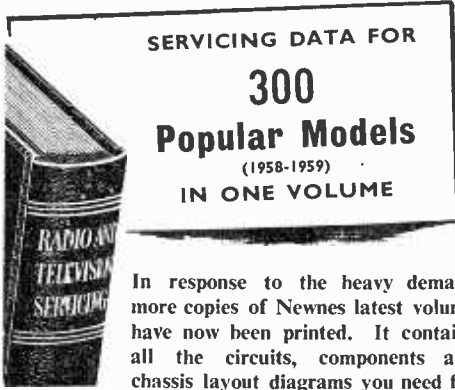

**SERVICING DATA FOR  
300  
Popular Models  
(1958-1959)  
IN ONE VOLUME**

In response to the heavy demand more copies of Newnes latest volume have now been printed. It contains all the circuits, components and chassis layout diagrams you need for

300 popular 1958-1959 Models. Examine it Free for 7 days —see next page.

**672  
PAGES  
OF  
WANTED  
DATA**

**TELEVISION, RADIO, RECORD AND TAPE SERVICING DATA**

Alba, Argosy, Berec, Beethoven, Bush, Champion, Collaro, Cossor, Cyldon, Decca, Defiant, E.A.R., Eddystone, Ekco, Ever Ready, Ferguson, Ferranti, G.E.C., Grundig, H.M.V., Invicta, K-B., McMichael, Marconiphone, Masteradio, Murphy, Pageant, Pam, Perdio, Peto

Scott, Philco, Philips, Pilot, Portadyne, Pye, Pye Telecommunications, Raymond, Regentone, R.G.D., Roberts' Radio, Sobell, Spencer-West, Stella, Ultra, Vidor, Walter.

**RECENT DEVELOPMENTS SECTION** Includes: Picture Tube Repair, Car Radio Interference Suppression, Valve and Picture Tube Data.

**HEATER RATINGS, BASE CONNECTIONS, EQUIVALENTS**

**SERVICING DATA PRE-1953 UP TO 1959  
Over  
2,300 Models  
COMPLETE LIBRARY IN SEVEN VOLUMES**

Includes the 300 models and data in the volume on the left

Here you have Newnes Complete Servicing Library—early popular models to 1959—almost every set you will ever be called upon to service. This data is, as you know, absolutely invaluable. It is worth its weight in gold for years on end—increasing your income by quicker servicing. Study the complete set for 7 days—without obligation.

**TELEVISION, RADIO, RECORD AND TAPE SERVICING DATA**

Ace, Alba, Ambassador, Argosy, Armstrong, Baird, Banner, Beethoven, Berec, Brayhead, Bush, Champion, Collaro, Cossor, Cyldon, Decca, Defiant, E.A.R., Eddystone, Ekco, E.M.I., English Electric, Ever Ready, Ferguson, Ferranti, G.E.C., Grundig, H.M.V., Invicta, K-B., McCarthy, McMichael, Marconiphone, Masteradio, Motorola, Murphy, Pageant, Pam, Perdio, Peto Scott, Philco, Philips, Pilot, Portadyne, Pye, Pye Telecommunications, Radiomobile, Rainbow, Raymond, Regentone, R.G.D., Roberts' Radio, Sobell, Spencer-West, Stella, Strad, Ultra, Valradio, Vidor, Walter, Webcor, White-Ibbotson.

Also—Large Fold-out Charts—Television Trouble Tracing; Servicing VHF/FM and AM/FM receivers; Servicing Printed Circuit Equipment; Servicing Transistorised Equipment. Data on—Colour Codes, Valves and Picture Tubes, Medium and Long Wave Broadcasting Station Wavelengths, TV and VHF/FM Stations and Channels.



**4,250  
CIRCUITS  
AND  
DIAGRAMS  
•  
4,150  
PAGES**

2 Years' Free Postal Advisory Service

**EXAMINE EITHER—  
FREE  
FOR 7 DAYS**

without obligation to buy

*See overleaf for more details and  
REPLY-PAID FORM FOR POSTING*

# Newnes Radio & Television Servicing

## PAYS FOR ITSELF OVER AND OVER AGAIN!

"More than repaid the cost in a short period," says E. J. S. (Wolvercote).

"One glance only was enough to convince me of its worth," writes J. F. B. (Leicester).

"Of immense help and in constant use."—T. A. (Uxbridge).

"A boon and a must."—J. S. (Manchester).

### SEND FOR FREE EXAMINATION TO-DAY—SEE BELOW

HOW TO FOLD THIS PAGE FOR POSTING

(B) Fold along here

Postage will be paid by George Newnes Ltd.

No Postage Stamp necessary if posted in Gt. Britain or Northern Ireland.



1. Detach complete page and fold across at (A), turning this strip downwards out of sight.

2. Then fold at (B) and (C).

3. Tick (C) into (B) so that Reply-paid portion with NEWNES address is shown.

(A) Fold along here

BUSINESS REPLY FOLDER  
Licence No. W.C. 1129

GEORGE NEWNES LIMITED,  
15-17 LONG ACRE,  
LONDON, W.C.99

FINALLY POST QUICKLY!

DETACH PAGE HERE

(C) Fold along here



## POST TO-DAY NO STAMP REQUIRED

Place tick against your choice below:

Radio and Television Servicing (Pre-1953 to 1959 Models)  
**SEVEN VOLUMES**  
10/- Dep. 15 monthly payments of 15/-, Paying £11.15s. in all. Cash price in 8 days £11.5s.

Radio and Television Servicing (1958-1959 Models)  
**SINGLE VOLUME**  
12/6 Deposit, 4 monthly payments of 10/-, Paying 52/6 in all. Cash price in 8 days 50/-.

Send me the book or books I have selected, without obligation to purchase. I will either return the book or books in 8 days or send the deposit 8 days after delivery, then the monthly subscriptions as set out above, until the total subscription price of the book or books I have selected has been paid.

Mr., Mrs., Miss. ....

Address .....

Occupation .....

Your Signature .....

(Or Parent signs if you are under 21)

R41/RV61

Tick (✓) where applicable

HouseOWNER	<input type="checkbox"/>
Householder	<input type="checkbox"/>
Living with Parents	<input type="checkbox"/>
Lodging Address	<input type="checkbox"/>

a bent gun assembly, i.e., a tube with an ion-trap. It is important to check that the bracket holding the neck of the tube and the focusing-deflection assembly is not of steel or other magnetic material. If necessary it should be changed to one of aluminium otherwise the proximity of the magnetic bracket to the ion-trap

planes by careful adjustment of the magnet. Re-adjust the ion trap if fitted.

**Shadows at the corners.**—The scan coils have moved down the tube neck. Push them right up towards the face of the tube. A tilted magnet can also be the cause. Even it up with the screws provided. Rotating the tube will sometimes effect a cure. Make sure that speaker magnets, chokes and transformers near the tube are not the cause.

**Picture tilted.**—Loosen the locking nut or band on the scan coils and turn the coils either to the left or right until correct, push the coils towards the tube face and tighten locking nut if fitted. When the coils have adhered to the tube neck, run the set for an hour or so until it is warm before attempting to move them. Do not place any strain on the neck of the tube.

**Trapezium distortion with reduced scan** can be caused by a short in the scanning coils or the coil may be out of alignment and twisted slightly, giving a sloping effect to the raster edges.

**Grid modulated tubes.**—Where a tube is grid modulated and fed direct from the video anode, if the video valve breaks down the full H.T. will be applied to the tube grid with disastrous results. The grid must never be allowed to go positive with respect to the cathode. If you are contemplating grid modulating a heater-to-cathode shorted tube, the necessary precautions should be

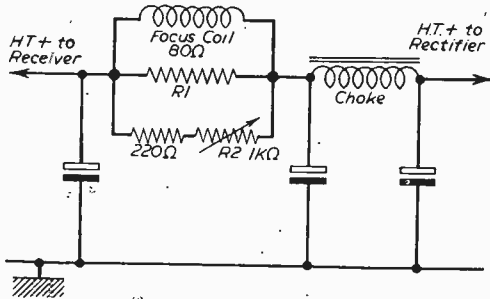

Fig. 44.—The focus coil is wired in series with the H.T. positive lead.

magnet will prevent it from functioning correctly. Sometimes the bracket can be obtained ready cut in aluminium from the manufacturers of the receiver.

**Tube and Focus Troubles**

**Picture drifts out of focus with electromagnetic focus coil.**—Check the H.T. line voltage and smoothing condensers for low capacity. A partial short in the smaller decoupling condensers will alter the current through the focus coil. In some sets, the focus ring is in series with the anode or cathode of the sound output valve, and this stage should be checked.

Deterioration in a permanent magnet will also cause poor focusing and definition. The position of the focus magnet is very important for good definition. On some sets the picture may appear to be in perfect focus with sharp lines, but the bandwidth gratings on the test card may only show 1½Mc/s. By pushing the magnet forward, the picture will still be in good focus and the 2½Mc/s bars will be seen. It is possible to receive good definition in both horizontal and vertical

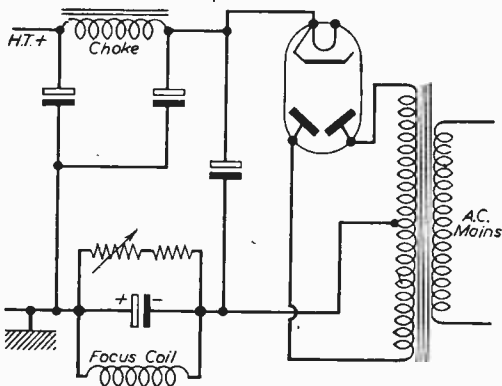

Fig. 45.—Wiring the focus coil in series with the H.T. negative lead.

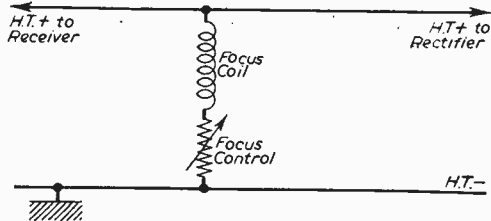

Fig. 46.—Energising the focus coil direct from the H.T. supply.

taken. The safest way is to follow the video amplifier with a D.C. restorer diode and a cathode-follower (Fig. 38). The picture signal is taken from the cathode and the sync from the anode. Tube safety is assured by this method.

**Pin cushion or barrel distortion.**—This fault is usually caused by the scanning coils not matching the tube. Do not replace a bowed-faced tube with a flat-faced one or vice versa.

**Tube Shorts and Remedies**

In the case of a C.R. tube developing a heater to cathode short, a sharp tap round the tube base may remove this intermittently. If it can be removed this way, it is often caused by a sagging heater, and rotating the tube will often clear the fault by moving the heater away from the cathode at the point of insulation breakdown. To prevent a recurrence of the fault, an isolating transformer should be fitted to the heater. A low-loss transformer is advisable to prevent smearing. Connecting a condenser or resistor across the cathode and heater is left to the discretion of the user. Definition is bound to suffer if this is done, but it may be essential if the intermittency

is troublesome. The condenser can be  $0.1\mu\text{F}$  or the resistor  $100\Omega$  or the two electrodes can be wired together in certain cases. However, a direct short is usually inadvisable as part of the heater is liable to be shorted out.

*Cathode to grid shorts* are sometimes caused by cathode particles dropping on the grid. Try to remove them by placing the tube face down and tapping round the tube base. In the case of sagging electrodes, rotate the tube and replace. By sharply tapping the base, the sag may be removed when the tube is put into use again. If these methods fail, and the tube is a tetrode or pentode, remove the wire from A1 and tape it up. Remove the wire from the grid and solder to A1 and short the grid and cathode together. This

method should work quite well providing the tube emission is reasonably good.

*Low emission.*—The picture is dim or lacks highlights (whites). The blacks are usually good and the focus remains fairly sharp. Increasing the brilliance will give a blushed appearance and turn the picture negative. Measure the cathode current in conjunction with the tube maker's data, and if the reading is satisfactory the fluorescent screen may have deteriorated. If the emission is low, fit a booster transformer to the heater. The writer has found this method is more lasting than rejuvenation.

*Impaired vacuum.*—The gun will sometimes light up bright violet, with arcing between the electrodes with the screen "dead."

## An Unusual Fault

By A. Bartholomew

**A** VERTICAL line superimposed on the picture is generally attributed either to misadjustment of the line-drive or spurious oscillations, of one type or another, in the line timebase.

### Independent Movement

However, when investigating a case in which the normal procedure did not remove the symptoms, it was noticed that the offending line could be moved horizontally independently of the picture by slight adjustment of the line hold control.

On the receiver under test, it was possible, by careful adjustment of the line hold control, to displace the picture in such a way that the line blanking period, including the sync pulse, could be brought to the centre of the screen, splitting the picture in two without complete loss of synchronism. It was thus observed that there was strong over-shoot on the trailing edge of the line sync pulse, giving rise to a thin bright vertical line.

With the picture in sync, this line appears during the line fly-back period and is expanded in width to perhaps half an inch owing to the fast fly-back trace on which it occurs.

### Overshoot

To sum up, if a receiver is found to have a vertical line which can be moved slightly, independently of the picture, across the screen by adjustment of the line hold, it is most probably caused by overshoot on the trailing edge of the line sync pulse.

Note, this fault cannot be ascertained simply by bringing in the picture width to show the edges of the picture as the back of the sync pulse will still occur during the fly-back period. However, in many receivers, by carefully adjusting the line hold control the picture can be split to make the sync pulse appear on the screen during the forward scan. The alternative method of observing the waveform by oscilloscope is in this case not so useful, as the input capacity of the scope will modify the amount of overshoot.

Having checked that the picture fault is indeed caused by overshoot on the line sync pulse, a cure can be effected by adjustment of picture controls, alignment, or both.

## Radio Show Attendance

**T**OTAL attendance at the Radio Show, Earls Court, London, which closed its ten-day run on Saturday (September 5) was 310,161, compared with 334,502 last year, the slight reduction being attributed by the organisers to the exceptionally fine weather this year.

The attendance of buyers from home and overseas was considerably higher. There were 4,109 overseas visitors in all, including 679 classified as buyers, the latter figure being 25 per cent. up on last year.

Of more than 100 countries represented, most visitors were from: Union of South Africa, nearly 400; India, over 350; Australia, about 275; Pakistan, over 200; New Zealand, about 175; and Ceylon, over 150.

### SEND A "PRACTICAL" CHRISTMAS GIFT!

You're holding the ideal Christmas gift in your hands now. Yes, PRACTICAL TELEVISION. Why not send a full year's subscription for this invaluable magazine to friends who are TV enthusiasts? It's a present you know they'll appreciate. And each new issue will be a renewal of your best wishes . . . month in, month out, right up until Christmas, 1960!

Simply send your friends' names and addresses, together with your own and remittance\* to cover each subscription, to The Subscription Manager (G.1), "Practical Television," Tower House, Southampton Street, London, W.C.2. We will dispatch first copies to arrive before Christmas, and send an attractive Christmas Greetings Card in your name to announce each gift.

\* RATES (INCLUDING POSTAGE) FOR ONE YEAR (12 ISSUES):—U.K. £1.2.0, OVERSEAS £1.0.6, CANADA £0.19.0, U.S.A. \$3.00.

## 7-VALVE AM/FM RADIOGRAM CHASSIS

Surplus Bargain Offer

**TRS**

Valve Line up: ECC85, ECH81, EF89, EABC80, EL84, EM81, EZ80.

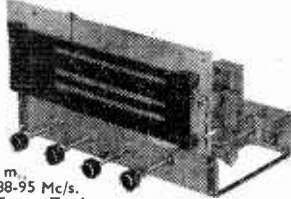

3 waveband and switched gram positions. Med. 200 m.-500 m., Long 1,000 m.-2,000 m.. VHF/FM 88-95 Mc/s. 4 Controls. Vol., On-off, Tone, Tuning, Wavechange. P.U., Ae. and E., and speaker sockets. Magic eye tuning. Philips continental tuning insert with permeability tuning on FM, and combined AM/FM IF transformers, 460 Kc/s and 10.7 Mc/s. Dust core tuning all coils. Latest circuitry, including AVC and Neg. Feedback. 3 watt output. Sensitivity and reproduction of a very high standard. Chassis size 13 1/2 in. x 6 1/2 in. Height 7 1/2 in. Edge illuminated glass dial 1 1/2 in. x 3 1/2 in. Vertical pointer, Horizontal station names, gold on brown background. A.C. 200/250 v. operation.

**£13.10.0** Carr. and Ins. 5/- Complete with 4 knobs walnut or ivory to choice.

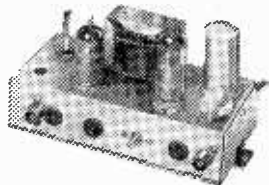

### BAND 3 TV CONVERTER

All channels 7-13 (180-205 Mc/s). Mk. 2 Model. Latest cascade circuit using 6X4 and 6F80 valves. 10db gain over "standard" circuits. Built-in Power Supply 200-250 v. A.C. Size 6 1/2 in. x 3 in. x 4 in. Simple to fit—only external plug-in connections. Wired and aligned ready to use. Only 79/6. P. & P. 2/6. B1-B3 changeover Sw. and BSC Aerial socket fitted and wired, 8/- extra. Band 3 Aerials. Single dipole with 4 yd. cable, 18/8. 3 Element Beam, 25/-, 5 Element, 32/6, etc. B1-B3 Crossover Units, 7/6.

### RECORD PLAYER BARGAINS

NEW RELEASE by E.M.I.—4-speed Sinter Player. Built fitted with latest stereo and monaural Xtal cartridge and dual sapphire s.y.l. Auto stop and start. A facility unit and bargain buy at only **26.10.0**. BSR—De Luxe UA12 Model.—4-speed auto-changer with stereo monaural turnover cartridge, etc. Bargain **£8.19.6**. Garrard—Latest RC12.D/Mk 2—fitted with Xtal cartridge, plug-in monaural head. Auto/manual selector, etc. The connoisseur's choice for audio perfection. Limited bargain offer only 91 gns. Plug-in stereo head GBS10 £2 extra. All above are brand new, fully guaranteed models, Carr. and Ins. 4/6. Comprehensive bargain range of Collars, BSR and Garrard Units in stock. Send for comprehensive bargain lists.

### RE-GUNNED TV TUBES

New Reduced Prices!

And now 12 months' Guarantee!

12in. ....	26	17in. ....	£8.10.0
14in. ....	27	21in. ....	£10.10.0
13in. ....	£7.10.0		

Carr. and Insur. 10/-  
All tubes Rebuilt with new Heater Cathode and Gun Assembly—reconditioned virtually as new! Full 6 months' unconditional Guarantee. As used by our own Service Dept. Comprehensive stocks—quick delivery. 10/- part exchange allowance on your old tube.

### RECORD PLAYER CABINETS

Contemporary Cabinet styled, rexine Price covered cabinet in two-tone **£3.3.0**. fawn and brown, Carr. and or mottled red Ins. 3/6.



with white polka dot. Size 18 1/2 x 13 1/2 x ht. 8 1/2 in., fitted with all accessories, including baffle board and anodised metal fret. Space available for all modern amplifiers and autochangers, etc. Circuit record player mounting board 14 x 13in. supplied.

### 2-valve AMPLIFIER Mk. 2

Latest developed circuit giving a higher fidelity response and greater output (2.3 watts) using twin stage valve ECL82 and neg. feedback Tone Control. Complete with knobs, etc., wired and tested ready to fit in above cabinet.

ONLY £2.17.8. P. & P. 1/-.  
6in. speaker and matching transformer, 22/- P. & P. 1/0.

**SENTEREL RECTIFIERS.** E.H.T. Type Fly-back Voltages: K3/25 2 kV, 5/-; K3/40 3.2 kV, 6/9; K2/45 3.6 kV, 7/8; K3/50 4 kV, 7/9; K3/100 8 kV, 1/6. MAINS TYPES.—RM1, 125 v. 60 mA., 4/8; RM2, 125 v. 100 mA., 5/6; RM3, 125 v. 120 mA., 7/8; RM4, 250 v. 250 mA., 16/-; RM4B type 270 mA., 17/8; RM5, 250 v. 300 mA., 21/-.

**SPEAKER FRET.**—Expanded Bronze anodised metal 8 x 8 in., 2/3; 12 x 8 in., 3/-; 12 x 12 in., 4/6; 12 x 15 in., 6/-; 24 x 12 in., 9/-, etc.  
Listed above are only a few items from our very large stock. Send 3d. stamp today for Complete Bargain List.

### FULLY GUARANTEED VALVES

1R5, 1T4 7/6	DP96	9/-	EP80	10/6
1R5	7/6	DK96	9/-	EP86
384, 3V4 8/-	DL96	9/-	EP91	12/6
3Z4	9/6	35L6	9/6	EL41
6X7	5/6	EABC80	9/6	EL34
6K8	8/6	EPCC1	9/6	EM51
6Q7	8/6	ECC83	9/6	EY51
6N7	8/6	ECC84	10/6	EY86
6V6	7/6	ECP80	11/6	EY280
6X4	7/6	ECP82	11/6	EZ81
7C5	9/-	ECH81	10/6	MT14
7Y4	8/6	ECL80	10/6	PCC34
DAF96	9/-	ECL82	11/6	PCCP80

Send for List.

### SPECIAL PRICE PER SET

1R5, 1T4, 1R5, 384 or 3V4	...	...	27/6
DK96, DP96, DAF96, DL96	...	...	35/-
6K8, 6K7, 6Q7, 6V6, 3Z4 or 6X5	...	...	35/-

### COAX 80 OHM CABLE.

Stand 1/2 in. diam. Low Loss Semi-Air Spaced Aerialaxial.

**SPECIAL REDUCED PRICES**  
20 yds. 12/6, p. & p. 1/6; 60 yds. 32/6, p. & p. 3/-; 40 yds. 22/6, p. & p. 2/6; All other lengths 8d. per yard.  
Coax Plugs 1/-. Sockets 1/-. Couplers 1/3.  
Cable End Sockets 1/6, Outlet Boxes 4/6.

### C.R.T. Heater Isolation Transformers

New Improved types—mains prim. 200/250 v. tapped.

All Isolation Transformers now supplied with alternative no boost plus 25%, and plus 50% boost taps, at no extra charge.  
2 v. 2A type 12/6 (P. & P. 1/6)  
6.3 v. .5A .. 12/6 ..  
10.5 v. .5A .. 12/6 ..  
13 v. .3A .. 12/6 ..  
Other voltages available at same prices.  
Small size and tax terminated for easy fitting.

### SPECIAL OFFER

Superior type Art leather covered Portable case. Well-known Manufacturer's surplus, in attractive tan colour with non-tarnish gilt fittings.

Knockout price **15/6** Post & Pack. 2/6

### ALTERNATIVE OFFER

Above case fitted with latest BSR 4-speed TUN Record Player Unit. Full-Fi Xtal pick-up. Ready mounted and wired. Complete with mains lead and detachable screened pick-up lead. An ideal portable record player unit for tape or amplifier use.

Bargain **5 gns.** Post & Pack. 4/6



### VOLUME CONTROLS

10,000 ohms—2 Megohms. All long spindles. Morganite Midget type. 1 1/2 in. diameter. Guard 1 year. Log or Lin. Ratios. Less sw. 3/-. D.P. Sw. 4/8. Twin Ganged controls, 1 meg., 1 meg., 1 mck., less Sw. 8/8 ea.

**TYGAN FRET** (Murphy pattern) 12 x 12 in., 2/-; 12 x 18 in., 3/-; 12 x 24 in., 4/-, etc.

**SPEAKERS P.M.** 3 ohm 2 1/2 in. Elac. 16.6. 2 1/2 in. Goodmans, 18/6. 5 1/2 in. R. & A. 17/8. 6 in. Celestion 18/8. 7 x 4 in. Goodmans, 18/6. 8 in. Rola, 20/-. 8 in. Special Cone Goodmans, 21.6. 10 in. R. & A., 25/-

Terms: C.W.O. or O.O.D. Kindly make cheques, P.O.s, etc., payable to T.R.S. Post/Packing up to 11b 7d., 11b. 1/3, 31b. 1/6, 64b. 2/-, 101b. 2/9. Hours: 9 a.m.—6 p.m. 1 p.m. Wed. Open all day Saturday.

**TRS**

## RADIO COMPONENT SPECIALISTS (Est. 1946)

70 BRIGSTOCK ROAD, THORNTON HEATH, SURREY (THO 2182)

50 yards Thornton Heath Station.

Buses: 130A, 133, 159, 166 and 190

**AUTOMATIC CHANGER UNITS**  
**B.S.R. UAB**, 4-speed Mixer Automatic changer, manual and auto-control complete with latest B.S.R. "full" pickup, Carriage and packing 3/6. OUR PRICE £6.19.6.  
 The new B.S.R. Model UA12, 4-speed Mixer Automatic record changer, fitted with latest type turnover cartridge. OUR PRICE £5.17.5. Carriage 3/6.  
 The latest Collaro Conquest, 4-speed auto-changer, in cream with Studio '0' insert. Brand new, fully guaranteed. £7.19.6, plus packing and post 3/6.  
 Collaro, 4-speed single player unit with automatic stop, cream, turnover crystal cartridge, brand new and guaranteed. £6.19.6.  
**GARRARD AUTOMATIC RECORD CHANGER**, 4 speed, type RC.120/D Mark 1. Price £8.17.6. Post & Packing 3/6.

**RECTIFIERS FOR BATTERY CHARGERS**  
 12 v. 1 amp. 4.3. 12 v. 2 amp., 7/- 12 v. 3 amp. 10/- 12 v. 1 amp., 12.6. 12 v. 5 amp., 14.6. 12 v. 5 amp. 15.9.

**AGOS MICROPHONES**  
**Agos Mic 29-1**, Crystal Stick Microphone for use as a hand, desk or floor stand unit for high quality recording, broadcasting and public address work. LIST PRICE £5.5.0. OUR PRICE 39/6. With Stand, 47/6. Postage 1/6.  
**Agos Mic Type 33-1**, Crystal hand or table microphone. Flat response 30-7,000 c.p.s. Omni-directional. Suitable for tape recording, etc. Dark brown plastic case. Brand new in maker's cartons. List 50/- OUR PRICE 29/6. Postage 1/6.  
**Mic 40**, as supplied with most modern tape recorders, listed at 35/-. Our Price, 25/-. With folding rest and 8ft. lead 40-5,000 c.p.s.

**ALPHA RADIO SUPPLY CO.**

**VALVES GUARANTEED ALL TESTED BEFORE DESPATCH**

DAF96	16 7	KTW61	6/6	5U4G	7/-
DF96	8/9	N78	19/11	5Y3GT	8/-
DK96	8/9	OZ4	5/6	5Z4G	9/-
DL96	8/9	PCC84	9/-	6A7	13/-
EL96	8/9	PCF80	9/6	6AL5	8/6
EBC33	6/9	PL81	12/6	6AM6	6/9
EBC41	9/6	PL82	8/6	6F6G	7/8
EBF80	9/9	PX25	12/6	6F1	14/-
ECC84	10/-	PY80	7/6	6F13	14/-
ECC85	9/6	PY81	8/6	6F15	14/-
ECH12	9/6	PY82	7/-	6KTG	4/-
EHC81	9/-	PEN4VA15	7/-	6KR8	7/6
ECL80	10/-	PEN25	6/-	6L6C	8/-
EP39	5/9	PENA4	15/-	6L18	13/6
EP40	14/6	SP41	3/-	6Q7G	8/6
EP41	9/9	SP81	3/-	6SL7GT	8/-
EP42	11/-	TP23	28/6	6SN7GT	7/6
EP50	4/-	U14	8/6	6U4GT	12/-
EP80	8/-	U25	14/-	6V6G	8/6
EP86	13/-	U191	11/6	6V8G	7/9
EL41	10/6	UCH42	10/6	6X5G	7/-
EL42	10/6	UF41	9/-	6X5GT	7/6
EL84	9/-	VU38 (MU12)	12AT7	7/6	6X7G
EM80	10/-	14)	8/9	12AU7	8/-
EY51	10/-	X78	16/-	12AX7	8/-
EY86	10/-	1CSGT	12/6	12C8	9/-
EZ40	7/6	1H5GT	10/6	25A6G	11/6
EZ80	7/-	1N5	10/6	25Y7	9/9
GZ32	12/-	1S5	7/6	35Z4GT	8/-
HLZDD	8/6	1T4	6/6	3V4	8/6
KT3C	8/6	3S4	7/3	42	8/-
KT86	17/6	3V4	8/6	83	8/6

**CYLON TURRET TUNERS TYPES E101, E16L & E381**. Brand New, all complete. Listed at £7.7.0 OUR PRICE, 55/- each, or available less valves at 35/- each.

**TELEVISION TURRET TUNERS**. TYPE TT13 fitted PCF80 & PCC84 valves, type TT19 fitted ECC80 & ECC84. Both are 55/- each or less valves. 35/- each. Wolsey Aerial Converters for ITV, listed £9.9.0 OUR PRICE £4.10.0

**EX-GOVERNMENT HEADPHONES**. Etc. High Resistance Headphones type CHR 13/6, pair available either cream or black. Low Resistance Headphones, impedance 120 ohms, type CLR 7/6 pair. American Throat Microphones, type T30 3/- set.

**LOUDSPEAKER UNITS**

\* All brand new. \* Note Special Prices. All Permanent Magnet 3 ohms impedance. Each

5in. Units by Plessey, Goodmans, Lectrona	17/6
6in. Units by Plessey	18/6
7in. Units by Goodmans	19/6
10in. Units by Elac, Plessey	25/6
6in. x 4in. Units by Plessey	19/6
7in. x 4in. Units by Goodmans	19/6
7in. x 5in. Units by Goodmans	19/6
8in. x 5in. Units by Goodmans	25/6
10in. x 6in. Units by Plessey	25/6
8in. Loudspeaker Unit 3 ohms impedance with a Matching Output Transformer suitable for 6V6 Brand New but soiled, offered at a Special Price of 11/6 each, postage 2/-	
6in. Mains Energised Loudspeaker with Matching Output Transformer, Field Coil, 600 ohms, 17/6 each.	
8in. Mains Energised Loudspeaker with Matching Output Transformer, Field Coil, 600 ohms, 21/- each.	

**CATALOGUE**  
 Our 1960 catalogue is now available. Please send 1/- stamps for your copy. Trade Catalogue also available, please attach your Business Letter Headings.

**ALPHA RADIO TERMS.**—Cash with order or C.O.D. Postage and Packing charges extra, as follows: Order value 10/- add 13/-; 20/- add 19/-; 40/- add 26/-; £5 add 3/6. Minimum C.O.D. Fee and Postage 3/-. For full terms of business see inside cover of our catalogue. Personal Shoppers 9 a.m. to 5 p.m. Monday to Friday. Saturday 10 a.m. to 1 p.m.

**103 LEEDS TERRACE, WINTOWN STREET, LEEDS, 7.**

**Now . . . in your own home, LEARN**

**RADIO - TELEVISION - ELECTRONICS**

**NO PREVIOUS TECHNICAL EXPERIENCE NEEDED!**  
**PRACTICAL EQUIPMENT (INCLUDING TOOLS) GIVES YOU A REAL LABORATORY TRAINING**

*"The trained electronics engineer has a great career ahead of him."*

Valuable FREE Book shows how E.M.I.

Institutes School of Electronics can train you for today's wonderful opportunities.

Radio, Television and Electronics provide an exciting field for the trained man—high pay, a prosperous future—or if you prefer it—independence in your own business. If you are trained at home by E.M.I. Institutes you will be in the hands of specialists who know the quickest way to prepare you for one of the fine jobs open to trained electronics-men. Whether you are a beginner or an advanced student with an examination in mind, E.M.I. Institutes School of Electronics has a Course exactly suited to your needs—with or without practical equipment—from electricity and magnetism to automation techniques.

Practical Radio Radio & Television Servicing Practical Electronics Electronics Engineering Automation Basic Practical and Theoretic Courses for beginners in Radio, T.V., Electronics, Etc. A.M.Brit.I.R.E., City & Guilds Radio Amateurs' Exam. R.T.E.B. Certificate P.M.G. Certificate "NO PASS—NO FEE"

**We Definitely Guarantee "NO PASS—NO FEE"**

Full details of the Courses, Practical Equipment, convenient monthly payments, our Employment and Advisory Depts., and much other helpful information is given in our Guide to Careers in Electronics. Write for your copy today. There is no obligation and the book will be sent to you quite free of charge.

**FREE BOOK - POST NOW!**

Please send me a free copy of your Guide to Careers in Electronics.

NAME .....  
 ADDRESS .....  
 Subject or Exam .....



**E.M.I. INSTITUTES**

**SCHOOL OF ELECTRONICS**

The Specialist Electronics Division of the British Institute of Engineering Technology.  
 (DEPT. SE/21), COLLEGE HOUSE, 29-31, WRIGHT'S LANE, KENSINGTON, LONDON, W.8.

# CORRESPONDENCE

The Editor does not necessarily agree with the opinions expressed by his correspondents. All letters must be accompanied by the name and address of the sender (not necessarily for publication).

## SPOT WOBBLING

**SIR**,—In your June issue you designed a home-made spot wobbler. I remember this was introduced by one firm at one of the radio shows and was claimed to be a wonderful invention, but it seems to have died out. Why has no other manufacturer used this idea if it is so good? Also, it would appear that the originators referred to above do not now use the device. Is it too tricky to adjust, or is it a fact that a similar effect may be obtained by slightly setting the focus control from its optimum position? I would have thought that with the much bigger screens now being used the need for some such device was even more pressing and as a result would have expected practically all manufacturers to have introduced this arrangement in the present day sets—after all, if it was introduced when the 12in. screen superseded the 9in.; now that the 21in. has come into general use what are we doing about the lines?—G. F. BASSETT (Bristol).

## HOME-MADE EQUIPMENT

**SIR**,—Some years ago you produced the P.T. TV receiver, and in later years the Supervisor. Is it not time you produced another home-constructor receiver for your readers, or has the science now become too complicated for the amateur. I remember the Viewmaster and other receivers by other publishers and regret the lack of such information in these days.—T. W. EVERETT (S.E.).

*[We would like to produce a design for the home construction of a TV receiver, but unfortunately components for the purpose are no longer on the market. The essential parts for a receiver are, of course, frame and line O/P transformers and scanning coils and these must be designed to work with each other. You cannot use one type of transformer with another type of scanning coil. Linearity also is tied up with the combination, and although blocking oscillator transformers may be dispensed with by using multivibrators the difficulty of obtaining the essential components will remain until some enterprising manufacturer puts suitable parts in the hands of the constructor. —ED.]*

## CHANGING CATHODE-RAY TUBES

**SIR**,—It has come to my notice that a reader has encountered a difficulty in following my advice given in the table on page 299 of the January issue of PRACTICAL TELEVISION. It should be noted that owing to its larger neck diameter the MW43/69 may not be used to replace the Mazda CRM171 and CRM172 in every case, as it may prove impossible to replace the deflector coils.

On page 496 of the May issue, the side-heading

"VT7 14in. Transportable" should read "PTV 14in. Transportable."—H. PETERS (Norfolk).

## TV AND THE EYES

**SIR**,—I remember seeing correspondence from various people in the past about the harmful effect, or otherwise, of TV on the eyes. It seems that it is generally admitted that there is no harm from the flickering picture viewed under normal lighting conditions. In the dark viewing may be harmful, I believe, but I think I am right in saying that all the investigations so far have been from an "optical" point of view. I

## SPECIAL NOTE

Will readers please note that we are unable to supply Service Sheets or Circuits of ex-government apparatus, or of proprietary makes of commercial receivers. We regret that we are also unable to publish letters from readers seeking a source of supply of such apparatus.

wonder if any account has been taken of the effects of electrical rays? I think the projection apparatus does actually emit measurable harmful rays over a short distance, and that if any experiments are conducted with the tube or its associated lens system, and the experimenter is likely to get close to it, a sheet of lead glass should be interposed. Whilst rays from an ordinary tube are admittedly weaker, what may be the additive effect of constant viewing, which we are told the majority of children are today doing? Is it not possible that it will affect the colour sensitivity of the eye over a prolonged period?—T. H. BOOTH (N.7).

## REPLACING C.R. TUBES

*(Continued from page 79)*

If the mirror is already badly scratched from some previous attempt to clean it, or has become pitted with age, a sharper picture may be obtained by reversing it. The double image formed by the glass surface is, in this case, less objectionable than the cloudiness due to the scratched mirror surface.

*Cleaning inside the optical box* should normally not be attempted, as it can only be done by removing the corrector lens, which must be put back in exactly the same place. The routine adopted by the makers is to remove the two diagonal clips and fix two rectangular jigs to them before removing the other pair. The rim of the corrector lens should be marked against the side of the optical box to ensure correct re-registration. Clean the mirrors in the same way as the cabinet mirror and replace the corrector lens carefully, removing the jigs one at a time. The underside of the corrector lens should not be handled.

## Transit Clamp

When despatched from the factory, a red transit plate secures the top of the focus unit to the optical box. This should have been removed upon installation and put in safe keeping to be refitted should you ever move. If your set has been running with this plate in position for many years its removal may upset the optical focus.



# FAULTS WITH FOCUS

SOME PRACTICAL ADVICE ON FAULTS AND CURES

By L. J. Sonn

**I**N a cathode-ray tube the electronic beam from the cathode has to be focused on to the screen to give a good picture. In all systems used at present this focusing is done either magnetically, electro-magnetically or electrostatically.

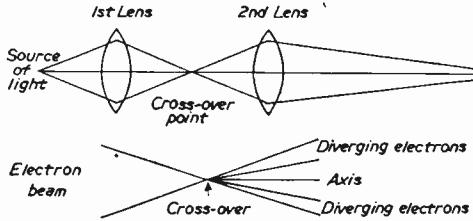

Figs. 1 and 2.—Principles of focusing.

Focusing is achieved in a cathode-ray tube in a way very similar to the focusing of light rays in an optical system (see Fig. 1).

The first lens system in a C.R.T. consists of the cathode, the grid and the first anode, and the second lens system consists of the focusing device and the second anode.

### Action of Focusing

When the electronic beam leaves the cathode it will come to a focus (at the cross-over point) due to the bending or curvature of the lines. This bending is caused by the action of the first anode and the amount of bend will depend upon the distance between the anode and the grid. This cross-over point may be considered to be (for the purpose of focus) the starting point of the electron beam. Now, electrons leaving the cross-over point are not all parallel to the axis of the tube. Some are leaving at small angles to the axis (see Fig. 1). To bring these back to meet at another point on the axis the second lens system is required. In all cathode-ray tubes the

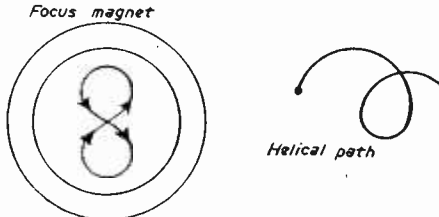

Fig. 3.—The helical path of the electrons.

first lens system is the same and it is only the second lens system that changes according to whether the tube is magnetically, electro-magnetically or electrostatically focused.

### Magnetic Focus

In a tube thus focused the electron beam leaving the cross-over point will, if they leave

at small angles to the axis, come under the magnetic field of the focus magnet. Now this field is at right angles to the resulting force of the electrons and this will cause them to move in a circular path. The electrons also, however, are speeding forward up the gun of the tube and consequently they will assume a helical path (see Fig. 3), and come back to the axis. Now the position where they arrive back at the axis will depend upon the strength of the magnetic field, and the forward velocity. Thus it becomes possible, by varying the position of the focusing magnet, to arrange for this electron beam to focus on the screen. It should be noticed that the velocity of the beam affects the focus point, so that if the EHT on second anode or volts on first anode are low, focusing may be very difficult or even impossible.

### Electro-magnetic

In electro-magnetic focusing the principles are very similar. The electro-magnetic field is at right angles to the beam and exerts a force on the

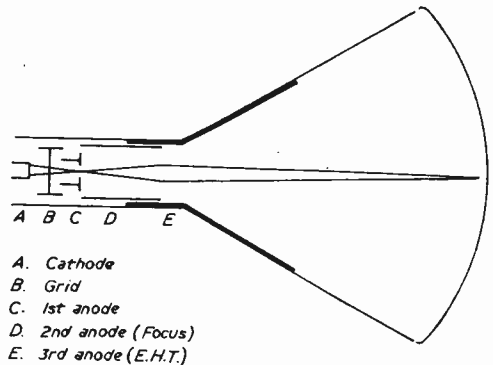
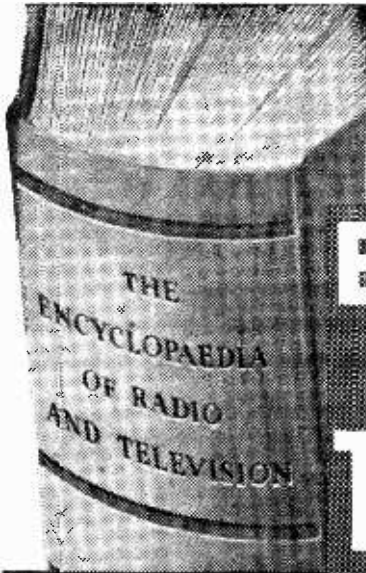

Fig. 4.—The auto-focus system.

divergent electrons, twisting them back to the axis. In this case the electro-magnetic field is generally controlled by a potentiometer, thus altering its effect on the beam. If trouble is met with on this type of focus, check the control first for open circuit or intermittent operation and also the coil for resistance value with the maker's figures.

### Electrostatic Focusing

This type of focusing is now being adopted by tube manufacturers. With this type the focus magnet with its problems of adjustment and mounting are abolished. A small potentiometer control can be fitted to the set to control the focusing, but as this adjustment is not often required this control is omitted by some makers. When this is done, the method is then called "auto focus" (see Fig. 4).



**YOURS on 7 DAYS' FREE APPROVAL!**

**ENCYCLOPAEDIA of RADIO and TELEVISION**

**Up to the Minute!**  
**Comprehensive! Authoritative!**

**736 PAGES**  
**Nearly 800**  
**SPECIALLY PREPARED**  
**ILLUSTRATIONS**

**OVER 3,000 A-Z ENTRIES**

Aerials; Amplification; Attenuation; Audio-Frequency Transmission; Automatic Gain Control; Broadcasting; Communication Systems; Colour Television; Detection; Direction-finding; Distortion; Electrical Machinery; Electrical Recording; Feedback; Feeders; Interference; Loudspeakers; Measuring Instruments; Modulation; Oscillators; Power Distribution; Power Supply; Public-address equipment; Pulse Code Modulation; Radar; Ratcheting; Receivers; Rectification; Relay systems; Senders; Stereophonic Reproduction; Symbols, Abbreviations; Testing and Fault Tracing; Tilt and Bend; Tuning; Transmission (general); Valves; Vision Frequency Transmission; VHF; Wave Propagation; etc.

**THE ESSENTIAL REFERENCE for AMATEUR or ENGINEER**

Here's the complete A-Z guide, packed with clear explanations, latest information and valuable reference data, that meets the practical man's every need! **Essential to the enthusiastic amateur, practising radio engineer, apprentice or student.** Over 3,000 easy-to-follow entries deal thoroughly with every aspect of the theory and practice of television, radio, radar, etc. *New edition, brought up to date by the inclusion of an appendix covering recent developments.* Special reference section gives useful formulae, abacs, etc. **The most remarkable value in any work of this type ever published!** 736 pages. Over 300,000 words. Nearly 800 illus. **De Luxe Edition, handsomely and strongly bound, yours (if kept) for only 30/- (cash price), or 11/6 down and 2 monthly payments of 10/- (31/6).**



**DO THIS NOW!**

To accept this great offer, simply fill in form and post in 2d. stamped, unsealed envelope to Dept. H.F.26, People's Home Library, Odhams Press Ltd., Basted, Sevenoaks, Kent. Book comes to you **ON APPROVAL**—if satisfied you send remittance (full cash or down payment)—otherwise you return book within 8 days. Offer applies in U.K. and Eire only, closes Nov. 30.

**POST FORM TODAY!**

**SEND NO MONEY NOW!**

To: Dept. H.F.26, People's Home Library, Odhams Press Ltd., Basted, Sevenoaks, Kent. Please send me, **WITHOUT OBLIGATION TO PURCHASE**, "Encyclopaedia of Radio & Television." I will EITHER return the book in good condition, postage paid, within 8 days. OR send down payment of 11/6 eight days after delivery, followed by 2 monthly instalments of 10/- (31/6). **ALTERNATIVELY, I will send the cash price of 30/- eight days after delivery.**

Signature..... Occupation.....

(Persons under 21 will be sent a Guarantor Form.) Age, if under 21.....

Put tick where applicable: Cash  Terms  Householder  Lodgings   
Furnished Prems.  Unfurnished Prems.  Hotel  Live with Parents

BLOCK LETTERS BELOW

NAME .....

Full Postal ADDRESS .....

H.F.26/Nov.59 .....

Firmly affix 2d. stamp in margin.



**STURDY CASES** (Ideal Record Case, 12/6. Covered in burgundy and grey washable rexine. Size 8 1/2 in. x 7 1/2 in. x 3 1/2 in. deep. Strong clasp hinges and carry handle. Ideal for Portable Radio Chassis or Transistor Set. Can be adapted as a Record Carrying Case to hold eighteen 7 in. long-playing records. Post and packing 2 6.

**T.V. AERIALS, 7/9.** Fitted with 9ft. co-axial cable. For door, rod or loft. P. & P. 13.

**T.V. AERIALS, 15/6.** Indoor type. Folded dipole with 12ft. co-axial fitted. P. & P. 19.

**T.V. AERIALS, 23 6.** Three-element. I.T.A. Outdoor or loft. P. & P. 26.

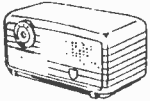

**BAKELITE CABINETS**

**5/9** Brand new. Colour brown. Attractive design. Size 12 x 7 x 5 1/2 in. Ideal for small receivers, converters, etc. P. & P. 3 9.

**XMAS GIFTS**

- ★ **BATTERY PLAYER.** 6 or 9 volt. 4-speed. **99/6.** P & P. 4/6.
- ★ **VALVE BATTERY AMPLIFIER.** **39 6.** 1 1/2 v. L.T. 60 or 90 volt H.T. Suitable for above. P. & P. 3 6.
- ★ **3 TRANSISTOR AMPLIFIER.** **79 6.** Ideal for use with player above. 9 volt. P. & P. 3 6.
- ★ **SPEAKERS.** 12 6. Round 6 1/2 in. Std.; matching 2-5 ohms. P. & P. 2 6.
- ★ **ELLIPTICAL SPEAKERS.** 19 6. 2 sizes: 7 in. x 4 in. or 8 in. x 5 in. P. & P. 2 6.
- ★ **8" P.M. SPEAKERS.** 5/9. Limited quantity. Tested and Guaranteed. Had a slight cone repair. Not affecting the quality. P. & P. 2/9. On 2 3 6.



DEPT. T11  
**COMPONENTS LTD.**

**XMAS SPECIALITY** →  
**RECORD PLAYER CABINETS**

R.P.2.  
**69/6**

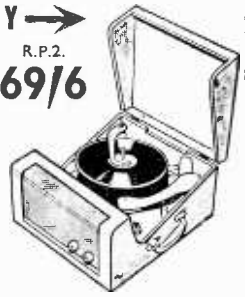

A beautifully styled cabinet. Made by a famous manufacturer. In polka dot cloth with clipped lid and carrying handle. Size: 15 x 14 1/2 x 8 1/2 in. deep. Will take B.S.R. Monarch 4-speed auto-changer and 4 x 7 in. elliptical speaker and most of the modern portable amplifiers.

Carr. & Ins. 4/6.

**T.V. MASKS**

**17 in. or 21 in. T.V. MASKS, 7/9.** In Blue or Pink plastic. P. & P. 2 3.

**17 in. T.V. MASKS, 5 3.** White or Cream plastic. Slightly soiled. P. & P. 2 3.

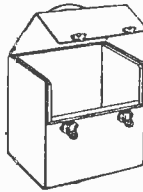

**RECORD CASES from 21/9**

Beautifully made in various colours. Covered in Rexine. Plated clip fasteners. Hinged lid. Carry handle. P. & P. 2 6.

- 7 in., holding 30 L.P. ... .. 21 6
- 7 in., holding 40 L.P. ... .. 23 6
- 10 in., holding 20 records ... .. 22 6
- 10 in., holding 50 records ... .. 24 6
- 12 in., holding 20 records ... .. 22 6
- 12 in., holding 50 records ... .. 27 6

**219, ILFORD LANE, ILFORD, ESSEX**

ILF. 0295

Stamp for FREE Catalogue.

**GOVERNMENT SURPLUS AND MANUFACTURERS CLEARANCE**

**METERS.** 500-0-500 microamp. 3 1/2 in. diam. 37 6 each.  
**I.T.A. AERIALS.** New and Boxed, 3 element, 22/6. 5 element, 27/6.  
**CO-AXIAL CABLE.** 6ft. per yd. **AIR SPACED.** 9d.  
**GERMANIUM CRYSTAL DIODES.** 1- .10- per doz.  
**VOLUME CONTROLS LONG SPINDLE MIDGET.** 10K to 2 Meg. Less switch. 3". D.P. switch. 4/6.  
**CONDENSERS.** Twin Gang 0005 Standard 5/6. Midget. 6/6.  
**VENNER SYNCHRONOUS A.C. MOTORS.** 200/250 v. for clocks, models, etc. 12 6 ea.  
**RELAYS.** High speed. 1,000-1,000 ohms. plat. cont. 7 6.  
**SELENIUM RECTIFIERS.** 12 V. 1 amp. 5-; 2 amp. 11 6; 4 amp. 15- each.  
**12-VOLT P.T.C.** Cable. Screened and P.V.C. covered. 2 6 yd.  
**ELECTROLYTICS.**—Metal Cans. 20+20 mfd. 450 v. 2 6 ea. 25- doz.  
**VARIABLE SLIDERS.**—10 ohm 30 w. Ideal for chargers, train controllers, etc. 3 - ep.  
**CARPENTER PLUG-IN RELAYS WITH BASES.**—100+145 ohms. 10 - ea.  
**VALVES.** All valves tested before despatch on MULLARDS latest ELECTRONIC TESTER.

1L4	5/-	6D2	6-	6X4	7-	EA50	1 6	EY51	5-
1T4	6/6	6F1	7 6	6X5	7-	EABC80	7-	EY51	8-
1U4	6-	6F6	7-	8D2	4 6	EB41	8-	P61	4-
3A4	6-	6F13	7 6	9D2	5-	EB81	7 6	PEN45	7 6
4D1	4-	6J5	6-	10F1	7 6	EB91	5 6	PEN46	7-
5Z4	9-	6J6	6-	12A6	7 6	ECH42	8-	SP41	4-
6AG5	5-	6J7	6-	12AH8	8-	ECL80	9-	SP61	4-
6AL5	5-	6K7	4 6	12AT7	6-	EF36	5-	VR150	30
6AM6	5-	6L6	6 6	12AU7	7-	EF37	9-	UL84	5-
6AM6	6-	6SA7	6-	12AX7	7-	EF39	5 6	VCR97	15-
6AQ5	6-	6SC7	4 6	12BH7	10-	EF50	3 6	VCR139A	25-
6AY6	7-	6SJ7	5-	12SH7	5-	EF50	5-	EL91	5 6
6BA6	8-	6SK7	5-	12SJ7	6 6	EF80	8-		
6BE6	5 6	6SL7	6-	12SK7	5-	EF81	6-		
6BB6	5-	6SN7	7-	15D2	6-	EF82	7-		
6BW6	6 6	6U5	6 6	60C5	10-	EL32	5-		
6C4	5-	6V6	6 6	807	6-	EL91	5 6		

OBsolete TYPES, LARGE STOCKS, ENQUIRIES INVITED. SECONDHAND VALVES, YOUR CHOICE. £1.0.0 for EIGHT P.L.81, ECL80, 6C4, 6AN6, 6AG5, 6J6, EF50, 6BE6, 3A4, PCF80, EF80, SP61, P61, 6J5, PY80, PY82, PCC84, Z77, 6AL5, 6K7, 6SJ7, EL32, EF42, 6D2.

**HUGGETT'S LIMITED**  
2-4 PAWSONS ROAD, WEST CROYDON

**SUPER REGUNNED TV TUBES**

**... £7 . 10 . 0**

**or 20 weeks at 8/6**

Every type and size for immediate delivery.

Carriage, insurance paid. Full trade discount.

Wanted: home engineers and small dealers in all parts of Britain to fit our tubes in customers' sets, if required.

Stamped, addressed envelope for full details.

**EXPRESS ELECTRONICS**  
281 Parliamentary Rd., Glasgow, C.4  
Telephone: BEL 4569

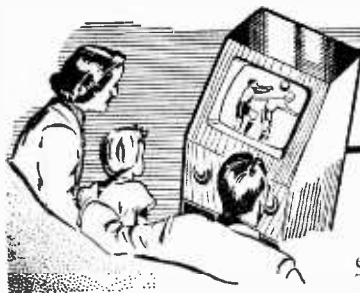

## UNDERNEATH THE DIPOLE

A MONTHLY COMMENTARY

By Iconos

WHO would have thought, just a year ago, that the pattern of organisation of live television production might, to a large extent, be changed within a few months. That is, in fact, what is now taking place—and the upheaval has been caused by the phenomenal success of the Ampex magnetic video tape recorder. It was about a year ago that a unit of the Ampex system was demonstrated at Television House by Associated Rediffusion and attracted a lot of interest from the chief engineers of the various British television organisations.

However, it was first regarded as a convenient means of delaying live transmissions, especially useful for large areas such as the United States, which have different time standards from the East coast to the West coast. New York peak-time live transmissions could, therefore, be recorded and delayed for sending over the co-axial or other links to the west coast stations at their peak times, about three hours later.

### Video Tape Use Increases

OTHER uses have been found for video tape, however, and there are now in England no less than 36 Ampex recording equipments in use, with another 15 on order. So many additional uses have been found for this picture recording system that it has become a "must" for every one of the commercial programme contractors. Granada have seven and all the others have two or three of them. The BBC have two machines, with two more ordered. Considering that the British model of the Ampex, operating on 405 lines, costs about £25,000, this represents a large sum of money invested in capital equipment. Even the newest I.T.A. contractors, Anglia, have two

equipments, while Tyne Tees Television is the proud possessor of a remarkably compact mobile Ampex unit. Why all this rush for Ampex?

First of all, the ability to delay the broadcasting of a programme has been found useful in Great Britain. Many features and plays, hitherto broadcast live and direct in the evenings, are played in front of the same studio television cameras in the daytime and recorded on video tape, for transmission a few hours, a few days or even a few months later. This has resulted in economies in the use of stage space and facilities. In the case of feature series programmes, it has been found convenient to record two or three episodes in rapid succession, so that certain of the main studio settings could be used in each episode, without all the need for putting them up and taking them down for each individual story. Furthermore, high quality picture recording can be carried out without all the panics and tensions that go

with direct live transmissions. Tapes can also be stored for re-use at later dates, or used as master recordings for transferring to 16mm film for export to Commonwealth or foreign TV stations.

### Unforeseen Advantages

IT has also been discovered that telerecording on to magnetic tape, with subsequent transfer by a second stage of telerecording, on to 16mm or 35mm film can be better than direct telerecording to film. Small errors in the latter can be corrected when the video tape machine is used as an intermediate, and the work can be carried out away from the stress and strain of direct live transmission. Another gratuitous advantage for the British television industry is the fact that the modern British-made 4½in. image orthicon camera gives a particularly good picture on the magnetic tape, superior to the standard American 3in. I.O. camera. This has led to a

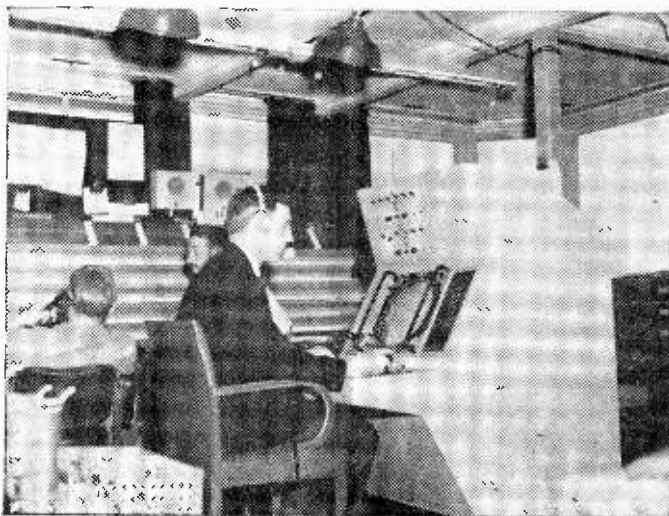

For the new long-range and terminal area surveillance radar system at Jersey Airport, Marconi's have supplied fixed coil radar displays incorporating many interesting features including intertrace marking and videomap

number of enquiries for these cameras from main American TV networks.

### Prompters

**T**ELEPROMPTERS. Autocues and other devices for conveying the words to the actors or announcers are admirable devices. They are especially useful for semi-topical documentary programmes of the "Panorama" and "Monitor" type, which are usually in course of compilation right up to the last minute before they go on the air. But the placing of these mechanical gadgets must be carefully done, especially if it is desired to give the effect of the speaker talking direct to the viewer. I have noticed lately a tendency for the speakers to look rather blankly in the general direction of the camera, with the eyes obviously not focused on the camera lens. This gives the odd effect sometimes seen in examples of photographic portraiture of fifty years or so ago, when the wretched victim had his head clamped in a head-rest and generally assumed a glassy-eyed expression, as though he was contemplating two parallel lines leading to infinity. When this kind of thing happens, as it did recently on BBC's "Monitor" the viewer has the feeling that the speaker is being mesmerised by some Svengali character standing by the side of the microphone. There are now reflective glass devices which enable to speaker to look straight at the camera lens and at the same time see his cue wording on the moving paper; but even this ingenious device fails if the lettering is placed at a greater distance than the lens itself. His eyes will be focused at the wrong distance. The trick is to focus the eyes on the lens, if that is possible. It is not always easy to achieve this effect, especially if the camera is taking a very close shot of the face.

### Studio Space

**T**HE British National Studios at Elstree was bought by Associated Television two or three years ago and has since been used for making films in the conventional way for the cinemas and for television. It is a fine studio plant having five

large stages and excellent servicing shops, power plant, dressing room accommodation and so forth.

A-TV have bided their time—wisely. Now they are going to convert it into a live television studio centre, mainly for drama and large feature productions, on the same lines as ABC-TV's Teddington studios, which used to be the home of Warner Brothers British films. Both centres will send out live production material, but both will also make use of magnetic video-tape recording for part or entire use in these productions. A new company called Alpha TV Services (London) Ltd. has been formed, a partnership of A-TV and ABC-TV for providing facilities for video tape recording for both centres, and for making transfers to 16mm film or duplicate magnetic tapes for export to overseas TV organisations. Alpha (London), is therefore a similar partnership to the highly successful Alpha TV studios at Birmingham.

### Armchair Theatre

**I** THOUGHT that ABC-TV's Armchair Theatre season started off very well with Ted Willis's aerial drama, "The Scent Of Fear," a story played almost entirely in an air liner. With an absolutely first-class cast, headed by Anthony Quayle and Dorothy Tutin, there was plenty of tension in the story of the smuggling of a young man

from Eastern Europe in a British plane by the attractive air hostess. On the plane are two secret police agents, one watching the other and both looking for the missing man, said to be wanted for murder. Willis's taut script was handled in just the right manner by director John Moxey, who introduced plenty of movement and quick cutting from camera to camera, with superb timing. I had only one criticism of the camera work. Some of the very near close-ups of eyes and parts of faces were evidently taken with wide angle lenses and suffered from distortions. A small point, I know, but in a production of this type, the odd distorted shot can bring one down to earth with a bump and break the tension. There were not many settings, but the interior of the aeroplane, flight deck and pantry were most convincing, for which George Haslam, the art director, must be credited. The work of a set designer is not confined to the construction and dressing of a setting on the studio stage as a factual representation. He has to construct it in a manner which permits the director to use his cameras in all kinds of odd places, without shooting off the top of the set and at the same time, allow the lighting expert to manœuvre his lamps and the sound man to place his microphones. Quite a constructional problem, this—in some cases more difficult than making a mere representation.

## PRACTICAL WIRELESS

### Chief Contents of November Issue

Now on Sale, 1/6.

A PERSONAL "MOBILE" RECEIVER  
 A D.C. TRANSISTOR OUTPUT STAGE  
 A SIMPLE TRANSISTOR PORTABLE  
 WORKING WITH "LIVE" CHASSIS  
 AN AERIAL-POWERED TRANSISTOR RECEIVER  
 D.C. TRANSISTOR RECEIVER  
 A BEGINNERS' TEST-METER  
 SELECTIVITY  
 ON YOUR WAVELENGTH  
 ETC. ETC. ETC.

**Band III Converter**



Suitable for Wales, London, Midlands, North and etc. All the parts including 2 EF90 valves, coils, fine tuner, contrast control, condensers and resistors. (Metal case available as an extra.) Price only 13/6, plus 2/6 post and insurance. Data free with parts or available separately, 1/6.

Please send two more kits, the one you sent last week is performing magnificently. We receive this sort of letter every day of the week. So if you have hesitated because you thought our kits too cheap you need hesitate no longer.

**Tube Tester and Reactivator**

We can supply all the main components for making this unit which will not only test Cathode Ray Tubes but will also reactivate them. Supplied complete with full instructions. Price £3, plus 2/6 post and ins.

**TV Service Sheets**

200 sheets covering most popular post-war televisions by leading makers—Coscor, Ekco, Ferguson, Eves, etc. 2/6 post free. PREVIOUS PURCHASERS OF THESE SHEETS PLEASE NOTE: WE CAN SUPPLY SHEETS Nos. 100-200, £1. or 150-200, 10/-.

**A.C./D.C. Multimeter Kit**

Ranges: D.C. volts 0-5, 0-50, 0-100, 0-500, 0-1,000. A.C. volts 0-5, 0-50, 0-100, 0-500, 0-1,000 D.C. milliamps 0-5, 0-100, 0-500. Ohms 0-50,000 with internal batteries 0-500,000 with external batteries. Measures A.C./D.C. volts, D.C. current and ohms. All the essential parts including metal case, 2 1/2" moving coil meter, selected resistors, wire for shunts, range selector, switches, calibrated scale and full instructions, price 13/6, plus 2/6 post and insurance.



**1960 All Mains Amplifier**



Undoubtedly finest value obtainable in amplifiers—powerful three valve circuit ideal for dances, parties, etc. Complete with valves, mains transformers, volume and tone controls, but less chassis, speaker and cabinet. Price only 23/6, plus 2/6 post and ins. Data free with parts or available separately 1/6.

**Unique Opportunity to build Fine Transistor Set**

Constructor's parcel: to build Pocket 6 Transistor Set as currently being sold at £17.17.0. Parcel comprises Motified two-toned cabinet as illustrated, tuning dial, two gang tuning condenser, combined bakelite chassis printed circuit and easy to follow circuit. Costing value 37/6—offered while supplies last at only 29/6 plus 2/6 post. Suitable for your own circuit or to build original circuit. All parts available at highly competitive prices. Do not miss the tremendous bargain.



**ASSURE YOUR FUTURE**

The ownership of a good instrument has been the turning point in many a career. It could easily be yours for you can own the latest AVO Test Instrument for the initial payment of only 10/-.



This test instrument is ultra-modern, has a sensitivity of 10,000 Ohms per Volt, measures A.C. Volts 0-1,000 in 5 ranges, D.C. Volts 0-1,000 in 7 ranges, D.C. current at 1 Amp. in 5 ranges and resistance up to 2 Megs. in two ranges.

Free Gift. To extend the uses of this instrument, for instance, to measure capacity, inductance, E.H.T., etc., we have developed a range of extender scale and operating notes, these will be sent free to purchasers of this instrument.

All sent immediately for 10/- deposit, balance by 21 payments of 10/-, which includes free insurance against accidental damage for 12 months. Non-callers add 3/6 post and insurance. Cash price, £9.10.0.

**12-CHANNEL TURRET TUNER**

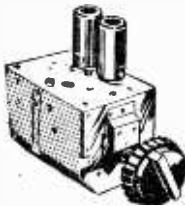

Ideal for converting an old or building into new T.V. These are brand new stock, not surplus, supplied complete with valves and coils for local Band I and Band III stations.

Model 1. I.F. Output 33/38 Mc/s series heaters (parallel heaters, 5/- extra).  
Model 2. I.F. Output 16/19 Mc/s parallel heaters (series heaters, 5/- extra).  
With instructions and circuit diagram, 79/6, knobs 3/6 extra, postage and insurance 2/6.

**FOUR ITEMS FOR PRICE OF ONE**

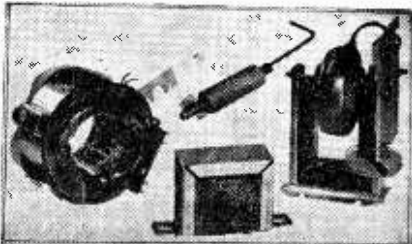

Set of modern T.V. parts suitable for modernising old television or for a new one. For wide angle 14in. or 17in. tubes comprises: (1) Line output E.H.T. transformer. (2) 700 scanning coils on ferrite yokes. (3) Width control with ferrite core. (4) Frame output transformer. (5) Circuit diagram of a modern television. Offered at the price of the Line output transformer only, namely, 57/6, plus 2/6 post and insurance.

All items advertised can be obtained from the following Companies.

If ordering by post, address your order to the Company nearest to you and please include postage.  
**Electronics (Manor Park) Ltd.**  
520, High St, North, Manor Park, E.12.

**Electronics (Ruislip) Ltd.**  
42-46, Windmill Hill, Ruislip, Middx.  
Phone: RUISLIP 5780.  
Half day Wednesday.

**Electronics (Croydon) Ltd.**  
268, London Road, Croydon.  
Phone: CRO 6558.  
Half day Wednesday.

**Electronics (Finsbury Park) Ltd.**  
28, Stroud Green Rd., Finsbury Park, N.4.  
Phone: ARChway 1049.  
Half day Thursday.

**BEGINNER'S SUPERHET**

All the components including metal chassis, valves, metal rectifier, coils, tuning condenser, etc., required to build the "Beginner's Superhet" as described in the January, 1958, issue, are available as a parcel. Price £3, plus 3/- post and insurance.



Cathode Ray Tube VCR517, 7/6, carriage, etc., 3/6.

**Morganite Potentiometer**

Single and 2-gang types available standard size with good length spindle, all new and boxed. Single types 1/- each, values available: 5K., 10K., 25K., 50K., 100K., 250K., 1 meg., 2 meg., Gang type 3/- each—values available: 5K. + 5K., 100K. + 100K., 1 meg. + 1 meg., 2 meg. + 2 meg.

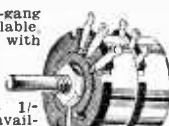

**Avo Proclips**



The advantage of these test prods is that by pressing the trigger at the side they become crocodile clips and can be left in circuit. This is a great time saver when servicing. Price 15/- pair.

**TV Masks**

Latest type grey crystallate.  
14in. 10' - 17in. 12".  
Plus 1/- post.

**Multi-Purpose Mains Transformer**

Heavy duty construction, must have cost at least £3 to make. Offered at a snip price of 14/6.

Specification:—  
Primary Standard 230 v.  
Secondary 1. 650 v.-200 mA. centre tapped.  
Secondary 2. 80 v.-100 mA.  
Secondary 3. 23 v.-750 mA.  
Secondary 4. 7 v.-5 amp. centre tapped.

Secondary 5. 5 v.-3 amp.  
In addition there is a window space for extra L.T. windings, winding ratio is 21 turns per volt. Weight of transformer is 12 lb., size approximately 6in. x 4in. x 4in. Connections all brought out to terminals on bakelite panel. We have only 500 of these, so order at once to avoid disappointment. Non-callers add 3/6 postage please.

# NEW! DO-IT-YOURSELF TRAINING TECHNIQUE in RADIO & ELECTRONICS

You LEARN while you BUILD...

SIMPLE...PRACTICAL...FASCINATING...

ANNOUNCING—after years of successful operating in other countries—the latest system in home training in electronics introduced by a new British training organisation. AT LAST—a simple way of learning —by practical means—the 'how and why' of electronics with the minimum of theory and *no mathematics!* YOU LEARN WHILST BUILDING actual equipment with the components and parts which we send you —and you really have fun whilst learning! And afterwards—you have a first rate piece of home equipment plus the knowledge of how it works and how it can be serviced. THIS NEW SYSTEM brings an exciting new opportunity and is very moderate in cost. Post the coupon now without any obligation for full details.



LOTS OF INSTRUCTIVE EXPERIMENTS AT HOME!

No Mathematics!

To: RADIOSTRUCTOR (Dept G29)  
46 Market Place, Reading, Berks.  
Please send brochure without obligation to:

Name .....

Address .....

(807) ..... 11-59



## RADIOSTRUCTOR

BRITAIN'S LEADING ELECTRONIC TRAINING ORGANISATION

# LINE OUTPUT TRANSFORMERS

Most types available. State Make and Model Number of Receiver when ordering.

S.A.E. please with all enquiries.

## HOWORTH

51 POLLARD LANE, BRADFORD, 2, YORKS  
Tel. 37030

# FACTORY REPLACEMENT T.V. TUBES

SPECIFICATION:

1. Exact plug in replacements.
2. New gun and electrode assembly.
3. Rescreened with latest type phosphors.
4. Regraphited and new getters fitted.
5. Full 12 months' new tube guarantee.

In fact, a completely new tube except the glass.

12in., 14in., **£6.10.0.** 15in., 16in., 17in., **£7.0.0.**

We can supply Mazdas, Mullards, Cossor, G.E.C., Cathodion, Emitron, English Electric, Brimar and Emiscope (including Pyrex Types).

Postage, etc., 5/- Terms C.W.O. or C.O.D.

All tubes supplied in special containers and in which your old tube must be returned.

**LAWSON TUBES,** 156, Pickersleigh Rd., Malvern, Worcestershire.

## SUPER-VISION LIMITED

Every Item Brand New and Guaranteed at Low Prices

**VALVE HOLDERS**  
Int. Octal 4d. each. B7G 4d. each. B9A 6d. each. CER. B9A with screen 1/9 each.

**CONDENSERS**  
2 to 100 pF., 5d. each. 220-5,000 pF., 7d. each. .01 to .1. 8d. each.

**RESISTANCES**  
Variable T/V type pots. 3K. 5K. 25K and 1M. 2/6 each.

**EGEN SLIDER TYPE**  
3K. 5K and 25K. 1/9 each.

**VOLUME CONTROLS**  
.5M. 2/9 each. .5M with DPS switch. 4/3 each.

**ELECTROLYTICS**  
60-100 mfd., 5/6 each. 32+32+16 mfd., 350 v., 2/6 each.  
Clips. 3d. each. 50 mfd., 12 v., 8d. each.

**AUTO TRANSFORMERS**  
50 w. to 1,000 w., from £1.10.0 to £9.0.0.

**D.C./A.C. CONVERTERS** for operating shavers, radio and tape recorders from 8 and 12 v. car batteries.  
6 v. D.C. to 230 v. A.C. 20 w. shaver converter. £2.15.0.  
6 v. D.C.—230 v. A.C. 30 w. converter for radio, etc. £4.5.0.  
12 v. D.C.—230 v. A.C. 20 w. shaver converter. £3.18.0.  
12 v. D.C.—230 v. A.C. 40 w. converter for radio, etc. £6.10.0.  
12 v. D.C.—230 v. A.C. 80 w. converter for tape recorder. £12.15.0.

Other types available. Send for List. Please include sufficient to cover Postage.

## SUPER-VISION LIMITED

136, High Street, Teddington, Middlesex. KINGSTON 4393.

## New SIM-TECH BOOKS

### T.V. AND RADIO TUBE TROUBLES,

by Heller. No. PG.68. Service T.V. and radio receivers by understanding valve and C.R. tube troubles. Explains how to recognise symptoms quickly. 224 pages. 23/-. Postage 10d.

### SERVICING TRANSISTOR RADIOS,

by D'Airo. No. PG.76. An excellent book covering types of construction, testing stage by stage servicing procedures, etc. 224 pages. 23/-. Postage 10d.

### RAPID RADIO REPAIR,

by Heath. No. PG.78. How to fix radios quickly. deals with receiver types servicing techniques including many valuable charts. Time saved will soon pay for this book. 220 pages. 23/-. Postage 10d.

### STEREO... HOW IT WORKS,

by Burnstein. The very latest book on this subject. No. PG.80. 218 pages. 23/-. Postage 10d.

### OSCILLOSCOPE TECHNIQUES,

by Haas. No. PG.72. Derivation and interpretation of waveforms Plot valve and transistor characteristics on the scope. Hundreds of photographs of actual traces. 224 pages. 23/-. Postage 10d.

## SIM-TECH BOOK Co.

3, HURST CLOSE, TOTTON, HANTS  
Complete Stock of Gernsback publications.

## FIRST-CLASS TELEVISION and RADIO COURSES . .

GET A CERTIFICATE!

After brief, intensely interesting study —undertaken at home in your spare time—YOU can secure your professional qualification or learn Servicing and Theory. Let us show you how!

### FREE GUIDE

The New Free Guide contains 132 pages of information of the greatest importance to those seeking such success compelling qualifications as A.M.Brit.I.R.E., City and Guilds Final Radio, P.M.G. Radio Amateurs' Exams., Gen. Cert. of Educ., London B.Sc. (Eng.), A.M.I.P.E., A.M.I.Mech.E., Draughtsmanship (all branches), etc., together with particulars of our remarkable Guarantee of SUCCESS OR NO FEE

Write now for your copy of this invaluable publication. It may well prove to be the turning point in your career.

FOUNDED 1885—OVER 150,000 SUCCESSSES.....

NATIONAL INSTITUTE OF ENGINEERING  
(Dept. 462), 148, HOLBORN, LONDON, E.C.1.

S. Africa: P.O. Box 8417, Jo'burg.  
Australia: P.O. Box 4570, Melbourne.



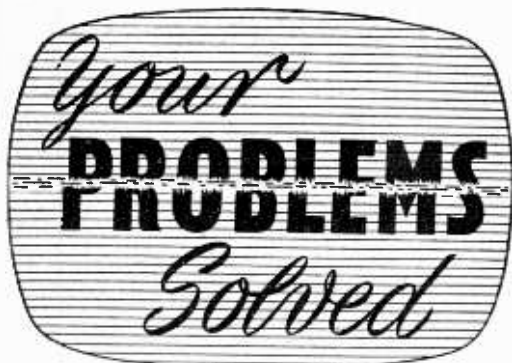

*Whilst we are, always pleased to assist readers with their technical difficulties, we regret that we are unable to supply diagrams or provide instructions for modifying surplus equipment. We cannot supply alternative details for constructional articles which appear in these pages. WE CANNOT UNDERTAKE TO ANSWER QUERIES OVER THE TELEPHONE. The coupon from p. 103 must be attached to all Queries, and if a postat reply is required a stamped and addressed envelope must be enclosed.*

#### FERGUSON 996T

I wish to add a Cyldon turret tuner model P16H to the above set in order to receive BBC and ITV channels 1 and 9. If this tuner is a suitable one, will you please tell me which two valves I remove from the chassis.—C. G. Gurney (London, N).

The P16H tuner is suitable for your Ferguson. The R.F. valve and frequency changer valve (V1 and V2) should be removed from the receiver chassis and their place taken by the tuner plugs.

#### COSSOR 932A

This set, fitted with a Brayhead converter 10S, works on channels 5 and 8. Prior to the converter being fixed the set worked all right, but now there is breakthrough on sound only on both channels in the form of foreign stations. The TV sound itself is strong. The coils are supposed to be aligned correctly and the unit is fixed inside the TV cabinet.—J. Wealleans (Chathill, Northumberland).

Your fault is I.F. breakthrough and may be picked up on the lead from the tuner to the set. Try varying the position of the wire attached to the chassis near the mixer and also disconnect the components beneath the chassis which previously produced the local oscillations. Also take a heavier bonding link between chassis and tuner.

#### EKCOVISION 207

The U801 has burnt out fairly frequently and on the last occasion the U801 and the on/off switch burnt out together. I replaced the U801 and in order to try the set I bridged over the switch, the screen lit up but there were diagonal lines from top left corner of the screen. This was with no aerial connected. Before connecting the aerial into the set I observed that the U801 was burning rather brightly and the 20P1 burnt with a purple glow. After altering the tapping on the mains transformer, which made no difference, I switched off the set and when again I switched

on, the U801 had burnt out. In the last two instances the filament of the valve has become separated from pin two and is shorted to pin one. I can find no visible cause for an increased voltage reaching the heater chain in which the U801 is situated.—F. Smythe (Glynneath, Glam).

Your fault may be due to heater cathode leakage on the 20P1 which is over-running the U801. This type of leakage occurs only when the set is warmed up, making cold tests difficult. Alternatively, some of the four 100Ω surge limiters on the U801 may be burned out, making the valve work in an unbalanced condition. A further possibility is a short to chassis of the heater winding on the mains transformer which feeds the U282.

#### PYE TV4

After it has been switched on for about two hours the picture gradually gets dimmer and dimmer until it is barely visible. Altering all the various controls outside the set makes no difference and when the set is switched off instead of clearing the screen instantly as it always has done, it slows up to a small oblong very bright, and takes two or three seconds to disappear from the screen.—S. Williams (S.E.15).

The symptoms your set displays are those of a faulty C.R. tube. Before changing or boosting it check that the ion trap magnet is set to give the brightest possible picture.

#### PHILIPS PROJECTION TG600A/15

Half an hour or more after switching on, the picture becomes distorted, shimmering and, finally, moves over to the left, leaving a black line on the right, fairly clear, but occasionally flickering and giving a double image. Adjustment of the horizontal hold fails to correct fault. Also the picture frames sometimes roll over and over downwards and only very fine adjustment to the vertical hold control will correct this. I live in a fringe area.—J. Merrett (Saltdan, Sussex).

You should check the UL44 line output/oscillator valve by replacement, also the electrolytic capacitors in general and the 65μF associated with the video amplifier in particular.

#### KB CONSOLE KF40/F

I bought this TV with an o/c filament in C.R. tube. I had it re-built and fitted it myself, but picture is very dim. I improved it by altering all the slugs in the coils and managed to get a fairly good picture, but if I turn up the brightness to get a good picture, it expands and the screen goes blank. Also when set for a good picture and a brighter scene is set on screen, the screen goes blank and I have to turn the brightness down again to get a picture. I have to keep on doing this during a programme and also the focus is not very good.—E. Brookes (Castle Cary, Som).

You should replace the R12 (EHT rectifier) valve which is wired on the top of the line output transformer which is situated inside the left side screened section.

The R12 (EY51) is soldered into position and

this soldering must be carefully done. No sharp ends or edges of solder must be left and the connecting wires must be kept short and direct.

#### FERRANTI 14T3

The first problem is serious overheating of the line output valve PL81 which becomes almost red hot after a few minutes. When I remove anode cap of either PL81 or PY81 it cools immediately to normal. The EHT transformer had short to heater winding of EY51, but otherwise no faults, but I have ordered a new one.

Could you give me wiring details for transformer also which one of two leads on the transformer tag board should go to PL81 and PY81. There is also a frame fault, causing foldover at bottom and loss of height. Height control is at limit.—G. Calling (Stirlingshire, Scotland).

Check 1.8K $\Omega$  resistor to pin 8 of the PL81. The heater winding of the EY51 could be hand wound with well insulated wire such as coaxial inner.

The L.O.T. should be numbered as follows: 6 to PL81 anode top cap; 5 to PY81 cathode top cap; 3 to scan coils, 0.5 $\mu$ F capacitor, 4.7M $\Omega$  resistor (to pin 10 of C.R.T.), 15K $\Omega$  to 33k $\Omega$  (height circuit); 2 $\Omega$  resistors to horizontal hold; 1 to 22k $\Omega$  resistor to 4.7k $\Omega$  and P181 control grid.

#### BUSH TV24

This set has no EHT. I find on taking scan-coils plug out, the EY51 lights up and EHT comes to life, but is very weak. On testing top cap of line output valve there is a very good spark.

Could you also give me the resistances of the scan-coils as I have no service sheet for this set? —J. Raffel (Co. Durham).

The scan-coils of the TV24 rarely give trouble, but if they are breaking down a meter is not likely to reveal the defect unless they are o/c at one point. The total resistance of the scan coils is 30 $\Omega$ .

Check 2 $\mu$ F capacitor under centre of main deck on the long tag strip, also PZ30 valve.

#### MURPHY V240

I wish to replace the EHT rectifier which I think is a Mazda U25 in the above set. Will you please tell me where this valve is positioned in the set and instruct me as to the procedure for removing and replacing same?

The U25 EHT rectifier is mounted inside the oil-filled line output transformer and to replace it involves discarding the complete transformer and replacing it by a new one. Several readers have tried repairing these units but have difficulty in making an airtight seal: in fact the makers have even discontinued their reconditioning service.

#### DECCA DM14

After switching on the set a bright, defocused raster appears, unaffected by the brilliance control. After about 10 minutes a normal picture appears. Sometimes after switching on there is a very, very faint picture, but low brilliance. The picture will jump back to normal itself, or by switching the set off and on again. I have

replaced the PL81 and H.T. smoothing condenser with no results. When fault is on, H.T. is 180 volts, when picture is normal H.T. is 205 volts. The sound is O.K. all the time. Am I right in thinking C.R. tube is faulty?—R. G. Dunn (Sutton Coldfield).

You describe two distinct faults. One, a bright defocused raster indicates a tube fault, probably a heater-cathode short, which occurs intermittently. The faint picture could be due to a partially shorted heater in the tube, but the fact that the H.T. falls to 180V at the same time seems to point to a different cause, such as variation in the mains supply voltage. Both effects could be due to a defective on/off brilliance control and we would suggest you replace this item first (250k $\Omega$  with D.P. switch).

#### PHILIPS MODEL 1115U-15

I cannot receive either vision or sound. Could you please tell me where to look? The tube shows a raster.—E. Mitchell (Ripon).

The fault will be located on the front of the right side R.F. chassis. Check first the two EF80 valves on the front left side of this chassis and the components associated with them. See that the coil cans are properly fitted.

#### ENGLISH ELECTRIC TV63 3360M

I get a fairly good picture on this receiver, but only about three-quarter size. If I try to get it larger it goes out of focus. I have renewed the SU25 and the 185BT in the cage. I am unable to get a service sheet to help me to check H.T. voltages. If you can suggest the parts most likely at fault will you please state their positions in the set? Another thing that may have some bearing on the fault is I get a light flick on the screen about 6in. from the top every few seconds—something like car interference, but much too slow for that.—W. Ayre (Kettering).

You should replace the metal rectifier situated in the centre of the power pack chassis. Check the 185BT frame output valve on the front left side.

#### FERGUSON 306T

At times, after the set has been switched on, sound goes dead and when the set is turned off for a few minutes and then turned on sound is restored, only to go dead after a period. If the set is not turned off but volume fully advanced, sometimes sound is heard very faintly and occasionally I am taken unawares when the sound rectifies itself and comes out full volume only to break down again.—A. McLean (Co. Down).

This is, indeed, a difficult fault to solve without the abundant use of instruments. We would not consider valve trouble initially, check for instance, the A.F. coupling capacitor, the loudspeaker connections, the sound detector and circuit, and wires to the volume control. There is every likelihood that the A.F. section is to blame. A few simple checks should prove this for you.

#### ULTRA Y84NF

When switching on the set all I get is a horizontal line across the tube face about  $\frac{1}{2}$ in. wide.

# A-REVOLUTIONARY NEW BRITISH INVENTION!

- ★ Uses standard tapes
- ★ Plays at 7½" per. sec. or 3 other speeds
- ★ Records direct from radio or microphone
- ★ Erase and fast rewind

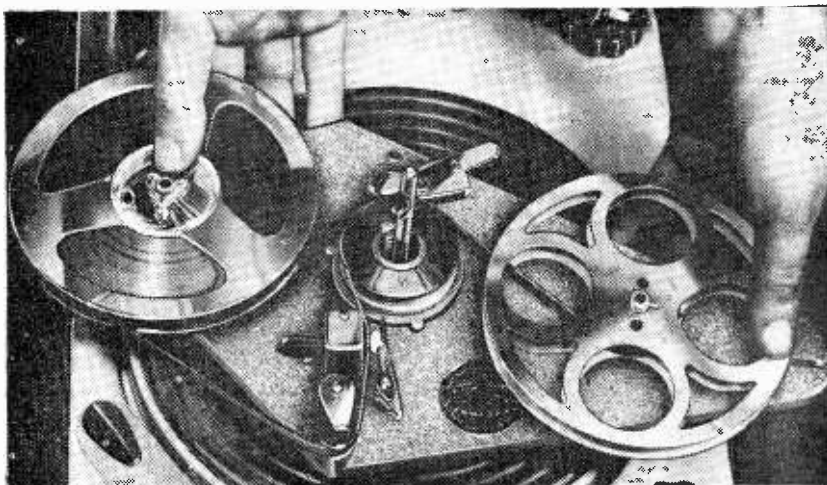

**FULLY  
GUARANTEED**

## Instantly turns any gramophone into a first-class Tape-Recorder and back into a record-player in a moment!

Gramdeck is completely new . . . a revolutionary and ingenious invention that instantly turns your gramophone into a tape-recorder and back into a gramophone at will! Slip the Gramdeck on to your turntable and you have the finest tape-recorder you've ever heard! Lift it off . . . your gramophone is ready to play records again. There are no motors or valves to go wrong—and you get a quality that has to be heard to be believed! Everyone is praising the Gramdeck.

**£17-11-0** Complete with Lustraphone moving-coil microphone and tapes

**£13-12-0** Without microphone or tape

### EASY TERMS

"Ingenious—simple . . . why on earth did no one think of it before!"—THE TAPE RECORDER.  
 "Ingenious and robust."—BRITISH SOUND RECORDING ASSOCIATION JOURNAL.  
 "Quality of reproduction excellent . . . real hi-fi results . . . potential is tremendous . . . both designer and manufacturer should be congratulated."  
 —BRITISH RADIO & T/V RETAILERS REVIEW.

"Better than many so-called hi-fi recorders . . . robust . . . carefully designed . . . excellent value."  
 —AMATEUR CINE WORLD.

"The quality is at least equal to that obtained from a good microgroove disc," says a leading professional journal.

### WORKS FROM ANY RECORD-PLAYER OR RADIOGRAM

Gramdeck records and reproduces with a wonderful depth and breadth of tone. Because it uses equipment that is already in your gramophone it only costs a fraction of the high-quality tape-recorder you would normally require. Full details, specifications, photographs, easy terms, etc., are given in the Gramdeck Book. Send for your FREE copy, today

**MADE BY THE FIRM THAT MAKES MICROWAVE WAVE-GUIDES FOR VISCOUNTS & BRITANNIAS**

*Free!*



### FREE BOOK—POST NOW!

I would like to know how to turn my gramophone into a first-class tape-recorder . . . please send me the Gramdeck Book—FREE and without obligation.

(Write if you prefer not to cut coupon)

NAME .....

ADDRESS .....

Gramdeck (Dept. PT/802) 29 Wright's Lane  
Kensington, London, W.8

**Gramdeck**  
GRAMOPHONE TAPE RECORDER  
HIGH QUALITY TAPE-RECORDING FOR EVERY HOME

**GRAMDECK TURNS A TURNTABLE INTO A TAPE-RECORDER**

# VALVES

## SAME DAY SERVICE

NEW! TESTED! GUARANTEED!

SETS		1R5, 1S5, 1T4, 3S4, 3V4, DAF91, DF91, DK91, DK92, DL92, DL94, any 4 for 27/6 DAF96, DF96, DK96, DL96 ... .. 4 for 32/6 6X7G, 6X8G, 6Q7G, 6V6G, 6X5G or 5Y3G ... .. 5 for 27/-									
1A7GT	14/6	6L18	12/3	25Z6GT	9/6	EBF89	8/9	EZ80	7/6	TH41	16/6
1U5	9/6	6P25	10/-	30C1	8/-	EBL21	20/6	EZ81	7/6	U25	12/6
1H5GT	10/-	6Q7G	7/6	30L1	8/-	ECC81	7/6	FW4/500	9/6	U26	12/6
1N5GT	10/-	6Q7GT	9/6	35L6GT	10/-	ECC82	6/6	CZ32	6/-	U30	7/6
1R5	7/6	6S17GT	7/-	35Z4GT	6/6	ECC83	7/-	KT33C	7/-	U52	6/6
1S4	9/-	6SN7GT	5/6	35Z5GT	8/6	ECC84	9/6	KT41	14/6	U76	6/6
1S5	7/6	6U4GT	11/-	43	12/6	ECC85	9/6	KT61	10/-	U78	6/6
1T4	6/3	6V6G	6/-	50CD6G	26/9	ECP80	11/6	KT63	8/6	UABC80	9/-
1U5	8/6	6V6GT	7/6	50L6GT	9/9	ECP82	11/6	KT71	12/6	UAF42	5/6
3A5	10/6	6X4	6/9	AZ31	9/6	ECH21	17/6	MH4	6/-	UBC41	8/6
3Q4	8/6	6X5GT	6/-	B36	15/6	ECH35	6/9	MU11	9/-	UBF80	9/6
3S4	7/6	7B7	8/-	CL33	11/6	ECH42	9/6	MX40	12/6	UBF89	9/6
3V4	8/-	7C5	8/-	DAC32	10/-	ECH81	8/6	N18	8/6	UBL21	20/6
5U4G	6/6	7C6	8/-	DAF91	7/6	ECL80	9/6	N15J	11/6	UCC84	12/9
5V4G	11/-	7H7	8/-	DAF95	8/6	ECL82	11/6	PCC34	8/-	UCC85	9/-
5Y3GT	7/6	7S7	9/9	DCC90	10/6	EF39	5/6	PCC39	11/-	UCF80	13/-
5Z4G	9/6	7Y4	8/-	DF33	10/-	EF41	9/6	PCF30	8/-	UCH21	20/6
6AL5	5/6	10C1	14/6	DF91	6/3	EF42	11/6	PCF82	10/6	UCH42	9/-
6AM5	5/-	10C2	17/6	DF95	8/6	EF80	6/6	PCL32	10/6	UCH31	9/-
6AM9	4/9	10P1	17/6	DH6	6/6	EF85	7/6	PCL31	12/6	UCI32	11/6
6AQ5	7/-	10F9	10/6	DH77	7/3	EF86	11/6	PCL34	11/3	UCL63	14/3
6AT6	7/3	10P13	15/9	DK32	14/6	EF89	8/-	PEN41	11/-	UF41	9/3
6BA5	7/6	12AH8	10/6	DK40	14/-	EF91	4/9	PEN38C	9/6	UF42	8/6
6BB5	7/-	12AT7	7/6	DK91	7/6	EF92	5/-	PEN45	8/-	UP89	7/6
6BH6	7/-	12AU7	6/6	DK92	8/6	EL33	10/-	PEN46	5/6	UL41	9/-
6BJ6	6/-	12AX7	7/-	DK96	8/6	EL38	21/6	PL36	13/-	UL44	8/6
6BR7	10/6	12BA6	8/-	DL33	9/-	EL41	9/-	PL38	21/6	UL84	8/6
6BW7	6/6	12K7GT	6/6	DL35	12/3	EL42	10/6	PL81	10/-	UR1C	9/6
6CD6G	26/9	12K8GT	12/6	DL92	7/6	EL84	8/6	PL82	8/6	UY1N	12/6
6E1	14/6	12Q7GT	6/6	DL94	8/-	EM34	8/6	PL83	8/6	UY21	14/-
6F9G	6/6	12Z3	7/6	DL96	8/6	EM80	9/6	PY32	12/3	UY41	7/-
6F13	12/6	14S7	16/9	EABC30	7/9	EM81	9/6	PY80	7/3	UY85	7/-
6P14	17/6	19AQ5	7/6	EAF42	9/6	EM84	10/-	PY81	6/9	VP4B	9/6
6K7G	3/9	20F2	17/6	EB91	5/6	EY31	9/6	PY82	7/-	VP41	9/-
6K7GT	8/-	20L1	17/6	EBC33	7/-	EY66	7/-	PY83	8/3	W76	6/6
6K9G	8/9	25A8G	11/-	EBC41	8/6	EZ40	7/6	PZ33	17/-	W77	5/-
6L1	16/9	25Z4G	9/-	EBF80	8/3	EZ41	7/6	SP61	3/6	Z77	4/9

# 54 Gns. — '17'

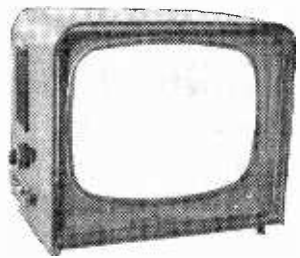

A full specification 17in. Television Receiver to Spencer-West standards now available at your Dealers. Remarkable performance and priced at 54 Gns. only, complete.

For Leaflet apply to :-  
**SPENCER - WEST LTD.**  
Quay Works, Great Yarmouth  
Norfolk

Phone : Sales 4908/9  
Grams : Spencer-West, Great Yarmouth

# READERS RADIO

24, COLBERG PLACE, STAMFORD HILL, LONDON, N.16. STA. 4587

Postage 6d. per valve extra  
Any Parcel insured Against Damage in Transit 6d. extra.  
Any C.O.D. Parcel 2/6 extra.

It pays to go—  
to **VIDIO**

For value in Rebuilt Cathode Ray Tubes try Vidio. Each tube fully Guaranteed for twelve months and fitted with a BRAND NEW electron Gun Unit.

Free Delivery in the U.K. with an immediate, off-the-shelf service. Trade enquiries invited.

Write direct to the  
**VIDIO REPLACEMENT COMPANY**

(They're Trade Association Approved)

Hales Street,  
Deptford High Street,  
London, S.E.8.

Tel.: Tideway 4506.



For Safety's Sake  
use  
**AVO Prodclips**



Safety first every time with these patented spring-loaded AVO Prodclips.

Cleverly designed for use as insulated prods, they are invaluable for reaching and holding test points which are difficult of access.

Post Free  
**15/-**  
per pair.

**AVO LTD** · AVOCET HOUSE,  
92-96 VAUXHALL BRIDGE ROAD, LONDON, S.W.1.  
PC 2 VICTORIA 3404 (12 lines).

**The sound is still very good. Please can you help me to locate the trouble?—W. Burrell (Kings Lynn, Norfolk).**

Check the 6K25 and UL46 on the front right side of the chassis. If these valves are in order, check the wire-wound anode resistor of the UL46. This has a resistance of 3K and no H.T. will reach the anode pin of the UL46 if it is open circuit.

#### DEFIANT TR1453/T

**I wish to fit a turret tuner in my set. Could you please advise a suitable tuner, also the I.F. of this set.—F. Hughes (Co. Durham).**

The I.F.s are: sound, 37.5Mc/s and vision, 34Mc/s. You would be well advised to contact your supplier regarding the best type of tuner for this model, as this model varies somewhat in different areas.

#### PYE B18T

**About 20 seconds after switching on, I get a rasping sound from the speaker. This lasts for a couple of seconds and then the sound comes on; about 10 seconds after this the picture comes on and is perfect. Sometimes I get a little cramping at the top right-hand corner, but this clears within a minute.—D. F. Jones (Sutton, Surrey).**

The initial disturbance may be caused by instability resulting from an impaired valve, which tends to correct itself as it warms up. The cramping at the corner of the screen is caused by the formation of electro-static charges on the tube face, and is often the mark of a failing tube.

#### SOBELL T121

**Recently I could only obtain a picture occupying about three-quarters of the screen, eventually no picture at all, with a white bar about  $\frac{3}{4}$ in. wide, extending vertically down the centre of the screen. Would you let me know if the tube is finished, or would it be possible to use a boosting transformer?—R. J. Spencer (Belfast).**

The fact that your picture has developed into a vertical line does not indicate that your C.R.T. is at fault, it is more likely to be due to a faulty PL81 valve or the 600pF condenser which comes from the cathode of EY51 to the anode of the PY80.

#### PHILIPS 1427U

**The vertical hold on the above set is very critical. I manage to stop the slipping after playing with the hold control, but the picture will not keep steady and jumps from the bottom. After about half an hour it loses  $\frac{1}{2}$ in. in height. I have replaced all the ECL80 valves.—J. Simpson (Blackburn, Lancs.).**

We would advise you to check for leakage the 1,000pF coupling condenser from the anode of the pentode sync separator ECL80 to the pentode frame clipper ECL80 grid.

Also check by replacement the 1.2M resistor in series with the frame hold control. View with

suspicion all the little 1/10W resistors around the stage as these have a habit of changing their values without warning or indication.

#### PORTADYNE T237

**Can you please oblige me with details on how to set up the above set for service?—A. Moxoy (London, E.3).**

Setting up is quite simple and a rough outline is as follows: Switch on and allow 4-5 minutes to warm up. Advance brilliance with aerial plug removed to show a blank raster. Reduce brilliance just enough to fade this out. Replace aerial plug, set to desired channel and advance volume and set fine tuner for maximum sound. Advance contrast half-way. Advance sensitivity to show modulation on the screen. Lock with frame hold and line hold. Adjust height and width as required.

#### SIMPLE LOFT AERIAL

*(Continued from page 67)*

(The best way of preparing the end of the cable is to remove 2in. of the outer covering of the end of the cable, exposing the copper braid. This is carefully unpicked with a needle and twisted to form a pigtail. About 1in. of the polythene insulation surrounding the inner core is removed. Care should be taken to prevent any wisps of wire from the inner core coming into contact with the outer sheath.)

#### Mounting

The use of a single rail holding the two parts of the frame together permits the aerial to be folded into a size small enough to go through the trapdoor into the loft. A glance at the outdoor aerials in the neighbourhood will show whether the aerial is to be mounted horizontally or vertically. If it is to be mounted vertically then it is best if the lower half of the dipole is that connected to the outer sheath of the coaxial cable. The aerial is directional and should be rotated until the best pictures are obtained and fixed in that position. This direction setting is not critical and little variation will be found on having the aerial over a fairly large angle. The aerial frame members should cross each other at 90deg. and the coaxial cable should be taken straight back from the aerial for several feet before a bend is made. Its subsequent path should be kept as far away from the aerial as possible. Elements of the diameter suggested will give ample bandwidth to secure good quality pictures on an average commercial set.

#### QUERIES COUPON

This coupon is available until NOVEMBER 22nd, 1959, and must accompany all Queries sent in accord with the notice on page 99.

PRACTICAL TELEVISION, NOVEMBER 1959.

## SETS &amp; COMPONENTS

H.M.V. 151N., English Electric 151n., Ultra, etc., Televisions not working, originally £175 each. £5/10/.

TOMLINS, 127, Brockley Rise, Forest Hill, S.E.23.

## IT'S A KNOCK-OUT!!

— the number of spare parts we stock for Radio and T.V.  
— and at lowest prices, too.

SEND FOR FREE LISTS

## MAINTENOR RADIO

222, Gt. West Road, Hounslow.

WE HAVE large Stocks of pretty well all TV Components, Valves and Tubes, at much lower than standard prices, especially for old type receivers. CUTTRISS LIMITED, Birmingham, 1.

VALVE KITS.—One of each type for your set; reclaimed but guaranteed. Standard Kits from 50/-, including post and packing. Quote make and model No. T.C.S. LTD., 28, Brockley Cross, S.E.4. (TIDeway 5394.)

CALLING 9in. Television owners. Brand new, factory fresh, 9in. Ferranti Tubes, originally £14/10/-, will replace Mazda, Brimar, G.E.C., etc., £4/10/-, each 6 months' guarantee. TOMLINS, 127, Brockley Rise, Forest Hill, S.E.23.

FIX IT YOURSELF AERIALS! Pre-assembled ready for instant fitting. New season models. Loft 5EL, 30/-, Clip on 5EL, 30/-, 3EL, 42/6, Diapole + 5EL + Chimney Kit, 75/-. FRINGE AREA MODELS for high gain. Band 1, 3EL array, 90/-, Band 2, Double 5 Array, 72/6, Double 3 Array, 100/-. Fringe area super low loss Coaxial, 1/3 yd. Standard low loss, 7 1/2 yd. T.V. Fault Finding Book, 5/8. All items carriage paid. C.W.O. S.A.E. for aerial list, etc.

BASE SUPPLIES, 34, PRINCE STREET, BRISTOL (Dept. P.T.1).

RECLAIMED VALVES.—Send s.a.e. perfect. Huge stocks. Any type, price 5/- plus 6d. postage each; delivery by return. LEWIS, 57, Chalford Walk, Woodford Green, Essex.

BREAKING HUNDREDS OF T.V.S for Spares, L.O.P. from £1. Scanning Coils from 15/-. Valves from 2/6, complete Chassis from 25/-. No lists. Send requirements for immediate attention. T.C.S. LTD., 28, Brockley Cross, S.E.4. (TIDeway 5394.)

VALVES 1/- each (tested, working). Radio/T.V. List stamp. 85, Charninster Ave., Bournemouth.

600 BARGAINS. Send stamped addressed envelope for free list. W. A. BENSON, 136, Rathbone Rd., Liverpool, 15.

AERIALS AT TRADE PRICES  
For Example DOUBLE FIVE ARRAY  
(COSTS ONLY 60/-)  
Band III Self-contained Pre-Amplifiers Only 60/-. Band II Converters, 100/-  
Turret Tuners, 94/-. Complete Rebuilt T.V. Tubes from £5. Revacuumed ones. All Sizes, £2-10-0. All Tubes are Guaranteed.  
1 1/2 yd. Super Low-loss Coaxial Cable, 11/- yd. Standard, 6d. yd. Diplexers, 5/- each.  
S.A.E. FOR FULL LISTS.  
G. A. STRANGE, Broadfield, North Wexall, Nr. Chippington, Wilts.  
Tel.: Marshfield 236.

RATES: 4/- per line or part thereof, average five words to line, minimum 2 lines. Box No. 1/- extra. Advertisements must be prepaid and addressed to Advertisement Manager, "Practical Television," Tower House, Southampton St., Strand, London, W.C.2.

## NEW TUBES

	2 Years' Guarantee	1 Year Guarantee
12in. Type M.W. ...	£10.10.0	£7.10.0
14in. Type M.W. ...	£10.10.0	£8. 0.0
17in. Type M.W. ...	£12. 0.0	£9. 0.0
17in. Type C.R.M. ...	—	£10. 0.0

and equivs. Carriage 5s.  
10in. Cossor, NEW—£5.10.0

## LINE OUTPUT TRANSFORMERS

Direct replacements for 500 sets. State Make and Model No. S.A.E. with enquiries, please.

## WESTWAY RADIO

5, Westward Way, Harrow, Middlesex.

BRAND NEW Tested Valves in maker's printed cartons. ECL80 EY86, U26, 10F1, 9/6; N339, PL81, PY32, U25, 11/3; 6CD6G, 20P1, 20P4, 17/9; U801, 18/9. J. STEVENSON, 653, Maryhill Rd., Glasgow.

VALVES, second-hand but tested, any type 5/- each, or 48/- per doz. assorted, any three of your choice included, cash with order. BURCHILL, MORGAN, 51, Wells Road, Bristol, 4.

## CHASSIS

Made drilled and punched to your design, any metal. Single or quantities. Standard sizes 18 s.w.g. aluminium, 2 1/2in. deep, undrilled, 6 x 4, 4 - 7 1/2 x 5 1/2, 5 6/8; 10 1/2 x 7 1/2, 6 6/8; 12 x 8, 8 - 14 x 9, 11 1/2. Flanges, 1/- extra. Plus postage 1. Latest Collaro 4-spd. Auto-changers, £7 10/- Post 4/6.

BOWERS ENGINEERING  
209a, Hertford Road, Edmonton, N.9  
HOWard 221

SAVE ON REPAIRS.—100,000 salvaged Radio and TV Spares. Valves, Tubes for practically any set made since 1936. Prices from LOT, 17/6; P.O.T. 7/6; osc. tr., 6/-; Sound, 2/6; Mains, 10/-; EHT Mains, 50/-; Def. Coils, 12/6; Speakers, 5/-; Tubes, Mullard, Mazda, etc., 9-10in., 30/-; 12-14in., £2/19/6; 17in., £3/19/6. All picture tested, fitted free or sent subject to 14 days' money-back guarantee; Mullard 6 months' guarantee. Valves, 1,000 types from 1/6; EF91, EB91, 6J5, 2/6; EF80, UF42, 10F1, 6F1, 6SN7, 3/6. We can save you pounds! Send s.a.e. with enquiries or for complete list. "ST. JOHN'S RADIO," 156, St. John's Hill, S.W.11. (BAT 9838.)

## SALVAGED VALVES

All at 2/6 each

EF91	U31	10F1
DH77	VP4B	B36
Z77	ECC81	KT33C
EB91	EF80	KT36
	6P23	

& Many Others  
Minimum Order £1. S.A.E. for List.  
All Valves Tested on Mullard High Speed Valve Tester. C.W.O. to—  
ARION TELEVISION, 4 Macted Rd., S.E.15

VALVES, new and used, from 1/6 each, all guaranteed. All types Radio, Television Components. Lists free. HAMILTON RADIO, 237, Sedlescombe Rd., N., Hastings.

SELLING UP.—Good Sets, Cabinets, Valves, Chassis, Convertors, Components, Service Sheets & Equipment, etc. Genuine bargains. A. PHILLIPS, 8, Fettes House, N.W.8. (PRI 7085). Sundays, evenings.

NEW T.V. TUBES—2 Yrs. GUARANTEE Suitable "Plug-In" replacement for Mullard, Mazda and other CRT, 14in. all types, £10.10. 17in. all types (except CRM), £12. 17in. CRM types, £13.10. S.A.E. for CRT list. BRAYHEAD TURRET TUNERS for any area, will convert over 600 models, 137.6. State model and channel. Television Circuit Refinements. A very useful handbook. Price 5/8. Satisfaction or money refunded. All items carriage paid. Terms C.W.O.  
BASE SUPPLIES, 34, PRINCE STREET, BRISTOL (Dept. P.T.2).

T.V. TUBES. Genuine re-gunned tubes with 6 months' guarantee. 14in. rectangular and 17in. £6 each, carriage extra. T.V. ELECTRIC & CYCLE CO., 1 High St., Chalvey, Slough (Tel.: 21860).

## UNREPEATABLE OFFER

200 Only:  
17in. S/H T.V. Sets.  
13 Channel £15. 0.0  
5 " £10. 0.0  
14in. 13 " £10. 0.0  
5 " £7.10.0

200 not working, offers wanted. Also 12in., 14in., 17in., and 21in. Regunned T.V. Tubes, 12 months' guarantee, lowest prices.

Call or phone only,

C. EDWARDS

1070, Harrow Rd., N.W.10.  
Phone: Ladbroke 1734.

## WANTED

IMPORTANT! New Valves and Metal Rectifiers wanted, state price. Same day payment. ROBERT, 414, Whitefoot Lane, Bromley, Kent.

ALL TYPES OF VALVES WANTED. PL81, ECL80, EY51, U25, PCF80, PY30, U801, etc., etc. Best cash price by return. STAN WILLETTS, 43, Spon Lane, West Bromwich, Staffs. (Tel.: WES 2392.)

NEW T.V. VALVES WANTED. Send valves, cash by return, to: P. J. F. ANDREWS, 61-63, Rosemary Rd., London, S.E.15.

NEW VALVES WANTED, all types. State prices, prompt payment. DX, 56, Teign Bank, Hincley, Leics.

NEW VALVES WANTED.—EY51, ECL80, PCC84, PCF80, PCL83, PL81, PCL82, PY81, R19, U801, 30P4, etc. Best cash prices by return. DURHAM SUPPLIES, 175, Durham Rd., Bradford 8, Yorkshire.

A PROMPT CASH OFFER for your surplus Brand New Valves, Speakers, Components, Test Instruments, etc. R.H.S., 155, Swan Arcade, Bradford, 1.

## AERIALS

## MAKE YOUR OWN AERIALS

SAVE £££. TV aerial manufacturer offers "do-it-yourself" kits. 50 components include castings, pressings, mouldings, tubes, brackets, can be utilized to make 100 different models. TV, V.H.F., amateur. Brochure gives full illustrations, element dimensions and prices. Discounts for quantities.

THE RICHARD MAURICE  
EQUIPMENT CO.,

Portsmouth Road, Cobham, Surrey.  
COBHAM 3239.

## MISCELLANEOUS

LOUDSPEAKERS. Electric Clocks and Shavers repaired promptly. MODEL LOUDSPEAKER SERVICE. Shipton on Cherwell, Oxford.

## FOR SALE

ASTOUNDING VALUE.—9in. Televisions, 45/-; 12in. Televisions, 70/-; 14in., £9/10/-; 15in., £5/10/-; 17in., £14. Complete but not guaranteed working; as received in part exchange. TOMLINS, 127, Brockley Rise, Forest Hill, London, S.E.23. All famous makes available; carriage 7/6.

VALVES, Condensers, Record Changers and Players, Cabinets, Amplifiers, Speakers, etc., etc. Send for free list to: H. F. JAMES, 21, Claremont Rd., Twickenham, Middx.

1,000 TELEVISIONS, all makes, from £3 working, 10/- not. Callers only. 9 till 6, including Sats. 39, Whitehorse Lane, Stepney, London.

SATISFACTION ASSURED.—12in. Televisions, £9/10/-; 14in., £16; 17in., £19/10/-. Write for quotation, stating requirements. We guarantee satisfaction. TOMLINS, 127, Brockley Rise, Forest Hill, S.E.23.

## BETTER SAFE THAN SORRY!

Our 'Gold Star' Fully Reconditioned 14in and 17in. T/V's by All Leading Makers are fitted with Brand New Not Rebuilt Tubes with 12 Month Guarantees.

14 Inch All Channel 29 gns., 17 inch All Channel 39 gns. Terms Available. Part Exchange Welcomed and Money Back Guarantee. Trade Supplied Standard Models BBC from £5. BBC/ITA from £10.

## T.C.S. LTD.

28, BROCKLEY CROSS, S.E.4.  
TIDeway 5394.

SPECIAL OFFER.—Famous Pye Invicta 12in. 13 channel, Televisions (without tubes or valves), £215/-, otherwise complete. Each one with walnut cabinet and Pye 13-channel turret. TOMLINS, 127, Brockley Rise, Forest Hill, S.E.23.

SERVICE SHEETS; also Current and Obsolete Valves for sale. JOHN GILBERT RADIO, 20, Extension, Shepherds Bush Market, London, W.12. (Phone: SHE 3052.)

## BRAND NEW TELEVISION TUBES

12 Months' Guarantee  
12in., £7.10.0 ; 14in., £8.0.0 ;  
17in., £9.0.0 ; 21in., £15.0.0.

Carriage & Insurance Paid.  
FIDELITY RECORD PLAYER  
Four speeds. Takes 7in., 10in. or 12in. records. Amazing reproduction. Colours: Fawn, Tweed/Tan, or Grey Cord/Maroon. A.C. only 200-250 volts. ONLY 94 gns. Carr. 5/-. S.A.E. with all enquiries.  
RELANCE ELECTRICAL SERVICES  
124, Salmon Street, London, N.W.9  
COL. 6842

100 BAYS of brand new adjustable steel Shelving, 72in. high x 34in. wide x 12in. deep stove enamelled dark green; sent unassembled. 6-shelf bay, £3/15/-; sample delivered free; quantity discounts. N. C. BROWN LTD., Eagle Steelworks, Heywood, Lancs. (Tel.: 69018.)

## WOT! YOU DON'T OWN A RELDA CATALOGUE?

We offer the World's finest selection of Electronic Equipment, every bargain-packed page is fully illustrated.

OBTAIN YOUR COPY NOW—  
SENT BY RETURN OF POST  
PRICE 1/3

**Relda Radio**

32A COPTIC ST., LONDON, W.C.1.  
87, TOTTENHAM COURT ROAD,  
LONDON, W.1.  
Tel: MUS. 9607

## SERVICE SHEETS

SERVICE SHEETS FOR SALE, all types, from 1/- each. Also Radio, Television Books. Lists free. 100 Television Service Sheets, covering 330 popular models. 18/6. HAMILTON RADIO, 237, Sedlescombe Rd. N., Hastings.

SERVICE SHEETS, Radio, T.V., 5,000 models. Lists 1/-. S.A.E. enquiries, TELRAY, 11, Maudland Bk., Preston.

SERVICE SHEETS.—We have the largest stock of Radio and TV Service Sheets in the country for sale at 4/- ea. and for hire. Why tolerate delay in obtaining Service Sheets when we will despatch by return? List 1/-: s.a.e. with enquiries. S.P. DISTRIBUTORS, 11, Old Bond St., London, W.1.

SERVICE SHEETS for sale, TV, 4/-; Radio, 3/-; also hire; immediate delivery; s.a.e., please. Callers welcomed. SULTAN RADIO, 6, Mt. Ephraim Rd., Tunbridge Wells, Kent.

SERVICE SHEETS.—Radio and TV, 2/6 ea.; or hire. List 1/-: s.a.e. GLOBE SUPPLIES, BCM/Electrique, Monmouth House, London, W.C.1.

FAULTFINDER FILES (TV) showing common faults that each receiver is prone to and other useful servicing information, 2/- ea. List 9d. plus postage. S.P. DISTRIBUTORS, 11, Old Bond St., London, W.1.

(Continued overleaf centre column)

## SITUATIONS VACANT



## The Royal Air Force

PILOTS, NAVIGATORS AND AIR ELECTRONICS OFFICERS  
COMMISSIONS IN THE GENERAL DUTIES BRANCH

Vacancies now exist for fit young men of character and good education and who are capable of taking responsibility, to train as pilots, navigators or air electronics officers in the general duties branch of the Royal Air Force.

## Methods of Entry

**University Entry**—University graduates may enter on permanent or four-year short-service commissions. Permanent commissions carry an ante-date, University students may be accepted subject to graduation. Maximum age limit 25.

**Direct Commissions**—The direct commission scheme offers the choice of a permanent career leading to a pension, or a twelve-year commission with the option of leaving after eight years. Age limits: 17½ to 25.

**Short-Service Commissions**—The short-service commission is for

five years and there are opportunities for transfer to either form of direct commission. Age limits: 17½ to 21.

**Pay and Gratuities**—Pay is high and terminal gratuities are generous. For example, a Flight Lieutenant of 25 can earn, with full allowances, nearly £1,700 a year. The tax-free gratuity paid at the end of a twelve-year commission is £4,000.

Write for further details, stating age and education, and the method of entry in which you are interested, to the Air Ministry M9, (PTN562), Admiralty House, London, W.C.1.



**EDDY'S (Nottm.) LTD.**

DEPT. P.T., 172, ALFRETON ROAD, NOTTINGHAM.

**NIFE ACCUMULATORS.**—Midget Single Unit. Size 3 x 2 1/2 in., 1/11, post 1/6.  
**ACOS CRYSTAL TURNOVER PICK-UPS.**—(2 Sapphire Stylis), 29/11, post 2/6.  
**DYNAMOTORS.**—200 volt D.C. to 12 volt D.C. Ideal for train sets on D.C. mains. 19/11 each, post 2/6.  
**MINIMOTORS.**—For model makers. High speed 1 1/2 volt, 8/6, post 1/-.  
**MORSE TAPPERS.**—Plated contacts. Adjustable gaps. Heavy Duty, 3/6, post 9d.  
**DIMMER SWITCHES.**—Ideal train speed regulators. 1/11, post 1/-.  
**TRANSISTOR PORTABLE CASES.**—Size 6 x 3 1/2 x 1 1/2 in. 3/11, post 9d.  
**VIBRATORS.**—12 v. 4 pin. 4/11, post 1/-.  
**ACOS CRYSTAL MICROPHONES.**—Type MIC 35/7. 25/11, post 2/6.  
**LUXEMBOURG EXPANDING AERIALS.**—Compact and easy to fit. No technical knowledge required. Greatly improves reception. 3/11, post 6d.  
**CONDENSERS.**—Tubular Wire End (not ex-Govt.) 8 mf. 450 v., 1/9; 8-8 450 v., 2/6; 16 mf. 450 v., 2/9; 16-8 450 v., 4/-; 16-16 450 v., 3/9; 32 mf. 450 v., 3/9; 32-32 350 v., 4/-, post 1/-.  
**RECTIFIERS.**—Contact Cooled Miniature 200 v. 60ma., 8/6. RMI, 4/9. RM2, 6/6. RM3, 7/6. RM4, 15/6. RM5, 19/6, post 1/-.  
**JACK PLUGS.**—Stand type, 1/11, post 6d.  
**NEON MAINSTAINER/SCREW DRIVER.**—4/6, post 6d.  
**TRANSISTOR CONDENSERS.**—Sub-miniature 5, 8, 10, 16, 25, 32 mf. post 6d.  
**GERMANIUM DIODES.**—1/- each, 10/- dozen, post 4d.  
**THROAT MIKES.**—1/-, post 6d. Could be used for electrifying musical insts.  
**TRANSISTORS.**—(Ediswan) XA101, 21/-; XA102, 21/-; XA103, 13/11; XA104, 17/6; XB102, 7/6; XB103, 7/6; XC101, 12/6. White Spot, 5/11. R.F. Yellow/Red, 13/11, post 6d.  
**CAR RADIO KITS.**—7 transistors Long and Medium Waves. 2 watts output. R.F. Stage and Automatic Gain Control. 6 or 12 volts. Complete Kit with cabinet, 10 gns., post 5/-.

**Supr-us, New and Guaranteed Valves**

ID5	9/6	12K7	7/6	EF37	4/6
1L4	3/9	12Q7	7/6	EF40	13/6
1S5	6/6	25A6G	8/-	EF41	9/-
1T4	5/3	25Z4G	8/6	EF42	9/6
5U4G	6/6	35W4	7/6	EF50	1/9
5Z4G	9/6	35Z3	13/11	EF80	6/6
6A7	12/6	35Z4	7/6	EF85	7/-
6B8G	2/11	90A4	4/6	EF86	13/6
6BA6	6/-	807(B)	3/9	EF91	4/-
6B16	7/-	954	1/6	EF92	5/-
6C4	3/6	955	3/11	EL41	9/6
6CH6	9/6	956	2/11	EL84	9/-
6F1	9/6	9001	4/6	EL85	9/6
6F6M	7/6	9004	4/-	GTIC	7/6
6F33	6/6	9006	4/-	KT36	9/6
6J5G	2/11	AZ1	12/6	KTW61	6/6
6J5GT	3/11	CY31	12/6	MU14	8/6
6J5M	4/6	DAF96	8/6	P61	2/6
6K7G	2/6	DF96	8/6	PCC84	8/6
6K8G	6/6	DK96	8/6	PCF80	9/-
6P28	11/-	DL96	8/6	PEN36C	9/-
6Q7G	8/6	DM70	7/6	PL33	9/6
6SA7	7/-	EB91	4/6	PL81	12/6
6S7GM	5/9	ECC81	6/-	PL82	8/6
6S7FM	7/-	ECC82	7/-	PL83	8/6
6S7FT	4/9	ECC83	8/-	PY31	8/6
6V6C	5/11	ECC84	8/6	PY81	8/6
6V6GT	6/-	ECC85	8/6	PY82	7/6
6X5GT	6/6	ECF80	11/6	U35	9/6
10F1	9/6	ECH42	9/-	UCH42	9/6
12A6	6/6	ECL80	9/6	UF41	9/6
12AH7	5/6	EF36	2/6	UL41	8/6

Any parcel insured against damage in transit for only 6d. extra per order. All uninsured parcels at customers' risk. C.W.O. or C.O.D. only. Postage and packing 6d. extra per valve. Over £3 free S.A.E. with enquiries.

(Classified continued)  
**RADIO**

**AT LAST VHF/EM/AM for the family man.** Astonishing De Luxe VHF/AM Radio offer. Merging of world famous C.O., enables us to offer £24 DE LUXE VHF/AM Radios for £15.10.0. Factory fresh. Maker's guarantee, extra thrilling quality. All features including Ferrite aerials. Our satisfaction guarantee or purchase price refunded. AC/DC 200/250 v. Smaller radio with VHF/AM. £13.10.0, originally £21. Or Miniature Superhet two-wave model, £8.10.0. Carriage paid. Send for illustration, TOMLIN ELECTRICAL, 127, Brockley Rise, London, S.E.23.

**EDUCATIONAL**

**EASY MATHEMATICS.**—Course 21/- for Radio/TV. Write. TUTORIALS, 200, Buchanan St., Glasgow, C.I.

**INCORPORATED Practical Radio Engineers home study courses of radio and T.V. engineering,** are recognised by the trade as outstanding and authoritative. Moderate fees to a limited number of students only. Syllabus of Instructional Text free. "The Practical Radio Engineer," journal, sample copy 2/-, 6,000 Alignment Peaks for Superhets, 5/9. Membership and Entry Conditions booklet 1/-, all post free from the SECRETARY, I.P.R.E., 20, Fairfield Road, London, N.8.

**BUILD YOUR OWN HI-FI at home!** At last, for reasonable cost—the chance to make your own quality HI-FI Audio Equipment and to gain the knowledge to service and maintain it. Free brochure from: Dept. P.T.20, RADIOSTRUCTOR, 46, Market Place, Reading, Berks.

**"HOW AND WHY"** of Radio and Electronics made easy by a new, non-maths, practical way. Postal Instructions, based on hosts of experiments and equipment building, carried out at home. New Courses bring enjoyment as well as knowledge of this fascinating subject. Free brochure from: Dept. P.T.12, RADIOSTRUCTOR, 46, Market Place Reading, Berks.

**STUDY RADIO, TELEVISION AND ELECTRONICS** with the world's largest home study organisation— I.C.S. Courses for the enthusiast and for those seeking examination qualification. Brit.I.R.E., City and Guilds, R.T.E.B., etc. Build your own equipment with Practical Radio Course. Write to-day for free book. INTERNATIONAL CORRESPONDENCE SCHOOLS, Intertext House Parkgate Road (Dept. 515), London, S.W.11.

**ALUMINIUM, LIGHT ALLOYS, BRASS, COPPER, BRONZE,**

IN ROD, BAR, SHEET, TUBE, STRIP WIRE, ANGLE, CHANNEL, TEE

**3,000 STANDARD STOCK SIZES**

**H. ROLLET & CO., LTD.**

6, CHESHAM PLACE, LONDON, S.W.1  
 SLOane 3463

Works:

36, ROSEBERY AVE., LONDON, E.C.1  
 Branches at Liverpool, Manchester, Birmingham, Leeds.

"No Quantity too Small"

**TECHNICAL TRADING CO.**

Satisfaction or Money Back Guarantee.

**TUBES**

**FACTORY REVAQUUMED. ALL GUARANTEED 8 MONTHS.** Carriage and insurance 12/6. Enquiries welcomed for any types not listed. Due to the high quality of our tubes, we are able to maintain the following unusually low prices.  
 6051, 6504, 6505, CRM91, CRM92, MW22-1, MW22-14C, MW22-17, MW22-18, MW22-18C, MW22-19, MW22-20, MW22-21, MW22-21C, MW22-21D, MW22-21E, MW22-21F, MW22-21G, MW22-21H, MW22-21I, MW22-21J, MW22-21K, MW22-21L, MW22-21M, MW22-21N, MW22-21O, MW22-21P, MW22-21Q, MW22-21R, MW22-21S, MW22-21T, MW22-21U, MW22-21V, MW22-21W, MW22-21X, MW22-21Y, MW22-21Z, MW22-22, MW22-23, MW22-24, MW22-25, MW22-26, MW22-27, MW22-28, MW22-29, MW22-30, MW22-31, MW22-32, MW22-33, MW22-34, MW22-35, MW22-36, MW22-37, MW22-38, MW22-39, MW22-40, MW22-41, MW22-42, MW22-43, MW22-44, MW22-45, MW22-46, MW22-47, MW22-48, MW22-49, MW22-50, MW22-51, MW22-52, MW22-53, MW22-54, MW22-55, MW22-56, MW22-57, MW22-58, MW22-59, MW22-60, MW22-61, MW22-62, MW22-63, MW22-64, MW22-65, MW22-66, MW22-67, MW22-68, MW22-69, MW22-70, MW22-71, MW22-72, MW22-73, MW22-74, MW22-75, MW22-76, MW22-77, MW22-78, MW22-79, MW22-80, MW22-81, MW22-82, MW22-83, MW22-84, MW22-85, MW22-86, MW22-87, MW22-88, MW22-89, MW22-90, MW22-91, MW22-92, MW22-93, MW22-94, MW22-95, MW22-96, MW22-97, MW22-98, MW22-99, MW22-100, MW22-101, MW22-102, MW22-103, MW22-104, MW22-105, MW22-106, MW22-107, MW22-108, MW22-109, MW22-110, MW22-111, MW22-112, MW22-113, MW22-114, MW22-115, MW22-116, MW22-117, MW22-118, MW22-119, MW22-120, MW22-121, MW22-122, MW22-123, MW22-124, MW22-125, MW22-126, MW22-127, MW22-128, MW22-129, MW22-130, MW22-131, MW22-132, MW22-133, MW22-134, MW22-135, MW22-136, MW22-137, MW22-138, MW22-139, MW22-140, MW22-141, MW22-142, MW22-143, MW22-144, MW22-145, MW22-146, MW22-147, MW22-148, MW22-149, MW22-150, MW22-151, MW22-152, MW22-153, MW22-154, MW22-155, MW22-156, MW22-157, MW22-158, MW22-159, MW22-160, MW22-161, MW22-162, MW22-163, MW22-164, MW22-165, MW22-166, MW22-167, MW22-168, MW22-169, MW22-170, MW22-171, MW22-172, MW22-173, MW22-174, MW22-175, MW22-176, MW22-177, MW22-178, MW22-179, MW22-180, MW22-181, MW22-182, MW22-183, MW22-184, MW22-185, MW22-186, MW22-187, MW22-188, MW22-189, MW22-190, MW22-191, MW22-192, MW22-193, MW22-194, MW22-195, MW22-196, MW22-197, MW22-198, MW22-199, MW22-200, MW22-201, MW22-202, MW22-203, MW22-204, MW22-205, MW22-206, MW22-207, MW22-208, MW22-209, MW22-210, MW22-211, MW22-212, MW22-213, MW22-214, MW22-215, MW22-216, MW22-217, MW22-218, MW22-219, MW22-220, MW22-221, MW22-222, MW22-223, MW22-224, MW22-225, MW22-226, MW22-227, MW22-228, MW22-229, MW22-230, MW22-231, MW22-232, MW22-233, MW22-234, MW22-235, MW22-236, MW22-237, MW22-238, MW22-239, MW22-240, MW22-241, MW22-242, MW22-243, MW22-244, MW22-245, MW22-246, MW22-247, MW22-248, MW22-249, MW22-250, MW22-251, MW22-252, MW22-253, MW22-254, MW22-255, MW22-256, MW22-257, MW22-258, MW22-259, MW22-260, MW22-261, MW22-262, MW22-263, MW22-264, MW22-265, MW22-266, MW22-267, MW22-268, MW22-269, MW22-270, MW22-271, MW22-272, MW22-273, MW22-274, MW22-275, MW22-276, MW22-277, MW22-278, MW22-279, MW22-280, MW22-281, MW22-282, MW22-283, MW22-284, MW22-285, MW22-286, MW22-287, MW22-288, MW22-289, MW22-290, MW22-291, MW22-292, MW22-293, MW22-294, MW22-295, MW22-296, MW22-297, MW22-298, MW22-299, MW22-300, MW22-301, MW22-302, MW22-303, MW22-304, MW22-305, MW22-306, MW22-307, MW22-308, MW22-309, MW22-310, MW22-311, MW22-312, MW22-313, MW22-314, MW22-315, MW22-316, MW22-317, MW22-318, MW22-319, MW22-320, MW22-321, MW22-322, MW22-323, MW22-324, MW22-325, MW22-326, MW22-327, MW22-328, MW22-329, MW22-330, MW22-331, MW22-332, MW22-333, MW22-334, MW22-335, MW22-336, MW22-337, MW22-338, MW22-339, MW22-340, MW22-341, MW22-342, MW22-343, MW22-344, MW22-345, MW22-346, MW22-347, MW22-348, MW22-349, MW22-350, MW22-351, MW22-352, MW22-353, MW22-354, MW22-355, MW22-356, MW22-357, MW22-358, MW22-359, MW22-360, MW22-361, MW22-362, MW22-363, MW22-364, MW22-365, MW22-366, MW22-367, MW22-368, MW22-369, MW22-370, MW22-371, MW22-372, MW22-373, MW22-374, MW22-375, MW22-376, MW22-377, MW22-378, MW22-379, MW22-380, MW22-381, MW22-382, MW22-383, MW22-384, MW22-385, MW22-386, MW22-387, MW22-388, MW22-389, MW22-390, MW22-391, MW22-392, MW22-393, MW22-394, MW22-395, MW22-396, MW22-397, MW22-398, MW22-399, MW22-400, MW22-401, MW22-402, MW22-403, MW22-404, MW22-405, MW22-406, MW22-407, MW22-408, MW22-409, MW22-410, MW22-411, MW22-412, MW22-413, MW22-414, MW22-415, MW22-416, MW22-417, MW22-418, MW22-419, MW22-420, MW22-421, MW22-422, MW22-423, MW22-424, MW22-425, MW22-426, MW22-427, MW22-428, MW22-429, MW22-430, MW22-431, MW22-432, MW22-433, MW22-434, MW22-435, MW22-436, MW22-437, MW22-438, MW22-439, MW22-440, MW22-441, MW22-442, MW22-443, MW22-444, MW22-445, MW22-446, MW22-447, MW22-448, MW22-449, MW22-450, MW22-451, MW22-452, MW22-453, MW22-454, MW22-455, MW22-456, MW22-457, MW22-458, MW22-459, MW22-460, MW22-461, MW22-462, MW22-463, MW22-464, MW22-465, MW22-466, MW22-467, MW22-468, MW22-469, MW22-470, MW22-471, MW22-472, MW22-473, MW22-474, MW22-475, MW22-476, MW22-477, MW22-478, MW22-479, MW22-480, MW22-481, MW22-482, MW22-483, MW22-484, MW22-485, MW22-486, MW22-487, MW22-488, MW22-489, MW22-490, MW22-491, MW22-492, MW22-493, MW22-494, MW22-495, MW22-496, MW22-497, MW22-498, MW22-499, MW22-500, MW22-501, MW22-502, MW22-503, MW22-504, MW22-505, MW22-506, MW22-507, MW22-508, MW22-509, MW22-510, MW22-511, MW22-512, MW22-513, MW22-514, MW22-515, MW22-516, MW22-517, MW22-518, MW22-519, MW22-520, MW22-521, MW22-522, MW22-523, MW22-524, MW22-525, MW22-526, MW22-527, MW22-528, MW22-529, MW22-530, MW22-531, MW22-532, MW22-533, MW22-534, MW22-535, MW22-536, MW22-537, MW22-538, MW22-539, MW22-540, MW22-541, MW22-542, MW22-543, MW22-544, MW22-545, MW22-546, MW22-547, MW22-548, MW22-549, MW22-550, MW22-551, MW22-552, MW22-553, MW22-554, MW22-555, MW22-556, MW22-557, MW22-558, MW22-559, MW22-560, MW22-561, MW22-562, MW22-563, MW22-564, MW22-565, MW22-566, MW22-567, MW22-568, MW22-569, MW22-570, MW22-571, MW22-572, MW22-573, MW22-574, MW22-575, MW22-576, MW22-577, MW22-578, MW22-579, MW22-580, MW22-581, MW22-582, MW22-583, MW22-584, MW22-585, MW22-586, MW22-587, MW22-588, MW22-589, MW22-590, MW22-591, MW22-592, MW22-593, MW22-594, MW22-595, MW22-596, MW22-597, MW22-598, MW22-599, MW22-600, MW22-601, MW22-602, MW22-603, MW22-604, MW22-605, MW22-606, MW22-607, MW22-608, MW22-609, MW22-610, MW22-611, MW22-612, MW22-613, MW22-614, MW22-615, MW22-616, MW22-617, MW22-618, MW22-619, MW22-620, MW22-621, MW22-622, MW22-623, MW22-624, MW22-625, MW22-626, MW22-627, MW22-628, MW22-629, MW22-630, MW22-631, MW22-632, MW22-633, MW22-634, MW22-635, MW22-636, MW22-637, MW22-638, MW22-639, MW22-640, MW22-641, MW22-642, MW22-643, MW22-644, MW22-645, MW22-646, MW22-647, MW22-648, MW22-649, MW22-650, MW22-651, MW22-652, MW22-653, MW22-654, MW22-655, MW22-656, MW22-657, MW22-658, MW22-659, MW22-660, MW22-661, MW22-662, MW22-663, MW22-664, MW22-665, MW22-666, MW22-667, MW22-668, MW22-669, MW22-670, MW22-671, MW22-672, MW22-673, MW22-674, MW22-675, MW22-676, MW22-677, MW22-678, MW22-679, MW22-680, MW22-681, MW22-682, MW22-683, MW22-684, MW22-685, MW22-686, MW22-687, MW22-688, MW22-689, MW22-690, MW22-691, MW22-692, MW22-693, MW22-694, MW22-695, MW22-696, MW22-697, MW22-698, MW22-699, MW22-700, MW22-701, MW22-702, MW22-703, MW22-704, MW22-705, MW22-706, MW22-707, MW22-708, MW22-709, MW22-710, MW22-711, MW22-712, MW22-713, MW22-714, MW22-715, MW22-716, MW22-717, MW22-718, MW22-719, MW22-720, MW22-721, MW22-722, MW22-723, MW22-724, MW22-725, MW22-726, MW22-727, MW22-728, MW22-729, MW22-730, MW22-731, MW22-732, MW22-733, MW22-734, MW22-735, MW22-736, MW22-737, MW22-738, MW22-739, MW22-740, MW22-741, MW22-742, MW22-743, MW22-744, MW22-745, MW22-746, MW22-747, MW22-748, MW22-749, MW22-750, MW22-751, MW22-752, MW22-753, MW22-754, MW22-755, MW22-756, MW22-757, MW22-758, MW22-759, MW22-760, MW22-761, MW22-762, MW22-763, MW22-764, MW22-765, MW22-766, MW22-767, MW22-768, MW22-769, MW22-770, MW22-771, MW22-772, MW22-773, MW22-774, MW22-775, MW22-776, MW22-777, MW22-778, MW22-779, MW22-780, MW22-781, MW22-782, MW22-783, MW22-784, MW22-785, MW22-786, MW22-787, MW22-788, MW22-789, MW22-790, MW22-791, MW22-792, MW22-793, MW22-794, MW22-795, MW22-796, MW22-797, MW22-798, MW22-799, MW22-800, MW22-801, MW22-802, MW22-803, MW22-804, MW22-805, MW22-806, MW22-807, MW22-808, MW22-809, MW22-810, MW22-811, MW22-812, MW22-813, MW22-814, MW22-815, MW22-816, MW22-817, MW22-818, MW22-819, MW22-820, MW22-821, MW22-822, MW22-823, MW22-824, MW22-825, MW22-826, MW22-827, MW22-828, MW22-829, MW22-830, MW22-831, MW22-832, MW22-833, MW22-834, MW22-835, MW22-836, MW22-837, MW22-838, MW22-839, MW22-840, MW22-841, MW22-842, MW22-843, MW22-844, MW22-845, MW22-846, MW22-847, MW22-848, MW22-849, MW22-850, MW22-851, MW22-852, MW22-853, MW22-854, MW22-855, MW22-856, MW22-857, MW22-858, MW22-859, MW22-860, MW22-861, MW22-862, MW22-863, MW22-864, MW22-865, MW22-866, MW22-867, MW22-868, MW22-869, MW22-870, MW22-871, MW22-872, MW22-873, MW22-874, MW22-875, MW22-876, MW22-877, MW22-878, MW22-879, MW22-880, MW22-881, MW22-882, MW22-883, MW22-884, MW22-885, MW22-886, MW22-887, MW22-888, MW22-889, MW22-890, MW22-891, MW22-892, MW22-893, MW22-894, MW22-895, MW22-896, MW22-897, MW22-898, MW22-899, MW22-900, MW22-901, MW22-902, MW22-903, MW22-904, MW22-905, MW22-906, MW22-907, MW22-908, MW22-909, MW22-910, MW22-911, MW22-912, MW22-913, MW22-914, MW22-915, MW22-916, MW22-917, MW22-918, MW22-919, MW22-920, MW22-921, MW22-922, MW22-923, MW22-924, MW22-925, MW22-926, MW22-927, MW22-928, MW22-929, MW22-930, MW22-931, MW22-932, MW22-933, MW22-934, MW22-935, MW22-936, MW22-937, MW22-938, MW22-939, MW22-940, MW22-941, MW22-942, MW22-943, MW22-944, MW22-945, MW22-946, MW22-947, MW22-948, MW22-949, MW22-950, MW22-951, MW22-952, MW22-953, MW22-954, MW22-955, MW22-956

Completely rebuilt with new electron Gun Units delivered immediately—free in the U.K.

## CATHODE RAY TUBES



All covered by a full 12 months guarantee. Midland Tubes for service and quality. A member of the Association of Tube Rebuilders.

For full details and prices please write direct to :

## MIDLAND TUBES LIMITED

37 George Street, Manchester, 1.  
Tel.: Cen. 4568.

### B.B.C. - I.T.V. - F.M. AERIALS



B.B.C. (BAND 1). Telescope loft, 18/6. External, S/D, 26/3.

I.T.V. (BAND 3). 3 Element loft array, 24". 5 Element, 32/6. Wall mounting, 3 Element, 33/6. 5 Element, 41/3.

COMBINED B.B.C. + I.T.V. Loft 1+3 Element, 41/3. 1+5 Element, 49/8. Wall mounting, 1+3 Element, 58/3. 1+5 Element, 63/8. Chimney and mast

mounting units also available. F.M. (BAND 2). Loft "H", 28". 3 Element loft, 52/6. S/D loft, 12/6. External S/D, 26/3. State channel when ordering. C.W.O. or C.O.D. P.P. 2/6. Coaxial cable, 8d. yd. Coaxial plugs, 1/3. Send 6d. stamps for illustrated lists.

**K.V.A. ELECTRONICS (Dept. T.P.)**  
3a, Godstone Road, Kenley, Surrey

### RES/CAP. BRIDGE 37/-

p. & p. 2/-  
Checks all types of resistors, condensers  
6 RANGES

Built in 1 hour. Direct reading

**READY CALIBRATED**

Stamp for details of this and other kits.

**RADIO MAIL (Dept. V5)**

Raleigh Mews, Raleigh Street, Nottingham

### TRANSFORMERS

Suppliers to B.B.C., I.T.A. and leading radio manufacturers, single or long runs, prompt delivery, home and export.

Rewinds to all makes.

**H.W. FORREST (Transformers) Ltd.**

Shirley, Solihull, Warwickshire

Tel.: SH1Ry 2483

### SPECIAL VALVE OFFER FOR LIMITED PERIOD

EF80	6/-	PY82	6/6	6P28	7/6
10F1	6/6	PL82	6/6	EB34	1/6
6F1	7/-	PL83	6/6	7C5	6/6
EB91	4/6	6P25	7/6	7Y4	7/-
EF91	5/-	KT33C	7/-	3D6	2/-
ECL80	8/6	EY83	7/6	1625	5/-
DH76	6/6	UCH42	8/-	807	4/-
DH77	6/-	SP61	3/-	4D1	2/6
UL46	8/6	SP41	3/-	EB41	7/-
6F13	6/6	Z63	6/-	6L18	9/6
6F14	6/6	Z66	6/-	N37	9/-
6F15	6/6	B36	7/-	20LD20	9/-
6L1	7/6	L63	5/-	UF42	6/6
UBC41	8/-	6SN7GT	5/6	6F6G	6/6
PY80	6/6	PZ30	13/6		

Postage 6d. per Valve.

Air-Spaced Coaxial Cable 75 ohms, 8d. per yard; Ion Traps, 5/-; F.M. Twin Feeder, 4d. per yard; T/V Aerials, Band III, 3 El., 23/6; 8 El., 57/6; F.M. Aerials, Single Dipole Wall Fixing, 29/6.

MAIL ORDER ONLY—NO CALLERS.

Terms: C.W.O. or C.O.D. Minimum C.O.D. charge 3/6. Postage and Packing other than valves: Under £2, 1/6; Under £5, 2/-; Aerials, 2/6 Carriage.

### ELECTRO-SERVICES & Co.

221 BATTERSEA PARK ROAD,  
LONDON, S.W.11. MAC 6833/4

### TELEVISION SERVICING

Vol. 4.

### PRACTICAL SERVICING AND FAULT-FINDING

More than 400 faults on a typical receiver have been considered, a large number of which have been placed on the receiver to obtain static and dynamic readings and oscillograph records.

The circuit has been divided into the various sections which are contained in fold-out pages at the ends of the book, and so can be viewed clear of the text.

By G. N. Patchett.

7/6. 6d. Postage.

A BEGINNER'S GUIDE TO TELEVISION, by F. J. Camm. 7/6. Postage 6d.

TELEVISION ENGINEERS' POCKET BOOK, by J. P. Hawker. 12/6. Postage 8d.

OSCILLOSCOPE TECHNIQUES, by A. Haas. 23/- Postage 1/-.

RADIO VALVE DATA, compiled by "WW." 6th Ed. 5/- Postage 9d.

### THE MODERN BOOK CO.

BRITAIN'S LARGEST STOCKISTS  
of British and American Technical Books

19-23 PRAED STREET,  
LONDON, W.2.

Complete catalogue 6d.

Phone: PADDington 4185.

Open 6 days 9-6 p.m.

# TELEVISION SPARES

**All Makes All Models By return of post**

**LINE OUTPUT TRANSFORMERS FRAME OUTPUT TRANSFORMERS  
DEFLECTOR COILS**

**LINE AND FRAME BLOCKING OSCILLATOR TRANSFORMERS  
ALL POTENTIOMETER AND SLIDER CONTROLS  
MAINS DROPPERS METAL RECTIFIERS  
GERMANIUM DIODES FOCUS MAGNETS  
ION TRAPS E.H.T. CONDENSERS**

Our Range of Spares is probably the most extensive in the country and includes all Spares for Tape Recorders, Radio and Record Player Units.

Technical Advice Free. Service Manuals supplied on loan.

Terms: C.W.O. or C.O.D. All Components are supplied at list prices, plus 2/6 p.p.

Please enclose S.A.E. with all enquiries.

## NEWBURY RADIO

272, ROMFORD ROAD, FOREST GATE, LONDON, E.7.

MARYland 3100

# TELEVISION TUBES REBUILT

12 months' guarantee

12''	...	£5. 0. 0
14''	...	£5. 10. 0
15''	...	£6. 0. 0
16''	...	£6. 0. 0
17''	...	£6. 10. 0
21''	...	£9. 0. 0

TRADE DISCOUNTS

## NEOTRONICS LTD.

Electronic Tube Manufacturers,  
9, MAYDAY ROAD,

THORNTON HEATH, SURREY

## RST

MAIL ORDER DEPARTMENT  
211 Streatham Road, Mitcham, Surrey  
ALL VALUES LISTED ARE NEW STOCK  
• Terms C.W.O. or C.O.D. Postage 3d. per value.  
MITCHAM 6201.

AZ31 10 6	EF92 5 -	PCF82 11 6	UY35 7 6	6K8C 7 6
B85 8 6	EL42 10 -	PCL82 11 6	VP4B 17 6	6K8GT 12 6
DAF91 9 6	EL94 10 -	PCL83 10 -	W81M 5 9	6L1 12 6
DAF96 9 6	EL00 8 6	WM19 7 4	W142 3 -	6L6C 7 6
DF91 5 -	EM80 10 -	W719 7 4	W727 7 6	6L18 12 6
DH719 7 6	EM81 10 -	X78 21 -	X79 21 -	6L19 21 -
DK91 9 -	EY81 10 6	Y21 12 6	Z77 5 -	6N7G GT 7 6
EABC80 7 6	EY86 9 6	PL36 15 -	Z152 7 8	6SL7GT 8 6
EAF4210 -	EY91 9 -	PI81 14 9	Z719 7 6	6SN7GT 8 6
EB91 5 -	EZ35 7 -	PL82 8 -	1R 7 -	6V8C 5 4
EBC41 4 6	EZ40 7 6	PL83 10 6	5U3G 7 6	6X5GT 5 6
EBF80 4 6	EZ41 7 6	PL88 8 6	5V1G 9 6	7S7 10 6
EBF89 9 -	EZ80 7 6	PV80 8 6	5Y3GT 8 6	7Y4 7 6
EC91 9 6	EZ81 7 6	PV81 9 -	5Z4G 10 -	8D3 5 6
ECC33 8 -	FC2 21 -	PV82 8 -	6A8CT 10L D11	
ECC81 8 -	FC4 17 4	PY82 8 -	6AL5 10 -	12AH8 10 -
ECC83 9 4	FC13 17 5	RY82 8 -	6AM6 5 6	12AT6 9 -
ECC84 9 4	FC19 21 -	R19 21 -	6AN5 7 6	12AT7 8 -
ECC85 9 6	GZ32 11 6	R19 19 6	6AQ3 8 3	12AU7 9 -
ECF80 12 6	H30 5 6	TDD4 17 6	6B4G 1 6	12AX7 9 6
ECF82 12 6	H63 9 6	TP22 17 6	6BE6 7 6	12BA6 9 -
ECH35 9 -	HBC90 9 6	U142 8 -	6B6E 7 6	12BE6 9 6
ECH42 10 -	HL82 9 6	U147 9 -	6BR7 15 -	12BH7 15 -
ECH81 9 -	HL33D 10 -	U153 9 -	6B8C 8 6	12J7G CT 9 6
ECL80 12 6	KT33C 10 -	UAB80 8 -	6B8E 7 6	12K7GT 9 6
ECL82 9 -	KT66 17 6	UAF42 9 6	6BR7 15 -	12K8GT 12 6
ECL83 12 6	LZ818 12 6	UBC41 9 6	6B8V 6 6	12Q7 8 6
EF37A 8 6	MKT4 (5) 9 -	UBF80 9 6	6B8X 7 -	12Q7GT 8 6
EF40 15 -	(or 7) 17 6	UCH2 9 -	6C12 5 -	35Z4GT 7 6
EF41 9 3	ML4 15 -	UCH81 9 -	6C13 17 6	60L6CT 9 -
EF42 10 6	MSH4 17 6	UCL83 23 6	6C1G 4 6	813 50 -
EF50(A) 4 6	MU14 9 -	UF41 9 -	6C1G 4 6	
EF80 4 6	MX40 17 6	UF80 8 -	6C7 4 6	
EF83 7 -	N142 9 6	UL41 9 -	6K7G 4 -	
EF86 13 6	N153 12 6	PCC84 9 6	6K7GT 10 6	
EF89 10 -	PCF82 11 6	UL84 9 6		
EF91 5 -	PCF82 11 6	UY41 7 6		

SEND FOR LISTS. Quotations given for any types not listed. Obsolete and old types a speciality

# Build your own Aerials...

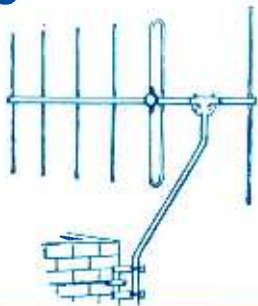

**Fringevision Ltd.**

MARLBOROUGH, WILTS. Phone : 657/8

## AT HOME

**AERIAL FITTINGS FOR BAND III, BAND I & RADIO F/M.**  
Useful formulæ and hints for constructing your own aerial quickly and cheaply. Catalogue illustrating our increased range of Diecast Alloy Fittings, including Band III to Band I Mast Couplers, Reflector and Director Rod Holders, Insulators (both "Inline" and "H" types), Masthead Fittings, Masts and Elements, Chimney Brackets, etc. Send 1/- in stamps for the above to —

### AS ADVERTISED ON TELEVISION

Save £££

12 Months' Guarantee

## FACTORY REBUILT... TELEVISION TUBES

Immediate delivery

### ALL TYPES FITTED WITH NEW GUN TYPES

MW31-74	- 12 in.	<b>£5.12.6</b>	MW36-24/44	14 in.	<b>£5.17.6</b>
MW43-64/69	17 in.	<b>£7.0.0</b>	MW53-20/80	21 in.	<b>£9.10.0</b>
CRM141	- - 14 in.	<b>£5.17.6</b>	CRM152-153	- 15 in.	<b>£6.5.0</b>
CRM171	- - 17 in.	<b>£7.0.0</b>			

TERMS TO  
THE TRADE

Plus 10/- carriage and insurance.  
Cash with order or C.O.D.

### RE-VIEW (LONDON) LTD.

10 High Street

Colliers Wood, S.W.19

Telephone: Liberty 3272

