

A SOUND-ONLY POCKET TELEVISION RECEIVER

# Practical Television 13

NOVEMBER 1958

AND TELEVISION TIMES

EDITOR: F.J. CANN



## CONTENTS

- IMPROVING TELEVISION SOUND
- SERVICING TV RECEIVERS
- INTERFERENCE WITH TV RECEPTION
- LINE TIME-BASE FAULTS
- TELEVISION TROUBLES
- BIG SCREEN TV: WILL IT COME? ETC. ETC. ETC.



This splendid AVO Instrument has been developed to meet a definite demand for a sturdy pocket-size multi-range test meter at a modest price, suitable for use on modern electronic apparatus as well as for radio and television receivers, motor vehicles, and all kinds of domestic appliances and workshop equipment. Readings are obtainable quickly and easily on a very open scale, and range selection is by means of a robust, clearly marked rotary switch of the characteristic AvoMeter type. Measurements of A.C. and D.C. Voltage, D.C. Current and Resistance are made by means of only two connection sockets.

Designed and Manufactured by

**AVO LTD** AVOCET HOUSE • 92-96 VAUXHALL BRIDGE RD. • LONDON • S.W.1

Telephone: VICTORIA 3404 (9 lines)

M.M.2

# Just Right for your pocket!

## THE MULTIMINOR

### 19 Ranges

D.C. Voltage: 0-1,000V in 7 ranges

A.C. Voltage: 0-1,000V in 5 ranges

D.C. Current: 0-1A in 5 ranges

Resistance: 0-20,000 Ω, 0-2M Ω.

Pocket Size: 5½ x 3½ x 1½ inches.

Weight: 1 lb. approx.

### Sensitivity:

10,000 ohms per volt on D.C. voltage ranges. 1,000 ohms per volt on A.C. voltage ranges.

### Accuracy:

On D.C. 3% of full scale value.

On A.C. 4% of full scale value.

To meet special requirements, instruments can be supplied to a higher degree of accuracy for a small additional charge.

List Price **£9: 10s.**

Complete with Test Leads and Clips. Leather Case if required 32/6.

**TAKE THE PROBLEMS  
OUT OF SOLDERING**

★RELIABLE ★SPEEDY ★LONG-LASTING

A model for every purpose  
65 watt round pencil bit (Illustrated)

**HENLEY  
SOLO**

TRADE MARK  
FOR 25 YEARS  
THE BEST ELECTRIC  
SOLDERING IRON

LEAFLETS ON REQUEST FROM:  
W. T. HENLEY'S  
TELEGRAPH WORKS CO. LTD.

ENGINEERING SALES DEPARTMENT  
59-62, High Holborn, London, W.C.1  
Telephone: CHAncery 4361  
Telegrams: "Henlecet, Holb, London"

# TELEVISION TUBES

WE OFFER

**MULLARD — COSSOR — EMITRON**

Etc., From Stock

**12" TUBES - - - £6**

Re 12" tubes, please confirm before placing order.

**14" MULLARD TUBES £6**

(Or equivalent)

**14" MAZDA TUBES £6 10.**

**17" TUBES - - £7 10.**

Please add 12/6 Carriage and Insurance.

12" tubes guaranteed for 3 months;

14" & 17", 6 months

**MARSHALLS for TELEVISION**

131 St. Ann's Road, Tottenham,  
London, N.15.

Callers welcome.

STAMford Hill 3267

# EMI "HIS MASTER'S VOICE" MARCONIPHONE · COLUMBIA

## Announce NEW PRACTICAL WAY OF LEARNING AT HOME

**NEW** — completely up-to-date methods of giving instruction in a wide range of technical subjects specially designed and arranged for self-study at home under the skilled guidance of our teaching staff.

**NEW** — experimental outfits and lesson manuals are despatched on enrolment and remain the student's property. A tutor is allotted to each student for personal and individual tuition throughout the course.

Radio and television courses, with which specially prepared components are supplied, teach the basic electronic circuits (amplifiers, oscillators, detectors, etc.) and lead, by easy stages, to the complete design and servicing of modern Radio and T/V equipments.

If you are studying for an examination, wanting a new hobby or interest, commencing a career in industry or running your own full-time or part-time business, these practical courses are ideal and may be yours for moderate cost. Send off the coupon to-day for a free Brochure giving full details. There is no obligation whatsoever.

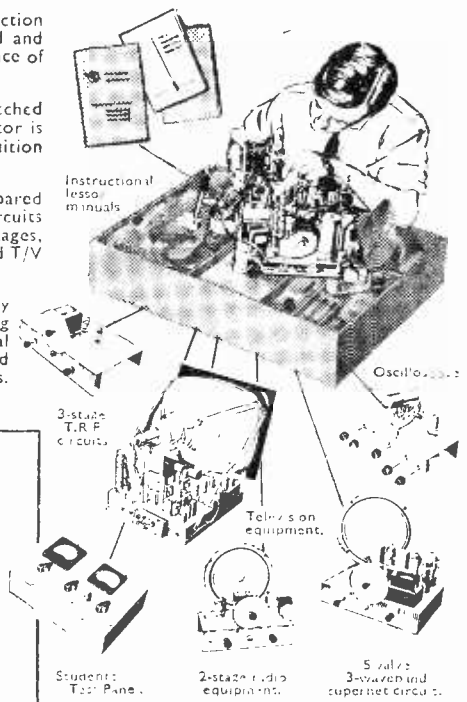

**Courses with Equipment**  
 RADIO · SHORT WAVE RADIO  
 TELEVISION · MECHANICS  
 CHEMISTRY · PHOTOGRAPHY  
 ELECTRICITY · CARPENTRY  
 ELECTRICAL WIRING · 'HI-FI'  
 DRAUGHTSMANSHIP · ART etc.

E.M.I. Institutes  
at Hayes  
England



# EMI INSTITUTES

Fill in for **FREE BROCHURE**  
 E.M.I. INSTITUTES, Dept. 138X, London, W.4.

Name ..... Age .....  
 (If under 21)

Address .....

I am interested in the following subject(s) with  
 without equipment: .....

(We shall not worry you with personal visits)



BLOCK  
CAPS  
PLEASE

NOV. 58

*The only Home Study College run by a World-wide industrial organisation*

# BENTLEY ACOUSTIC CORPORATION LTD.

THE VALVE SPECIALISTS

38 CHALCOT ROAD, LONDON, N.W.1

Nearest Underground Station, Chalk Farm.

PR11rose 9090.

**EXPRESS SERVICE !!!**

PHONE OR WIRE THAT URGENT ORDER FOR IMMEDIATE DESPATCH C.O.D. ALL POST ORDERS ARE CLEARED SAME DAY AS RECEIVED.

ANY PARCEL UP TO £10 INSURED AGAINST DAMAGE IN TRANSIT FOR ONLY 6d. EXTRA. ORDERS OVER £10 INSURED FREE.

024	6/-	6AT6	8/6	6L18	13/-	12AH8	10/6	35A5	11/-	D77	6/6	ECC85	9/6	FW4/500	PCL82	12/6	UB41	12/7
IA3	3/-	6AU6	10/6	6N7	8/-	12AT6	10/6	35L6GT	9/6	DAC32	11/-	ECC91	5/6		PCL83	11/6	UBC41	8/6
IA5	6/-	6B4G	6/6	6Q7G	10/-	12AT7	8/-	35V4	8/6	DAF91	8/-	ECCF80	13/6	GZ30	10/6	PEN40DD	UBF89	9/6
IC5	12/6	5B8	10/6	6Q7GT	11/-	12AU7	7/6	35Z3	10/6	DAF96	10/-	ECCF82	13/6	GZ32	12/6		UBF89	10/6
ID6	10/6	6B8G	4/6	6R7G	10/-	12AX7	9/-	35Z4	7/6	DF33	11/-	ECH35	9/6	GZ34	14/-	PEN45	UCC85	10/6
IHSGT	11/-	6B8GTM	5/-	6SA7GT	8/6	12BA6	9/-	35Z5GT	9/-	DF91	6/6	ECH42	9/6	H30	5/-	PEN45	UCH42	11/-
IL4	6/6	6BA6	7/6	6SC7GT	10/6	12BE6	10/-	41MTL	8/-	DF96	10/-	ECH81	9/-	H63	12/6	PL81	UCH81	11/6
ILD5	5/-	6BE6	7/6	6SG7GT	8/-	12EI	10/-	50C5	12/6	DM63(C)	10/-	ECL80	14/-	HABC8J		PL82	UCL82	15/6
ILN5	5/-	6BJ6	7/6	6SH7GT	8/-	12J5GT	4/6	50L6GT	9/6		10/-	ECL82	12/6			PL83	UCL82	15/6
INS	11/-	6BR7	11/6	6S7GT	8/-	12J7GT	10/6	72	4/6	DM63(M)	10/-	EF36	6/-	HK90	13/6	PM2B	UF41	9/-
IRS	8/-	6BW6	9/6	6SK7GT	8/-	12K7GT	7/6	77	8/-		17/6	EF37A	8/-	HL23	10/6	PM12	UF80	10/6
IS5	8/-	6BW7	8/-	6SL7GT	8/-	12K8GT	14/-	78	8/6	DH76	7/6	EF39	6/-	HL41	12/6	PM12M	UF89	10/6
IT4	6/6	6BX6	8/-	6SN7GT	7/6	12Q7GT	7/6	80	9/-	DH77	8/6	EF40	15/-	HL133DD		PM12	UL41	10/6
IUS	10/-	6C4	7/-	6SQ7GT	9/-	12QA7	10/6	83V	12/6	DK91	8/6	EF41	9/6	HVR2	12/6	PY81	UL46	15/-
2A7	10/6	6C5	6/6	6SS7GT	8/-	12SC7	8/6	85A2	15/-	DK92	10/6	EF42	12/6	HVR2A	6/-	PY83	UY41	8/6
2D13C	7/6	6C6	6/6	6U4GT	14/-	12SG7	8/6	150B2	15/-	DK96	10/-	EF50(A)	7/-	KF35	8/6	PY82	UY85	10/6
2X2	4/6	6C8	12/6	6U5G	7/6	12SH7	8/6	220P	10/6	DL2	15/6	EF50(E)	5/-	KL35	8/6	QP25	Y1507	5/6
3A4	7/-	6C9	12/6	6U7G	8/6	12SI7	8/6	807	7/6	DL33	9/6	EF54	5/-	KT2	5/6	QPS150/15	VLS492A	£3
3A5	12/6	6C10	12/6	6V6G	7/-	12SK7	8/6	956	3/6	DL66	15/6	EF73	10/6	KT22	5/6		VMP4G	15/-
3B7	12/6	6CH6	12/6	6V6GTG	8/-	12SQ7	8/6	1203	3/6	DL92	7/6	EF80	8/-	KT33C	10/-		VP2(7)	12/6
3D6	5/-	6D6	6/6	6X4	7/-	12SR7	8/6	1204	4/6	DL94	9/-	EF85	7/6	KT44	15/-	OVO4/7	VP4(1)	12/6
3Q4	7/6	6E5	12/6	6X5GT	6/6	12Y4	8/6	5763	12/6	DL96	10/6	EF86	17/6	KT63	7/6	R2	VP4(7)	15/-
3Q5GT	9/6	6F6G	7/-	6Z4/84	12/6	14R7	10/6	7193	5/6	DLS10	10/6	EF89	10/-	KTW61	8/-	R12	VP13C	7/6
354	7/6	6F8	12/6	6Z0L2	10/-	19AQ5	11/-	9002	5/6	DM70	8/6	EF91	7/6	KTW62	8/-	SD6	VP41	6/6
3V4	17/6	6F12	7/6	7A7	12/6	19H1	10/-	9003	5/6	EAT6	9/6	EL32	5/6	KTZ41	8/-	SP41		9/-
3R4GY	17/6	6F13	12/6	7B7	8/6	20D1	16/-	9006	6/-	EABC80	9/-	EL34	17/6	KTZ63	10/6	SP42	VR150/30	
U04G	8/6	6F17	12/6	7C5	8/-	25L6GT	10/6	AC/6PEN	7/6	EAC91	7/6	EL41	11/-	L63	6/-	SP61		9/-
5K4G	12/6	6F32	10/6	7C6	8/-	25S5	10/6	AC/HL/	10/6	EAF42	10/6	EL42	11/6	LN152	14/-	U061	VT61A	5/6
5Y3G	8/-	6F33	7/6	7H7	8/-	25S5G	10/6	DDD	15/-	EB34	2/6	EL81	15/-	LZ319	9/-	TP22	VT501	5/6
5Y3GT	8/6	6G6	6/6	7S7	10/6	25Z5	10/6	AC/VP1	15/-	EB41	8/6	EL84	10/6	MH4	7/-	U16	W76	7/6
5Y4	12/6	6H6GTG	3/-	7V7	8/6	25Z4G	10/6	AL/60	10/6	EB91	6/6	EL91	5/-	MHLD6	12/6	U18/20	WB8M	6/-
5Z3	12/6	6H6M	3/6	7Y4	8/-	25Z6G	10/6	AP4	7/6	EB34	7/6	EM34	10/6	ML4	12/6	U22	X61	12/6
5Z4G	10/6	6J5G	5/-	8D2	3/6	28D7	7/-	AP4	7/6	EB81	10/6	EM80	10/6	ML6	6/6	U31	X63	10/6
5Z4GT	12/6	6J5GTG	5/6	8D3	7/6	30	7/6	ATP4	5/-	EBF80	10/6	EM81	10/6	MU14	10/6	U43	X65	12/6
6A8	10/-	6J5GTM	6/-	9D2	4/-	30C1	9/-	AZ31	10/6	EBF89	9/6	EN31	34/9	OA10	12/6	U45	X66	12/6
6A87	8/-	6J6	5/6	10C1	15/6	30F5	8/-	BL63	7/6	EC52	5/6	EY51		OA70	5/6	U50	XD(1.5)	6/6
6A88	14/-	6J7G	6/-	10F1	19/6	30FL1	10/6	CK506	6/6	EC54	6/-	(Small)	10/6	OA71	5/6	U52	XFY12	6/6
6AC7	6/6	6J7GT	10/6	10F9	11/6	30L1	9/-	CK523	6/6	EC70	12/6	EY51		OC72	30/-	U76	XH(1.5)	6/6
6AG5	6/6	6K6GT	8/-	10F18	12/6	30P12	12/6	CV63	12/6	ECC31	15/-	(Large)	12/6	P61	3/6	U78	XSG(1.5)	6/6
6AJ8	9/-	6K7G	5/-	10LD3	8/6	30P16	10/6	CV85	10/6	ECC32	10/6	EY86	14/6	P215	10/6	U78		15/6
6AK5	8/-	6K7GT	6/-	10LD11	16/9	30PL1	12/6	CV271	10/6	ECC33	8/6	EZ35	6/6	PABC80	15/-	U251	Y63	7/6
6AK8	9/-	6K8G	8/-	10P13	17/6	31	7/6	CV428	30/-	ECC35	8/6	EZ40	8/6	PCC84	9/6	U404	Z63	10/6
6AL5	6/6	6K8GT/G	11/6	12A6	6/6	33A/158M	D1		3/-	ECC81	8/6	EZ41	10/-	PCC85	12/6	UABC80	Z66	20/-
6AM5	5/6	6L6GT	11/-	12A6	6/6	30/-	D42		10/6	ECC82	9/6	EZ80	9/6	PCF80	9/6		Z77	7/6
6AM6	7/6					35/51	D63		12/6	ECC83	9/6	EZ81	9/-	PCF82	12/6	UAF42	Z719	8/-
6AQ5	8/6	6L6G	9/6	12AH7	8/-					ECC84	10/-						Z729	17/6

**VOLUME CONTROLS**

All with long spindle and double-pole switch.

10K. 25K. 50K. 100K.  
 1 meg. 2 meg. 4 meg. 8 meg.

4/6 each.

**ELECTROLYTIC CONDENSERS**

Standard Can.		Wire-ended Tubular	
32 x 32 mfd., 450 V.	5/9	8 mfd., 450 V.	1/9
64 x 120 mfd., 350 V.	8/3	16 mfd., 450 V.	2/9
60 x 250 mfd., 275 V.	9/6	32 mfd., 450 V.	3/9
100 x 400 mfd., 275 V.	12/6	8 x 8 mfd., 450 V.	3/-
100 mfd., 275 V. 2/6		16 x 16 mfd., 450 V.	3/9
200 mfd., 275 V. 3/6		32 x 32 mfd., 350 V.	4/-
100 x 200 mfd., 275 V.	6/6	8 x 16 mfd., 450 V.	4/-

**NEW METAL RECTIFIERS, FULLY GUARANTEED**

DRM1B	15/4	RM-2	7/6	W6	3/6	14A97	25/-	14B261	11/6	16R2 2-1-8-1	8/6
DRM2B	16/2	RM-3	9/6	WX3	3/6	14A100	27/-	14RA 1-2-8-2	19/-	18RA 1-1-8-1	4/6
DRM3B	23/3	RM-4	18/-	WX4	3/6	14A124	28/-	14RA 1-2-8-3	23/6	18RA 1-1-16-1	6/6
RM-O	7/11	RM-5	24/-	WX6	3/6	14A163	38/-	16RC 1-1-16-1	8/6	18RA 1-2-8-1	11/-
RM-I	7/-	W4	3/6	14A86	18/-	14B130	35/-	16RD 2-2-8-1	12/-	18RD 2-2-8-1	15/-

Hivac miniature valve list or Metal rectifier technical leaflet free on receipt of S.A.E.

TERMS OF BUSINESS:—CASH WITH ORDER OR C.O.D. ONLY. POST/PACKING CHARGES 6d. PER ITEM; ORDERS VALUE £3 OR MORE POST FREE. C.O.D. 2/6 EXTRA. WE ARE OPEN FOR PERSONAL SHOPPERS MON.-FRI. 8.30-5.30. SATS. 8.30-1 P.M.

ALL VALVES NEW, BOXED AND SUBJECT TO MAKERS' FULL PERIOD GUARANTEE. FIRST GRADE GOODS ONLY. NO SECONDS OR REJECTS. LATEST CATALOGUE OF OVER 1,000 DIFFERENT VALVES, INCLUDING MANY SCARCE TYPES, WITH FULL TERMS OF BUSINESS, PRICE 3d., PLUS 2d. POST.

PLEASE ENQUIRE FOR ANY VALVE NOT LISTED. 3d. STAMP, PLEASE.

# PREMIER RADIO COMPANY

Tel.: AMBassador 4033

B. H. MORRIS & CO. (RADIO) LTD.

Tel.: MUS. 3451

207 EDGWARE RD., LONDON, W.2 & 23 TOTTENHAM COURT RD., LONDON, W.1



The "Petite"  
**PORTABLE**

MAY BE BUILT FOR  
**£7.7.0**

Plus p. & p. 3'.

Batteries Extra. H.T. 10' (Type B126 or equiv.) ; L.T. 996, 3'6 (Type AD35) or equivalent.

- ★ Size only 8in. x 8in. x 4in.
- ★ Instruction Book 1'6.

**PREMIER BATTERY ELIMINATOR**, housed in two containers which are approx. the same size as AD35 and B126 Batteries. Kit 37'6 plus 2' p. & p.

These two receivers use the latest type circuitry and are fitted into attractive cabinets 12in. x 6in. x 5in. in either walnut or ivory bakelite or wood (1/- extra). Individual instruction books 1/- each, post free.

**2 BAND T. R. F**  
MAY BE BUILT FOR **£5.10.0**

Plus 3' p. & p.



**3 BAND SUPERHET**  
MAY BE BUILT FOR **£7.7.0**

Plus 3' p. & p.



The "Petite"  
**PORTABLE & REPRODUCER**

MAY BE BUILT FOR **13GNS** plus 5/- p. p.

Batteries Extra. H.T. 10' (Type B126 or equiv.) ; L.T. 996, 3'6. 45 r.p.m. Single Record Player ... £5. 5.0 (including P.T.)

"Petite" Components £5.18.0 Cabinet ... £2.10.0

- ★ Size 10in. x 9in. x 6in.
- ★ Weight, including Batteries, 7 lb.
- ★ 45 r.p.m. Single Record Player complete with pickup.
- ★ 6 volt Battery operated.
- ★ Incorporates Pick-up Head protection dome and automatic stylus cleaning brush. Overall size 7in. x 6in. only.
- ★ Made by well-known British manufacturer.
- ★ Automatic Stop/Start.
- ★ Complete<sup>ly</sup> Battery operated

- ★ Attractive two-tone rexine covered case.
- ★ Construction simplicity itself.
- ★ Components available separately if required.
- ★ Instruction Book, 1'6.

ADDRESS ALL MAIL ORDER ENQUIRIES TO : (Dept. P.W.) 207 EDGWARE RD., LONDON, W.2

## REVAQUUMED T.V. TUBES

SIX MONTHS' STRAIGHT GUARANTEE

### Mullard

in.		£	s.	d.
14	MW 36-22	5	10	0
14	MW 36-24	5	10	0
14	MW 36-44	5	10	0
14	AW 36-21	5	10	0
16	MW 41-1	7	0	0
17	MW 43-43	7	10	0
17	MW 43-64	7	10	0
17	MW 43-69	7	10	0
21	MW 53-20	10	10	0
21	MW 53-80	10	10	0

### Mazda

in.		£	s.	d.
14	CRM 141	5	10	0
14	CRM 142	5	10	0
14	CRM 143	5	10	0
15	CRM 153	6	10	0
17	CRM 171	7	10	0
17	CRM 172	7	10	0
21	CRM 211	10	10	0
21	CRM 212	10	10	0

### Brimar

14	C14BM	5	10	0
14	C14FM	5	10	0
17	C17BM	7	10	0
17	C17FM	7	10	0
17	C17JM	7	10	0

### Cossor

14	I4IK	5	10	0
17	I7IK	7	10	0
17	I72K	7	10	0

14 in. Marconi, Emitron, Ferranti, G.E.C. **£5 10 0.**  
17 in. Marconi, Emitron, Ferranti, G.E.C. **£7 10 0.**

Carriage and Insurance 12/6 (U.K.). Cash with order. Personal Callers Welcome.

## VIDIO REPLACEMENT CO.

HALES ST., DEPTFORD HIGH ST., LONDON, S.E.8

Telephone : TIDEWAY 4506

## MAKE SOUND JOINTS SIMPLY BY USING Multicore

### ERSIN MULTICORE

Contains 5 cores of extra-active, non-corrosive Ersin Flux. Prevents oxidation and cleans surface oxides.

SIZE 1 CARTON

5/-

HANDYMAN'S CARTON

Suitable for 200 average joints. 6d.



HOME CONSTRUCTORS 2/6 PACK

In addition to the well-known Home Constructors Pack (containing 19ft. of 18 s.w.g. 60/40 alloy) a similar pack is now available containing 40ft. of 22 s.w.g. 60/40 alloy especially suitable for printed circuits.



Wherever precision soldering is essential, manufacturers, engineers and handymen rely on MULTICORE. There's a MULTICORE SOLDER just made for the job you have in hand. Here are some of them.

### SAVBIT TYPE 1 ALLOY

A specially formulated alloy to reduce the wear of soldering iron bits. Contains 5 cores of non-corrosive Ersin Flux and is ideal for all soldering purposes.

SIZE 1 CARTON 5/-

Available in three specifications.



### BIB WIRE STRIPPER AND CUTTER

Strips insulation without nicking wire, cuts wire cleanly, splits extruded flex 3/16 each



## MULTICORE SOLDERS LTD.,

MULTICORE WORKS, HEMEL HEMPSTEAD, HERTS. (BOXMOOR 3636)

**Unrepeatable Bargains**

**Metal Rectifier.** Equivalent of RM5-250 mA., 250 v., 12/6.  
**Welding Transformer.** 12v.-50 amp., continuous rating—intermittent rating for spot welding—exceeds 2,000 amps. 45" carriage and packing 5/-.  
**6ft. Unbreakable Mains Lead.** Type of lead fitted to electric razors, makes fine lead for test meters and any other devices where subject to continuous bending. Twin figure eight construction, soft cream P.V.C. covered. Normally costs 2/- per yard—we offer three leads for 2/-, 1 mFfd 350. 1 Small tubular metal cased condensers made by Duublier. 2/6 doz.  
**Connecting Wire P.V.C. Covering.** All colours. Sale price 2/6 per 100 ft. coil or 5 coils different colours. 10/- the lot.  
**50 Assorted Resistors.** Well mixed and useful values; and 1 watt, 5/- for 50.  
 Ditto, but 1 watt, 6/6 for 50.  
**Mains Transformer.** Standard 230 v., input 250-0-250 at 80 mA., 6.3 v. at 5 A. 12/6.  
**Toggle Switch.** Standard metal body, type with round dolly, fixing ring and on/off indicating plate. 1/3 or 12/- doz.  
**Metal Rectifier.** 250 v., 60-30 milliamps. Ideal for mains set or instrument or to replace that expensive valve. 4/6.  
**Screened Cable.** Rubber covered flexible with metal braiding, ideal for microphone or gramophone extensions. 4d. per yd., 30/- per 100 yds.  
**Install 2-way Switches.** Our outfit comprise 2-way multicore cable, two 2-way switches, two wood blocks. Full instructions. 9/6 each, post and insurance 2/6.  
**Long, Medium and Short Wave Coil Pack.** An exceptionally well made coil pack which covers the standard long, medium and short wave bands for 465 Kc. I.F. complete with diagram of connections. 14/6 plus 1/6 postage and insurance—limited quantity only.  
**Neon Lamp, midge wire ended.** Ideal for making mains tester or for any of the dozens of other applications to which a neon can be put. 2/-.  
**Instrument Transformer.** Input 200-230 v., output 6.3 v. at 3/4 amps., and two separate 85 v. 10 milliamp windings which can be joined in series or parallel, 8/6, plus 1/6 post & packing.  
**3in. Midget Wire Coat** flush mounting, really beautifully made by G.E.C. Two types available 500-0-500 microamp and 1 milliamp i.s.d. 37/6, plus 2/- p. & l.  
**Winking Eye, telephone or circuit indicator.** 5/-.  
**Cathode Ray Tube VCR517.** 7/6, carriage, etc. 3/6.  
**Install These Extra Power Point—** 3 core cable 7.029 (15 Amps) 500 v. grade—a big purchase enables us to sell this at 37/6 per coil (50 yds.) carriage 7/6.  
**Auto Transformer.** Totally enclosed, primary 200-250 v., secondary 110-120 rated 200-250, 27/6, carriage and insurance 2/6.  
**Dimmer or Regulator.** Total resistance 1,000 ohms. Maximum current of .59 amps. This is a beautiful unit which uses a 32 position stud switch, resistance is divided into 31 sections each approx. 30 ohms. In ventilated metal case, size approx. 7in. x 7in. x 5 1/2in. with wall mounting brackets and large control knob. 15/- plus 2/6 post & insurance.  
**E.H.T. Transformers.** Standard mains input, three secondaries, one gives 1,540 v. at 20 mA., another gives 2 v. at 2 amps, the third 4 v. at 1 amp. This is a heavy duty potted transformer in a cast case but where extreme ruggedness is not required it can be taken out of its case. Price 20/-, carriage 3/6.

**PULLIN SERIES 100 TEST SET**

Undoubtedly a most useful instrument by a firm long famous for fine instruments, entirely redesigned, it has a square movement with diacron plastic cover, this makes for a brighter more readable scale—extra scale length and wider angle of vision. With the test set is included a pair of combined test prods and crocodile clips also a stand for inclining the meter at the best reading positions. Ranges A.C. Volts - 0-10, 0-25, 0-100, 0-250, 0-500, 0-1,000, ditto D.C. A.C. Current 0-100 mA., D.C. Current 0-2.5, 0-10, 0-100, 0-500 mA. Resistance - 0-1M and 0-10K. All at 10,000 ohms per volt—Price £12.7.6, or £1 deposit and 24 weekly payments of 10/-, non callers add 5/- carr. & ins. F.R.E. & F.F.I.—All purchasers of the above item this month will receive Range Extender scale and data which add capacity 2pF.-1 mFfd., in two ranges, Inductance 0-100 henrys, etc. etc.



**THE INDUCTOR 80**

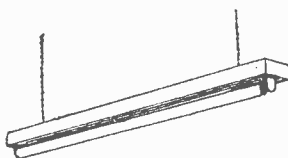

80 w 5ft. fluorescent fitting with a 5 year guarantee—latest type (choke) control gear—absolutely quiet in operation—all steel batten type construction stove enamelled white—suitable for direct mounting or for suspending. Will last a lifetime. Type A, price 39/6. Type B. Variable for 200-250 v., price 45/-, carriage and insurance up to 150 miles 5/6; up to 250 miles 7/6. Tubes, latest type which give more light for same electricity, daylight or natural to your choice. 14/6 each—no extra carriage if ordered with fitting.

**SUPER SENSITIVE (2,000 O.P.V.) MULTIMETER KIT**

17 ranges including D.C. volts to 1,000 v., A.C. volts to 1,000 v., D.C. milliamps to 500, ohms to 2 meg., capacity and inductance. All the essential parts, including metal case, selected resistors, wire for shunts, selected switches, calibrated scale and instructions. 32/6, plus 2/6 post and ins.

**FOUR ITEMS FOR PRICE OF ONE**

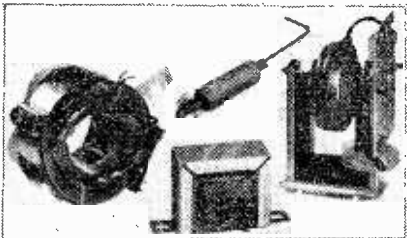

This set of modern T.V. parts is equally suitable for modernising an old television or for building into a new one. Suitable for wide angle 14in. or 17in. tubes using E.H.T. or 12-14 kV. The four items comprise: (1) Line output E.H.T. transformer. (2) 70° scanning coils on ferrite yokes. (3) Width control with ferrite core. (4) Frame output transformer. With these parts we also give free, complete circuit diagram of a modern television which uses them. We offer the whole lot at the price of the Line output transformer only, namely, 57/6, plus 2/6 post and insurance.

**BEGINNER'S SUPERHET**

All the components including metal chassis, valves, metal rectifier, coils, tuning condenser, etc. etc. required to build the "Beginner's Superhet" as described in the January issue, are available as a parcel. Price £3 plus 3/- post and insurance.



**14in. T.V. CABINET**

14in. T.V. cabinet of latest styling made for one of our most famous firms—beautifully veneered and limited quantity—15/- each. Carriage and packing 3/6 extra.

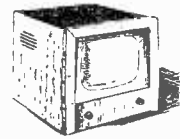

**Avo Prodclips**

The advantage of these test prods is that by pressing the trigger at the side they become crocodile clips and can be left in circuit. This is a great time saver, when servicing. Price 15/- pair.



**Novelty Radio**

Completely wired tunable medium and long wave, originally intended for BTG valves and external batteries but could easily be converted for transistors with internal batteries. Less valves and speaker, otherwise complete 15/- plus 1/6 postage.



**Miniature Microphone**

American made. Dynamic type, real bargain at 1/6.



**Simplex Transistor Kit.**

Makes ideal bedroom radio, uses one transistor and one crystal diode. Complete less case 19/6, case 5/- extra, post 1/6.



**TV Masks**

Latest type grey crystallate. 14in 10/- 17in, 12/- Plus 1/- post.

**ELECTRONIC PRECISION EQUIPMENT LTD.**

66, GROVE ROAD, EASTBOURNE, SUSSEX.

This is the correct address for post orders and for prompt attention please mark your envelope Dept. 5., also enough for postage.

**Band III Converter**

Suitable Wales, London, Midlands, North, Scotland, etc. All the parts including 2 EF80 valves, coils



tuner, contrast control, condenser and resistors. (Metal case available as an extra.) Price only 19/6, plus 2/6 post and insurance. Data free with parts or available separately, 1/6.

**All-Mains Amplifier**

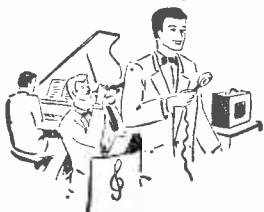

Powerful three-valves mains amplifier ideal for dances, parties, etc. Complete less chassis, cabinet and speaker (available if required)—data 1/6 (free with parts). Price 19/6, plus 2/6 post and insurance.

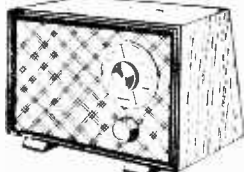

**The Skysearcher**

This is a 2-valve plus-metal receiver set useful as an educational set for beginners, also makes a fine second set for the bedroom, workshop, etc. All parts, less cabinet, chassis and speaker, 19/6. Post and ins., 2/6. Data free with parts or available separately, 1/6. 3-valve battery version also available at the same price.

**A.C./D.C. Multimeter Kit**



Ranges: D.C. volts 0-5, 0-50, 0-100, 0-500, 0-1,000. A.C. volts 0-5, 0-50, 0-100, 0-500, 0-1,000. D.C. milliamps 0-5, 0-100, 0-500. Ohms 0-50,000 with internal batteries, 0-500,000 with external batteries. Measures A.C./D.C. volts, D.C. current and

ohms. All the essential parts including metal case, 2in. moving coil motor, selected resistors, wire for shunts, range selector, switches, calibrated scale and full instructions, price 19/6, plus 2/6 post and insurance.

**50 More T.V. Service Sheets**

Readers already possessing our service sheets numbers 1-103 will be glad to know that 104-150 are now ready, price 10/-, post free.

For convenience of callers all items advertised may be obtained by the following companies:

<b>Electronics (Ruislip) Ltd.</b> 42-48, Windmill Hill, Ruislip, Middx. Phone: RUISLIP 5780. Half day, Wednesday.	<b>Electronics (Croydon) Ltd.</b> 268, London Road, Croydon. Phone: CRO 6558 Half day, Wednesday.	<b>Electronics (Finsbury Park) Ltd.</b> 28, Stroud Green Rd., Finsbury Park, N.4. Phone: ARCHway 1049 Half day, Thursday.
---	---	---

**BUILD THIS 17" TV FOR 22 GUINEAS**

This is a very modern circuit and when you have completed it it will be equal to any factory made model. Note these special features:

- Miniature valves and metal rectifier.
- 12 channel turret tuner.
- Ferrox E.H.T. and scan coils.
- A.C.C. and A.V.C.

Supplied in component form with all metal work prepared and supplied with pictorial layout and theoretical wiring diagram (these are available separately, price 3/6). Total cost is only £23.2.0.

**This Month's Snip**

Stereo Amplifier outfit comprising 8-watt twin channel amplifier for A.C. mains working and two 8in. P.M. speakers on veneered and polished corner baffles. Whole outfit giving really terrific reproduction and amazing 3-D effects—£14 complete, plus carriage and insurance. Or £1 down and 28 weekly payments of 10/-.

**Now 2 Models Turret Tuner**

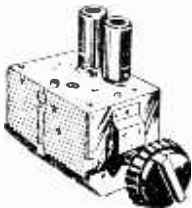

Brand new stock not surplus, with coils for Band I and III complete with valves. Model 1 I.F. output 33/33 Mc/s. Series heaters Model 2 I.F. output 16.19 Mc/s. Parallel heaters. With instructions and circuit diagram, 79/6. With knobs 3/6 extra, post and insurance 2/6.

**Medresco Hearing Aid**

As supplied by National Health, completely overhauled and in good working order with six months' guarantee. Only £2.15.0 plus 2/6 post and ins. Complete with earphone and *new* ear plug but not batteries, these can be supplied as an extra for 5/- per set.



Special Offer.—Latest luxury model, smaller and with self-contained batteries new and unused—normally 20 gns., limited quantity, only £10 each or 20/- deposit and 20 weekly payments of 10/-. Willingly sent on approval against cash.

**Short Wave Communications Receiver R.208. Only £6.19.6. 10/- Deposit**

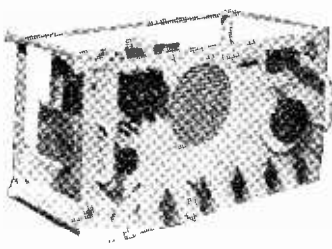

This is a super short-wave receiver covering 5-30 metres (10-60 Mc/s). Uses 6 valves. Has R.F. stage, 2 I.F. stages, B.F.O. etc. Muirhead instrument drive, two internal power packs, mains and battery vibrator pack. Complete with own P.M. speaker. Provision for phones and speaker muting. Complete in metal transit case, size approx. 24 x 16 x 12in.; weight 70lb. Suitable A.C. mains 100-250 and 6 volt battery. In perfect condition, practically unused. Tested before despatch and guaranteed. Handbook free with each. Price £6.19.6, carriage and insurance 15/-, Or 10/- deposit plus 15/- carriage and ins., then 15 weekly payments of 10/- each.

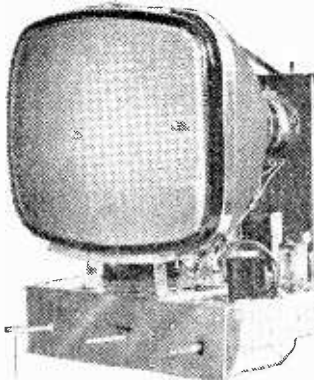

**FLUORESCENT LIGHTS**

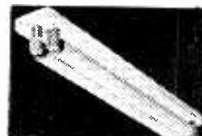

These are complete fluorescent lighting fittings. Built-in ballast and starters—stove enamelled white and ready to work. Ideal for the kitchen, over the work-bench and in similar locations.

Single 40, 4 ft. 3 in. long, uses a 40 watt tube.  
Twin 20. Uses 2 20-watt standard tubes.  
Price for either type 39/6, with tubes. Carriage and ins. up to 150 miles 5/6, up to 250 miles 7/6.

**Tube Tester and Re-Activator**



We can supply all the main components for making this unit which will not only test Cathode Ray Tubes but also will re-activate them, supplied complete with full instructions. Price £3, plus 2/6 post and ins.

**Unused and Boxed Valves**

OZ4	9/-	6F5	9/6	7B5	12/6
1A4	9/-	6P6	7/6	7C7	12/6
1A6	9/-	6P7	12/6	7D5	5/6
1F7	12/6	6P8	9/6	7D3	9/6
1L8	8/6	6F32	10/6	7H7	8/-
1LA6	8/6	6G6	7/6	7K8	12/6
1N56	3/6	6H6	2/6	7R7	10/-
1L5	9/6	6J5	5/6	7S7	10/-
1T4	7/6	6J7	8/-	12H6	8/6
1R5	7/6	6K6	7/-	12SH7	8/6
1S5	7/6	6K7	5/-	12SJ7	8/6
1T5	8/-	6L5	9/-	12SK7	8/6
2A5	12/6	6L6	9/-	2B5	12/6
2A6	12/6	6L7	10/7	2E7	10/-
2A7	12/6	6N7	8/6	27	10/-
2D13C	5/-	6R7	9/-	28D7	3/6
2X2	4/6	8S7	9/-	31	7/6
3A4	7/-	8SA7	8/-	32	7/6
3D6	5/-	8SG7	8/-	34	12/6
3Q4	7/6	8SH7	8/-	39, 44	10/-
4D1	2/6	6SJ7	8/6	41	9/6
5U4	8/-	6SK7	6/-	42	8/-
5Z3	12/6	6SL7	8/-	43	10/-
5Z4	9/6	6SN7	7/6	57	10/-
6A6	12/6	6SQ7	8/-	58	10/-
6AG5	6/6	6SST	9/-	71	9/6
6AC7	6/6	6T7	12/6	75	12/6
6A8	10/-	6TH8	12/-	77	8/-
6B4	5/-	6U5	8/6	83	12/6
6B7	10/-	6V6	8/6	84	8/6
6B8	4/-	6X5	7/6	807	8/6
6BQ6	12/6	6Y6	6/-	954	3/6
6C4	6/6	6Z5	15/-	1625	10/6
6C8	5/-	7A2	12/6	805	8/6
6D6	6/6	7A7	8/6	913	9/6

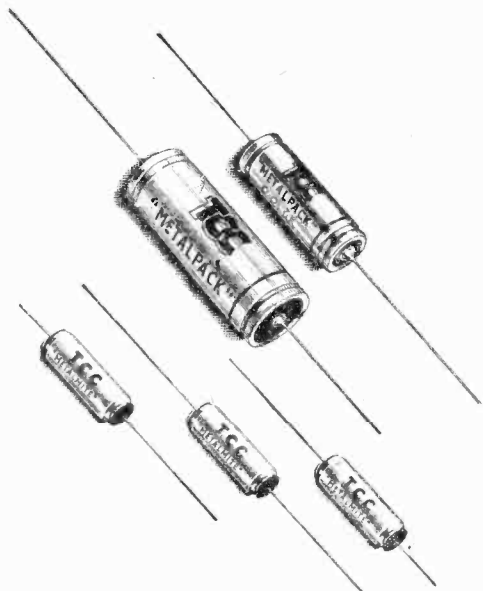

# CONDENSERS

Here are two ranges representative of the wide variety of T.C.C. condensers available, for all possible electronic applications. Details on request.

### 'METALPACK'

These paper condensers have been developed for operation in high humidities and high temperatures. Their ability to withstand variations from  $-40^{\circ}\text{C}.$  to  $-100^{\circ}\text{C}.$  makes them the obvious choice for the most stringent conditions.

### 'METALMITE'

Set a new standard both for compactness and ability to withstand extreme tropical conditions: satisfactory insulation resistance is maintained after extensive tests at  $100^{\circ}\text{C}.$  and 100% humidity.

CONDENSER SPECIALISTS SINCE 1906

## THE TELEGRAPH CONDENSER CO. LTD.

RADIO DIVISION North Acton · London W3 · Telephone: ACORN 0061

# How's this!

## YOUR VERY OWN TEST SET NOW

It's as simple as this. You just send 47 6 deposit to have one of the newly stylised M.I.P. Multi-Range Series 100 Test Sets posted to you almost by return of post. Balance is payable over 6 months at £1.16.0 per month. Cash price is £12.7.6. Post coupon now for full details.

There is also the **SERIES 90 MULTI-RANGE TEST SET**, having 19 SELF-CONTAINED ranges, a.c./d.c. volts up to 1,000 V., d.c. current up to 500 mA., a/c current up to 200 mA, resistance 0-200,000  $\Omega$ . All voltage measurements a.c. and d.c. are at 5,000 ohms per volt.

Deposit 35/- and six monthly payments of 28/10.  
Cash price £9.15.0.

GD22

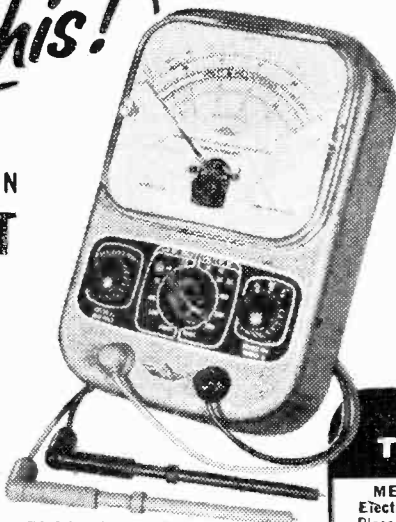

### 21 RANGES

covering

- 10-1,000 d.c. volts
- 10-1,000 a.c. volts
- 100 Microamps to 500 Milliamps d.c.
- 100 Microamps a.c.
- 0 to 1 Megohm
- 0 to 10,000 ohms

All voltage measurements a.c. and d.c. are at 10,000 ohms per volt.



## MULTI-RANGE TEST SET-SERIES 100

MEASURING INSTRUMENTS (PULLIN) LTD.  
Electrin Works, Winchesler St., Acton, London, W.3.  
Please send illustrated leaflet of the Series 100 Test Set with details of new easy payments scheme .....

Ditto Series 90.....  
\*Please indicate instrument required.

NAME .....

ADDRESS .....

D1158





# Practical Television



## & TELEVISION TIMES

Editor : F. J. CAMM

Vol. 9 No. 100

EVERY MONTH

NOVEMBER, 1958

### TELEVIEWS

#### RADIO INTERFERENCE REGULATIONS

**T**HE Postmaster-General has accepted the recommendations of the committee set up to advise him on the problem of electrical interference with radio and TV. Regulations designed to reduce the effects of interference are now being prepared. The recommendations of the committee are that the regulations should cover the manufacture and use of new electro-medical equipment and the use of existing apparatus on the site. Regulations dealing with new equipment should come into force one year after being laid before Parliament, and those dealing with existing equipment in three years. The committee has also recommended in principle that there should be regulations on the manufacture and use of industrial radio frequency apparatus, although it has made no final recommendations until further study.

#### THE "P.T." AND "P.W." CAXTON HALL FILM SHOW

**T**HE film show which we are organising in conjunction with Mullard Ltd. takes place at the Caxton Hall, Westminster, at 7.30 p.m. on January 22nd, 1959, when I shall take the chair. Applications for tickets, which are free, should be made at once, as accommodation is limited to 500 seats. Members of the I.P.R.E. should apply to their secretaries direct for tickets, as they will be our guests on this occasion. The films are, of course, entirely different from those shown last year. This year they will deal with the principles of the transistor, the manufacture of junction transistors, and "The Conquest of the Atom," which will be in Eastman Colour. There will be an interval for refreshments, which also are free. Mark envelopes containing applications for tickets, Caxton Hall, in the top left-hand corner.

#### NOISY SWITCHES AND TUNERS

**S**ERVICE engineers are well aware of the complaint that some TV switches and turret tuners are noisy and that the usual cleaner fluids do not provide a permanent remedy. One of the largest tuner unit manufacturers states that only M.S.4 silicone grease should be used on tuner units. It is recommended for use on all wave-change and tuner unit contacts. The wiping action associated with most switches causes the fine film of grease to be removed from the point of contact. M.S.4 grease repels moisture, and does not harden or melt with changes of temperature.

#### WIDESCAN

**E**LSEWHERE in this issue, we discuss the BBC experiments with the aspect ratio of viewing screens. It is a portent of what we may expect in, say, 10 years time, if direct viewing is still in existence! The suggested alteration from 4 : 3 to 7 : 4 is an undoubted improvement.—F. J. C.

*Our next issue, dated December, will be published on November 21st*

Editorial and Advertisement Offices :

PRACTICAL TELEVISION

George Newnes, Ltd., Tower House,  
Southampton Street, Strand, W.C.2.

© George Newnes Ltd., 1958.

Phone : Temple Bar 4363.

Telegrams : Newnes, Rand, London.

Registered at the G.P.O. for transmission  
by Canadian Magazine Post.

#### SUBSCRIPTION RATES

including postage for one year

Inland - - - 19s. per annum  
Abroad - - 17s. 6d. per annum  
Canada - - - 16s. per annum

#### CONTENTS :

	Page
Televiews .....	171
A Sound Only Pocket TV .....	172
Television Troubles.....	174
A Home Constructed TV .....	176
Line Timebase Faults .....	178
Interference with Reception	181
Telenews .....	184
Servicing TV Receivers .....	186
Improving Television Sound	190
Big Screen TV .....	192
Vision and Electronic	
Recording Apparatus .....	196
Television in the South .....	197
Widescan Television .....	199
BBC Television Translator.....	200
Silver Jubilee Radio Show .....	203
Underneath the Dipole .....	207
Correspondence .....	211
Your Problems Solved .....	212

The Editor will be pleased to consider articles of a practical nature suitable for publication in "Practical Television."

Such articles should be written on one side of the paper only, and should contain the name and address of the sender. Whilst the Editor does not hold himself responsible for manuscripts, every effort will be made to return them if a stamped and addressed envelope is enclosed. All correspondence intended for the Editor should be addressed to: The Editor, "Practical Television," George Newnes, Ltd., Tower House, Southampton Street, Strand, W.C.2.

Owing to the rapid progress in the design of radio and television apparatus and to our efforts to keep our readers in touch with the latest developments, we give no warranty that apparatus described in our columns is not the subject of letters patent.

Copyright in all drawings, photographs and articles published in "Practical Television" is specifically reserved throughout the countries signatory to the Berne Convention and the U.S.A. Reproductions or imitations of any of these are therefore expressly forbidden.

# A Sound only Pocket T.V. Receiver

## BUILDING A TRANSISTORISED AUDIO SECTION

IT is likely to be some time yet before fully transistorised television receivers appear on the market, although several have already been built by the large firms. The reason for this is, of course, the very high cost of the transistors themselves: as soon as these prices drop to those of valves, fully transistorised battery-operated TV portables will become commonplace. In the meantime, however, there is no reason why the home constructor should not build himself a transistorised audio section at very reasonable cost, and that is what is described here. The prototype cost only £2 to build and all

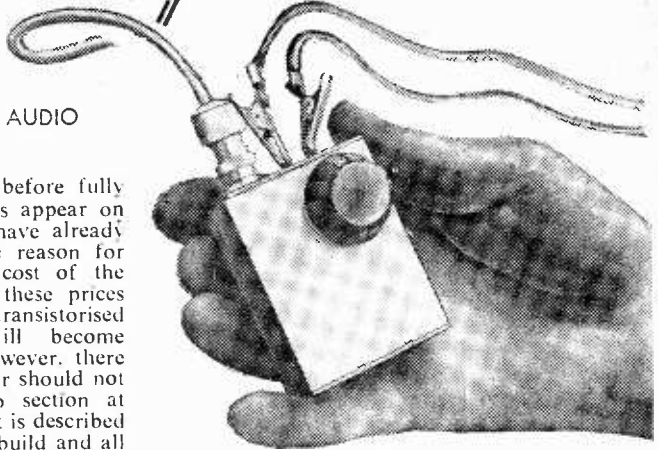
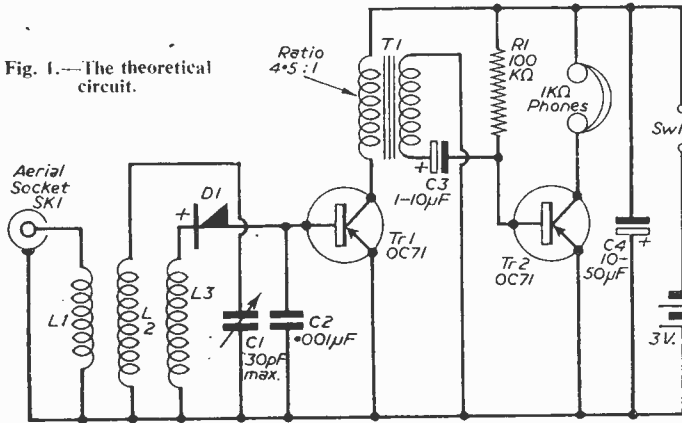

Fig. 1.—The theoretical circuit.



type. As the sensitivity of the set depends upon this diode, it is preferable to use a good quality make, such as the Mullard OA70, although surplus crystals were found to operate quite successfully in the prototype. Any residual R.F. component is now removed by C2 which offers a high impedance to the A.F. signal. At first sight it might appear that the condenser would seriously reduce the A.F. strength, but it must be remembered that the input impedance of the transistor is extremely low when compared with a valve. Thus the loss is negligible.

the parts are very easily obtainable.

### The Circuit

The theoretical circuit diagram is shown in Fig. 1. The aerial is fed to L1, which is the primary winding of an ordinary television aerial coil. A signal is then induced in L2-C1, which forms the tuned circuit of the receiver. When tuned correctly, the circuit rejects only the required signal and this is fed to L3 which consists of one-third the number of turns of the tuning coil, and is tightly coupled to it. The purpose of this R.F. transformation is to match the signal into the relatively low impedance detector. The detection is performed by a germanium diode of the video

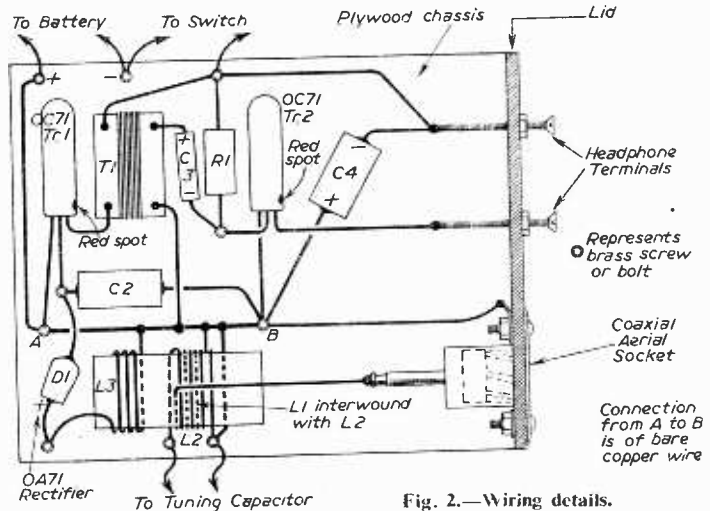

Fig. 2.—Wiring details.

Tr1 is a common emitter amplifier, and should give a gain of about 30 db. The common emitter configuration is used as this gives both current and voltage gain and has the highest overall power increase of the three different systems.

**The Output Stage**

In order to provide optimum matching between the driver and output stages, and at the same

slightly reduced volume. A wiring diagram is given in Fig. 2.

**The Case**

The case is made from 1/16in. three-plywood and measures 2½in. X 1in. X 2in. It consists of a small box with a closely fitting lid to which are attached a plywood chassis and the input and output terminals.

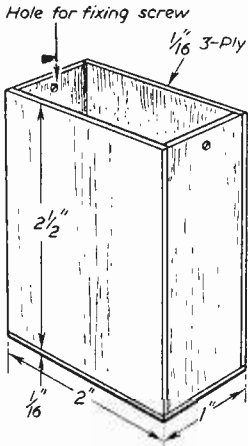

- COMPONENTS LIST**
- Tr1) OC71 or similar.
  - Tr2) OA71 or similar.
  - D1, OA71 or similar.
  - L1, L2, L3, see text.
  - SK1, flush-mounting coaxial socket.
  - C1, 30 pF maximum trimmer for tuning.
  - C2, 0.001 µF.
  - C3, 1-10 µF electrolytic (sub-miniature).
  - C4, 10-50 µF electrolytic (sub-miniature).
  - R1, 100 KΩ ¼ or ½ watt.
  - T1, 4-5 : 1 miniature interstage transformer.
  - SW, single-pole, one-way switch.
  - 1.5 v. or 3.0 v. battery.
  - Headphones (1 kΩ).

Fig. 3.—Structure of the box.

To make the box, five pieces of plywood are required: two 2in. X 2½in., two ¾in. X 2½in. and one 2in. X 1in. (Two pieces 2in. X 1in. may be cut; the second is used for the lid.) These five pieces of wood are glued together using unreinforced butt joints (Fig. 3). Almost any quick-setting glue is suitable except a latex type.

For the lid, five pieces of plywood are necessary—

one 2in. X 1in.; two ¾in. X 3/16in.; and two ¼in. X 1 23/32in. The construction of the lid is shown in Figs. 4 and 5. Small holes are drilled in the lid and in the box for fixing screws (Figs. 3 and 4). Other holes are drilled in the lid for the coaxial socket and its

time maximum gain, transformer coupling has been used. T1 is a miniature transistor interstage transformer and has a step-down ratio of 4.5 : 1. The coupling condenser C3 must have a value of 1 µF or more because of the low input impedance of Tr2. However, as the H.T. is so low a 3- or 6-volt subminiature type may be used with full satisfaction. R1 supplies the base bias to the output transistor and has a value of 100 kΩ. The output is directly coupled into a pair of high impedance headphones, 1,000 ohms

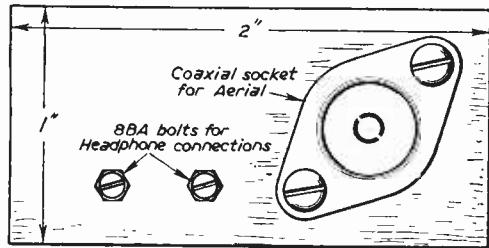

Fig. 5.—Plan view of the lid.

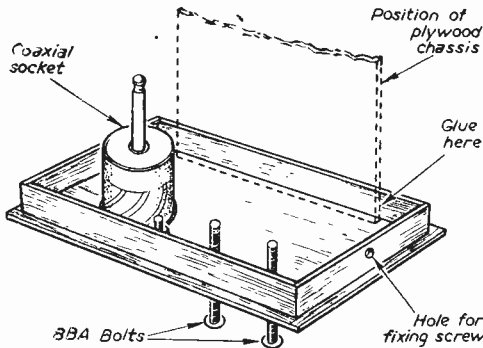

Fig. 4.—Underside of the lid.

fixing bolts and for the bolts-cum-headphone terminals (Figs. 4 and 5).

The box and lid are sanded smooth and painted with a grain filler, and then with a coloured cellulose paint of the constructor's choice.

**Operation**

As this receiver has only one tuned circuit no problems of alignment arise; furthermore, the circuit is inherently extremely stable and unless the leads from the input to the tuned circuit are unusually long no problems are likely to arise. If a sensitive power-output meter is connected across the output terminals, the receiver is very useful as an aerial alignment aid. It is, of course, possible to align an aerial by comparing signal strengths on headphones, but it is preferable to use a meter.

If standard broadcast band reception is wanted the coil and condenser may be replaced by ones for the required wavelength. Used on the medium waveband, the set is capable of loud-speaker strength signals with a fairly short aerial.

being the optimum value. Crystal types must not be used as these would prevent any H.T. current from reaching the transistor. The battery is made from two 1.5 v. slim penlight cells fixed side by side and wired in series to give 3 v. If a smaller receiver is required for some reason, then a single cell could well be used with only

# TELEVISION TROUBLES

## Their Symptoms and How They May be Cured—4

By G. J. King

**S**TILL dealing with the symptoms which are produced by faults in the timebase and sync circuits, this month consideration is given to further models in the popular range of Bush receivers.

### Bush TUG36: Distorted Raster

In common with certain other makes of receiver, the Bush range utilises the boosted H.T. voltage obtained from the line amplifier section to energise the tube first anode and the timebase oscillator circuits. The arrangement employed in the Bush TUG36 and TUG34A receivers is shown in Fig. 1(a), with component references as given in the makers' service manual. The boosted H.T. voltage will depend to a large degree upon the setting of the horizontal form control and whether or not the line timebase is synchronised. Under normal operating conditions, however, the boosted H.T. should be in the region of 400 volts, as shown on the diagram, relative to chassis.

All is well provided the filter capacitor C21 (8  $\mu$ F electrolytic) is in good order. Should it go open-circuit the curious symptom as depicted in Fig. 1 (b) is produced. The boosted H.T. drops below the normal 400 volts and the frame timebase is considerably influenced by the line flyback pulses. The height of the picture is affected mainly, though in some cases the width may also be reduced; the actual twisting and distortion of the raster varies as the brightness control is adjusted and as this effects the EHT loading.

The capacitor is of the wire-ended type and is situated beneath the main deck in the corner of the chassis near the volume control.

### Impaired Frame Linearity

There are a host of possible causes of this symptom, but if it is accompanied by a general fall-off in efficiency of the receiver as a whole, and it is found that the receiver takes longer than normal to warm up, attention should be directed towards the Brimistor in the heater chain.

This component is shunted by a 400-ohm resistor (R29), and should normally decrease in resistance with increase in temperature. Sometimes, however, a fault develops in the component and it remains at a relatively high resistance even when hot. When this happens the current in the series-connected heater chain is reduced accordingly and a smaller than normal voltage occurs across the heaters of the tube and valves. As the ECL80 valves are most sensitive to under-running of their heaters, circuits in which such valves are employed give the first sign of trouble, such as the frame timebase circuits.

When this trouble exists it is often noticed that the valves do not light up as bright as usual,

and a voltage test across the tube heater confirms that the voltage is, in fact, low. If the Brimistor goes almost completely open-circuit, the tube heater voltage may drop as low as 4 volts and R29 may exhibit signs of overheating.

It is interesting to note that frame non-linearity, which has no apparent cause, is often aggravated by the mains selector being adjusted a step above the applied mains voltage. This, again, causes under-running of the heaters, and if ECL80s are featured in the frame timebase circuits an effect similar to that above, though possibly less severe, is produced.

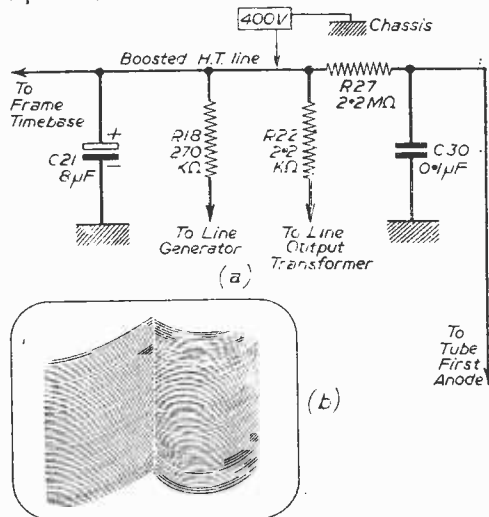

Fig. 1.—The boosted H.T. line circuit of the Bush TUG36 series at (a), and the distorted raster symptom produced owing to failure of the boost smoothing capacitor C21 at (b).

### Bush TV36C and TV45: Intermittent Line Tearing

This symptom is often caused by loose electrodes in the EF80 line oscillator valve. The valve is situated on the main chassis next to the PL81, pretty well in line with the "interlace" pre-set control on the back of the chassis. If the symptom is promoted by tapping the valve with the eraser end of a pencil, then the valve should be replaced. There are times when a valve which is unstable as line oscillator serves without trouble in another section of the receiver, in which case the trouble can be cleared simply by interchanging the two EF80s.

### Intermittent Picture Height

If the height drops intermittently to about 1½ in. and the resulting compressed picture has a ripple effect across it, the trouble is invariably caused

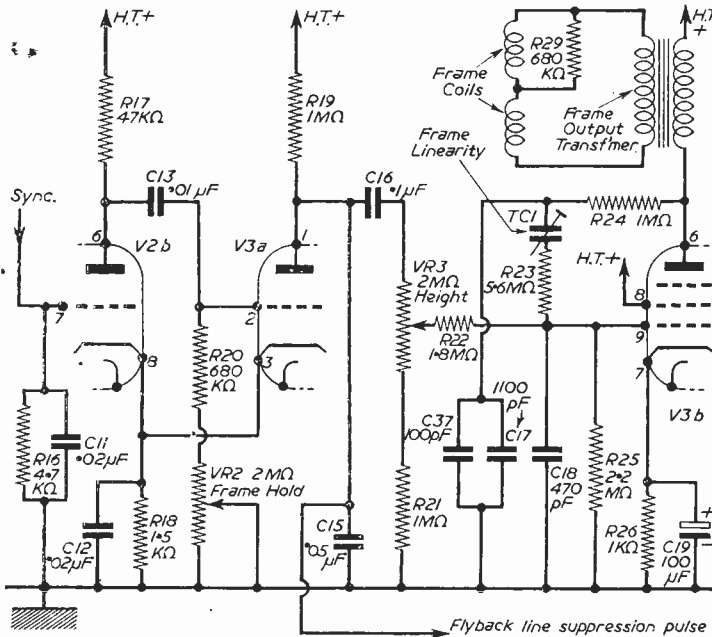

Fig. 2.—Circuit diagram of the frame timebase section of the Bush TV53 and TV56 series.

by open-circuit of the frame scanning coil. One section usually suffers, the circuit being completed through one of the 3.3 k resistors which shunt the coils. Before the scanning coils are eventually replaced, it sometimes pays to check the soldered connection on the coil unit relating to the frame section.

**Fluctuating Width**

If this symptom is accompanied by a disturbing alteration in focus, the trouble is almost certainly caused by an intermittent open-circuit in the 2 mF electrolytic capacitor across the cathode bias resistor of the PL81 valve. This component is designated C18 in the makers' circuit, but is not used in Model TV36C.

**Bush TV53 and TV56: Insufficient Height**

When the resulting raster cannot be synchronised in the frame and a spark occasionally jumps between pins 5 and 6 (heater and anode) of the PCL83 frame timebase valve, the rate of change of current in the primary of the frame output transformer is increased well above normal as the result of a timebase fault.

In Fig. 2 is given the frame timebase circuit, in which triodes V2b and V3a form a multi-triode stage and the pentode V3b serves as the output valve. V3 is the PCL83, while V2 is an ECC83, and the section not shown in the diagram (section V2a) is associated with the sync separator circuit.

Open-circuit of C15, the 0.05 mF capacitor connected between pin 1 of V3 and chassis, is usually responsible for the trouble. When this component fails normal operation of the frame

timebase is upset in terms of both frequency and waveform, and the distorted drive signal applied to V3b causes abnormally high current changes in the transformer primary winding. Since considerable inductance is reflected across this winding from the scanning coils, the rapidly changing current incites large values of back EMF which are released in the form of sparks between the two points mentioned.

If the flashover is permitted to continue for any length of time, the insulation between the sockets of the valvholder eventually breaks down and the holder has to be replaced. Indeed, when the symptom is first encountered by the engineer it is often considered that bad insulation is the actual cause of the trouble, but this is disproved, of course, when it is later discovered that the symptoms still occur when a new holder is installed.

**Foldover at Top of Picture**

There is also progressive cramping towards the top of the picture and a display of flyback lines which are broken along their length. The trouble is invariably caused by open-circuit of C17, the 1,100 pF. capacitor in the frame linearity correcting network. When this fault exists it may be found that the frame linearity control has little effect in the correcting of the symptom.

(Continued on page 177)

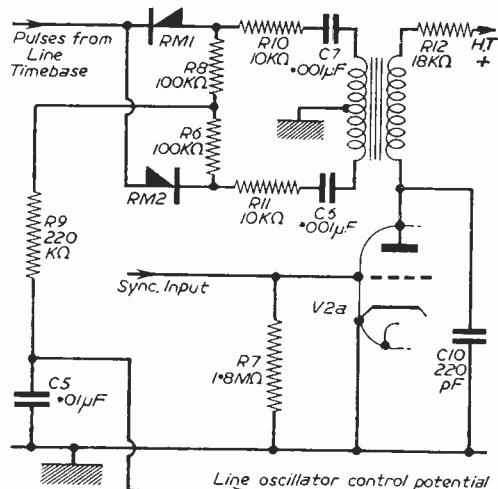
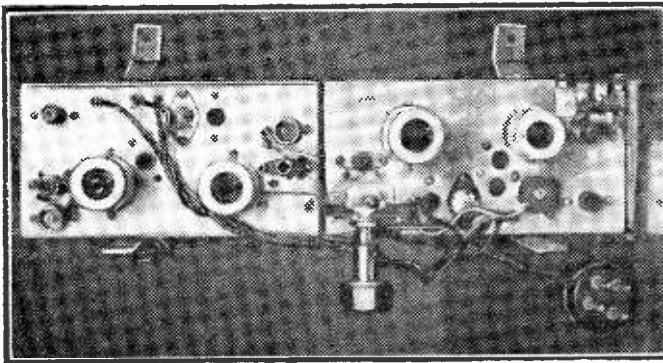

Fig. 3.—The flywheel sync control circuit used in the Bush TV53 and TV56 series.

# A Home Constructed TV

## Receiver



Plan view of the converters used in the receiver.

No. 2—THIS ARTICLE DEALS WITH THE CONVERTERS AND TUBE MOUNTING

(Continued from page 139 of the October issue)

By P. Green

are clearly shown in the photograph of the rear view of the cabinet. It will also be seen that a jack plug is mounted near

the speaker. This can be used for recording, or for a deaf aid.

THE BBC converter mentioned last month is shown in Fig. 11. A 6F12 valve was used in the first stage. As there was not sufficient gain a further coil was added as previously stated.

### Mounting the Tube

The two converters were bolted together (see plan view) and a 2-pole 3-way switch fitted in the middle. This switch isolates the valve filaments and output coil of the converter not in use. As little as twelve seconds is required to switch to either programme.

The photograph of the cabinet with its easily removable sides and top shows the mounting of

When the 1K ohms gain controls have been adjusted, a similar picture is obtained with little alteration to the brilliance control. The heater supply for the converters is taken from the 22 v. 3 amp. winding (see Fig. 12), and as the total voltage required for the PCF80 and PCC84 valves is only 16 volts, a suitable resistance of 20 ohms was made from an old iron element. The terminal strips were carefully removed and reassembled on a length of mica strip wound with resistance wire. As this wire cannot be soldered, it must be pressed under the terminal strips, which are then soldered in the chassis to stiff wires. To obtain 180 volts for the H.T., a 4,500 ohm resistance in series with a .1 mfd condenser was put in the supply (see Fig. 12). A further 2 ohm resistance is mounted on the BBC converter chassis.

### Cooling

To ensure adequate cooling, the converters are mounted well above the bottom of the cabinet, and little tuning drift has been experienced. Large holes are drilled under the other two chassis, and these holes

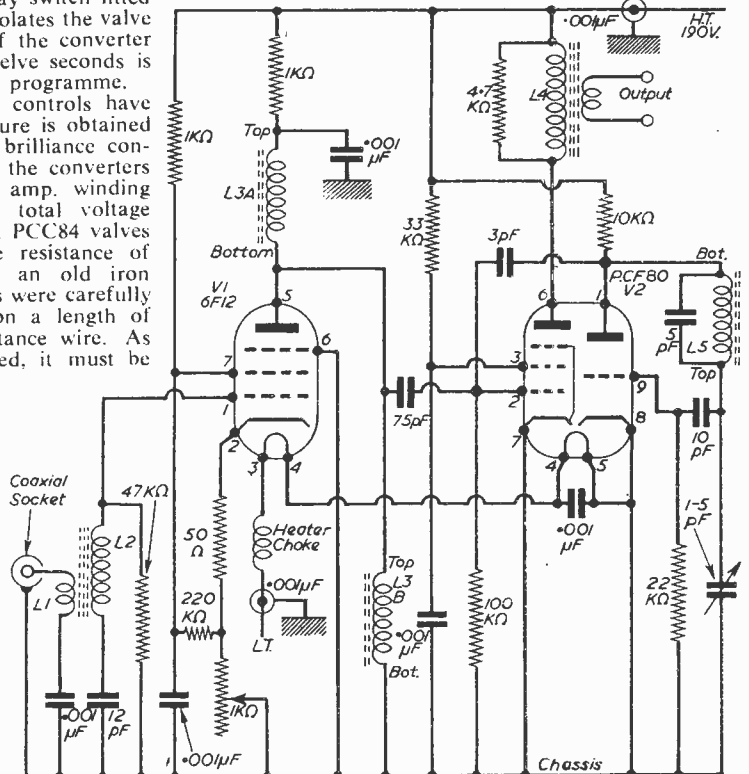

Fig. 11.—BBC converter. All .001 mfd. ceramic condensers. L3A and L3B are inductively coupled.

COIL WINDING DATA (See page 137, October issue)

Coil	A	B	C	D	E	F	G	H	I	J	K
Birmingham	7½	11½	4½	13½	6½	10½	12	8	12½	13½	Sound Rejector Coil 14
Holme Moss	9½	14½	7½	13½	6½	12½	15	8	14½	16½	
33-38 Mc. s.	15½	15½	13½	15½	13½ C.T.	15½	21	9½	16½	18½	

the tube. This method enables one to change the tube easily, and tubes of 9in. to 17in. can be fitted in the same mounting by using suitable packers. With all the recondi-

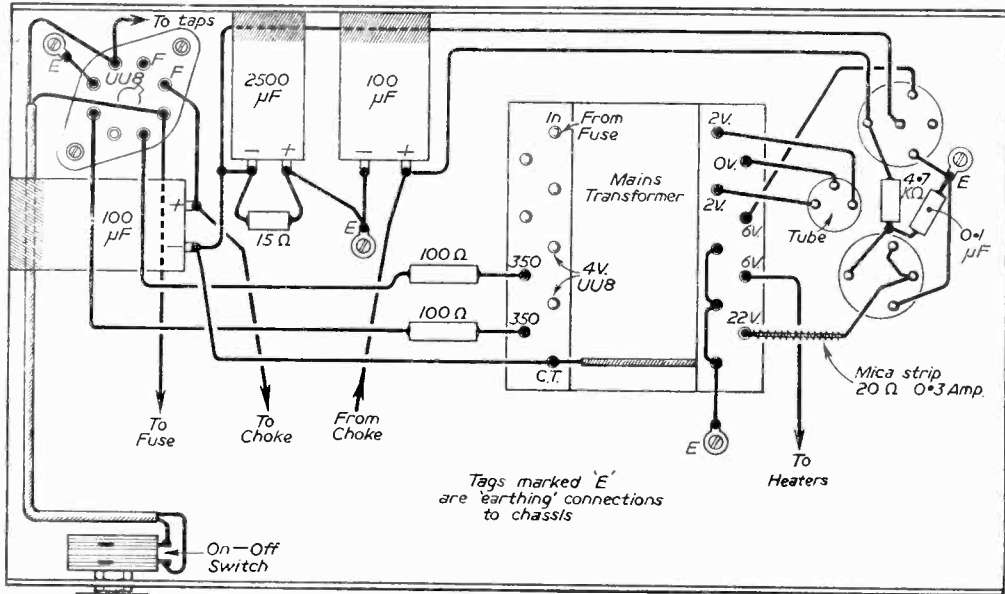
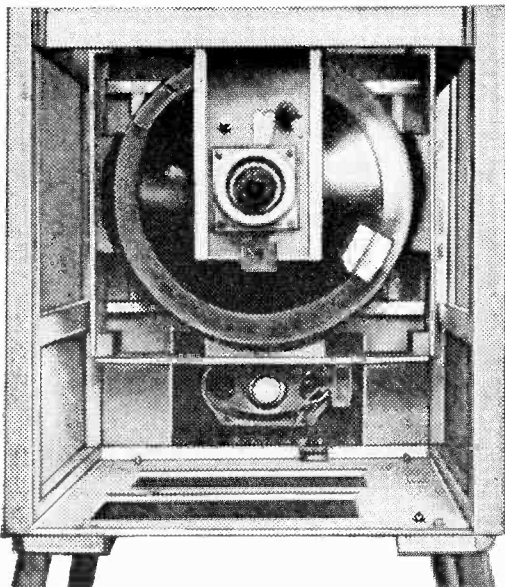

Fig. 12.—Wiring of the power supply.



Showing the large holes drilled under the chassis, the jack plug which is mounted near the speaker, and the mounting of the tube.

tioned tubes available, one has a large and cheap choice. The line transformer, the frame transformer and scan coils are the standard "View Master," and the focus magnet is an Elac.

(To be continued)

TELEVISION TROUBLES

(Continued from page 175)

Fluctuating Height

Sometimes caused by intermittency in the 0.1 mF. coupling capacitor, C16 in the circuit. The symptom may also be promoted by trouble in C19, the 100 mF. bias electrolytic of V3b.

Flyback Lines at Top of Pictures

Check the value of R17 and R19, and replace if high. The symptom may also be caused by trouble in V2 or V3, the effect, of course, is that of a slow frame flyback.

Intermittent Line Hold

This range of Bush models use a form of fly-wheel line synchronising, in which two small rectifiers (MR1 and MR2) are used in a phase discriminator circuit, as shown in Fig. 3. If line stability is impaired and it is found necessary to make frequent adjustments to the line hold control, the trouble is invariably caused by unbalance of the rectifiers, which may occur as their temperature rises.

# LINE TIMEBASE FAULTS

THIS ARTICLE TELLS YOU HOW TO LOCATE  
AND CURE THEM

By J. Brown

**T**HE line timebase and its associated components are among the most fascinating and tricky circuits. By arranging an oscillator to feed an output stage having a specially designed output transformer, we can scan the tube and use the flyback to obtain EHT. There have been many suggested ways of testing these transformers: instruments have been developed, but of the latter the writer has had little experience, and he has adopted a method which has never yet failed. If a line transformer is suspected to be faulty, the test is to replace it. This is impossible in the case of the amateur, because of the cost, and the writer has compiled this article in the hope that a reader will have some new ideas or think of another way to go about this problem.

## Line Transformer

The line transformer (Fig. 1) is an auto transformer, with an extra winding "overwound" to obtain EHT. This overwind used once to be wound with special wire, and can be easily recognised as it has the largest diameter. The resistance is usually very high, about 10 kilohms. The resistance shows there is continuity from the anode of the line output valve to the EHT rectifier anode. However, one shorted turn will ruin the performance. (In defence of the line transformer, and the manufacturers of these components, many are suspected and scrapped

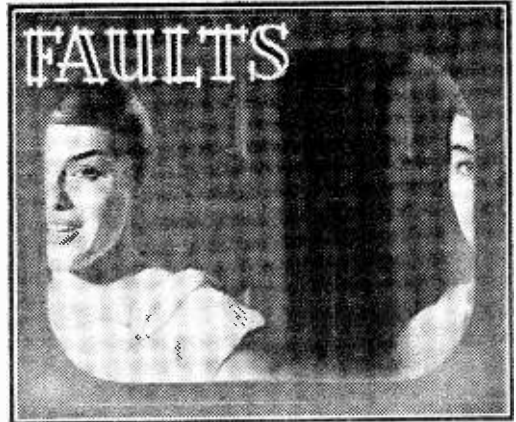

whilst not at all faulty.) There are various types of windings: some are tapped for use as a width control, the windings being switched or capable of adjustment. Winding or rewinding are for the specialist alone, because of the need for high insulation.

If the screen is blank and the sound section is working perfectly, it is wise, before suspecting the line timebase circuit, to see whether all the heaters, including that of the tube, are alight. Next, check the continuity of the fuses because some makers wire a fuse in the H.T. supply of the line timebase.

Look for any undue heating in components and valves. Place a screwdriver near the anode of the EHT rectifier; if a good spark can be drawn from it, it may be faulty. Remember that this heater does not light if the line timebase is not working, because the heater supply comes from a couple of well insulated turns on the line transformer. Some receivers have a resistor in series with the heater of the EHT rectifier and this should be checked. If there is a spark at the anode, and the heater is alight, with a well insulated screwdriver see if there is any spark from the lead that goes from the rectifier to the cap on the side of the cathode ray tube. If there is a spark, with a good cracking sound, the ion-trap is faulty or out of adjustment. Some sets have a resistor in series with the tube lead and this may go high in value and need replacing. If there is no spark from the tube lead, the EHT rectifier is faulty. Where the rectifier shows a blue or pink glow, it should be replaced. U25 valves develop this fault and may sometimes prevent the line timebase from working, when the line output valve becomes very hot. Sometimes a U25 heater burns out and falls near the anode. Then, a spark is obtained from the anode of the U25 and the tube

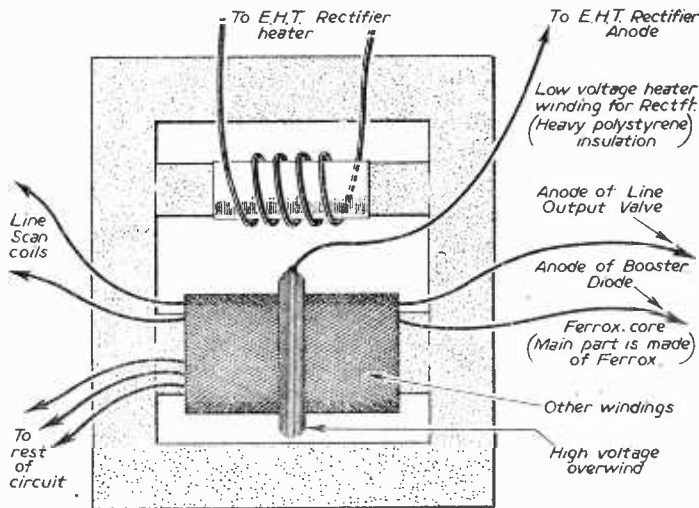

Fig. 1.—The line transformer.



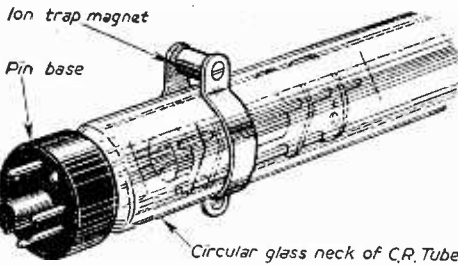

Fig. 2.—The ion-trap magnet fitted to the neck of the tube.

lead. If this happens, the sound of the spark is different from that obtained when the rectifier is working and is easily recognised. If the line timebase is working, the familiar 10 kc/s whistle will be heard; weak if only the oscillator is working, stronger if the line output stage is also in action.

**Ion-trap Magnets**

Many suggestions have been given for the correct setting of ion-trap magnets. The method the writer adopts is to switch on the set; allow it to warm up for a period of two minutes, with the arrow on the magnet facing the screen; to turn the brilliance fully up, and slowly to rotate it back and forth and move it along the neck of the tube towards the screen until there is light there. If a small area of defocused brilliance is seen, the magnet is turned through 180 degrees. At one position, the screen will light up brilliantly. The brilliance is reduced and the magnet adjusted for maximum brightness at the lowest setting of the brilliance control. Positioning and focusing of the raster are carried out by the picture shift and focus controls, not by adjustment of the ion-trap magnet's position. Should corners of the picture or raster be cut off, this is usually due to maladjustment of the magnet. Many cases of a blank screen are due to a broken or moved magnet.

After the optimum position has been found, seal the magnet with some "Durofix" or other adhesive. Do not overtighten the screws on the magnet, for the fibre band may break owing to expansion on heating.

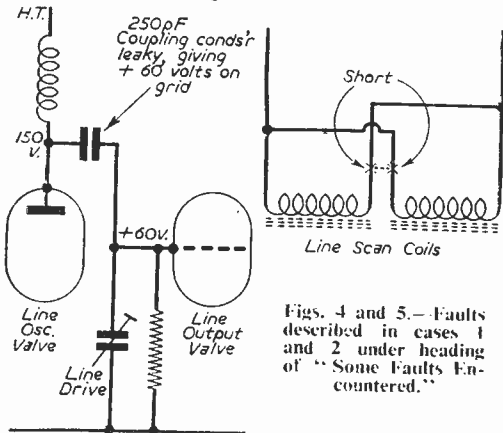

Figs. 4 and 5.—Faults described in cases 1 and 2 under heading of "Some Faults Encountered."

Fig. 2 shows the ion-trap magnet fitted to the neck of the tube. Normally the arrow points to the screen. Mullard Ltd. will supply instructions for fitting ion-trap magnets. Their method is different from that of the writer.

**Fault Finding**

Suppose there is no spark at the anode of the EHT rectifier and its heater is not alight. First, listen for the 10 kc/s whistle. If this cannot be heard, the oscillator section is not working. This is usually due to faulty valves, or to components open-circuited or short-circuited. Some circuits use self-oscillation in the line-output stage and all components must then be checked. If the faintest 10 kc/s whistle is heard, the oscillator is working. This whistle can be varied by the line or horizontal hold control. Tracing the fault here can be very tedious. Resistors, condensers, line transformer, and linearity and width components must be checked; valves tested or replaced. Voltage readings must be taken, especially on the screen of the line output valve. Voltage tests must not be made at the anode of the line output valve, as very high R.F. voltages are present. The writer uses a neon on a polystyrene handle (see Fig. 3). This will light about 1 to 2in. from any part of the line circuit. If the neon lights, the EHT rectifier is tested as explained.

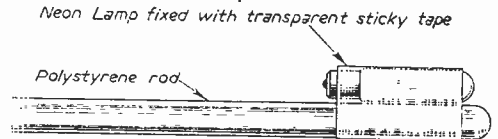

Fig. 3.—The neon tester attached to a polystyrene rod.

If it does not, measure voltages and compare with the maker's figures. Check the cathode voltage of the line output valves. Test the valves, or replace them, and if there is no spark at the anode of the EHT rectifier, first see if the line drive is too high. The compression trimmer may be too tight or the potentiometer may be advanced too far. If these are in order, disconnect the line scan coils. If there is a spark from the anode of the rectifier, the coils or an associated component is faulty. Some coils are fitted with a high voltage capacitor of about 500 pf. across them, and this should be tested. Test the coils for short-circuiting. This may not show up on a normal test meter, for when the energy from the line timebase is applied, this is enough to break down the insulation of the coils. Perhaps they have shorted turns, when sparks from the coils may be seen, or they become hot. If no spark can be obtained after the valves and components have been tested the line output transformer is faulty.

**Lack of Width**

If lack of width is experienced, again this may be due to a faulty line transformer, or condenser across the line scan coils, or to the width coil, which usually becomes very hot if it is faulty. If there is loss of width and height, this is usually due to a low H.T. supply voltage. Suspected metal rectifiers should be replaced. Valve rectifiers can be replaced after testing the

surge limiting resistors in the anode leads. The U801 valve has four anodes and a wire-wound resistor in each anode circuit. If one of these is open-circuited, H.T. voltage will be low. These resistors are usually of 50 ohms. If the screen is blank and a spark can be drawn from the anode of the EHT rectifier and from the tube connection, and movement of the ion-trap magnet has no effect, the voltages of the various tube electrodes must be measured.

Three readings are taken if the tube is a pentode or tetrode. First, the modulation, secondly the brilliance, thirdly the first anode. These readings depend on the type of modulation used. Cathode modulation is mostly used nowadays: the cathode of the tube is connected to the anode of the video amplifier valve. The reading should be from 100 to 150 volts. The grid of the tube is connected to the brilliance control. The reading here is from 0 to about 150 volts, dependent on the setting of the control. The first anode is from 300-600 volts positive. All measurements are taken negative to the chassis, positive to the electrode. Low readings may be due to burning out of the video amplifier anode resistor or choke, or other burnt-out resistors, controls, a faulty video amplifier valve, or its associated components. Before condemning the cathode-ray tube, test it in a friend's set, or have it tested at a reliable dealer's.

## Latest E.M.I. Transmitters

THE BBC has placed an order with E.M.I. Electronics Ltd. for six frequency modulated transmitters of a new type for the V.H.F. sound station now being built at Llanddona (N. Wales). The station, which will provide a full service of Home, Light and Third programmes, will serve some 180,000 people living in Anglesey and North Wales. The BBC has also ordered six similar transmitters for the new station to be built at Nether Button, Orkney. The new method of frequency modulation used provides an improved signal-to-noise ratio with reduced harmonic distortion.

The transmitter has been designed to operate on Band II frequencies (87.5 to 100 Mc/s) at 1 or 2 kilowatts output. Duplication of the complete transmitter and operation of two units in parallel ensure greater reliability of service as transmission will be maintained should a fault develop in one unit.

## Modern Colour Television

THE International Radio Hobbies Exhibition will again be held on 26th to 29th November, 1958, at the Royal Horticultural Old Hall, Vincent-Square, London, S.W.1.

For the first time modern colour television will be shown to the public and the latest outstanding world-famous Racal communication receiver worth £400 will be given away to the lucky card winner obtainable free at exhibition entrance.

Displays will be staged by the Royal Navy, Royal Air Force and the Army Territorials radio sections, British Amateur Television Club

## Some Faults Encountered

1. The screen was blank and the sound perfect. A weak 10 kc/s whistle could be heard. No sparks could be drawn from the line output valve or from the anode of the EHT rectifier. A 250 pf. coupling capacitor connected from the anode of the oscillator to the grid of the output valve was found to have a low resistance. The grid of the output valve was about 60 volts positive.

2. The line oscillator was working and the anode of the output valve was red-hot. The valve was replaced, but results were as before. When the line scan coils were disconnected, a spark could be drawn from the anodes of the EHT rectifier and tube. The line scan coils had a short and when these were replaced the set operated normally.

3. The screen was blank and the heater of the EHT rectifier was not alight. The rectifier had a blue glow and when replaced the fault was cured.

4. There was a lack of width. No faulty components were found and the line transformer was returned to the makers who found that it had shorted turns. Its replacement effected a cure.

Figs. 5 and 6 show the faults described in cases 1 and 2.

also Live Amateur GB3RS Radio Station working the world. Radio and IGY will also be featured. Many radio manufacturers will be showing components for "Do-it-Yourself" construction together with kits of parts for transmitters, receivers, hi-fi, and aeriels.

Two multiband and transportable aeriels and towers will be exhibited for the first time in this country also a new low-priced communication receiver. Transistors for amplifiers and mobile working will be featured together with many technical leaflets on home construction.

The show opens at 11 a.m. until 9 p.m. Admission 2s.

## THE MOST PRACTICAL GIFT OF ALL!

Christmas gifts just don't come any more practical than the one you're holding in your hands right now! **PRACTICAL TELEVISION**... why not send a full year's subscription for this invaluable magazine to friends who are TV enthusiasts? It's a present you know they'll enjoy. And each new issue will be a renewal of your best wishes... month in, month out, right up until Christmas 1959!

Simply send your friends' names and addresses, together with your own and remittance\* to cover each subscription, to Subscription Manager (G.1), George Newnes, Ltd., Tower House, Southampton Street, W.C.2. We will dispatch first copies to arrive before Christmas, and send an attractive Christmas Greetings Card in your name to announce each gift.

\* **RATES (INCLUDING POSTAGE) FOR ONE YEAR (12 ISSUES): U.K. 19.0, OVERSEAS 17.6. CANADA 16.0. U.S.A. \$2.50.**

# Interference With TV Reception

By G. J. Gordon

**W**HEN a television picture is disturbed in some way it is often difficult for the viewer and, indeed, the service engineer to establish immediately whether the trouble is caused by a receiver fault or by external interference. External interference can produce a host of curious effects across the picture depending on its type, but the problem is that certain set faults can give almost identical symptoms. It is the purpose of this article to investigate the various kinds of interference effects and to suggest ways of checking whether or not the receiver is to blame.

## White Spots on Picture

Although the spots may be grey if the receiver features an interference inverter circuit, the effect is well known and is caused mostly by car ignition systems. The car responsible can usually be seen by looking out of the window, but if such definite proof is not available the disturbance is rarely persistent unless, of course, one happens to live on a main road or close to a garage or ignition-type engine which is constantly in operation; but in this case the cause of the interference would have long been established. The cure is simple, and usually requires the inclusion of a resistive suppressor in the H.T. lead between the distributor and ignition coil of the offending engine.

White spots are also caused by electric motors such as used in most domestic appliances. Here, however, the interference spots are invariably concentrated in narrow horizontal bands across the picture and the bands drift up and down the picture depending on the speed of the motor in relation to the 50 c/s frame timebase frequency.

Flashes and spots are caused by pretty well any electrical circuit which is switched on and off and the cure is somewhat influenced by the offending equipment. In most cases of television interference small television suppressor chokes and 470 pF capacitors located as near as possible to the motor clear the trouble fairly successfully (see Fig. 1).

Sparking in the receiver itself caused by poor insulation of a component or EHT corona will produce similar trouble but in this case it is fairly easy to prove by removing the aerial from the set and adjusting the brightness control to get a raster; it is also as well to turn the contrast control fully up. If the screen is clear of spots, then the interference is possibly external and getting in through the aerial; if the trouble is equally as bad as with the aerial inserted, the set is in trouble and crackles will probably be heard emitting from the loudspeaker. However, if most of the interference disappears, the trouble may be in the set or the external interference may be so strong that it is getting into the set without an aerial, some of it probably coming in through the mains lead, though mains borne interference is not very common at television frequencies.

Similarly, interference generated as the result of a set fault may require connection of the aerial to reintroduce it to the signal circuits so that it is carried through the receiver and produces the symptom in the ordinary way.

Strong external interference is readily established since it more or less disappears when the aerial is disconnected, is rarely persistent and affects other viewers in the vicinity. It also has the character of either ignition or electric motor interference as described above.

## Receiver Generated Interference

The line amplifier and EHT circuits are particularly vulnerable to discharge effects and the production of interference. If a discharge occurs at the D.C. side of the EHT rectifier a blanket of very small spots covers the whole

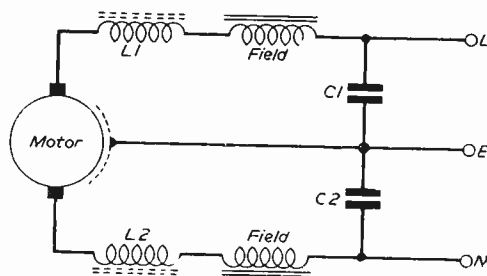

Fig. 1.—Television interference suppression circuit in which L1 and L2 are dust-iron television chokes and C1 and C2 are 470 pF capacitors suitable for mains operation.

screen area. This can be demonstrated by promoting an EHT discharge with the blade of a screwdriver at the final anode connector of the picture tube.

Such discharge may occur while the receiver is working due to humidity or dampness in the room, as the result of a heavy layer of dust on the EHT components or due to bad soldering of connections in the EHT circuit. To avoid this trouble, all connections on the EHT rectifier valve, smoothing capacitors and EHT connecting cables should be formed with a perfectly smooth blob of solder. The wires and tags should first be well tinned with solder, and then a hot iron should be used to drop a symmetrical blob of solder over the connections. Resin-cored solder should be used, of course, and the temperature of the connecting junction should be maintained while the join is made. Sharp points of solder and protruding strands of wire must be eliminated as these are conducive of corona discharge.

If a discharge takes place at the anode side of the EHT rectifier or line amplifier valve, in the circuit of the line scanning coils or width and linearity inductors or controls, the interference on

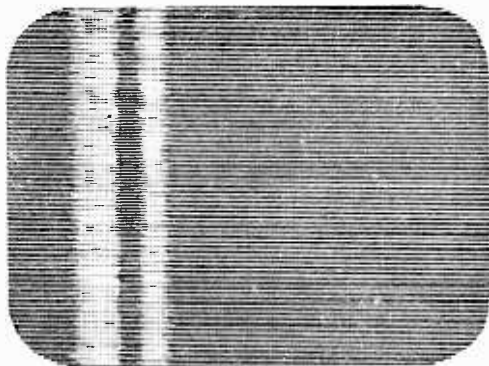

Fig. 2.—The symptom of corona in the line output transformer or component associated with line amplifier pulse voltage.

the picture will have a definite pattern. Because the discharge is promoted by the line flyback, spots or dashes of interference occur at the same point on each line scan and vertical columns of irregular horizontal lines appear somewhere across the picture, usually towards the left-hand side as shown in Fig. 2.

Again, this effect can be demonstrated by promoting a discharge at the anode of the line amplifier valve while the screen is observed. It is a good idea to try this to get some idea of the appearance of the symptom.

The usual cause of the trouble is poor insulation in the line output transformer, but a substitution test is often necessary if the trouble cannot be located in any other part. In severe cases a hiss can be heard from the loudspeaker and if the chassis is viewed in a darkened room the discharge may well be visible in the region of the line output transformer.

This trouble can be reflected into neighbours' receivers, and if they happen to be working on a channel different from that to which the offending set is tuned, the columns of interference may sweep across the screen and produce so-called windscreen-wiper interference, which has already been dealt with in these pages.

A horizontal band of interference spots, as shown in Fig. 3, rather like electric motor interference, often results from insulation collapse of a mains transformer or component in the set which carries mains current. The interference band is generally stationary since the interference is synchronous with the frame timebase, the frequency being the same in both cases.

Sparking in a component carrying direct current will cause random interference spots on the screen, but an associated symptom may also result by the disturbance in the circuit of the defective part. Severe crackles are usually heard from the loudspeaker when the component responsible for the picture interference has anything to do with the sound channel. Random interference spots also develop if the heater winding of the E.H.T. rectifier valve loses its insulation between the transformer core or adjacent windings. This frequently happens in receivers where the EHT is obtained from a mains transformer.

### Pattern Effects

Interference producing patterns on the picture can also be troublesome and may originate either from external sources or from the receiver itself. The trouble is caused by radio-frequency signals getting into the receiver along with the wanted television signals. When this happens the interfering signal beats with the vision carrier and the difference frequency so produced is detected by the receiver in the normal manner and shows up on the picture as patterns. If the frequency of the interfering signal drifts slightly, then the difference frequency changes and the patterns change their character accordingly, but if the two signals are of constant frequency the patterns remain locked on the picture.

If the interfering signal is lightly modulated at mains frequency the patterns may be "S"-shaped, but if it is heavily modulated at mains frequency the patterns may be confined to a horizontal band across the picture. Pattern interference is really the visual representation of beat whistles which are produced in a sound receiver when an interfering R.F. signal beats or heterodynes with the sound carrier or intermediate-frequency. With sound, however, whistles are produced only when the difference frequency falls within the receiver's A.F. passband, which is usually limited to about 8-10 kc/s. With vision, patterns are produced right up to a difference frequency of 2.0-2.5 Mc/s, depending upon the resolution efficiency of the receiver.

The interference may be either of a frequency which is acceptable by the receiver's main vision channel or I.F. channel. For example, an interfering signal at 42 Mc/s would cause a 500 kc/s pattern on the picture of a receiver tuned to Channel 1 (vision 41.5 Mc/s), as also would a 34.5 Mc/s signal getting into a receiver whose I.F. is 34 Mc/s. In the case of superhet receivers a strong interfering signal may cause a beat in the I.F. channel even though the frequency of the interference is removed from the main or I.F. acceptance.

The interference may get through by way of the receiver's second channel or other spurious acceptance channel, or it may be so strong that it overloads the first valves and produces

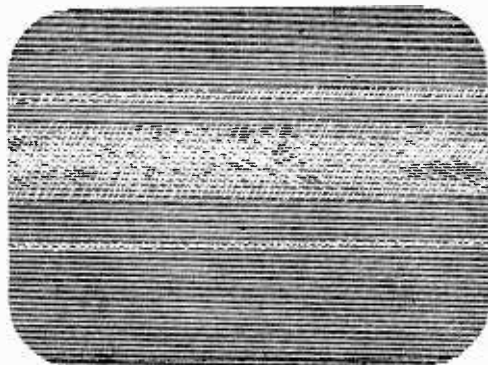

Fig. 3.—Electric motor interference. The symptom may also be produced by insulation breakdown of a receiver component carrying mains current.

harmonics or sub-harmonics which themselves are acceptable by the receiver.

Interfering R.F. signals may also be produced by the set itself. Patterns are sometimes produced if the contrast control is turned right up in a strong signal area in an endeavour to obtain a brighter picture on a worn tube. This causes the production of harmonics in the I.F. channel and vision detector which find their way back to the signal circuits as interference. Poor screening or filtering of the vision detector stage may also aggravate this trouble.

Instability in the I.F. stages, possibly due to impaired decoupling or a faulty valve, gives rise to a spurious signal which beats with the vision carrier and results in a pattern which invariably changes its form as the contrast control is adjusted, and possibly disappears when the control is turned below the critical feedback point. In a receiver which is prone to instability, a mismatch at the aerial socket may start the trouble, and in this case it may be found that the trouble can be cleared by altering the position of the aerial feeder at the back of the set.

Very heavy feedback in the receiver will promote uncontrollable brightness and there will be no trace of picture at maximum contrast setting, but as the control is retarded the feedback intensity may reduce and a picture affected with patterns may be obtained; reducing the contrast still further may clear the patterns, but then the picture may be below optimum contrast.

### External Interference

There are very many external sources of interference, and it is impossible in an article of this nature to go into detail, but it will help to mention one or two of the chief causes.

Patterning is often very bad on the ITV programmes when a simple add-on type Band III converter is employed, especially in areas close to a powerful Band I transmitter. With this kind of converter the receiver is still acceptable to Band I signals on the local channel even when the combination is set up for the reception of the ITV signals. The receiver may, therefore, pick up the Band I signals when it is receiving the converted ITV signals. The two signals heterodyne and cause patterning, exactly the same as described above.

The cure is to use a filter or stub in the converter-receiver connecting link or to increase the Band II signal pick-up so that the receiver's contrast control may be turned down, thereby rendering the set less sensitive to the Band I signal. It may also help to remove the Band I aerial from the converter while receiving the ITV signals.

Such a combination may also cause patterning on a neighbour's receiver tuned to the BBC. This is the result of the converted ITV signals being radiated in Band I and being picked up by the affected set. In really severe cases, the ITV picture may actually appear on the affected receivers, superimposed on the BBC picture—experimenters in range of the Isle of Wight ITV transmitter beware!

Local oscillator signals or their harmonics may

radiate and cause patterns on sets tuned to a different channel. This trouble is present in the Oxford area at the present time, and a wired television service is being contemplated to give the viewers interference-free pictures. Oxford is in the range of both Birmingham (Channel 4) and London (Channel 1) transmitters. Viewers on Channel 4 are being cut out with patterns due to oscillator radiation from sets tuned to Channel 1. This is because the oscillator frequency of sets with 16 Mc/s vision I.F.s falls within the vision passband of Channel 4.

This trouble may occur with other channel combinations. For example, the second-harmonic of the oscillator of sets with 34.65 Mc/s vision I.F.s tuned to Channel 4 causes patterns on nearby sets tuned to Channel 9.

Patterns may also result from R.F. heating and medical appliances, from mobile transmitters and even from other television stations on the Continent when the ionospheric conditions favour long-distance television reception. Interference getting into the I.F. channel through the aerial system can be eliminated by the inclusion of a high-pass filter, while a low-pass filter serves to block interfering signals at frequencies above the frequency of the required television signal.

Vacuum type electric lamps, particularly those used in electric fire displays, can oscillate at frequencies in the range 30 to 130 Mc/s.

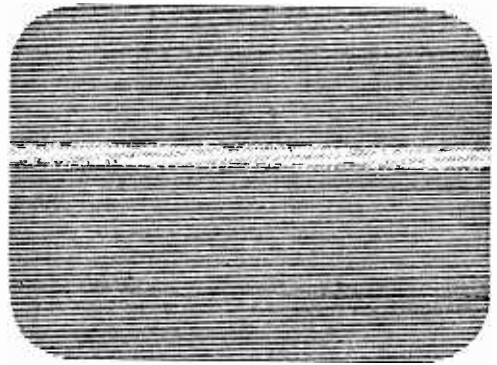
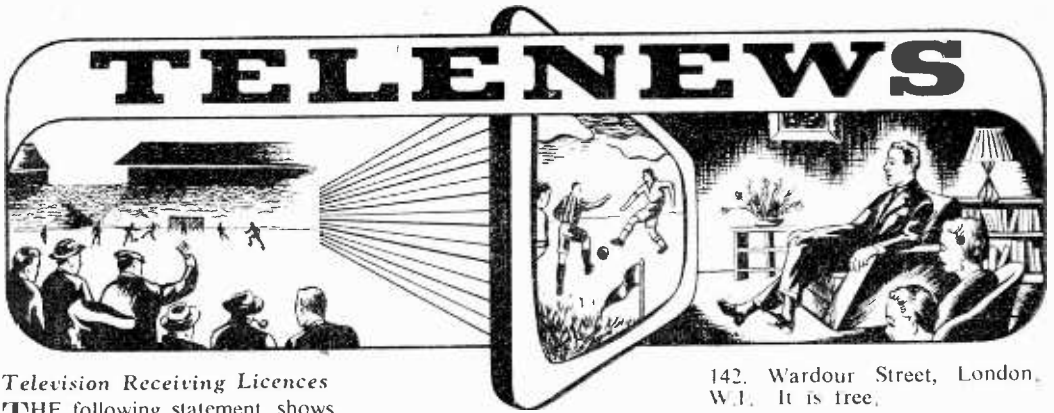

Fig. 4.—A rough idea of the effect on the screen caused by an oscillating vacuum lamp.

Television interference due to this cause is easily distinguishable by the very narrow horizontal band of pattern which occurs across the picture. In some cases it is rather like the knitting together of one or two scanning lines, but in other cases the band may be a little wider containing pattern information of a definite character. A rough idea of the symptom is given in Fig. 4.

As the resulting interference is not very widespread, the guilty lamp can usually be discovered by switching off suspect lamps in turn while having a helper observing the screen. It may be necessary to have the neighbours do likewise if the trouble does not appear to be in the house of the affected viewer. Unfortunately, lamps suffering from this trouble may well be in normal working order from the aspect of illumination.



**Television Receiving Licences**  
 THE following statement shows the approximate number of Television Receiving Licences in force at the end of August, 1958, in respect of receiving stations situated within the various Postal Regions of England, Wales, Scotland and Northern Ireland.

Region	Total
London Postal ... ..	1,603,018
Home Counties... ..	1,037,310
Midland ... ..	1,333,920
North Eastern ... ..	1,341,943
North Western ... ..	1,164,728
South Western ... ..	655,502
Wales and Border Counties ... ..	483,656
<b>Total England and Wales ... ..</b>	<b>7,620,077</b>
Scotland ... ..	634,332
Northern Ireland ... ..	90,240
<b>Grand Total ... ..</b>	<b>8,344,649</b>

**TV Effect on Films**

TV has undoubtedly had an effect on public taste in films, and may account for the decline in film attendances. There is almost national criticism of the very poor film. The public requires something different from Westerns, gangster films and sickly love stories. The film show has become a weekly event.

**Coin-in-the-slot TV**

A FURTHER development in visual entertainment will compete with the films—namely coin-in-the-slot television, which may become the home cinema. To provide this service, existing receivers will have attached to them a coin box through which the public will be able to pay for special programmes which will only be shown once or twice a day. By this system the programme is televised through a scrambler, and the insertion of the coin unscrambles the picture. Alternatively, the programme may be transmitted by lines.

**East Anglia**

THE BBC has announced its plan for East Anglia and the East region. A permanent TV link is to connect Birmingham with the Norwich TV station and a new station is to be built at Peterborough. There will be a two-way link enabling programmes from East Anglia to be fed into the national programme. Next year the BBC intends to install cameras in its Norwich studios so that a daily news service of interest mainly to East Anglians may be transmitted.

**"The Church and Television"**

A BROCHURE entitled "The Church and Television" endeavours to answer the question as to whether television is a competitor with the Church or an opportunity. It is a transcript of the ABC Television programme "Living Your Life," which was originally transmitted on June 8th this year. It is published by ABC Television Ltd..

142, Wardour Street, London, W.1. It is free.

**Chillerton Down**

MORE than 80 per cent. of the population may now view commercial TV as a result of the opening of the Southern TV station at Chillerton Down.

**Glass Plastic TV Tubes**

A CERAMIC - IN - GLASS electron tube, capable of withstanding extreme conditions of vibration, shock and fatigue, has been produced and is expected to permit improved

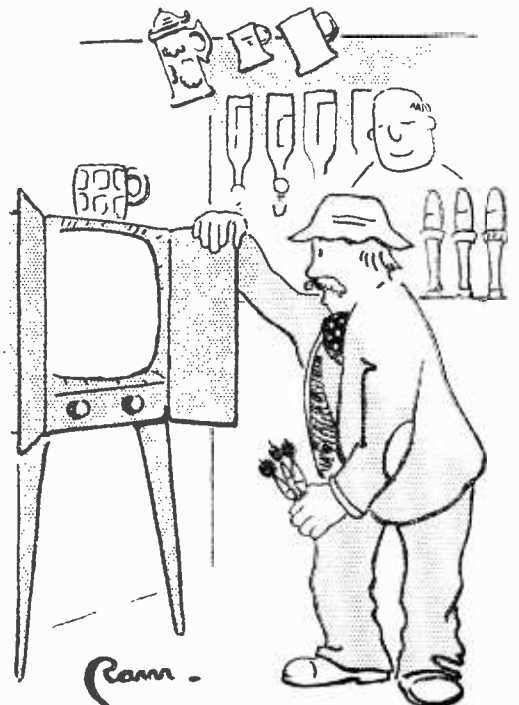

"Why, this be a queer sort of dart board!"

performance in electronic equipment.

Within its glass envelope, the device employs a "planar," or sandwich-type mount structure. In the assembly process, various elements of the mount are stacked one on top of the other, instead of being built around a common axis as in conventional tubes. Ceramic spacers are used to separate components of the stacked mount.

### TV Sales in 1958

TELEVISION receiver manufacturers expect their sales of sets in 1958 to total between 1,600,000 and 1,700,000, although production has been running at a higher annual rate than this.

### Sight and Sound on Tape

SPOOLS of tape containing sight and sound tracks may shortly be available to home viewers. We understand that two British radio firms are perfecting recorders which will plug into the aerial sockets of ordinary TV sets. There is bound to be a big demand for them.

### Television Colour Standards

BRIGHTNESS standards for colour television tubes have been made available by the U.S. National Bureau of Standards. Each set consists of three standards, red, green and blue, closely matching in spectral energy the three phosphors which in the tube act together to produce various colours in the image. The standards are used to calibrate instruments for measuring the colour and brightness of the phosphors. They thus provide a simple means for achieving uniform colour reproduction in television tubes.

### ITV Programmes in N.E. England

THE I.T.A. announce that Independent Television programmes will begin in north-east England on January 15 next year. About 2,660,000 people live in the area to be served by the new station at Burnhope, six miles north-west of Durham. It will operate on Channel 8 and it will transmit horizontally-polarised signals. The receiving aerial will thus have to be mounted in a horizontal plane and low powered test transmis-

sions are now being broadcast to assist dealers in orientating Channel 8 aerials.

### I.T.A. Service for Northern Ireland

THE Independent Television Authority has invited applications for the provision of programmes from a station in Northern Ireland which is to be built on the Black Mountain, near Belfast, and which the Authority hopes to bring into operation at the end of next year. The station will serve over one million people and its coverage area will include practically the whole of Northern Ireland, with the exception of Fermanagh, the western parts of the counties of Tyrone and Londonderry, a small part of County Down in the Warrenpoint and Kilkeel areas, and the Antrim coast from Larne to Portrush.

The station will have a 750ft. mast and will transmit on Channel 9, horizontally polarised. It will have a directional aerial system designed to transmit a maximum radiated power of 100 kW. to ensure as wide a coverage as possible in the hilly terrain of Northern Ireland.

### 20 Million ITV Viewers

MORE than 20 million people in some 5,800,000 homes throughout the country can now watch ITV programmes, reports Television Audience Measurement Ltd. This compares with an audience of only 670,000 viewers when Independent Television first began operations in the London area less than three years ago.

Other landmarks in ITV's progress were: May, 1956—5 million viewers, February, 1957—10 million, November, 1957—15 million viewers.

### Watching ITV

DURING August, 72 per cent. of the total time spent viewing television in homes with a choice of BBC and ITV programmes, was devoted to watching ITV—two per cent more than in July. This is revealed in the latest of a monthly series of statements by Television Audience Measurement Ltd. (TAM) giving details of the ITV share of time spent viewing television in BBC/TV homes in ITV areas.

ITV's share in BBC/ITV homes was as follows: London 71 per cent.; Midlands 72 per cent.; Northern 73 per cent.; Scotland 71 per cent.; South Wales and the west of England 68 per cent.

### Equipment Hire Service

PYE LTD. have instituted a hire service which will include technical and production facilities and enable customers to call upon any form of TV apparatus ranging from complete outside broadcasting bands or underwater television cameras to a single miniature industrial TV camera and monitor. The service will probably be used extensively by firms and organisations requiring only occasional TV facilities, as might occur when conferences are held simultaneously in different parts of the country or in different rooms within the same building.

### ITV/BBC in Southern ITV Area

A BASIC survey of the Southern Television ITV area carried out in June/July by Television Audience Measurement Ltd. (TAM) shows that 312,000 homes—36 per cent. of all homes in the area—possessed sets built to receive ITV programmes. This figure represents the highest incidence of ITV/BBC sets yet experienced in any ITV area during the basic survey period.

Of the Band III sets in the area, 45 per cent. were of recent manufacture and were installed in 1957 or 1958. Forty-two per cent. of all Band III sets had ITV aerials and the majority of the remaining 58 per cent. of Band III sets without aerials were within the primary zone of the transmission area, where reception may be possible without special aerials.

### 25 Next Year

THE first issue of PRACTICAL TELEVISION was published in September 1934. It suspended publication, however, just before the war when it was carried on as a supplement in our companion journal, *Practical Wireless*. It was reissued April, 1950. It will thus celebrate its 25th anniversary in September next year.

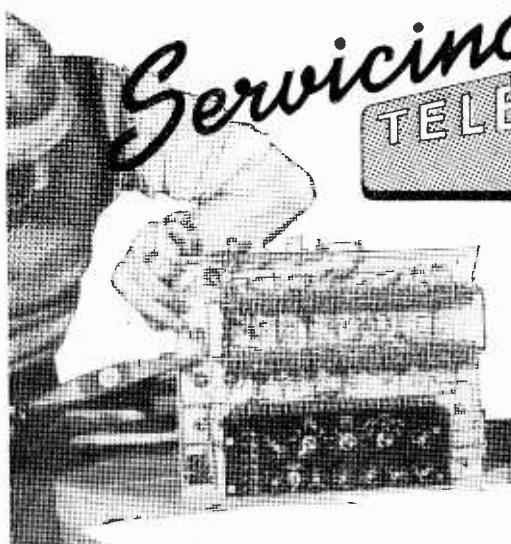

# Servicing TELEVISION RECEIVERS

No. 42.—THE BUSH TV53 SERIES (Continued)

By L. Lawry-Johns

determined by the line drive control (TC2). The PY81 functions as a conventional efficiency diode whilst the overwind on the line output transformer supplies the EHT rectifier V16. This is a wired-in EY51 on the "50" series, and a plug in EY86 on the "60" series.

After being amplified by V8 and V9 the sound signals are detected by V10 EB91 which functions also as a series noise limiter. After passing through the noise limiter the signals are passed to the volume control and thence to V11 on the main deck (PCL83). This valve is a triode-pentode, the triode working as an A.F. amplifier, the pentode as the sound output.

**T**HE fine tuning control on this receiver moves the entire channel selector assembly, thus providing a small variation on each channel position. Band I change over to Band III is achieved by an auxiliary cam on the channel selector mechanism.

A common sound and vision I.F. amplifier V3 follows the tuner unit and the output of this is split and fed to a two-stage, V4 and V5, vision I.F. strip and a similar, V8 and V9, sound strip. The vision detector and noise limiter is V6 and the video signals are amplified by V7 PCF80. This is a triode-pentode. The pentode section is the video amplifier, the output of which is directly coupled to the control grid of the triode section which functions as a cathode follower. The video signals appearing at the cathode are coupled to the C.R.T. cathode and the sync separator. The latter is one half of the V12 ECC83 and the A.G.C. is derived from this sync input. The A.G.C. system is probably the simplest in use and merely consists of applying part of the heavy negative voltage appearing at the sync separator grid to the I.F. stages after smoothing. The amount of negative voltage applied is determined by the contrast control and, of course, the signal strength. This negative voltage is also applied to the V1 (PCC84) stage when the selector plug is inserted in the *local* socket. It is not applied when the plug is inserted into *distant* and when it is so placed the V1 stage works at maximum efficiency. The second half of the ECC83 (V12) functions as part of the frame timebase oscillator being cross-connected with the PCL83 triode section to form a multivibrator. The pentode section of the PCL83 (V13) functions as the frame amplifier.

### The Line Timebase

An ECC82 (V14) double triode operates as the line multivibrator, the output of which feeds a saw-toothed waveform to the PL81 (V15) control grid. The amplitude of this waveform is

### Power Supplies

Two PY82 half-wave rectifiers, V18 and V19, are connected in parallel to provide an H.T. voltage of some 185 volts. Large capacity electrolytics provide smoothing in conjunction with a tapped resistor.

All valve heaters are in a single series chain fed from the mains dropper via the thermistor (Mullard VA1015). Pin 1 of the C.R.T. base completes the chain to chassis.

### Faults to be Expected

Almost certainly at some period of its life the receiver will exhibit the symptoms of *no vision—sound O.K.* No raster will be displayed when the brilliance is advanced. With the rear cover removed, release the two small P.K. screws which secure the screening cover of the right side line timebase section. Pull the screen to the rear. In all probability the EHT rectifier EY51, situated on the top of the line output transformer, will be "out." The line timebase whistle should be audible and a spark can usually be drawn from the single wire end. The obvious conclusion that the EY51 is defective is probably correct. However, "just in case," remove the anode clip from the side of the C.R.T. If the EY51 now lights up the C.R.T. itself may be at fault. To check upon this, replace the clip on the C.R.T., clip a shorting lead between pins 1 and 12 of the tube base socket and remove the socket from the C.R.T. The valve heaters will continue to glow as the heater continuity is maintained by the short across the heater pins 1 and 12. If the EY51 is still out, replace it as it almost certainly has an internal short thereby causing A.C. to be applied to the C.R.T. inner and outer coatings which function as a capacitor to smooth the normal

(Continued on page 189)



## WONDERFUL OFFER OF A.M.-F.M. CHASSIS AT £14 (P. & P. 10/-)

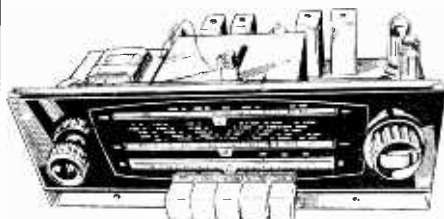

ments of 38/-, or with Cabinet and Speaker £6 down + carr. and 5 Monthly Payments of 38/-, or with Cabinet and Speaker £6 down + carr. and 6 Monthly Payments of £2.

Why buy a F.M. Tuner at the same price?

Tapped input 200-225 v. and 226-250 v. A.C. ONLY.

Chassis size 15" x 6 1/2" x 5 1/2" high. New manufacture.

Dial 14 1/2" x 4" in gold, red and deep brown.

Pick-up, Extension speaker, Ac., E. and Dipole sockets. Five "piano" push buttons—OFF, L.W., M.W., F.M. and Gram. Aligned and tested. With all valves.

Covers 1,000-1,900 M.; 200-500 M.; 88-99 Mc/s.

Valves EZ80 rect. ECH81, EF89, EABC80, EL84, ECC85.

Speaker & Cabinet to fit, polished, with back, 70/-.

10" x 6" ELLIPTICAL SPEAKER 20/-.

TERMS:—(Chass) £5 down + carr. and 5 Monthly Payments of 38/-, or with Cabinet and Speaker £6 down + carr. and 6 Monthly Payments of £2.

### HIGH GAIN I.T.A. CONVERTER ONLY £4.7.6

(3/- p. & p.)

All areas, all sets except Philips' with only twin feeder input. Internal power pack; direct switching I.T.A. to B.B.C.; no alteration to your set; fitted in 10 mins. Valves ECC81, metal rectifier; fine tuner; grey hammer finish; walnut finish wood cabinet 10/- extra.

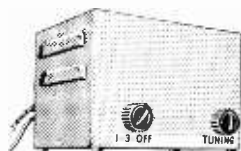

### GRAMOPHONE AMPLIFIER with 5in. SPEAKER

## WHY PAY MORE? ONLY 60/- (POST 3/-)

On Fabric-covered Baffle 12 1/2" x 5".

Mains and Output Transformers. Metal Rectifier. ECL82 Valve. Tone and Volume Controls. On-off switch. Plenty of volume. Fully Guaranteed. Two Knobs supplied. Ready to play.

**BATTERY ELIMINATOR.** Converts your Battery Set to Mains. For 4 Low Consumption Valves (DK96 range). 90 v. 15 mA. and 1.4 v. 250 mA., 42/6 (2/6 post). 200-250 v. A.C. Size 5 1/2" x 3 1/4" x 2".

**I.T.A. AERIALS** clipping to existing mast 1-2" dia. 3-element, 27/-; 5-el., 35/-; 9-el., 55/-; Loft mountg. 3-el., 20/-; 5-el., 27/6; Combined single B.B.C. and 5-el. I.T.A., 75/- with chimney lashings; Co-axial cable semi-air-spaced, 8d. yd. or 20 yds., 12/6; aerial and cable prices carr. pd.

SEND 6d. FOR CATALOGUE

**GARRARD AUTOCHANGER RC121/D Mark 2;** GC8 plug-in pick-up. 4-speed. Plays up to 10 records all sizes and 10" and 12" mixed. Also manual play. Brown with cream pick-up. Brand new at £9.17.6, plus 5/- carr.

Collaro Autochanger CONQUEST with manual play. 4-speed £8.15.0, 5/- carr. BRAND NEW.

Collaro Single Player AC1/554, 4-speed £6.16.6 (3/6 post). All players are in original boxes, brand new.

**LOUDSPEAKERS—VERY SPECIAL OFFER!**—Rola (10,000 line (2-3 ohm), 3 1/2" square 15/- (1/-); 8" x 5" Celestion elliptical 20/- (1/6); 6 1/2" circ. 14/6 (1/6); 5" circ. 13/- (1/6); 5 1/2" with trans. 15/- (1/6); all 2-3 ohm (p. & p. in brackets). Brand New.

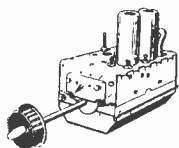

**CYLDON 16 Mc/s and 19 Mc/s TURRET TUNER** with two sets coils (state B.B.C. & I.T.A. channels). Extra pairs of coils, 5/- pr. With knobs. ONLY 77/6 (2/6 post). Brand new in original carton. Valves PCC84 and PCF80 included.

### THE BRAYHEAD TURRET

TUNER, £7.7.0, post free.

Complete with booklet and fitting instructions. State set and model no. when ordering.

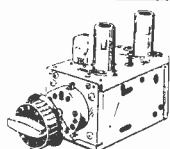
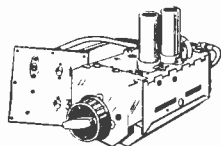

### INCREMENTAL TURRET

TUNER by famous manufacturer for 35 Mc/s only; with knobs. Valves PCC84 and PCF80. ONLY 77/6 post free or without valves, 60/- NEW.



UNIC

### A NEW LINE FOR US

Electric shaver by Swiss precision watchmakers. As good as anything on the market and better than most. Rotary cutters with trimmer (patented) for sides and moustache. Make shaving a pleasure. 12 mths. guarantee. Proved in the difficult American market. A.C. and D.C. mains. Two types (A) 220-240 v.,

£7.17.6 in Gold Filled Red Box; (B) 110 v. and 200-250 v. in Presentation Case, £8.10.0, both post paid. No free trials as they work first time.

**PERSPEX UNSCRATCHED**, post 2/- each size, 6 post free; sizes n ins. 14 1/2 x 11 x 3/16 clear, 5/-; 12 x 9 1/2 x 1/2 clear, 4/-; 16 x 14 x 3/16 clear, 7/-; 15 x 12 x 1/2 tinted, 6/-.

**EX-W.D. PERISCOPES**, size 10" x 6" 7/6 (p. & p. 2/6).

**ELECTROLYTICS** 200-200-200 mf. 275 v., 7/6 (post 1/6). 200-100 mf. 275 v., 4/6 (post 1/-); many others.

**BATTERY CHARGER.** 1 amp. 6 v. and 12 v., £2, post paid.

Posted Orders to Worthing, please. Delivery by return. Terms:—One-third down and balance plus 7/6 in four equal monthly payments. Postage with down payment. (C.O.D. 2/- extra.)

These terms are applicable to all items except A.M.-F.M. chassis.

## GLADSTONE RADIO

25 Wordsworth Road, Worthing. Tel.: 235; and 3 Church Road, Redfield, Bristol. Tel.: 51207.

# ENJOY FREEDOM FROM TV INTERFERENCE

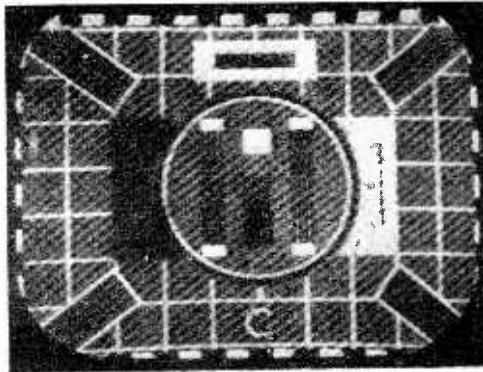

## with *Labgear* PRINTED CIRCUIT FILTERS

which plug directly into your receiver



PATTERNS LIKE THAT ILLUSTRATED ABOVE RUIN T.V. RECEPTION, BUT THANKS TO THE NEW LABGEAR PRINTED CIRCUIT FILTERS CAN USUALLY BE CLEARED INSTANTLY. SEND FOR EXPLANATORY LEAFLET WHICH TELLS YOU WHICH OF OUR 3 MODELS YOU SHOULD EMPLOY.

### TYPES OF INTERFERENCE MINIMISED BY LABGEAR FILTERS :

Broadcasting Stations, Shipping, F.M., Radar, Police, Ambulance and Fire Services, Amateur Stations, Diathermy and R.F. Heating Equipment, and " Forward Scatter " Stations.

**Labgear Ltd.,**

**WILLOW PLACE, CAMBRIDGE.**

'Phone 2494/5. 'Grams. Labgear, Cambridge.

## RST

MAIL ORDER DEPARTMENT  
211 Streatham Road, Mitcham, Surrey.

ALL VALVES LISTED ARE NEW STOCK.

• Terms C.W.O. or C.O.D. Postage 3d. per valve.

MITCHAM 6201.

AZ31 10/6	EF42 12/-	N142 9/6	UCL83	6J7GT
B65 8/6	EF50 (A)	N153 11/3	15/6	6K7 4/6
DAF32 9/9	EF80 4/6	N154 11/3	UF41 9/-	6K7GT 10/-
DAF91 9/-	EF85 7/6	N727 8/6	UF89 10/-	6K8GT
DAF93 9/6	EF88 12/-	PC94 9/-	UL41 9/6	
DD320 10/6	EF89 10/-	PCF80 12/6	UL84 9/-	6L1 12/3
DF31 9/9	EF91 10/-		UL8 23/6	6L1 17/6
DF91 8/6	EF93 14/-	PCF82	UY41 7/6	6L8G 7/6
DF93 8/6	EL42 10/-	11/6	UY8 8/-	6L18 12/6
DH119 9/6	EL31 9/-	PCL82 12/6	VP4B 17/6	6L19 21/-
DK91 9/-	EL90 8/6	PCL93	W81M 8/6	6N7G GT
DL33 9/9	EM80 10/-	12/6	W142 9/-	8/-
DL92 8/-	EM81 11/6	PENA4	W719 8/6	6SL7GT
DL96 8/9	EY81 10/-	11/6	X78 19/-	7/6
EABC30	EY84 13/-	PEN4VA	X79 11/9	6SN7GT
	EY91 9/-	11/6	Z21 10/6	6X5GT 8/6
EAF42 10/6	EZ35 8/6	PL36 15/-	Z77 10/6	757 12/6
EB91 5/9	EZ40 8/-	PI32 10/-	Z192 8/6	7Y4 7/6
EBC41 9/3	EZ41 10/6	PI33 11/6	Z719 8/6	8D3 9/6
EBF90 9/6	EZ80 8/-	PY80 8/3	1R5 9/-	10LD11
EBF93 9/6	EZ81 8/-	PY81 9/6	5Y3GT 8/6	14/9
EC91 8/9	FC2 14/6	PY82 8/6	5Z4G 10/-	12AH8 10/-
ECC33 8/6	FC4 23/6	PY83 8/6	6A8GT 10/-	12AT6 8/9
ECC31 8/6	FC13 14/6	R10 22/-	6AL5 15/9	12AT7 8/9
ECC32 9/-	FC19C 19/6	R19 15/-	6AM6 9/-	12AUX 9/-
ECC33 9/-	G232 11/6	SP41 3/6	6AN5 5/-	12AX7 9/-
ECC84 10/-	H30 4/9	TD4 15/-	6AQ5 7/6	12BA6 8/9
ECC85 10/6	H63 10/-	TP22 12/6	6BA6 8/6	12BE6 9/3
ECC86 10/6	HBC90 8/-	U142 8/6	6BE6 9/3	12BH7 10/-
ECF80	HL92 11/6	U147 8/6	6BJ6 7/6	12J7G/GT
ECF82 12/6	HL139D 11/6	U153 9/6	6BR7 12/-	10/-
ECH35	KT33C	UABC90	6BW6 8/6	12K7GT
12/6	12/6	10/-	6BW7 8/6	10/6
ECH42 9/6	KT68 16/6	UAF42 10/-	6CX6 8/6	12K8GT
ECH81 9/6	LZ319 12/6	6CD6C	12Q7 8/6	12/3
ECL82 13/6	MKT4(5)	UBC41 8/6	12Q7GT	8/6
	(or 7) 21/-	UBF80 9/6	6D2 5/9	52Z4GT
EF37A	ML4 12/6	UCH42	6E1 19/6	8/6
EF40 15/-	MSF4 15/-	UCH81 10/-	6F12 8/6	50L6GT
EF41 9/6	MU14 10/6	10/6	6F13 18/6	10/-
	MX30 15/-	10/6	6J5G 6/6	10/-

Quotations given for any types not listed. Obsolete and old types a speciality. Send for lists.

## Build your own HI-FI

—with an  
entirely  
**NEW**  
range  
of Hi-Fi  
units  
and  
cabinets!

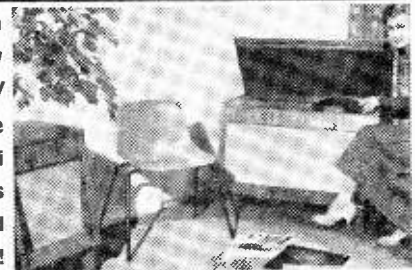

Imagine the pleasure of having this magnificent Hi-Fi equipment in its beautiful contemporary style furniture for your home . . . and experiencing an entirely new realism in sound reproduction. Yet the Emistructor Hi-Fi will save you money and give you all the extra fun and satisfaction of building it yourself—and being able to service and maintain it afterwards. Special instruction manuals guide you at each stage and teach you all about the equipment in simple terms as you build. No skill or experience is needed—only a few simple tools.

Emistructor equipment is made to the highest quality standards and is a product of E.M.I. Institutes Ltd.—part of a Company world famous for sound recording and reproducing equipment.

There is a wide variety of equipment and cabinets at different price levels to suit individual tastes and requirements. The range varies from a complete Hi-Fi installation with separate speaker enclosures to a simple all-in-one compact system for those with more modest requirements. All equipment is suitable for stereo or non-stereo reproduction of records. Full details and complete specifications will be sent with our free Brochure.

## EMISTRUCTOR

Dept. H.F. 138, 43, Grove Park Road, London, W.4

Associated with one of the World's largest recording organisations comprising—

"HIS MASTER'S VOICE" · CAPITOL · COLUMBIA · MGM etc.

D.C. but which short (virtually) an applied A.C. voltage. Many readers have been mystified by what appears to be an internal short in the C.R.T. eventually turning out to be an EY51 defect. The short explanation given above should enable the reason for this to be grasped. However, should the EY51 light up with the base removed but fail when the socket is replaced and the short removed (giving the C.R.T. cathode time to warm up) the reason may justly be attributed to a *grid-cathode* short in tube. Such a short can sometimes be cleared by applying a high-frequency high voltage between the grid and cathode electrodes, by lowering the first anode (tag 10) voltage to that of the H.T. line or the short may be accepted and the base rewired for triode working.

Should the EY51 be out but the spark at the anode be weak and the line timebase whistle almost inaudible, check the PL81 and the ECC82, V15 and V14. It should be borne in mind that a low emission ECC82 will cause the PL81 to be under-driven. Thus it is possible for the PL81 to be replaced on several occasions when the actual cause of the failure of this valve is the ECC82. If the width is only "on the edge" and PL81 appears to overheat, replace the ECC82.

**Another Common Fault**

If upon switching on a loud hum is heard and inspection shows that the right side valves are lighting up brightly but the left side valves are not lighting at all, switch off before more damage is done and suspect a heater/cathode short in V11 the PCL83 sound output valve (front right side). A less serious leak of the same type in this valve may cause hum and distortion on the sound although the receiver may otherwise function well. Complete loss of sound may also be due to this PCL83 valve. V13 is another PCL83 valve and may also develop defects as described above, but producing symptoms applicable to the frame timebase. If only a horizontal white line is displayed on the tube face, suspect this valve.

Loss of line hold (picture running into lines) which may be intermittent, can often be traced to a defective V14 ECC82.

Sound on vision is often due to excessive signal input and if the sensitivity plug is in the *distant* position, this should be replaced into the *local*. If the sound on vision is stubborn, L22 and L24 are the sound rejectors.

**Receiving a Weak Signal**

Grainy picture, perhaps only on Band III. Where the picture has been of good quality, check the tuner valves, firstly the PCC84 (V1) and then the PCF80 (V2).

If Band III has not hitherto been received, the above valves may be checked after having seen that the local/distant plug is in the distant position. Thereafter, efforts should be directed to improving the input signal by erecting the most efficient aerial possible and seeing that this is correctly sited. Usually this will be in the highest available position, but not necessarily so. We know of superior results obtained with the aerial just clear of the ground in situations where a chimney position was hopeless.

**Removing the R.F. Chassis**

Disconnect the picture and sync output leads from their terminals on both chassis; remove tuning and channel selector knobs and unplug 5-pin power supply plug connecting receiver to main deck.

Remove aerial socket panel from rear of cabinet, the bonding strap between the two chassis and the flex lead connecting to the cabinet foil. Unscrew the two 2B.A. bolts securing the receiver unit to the cabinet.

(Continued on page 198)

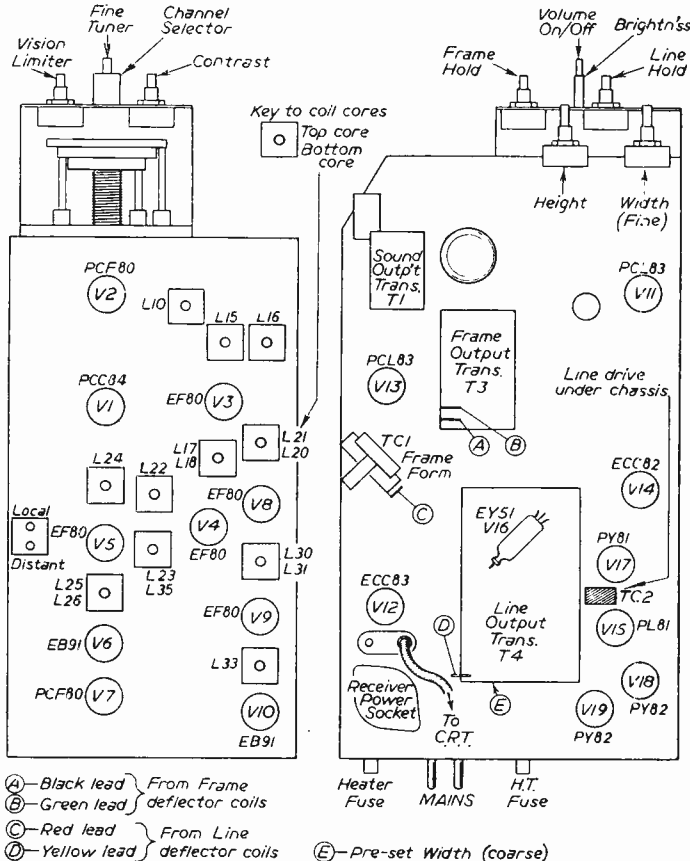

Top view of the chassis.

# Improving Television Sound

THIS ARTICLE DEALS WITH FAULTS CAUSING  
POOR SOUND REPRODUCTION

By Rex Jenkins

IT is surprising how many readers' queries we receive which complain that the sound decreases in volume when the contrast control is retarded. It is often said that the volume is quite adequate when the contrast control is approaching maximum, but that when the contrast is backed off to secure a reasonable picture the sound falls to too low a level and cannot be raised sufficiently by means of the volume control, which needs to be set at maximum.

First, let us establish that it is perfectly normal for the sound level to be affected when the contrast control is adjusted. The reason for this is that the contrast control serves really as an R.F./I.F. gain control and is associated with the valves that are common to both sound and vision as well as with one or two of the vision channel

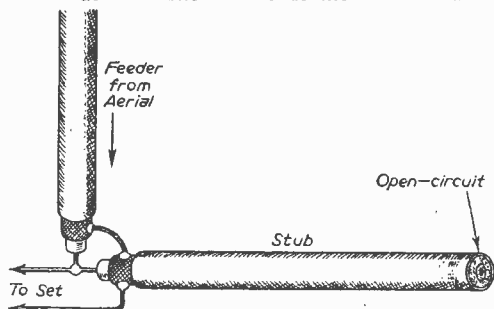
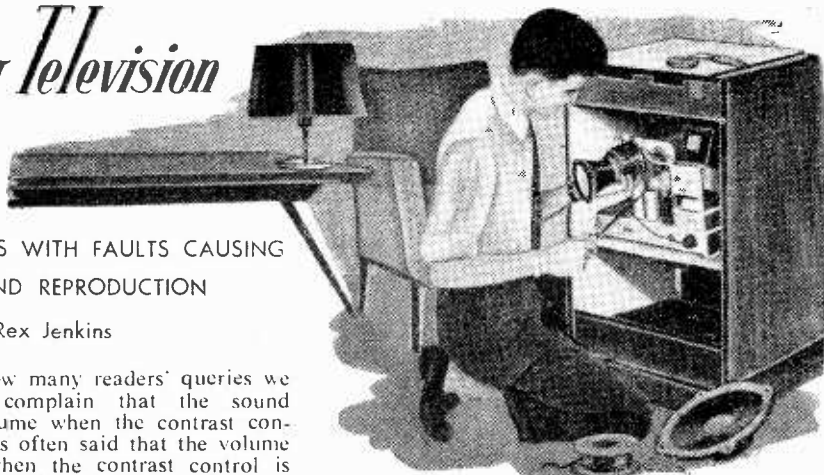

Fig. 1.—A simple stub which can serve to counter standing waves in the feeder due to mismatch. The feeders can be joined neatly together by using the Belling and Lee type L615 twin right-angle coaxial plug.

I.F. valves. Thus when the control is retarded, the gain of the common stages is reduced and this reduces the sound as well as the vision signal.

With recent model receivers, however, an efficient sound A.G.C. system is usually incorporated, so that the net volume from the loud-speaker is maintained reasonably constant even though the R.F./I.F. gain may be decreased. This may not be true if the set is working on a weak signal, for then a gain decrease may push back the I.F. signal to a level which is insufficient to produce a sound A.G.C. bias.

With sets which feature A.G.C. of the vision channel the same general principles still hold, but here the contrast control is associated with the A.G.C. amplifier, and as it is adjusted so



the vision A.G.C. bias, which is produced by the vision signal, alters about a mean level, and this bias is applied to the common vision and sound valves as well as to the vision-only I.F. amplifiers.

With older receivers, as well as a contrast control there may also be a sensitivity control. Since this is arranged to control the gain of the first R.F. amplifier, which is carrying both the vision and sound signals, its adjustment will also affect the sound as well as the vision.

## Poor Sound and Vision Balance

In cases where the sound volume is insufficient when the contrast is adjusted for optimum picture quality the trouble may lie in the aerial system and not in the receiver itself. As is well known, the aerial has to be fairly flatly tuned so that it will embrace with even response the 5 Mc/s spectrum of the required channel. There are various aerial designs, which account for the slightly different lengths of the elements between aerials of different makes. Some are tuned to give a slightly greater gain at the vision frequency, some are tuned to the geometrical centre of the band, while others may be tuned in favour of the sound frequency.

The trouble is aggravated considerably by using an aerial which is not designed for the channel to which the receiver is tuned. This not only gives a sloping response which is considerably below what is would be at the correct frequency, but it also promotes an impedance mismatch between the aerial and feeder. Standing waves thus occur on the feeder, and severe attenuation of the signal at a certain frequency within the band spectrum may result if the feeder happens to be of a critical length—and this, of course, may occur at the sound frequency.

If this trouble is suspected, a better balance can often be secured by reducing the length of the feeder at the receiver end by cutting off about 1 in. at a time while testing the effect between cuts. If the sound is affected in this way, the volume will gradually increase to a maximum as the feeder length is reduced.

Another idea is to use a stub consisting of a

length of feeder in parallel with the main feeder (see Fig. 1). The stub should be about 70in. long on Band I and about 21in. on Band III, and should be cut, about 1in. at a time until the required balance is achieved. At a certain length the picture may deteriorate badly, as also the sound, but a compromise can often be found which gives the desired effect. Care should be taken to ensure that the stub remains open-circuit at the far end after each cut. The principle is that the reflections in the main cable due to the mismatch are cancelled out by the further reflections in the stub when it is properly balanced in terms of length. To avoid having to join the cables as shown in Fig. 1, the Belling & Lee type 1.615 twin right-angle coaxial plug can be utilised.

Metal conductors and other aerials in proximity can also affect the tuning and impedance of an aerial and cause it to favour either the vision or sound signal at the expense of the other. Attic and indoor aerials are especially vulnerable in this respect, as also are aerials which are mounted with a host of others on a shared chimney stack.

### Misalignment

As with the aerial, the tuning of the stages common to both sound and vision may emphasise the vision at the expense of the sound. It is often quite a simple matter, after attending to possible aerial troubles, to restore a good balance by adjusting the cores in the aerial and R.F. coils so that slightly greater amplification is given to the sound signals. This will, of course, reduce the picture, but then this can be brought back by advancing the contrast control and at the same time the sound will also be increased. Excellent balancing is possible by this means, as will be appreciated.

With sets featuring a turret or multi-channel tuner it is not always easy to get to the aerial and R.F. cores while the set is working. Here it is usually necessary to unclip the aerial coil and turn the appropriate core a turn or so and then try the set again after re-inserting the coil. This is purely a matter of trial and error to find which way the core needs to be adjusted to give the required effect.

One must never be tempted to adjust the trimmers associated with the R.F. and oscillator circuits which are present on the top of the tuner chassis, as this will throw the multi-channel alignment right out of balance. It is permissible, however, to adjust the I.F. coil or transformer on the unit, and this represents another effective method of obtaining sound and vision balance. It will be found that as the core is rotated in one direction the vision will increase, and that as it is rotated in the other direction the sound will increase. A compromise setting can easily be established.

If the sound is well below normal the trouble may be caused by misalignment of the sound I.F. channel. This can be checked quite simply by first ensuring that the local oscillator is adjusted for optimum vision quality and minimum sound-on-vision and then adjusting the cores in the sound I.F. transformers for maximum sound. Care should be taken not to disturb the sound

rejector cores or the core associated with the sound pick-up coil as their correct adjustment is critical and calls for the use of a signal generator and video output meter.

Fig. 2 shows the skeleton circuit of a common stage and the sound I.F. stages. The sound signal is extracted from the anode circuit of the common stage and fed to the first sound I.F. amplifier valve through the coupling capacitor C1. The cores which would need to be adjusted in this case are L1, L2, L3 and L4. At this stage it is worth noting that value alteration or failure of C1 would reduce the sound signal applied to the sound I.F.s and also possibly detune L5.

There is also another angle to this problem of unbalance, and that is, if one of the damping resistors happens to go open-circuit, such as R1 and R2 in the diagram, the sensitivity of the vision

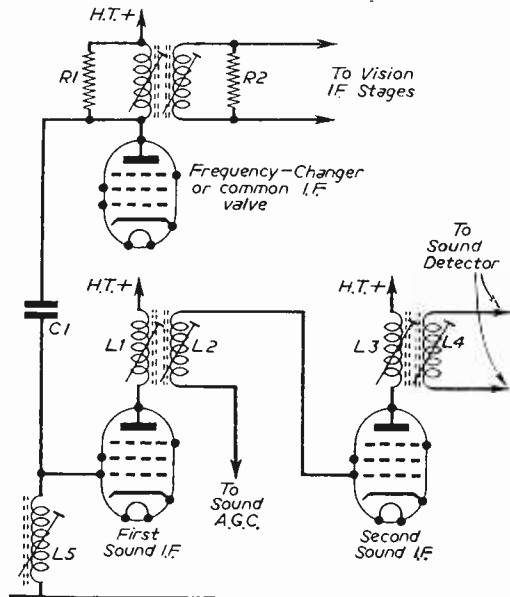
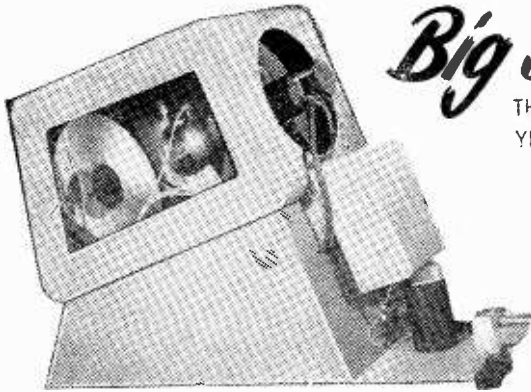

Fig. 2.—Skeleton circuit of a common stage and the sound I.F. stages.

channel would increase, and this would call for a decrease in contrast setting to avoid the picture being too black and white. This, then, would also mean that the sound signal would be attenuated and the sound volume may fall well below normal. With this trouble, however, the definition of the picture may be impaired due to the resistor failure narrowing the vision passband.

There are, of course, a host of other causes of poor sound which cannot adequately be dealt with in this article, but if the unbalance does not appear to be between the actual vision and sound R.F. or I.F. signals, attention should be directed to the sound detector and A.F. stages. Germanium crystal diodes serving as the sound detector and noise limiter should be investigated, as also should the A.F. and sound output valves.

The best way of proving whether or not the aerial is responsible is to check the set on a neighbour's aerial. This may save considerable time and avoid unnecessary work in the receiver.



The Cintel projector with side removed to show the cathode ray tube and mirror and correcting plate for projecting pictures on to a screen 40ft. away.

WHEN a bountiful science saw fit to accelerate the progress of TV developments so that it could dovetail its many benefits into the sphere of everyday life, it gave birth to countless arguments on what constituted a satisfactory-sized television picture for both public and domestic viewing. The advent of television took place in the prosperous cinema era, when, at a relatively low cost, the whole family could be entertained in comfort at the local picture theatre, and the yardstick for public television viewing became the large dimensioned cinema screen. This served as a challenge to those engaged in television's development apart from the domestic viewing, and the pace at which the required goal was achieved did credit to those who kept to this side of the industry's development.

### Low Definition 30-line Period

In the low definition 30-line period there were two companies who devoted considerable effort to this work—Scophony and Baird. The latter achieved a small measure of success with simple Kerr cells and neon tubes, but the first screen of any size to be seen by a large audience was the lamp screen shown in 1930 on the roof of the Baird laboratories in Long Acre, London. This was made up from 2,100 small metal-filament lamps, each housed in a cubicle, the whole having the appearance of an out-size honeycomb. The lamps were connected individually to a bar of a stationary circular commutator and this was swept with a contact arm which revolved at 750 r.p.m. thus giving 26,250 contacts every second. The incoming television signal was fed to the revolving contact after amplification, with the result that the degree of incandescence of each bulb was dependent on the degree of television signal modulation at that instant. The resultant mosaic of bright and dim lamps when viewed in this manner gave a picture of somewhat surprising brilliance within the limits of the low definition system then existing.

Prior to this, the American Telephone and Telegraph Company had, in 1927, shown a small screen built up from a continuous neon tube,

# Big Screen T.V.: Will it

THE AUTHOR TRACES BACK OVER THE PAST 30 YEARS THE VARIOUS TRENDS IN THE DEVELOPMENT OF LARGE SCREEN VIEWING

By H. J. Barton Chapple, B.Sc.

the fluorescent areas of which were activated in sequence with the aid of a commutator. This was followed by the General Electric Company of America and Telefunken of Germany showing a spot-light projector. Since the metal-filament lamps had luminous inertia, however, the overall brightness of the picture was an improvement on these other methods, for persistence of illumination supplemented persistence of vision.

Then early in 1931 an arc lamp was adapted to permit of direct modulation by television signals and the resulting picture was built up with the aid of a large mirror drum scanner. Because an arc lamp formed the basis of this device, there was naturally an increase in the intrinsic brilliance of the resulting picture, but although *Nature* in its subsequent write-up of the demonstrations voiced an opinion that "the television arc would appear to have a useful future" this was not to be and its development was shelved in the light of subsequent research.

### Three-zone Television

The summer of 1932 was, in its way, historic in the annals of big-screen television, for it saw the advent of three-zone television linked to that world-famous horse race—the Derby. For this ambitious experiment a caravan was used to

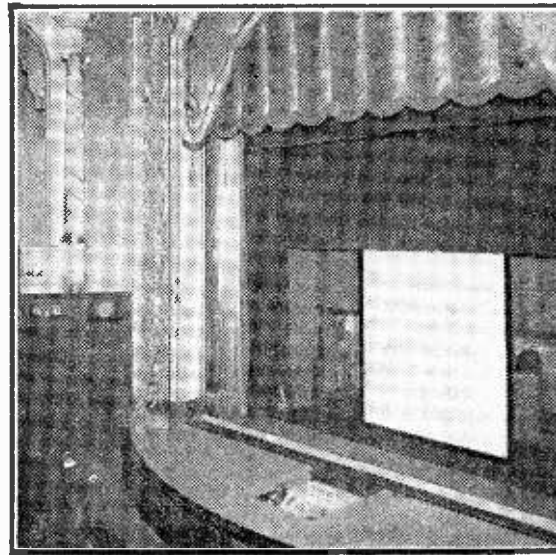

The television screen with the three-zone equipment seen

ome?

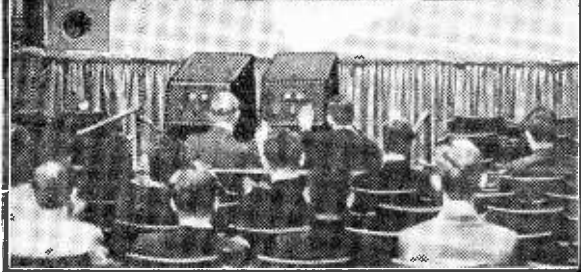
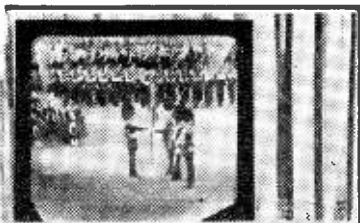

The early cathode ray tube projection equipment at the Tatler Cinema.

house the transmitting equipment on the Epsom Downs opposite the Grand Stand. It included a large mirror drum which, when revolved, reflected images of the scene on to a lens and thence to three separate photo-electric cells. The electrical signal output of each cell, after amplification, was fed into 25 miles of telephone cable linking up to the Metropole Cinema, London. The signals terminated at three separate grid cells which, in effect, were modifications of Kerr cells. The cells were built up from Nichol prisms and a glass container filled with nitrobenzine.\* Changes in the refractive index of the fluid under the influence of electric potential stresses together with the prisms, alters the proportion of light passing through the combination. These cells, when placed in the beams from three arc lamps, modulated them and in conjunction with a mirror drum synchronised to that at the transmitting end, the television picture was back projected in three adjacent zones on a screen 10ft. wide  $\times$  8ft. high. This was the first time a television screen so large had been seen by a cinema audience, and in spite of the extreme difficulties of matching the three zones so that they phased side by side the finish of the Derby was seen clearly on the screen and two days later the experiment was repeated for the Oaks.

Although multizone television was a big step forward, since with the three matched zones in juxtaposition it gave a 90-line definition picture from the 30-line standard vertically scanned, it still fell far short of the larger, good quality film pictures seen in the cinema. The novelty appeal would soon wear off and it was not until the advent of high definition television (the Marconi-

E.M.I. standard of 405 lines was accepted for BBC use early in 1937) that interest was once more stimulated in this big-screen field.

### Projection Tubes

With the concentration of effort on cathode ray tubes as the most suitable medium for reproducing the high quality television pictures then available, work was undertaken on projection types which had to be of a special character to provide pictures for screens approaching cinema size. One of the main deficiencies of projection tubes relates to the use of the beam of electrons as the source of energy to produce the light for the projected picture, while the efficiency of the phosphors used in the fluorescent screen has to be studied. High accelerating voltages are necessary and this in turn has its corollary in large line and frame deflecting voltages. In spite of this drawback, however, the Baird Company in 1938 installed dual projection units in the Tatler Cinema, London. These were quite compact as will be seen from the exploded line drawing, while the EHT units were accommodated in a remote position and suitably protected to meet the L.C.C. by-laws relating to fire risks. The projectors, side by side (one in use and one spare), were located in the front row of the stalls. Many successful demon-



Timebase generators, scanning and focusing coils are all clearly visible when the panel is removed.

strations were given using the standard BBC television transmissions, the picture screen being 8ft. wide  $\times$  6ft. deep.

### Phosphor Coating

At that time a good deal of research was being devoted to ways and means of improving

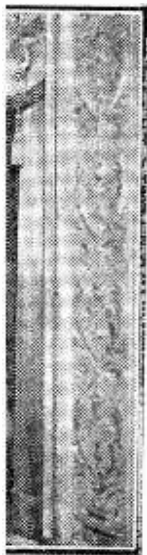

the right.

the efficiency of projection cathode ray tubes and one scheme which showed promise used a luminescent screen made up from an aluminium membrane having a suitable phosphor coating on one side. The uncoated side faced the beam of electrons, for it had been found that although thin aluminium was transparent to a beam of electrons it did not allow the ions to pass through. Thus the destructive effect of the ions on the luminescent screen was avoided, the membrane acted as a conductor of heat and improved the tube's performance, while by connecting the final anode of the tube to the membrane the space charge was dissipated. Tubes made up in this form were used quite successfully before the second world war, particularly on the Continent, and even over long periods diminution in the brilliance of the cinema-sized screen was hardly noticeable.

Yet another successful scheme took cognisance of the fact that the picture built up on the back of the phosphors used in a conventional form of projection tube lost a considerable amount of light from the absorption of the phosphors before the picture entered the optical system for ultimate projection on to the screen. A tube was therefore constructed whose shape resembled somewhat the glass envelope of the original iconoscope. A screen with its phosphor deposit was mounted inside this tube vertically opposite an optically flat glass window in front of which was the projection lens. The source of electrons, focusing

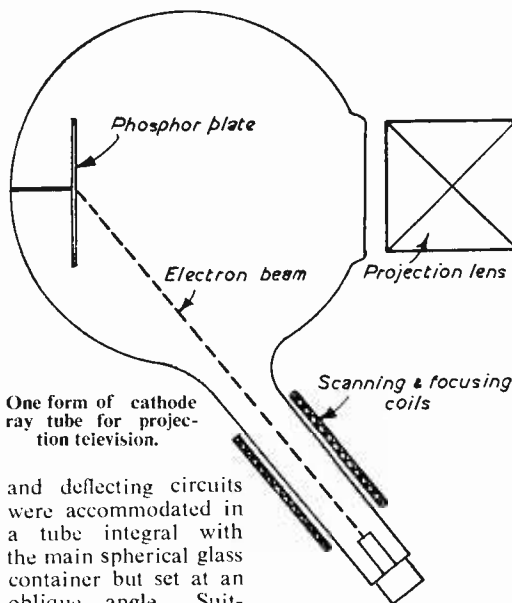

and deflecting circuits were accommodated in a tube integral with the main spherical glass container but set at an oblique angle. Suitable electrical correction was made to counteract the effects of the angle at which the scanning of the fluorescent screen was undertaken and the result was a picture twice as bright as that produced when the phosphor screen was scanned from the rear.

The first projection unit using these cathode ray tubes was installed in a London cinema by

the Baird Company and made its début on the occasion of the Boon-Danahar boxing match early in 1939. The rectangular shaped metal container was positioned in a small area towards the front of the stalls. Two tubes with their associated scanner circuits were mounted side by side so as to constitute two entirely separate projectors, capable of being faded in or out as required, to serve as one live and one standby. The EHT units were positioned in a remote screened room. All the controls (duplicated, of course) were mounted in a panel within easy reach of the operator, who sat in a low, partially screened enclosure. Specially designed projection lenses enabled the intensely brilliant pictures built up on the phosphor plate to be thrown on to a large screen on the cinema stage, the surface of the screen having been designed to give maximum light reflection to the whole of the seated audience. This equipment proved most effective and other London cinemas were similarly fitted out, but the advent of war called a premature halt to what promised to be an interesting addition to a cinema's overall programme.

### Mechanical Projectors

Coincident with this original demonstration at the beginning of 1939, the Scopony Company, which had devoted considerable effort to developing big-screen pictures, installed its mechanical projectors in a London cinema a few doors away. This equipment produced excellent pictures, using as a light valve a cell whose liquid was subjected to the action of supersonic waves. The cell, with its light output controlled by the television voltage input in conjunction with the supersonic waves and a very high speed, mirror segmented line scanner, was capable of reproducing on a screen not a single picture element at a time, as in most other systems, but one complete picture line. This, together with a low-speed frame scanner, built up a complete television picture of considerable brilliance on a remote cinema-size screen. Similar equipment was installed in one or two other London cinemas and successful demonstrations given of BBC television pictures, but the war halted progress.

After the war, the Cintel Company designed apparatus using cathode ray tubes in conjunction with a Schmidt optical projection system for cinema-size television pictures.

It is well known that even very expensive lens systems are relatively inefficient from the point of view of the overall light intensity provided on the remote viewing screen when used in conjunction with the small light output from luminescent cathode ray tube screen phosphors. Because of this, recourse was made to a Schmidt lens which comprises a spherical reflecting mirror and a plate for correcting the spherical aberrations resulting from the use of a spherical mirror. This combination has several advantages over normal lenses, the foremost being simplicity and the absence of numerous free surfaces with the consequent elimination of reflection losses. The lens has a fixed unalterable focal length, however, but its overall efficiency is very much higher and since the lenses are costly, work has been undertaken on plastic lenses with a large aperture ratio.



### Cintel Equipment

During 1940 the Radio Corporation of America showed, in that country, a picture 20ft.  $\times$  15ft. with a high-light peak brightness of 5ft./Lamberts using this method. The Cintel equipment using a Schmidt lens was first shown at a small cinema in a London suburb, and a larger version was demonstrated subsequently to a party of international delegates investigating the development of television in various countries in 1950. The screen size then was 20ft.  $\times$  16ft. and the pictures seen had a high-light brightness comparable to that of normal cinema film projection.

Technically the results achieved appear satisfactory so that any subsequent use would seem to be bound up in politics or the policy associated with viewing by a public paying audience. No such obstacle exists, however, when it comes to home viewing, but during the last year or two domestic projection sets have not achieved great popularity.

There seems to be a divergence of opinion as to what constitutes a satisfactory sized television picture for domestic viewing. So many factors have to be taken into consideration. Is the picture required to fill the angle of vision within which the eye can concentrate its attention, or is the picture size to be based on the attainment of true perspective?

The dimensions of the average sitting-room are all-important as well as the size of the family. Is the viewing distance to be X times the picture height to conform to technical standards and if the picture is too large will the set have to be located in the hall so that the scanning lines building up the picture are just not visible? Is it better to counteract the line structure by incorporating spot wobble as part of the receiver equipment? To the technically minded all these questions should be studied to achieve optimum results for home viewing, but in practice on many occasions the answer is dictated by how much the family can afford to pay for a set. It will also be found that the family just group themselves in comfortable positions round the fireside at distances from the screen to suit their own tastes and convenience.

### Viewing Screen Separate

It was not very long ago that the 9in. and 12in. diameter tubes held sway, but these have now given way to 14in., 17in. and even 21in. with the picture reconstituted on the back of the tube's fluorescent screen and viewed from the front. To many, the idea of having the viewing screen separate and detached from the picture equipment is the correct one and here the projection tube would seem to be the only answer at the moment. A small 2in. to 3in. diameter tube with a Schmidt optical system of appropriate focal length is capable of giving pictures ranging in size from a 15in. to a 5ft. diagonal. If space has to be considered, the screen can be made

integral with the receiver cabinet housing the set and in this case recourse is made to what is termed a folded version of the Schmidt optical system.

Fashions change and it is easy to conceive that research can provide some other method for television viewing. This has been made apparent

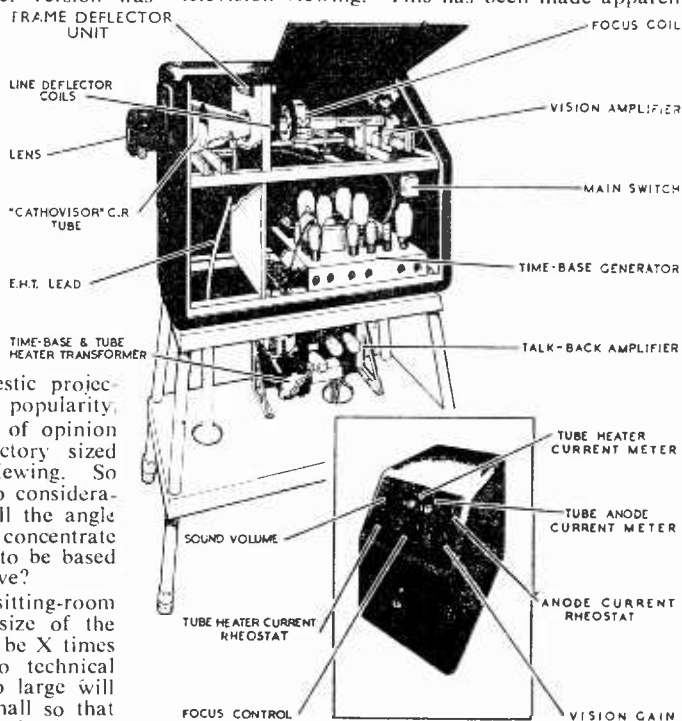

Internal view of the projection receiver with external view inset.

in colour television where triple projection tubes have been used to give satisfactory pictures. No one at the moment can give a wholly satisfactory answer to the question "Whither big-screen television?" for public or domestic viewing, but this brief survey has shown that, over the last twenty years or so, many schemes have indicated their capabilities and shortcomings, and modern science is sure to fit others into this rapidly expanding electronic age.

*A Standard Work*

## TELEVISION PRINCIPLES AND PRACTICE

2nd Edition

By F. J. CANN

Price 25/-. By post 25/8.

From GEORGE NEWNES, LTD., Tower House, Southampton Street, Strand, W.C.2.

# Vision and Electronic Recording Apparatus

## THREE-TRACK SYSTEM OF RECORDING

By J. B. Heavychurch

THE advent of the BBC's Vision and Electronic Recording Apparatus (VERA) has brought into sharp focus the whole question of the recording of high definition television signals which has remained almost dormant since the advent of the American Ampex Video-tape Recorder. The impact of the demonstrations of this latter machine given in 1956 were considerable when it is remembered that the video signals use maximum frequencies in terms of megacycles, whereas magnetic tape normally dealt with the kilocycles of audio for sound recording. Up-to-date details of the Ampex machine were given in the August issue of this journal following a demonstration given by Associated-Rediffusion Limited. Readers will recall that there were four recording heads and a relative writing velocity of tape to head of 1500in./sec., although the tape speed is only 15in./sec.

### Sound and Video Signals

With Vera there is a three-track system of recording, one being employed for the sound signal and the other two for the video signal, band split to cover 0 to 100 kc/s and 100 kc/s to 3 Mc/s. This coupled with the recording tape speed of 200in./

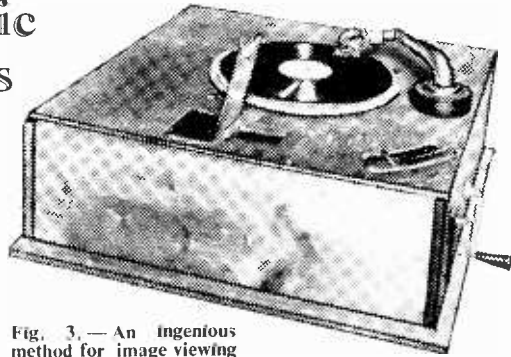

Fig. 3.—An ingenious method for image viewing from Phonovision records.

sec. is the basis of a machine which is hailed as an outstanding engineering achievement, both mechanically and electronically.

The commercial implications of these two

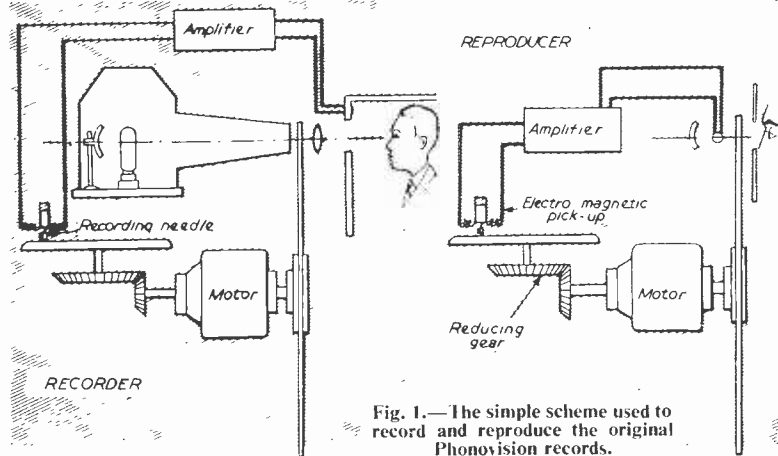

Fig. 1.—The simple scheme used to record and reproduce the original Phonovision records.

television signal recorders emphasised the tremendous strides which have been made since Phonovision, as it was then called, was first

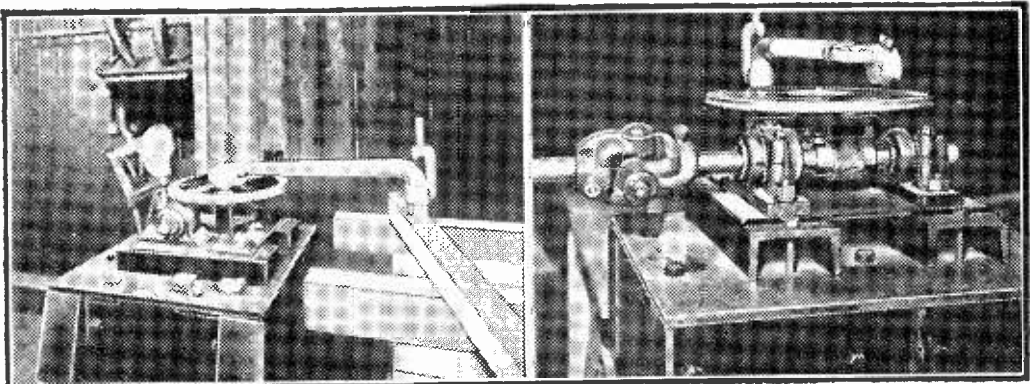

Fig. 2.—Making Phonovision records 30 years ago was almost a "heavy engineering" task, but was successful for low definition pictures.

demonstrated by Baird in the middle of 1928. The low definition system then used had a frequency range within the audio spectrum and it was, therefore, quite natural to record these frequencies on an ordinary gramophone record. The scheme is made clear in the diagram, Fig. 1. On the recording side the record turntable and scanning disc are driven from the same motor with the aid of reduction gearing and the electrical impulses proportional to the photoelectric signals derived from the scanning light pulses were passed to the recording needle. Two of the accompanying illustrations bring to light the "heavy engineering" side of this work for on one is seen the famous dummy's head Stookie, the photoelectric cells above it, the recording table and the large diameter shaft passing through the

wooden partition to the main motor driving the scanning disc. The second illustration gives a clear impression of the worm drive and coupling all of which were clamped via metal channelling to a rigid table (see Fig. 2).

### Reproducing Mechanism

On the right of the diagram is the reproducing mechanism where the pick-up on the record had its impulses amplified and fed to the neon lamp scanning disc viewing mechanism. One simple form of this was a record player mounted on top of a wooden case with the disc turning horizontally inside, the small picture being viewed in a mirror something like a periscope (see Fig. 3). It is understood that a few of these Phonovision records are still in existence—curios of a pioneering age.

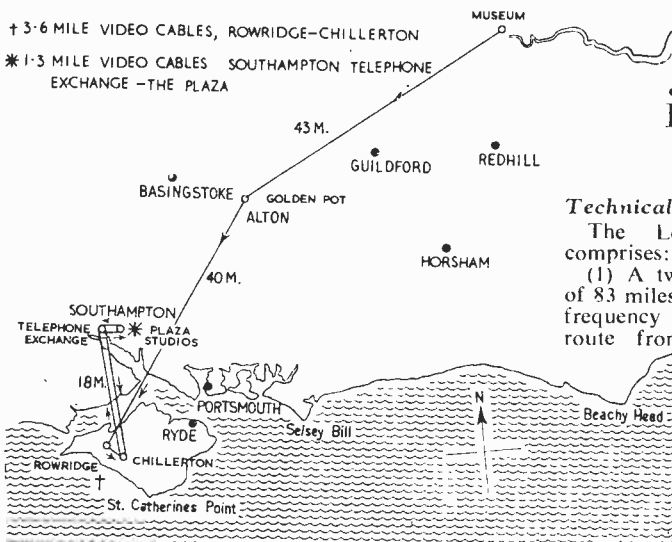

## Television in the South

NEW POST OFFICE LINK

### Technical Details

The London to Southampton system comprises:

(1) A two-hop microwave radio-relay link, of 83 miles length, operating in the 4,000 Mc/s frequency band and installed on the existing route from Museum Telephone Exchange,

London, via a repeater station at Golden Pot, near Alton, Hants, to the receiving terminal situated in the BBC television broadcasting station at Rowridge, I.O.W.;

(2) A video link of  $3\frac{1}{2}$  miles on co-axial cable from Rowridge to the I.T.A. station at Chillerton Down;

(3) A single-hop microwave radio-relay link, of 18 miles length, operating in the 2,000 Mc/s frequency band, from the I.T.A. station at Chillerton Down to the Post Office Telephone Exchange in Southampton;

(4) A video link of  $1\frac{1}{2}$  miles length on co-axial cable from the Southampton Telephone Exchange to the Plaza Studio.

The Southampton to Chillerton Down system comprises:—

(1) A video link of  $1\frac{1}{2}$  miles length on co-axial cable from the Plaza Studio to Southampton Telephone Exchange;

(2) A single-hop 2,000 Mc/s microwave radio-relay link, of 18 miles length, from Southampton Exchange to Chillerton Down.

To guard against interruption of television signals by equipment failures during programme time, the equipment, with the exception of aerials, is duplicated throughout to provide two independent signal paths.

**W**HEN Southern Television opened on August 30th, its programmes were carried to the I.T.A. transmitter at Chillerton Down, I.O.W., over a link provided and operated by the Post Office. This link is in two parts. One carries the I.T.A. national network programme from London to the Southern Television Plaza Studios at Southampton. The other carries the network programme, locally provided programmes and advertising material inserted at the Plaza Studios, to the I.T.A. transmitter at Chillerton Down.

The link is about 125 miles in length, most of which is provided by microwave radio relays. Short connections between Rowridge and Chillerton Down, and between Southampton Telephone Exchange and the Plaza Studios, use co-axial cables. Television signals are transmitted by radio from the Museum Telephone Exchange in London to Rowridge, I.O.W. A new 30ft. aerial has been erected on the roof of the Southampton Telephone Exchange for the radio link to Chillerton Down.

### Radio Equipment

The 4,000 Mc/s radio equipment serving the Museum-Golden Pot-Rowridge link was designed, manufactured and installed by the Radio Experimental Branch of the Post Office Engineering Department. At each transmitter the video signal is arranged to frequency-modulate an intermediate frequency carrier of 60 Mc/s which in turn phase-modulates a travelling-wave valve driven by a 4,000 Mc/s carrier. A second travelling-wave valve further amplifies the microwave signal to produce an output power of about 1 watt. At each terminal receiver the microwave signal is translated to the 60 Mc/s intermediate frequency range by means of a crystal mixer. Amplification at this frequency is followed by demodulation to recover the video signal. At each repeater similar techniques are used except that the intermediate frequency signal, instead of being demodulated, is amplified and caused to remodulate the travelling-wave valve.

### Microwave Carrier Frequency

The frequency of microwave carrier driving this valve differs by 72 Mc/s from that incoming to the repeater. Waveguide branching filters are used for combining the outputs of the transmitters and repeaters with those of the radio link provided on this route for the BBC. The inputs of the receivers and repeaters are combined in similar fashion. This enables the use of common aerials and aerial feeders for the I.T.A. and BBC links. The aerials are paraboloid dishes each of 10ft. diameter and with waveguide feeders. The aerial at Museum Exchange is 70ft. above roof level, at Golden Pot 200ft. to 300ft. above ground, at Rowridge 70ft. up the BBC mast.

The 2,000 Mc/s radio equipment serving the links between Chillerton Down and Southampton was provided and installed by the General Electric Company, Coventry, under Post Office contract. At each transmitter the video signal is arranged to frequency-modulate a 70 Mc/s intermediate frequency carrier which is amplified and then translated to 2,000 Mc/s by means of a triode valve mixer. Amplification at this frequency is by use of triode valves in two stages to produce an output power of about 2 watts. At each receiver the signal is translated to the 70 Mc/s intermediate frequency range by means of a crystal mixer; and, after amplification, is demodulated to obtain the video signal. Co-axial-type branching filters are used for combining the transmitter outputs at each station. The receiver inputs are combined in similar fashion. At each station two co-axial aerial feeders are used; the one serving the transmitters and the other the receivers. The 12ft. diameter paraboloid dish acts as a common aerial for transmitting and receiving. The feeders enter the launching units which illuminate the paraboloids so that the radio signals being sent and received at a station have orthogonal polarisation, thus avoiding interference between transmitters and receivers. The aerial at Southampton Exchange is 30ft. above roof level and that at Chillerton Down is 160ft. up the I.T.A. mast.

## SERVICING TELEVISION RECEIVERS

(Continued from page 189)

### Removal of Main Chassis

Disconnect scan coil leads from main deck, C.R.T. base socket and EHT lead. Remove volume and brightness knobs and unplug speaker leads from socket on side of cabinet. Remove lead from cabinet foil and disconnect bonding strip between chassis if this has not already been removed from R.F. unit. Remove the two 2 B.A. bolts securing chassis flange to cabinet.

### Removal of C.R.T.

Remove chassis as above, place cabinet face downwards on soft surface and remove the *ion trap magnet* from the tube neck. Unscrew the two P.K. screws securing cross member to cabinet and remove complete with focus assembly. Slacken deflector coil assembly clamp (immediately above line form control TC3) and withdraw scan coil assembly. Unscrew all nuts securing front C.R.T. supporting strap to inside of cabinet and withdraw C.R.T. from cabinet complete with mask.

### Useful Details

**Valves.**—Five ECL80, two EB91, two PCF80, two PCL83, two PY82, one ECC82, one ECC83, one EY51, one PCC84, one PL81, one PY81, two 39K1 (small metal rectifiers) used in discriminator—line sync circuit, two OA71 crystal diodes, one as a pulse limiter, the other as an interlace diode.

**Fuses.**—Two 500 mA. I.F. sound 38.15 Mc/s, vision 34.65 Mc/s.

**Electrolytic Capacitors.**—Two 2 mfd. 350v, 50 mfd. 25v, 100 mfd. 25v, 100 + 100 mfd. 275v, 200 mfd. 275v.

**EHT Voltage.**—13.5 kV approx.

**Mains.**—A.C. or D.C. 200-250v.

**Controls.**—Vis limiter, 100 K $\Omega$ ; contrast, 1 M $\Omega$ ; volume, 1 M $\Omega$ —brightness, 200 K $\Omega$  (combined); frame hold, 2 M $\Omega$ ; height, 2M $\Omega$ ; line hold, 1M $\Omega$ ; width, 2K $\Omega$ .

(To be continued)

## JOIN THE PRACTICAL GROUP

Edited by F. J. CAMM

PRACTICAL WIRELESS ... ..	1/3
PRACTICAL TELEVISION ... ..	1/3
PRACTICAL HOUSEHOLDER ... ..	1/3
PRACTICAL MECHANICS ... ..	1/3
PRACTICAL MOTORIST & MOTOR CYCLIST ... ..	1/3

They are all published monthly

# Widescan Television

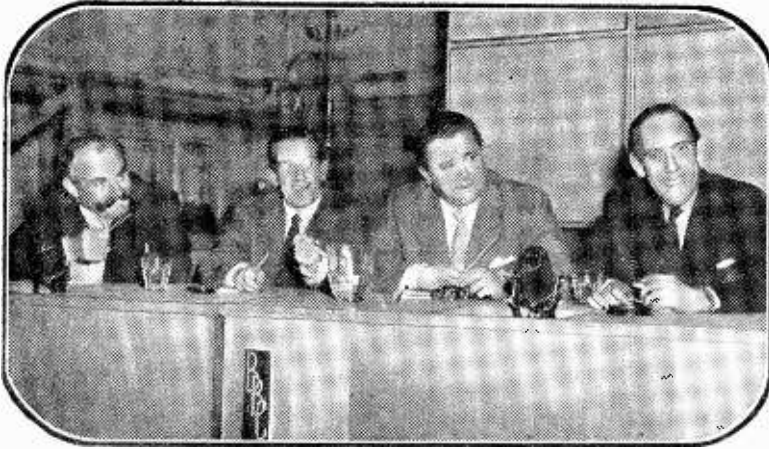

A comparison between the present aspect ratio of 4:3 and widescan 7:4.

**T**HE BBC has recently undertaken experiments using a picture aspect ratio of 7:4 instead of the present 4:3, and the illustrations on this page show a comparison between the present and the proposed ratios. It must be stressed, however, that there is no possibility of any immediate change as far as the viewer is concerned: it is only a possibility of the distant future. *Do not therefore defer purchasing a new TV receiver in the mistaken belief that this change is imminent. It is not.*

## More Detail

The experiments, however, demonstrate clearly that such a change is necessary when the industry is prepared for it, and that will not be for several years. You will see from the wider picture that much more detail can be incorporated. The movement and action in a television picture or cinematograph picture takes place more in a horizontal direction than in a vertical direction, and the increase in width proposed shows that much more detail can be given. Our present aspect ratio of 4:3 is based to some extent on the shape of the cinematograph picture, and of course on the shape of the TV tube. Mr. Richard Levin, the BBC head of design, who is responsible for the experiments believes that the aspect ratio of the TV picture should be related to the scene depicted and not to the shape of the tube.

## More Pleasing Picture

There is very little upward movement in a television stage set. No doubt the idea germinated after wide-screen cinema pictures were introduced to the cinema. It is a logical development for TV. There can be no doubt that a more pleasing picture results from the new aspect ratio. It cuts out unwanted top detail and increases horizontal detail. In fact, it enlarges the area of the picture upon which the viewer concentrates. It also

## A BBC EXPERIMENT IN ASPECT RATIO

By F. J. Camm

means less crowding of the actors, and for outside broadcasts it would be a vast improvement. It is also much easier on the eye to watch.

## Making the Change

Sir Ian Jacob is entirely in favour of the change, but the first move must obviously come first from the industry and next from the public. It



would mean a long-term policy so that the change could be made without disturbing the production lines, and I suggest that in order to spread the change over a period sufficient to enable the new system to be adopted without disturbing production the BBC should put out two programmes, one on the old system and one on the new, gradually fading out on the old.

## No Technical Snags

There are few technical problems involved. Some system of masking existing receivers could be a temporary measure until the change over is complete. It is well known that the industry is in need of some new development to revive public interest.

However, design cannot be allowed to remain static and there have been no major improvements in design in TV since the introduction of EHT from the flyback, and the introduction of wide-angle tubes. Another point arises: is direct viewing to remain? Will projection TV be the eventual answer? The TV tube at present is cumbersome and looks wrong, and it is a fundamental of design that a thing which looks wrong is wrong. There can be no doubt, however, that once the public has viewed on the widescan idea they will not wish to return to the old.

# BBC Television Translator

THIS EQUIPMENT CAN BE USED FOR AUTOMATIC OPERATION

**T**HE BBC began transmitting programmes on July 14th, 1958, from a new type of low-power television transmitter, known as a "translator," which is undergoing extended service trials at Folkestone. This town is typical of small populated areas which are within or adjacent to the service areas of the main BBC stations, but are prevented by surrounding hills from obtaining satisfactory reception.

## Converts Sound and Vision Transmission Frequencies

A translator converts the sound and vision transmission frequencies from one channel to another without demodulation to audio and video frequencies, which occurs when a normal receiver and transmitter relay installation is employed. This simplification increases the reliability of the equipment which can therefore be arranged for automatic operation without attendant staff. Because the equipment is small it can conveniently be housed in weatherproof and insect-proof cabinets, thus dispensing with the need for a station building. The BBC utilises cabinets of existing design and special precautions have been taken to provide sufficient cooling. The power supply is included in the steel cabinets, so that the translator can work direct from the mains.

## Location

The translator must be on high ground where good reception is possible from an existing station in the BBC network and from where its transmissions can be radiated over line-of-sight paths to the area to be served. In this way only a very low-power output is required, which therefore does not add to the already serious co-channel interference problem.

The receiving aerial system consists of a double 3-element array and the transmitting aerial has four tiers of single, folded dipoles.

## Difficulties

If the sound and vision signals of a television system are amplitude modulated, difficulties are introduced if they share a common amplifier in the translator because of the greater possibility of intermodulation. These difficulties are eased in the systems such as those used on the Continent in which the sound signal is frequently modulated. It is hoped that these and other difficulties have now been overcome with the system developed by the BBC. Separate channels have been provided for the amplification of the sound and vision signals using common frequency-changing oscillators. The separate channel arrangement reduces the risk of intermodulation and enables separate

automatic gain control to be employed to combat the effect of differential fading between the sound and vision signals, which could occur if a translator were dependent upon reception from a really remote BBC station. The automatic gain control voltages are also used to initiate an automatic changeover to reserve translator equipment should the normal unit become faulty.

## Spurious Signals

The double frequency-changing process facilitates the rejection of spurious signals and provides additional protection against "in band" feedback. The first frequency-changing process resembles that in a normal television receiver, producing vision and sound intermediate frequencies of 34.65 Mc/s and 38.15 Mc/s respectively, and the second frequency-changing stage produces vision and sound signal frequencies in the required channel.

## Power Output

The Folkestone translator peak white vision power output is 1.5 watts and in conjunction with the type of transmitting aerial used gives an effective radiated power of 7 watts in the direction of maximum radiation. It is hoped that the installation of similar low-power translators which have been developed by the BBC's Designs Department will enable at least some of the small populated areas, in which satisfactory reception is difficult, to be given an improved television service. The illustration below shows the television translator equipment being installed at Folkestone in special weatherproof cabinets.

The BBC also intends to develop translators to extend the BBC's V.H.F. Sound Broadcasting Service to small areas which are prevented by intervening high ground from obtaining direct reception from the main stations.

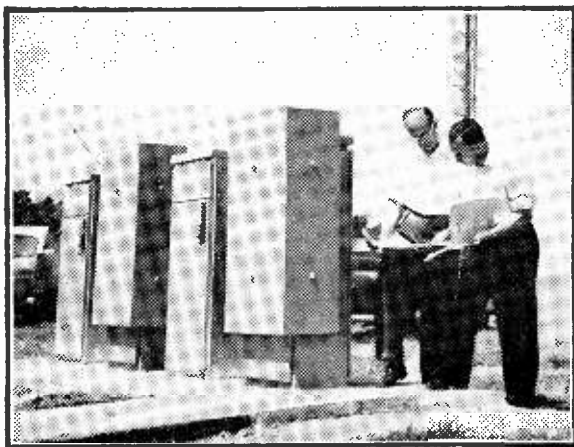

Showing engineers installing the equipment.

**17in. T.V. CHASSIS, TUBE & SPEAKER, £19.19.6.**

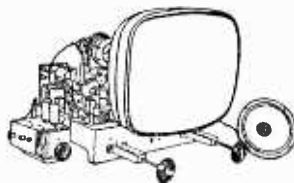

17in. Rectangular Tube on modified chassis. Supplied as single channel chassis covering B.B.C. channels 1-5, or incorporating Turret Tuner which can be added as an extra, at our special price to chassis purchasers 50/- giving choice of any 2 channels (B.B.C. and I.T.A.). Extra

channels can be supplied at 7/6 each. Chassis size 12in. x 14 1/2in. x 11in. less valves. Similar chassis were used by well-known companies because of their stability and reliability. With tube and speaker, £19.19.6. With all valves, £25.19.6. Complete and working with Turret Tuner, £28.9.6. 12 months' guarantee on the tube, 3 months' guarantee on the valves and chassis. Ins. Carr. (incl. tube) 25/-.

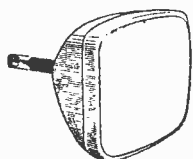

**REGITTERED IMPROVED VACUUM T.V. TUBES,**

17in., £7.10.0.  
14in., £5.10.0.

**12 MONTHS' GUARANTEE**

Our 12 months' guarantee (6 months full replacement, 6 months progressive) illustrates our wholehearted confidence in the Tubes we offer. We sell many hundreds a week throughout the country and have done so for the past 7 years. Many of them go to the Trade, i.e., to Insurance Companies, Renters and Retailers who are thoroughly satisfied with our supplies. Remember they also hold a 10 days' money back guarantee.

**9in., 10in., 14in., 15in. and 16in. ROUND TUBES.** Our special offer of these sizes, £5. 12in. T.V. tubes, £6. Three months' guarantee on round tubes. Ins. Carr. 15/6

**14in. RECTANGULAR T.V. TUBES** with burns, 30/- Ideal as a standby or testing purposes. Carriage 10/-

**EXPRESS DESPATCH SERVICE.** Phone to confirm tube in stock. Send Telegraph Money Order. On receipt of same, tube despatched Passenger Train same day.

**ELECTRIC CONVECTOR HEATER, 99/6**

Start to prepare for Winter now. Draughty corners no longer necessary. Electric Convector Heaters will give you a steady comfortable heat. They can be used in any part of the house where there is a plug. Don't forget—luxurious warmth at an economical price. A.C./D.C. Switched for 1 or 2 kW. Illuminated grille. Size 26in. x 18in. x 7 1/2in. deep. Ins. Carr. 10/6.

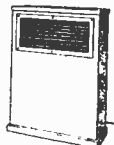

**EXTENSION SPEAKERS, 29/9**

Fitted with an 8in. P.M. Speaker W.B. or Goodmans of the highest quality. Standard matching to any receiver (2-5 ohms.). Switch and flex included. Unrepeatable at this price. Money back if not completely satisfied. Ins. Carr. 3/6.

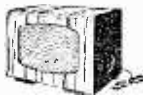

**8in. P.M. SPEAKERS, 8/9**

Don't miss the football results just because you want to wipe up for the wife. Why not fit a speaker in the kitchen. She'll be pleased, too. 8in. P.M. Speakers, 8/9. With O.P. Transformer fitted, 10/- 6 1/2in. P.M. Speaker, 12/6. Postage 2/9.

**PLESSEY SOUND AND VISION STRIP, 25/6** Superhet. Tested. I.F.s 10.5 Mc/s sound. 15 Mc/s vision. 8 valve bases (6-6Fs and 2-6D2s not included). Size 8 1/2in. x 5in. x 4 1/2in. high. Post and packing 2/6. The Turret Tuner plugs directly into this chassis.

**SOUND AND VISION STRIP, 10/6.** Superhet. Complete vision strip. Less valves. Not tested. Drawings free. Postage 2/6. **CHASSIS, 1/-** each, 6 or 8 valve. Latest type midge valve design for A.M. or F.M. Brand new cadmium plated. Size 12 1/2in. x 7 1/2in. x 2 1/2in. Post 1/9, 4 for 4/-, Post 3/-, 12 for 10/-, Carr. 5/-.

**SUPER CHASSIS, 99/6**

5 valve superhet chassis including 8 in. P.M. speaker and valves. Four control knobs (tone, volume, tuning, w/change switch). Four w/bands with position for gram. P.U. and extension speaker. A.C. Ins. Carr. 5/6.

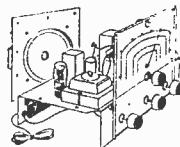

**SOLO SOLDERING TOOL, 12/6**

110 v. or 6 v. (special adaptor for 200/240 v., 10/- extra). Automatic solder feed, including a 20 ft. reel of Ersin 60/40 solder and spare parts. It is a tool for electronic soldering or car wiring. Revolutionary in design. Instantly ready for use and cannot burn. In light metal case with full instructions for use. Post 2/9.



**AND NOW WE PROUDLY PRESENT SOME NEW LINES**

**RECORD CABINETS, £3.15.0**



No more piles of records—bad for them and an eyesore to you. We are delighted to be able to offer this attractive record cabinet at such a remarkably low price. It is

reed fronted and wood partitioned for easy classification and filing. It will take 200-300 records in an upright position. The overall size is 24in. x 24in. x 15in. and the legs are detachable if you so wish. The design is modern and it is space saving because it will serve a dual purpose being ideal also as a T.V., Radio or Record Player stand. Complete, sand papered finish, ready for staining, French polishing, painting, etc. Postage, packing and Ins., 5/-.

**RECORD PLAYER CABINET, 39/6**

Amazing offer. Latest contemporary style, rexine covered cabinet in two-tone colour scheme. Hinged, clipped lid, carrying handle. Space available for all modern amplifiers and auto changers, etc. Store soiled. Carr. and Ins. 4/6.

**COLLARO 4-SPEED AUTO CHANGERS, £7.19.6.** Type R.C.457 incorporating auto and manual control, complete with studio crystal p.u. and sapphire stylus. Post, packing and Ins. 5/6.

**PORTABLE AMPLIFIER MARK D.1, 59/6.** Brand new. Latest design with printed circuit. Dimensions 7in. x 2 1/2in. x 5in. A.C. only. Mains isolated. 2-3 watts output. Incorporating EL84 high gain output valves. Volume and tone controls. Post and packing 3/6.

**PORTABLE AMPLIFIER MARK D.4, 69/6.** Brand new. By famous manufacturer. Especially built for portable record players. Dimensions 4 1/2in. x 3 1/2in. x 4in. A.C. only. 2 valves EL84 as high gain output valve. EZ80 as rectifier. Volume and tone controls. Post and packing 3/6.

**STEREOPHONIC AMPLIFIER, £7.19.6.** (12 months' guarantee). Beautifully made for portable stereophonic record players. Latest design with printed circuit. Dimensions 3in. x 5 1/2in. x 9 1/2in. A.C. only. Mains isolated. Each amplifier gives 3-4 watt output. Incorporating ECL82 triode pentode valves. Tone volume and balance controls. Complete and ready to fit. Knobs 3/6 per set extra. Post, packing and Ins. 4/6.

**MAINS TRANSFORMERS, 15/9.** 350-0-350 v. 250 mA., 6 v. at 5 amp., 4 v. at 4 amp., 22 v. at 6 amp., extra winding for 2 v. or 4 v. tubes. Primary 200-250 v. 50 cycles. Post and packing 3/9.

**MAINS POWER TRANS., 12/9.** 350-0-350 v. 250 mA., 6 v. heater at 5 amp. 4 v. at 5 amp., 4 v. centre tapped. Drop through type. Prim. 200-250 v. (4 1/2in. x 5in. x 5in.). Post 3/9.

**MAINS TRANS., 3/9.** 350-0-350 v. 80 mA., 4 v., 4 v. heaters. 250-250 v. prim. Post 2/3.

**MAINS TRANS., 5/9.** 280-0-280 v. 80 mA., 6 v. 4 v. heaters. 200-250 v. prim. Post 2/3.

**TERMS AVAILABLE**  
Liverpool St. to  
Manor Park 10  
Mins.

Send for **FREE Catalogue** to:—  
**DUKE & CO.**  
(Dept. E.11), 621/3, Romford Road, Manor Park, E.12.  
Telephone: ILFORD 6001/3

**OPEN SATURDAY**  
**ALL DAY**  
**CLOSED THURSDAY**  
1 p.m.

**COMPLETELY BUILT  
8 WATT AMPLIFIER**

Complete with Crystal Mike and 8" Loudspeaker A.C. Mains 110/250 v. Size 10 1/2 in. x 6 1/2 in. x 2 1/2 in. Incorporating 6 valves, H.F. pen., 2 triodes, 2 output pens, and rectifier. For use with all makes and types of pick-up and mike. Negative feedback. Two inputs, mike and gram, and controls for same. Separate controls for Bass and Treble lift. For use with Std. or L.P. records, musical instruments such as Guitars, etc.

**£4.19.6**  
Plus P. & P. 5/-

**SIGNAL GENERATORS**

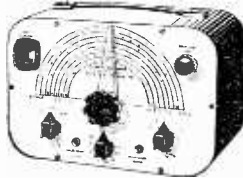

£6.19.6 or 25 - deposit and 6 monthly payments of 21/6. P. & P. 5/- extra. Coverage 100 Kc - 100 Mc's on fundamentals and 100 Mc's to 200 Mc's on harmonics. Metal case 10 1/2 in. x 6 1/2 in. x 5 1/2 in., grey hammer finish. Incorporating three miniature valves and Metal Rectifier. A.C. Mains 200-250. Internal Modulation of 400 c.p.s. to a depth of 30%; modulated or unmodulated R.F. output, continuously variable, 100 milli-volts, A.F. output. Incorporating Accuracy plus or minus 2%.

C.W. and mod. switch, variable magic-eye as output indicator.

£4.19.6 or 25 - deposit and 4 monthly payments of 21/6. P. & P. 5/- extra. Coverage 120 Kc - 94 Mc's. Metal case 10 1/2 in. x 6 1/2 in. x 4 1/2 in. Size of scale, 6 1/2 in. x 3 1/2 in., 2 valves and rectifier, A.C. mains 230-250 v. Internal modulation of 400 c.p.s. to a depth of 30%, modulated, or unmodulated R.F. output continuously variable 100 milli-volts, C.W. and mod. switch, variable A.F. output and moving coil output meter. Grey hammer finished case and white panel. Accuracy plus or minus 2%.

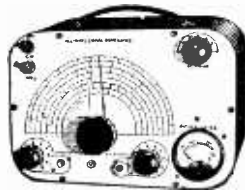

**SIGNAL & PATTERN GENERATOR**

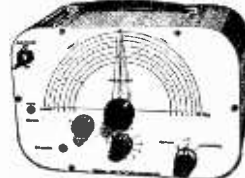

25/- deposit plus P. & P. 5/- and 6 monthly payments of 21/6. Cash £6.19.6 plus P. & P. 5/-, Coverage 7.6 Mc's - 210 Mc's in five bands, all on fundamentals, slow-motion tuning, audio output, 8 vertical and horizontal bars, logging scale. In grey hammer finished case with carrying handle. Accuracy ± 1%. A.C. mains 200-250 v.

**AC/DC POCKET MULTI-METER KIT**

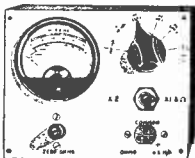

Comprising 2in. moving coil meter scale calibrated in AC/DC volts, ohms and milli-amps. Voltage range AC/DC 0-50, 0-100, 0-250, 0-500, milli-amps 0-10, 0-100. Ohms range 0-10,000. Front panel, range switch, wire-wound pot (for ohms zero setting), toggle switch, resistors and rectifier. Basic movement 2 mA. In grey hammer finished case.

**19/6** Plus P. & P. 1/6. Built and tested 7/6 extra.

Point to point wiring diagram 1/-, free with kit.

**13 CHANNEL TUNER**

L.F. 11-16 Mc's. Complete with PCF80 & PCF84. These have been removed **19/6** Plus P. & P. from chassis. 26. Less valves 9/6. Plus P. & P. 2/6.

**RADIO & T.V. COMPONENTS (Acton) LTD.**

23, HIGH STREET, ACTON, LONDON, W.3  
All enquiries S.A.E. GOODS NOT DESPATCHED OUTSIDE U.K.

**SUPER-VISION LIMITED**

EVERY ITEM BRAND NEW AND GUARANTEED AT LOW PRICES

**Enamelled Copper Wire**  
12 to 45 SWG from 11/6 lb. Also available in smaller quantities.

**Valve Holders**  
Int. Octal, 4d. each. B7G, 4d. each. B9A, 6d. each. CER. B9A with screen, 1/9 each.

**Condensers**  
2 to 100 pF., 5d. each. 220-5,000 pF., 7d. each. .01 to 1, 8d. each.

**Coil Formers and Screens**  
1/2 x 1/2 x 1 1/2 .3 dia. with iron dust core, 2/- each.  
1/2 x 1/2 x 2 1/2 .3 dia. with two iron dust cores, 3/- each.

**Resistances**  
Carbon.  
10 to 5 M. 1/2 W., 3d. each. 1/2 W., 4d. each. 1 W., 6d. each.  
2 W., 1/- each.  
Wire Wound.  
2,200 5 M. 1/2 W., 1/3 each. 5, 10 and 20 ohms, 10 W., 1/6 each.  
5, 10, 50 and 100 ohms, 20 W., 3/- each.

**Variable T/V type pots**  
3 K., 5 K., 25 K., and 1 M. 2/6 each.

**Egen Slider type**  
3 K., 5 K. and 25 K., 1/9 each.

**Volume Controls**  
.5 M., 2/9 each. .5 M. with DPS Switch, 4/3 each.

**Electrolytics**  
60/100 mfd., 5/6 each. 32+32+16 mfd. 350 v., 3/6 each.  
40+40 mfd., 450 v., 3/6 each. Clips 3d. each. 50 mfd. 12 v. 8d. each.

**Auto Transformers**  
50 W. to 1,000 W. from £1.10.0 to £9.0.0.  
Send for list, price 3d.

**SUPER-VISION LIMITED**

136 HIGH ST., TEDDINGTON, MIDDX. KINGSTON 4393.

**VALVES • SAME DAY SERVICE**

All Guaranteed New and Boxed

1.4 v. midget, 1R5, 1S5, 1T4, 3S4, 3Q4, 3V4, DAF91, DF91, DK91, DL92, DL94; ANY 4 for 27/6.

1A7GT	16/6	6V6GT	7/6	DCC90	10/6	EF42	11/6	PL83	10/6
1D5	9/6	6X4	7/6	DF33	11/6	EP60	7/6	UF30	8/-
1H5GT	11/6	6X5GT	6/6	DF91	7/-	EP86	14/-	PY81	8/6
1N5GT	11/-	7B6	12/6	DF96	8/6	EP91	6/9	PY82	8/6
1R5	8/-	7B7	8/-	DH76	7/6	EP92	5/-	PY83	8/6
1S4	10/-	7C5	8/-	DH77	7/3	EL33	16/9	PZ30	18/-
1S5	7/6	7C6	8/-	DK32	16/6	EL35	22/6	R19	13/-
1T4	7/-	7H7	8/-	DK31	8/-	EL41	9/6	SP61	3/6
1U5	6/6	7S7	8/-	DK32	8/6	EL42	11/6	U25	15/-
3A5	10/6	7Y4	8/-	DK36	8/6	EL84	8/9	U50	7/6
3Q4	8/6	12A8H	9/-	DL33	9/-	EM80	9/6	U52	7/-
3S4	7/6	12A7T	8/-	DL35	14/6	EM81	10/-	U76	7/6
3V4	8/6	12A7U	7/-	DL32	7/6	EX51	11/6	U78	7/-
5U4G	7/-	12AX7	8/-	DL94	8/6	EY86	12/6	UABC80	9/-
5V4G	11/9	12BA6	8/6	DL96	8/6	EZ40	7/9	UAF42	9/6
5Y3GT	7/6	12K7GT	7/6	EABC80	7/9	EZ41	10/-	UBC41	9/6
5Z4C	9/6	12K8GT	12/6	EAF42	9/6	EZ80	6/6	UBF80	9/6
6AL5	5/6	12Q7GT	7/6	EB91	5/6	EZ81	8/6	UPC84	18/-
6AM5	5/-	14S7	15/6	EBC33	7/-	FW4500	10/6	UCB85	9/-
6AM6	6/9	19A5	7/6	EBC41	9/6	GZ32	11/-	UCF80	19/6
6AQ5	7/6	25A6C	11/6	EBF80	8/9	KT33C	8/6	UCH42	9/9
6AT6	7/3	25L6GT	8/6	ECC81	8/-	KT41	14/6	UCH81	9/6
6BA6	7/6	25Z4G	9/6	ECC82	7/6	KT63	6/6	UCL83	14/6
6BE6	7/-	25Z6C	9/-	ECC83	8/-	MH4	8/-	UP41	8/-
6BB6	6/6	35L6GT	9/6	ECC84	9/6	MU4	9/-	UF42	15/-
6BJ6	7/6	35Z4GT	7/6	ECC85	9/6	N18	8/6	UF89	9/8
6BR7	10/6	35Z6GT	8/6	ECC80	10/6	PC84	9/-	UL41	9/3
6BW6	8/3	50CD6G	24/6	ECF82	11/-	PCF80	9/-	UL44	22/6
6BW7	7/6	50L6GT	8/6	ECH21	16/9	PCF82	10/-	UL94	8/6
6CD6G	26/9	AZ31	11/6	ECH35	10/-	PCL82	10/-	UR10	9/6
6FR3	6/6	B38	15/6	ECH42	9/-	PCL83	12/-	UY21	15/-
6K7G	4/6	CL33	16/9	ECH81	8/-	PEN44	11/-	UY41	6/6
6K7GT	6/-	CY31	12/6	ECL80	11/9	PEN36C	9/6	UY85	7/6
6K8G	7/9	D77	5/6	ECL82	11/9	PEN46	6/-	VP4B	9/6
6Q7GT	8/6	DAC32	11/-	EP37A	7/6	PL36	22/6	VP41	9/-
6S1GT	6/6	DAF91	7/6	EP33	5/6	PL81	15/-	W76	7/6
6SNTGT	7/6	DAF96	8/6	EP41	9/6	PL82	8/6	W77	5/-
6U4GT	11/-					X79	11/-	Z77	11/-
6V6G	7/-					Z77	6/9		

Any Parcel Insured Against Damage in Transit 6d. extra.

**READERS RADIO**

24, COLBERG PLACE, STAMFORD HILL, LONDON, N.16 STA 4587



# The Silver Jubilee Radio/TV Show

THE MARQUIS OF DONEGALL REVIEWS SOME OF THIS YEAR'S MODELS

"STEREO-CRAZY, just like back home!" That was the verdict of the American visitor I took to the 25th Radio and Television Show at Earls Court.

A slight exaggeration, one feels. True, audio equipment, for the first time, had a hall of its own on the first floor (second floor to my American!) and it was exhibited and demonstrated on many of the ground floor stands and in the demonstration rooms. This reflected the public's interest in the possibilities of 3D sound.

## New Trends

As we go round the exhibits, certain trends in TV become apparent. For instance, there is a marked decrease in size, partly due to the increasing use of the 90 deg. wide-angle tube, replacing the 70 deg. tube. There is talk of a 110 deg. tube in the near future.

Further reduction in length from front-to-back is made possible in some cases by pushing the tube-face through the encircling mask. This also increases picture area and even more space is saved, in sets using printed wiring, by doing away with the conventional chassis and assembling "printed boards" round the neck of the tube. We see examples of these trends with Cossor, Philco and G.E.C.

In some cases, notably Marconiphone, H.M.V. and McMichael, the screen has been stuck right through the cabinet, to be contained in a projecting frame.

Reduction in the depth of the set sometimes means that the speaker is moved from the side to the front, an innovation permitted by a new speaker shape—only 2in. deep for a width of as much as 8in. Again, the bentwood cabinet remains popular owing to its bulk reducing qualities.

Another trend that strikes us is that the consolette (the spindly-leg type) is growing vertical speakers alongside the screen and shelves in the hitherto useless space between its legs (Philco, R.G.D.). Rolling doors are featured by Decca and H.M.V.

## Portables

Last year there were many portable TV sets with 12in. and 14in. tubes. The drive towards smaller sets has produced a number of transportable sets with 17in. tubes. Clever chassis design, combined with very light fibre cases, has resulted in many of these transportable sets working on telescopic rod aerials (Sobell, McMichael, Ekco, Ferranti, Murphy, Ferguson, H.M.V., etc.).

At present, the 17in. tube remains the most popular size against the 21in. tube models offered by most manufacturers.

At the K.B. and Masteradio stands we see 24in. tubes, and the Valradio is the only projection set we can find in the show. (Incidentally, my old Decca projection set with 4ft. x 3ft. screen is still inducing: "Say, is that home

movies?" from American visitors who have never heard of projection TV.)

## TV Plus V.H.F.

The increasing incorporation of V.H.F. radio into TV sets strikes us all the way round the exhibition. To take one example, we see the new Bush 77 at 80 guineas. This is a 17in. set incorporating a separate V.H.F. set. At 84 to 89 guineas the Decca DM 4/C 17in. provides V.H.F./F.M., in five wood finishes and black and white. Somewhat cheaper 17in. sets with V.H.F. are the Ultra at 72 guineas and the R.G.D. "Deep Seventeen" at 67 guineas plus 2 guineas extra for its legs. Its brother, with 21in. tube, V.H.F./F.M., front-facing speaker, costs, with legs, 101 guineas or 103 guineas with a table.

Push-button TV is introduced to us by Bush. By way of demonstration, this 14in. transportable switched from BBC to I.T.A. 20,000 times during the show. (Let's hope that is more times than it will take for little Johnny to get tired of jumping it from one channel to the other!)

The mechanism caters for all 13 channels with only 4 push-buttons.

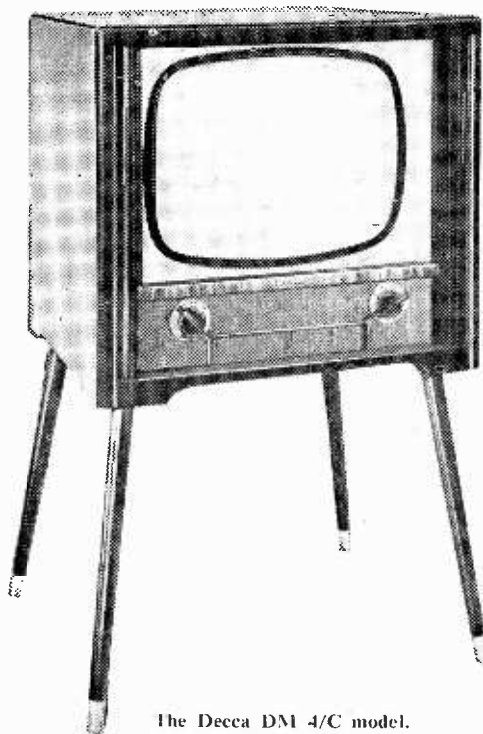

The Decca DM 4/C model.

We pause to admire the 185 guineas Pam. This is a late arrival. Pam's previous most expensive set being the 521 CF at 116 guineas which is a 21in. set. The newcomer is a console contain-

ing 21in. TV, a 10-valve, four waveband A.M./V.H.F. radiogram with provision for stereo records.

### Automatic Assembly

We have already noted that printed wiring has the effect of reducing bulk. The next visible step has been fully automatic assembly and soldering of printed panels (Ferguson).

Some firms are using special "plated" panels on hinges, to make parts readily accessible (McMichael, Sobell). Philco uses handy screw fixings for the panels.

As we know, a large proportion of faults occurs in the main panels. Alba have had the excellent idea of developing these into plug-in units. No testing; all you do is plug in a replacement and return the faulty panel to the factory.

Considerable improvement in picture quality results from research in circuitry. Ultra certainly achieve unusual vertical precision with the new Model 17, already mentioned. Direct synchronising is coming in again.

### Reduced Prices

New constructional methods are having the effect of reducing prices. We noticed this everywhere at the show. Last year, the average price of a 17in. table model was about 69 guineas. This year, several are priced at 65-66 guineas, and the Corsor is even more competitive at 63 guineas.

A 14in. table model seems to average 56 guineas, as opposed to 59 guineas a year ago.

A word about the BBC and I.T.A. activities at the show. Our old friend Cecil Madden, the BBC television pioneer who produced the first high-definition TV programme, "Here's Looking at You!" at Alexandra Palace in August, 1935, was once again in charge of the BBC's celebrity dais.

Altogether invitations were sent out to 400 stars to appear, which means a different star made a personal appearance every ten minutes.

At Independent Television's Wonderland seven halls were devoted to different aspects of Independent Television. For instance, in the Quiz Hall we saw exhibits from the Panel Games. Then there was the Display Hall with a studio set of "Emergency Ward 10," from which we emerge into the Hall of Music. The Wild West Hall was a small boy's paradise and the Hall of Personalities even included seeing ourselves on a monitoring screen.

### Stereo Record Players

It would not be right for us to leave the Radio Show without a mention of stereo, although at present the subject has little to do with television as such. Stereo models are to be seen on the stands of nearly every firm.

Complete stereo radiograms are to be seen with speakers on left and right of a broad console, and either built-in or arranged so that one or both can be moved away.

The slide-out form of speaker-housing is sometimes combined with a full width sideboard top (Hobday, Hobart). In others the style of speaker-housing can be selected by the customer (Ferguson).

Most stereo radiograms are of the two-unit type (Decca, E.M.I., and R.G.D.). The medium priced models usually have a fairly compact extension speaker (Decca, Ferguson, H.M.V., Invicta, Pam and Regentone).

Of the rest, the majority are "wired for stereo";—a plug-in stereo head and additional amplifier/loudspeaker unit can be bought at some future time (Alba, Bush, Dynatron, Ekco, Ferranti, H.M.V., Masteradio and Philips).

In stereo gramophones, as distinct from radiograms, there are many models of both portable and "cabinet" types and the two types merge in some models. Between the portable player in plastic covering, with detachable extension speaker (or speakers) and the polished wood model in console/tee or coffee-table style with matching extension speaker or speakers, there are console models in fabric finishes (Margolin, Pilot). One, having fold-away legs, is both portable and "permanent"! (Fidelity).

Stereo models are to be seen on the stands of nearly every set maker and, certainly, among every display by firms specialising in hi-fi and/or electric gramophones. As an indication of the enthusiasm with which firms are taking up the new system, one specialist in record producers (E.A.R.) is introducing stereo versions of practically every model in its range—no fewer than seven players and three amplifiers. The price range is typical of competitive levels throughout the show—stereo players at from 20 guineas for a single non-auto portable to 65 guineas for a compact console model; amplifiers at from 10 to 30 guineas.

It seems that stereo discs have increased interest in, rather than competed with, stereo tape records. Most of the stereo pre-amplifier units introduced for linking stereo pickups to their two amplifiers also allow for the connection of the twin magnetic heads of stereo tape players (Beam-Echo, S.T.D.). Many tape decks available for fitting into hi-fi installations make provision for the fitting of stereo heads (Brenell, Truvox).

### Tape Recorders

In general, the tape recorders at the show offer improved value and also greater economy by giving acceptable quality at low tape speeds, even down to 1½in./sec. (R.G.D.). The machines in the 45-55 guineas bracket provide several facilities hitherto reserved for *de luxe* models, facilities that go to make the recorder a very comprehensive and versatile instrument for those seriously interested in music and sound (Magnafon).

Not the least of developments in tape recorders is the coming of very neat little models at prices hitherto considered impossible. The least expensive is 26 guineas and another is 29 guineas (Walter, Tape Recorders (Electronic)).

We may well conclude our visit to the Silver Jubilee Radio and Television Exhibition with the last sentence of Lord Brabazon's opening speech: "We have developed Eurovision, and it is interesting to note that 98 per cent. of our population is covered by television—a remarkable feat. Then, in the future, there must come coloured and stereoscopic television."

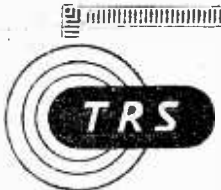

Our specialist buying knowledge and reputation ensure a square deal... and enable us to

**SPEEDY MAIL ORDER SERVICE**

# offer the best for your money!

## BAND 3 T/V CONVERTER—180 Mc/s - 205 Mc/s

Suitable for London, Midland, North, Scottish, Welsh and I.o.W. ITA Transmissions.

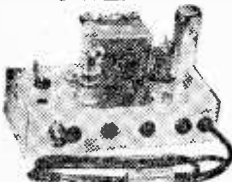

Mk. 2 Model as illustrated. Latest Cascode circuit using ECC84 and EF80 valves giving improved sensitivity (-18db) over standard circuits. Built-in Power supply AC 200-250 v. Dimensions only 6 1/2 in. x 3 in. Ht. 4 in. Simple and easy to fit—only external plug-in connections, wired, aligned and tested ready for use. State Channel required. Guar. Bargain Offer—good results or full refund.

only £3.19.6. Carr. & Pack., 2/6. Band 1 Band 3 c/o Switch and BBC aerial socket, fitted and wired to converter, 8/- extra. **CONVERTER ACCESSORIES**  
Band 1-Band 3 Cross-over Unit, 7/6. Var. Attenuators (edt-3cdd., 7/6. BEC Pattern Filter 8/6. Band 3 Aerials—outside Single Dipole with 4 yds. co-ax., etc., 13.9. 3 Element Beam, 27/6. 5 Element, 35-, etc.

**VOLUME CONTROLS**  
10,000 ohms. 2 Megohms. All long spindles. Morganite Midget type. 1 1/2" diameter. Guar. 1 year.  
Log. or Linear Ratios. Less Sw. 3/-, D.P. Sw. 4/6.  
**RESISTORS**—Full range, 10 ohms-10 Megohms, 20% 1 w. 3d., 1 w. 5d., 1 w. 6d., 2 w. 9d., 10% Hi-Stab. 1 w. 5d., 1 w. 7d., 5% 1 w. 9d.  
10% Hi-Stab. 1 w. 16 (10 ohms-100 ohms, 2-), 10% 1 w. 9d.  
**RECORDING TAPE**—1,200 ft. on 7 in. Plastic reel. 8% type. Hi Quality Product. Each boxed. 22.6.

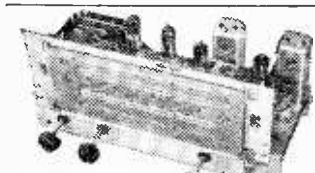

**ALL-WAVE RADIOGRAM CHASSIS**  
3 WAVEBANDS  
M.W. 10 m. - 50 m.  
L.W. 200 m. - 500 m.  
L.W. 800 m. - 2,100 m.  
Brand new and guar. A.C. 200-250 v., 4 pos. W.C. Sw. Short-Medium-Long-Gran. P.U. socket. High Q dist. core coils. Latest circuit technique. Delayed AVC and neg. feedback. 0 P 4 watts. Chassis Size 12 1/2 x 2 1/2 x 2 1/2 in. Dial Unit, 4 1/2 in. Hor. or Vert. station names. Walnut or Ivory knobs to choice. Aligned and calibrated ready for use. Sensitivity and Quality at Low Cost.  
Chassis isolated from mains. **BARGAIN PRICE 9.5 gns.**  
Carr. and Ins. 4/6.  
\*or 10 in. speakers to match. 5/- and 25-  
7 Valve De Luxe, push-pull Mk. 41 version, 7 watt output, with H Duty 0 p Trans., £12.10.0. Carr. & Ins. 5/-

### C.R.T. Heater Isolation Transformers

New Improved types—mains prim. 200/250 v. tapped.

All Isolation Transformers now supplied with alternative no boost, plus 25%, and plus 50% boost types, at no extra charge.

2V.	2A type	12.6 (P. & P. 16)
0.25V.	..	12.6 ..
10.5V.	..	12.6 ..
12V.	..	12.6 ..

Other voltages in course of production. Small size and tag terminated for easy fitting.

**JASON P.M. TUNER UNIT 87-105 Mc/s.**  
Designer Approved Kit of parts to build this modern highly successful unit, drilled chassis and superior type dial. Coils, cans, and all quality components, etc., for only 5 gns., post free. Set of 4 spec. RF coils or eqn't. valves, 30/-, post free. **WIRE WITH KIT.** 49 hr. alignment service, 7/6 plus 2/- P. & P.

NEW BOXED	VALVES	ALL GUARANTEED		
1R5, 1T4 7	6 10P98	8 - 6P41	10.6 6P4F82	10.6
185, 184 7	6 6R36	8 - 6P80	10.6 6P4L83	12.9
284, 2V4 8	6 6L96	8 - 6K6	13.6 6P181	14.6
5Z4	6 65L6	10.6 6P91	8.6 6P182	10.6
6AT6	6 6AB7	9.6 6E141	10.6 6P183	11.6
6K7	6 6EB1	6.6 6E184	11.6 6P180	9.6
6K8	6 6B741	10.6 6B85	11.6 6P181	9.6
6Q7	6 6C98	8.6 6Y31	12.6 6P182	8.6
6N7	6 6C94	12.6 6Y86	14.6 6P183	10.6
6V6	7.6 6CF80	12.6 6Z40	8.6 6L22	8.6
6X4	7.6 6CF82	12.6 6Z80	8.6 6L25	13.6
6X5	7.6 6CF82	10.6 6Z81	8.6 6CH42	10.6
7C5	9 - 6CH81	10.6 6M14	9.6 6Y91	10.6
7Y4	8.6 6CL80	12.6 6PC84	10.6 6U141	10.6
6AF96	8 - 6CL82	12.6 6PF80	10.6 6U141	8.6

### ELECTROLYTICS ALL TYPES NEW STOCK

Tabular Wire Ends	102-32 550 v. B.E.C.	6.8
25 25 v. 50 12 v. 1	Can Types, Gips 2d. ea.	
25 50 v. T.C.C.	2 - 8 500 v. Dub.	
50 50 v. 4 500 v. 2	8+4 450 v. T.C.C.	4.6
100 25 v. 2 450 v. 2	8+16 450 v. Pains	5.6
8 450 v. T.C.C.	2 16-16 450 v. T.C.C.	6.6
8+8 450 v. B.E.C.	4 32 250 v. B.E.C.	4.6
8+16 450 v. T.C.C.	5 32-32 275 v. Huts	5.6
16 450 v. B.E.C.	3 32-32 450 v. T.C.C.	6.6
16 500 v. Dub.	4 250 750 v. B.E.C.	8.6
16-16 450 v. T.C.C.	5 60 250 v. T.C.C.	6.6
32 550 v. B.E.C.	4 60+100 350 v. B.E.C.	11.6
32 500 v. Dub.	5 60-250 275 v. B.E.C.	12.6
50+50 250 v. B.E.C.	8 100-200 275 v. B.E.C.	12.6

**RECORD PLAYER CABINETS**  
Contemporary style, rexine covered cabinet, as illus. in previous advertisements, in fawn or buff brown with cream interior. Size 18 1/2 x 13 1/2 x 8 1/2 in., fitted with all accessories, including speaker baffle board and plastic fret. Space available for all modern amplifiers and autochangers, etc. Next record player mounting board 14 x 13 in. supplied. Cabinet Price, **£3. 3. 0.** Carr. and Ins. 3/6.

**2-VALUE AMPLIFIER Mk. 1**  
200-250 v. A.C. Modern circuit with High Gain PL84 output and double wound Mains Transformer. Variable tone and volume controls, wired and tested with gain. Speaker and 0 P Trans. complete with knobs and drilled ready to fit Baffle Board in above cabinet. Only **£3.12.6.** Carr. & Pack., 2/6.

**2-VALUE AMPLIFIER Mk. 2**  
200-250 v. A.C. Specification as above but a higher fidelity and greater output (approx. 3 watts) is obtained by using latest Twin Stage Triode-pentode Valve EC182 and negative feedback Tone Control. Complete wired and tested as above **£3.18.6.** Carr. & Pack., 2/6.

**SPEAKER FRET**—Expanded Bronze stranded metal 8 x 8 in., 2 3/4 x 12 in. 8-, 12 x 12 in., 4.6; 12 x 15 in., 6-7 24 x 12 in., 8-, etc., 2-; **TYGAN FRET** (Murphy pattern) 12 x 12 in., 2-; 12 x 18 in., 3-; 12 x 24 in., 4-, etc.

**80 OHM COAX. CABLE NOW ONLY 8D. YARD!**  
Highest Quality Cable, low-loss Polythene Aerial, semi-air spaced, feeder losses cut 50%. Stand 1/2 in. dia. Stranded core. 20 yds., 12.6. Carr. 1.6. 40 yds. 20-, carr. 2.2.  
**Coax. Plugs 1/2-, Coax. Sockets 1/2- Couplers 1/3, Outlet Boxes 4/6, B1-B3 Xover Unit 7/6.**

**TRANSFORMER & COIL WINDING CAPACITY AVAILABLE FOR PROTOTYPES & SMALL RUNS**

**RECORD PLAYER BARGAINS New Reduced Prices!**  
**SINGLE PLAYERS** 4-speed BSR (TC9), 92.6; 4-speed COLLARO JUNIOR, 80.-; 4-speed GARRARD (4 R.P.), 27.5.0, carr. and Ins. 3/6.  
**AUTO-CHANGERS**, 4-speed BSR (UAS), 56.19.6; 4-speed COLLARO, 27.19.6; 4-speed BSR (UA12), 81 gns.; 4-speed GARRARD (RC120 4R2), 29.10.0.; 4-speed GARRARD (RC121 4R2), 20.10 gns., carr. and Ins. 5/-. All above units are latest 2-speed models, fitted light weight crystal pick-up and twin sulphide styl. Complete and ready to use. **FINEST SELECTION AVAILABLE—ALL BRAND NEW AND GUAR.**  
\* Adapted for stereo operation.  
\*\* Fitted with stereo cartridge.

**SPECIAL PRICE PER SET**  
1R5, 1T4, 185, 184 or 284, or 2V4 ... 27.6  
6R96, 6P96, 6AF96, 6L96 ... 35.-  
6K6, 6K7, 6Q7, 6V6, 6Z4 or 6X5 ... 35.-

**RECONDITIONED TV TUBES**  
Re-vacuumed and re-activated. Guar. 6 months-12 in. Mullard, Mazda, etc. **£6.10.0** (as available).  
14 in. Mullard, Mazda (Rect.), 27.0.0.  
17 in. Mullard, Mazda (Rect.), 28.10.0.  
Carr. and Ins., 12.6.

**AND NOW NEW HEATER, CATHODE and GUY ASSEMBLIES. FITTED TO YOUR OWN TUBES.**—Reconditioned virtually new. Only 30- extra. Incorp. guaranteed. 7 days delivery. Regret only Mullard and Mazda types at present. Carr. & Ins. 12.6. As used in our own Workshops.

Listed above are only a few items from our very large stock. Send 2d. stamp today for complete Bargain List.

Terms: C.F.O. or C.O.D. Kindly make cheques, P.O.s. etc., payable to T.R.S. Post, Packing up to 1 1/2 lbs. 11b. 1/2, 51b. 1.6, 51b. 2-, 10lb. 2.2. Hours: 9 a.m.-6 p.m. 1 p.m. Wed. Open all day Saturday.



**RADIO COMPONENT SPECIALISTS** (Est. 1946)  
70 BRIGSTOCK ROAD, THORNTON HEATH, SURREY (THO 2188)  
50 yards Thornton Heath Station.  
Buses: 130A, 133, 159, 166 and 193

### METAL RECTIFIERS

**WESTINGHOUSE**

4A83	21-	14A163	42 6	15B261	13 -
4C1017	7 6	14A342	42-	15D19	8 -
4D358	6-	14A962	49-	15D39	12/6
5D1	3 6	14A975	16 10	15D967	10 7
13B989	59-	14B275	15-	16K7	6 10
14A86	17 6	14B46	16 6	39K1	4 2
14A97	17 6	14B130	37 6	39K2	4 4
14A103	17 6	14B261	13 -	LW7	27 7
14A116	31 6	14B880	13 -	LW9	29/8
14A124	31 6	14B886	14 8	LW13	30 6
14A130	37 6	15B35	14 6	LW14	26 4
14A144	37 6	15B39	14 6	LW15	28 9

**CONTACT COOLED TYPES**

14RA-1-2-8-23	4	18RA-1-1-8-1	5 8
14RA-1-2-3-23	4	18RA-1-1-16-1	9 -
16RC-1-1-16-1		18RA-1-2-8-1	13 8
	10 8	18RD-2-2-8-1	16 4
16RE-2-1-9-1	10 8	18RD-2N-1-16-1	16 6

**MINIATURE E.H.T. TYPES**

16EHT6	7 -	36EHT100	37 2
36EHT19	24 4	36EHT180	101 2

**L.T. UNITS**

LT51	7 8	LT56	32 9
LT52	22 3	LT57	47 9
LT53	31 3	LT58	63 9
LT54	42 9		

**L.T. UNITS**

HT43	39 9	HT50	39 -
HT44	39 9	HT51	45 9
HT45	25 3	HT52	49 3
HT46	25 3	HT53	65 3
HT47	25 3	HT54	18 2
HT48	25 3	HT55	27 6
HT49	13 9	HT59	29 9

## ALPHA RADIO SUPPLY CO.

### VALVES

GUARANTEED ALL TESTED  
BEFORE DISPATCH

DAF53	10 6	KT39C	10 -	3V4	9 -
DF96	10 6	KT6	15 -	5U4	8 -
DK96	10 6	KTW61	8 -	5Y3GT	8 -
DL96	10 6	N78	12 6	5Z4	11 -
EBC34	7 6	OZ4	5 6	6A7	13 -
EBC41	10 -	PCC84	10 -	6AL5	6 6
EBP80	10 6	PCF80	13 6	6AM6	9 -
ECC81	10 4	PL81	16 -	6FG6	7 6
ECC85	9 6	PL82	8 6	6F13	14 -
ECH35	10 6	PX25	12 6	6F15	14 -
ECH42	10 6	PY80	9 -	6K7G	5 -
ECH81	11 -	PY81	10 -	6K8C	8 6
ECL80	13 6	PY82	8 -	6L6C	9 -
EP39	7 6	PEN4VA	15 -	6Q7G	9 -
EP40	14 6	PEN25	5 -	6SN7	7 6
EP41	9 9	PEN41	15 -	6SL7	8 -
EP42	14 -	SP41	3 -	6U4	14 -
EP59	4 -	SP61	3 -	6V6G	7 -
EP80	9 -	TP25	27 10	6V6GT	7 6
EP86	14 6	U14	8 6	6X6G	7 -
EL41	11 -	U25	14 6	12AT7	9 -
EL42	12 -	UCH2	10 6	12AU7	8 -
EL84	10 6	UL41	10 -	12AX7	9 -
EM80	10 6	VU39	8 9	25A6	11 6
EY51	13 6	IC5	12 6	25L6	10 -
EY86	13 6	1H5	10 6	25V5	9 -
EZ40	9 -	1N5	10 6	35L6	9 6
EZ80	8 9	1S5	8 9	35T1	8 -
GZ32	12 -	1T4	7 -	42	8 -
HL23DD	8 6	3S1	8 -	80	8 6

### METAL RECTIFIERS

**METER TYPES**

1mA	14/6	10mA	14/6
5mA	14/6		

**WESTECTORS**

W4	4 4	WX3	4 4
W6	4 4	WX4	4 4
WX2	4 4	WX6	3 -
WX12	6 -		

SUITABLE FOR BATTERY CHARGERS, ETC.

12 v. 1 a.	4 3	12 v. 4 a.	12/6
12 v. 2 a.	7 -	12 v. 6 a.	15/9
12 v. 3 a.	10 -		

**Garrard 4 Speed Single Player**, with turnover Crystal Cartridge, **£6.19.6** plus postage 3/6.

**ACOS MIC 33-1**

A Crystal Hand or Desk Microphone designed for high quality public address and tape recording field. Listed at 50 - . Our Price 29 6.

**HEADPHONES - MICROPHONES**  
Ex. Government. Headphones and Microphones  
CLR low resistance type 120 ohms 7 6 pair  
Throat Microphones ..... 3 - set  
High Resistance Phones, 1,000 ohms- 13 6 pair  
High Resistance DLR Phones...16 - pair

Our 1958 50 Fully Illustrated CATALOGUE of components and accessories— invaluable for enthusiasts and engineers—is now available. Send 1 - in stamps for your copy to-day.

**TERMS:** Cash with order or C.O.D. Postage and Packing charges extra, as follows: Order value 10 - add 13; 20 - add 19; 40 - add 26; £5 add 3n. Minimum C.O.D. Fee and Postage 3-. For full terms of business see inside cover of our catalogue. Personal Shopper 9 a.m. to 3 p.m. Monday to Friday. Saturday 10 a.m. to 1 p.m.

**103 LEEDS TERRACE, WINTOUN STREET, LEEDS, 7.**

## Is your T.V. TUBE DIMMING ?

**YOU CAN EXTEND THE LIFE OF THAT TUBE AND IMPROVE THE PICTURE**



Pat. pending.  
Reg. designs.

**TYPE SERIES**  
For 6.3 volts  
.3 amp, 12.6 volts, 3 amp.  
All tube sizes  
Duodecal base

**PRICE 30/-**

Package & Postage 1/6.  
(Postal Orders.  
C.W.O. C.O.D.)

- NO SOLDERING
- NO WIRING
- JUST PLUG IN
- IT'S AUTOMATIC
- IT'S GUARANTEED!

Sinclair Electronics introduces the first series wired plug in booster unit, for all universal TV sets, using B12A Duodecal base.

When ordering state make of set, model no. and type of tube. Two types available (voltage range from 6.3 volts at 3 amps to 12.6 volts at 3 amps.)

(a) For Universal sets—Series Type.  
(b) A.C. Sets (Transformer Feed)—Parallel Type.

If not satisfied money refunded within 7 days.

## SINCLAIR ELECTRONICS,

247, BRICK LANE, LONDON, E.2.  
Phone: SHO 7424

## ARTHURS HAVE IT!

NOTE NEW ADDRESS:

125 TOTTENHAM COURT ROAD  
LONDON, W.1.  
(Close to Warren Street Station)

You will have the same service and obtain all your requirements in Radio Components, Electrical Goods, Accessories and Television as previously.

Test Instruments in Stock include: AVO, ADVANCE, COSSOR, MEGGARS and TAYLOR.

### VALVE MANUALS AVAILABLE

Mullard 10/6, Brimar No. 7 6/-, Osram Part 1, 2nd Edition 7/6. POST AND PACKING 9d, EACH EXTRA.

Est. 1919

# Arthurs

PROPS: ARTHUR GRAY, LTD.

OUR ONLY ADDRESS: Gray House,  
125, Tottenham Court Road, London, W.1.  
EUSon 5802-3-4  
TELEGRAMS—"TELEGRAY, WESDO. LONDON."  
CABLES—"TELEGRAY," LONDON.

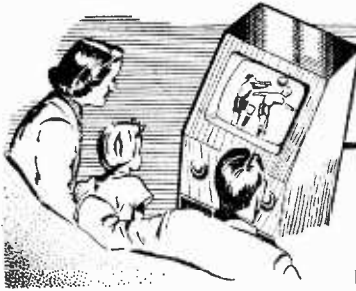

# UNDERNEATH THE DIPOLE

A MONTHLY COMMENTARY

By Iconos

## Picture and Sound Variations

WHAT a wide variety of picture and sound qualities we see and hear during the course of an evening's viewing! In spite of all the checking and testing on closed circuits that goes on prior to transmission, these variations in quality persist and cannot be entirely ascribed to the individual tastes of the studio lighting and sound technicians. Such variations are naturally greater on the I.T.A. transmissions, especially when successive programmes originate from different programme contractors' studios. But they are also noticeable to some extent on the BBC transmissions.

## "Cutting Through"

IT is a fact that the top technical policies of the many television organisations in this country are not identical. The main objective of most of the I.T.A. programme companies' chief engineers is to secure a reasonable reproduction on the largest possible number of receivers, including those viewed in clubs, pubs and homes with fully lighted rooms, and on sets which are badly out of adjustment. In order to carry out this aim, their first consideration is for a picture which is extremely sharp and hard, and which, in my opinion, often has a "soot and whitewash" effect when viewed in total darkness or in a dim room light. On the other hand, I admit that a carefully graded picture possessing all the delicate gradations essential for good portraiture, good skin texture in close-ups and good modelling, fails to "cut through" under bad viewing conditions. Some of the

best quality pictures come from the BBC, particularly in the plays from Lime Grove. But these pictures are seen at their best only when the lights are lowered. I tried a few experiments at home with room lighting during the transmission of *Green Pastures*, a fine BBC play from Studios D and H at Lime Grove, which was especially notable for its magnificent photographic quality. However, with the room lights fully up, the picture looked rather woolly and soft. With the set thrown slightly out of adjustment, it looked worse. But with all the room lights out (excepting one), the picture was absolutely superb. *Green Pastures* was followed by the International Ballet from Riverside Studios, also a fine technical job, but rather harsher in tonal values. But the pictures of the ballet fared better when subjected to the poorer viewing conditions.

## Lightweight TV Cameras

AT long last the much talked about lightweight TV cameras are coming into service. The BBC are first in the field with the new Marconi Mark IV cameras, which are less than 100lb. in weight, with printed circuits and 4½in. image orthicon camera tubes. It will not be long before the lenses on a camera weigh more than the camera itself. Already the industrial-type Vidicon cameras, used for captions and clocks, are being used in announcers' and "presentation" studios. For such very lightweight cameras, costing about £450 each—compared with the £3,500 for an

image orthicon camera—new lightweight camera pedestals will be required. It somehow does not seem to make sense to spend £2,000 or more on a heavy mounting to carry a camera about a quarter its value and about one-tenth its weight. The firm of Vinten, which specialises in all kinds of motion picture and television camera mountings, is well aware of this point of view and will be supplying the BBC and other TV programme organisations all over the world with a new type of lightweight pedestal of highly ingenious and revolutionary design.

## Minority Opinion

THIS is a problem similar to that which film studio technicians have had for years. With lighting, photography, developing and printing adjusted to give the best effect at cinemas fitted with the latest projection equipment, the results at older cinemas are often disappointing, both for sight and sound. What is the

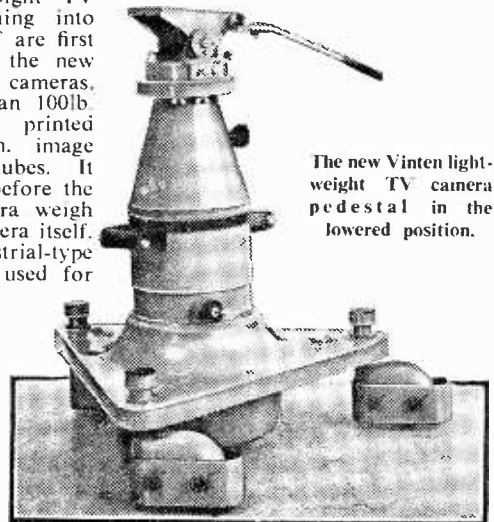

The new Vinten lightweight TV camera pedestal in the lowered position.

answer to this problem, so far as TV is concerned? My own inclination is to obtain the best possible results on reasonably modern TV receivers under good viewing conditions, and not to bother too much about the bad sets. But in writing this opinion, I am well aware that I am stating a minority choice.

### Old TV Sets Persist

THE increasingly slow rate at which BBC-only sets in the London and Midlands ITV areas are converted or adapted to receive ITV programmes, is explained by the results of a March survey conducted in these areas by Television Audience Measurement Limited. Of the 595,000 BBC-only sets in the London area at the time of the survey, no fewer than 371,000 (62 per cent.) were unsuitable for modification to receive ITV programmes. In the Midlands a further 114,000 BBC-only sets—29 per cent. of all BBC-only sets in the area—were found to be unsuitable.

### Southern Television

SOUTHERN TELEVISION has tackled in a big way the stiff task of attracting the attention of about 25 million potential viewers in its area. This compares with about 13 millions served jointly by Associated Rediffusion and A-TV through the Croydon transmitter, whose service area Southern overlaps in several "fringe" places. As with T.W.W. and Scottish Television, it is compensated to some extent by having a full seven-day operation. To ensure a good send-off and a large viewing public from the very start, an impressive publicity campaign was launched, costing about £50,000. This money was spent upon exhibitions, posters, press advertising and tie-ups with radio dealers in all parts of the area. Judging by the large number of bright new Channel 11 aerials in the district, I would guess that this investment paid off handsomely. Not many months before the opening of the station, Roy Rich decided not only to put out his full 15 per cent. or more quota of locally originated programmes

of a high standard, but to send back to the I.T.A. network a weekly serial, *Mary Britten, M.D.* and a large number of outside broadcasts of sporting events. It is not easy for the smaller I.T.A. companies to break into the network. In any case, the G.P.O. return-network lines or microwave links hired on an annual basis are a very large additional expense. No doubt the Tyne-Tees and the East Anglia companies, who start operating in a few months' time, will watch Southern's bold policy with considerable interest. The opening show, *Southern Rhapsody*, a spectacular, was an ambitious start, which nearly came to grief in the first few minutes when one of the camera pedestals ran over the cable of another camera. That accounted for a poor picture on one of the cameras for a short time. These openings are a stiff trial for artistes, producers and technicians alike, who are naturally somewhat far from relaxed. But on the whole, I think it was one of the most successful station openings, which certainly put the Southampton studio well on the I.T.A. map.

### Regional Progress

I DOUBT whether any of the I.T.A. areas remaining unallocated will produce large enough revenues to support such a large staff and extensive studio and equipment facilities as at Southern Television. It was considered to be extremely good in I.T.A. programme company board-rooms if there was an

annual return of £1 per head of population served, by way of gross revenue from advertising "slots" and magazines. Some of the I.T.A. companies have managed to exceed this amount during the past year, which accounts for the prosperous atmosphere which surrounds those companies which operate in London and Manchester areas. Scotland and Wales have lagged behind a little, but are fast catching up, and in any case were not faced with the huge financial losses that were sustained in the first year or so by AR-TV and A-TV. The BBC, too, have benefited by the tremendous increase in television licences, and have put on strong competitive programmes. Some of the best of these are missed by viewers who won't be bothered to switch over or retune to the opposition programme. A great many sets have not been installed by the retailer in a manner which can give equally good reception from more than one station. Recently, I heard a dealer in a shop near Aldershot discourage a customer from tuning to Southern. "It's pretty well the same as from London, anyway," he said. That customer was on high ground and received a very strong signal from Croydon I.T.A. on an elaborate aerial. He could have received Croydon equally well on a new, simpler aerial and twisted his existing Channel 9 aerial towards the Isle of Wight transmitter, leaving his BBC aerial in its present position.

## PRACTICAL WIRELESS

Chief Contents of November Issue. Now on Sale, 1/3.

THE WORLD'S SMALLEST RECEIVER—  
THE MICRO MIDGET 3 TRANSISTOR VEST-  
POCKET SET

A HIGH QUALITY TRANSISTOR POWER  
AMPLIFIER

A TWO-VALVE HI-FI AMPLIFIER

A HIGH QUALITY RECORD PLAYER  
MAINS MODEL CONTROL TRANSMITTER  
TRACKING THE SUPERHET

COLOUR ORGAN

STABILISED TRANSISTOR CIRCUITS  
A PRE-TUNED TRANSISTOR FEEDER

# Wanted!

## QUALIFIED MEN AND WOMEN

Industry and Commerce offer their best posts to those with the qualifications—appointments that will bring personal satisfaction, good money, status and security. As part of a modern industrial organisation, we have skilled knowledge of what is required and the best means of training personnel for present day and future requirements. We specialise also in teaching for hobbies, new interests or part-time occupations in any of the subjects listed here. Write to us to-day for further information. There is no obligation of any kind.

**PERSONAL & INDIVIDUAL TRAINING IN —**

- |                                       |                         |                               |                                |
|---------------------------------------|-------------------------|-------------------------------|--------------------------------|
| Accountancy                           | Draughtsmanship         | Mathematics                   | Sales Management               |
| Advertising                           | Economics               | M.C.A. Licences               | Sanitary Engineering           |
| Aeronautical Eng.                     | Electrical Instal.      | Mechanical Eng.               | Salesmanship                   |
| A.R.B. Licences                       | Electronics             | Metallurgy                    | Secretaryship                  |
| Art (Fashion, Illustrating, Humorous) | Electronic              | Motor Eng.                    | Servo Mechanisms               |
| Automobile Eng.                       | Draughtsmanship         | Painting & Decorating         | Shorthand & Typing             |
| Banking                               | Eng. Drawing            | Photography                   | Short Story Writing            |
| Book-keeping                          | Export                  | P.M.G. Certs.                 | Short Wave Radio               |
| Building                              | Gen. Cert. of Education | Police                        | Sound Recording                |
| Business Management                   | Heat & Vent. Eng.       | Production Eng.               | Telecommunications             |
| Carpentry                             | 'Hi-Fi' Equipment       | Production Planning           | Television Time & Motion Study |
| Chemistry                             | High Speed Oil Engines  | Radar                         | Tracing                        |
| City & Guilds Exams                   | Industrial Admin.       | Radio                         | Transistors                    |
| Civil Service                         | Jig & Tool Design       | Radio Amateur (C & G) Licence | Welding                        |
| Commercial Subjects                   | Journalism              | Radio Engineering             | Workshop Practice              |
| Commercial Art                        | Languages               | Radio & Television Servicing  | Works M'gement etc., etc.      |
| Computers                             | Management              | Refrigeration                 |                                |
| Customs Officer                       | Maintenance Eng.        |                               |                                |

Also courses for GENERAL CERTIFICATE OF EDUCATION, A.M.I.H.&V.E., A.M.S.E., A.M.Brit.I.R.E., A.M.I.Mech.E., A.M.I.E.D., A.M.I.M.I., A.F.R.Ae.S., A.M.I.P.E., A.M.I.I.A., A.C.C.A., A.C.I.S., A.C.C.S., A.C.W.A., City & Guilds Exams., R.T.E.B. Servicing Certificates, R.S.A. Certs., etc., etc. Moderate fees.

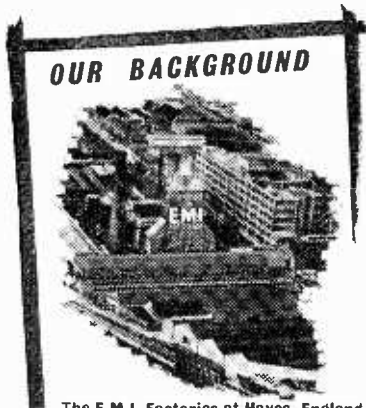

The E.M.I. Factories at Hayes, England.  
**The only Home Study College**  
 operated by a world-wide  
 manufacturing organisation

# EMI

## INSTITUTES

**NEW!** Courses with PRACTICAL EQUIPMENT

in RADIO · TELEVISION · MECHANICS  
 CHEMISTRY · ELECTRICITY  
 DRAUGHTSMANSHIP · PHOTOGRAPHY etc., etc.

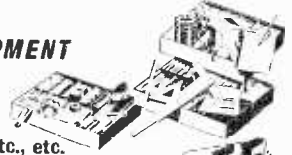

**POST THIS TODAY**

To :- E.M.I. INSTITUTES, Dept. 138K, London, W.4.  
 NAME \_\_\_\_\_ AGE \_\_\_\_\_  
 (if under 21)  
 ADDRESS \_\_\_\_\_  
 I am interested in the following subject(s) with/without equipment \_\_\_\_\_



BLOCK  
 CAPS  
 PLEASE

NOV. 58 (We shall not worry you with personal visits)

1C91

*-Part of "His Master's Voice" Columbia, etc., etc.*

**MIXER UNIT TYPE 79**

Frequency Range : 172 to 190 Mc/s.  
Includes : VCR133A tube, 7-EP50, 4-EA50, EP55, 5U4, VU123, 2-EB91, EC52.  
Standard Mains Input, 200-250 volt 50 c/s.  
**£5.10.0.** Carriage 5/-.

**PYE 45 Mc/s STRIP TYPE 3583**

Complete with 10-EP50, EB34 and EA50 valves.  
**ABSOLUTE BARGAIN. 39/6** post free.  
Includes Modification Data.

**TV PRE-AMP.** 45 Mc/s Unit with 2-VR91 valves. (Slight modification necessary.) 10/- post free.

**R.F. UNITS**

TYPE 25. Switched tuning 20 to 30 Mc/s. with 3-SP61 valves. 10/- Circuit 9d.  
TYPE 26. Variable tuning, 50 to 65 Mc/s. with 2-EP54 and EC52. 25/- Circuit 9d.  
Carriage 2/6 (both types).

**TESTMETER TYPE 834-S**

15 Ranges. F.S.D. 1,000 O.P.V. A.C./D.C. volts : 12/60/300/600/1,200/6,000. Milliamps 1.2/12/60/600. Resistance 0 to 500 5 K/5 Meg.  
**£6.19.6.** P. P. 2 6  
Complete in case and including batteries, test leads and booklet.

**SHORT-WAVE RECEIVER**

THE WORLD IN YOUR HOME  
**10-60 Mc/s (5-30 Metres)**  
RECEPTION SET TYPE 209

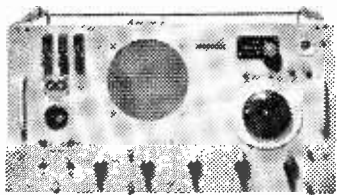

J  
U  
S  
T  
P  
L  
U  
G  
I  
N

Complete with 6 valves, 2-6K8C, 2-EP39, 6Q7G and 6V6G. Internal mains power pack and 6 v. vibrator pack. Built-in 6 1/2 in. speaker. Muirhead slow-motion drive. B.F.O. and R.F. stage. Provision for Phones and Muting and 600 ohms. Input 100/250 v. A.C. or 6 v. D.C. All sets in new condition and air tested. I.F. Frequency 2 Mc/s  
**£6/19/6** Carr. 15/6.  
**NO WORK REQUIRED : JUST PLUG IN AND SWITCH ON!**

**R.F. WATTMETER TS-87-AP**

3 position 0-10 15 30 watts  
Complete with photo-cell, 2 spare lamps and leads, with transit case.  
**BRAND NEW £10.10.0.** P.P. 7/6.

**QUARTZ CRYSTALS**

LARGE RANGE IN STOCK from 100 kc/s upwards. Also available Quartz Plates in various sizes. Send for free complete list.

**"373" MINIATURE I.F. STRIP 9.72 MC/S.**

THE IDEAL F.M. CONVERSION UNIT, as described in *Practical Wireless*. Complete with 3-EF91, 2-E92, 1-EB91, I.F.T.s. etc. Includes Circuit and Conversion Data.  
12/6 (less valves) 42/6 (with valves). Carriage 2/6  
**F.M. AT ITS CHEAPEST!**

**NEW BOXED VALVES!**

EQUIVALENT TO FOLLOWING TYPES

AC SG	FC4	MS4B	VP4 5-pin
AC SGVM	HU50	MX40	VP4 7-pin
AC IPEN	G30	PEN4VA	VP4B
AC PEN	MSPEN 5-pin	PEN36C	VMS4
AC VP1 5-pin	MSPEN 7-pin	PP36	VMP4G
AC VP1 7-pin	MVSPEN5-pin	SP4 5-pin	W42
AC VP2	MVSPEN7-pin	SP4 7-pin	1D5
AC HLDD	MVSPENB	S4VB	7D5
CY1C	MHD4	TDD4	7D6
DDT4	MKT4	URIC	41MPG

SEND FOR FREE COMPLETE VALVE LIST.

**10/- each**

OPEN MONDAY TO SAT. 9.6.—THUR. 1 o'clock.

**HENRY'S RADIO LTD.**

(DEPT. PTN)  
5 HARROW ROAD, EDGWARE ROAD, LONDON, W.2  
TEL.: PADDINGTON 1008-9

**AN ELECTRONIC ORGAN FOR THE HOME CONSTRUCTOR**

By Alan Douglas, M.I.R.E., M.A.I.E.E.  
Here is a do-it-yourself book which gives straightforward instructions for building an inexpensive electronic organ. Compact and easily transportable, the instrument has been specially designed for amateur use in church, hall or home. Detailed step-by-step instructions are given, as well as a complete list of materials and their suppliers. Illustrated with photographs and diagrams. From booksellers, 15/- net.

**PITMAN**

Parker St., Kingsway, London, W.C.2.

**TELEVISION TUBES**

RE-ACTIVATED AND RE-GETTERED, 50/-. PROVIDED YOUR OLD TUBE HAS NO ELECTRODE FAULTS AND HAS NOT BEEN SEVERELY BOOSTED THERE IS A 70% CHANCE OF RE-ACTIVATION LASTING UP TO 12 MONTHS. NO RESULT, NO CHARGE. SPECIAL PRICE TO TRADE.

T.V. TUBES IN STOCK, ALL MAKES, MOST SIZES. £5.00 EACH, plus POSTAGE AND INSURANCE 12/6. GUARANTEED 3 MONTHS. 12" MAZDA. 6 WEEKS DELIVERY

**GOVERNMENT SURPLUS & MANUFACTURERS' CLEARANCE**

I.T.A. AERIALS. New and boxed. 3 element, 22/6. 5 element, 27/6.  
CO-AX CABLE. 6d. per yd. AIR SPACED. 9d.  
METERS. Moving Coil 2 1/2" diam. 50 Micro-amp. £2/10/- 100 Micro-amp. £2.5.0. 100 Milliamp. 12/6. 0-50 amp. A.C. 4 1/2" diam., 25/-.  
NEE CELLS. 3 x 2 1/2 x 1", unused, 5 - ea., 48/- doz.  
INERT CELLS. 1 1/2 v., 2 - each, 18/- doz.  
RELAYS. High speed, 1,000-1,000 ohms. Plat. cont., 7/6. P.O. 3,000 type, 20,000 ohm coil 4 pole c o, 20/- ea. 6,500 ohm coil, 2 make 2 break, 11/6.  
TORCH BULBS. Ever Ready 2.5 v. and 3.5 v., 16/- per 100 9/- per 50.  
HEAD PHONES. Moving iron, low impedance, 6/-; High, 9/-; Balanced armature, low, 10/-; high, 15/-. Moving coil, low only, 10/- per pair.

VALUES. All valves tested before despatch on MULLARDS latest ELECTRONIC TESTER.

3A4	6/-	6P1	7/6	6V6	6/6	EB91	5/6	EY51	6/-
3Z1	9/6	6A5	6/-	6X4	7/-	ECH42	9/-	EY51	9/-
6AB8	10/-	6A6	6/-	6X5	7/-	EF36	6/-	EL32	5/-
6AC5	5/-	6J7	6/-	12AHR	9/-	EF50	3/6	PG1	4/-
6AL5	5/6	6K7	4/6	12AT7	7/6	EF30	5/-	SP61	4/6
6AM6	7/6	6L6	6/6	12AU7	7/6	EF37A	9/-	VR150/30	
6AQ5	7/6	6SA7	7/-	12AX7	8/6	EF39	5/6		5/-
6AU6	8/-	6SC7	4/6	12BH7	10/-	EP80	8/6	DAF96	9/-
6BE6	6/-	6SJ7	6/-	12SH7	6/-	EP91	7/6	DF96	9/-
6BH6	5/-	6SK7	5/-	12SJ7	7/6	EP92	8/-	DK96	9/-
6BW6	6/6	6SL7	7/-	12SK7	6/-	EL32	5/-	DL96	9/-
6C4	6/-	6SN7	7/6	50C5	10/-				

**HUGGETT'S LIMITED**

2-4 PAWSONS ROAD, WEST CROYDON



# CORRESPONDENCE

The Editor does not necessarily agree with the opinions expressed by his correspondents. All letters must be accompanied by the name and address of the sender (not necessarily for publication).

## SERVICE DATA

**SIR.**—I was pleasantly surprised to read in your September issue correspondence that a reader had been assisted with technical queries by Messrs. Marconi, as my similar request to their sister organisation produced only a mimeographed refusal, indicating in addition that I should take the set to a dealer.

On reflection, I cannot understand why any manufacturer should refuse information. The amount of servicing work lost to the trade thereby is surely but a drop in the ocean, as only a very limited number of interested amateurs possess the costly sets of spare valves and components necessary for substitution tests on sets; such tests being, I imagine, the backbone of most television servicing.—F. TURNER (Manchester).

## FAULT WITH THE T141

**SIR.**—Many thanks for your assistance re my Ekco T141. I fitted a new sync separator screen decoupling condenser as you suggested, and it has cured my trouble.

Some time ago I wrote E. K. Cole Ltd. asking for service information and I received the same childish reply as your reader C. B. C. (August issue).

Surely when one has an article—whether it is TV, motor car, or anything, in fact—one is entitled to seek information from the makers. Usually it is freely given.—W. CONNER (Altrincham).

## BAIRD P167 RECEIVER

**SIR.**—Many thanks for your assistance in identifying the receiver and guidance in using an alternative C.R.T.

The results obtained being extremely satisfying the following may assist others who may desire to improve this receiver.

CRM123 was replaced by Mullard MW31-74 and an ion trap magnet and 6.3v. transformer was obtained to begin the changeover. However, A1 of C.R.T. supply was obtained from H.T. line at junction of choke and reservoir condenser but result was a coarse badly focused picture. The correct type of focus assembly was obtained which improved matters slightly—it was then observed that slight movement of the tube caused the focus to appear sharper and subsequently a firmer contact between C.R.T. envelope and chassis by means of a spring clip, was made. Further experiment showed that complete focus and improved picture could be obtained by connecting a 120 K $\Omega$  resistor from pin 12 C.R.T. (heater) to chassis.

One caution appears to be necessary—the scan coils can easily be disturbed by handling, these being rather loosely wound and trapezium dis-

ortion becomes apparent. The turns are easily bent whilst being fitted and considerable trouble can be experienced due to careless handling which, however, can be rectified with a little care and the addition of adhesive tape.—G. SHAW (Chiswick).

## ITV IN DIFFICULT AREAS

**SIR.**—Mr. B. L. Morley in his numerous articles in PRACTICAL TELEVISION has been of great help and interest to me. I wish to point out, however, that in my opinion the leads to a pair of phones connected to the speech coil of the loud-speaker may be at mains voltage if one is connected to the chassis and the chassis is connected

to the line side of the mains (see paragraph 5 on page 13, PRACTICAL TELEVISION, August, 1958).

I suggest using isolating condensers about 0.005 mfd. on the leads and those of good insulation test—also, as a precaution when working on a roof. The

insulation between speech coil and chassis is very small sometimes.—J. L. BENT (Dublin).

[*Author's comments.*—This is a point which is worth bearing in mind, particularly with the prevalent use of "D.C." method of working.

It is considered that 0.005 mfd. condensers are a bit on the low side. A more suitable value would be between 0.01 and 0.05. The condensers, should, of course, be fitted at the television end.]

## INVICTA 126

**SIR.**—As a radio and television dealer, I have at many times gained information from "Your Problems Solved" and I would like to give you a tip for the Invicta 126.

Mr. Kingham (Peterborough) has enquired, in the October issue, about picture break up after the set has become hot. This is not line trouble but a fault in the video stage. The faulty components are between V5 and V13: the Q of coil 1.6 decreases and the capacity of C24 and C23 becomes low. If the coil is rewound on a bakelite former, and the two waxed condensers are replaced by ceramic condensers (having a negative temperature co-efficient), the fault will be cured.—W. D. (Essex).

## "YOUR PROBLEMS SOLVED"

**SIR.**—I would like to support your correspondents who suggest that "Your Problems Solved" should be published in book form.

Perhaps S. T. (Ipswich, will tell me how to cut these out and paste them in a book as my problem is what to do with the answers on the reverse side of the page.—K. MUIR (Anerley).

[The reader merely pastes the margins, so that the pages can be turned.—ED.]

**SPECIAL NOTE**  
Will readers please note that we are unable to supply Service Sheets or Circuits of ex-government apparatus, or of proprietary makes of commercial receivers. We regret that we are also unable to publish letters from readers seeking a source of supply of such apparatus.



*Whilst we are always pleased to assist readers with their technical difficulties, we regret that we are unable to supply diagrams or provide instructions for modifying surplus equipment. We cannot supply alternative details for constructional articles which appear in these pages. WE CANNOT UNDERTAKE TO ANSWER QUERIES OVER THE TELEPHONE. The coupon from p. 215 must be attached to all Queries, and if a postal reply is required a stamped and addressed envelope must be enclosed.*

#### DECCA D17

I receive Channel 5, but would also like Channel 10. Welsh I.T.A.

Could you advise me what type converter to buy as I am given to understand the converters advertised in the "Practical Television" might not suit—W. J. Morse (Swansea).

We would advise you to obtain and fit a Brayhead 10s (5/10) tuner unit with B9a R.F. plug and 10BA1 adaptor. Full fitting instructions are supplied.

#### REGENTONE 143/T

Will you give me the correct details of tube-changing for my set as above?—W. Smith (Mon.).

To remove the C.R.T., remove the base socket, ion trap magnet and EHT connection. Release the front fixing band and withdraw the C.R.T. forwards through the focus magnet and scanning coils, taking care not to damage the latter, easing them off the tube neck. Take care to replace rings and rubber bands in the order in which they were removed. Do not expect to pull the tube neck through. It is to be eased a little at a time. When replacing, observe the same precautions. Adjust the ion trap to obtain maximum brilliance.

#### PHILIPS 17480

I have purchased a Brayhead Turret Tuner, to convert my set to I.T.A.

My problem is that I am unable to get a picture either on BBC or ITV although the sound is very good. I have tried two different aerials, and altering the spacing of the wire on the oscillator coil on the unit.

The vision I.F.s of both sets differ by 2 mc/s. the Philips is 12 mc/s. and Brayhead is 14 mc/s.—E. G. Sullivan (Leeds, 16).

When using a Brayhead turret tuner unit with a Philips 1748u, and where the signal strength is not too good, it is always necessary to tune the oscillator coil of the converter to obtain maxi-

mum sound and then tune the I.F. output core (on top of the tuner) to obtain optimum sound and vision. Then tune the adaptor (if used) coil core similarly. We have fitted several of these tuners to Philips receivers in the 1748u range and once the above trimming has been carried out no difficulty has been experienced.

#### BANNER D436

The width control has little effect and brings the width of the picture up to about two-thirds full size. When the horizontal hold control (which was faulty and has now been replaced) is turned back, the picture increases to full width but completely breaks up, or alternatively it is possible to obtain a picture with several images spaced at approximately 3in. apart.

The following have been tested or replaced: EY51, PY81 and PL8. In addition to the above, sound on vision is apparent with loud notes, and advancing the contrast control increases volume. The ECL80s and EF80s have been changed round in the set with no apparent results.—J. E. Sutcliffe (Leeds).

The Banner receiver referred to is directly equivalent to the Sobell T277. A service sheet for this receiver or the T144, T174, T274, etc., will apply. You should have no difficulty in obtaining one of these from one of our advertisers. Referring to the lack of width, check the ECL80 100 K $\Omega$  and 330 K $\Omega$  resistors (pin L to H.T.). Then check the PL81 3.3 K $\Omega$  screen dropping resistor (pin 8) and cathode capacitor of 50 mfd. pin 3. The trimmer on the scanning coils is the balancing capacitor intended to eliminate any left side strips on the picture. The trimmer under the front of the chassis is the vertical (frame) linearity control.

#### INVICTA MODEL 137

The picture is good, but thick wavy lines or thin straight lines appear horizontally across the screen frequently. At other times the set works well for an hour. I can cure this by controlling the horizontal hold, but this entails constant adjustment.—D. Goulding (Whitby).

We would advise you to replace the PCF80 valve mounted on the rear centre of the chassis. This is the line timebase oscillator and is often responsible for the fault described.

#### PHILIPS PROJECTION 1700A

When I turn the contrast control the picture goes very bright and enlarges, then drops back to normal. This only occurs when the contrast control is turned up or increased. I have circuit of the 704 and 1800A; does this apply to the above? What is wrong, and where do I look for the trouble?—A. Reeves (Winchmore Hill, N.21).

The circuit for the 704 and 1800A applies to the 1700A. We do not know which circuit you have to hand and thus cannot quote circuit references with confidence. The negative voltage for the contrast circuit is derived from the H.T. negative return. The final resistor in this chain often changes value. It should be 2.2 K $\Omega$ . It is

(Continued on page 215)

# RADIO SUPPLY CO. (LEEDS) LTD., Dept. N, MAUDE ST. (opposite parish church school), LEEDS 2.

Post Terms C.W.O. or C.O.D. NO C.O.D. under £1. Postage 1/9 extra under £2. 2/9 under £5. Open to callers 9 a.m. to 5.30 p.m. Sats. until 1 p.m. S.A.E. with enquiries, please. Full list 6d.

## R.S.C. TRANSFORMERS

Fully Guaranteed  
Interleaved and Impregnated.  
Primaries 200-230-250 v 50 c/s screened

**TOP SHROUDED DROP THROUGH**  
280-0-280 v 70 ma, 6.3 v 2 a, 5 v 2 a ... 16/9  
350-0-350 v 80 ma, 6.3 v 2 a, 5 v 2 a ... 18/9  
250-0-250 v 100 ma, 6.3 v 4 a, 5 v 3 a ... 23/9  
350-0-350 v 100 ma, 6.3 v 4 a, 5 v 3 a ... 23/9  
350-0-350 v 150 ma, 6.3 v 4 a, 5 v 3 a ... 28/9

**FULLY SHROUDED UPRIGHT**  
250-0-250 v 60 ma, 6.3 v 2 a, 5 v 2 a

Midjet type 2 1/2-3 1/2 in. ... 17/9  
250-0-250 v 100 ma, 6.3 v 4 a, 5 v 3 a ... 26/9  
300-0-300 v 100 ma, 6.3 v 4 a, 5 v 3 a ... 23/9  
350-0-350 v 100 ma, 6.3 v 4 a, 5 v 3 a ... 23/9  
350-0-350 v 150 ma, 6.3 v 4 a, 5 v 3 a ... 33/9  
425-0-425 v 200 ma, 6.3 v 4 a, C.T. 6.3 v 4 a, C.T. 5 v 3 a ... 49/9

**FILAMENT TRANSFORMERS**  
All with 200-250 v 50 c/s Primaries : 6.3 v 1.5 a, 5/8 ; 6.3 v 2 a, 7/8 ; 0.4-6.3 v 2 a, 7/8 ; 12 v 1 a, 7/11 ; 6.3 v 3 a, 8/11 ; 6.3 v 6 a, 17/9.

**CHARGER TRANSFORMERS**  
200-250 v 0-9-15 v 1 a, 11/9 ; 0-9-15 v 3 a, 16/9 ; 0-9-15 v 5 a, 19/9 ; 0-9-15 v 6 a, 22/9.

**OUTPUT TRANSFORMERS**  
Standard Pentode 5.000 to 3 ohms ... 4/9  
Small Pentode 5.000 to 3 ohms ... 3/9

**SMOOTHING CHOKES**  
100 ma 10 h 250 ohms ... 8/6  
80 ma 10 h 350 ohms ... 8/6  
60 ma 10 h 400 ohms ... 4/11

**SELENIUM METAL RECTIFIERS**  
250 v 250 ma, 11/9 ; 120 v 40 ma, 3/9 ; 6/12 v 1 a F.W., 4/11 ; 240 v 50 ma, 4/11 ; 6/12 v 2 a F.W., 8/9 ; 6/12 v 4 a, 14/9 ; 250 v 80 ma, 7/9 ; 6/12 v 5 a, 16/9 ; 6/12 v 6 a F.W., 19/9 ; 6/12 v 10 a, 25/9 ; 6/12 v 15 a, 35/9 ; 24 v 2 a, 14/9.

**CO-AXIAL CABLE 1in.**  
75 ohms 14/36 ... 8d. yd.  
Twin-screened Feeder ... 11d. yd.

**BATTERY SET CONVERTER KIT**  
All parts for converting any normal type of Battery Receiver to A.C. mains 200-250 v 50 c/s. Supplies 120 v, 90 v or 60 v at 40 ma, fully smoothed and fully smoothed L.T. of 2 v at 0.4 a to 1 a. Price including circuit 49/9. Or ready for use, 9/9 extra.

**ALL DRY RECEIVER BATTERY ELIMINATOR KIT**—All parts for the construction of a unit (metal-case 5 1/4-4 1/2 in.) to supply Battery Portable receivers requiring 90 v and 1.5 v. Fully smoothed. From 200-250 v 50 c/s mains. Price, inc. point-to-point wiring diagrams, 39/9. Or ready for use, 46/9.

**D.C. SUPPLY KIT**—Suitable for Electric Trans. Consists of mains trans. 200-250 v 50 c.d.s. A.C. 12 v 1 a Selenium F.W. Bridge Rectifier. 2 Fuseholders. 2 Fuses. Change Direction Switch. Variable Speed Regulator. Partially drilled Steel Case, and Circuit. **29/9**

**EX-GOVT. CASES**. Well ventilated, black crackle finished, undrilled cover. Size 14 x 10 x 8 1/2 in. high. **IDEAL FOR BATTERY CHARGER OR INSTRUMENT CASE, OR COVER WOULD BE USED FOR AMPLIFIER**. Only 9/9, plus 2/9 postage. Size 13 1/2 x 8 1/2 x 6 1/2 in. with undrilled perforated cover finished stoved grey enamel, 7/9, plus 2/9 post.

**EX-GOVT. VALVES (NEW)**

1R5	7/9	FJ6	4/9	MH4	4/9
1R7	7/9	6E7G	3/9	6A7S	7/9
1S5	7/9	607G	9/11	DF96	6/9
3S4	8/9	6X4	6/9	EBC33	8/9
5Y3G	7/9	6X5GT	7/9	EB81	8/9
5Z4G	9/9	68N7GT	8/9	ECC91	4/6
5Y4G	8/9	6L6G	11/9	EP91	8/9
6J5G	4/9	807	7/9	EL32	3/9
6R8G	9/9	12A6	7/9	EL91	5/9
6SJ7GT	6/9	6V6G	7/9	FW4 500	8/9
6V6G	7/9	6U5G	3/9	SP61	2/9

## EX-GOVT. MAINS TRANSF.

All 200-250 v 50 c/s input.  
Removed from New ex-Govt. units. **22/9**  
275-0-275 v 100 ma, 6.3 v 7 a, 5 v 3 a ... 11/9  
230-0-230 v 80 ma, 12.6 v 1.5 a, 5 v 2 a ... 16/9  
250-0-250 v 150 ma, 5 v 3 a ... 16/9  
350-0-350 v 160 ma, 6.3 v 5 a, 5 v 3 a ... 27/9  
400-0-400 v 250 ma, 5 v 2 a, 5 v 2 a ... 18/9  
450-0-450 v 150 ma, 6.3 v 5 a, 6.3 v 1 a, 5 v 3 a ... 29/9  
450-0-450 v 250 ma, 6.3 v 3 a, 6.3 v 1 a, 5 v 6 a ... 49/9  
12.5 v 3 a, 5 v 3 a ... 12/9

**EX-GOVT. SMOOTHING CHOKES**—  
80 ma 10 h 150 ohms ... 6/9  
100 ma 5 h 100 ohms Tropicalised ... 3/11  
100 ma 8-10 h 100 ohms Parmeko ... 6/9  
120 ma 12 h 100 ohms ... 8/9  
150 ma 6-10 h 150 ohms, Trop. ... 6/9  
150 ma 10 h 150 ohms ... 11/9  
250 ma 20 h 200 ohms ... 19/9  
200 ma 3-5 h 100 ohms Parmeko ... 9/9

**ELECTROLYTICS (NEW)**

Tubular		Can Type	
8 mfd 450 v	1/9	8-8 mfd 450 v	2/11
16 mfd 450 v	2/9	8-16 mfd 450 v	3/11
8-16 mfd 500 v	4/11	16-16 mfd 450 v	4/11
25 mfd 25 v	1/3	32-32 mfd 350 v	4/9
50 mfd 12 v	1/3	32-32 mfd 450 v	5/9
50 mfd 15 v	1/9	150-100 mfd 450 v	5/9
100 mfd 25 v	2/3	100-100 mfd 350v	5/8
3,000 mfd 6 v	3/9	100-200 mfd 275 v	6/11
6,000 mfd 6 v	3/11		

**BATTERY CHARGERS**  
For 200 250 v 50 c/s A.C. mains. 12 months guarantee. Attractive, well ventilated, hammer finished cases, 6 v or 12 v 4 amp. with meter and variable charge rate selector, as illustrated. 75 v, cur. 4.8; 6 v or 12 v 1 amp type. Also suitable for electric train power supply. Only 27/9, post 2/9.



## TUBES REBUILT

### SEND YOUR T.V. TUBES TO US FOR REBUILDING

Via BRS (PARCELS) LTD. or BRITISH RAILWAYS

14"                      15", 16" and 17"                      21"  
**£8.10                      £10.10                      £12.10**

12" only Mullard and CRM 123 and 124 Mazda  
**£7.10**

Carriage and insurance 10/- each tube.

FULLY GUARANTEED SIX MONTHS

TERMS TO TRADE

### LINE OUTPUT TRANSFORMERS AND DEFLECTOR COILS

Most types can be supplied. State set, make, model number and part required. S.A.E. please.

Terms : C.W.O. or PRO-FORMA

**PRIME ELECTRICS (Dept. W/2)**  
36, QUEENSDALE ROAD, LONDON, W.11  
(Nr. Shepherds Bush Central Line). Phone PARK 1131  
Callers : 10.30-3 Mon.-Sat. Closed Wed.

## BAND III CONVERTOR

### for ANY SET in ANY AREA

This unit has been widely used since I.T.A. Transmissions began to convert all types of sets, Superhet and T.R.F., to receive on Band III.

Unlike many other convertors this unit is small enough to be fitted inside your cabinet, enabling the job to appear finished and perfectly safe for all to use.

- The wiring is simple to follow, and alignment is not difficult.
- ★ IT will convert any set, any age, T.R.F. or Superhet.
- ★ IT includes station switching.
- ★ IT provides pre-set contrast balancing.
- ★ IT uses only one aerial input for both bands
- ★ IT provides manual tuning on Band III.
- ★ IT is totally screened.
- ★ IT completely rejects unwanted signals.
- ★ IT requires no additional power supply where either 6.3 v. or .3 amp. heater line is available.

**CONVERTOR** wired and aligned with fitting instructions ... **£3 10 6**  
**KIT** complete in every detail, less knobs ... **£2 10 6**  
**KNOBS** each ... **1 0**  
**CIRCUIT** and instructions in detail (free with kit) **1 6**  
**KITS** made up by customers checked and aligned, including post ... **12 6**

When ordering please state present B.B.C. Station, and I.T.A. Orders over £2 post free.

**C. & G. KITS**  
285, LOWER ADDISCOMBE ROAD,  
ADDISCOMBE, CROYDON, SURREY  
Phone : ADDiscombe 5262

# LASKY'S RADIO

## MAKER'S SURPLUS COMPONENT BARGAINS

- WIDE ANGLE 38 mm.**  
 Line E.H.T. Trans. Ferro-cube core, 9-16 kv. .... 25/-  
 Scanning Coils. Low imp. line and frame. .... 25/-  
 Ferro-cube cored Scanning Coils and Line Output Trans. 10-15 kv. EY51 winding Line Trans. with circuit dia. part. .... 50/-  
 Frame Output Transformer Scanning Coils. Low imp. line and frame. .... 17/6  
 Frame or line block osc. Transformer. .... 4/8  
 Focus Magnets Ferro-cube P.M. Focus Magnets, Iron Cored. .... 19/6  
 Duomas Focallisers. .... 22/8  
 300 m'a Smoothing Chokes. .... 15/-
- STANDARD 35 mm.**  
 Line Output Transformers 6.9 kv. E.H.T. and 6.3 v. winding Ferro-cube. .... 19/6  
 Scanning Coils. Low imp. line and frame. .... 12/6  
 Ditto, by Igranite. .... 14/9  
 Frame or line blocking oscillator Transformer. .... 4/6  
 Frame Output Transformer. .... 7/6  
 Focus Magnets. .... 12/6  
 Without Vernier. .... 12/6  
 With Vernier. .... 17/6  
 200 m'a Smoothing Chokes 10/6

## THE "STIRLING" BAND III CONVERTER

AVAILABLE ON CREDIT SALES TERMS

CASH PRICE  
**6 GNS.**  
 Post paid  
 or



21/- deposit and 5 monthly payments of 21/-  
 This very efficient CONVERTER employing R.F. amplifier ECC85 and metal rectifier is TUNABLE OVER ALL 13 CHANNELS and incorporates its own power supply for 200-250 v. A.C. mains. Can be fixed to rear of set or used as separate unit. Metal brown crackle finish case : 4in. wide, 7in. deep, 2in. high.

**TURRET TUNERS.** All types in stock—Cyldon, Brayhead, Telenge, Valradio. Describe your set and we will quote you. Prices from 79/6.

**C. R. TUBES,** new, unused, 14", £14.19.6. 17", £16.19.6. 12", £8.19.6. 9", £5.17.6. Carr. & ins. 22/6.

MAIL ORDERS TO HARROW ROAD, PLEASE  
**LASKY'S (HARROW RD.) LTD.**  
 42, TOTTENHAM COURT ROAD, W.1.  
 Telephone: MUSEUM 2905.  
 370, HARROW ROAD, PADDINGTON, W.9.  
 LADbroke 4075 and CUNningham 1979.  
 Open all day SATURDAY. Half day THURSDAY.

## SPEAKER BARGAIN

Special Purchase of Plessey P.M. Speakers, 5in. round or 7in. x 4in. elliptical. Lasky's Price **14/6**  
 Post 1/6.

## SPECIAL OFFER OF SOLDERING IRONS

SOLOON, ex-Govt., new and unused. Pencil bit, 65 watts, 220-250 v. A.C./D.C. List 27/6. Lasky's **16/6**  
 Price  
 Post 1/6. Spare Bits, 1/- each. Spare Element (state voltage), 5/9.



**COLLARO 4-SPD. MIXER AUTO CHANGERS**  
 RC. 457, incorporates auto and manual control. Complete with Studio crystal P.U. and sapphire stylus. List £13/17/-. Lasky's Price **£7.19.6**  
 Post 5/-.

B.S.R., type UAB, 4-spd., mixer auto-changer with latest **£6.19.6**  
 B.S.R. fu-fi P.U.  
 Post 5/-.

Television Aerials, Band III 3-element 24/6 ; 5-element, 37/6 ; 8-element, 57/6. B.B.C. Single Dipole, 32/6 ; H. 74/8 ; "X" 74/8. We carry large stocks of good aerials. Send S.A.2. with your requirements and we will reply by return.  
 Air-Spaced Coaxial Cable, 9d. per yd. 70/- per 100 yds. Crossover Boxes, 12/- Coaxial Plugs, 1/- Coaxial Sockets, 1/- Ion-Trap Magnets, 5/- Television Tables, 62/6 Electrostatic Condensers, 64-120 mfd., 9"-, 100-200 mfd., 10/6, 100 mfd., 6/6, 13 mfd., 3"-, 8+8 mfd., 2/6, 8 mfd., 1/9. Speakers, 5in., 19/6. 6in., 18/6. 8in., 22/6. 12in., 28/6, 7" x 4in., 16/6. 9" x 5in., 22/6. Guaranteed Brand New Stock. Electric Blankets, Single Size, 67/6. Double Size, 87/6. B.S.R. 4-speed Record Changers, 87.12.6. plus 3/6 carriage.

Guaranteed Valves			
AZ1	12/-	PCL83	UCL83
AZ31	12/-	18/6	15/-
CB11	19/6	PL33	15/-
CB131	17/6	PY31	17/6
CI.33	14/6	PY32	17/6
CY31	12/6	PZ30	17/6
DDT4	18/6	PCF80	17/6
EBL31	13/6	PY81	17/6
EBC33	14/6	PY82	8/6
EF65	9/6	PL81	15/6
EF96	11/6	PL36	18/6
EL33	14/6	PCC84	10/6
GZ32	15/-	MU14	12/6
FCI.82	15/-	UBCH1	8/6
EL38	21/6	UBF90	12/6
PCL82	15/-	UCL82	15/-

MAIL ORDER ONLY—NO CALLERS  
 Terms : C.W.O. or C.O.D. Minimum C.O.D. charge 3/6. Postage and packing per valve, 6d. Other items, under £2, 1/9 ; £5, 2/- Aerials 3/- carriage.

**ELECTRO-SERVICES & Co.**  
 221 BATTERSEA PARK ROAD,  
 LONDON, S.W.11.      MAC 8155

## TRANSFORMERS ?

CONTACT **FORREST FIRST!**  
 Rewinding and manufacture of all types for Television, Radio and Electronic Application.  
**FORREST (TRANSFORMERS) LTD.,**  
 Shirley, Solihull, Warwickshire.  
 Phone : SH1. 2483. Est. 34 years.

## B.B.C.-I.T.V.-F.M. AERIALS

B.B.C. (Band 1).—Telescope loft, 19/6. External S/D, 23/6. "X" Chimney unit, 75/-.  
 I.T.V. (Band 3).—3-element loft array, 24/-; 5-element, 42/6. Wall mounting, 3-element, 33/9 ; 5-element, 41/3.  
 Combined B.B.C. + I.T.V. Loft 1+3 element, 41/3 ; 1+5 element, 48/9. Wall mounting, 1+3 element, 56/3 ; 1+5 element, 63/9.  
 Belling "Golden V" room aerial, 42/- Antiference "V", 25/-.  
 F.M. (Band 2).—Loft "H", 24/-; 3-element, 52/6. S/D loft, 12/8. External S/D, 26/3. State channel, when ordering. C.W.O. or C.O.D. P/P 2/6. Coaxial cable, 8d. yd. Coaxial plugs, 1/3. Send 6d. stamps for Illustrated Lists.  
**K.V.A. ELECTRONICS (Dept. T.P.),**  
 31, Godstone Road, Kenley, Surrey.

## An invaluable book . . . F. J. Camm's A BEGINNER'S GUIDE TO TELEVISION

Covers persistence of vision and scanning ; the cathode-ray tube and timebase ; interlacing ; the aerial ; the TV camera ; scanning systems ; colour and stereoscopic television, etc. **61 illustrations.**  
 From all booksellers or 8s. 3d., by post from **GEORGE NEWNES LTD.,** Tower House, Southampton Street, W.C.2.  
**7s. 6d.**

## OPPORTUNITIES IN TELEVISION

148 pages  
**Free!**

Television offers unlimited scope to the technically qualified. Details of the easiest way to study for A.M.Brit.I.R.E., R.T.E.B. Cert., City and Guilds, Television, Television Servicing, Sound Film Projection, Radio Diploma Courses, etc., are given in our 248-page Handbook "ENGINEERING OPPORTUNITIES" which also explains the benefits of our Appointments Dept.

**We Guarantee "NO PASS—NO FEE"**  
 If you are earning less than £20 a week you must read this enlightening book.  
 Send for your copy NOW—FREE and without obligation.

**WRITE TO-DAY!**  
 British Institute of Engineering Technology  
 237, College House,  
 29-31, Wright's Lane, **BIET**  
 Kensington, W.8.

the rearmost of a group of four under the rear centre of the chassis. Check this resistor, the contrast control itself and the resistors connected to either end.

#### FERGUSON MODEL 968T

A black band creeps up the picture from the bottom. It extends for about  $\frac{3}{4}$  in. The rest of the picture is perfect. Also, could you please tell me which is the sound output valve?—G. J. Chipp (High Wycombe).

For the frame fault replace the ECL80 (V13), which is situated in the far left-hand corner of the chassis when viewing from the rear of the cabinet. The sound amplifier (output) valve is the ECL80 situated in the near right-hand corner of the chassis.

#### PETO SCOTT 1712T

The picture is showing a white line about  $\frac{1}{2}$  in. wide on the right-hand side of all black objects. The effect on test card C is a similar white line at the right-hand side of the vertical black bar on a white background. I am told that this fault is known as "overshoot" or "ringing" and I should be grateful if you would confirm this and offer any assistance regarding its cure.—H Hewitt (Chester).

This trouble may be promoted by misalignment of the vision I.F. channel or by an aerial mismatch and accompanying low signal. A certain degree of overshoot is purposely introduced to "liven" the picture, but you will probably find that a better balance can be obtained by carefully adjusting the final vision I.F. transformer. There is also a possibility that a component associated with the video amplifier has altered slightly in value.

#### R.G.D. "DEEP SEVENTEEN"

I have had to replace the EHT rectifier EY51 four times within the 12 months I have had the set.—W. T. H. (Ipswich).

Check that the mains selector is adjusted to suit the mains supply voltage. A tolerance error in the line output transformer may aggravate the trouble, but in this case can be overcome by connecting a 10 ohm resistor in series with the EY51 heater. Take care in connecting and placement to avoid corona.

#### SOBELL TS17

I have fitted "Channel 10" coils for ITV reception and tried a "double nine" aerial. The sound has been excellent but no vision, even though low loss cable has been fitted. My set has been connected to a neighbour's aerial who receives good vision but again with the same result.—M. Thomas (Neath).

Since BBC reception and the I.T.A. sound are satisfactory, it is unlikely that the set is at fault, though there is a possibility of a fault or misalignment of the Channel 10 coils. If this is suspected the coils should be returned for a replacement set. The signal may, however, be

too low for your model, which would account for your neighbour receiving a Channel 10 picture if his is a more sensitive model.

#### ENGLISH ELECTRIC 16T18F

One evening the picture quite rapidly got smaller and disappeared. The 10 kc/s whistle is still audible. I haven't had the valves checked but all, including the EY51s, have their heaters continuous.—R. J. R. (Aylesbury).

We are unable to supply a circuit diagram or service manual, but one of our advertisers may be able to help here. Check for EHT. If the EY51 is lighting up, EHT is almost certainly available. However, you will probably find that the EHT has failed, in which case a check should be made of (a) the thermal cut-out in the anode circuit of the PY81 valve, (b) the PY81 valve, (c) the PL81 valve.

#### PHILIPS 1100U

Symptoms: no line hold, no frame hold. I have checked ECL80 valve (sync sep.) and resistance and condenser (.01  $\mu$ F) feeding it from video output stage. I have checked video output valve (EF80) but not associated circuit. Line synchronising is impossible; frame synchronising almost so. Sound output and voltages appear to be O.K. Raster O.K. (quite bright and full scan).—J. L. (Manchester).

If the sync separator valve and associated components are in order suspect open-circuit of the 100 mF electrolytic capacitor in the cathode circuit of the video amplifier valve.

#### EKCO T231

A band approximately  $1\frac{1}{2}$  in. wide down the left-hand side of the picture is brighter than the remainder, and slightly out of focus. In between this band and the remainder of the picture there is a narrow darker line. The fault appears on both Band I and III, and persists despite adjustment of brightness and contrast controls. Apart from this difference in brightness between the sections, the whole of the picture appears normal in other respects. The spot-wobble unit is not in use on the set.—C. F. Lovegrove (Surrey).

We have only met this fault once and it took ages to find due to the "red herrings" provided by the feeding back of line pulses into the video amplifier for A.G.C. gating purposes. In our case it turned out to be the .1 mfd condenser which decouples the brightness network to H.T. This is located under the chassis between the main smoothing block and the metal rectifier. There are many other likely causes of this fault, however, as we discovered to our cost!

#### QUERIES COUPON

This coupon is available until NOVEMBER 21st, 1958, and must accompany all Queries sent in accord with the notice on page 212.

PRACTICAL TELEVISION, NOVEMBER, 1958

**SETS & COMPONENTS**

**MAINS FROM 12v. CAR BATTERY.**—American Dynamotor Unit, runs 200/250 AC/DC radios, televisions, tape recorders, etc., from 12v. car battery, continuous duty, perfect cost £25, 80/-; s.a.e. full details. **SCIENTIFIC PRODUCTS**, Cleveleys, Lancs.

**T.V. TUBES** as new, revacuumated; all makes: 6 months' straight guarantee 14in. £5/10/-, 17in. £7/10/-; carriage and insurance 12/6 U.K. Free delivery greater London. **VIDIO REPLACEMENT CO.**, Hales St., Deptford High St., London, S.E.8. (Tideway 4506.)

**MAKE YOUR AERIALS** with our fully machined parts. Examples: Band 1, "H." complete with lashings, for £3/10/-; 5 Element, Band 3, with folded dipole, mast and clamp for 45/-. Get further details from our illustrated lists and data on all aerials, sent for 1/- P.O. (Trade supplied). **SKYLINE WORKS**, Burnhall Rd., Coventry. (Tel.: 60418.)

**LOW-EMISSION MULLARD C.R. TUBES**, re-activated by new patented process, only 30/- per tube, with 3 months' guarantee; carriage and insurance 15/-. Quantity orders collected and delivered free within 100 miles radius. S.C.L., 77, Cranleigh Rd., Bournemouth. (Tel.: Southbourne 46903.)

**T.V. BARGAINS.**—12in. 5-channel T.V. £12/10/-; 14in. £17/10/-; 17in. £20/-; immediate despatch. Sets demonstrated. Call 1070, Harrow Rd., London, N.W.10. (Phone: LADBroke 1734.)

**TELEVISION CATHODE RAY TUBES**

Reconditioned and Guaranteed 6 months. 14" round Mazdas—£5.00. 15" round Mazdas—£6.00. 17" rect. Mazdas—£6.00. Carriage and Insurance, 10/-. Cash with orders to **"TELESPED,"** Dept. 2/B, 6, Clements Street, Coventry, Tel. 41062.

**CATHODE RAY TUBES**, ex-chassis. Picture-tested, 3 months' guarantee. Mullard, Mazda, Brimar, etc., 14in. £3/10/-; 17in. £4/-; carriage and insurance, 15/-. Miniature Valves, 10/- dozen. S.C.L., 77, Cranleigh Rd., Bournemouth.

**TELEVISION BARGAINS.**—12in. from £9, 14in. from £18, 17in. from £25. **TYLER TELEVISION**, 63, Lee High Rd., Lewisham, S.E.13. (Lee 5979.)

**COMPONENTS, Valves, Tubes, etc.** Write or phone for free list. **ARION TELEVISION**, 4, Maxted Rd., Peckham, S.E.15. (New Cross 7152.)

**TELEVISIONS**, 9in. models. £7/10/-; 12in. models. £13/10/-; 15in. Channel models. £19/10/- each; all working; carriage paid. Send for list. **TOMLINS**, 127, Brockley Rise, Forest Hill, S.E.28. (FOR 5497.)

**T.V. TUBES**

MULLARD	MAZDA
36.24. £5.10.0	CRM141. £5.10.0
33.44. £5.10.0	CRM142. £5.10.0
43.94. £7.10.0	CRM153. £8.10.0
43.63. £7.10.0	CRM171. £7.10.0

Carriage and insurance 10/-. Cash with order, please, to:

**MIDLAND TUBES LIMITED**  
37, George St., Manchester, 1. Central 0432

**RATES:** 4/- per line or part thereof, average five words to line, minimum 2 lines, Box No. 1/- extra. Advertisements must be prepaid and addressed to Advertisement Manager, "Practical Television," Tower House, Southampton St., Strand, London, W.C.2.

**LINE OUTPUT TRANSFORMERS**

**DIRECT REPLACEMENTS** for 500 sets. State make and model No. (3d. stamp).

**BRAYHEAD TURRET TUNER** for ANY AREA. The best converter! State Channels, set make, model No. £6.15.0 post/ins. 2/6.

**WESTWAY RADIO**  
5 Westward Way, Harrow, Middx.

**12 MONTHS' GUARANTEE!** The very best reconditioned c.r.t. ever offered. 12in. £9, 14in. £10, 15in. and 17in. £12/10/-, 21in. £16; carriage and insurance 22/6. S.C.L., 77, Cranleigh Road, Bournemouth.

**TELEVISIONS FROM £5**, Radios from £2, all working. Tubes, Valves, Components, cheap (callers only). **J. PALMER**, 32, Neasden Lane, N.W.10.

**TELEVISION BARGAINS.**—Huge quantity of Televisions, all sizes, at still lower prices. We can supply 12in. chan. 2 at £8; 12in. 5 chan. at £12/10/-; 14in. and 15in. from £16; 17in. from £22. All in good working order. Non-working: 12in at £4; 14in. at £10. We also have a quantity of modern 13 chan. Receivers with 6 months' full guarantee on tubes. 14in. at £35; 17in. at £40. All in new condition; buy with confidence. Prices quoted are plus £1 for carriage. Special discount on quantities. Trade enquiries and callers welcomed. **GRAINGERS**, 21, Kenwyn Ave., Blackpool, Lancs.

**TELEVISIONS**, London only. 12in. £10; 5-channel, 12in., £14; 14in., £18; 17in., £27; 13-channel, 12in., £20; 14in., £25; 17in., £35. (Callers only.) **JOHN GILBERT TELEVISION**, 1B, Shepherds Bush Rd., London, W.6. (SHE 8441.)

**C. EDWARDS**

1070 HARROW ROAD  
LONDON, N.W.10  
LADBROKE 1734

Offers  
S/H T.V. in  
First-class  
Condition

12in. £12.10.0.  
14in. £17. 0.0.  
17in. £25. 0.0.  
(all 5 channel)



In stock : **PYE, FERGUSON, EKCO**  
CASH ONLY. 10/- Carriage.  
Trade Enquiries Welcome.

**TELEVISION TUBES**

**FACTORY** reconditioned T.V. picture tubes. 51X months' guarantee. £ s. d.  
12in. MW31-74, ..... 7 0 0  
14in. MW36-24, AW36-21, ..... 7 10 0  
17in. MW43-64, MW43-80, ..... 9 15 0  
21in. MW53-20, MW53-80 ..... 13 10 0

**CATHODE-RAY TUBE SERVICE**  
35, Broomwood Road, St. Paul's Cray  
Orpington 21285

**ASSIST-U-AERIAL KITS**, containing insulator and cap for lin. boom, elements, 20 jin. plugs, 2 lin. end plugs, 2 jin. grommets, suitable for construction of Band II or Band III Aerials, 6/6 complete. Send P.O. with order. **ROBERT MOSS, LTD.**, 35, Banbury Rd., Kidlington, Oxford. Trade inquiries invited.

**CATHODE RAY TUBES** used but in good working order, with three months' written guarantee. 12in. to 17in. Mazda, Mullard and Equivalent types only, at £4/10/-, plus 12/6 for carriage and insurance. Enquiries and orders to **BHP DISTRIBUTORS (LONDON) LTD.**, 379, Staines Rd., Hounslow, Middlesex. (Tel.: HOU 5144.) Our terms are c.w.o. or c.o.d.

Save 30% on all outdoor aerials and fittings. Example: Double Five Array costs only 70/-. Self-contained Band III Pre-amplifiers only 60/-. Convertors 80/- complete. Fringe Area Super Low-loss Co-axial, months' guarantee. 12" & 14" 110/-, 17" 150/-, 21" 210/-. C.W.O., carriage 10/- extra. Tubes delivered in 24 hours all parts U.K. S.A.E FOR FULL LISTS.

**G. A. STRANGE**

North Wrexall, Nr. Chippenham, Wilts.  
Tel.: Marshfield 236.

**RF27** or 26, 19/6; 24, 12/6; 25, 9/- Brand new, post 3/6. E.W.S. CO., 69, Church Rd., Moseley, Birmingham.

**MAGNETRON POWER UNIT**, input 200v. A.C., with 5 valves and 4 neons 1 mA. 5jin. meter and neat perforated case, 50/- (rail 7/6). Condensers, 60 mfd., 350 v.w., 1jin. dia., 3/6. Indicators with C.R.T.s VCR530 and VCR139A, valves, etc., 50/- (rail 8/6). Convertors (Rotary), 24v. D.C. to 50v A.C., 4A., 40/- (rail 7/6). Drives: slow-motion, Admiralty 200 : 1 ratio, scaled 0-100, 5/6. R1155 S.M. "N" type, new, 10/6. Brand new RF26, 20/- (post 3/-); RF27, good cond., 18/-. Lists and enquiries: S.A.E., please! Terms, c.w.o. Postage extra. Immediate despatch. **W. A. BENSON (P.T.)**, 136, Rathbone Road, Liverpool, 15.

**CHANNEL 11 OFFER.**—5 Element folded Dipole array with mast and universal clip for fixing to any size Band I aerial mast, 39/6. Trade rates 6 or more. Post paid. All types of Aerials and Machined Parts available. Send 1/- P.O. only for details and technical data for "Do it Yourself." **SKYLINE WORKS**, Burnhall Rd., Coventry.

**T.V. TUBES**

14in. Rectangular types, £4; 14in. Round types, £3.10; 15in. CRM 153, £4; 17in. Types, £5. Picture tested and guaranteed 3 months. A few 14in. and 17in. for testing or boosting at 25/- each. All carriage paid. Your own tube reconditioned at 4/- per inch, return carriage paid, 48 hour service. S.A.E. all enquiries please.

**S. BRADLEY**

6, Beadon Avenue, Waterloo, Huddersfield.

**SETS & COMPONENTS** *continued*

**RECLAIMED TUBES**, 12in., 14in., 17in., all at £5 each, guaranteed; 100 (5 channel) T.V. Ekco 161. Ferguson 988. £15 each. C. EDWARDS, 1070, Harrow Rd. (Phone: LADbroke 1734.)

**TELEVISIONS?** Not working sets from: 9in., £2; 12in., £3/10/-; 14in., £10. Working sets: 9in., £5; 12in., £9; 14in., £15. (Trade enquiries invited.) **RELYON RADIO**, 439, Katherine Rd., London, E.7. (Tel.: GRA 1820.)

**AUCTIONS**

**EVERY THURSDAY AT 11 a.m.**

Sales by private treaty.

**DAILY 9 till 6 including SATS.**

Over 500 TVs from £3 working, 10/- not. Radios, grams, washing machines, fridges, vacuum cleaners, typewriters.

**EASTERN AUCTION MART**

Whitehorse Lane, Stepney, London, E.1

**FOR SALE**

**AMAZING OFFER.**—Originally £40/£100 each. Ekco, Pye, H.M.V., Marconi, Philips, Murphy, etc., 9/10in. Televisions, complete, not working, 50/- each; carriage paid; immediate dispatch. 12in. £5/5/-; 15in., £9; Philips 17in. Projection Televisions, £9/15/-. **TOMLINS**, 127, Brockley Rise, London, S.E.23.

**MAINS RADIO IN YOUR CAR**, complete unit runs 200/250 AC/DC radio, television, tape recorders, etc., from 12v. battery, perfect, cost £25, 80/-; stamp full details. **SCIENTIFIC PRODUCTS** Cleveleys, Lancs.

**VALVE CARTONS** at keen prices. Send 1/- for samples and list. **J. & A. BOXMAKERS**, 75a, Godwin St., Bradford, 1.

**TELEVISION BARGAINS**, 12in., O.K., £10; 14in. and 17in. cheap for cash. New sets at bargain price. **T.V. SUPPLIES**, 1, High St., Chalvey. (Tel.: Slough 21860.)

**SECONDHAND TELEVISIONS**, 9in. to 21in., all makes; faulty and working. **WILKINSON'S**, 146a, Goldhawk Rd., Shepherds Bush, 4379.

**100 BAYS** of brand new adjustable steel Shelving, 72in. high x 34in. wide x 12in. deep, stove enamelled, dark green; sent unassembled, 6-shelf bay, £3/15/-; sample delivered free; quantity discounts. **N. C. BROWN LTD.**, Eagle Steelworks, Heywood, Lancs. (Tel.: 69918.)

**CO-AXIAL CABLE**, unbeatable offer. 8d. a yard air spaced.

**TELEVISION TABLES** cancelled order. 20" x 20", 18" legs, 4-quartered veneering, veneered both sides, in medium oak, walnut and supele mahogany. Unrepeatable offer while stocks last. 32/6, carriage 2/6.

**MARSHALLS FOR TELEVISION**

131, ST. ANN'S ROAD, TOTTENHAM, N.15. Phone: STAmford Hill 3267.

**FOR SALE** *continued*

**HOW TO USE EX-GOVT. LENSES** and Prisms. Nos. 1 and 2, 2/6 ea. Vertical Enlarger Plans for 35mm. to 21in. sq., 3/6 ea. Optical Condensers and Achromatic Lens to suit, 33/-, Lists. S.A.E. H. W. ENGLISH, Rayleigh Rd., Hutton, Essex.

**TV AERIALS**, 25/6. For all I.T.A. Channels. Outdoor or loft. 3 elements. P. & P. 2/6.

**AERIALS**, 15/9. B.B.C. indoor type. Folded dipole with 12 ft. Co-ax. cable fitted. Postage 1/9.

**TV AERIALS**, 7/9. For all channels complete with Co-ax. cable. For use indoors or in the loft. Postage 1/3.

**DUKE & CO.** (Dept. E.11), 621/3, Romford Road, Manor Park, E.12. Tel.: ILFord 6001.3.

**WANTED**

**ALL TYPES OF VALVES WANTED**, PL81, ECL80, EY51, U25, PCF80, PZ30, U801, etc., etc. Best cash price by return. **STAN WILLETTTS**, 43, Spon Lane, West Bromwich, Staffs. (Tel.: WES 2392.)

**NEW VALVES WANTED.** — EY51, PL81, ECL80, and similar types. R.H.S., 155, Swan Arcade, Bradford, 1, Yorks.

**IMPORTANT.**—All types new B.V.A. Valves wanted. Same day payment. **ROBERT**, 414, Whitefoot Lane, Bromley, Kent.

**EDUCATIONAL**

**FREE!** Brochure giving details of Home Study Training in Radio, Television and all branches of Electronics. Courses for the Hobby Enthusiast or for those aiming at the A.M.Brit.I.R.E., City and Guilds, R.T.E.B. and other Professional examinations. Train with college operated by Britain's largest Electronics organisation. Moderate fees. Write to **E.M.I. INSTITUTES**, Dept. PT28, London, W.4.

**STUDY RADIO, TELEVISION AND ELECTRONICS** with the world's largest home study organisation—**I.C.S.** Courses for the enthusiast and for those seeking examination qualification: Brit. I.R.E., City and Guilds, R.T.E.B., etc. Build your own equipment with Practical Radio Course. Write to-day for free book. **INTERNATIONAL CORRESPONDENCE SCHOOLS**, 71, Kingsway, (Dept. 516), London, W.C.2.

**LEARN IT** as you do it—we provide practical equipment combined with instruction in Radio, Television, Electricity, Mechanics, Chemistry, Photography, etc. Write for full details to **E.M.I. INSTITUTES**, Dept. PT47, London, W.4.

**EASY MATHEMATICS** Course for Radio/T.V. Write: **TUTORIALS**, 200, Buchanan Street, Glasgow, C.1.

**INCORPORATED** Practical Radio Engineers home study courses of radio and T.V. engineering are recognised by the trade as outstanding and authoritative. Moderate fees to a limited number of students only. Syllabus of Instructional Text is free. "The Practical Radio Engineer," journal, sample copy 2/-. 6,000 Alignment Peaks for Superhets, 5/9. Membership and Entry Conditions booklet 1/-, all post free from the **SECRETARY**, I.P.R.E., 20, Fairfield Road, London, N.8. (Continued overleaf)

Satisfaction or Money Back Guarantee. If returned unused within 7 days.

**TV TUBES** (ex-Equipment). Guaranteed 6 months, carr. and ins. 12/6  
12" MW31/74, CRM121, etc. ... £5.20  
14" MW36/24, CRM141 4/14, etc. ... £4.10.0  
15"-16" 152B, 411, etc. ... £5.00.  
17" MW43/64, CRM171, etc. ... £5.15.0  
21" MW53/80, CRM211 ... £8.10.0

**FOCUS MAGNETS**, wide angle, with centering and mounting, 8/6. Ditto double magnet 12/6

**I.C. CHOKES** 10H 60 ma. 5/-; 5H 250ma. 4/6

**RECTIFIERS**, Iron Selenium. 15V. 1A., 5/-; 12V. 2A., 7/6; 12V. 31A., 9/6; 250V. 80mA., 5/-; 250V. 250mA., 12/6; contact, contact, 250V. 50mA., 7/6; 250V. 250mA., 19/-; 250V. 300mA., 23/-.

**ION TRAPS**, standard type, 4/-

**ALADDIN COILS**, screened, slugged, 6/- doz.

**4-spd. SINGLE PLAYERS**, Consisting Collaro latest 4-speed turntable together with Siasr Galaxy turnover crystal-sapphire pick-up. This month's special snip. **£3.10.0** (Carr. 3/-) Garrard 4-spd. type 4SP, £7.7.6.

**STAR GALAXY SPARES** (auto-changer). 100's available, low prices, S.A.E. List.

**13 CHANNEL CONVERTERS** **INTERNAL FITTINGS**, For T.R.F. or Superhets. Famous make, fine tuner, 9 quick set trimmers, giving any 3 channels output to aerial, socket, With PCC84, PCF80. Full instructions. **£3.15.0** (Post 3/-).

**DIPLEXER BOXES**, Latest type full instructions, 11/-, Wall mounting Coax outlet boxes, 3/6.

**STERLING MAINS DRIVEN CONVERTERS**, Latest Famous Miniature design. In crackle case, highest anti-pattern properties complete with circuit and instructions one year guarantee. 6 Kns., post free.

**TV AERIALS** *By View-Well.* Top quality finish. Unapproachable value. Please state channels. **E.M.**—existing mast, W.—wall mounting. Number—No. of elements. Carr. 3/-  
Band III Aerials: 3 E.M. 26/-, 4 E.M. 31/-, 5 E.M. 38/6, 6 E.M. 43/6, 8 E.M. 53/6, 3 W. 30/-, 4 W. 35/-, 5 W. 42/6, 6 W. 47/6, 8 W. 57/6.  
Combined Band 1/11 (consisting B.B.C. folded dipole mounted with I.T.V. multi-element); C3 W. 34/-, C4 W. 39/-, C5 W. 46/6, C8 W. 51/6, C8 W. 61/6.

**GUARANTEED RADIO VALVES 24-HOUR SERVICE**

185	7 6/68GTM	5 6/EC81	9 6/EZ80	7 6
185	7 6/68JTM	7 - EC82	9 - HVR2A	5 6
174	6 6/68K7GT	6 - EC81	7 6/RTW63	9 -
3144	6 6/68M7GT	5 6/EC82	6 6/MT14	9 -
5240	9 - 6/4AT	12 6/EC84	9 6/ST8	8 -
6AC7	5 6/6V6	6 - EC84	9 6/PG1	9 6
6AL5	5 6/6V6G	6 6/EC85	9 - PCC84	9 6
6AM6	6 6/6X4	6 - EC86	12 - PCC85	11 6
6BA6	6 6/7B7	7 6/EC82	11 - PC880	9 6
6BB6	6 6/7C7	7 6/EC82	9 6/PC82	11 -
6C4	4 6/12A7	7 6/EC80	12 6/PC825	5 -
6C6	4 6/12A7	6 6/EF36	4 - PL81	13 6
6C8/6	11 - 12A7	8 6/EF37	7 - PL82	9 6
8106	4 6/12K7G1	6 6/EF39	5 - PL83	11 -
610	2 - 12Q7G7	7 - EF36A	3 6/PY80	8 6
6105	5 - 250A6	8 6/EF36B	4 6/PY81	8 6
6154T	4 6/35Z4G7	7 6/EF54	4 - PY82	8 6
6159	3 - 80	7 6/EF80	7 6/PY83	8 6
6170	4 - 80	7 6/EF85	7 - RT4B	9 6
6K71	4 6/807(BR)	3 6/EF81	9 6/RT41	2 6
6K72T	5 6/830	1 6/EF81	6 6/RT2	7 6
6K80	7 6/8B4	1 6/EL32	4 6/RT2	6 6
6166	8 - EB91	5 6/EL84	9 6/UY41	8 6
607G	9 6/EB93	7 - EY51	10 8/VP41	8 -
68ATM	7 - EC82	5 - EY86	15 - Z86	15 -

For full list of valves, etc., send **S.A.E. FREE LIST, 500 SNIPS**

We would like to thank some of our customers, who were inconvenienced by the inefficiency of an ex-employee, for the patience and co-operation they have afforded us in completing their orders.

All items less 5", and post free for a dozen. Post 1.3 in fl. Min. 9d. No. C.O.D. 10,000 SNIPS FOR CALLERS.

**TECHNICAL TRADING CO.** 350/352, FRATTON ROAD PORTSMOUTH

## SERVICE SHEETS

**SERVICE SHEETS** for sale and hire. Radio/T.V.; s.a.e. enquiries. J. PALMER, 32, Neasden Lane, N.W.10.

**SERVICE MANUALS/SHEETS** Tel/Radio for hire. Sale and wanted. Mixed Manuals and Sheets. 12 for 10/-; s.a.e. enquiries. W. J. GILBERT (P.T.), 24, Frithville Gdns., London, W.12.

**SERVICE SHEETS.** Radio, T.V., 5,000 models. Lists 1/-. S.A.E. enquiries. TELRAY, 11, Maudland Bk., Preston.

**NEWNES RADIO AND TELEVISION SERVICING.** Vols. III, IV, 30/- each. Box. No. 14.

## LINE OUTPUT TRANSFORMERS

Most types available. State Make and Model Number of Receiver when ordering.

S.A.E. please with all enquiries.

## HOWORTH

51 POLLARD LANE,  
BRADFORD, 2, YORKS

Tel. 37030

## NYLON : P.T.F.E.

ROD, BAR, SHEET, TUBE, STRIP, WIRE

No Quantity too Small  
List on application

**ALUMINIUM, LIGHT ALLOYS,  
BRASS, COPPER, BRONZE**

**H. ROLLET & CO., LTD.**

6, CHESHAM PLACE, LONDON, S.W.1  
SLOane 3463

Works :

36, ROSEBERY AVE., LONDON, E.C.1  
Branches at Liverpool, Manchester,  
Birmingham, Leeds.

## RES/CAP. BRIDGE 35/-

p. & p. 2/-  
Checks all types of resistors and condensers.

Easy to Build Up Easy to Use  
**READY CALIBRATED**

Stamp for details of this and other kits.

**RADIO MAIL (Dept. VG)**

Raleigh Mews, Raleigh Street, Nottingham

# P. P. COMPONENTS LTD.

(Dept. T11.)

219 ILFORD LANE, ILFORD, ESSEX.

Phone : ILF. 0295.

**SOUND / VISION STRIP.** 10/6 Sheet. Take 6-6F1s. 1-102. 1-6F14. (Valves 62/- extra). Not tested. Post & packing 2/6.

**PLESNEY SOUND/VISION STRIP.** 25/6. Sheet Takes 6-6F1s, 2-6D2s. (Valves extra). Not tested: I.F.s 10.5 Mc/s sound, 15 Mc/s vision. Bargain. Post and packing 2/6.

**12 CHANNEL TURRET TUNER.** £6.17.6. 12 ft above. Will plug straight in. Incl. 2 valves, replacing 2-6F1s. Post FREE.

**CAR AERIALS.** 6/9. Plated. Whip antennae. 50" long, collapsing to 11". One hole fixing. Post and packing 1/-.  
**T.V. AERIALS.** 25/6. For all I.T.A. Channels. For outdoor or loft. 3 elements. Sold at half their normal price. Post and packing 2/6.

**AERIALS 3d.** each. Copper plated steel. Interlocking to any required length. 12" long. Post and packing on 1 doz. 1/- . Post on 2 dozen 1/6.

**INSULATING TAPE.** 1/8. Finest quality tape. 75ft. x 1" wide. In sealed metal tin. Bargain. Post and packing on 1 tin 9d. On 6 tins 2/-.

**NICKEL CHROME WIRE.** 1/-. .014 dia. on 50 yd. spools. .032 dia. on 25 yd. spools. Packed in ready use tins with run out mechanism. Special dulled finish. Rust proof. Ideal for outdoor use. Post and packing 9d. 25 for £1. Postage 2/6.

**SPRING STEEL WIRE.** 6d. .014 dia. on 50 yd. wooden spool. Ideal for garden use. Postage 9d. 25 for 10/- . Post and packing 2/6.

**HEADPHONES.** 3/9. "Marconi". Brand new. 60 ohms. Very sensitive. Less lead. Post and packing 1/3.

**SOLDER REELS 1/6.** 20 ft. 3 core ERSIN solder. 60/40. Post and packing 6d.

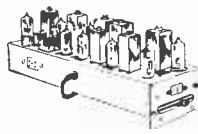

**8" P.M. SPEAKERS.** 5/9. A bargain offer, but limited quantity of these modern type speakers. All tested and "Money Back Guarantee". They have a slight cone fault which is repaired not affecting the quality. Post and packing on 1, 2/6. On 2, 3/6.



**8" P.M. SPEAKERS.** 8/9. Ideal gift, if fitted in small cabinet. At this price you can afford one in every room. Complete with O.P. transformer fitted. 10/- . Post and packing 2/9.

**EXTENSION SPEAKERS.** 29/9. Attractive cabinet. Complete with 8" P.M. speaker, flex and switch. Standard matching to any receiver 2-5 ohms. Size: 11" x 13 1/2" x 6 1/2". A nice present and a real bargain. Post and packing 3/6.

**RECTIFIERS.** 2/9. Westinghouse. 250 v., 100 m.a. Full or half wave. Salvage guaranteed. Post and packing 1/3. (Please state if full or half wave required.)

**CONDENSERS.** 1/9. Salvage guaranteed. .0005 (500 pf) 2 gang. Post and packing 1/3.

**GANG CONDENSERS.** 1/9. Salvage guaranteed. .0005 (500 pF) 3 gang. Post and packing 1/3.

**GANG CONDENSERS.** 1/9. Salvage guaranteed. .0003 (300 pF). 2 gang. Post and packing 1/3.

**VISCONAL CONDENSERS.** 5/9. 0.001  $\mu$ F 12.5kv working. Post and packing 6d.

**VISCONAL CONDENSERS.** 5/9. 0.1-7kv. Working. Post and packing 6d.

**TRIMMERS.** 6d. 3-30 pF. 5/- per dozen. Post on 1 doz. 1/- .  
**SEND FOR FREE CATALOGUE.**  
Regret U.K. only.

## NEW-MAX ELECTRONICS

220 Edgware Road, London, W.2.  
PAD 5607

For London's Finest Bargains in electronics, television and radio equipment.

LARGE SELECTION OF TAPE RECORDERS ALL GUARANTEED.

### T.V. TUBES

REVAUCUMED & GUARANTEED  
10in. and 12in.. £6 ; 14in.. £5 ; 15in. and 17in.. £7.10.0.

BRAND NEW FULLY GUARANTEED  
14in. M.W. 36-24 tubes, £16.10.0.  
17in. M.W. 43-64 tubes, £17.10.0.

21in. M.W. 53-80 tubes, £20.0.0.  
P.P. & Insurance on all tubes, 15/-.

BRAND NEW T1291 12in. flat face 2 volt filament. Ferranti tube with replace Brimar-Mazda-G.E.C. 12in. tubes. Price £10.10.0. Guaranteed 6 months.

Also Ferranti 9in. T93 brand new 4 volt filament will replace G.E.C. Mazda or Brimar. £7.0.0.

A full range of F.M. and A.M. Tuners. Hi-Fi and stereophonic amplifiers. record players, record changers, A.M. and P.M. Radiogram chassis. All types and rakes of test Instruments, shavers, typewriters, radios (battery and transistor).

All Prices below include Package & Postage.

AM-PM 3-speed Table Radiogram medium-longwave & VHF. Made to sell at 43 gns. Our price £26.0.0.

6 Valve Superhet AM/PM Radio-chassis complete with 2-8in. speakers & Tweeter. £17.10.0.

Twin Channel Stereo Amplifier including 2 speakers. 11 gns.

AM/PM all wave Stereo Radiogram Chassis including 3 speakers. £29.10.0.

Special Offer. German "3-D" Radiogram Chassis. Med., long, short and P.M. 3 speakers. Only £36, or complete in beautiful cabinet. £38.

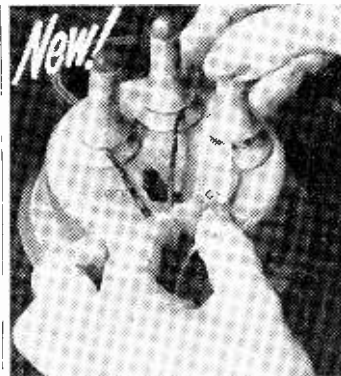

**T.I.M.** Snap-action  
Appliance Connector  
TEST BENCH MODEL

Equipment under test connected to mains without plugs or screw terminals. Safe, positive grip contact is made and unmade in an instant. A low-priced workshop time saver for both amateurs and manufacturers. With colour coded Mycalex insulated terminals and on/off switch.

Stove enamelled, Price, 35/- each.

**MYCALEX & T.I.M.**  
LIMITED,

ASHCROFT ROAD, CIRENCESTER,  
GLOS

Telephone : Cirencester 400.



# AT LAST!

A REAL I.T.V. CONVERSION SERVICE

WE OFFER A COMPLETE AFTER-SALES SERVICE WITH ALL I.T.V. EQUIPMENT SOLD BY US.

Your problems settled by return mail. Whether novice or expert, let our extensive I.T.V. experience ensure your success.

### PRE-AMPS

#### I.T.V. SIGNAL BOOSTER AT 37/6 COMPLETE

- **SMALL.** Fits neatly in cabinet corner.
- **EFFICIENT.** Simple but clever circuitry giving pentode gain and triode noise level.
- **EASIFIX.** One-hole fixing to cabinet fillet. Plug-in feeder steals power from main T.V.

STATE CHANNELS, SET MAKE AND MODEL WITH ORDER.

Standard pattern suits most T.V.s using EF80 valves.

### CONVERTERS

#### THE FAMOUS BRAYHEAD TURRET TUNER AT £6.19.6 COMPLETE.

- **EASIFIX.** Over 600 models converted by simple plug-in technique.
- **SPECIAL OFFER.** We can supply a modified version of our standard I.T.V. booster as an add-on fitment, thus improving I.T.V. performance.

Special at 25/- extra.

STATE CHANNELS, SET MAKE AND MODEL WITH ORDER.

### AERIALS

#### OUR 5-ELEMENT ADD-ON I.T.V. AERIAL 39/6 COMPLETE

with Universal Clamp and Stand-off Arm.

- Diplexers and Low-Loss Cable to order. State your needs or **ASK OUR ADVICE** with order.

# WILSON

48, CATHAY, BRISTOL, 1

(Phone BRISTOL 26242)

Mail Order only. Terms: C.W.O. Postage 1/6, above £2 free except aeriels 2/6.

## 59 Gns.—'17'

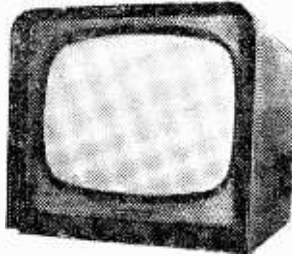

A full specification 17in. Television Receiver to Spencer-West standards now available at your Dealers. Remarkable performance and priced at 59 Gns. only, complete.

For Leaflet apply to:—

**SPENCER-WEST LTD.**  
Quay Works, Great Yarmouth  
Norfolk

Phones: Works 4794; Sales 3009  
Grams: Spencer-West, Great Yarmouth

### NEW 6TH EDITION "Wireless World" RADIO VALVE DATA

5/-. Postage 9d.

#### OSCILLOSCOPE TECHNIQUES.

By A. Haas. 23/-. Postage 1/-. 68J6 9/6

#### AUDIO DESIGN HANDBOOK.

By H. A. Hartley. 23/-. Postage 1/-. 6F13 12/6

#### TELEVISION SERVICING.

By G. N. Patchett. Vol. I, 5/-; Vol. II, 6/-. Postage 4d. each. 6K7G 2/11

#### AN INTRODUCTION TO THE CATHODE-RAY OSCILLOSCOPE.

By H. Carter. 12/6. Postage 9d. 6Q7G 8/6

#### TV & RADIO TUBE TROUBLES.

By S. Heller. 23/-. Postage 1/-. 6V6G 5/11

#### A BEGINNER'S GUIDE TO TELEVISION.

By F. J. Camm. 7/6. Postage 6d. 7C5 8/6

#### TV FAULT FINDING. A Data Publication.

5/-. Postage 6d. 7Y4 7/11

#### THE MODERN BOOK CO.

BRITAIN'S LARGEST STOCKISTS of British and American Technical Books

19-23 PRAED STREET, LONDON, W.2.

Complete catalogue 6d.

Phone: PADdington 4185.

Open 6 days 9-6 p.m.

## EDDY'S (Nottm.) LTD.

DEPT. P.T.

172, ALFRETON ROAD, NOTTINGHAM.

**ACOS CRYSTAL MIKES.** Excellent for tape recorders, amplifiers, baby alarms, etc., 29/11. Brand New and Boxed. Post, etc., 8d. extra.

**MIDGET BATTERY ELIMINATORS.** To convert all types battery portables to mains operation, 57/6, plus 2/6 post. etc. Smaller than H.T. battery alone. Size 3.7in. x 2.5in. x 1.8in. (Please state make and model No.) Brand New and Boxed.

**ACOS CRYSTAL PICK-UPS** (2 sapphire styl), 29/11 each. Post 2/6 extra. Brand New and Boxed.

**B.S.R. MONARCH 4-SPEED AUTOMATIC RECORD CHANGER,** complete with High Fidelity turnover head type HGP37-1, capacity 10 records. Play 12in., 10in. and 7in. intermixed in any order. 78, 45, 33 and 16 r.p.m. For A.C. mains 100-250 volts with full instructions. Special Price, £6.19.6, plus 5/- post, etc. Brand New.

**LOUDSPEAKERS.** Best makes. 5 in., 17/6 Bin., 18/11 6 1/2 in., 17/6 7 x 4 Ellipse, 17/6 All Brand New. Post, etc., 2/- each.

**THROAT MIKES,** 1/- each, post 4d. extra. Can be used for electrifying musical instruments.

**25 x 25 CONDENSERS.** Midget, 1 3 each. Brand New. Post, etc., 4d.

**MORSE TAPPERS.** Plated contacts. Adjustable gaps. Heavy Duty, good quality. 3/6 each. Post, etc., 9d. each extra.

### GUARANTEED NEW AND SURPLUS VALVES

1D5	10/-	1457	15/6	EF40	13/11
1R5	7/6	25A6G	12/11	EF41	9/6
1S5	7/3	25L6GT	9/11	EF42	12/6
1T4	6/6	25Z4G	9/11	EF80	8/-
1D6	5/-	35L6GT	9/11	EF86	15/6
3Q5GT	9/6	35Z3C	13/6	EF89	9/11
3U4G	6/6	35Z4G	7/6	EF91	7/11
5Y3G	8/-	35A5	10/6	EL41	11/-
5Z4G	9/-	35W4	7/6	EL42	11/6
5Z4M	10/-	80	8/6	EL84	9/11
5AG5	5/11	807(B)	3/9	EY51	12/6
688G	2/11	807(USA)	3/9	EY86	15/6
68J6	9/6	5/6	EZ80	8/3	
6F1	13/11	954	1/6	EZ81	9/11
6F13	12/6	955	3/11	KT33C	8/6
6J5G	2/11	956	2/11	KT66	15/-
6K7G	2/11	AZ1	12/11	L63	5/11
6K8G	7/6	AZ31	12/11	MU14	9/6
6L6G	5/11	CL33	12/11	PCC84	9/-
6Q7G	8/6	CY31	12/11	PCF80	12/6
6SK7GT	6/-	DAF96	9/6	PCF82	12/6
6SN7GT	5/9	DF96	9/6	PCF83	15/6
6V6G	5/11	DL96	9/6	PL81	16/-
6V6GT	6/6	DK92	9/6	PL82	9/6
6X5GT	6/6	DK96	9/6	PL83	10/6
6B7	8/6	DM90	7/11	PY80	8/6
7C5	8/-	EB91	5/11	PY81	8/6
7C6	8/-	EB41	9/11	PY82	8/6
7H7	8/-	EBF80	9/11	TDD4	12/6
7Y4	7/11	ECC81	8/-	UCH42	8/11
70F9	10/6	ECC82	8/-	UAF42	10/6
12AH7	7/6	ECC83	8/11	UF41	9/-
12AH8	9/11	ECC84	9/6	UL41	9/6
12K7	7/6	ECC85	8/11	UF42	14/6
12Q7	7/6	ECL80	12/6	UL84	10/6
12SH7	5/6	ECH35	10/6	VP23	6/6
12SQ7	7/6	ECH42	10/6	VT52	2/11
12S7	7/6	ECH81	9/-		

All tested before despatch.

C.O.D. or C.W.O. only. S.A.E. with enquiries. Postage and Packing, 6d. per valve extra. Over £3 free.

Any parcel insured against damage in transit for only 6d. extra per order. All uninsured parcels at customer's risk.

A practical book on conversion—

# T.V. CONVERSION for I.T.A.



by **C. E. Lotcho** THIS book provides information on the conversion of those television sets which receive B.B.C. programmes only so that they will receive both B.B.C. and I.T.A. stations. Included in the Reference Data given in Section 3 are the sound and vision intermediate frequencies of many hundreds of television models. The book contains over 170 illustrations and circuit diagrams, and is fully indexed.

*With over 170 illustrations and circuit diagrams!*

**CONTENTS** Section 1—General Principles:—Conversion Methods; Aerial Installations for Bands I and III; Interference Problems. Section 2—Conversion Data:—Aerialite; Alba; Banner; Bush; Cossor; Decca; Defiant; E.M.I.; Ekco; English Electric; Ferguson; Ferranti; G.E.C.; H.M.V.; Invicta; Kolster-Brandes; Marcaniphone; Masteradio; Murphy; Peto Scott; Philips; Pilot; Pye; Rainbow; Sobell; Spencer West; Telemechanics; Teletron; Ultra; Valradio; Vidor. Section 3—Reference Data:—B.B.C. Television Transmitters; I.T.A. Television Transmitters; Frequencies of Television Transmitting Stations; Television Receiver Intermediate Frequencies; Models Aligned to the Upper Side Band; General Index; Index to Receiver Models; Index to Universal Converters.

**25s. FROM ALL BOOKSELLERS**

*... or in case of difficulty 26s. 3d. by post from the publishers  
GEORGE NEWNES LTD., Tower House, Southampton  
Street, London, W.C.2.*

NEWNES

## COVENTRY RADIO

Audio & Component Specialists Est. 1925  
189-191, Dunstable Rd., Luton, Beds.

**HI-FI EQUIPMENT CABINETS IN STOCK**

Record Housing: Nordisk Range in Oak, Walnut, Mahogany.

Speaker Enclosure ... ..	£5.17.6
Equipment Cabinet ... ..	£5.19.6
Record Cabinet (150 records)	£4.17.6
Continental Bench ... ..	£4.17.6
Polenaise Hi-Fi Cabinet ... ..	£19.19.0
W.B. Prelude Speaker Cabinet	£11.11.0
W.B. Prelude Equipment Cabinet	£13.13.0

W.B. Prelude Corner Speaker Cabinet ... ..	£10.10.0
W.B. Table Equipment Cabinet	£9.19.6
W.B. Senior Hi-Fi Console ... ..	£16.16.0
W.B. Junior Hi-Fi Console ... ..	£12.12.0
W.B. Junior Base Reflex ... ..	£9. 9.0
W.B. Standard Base Reflex ... ..	£10.10.0
W.B. Senior Base Reflex Corner	£11.11.0

### B.K. AUDIO PLAN

B.K. Speaker Cabinet ... ..	£16.19.6
B.K. Equipment Cabinet ... ..	£17.19.6
B.K. Record Cabinet ... ..	£16.16.0
B.K. Continental Bench 4Bin. ... ..	£7. 7.0
B.K. Continental Bench 72in. ... ..	£13.13.0
B.K. Set 4 Legs tilt & glide feet	£2. 2.0
B.K. Set 4 Legs Plain Ebonised	19.6

<b>SOUTHDOWN</b> Hi-Fi Cabinet	£29.10.0
R.C.A. Lowboy Cabinet ... ..	£18.10.0
HEALS Chairside for Quad ... ..	£29.15.0
HEALS Chairside ... ..	£37. 0.0
BREARCLIFFE Equip. Cab. ... ..	£30. 9.0
BREARCLIFFE Equip. Cab. ... ..	£22. 1.0
ARMSTRONG Equipment Cabinet	£34.19.0

Leaflets available on request.

## LINE OUTPUT TRANSFORMERS

replacement or rewind. Send us your faulty one and we will be pleased to quote and save you money.

## AUDIO LTD.

Tower Road, London, N.W.10

## FIRST-CLASS TELEVISION and RADIO COURSES . . .

**GET A CERTIFICATE!**

After brief, intensely interesting study—undertaken at home in your spare time—YOU can secure your professional qualification or learn Servicing and Theory. Let us show you how!

### FREE GUIDE

The New Free Guide contains 132 pages of information of the greatest importance to those seeking such success compelling qualifications as A.M.Brit.I.R.E., City and Guilds Final Radio, P.M.G. Radio Amateurs' Exams, Gen. Cert. of Educ., London B.Sc. (Eng.), A. M. I. P. E., A.M.I.Mech.E., Draughtsmanship (all branches), etc., together with particulars of our remarkable Guarantee of

### SUCCESS OR NO FEE

Write now for your copy of this invaluable publication. It may well prove to be the turning point in your career.

FOUNDED 1885—OVER  
150,000 SUCCESSES

NATIONAL INSTITUTE OF  
ENGINEERING  
(Dept. 462), 148, HOLBORN,  
LONDON, E.C.1.

# Build your own Aerials...

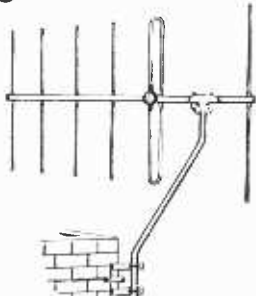

**Fringevision Ltd.**

MARLBOROUGH, WILTS. Phone : 657/8

## AT HOME

AERIAL FITTINGS FOR BAND III, BAND I & RADIO F/M. Useful formulae and hints for constructing your own aerial quickly and cheaply. Catalogue illustrating our increased range of Diecast Alloy Fittings, including Band III to Band I Mast Couplers, Reflector and Director Rod Holders, Insulators (both "Inline" and "H" types), Masthead Fittings, Masts and Elements, Chimney Brackets, etc. Send 1/- in stamps for the above to —

## YOUR OWN TELEVISION TUBE RE-BUILT

THE FOLLOWING TYPES AND SIZES ONLY

<b>MULLARD . .</b>	12in. £7-10-0.	14in. £8-10-0.
OR EQUIVALENTS		
COSSOR-EMITRON-CATHODEON	17in. £10-10-0.	21in. £12-10-0.

### 48 Hr. SERVICE

All Tubes plus 10/- carriage and insurance.

### SIX MONTHS' GUARANTEE

Terms to the Trade.

OWING TO PURCHASE TAX REGULATIONS WE CAN ONLY RE-BUILD YOUR OWN TUBE. THESE CAN BE SENT TO US BY BRITISH ROAD SERVICES (Parcels) LTD., CARRIAGE FORWARD.

TERMS, CASH WITH ORDER or C.O.D.

## RE-VIEW (LONDON) LTD.

81, HIGH STREET

MERTON S.W.19

Telephone : CHERRYWOOD 3255

