

SERVICING COMMERCIAL RECEIVERS

Practical Television 13

JANUARY 1957

AND TELEVISION TIMES

EDITOR: F.J. CAMM

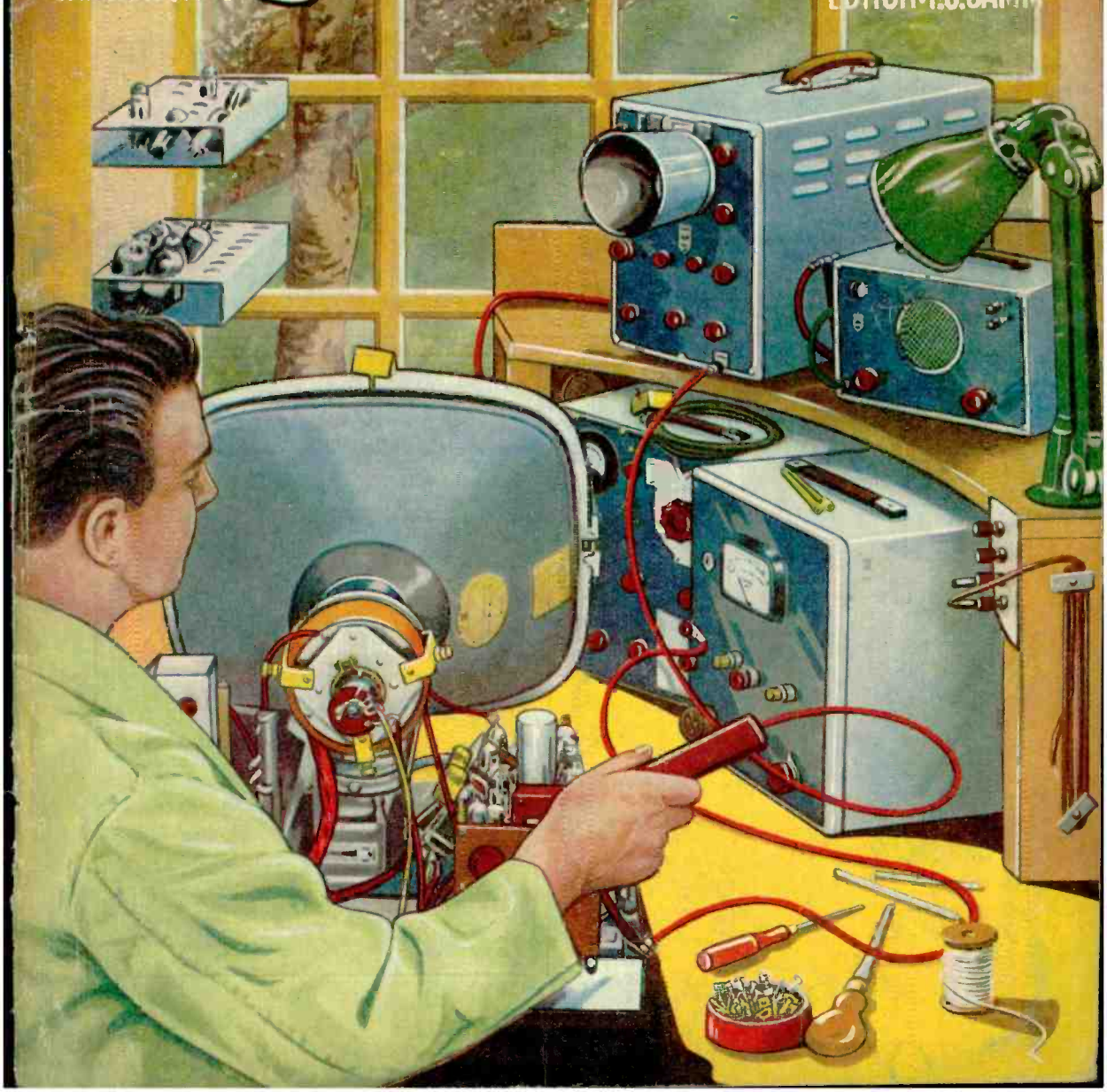

PREMIER RADIO COMPANY

OPEN TILL
6 P.M. SATURDAYS

(Regd.) B. H. MORRIS & CO. (RADIO) LTD.

(Dept. P.T.) 207, EDGWARE ROAD, LONDON, W.2

Telephones :
AMBASSADOR 4033
PADDINGTON 3271

SAFETY FIRST!

Build these **PREMIER TELEVISORS**
WHICH GIVE
COMPLETE SAFETY
TO THE CONSTRUCTOR



These Televisors use a double wound mains transformer which gives you complete safety from contact with the mains supply when handling the chassis or controls

★ **BBC & I.T.A. (WITH NEW TURRET TUNER)**

★ **BBC (ALL CHANNELS)**

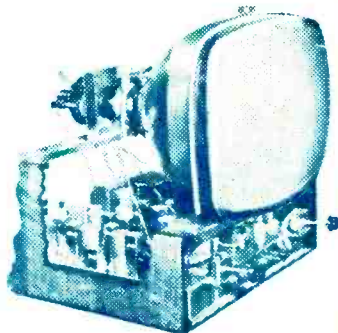

DESIGN NO. 1. **£33.7.11** PLUS COST OF C.R.T.

DESIGN NO. 2. **£27.9.4** PLUS COST OF C.R.T.

CONSOLE CABINETS with full length doors for 14in., 16in. and 17in. tubes. PRICE £14.14.0. H.P. Terms: Deposit £7.7.6 and 9 monthly payments of 18/6. **CONSOLE CABINETS**, half door, still available at £12.12.0. H.P. Terms: Deposit £6.6.0 and 8 monthly payments of 18/3.

On above cabinets add 21/- for pkg. and carr.

BUILD IN 5 EASY STAGES. FULL CONSTRUCTION DETAILS AVAILABLE. INSTRUCTION BOOK 3/6 POST FREE INCLUDES BOTH DESIGNS.

ADCOLA

PRODUCTS LIMITED
(Regd. Trade Mark)

SOLDERING EQUIPMENT

ILLUSTRATED

Detachable bit type (List No. 64)

Protective Shield (List No. 68)

Catalogues sent FREE

Telephones :
MACaulay 4272
& 3101



British and Foreign Pats.

Reg. Designs, etc.

Head Office, Sales :

ADCOLA PRODUCTS LTD.

Gauden Road,
Clapham High St., London, S.W.4

BAND III AERIALS OR FITTINGS

Whether you are contemplating the construction of a Band III aerial or purchasing one complete it will be well worth your while to write to us who, as manufacturers, can offer you real

VALUE FOR MONEY

THE FOLLOWING IS A CROSS SECTION OF ITEMS TAKEN FROM OUR NEW COMPREHENSIVE CATALOGUE.

- * 10 Element Band III Aerial, 77/6.
- * 8 Element Band III Aerial, 62/6.
- * 6 Element Band III Aerial, 47/6.

FITTINGS

- * Universal Band III Clamp-on Fitting.
- * Band III Insulator, complete with folded dipole.
- * Director and Reflector Rod Holders for Bands I, II, and III.
- * Straight and Cranked Masts (all sizes).
- * Chimney and Wall Brackets. Alloy Tubing, etc. etc.

Send 1/- P.O. for the **NEW MULTI-PAGE** illustrated Catalogue (together with element and boom measurements (all Bands) to help the constructor)

to : **FRINGEVISION LTD.** MARLBOROUGH, WILTS.
Phone 657/8



FOR VALVES GUARANTEED ALL TESTED BEFORE DISPATCH

Table listing various vacuum tubes with their types, manufacturers, and prices. Includes models like 6X4, 6X5, 6X6, 6X8, 6X9, 6X45, 6X50, 6X55, 6X60, 6X65, 6X70, 6X75, 6X80, 6X85, 6X90, 6X95, 6Y1, 6Y2, 6Y3, 6Y4, 6Y5, 6Y6, 6Y7, 6Y8, 6Y9, 6Z1, 6Z2, 6Z3, 6Z4, 6Z5, 6Z6, 6Z7, 6Z8, 6Z9, 6Z10, 6Z11, 6Z12, 6Z13, 6Z14, 6Z15, 6Z16, 6Z17, 6Z18, 6Z19, 6Z20, 6Z21, 6Z22, 6Z23, 6Z24, 6Z25, 6Z26, 6Z27, 6Z28, 6Z29, 6Z30, 6Z31, 6Z32, 6Z33, 6Z34, 6Z35, 6Z36, 6Z37, 6Z38, 6Z39, 6Z40, 6Z41, 6Z42, 6Z43, 6Z44, 6Z45, 6Z46, 6Z47, 6Z48, 6Z49, 6Z50, 6Z51, 6Z52, 6Z53, 6Z54, 6Z55, 6Z56, 6Z57, 6Z58, 6Z59, 6Z60, 6Z61, 6Z62, 6Z63, 6Z64, 6Z65, 6Z66, 6Z67, 6Z68, 6Z69, 6Z70, 6Z71, 6Z72, 6Z73, 6Z74, 6Z75, 6Z76, 6Z77, 6Z78, 6Z79, 6Z80, 6Z81, 6Z82, 6Z83, 6Z84, 6Z85, 6Z86, 6Z87, 6Z88, 6Z89, 6Z90, 6Z91, 6Z92, 6Z93, 6Z94, 6Z95, 6Z96, 6Z97, 6Z98, 6Z99, 6Z100.

TRANSFORMERS, ETC. HEATER TRANSFORMERS each 230 v. Input 2 v. 5 amp 5 230 v. Input 2 v. 3.0 amp 8.6 230 v. Input 1 v. 1.5 amp 10.7 230 v. Input 1 v. 3.0 amp 10.7 230 v. Input 3 v. 2.0 amp 5.9 230 v. Input 6 v. 1.5 amp 5.9 230 v. Input 6 v. 3.0 amp 11.8 230 v. Input 12 v. 1.5 amp 14.3

OUTPUT TRANSFORMERS Multi Ratio, Suitable for all ordinary receivers, giving six single ratios, 6:6 each. 12:12 12:6 12:3 12:1.5 12:0.75 12:0.375

HEATER AUTO TRANSFORMERS Designed to adapt common low tension voltages 4 v., 5 v., 6.3 v. at 3 amp., and 12 v. at 1 amp. and interchangeable, each, 7/9.

TELEDECTOR TRANSFORMERS TYPE TB8 SMALL MAINS TRANSFORMERS Suitable for TELEVISION CONVERTERS, Etc. SPECIFICATION OVERALL SIZE Primary: 230 v. Clamp Construction: 50 ma. Secondary: 1: 250 2.0in. x 2.4in. x 10 mA. 2in. Over Windings. Secondary: 2: 6.3 Fixing Centres: v. 1.5 A. Price 15/- each. 3.3in.

KNOB BAKELITE LARGE PURCHASE GOOD QUALITY TYPE JK1 Cream 1 1/2in. diameter. Spring Fixing, Fluted Grip. Type JK2 Brown 1 1/2in. diameter. Spring Fixing, Fluted Grip. Type JK3 Brown 1 1/2in. diameter. Spring Fixing, Plain Grip. (This one has White Ring on Knob Face.) All have a small finger flange to avoid marking cabinets. * OFFERED AT A FRACTION OF ORIGINAL COST * Price 6d. each, 5/- doz. any types.

TRANSFORMERS 3-way Mounting Type MT1 Primary: 250-250-230 v. Secondary: 2: 250-0-250 v., 50 M.A. 0-6-3 v. 4 amp. 0-3 v. 2 amp. both tapped at 3v. each 19/6 MT2 Primary: 250-250-230 v. Secondary: 2: 250-0-250 v., 50 M.A. 0-6-3 v. 1 amp. 0-3 v. 2 amp. both tapped at 3v. each 19/6 MT3 Primary: 250-250-230 v. Secondary: 2: 250 v. 2 amp. taps at 3 v., 4 v., 5 v., 8 v., 9 v., 10 v., 15 v., 18 v., 20 v., 24 v. each 19/6

Table listing transformer models and prices. Includes models like V156, V157, V158, V159, V160, V161, V162, V163, V164, V165, V166, V167, V168, V169, V170, V171, V172, V173, V174, V175, V176, V177, V178, V179, V180, V181, V182, V183, V184, V185, V186, V187, V188, V189, V190, V191, V192, V193, V194, V195, V196, V197, V198, V199, V200.

COMMERCIAL ALPHA CONVERTER Price, £6.15. *Tuneable over Band 111 Range. *Single Knob Channel Changing. *4-Valve Circuit. *Hammer-Tone Iron-on Finish. NOTE THE PRICE, £6.15. Fully Guaranteed against Faulty Workmanship or Materials (other than valves) for 12 Months.

Our 1956/57 44-page Catalogue is now available. Please send 1/- in stamps.

SWITCHES WAVE CHANGE SWITCHES, ETC. 2 pole, 4 way 2/9 each 4 pole, 3 way 2/9 each 4 pole, 1 way 1/9 each 1 pole, 12 way 2/9 each 2 pole, 6 way 2/9 each TRF Switch 2 pole Change-over 1/6 each 2 pole, 3 way, 3 bank 1/9 each 2 pole, 2 way, 3 bank 2/- each 4 pole, 2 way, 3 bank 1/8 each 4 pole, 2 way, 2 bank 2/- each 1 pole, 8 way 1/9 each 2 pole, 2 way, 19 each Vaxley Type, 1 pole, 5 way, 1/9 each Vaxley Type, 2 pole, 3 way, 1/9 each Vaxley Type, 4 pole, 3 way, 2 bank 2/- each

We have large stocks of Vaxley Type Switches, ALL BRAND NEW. With Long Leaning Spindles. Various numbers of Switch and Water Combinations. To clear at the SPECIAL PRICE, 9/- Per Dozen, Post 1/6.

HEADPHONES MICROPHONES CLR Low Resistance type 120 ohms 7/8 Thread Microphones, American surplus. Complete with strap, lead and plug type TR0B. 3/- set High Resistance Phones, 4,000 ohms. Complete with Jack plug. 13/6 High Resistance CLR Phones 16

PUBLICATIONS No. 134 F.M. TUNER CONSTRUCTION by W. J. May *Easy to Build, Point-to-Point Wiring *Super High Fidelity Response *32 Pages *All Components for this Circuit available ex stock. A COMPREHENSIVE VALVE GUIDE BOOK No. 3 International Edition. Includes all English, American and European receiving valves issued since 1951. 5/-

No. 135 ALL DRY BATTERY PORTABLE CONSTRUCTION. *Simple and cheap to build *Point-to-point wiring *Dual Pointe arial for high sensitivity. 2/6 No. 100 A COMPREHENSIVE VALVE GUIDE, Book No. 1. No. 101 A COMPREHENSIVE VALVE GUIDE, Book No. 2 (Characteristics and Base Connections) 5/-

No. 103 RADIOFOLDER "A" The Master Colour Code-Index for Radio and Television 1/6 No. 114 RADIOFOLDER "E". An inexpensive Type Receiver 2/6

No. 125 PRACTICAL TRANSISTORS AND TRANSISTOR CIRCUITS 3/6 No. 130-PRACTICAL F.M. CIRCUITS FOR THE HOME CONSTRUCTOR 5/-

No. 140 T.V. SERVICING FOR BEGINNERS 4/6 No. 141 MODERN T.V. CIRCUITRY AND GENERAL FAULT FINDING GUIDE 4/6 SERVICING THE MODERN RADIO RECEIVER 1/6 Please include 4d. postage per copy.

CHOKES 20H, 250 ohms, 90 M.A. Clamp construction, each 6/- 10H, 200 ohms, 90 M.A. Clamp construction, each 9/3 10H, 200 ohms, 150 M.A. Clamp construction, each 13/- 10H, 200 ohms, 40 M.A. Midget Clamp construction, each 5/3

TRANSFORMERS FOR BATTERY CHARGERS 230 v. Input Tapped 6-12 v. 1 amp. each 13/6 250 v. Input Tapped 6-12 v. 2 amp. (both with tap on Primary for 2.5 v. Pilot light) each 18/-

MAINS TRANSFORMERS 3-way Mounting Type

LOUD SPEAKERS

All PM Types less Transformers

Table listing loudspeaker models and prices. Includes models like WATERHOUSE 5in. Unit, PLESSEY 6in. Unit, PLESSEY 12in. Unit, LECTRONA 5in. Unit, GODMANS 6in. Unit, GODMANS 8in. Unit, GODMANS 4in. x 7in. Unit, R. A. 6in. Unit, PLESSEY 5in. Unit, GODMANS or LECTRONA 8in. with Output Transformer.

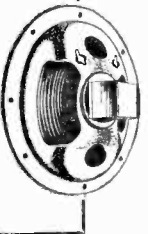

TERMS: Cash with order or C.O.D. Postage and Packing charges extra, as follows: Orders value 10/- add 1/-; 20/- add 1/6; 40/- add 2/-; £5 add 3/- unless otherwise stated. Minimum C.O.D. fee and postage 3/-. All single valves postage 6d. MAIL ORDER ONLY

ALPHA RADIO SUPPLY CO. 5/6 VINCES CHAMBERS VICTORIA SQUARE LEEDS I.

NEW Signal Generator

FOR BANDS I, II & III

Regd. Trade Mark

... ON FUNDAMENTALS

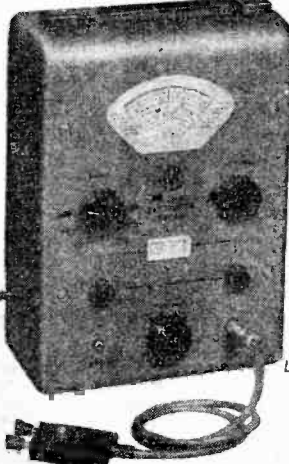

The "AVO" Signal Generator Type III

An inexpensive A.M. Signal Generator of entirely new design, for the Service Engineer. Provides six frequency bands covering 150kc/s—220Mc/s. Accuracy — 1%.

- 150 kc/s — 500 kc/s
 - 500 kc/s — 1.6 Mc/s
 - 1.6 Mc/s — 5.5 Mc/s
 - 5.5 Mc/s — 18 Mc/s
 - 18 Mc/s — 70 Mc/s
 - 70 Mc/s — 220 Mc/s
- Continuous wave or modulated at 1,000c/s. L.F. signal available for test purposes.

A new type of attenuator, ensures close adherence of the output to the attenuator calibration. The instrument provides a force output of 250mV, whilst the following outputs are available via the attenuator:—

- Minimum to 100 μ V, x 1, x 10, x 100, x 1000.
- Output impedances—80 Ω , 200 Ω and 400 Ω .

List Price £29

This instrument operates on 100-120, 200-260V, 50-60 c/s A.C. mains. It is light and compact and employs double screening to ensure minimum radiation.

Full details available on request.



Sole Proprietors and Manufacturers:—

THE AUTOMATIC COIL WINDER & ELECTRICAL EQUIPMENT CO. LTD.
 AVOCET HOUSE · 92-96 VAUXHALL BRIDGE ROAD · LONDON · S.W.1 Telephone: VIctoria 3404 (9 lines)

BENTLEY ACOUSTIC CORPORATION LTD.

EXPRESS SERVICE !!!
 C.O.D. ORDERS RECEIVED BY 3.30 P.M. EITHER BY LETTER, PHONE, OR WIRE, DESPATCHED SAME AFTERNOON.

THE VALVE SPECIALISTS
 38 CHALCOT RD., LONDON, N.W.1
 Plrimrose 9090

UNIQUE OFFER
 ANY PARCEL INSURED AGAINST DAMAGE IN TRANSIT FOR ONLY 6d. EXTRA. SAVES TIME IN CLAIMS AND Worry!

024	6-6AB8	10-6F13	12-6X4	7-12SA7	8-6 73	4-6 DAP96	9-6 EOC85	10-6GZ20	8-6 N142	10-6R12	10-6 UY41	8-6
1A3	3-6AC7	6-6 6F15	12-6 6X5GT	6-6 128C7	7-6 77	7-6 DCU90	7-6 EOC91	8-6 GZ32	12-6 N150	10-6 S06	7-6 V1507	5-6
1A7	6-6AG5	6-6 6F16	9-6 6Z4/34	12-6 128C7	7-6 77	8-6 DP35	11-6 ECF80	12-6 GZ34	14-6 N152	11-6 SP47	8-6 VL8492A	23
126	12-6AG7	12-6 6F17	12-6 6Z5	12-6 128H7	5-6 78	8-6 DP98	9-6 ECF82	13-6 H30	5-6 N154	9-6 SP47	15-6 VMS46	15-
1C2	9-6AJ8	8-6 6F32	12-6 7A7	12-6 128J7	8-6 80	8-6 DH63	8-6 ECH33	10-6 H63	12-6 N300	11-6 SP42	12-6 VMS48	15-
1D6	8-6AK5	5-6 6F33	12-6 7B7	8-6 128K7	6-6 83	8-6 DH76	8-6 ECH42	10-6 HK90	10-6 N329	9-6 SP61	3-6 VP2	8-6
1E5	11-6AK8	7-6 6F6	6-6 7C5	8-6 128Q7	8-6 85A2	12-6 DH77	8-6 ECH81	8-6 H12	3-6 N329	10-6 TDD2A	8-6 VP4	15-
1E6	11-6AK8	7-6 6F6	6-6 7C5	8-6 128Q7	7-6 130B2	12-6 DK91	8-6 ECL80	10-6 H13C	7-6 O73	9-6 TH233	12-6 VP13C	7-
1E4	6-6AL5	6-6 6H6G	2-6 7C8	8-6 128R7	7-6 130B2	3-6 DK92	9-6 E26	10-6 H122	10-6 O13	9-6 TH30C	25-6 VP23	6-6
1E5	5-6AM5	6-6 6H6M	3-6 7H7	8-6 128U9	7-6 210L7	3-6 DK92	9-6 E26	10-6 H122	10-6 O13	9-6 TH30C	25-6 VP23	6-6
1E6	5-6AM6	9-6 6J5G	5-6 797	8-6 12Y4	10-6 807	6-6 DK96	9-6 E26	4-6 H141	7-6 P61	9-6 TP22	10-6 VP41	7-6
1E5	11-6AQ5	7-6 6J5GTG	5-6 787	9-6 13VPA	10-6 808	25-6 DL2	15-6 E27A	9-6 H141DP	PABCS0	U16	12-6 VP133	10-6
1E5	8-6AQ8	10-6 6J5GTM	6-6 7V7	8-6 14R7	10-6 866A	12-6 DL33	9-6 E27B	11-6	12-6	U17	12-6 VP501	5-6
1E5	7-6ATU	8-6 6J6	6-6 7Y4	8-6 14S7	14-6 885	10-6 DL32	7-6 E27C	11-6 HVR2	20-6 EOC84	8-6 U22	7-6 W76	9-6
1E4	7-6BB4	8-6 6J7G	8-6 8A8	10-6 14H1	10-6 905	3-6 DL34	8-6 E27D	9-6 HVR2A	7-6 EOC85	12-6 U31	9-6 W152	8-6
1E5	7-6BT	10-6 6K7G	5-6 8D2	2-6 20L1	10-6 1203	7-6 DL96	8-6 E27E	12-6 HRC2	8-6	U30	7-6 W150	8-6
2A3	12-6BR8G	4-6 6K3G	8-6 8D3	9-6 20P1	10-6 1203	12-6 DL810	10-6 E27F	7-6 KFS5	9-6 EOC86	11-6 U50	7-6 W150	8-6
2E26	4-6BRM	4-6 6L19G	10-6 9D2	3-6 20P2	12-6 7193	2-6 EL148	2-6 E27G	5-6 KL35	8-6 PCL83	12-6 U52	8-6 WD142	11-
2D13C	7-6BRX	7-6 6L4G	9-6 10D1	7-6 25Y5	8-6 7475	7-6 EA50	5-6 E27H	5-6 KT2	5-6 PEN25	6-6 U76	8-6 X61	10-6
2X2	4-6BRX	7-6 6L7	7-6 10L33	8-6 25Z4G	9-6 9922	5-6 EA76	9-6 E27I	10-6 KTR3C	10-6 PEN40DD	U78	7-6 X65	10-6
3A4	7-6BRG6G	12-6 6N7	7-6 10P13	11-6 25Z5	8-6 9003	5-6 EAB97	8-6 E27J	8-6 KTR3	7-6 PEN16	6-6 U78	8-6 X42	10-
3A5	7-6BRJ6	8-6 6Q7G	8-6 11P3	15-6 27	7-6 9006	6-6 EAF42	11-6 E27K	8-6 KTR3	7-6 PEN16	6-6 U78	8-6 X42	10-
3B7	8-6BRW6	7-6 6Q7GT	9-6 12A6	6-6 28D7	7-6 ACPEN0	6-6 EB34	2-6 E27L	8-6 KTR1	8-6 PLS1	11-6 U132	9-6 X150	10-
3D6	2-6BRW7	9-6 6R7G	8-6 12A7	8-6 30	7-6 AC1H1	6-6 EB41	8-6 E27M	10-6 KTW61	7-6 PLS2	9-6 U133	8-6 X150	6-6
3Q1	9-6BRX4	9-6 6SA7	8-6 12A18	12-6 30CL	7-6 ADD15	6-6 EB91	6-6 E27N	9-6 KTW62	7-6 PLS3	11-6 U134	7-6 X151	6-6
3Q5	9-6BRX4	9-6 6SA7	8-6 12A18	12-6 30CL	8-6 AC1P4	8-6 E27O	12-6 E27P	6-6 KTW63	7-6 PM13	12-6 U231	12-6 X151	4-6
3E4	7-6BRX4	7-6 6SH7	6-6 12A17	8-6 31	7-6 AP14	7-6 E27Q	7-6 E27R	6-6 KTW64	6-6 PM12	4-6 U131	7-6 X151	1-54
3V4	8-6BRX	6-6 6SJ7	8-6 12A17	10-6 35S1	12-6 ATP4	3-6 E27S	10-6 EL41	10-6 KTW65	6-6 PM12M	6-6 U132	9-6 X150	10-
504	8-6C6	8-6 6BK7	5-6 12BA6	9-6 35L6	9-6 AZ31	12-6 EBF80	EL42	13-6 L63	6-6 PY80	9-6 U404	8-6 Y63	10-6
5V1	10-6C10	10-6 6BL7GT	8-6 12B36	10-6 35Z4	8-6 B309	9-6	10-6 EL81	15-6 LN152	10-6 PY81	9-6 U404	11-6 Z03	6-6
5X4	19-6C14	7-6 6SN7GT	7-6 12C1	30-6 35Z5	8-6 B329	10-6 E27S	5-6 EL84	10-6 LN209	EX82	7-6 E27S	8-6 Z06	20-
5Y1	7-6D16	6-6 6B87	7-6 12B16M	3-6 41MP	12-6 BL63	7-6 E27T	6-6 EL81	5-6	12-6 PY83	10-6 U404	10-6 Z77	8-6
5Y4	10-6F1	12-6 6U4GT	14-6 12J5GT	4-6 41MTL	7-6 CK23	6-6 E27U	15-6 EM34	10-6 LZ319	7-6 Q21	7-6 UCH42	10-6 Z150	12-6
5Z3	8-6GPG	7-6 6I5G	7-6 12J7	9-6 50C5	10-6 CK55	6-6 E27V	10-6 EY51	10-6 MH4	5-6 Q222	12-6 U41	9-6 Z152	8-6
5Z4	8-6G7	10-6 G7	8-6 12K7	9-6 50L6	8-6 CV85	12-6 E27W	8-6 E27X	12-6 MH14	7-6 Q225	6-6 U41	10-6 Z151	9-6
6A8	19-6G8	10-6 6V6G	7-6 12K9	14-6 57	8-6 D1	3-6 E27Y	8-6 E27Z	6-6 M814	15-6 Q215	U146	12-6 Z152	12-6
6A7	8-6G12	9-6 6V6GT	7-6 12Q7	8-6 58	8-6 D2	10-6 E27Z	12-6 E27A	3-6 N77	10-6	10-6 U41	8-6 Z152	10-6
				61BT	12-6 D63	5-6 E27A	8-6 E27B	8-6				
				61MP	10-6 D77	6-6 E27C	10-6 E27D	8-6				
				61NPT	15-6 DAC82	11-6 E27E	9-6 E27F	11-6				
				64ME	10-6 DAF91	7-6 E27G	12-6 E27H	12-6				

Terms of business—Cash with order or C.O.D. only. Orders value 4% or more sent post/packing free. Orders below 4% please add 6d. per valve. C.O.D. orders—Minimum fee, including post and packing, 3/- We are open for personal shoppers. Mon-Fri: 8.30-5.30. Sat: 8.30-1 p.m.

CRYSTAL DIODES (1st Grade), OA71, OEX34, CV62, M1, C010, all 7- each.

All valves new, boxed, tax paid, and subject to makers' guarantee. First grade goods only, no seconds or rejects. All orders received by first post/despatched same day. S.A.E. for free complete list, with terms of guarantee and conditions of sale.

NEW! THE PRACTICAL WAY

of learning **RADIO • TELEVISION • ELECTRONICS**
AMATEUR S.W. RADIO • MECHANICS • PHOTOGRAPHY • CARPENTRY, Etc. Etc.

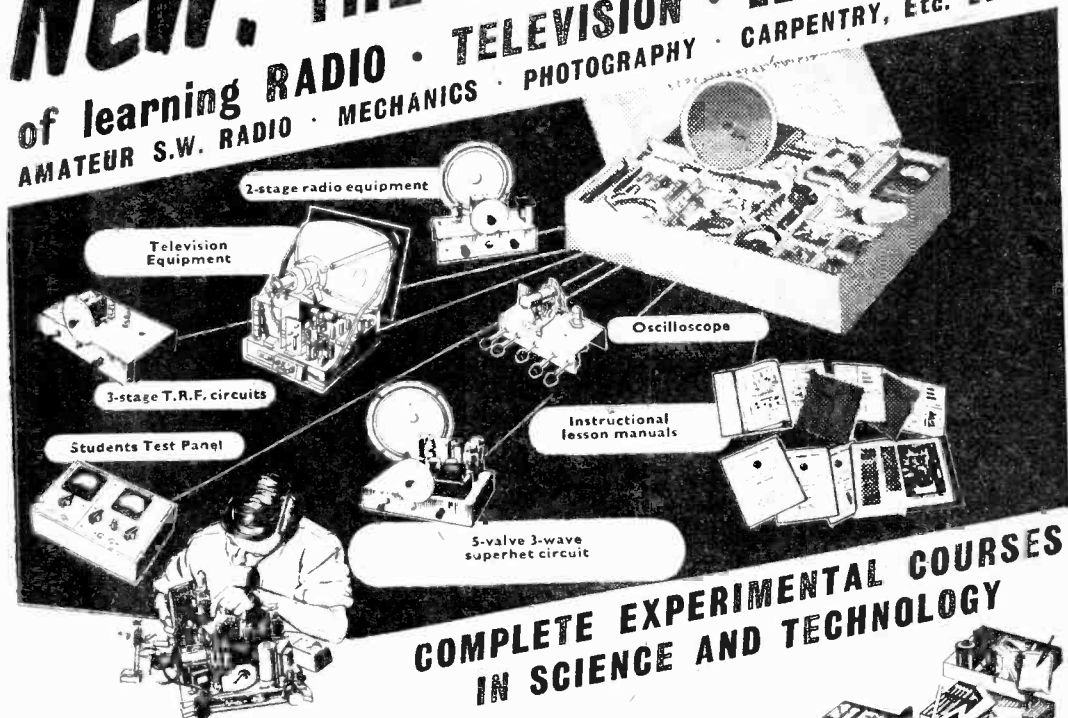

COMPLETE EXPERIMENTAL COURSES IN SCIENCE AND TECHNOLOGY

NEW... completely up-to-date methods of giving instruction in a wide range of technical subjects specially designed and arranged for self-study at home under the skilled guidance of our teaching staff.

NEW... experimental outfits and lesson manuals are despatched on enrolment and remain the student's property. A tutor is allotted to each student for personal and individual tuition throughout the course. In the case of radio and television, specially prepared components are supplied which teach the basic electronic circuits (amplifiers, oscillators, detectors, etc.) and lead, by easy stages, to the complete design and servicing of modern commercial radio and television receivers.

If you are studying for an examination, wanting a new hobby or interest, commencing a career in industry or running your own full-time or part-time business, these practical courses are ideal and may be yours for moderate cost. Send off the coupon to-day for a free Brochure and full details. There is no obligation whatsoever.

The only Home Study
College run by
a World-wide
industrial
organisation.

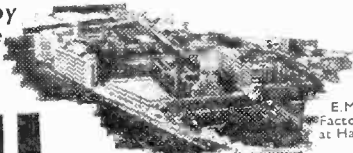

E.M.I.
Factories
at Hayes.

EMI INSTITUTES

- Part of "His Master's Voice" Marconiphone, etc. etc.

SUBJECTS INCLUDE—

- RADIO • SHORT WAVE RADIO
- TELEVISION • MECHANICS • CHEMISTRY
- PHOTOGRAPHY • ELECTRICITY • WOODWORK
- ELECTRICAL WIRING • DRAUGHTSMANSHIP
- ART, etc.

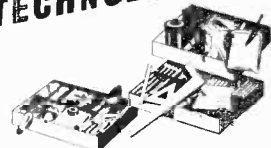

COURSES FROM
15/- PER MONTH

FILL IN COUPON
FOR
FREE
PROSPECTUS



E.M.I. INSTITUTES Dept. 138, London, W.4

NAME _____ AGE _____ (if under 21)

ADDRESS _____

BLGCK
CAPS
PLEASE

I am interested in the following subject(s) with/without equipment

JAN. _____ We shall not worry you with personal visits

IC85



'CATHODRAY' VISCONOL CONDENSERS

for the most stringent conditions

The 'Visconol' Process — exclusive to T.C.C. — means greater dependability and a longer useful life than ever before. It is the answer by T.C.C. research engineers to the insistent demand for condensers which will stand up to higher and still higher voltages. A selection from the range is given below. Features include: low power factor; complete dielectric stability; resistant to voltage surges; ample rating at higher temperatures; proof against breakdown or flash-over. Full details on request.

Cap. in μ F.	Max. Wkg. at 60°C.	Dimens. (Overall)		T.C.C. Type No.	Price
		Length	Dia.		
.0005	25000	5 $\frac{1}{8}$	1 $\frac{3}{8}$	CP57H00	18/-
.001	6000	2 $\frac{1}{2}$	2 $\frac{7}{32}$	CP55Q00	6/-
.001	12500	3	1 $\frac{1}{8}$	CP56V00	10/-
.001	20000	2 $\frac{1}{2}$	1 $\frac{1}{8}$	CP56G00	10/-
.002	18000	5 $\frac{1}{8}$	1 $\frac{1}{8}$	CP57X00	18/-
.01	6000	3	1 $\frac{1}{8}$	CP56Q00	10/-
.02	12500	6	2	CP58V00	20/-
.05	6000	5 $\frac{1}{8}$	1 $\frac{1}{8}$	CP57Q00	18/-
.1	7000	6 $\frac{1}{8}$	2	CP58Q00	20/-
.25	1000	3	1 $\frac{1}{8}$	CP56V	10/-



THE TELEGRAPH CONDENSER CO. LTD

RADIO DIVISION: NORTH ACTON · LONDON · W.3

Tel: ACORN 0061

Junction Transistors by **G.E.C.**

GET 3 · GET 4 · GET 6

The accumulated improvements resulting from a year's run on pilot plant of EW53, EW58 and EW59 have been incorporated in the factory product which is being issued under references GET 3, GET 4 and GET 6.



GET 3 · GET 4

These are general purpose transistors for 6 and 12V operation. They are capable of a good HF performance and can be used in amplifiers at 315 and 465 kc/s.



GET 6

A low noise junction transistor. This transistor features an extremely low noise level which has hitherto been unobtainable with transistors.

Noise factor

6db

$f = 1 \text{ kc}$

$R_s = 500\Omega$

$V_c = 2V$

$I_c = 0.5 \text{ mA}$

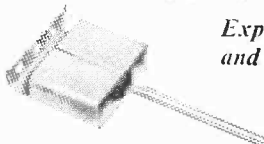

Experimental type EW70 is at the moment in pilot plant production and available to equipment manufacturers.

Two watts of audio are available from a pair under class B push-pull conditions. This performance is obtainable combined with the high frequency performance typical of a small transistor.

Full particulars of these devices can be obtained from

G.E.C. VALVE & ELECTRONICS DEPT.

THE GENERAL ELECTRIC CO. LTD., MAGNET HOUSE, KINGSWAY, LONDON, W.2



Practical Television

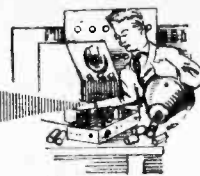

& TELEVISION TIMES

Editor : F. J. CANN

Editorial and Advertisement Offices : "Practical Television," George Newnes, Ltd., Tower House, Southampton Street, Strand, W.C.2. Phone : Temple Bar 4363. Telegrams : Newnes, Rand, London.
Registered at the G.P.O. for transmission by Canadian Magazine Post.

Vol. 7 No. 78

EVERY MONTH

JANUARY, 1957

TelevIEWS

P.T. AND P.W. FILM SHOW

THE PRACTICAL TELEVISION and *Practical Wireless* Film Show takes place at the Caxton Hall (Great Hall Site), on Thursday, February 21st. Admission will be free, but by ticket. We are all aware that the wonders of television and radio are made possible by the electronic valve. Recently, the transistor has entered the field and bids fair eventually to replace the valve in certain parts of TV and radio circuits. One of the leading manufacturers of valves, Mullard, Ltd., have produced many interesting films on the manufacture of valve tubes and transistors, and I am grateful to them for their co-operation in providing the films for the meeting, which will start promptly at 8 o'clock in the evening. There will be an interval for refreshments. I shall be in the chair, and readers wishing to attend should send in their requests for tickets immediately to "Film Show," PRACTICAL TELEVISION, address as on this page. The Hall accommodates 500 people, and tickets will be despatched to the first applicants, so send your application now. There is bound to be a large demand.

AMERICAN COLOUR TV FAILS

THOSE American manufacturers who thought that there would be an enormous demand for colour TV receivers have suffered a severe disappointment. It was stated that there would be at least 1½ million colour TV sets in operation by the middle of 1956. The actual figure is under 80,000. This compares with a sale of 35 million monochrome sets, notwithstanding that prices have dropped from 1,000 dollars to 500 dollars within the year, and colour TV programmes have increased to 10 hours and five hours a week on two of the leading networks. These encouragements have not stimulated sales, and it is said that the sets are in need of constant adjustments during reception and require also a large amount of maintenance and replacements. Colour TV

receivers are, of course, more complicated to operate than black and white receivers, but it is thought that the high prices have been the main cause of poor sales.

BINDERS FOR "P.T."

WITH reference to the self binders for PRACTICAL TELEVISION which we are supplying for 10s., post free, and which we described and illustrated on page 211 of our issue dated December, 1956, will readers when ordering please state the number of the volume which they require blocked on the spine of the binder. If you wish to have all your loose copies bound in this way, you will, of course, need several binders, and when ordering them it is necessary to state the number of each volume.

"THE ELEMENTS OF MECHANICS AND MECHANISMS"

THIS important new book published recently from the offices of this journal at 30s., or 31s. by post, is a fascinating volume for all those interested in how things work. It is not only intended for engineering students, teachers, designers and draughtsmen, but also for those interested in making things. It explains the natural forces and the laws of motion, and the principles of every well-known mechanical movement. Its 431 pages and 481 illustrations deal with force, energy, power, heat, the lever, the wheel and axle, pulleys, the Geneva mechanism, gears, the natural forces, the inclined plane, the wedge and screw, hydraulics, pumps and water wheels, intermittent mechanisms, etc., etc.

1957 RADIO SHOW

STRIKES or international situations permitting, the next Radio Show will take place at Earls Court from Wednesday, August 28th, to Saturday, September 7th, with a preview on Saturday, August 24th. It will be observed that this is a week later than the 1956 Show.—F. J. C.

OUR NEXT ISSUE, DATED FEBRUARY, WILL BE ON SALE ON TUESDAY, JANUARY 22nd.

A Beginner's Guide to Television

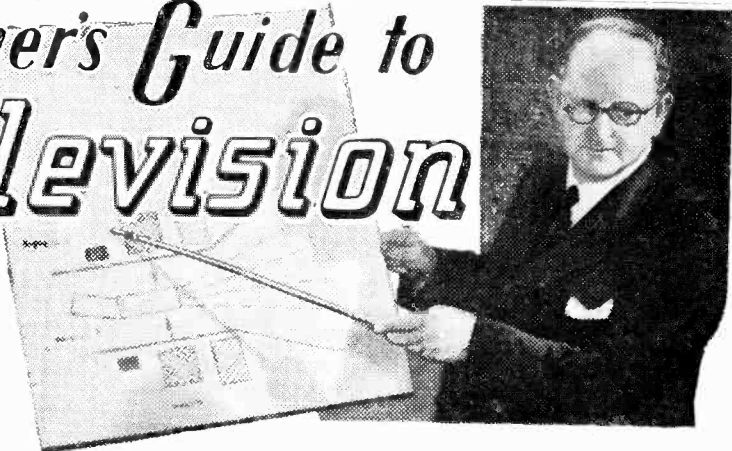

10.—MORE ABOUT COLOUR TV TUBES AND RECEIVERS

By F. J. Camm

THE combination of band saving, band sharing, carrier modulation and "frequency interleaving" (see last month's issue) is claimed in the U.S.A. to produce an adequately compatible signal. Whether or not such is the case in the British version applied to typical domestic receivers in this country, is the chief matter under investigation by English authorities.

Tricolour Tubes

At the present time, there are two types of colour tube in use. The most popular employs three electron beams and, obviously, three electron guns, and it is therefore known as a 3-gun tube. They are 21in. tubes, although some 22in. tubes are also available.

The 21in. tube is of the R.C.A. type, and the electrodes and guns are housed in a round glass casing. The C.B.S. 22in. tube is of the standard rectangular type. There is a third type being produced in small quantities—the Colortron and is of the I-gun type. The 3-gun tubes are what is known as "Aperture" controlled, and the I-gun tubes have "colour grid switching."

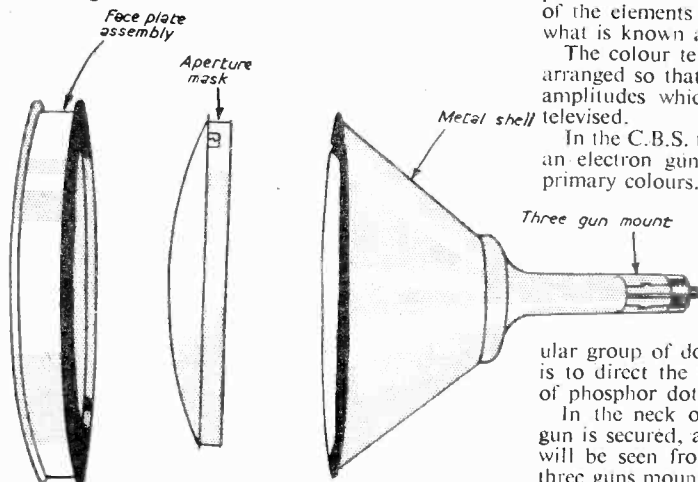

Fig. 48.—The RCA colour tube dissected.

Persistence of Vision

We have seen that only the three primary colours of red, blue and green are necessary for good quality colour reproduction. It is well known that the eye is not particularly colour sensitive to the detail information of a picture, and thus we arrive at the conclusion that a good colour picture tube only requires good three-colour reproduction for the larger areas and good black and white for the finer details. Hence, the minimum requirements of a tri-colour picture tube are light sources for the three colours, a method of controlling the output of each primary colour and a system of adding to the primary colours.

I explained earlier that the three primary colour sources are the three different phosphors on the end of the tube, each of which glows when excited by an electron beam. Advantage is taken of two defects or characteristics of the eye, namely, the inability of the eye to separate or to distinguish fine details, and persistence of vision which has been explained earlier. The picture is divided into a large number of colour elements which really consist of groups of the primary colours. When they are excited or energised the persistence of vision defect gives the illusion that all of the elements are excited at once, thus providing what is known as colour addition.

The colour television receiver must, of course, be arranged so that the colour output voltages provide amplitudes which match those of the scene being televised.

In the C.B.S. three-gun aperture mask colour tube, an electron gun is provided to excite each of the primary colours.

In the Colortron there is associated with the phosphor plate an aperture known as a shadow mask, which has closely spaced holes equivalent in number to the groups of phosphor dots, each hole being aligned with a particular group of dots. The object of the shadow mask is to direct the electron beam to particular groups of phosphor dots during scanning.

In the neck of the tube the three-beam electron gun is secured, as shown in Fig. 42, last month. It will be seen from that diagram that it consists of three guns mounted close together, the axes of which are parallel. They form a single unit. Fig. 40, given last month, shows how the shadow mask tube

works. It will be seen that each beam is aimed through the holes so that it will reach only dots of a particular colour. It is important to note that the three beams pass through the same hole and after deflection advance from hole to hole successively, and as the three guns are spaced 120 deg. apart it is obvious that each will only observe the dot colour associated with it. The shadow mask obscures the phosphor dots of the other two colours.

The Chromatron

The Chromatron colour tube differs in important particulars from the Colortron. Its main difference is that it uses only one electron gun and there is thus only one beam. It employs red, green and blue phosphor strips, instead of phosphor dots as in the tube just described. These strips are arranged horizontally and in successive tri-colour groups over the surface of a viewing screen located behind the outer space plate.

Two sets of wires fixed parallel to the phosphor strips are secured behind the screen, forming the colour grid. They are, of course, insulated from one another and so disposed in relation to the phosphor

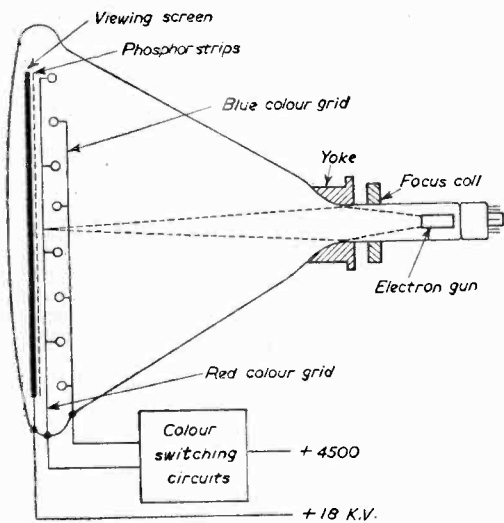

Fig. 49.—The chromatron colour tube.

strips that the electron beam which passes between them can impact on either of the three colours. In other respects the tube resembles a monochrome tube. The Chromatron is shown in Fig. 49.

The Colour TV Receiver

A TV receiver designed for colour resembles an ordinary monochrome receiver except in some minor details. The diagram, Fig. 50, shows the elements of such a receiver. Where the lines are dotted that is intended to indicate the parts which are similar in both types of receiver, whereas the solid lines represent additions to make a monochrome receiver a colour receiver. The additions for colour are not arranged in those channels associated with the colour picture tube, and when these particular parts are inactive a picture signal in monochrome can still be received. This is a decided advantage for owners of monochrome receivers.

Whilst this description of the present state of colour television reasonably indicates the tendencies of the science, and the direction in which it is developing, it is important to note that scientific opinion in America is that colour TV has not yet arrived. It has by no means been so successful in America as was first thought and the demand for colour TV receivers has been remarkably low and prices have dropped.

About Bands

The wavelengths (frequencies) used for radio and television are divided into sections by International agreement.

These were decided at the International Telecommunications and Radio Conference at Atlantic City, 1947, and the division is as follows:

Band shared with maritime mobile	150-160 kc/s
Low-frequency (not world wide)	160-285 Mc/s
Medium frequency (Regional 1 only)	525-535 "
Medium frequency (world wide)	535-1605 "
Shortwave frequencies (world wide)	5.95 to 6.2 Mc/s
	9.5 - 9.775 "
	11.7-11.975 "
	15.1-15.45 "
	17.7-17.9 "
	21.45-21.75 "
	25.6-26.1 "

Very high frequency (world wide)	88-100 Mc/s
(U.S.A.)	88-108
Ultra high frequency	300-3,000 Mc/s
Super high frequency	3,000 to 30,000 Mc/s
Extremely high frequency	30,000-300,000 Mc/s

In addition to the above allocations the bands given above may be divided into channels, and thus we have in this country Band I in which the BBC transmitters are found and which ranges from 41 Mc/s to 68 Mc/s, and Band III which is at present used by I.T.A., from 174 Mc/s to 216 Mc/s. In addition to these there is also what is known as Band II and this is used for the F.M. BBC transmissions. Band II comes in the V.H.F. band and covers from 87.5 to 100 Mc/s.

The following are the various channels in Bands I and III.

	Channel	Sound (Mc/s)	Vision (Mc/s)
Band I (BBC)	1	41.50	45.00
	2	48.25	51.75
	3	53.25	56.75
	4	58.25	61.75
	5	63.25	66.75
Band III	6	176.25	179.75
	7	181.25	184.75
	8	186.25	189.75
	9	191.25	194.75
	10	196.25	199.75
	11	201.25	204.75
	12	206.25	209.75
	13	211.25	214.75

All of the five channels in Band I are used by the BBC and it will be noted that as there are more than five transmitters the wavelengths have been used more than once in certain cases. To avoid interference the stations using common wavelengths are situated as far apart as possible and the signals are horizontally polarised. That is, the aerial is horizontal instead of the usual vertical.

In Band III only channels 8, 9 and 10 are so far in use. The allocations are as follows:

Croydon (London)	Channel 9
Lichfield (Midlands)	Channel 8
Winter Hill (Lancashire)	Channel 9
Emley Moor (Yorkshire)	Channel 10

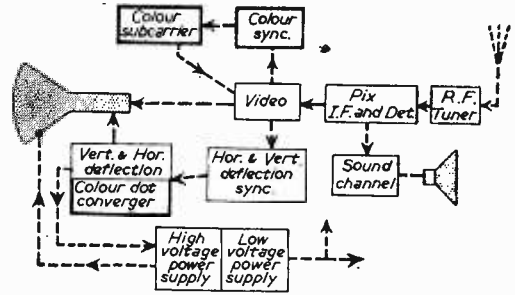

Fig. 50. — The elements of a modern TV colour receiver.

Notes on Viewmaster I.F. Strip

By G. T. Layton

IN the articles in August and September last dealing with a switched method of converter for two stations, some mention was made of certain suggested modifications that could be added to a previously described Viewmaster I.F. strip conversion. As some interest has been shown in this, it is worth while enlarging a little on the remarks made.

The 6F12s can be used in place of EF50s for all R.F. uses, an EL84 for the sound output, and 6CH6 for the video output. As regards bias, if the variable bias from the diode is used for the video output valve this can be adjusted from 0.6, a figure of two or three volts being the desirable amount. In order to obtain enough gain on the output stage, it is desirable to make the load resistance on the anode of the 6CH6 not more than 3,000 ohms, and at least 10-watt carrying capacity. Bias on the sound output stage is not very vital, but should be checked across the cathode resistor to see that 6 or 7 volts of bias exists with, say, 250 volts on the anode. As regards the original double-diode-triode used in the sound section, it is possible to get single-ended diode triodes in the seven-pin base series, but the writer has found hum difficulties to be present with these. An easier approach is to have a separate diode as shown in the diagram, feeding into a triode; any L.F. triode in the seven-pin series will do, but for the sake of uniformity it is well worth while strapping anode and screening grids together to convert a 6F12 to a triode.

Given an existing Viewmaster chassis, blanks need to be cut to the original valve base sizes and appropriately drilled for B7G bases. These should be so set that a tinplate screen about 2in. by 1in. soldered across the underside of the valve base and attached by soldering to pin 4 heater earth will divide off anode from grid as originally.

With these more modern valves the overall gain on both sound and vision is greater than originally, and in the process of tuning to obtain the necessary stagger-tuning for the correct vision response curve when accidentally anode and grid coils are brought into line as regards frequency there will be instability, but without altering the existing damping resistance across the coil, the writer has found no instability when the coils are properly stagger-tuned. However, there is so much overall gain that it is quite easy to broaden the bandwidth more than desired if any instability is experienced.

Apart from the foregoing, many other variations

can individually be put into this chassis, because it is fundamentally such a simple design that it lends itself to modification. One of the great advantages with the individual coils used is that all slugs can be tuned from the top side of the chassis, and thus even if the coils as wound are considerably off the correct number of turns, by use of either a brass plug or an iron dust slug a very wide range can be covered.

One other point is that the original gas-filled timebase valves on the Viewmaster need a circuit taking the input from the output of the video output valve. This, unfortunately, means that the requirements of the timebase signal against that of the video signal leads to a compromised bias value needing to be selected. If, on the other hand, the synchronising signal were taken off from the diode prior to the video output, then the bias of the video output valve could be adjusted to the right value for video purposes. The disadvantage here is that the synchronising signal would now be of opposite phase and would therefore need a reversal stage consisting of an ordinary pentode amplifier before it could be fed into the timebase.

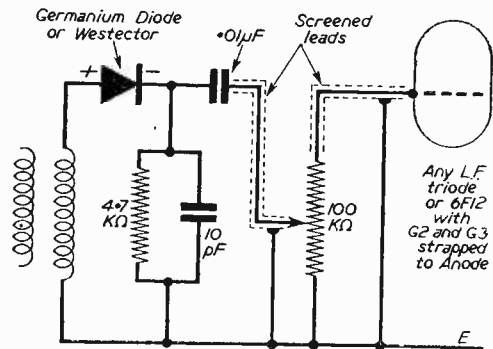

Mr. Layton's modified sound stage.

Lastly, it is quite possible instead of using the existing Viewmaster chassis, which is now rather bigger than is needed, to scale down its size by 2in. or 3in. both ways, taking advantage of the fact that the miniature valves need only $\frac{1}{2}$ in. overall instead of the $1\frac{1}{2}$ in. overall of the EF50s.

REFRESHER COURSE IN MATHEMATICS
8/6, by post 8/10. 4th Edition. By F. J. CAMM
From: **GEORGE NEWNES, LTD.**
Tower House, Southampton Street, Strand, W.C.2

Slot Aerials for Television

SOME PRACTICAL AND THEORETICAL CONSIDERATIONS By B. L. Morley

AS the number of BBC television transmitters increases many more viewers are getting better signals by virtue of the increase in signal strength in their locality. However, the increased signal strength often brings other problems with it, not the least being the production of "ghost" signals which can often completely spoil reception.

The slot aerial is a very effective antidote to ghost troubles besides being one of the best types of aerial to erect in a loft where space is restricted, and more and more amateurs are investigating the possibilities of them.

In Band III they are also received with favour and, because of the smaller dimensions, outdoor slots are a practical possibility.

Basic Dipole Principles

To understand the way in which the slot aerial works the best method is to go back to the basic operation of the half-wave dipole.

In Fig. 1(a) we have a rod or wire which is exactly as long as the wavelength (λ) of the incoming signal, which induces in it a current wave, which can be exactly accommodated in the length of the wire or rod. In Fig. 1(b) we have a wire or rod which is somewhere between half a wavelength and a whole wavelength long and it will be seen that the incoming wave cannot be accommodated fully along the length of the rod.

The portion from "x" to "y" is, so to speak, surplus. In practice it will rebound along the rod in an out-of-phase condition and mixing with the half-wave section will oppose it. The net result is that the signal strength in the rod will be considerably reduced.

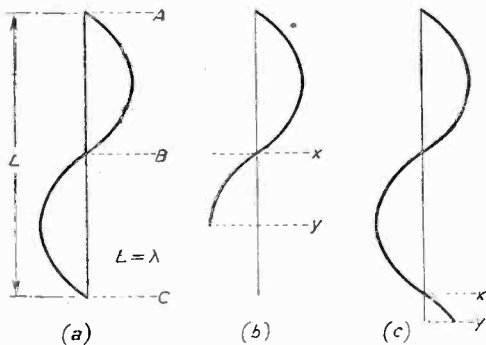

Fig. 1. — Signal voltage along a rod or wire.

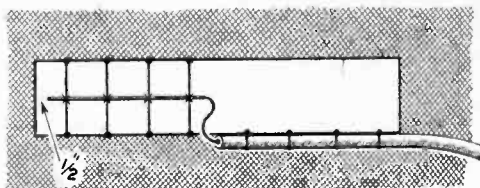

Fig. 8. — Details of coaxial connections.

We have a similar effect when the rod is greater than a full wavelength as shown in Fig. 1c. Here again we have a small "surplus" section of current waveform which will rebound along the rod and reduce the overall signal strength because of its out-of-phase condition.

Summarising, we can say that to get the maximum power from an incoming signal the receptor should equal the wavelength of the required signal.

If we look at Fig. 1(a) again we note that the section from A to B is exactly the same as from B to C except that from B to C the polarity of the signal is reversed. As the signal rises from zero to a maximum in the first half it falls again to zero. We can, therefore, accommodate the complete cycle of events in a rod which is half as long as that in Fig. 1(a).

It will be seen that the first half of the incoming wave will spread throughout the rod from A to B and the second half from B to C. Clearly, a rod which is one half-wave long will be as effective as one which is one complete wavelength.

Such a rod or wire is termed a half-wave dipole.

It would appear, then, that to pick up the maximum signal all that is necessary is to know the wavelength of the transmitter and then to cut a rod half this length.

Unfortunately this is not strictly correct as the wavelength of a transmitter is given as that in free space. Some correction must be added for the fact that the rod has to be supported in some fashion and connection made to it; also the immediate surroundings have some effect. For all practical purposes, however, if we take our wavelength as being 95 per cent. of the theoretical wavelength, then what we have said holds true and a half-wave rod will if cut to those figures have maximum efficiency.

Connecting the Feeder

Having obtained our efficient receiver of signals, the next step is to connect it to a feeder so as to transfer the signal to the television.

It is a fact that the feeder can be connected at almost

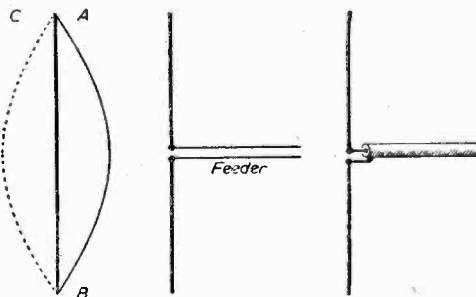

Figs. 2, 3 and 3A.—A half-wave rod; a dipole with balanced feeder, and a dipole with coaxial feeder.

any point of the dipole, but the practical connecting point will usually be determined by the impedance of the feeder which is to be used.

Examining Fig. 2 it will be seen that the current is at a maximum at the centre of the dipole; this means that here the impedance of the dipole is at its lowest.

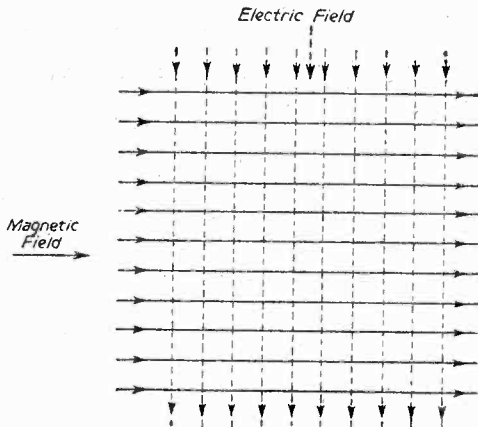

Fig. 4.—An electro-magnetic field.

It is, in fact, about 75 ohms at this point and it is, therefore, convenient to connect 70 to 80 ohm cable at this point as shown in Fig. 3.

Ideally, the feeder connected at this point should be a balanced one and, therefore, balanced twin feeder should be employed. A dipole, split at the centre, forms a balanced circuit and for maximum efficiency it should be connected to another balanced circuit.

It is possible to use an unbalanced feeder such as the very convenient coaxial cable and it can be connected as shown in Fig. 3A. To ensure maximum efficiency some form of balance-to-unbalance transformer must be used such as a baluns or bazooka, but at Band I frequencies at any rate, the extra complication does not seem worth while. It may pay to use such a method with Band III.

The Electro-magnetic Wave

We are apt, sometimes, to lose sight of the fact that the incoming wave from the transmitter is an electro-magnetic one. It is composed of an electric field and a magnetic field which are at right angles to each other as shown in Fig. 4.

The direction of the electric field is used to determine the polarity of the field. Where the electric field is vertical, then the wave is said to be vertically polarised; where the electric field is horizontal, then the wave is said to be horizontally polarised.

Whether a wave is vertically or horizontally polarised is determined solely at the transmitter, the deciding factor being the plane in which the aerial is situated.

If the aerial is placed vertically, then the field will be vertically polarised and vice versa.

It is important to note that when receiving a signal the maximum results are obtained when the receiving aerial is placed in the same plane as the sending aerial. For a vertically polarised signal this means that the receiving dipole must be mounted vertically.

A rod aerial such as we have described uses the electric part of the electro-magnetic wave; we can say it uses the electric field. It has been seen that the wave consists of two fields, one being electric and the other being magnetic. It is possible to make a receiver which will make use of the magnetic field.

Fig. 5 shows the scheme. Here we have a metal plate in the centre of which is cut a slot. The length of the slot "L" determines the wavelength to which the receiver will tune and is made the same length as a normal dipole. The width of the slot has a bearing on the bandwidth of the signals received, but is not over critical and can be in the region of 9in.-12in.

The dimensions of the material surrounding the slot should be sufficient to cover the electric and magnetic fields which would surround a dipole and the minimum figure for satisfactory operation can be taken to be in the region of one-fifth of a wavelength.

The slot can be taken to have similar characteristics to that of the complementary normal dipole which is in the form of a strip.

Another interesting point is that the surrounding material need not be of solid construction: the aerial will work quite effectively if an open mesh material such as chicken wire is used.

It should be noted that the slot aerial uses the magnetic part of the electro-magnetic field and as this is at right angles to the electric field the slot

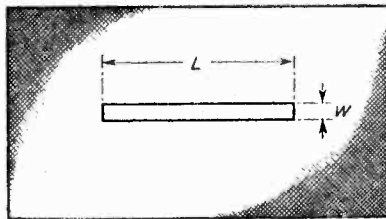

Fig. 5.—A magnetic dipole.

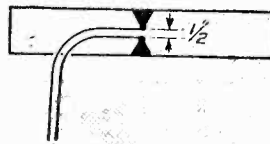

Fig. 6.—Connection of the feeder.

must be mounted at right angles to the normal dipole. For vertical polarisation, then, the slot should be mounted horizontally and vice versa. It should now be clear why this is so.

The material in which the slot is made can be of very simple form and 1/2 in. chicken wire will be found quite suitable.

Connecting the Feeder

At the centre of the slot we have an impedance of about 500 ohms, which is approximately the impedance of a triple folded dipole.

For correct matching 600 ohm balanced twin feeder

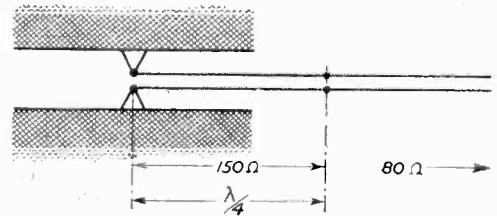

Fig. 7.—A matching section.

should be used—balanced because the slot is a balanced receptor. Connection can be made at the centre as shown in Fig. 6, triangular metal plates (brass or copper or tin) being fitted at the centre of each inner edge. The distance between the ends of these pieces should be $\frac{1}{2}$ in.

Where the television uses a different feeder input (usually 80 ohm instead of 600 ohm), then a matching stub or transformer must be used. A simple method is to use a quarter wavelength section of 150 ohm balanced twin cable connected between the 80 ohm feeder and the aerial as shown in Fig. 7.

It is possible to use coaxial cable to connect the aerial and a special, though simple, method couples the aerial in the form of a baluns and transformer. Thus it is possible to employ 80 ohm coaxial cable directly to the dipole.

Fig. 8 shows the method of connection. The coaxial cable has its sheath removed to expose the outer conductor. Cut the inner polythene so as to leave about 6 in. of the inner conductor available, and then there should be sufficient bare outer conductor so that it can be fitted along one half of the slot. (The actual physical length of this portion will vary with the length of the slot and hence the wavelength it is desired to receive.) It is important that the outer braid should not touch the aerial at any other point than along the bottom edge of the slot as shown in the diagram.

In order to make good contact the braided outer cover should be bound and soldered at intervals along the bottom edge of the slot at not more than 12 in. between the points. It is a good idea to strengthen the edges of the slot all round by the use of heavy gauge copper conductor, especially if chicken-wire netting is used.

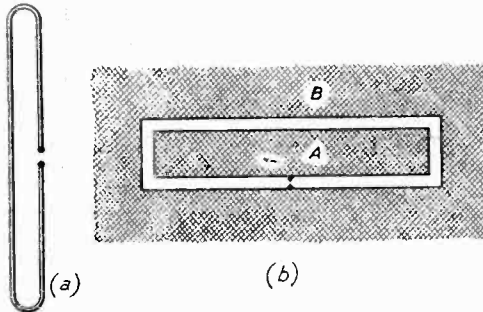

Fig. 9.—A folded dipole and a folded slot.

The braided outer cover goes along one half of the slot. In the centre of the other half is fitted a length of stout copper wire or rod of brass, copper or duralumin. It is fitted so as to lie halfway between opposite edges of the slot, one end being dead central in the length of the slot and the other end being $\frac{1}{2}$ in. from the vertical edge.

Stout copper wire is used to connect the rod to the slot edges at intervals of not less than 1 ft. as shown in the diagram.

The centre conductor of the coaxial cable is connected to the rod at the central position.

Consultation of the diagram should make the method clear.

This method of connection overcomes the objection of balance-to-unbalance conditions and the matching of 80 ohm coaxial cable to the 500 ohm slot.

Folded Slots

When a normal dipole is folded the impedance is increased four times. When a slot is folded the impedance is reduced by a quarter. Therefore, where space is available, a simple method of reducing the impedance of the slot is to fold it.

In Fig. 9(a) we have shown the elements of a folded

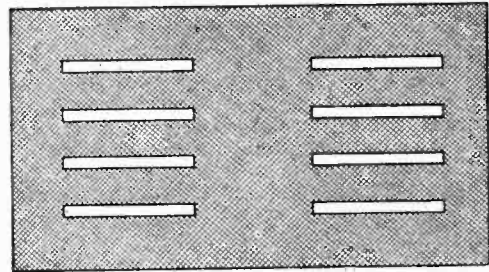

Fig. 10.—Curtain slots.

dipole and in Fig. 9(b) the elements of a folded slot. The centre section "A" must be insulated from the outer "B" and this involves difficulties with mechanical construction.

At the U.H.F. range such application becomes more practical and slots can be arranged in curtain arrays as shown in Fig. 10.

This method would appear to be a modern version of the old, well-tried Kooman Arrays.

Practical Slot Construction

The construction of slot aeriels is of the simplest degree. All that is necessary is a quantity of wire netting with some copper wire or rod and some solder.

The overall measurement of the chicken-wire netting is given in Table I and the slot dimensions in Table II for Band I. Band III conditions are such that another technique can be used and will be discussed later.

TABLE I		
Channel	Length	Width
1	15' 0"	5' 0"
2	14' 0"	5' 0"
3	12' 0"	4' 6"
4	10' 0"	4' 0"
5	9' 0"	4' 0"

TABLE II	
Channel	Length
1	10' 10"
2	9' 4"
3	8' 6"
4	7' 9"
5	7' 3"

Use $\frac{1}{2}$ in. chicken wire, though 1 in. can be used if to hand. Cut the overall dimensions as given in the tables, and if the dimensions cannot be accommodated within the width of the wire, then two pieces can be joined together provided copper wire is used, which is tinned and is soldered at every possible point.

(To be continued.)

Aerial Filters and Crossovers

DETAILS OF CIRCUITS, PRINCIPLES, AND COMMERCIAL APPLICATIONS

AS the Band III transmissions spread across the country we are receiving an increasing number of enquiries concerning the best methods of connecting the necessary aerials to the sets. A viewer may have a receiver which has only a single input socket (although the set is designed for Band I and Band III viewing), and when he puts up his second aerial he is confronted with two aerial leads and does not know the best way of combining them. Alternatively, he may have fitted a combined aerial and have

Furthermore, the printed coils embodied in these units can be produced to a closer tolerance than could otherwise be achieved by conventional winding methods, thereby ensuring that the performance of all units is identical and conforms to the laboratory specification.

The printed circuits are supplied printed and drilled ready for the necessary condensers to be soldered into position. A screened metal box or an insulated container such as a plastic box may be used for mounting the assembled circuit.

The completed assembly is then fitted in some convenient position which, for example, for an aerial cross-over unit may be close to the aerials themselves and could be either under the eaves of the roof or in the loft. High-pass filters should, however, be mounted as close to the receiver as possible to prevent pick-up of interference on that section of the feeder between the filters and the receiver itself. If a metal case is used, then there must be at least $\frac{1}{8}$ in. clearance between the printed panel and the sides of the case.

Where an aerial cross-over unit or filter is mounted in the open it is essential that the container be waterproof and any opening sealed against the ingress of moisture. The printed panel should also be protected by a coating of a moisture-proof lacquer or varnish, and this should be done after assembly.

Aerial Cross-over Units

It has already been explained that the necessity has arisen for coupling together Band I and Band III aerials feeding a single receiver. In many cases this can be done at the aerial, and a single feeder is then taken direct to the television receiver, thereby economising in the relatively expensive co-axial

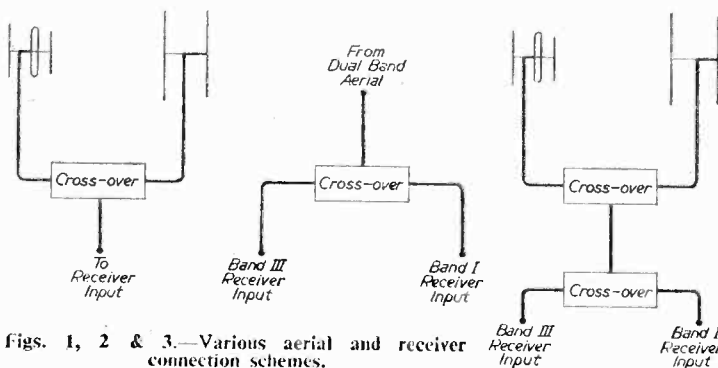

Figs. 1, 2 & 3.—Various aerial and receiver connection schemes.

a receiver which is intended only for Band I. When the Band III station opens up in his district he may fit a Band III converter and that means he has another aerial socket to fill, and the combined aerial will only have a single lead. There are many variations of these two examples, and in addition there is the question of interference between the two signals. To answer them it is probably most satisfactory to quote the following extracts from a bulletin issued by the T.C.C., makers of printed circuits, and producers of a number of interesting aerial units of the type being dealt with. These are, of course, referred to by suppliers of the equipment as duplexers, combiners, splitters, couplers and invented proprietary names.

Patterning

Experience has confirmed that many multi-channel television receivers are subject to interference which causes severe patterning on the screen and require a high-pass filter to be fitted in series with the aerial feeder to overcome this source of interference. The T.C.C. range of cross-over units and filters has been the subject of considerable development and all the following types have undergone tests under the most adverse conditions. These tests have confirmed their entire suitability for the purposes for which they were designed. By the use of printed circuits the efficiency and reliability of both cross-over units and filters has been increased, whilst at the same time a robust assembly is achieved.

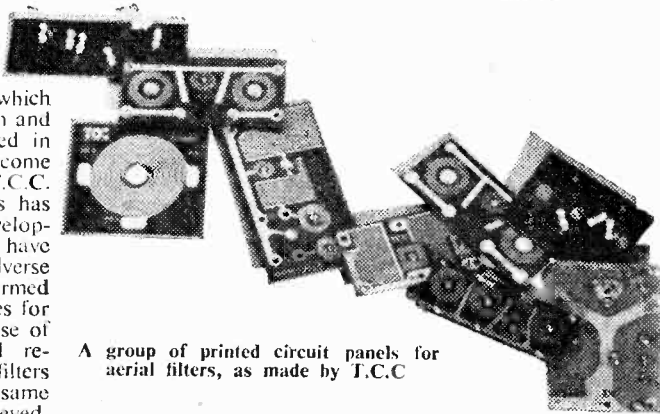

A group of printed circuit panels for aerial filters, as made by T.C.C.

feeder. A schematic diagram indicating the method of connection is given in Fig. 1.

All T.C.C. cross-over units have been designed for use with 75Ω co-axial feeder, though it is not absolutely essential to have these units matched for impedance, since the main requirement is to ensure that the two aerials do not shunt each other at their

connections between feeders and the cross-over units are relatively simple, and these may be done by the soldering of the centre conductors and the screens or screwing in position by means of suitable terminals. The dimensions of the printed panel which is engraved to indicate I, III or Receiver, are 4in. \times 2in. \times 1/16in. thick.

Type C 160

This cross-over unit has identical characteristics to C 156/3 above, but in this case all three condensers are of the conventional type and are mounted on the back of the panel. By this means the size of the printed panel has been reduced and this may be of some importance in certain applications. All other notes referring to the operation of C 156/3 refer also to C 160. Dimensions: $2\frac{1}{2}$ in. \times $1\frac{1}{4}$ in. \times 1/16in. thick.

Type C 275/1

This is a completely printed cross-over unit having printed condensers and inductors (Fig. 5). Because of its simpler configuration, the impedance between the aerials is somewhat less than C 156/3 and lies between 15-22 dB on the two bands. The performance has, however, been found to be entirely satisfactory for good reception and no noticeable effect can be seen on the picture. The insertion loss is extremely low being appreciably less than one dB on both bands. Dimensions: $2\frac{1}{2}$ in. \times $1\frac{1}{4}$ in. \times 1/16in. thick.

High-pass Filters

Many of the multi-channel TV receivers now in use suffer from patterning on the screen, this interference being caused by frequencies around the I.F. being picked

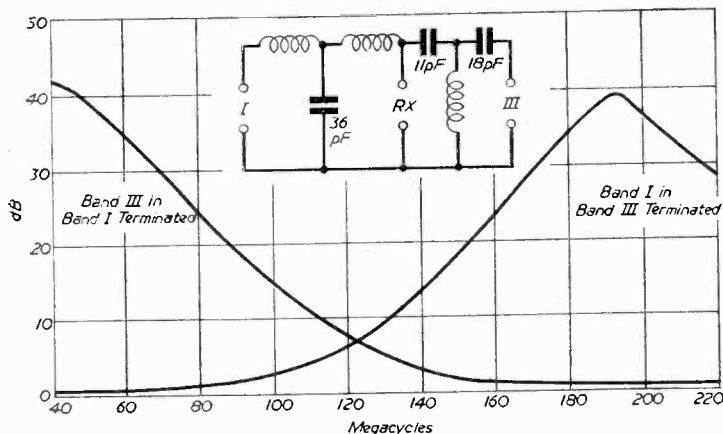

Fig. 4.—Theoretical circuit and performance characteristic of the C 156/3 filter.

operating frequencies: the filters effectively separate the two aerial systems.

There is yet a further use for these cross-over units, this being to separate the Band I and Band III signals in a combined aerial, for those cases where a television receiver requires separate inputs. This arrangement is shown in Fig. 2. A further application is, to combine and then separate the two signals if the aerials happen to be some distance from the receiver, Fig. 3, since by this means it is possible to use only a single length of feeder with a receiver intended for separate inputs.

Type C 156/3

The theoretical arrangement and the characteristic are shown in Fig. 4. It will be seen that the cross-over unit consists of a high-pass and low-pass filter coupled together, each filter having three elements. From Fig. 4 it can be seen that each aerial offers an impedance greater than 30 dB to the alternative frequency. The printed circuit has on it the three inductors and two condensers and to complete it, it is only necessary to fix one condenser having a capacity of 36 pF on to the appropriate points which are already allowed for. The

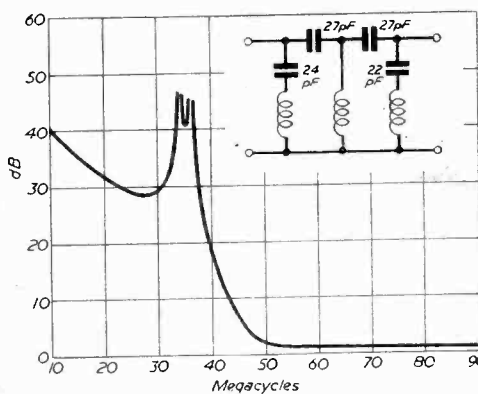

Fig. 6.—Circuit and performance data of the three-stage high-pass filter C 102.

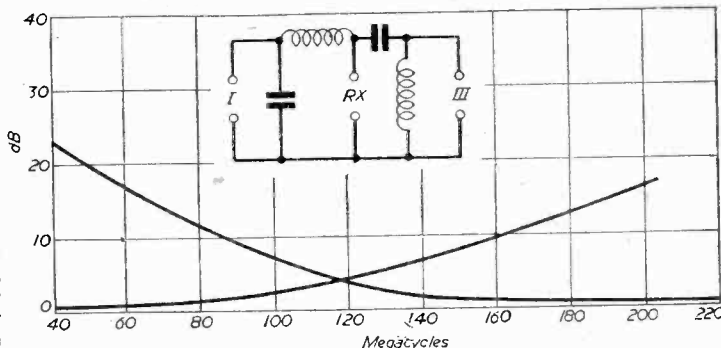

Fig. 5.—Theoretical and performance data of the C 275/1.

up and causing a beat to appear in the receiver. This is particularly serious in a swamp area where transmitters of very different frequencies may cause interference due to harmonics. The filters operate by having a high attenuation to the unwanted

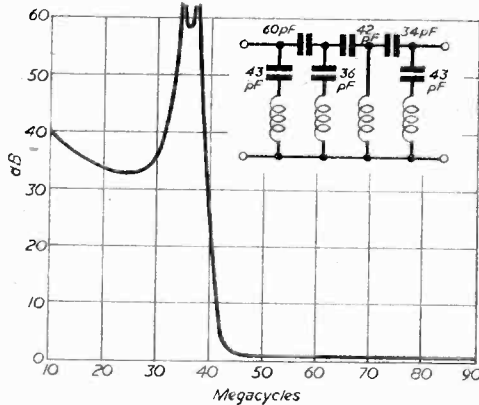

Fig. 7.—Four-stage high-pass filter type C 129.

frequencies and a low insertion loss at the wanted frequencies.

Details of the individual filters follow :

Type C 102

This is a three-stage high-pass filter giving maximum attenuation over the range of 34-40 Mc/s (Fig. 6). The insertion loss over the acceptance band is relatively low being 1 dB at 50 Mc/s and falling below this figure at 70 Mc/s and 200 Mc/s, though at 41.5 Mc/s it may be around 12 dB. For this reason this filter may not be entirely suitable when used on Band I, Channel I (London) but will be perfectly satisfactory on other TV channels. It is also suitable for use with the continental frequencies above 41.5 Mc/s. This filter is primarily designed for TV receivers employing a 35 Mc/s I.F., but is suitable for other I.F.'s as the attenuation is still maintained below 35 Mc/s being greater than 33 dB at 19 Mc/s and 10 Mc/s. Dimensions : 3 in. \times 1 $\frac{1}{8}$ in. \times 1/16 in. thick.

Type C 129

This is a four-stage high-pass filter of similar characteristics to C 102 but with the addition of the extra stage (Fig. 7). The attenuation over the rejection band is therefore greater than 50 dB over the range 34-38 Mc/s. The insertion loss over the acceptance band is less than 1 dB whilst at 41.5 Mc/s it is approximately 10 dB. The filter is intended for similar application to those mentioned above but will more effectively eliminate interference due to R.F. signals

appearing in the receiver and beating with the I.F. Though this filter has been designed primarily for use with receivers having a 35 Mc/s I.F., the attenuation at 9, 16 and 20 Mc/s is in excess of 30 dB and the filter will, therefore, perform satisfactorily in

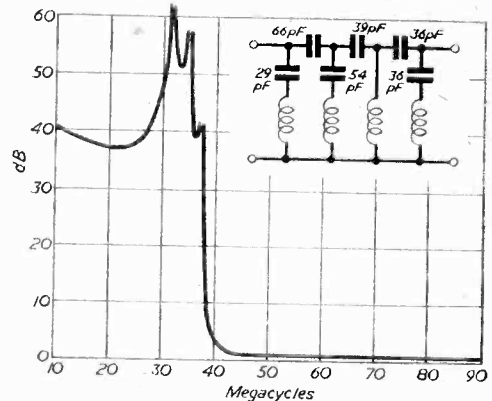

Fig. 8.—High-pass filter type C 263.

those cases. Dimensions : 3 $\frac{3}{8}$ in. \times 1 $\frac{1}{2}$ in. \times 1/16 in. thick.

Type C 263

High-pass filter C 263 (see Fig. 8) has been designed to have a similar characteristic to C 129 but with reduced attenuation at 41.5 Mc/s, so making it more suitable for operation on Band I, Channel I. The insertion loss at 41.5 Mc/s has been reduced to 1 dB whilst above this frequency the loss is around 0.5 dB. Because of higher inductance values the dimensions of this filter are slightly larger than C 129. Dimensions : 3 $\frac{11}{16}$ in. \times 1 $\frac{7}{16}$ in. \times 1/16 in.

PRACTICAL WIRELESS NOW ON SALE

JANUARY ISSUE
PRICE 1s. 3d.

The main constructional feature in the January issue of our companion paper, "Practical Wireless," which is now on sale, is a direct-coupled amplifier suitable for record-playing, or for the addition of a radio tuner. Unlike the majority of amplifiers there are no coupling condensers in the unit and this removes certain forms of phase shift and its resultant distortion. It is an easy-to-build unit, and in addition a pre-amplifier is also described, with tone-control arrangements.

Also as a constructional feature is an article on a Quality Diode-transistor Receiver, a small novel design with a detached loudspeaker in a small cabinet with adjustable port on the Helmholtz principle. The two together make a nice simple quality type of receiver.

Also as a constructional article is a description of a Superhet Portable 4, a small battery model with built-in frame aerial.

Other articles deal with Autochanger Maintenance, Operating Battery Sets from the Mains, Equalising Circuits, Power Supplies, Compact and Multi-band Aerials for Transmitters, Converting a Portable to Car Radio, and a description of the new Leak Trough-line Tuner for F.M. Our regular features are also included.

Independent TV in Scotland

Pilot test transmissions on low power will be radiated from the site from May, 1957, onwards in order to assist conversion of sets and aerials. It is planned that the start of these tests should coincide with the opening of the Radio and Television Exhibition organised by the Radio Industry Council in the Kelvin Hall, Glasgow.

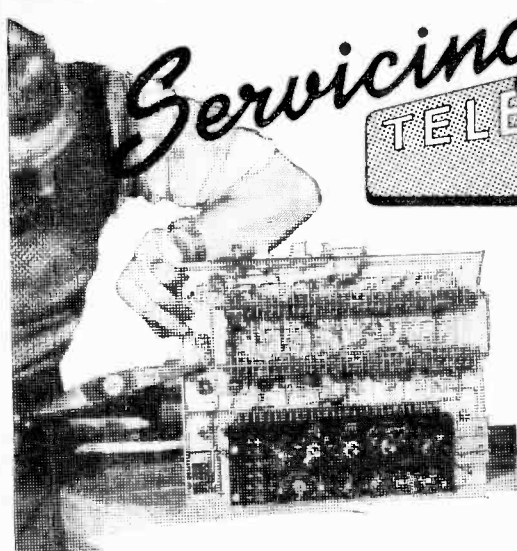

Servicing TELEVISION RECEIVERS

No. 26.—THE BUSH TV1 AND TV2

By L. Lawry-Johns

BOTH console models, these receivers employ the same basic chassis, the TV1 having a 9in. tube and the TV2 a 12in.

The vision receiver section was designed for reception of the double sideband Alexandra Palace transmitter, and therefore it is not ideally suited to the present transmissions. Nevertheless, without alteration the displayed picture remains extremely good on the Crystal Palace signal, provided the receivers are used in the service area. Therefore, in the majority of cases conversion is quite successful where a reasonably strong signal is available. The sound section is divorced from the vision receiver, being fed from the second EF50 vision and sound R.F. amplifier anode circuit by a short length of coaxial cable. Unlike the vision receiver, the sound strip is of the superhet type, almost on radio lines. The frequency changer is an FCH35, the I.F. amplifier an EF39, the double-diode-triode detector, A.V.C. and audio amplifier an EBC33. The sound output is an EL33 mounted on the lower power pack.

The sound I.F. frequency is 725 kc/s with an average bandwidth of 40 kc/s. A fairly wide bandwidth is essential if the sound noise-limiter circuit is to operate efficiently. A small metal rectifier functions as the limiter diode, being effectively shunted across the volume-control, conducting upon the sharp "spikes" of the interference pulses, provided that these have been preserved by the bandwidth of the sound I.F. stages.

On the upper vision chassis are four EF50 R.F. amplifiers followed by an EA50 vision detector in a spring-secured screening can. This is followed by a further EF50 operating as the video amplifier. The video signal input to this is negative-going. The positive-going output at the anode is fed to the grid of the C.R.T., whilst the negative-going signals at the cathode circuit are fed to the sync separator, which is an EA50 in the second screening can.

The cathode circuit is split as shown in Fig. 2. The actual bias resistor R19 is 47 ohms, this low value being essential, since the grid input is negative-going. R20 is of 2.2 K and forms actually a load resistor across which is developed the signal voltages required to feed the sync separator. The anode of the EA50 is normally held at a slightly positive voltage enabling the diode to conduct. The negative-going signal is applied to the anode, the picture content causing the diode to cease conducting whilst the sync pulses, having less magnitude, do not do so and are thus passed by the diode.

It will thus be seen that if the coupling capacitor

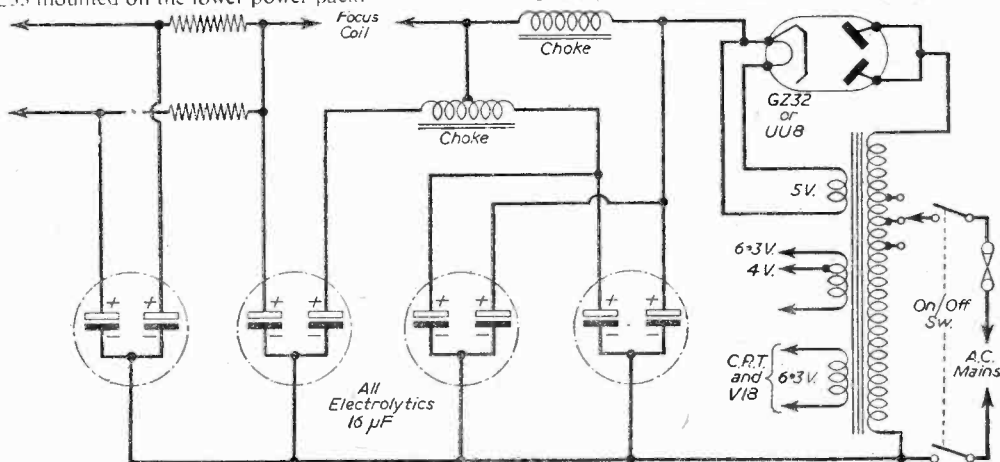

Fig. 1.—Details of the Power Pack. The plug and socket connections are omitted.

C32 (.5 μ F) should develop a leak, the anode of the diode (V7) will become more positive and the valve will continue to conduct on the picture signal. This, of course, upsets the sync separation and the normal effect of this is to cause sections of the picture to be displaced horizontally as the picture content changes. This gives rise to a "stepped" appearance on test card C, and a constantly moving or tearing effect on a changing picture signal. This is quite a common fault on these receivers, and some readers appear to be under the impression that the trouble should be located in the line timebase when actually the culprit is, of course, in the top deck R.F. chassis.

The actual picture signal is developed across the R21 (3.3 K) anode load resistor, and is applied to the C.R.T. grid via the plug and socket connector.

The C.R.T. grid is also wired to the anode of an EA50 diode which functions as a vision-interference limiter. This is located on a panel at the rear of the line timebase section, a variable control providing a means of adjusting its operating point.

When the tube is beginning to lose efficiency and an increase in contrast is called for the resulting "flat" picture can often be minimised by removing the clip from the diode anode (single wire end).

C.R.T. Circuit

Since the grid is connected to the anode of V6, and since this is at a fairly high H.T. potential, the cathode is connected to the centre tag of the brilliance control, which has one end joined to the H.T. line at a point of somewhat higher voltage, whilst the other end is taken to a 56 K Ω resistor, which is then wired to chassis. The value of the brilliance control is 50 K Ω (wirewound), and the track of this often becomes

open circuited. This causes the symptom of a raster which is either too bright or very dark, depending upon the position of the control.

The tube, being a tetrode, requires a first anode voltage, which is derived partly from the EHT bleeder chain and partly from the H.T. line at the cathode (brilliance control) circuit.

A very common fault is fluctuating brilliance. This is caused most often by a defective 8.2 M Ω resistor in the EHT bleeder chain. More will be said of this later when the EHT section is described.

The tube in the TV1 is a Mullard MW22-7 or MW22-14c, this, of course, being the 9in., whilst the TV2 has a 12in. MW31-7 or MW31-14c. As these are no longer generally available they should be replaced by, in the case of the 9in., an MW22-17 or MW22-18. The difference between these two is that the MW22-18 has an external conductive coating which requires an efficient chassis connection. These tubes have a duodecal base, which means that this type of socket will need to be fitted in place of the original Loctal B8G. An MW22-16 can be used if the tube neck clamp (wood) is removed. This is secured to the assembly by two wood screws, its removal being necessitated by the required fitting of an ion trap magnet on the rear of the tube neck.

In the case of the TV2, the 12in. tube can be replaced by a MW31-17 or MW31-18, the same remarks applying, and if neither is available an MW31-16 or MW31-74 can be used with the addition of an ion trap magnet.

To remove the tube in these receivers, slacken the two clamping screws on the top of the wood block which secures the tube neck, remove the tube base holder, unscrew the four wood screws from the front

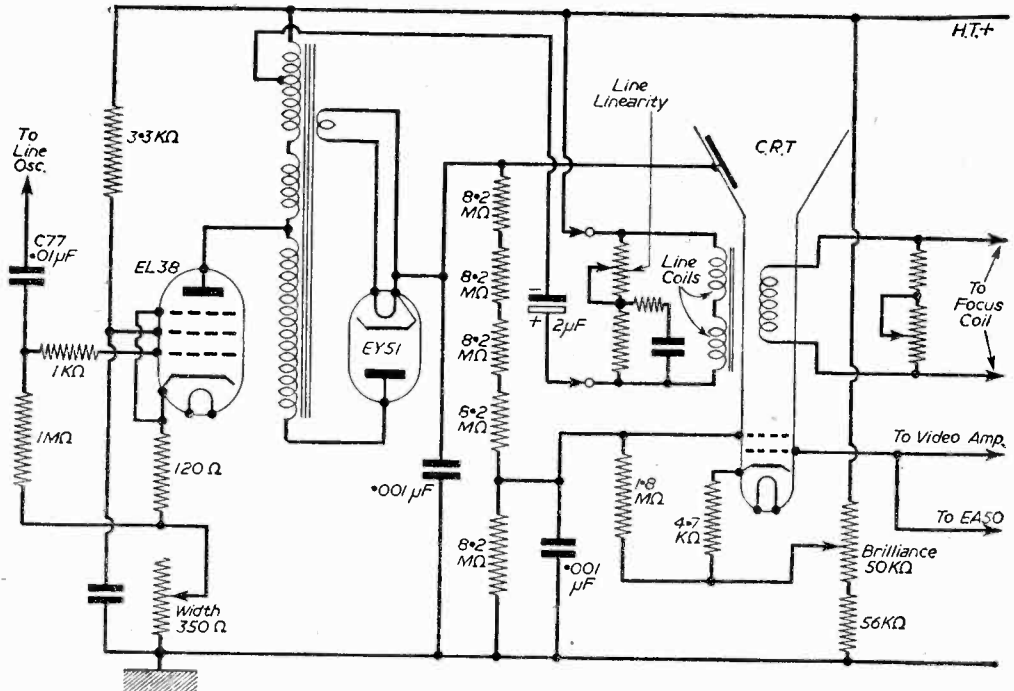

Fig. 4.—Simplified line output and EHT circuit.

sides of the cabinet and ease out the panel which contains the viewing window. Withdraw the tube forwards until the EHT cap can be removed from the side of the bulb. The tube can now be completely withdrawn, exposing the EHT components and the front control panel, etc.

The Line Timebase

Viewing the receiver from the rear, on the right side are the line timebase valves, the line output

In the line output stage the EL38 is very reliable, but the line output transformer seems prone to develop an open-circuited primary winding. The replacement of this transformer demands a certain amount of patience and the removal of the upper R.F. sub-chassis helps matters by providing direct access from above. A check on the primary winding can be made in two ways. With the set off, continuity can be established by means of an ohmmeter check between the EL38 top cap lead to the H.T. tag on the panel behind.

Alternatively, with the set on, H.T. can be checked for at the anode lead, with the cap removed, of course. If no H.T. can be recorded, and yet the normal H.T. is present at the tag panel to the rear, it can be assumed that the winding is at fault.

The line linearity (or horizontal form) control is mounted in front of and above the focus magnet, being wired with its associated components across the line scanning coils. Fold-over on one side of the screen should direct attention to the .01 μ F capacitor feeding the EL38 control grid (C77), the linearity circuit or the line output transformer (shorted turns). The extension winding of the line output transformer which feeds the EHT rectifier (EY51) is located to the rear of the panel and two-leads from this connect, one to the anode of the EL38 and the other to the main transformer, both leads terminating on the tag panel. A third lead supplies the anode (single wire end) of the EY51. This section does not normally give trouble.

The EY51 itself is mounted on a paxolin panel

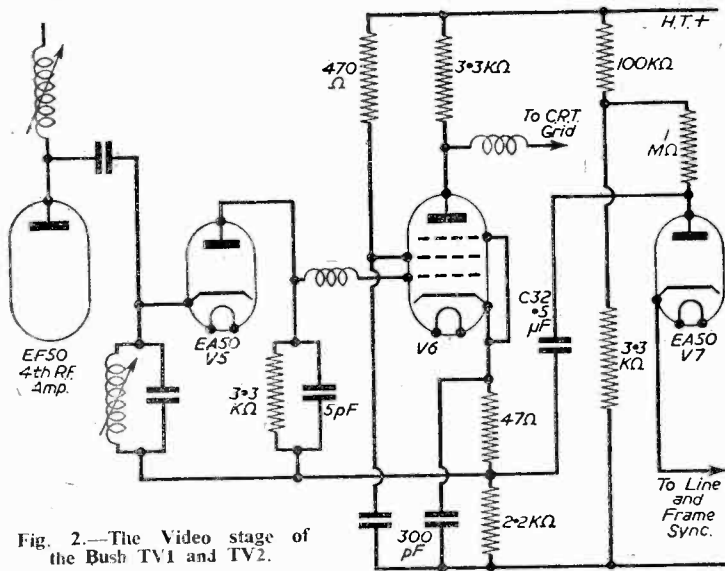

Fig. 2.—The Video stage of the Bush TV1 and TV2.

transformer and associated components. In some receivers the line oscillator is an EN31, whilst on others it may be a T41. The line output valve is an EL38. Beneath the EA50 vision limiter and its control, is the preset line, or horizontal hold control. If it is found that insufficient adjustment is available on the normal side mounted panel control, adjust this to the centre of its travel and lock the picture horizontally by means of the preset. If unsatisfactory line hold is experienced and reliable picture lock cannot be held in a horizontal sense, suspect the line oscillator, especially where a T41 is used. A defective valve can give many symptoms, some of which may resemble poor sync separation, i.e., picture tearing, ragged outlines, lack of positive hold, etc. A completely defective valve in this position will, of course, promote a "no picture, no raster" condition, since the EHT is derived from the line output section. Less obvious is the fact that the line oscillator is often responsible for lack of width, poor EHT regulation coupled with varying focus. Insufficient line drive from the line oscillator causes a general deterioration of the line output performance and thus an under-run EY51.

When the focus and picture size vary with the white content of the picture or with the operation of the brilliance control and in the extreme case where the picture fails as soon as an attempt is made to brighten it do not immediately suspect the EY51; although, of course, this may well be at fault, check the line oscillator valve, which is the easiest thing to do in any case.

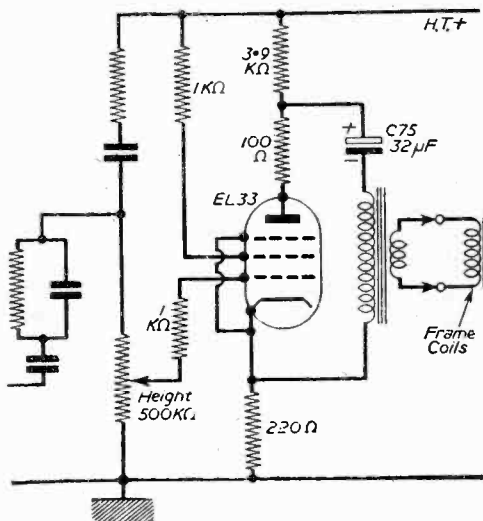

Fig. 3.—The frame output section.

which also holds the smoothing (.001 μ F) capacitor and the bleeder resistors.

As previously mentioned, these resistors often become defective, causing variation of picture brilliance, and inspection will often reveal which is defective due to the discoloration usually evident at the ends. A fault which sometimes occurs causes loss of picture and obvious overheating of the EY51. As the cathode or heater end of this valve is wired no great distance from one of the corner panel fixing screws, a track develops between them, causing a virtual short. This fault can cause violent sparking, an objectionable smell and the early loss of the EY51.

The Frame Timebase

This consists of an EN31 (or T41) driving an EL33. These are mounted on the left side opposite the line timebase section. A preset hold control is again provided. Erratic vertical hold, lines at the top of the screen and a jittery picture can normally be attributed to the frame oscillator valve, and it is not usually necessary to go beyond the T41 (where this is fitted) in order to cure this type of trouble. The presence of a 32 μ F capacitor feeding the frame scanning coils should be noted. Leakage through this will cause the picture to be pushed off the screen to an extent depending upon the leak, and when this becomes serious the cathode resistor R65 (220 Ω) will overheat and probably burn out. The visual effect of this is a narrow horizontal line across the screen. Where some current is still flowing the line will

be pushed off the screen, giving a blank raster, which, of course, can be extremely misleading!

The Power Pack

It should be noted that the chassis of this receiver is "live" inasmuch that one side of the mains is connected directly to it. The primary winding of the mains transformer is overwound to supply the anodes of the H.T. rectifier, which may either be a GZ32 or a UU8. A blown fuse often denotes a short in whichever one of these valves may be fitted, although a defective electrolytic capacitor or a similar fault can, of course, cause the short to occur in the valve and/or the fuse (one spare) to blow, it will normally be found that only the valve is at fault and replacement brings things back to normal again.

Modifications

The video amplifier cathode load resistor R20 is changed from 2.2 K Ω to 1 K Ω .

A resistor of 33 ohms 2 watts is placed in series with each anode lead of the H.T. rectifier.

C.R.T. Voltages

The first anode voltage is difficult to measure due to the high valve resistors in the circuit. Indication on a valve voltmeter is approximately 400.

The final anode should register something like 4.5 kV and the cathode up to 330 volts. The grid should record the same voltage as the video amplifier anode—220 volts.

Closed Circuit Car TV

THE Buick "Centurion" is fitted with a complete closed-circuit television which depicts to the driver a good view from the rear.

By incorporating a compensator into the circuit, a conventional "mirror-like" image is obtained, instead of a standard television image.

Two simple controls allow the driver to adjust for contrast and brightness. A spokesman of Lendrum & Hartman, the Buick distributors, explained that on a dull day the electronic rear viewer can actually see farther than the conventional mirror—and with less eyestrain. The equipment is also designed to eliminate the hazards of glare from cars approaching from the rear at night. It was noted that the screen presented a green image which has been tested and is recommended for greater clarity and less eyestrain.

While on exhibition at the Motor Show, people who stood in front of the camera were able to see themselves on the viewing screen. However, at predetermined times throughout the day the camera in the rear of the "Centurion" was switched off, and a special television control room transmitted to the screen the view that the driver would actually see if the "Centurion" was being driven along the high-

way. These pictures, actually filmed from the rear of a moving car, were shown for five-minute periods. They demonstrated how greater visibility and increased safety are possible with the electronic rear viewer as the driver corners and overtakes other vehicles.

The set was an American design, and was demonstrated by engineers from America.

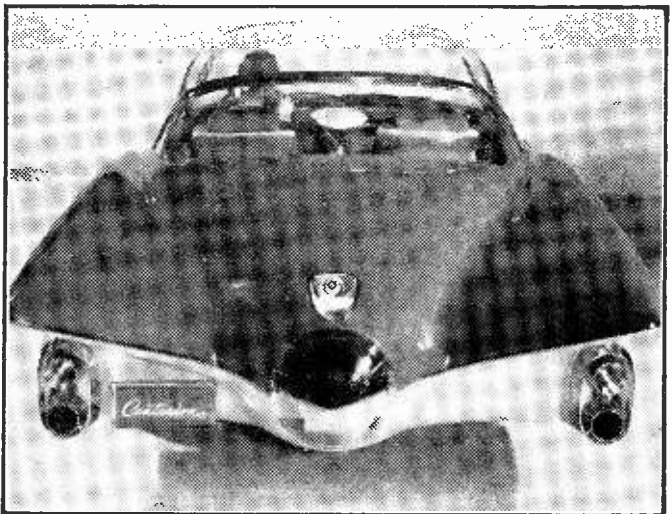

A rear view of the "Centurion" showing the camera (above the centre stop and back light "bomb") and the screen in the centre of the dash.

HOW TO USE AN OSCILLOSCOPE

HOW TO UNDERSTAND AND EMPLOY THIS VALUABLE SERVICING ACCESSORY

By J. Hillman

(Continued from page 160 November Issue)

WHEN using any oscilloscope there are one or two things to bear in mind. Although the oscilloscope will show the waveform at the point at which it is connected it must be remembered that the waveform may be different from that when the oscilloscope is not connected. The oscilloscope leads can alter the waveform, especially of the oscillatory circuits such as timebases. Also, the amplifier of the oscilloscope can alter the wave shape, especially if condensers are used in the coupling circuits. Besides altering the shape of the wave the condensers also alter the phase, and if the waveform is as in Fig. 1 on the direct connection, then when the Y amplifier is used the wave will be inverted as at Fig. 2. The fact that the oscilloscope does not always give a true picture of the waveform is not of much concern in servicing work, so long as we know what waveform to expect at any particular point in any particular set. This can be obtained by checking a set known to be working perfectly and entering in the relevant data on its service sheet for future use. In the majority of repair work the exact shape of the waveform is not really required so long as we get a certain type of waveform at a particular place in

On the right is the 'scope which was described in our May and June Issues.

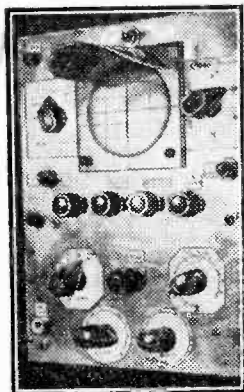

the circuit. For instance, if we get a sawtooth waveform like Fig. 3 at the anode of the frame timebase oscillator, we know this part of the circuit is working at least, and we can then follow the waveform right through to the scan coils. Obviously, there are occasions when the exact shape of a waveform is important; for instance, when a linearity fault arises, and then certain precautions need to be taken. First, use a very small capacitance to couple the oscilloscope lead to the set—usually, the lead need only be clipped on the insulation of the set wire; secondly, use only the direct connection to the oscilloscope and keep the input down low. If the waveform voltage is too high to keep the waveform on the oscilloscope reasonably low, then use a simple voltage divider, as in Fig. 4, which gives a 10:1 ratio. For checking R.F. stages a suitable probe is required such as the one in Fig. 5, in which the diode, condenser and two resistors are taped up on the end of the coaxial cable, leaving the 18 S.W.C. T.C. wire sticking out sufficiently to use as a probe.

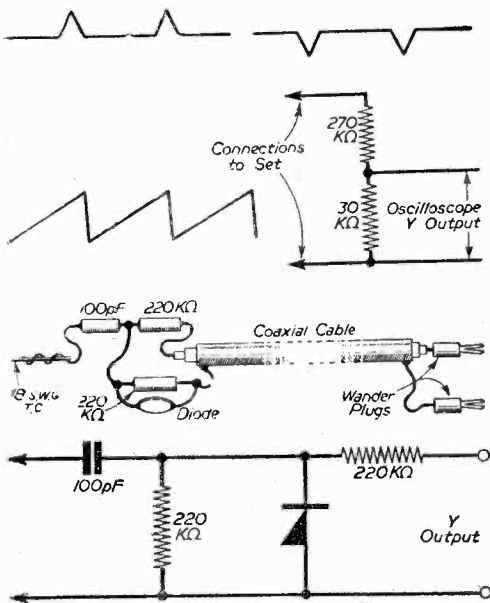

Figs. 1 to 5.—Waveforms and theoretical and practical probe.

Radio Testing

With oscilloscope set at a frequency of 25 c.p.s., Y amp. low X amp. 4, Y amp. 4. The trace in Fig. 6 was obtained at the cathode of the rectifier valve whilst that in Fig. 7 was at smoothed side of resistor R16, in a Philips 209U set, and this shows the half-wave rectifier waveform. With oscilloscope set to 50 c.p.s., Y amp. low, Y amp. 4, X amp. 4, the trace in Fig. 8 was obtained at the H.T. side of the vibrator in a radiomobile 100 car radio, whilst that at Fig. 9 was obtained at the L.T. side of the vibrator. A full-wave rectifier trace is shown in Fig. 10, which was obtained from a G.E.C. BC5442 with slight mains hum audible. Oscilloscope set to 25 c.p.s., Y amp. low, Y amp. 3, X amp. 4, and connected at

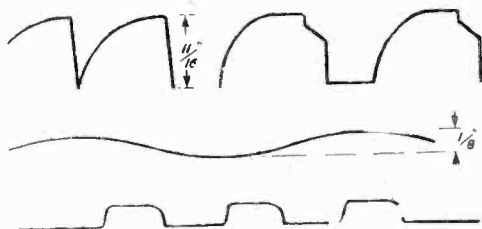

Figs. 6 to 9.—Radio responses.

reservoir condenser, whilst when connected at smoothing condenser the trace was very nearly a straight line.

TV Testing.—Pye VT4

Traces obtained on a Pye VT4 working on test card C and using sheet No. 1120 :

(a) Y amp. low, Y amp. max., oscilloscope 25 c.p.s., X amp. 4, connected at L36, unsmoothed side Fig. 11, smoothed side Fig. 12.

(b) T1 phase-inverter transformer oscilloscope set as in (a) and connected at junction R45, C38, that is, anode side ; then the trace was as Fig. 13 using ordinary probe and as in Fig. 14 when using R.F. probe. Similarly, at the junction MR4 and 5 the trace was as Fig. 15 for ordinary probe and Fig. 16 for R.F. probe.

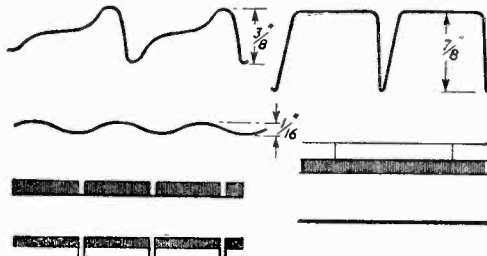

Figs. 10 to 15.—Responses from a Pye VT4.

(c) With oscilloscope set at approximately 3.5 kc/s and Y amp. direct the trace at C39, T3 was as Fig. 17 with ordinary probe and at C40, T3 as Fig. 18.

(d) With oscilloscope set as for (c) and connected to pins 6 and 7, and on ECL80 (V9B) trace was as Fig. 19 with ordinary probe and at junction of L19 and R54 trace was as Fig. 20.

(e) With connections as before for (c) connected at pin 8 of PL81 (V10) trace was as Fig. 21 and at junction of C53 (L22) as Fig. 22.

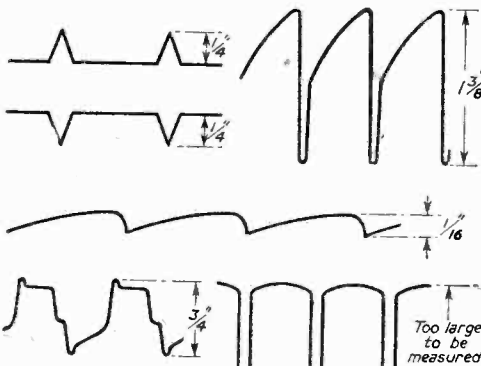

Figs. 17 to 22.—Further waveforms from the Pye.

(f) Junction R74, R73 trace as Fig. 23. 3.5 kc/s Y amp. direct as before, whilst at pin 8 ECC82 (V2B) trace was as in Fig. 24 and at pin 6 trace was as Fig. 25.

(g) With oscilloscope set at 25 c.p.s., Y amp. direct, the trace at pin 1, PL82 (V18), was as Fig. 26, whilst with Y amp. low, Y amp. 7, trace was then as Fig. 27.

(h) With oscilloscope 25 c.p.s. and Y amp. direct the trace at pin 1 ECC82 (V17) was as in Fig. 28, whilst at pin 6 the trace was as Fig. 29.

(i) Oscilloscope 25 c.p.s. Y amp. direct, the trace at junction R122 (124) was as Fig. 30, whilst at pin 7 PL82 (V18) the trace was as Fig. 31.

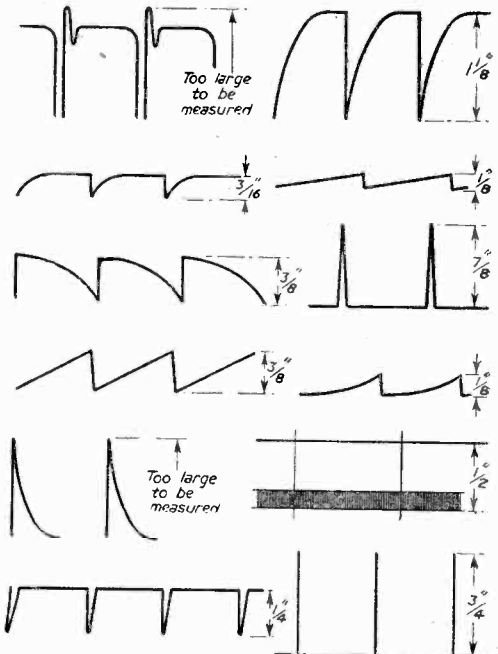

Figs. 23 to 34.—More waveforms from the Pye VT4 as described here.

With the test signal across the junction of MR4, 5 the trace was as Fig. 32, whilst at junction MR9 and R110 frequency 50 c.p.s. Y amp. direct trace was as Fig. 33.

(k) With conditions as for (j) the trace at pin 1 ECC82 (V17) was as Fig. 34, whilst trace at pin 7 EF80 (V8) was as Fig. 35.

(l) With oscilloscope at 50 c.p.s. and Y amp. direct the trace at the junction of MR8 and 9 was as Fig. 36, whilst the trace at pin 6 ECC82 (V17) was as Fig. 37.

(m) With test signal C, oscilloscope set 25 c.p.s., Y amp. direct, the trace at cathode of C.R.T. was

(Continued on page 271)

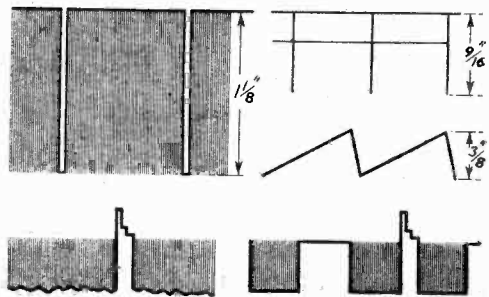

Figs. 35 to 39.—The remainder of the Pye VT4 tests.

C.R.T. ISOLATION TRANSFORMER

Type A. Low leakage windings. Ratio 1:125 giving a 25% boost on secondary. 2 v. 10/8; 4 v. 10/8; 6.3 v. 10/8; 10.5 v. 10/8; 13.5 v. 10/8. 12/10 with mains primaries, 12/8 each. Type B. Mains input 230/240 volts. Multi Output 2, 4, 6.3, 7.3, 10 and 15 volts. Input has two taps which increase output volts by 25% and 50% respectively. Low capacity, suitable for most Cathode Ray Tubes. With Tag Panel, 21/- each. Type C. Low capacity wound transformer for use with 2 volt Tubes with falling emission. Input 230/240 volts. Output 2-21-21-23 volts at 2 amps. With Tag Panel, 17/6 each. NOTE. It is essential to use mains primary types with T.V. receivers having series-connected heaters.

TRIMMERS, Ceramic, 30, 50, 70 pf., 9d., 10c. pt., 150 pf., 1/3; 250 pf., 1/8; 500 pf., 7d. pf., 1/9. RESISTORS. All values, 10 ohms to 10 meg., 1 w., 4d., 1 w., 6d., 1 w., 8d., 2 w., 1s. HIGH STABILITY. 1 w., 1% 2/- Preferred values 100 ohms to 10 meg. 5 watt } WIRE-WOUND RESISTORS } 1/3 10 watt } 25 ohms-10,000 ohms } 1/6 15,000 ohms, 50,000 ohms, 5 w., 1/2; 10 w., 2/3. KNOBS, GOLD ENGRAVED.-Walnut or Ivory, 1 1/2 in. diam., 1/6 each. Not engraved, 1/- each.

12 6 PURETONE RECORDING TAPE

1,200 Ft. on standard, fitting 7 Plastic reels. Brand new, boxed, 12/6. Spools 5" metal, 1/6, 7 plastic, 4/3.

OP TRANSFORMERS, Heavy Duty 50 mA., 4/6. Multiratio, push-pull 6/6. Tapped auto pentode, 3/9. L.F. CHOKES 15/10 1H, 60/65 mA., 5/-; 10 H, 120 mA., 10/8; 15 H, 150 mA., 12/8. MAINS TRANS. 350-0-350, 80 mA., 9/3 v. tapped 4 v., 5 v. tapped 4 v., 2 v., 11/6 to 250-0-250, 21/5. HEATER TRANS. Tapped primary, 200-250 v., 6/3 v. 11 amp., 7/8; tapped sec. 2, 4, 6.3 v., 11 amp., 8/6 v. 250 v. to 6.3 v. 3 amp., 10/6.

VC97 TESTED VUL PICTURE, 25/- COPPER PLATED AERIAL RODS, 1 x 12 in. push fitting, 3/- doz., 6 p. 1/2.

ALADDIN FORMERS and cores, 1 in., 9d.; 2 in., 10d. 3 in. FORMERS 5937/8 and Cans TV12, 2 in. sq. x 2 in. and 1 in. sq. x 1 in., 2/- ea. with cores. TYANA.-Midget Soldering Iron, 200/240 v. or 230/250 v., 16/9. Solon Instrument Iron, 24/-.

MIKE TRANSF. Ratio 50:1, 3/9 ea.; 100:1, 1/10.6. MAINS DROPPERS, 3 x 1 1/2 in. Adj. Sliders, 3/1 sup. 750 ohms, 4/3. 2 amp., 1,000 ohms, 4/3. LINE CORD, 3 amp., 60 ohms per foot, 2 amp., 100 ohms per foot, 2-way, 6d. per foot, 3-way, 7d. per foot. LOUDSPEAKERS, 2" M. OHM.

Goodmans, 17/6. 7 in. x 4 in. Goodmans, 21/6. 8 in. square, Elac., 21/- 8 in. Elac., 22/- 6 in. Goodmans, 18/6. 10 in. K. & A., 30/- T84, Tweeter, LSH75, 8/8. 12 in. Pleassey, 30/- 8 in. M.B. 25K, Held, tapped O.P. trans., 24/6. CRYSTAL DIODE, G.E.C., 2/- GEX34, 4/- HIGH RESISTANCE PHONES, 4,000 ohms, 16/3 ea.

CRYSTAL MIKE INERT by Acos, precision engineered. Size only 1 1/2 x 3/16 in. Bargain Price 6/6. No transformer required.

SWITCH CLEANER Fluid, squirt about, 4/3 tin. TWIN GANG TUNING CONDENSERS, .0005-.0010 mfd., less trimmers, 6/9; .0005 Standard size with trimmers, 8/9; less trimmers, 8/-; ditto, soldered, 2/-; 2000 p.f. 3-zang, 7/8. SPEAKER FRET. Expanded Metal Silver, 15 1/2 in. x 9 1/2 in., 2/- ea.; 14 1/2 in. x 12 in., 3/- ea. GOLD CLOTH, 18 in. x 25 in., 5/-; 25 in. x 26 in., 10/-.

VALUES

Table with columns: All Boxed, 5/8, 1/8, New & Guaranteed, 9/8, 10/8. Rows list various electronic components like resistors, capacitors, and transformers with their respective prices.

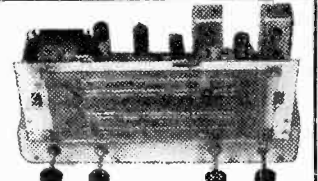

1957 RADIOGRAM CHASSIS

THREE WAVEBANDS FIVE VALVES LATEST MULTARID. M.W. 200 m.-550 m. FCH42, EFL1, EBC41, L.W. 800 m.-2,000 m. EL41, EZ40. 12 month guarantee. A.C. 200/250 v. 4-way Switch; Short-Medium-Long-Rang. A.V.C. and Negative feedback 4.2 watts. Chassis 13 x 9 1/2 x 2 1/2 in. (Chassis Dial 10 x 4 in. horizontal or vertical available. 2 Pilot Lamps, Four Knobs, Walnut or Ivory. Aligned and calibrated. Chassis isolated from mains. T.S.L. Tweeter Supplied Free!

10 gns. Carr. & Ins., 4/6.

AM/FM RADIOGRAM CHASSIS

Measurements 13 in. x 9 1/2 in. x 2 1/2 in. Dial cut and required only 10 1/2 in. 5 valve plus metal ret., gram socket, piano key wavechange, tone control, med., long and V.H.F. wavebands. Valve input: 60R85, ECH81, EP98, LA8C80, EL81. For A.C. mains 100-250 v.

PRICE £16.19.6 Carriage 10/6

MATCHED SPEAKERS FOR ABOVE CHASSIS

8 in., 19/8; 10 in., 25/-; 12 in., 30/-

Collaro Auto-changer RC531 for 78 r.p.m. 10 in. and 12 in. records. Brand new in maker's boxes. High impedance lightweight Pick-up with sapphire needle, will operate any Amplifier or Radio. Less than half price. Carr. and Ins., 5/6. sorry-No C.O.D.

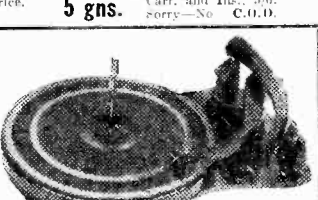

5 gns. Carr. and Ins., 5/6. sorry-No C.O.D.

£7-19-6 Post Free.

Terms: Deposit £4 and six monthly payments of 15/-.

Brand new Pleassey 3-speed Autochanger Mixer. Xial Head with Duopoint sapphire stylus. Board required 15 1/2 x 12 in. Height 5 1/2 in. Walnut Veneered Playing Desk 10/8 extra.

ALLDRY UNIT POWER PACK

Replaces Battery B114, etc., 69 v. plus 1 v. Size 4 1/2 in. x 3 1/2 in. 4-pin socket. A.C. 200/250 v. FAMOUS MAKE. LIST PRICE, 65/- OUR PRICE, 39/6. Ready for use.

B.S.R. MONARCH, 3-speed Motor and Turntable with selecting switch for 25, 45 and 78 r.p.m. records, 100-120 v. and 200-250 v. A.C. 50 cps. Also B.S.R. MONARCH Lightweight Pick-up with Acos Xial turnover head, separate Sapphire stylus for L.P. and Standard records.

SPECIAL OFFER, THE TWO £4.12.6 post 2/8

T.V. PRE-AMP (McMICHAEL). Tunable Channels 1 to 5. (With Amplify Output of your Radio Converter). Midget size. High Gain Ready for use. (H.T. 200 v., L.T. 6.3 v., .3 amp. required). BRAND NEW, 25/- each.

MAINS POWER PACK for above, 25/- extra.

SUPERHET COIL PACK, 27/6. Miniature size 2 1/2 in. x 2 1/2 in. x 1 1/2 in. HIGH Q? Dust coated Coils, short Medium, Long Gram switching, single hole fixing. Complete with connection diagram, and circuit.

TELETRON BAND III CONVERTER

For London, Midlands and Northern Transmissions. Suitable all T.V. makes. T.R.F. or Superhet. Ready wound coils, two EF80 valves, all components, punched chassis, circuit diagram, wiring plans. COMPLETE KIT for mains operation 200-250 v. A.C. £3.10.0.

As Above less POWER PACK. Requires 200 v. 20 mA. H.T. 6.3 v. 5 p. A. L.T. £2.5.0. Mains Transformers to above Spec. ... 10/6 Min. Contact Rect. 250 v. 50 mA. ... 8/6 B.B.C. I.T.A. aerial converter unit ... 7/6 Punched and drilled chassis ... 3/9 Larger chassis for Mains Model ... 8/- Teletron Coilset with plans ... 15/- Full plans and circuit details ... 6d.

Volume Controls 80 ohm COAX

Thin spindles. Guanaco Semi-conductor Polystyrene 1 year. Midget, thin insulated, pin dia. 10,000 ohms to 2 Meg. Stranded core, 9d. yd. No Sw. S.P.S.W. D.P.S.W. Losses cut 50% 3- 4- 4-9 STANDARD 8d. yd. Lin or Log Tracks. pin. Coax. 8d. yd.

COAX PLUGS...

1- DOUBLE SOCKET ... 1/3 1- OUTLET BOXES ... 4/3 BALANCED TWIN FEEDER, yd. 6d. 80 or 300 ohms. WIRE-WOUND POTTS, 3 WATT. Pre-set Min. T.V. Type, all values 25 ohms to 30 K. 2/- ea. 50 K. 4/- (Carbon 50 K. to 2 m. 3/-).

WIRE-WOUND 4 WATT. POTTS.

Values: 100 ohms to 50 K. 5/8 1/2 in. Spindle. CONDENSERS. Best stock. 500 mid. 7/8 100 p.f., 5/8 20 kV., 9/8; 100 p.f. to 500 p.f. Micas, 6d.; Tubular 500 v., 100 to 40 mid., 9d.; .05, .1, .1, .2, .25, 1.6, 3.550 v., 1.9; 1.350 v., 9d.; 1.600 v., 1.3; 1 mid., 2,000 volts, 4/- CERAMIC CONDENSERS. 500 p.f. to 401 mid., 10d. SILVER MICA CONDENSERS. 10%, 5 p.f. to 500 p.f., 1-; 600 p.f. to 3,000 p.f., 1.3. DITTO 150 1.5 p.f. to 500 p.f., 1.9; 515 p.f. to 3,000 p.f., 2/-.

45 Kcs. TRANSFORMERS 7 1/2 pair

185 Kcs. Flux tuning Miniature Can 2 1/2 in. x 1 1/2 in. High Q and good bandwidth. By Pye Radio. Data sheet supplied.

NEW ELECTROLYTICS. FAMOUS MAKES

Table with columns: TUBULAR, TUBULAR, CAN TYPES. Rows list various electrolytic capacitor models and their prices.

SENTRECEL RECTIFIERS, E.H.T. TYPE FLY-BACK VOLTAGES.

K325 2 kV., 5/-; K340 3.2 kV., 7/-; K345 3.6 kV., 7/8; K350 4 kV., 8/-; K3100 8 kV., 14/6; MAINS TYPE, RML 125 v. 60 mA., 5/-; RML 196 mA., 6/-; RML 120 mA. 60 Hz., RML 250 v. 275 mA., 18/-.

PANEL LAMPS (Neon Lit), 230 v., A.C./D.C., 3/6.

COILS Wearite, "P" type, 3/- each. Osamor Midget "Q" type adj. dust core, 4/- each. All ranges. TELETRON L & Med. T.H.F. with reaction, 3/6. FERRITE ROD AERIALS, M.W., 8/9, M.S.L., 12/9. T.R.F. COILS WHF, 7/- pair.

H.F. CHOKES, Teletron 2/8 each.

ALUMINIUM CHASSIS, 18 s.w.g. un-drilled.

With 4 sides, riveted corners and lattice flying holes. 24 in. sides, 7 x 4 in., 4/8; 9 x 6 in., 5/9; 11 x 7 in., 6/9; 13 x 9 in., 8/8; 14 x 11 in., 10/8; 15 x 14 in., 12/8; 18 x 16 x 3 in., 18/8.

FULL WAVE BRIDGE SELENIUM RECTIFIERS.

2, 6 or 12 v., 1 1/2 amp., 8/9; 2.5, 11.3; 4.5, 17/8. CHARGER TRANSFORMERS. Tapped input 200/250 v. for charging at 2, 6 or 12 v., 1 1/2 amp., 13/9; 4 amp., 21/6.

WAVE MANUALS I, II & III, 5/- each.

TOGGLE SWITCHES, S.P. 2/-, D.P. 3/6. D.P.D.T. 4/- ADJUSTABLE HYDROMETER. New Ex. Govt. Unbreakable. Packaged in metal case, 7 x 1 1/2 in. dia., 4/8. WAVECHANGE SWITCHES.

5 p. 4-way 2 water, long spindle ... 6/8 2 p. 2-way, 3 p. 2-way, short spindle ... 6/8 2 p. 6-way, 4 p. 2-way, 4 p. 3-way, long spindle 3/6 3 p. 4-way, 1 p. 13-way, long spindle ... 3/6

VALVE HOLDERS. Rep. Int. Oct. 4d., EF50, EA50, 60, EL24, CRT, 3/-, Eng. and Amer. 4, 5, 8, 7, and 9.

SUPERHET COIL PACK, 27/6. Miniature size 2 1/2 in. x 2 1/2 in. x 1 1/2 in. HIGH Q? Dust coated Coils, short Medium, Long Gram switching, single hole fixing. Complete with connection diagram, and circuit.

BLACK CRACKLE PAINT, air drying, 3/- tin.

We have no connection with any other firm. Please address all Mail Orders correctly as below.

RADIO COMPONENT SPECIALISTS 307 WHITEHORSE RD., WEST CROYDON

OPEN ALL DAY--(Wed. 1 p.m.) 10 page list 3d.

Tel. THO 1555, Buses 133, or 63 pass door. 48-hour postal Service. P. & P., 1/- £2 orders post free. (Export Extra.) C.O.D. Service 1/6

*For a regular
smooth response curve*

You need a PHILIPS

**dual-cone
loudspeaker**

Made in Holland



A special dual-cone design distinguishes Philips high fidelity speakers, resulting in energy transmissions almost independent of frequency. This ensures that, in an ordinary room, sound pressure within an angle of 90 degrees varies by not more than six decibels; while the excellent spatial distribution of acoustic energy — even at the highest frequencies — is obtained by Philips choice of coupling factor between high-range and low-range cones.



The small cone acts as a high note radiator for frequencies above 10,000 cycles and as a diffuser for frequencies below 10,000 cycles from the large cone. The large cone itself acts as a low note radiator below 10,000 cycles, and as a reflector for the high notes above this frequency. The distribution of sound over the entire frequency range is thus much wider than on a normal loudspeaker. These loudspeakers have a very smooth response curve combined with a low resonance frequency.

N.B. Any of these speakers may be used on their own or with another suitable loudspeaker using a crossover unit.

The Philips dual-cone loudspeaker comes in two sizes: 8" and 12", price 6½ gns. (tax paid) and 10 gns. respectively. There is also a single-cone loudspeaker, available in the same two sizes: price £6.2s. 6d. (tax paid) and £10.0s. 0d. respectively.

For full details write to:



PHILIPS ELECTRICAL LTD

Musical Equipment Dept. • Century House
Shaftesbury Avenue • London • WC2

(PR436)

OSMOR VARIABLE Band I ATTENUATOR

Balances reception of ITA and BBC in all areas and avoids constant adjustment of controls. The Osmor is the only variable attenuator that will reduce the signal exactly to the required level. Easily Fitted—just plug in. Reduction ratios variable 2-1 to 10-1. An Essential with all types of Band III Converters. 10/-, plus 9d. p. & p. From your Dealer—or direct.



BAND I FILTER

Rejects BBC from ITA aerial and improves picture. Suitable for all makes. Fitted in 2 minutes. 10/-, plus 6d. p. & p. including instructions.

SWITCH-TUNED F.M.
Complete Kit for Switch-tuned F.M. Tuner with Automatic Frequency control available.

ITA CONVERTERS

LONDON • LICHFIELD • MANCHESTER

A very efficient Band III Converter for all TV sets of any age (including TRF). Approximately one hour to build! Will convert any Band III Channel to any Band I Channel. Station switching, A.C. or A.C./D.C. Size 4½in. x 2½in x 3in. Circuits, Wiring Diagrams and full constructional information, ready to fit inside your TV cabinet.

Complete Kit **65/-** Completely wired **80/-**

Both plus 2/- post and packing.

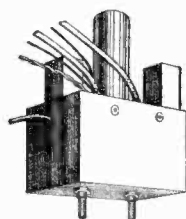

FREE

We keep right up to date in building the latest circuits published in "Practical Wireless," "Wireless World" and "Radio Constructor" and we stock the components specified. Send 7½d. in stamps for circuits, fully descriptive literature together with coil and coilpack leaflets, component lists, chassis drawings and templates.

ITA Band III CONVERTER KIT

Complete with all components, including power unit, for construction of an efficient Band III converter. Nothing else to buy. Circuit, wiring diagram, chassis templates and complete instructions, **£6.19.0.**

Plus 2/6 p. & p.

OSMOR RADIO PRODUCTS LTD. 418 Brighton Road, South Croydon, Surrey, Croydon 5148-9

Dept. PT6.

as Fig. 38, whilst for the cross test card the trace was as Fig. 39.

Murphy V250A

The following traces were obtained on a Murphy V250A TV set receiving an ordinary TV transmission. With oscilloscope set up as follows: 25 c.p.s.; X amp. 4 Y amp. 4 Y amp low the trace at pin 2 10C2 (V11), line and frame sync separator—

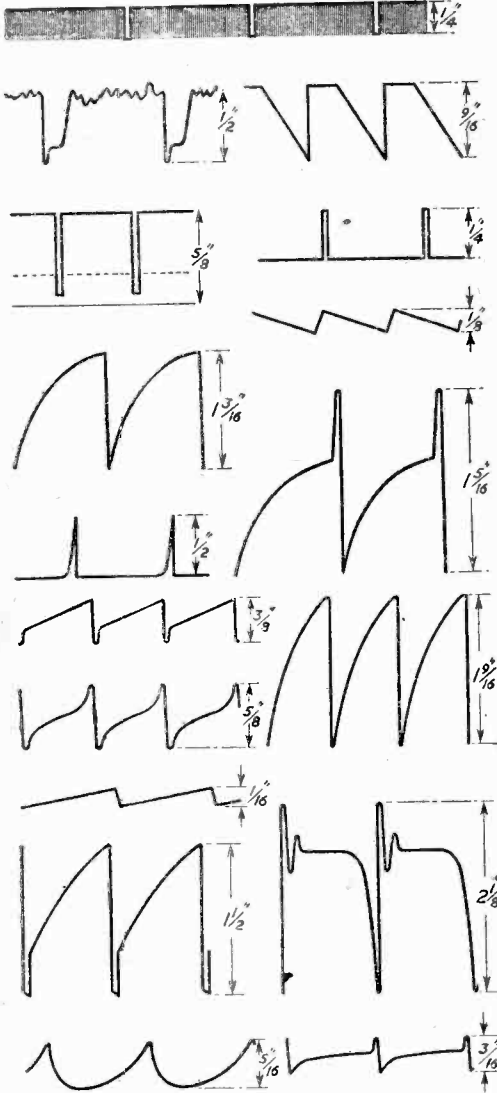

Figs. 40 to 56.—Set of scope traces from a Murphy V250A.

was as Fig. 40, whilst the trace at pin 6 was as Fig. 41. At pin 2, 20L1 (V12)—frame oscillator—trace was as at Fig. 42. Whilst at pin 2, 20L1 (V15)—flywheel sync phase splitter—trace was as Fig. 43. At pin 4, V15, trace was as Fig. 44. At pin 2, V16—flywheel discriminator—with oscilloscope set 3.5 kc/s, Y amp.

direct, X amp. 4, trace was as Fig. 45. With no signal input and oscilloscope set to 25 c.p.s., Y amp. direct, X amp. 4, trace at pin 2, 20L1 (V12)—frame oscillator—was as Fig. 46; trace at pin 7, V12, was as Fig. 47; trace at pin 3, V12, was as Fig. 48; whilst trace at pin 5, 20P3 (V13)—frame output—was as Fig. 49. With oscilloscope set at 3.5 kc/s, Y amp. direct, trace at pin 5, 20P4 (V18)—line output—was as Fig. 50; trace at pin 6, 20L1 (V17)—line oscillator—was as Fig. 51; trace at pin 5, 20L1 (V15)—flywheel sync—was as Fig. 52, trace at pin 5, V17, was as Fig. 53; trace at pin 2, V17, was as Fig. 54; whilst trace at pin 6, V15, with Y amp. now at high, other controls as before, then trace is as Fig. 55, and trace at pin 7, 20D1 (V16)—flywheel discriminator—with Y amp. high, is as Fig. 56.

Philips 1458U

With a Philips 1458U and oscilloscope set to 25 c.p.s., Y amp. low, Y amp. 5, trace at pin 2, ECL80 (V14)—frame output—was as Fig. 57, and with

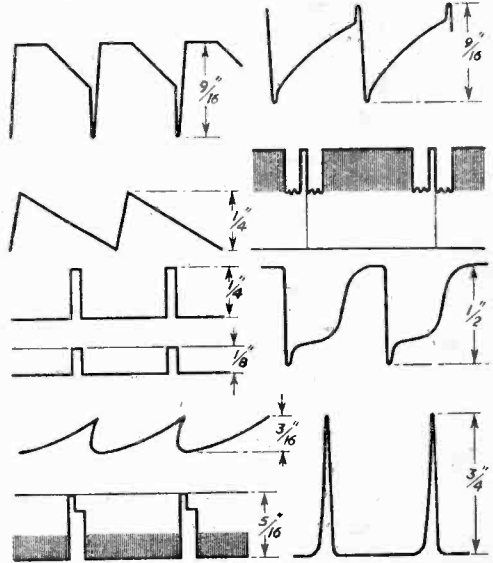

Figs. 57 to 66.—The Philips 1458U gives these waveforms.

Y amp. direct trace was as Fig. 58. Trace at pin 9, PL81 (V14), was as Fig. 59, and trace at pin 9, ECL80 (V13)—frame oscillator—was as Fig. 60; trace at pin 2, V13, was as Fig. 61, whilst trace at pin 6, V13, was as Fig. 62. With oscilloscope at 3.5 kc/s; Y amp. low, Y amp. 5, X amp. 4, trace at pin 2, V9—line output—was as Fig. 63, whilst at pin 2, V9, was as Fig. 67. With oscilloscope at 25 c.p.s. Y amp. direct trace at pin 9, PL81 (V14), was as Fig. 64; Trace at pin 9, V13—frame oscillator—was as Fig. 65, whilst trace at pin 1, V13, was as Fig. 66.

Philips 1756U

The following traces were obtained from a Philips 1756U TV set working on a normal TV transmission. Oscilloscope set at 50 c.p.s. Y amp. high, Y amp. 4. Trace at pin 3, ECL80 (V14) was as Fig. 68. With Y amp. at 1, Y amp. high X amp. 4, trace at pin 8, V14, was as Fig. 69. Trace with Y amp. 2 at pin 6, V14, was as Fig. 70. With Y amp. low; frequency 100 c.p.s.; Y amp. 2; X amp. 4, trace at pin 9, V14,

was as Fig. 71, whilst with trace at pin 2, V14, and Y amp. 4, trace was as Fig. 72. With Y amp. high; frequency 1,300 c.p.s.; Y amp. 4, trace at pin 3, V17—line output valve—was as Fig. 73. With Y amp. low, Y amp. 4, frequency 50 c.p.s., trace at pin 1, V16—frame oscillator—was as Fig. 74; trace at

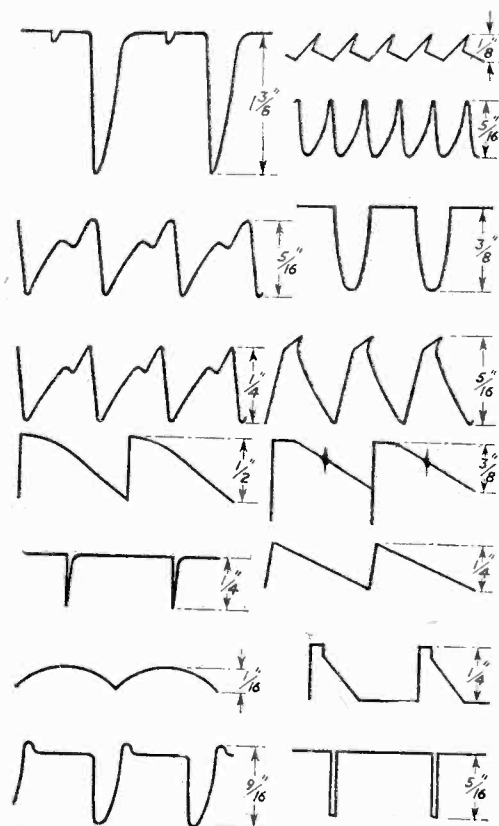

Figs. 67 to 81.—Waveforms obtained from a Philips 1756U.

pin 2, V16, was as Fig. 75; trace at pin 3, V16, was as Fig. 76; whilst trace at pin 9, V15—frame output—was as Fig. 77. With Y amp. high, Y amp. 4 frequency 50 c.p.s., trace at pin 3, V15, was as Fig. 78, whilst with Y amp. low, trace at pin 2, V15, was as Fig. 79, and trace at pin 1, V15, was as Fig. 80.

Ferguson 203T

The following traces were obtained on a Ferguson 203T TV set, no signal input, oscilloscope set at 25 c.p.s. With Y amp. low, Y amp. 1. Trace at pin 6, ECL80 (V20)—frame oscillator—was as Fig. 81; trace with Y amp. direct at pin 9, V20, was as Fig. 82. Whilst at pin 1, V20, trace was as Fig. 83, and at pin 2, V20, trace was as Fig. 84. With Y amp. low, Y amp. 4, frequency 25 c.p.s. and no signal, trace at pin 1, ECL80 (V19) was as Fig. 87, whilst with normal signal trace was as Fig. 88. Similarly trace at pin 2, V19, with no signal was as Fig. 86, and with normal signal as Fig. 85. Also pin 6, V19, with no signal trace was as Fig. 89A, and with normal signal as Fig. 89B. With Y amp. direct, trace at sync separator

valve, PCF80 (V7), pin 1 was as Fig. 90, and with no signal at pin 6, V7, trace was as Fig. 91. With a normal signal Y amp. low, Y amp. 2, frequency 3.5 kc/s, trace at pin 6 was as Fig. 92. And at pin 9 as Fig. 93. Trace at line scan coils C73 with Y amp. direct and frequency 3.5 kc/s, trace was as Fig. 94. Whilst at pin 2, PL81 (V11)—line output—valve trace was as Fig. 95.

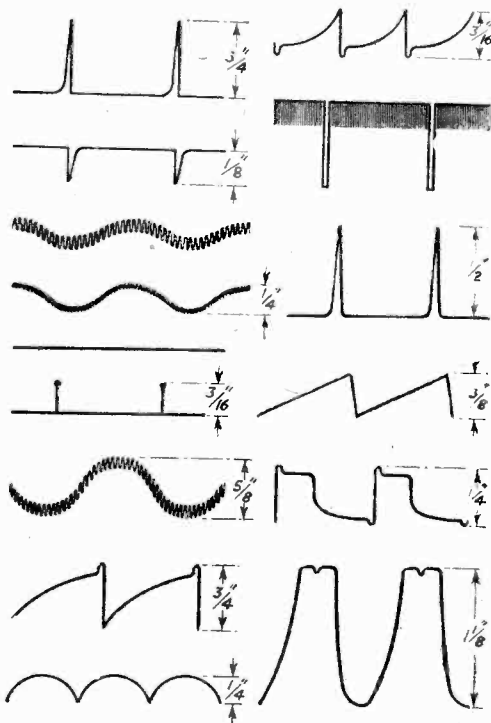

Figs. 82 to 95.—The Ferguson 203T test waveforms.

Scottish I.T.A. Station

THE Independent Television Authority announces that its Central Scotland station, at Black Hill, Lanarkshire, will transmit programmes on Channel 10 when it comes into service this year. The precise frequencies will be 199.7305 Mc/s for vision and 196.2395 Mc/s for sound.

Test transmissions on a power of 1 kilowatt will be sent out from a pilot transmitter at Black Hill from March 1st until the main transmitter comes into operation, probably in July. These low power test transmissions are designed to help dealers install Band III aerials and adjust sets throughout the spring and summer and so reduce delays and disappointments when programmes begin. The first programmes will be transmitted towards the end of August and will be provided by Scottish Television, Ltd.

Construction of the transmitter building is proceeding very rapidly and the brickwork is up to roof level on the main building. The mast, which will be 750 feet high and the highest to be installed at an I.T.A. station, is being supplied by Marconi's Wireless Telegraph Company.

THE A-TV EMPIRES

ICONOS MAKES A TOUR OF THE A-TV TELEVISION THEATRES

IT is not quite true that the days of the Empires—or the Hippodromes—are ended. Many of them have been closed, unable to compete with the cinema, radio, television and other forms of entertainment, not to mention the heavy drain of the entertainment tax. But there are still quite a few carrying on, some of them quite prosperously. Others have been pulled down or turned into stores or furniture repositories, or, like some of the redundant film studios, have been converted into radio or TV theatres.

Music Hall Design

The palmiest days of the music-hall was not in the gay nineties, a time when it had scarcely developed from the concert tavern, but in the early 1900s. Between 1900 and 1914, there must have been two or three hundred large music-halls constructed in the British Isles, the most elaborate being built by Moss, Stoll, Broadhead, L.T.V. and Barrasford circuits. There were no fewer than 72 in the London area. In the large auditoria seating upwards of 2,000 persons, acoustic and reverberation problems were of major importance. The most famous of all theatrical architects was Frank Matcham, who designed many of the Moss and Stoll houses, including the London and Manchester Hippodromes, the Coliseum and the Empires at Chiswick, Finsbury Park and Wood Green. In days long before vocalists could carry a microphone about with them on the stage, or the architects fully appreciated the acoustic theories of Sabine, Frank Matcham established that certain proportions of plaster decoration, wood panelling and curtains, together with carefully worked-out sight lines from all seats in the large circles and galleries, enabled the absolute maximum audience to see and hear the artists on the stage.

The A-TV "Circuit"

This, then, was the heritage wisely acquired by A-TV, when they decided to take over the Wood Green Empire and the Hackney Empire on a permanent TV installation basis, and to make use of the London Palladium for regular O.B.s. In addition to these variety theatres, A-TV have a joint interest with ABC-TV in the Astoria, Birmingham, and "running powers," as the railways used to say, into many active London and provincial music-halls and theatres. This is a policy that one would expect of a board which includes such names as Prince Littler, Val Parnell and Lew Grade.

Wood Green Empire

One of my earliest memories as a small boy was a visit to a music-

hall where a wonderful Chinese magician performed. A day or so later, I heard that the magician had been killed while performing one of his startling and dangerous rifle tricks. The performer was Chung Ling Soo—and the place was Wood Green Empire, now A-TV's leading permanent television theatre.

Thoughts of Chung Ling Soo, The Great Lafayette, David Devant, Carl Hertz, Harry Houdini and other great illusionists who had performed there flashed through my mind as I drove my car up to the front of the Wood Green Empire—only to find it was not there! The entire façade, canopy and other front-of-the-house paraphernalia had disappeared, and in its place, were brightly-lit dress shops. As I made my way around a side road to the stage door, I fancied that I heard the ghosts of these great illusionists chuckle and say "Abracadabra!"

Theatrical Superstitions

Fortunately, the stage door was there, quite solid, almost hidden behind a pile of new scenery and stage properties, and the back of the theatre seemed to have been extended. I discovered at once that additions had been made to the backstage facilities, particularly as to make-up, wardrobe and dressing-rooms. The old music-hall atmosphere persisted: there was no dressing-room 13—instead, there was 12A! Crossing my fingers as I went under a ladder, I wandered on to the stage to meet Bernard Bibby, A-TV's Chief Engineer of studios and O.B.s. Mr. Bibby is an ex-BBC man (from Lime Grove and the Alexandra Palace) and he brought me down to earth rapidly with facts and figures, including lighting three cigarettes with one match.

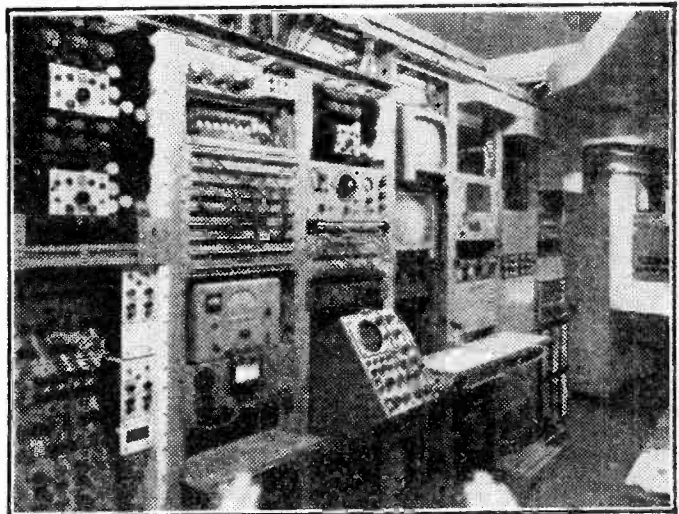

A part of the central apparatus room at Foley Street.

The Stage

A-TV had set out to make Wood Green Empire the best equipped television theatre in the country, and had made considerable constructional alterations. The original Matcham design had provided a stage with a slight rake, sloping down to the footlights. This had been entirely replaced with a level stage, extended beyond the proscenium over the old

orchestral pit. There is a Bodie stereopticon for the back projection of lantern slides on to a big 18ft. x 12ft. screen. Another unusual device for a TV studio is the provision of microphones which emerge from traps in the front of the old stage—remote controlled, of course! Abracadabra again!

Cameras and Control Equipment

Wood Green Empire permanent TV installation is equipped with Pye 3in. image orthicon cameras, of which there are three in use and one spare. Zoom lenses are used. The cameras are mounted on Vinten pathfinder dollies and pedestals and there is also a very fine Mole Richardson camera crane. The dollies and crane can be easily pushed all around the stage and extension, the Roboleum floor covering on the new stage-boards being absolutely smooth and level. I must also mention the excellent light Proctor camera pedestals, mostly used on O.B.s but also used in the studio. Camera tracks are not required for any of them.

S. T. & C. cardioid microphones are normally used, but the tiny German Hiller M59 condenser microphones have proved particularly useful when they have to be hidden or otherwise

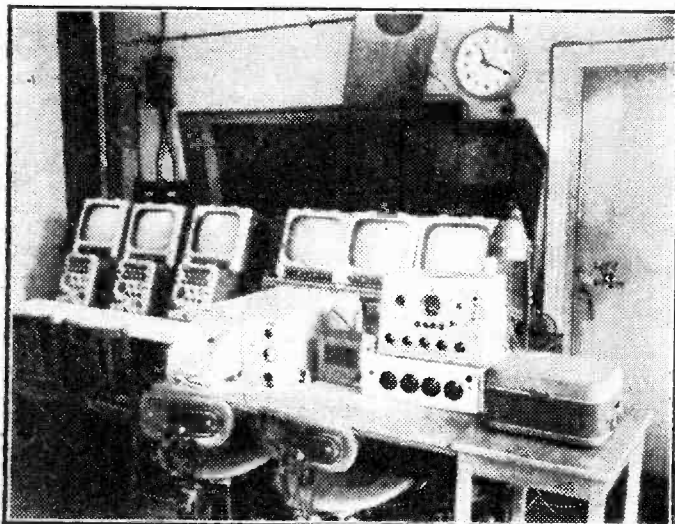

A-TV control room.

orchestral pit and with camera runways in the old orchestral stalls. In this way, the original stage of 75ft. x 35ft. had been extended with a 15ft. x 58ft. apron in the front. Experience had shown that this was insufficient for elaborate shows, and so a further extension had been made on one side, almost to the back of the pit. This gave a further stage space of 36ft. x 50ft. This seems to be quite unique in television theatre facilities. The original excellent stage fittings and flies remain intact, but many additions have been made, especially as regards lighting.

Lighting

The original lighting switchboard, perched up above the old stage manager's control point, survives and is very much in action. As a matter of fact, it is a fine Strand Electric Grandmaster board. This controls all lighting behind the proscenium opening. There is, of course, a great deal of lighting required in front of the proscenium, on the apron stage and over the newly-extended stage section which juts out to the back of the auditorium. Some of the lamps are mounted on five steel tubes each about 20ft. long, suspended from the roof, which can be raised and lowered individually with servo-controlled hoists. Each tube will carry about 5 cwt. in weight of lamps and the height is smoothly regulated from a position in the vision control room. At the same point is a small Strand lighting control panel, for remotely controlling with contactors and dimmers all lighting in front of the proscenium. The maximum lighting load is 300 kW, and the supply is 240 volts A.C.

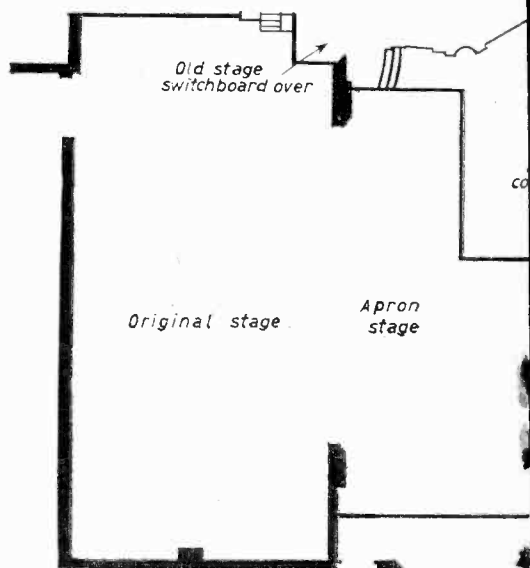

Plan of the layout at the V

made inconspicuous. The vision equipment is installed in a double-glass-fronted booth underneath the circle, with the sound control room, also glass-fronted, adjacent. All the vision and sound control equipment is by Pye.

Telefilm and Ancillary Equipment

Behind vision and sound control rooms is the telefilm room. Here there is 35 and 16 mm. film and slide equipment multiplexed into a Pye telecine channel. The slide equipment includes a Gray Telejector system, which enables slides to be dissolved from one to another into the same optical system. The caption arrangements are mounted in front of a specially modified Pye industrial station. But perhaps the most striking and original exhibit, in some respects, is the cue dot generator, which enables a small square dot to be placed at the top right-hand corner of a live picture, in a position to be seen on the monitor screens only and out of sight of ordinary viewers. This is a new device for cueing all control points on the I.T.A. networks at the exact moment to switch in the commercials. It is still in prototype form and is an instrument which is now receiving its first trials. The coaxial links from Wood Green go first to the Highbury Studios and then on (via Museum Telephone Exchange) to the A-TV Headquarters at Foley Street, W. The vision is sent on a modulated carrier wave.

Workshops

Foley Street may be the headquarters of A-TV, but Wood Green Empire premises house most of the workshops and garage the TV O.B. trucks. Scenery is made and stored here. There is a fine mechanical workshop where quite a lot of electrical and mechanical equipment is made. This comes under J. Proctor, the senior mechanic, who designed the ingenious

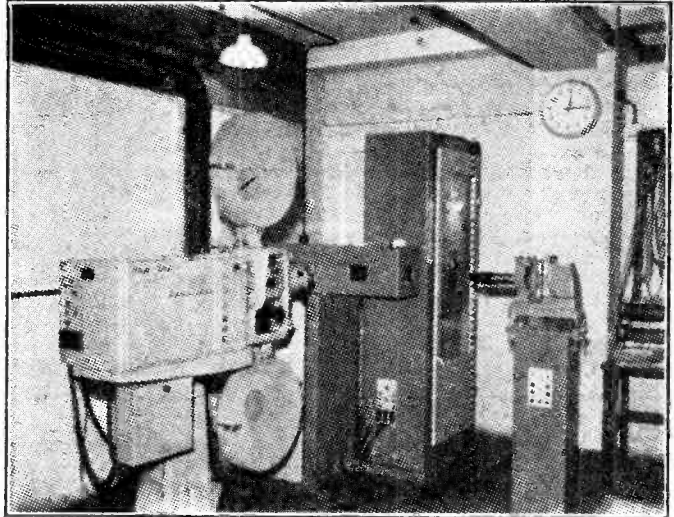

The Pye Stationer Telecine scanner with film and slide positions.

light camera pedestal already mentioned. There are two complete O.B. trucks, each with four Pye 3in. image orthicon cameras and associated control equipment. One of these makes a weekly journey to the London Palladium.

Programmes

The Wood Green Empire puts out about six to seven hours of live programme each week. The film and slide equipment is mainly used for interpolated film sequences and titles. A great deal of time, of course, is occupied with rehearsals for artists, cameras and lighting. Occasionally, the studio is used by other I.T.A. contractors when they are in need of extra space, but this does not occur very often.

Hackney Empire

The next port of call was the Hackney Empire, formerly an outpost of the Stoll circuit. This is equipped very much on the same lines as Wood Green, with similar Pye equipment for cameras, caption and telefilm. The output vision goes to Highbury on a coaxial link, straight video, without a carrier. The building has not been altered structurally to the same extent as at Wood Green but the stage has been modified by making it level and fitting a 15ft. apron stage over the old orchestral pit. Invited audiences are seated in the circle and upper circle, and the orchestra placed in a space formerly occupied by stalls seating. Power for lighting is 150 kW, controlled remotely by a Strand Grandmaster control console, with two additional Mole Richardson dimmer control trucks. Scenery and properties are brought

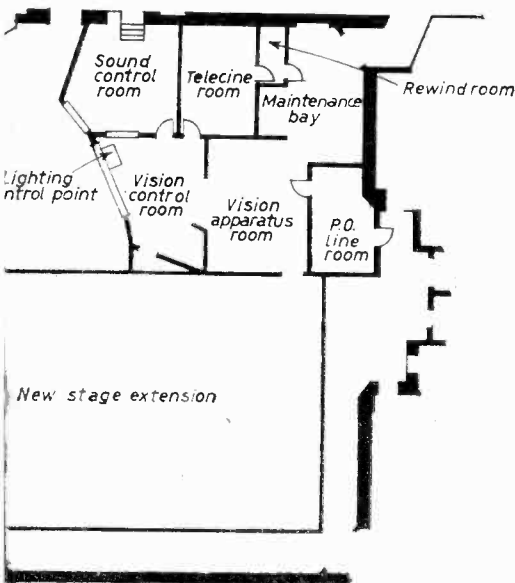

Wood Green Empire Studio.

over from Wood Green as and when required. The engineer-in-charge of both Wood Green and Hackney Empire installations is J. T. P. Robinson, an ex-BBC TV engineer.

The Palladium

The most important A-TV outside broadcast each week is undoubtedly the London Palladium Show. This has gradually developed technically into an almost fixed installation, inasmuch as the camera and microphone cables have been permanently laid. The O.B. trucks are driven from Wood Green on Sunday mornings and parked in a street behind the Palladium. In little more than an hour the engineers have connected up cameras and microphones and are ready for preliminary lighting rehearsals. These are quickly carried out by Tony Hudspeth, an ex-Lime Grove man, who is in charge of the lighting, and rehearsals proper commence at about 2 p.m. The whole operation usually proceeds quite smoothly and the show is gradually polished up artistically and technically until transmission time in the evening. The A-TV engineer in charge of the O.B. equipment is another ex-BBC man, Cliff Webster.

Astoria, Birmingham

We have not yet exhausted the list of television theatres operated or partly operated by A-TV. At Birmingham, the Astoria Cinema (in earlier days a theatre) is jointly owned by A-TV and ABC Television, in the name of Alpha Television Services. When the Astoria was a cinema, the picture was back-projected on to the screen, the projection box being at the end of a short brick tunnel behind the stage. This has been ingeniously brought into use as a small secondary studio, about 30ft. square. This small studio is equipped with two 4½ in. Marconi image orthicon cameras and a spare.

The sound equipment is by Marconi, and lighting by Mole Richardson and Strand. About 10 hours of live transmission per week is put out from these two stages.

This joint Birmingham studio has quite elaborate telefilm equipment, comprising three Pye staticons for dealing with 35 and 16 mm. film and slides. One of the mysterious and amazing Gray Telejector slide devices has been fitted to a Pye staticon. This device is a wonderful toy which would have delighted the star lantern lecturers at the London Polytechnic in the gay nineties. Alpha's outside broadcasts are handled by two Marconi O.B. units, each of which carry three

3in. image orthicon cameras and one spare. Philip Dorté is the A-TV executive at Birmingham and Alpha's general manager is Bernard Greenhead. The engineer-in-charge is Dave Whittle, an ex-Marconi man.

Foley Street H.Q.

I end my tour with a visit to the London studio headquarters of A-TV in Foley Street, not far from Oxford Circus. Here is a highly concentrated hive of electronic abracadabra, where the quart has really been conjured into the pint pot. The studio measures 25ft. x 23ft. and thereby resembles a large number of American television studios which are, surprisingly enough, mainly on the small side. It is fitted with two 3in. Pye image orthicon cameras plus one spare, and Mole Richardson pedestals are used. 20 kW of lighting is all that is necessary to achieve 100ft. candles maximum required by the cameras.

The Heart of A-TV Empires

Apart from the studio, however, the Foley Street equipment must be the most comprehensive set of

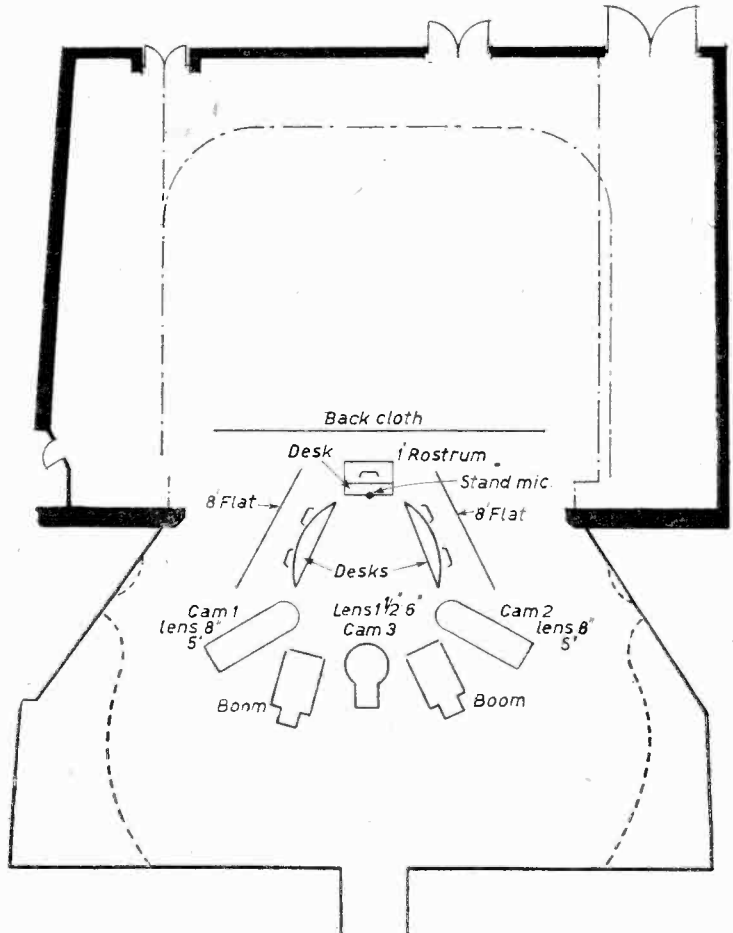

The layout at the A-TV Theatre at Hackney—the old Hackney Empire.

television control apparatus concentrated in one spot in the kingdom, not excluding Lime Grove. The telefilm equipment is on a very elaborate scale. There are two E.M.I. flying spot film scanners of the latest type, for handling 35 and 16 mm. film and slides. One of these machines has been modified for transmitting the line suppressing device which gives the peculiar colour effect commercials recently put out. There are two Pye station telecine machines, also for the two gauges of film and slides, both fitted with that fascinating Telejector device mentioned earlier.

In the event of the frequency of the electric mains supply dropping below 50 cycles, it will be appreciated that film might travel at a slower rate and the programme timing and space for the commercials imperilled. A unique time control, synchronised from the G.P.O., Dollis Hill H.Q., is being devised which ensures that the film machines run at exactly the correct speed to within very fine tolerances. This is an entirely new development, exclusive to A-TV. All of the above outputs can be fed to either of two master control rooms, which can be connected up with Wood Green, Hackney, Highbury, the Palladium or the other J.T.A. contractors.

D. Hintridge, the engineer-in-charge at Foley Street, seems to take all these complications in his stride. Miracles of electronic legerdemain are performed here daily, as befits premises so near the old home of Maskelyne and Devant. Here, for instance, is the control which enabled Granada's "My Wildest Dream" to be televised from the stage at Hackney, via Highbury, Foley Street and the Museum Telephone Exchange, up to AR-TV at Wembley, where it was telerecorded. The tele-recorded film was later put out at various J.T.A. stations at different times. The fact that "My Wildest Dream" is my most unfavourite television programme is beside the point; I know that I am in a minority!

Australian TV

CONTRACTS to a value of approximately £1,000,000 for television equipment for Australia are now in the final stages of fulfilment by Marconi's Wireless Telegraph Company Ltd. The orders were placed by Amalgamated Wireless (Australasia) Ltd. on behalf of various Australian interests.

No less than 75 per cent. of the total value of Australia's television requirements in the transmitting and studio fields (including four out of the six stations) has been supplied by this company, despite highly competitive tenders from British and foreign rivals.

Station ABN, the first of two Government-controlled stations, was officially opened at Sydney on November 5th by the Australian Prime Minister, Mr. Menzies. This has a Marconi installation consisting of an 18 kW vision transmitter and a 4 kW sound transmitter, with standbys of 5 kW and 1½ kW respectively, together with programme input equipment, combining units, monitoring equipment and ancillary units. Initially, the standby transmitters are in use, the programmes being radiated from an 80ft. temporary mast, but the main transmitters will shortly take over, feeding into an 8-stack aerial array mounted on a permanent 500ft. tower (ordered from Marconi's and supplied by B.I. Callender's

The Men Behind A-TV

The technical facilities of A-TV are complicated by the wide field they cover, but everything seems to be well under control. The head of the technical side of A-TV is T. C. MacNamara (2TQ to the brass-pounders of the pre-BBC days, another top ex-BBC engineer) who is the technical controller of the organisation. He seems to be able to provide all the facilities required by the board of the company, which includes some of the biggest names in the entertainment and radio world. The chairman is Prince Littler, of the Stoll Theatres Corporation, and supporting him are Val Parnell, Norman Collins and Lew Grade, from the theatre side, with C. O. Stanley, the Earl of Bessborough, Sir Robert Renwick, R. L. Meyer and J. A. Drummond from the radio, industrial and newspaper fields.

Such a mixture of impresarios, showmen, technicians and business men seems almost nuclear in its dynamic possibilities. They look to Bill Ward, programme controller, to perform the trick which seems to be pleasing such a large proportion of viewers. He is ably assisted by Keith Rogers, operations controller and Frank Beal, production executive.

I formed an impression that A-TV is a very live organisation which has not been misled into too much "new thinking." By that, I mean that they have selected their staff with immense care from the television, film and stage world—men of considerable experience who are unlikely to make novice's mistakes. After all, it took Carl Hertz and David Devant quite a few years to learn to produce a rabbit out of a hat with confidence and conviction. A-TV seem to do it seven days a week—weekdays at Birmingham and weekends in London. Bill Ward wields the magic wand. Abracadabra!

The closing of Wood Green and Hackney Empires is not without its note of sadness, but I am sure that those old-time star illusionists would have been glad that, thanks to A-TV, they remain in show business. The show still goes on!

Cable Construction Co. Ltd.) to give an effective radiated (vision) power of 100 kW.

The two studios associated with this station are also Marconi-equipped; three camera channels are installed in each, Mk. III cameras with 4½in. image orthicons being used throughout. The installation also includes sound and vision mixing and master control apparatus. Both the transmitting station and the studios are at Gore Hill.

The second national station, ABV, is similarly equipped, but with the addition of Marconi S.H.F. and V.H.F. radio links to connect the studios with the transmitting station, which in this instance are 20 miles apart, the transmitters being sited on Mount Dandenong, 20 miles from Melbourne, with the studios at Ripponlea, in Melbourne itself.

The Australian commercial television service will at the onset consist of four stations, two at Melbourne and two at Sydney.

The national transmitters operate on Band I, while the commercial stations are on Band III, 10 channels having been allocated by the Australian Broadcasting Control Board for this purpose and to cover possible future requirements. The six stations so far planned employ horizontally polarised radiation. The C.C.I.R. standard of 625 lines, 25 frames has been adopted, with the sound transmitters frequency modulated.

THE P.T. DATA SHEETS

No. 2.—G.E.C. MODELS BT3251 AND BT9343

THESE two receivers are found in the BT1748 series, which have very similar chassis but which, in these two particular models, employ 21in. tubes. The main differences between these two receivers and the rest of the 1748 series will, therefore, be found in the line timebase, due to the extra EHT which is required for the larger tube and the resultant increase in power of the line oscillator.

Both are 17-valve sets, fitted with a turret tuner. Following this, which has the usual cascode and pentode frequency changer stage, there are three I.F. stages, a metal rectifier and a pentode video output stage. A diode interference limiter follows, after which is the usual sync separator stage. The sound section has a single I.F. stage, but is fed from the anode circuit of the second video I.F. A diode rectifier is used with a metal rectifier limiter, followed by a triode feeding a pentode output stage.

It will thus be seen that the circuit is more or less orthodox and nothing spectacular will be found in either the layout or circuit. As with many receivers, the straightforward arrangement is often productive of the best results, and the circuit used has been found in previous G.E.C. models and is, therefore, tried and tested. Wide-band circuits and a series of rejector circuits ensure that the full 3 Mc/s band-

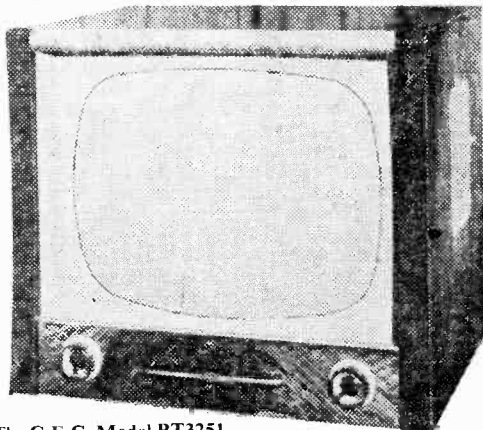

The G.E.C. Model BT3251

width is obtained, with adequate sound and adjacent channel rejection. The A.G.C. in this circuit is obtained from the voltage developed across the sync separator grid leak, and this is applied to the first half of the cascode stage, and also to the first I.F. stage.

G.E.C. SPECIFICATION

Physical Dimensions

Model	Type	Height	Width	Depth
BT3251	21in. Table Model	21 $\frac{1}{2}$ in.	25in.	22 $\frac{1}{2}$ in.
BT9343	21in. Console Model	39 $\frac{1}{2}$ in.	27 $\frac{1}{2}$ in.	23 $\frac{1}{2}$ in.

Mains Supply

A.C. or D.C. 200-250 volts (50 cycles A.C.).

Consumption

200 watts on A.C. 150 watts on D.C.

Channels

Channel selection by 12 position turret. Supplied with coils for Band I channels 1-5 and the three known Band III channels 8, 9 and 10. Additional clip-in coil sets will be available when other channels are allocated.

Intermediate Frequencies

Vision, 34.65 Mc/s. Sound, 38.15 Mc/s.

Valves

Cascode R.F. Amp.	B319
Frequency Changer	LZ319
Common I.F.	W729 and Z77
Vision I.F.	Z77
Demodulator	GEX35 (Germanium)
Video Amp.	Z77
Vision Interference Limiter	$\frac{1}{2}$ D77
Sync. Separator	Z77 and $\frac{1}{2}$ D77
Sound I.F.	Z77
Sound Noise Limiter	GEX34 (Germanium)

Sound det. A.V.C. and

audio	DH77
Sound Output	N329
Line Osc.	LN309
Line Output	PL36 (Mullard)
Boost Diode	U329
EHT Rectifier	EY86 (Mullard)
Frame Osc.	LN309
Frame Output	N329
H.T. Rectifier	RM5 (Selenium)

C.R.T.

Mullard MW53-80 21in. aluminised rectangular with integral neutral filter, operating at 16 kV. The armoured front glass is sealed to the tube face by the flexible mask to exclude dust.

Loudspeaker

Table model.—Two 8in. speakers, one on each side of cabinet.

Console model.—One 8in. speaker.

Sensitivity

Band I Channels 1-5. 15-25 microvolts.
Band III Channels 6-13. 40-50 microvolts.

Aerial Input

60/80 unbalanced. Single co-axial plug and socket.

12in. TV. CABINET—15/-

We are offering these at not much more than the cost of the plywood they contain. If not wanted for TV, many useful items can be made—record storage cabinet, H.F. loudspeaker case, book case, etc., etc. Price 15/-, Carriage 3/6.



DON'T STUMBLE IN THE DARK



Install 2-way switches. Our outfit comprises: 30 yds. Multi-core cable, two 2-way switches, two wood blocks. Full instructions. 1/9/6 each (post and insurance 2/6).

THE ELPREQ E.H.T. GENERATOR

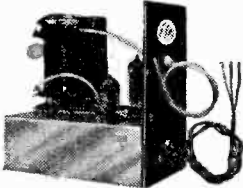

This unit contains three BVA valves. Output from 6 kV to 9 kV rectified with normal H.T. rail input but somewhat higher outputs can be obtained with higher H.T. supply. Dimensions are 6 1/2 x 4 1/2 x 7 1/2 in. Price 6/6, post packing, etc., 5/-.

FLOUORESCENT LAMPS

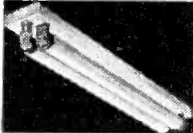

These are a complete fluorescent lighting fitting. Built-in ballast and starters—stove enamelled white and ready to work. Ideal for the kitchen, over the workbench and in similar locations. Single 40. 4ft. 3in. long, uses a 40 watt tube. Price 3/6 complete with tube. Carriage and ins. 5/6. Twin 20. Uses 2 20-watt standard tubes. Price 2/6 less tubes. Carriage and ins. 4/6.

THE UNI—TV.

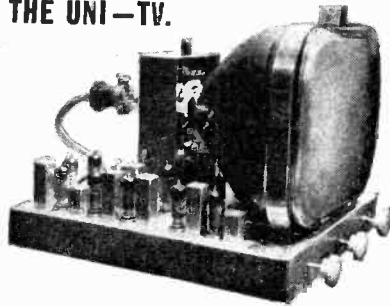

Undoubtedly the most up-to-date televisor for the home constructor. You can build all or only part and the set when finished will be equal to a factory-made equivalent. What other constructor TV. has all these features?

- ★ Made up units if required.
- ★ All miniature valves.
- ★ Metal rectifier.
- ★ No expensive transformers.
- ★ 13-channel circuitry.
- ★ Multi-vibrator time bases.
- ★ Ferruxcube, E.H.T. and scan coils.
- ★ 34/38 Mc.s I.F.
- ★ Suitable for any modern 12, 14 or 17in. tube.
- ★ Modern contemporary cabinet if required.

The building cost (less tube) is only £31.10.0. plus 10-carriage and insurance. All parts guaranteed 12 months. Full information and data free with parts or available, separately, price 3/6.

TV. Commercialising Outfit

Do it yourself—it's really quite easy and you will manage it in an evening and we guarantee **SUCCESSFUL RESULTS OR MONEY BACK**

Our parcel contains:— I.T.A. Aerial, 36ft. I.T.A. Down Lead, I.T.A. Converter, I.T.A. B.B.C. Interference Eliminator.

Illustrated instructions free with parts or available separately 1/6. A special bargain price for all the above items if bought together is £8/10- (Post and insurance 4/6) Or £2/10- down and 7 payments of £1.



CONNECTING WIRE

P.V.C. covered in 100ft. coils—2/9 a coil or four coils different colours, 10/- post free.

The "ESTRONIC" Band III Converter

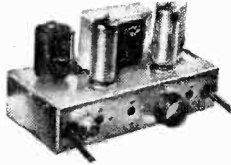

To-day's best value in Band III converters suitable for your TV. or money refunded. Complete ready to operate 4/9 6 non-mains, or 7/9 6 mains, post and insurance, 3/6.



STOP! FREEZE WIPERS!
Wrap your heater cable around the pipes in your loft to prevent a freeze up. 21 yards with full instructions. 30/-, plus 1/- post and packing.

19/6 AMPLIFIER



Powerful three-valve mains amplifier. Ideal for dances, parties, etc. Complete less chassis, cabinet and speaker (available if required). Data 1/6 (free with parts).

INFRAY LAMP WARMER

Means real comfort in bed as it emits Infra Red Rays which warm and keep you healthy.

- Economical. ● Costs only 1d. per hour (elec'y at 1d. per unit).
 - Absolutely safe, no health or fire risk.
 - Ideal for many other uses—over pet's basket, rearing pup-chicks, over desk, work-bench, etc. ● All complete and ready to work.
- Price 3/6-. Post and packing 2/-.

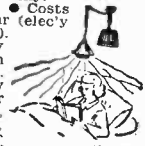

BAND III PRE-AMP

In difficult areas it will be necessary to increase the signal level and this is the ideal unit for this purpose. It is A.C. mains operated and is fitted with input and output coax. plugs. Price 2/4, post and packing 3/6.



GLASS PANELS

Size 10 1/2 x 9 1/2—parcel of five panels.

8/6

Post free.



ELECTRONIC PRECISION EQUIPMENT, LTD.

Post orders should be addressed to E.P.E., LTD., Dept. 5, Sutton Road, Eastbourns.

Personal shoppers to one of these addresses, please.

266, London Road, Croydon. Phone: CRO 6559 Half day, Wednesday.

42-46, Windmill Hill, Ruimsip, Middx. Phone: RUISLIP 5789 Half day, Wednesday.

152-3, Fleet Street, E.C.4. Phone: FLEET 2833 Half day, Saturday.

29 Stroud Green Rd., Finsbury Park, N.4. Phone: ARCHWAY 1049 Half day, Thursday.

249, Kilburn High Road, Kilburn. MAIda Vale 4921.

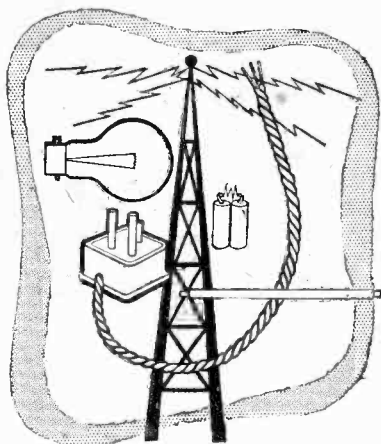

ON THE BEAM

Smith's have books on the newest developments in radio and television circuit design, construction and servicing. No matter what your problems or interests are, you can be sure of getting the books you need through your local branch of Smith's. Books not available on demand can be quickly obtained from Head Office. Lists of the standard works on any subject gladly supplied.

• Stationery and printing can also be supplied by your nearest Smith's branch.

W. H. SMITH & SON

for technical books

HEAD OFFICE: STRAND HOUSE, LONDON, W.C.2

T.V. CHASSIS

97/6

Complete chassis by famous mfr.: R.F. EHT unit included. FREE drawing with order. Easily fitted to table or console model, owing to this chassis being in 3 separate units (Power, vision, t.base) interconnected. This chassis is less valves & tube. Free speaker.

List of valves on request. I.F.'s 16.5-19.5 m/cs. Channels, 1-2 or 3, 4. Easily converted to I.T.V. Ins. Carr., 10/-.

T.V. TUBES 17" £7.10. 14" £5.10.
6 MONTHS' GUARANTEE. RECTANGULAR.

FREE. 9in., 10in., 12in., 14in., 15in., 17in. Conversion Pamphlet. Remember! Your old chassis will take these larger tubes, with little or no modification. Many sets shown working in our shop.

14" T.V. CHASSIS £19.19.6

Complete with tube, valves, speaker. Sheet. 14 valves. Complete chassis by famous mfr.: I.F.'s 10.5-14 m/cs. Channels 1-2 shown working in shop, easily converted to I.T.A. Guaranteed 3 months, including tube. Ins. carr., 25/-.

T.V. CONSTRUCTOR CHASSIS

SOUND AND VISION STRIP. 27/6. Sheet complete v/strip. 10 valve holders (EF91, etc.), less valves. FREE drawing. Post 2/6.

TIME BASE. 10/6. Containing scanning coil, focus unit, line trans., etc. FREE drawing. Post 3/6.

OPEN SATURDAY ALL DAY.

DUKE & CO.

621, Romford Road, Manor Park, London, E.12

GRA. 6677-8

CONVERSION ACCESSORIES

WOLSEY PRINTED CIRCUIT

Crossover units essential for coupling separate Band I and III aerials to receiver now only 11/6 each.

NURAY Mark III

gives your cathode ray tube a new life. It is a remedy for cathode heater shorts and low emission tubes. Available for 2 volt Mazda Tubes.

Only 27/6.

Low Price BOOSTER ISOLATOR TRANSFORMERS

230 Volt Input. Output, 2 Volt, 4 Volt, 6 Volt, 15 Volt. All plus 25 per cent. boost. State voltage required, 15/9.

AUTOMATIC TELEPHONE SERVICE

DAY or NIGHT—TID 2230

SPENCER WEST PATTERNING

REMOVAL UNIT No. 54

This unit will completely remove patterning from the picture. Enables you to obtain satisfactory results with the external type converters. 25/-.

UNISCAN. This line output transformer is being supplied by our company at a fraction of the set makers' price. Suitable for Alba T411, T421, Ambassador TV1, Beethoven TV50, TV50M, Peto Scott TV92, TV122, Masteradio T409, T412, Ekco TS46, TS90, Vidor CT370, CN377, Ferguson 841T, 841T/12, 842T, 843T, Regentone TR20L, TR20B, Philco 1707, 1708.

39/-

Please add postage and packing (1/6 up to 10/-, 2/- up to £1, 2/6 up to £2). The minimum rate for postage and C.O.D. made by the G.P.O. is 2/6. All orders over £5 Packing and Postage Free.

direct TV

REPLACEMENTS

134/136 LEWISHAM WAY, NEW CROSS, S.E.14. TID:way 3696/2330. Telegrams: FLIBAK, London, S.E.14.

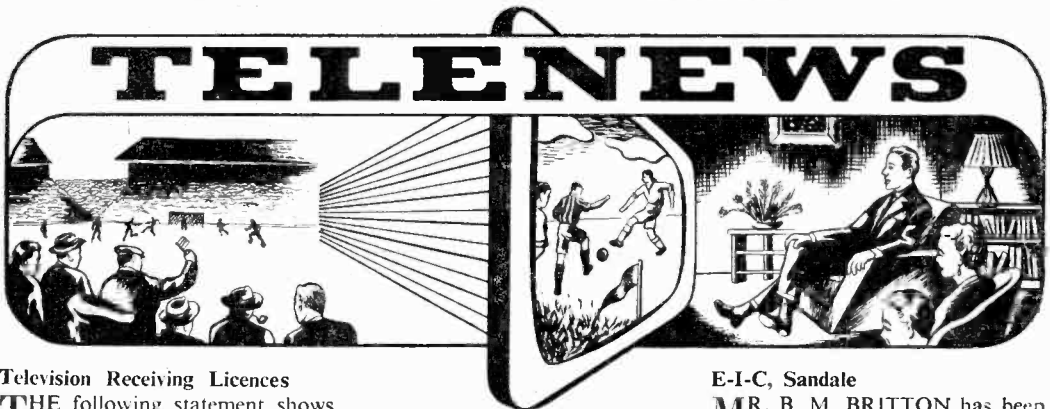

Television Receiving Licences

THE following statement shows the approximate number of Television Receiving Licences in force at the end of October, 1956, in respect of receiving stations situated within the various Postal Regions of England, Wales, Scotland and Northern Ireland.

Region	Total
London Postal	1,369,184
Home Counties	730,395
Midland	1,074,416
North Eastern	967,689
North Western	900,931
South Western	441,638
Wales and Border Counties	349,090
Total England and Wales	5,833,343
Scotland	406,511
Northern Ireland	51,213
Grand Total	6,291,067

October TV Increase 151,000

DURING October the number of television licences increased by 151,299.

At the end of October, 1956, 14,419,741 broadcast receiving licences, including 6,291,067 for television, and 310,301 for sets fitted in cars, were current in Great Britain and Northern Ireland.

Plastics Exhibition

“PLASTICS manufacturers from eight countries (and there may be more yet)—including Great Britain, U.S.A., Germany, Switzerland, Sweden, Italy, France and Holland—are exhibiting at the largest and first-ever international British Plastics Exhibition in the Grand and National Halls, Olympia, from July 10-20, 1957.”

This was disclosed in London recently after a Ballot for space was held at the British Plastics Federation Headquarters in Piccadilly. The draw, which was attended by representatives of all previous exhibitors, took place under the chairmanship of Mr. David Radford, chief of the Federation's Publicity Committee.

The exhibition which is held every two years, was started in 1951.

A limited amount of first floor stand space is still available for which manufacturers wishing to participate should apply without delay to: Mr. John L. Wood, British Plastics Exhibition, Dorset House, Stamford Street, London, S.E.1.

It will be the first time in history that Britain has seen such a display of plastics from all over the world!

Band III Viewers Increase

IN the four weeks from October 1st to 28th, the number of Band III homes showed the biggest monthly increase ever recorded: 204,000, or over 7,000 every day. This increase was brought about by the conversion of some 120,000 BBC only television homes to Band III, to which were added approximately 80,000 new television homes.

The grand total of Band III homes is now estimated to be 2,164,000.

None of the above figures takes account of the additional homes which will receive programmes from the new transmitting station at Emley Moor.

E-I-C, Sandale

MR. B. M. BRITTON has been appointed engineer-in-charge of the Sandale Television Transmitting Station in Cumberland. Mr. Britton joined the BBC in 1942 and has served as a maintenance engineer at a number of the corporation's transmitting stations. He became assistant engineer-in-charge of the Meldrum television and V.H.F. sound broadcasting station in Scotland in

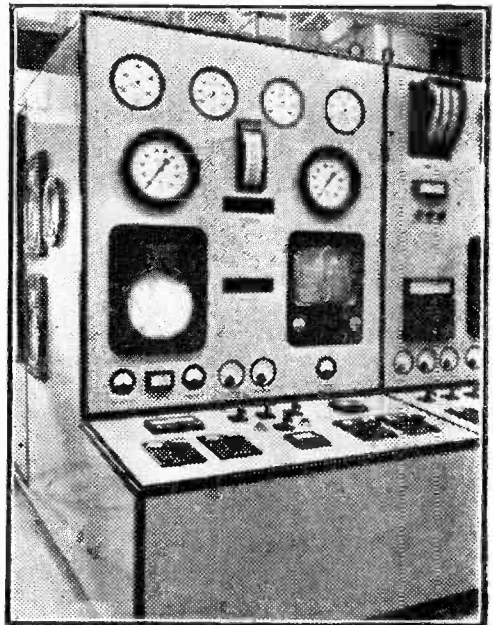

Marconi's Wireless Telegraph Company Ltd., has supplied a number of industrial television equipments to the Central Electricity Authority for use in power stations. At Castle Donington this equipment has been installed to enable a check to be kept from the plant control room on water level gauges situated some distance away. The picture shows the control panel with built-in picture monitor, and a picture of the gauges can be seen on the screen.

1955, where he remained until taking up his present appointment.

Televising of Football Matches

IN an agreement now signed with the Football Association, the BBC has been granted the exclusive "live" television, tele-

Under the agreement, the F.A. and the BBC will also endeavour to arrange the televising of two Saturday evening floodlit matches in line with the limited experiment proposed by the BBC to the football authorities earlier in the season. The agreement also covers filmed excerpts of each round of the F.A. Cup Competition.

The BBC have also reached agreement with the Football League whereby the BBC will be permitted, as last season, to film exclusively excerpts from certain League matches on Saturdays.

Picture Phone

THE telephone which includes picture transmission, and which was recently opened over standard telephone lines in America, utilise a raster made up of 60 lines, each of which may have a maximum of 40 dots. Thus, each complete frame may be considered to contain 2,400 dots. If a single frame were transmitted each second an overall bandwidth of 1,200 cycles would be necessary. The

American system transmits one complete frame every two seconds requiring a bandwidth of only 600 cycles. A carrier system is used in which the video signal amplitude modulates a 1,200 cycle carrier. The transmitted signal is then a conventional A.M. double-sideband signal with a frequency range of 600 to 1,800 cycles. It was developed by Bell Laboratories, but is not yet ready for commercial use. Development is continuing.

Russian TV

IT is stated that there are 20 State stations in the U.S.S.R. in addition to some 60 local stations. Most receivers are of the 14in. and 17in. tube type and it is claimed that by the end of this year there will be over two million sets in use.

Transistor TV

IN the U.S.A. the R.C.A. have developed a portable TV transmitter weighing only 19 lb. (camera and transmitter). The camera has an electronic viewfinder. The pick-up C.R.T. is only $\frac{1}{2}$ in. in diameter and the camera and transmitter combined use altogether 70 transistors. The transmitter is housed in a "pack" on the back and is rated at $\frac{1}{2}$ watt. The batteries will operate the equipment for five hours.

In Germany an even smaller camera has been produced by Grundig. This weighs only 10 ounces, is 4in. long by 2in. in diameter and has what is claimed to be the smallest tube ever produced. It has a $\frac{1}{2}$ in. lens.

TV Speeds Up Banking

THE first permanent installation of British television in a bank has been carried out in Australia. Pye industrial television equipment links the English, Scottish and Australian Bank's chief office in Melbourne and its Royal Bank branch (also in the city) with the Ledger Posting Centre, which is located in another part of Melbourne.

The camera which operates at the TV accounting centre transmits statements to the receiving screens at each of the two mentioned banks.

This service, which is unique in the southern hemisphere and probably the English-speaking world, enables either bank to deal promptly with customers' day-to-day enquiries and transactions with the ledger department. For example, customers who want to see details of their accounts or cheques which have been cashed, are able to do so on any one of a number of TV screens.

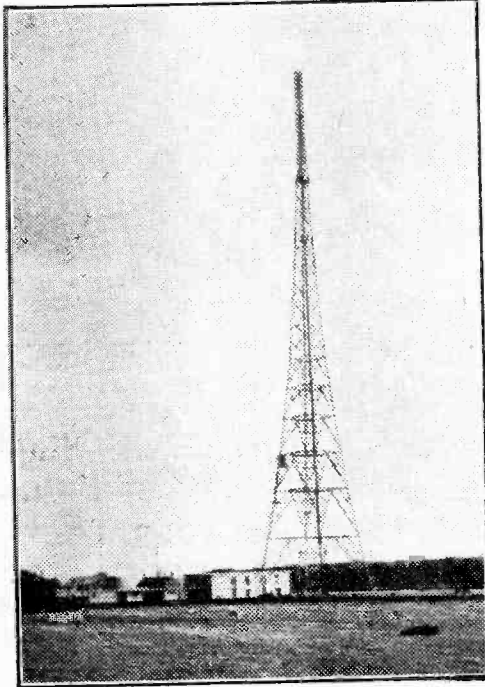

A view of the 445ft. tower and directional 16-stack aerial at Emley Moor. The 4,000 mc/s studio link receiving "dish" can be seen on the third bay of the tower.

recording and film rights, for all matches directly controlled by the Football Association during the season 1956-57 with the exception of the F.A. Cup Final, which, although it will be televised by the BBC, is deemed to be non-exclusive within the agreement.

As in the past, "live" television outside broadcasts, will in the best long-term interests of the sport, continue to be subject to the satisfactory sales of tickets at any particular match.

The Editor will be pleased to consider articles of a practical nature suitable for publication in "Practical Television." Such articles should be written on one side of the paper only, and should contain the name and address of the sender. Whilst the Editor does not hold himself responsible for manuscripts, every effort will be made to return them if a stamped and addressed envelope is enclosed. All correspondence intended for the Editor should be addressed to: The Editor, "Practical Television," George Newnes, Ltd., Tower House, Southampton Street, Strand, W.C.2.

Owing to the rapid progress in the design of radio apparatus and to our efforts to keep our readers in touch with the latest developments, we give no warranty that apparatus described in our columns is not the subject of letters patent.

Copyright in all drawings, photographs and articles published in "Practical Television" is specifically reserved throughout the countries signatory to the Berne Convention and the U.S.A. Reproductions or imitations of any of these are therefore expressly forbidden.

5-VALVE 3-WAVEBAND SUPERHET

A.C. Mains 200 250 volts. Latest type valves. Negative Feedback. Spin-wheel Tuning. Bandswitching and Radiogram. Size 11in. x 7 1/2in. x 4 1/2in. Well-known manufacturer's product. £9 5/-. Carr. 5/-.

U.S.A. INDICATOR UNIT RC929A

Complete with 3BP1 CR tube and screen, 7-valves—2-6SN7GT, 2-6HG7, 6C6, 2X2-6X5G, volume controls, condensers, etc. Ideal for portable scope, in black crackle case, size 15 1/2in. x 9in. x 9in. BRAND NEW. 65/- Carr. FREE.

62A INDICATOR UNIT

Containing VCR97 with Mu-Metal Screen. 21 valves: 12-EF50, 4-SP61, 3-EA50, 2-EB34, Plus Pots., Switches, H.V. Cond., Resistors, Murchhead S.M. Dial, Double Deck Chassis and Crystal. BRAND NEW ORIGINAL CASES. 67.6. CARR. FREE.

1355 RECEIVER

Complete with 11 valves 8-SP61, 5U4G, VU120, VR92. As specified for inexpensive TV. In absolute new condition. 27.6. carr. 5/-.

RF24, 10/-; RF25, 12.6; RF26, 25/-; BRAND NEW WITH VALVES. Carr. 2.6.

CATHODE-RAY TUBES VCR138A WITH SCREEN

VCR138A, 2 1/2in. CR Tube. Brand new in original cartons. (carr. free) £11.5-

VCR97. Guaranteed full TV picture (carr. 2/-) £2.-

VCR517C. Guaranteed full TV picture £11.5-

MU-METAL SCREENS for VCR97 or 517. P.P. 16 10/-

VCR97. Slight cut-off. Carr. 2/- 15/-

3BP1. Brand New £11.0-

B.S.R. RECORD CHANGERS

Very latest type "Monarch." 3-speed with HGF37 crystal turnover pick-up. Plays mixed records. Brand new and guaranteed. Listed at £16.10-. £7 19.6. carr. paid. B.S.R. 4-SP61. Plays mixed records. £8 15.- P/P 3.6.

TRANSISTORS

JUNCTION TYPE (RED-SPOT)
(OFFERED AT LESS THAN HALF-PRICE)

Designed for A.F. application up to 800 kc/s and suitable for use in Radio Control, Signal Tracers, Local Station Receivers, Oscillators, Transistor Voltmeters, Microphone Pre-Amplifiers, etc.

10/- EACH

(Tested and complete with Data and Circuits)

N.B.—These Transistors may be used in place of Mullard OCT1 or similar Transistors.

Please note that these Red Spot Transistors are ideal for most circuits including "W.W.V." Pocket Transistor Receiver and Transistor Amplifier. All Transistors are British Manufactured and Guaranteed. Send for circuits and Data.

PRE-SELECTED TRANSISTOR-SIX PUSH-PULL PORTABLE SUPERHET

Just switch to your favourite Station. No tuning, no aerial or earth. Pre-select 3 stations. Complete with all components and six Transistors. 7 x 4 Elliptical speaker. Teletron Superhet Coils and I.F.T.'s. Powered by 7 1/2 v. dry battery which lasts for months. 150 Milliwatts output. All the above with Circuits, etc. £9.-. Carriage paid.

Or with Matched Mullard OCT2's (200 Milliwatts Output) and 7 x 4 Elliptical High Resistance Speaker. 30/- extra. Suitable Plastic Cabinet easy to assemble, 18.6. Call and hear demonstration model working.

TRANSISTOR SQUARE WAVE GENERATOR

Complete Kit with 2 Transistors, Components and Circuit 25.-

TRANSISTOR PUSH-PULL AUDIO AMPLIFIER

(150 Milliwatts Output)
Build this Push-Pull Amplifier which is ideal for Crystal or Magnetic Pick-Up Amplification; Baby Alarm, Microphone Amplifier, etc. Powered by 6 volt Dry Battery lasting for months. Complete Kit of Parts including 4 Transistors and all Components with Circuit (less Speaker), £4 10.-.

SPECIAL OFFER

Set of four Transistors including one R.F. Transistor ... 42.6
Set of six Transistors including one R.F. Transistor ... 60.-

TRANSISTOR SIGNAL TRACER

Complete Kit with 2 Transistors, Components and Phones with Circuit ... 42.6

LATEST TYPES NOW IN STOCK

EBC41	10/-	DK40	10/-	PY82	10/-	35W4	8.6	12A7J	10/-
EY51	12/-	EF80	10/-	PCC84	12.6	PCF80	15.6	DK96	9/-
EP41	11/-	EACB00	10/-	PCF82	12.6	EBF80	11.6	DL96	9/-
EL41	11/-	ECC85	10/-	12A7T	9/-	EF85	10.6	DAP96	9/-
EZ40	10/-	EF80	10/-	12A7E	8/-	EF88	10.6	DF86	9/-
EM34	10/-	ECL80	12.6	12A7T	9/-	ECF82	15.6	ECC84	12.6
UL32	11/-	PL81	12.6	12A06	9/-	EF86	12.6	6AQ5	10.6
UY41	11/-	PL32	10/-	12BA6	9/-	PABC30	15.6	PCL82	12.6
UF41	11/-	PY81	10/-	12BE6	10/-	6AU6	9.6	ECH42	12.6
UCH42	12.6	EM60	10/-	12BE6	10/-	6AU6	9.6	ECH42	12.6
UBC41	10/-	6X4	8/-	12A8H	12.6	6L7Z3	8.6	3A5	12.6

SPECIAL REDUCTION FOR SETS OF VALVES

1A7GT, 1N5GT, 1H5GT, 1A5GT (or 1Q5GT or 3Q5GT) ...	37.6	Set
10 EF50 (Ex-Brand New Units), 5 - each ...	45/-	...
10 EF50 (Red Stylavia, ex-new units), 6/- each ...	55/-	...
6K8G, 6K7G, 6Q7G, 5Z4G, 6V6G ...	35/-	...
1R5, 1S5, 1T4, 1S4 or (3S4 or 3V4) ...	27.6	...
TP25, VP23, HL23 DD, Pen25 (or QP25) ...	25/-	...
DK96, DF96, DAF96, DL96 ...	32.6	...
6K8G, 6K7G, 6Q7G, 25A6G, 25Z5 (or 25Z8C) ...	37.6	...
12K8GT, 12K7GT, 12Q7GT, 35Z4GT, 35L6GT (or 50L6GT) ...	37.6	...
12SA7GT, 12SK7GT, 12SQ7GT, 35Z4GT, 35L6GT or 50L6GT 35 ...	37.6	...

SEND STAMPS FOR NEW 1957 28-PAGE CATALOGUE

OPEN MONDAY TO SAT. 9.6. THURS. 1 o'clock.

HENRY'S
(RADIO LTD.)

TRANSMITTER/RECEIVER

(Army Type "17" Mk II)
This well-known R/T Transceiver is offered complete with Valves, High Resistance Headphones, No. 3 Handmade and Instruction Book all contained in wooden cabinet.

Frequency: 44.0 to 61.0 Mc/s.
Approximate Range: 3 to 8 miles.
Variable Tuning.
Power Requirements: Standard 120 v. H.T. and 2 v. L.T.

Ideal for Civil Defence and intercommunications. BRAND NEW.

59/6 carr. 3/6

Calibrated Wavemeter for same. 10.-

GARRARD 3-SPEED MINIATURE CHANGER Model RC110

A.C. 200 250. List price £14.13/- Brand New. £7 19.6. P. & P. 3.6.

PYE 45 Mc/s STRIP TYPE 3583 UNITS

Size 15in. x 8in. x 2in. Complete with 45 Mc/s Eye Strip, 12 valves, 10-EF50, EB34 and EA50. Volume controls, and hosts of Resistors and Condensers. New condition. Modification data supplied. Price 69.6. Carr. paid.

INDICATOR UNIT TYPE 182A

Unit contains VCR517 Cathode Ray 6in. tube, complete with Mu-Metal screen, 3 EF50, 4-SP61 and 1 5U4G valves, 9 wire-wound volume controls and quantity of resistors and condensers. Offered BRAND NEW less relay. at £7.6. Plus carr. Radio-Constructor scope circuit included.

MINIATURE TRANS-MITTING STRIP TYPE 81

Size 7 1/2in. x 6in. x 3in. Complete with Valves Type CV415, CV309, 2-6AM8, 2-7D9 and Quartz Crystal, 4.860 kc/s. Fully wired with circuit. £4 10/- complete.

MINIATURE I.F. STRIP TYPE 373 9-72 MBK2

Brand new miniature I.F. Strip size 10 1/2in. x 2 1/2in. x 3in. high. Valve line-up 2-5F92, 3-EF91 and EB91. With circuit. Complete with valves 42.6. Less valves 8.-. This I.F. Strip is part of above equipment.

F.M. CONVERTER UNIT 88 100 Mc/s

Containing 6 valves—2-6BA6, EB91, VR137, 2-EF54. Two I.F. stages and separate local oscillator, graduated Vernier tuning. Just plug in to your radio and obtain good listening on F.M. Voltage required 250 v. 50M A. and 6.3 A. 2 amps. £7 19.6.

RADIO SUPPLY CO. (LEEDS) LTD.

Post Terms C.W.O. or C.O.D. NO C.O.D. under £1. Postage 1/9 extra under £2. 2/9 under £5. Open to callers 9 a.m. to 5.30 p.m. Sat. until 1 p.m. S.A.E. with enquiries, please. Full list 6d. Trade list 5d.

R.S.C. TRANSFORMERS

Fully Guaranteed.

Interleaved and Impregnated.
Primaries 200-230-250 v. 50 c.s. screened TOP SHROUDED DROP THROUGH
 250-0-250 v 70 ma. 6.3 v 2 a. 5 v 2 a ...16/9
 350-0-350 v 80 ma. 6.3 v 2 a. 5 v 2 a ...18/9
 250-0-250 v 100 ma. 6.3 v 4 a. 5 v 3 a ...23/9
 350-0-350 v 100 ma. 6.3 v 4 a. 5 v 3 a ...23/9
 350-0-350 v 150 ma. 6.3 v 4 a. 5 v 3 a ...29/9
FULLY SHROUDED UPRIGHT
 250-0-250 v 60 ma. 6.3 v 2 a. 5 v 2 a ...17/9
 Midget type, 21-3-3in. ...17/9
 250-0-250 v 100 ma. 6.3 v 4 a. 5 v 3 a ...26/9
 250-0-250 v 100 ma. 6.3 v 6 a. 5 v 3 a ...31/9
 for R1335 Conversion ...31/9
 300-0-300 v 100 ma. 6.3 v 4 a. 5 v 3 a ...25/9
 350-0-350 v 100 ma. 6.3 v 4 a. 5 v 3 a ...25/9
 350-0-350 v 150 ma. 6.3 v 4 a. 0-4-5 v 3 a 31/6
 425-0-425 v 200 ma. 6.3 v 4 a. C.T. 6.3 v 4 a. C.T. 5 v 3 a ...49/9

FILAMENT TRANSFORMERS
 All with 200-250 v 50 c.s. Primaries: 6.3 v 1.5 a, 5/9; 6.3 v 2 a, 7/6; 0-4-6.3 v 2 a, 7/9; 12-1 a, 7/11; 6.3 v 3 a, 8/11; 6.3 v 6 a, 17/9.

CHARGER TRANSFORMERS
 200-250 v 0-9-15 v 1 a, 11/9; 0-9-15 v 3 a, 16/9; 0-9-15 v 5 a, 19/9; 0-9-15 v 6 a, 22/9.

OUTPUT TRANSFORMERS
 Standard Pentode 5,000 to 3 ohms ... 4/9
 Small Pentode 5,000 to 3 ohms. ... 3/9

E.I.T. TRANSFORMERS 200-230-250 v. 2,500 v 5 ma. 2-0-2 v 1.1 a, 2-0-2 v 1.1 a
 for VCR87, VCR517 ...36/6

SMOOTHING CHOKES
 250 ma 5 h 50 ohms ... 11/9
 100 ma 10 h 250 ohms ... 8/9
 80 ma 10 h 350 ohms ... 5/6
 60 ma 10 h 400 ohms ... 4/11

SELENIUM METAL RECTIFIERS
 G.E.C. 300 v 250 ma, 12/9; 120 v 40 ma, 3/9.
 6-12 v 1 a F.W. 4/11; 240 v 50 ma, 4/11;
 6-12 v 2 a F.W. 8/9; 6-12 v 4 a, 14/9; 250 v 80 ma, 4/9; 6-12 v 6 a F.W. 19/9; 6-12 v 10 a, 25/9.

BATTERY SET CONVERTER KIT
 All parts for converting any normal type of Battery Receiver to A.C. mains 200-250 v 50 c.s. Supplies 120 v 90 v or 60 v at 40 ma. Fully smoothed and fully smoothed L.T. of 2v at 0.4a to 1 a. Price including circuit 49/9. Or ready for use, 9/9 extra.

ALL DRY RECEIVER BATTERY ELIMINATOR KIT.—All parts for the construction of a unit (metal-case 5 1/4-2 1/2-in.) to supply Battery Portable receivers requiring 90 v and 1.5 v. Fully smoothed. From 200-250 v 50 c.s. mains. Price, inc. point-to-point wiring diagrams, 39/9. Or assembled and tested at 46/9.

EX-GOVT. DOUBLE WOUND STEP UP/STEP DOWN TRANSFORMER
 10-0-100-200-220-240 v. to 5-0-75-115-135 v. or REVERSE. 80-100 watts. Only 11/9. plus 2/9 post.

EX-GOVT. CASE. Well ventilated black crackle finished, undrilled cover. Size 14 x 10 x 8 1/2 in. high. IDEAL FOR BATTERY CHARGER OR INSTRUMENT CASE. OR COVER COULD BE USED FOR AMPLIFIER. Only 9/9. plus 2/9 postage.

EX-GOVT VALVES (NEW)

1T4	7/9	6KT6	3/9	6AT5	7/9
1S5	7/9	6XSGT	7/9	EB91	8/9
3S4	8/9	6L6G	11/9	EF80	8/9
6KR6	9/9	807	7/9	EF85	4/9
6SU7GT	6/9	12A6	7/9	EL32	3/9
6FG6	7/9	15D2	4/9	EL91	5/9
EF82	5/9	25Z4G	8/9	KT66	11/9
6V6GT	6/9	3Z4	6/9	SP81	2/9
6U5G	3/9	MH4	4/9	MU14	8/9

EX-GOVT. UNIT RDF1.—Brand new, cartoned. Complete with 14 valves, including 5Z4G. Also mains trans. L.F. choke, rectifier, etc., etc. Only 29/6. Carr. 7/9.

Dept. N. 32, THE CALLS, LEEDS 2.

SMALL POTTED MAINS TRANSF.
 Removed from New Ex-Govt. units.
 Primary 0-200-230-250 v Secs 250-0-250 v 60 ma. 6.3 v 2 a. 5 v 2 a.
 Size 3 1/2 x 4 1/2 in. **11/9**

CO-AXIAL CABLE lin. ... 8d. yd.
 75 ohms 14/36 ... 11d. yd.
EX-GOVT. SMOOTHING CHOKES.
 100 ma 5 h 100 ohms Tropicalised ...31/11
 150 ma 6-10 h 150 ohms ... 6/9
 150 ma 10 h 150 ohms ... 11/9
 250 ma 5 h 50 ohms ... 12/9

E.H.T. SMOOTHERS
 0.2 mid. 5,000 v Cans (Ex-Govt.), 2/11.
BATTERY CHARGER KITS.—Consisting of attractive Blue Hammer Case. Transformer, F.W. Rectifier, Fuse, Fuseholder, Tag Strip, Grommets and Circuits. For mains input 200-230-250 v 50 c.s. 6 v 2 a. 25/9; 6 v or 12 v 2 a 31/6; 6 v or 12 v 4 a. 49/9. Any type assembled and tested for 49/9 extra.

R.S.C. 6 v. or 12 v. BATTERY CHARGER
 For normal A.C. mains input 200-230-250 v 50 c.s.
 Selector panel for 6 v or 12 v charging. Variable charge rate of up to 4 AMP. Fused, and with meter. Well ventilated case with attractive hammer finish. Guaranteed for 12 months. 69/9. Carr. 3/6.



TV. CABINETS
 Handsome well-constructed with walnut veneer finish. Size 18in. high, 20in. wide, 13in. deep. Size of aperture 17in. 13 1/2 in. Fitted Doors. For 15in. or 17in. Tube. Limited number at only **79/6**
 Plus 7/6 carr. 12in. Tube, 29/9. 5- carr. **BATTERY CHARGERS.**—For mains 200-250 v 50 c.s. Output for charging 6 v or 12 v at 1 amp. In strong metal case. Only 25/9. Above can also be used for electric train power supply.

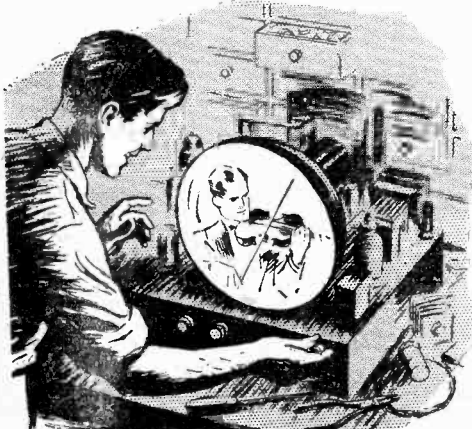

The Bennett College can make you an expert TV technician

—IN YOUR OWN HOME!

Here's your big chance! The Bennett College, famous the world over for its first-class postal tuition, now offers you a course in Television Servicing. Right away you can start adding to your knowledge of television repairs and maintenance, increasing your technical ability—and making a sound investment for your future.

Studying with The Bennett College is a pleasure. You work in your own home, as quickly—or as slowly—as you like. Your personal tutor at the College sends you your lessons—and gives you his friendly help based on years of teaching experience. The College guarantees to continue teaching you until you reach the standard you wish—and all your text-books are provided free of charge.

Send for a free prospectus today! Just fill in the coupon opposite and post it off—The Bennett College will send you a prospectus free of charge and without obligation.

EXCELLENT COURSES in the following subjects are also offered by The Bennett College. Write on your coupon the course that interests you.

- ELECTRICAL ENGINEERING
- ELECTRICAL WIRING
- POWER STATION ENGINEERING
- RADIO ENGINEERING
- TELECOMMUNICATIONS

To: THE BENNETT COLLEGE (Dept. A.55), SHEFFIELD.

Please send me free of charge and without obligation, a copy of your prospectus on _____ (subject/s)

NAME _____

ADDRESS _____

Age (if under 21) _____ Please write in block letters.

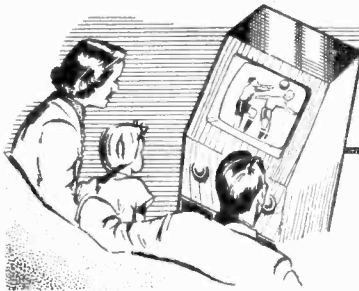

UNDERNEATH THE DIPOLE

TELEVISION PICK-UPS AND REFLECTIONS

By Iconos

A PICTURE of the wanted criminal—that is what a passport photograph usually looks like. Unposed, flatly-lit, snapped in a jiffy, developed and printed at high speed and with the negative unretouched—no wonder the result rarely flatters the victim. Compare it with the carefully posed studio portrait, upon which all the arts and crafts of lighting, composition, retouching and printing have been lavished. If sufficient wrinkles have vanished and years have been shed, the customer is highly delighted.

It is true that the press photographer and miniature "candid camera" specialists sometimes secure good likenesses which may even flatter the subject, but usually the good specimen negative is picked out of dozens of bad ones. The television camera operator is a candid cameraman, too, rarely able to light his subject specially for individual close-ups, (as the film men do) and, of course, without the assistance of the retoucher. He has to put his trust in the skill of the make-up man and the availability of plenty of soft front-light spiced with "kicker light" from side and back lights. His lighting has to be varied according to the type of camera used, C.P.S. Emitron cameras requiring a lighting technique quite different from image orthicon cameras. This puts a further test upon the adaptability of the engineer in charge of the lighting. No wonder the result we see on our sets frequently leaves much to be desired from the portraitist's point of view.

SMALL AMERICAN TV STAGES

THE statistics resulting from the S.M.P.T.E. survey show that out of 134 stations, 57 had one studio only, 65 had two, 8 had three, 2 had four, 1 had five and 1 had six. Some of the stages are quite big, the largest having a floor area of 3,690 sq. ft., but the

average small studio has an area of 824 sq. ft. only. The largest stages have up to six separately lit areas for sets and much use is made of dimmers. The dimensions are especially interesting when compared with the enormous ex-film studio stages now being used by the BBC, which has several with areas in the 10,000 sq. ft. region. Over half of the stations reporting possessed rear projection equipment for slides or films, and the average size of screen used for this process was 9ft. x 12ft. On the whole, this valuable survey shows that so far as permanent TV studios are concerned, and not including TV theatres, we are certainly not lagging behind the Americans.

"MURDER MISTAKEN"

THE fact that I had already seen *Murder Mistaken* three times when I deliberately switched my set on to see it a fourth time—on BBC

TV—must be some kind of testimonial to the worth of this thriller by Janet Green. First, I saw it in the West End, with Brenda de Banzie playing the part of Mrs. Jeffries, the rich ex-barmaid, and Derek Farr the spiv murderer. Next I saw it at the Hippodrome, Aldershot, performed by a first-class repertory company, with Hermione Baddeley (guest star) as the first Mrs. Bare and also (in a blonde wig) Mrs. Jeffries. Next I saw the film, in which Margaret Lockwood gave her interpretation of Mrs. Jeffries, which she repeated in the TV play. Each version had its own particular merits, but it was the differing performances of the principal artistes which interested me. I cannot make up my mind who was the best Mrs. Jeffries; the hearty yet calculating female portrayed by Brenda de Banzie, the earthy and temperamental performance of Hermione Baddeley

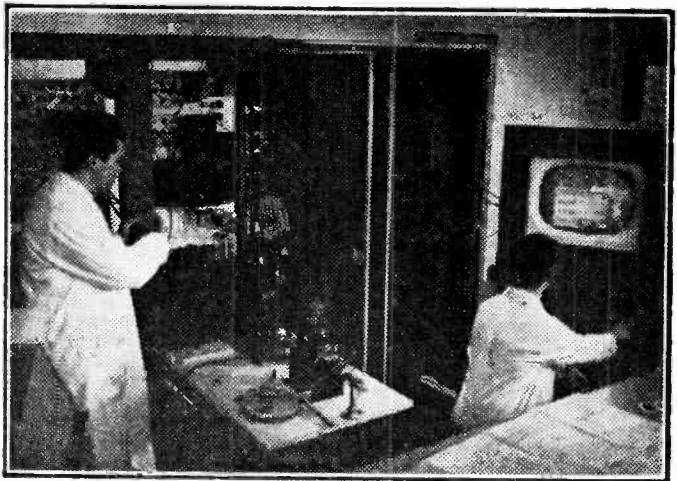

The experimental colour television transmitter shown above is believed to be the first in England using the American N.T.S.C. system. Although the transmitter was built mainly at Enfield, and is used in the new Sylvania-Thorn Colour Laboratories there, certain items of equipment were brought from the U.S.A. to ensure conformation with American standards.

or the big-hearted brassiness of Margaret Lockwood, who was equally good on film or on TV. With the skilled use of interpolated film exterior sequences, the television version had a variety of settings which gave the impression of a broad canvas, notwithstanding the fact that there were only two interior sets. The producer made much use of inserts (close-ups of glasses, door handles, gas fire, etc.) introduced smoothly at appropriate moments to cover time lapses—a trick in common usage on films, but not always convenient to use on live TV. The technical values and smoothness of the continuity are to the credit of the producer, Campbell Logan. The lighting and photography were of a very high standard, for which the film cameraman received only a credit title, and the name of the lighting man on live TV was omitted. I am against the wholesale distribution of credits to make-up, hair-dressing, continuity, production managers, etc., but I must say there are occasions when outstanding technical values on live television should be credited to some individual—possibly the lighting engineer.

TECHNICAL SURREALISM

It has taken me a good many years to get over my school-days' aversion to Shakespeare. Even now the sound of certain passages from the Bard repeat like an onion, bringing back memories of hastily gabbled "recitations" set as an imposition! Provided I don't take it too often, however, I now take Shakespeare in my stride and can settle down to enjoy properly spoken dialogue without too many twinges. The BBC's *The Tempest* was notable for the fine performance of Robert Atkins, the veteran actor and producer, in the rôle of Caliban. Fine direction, camera handling and costumes were nullified to some extent by the extraordinary modernistic sets, which not only offended the eye, but they muddled up the actors with the backgrounds in some of the long shots. Ugly monstrosities of metal and wood, the modern artist's impressionistic ideas, were the scenery and seemed to grow out of the actor's heads. To be consistent, the actors should have worn ultra-modern dress of the most bizarre type. Jazzy designs on curtains, drapes and gaudes have also detracted from other items lately, notably the Palladium

Show. Here, the dancing girls became visually mixed up with bold stripes on gauze curtains, with eye-straining effect. The craze for superimposition of filmed scenes is taken too far.

BAD NEWS

I AM told that BBC policy on method of presentation of TV news has not changed over the past few months. Comparison with the present style of the I.T. news may be odious, but it must be made. The utterly impersonal delivery of news by the BBC TV news readers seems to be plumbing sombre depths. With sepulchral tones and wearing the expressions of funeral mutes, the BBC announcers too often seem to make good news sound bad, and bad news catastrophic. Many viewers have given up suffering half way through the news and have switched over to the gay, fireside chattiness of the I.T. news. Especially popular is the end item, with its humorous tag. Robin Day is adept at handling the rather specialised type of dry humour which is now expected for this end item. At any rate, he leaves you with the idea that life is worth living, at least until you have your next viewing of the BBC TV news. Pity. The fine TV news coverage of the BBC TV doesn't really require a news reader to be in view at all. The Americans introduced the idea of the news-

reader with the express purpose of helping along the news items with the personal touch. The BBC's idea of turning the news reader into an automaton completely misses the point.

FILM TRAILERS

THE film people are now recognising the value of TV publicity not so much by buying advertising space on I.T.A. (though this has been done), as by making special little filmed features about productions now being made. Some of these specialised trailers are highly entertaining, and inducement to see the film concerned when it comes to the local cinema months later. Others are the reverse. A great deal of money is spent in making them. There was a good one about the forthcoming *H.M.S. Amethyst* film, called "The Yangtse Incident," now being filmed near Harwich. Unfortunately, the narrator's voice dropped away at the ends of sentences and he was submerged in an angry sea of music and effects. Notwithstanding this small fault, the general result was entertaining and registered the film's name with viewers. Not so effective was a rather silly series of scenes taken during the shooting of "Three Men in a Boat." Making these teaser-trailers, as they are called, is a tricky business. If they don't succeed, then they have the effect of a warning.



This view of a film studio set-up gives an idea of the similarity in the technique of TV and films.

BAND 3 T/V CONVERTER—185 Mc/s - 199 Mc/s

Suitable for London, Birmingham and Northern Transmissions

£2-5-0 post free.

A highly successful unit (H World circuit), incorporating variable oscillator tuning, Midget BVA valves, etc. Chassis size 7 x 4 x 2 1/2 in. Thousands already in use. Suitable for most types of T V sets. TRF or Superhet. Kit of parts 45/- . Blueprint 1/6, Power pack kit 30/- . Switch kit (Band 1—Band 3 Ae. switching),

6/6—all Post free. Wiring and aligning of above 20/- extra. Full range of Band 3 aerials in stock. Adaptors from 7.6 per set. Indoor dipoles, 6.6. Outdoor with cable 13.9. Band 1—Band 3 cross-over filter unit, 7.6. Variable attenuators, 6 db—36 db, 7.6. BBC Break-through Filter, suitable for BBC pattern rejection, 8/6.

Volume Controls

Log. ratios, 10,000 ohms
2 Megohms. Long
spindle. 1 year
warranty. Midget Edwar-
dian type.
S.W.S., S.P. Sw. D.P. Sw.
3/- . 4/- . 9/-
Linear Ratio, 10,000
ohms—2 Megohms.
Lose switch, 4/- each.
Coax plugs, 1/2. Coax
sockets 1/2. Couplers
1/3. Outlet boxes, 4/6.

80 ohm COAX CABLE

STANDARD 1/4 in. diam. Polythene insulated.

GRADE "A" ONLY

8d. yd.

SPECIAL—Semi-air
spaced polythene. 80
ohm. Coax 1/4 in. diam.
stranded core. Losses
cut 50%.

9d. yd.

TWIN FEEDER, 80 ohms, 6d. yd. 1000 ohms, 8d. yd.
TWIN SCREEN FEEDER, 80 ohms, 13/- yd.
50 OHM COAX CABLE 8d. per yd. 1/4 in. dia.
TRIMMERS, Ceramic, 4 pt., 70 pf., 9d. 100 pf.,
150 pf., 1/3; 250 pf., 1/6; 500 pf., 1/9. **PHILIPS**
Resistive Type—2 to 8 pf. or 3 to 30 pf., 1/2 each.

RESISTORS—Pref. values 10 ohms to megohms.
CARBON WIRE WOUND
20% Type, 1 w., 3d.;
1 w., 5d.; 1 w., 6d.;
2 w., 9d.;
10% Type, 1 w., 9d.;
5% Type, 1 w., 1/-;
Hi-Stab., 1 w., 2/-.

WIRE-WOUND POTS.
Pre-set Min. T.V. Type.
Knifed Slotted Knob.
All values 25 ohms to 20
k. 3/- ea. 30 k., 4/- .
Ditto Carbon Track
50 K. 2/2 Meg. 3/- .

CONDENSERS—Mica or S. Mica. All pref. values.
3 pf. to 680 pf., 6d. ea. Ceramic types, 2.2 pf., 3,000
pf. as available, 9d. each. Tubulars, 450 v., Hunts
and T.C.C., 600, 601, 605, 611 and 1,350 v., 9d.,
102, 105, 1,500v. Hunts, T.C.C., 25 Hunts, 1/6,
5 Hunts, 1/9. 1,150 v. T.C.C., 25 Hunts, 3/6.
100 v. K.V., T.C.C., 5/6. 500 to 200 kV. T.C.C., 9/6.

SILVER MICA CONDENSERS
10% 3 pf. to 500 pf., 1/- . 500 pf. to 3,000 pf., 1/3.
1% 10 pf. to 500 pf., 1/9. 315 pf. to 5,000 pf., 2/- .
STANDARD 3 WAVEBAND COIL PACK. Size
2 1/2 in. x 2 1/2 in. x 1 1/2 in. depth. 4 pos. Switching. Long.
Mell. short. Frame. Dist. core coils prealigned for
405 Kcs I.F. Complete with trimmer, ready to use.
A very sensitive and efficient Coil Pack.
Manufacturer's Surplus. Bargain Offer, 27/6.

3 SPEED COLLARO RECORD PLAYER
Complete with amplifier and speaker (as illustrated).
A.C. 200-250 v. Bargain value—KIT PRICE ONLY
£12.10.0, carr. and ins. 7/6.

UNIT PRICES—Cabinet, etc., £33.0.0, carr. 3/6.
Amplifier and 6 in. speaker, wired and tested, £2.12.6,
carr. 2/6. 3 Speed Collaro Gram unit with Studio
Hi-Fi pick-up, £5.19.6, carr. 2/6.



3 SPEED COLLARO RECORD PLAYER
Complete with amplifier and speaker (as illustrated).
A.C. 200-250 v. Bargain value—KIT PRICE ONLY
£12.10.0, carr. and ins. 7/6.

UNIT PRICES—Cabinet, etc., £33.0.0, carr. 3/6.
Amplifier and 6 in. speaker, wired and tested, £2.12.6,
carr. 2/6. 3 Speed Collaro Gram unit with Studio
Hi-Fi pick-up, £5.19.6, carr. 2/6.

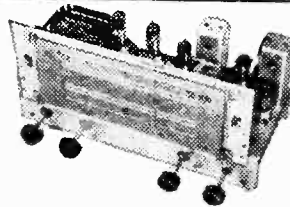

ALL WAVE RADIOGRAM CHASSIS

3 WAVEBANDS, 5 VALVES
8.W., 16 in. — 50 m. LATEST MIDGET
30 W., 300 m. — 550 m. BVA
L.M., 500 m. — 2,000 m. 4-THRESH
Brand new and cur. A.C. 200-250 v. 4 pow. W.C.
sv. Short-Medium-Long-Trans. P.U. socket. High Q
dist. core coils. Latest circuit technique, delayed
A.V.C. and neg. feedback. O.P. 4 watts. Chassis
size, 12 1/2 x 8 1/2 in. Dial 10 in. x 4 in. Hor. or vert.
station names. Walnut or ivory knobs to choice.
Aligned and calibrated ready for use. Sensitivity
and Quality at Low Cost.
Double wound mains transformer. **BARGAIN 9! Gns.**
Price 2/-
8 or 10 in. speakers to match, 21/6 and 25/- .
7 Valve De Luxe, push-pull version, 7 watt output,
£12.10.0. Carr. & ins. 3/6.

RECORD PLAYER BARGAINS

3-speed COLLARO gram unit with studio type
pick-up, £5.19.6, carr. 2/6. 4-speed COLLARO
gram unit with studio type pick-up, 6 gns.,
carr. 3/6. Latest model GARRARD 3-speed
Autochanger with manual for auto stop positions,
£12.10.0, carr. 2/6. GARRARD and COLLARO
4-speed Autochangers (as available from 9! gns.,
carr. 1/6).

ALUMINIUM CHASSIS. 18 s.w.g. Plain, undrilled,
folded 4 sides and riveted corners. Latex Baring holes.
Strong and soundly constructed with 2 in. sides.
7 in. x 4 in., 4.6; 8 in. x 6 in., 5.8; 11 in. x 7 in., 6.9;
13 in. x 9 in., 8.6; 14 in. x 11 in., 10.6; and 18 in. x
16 in. x 9 in., 16.8.

NEW BOXED VALVES GUARANTEED ALL

145,114	DF96	9/-	EF150	10/6	PC183	12/6	
	7/6	DK06	9/-	EF41	10/6	PL81	11/6
185, 184	7/6	DL06	9/-	EF80	9/6	PL82	10/6
324, 3V4	8/-	EAB050	9/6	EF96	12/6	PL83	11/6
324	9/6		9/6	EF91	8/6	PY80	9/6
6AT6	8/6	EB91	6/6	EL41	10/6	PF81	9/6
6K7	6/6	EB44	10/6	EL84	11/6	PY82	8/6
6K8	8/6	EB03	8/6	EY01	10/6	U25	11/6
6Q7	8/6	EB84	12/6	EZ40	8/6	UIC41	9/6
6SN7	6/6	EC90	12/6	IZ40	8/6	UCH49	10/6
6V6	6/6	EF82	12/6	MU14	9/6		
6X4	7/6	ECH42	10/6	PC81	10/6	UF41	10/6
6X5	7/6		10/6	PCF80	10/6	UL41	10/6
DAF96	9/-	ECH81	10/6	PF82	10/6	CV41	8/6

SPECIAL PRICE PER SET
145, 114, 185, 184 or 324 or 3V4 27/6
DK06, DF96, DAF96, DL06 35/-
6K8, 6K7, 6Q7, 6V6, 5Z4 or 6X5 35/-
SPEAKER FRET—Expanded Bronze anodised
metal 8 in. x 8 in., 2/3; 12 in. x 8 in., 3/-; 12 in. x
12 in., 4/3; 12 in. x 10 in., 6/-; 24 in. x 12 in., 8/6, etc.
BRIMISTONS—CZ1 for 3A heater, chassis, 3/6
CZ2 for 13A, or 2A, 2/6. CZ3 (Pilot Lamp), 1/6.
COPPER ENAMEL WIRE—1 lb. 14 to 29 s.w.g.,
2/-; 22 to 28 s.w.g., 2/8; 30 to 40 s.w.g., 3/6.
SWITCH CLEANER Fluid—10 oz. tin 3/9.
CHARGER TRANS.—P.T.M.—200/250 v. sec., 0-9
x 15 v. (for charging 6v. and 12 v. cells), 1/5 a., 13/6;
3 a., 19/6; 4 a., 22/6; 6 a., 28/6.

ELECTROLYTICS ALL TYPES NEW STOCK

Tubular Wire Ends	32	32350 v. B.E.C.	5/6
25 25 v., 50 12 v.	1/9	Can. Types, Clips, 3d. ea.	6/6
350 50 v., 450 50 v.	2/8	8 8 450 v. T.C.C.	4/6
100 25 v. B.E.C.	2/3	8 16 450 v. Hunts	5/-
8 500 v. Doh.	2/6	16 16 450 v. T.C.C.	5/6
8 8 500 v. Doh.	4/6	16 16 450 v. B.E.C.	5/6
8 16 450 v. T.C.C.	5/6	32 350 v. Dub.	4/-
8 16 450 v. B.E.C.	3/6	32 350 v. 450 v. T.C.C.	6/6
16 16 450 v. Doh.	4/6	60 350 v. T.C.C.	6/6
16 16 450 v. T.C.C.	6/6	60 100 350 v.	11/6
32 350 v. Doh.	4/6	60 250 275 v.	12/6
32 350 v. Doh.	5/6	100 200 275 v.	12/6
50 450 350 v. B.E.C.	6/6	6,000 mfd. 8 v.	3/9

SENERCEL RECTIFIERS. E.H.T. TYPE FLY-BACK VOLTAGES.

K325 2 kV. 4.3; K310 4.2
K3100 5 kV. 6.8; K350 4 kV. 7.3;
K3100 5 kV. 12.6; **MAINS TYPE**. RM1, 125 v.,
90 mA., 4/- . RM2, 100 mA., 4/3; RM3, 120 mA.,
5/9; RM4 type, 200 v., 275 mA., 16/- .
ENGRAVED CONTROL KNOBS for tin, spindle,
1 1/2 in. diam. Walnut or Ivory. Gold filled. 16
Standard engravings, 1/6 ea. Plain knobs to match
above, 1/10. 10 in. dia., 8d. ea. Walnut or
Ivory. 1 1/2 in. dia., 1 in. 9d. ea. Painter Knobs
Black with White Line, 9d.
WEARITE P.P. TYPE COILS. All ranges, 1 to 7,
2 or 4 or 6 or 9 series coils. Slug tuned. All
ranges from 3/6. Full range popular Coil Packs.

I.F. TRANSFORMERS—465 kc/s

Brand new ex-manufacturer's midget I.F.T.
size 2 1/2 in. x 1 in. dust core tuning. Litz
wound coils. High Q. Bargain offer, 7/6 pair.

MAINS TRANSFORMERS

Made in our own
Workshop to Top Grade spec. Fully interlocked
and impregnated. **RADIO AND AMPLIFIER**
TYPE. 250 v., 50 ma. F.W. sec. 5 v. or 8.5 v. or
rect. 6.3 v. 2.5 a. set Htrs., 21/- . etc. **C.R.T. HTR.**
ISOLATION TYPE. Low leakage for or without
50% sec. loss voltage. Ratio 1:1 or 1:2.5, 3 v.,
10/6; 4 v., 10/6; 6.3 v., 10/6; 13.3 v., 10/6.
Ditto with mains primaries 200/250 v., 12.6. Specimens
to order.

L.F. CHOKES.—10 H. 65 ma., 5/-; 15 H. 100 ma.,
10/6; 20 H. 120 ma., 10/6; 20 H. 150 ma., 15/6.
Smaller, 10/6. Sounders, 10/6.

ERSIN MULTICORE SOLDER 60/40 grade. 18g.,
3d. per yd.; 18g., 4d. per yd.; 1lb., 2/6.

LOUDSPEAKERS P.M. 3 OHM. 5 in. Ceres, 17/6;
6 in. Ceres, 18/6; 7 x 4 in. Goodmans Elliptical
15; 8 in. Flaco, 20/-; 8 in. Goodmans special
21/6; 10 in. R. and A., 25/-; 12 in. Presses, 35/-;
8 in. M.E. 2 K. ohms field, tapped O.P. trans., 24/6.

SCOTCH BOY, EMITAPE, etc., 1/200 ft., 30/- . Long
playing, 1/500 ft., 45/- . Paper tape, good
quality, 1/500 ft., 12/6. Reels only, 3 in., 3/8, 7 in., 4/3
TWIN GANG TUNING CONDENSERS—373 pf.
Midget, 6/6. 1000 pf. with dust cover and trimmers
8/6; 1000 mfd. standard size with feet, 8/6.

TYGAN FRET, Murphy pattern.—12 in. x 12 in., 2/- .
18 in. x 18 in., 3/- . 12 in. x 24 in., 4/- . etc., etc.
FULL WAVE BRIDGE SELENIUM RECTIFIERS—
9 or 12 v., 1 amp., 6/9; 3 a., 15/6; 4 a., 18/6
5 a., 24/6.

F.M. TUNER UNIT (87 mcs—105 mcs by
Jard), 4s. tested and approved by Radio
Constructor, complete kit of parts to build
this modern highly successful unit, drilled
chassis and J. B. dial, coils and cans. 4 BVA
miniature valves and all components, etc., for
only £8.10.0 post free. **SUPERIOR TYPE**
CLASMA DIAL—"Alibrated" M.A. and edge
lit by 2 pilot lamps, 12/6 extra.
Illustrated handbook with full details, 2/- post
free.

TRS RADIO COMPONENT SPECIALISTS (Est. 1946)

270 BRIGSTOCK ROAD, THORNTON HEATH, SURREY (THO 2188)



50 yards Thornton Heath Station.
Listed above are only a few items from our very large stock.
Hours: 9 a.m.—6 p.m., 1 p.m. Wed.
Terms: C.W.O. or C.O.D. kindly make cheques P.O.s, etc. payable to P.R.S.
Post-Telex No. 107, 108, 109, 110, 111, 112, 113, 114, 115, 116, 117, 118, 119, 120, 121, 122, 123, 124, 125, 126, 127, 128, 129, 130, 131, 132, 133, 134, 135, 136, 137, 138, 139, 140, 141, 142, 143, 144, 145, 146, 147, 148, 149, 150, 151, 152, 153, 154, 155, 156, 157, 158, 159, 160, 161, 162, 163, 164, 165, 166, 167, 168, 169, 170, 171, 172, 173, 174, 175, 176, 177, 178, 179, 180, 181, 182, 183, 184, 185, 186, 187, 188, 189, 190, 191, 192, 193, 194, 195, 196, 197, 198, 199, 200.

Bus 130A, 133, 159, 166 & 190.
Seal 3d. stamp today for Sample Bargain List.
OPEN ALL DAY SAT.

LASKY'S RADIO

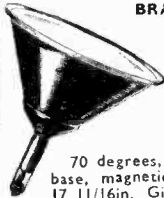

**BRAND NEW AND PERFECT
16" METAL CONE C.R.T.
AT ENORMOUS
PRICE-SAVING**

Brief specification : 6.3 v. heater, Ion trap, 14 kv. E.H.T. wide angle 70 degrees, standard 38 mm. neck, duodecal base, magnetic focus and deflection. Length 17 11/16in. Gives large black and white picture 11 x 14in. Unused in original cartons. **GUARANTEED BY US FOR 3 MONTHS.** Full data, connections and suggested time bases supplied with every Tube.

LISTED AT £23.9.10 LASKY'S PRICE £8.9.6

Carr. & Insur. 22 s extra.
Mask's, Anti-Corona. Bases and Ion Traps available

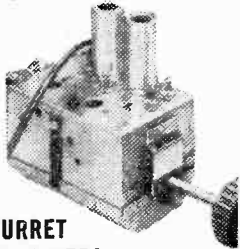

TURRET TV TUNERS

Complete with 12 coil sets. Covers all Channels Band I and III London and Birmingham. Valves used : PCC84, R.F. double triode, cascode R.F. amplifier, PCF80, triode pentode t.c. and mixer, I.F. output 33-38 Mc.s, easily modified to other I.F. outputs With full instructions and circuit diagram. Knobs, 3/6. **99/6.** Post 2/6.

BAND III CONVERTERS WELL BELOW HALF-PRICE COMPLETE WITH OWN POWER SUPPLIES

Manufactured by one of the well-known Pye group. In attractive plastic case complete with three brand new Mullard valves: Cascode R.F. amp PCC84, Osc. Mixer ECC81, Rectifier EZ90.

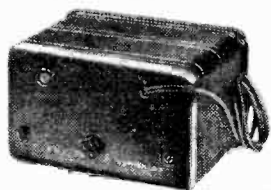

Original List Price £9.9.0.

**LASKY'S 79/6
PRICE**

Post & Pkg. 5/-

MAKERS' SURPLUS COMPONENT BARGAINS WIDE ANGLE 38 mm.

Line E.H.T. trans. Ferroxcube core, 9-16 kv.....	25-
Scanning Coils, low imp. line and frame.....	25-
Ferroxcube cored Scanning Coils and Line Output Trans., 10-15 kv. EY51 winding Line Trans. incorporates width and linearity control. Complete with circuit diagram, the pair.....	50- 6/6
Frame Output Transformer Scanning Coils low imp. line and frame.....	17/6
Frame or line block osc. transformer.....	4/6
Focus Magnets Ferroxcube Cored.....	19/6
P.M. Focus Magnets, Iron Cored.....	19/6
Duomas Focallisers.....	22/6
300 m.a. Smoothing chokes.....	15-
Electromagnetic focus coil, with combined scan coils.....	25-
STANDARD 35 mm.	
Line Output Transformers, No E.H.T.....	12/6
Line Output Transformers, 6.9 kv. E.H.T. and 6.3 v. winding, Ferroxcube.....	19/6
Scanning coils, Low imp. line and frame.....	12/6
Ditto by Igranico.....	14/6
Frame or line blocking oscillator transformer.....	4/6
Frame output transformer.....	7/6
Focus Magnets.....	12/6
Without Vernier.....	12/6
With Vernier.....	17/6
Focus coils, Electromag.....	12/6
200 m a Smoothing Chokes.....	10/6

LASKY'S (HARROW ROAD) LTD.

Both Addresses Open All Day Saturday. Early Closing, Thursday.

42, TOTTENHAM COURTROAD, W.1. Telephone : MUSeum 2605.1
370, HARROW ROAD, PADDINGTON, W.9. LADbroke 4073 and CU'Ningham 1979.

All Mail Orders to Harrow Road, please.
SEND FOR OUR NEW LIST enclosing 3d. in stamps.

BAND 3 T.V. CONVERTERS

12 months' guarantee. 1/6 extra C.O.D.

For I.T.A. London, Birmingham, Winter Hill, Emley Moor, Glasgow. Superhet or T.R.F. State B.B.C.

ARE YOU SUFFERING from B.B.C. breakthrough? All our converters now fitted with B.B.C. breakthrough pattern rejector. ALL fully wired, aligned and ready for use. ALL with power pack, knobs, aerial switching, metal rectifier and 2 valves 12AT7. Direct switching from B.B.C. to I.T.A.

DON'T FIDDLE at the back of your set, our converters have rubber feet to stand on top where you can reach.

SURELY THE CHEAPEST?

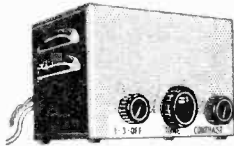

£3.17.6 (p. & p. 2/6)

With two knobs. Stove enamel grey hammer finish, slug tuning.

- OR metal cabinet, 3 knobs, fine tuning on front, and as illustrated, £4.7.6 (p. & p. 2/6).
- OR Walnut cabinet, or Lizard Rexine, £4.17.6 (p. & p. 2/6).
- OR chassis, i.e., less cabinet, £4 (p. & p. 2/6).
- OR in kit form, 61/- (p. & p. 1/6).
- Variable Attenuator, 7/6 (p. & p. 1/-).
- Aerial Splitter, 8/- (p. & p. 1/-).
- Band 3 Aerials, mast mounting. 3E, 27/- ; 5E, 35/- ; 8E, 57/-.

GLADSTONE RADIO

82B, High Street, Camberley, Surrey
Open Sats. to 5 p.m.

"You can rely on US" for ...

ALL RADIO and ELECTRONIC COMPONENTS

One of Britain's Largest Stockists of all Leading Makes : Hunts, T.C.C., Haynes, Allen, Denco, Osmor, Weymouth, Morganite, Bulgin, Belling Lee, Teletron, R.E.P., Scotch Boy, Ellison, Elstone, Partridge, Wynall, Westinghouse, S.T.C., AVO, Taylor, Goodmans, J.B., Wharfedale, Wearite, Acos, etc.

Suppliers to : Ministries, Development Laboratories, Education Authorities, etc.

Some of the more difficult parts you may not be able to acquire :

- Tapped Vol. Control, Linear C.T. 1/2 mg., 1 mg., 1 mg., 7/6, Linear 1/2 mg., 1 mg., 1 mg., 6/6. Post 6d.
- High Stab. 1/2 w. Resistors. 2% Range, 100Ω to 2 mg., 1/6 each. 1% Silver Micas up to 100 pf., 1/-, 280 pf., 1/2. 500 pf., 1/4. 1,000-5,000, 2/6. Post 6d.
- Now a full range of 1/2 w. 1% High Stab. resistors 100 Ohms to 2.2 mg., 2- each.

Thousands of Valves, Condensers, Resistors—Can We Help You?

MULLARD 510 and GEC 912 all specified parts and lists available.

Catalogue, Book Lists, S.A.E.

RADIO SERVICING CO.,

82, SOUTH EALING ROAD, LONDON, W.5.

Tel. : EAL 5737. Next Sth. Ealing Tube. 65 Bus. 1 p.m. Wed.

CORRESPONDENCE

The Editor does not necessarily agree with the opinions expressed by his correspondents. All letters must be accompanied by the name and address of the sender (not necessarily for publication).

COMPONENTS FOR AMATEURS

SIR—A friend recently sent me some copies of a French television magazine on similar lines to PRACTICAL TELEVISION. On looking through them I was greatly impressed by the various parts which were advertised and which so far as I know are not available on the English market. I refer mainly to tuners and I.F. strips. I do not know of any firm in this country—at least so far as your advertisers go—who will supply an I.F. strip, with or without provision for a tuner. In the magazines I refer to there are several firms advertising vision and sound strips, as well as timebase strips to match, and the vision and sound strips have either space for, or are complete with, multi-channel tuners. I would have thought there would be a good demand for these if they were available here, and from the circuitry it would appear that a similar strip for British television would be very much simpler and therefore cheaper—the French use F.M. as well as having a very much greater bandwidth due to the higher definition, etc. What about it, manufacturers?—G. ROBERTS (Harrow).

SPECIAL NOTE

Will readers please note that we are unable to supply Service Sheets or Circuits of ex-government apparatus, or of proprietary makes of commercial receivers. We regret that we are also unable to publish letters from readers seeking a source of supply of such apparatus.

SUPERVISOR RESULTS

SIR—I am sure you will be glad to know that another Supervisor has recently been built and is giving great satisfaction. There is good signal strength here from the BBC, but local interference is heavy from car ignition and electric motors; the limiters cope very well with all but the worst, which usually occurs when a car is accelerating to climb the hill on which I live. Other commercial televisions in the immediate neighbourhood invariably suffer from picture tearing and slipping, but the Supervisor beats them all; tearing is completely absent and only occasional slipping occurs. The worst trouble I get is due to foreign TV interference which causes patterning.

This being my first effort at a large size televisor, I suppose it was inevitable that I should encounter some snags. The first one was excessive heating of the AT310, which became too hot to touch after running for about half an hour. I found out from Allens that the heater winding was rated at only 9 amps, whereas the valve heater ratings totalled 10.45. I therefore added a 3-amp. filament transformer in parallel, re-arranging the heater circuits so that this fed V17 and V20; this resulted in a considerable reduction of the heating of the AT310. The next snag to be ironed out was with the frame sync. At first I could only obtain two superimposed half pictures, so I turned up the article in the February, 1955, PRACTICAL TELEVISION and started operations accordingly. I soon found out with the aid of a signal tracer that there certainly was no lack of frame pulse—it nearly shook the speaker loose! Further digging around with the probe showed the time constant of the C55/R70/VR6 to be much too low. On increasing C55 to .02 μ F, the cure was complete.

Another snag was mainly of a mechanical nature; both the theoretical and practical diagrams show the sound demodulation diode of V11 connected to the end of the secondary winding of L13. The set of Allen coils I obtained, however, had no connection spill in that position, but only a centre-tap in position five, which, of course, I had to use. Despite this I had no trouble with the circuit, either for alignment purposes or adequacy of sound volume. I was interested to compare the Supervisor circuit with another which uses the same coils; the latter uses the centre-tap, but the take-off coil is fed from the first vision I.F.

I have not yet tried the Supervisor on Band III; the signal here is not too good—gives rather a wishy-washy picture—but I'm trying out some tricks on a smaller experimental TV in the shack.

Anyway, congratulations on the production of an excellent televisor for home construction.

The total cost, by the way, was just under £65, which includes everything from the aerial down to cabinet castors and also the hire of two riggers. I am certain there is little of commercial make to touch it under about £120.—L. E. SNASHALL (Caversham).

TV CONVERTER EXPERIENCES

SIR—In answer to many inquiries regarding TV converters and their merits (if any), may I give my own experience of such?

In the first place I built the service area PRACTICAL TELEVISION converter, and after removing a couple of turns from the aerial coil and screening the base by separating into stages, I received Lichfield pilot signals very clear and loud.

The whole converter is in a unit complete with power supplies with a switch in a screened compartment (an ordinary oak switch), and the control knob extends some way out so that the unit fits under, and is attached to, the TV table with the switch just flush.

The switch is marked 1, 2, 3, and is wired up thus:

No. 1.—Band I mains off.

No. 2.—Band I mains on.

No. 3.—Band III mains on.

Using this system, I can, after allowing the converter to warm up for about 5-10 minutes, turn from one to the other with only a slight difference in picture levels at times, which can easily be corrected by the contrast control, anyhow.

I can assure anyone who has built the above converter that it really does work, and with no "grain" on the picture if one or two modifications are carried out.

These are that good screening is essential, also that the valves must be held firm and the valve cans must be a very tight fit to the chassis or there will be drift all over the place!



Whilst we are always pleased to assist readers with their technical difficulties, we regret that we are unable to supply diagrams or provide instructions for modifying surplus equipment. We cannot supply alternative details for constructional articles which appear in these pages. **WE CANNOT UNDERTAKE TO ANSWER QUERIES OVER THE TELEPHONE.** The coupon from p. 297 must be attached to all Queries, and if a postal reply is required a stamped and addressed envelope must be enclosed.

PHILIPS 1101U

I have had my television set about four years and it is a Philips type 1101U. I would like your advice on a converter for this set. In "Practical Television" there are various types of converters offered at a price of about £4. Would you please advise me on this matter?—E. Harding (Ramsgate).

Where a manufacturer's adaptor is available we always recommend this in favour of an add-on type superhet converter. The Philips Adaptor Type AT7522 is specially developed for your model, and whilst this may be a little more expensive than a simple add-on converter of the type to which you refer, it does at least ensure the optimum of performance and the complete elimination of break-through of the BBC, which, unfortunately, is a failing of nearly all types of add-on units.

ETRONIC ECV1527B

The resistor going to No. 4 tag on the GZ32 valve gives out heat. Could you tell me where the short is, as the valve strikes with a bluish tinge?—W. O. Thomas.

This is a surge limiting resistor (240 ohms wire-wound) and normally operates at high temperature, as should the same type resistor connected to tag 6. If the component overheats and burns out, suspect a short either in the GZ32 itself or on the H.T. line.

PYE BV51

I should be pleased if you would give me some advice on the faults of my TV.

The line hold and line amp. controls have for some time been at their limit of adjustment and a few months ago a black line appeared at the right-hand side of the picture.

This line has gradually increased until it is now about 1in. wide.

The linearity control will move only the left-hand side of the picture.

The picture is not out of centre and it appears as if it is closing up at the right side, not cut off; also recently the picture has narrowed and does not quite fill the left side. Frame hold and amp. are O.K.

The picture is quite good otherwise and sound is O.K.—S. H. Scottford (Smethwick).

If you have the PZ30 and the PL38 valves tested one will be found to be low.

Access is by removing the two P.K. screws from the left side screening box and removing the lid.

H.M.V. 1807A

With vertical hold control at maximum and by reducing the picture height by about 1in. the picture can be held steady. Any movement of vertical hold or increasing height of picture sends the picture flying round fast. There is some slight increase in picture height as the set warms up. V11, B36, also R32 have been replaced with no results.—P. C. Davis (Neasden).

Check the condition of the 3.3 megohm resistor connected between the slider of the vertical hold control and the frame oscillator transformer. This often increases in value and causes the symptom described, as also does the 10 K resistor connected to the slider element of the control. Check the condition of the 0.015 μ F frame oscillator charging capacitor.

AUTO. CONTRAST CONTROL

I am building a TV receiver using a Valradio type of 13 Channel TV tuner, and I am interested in fitting some sort of automatic contrast control to the I.F. strip.

Looking through all my back copies of "Practical Television" I came across an automatic contrast control circuit submitted to your correspondence column by a Mr. E. J. Southward (Beckermet), March, 1954, which I have enclosed. I am also using a grid-modulated C.R.T. and an Allen timebase circuit, using their frame output transformer. But my frame output valve is an N78, instead of a PL33, as in Mr. Southward's circuit. Would you please be good enough to answer my queries on fitting the above to my I.F. strip?

Will the difference in the types of valves used (N78, PL33) make a great deal of difference to the working of the circuit? If it does, what components would be affected?

I enclose a circuit of my first I.F. stage (the second stage being exactly similar). Would you please show on my circuit how the output from the automatic contrast control should be connected to the grids of my I.F. stages and the values of the necessary components.

Lastly, should an oscilloscope not be available, how would you decide whether the values of C1, C2, R3 and R4 were correct? If the components were wrong, can the effect be seen on the picture, and in what sequence should the above be altered if it should be necessary?—J. Hoggarth (Darlington).

The circuit mentioned should operate quite successfully without modification in your case. The type of frame amplifier valve has little influence on the function of the gating valve. The main point is to pick up positive-going video signal from the grid of the picture tube.

There is no satisfactory method, apart from the 'scope method mentioned, of adjusting the values of the delay components. Vertical shading on the left-hand side of the picture may occur, however, if the wrong value components are used. Without a 'scope it is a matter of trial and error, but the values shown should be used to start with.

It is not necessary to screen the A.G.C. feed leads. We have shown the decoupling components on your circuit.

(Continued on page 293)

Wanted!

QUALIFIED MEN AND WOMEN

Industry & Commerce offer their best posts to those with the necessary qualifications—such posts that will bring personal satisfaction, happiness, good money and security. As part of a modern industrial organisation, we have skilled knowledge of what is required in industry to-day and the best means of training personnel for its present day and future requirements. We specialise also in teaching for hobbies, new interests or part-time occupations in any of the subjects listed below. Make your own choice and write to us to-day for further information. There is no obligation of any kind.

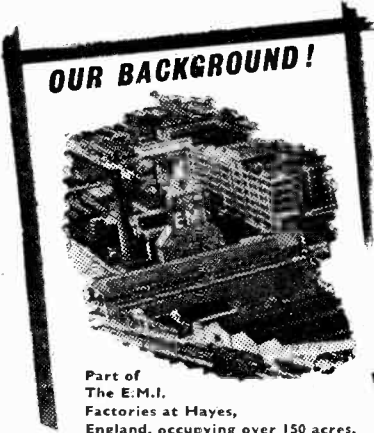

OUR BACKGROUND!

Part of The E.M.I. Factories at Hayes, England, occupying over 150 acres.

The only Home Study College operated by a world-wide manufacturing organisation

EMI

INSTITUTES

PERSONAL & INDIVIDUAL TRAINING IN—

- | | | | |
|---------------------------------------|-----------------------------------|------------------------------|----------------------------------|
| Accountancy | Customs Officer | Languages | Refrigeration |
| Advertising | Draughtsmanship | Management | Sales Management |
| Aeronautical Eng. | Economics | Maintenance Eng. | Sanitary Engineering |
| A.R.B. Licences | Electrical Eng. | Mathematics | Secretarial |
| Art (Fashion, Illustrating, Humorous) | Electrical Installations | M.C.A. Licences | Secretaryship |
| Automobile Eng. | Electronics | Mechanical Eng. | Shorthand & Typing |
| Banking | Electronic | Metallurgy | Short Story Writing |
| Book-keeping | Draughtsmanship | Motor Eng. | Short Wave Radio |
| Building | Eng. Drawing | Painting & Decorating | Sound Recording & Reproduction |
| Business Management | Export Heating & Ventilation Eng. | Photography P.M.G. Certs. | Telecommunications |
| Carpentry | High Speed Oil Engines | Police Production Eng. | Television Time & Motion Study |
| Chemistry | Industrial Admin. | Production Planning | Tracing |
| City & Guilds Exams | Jig & Tool Design | Radio Amateurs (C&G) Licence | Welding |
| Civil Service | Journalism | Radio & Television Servicing | Workshop Practice |
| Commercial Subjects | | | Works Management and many others |
| Commercial Art & Drawing | | | |

Also courses for GENERAL CERTIFICATE OF EDUCATION, A.M.I.H.&V.E., A.M.S.E., A.M.Brit.I.R.E., A.M.I.Mech.E., A.M.I.E.D., A.M.I.M.I., A.F.R.Ae.S., A.M.I.P.E., A.M.I.I.A., A.C.C.A., A.C.I.S., A.C.C.S., A.C.W.A., City & Guilds Examinations, R.T.E.B. Serv. Cert., R.S.A. Certificates, etc.

NEW! Courses with PRACTICAL EQUIPMENT

in RADIO · TELEVISION · MECHANICS
CHEMISTRY · ELECTRICITY
DRAUGHTSMANSHIP · PHOTOGRAPHY etc., etc.

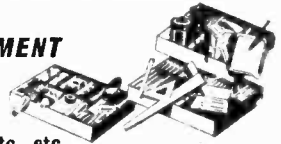

COURSES FROM 15/- PER MONTH

POST THIS TODAY

FREE

E.M.I. INSTITUTES, Dept. 138, London, W.4.

NAME _____ AGE _____
(if under 21)

ADDRESS _____

Subject(s) with/without equipment _____

JAN. _____ We shall not worry you with personal visits

BLOCK CAPS PLEASE

IC 92

-Part of "His Master's Voice", Marconiphone, etc., etc.

BAND III CONVERTER

Coil Kit by TELETRON, with circuit and wiring details, etc. For use with TRF or Superhet TV Receivers. **ONLY 12/-**.
Drilled chassis 3/-. Instruction leaflet only. 6d.

POWER UNIT TYPE 3.—Primary 200/250 v. 50 cycles. Outputs of 250 v. 100 ma. and 6.3 v. 4 amps. Fitted with H.T. current meter, and volt meter. For normal rack mounting, and has grey front panel. Size 19" x 7". **ONLY 90/-** (carriage, etc., 7/6).

MARCONI BAND III CRYSTAL CALIBRATORS.—Frequency range 170-240 Mc/s. Incorporates 5 Mc/s. crystal for better than .001 per cent. accuracy. Directly calibrated dial, internal A.C. mains pack. Complete with spare set of valves and instruction manual in maker's transit cases. **BRAND NEW. ONLY £4/19/6.**

TR 1196 TRANSMITTER SECTION.—Complete with valves EL32, EF50, CV501, and all components. **BRAND NEW. ONLY 12/6.**

RECEIVER UNIT 159.—Contains 4 valves, 1 each EF50, EA50, SP61, RL37 and 24 v. Selector switch. **ONLY 7/6** (post etc., 2/-).

R.F. UNITS TYPE 26.—Complete with 2 valves EF54 and 1 of EC52, this is the variable tuning unit covering 65-50 mc/s (5-6 metres). **BRAND NEW IN MAKER'S CARTONS. ONLY 25/-**.

POCKET VOLTMETERS.—Read 0-15 and 0-300 v. A.C. or D.C. **BRAND NEW. ONLY 18/6.**

Open until 1 p.m. Saturdays, we are 2 mins. from High Holborn (Chancery Lane Station), 5 mins. by bus from King's Cross
Cash with order, please, and print name and address clearly. Include postage and carriage on all items.

U.E.I. CORPN. THE RADIO CORNER, 138, GRAY'S INN ROAD, LONDON, W.C.1
{(Phone TERminus 7937.)

COMMAND RECEIVERS.—Huge purchase from the Air Ministry. These famous compact American receivers which can be used for a variety of purposes are offered at ridiculously low prices while stocks last. Complete with six metal type valves, one each of 12K8, 12SF7, 12A6 and 3 of 12S77, in aluminium case, size 1 1/2 in. x 5 1/2 in. x 5 in. Used, but in good condition. Choice of models, BC454 (3-6 Mc/s), 27/6, BC453 (190-550 kc/s), 59/6 and a few of the 1.5-3 Mc/s model 65/-. (Postage on all models 3/-). Circuits supplied.

METERS.—50 microamps D.C. 2 1/2" Fl. Sq., 27/6. 1 ma D.C. 2" Fl. Sq., 22/6. 10 ma D.C. 2" Fl. Rd. with blank, 10/6. 150 ma D.C. 2" Fl. Sq., 7/6. 200 ma D.C. 2" Fl. Rd., 12/6. 500 ma thermo 2" Proj. Rd., 5/-, 4 amps D.C. 2 1/2" Fl. Rd., 15/-, 20 amps D.C. 2" Proj. Rd., 7/6. 40 amps D.C. 2" Proj. Rd., 7/6. 30-0-30 amps D.C. car type, 5/-, 15v. A.C. 2 1/2" Fl. Rd. M.I., 8/6. 300 v. A.C. 2 1/2" Fl. Rd. M.I., 25/-. 2,000 v. A.C. 2 1/2" Proj. electrostatic, 22/6. 300 v. D.C. 2" Fl. Sq., 10/6.

L.T. HEAVY DUTY TRANSFORMERS.—Ex Admiralty with 230 v. 50 cycles primary. 1. Secondaries 5, 10, 15, 20, 25, 30 v. at 5 amps. **ONLY 29/6.** 2. Secondaries 7, 14, 21, 28 v. at 15 amps. **ONLY 42/6.** (Postage on either 2/-).

E.H.T. TRANSFORMERS.—5.5 Kv (Rect.) with 2 v. 1 a. 79/6. 7 Kv (Rect.) with 2 v. 1 a., 89/6. 2.5 Kv (Rect.) with 2-0-2 v. 1.1 a., 2-0-2 v. 2 a. (for VCR97 tube, etc.). 42/6 (postage 2/- per trans.).

TRANSFORMERS.—H.T. Fully shrouded upright mounting. 250-0-250 v. 60 ma., 6.3 v. 3 a., 5 v. 2 a., **ONLY 21/-**. 250-0-250 v. 100 ma., 6.3 v. 6 a., 5 v. 3 a., **ONLY 37/6**. 350-0-350 v. 180 ma., 6.3 v. 5 a., 5 v. 3 a., **ONLY 37/6** (postage 2/- per trans.)

WALKIE TALKIE TYPE 18.—Covers 6.0-9.0 mcs. Transmitting and receiving units in metal case, complete with valves, in excellent condition. **ONLY 79/6.**

SPEAKERS.—P.M. 6 1/2 in. less trans., 10/6; 8 in., less trans. In black crackle metal cabinet, 45/-.

CHOKES.—10H 60 mA., 4/-; 5H 200 mA. 7/6 (post 1/-).

CRYSTALS.—British standard 2-pin 500 kc/s. 15/-; Miniature 200 kc/s and 485 kc/s. 10/- each.

AMERICAN 14 v. DYNAMOTORS.—Output 225 v. 60 ma. Ideal for car radio or running electric shaver from car battery. **ONLY 45/-**.

12-WAY SCREENED CABLE.—In 10ft. lengths, fitted with plugs, originally made for use with the Army No. 19 transmitter receiver. **UNUSED. ONLY 17/6** per lead.

WHY WASTE TIME

Give that set its best chance
FIT QUALITY COMPONENTS

Catalogue 1/-.

Parts for the following:—

- Manual Osram "912" plus Amplifier 4/-
- Mullard 10-watt Amplifier 3/6
- The Coventry
- 2-watt Amplifier ... } 1/-
- 4-watt Amplifier ... }
- 6-watt Quality Amplifier }
- The Coventry A.M. Tuner Unit ... 1/-
- Denco F.M. Tuner Unit ... 1/6

Complete Component Price Lists will be supplied with each Manual.

COVENTRY RADIO

EST. 1925

189, DUNSTABLE ROAD, LUTON, BEDS.

Phone: Luton 2677

FIRST-CLASS TELEVISION and RADIO COURSES

GET A CERTIFICATE!

After brief, intensely interesting study—undertaken at home in your spare time—**YOU** can secure your professional qualification or learn Servicing and Theory. Let us show you how!

FREE GUIDE

The New Free Guide contains 132 pages of information of the greatest importance to those seeking such success compelling qualifications as:

- A.M. Brit. I.R.E., City and Guilds Final Radio, P.M.G. Radio
- Amateurs' Exams., Gen. Cert. of Educ., London E.S.C. (Eng.), A.M.I.P.E., A.M.I. Mech.E., Draughtsmanship (all branches), etc., together with particulars of our remarkable Guarantee of

SUCCESS OR NO FEE

Write now for your copy of this invaluable publication. It may well prove to be the turning point in your career.

FOUNDED 1885—OVER 150,000 SUCCESSES

NATIONAL INSTITUTE OF ENGINEERING
(Dept. 462), 148, HOLBORN, LONDON, E.C.1.

AIR-SPACE CO-AXIAL CABLE. 75/80

7/36 new standard size, 9d. per yd. **VOLUME CONTROLS.** All values. Less switch, 2/10; S.P., 4/-; D.P., 4/4. Special Offer: 1 meg. S.P. standard size, long spindle, 2/9.

F.M. SPEAKERS. 3 1/2 in., 18/6; 5 in., 18/-; 6 in., 18/-; 8 in., 19/6; 10 in., 27/6; 12 in., 27/6.

WALNUT EXTENSION SPEAKER CABINETS. 6 in., 14/6; 8 in., 18/-.

T.V. AERIALS. 3-element Band III, 28/6; 5-element 29/6; Chimney Lashed "H", 7/6; "X", 7/6; S.A.E. with your requirements and we will quote by return; Aerialite, Wolsey, Lumex, etc. Crossover Boxes, Coax Plugs, Sockets, etc., also supplied.

NR15 INPUT 220/240 v. Output 6.3 v. with 25 per cent. and 50 per cent. Boost. Price, 17/6 each, p. & p. 19.

FILAMENT TRANSFORMERS. Mains Input 6.3 v. 1.5 amp. Price, 6/8 each. 8+8 350 v. Dubilier Condensers, 2/6 each.

NR12. Input 220/240 v. Output 0.2-4-6.3-7.3-10-13 volts. 25 per cent. and 50 per cent. boost if required, 21/- each. 19 p. & p.

GUARANTEED VALUES

OZ4	5/6	6USG	7/-	ECL80	U25	14/9	
1A5	5/-	6CD6	19/6	11 10	PY81	10/6	
1LN5	4/6	6V6G	7/6	ECF8213	PY82	7/3	
1LD6	5/-	6J5	5/6	ECC84	EB91	7/-	
1A7	12/6	6AQ5	7/6	12 16	PL81	13/-	
1R5	8/6	6AT6	7/6	EY51	11/3	PL82	10/-
1T4	7/-	6BW6	7/6	PCC84	EP90	9/6	
155	7/-	7Y4	8/-	12 6	CR810	6/6	
2P	8/6	12A6	8/-	EI84	9/-	KT86	19/6
2X2	5/-	12AT7	9/-	DK96	9/6	35Z4	8/6
5Y3	8/-	B36	18/6	DF86	9/6	12Q7	9/6
5Z4	8/-	25L6	7/-	DAF9610	U76	8/6	
5U1	8/-	807	6/-	DL96	9/6	DH76	9/6
6X7	7/-	1825	8/-	UCH42	8/6	6BG6C	7/6
6K6	8/6	PEN46	6/6	UBC41	8/-	19/6	

Terms: C.W.O. or C.O.D. Minimum C.O.D. fee including postage 3/-. Postage and packing charges, under £1, 1/-; under £2, 1/3; under £3, 1/9; £4 and over goods sent post free.

ELECTRO-SERVICES & CO.

221, BATTERSEA PARK RD., LONDON, S.W.11. MAC. 8155

PYE LV30

My set has developed the following fault. After half an hour's use the picture shrinks into the centre. Could this be a short inside the line output transformer, as this gets very hot, and two .5 μ F capacitors near it have apparently partly melted? If the transformer is at fault, would you kindly advise type number to use?—A. H. Wood (W.1).

The transformer could, of course, be responsible for this symptom, but so could practically any other component in the line timebase. In the first place we would suggest that you check the condition of the line timebase valves, paying particular attention to the PL38 and PZ30, half of the latter of which is used as efficiency diode.

BAIRD P167 (?)

I have in my possession a televisor of indeterminate make, and I would be grateful if you could identify it and give me some information regarding trimming.

The set is a table model with a 12in. Mazda CRM 121B tube fitted. The valve line-up is largely Mazda 10F1 in the sound and vision circuits.

All pre-set controls are accessible through the front panel of the set through small holes made for the purpose, and the three controls on the front are Shade, Light and Tone.

The main chassis seems to me to be equipped with a removable R.F. or superhet chassis which is, at the moment, tuned to Holme Moss frequency. It is my intention, if it is at all possible, to retune this unit to Norwich frequency, and it is this information that I require.

The coil cans on the R.F. superhet unit are marked with part numbers, as are the rest of them in the set. The part numbers on the R.F. unit being 1-9868 on a yellow tag and 1-0869 on a red tag. The two valves being Mazda 10F1 and Brimax 12AT7.

With the foregoing information I hope that you can identify the set for me and give me the trimming gen.—James J. Alderdice (Bury St. Edmunds).

The receiver would appear to be a Baird—most likely a P167. The service sheet shows the position of the coils. Unscrew L6 some three or four turns. Note RFT1; unscrew L1 core (top) and L2 (bottom). RFT2: unscrew L4 core (top) and L5 core (bottom). Tune L6 for maximum sound. Retune L1, L2, L4 and L5 for best results; retune L6 for maximum sound, then minimum sound interference with vision.

BUSH TUG12A

I would like your views on a peculiarity I shall put later in this letter, but first a brief history of this receiver.

The set is a T.R.F. Double Side Band Receiver and is now six and a half years old. During this time the only attention it has required has been the replacement of EF50s in the two timebases and sync separator. Otherwise C.R.T. and all components have functioned properly, with no need for replacements.

With the BBC moving their transmitter to Crystal Palace and operating on the lower sideband 1, of course, lost bandwidth and definition.

By the insertion of a sound rejector in the cathode of the Third Vision R.F. valve and returning the coils, I succeeded in getting the receiver to resolve the 3 Mc/s bars on Test Card C with no bother at all. Needless to say I had to take care of the big increase in sound output coming nearer 41.5 Mc/s.

Now for the peculiarity. With contrast and focus

set O.K. at the start of an evening's transmission after about three hours, i.e., around 10 o'clock, the gain of the receiver increases so that I have to pull back the contrast to avoid the "soot and whitewash" picture that develops; it also goes out of focus.

At first I wondered if this "gain" was due to a variation in receiving conditions, particularly since the circuit was built for double power and is now really being "made to work," being 6 db. down (I am receiving these 3 Mc/s pictures on an inverted "T" loft aerial—being on a hill).

However, I am now wondering if the six-and-a-half-year-old rectifier may be getting tired and delivering the full working voltage after about only three hours' operation.—C. Ryder (Edgware).

Most of the valves and the tube by now are probably losing efficiency. When this happens the efficiency of the valves may be very low when first switching on, but might well rise to something approaching normal after they have been working for several hours.

G.E.C. BT.5144

I have just bought a G.E.C. Television Set Type BT.5144 cheaply, because it had a fault—no sound or vision. I have rectified the sound problem but I am unable to get a picture. I have a raster with slight brilliance control. With the exception of two with not too good emission the valves are O.K. I have inserted a new crystal diode in the circuit between valves 4 and 5 (vision I.F. and Video Amp.) and I have tested the associate components as best I can, but I am still a novice at servicing.—F. W. Cochrane (Manchester).

Check valve voltages against the figures given on the service sheet. If all are approximately correct it would appear that the alignment is incorrect, and this, of course, will be so if it is a London-tuned model.

Alignment details are given in the service sheet, but, of course, the actual figures do not apply for Channel 2 working.

PETO SCOTT 1717T

I am servicing a Peto Scott television 1717T. The fault is intermittent and may not show for a week or more—other times will appear every time the set is switched on. The symptoms are as follows: the picture closes up from the bottom to leave about 1in. gap at the bottom of the mask and also folds up so that the last 1in. of picture is reversed. The ECL80 has been changed and the PCL83 checked and both found O.K. All resistors have been checked and found O.K. I do not wish to change circuit condensers if it is not necessary, but I cannot obtain a service sheet for this model.—W. Edson (London, N.1).

Unfortunately it will be necessary to change several capacitors if much tedious work is to be avoided. If you are sure the frame output valve is in order, check the feedback capacitors by substitution and the coupling capacitor from the multi-vibrator to the output section control grid.

PYE B16T

I had the ECC34 valve tested and found O.K. Upon inspection of the chassis I found that R79 (resistor in EHT lead) was burnt, and on testing found it to be 1 K Ω instead of 100 Ω . This was replaced, the chassis returned to cabinet and the set switched

on. Everything appeared to be all right and then a slight popping noise started. This again appeared to be in the neck of the C.R.T. The popping stopped and turning up the brilliance control produced nothing. Sound appeared O.K. The popping started again, this time more rapidly. After about five minutes there was a louder pop, and some smoke came from the power unit. Visual inspection showed that the new R79 was hot (a blob of wax at one end, which dropped off after a short while). After about half an hour the R79 was checked and found O/C. The loud pop was a fuse blowing.

Whilst the set was on, before the blowing of the fuse, the EL38 valve appeared to glow blue.—K. H. Lockyer (Southampton).

It is evident that the tube has an internal short and will have to be replaced.

There is no "way round" this type of direct short as the second anode is directly shorting to the other elements.

BAIRD P1717

On switching on the set the sound comes in normally, but the timebases do not start on all occasions for some time afterwards, twenty minutes to half an hour being nothing unusual.

This fault was noticed first about two years ago on a rather small basis, but it has gradually got worse and during the past few months has been really bad.

It was possible in the early stages of the fault to start the timebases off by just removing the aerial plug from its socket and inserting it again, or by switching the set off and on very quickly when it had been warmed up; but at the present time these operations have no effect on it and the only means of obtaining a picture at the moment is by advancing the shade control well beyond its normal setting until the timebases start and then returning it to normal, whereby the set then functions quite normally in every way until it is switched off and the same trouble encountered all over again.

I would be glad of your advice in this matter.—M. Sparrow (S.E.19).

If a replacement of the 20P1 valve does not effect a cure, then you should make a careful check of the capacitors in the grid circuit of the valve. Replace any which are at all dubious. Suspect leakage in the line output transformer.

VIEW MASTER BRIGHTNESS

After many months of good service the picture and raster suddenly disappeared. EHT very low. Sound normal. Changing many components and valves has restored EHT, but the raster can only be seen in a darkened room and the brightness control works in reverse, i.e., turning the control down the raster appears, but not too bright.

I seem to have changed most components in an effort to find the trouble and would be most grateful for your help and suggestions.—A. G. Ayres (Brighton).

From your description it would appear that the EHT supply has either fallen to a very low value or alternatively your cathode ray tube itself has developed a fault.

The fact that you mention that the brightness control works in reverse merely indicates that when the cathode ray tube is not taking a heavy current a raster may be seen and when the brightness control is turned up and the cathode ray tube current increases it has the effect of causing the cathode ray tube to

fall, with the result that the raster brightness also falls. If the EHT is low it may be due to MR3 or C45 being faulty or even to a fault having developed in the line transformer. If, however, it is the cathode ray tube which is at fault, then nothing can be done to overcome this.

BUSH TV53

I can centre picture on Test Card C after set is really warmed up, but the next time it is put on picture will be out again, sometimes height or width, perhaps both. Very often picture closes in a programme top or bottom of the frame. When set is switched on and picture appears it is slow to fill out vertically. In the last two months I have replaced valves PY86, EY51, PCL83 frame output and PL81, the first three flat, the PL81 48 per cent. I have also had tracking at final anode, which I cured with anti-tracking varnish.—R. G. Stevenson (Northampton).

A voltage check may show that the H.T. line voltage falls slightly after the set has been running for a while. If this happens the H.T. rectifier (PY82) may be losing efficiency.

CONVERTER FOR CHANNEL 10

Now Emley Moor I.T.V. has opened up I wish to build a converter for my home-made TV, which consists of an ex-radar unit with 30 Mc/s I.F. (3701A).

I am interested in the September issue of "Practical Television," which describes an EF50 converter for use on the Winter Hill station. Could this unit be adapted for Emley Moor, or will you be publishing one on the same lines—using surplus spares box components such as EF50 or 6F1 valves—in the near future?

As usual expense is the main difficulty, and I am looking for something which can be built from the components I have collected during the last few years that I have been experimenting with different circuits published in your past editions of "Practical Television."—C. W. Thornton (Rotherham).

The converter to which you refer could be made to tune Channel 10 with very little modification. In the main you will probably find it necessary simply to open the turns spacing of the R.F. and oscillator coils slightly. We are unable to say at the present time whether we shall be publishing an article of the kind mentioned in your query.

MARCONIPHONE VC59DA

For the last two days I have had a persistent intermittent buzzing on sound only, and I wondered if you could suggest the probable cause of this?

Also I would like to know which converter would be most suitable for my set? Could you also let me know if you have published a servicing chart for this receiver yet, or will it be published later?—W. A. West (Hull).

If the sound disturbance decreases on turning down the volume control, and if it is accompanied by flashing on the picture, it might well be caused by external interference. Suspect this possibility if the effect disappears on removing the aerial from the set.

The receiver was dealt with in the July, 1955, issue of PRACTICAL TELEVISION.

Marconiphone Type T2211 converter is suitable.

WIRELESS COILS, CHOKES AND TRANSFORMERS

8th Edition.

Price 6/., by post 6/9.

TELEVISION SETS

TELEVISION, 9in. models, £7/10/-; 12in. models, £15; all makes; working; carriage paid. TOMLINS, 127, Brockley Rise, Forest Hill, S.E.23.

SEVERAL EARLY MODELS, 9in. Television, complete and mostly working, £5/5/- each, carriage paid. TOMLINS, 127, Brockley Rise, Forest Hill, S.E.23. (FOR 5497.)

GUARANTEED TELEVISION, 12in. models, first-class picture, 5-channel, £26 each, carriage paid. THE GRAMOPHONE SHOP, 19-21, Brockley Rise, Forest Hill, S.E.23.

TELEVISION, 12in. Televisions, £13/10/- each, carr. paid. TOMLINS, 127, Brockley Rise, Forest Hill, S.E.23. (FOR 5497.)

5-CHANNEL TELEVISIONS, 12in. screen Ferguson 988, Ekco 161, etc. £25 each. A good selection of 12in. T/Vs (London), 100% condition, from £15; 9in. from £7. Also 12in. T/Vs, slight faults, from £7. 9in. from £4. TYLER TELEVISION, 63, Lee High Rd., Lewisham, S.E.13. (LEE 5979.)

COMPONENTS

VALVES at 5/6: 6C4, 6AG5, 9001, 6AM6, EL91, VR99, VR102, 3A5, 12SK7M, 12A6, 807E, 12SL7, EP54, 6AG7, EC52, 6K7GT, 6SH7M, 6AC7, Pen46. At 4/-: EF50, RK34, EP36, VP23, T111, Command Rxs, 1.5-3.0 mc/s. brand new, with valves, 55/-; BC454, 3-6 mc/s, 45/- (post 3/-). Condensers, var., spindled ceramic, 15, 25 or 50 pfs., 1/3; 75 pfs., 1/6; butterfly, 25 pfs., 1/6. Speakers, new 8in., in round grey metal case, 2/7 (p.p. 3/-). Brand new R.F. 26, 27/6 (postage 2/6); RP24, RP25, 10/6. Dynamotors (post 3/-), 12v to 250v, 65 mA and 6.3v, 2.5 A, 10/6. Eddy-stone, 12v to 190v, 75 mA, cased, 15/-; 11v to 300v, 200mA, cased, 15/- (carr. 8/6). Throat Mics, USA, new, 2/6. Metal Rectifiers: 240v, 30 mA, 3/6; 600v, 30 mA, 6/-; 500v, 500 mA, 10/6; 1,000v, 30 mA, 7/6. Wafer Switches, 1 pole 11 way 2 Bank, 3/6; 4 P 3 W, 4 P 2 W, 1 P 6 W 5 B, 2/7. L.F. Amplifier 178, 13.0 mc/s, with valves, 15/6 (postage 2/6) each. I.F.T.s, 10/13 mc/s cased, new, 1/3. Chokes, L.F. Ferranti, 10H, 120 mA, screened, 7/6; 10H, 200 mA, 8/6; 5H, 200 mA, 5/6. Vibrapacks: Mallory 12v to 250v, 30 mA, synch. reversible, 18/6; 12v to 150v, 30 mA, smoothed, filtered, 15/6; 2v to 480v and 150v (dual-vibrator), smoothed, filtered, 30/- (post. each, 3/-). List and enquiries; s.a.e. please! Terms: c.w.o. postage extra; immediate despatch. W. A. BENSON (PT), 136, Rathbone Rd., Liverpool, 15.

IDENTIFICATION UNITS, RFP No 1, ZC13312, each 2/6, plus carr. (7/6), all as new and complete with free data for conversion to T.V. Each unit contains many useful components and the following valves: one 5Z4G, one VR54, five VR65, two VR68, three VR92, one CV63 and one VR137, in totally enclosed case. From J. A. B. JACOBSEN LTD., 22, Ritherdon Rd., Balham, London, S.W.17.

LOUDSPEAKERS repaired promptly. MODEL LOUDSPEAKER SERVICE, Bullington Rd., Oxford

RATES: 4/- per line or part thereof, average five words to line, minimum 2 lines, Box No. 1 - extra. Advertisements must be prepaid and addressed to Advertisement Manager, "Practical Television", Tower House, Southampton St., Strand, London, W.C.2.

VCR97 tube/time bases, Power and Receiver Units, £10; 12in. Magnetic Tube, time bases, Power and Receiver Units, £15; walnut veneered Console TV Cabinet with castors, £6; Valves, EF50 4/-, EA50 1/6, EBC33, 6/6, EL32 5/-, HAYWARD, 70, Meadvale Road, Croydon, Surrey.

TELEVISION INTERFERENCE, Receiver Filters, High-Pass E.5037, 30/-; Low-Pass E.5031, 30/-; Composite Band III, 49/6; Transmitter Filter E.5043-80dB, 1kW, £6. LABGEAR (CAMBRIDGE) LTD., Willow Place, Cambridge.

SERVICE SHEETS, Radio TV, 5,000 Models Lists 1/-, Enquiries s.a.e. TELRAY, 11, Maudland Bk., Preston.

SITUATIONS VACANT

THE ROYAL NEW ZEALAND AIR FORCE

has vacancies for

British Ex-servicemen

in the following trades:-

**RADIO MECHANICS
RADAR MECHANICS**

Commencing pay between £10.16.2 per week and £17.1.3 per week according to previous experience. Ages between 21 & 40, married or single. This is an opportunity to start a new life in New Zealand with excellent conditions of service and free passage. Limited vacancies also exist in other trade groups. Write for full information to:-

THE ROYAL NEW ZEALAND AIR FORCE HEADQUARTERS (Dept. PTY)

Adelphi Building

John Adam Street, London, W.C.2.

REQUIRED

for Domestic Television Production:

Experienced Final Tester.

Several Alignment & Functional Testers.

Male & Female Electrical/Mechanical Inspectors.

(youths would suit)

Continuous employment for suitable personnel, 44-hour, 5-day week, with opportunities for overtime. Top rates of pay. Clean working conditions. Canteen, Social Club.

**APPLY: Personnel Officer,
Peto-Scott Electrical Instruments Limited**

Addlestone Road, Weybridge, Surrey

ELECTRADIO offers Jason F.M. Tuner Kits at £5/7/6. Weymouth Coils, Coil Packs, Dublier & W resistors, 6d.; capacitors. All Radio and TV Components, Valves, etc., stocked. Send for lists: 18, Broadlands Av., Keynsham, Somerset.

I.T.V. CONVERTERS from £3/19/6, self-contained, guaranteed. H.P. without fuss. Aerials from 14/6. Trade enquiries invited. G. A. STRANGE, Dept. P, North Wrexall, Chippenham, Wilts.

WANTED

WANTED, Valves 6F13, 6F15, 6U4, EY51, 5Z4, ECL80, KT61, 25A6, etc.; prompt cash. WM. CARVIS LTD., 103, North Street, Leeds, 7.

ALL TYPES of new radio valves wanted, small or large quantities; cash payment. R. H. S. LTD. (T), 153, Swan Arcade, Bradford, 1.

ALL TYPES OF VALVES REQUIRED for cash. State quantity and condition. RADIO FACILITIES LTD., 38, Chalcot Road, N.W.1. (PRImrose 9090.)

FOR SALE

1,000s & 1,000s of Service Sheets. Large purchase enables us to offer Service Sheets for sale this month at hire charges. Take advantage of this sensational offer. Send s.a.e. with enquiry now! 60-page Catalogue; Engineers! Experimenters! Labs! It's packed with new servicing components, exact replacements and fully guaranteed. Don't take chances—fit the best. Price 1/-, post fr.e. Full Elstone Transformer Range, incl. C.R.T. Isolation Trans. 2v, 4v, 6.3v, 10.8v, 13.3v; 20% boost optional; state heater voltage required; mains prim.; 18"., p.p. 9d. Attention! Northern customers: "Labgear" Band III 3-element Aerial, 22/6, post free. "Labgear" Cross-over Units, 12/6, post free. "Air Spaced" Co-axial Cables, 8d. per yd., p.p. 6d. 12 yds. Orders by return. M. FOY, 6, Wykebeck Gdns., Leeds, 9, Yorkshire.

TELEVISION AND TUBE BARGAINS, 12in. 5-channel Ferguson, tunable anywhere, M/No. 988, £25 each. Reclaimed and guaranteed C.R. Tubes, 9in. £3/15/-, 12in. £5, 14in. £5, 15in. £5/10/-, 17in. £6/10/-, plus 5/- carriage. All makes in stock. Phone Ladbroke 1734, or call 1070, Harrow Road, London, N.W.10.

MISCELLANEOUS

ENGRAVING—Amateurs and trade surplus can be undertaken by setting in touch with A. G. ENGRAVING, now at 292, Earsfield Road, London, S.W.18. Tel.: BAT 9897. (Engravers to well-known makers of Electronic Equipment used by the Aircraft industry, A.W.R.E., etc.)

TAN IN 24 HOURS—Super-tonic Sunray Lamps, ultra-violet infra-red combined; automatic exposure; controlled emission; all mains; listed £7/10/-, our price 80/- S.A.E. brochure, Dept. 16, SCIENTIFIC PRODUCTS, Cleveleys, Lancs.

(Continued on page 296)

MAKING YOUR OWN? Telescopes. Enlargers. Binoculars. Microscopes. Projectors, or, in fact, anything that needs lenses. Then get our booklets "How to Use Ex-Gov. Lenses & Prisms." Nos. 1 & 2. Price 2/6 ea. Also our stereo book, "3-D Without Viewers," price 7/6. Comprehensive list of lenses, optical, radio and scientific gear free for s.a.e. **H. W. ENGLISH**, Rayleigh Road, Hutton, Brentwood, Essex.

SERVICE MANUALS/SHEETS. Tel/Radio for hire, sale and wanted. S.A.E. enquiries. **W. J. GILBERT (PT.)**, 24, Frithville Gardens, London, W.12.

EDUCATIONAL

INCORPORATED Practical Radio Engineers home study courses of Radio and TV Engineering are recognised by the trade as outstanding and authoritative. Moderate fees to a limited number of students only. Syllabus of Instructional Text is free. "The Practical Radio Engineer" journal, sample copy 2/-. 6,000 Alignment Peaks for Superhets, 5/9. Membership and Entry Conditions booklet, 1/-. All post free from the **SECRETARY, I.P.R.E.**, 20, Fairfield Road, London, N.8.

FREE! Brochure giving details of Home Study Training in Radio, Television and all branches of Electronics. Courses for the Hobby Enthusiast or for those aiming at the A.M.E.I., I.R.E., City and Guilds, R.T.E.B. and other Professional examinations. Train with college operated by Britain's largest Electronics organisation. Moderate Fees. Write to **E.M.I. INSTITUTES**, Dept. PT28, London, W.4.

LEARN IT AS YOU DO IT—we provide practical equipment combined with instruction in Radio, Television, Electricity, Mechanics, Chemistry, Photography, etc. Write for full details to **E.M.I. INSTITUTES**, Dept. PT47, London, W.4.

ALUMINIUM, LIGHT ALLOYS, BRASS, COPPER, BRONZE,

IN ROD, BAR, SHEET, TUBE, STRIP,
WIRE, ANGLE, CHANNEL, TEE

3000 STANDARD STOCK SIZES

H. ROLLET & CO., LTD.

6, CHESHAM PLACE, LONDON, S.W.1.
SLOane 3463

Works:

36, ROSEBERY AVE., LONDON, E.C.1.

Branches at Liverpool, Manchester,
Birmingham, Leeds.

"No Quantity too Small"

RADIO AND TELEVISION COMPONENTS

All parts in stock for:
Viewmaster, Soundmaster, Telemek, etc.
Easy Terms available.
21d. stamp (only) for Catalogue.

JAMES H. MARTIN & CO.
FINSTHWAITHE, NEWBY BRIDGE,
ULVERSTON, LANCs.

SPENCER-WEST TYPE 50 BAND III CONVERTER



Ask for Leaflet Ref. 2356 which gives
full technical details of this wonderful
new unit.

Perfect results with any receiver.
From your dealer or on 7 days'
approval from:

SPENCER-WEST, LTD.

Quay Works, Great Yarmouth

Phones: 4794 & 3009

OPPORTUNITIES IN TELEVISION

144 pages

Free!

Television offers unlimited scope to the technically qualified. Details of the easiest way to study for **A.M.B.E.I., I.R.E., R.T.E.B., Cert., City and Guilds, Television, Television Servicing, Sound Film Projection, Radio Diploma Courses, etc.**, are given in our 144-page Handbook "**ENGINEERING OPPORTUNITIES**" which also explains the benefits of our Appointments Dept.

We Guarantee

"NO PASS—NO FEE"

If you are earning less than £15 a week you must read this enlightening book.

Send for your copy NOW—FREE and without obligation.

WRITE TODAY!

British Institute of Engineering Technology
237, College House,
29-31, Wright's Lane,
Kensington, W.8. **BIET**

NEW VALVES

(From Government and Trade Surplus Sources, Bankrupt Stocks, etc., No Rejects. All Guaranteed. Unused and Boxed.)

DF91	7/6EK32	8/6174	7/66SQT
DK91	7/6EK90	8/3S4	7/6
DAF91	7/6EL32	6/63V4	7/66SS7
DL92	7/6EL41	10/62C34	3/68V6
DL91	7/6EL84	10/62X2	4/68X4
DK92	7/6EY51	11/65U4	8/68X5
DK96	9/6EZ35	8/524	8/612A6
DET19	1/6EZ40	8/6AC5	6/612AH7
EA50	1/-KT33C	9/66AK5	6/612AT7
EB34	2/6KT44	7/66AL5	6/612AU7
EB91	6/-KT66	10/6AM6	6/612AX7
EB33	8/6PL81	10/66AT6	8/612H6
EB41	9/6PL82	10/66BE6	8/612J5
EBF90	9/-PY81	8/66BAG	8/612J7
ECC81	9/-PCF82	11/68B7	8/612K7GT
ECC84	11/6PCC81	10/68W6	8/6
ECH35	8/6PCC81	11/68B8	7/612K8GT
ECH81	9/-RK34	3/66B8	7/6
DCH42	RL37	6/6C6	6/612Q7GT
10/-SP41	4/66C4	5/6	8/6
ECF82	11/6SP61	4/68W6	2/612SC7
ECL80	9/6UBC41	10/68J5	5/612SQ7
EC52	5/6UB41	10/68J6	7/612SK7
EC90	6/6UL41	10/68K7	5/635L6
EP36	6/6UY41	8/68K8	9/6307
EP37A	6/6V23	5/68L6	10/632
12/6HL23DD	8/6V7	7/6831	50/-
EF30	6/6V7	8/6831A	60/-
EF41	10/6VR116	6/68T7	7/6951
EF50	5/6VR150/30	6/6SA7	8/6955
EF35	9/6V111	7/66SH7	7/695783
EP30	8/6VU111	2/66SJT	10/6
EP35	10/6X85	10/6	7/68012
EF91	6/6OZ4A	6/66SK7	7/69001
EF92	5/6IR5	7/66SL7	6/69002
EF95	6/6IS5	7/66SN7	7/69003

MATCHED PAIRS.—EL84, 23/-; 6V6, 16/6; KT66, 22/-; 6BW6, 17/6; EL32, 14/-; 807, 16/6; KT33C, 19/6.
OBsolete TYPES.—Large range available. British, U.K. Side Contact. Continental, etc., S.A.E. please with enquiries. No lists available.

C. LAWRENCE (Dept. 8)

15D, Chipstead Valley Road, Coulsdon, Surrey.

Post and packing 6d., free over £1. Mail order only.

"VIEWMASTER"

Printed Circuit Converter
No Patterning
or Breakthrough

We can supply the complete kit of parts including valves, **£5.0.0**

Send for detailed list of this kit and others, **POST FREE.**

Set of coils for conversion of Viewmaster receiver, **£1.15.0**

AUDIO LTD.,
Tower Road, London, N.W.10

News From the Trade

Channel Band III Converter

A NEW and improved Band III converter is announced by Channel Electronics and it is claimed that this model is receiving London, Lichfield or Winter Hill at Burnham-on-Sea, using a standard commercial double-four aerial and a normal receiver without pre-amplifier. It is housed in a gold and brown finished case and has the following specification:



The new Channel Band III Converter.

Two Channels: Band I—Channel 1-5 (as ordered). Band III—any one Channel 1-9 (as ordered).

Controls: Front—Fine tuner; Band I/Band III switch; mains switch, also controls TV receiver. Rear—gain control.

Connections: Input—Band I and Band III—co-axial 80 ohms. Output—to receiver. TV receiver mains socket.

Mains: A.C. only—200-250 volt, adjustable (supplied as 230 volts), fitted with 6ft. of three-core P.V.C. mains flex.

Circuit: Neutralised cascade R.F. stage (ECC84), transformer-coupled to mixer/oscillator (ECF82 or ECF80). Integral power pack employing metal rectifier and adequate smoothing.

Performance: Very high gain—average 25 db input to output. Band width approximately 5 Mc/s.

Servicing: Quick access to under chassis for easy servicing or re-alignment.

Construction: Metal case, with fine mesh expanded metal grille front and top for adequate ventilation. Rear-removal chassis, of bright cadmium-plated steel. Removable bottom plate, fitted with non-scratch rubber feet.

Finish: Metal-mesh front and top in high-lustre gold, contrasting with remainder in dark brown. Control knobs, dark brown/gold to match. Price: £7 10s. 0d. retail.—Channel Electronic Industries, Ltd., Dunstan Road, Burnham-on-Sea, Somerset.



A Re-designed BBC Television Aerial

A NEW type array which was recently introduced to the Aerialite range, and which is already being marketed, is the Model 93 Unex.

With a re-designed centre casting and the introduction of factory pre-assembly, the unique X-type aerial has been further improved. Now, all Unex models are supplied with elements that merely swing into position and are locked by wing nuts.

Due to the new design of the backing plate and the phenolic moulded (waterproofed) insulator, the Unex is easier to erect and easier to install. There are no assembling difficulties and, moreover, no loose parts.

The electrical characteristics of the Unex are the same as the old version, which are:

Forward gain, 3.0 db. Max./min. ratio, 25 db. Acceptance angle, 176 deg.

Models available are:	Retail Prices
93/XO Array only	£2 0 0
93/S 6ft. mast Single Lashing Bracket	£3 14 6
93/T 10ft. mast Double Lashing Bracket	£6 15 0
93/CL Cranked Arm and Single Lashing Bracket	£3 14 6

Horizontally polarised Unex models are available, if required.—Aerialite Ltd., Castle Works, Stalybridge, Cheshire.

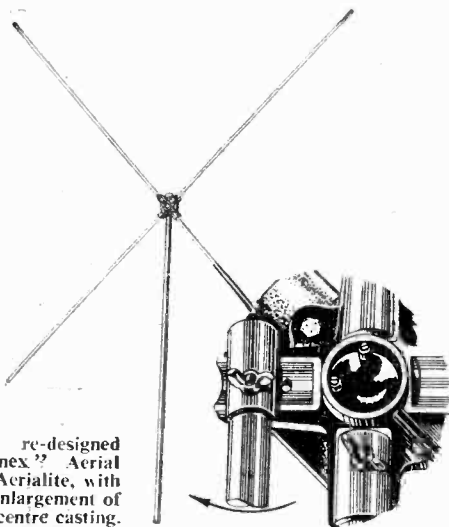

The re-designed "Unex" Aerial by Aerialite, with an enlargement of the centre casting.

QUERIES COUPON

This coupon is available until JANUARY 21st, 1957, and must accompany all Queries sent in accord with the notice on page 290.

PRACTICAL TELEVISION, JANUARY, 1957

Published on the 22nd of each month by GEORGE NEWNES, LIMITED, Tower House, Southampton Street, Strand, London, W.C.2, and printed in England by W. SWEAIGHT & SONS, Essex Street, London, W.10. Sole Agents for Australia and New Zealand: GORDON & GOTCH (A.SIA), LTD. South Africa: CENTRAL NEWS AGENCY, LTD. Subscription rate including postage, for one year: Inland 17s. 6d., Abroad 16s. 6d. (Canada 16s.). Registered at the General Post Office for the Canadian Magazine Post.

BAND III CONVERTERS

200 ONLY AT **49/-**

(C.O.D. 1/-)

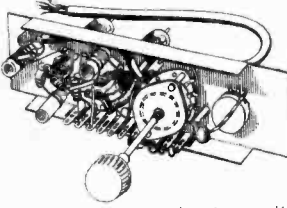

For internal conversions — fully wired chassis, approx. 9in. x 2 1/2 in. x 2in. deep. Complete with 2 valves EF91, contrast control, aerial and band switching.

Coaxial plug and one knob supplied. Suits 6.3 v. 3 A. and 12.6 v. 15 A. heater chains. ALL NEW COMPONENTS and VALVES. For complete converters see advert., page 288.

50 mixed new resistors 9/- (post 1/-). 40 of 1/4 and 1/2 W. and 10 of 1 and 2 W., all standard values Dubilier, Erie, Morgan.

40 mixed new silv. mica and ceramic condensers 9/- (post 1/-), standard values 1/2 pf. to 6,000 pf. Lemco, T.C.C., etc.

Pre-amplifiers less power pack, with EF80 valve 20/-. With power pack in metal case 40/- (post 2/-). When used with converter, also amplifies Band 3 signal.

GLADSTONE RADIO, P.O. Box 8,

82b, HIGH STREET, CAMBERLEY, SURREY

TECHNICAL TRADING CO.

COMMAND RECEIVERS. American, 34.58 mc/s. 10 B7C Valves and 12A6 output, continuous tuning Ideal TV sound, 45°. **AHRROR GALVANOMETERS,** new, 45 sec. damping, high sensitivity, all adjustments, top make, in case, 66. **PICTURE-SCREEN FILTERS,** 14in. x 1 1/2in., laminated glass, 5-. **TRANSCEIVERS No. 38** complete 5 valves, 29-. **NEW CONDENSERS,** 10 pF., 5 mid., our assortment, 50 for 6.6, 100 for 12-. **SPECIAL BARGAIN 12 V. 4 AMP. RECTS.,** 9/6 F.A., £5 10oz. Iron Selenium, Full Wave, heavy, compact. **WIDE ANGLE TRANSFORMER KITS,** boxed, consisting: (a) Line Transformer 14 Kv., ceramic base, BY51 mountings, ferroxcide core, 17.6 with instructions. (b) Frame Transformer for ECI.80, 9/6. (c) 250 ma 7 II Smoothing Chokes, 7/6. **COMPLETE KIT AS ABOVE.** Ship Price for 3 Items, 30-. Width Coils to match above, 4-. ea. **WAVELENGTH COILS** matching above, 17/6. **WAVE FOCUS MAGNETS,** 12/6. **ION TRAP MAGNETS,** best quality 3/6. **ALADDIN FORMERS** 1in. with slug, 4- doz. **VISCONOL CONDS.,** .002 mf., 18 Kv., 4/9. **DEFLECTION COILS,** Standard 35 mm., iron cored, 9/6. **BOWLER HATS, 1-. LOUDSPEAKERS,** Top makes 7 x 4 elliptical, 17/6. 6 1/2in. P.M., 10-. 8in. P.M., 12/6. Ditto. ex. EQPT. 7/6. 12" heavy hi-flux P.M. hammer finish 44/10.

TELESCOPE 16 mm. TALKIE PROJECTORS at far below market price. L516 sound silent built in push-pull amplifier, separate heavy 12in. speaker, A.C. D.C. 110/250 complete for mains operation, tested, good condition. £33. Mint Condition. £38.

TV TABLE CABINETS, Less mark, brand new, boxed, 14in., 19-; 17in., 29/6. 7/6 cart. **WIREWOUND PRE-SET POTS,** 500p, 1 K., 2.5 K., 5 K., 10 K., 20 K., 25 K., 50 K., 2- ea. **AMPHENOL HOLDERS,** Octal, Mazda, Noval, B7C, B9A, 6- doz. B9C W Screen, 1/6 ea. **Tube Holders,** Octal, 6d. **Duocecal, 1/-.** **MEG. POTS D.P. SWITCH,** 3 1/2in. spindle, small type, 3/6. **Ditto, 1 1/2in. spindle, 2/6.** **PERSISTANT RES. ASSORTED,** 1/2, 1/3, 1/4, 1/2, 1, 2, 5, 10, 20, 50, 100, 1000. **WIDGET CERAMIC CONDENSERS,** 10, 20, 50, 300, 1,000, 3,000, 6- doz. Midget 16 1/2 350 v. 73/2. Midget 32 32 250 v. 2/6. Midget 8 x 250 v. 1-. Midget 100 mid x 6 v., 1-. 60 100 350 v. 6-.

IMPERIAL F.M. A.M. CHASSIS, Latest high finish German import, gold black knobs and scale, special F.M. tuner, standard miniature valves, opportunity at 15 Gns., cart. 5/-.

GUARANTEED VALVES, BB34 1/6 - SP6A 2/6 - SP6L 3- - SP210 3/6 - 6AK5, 6JG5, 4 - 6SK7, 4/6 - 6J6, 6J7G, 6F9E, PEN25, 5 - 6AC5, 807, EL91, 5/6 - 6K7M, VR150 30, 6 - 6V6G, 6C5GT, 6C4, 6F6G, 6K6, 6/6 - ECC31, 8 - 12A7, U22 8/6 - 6F33, 9/6 - 6L6 (Metal), 11 - B13, 39 - Postage 1/- in £1 (9 in £1 Special Trans.) minimum 6d. No C.O.D. 1,000 OTHER BARGAINS TO CALLERS AT:

350/352, FRATTON ROAD, PORTSMOUTH
PORTSMOUTH'S RADIO, TV AND TOOL SHOP

NEW-MAX ELECTRONICS LTD.

TUBES. Reclaimed and guaranteed Cathode Ray Tubes 12in., £5; 14in., £6.10.0; 15in., £7.10.0; 17in., £8.0.0. Heater Cathode Tubes half-price. Just arrived: brand new fully guaranteed Brimar C.17 F.M. Tubes, £15.15.0, inc. p. & p. Callers only until after Christmas.

500 TV SETS. Always in stock 500 H.P. reprocessed TV. sets — all makes and sizes, spares, valves, test equipment, etc. TV. Projection units with focus and frame coil, £6.0.0 inc. p. & p.

IMPERIAL MINOR AM FM Radiogram Chassis. L.W., M.W. & F.M. Size 12 x 6 x 6 1/2 in. high, £15.15.0, + 8in. Speaker £1 extra. **IMPERIAL MAJOR AM FM** Radiogram Chassis L.W., M.W., S.W. & F.M. Size 20 x 10 x 6in. high. Piano keyselector, ferrite rod, directional aerial. Base & Treble control. 3 speakers for stereophonic sound. £25.0.0, p.p. extra.

STOP PRESS OFFER:

NEW 14in. 13 channel TV table receiver, well-known make with maker's guarantee. List Price 64 gns. **Our Price 49 gns.**

220, Edgware Rd., London, W.2.
Tel. PAD. 5607

PULLIN
SERIES 100
TEST METER
AC/DC 10,000 Ω/V
21 RANGES
100μA to 1000V
COMPLETE IN CASE
WITH TEST LEADS
COILS AND PRODS
FULLY GUARANTEED

SENT POST FREE FOR £2.10.0 AND NINE FURTHER MONTHLY PAYMENTS OF £1.4.6. CASH PRICE £12.7.0.

FRITH RADIOWAVE LTD

69-71 CHURCH GATE LEICESTER
& 28 HIGH ST NEWPORT PAGENELL Bucks

TELEVISION COMPONENTS

in stock for the
P.T. SUPER-VISOR, TELE-KING, VIEWMASTER, E.E. TELEVISOR AND BAND III and wide angle modifications
Price lists available on request to:
J. T. FILMER, Maypole Estate, Bexley, Kent.
Tel.: Bexleyheath 7267

OSMOR CONVERTERS
LONDON, LICHFIELD, WINTER HILL. Simple, efficient for all TV (including TRF). Guaranteed no break-through of Band I or re-radiation. Approx. 1 hr. to build. Will convert any Band III channel to any Band I channel. AC or DC Kit. £3.5.0. Ready wired, £4.0.0. Post free. Terms: C.W.O. Post orders only.
THE ELECTRONIC SUPPLY CO.
29, Leigh Rd., Highbury, London, N.5

Improve your TELEVISION RECEPTION

by J. Cura & L. Scanley.
Over 100 "Tele-Snaps"
5 - Postage 4d.

- TELEVISION RECEIVER SERVICING VOL. 1.** By E. A. W. Spreadbury, 21/- Postage 1/-.
- TELEVISION RECEIVER SERVICING VOL. 2.** By E. A. W. Spreadbury, 21/- Postage 1/-.
- PRACTICAL TV AERIAL MANUAL FOR BANDS I AND III.** By R. Laidlaw, 4/6 Postage 4d.
- SUPPRESSING RADIO & TELEVISION INTERFERENCE.** By B. L. Morley, 5/- Postage 4d.
- RADIO, TELEVISION & ELECTRICAL REPAIRS.** Odhams Publication, 16/- Postage 1/-.
- RADIO VALVE DATA.** By Wireless World, 4/6 Postage 6d.
- TV FAULT FINDING DATA PUBLICATION NO. 5.** 5/- Postage 4d.

The MODERN BOOK CO.

BRITAIN'S LARGEST STOCKISTS of British and American Technical Books
19-23, PRAED STREET, LONDON, W.2
Write or call for our catalogue.
Phone: PADDINGTON 4185.
Open 6 days 9-6 p.m.

VALVES • SAME DAY SERVICE

All Guaranteed New and Boxed

14v. midget, 1R5, 1S5, 1T4, 1U5, 3S4, DAF91, DF91, DK91, DL92, DL94, any 4 for 27/6.

1A7GT	12/6	6K8G	7/9	CB33	14/-	ECH81	8/6	PCC84	8/6
1C6GT	11/-	6K8GP	8/6	CV1	11/9	ECL80	10/-	PCF80	7/6
1D5	14/6	6Q7GT	9/6	D1	3/6	EP36	4/6	PCP82	11/6
1H5GT	11/-	6SN7GT	7/9	D15	6/6	EP37A	9/-	PEN36C	16/-
1N5GT	11/-	6U4GT	14/6	DAC32	11/-	EP39	6/-	PEN46	6/6
1R5	8/6	6V6GT	7/6	DAF96	8/6	EP40	12/-	PL81	11/9
1S5	7/6	6V8GT	7/6	DCC90	8/6	EP41	9/6	PL82	9/-
1T4	7/3	6X4	7/-	DF33	11/-	EP42	12/-	PL83	11/9
3A5	6/6	6X5GT	6/9	DF96	8/6	EP50	7/6	PY60	9/-
3Q5GT	9/6	7B7	8/-	DH76	8/6	EP80	9/-	PY81	9/-
3S4	7/6	7C5	8/-	DH77	8/6	EP85	8/6	PY82	7/9
3V4	8/6	7C8	8/-	DK32	12/6	EP86	12/6	PZ30	18/-
5U4G	8/-	7H7	8/-	DK82	9/6	EP89	10/-	SP41	3/6
5Y3GT	7/6	7S7	9/-	DK96	8/6	EP91	7/6	SP61	3/6
5Z4G	9/-	7Y4	8/-	DL33	9/6	EP92	8/6	U25	12/6
6AK5	5/-	10C2	10/-	DL35	8/6	EL33	6/-	U50	12/6
6AL5	6/9	10F9	9/6	DL36	8/6	EL33	14/-	U76	8/-
6AM5	5/-	10P1	13/6	EA50	2/6	EL41	10/6	U78	7/-
6AQ5	7/6	12A1H	10/6	EA1C80	7/9	EL42	11/-	U404	8/6
6A7S	7/6	12A17	8/6	EAQ1	8/6	EL84	10/6	UADC90	11/6
6A7S	8/6	12A16	7/6	EAF42	10/6	EL91	5/-	UAF32	10/6
6BA6	7/6	12A17	7/6	EB91	6/9	EM34	10/-	UBC41	8/9
6BE6	7/6	12J7GT	10/6	EB33	7/6	EY51	10/6	UBF80	11/9
6B76	7/-	12K7GT	8/6	EBC41	10/-	EY86	11/6	UCH42	10/3
6B77	13/6	12K8GT	14/6	EBP60	9/6	EZ40	8/-	UF41	9/-
6B78	7/6	12J7GT	8/6	ECC40	11/6	EZ41	8/-	UL41	10/-
6C9	10/-	14S7	14/-	ECC81	9/-	EZ90	8/6	UL84	11/6
6P1	13/-	2516GT	9/6	ECC82	7/6	EW4500	10/-	UU9	9/-
6P6G	6/6	25Z4G	9/6	ECC83	9/-	GZ32	12/6	UY21	14/-
6P12	9/-	25Z6GT	9/6	ECC84	12/6	HV R2A	6/6	UY41	8/6
6F13	13/-	35L6GT	9/6	ECC85	9/6	KT3C	10/-	UY85	10/6
6F15	13/-	35Z4GT	8/-	ECC91	6/-	KT83	7/6	W76	8/6
6J6	6/-	35Z5GT	9/-	ECP80	12/6	MU14	8/6	W77	6/6
6J7C	7/6	50L6GT	8/-	ECP82	13/6	N77	6/6	X79	12/6
6K7G	5/-	80	8/6	ECH35	10/3	N78	14/6	Y83	7/6
6K7GT	6/-	B36	15/6	ECH42	10/-	P61	3/6	Z77	7/6

Postage 5d. per valve extra.

READERS RADIO

24, COLBERG PLACE, STAMFORD HILL, LONDON, N.16 STA. 4587



QUALITY TELEVISION COMPONENTS

SCANNING COILS, 6/10 KV. R.F., E.H.T. UNITS, E.H.T. and OUTPUT TRANSFORMERS, LINE FLY-BACK E.H.T. UNITS.

COIL KITS FOR "P.T." BAND III CONVERTERS

Write for illustrated list (Publication 75)

HAYNES RADIO Ltd., Queensway, Enfield, Middlesex.

CRT Transformers specially designed to deal with interelectrode shorts. Varnish impregnated with tag panel, and 20% booster tap. 22/6 ea. **Mains transformers** of all types. If we haven't got it we will make to specification. **TV electrolytics**, brand new, can type first quality only. 64-120 mfd., 450 v., 25/-; 100-200 mfd. 350 v., 26/6; 200-250-250 mfd., 37/-; 100 mfd. 450 v., 15/-. Electronic equipment of every description. Cash with order, please. Postage up to £1, 2/-; £2, 2/6; £3, 3/-; £5, 4/-.

HOWORTH,

51, Pollard Lane, Bradford, 2, Yorks.

Tel. 37030

SURPLUS TELEVISION STOCK AVAILABLE

IDEAL FOR THE HOME CONSTRUCTOR

Limited number of 14in. table model cabinets, modern design, 19/6d. each. packing and postage 8/- extra. 14in. glass 5/-, 14in. mask 6/-, escutcheon and plate 1/-.

Complete set of time base transformers and deflector coils, line output transformers, 10-15 Kv. £2, postage and packing 1/- extra.

Boxes of 100 assorted resistances, 1/2 and 1/3 watt, 12/6, postage and packing 6d.

Electrolytic condensers, 100+200mf., 275 v., 5/1 each. 250 mf., 25 v., 1/1 each. Pots., pre-set 5k, 25k, 100k, 500k, 1M, 1/9 each. Pots., long-spindled, 25k, 100k, 500k, 1M, 3/- each. Pots., long-spindled, 1M with double-pole switch, 4/- each.

Focus units for 14in. and 17in. tubes, 9/9 each. Ion traps for 14in. and 17in. tubes, 1/2 each.

Many other components available. Write for catalogue to

LIGHT DIFFUSION LTD.

FRANKLIN ROAD, PORTSLADE, SUSSEX.

HANNEY OF BATH offers:-

ERIE RESISTORS, all values from 10Ω to 10MΩ. Type 9 (4 watt), 6d.; Type 8 (1 watt), 8d.; 10 watt Silertex wire-wound resistors, all values 10Ω to 10KΩ; 2/- each.

SILVER MICA CONDENSERS, top quality, close tolerance (up to 33 pF ± 1pF, from 33 pF up -1%), 1.5 pF to 300 pF, 1/- each; 316 pF to 615 pF, 1/3 each; 1,000, 1,500, 1,800 and 5,000 pF, 2/- each.

SILVER CERAMIC CONDENSERS, .3 pF to 500 pF, 1/- each. Hi-K Midget ceramics, 500, 820, 1,000, 1,500, 2,200, 3,000, 5,000 and 10,000 pF, 1/- each.

COILS, Osrom "O" full range 4/- each; Weymouth "H" type, full range, 3/9 each; Weymouth C12W2 coils, TRF, 10/3 pr.; Denco Type "C" TRF, 9/- pr.; REP Crystal set coils, 2/6; single TRF, 4/-; Matched pr. TRF, 8/-; Denco 465 Kcs midget I.F.s, 12/- pr.; Weymouth, ditto, 15/- pr.

COILPACKS, Osrom Type HO, 50/5; H.F. stage for HO, 21/-; Osrom TRF (L. and M.W. only), 42/-; Denco CP.3 370 and CP.3 500, 44/9 each; CP.4L and CP.4M, 35/- each; CP.4L G and CP.4M G, 43/5 each.

FERRITE ROD AERIALS, M. and L.W., 12/6 each by Denco, REP and Teletron.

TRANSISTORS, MULLARD OC.50, OC.51, OC.72, 30/- each; OC.70, 21/-; OC.71, 24/-; BRIMAR 3X100N, 3X101N and 3X300N, 40/- each; 3X301N, 45/-; 3X302N, 50/-.

GERMANIUM DIODES, BRIMAR GD3, GD4 and GD5, 7/6 each. MULLARD OA70, 5/-; OA71, 6/-; G.E.C. GEX34 and GEX35, 4/- each.

METAL RECTIFIERS, Full range of the popular types of Westinghouse and Brimar available.

ALL COMPONENTS AND PRICED PARTS LIST ARE AVAILABLE for:

Osram 912 AMPLIFIER, Passive Unit and Pre-Amplifier. MULLARD 510, 20 watt, 3 watt Amplifiers and Pre-Amplifiers. MULLARD. OSRAM. WIRELESS WORLD. DENCO and TEL. F.M. UNITS. HIWAYMAN. VIEWMASTER. V-MASTER 3 STATION TUNER CONVERTER. TELEKING. MAGNAVUE, etc., etc. Send 2d. stamp for lists required. Please add sufficient postage to orders under £3.

L. F. HANNEY

77 LOWER BRISTOL ROAD, BATH

Tel.: 3811

SAFE, RELIABLE E.H.T.

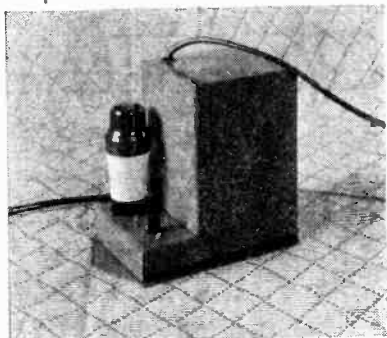

PRICE **£7.10.0** COMPLETE

The **NERA R.F. E.H.T. UNIT** has been designed to provide a safe and reliable source of D.C. high voltage for C.R. Tubes including the new wide anode and aluminised types. The output is continuously variable between 8 to 12 kV at approximately 500 microamps. The unit is completely wired and tested ready to switch on, requiring only H.T. and L.T. connections. Ample shielding is provided to prevent radiation and interference to Broadcast receivers. The coil with rectifier incorporated may be purchased separately, price **£4/10/0**. Full instructions and data supplied.

NERA R.F. E.H.T. UNIT.

Full details from

P.A.M. LIMITED
ELECTRONICS BRANCH, JEFFRIES PASSAGE,
HIGH STREET, GUILDFORD

Manufacturers of *NERA* Big-screen Television Receivers

DARK EVENINGS AHEAD...

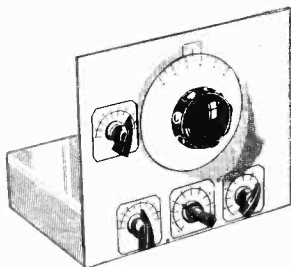

Never mind the weather this winter, build the "Practical Wireless" Beginners' Short Wave Three and bring the whole world to your own fireside. Enjoy the thrill of travelling the world on short

waves, music from America, sport from Australia, news from all parts, and the fun of listening in to amateurs in the remotest corners.

Join the happy band of Short Wave Listeners TO-DAY. Without doubt the most satisfying and interesting side of Home Constructor radio work. Your globe-trotting will be the envy of all your friends.

Complete detailed list of all components and prices available on request from :

HOME RADIO (MITCHAM) LTD.
187, London Road, Mitcham, Surrey. MIT 3282

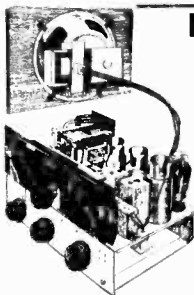

RADIOGRAM CHASSIS 29/9

5-valve superhet. Including 6" speaker. 3 w/band. A.C. mains. Complete, less valves. Front drive. Chassis size 12" x 10" x 8". Free printed dial. Carriage and insurance 4/6.

ELECTRIC CONVECTOR HEATER 99/6

2kW (1 or 2 unics per hr.). Switched. Gilt finish. Illuminated grille, size 26" x 18" x 7 1/2" deep, 200-250V, A.C. or D.C. Famous

manufacturer. Ideal for home, office, works. Carr. & ins. 10/6.

8" P.M. SPEAKERS 8/9

Ideal for fitting in small cabinet or cupboard door for the lady of the house to follow that radio or T.V. programme. Buy now while stocks last. With O.P. Trans., 10/- P. & P. 1/9.

COIL PACKS, 3/9. 3 w/band Complete with 2 gang condenser, pair 465 I.F.s and printed dial. (Similar drawing FREE.) P. & P. 2/3.

TRANSFORMERS

MAINS TRANS., 5/9. 350-0-350V 80 mA, 6V, 5V heaters. Prim. 200-250V. Post 2/9.

MAINS TRANS., 3/9. 350-0-350V 80mA, 12V, 4V heaters. Prim. 100-250V. Ideal auto-trans. Post 2/9.

O.P. TRANS., 1/3. Salvage guaranteed. Std. 2-5 ohms. Post 9d.

T.V. MASKS, 3/9. New, rubber for 12" tubes. P. & P. 1/9.

T.V. MASKS, 1/9. Soiled, need washing, 12" rubber. P. & P. 1/9.

Free Catalogue on Request.

OPEN SATURDAY ALL DAY.

DUKE & CO.

621, Romford Road, Manor Park, London, E.12
GRA 6677-8

VIEW MASTER CONVERTER

All items for the View Master Converter as described in "Practical Television" are available from stock and can be supplied by return of post. Full details are given in our lists, which are available free.

FULL INSTRUCTIONS NOW AVAILABLE

We can supply the special "Practical Television" booklet giving construction information from stock. Price 2/6, plus 3d. postage.

COMPLETE KITS

Complete Kits are available as follows :

KIT A.—All specified components with new Mullard Valves. **£8.18.0.**

KIT B.—All specified components with alternative valves. **£8.2.0.**

Remember that our kits are really complete.

CREDIT TERMS

Credit Terms are available on the above kits.

KIT A.—Deposit **£1.6.0** and seven monthly payments of **£1.6.0.**

KIT B.—**£1.4.0** deposit and seven monthly payments of **£1.4.0.**

WATTS RADIO

8, Apple Market, Kingston-on-Thames, Surrey

Telephone: KINGston 4099.

TELEVISION TUBES

MULLARD ...	12in. £6.10.0	14in. £7.0.0	17in. £8.10.0	} Ex Stock
COSSOR ...	12in. £6.10.0	14in. £7.0.0	17in. £8.10.0	
EMITRON ...	12in. £6.10.0	14in. £7.0.0	17in. £8.10.0	

MAZDA. 12in. only £6.10.0. 14 Weeks Delivery.

All Tubes plus 12.6 carriage and insurance.

SIX MONTHS' GUARANTEE

- Converter M.1. Midlands area, high gain, own power supply, built in crossover unit £9.9.0
- Converter M.2. Midland fringe area, own power supply £9.18.0
- Crossover Box. Low loss 12.6

Finished in Stove Enamelled Steel Case.

Terms to the Trade.

RE-VIEW (LONDON) LTD.

81, HIGH STREET : MERTON, S.W.19

Telephone : CHERRYWOOD 3255

MAKE SOUND JOINTS SIMPLY BY USING Multicore

ERSIN MULTICORE

Contains 5 cores of extra-active, non-corrosive Ersin Flux. Prevents oxidation and cleans surface oxides.

SIZE 1 CARTON

5/-

HANDYMAN'S CARTON

Suitable for 200 average joints. 6d.



Wherever precision soldering is essential, manufacturers, engineers and handymen rely on MULTICORE. There's a MULTICORE SOLDER just made for the job you have in hand. Here are some of them.

ARAX MULTICORE

FOR METAL FABRICATION

(Not wire-to-tag joints)

Contains 2 cores of Arax Flux. Flux residue is easily removed with water.

SIZE 8 CARTON

5/- Handymans Carton 6d.



HOME CONSTRUCTORS 2/6 PACK

In addition to the well-known Home Constructors Pack (containing 19ft. of 18 s.w.g. 60/40 alloy) a similar pack is now available containing 40ft. of 22 s.w.g. 60/40 alloy especially suitable for printed circuits.



BIB WIRE STRIPPER AND CUTTER

Strips insulation without nicking wire, cuts wire cleanly, splits extruded flex 3/6 each



ARTHURS HAVE IT!

LARGE STOCKS OF VALVES and C.R.T.s. METERS, Avo, Advance, Taylor and Cossor Oscilloscopes in stock. AMPLIFIERS, Leak, Trix & Quad. GRAM UNITS, Garrard & Collaro. Collaro TRANSCRIPTION UNIT 2010PX.

LOUDSPEAKERS, Goodmans, Wharfedale, WB, Tannoy and leading makes. PICK-UPS and STYLI of most makes. TAPE RECORDERS, Grundig, Philips, Truvox, Playtime & Ferrograph.

LATEST VALVE MANUALS

Mullard, 10/6 ; Osram & Brimar No. 6, 5/- each ; Osram Part 2, 10/-.

Postage 9d. each extra.

PARTICULARS ON REQUEST.

Terms C.O.D. OR CASH with order.

Arthurs

Est. 1919

PROPS: ARTHUR GRAY, LTD.

OUR ONLY ADDRESS : Gray House

150-152 Charing Cross Road, London, W.C.2

TEmpLe Bar 5833/4 and 4765

TELEGRAMS—"TELEGRAY, WESTCENT, LONDON."

CABLES—"TELEGRAY, LONDON."

MULTICORE SOLDERS LTD.,

MULTICORE WORKS, HEMEL HEMPSTEAD, HERTS. (BDXMOOR 3636)

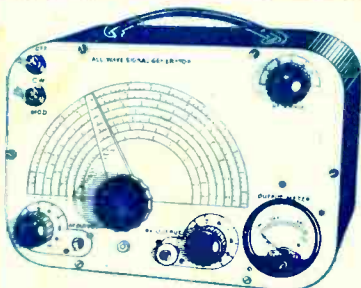

COMPLETELY BUILT SIGNAL GENERATOR

Completely built Signal Generator, coverage 120 Kc/s-320 Kc/s, 300 Kc/s-900 Kc/s, 900 Kc/s-2.75 Mc/s, 2.75 Mc/s-8.5 Mc/s, 8 Mc/s-28 Mc/s, 16 Mc/s-56 Mc/s, 24 Mc/s-84 Mc/s. Metal case 10 x 6 1/2 x 4 1/2 in. Size of scale 6 1/2 x 3 1/2 in. 2 valves and rectifier. A.C. mains 230-250 v. Internal modulation of 400 c.p.s. to a depth of 30 per cent., modulated or unmodulated R.F. output continuously variable 100 milli-volts. C.W. and mod. switch, variable A.F. output and moving coil output meter. Grey hammer-finish case and white panel. Accuracy plus or minus 2%. £4.19.6 or 34/- deposit and 3 monthly payments 25/-. P. & P. 4/6 extra.

COMMERCIAL TELEVISION CONVERTER

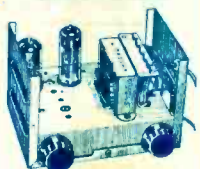

Illustrated with cover removed
SUITABLE ANY T.V.
with lower side band
ALL CHANNELS
No Alterations To Set
£3.19.6 Plus Post
& Pkg. 2/6.

Complete with built-in power supply, 230-250 v. A.C. mains. Crackle finish case 5 1/2 in. long, 3 1/2 in. wide, 4 1/2 in. high. Incorporating gain control and band switch.

BOTH GENERATORS GUARANTEED FOR 12 MONTHS

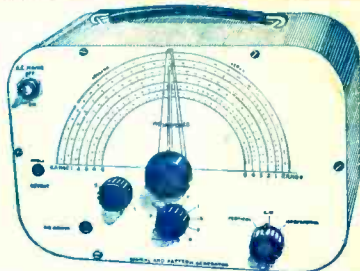

SIGNAL & PATTERN GENERATOR

Coverage 7.6 Mc/s-210 Mc/s in five bands, all on fundamentals, slow-motion tuning, audio output, 8 vertical and horizontal bars, logging scale, in grey hammer finished case with carrying handle.

£6.19.6 P. & P.

Accuracy $\pm 1\%$. A.C. mains 200-250 v. Or £3 deposit, P. & P. 5/6 and 3 payments of 30/-.
Line or Frame oscillator Blocking Transformers, 4/6 each.
Smoothing Choke, 250 mA, 5 Henry, 8/6; 250 mA, 10 Henry, 10/6.
Wide Angle P.M. Focus Unit, vernier adj., state tube, 15/-.
P.M. Focus Unit for Mullard tubes with vernier adj., 15/-.
Ion Traps for Mullard or English Electric tubes, 5/-. Post paid.
T.V. Coils, moulded former, iron cored, wound for rewinding purposes only. All-can 1 1/2 in. x 1 in., 1/- each; 2-in. cores All-can, 2 1/2 in. x 4 in., 1/6 each. These coil formers are suitable for the Prac. T.V. Converter.

T.R.F. KIT IN PLASTIC CABINET

3 valve plus metal rectifier. A.C. mains 200-250 v. Medium and long waves. In pastel blue or brown. Valve line-up: 2 VR6SS and VT52. Size 16 1/2 in. long by 9 in. high by 7 in. deep. £3.19.6. P. & P. 4/6. A point-to-point wiring diagram, 1/6. Free with complete kit. All parts supplied separately.

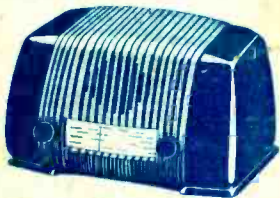

Three-speed automatic changer by B.S.R. MONARCH, current model. Will take 7in., 10in., or 12in. records mixed. Turnover crystal head. Cream finish. BRAND NEW. VERY LIMITED QUANTITY. A.C. Mains 200/250. £7.15.0. P. & P. 3/6.

Line and E.H.T. Transformer. 8kv. Ferrocart core. EY51 heater winding, complete with scan coils and frame output transformer and line and width control. 35/-. P. & P. 3/-.
As above but complete with line and frame blocking transformers, 4 Henry 250 mA chokes, 0 mfd. and 150 mfd. 350 wks. 300 mA. A.C. ripple. £2.9.6. P. & P. 3/-.
Standard wave-change switch. 4-pole 3-way; 5-pole 3-way; 3-pole 3-way, 1/9 each; 9-pole 3-way, 3/6; Miniature type, long spindle, 1-pole 3-way and 4-pole 2-way, 2/6 each.
3-pole 11-way twin wafer, 5/-; 1-pole 12-way, 5/-. P. & P. 3d.
1 SED metal rectifier, 250 v. 150 mA., 6/6.
Combined 12in. Mask and Eutecticon perspex. New aspect added in brown. Fits on front of cabinet. 12/6. As above for 15in. tubes. 17/6.

COLLARO RC54

3-speed automatic changer, will take 10 records mixed Studio 'O' pick-up. A.C. mains 200/250v. £7.19.6 P. & P. 5/-.
P. & P. 5/-.

GARRARD RC/110

3-SPEED AUTOMATIC MIXER CHANGER



Will take 10 records, 7in., 10in., or 12in. mixed, turnover crystal head, brand new, current model. A.C. mains 200/250 v. (List price £14.10.-)

£7.19.6

P. & P. 3/6.

FAMOUS MAKE TURRET "TELETUNER"

Covers all Channels, Bands 1 and 3. Valves used: PCC84, R.F. double triode, cascade R.F. amplifier, PCF80, triode pentode i.c. and mixer. I.F. output 33-38 Mc/s. Easily modified to other I.F. outputs. Full instructions and circuit diagram supplied. Complete with 12 Coil Sets. 99/6 post Knobs, 3/6. 2/6.

Dubilier .001-10 kV. working, 3/6.

Primary 200-250 v., P. & P. 2/-.
300-4-300, 100 mA., 6 v. 3 amp., 5 v. 2 amp., 22/6.
Drop thro' 350-0-350 v. 70 mA., 6 v. 2.5 amp., 5 v. 2 amp., 14/6.
Drop thro' 250-0-250 v. 80 mA., 6 v. 3 amp., 5 v. 2 amp., 14/6.
280-0-280 drop through, 80 mA., 6 v. 3 amp., 5 v. 2 amp., 14/6.
Drop thro' 270-0-270 60 mA., 6 v. 3 amp., 11/6.
250 v. 350 mA., 6.4 v. 4 a., twice 2 v. 2 a., 19/6.
Semi-shrouded drop-through 380-0-380 120 mA., 6.3 v. 3 amp., 5 v. 2 amp., 25/-.
Auto Trans. Input 200/250 H.T. 500 v., 250 mA., 6 v. 4 a., twice 2 v. 2 a., 19/6.
Auto Trans. Input 200/250 H.T. 350 v. 350 mA. Separate L.T. 3.3 v. 7 a., 5.3 v. 1 1/2 amp., 5 v. 3 amp., 25/-. P. & P. 3/-.
Heater Transformer, Pri. 230/250 v. 6 v. 11 amp., 6/-.
350-0-350 75 mA., 6.3 v. 3 a. tap, 4 v. 6.3 v. 1 a., 13/6.
500-0-500 125 mA., 4 v. C.T. 4 a., 4 v. C.T. 4 a., 4 v. C.T. 2.5 a., 27/6.
500-0-500 250 mA., 4 v. C.T. 5 a., 4 v. C.T. 5 a., 4 v. C.T. 4 a., 39/6.
Chassis mounting or drop-thro'. Pri. 110/250 v. Sec. 350-0-350 250 mA., 6.3 v. 7 amp., 6.3 v. 0.5 amp., 5 v. C.T. 0.5 amp., 4 v. 4 amp., 32/6. P. & P. 3/6.
P.M. Speakers, closed field 3 ohm speech coil 12in., 25/-; 10in., 25/-; 8in., 20/6; 6in., 18/6; 5in., 18/6. P. & P. 2/- each extra.
1,200 ft. High Impedance recording tape on plastic spool. 12/6. P. & P. 1/-.
Point to point wiring diagram 1/-. free with kit.

AC/DC MULTI-METER KIT



Comprising 2in. moving coil meter, scale calibrated in AC/DC volts, ohms and milli-amps. Voltage range AC/DC 0-10, 0-100 and 0-500. Milli-amps 0-10, 0-100. Ohms 0-1,000 and 0-10,000. Front panel, range switch, wire-wound pot (for ohms zero setting) two toggle switches, resistors and meter rectifier. In grey hammer-finish case. 19/6 Plus P. & P. 1/6.

Valve Holders, moulded octal Mazda and Octal, 7d. each. Pavlin, octal Mazda and Octal, 7d. each. Moulded B7G, B8A and B9A, 7d. each.

Where post and packing charge is not stated, please add 1/6 up to 10/-, 2/- up to 41 and 2/6 up to £2. All enquiries S.A.E. Lists 5d. each.

RADIO & T.V. COMPONENTS (ACTON) LTD.
23 HIGH STREET, ACTON, LONDON, W3